

**Table 14.1-35: SAR Values (LTE Band66 – Hotspot)**

Ambient Temperature: 22.9 °C      Liquid Temperature: 22.5 °C

Frequency		Mode	Figure No.	Conduct ed Power (dBm)	Max. tune-up Power (dBm)	Measured SAR(10g) (W/kg)	Reported SAR(10g) (W/kg)	Measured SAR(1g) (W/kg)	Reported SAR(1g) (W/kg)	Power Drift (dB)
Ch.	MHz									
132322	1745	1RB-Mid Front	/	19.75	21.00	0.121	<b>0.16</b>	0.196	<b>0.26</b>	-0.04
132572	1770	1RB-Mid Rear	/	19.56	21.00	0.348	<b>0.48</b>	0.576	<b>0.80</b>	0.09
132322	1745	1RB-Mid Rear		19.75	21.00	0.38	<b>0.51</b>	0.63	<b>0.84</b>	0.02
132072	1720	1RB-Mid Rear		19.64	21.00	0.35	<b>0.48</b>	0.58	<b>0.79</b>	0.03
132322	1745	1RB-Mid Rear	unfold	19.75	21.00	0.278	<b>0.37</b>	0.452	<b>0.60</b>	-0.17
132322	1745	1RB-Mid Left	/	19.75	21.00	0.087	<b>0.12</b>	0.142	<b>0.19</b>	0.08
132322	1745	1RB-Mid Right	/	19.75	21.00	0.045	<b>0.06</b>	0.074	<b>0.10</b>	0.07
132572	1770	1RB-Mid Bottom	/	19.56	21.00	0.323	<b>0.45</b>	0.586	<b>0.82</b>	0.08
132322	1745	1RB-Mid Bottom	Fig.35	19.75	21.00	0.361	<b>0.48</b>	0.656	<b>0.87</b>	-0.07
132072	1720	1RB-Mid Bottom	/	19.64	21.00	0.345	<b>0.47</b>	0.623	<b>0.85</b>	0.07
132322	1745	50RB-Mid Front	/	19.65	21.00	0.115	<b>0.16</b>	0.187	<b>0.26</b>	0.16
132572	1770	50RB-Mid Rear	/	19.48	21.00	0.354	<b>0.50</b>	0.595	<b>0.84</b>	-0.15
132322	1745	50RB-Mid Rear		19.65	21.00	0.348	<b>0.47</b>	0.603	<b>0.82</b>	-0.17
132072	1720	50RB-Mid Rear		19.53	21.00	0.345	<b>0.48</b>	0.576	<b>0.81</b>	-0.03
132322	1745	100RB Rear		19.69	21.00	0.38	<b>0.51</b>	0.631	<b>0.85</b>	0.04
132322	1745	50RB-Mid Rear	unfold	19.65	21.00	0.265	<b>0.36</b>	0.432	<b>0.59</b>	-0.16
132322	1745	50RB-Mid Left	/	19.65	21.00	0.084	<b>0.11</b>	0.137	<b>0.19</b>	-0.18
132322	1745	50RB-Mid Right	/	19.65	21.00	0.044	<b>0.06</b>	0.073	<b>0.10</b>	-0.16
132572	1770	50RB-Mid Bottom	/	19.48	21.00	0.33	<b>0.47</b>	0.599	<b>0.85</b>	-0.18
132322	1745	50RB-Mid Bottom	/	19.65	21.00	0.354	<b>0.48</b>	0.641	<b>0.87</b>	0.14
132072	1720	50RB-Mid Bottom	/	19.53	21.00	0.356	<b>0.50</b>	0.643	<b>0.90</b>	-0.08
132322	1745	100RB Bottom	/	19.69	21.00	0.345	<b>0.47</b>	0.633	<b>0.86</b>	0.02

Note1: The distance between the EUT and the phantom bottom is 10mm

Note2: The LTE mode is QPSK\_20MHz.

**Table 14.1-36: SAR Values (LTE Band71- Head)**

Frequency		Mode	Side	Test Position	Figure No.	Conduct ed Power (dBm)	Max. tune-up Power (dBm)	Measured SAR(10g) (W/kg)	Reported SAR(10g) (W/kg)	Measure d SAR(1g) (W/kg)	Reporte d SAR(1g) (W/kg)	Pow er Drift (dB)
Ch.	MHz											
133222	673	1RB-Mid	Left	Cheek	Fig.36	23.50	24.50	0.349	<b>0.44</b>	0.562	<b>0.71</b>	-0.01
133222	673	1RB-Mid	Left	Tilt	/	23.50	24.50	0.14	<b>0.18</b>	0.204	<b>0.26</b>	0.03
133222	673	1RB-Mid	Right	Cheek	/	23.50	24.50	0.346	<b>0.44</b>	0.547	<b>0.69</b>	-0.17
133222	673	1RB-Mid	Right	Tilt	/	23.50	24.50	0.172	<b>0.22</b>	0.249	<b>0.31</b>	0.18
133222	673	50RB-Low	Left	Cheek	/	22.60	23.50	0.343	<b>0.42</b>	0.548	<b>0.67</b>	0.15
133222	673	50RB-Low	Left	Tilt	/	22.60	23.50	0.131	<b>0.16</b>	0.182	<b>0.22</b>	-0.12
133222	673	50RB-Low	Right	Cheek	/	22.60	23.50	0.281	<b>0.35</b>	0.458	<b>0.56</b>	-0.07
133222	673	50RB-Low	Right	Tilt	/	22.60	23.50	0.138	<b>0.17</b>	0.201	<b>0.25</b>	0.01

Note1: The LTE mode is QPSK\_20MHz.

**Table 14.1-37 SAR Values (LTE Band71 – Body)**

Frequency		Mode	Figure No.	Conduct ed Power (dBm)	Max. tune-up Power (dBm)	Measured SAR(10g) (W/kg)	Reported SAR(10g) (W/kg)	Measured SAR(1g) (W/kg)	Reported SAR(1g) (W/kg)	Power Drift (dB)
Ch.	MHz									
133222	673	1RB-Mid Front	/	23.50	24.50	0.108	<b>0.14</b>	0.141	<b>0.18</b>	-0.06
133222	673	1RB-Mid Rear	Fig.37	23.50	24.50	0.285	<b>0.36</b>	0.398	<b>0.50</b>	-0.06
133222	673	1RB-Mid Rear	Unfold	23.50	24.50	0.24	<b>0.30</b>	0.318	<b>0.40</b>	0.03
133222	673	1RB-Mid Left	/	23.50	24.50	0.13	<b>0.16</b>	0.185	<b>0.23</b>	0.16
133222	673	1RB-Mid Right	/	23.50	24.50	0.098	<b>0.12</b>	0.136	<b>0.17</b>	-0.14
133222	673	1RB-Mid Bottom	/	23.50	24.50	0.053	<b>0.07</b>	0.088	<b>0.11</b>	-0.15
133222	673	50RB-Low Front	/	22.60	23.50	0.085	<b>0.10</b>	0.111	<b>0.14</b>	-0.16
133222	673	50RB-Low Rear	/	22.60	23.50	0.214	<b>0.26</b>	0.304	<b>0.37</b>	0.14
133222	673	50RB-Low Rear	Unfold	22.60	23.50	0.181	<b>0.22</b>	0.243	<b>0.30</b>	0.11
133222	673	50RB-Low Left	/	22.60	23.50	0.101	<b>0.12</b>	0.144	<b>0.18</b>	-0.03
133222	673	50RB-Low Right	/	22.60	23.50	0.078	<b>0.10</b>	0.106	<b>0.13</b>	-0.12
133222	673	50RB-Low Bottom	/	22.60	23.50	0.042	<b>0.05</b>	0.069	<b>0.08</b>	-0.09

Note1: The distance between the EUT and the phantom bottom is 10mm

Note2: The LTE mode is QPSK\_20MHz.

## 14.2 WLAN Evaluation for 2.4G

According to the KDB248227 D01, SAR is measured for 2.4GHz 802.11b DSSS using the initial test position procedure.

### Head Evaluation

**Table 14.2-1: SAR Values (WLAN - Head)– 802.11b (Fast SAR)**

Frequency		Side	Test Position	Note	Conducted Power (dBm)	Max. tune-up Power (dBm)	Measured SAR(1g) (W/kg)	Reported SAR(1g)(W/kg)	Measured SAR(10g) (W/kg)	Reported SAR(10g)(W/kg)	Power Drift (dB)
Ch.	MHz										
Ambient Temperature: 22.9 °C      Liquid Temperature: 22.5 °C											
11	2462	Left	Cheek	/	14.88	15.50	0.12	<b>0.14</b>	0.291	<b>0.34</b>	0.08
11	2462	Left	Tilt	/	14.88	15.50	<0.01	<0.01	<0.01	<0.01	/
11	2462	Right	Cheek	/	14.88	15.50	0.063	<b>0.07</b>	0.124	<b>0.14</b>	0.09
11	2462	Right	Tilt	/	14.88	15.50	<0.01	<0.01	<0.01	<0.01	/

As shown above table, the initial test position for head is “Left Cheek”. So the head SAR of WLAN is presented as below:

**Table 14.2-2: SAR Values (WLAN - Head)– 802.11b (Full SAR)**

Frequency		Side	Test Position	Figure No./ Note	Conducted Power (dBm)	Max. tune-up Power (dBm)	Measured SAR(1g) (W/kg)	Reported SAR(1g)(W/kg)	Measured SAR(10g) (W/kg)	Reported SAR(10g)(W/kg)	Power Drift (dB)
Ch.	MHz										
Ambient Temperature: 22.9 °C      Liquid Temperature: 22.5 °C											
11	2462	Left	Cheek	Fig.38	14.88	15.50	0.122	<b>0.14</b>	0.296	<b>0.34</b>	-0.01

Note1: When the reported SAR of the initial test position is > 0.4 W/kg, SAR is repeated for the 802.11 transmission mode configuration tested in the initial test position using subsequent highest estimated 1-g SAR conditions determined by area scans, on the highest maximum output power channel, until the reported SAR is ≤ 0.8 W/kg.

Note2: For all positions/configurations tested using the initial test position and subsequent test positions, when the reported SAR is > 0.8 W/kg, SAR is measured for these test positions/configurations on the subsequent next highest measured output power channel until the reported SAR is ≤ 1.2 W/kg or all required channels are tested.

According to the KDB248227 D01, The reported SAR must be scaled to 100% transmission duty factor to determine compliance at the maximum tune-up tolerance limit. The scaled reported SAR is presented as below.

**Table 14.2-3: SAR Values (WLAN - Head) – 802.11b (Scaled Reported SAR)**

Frequency		Side	Test Position	Actual duty factor	maximum duty factor	Reported SAR (1g)(W/kg)	Scaled reported SAR (1g)(W/kg)
Ch.	MHz						
11	2462	Left	Cheek	100%	100%	<b>0.34</b>	<b>0.34</b>

SAR is not required for OFDM because the 802.11b adjusted SAR  $\leq 1.2$  W/kg.

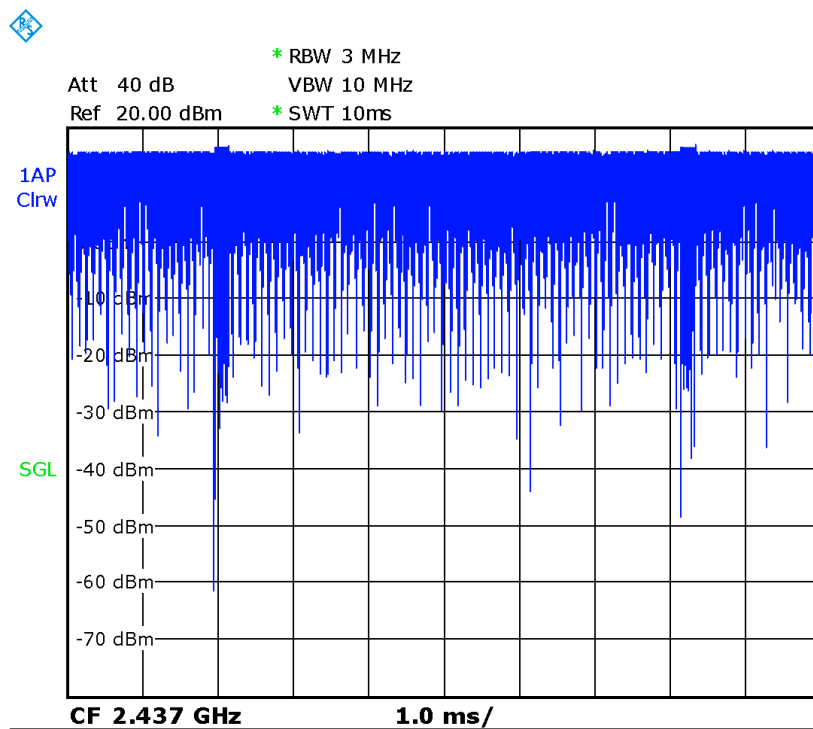

Picture 14.2-1 Duty factor plot

**Body Evaluation**
**Table 14.2-4: SAR Values (WLAN - Body)– 802.11b (Fast SAR)**

Frequency		Test Position	Note	Conducted Power (dBm)	Max. tune-up Power (dBm)	Measured SAR(1g) (W/kg)	Reported SAR(1g)(W/kg)	Measured SAR(10g) (W/kg)	Reported SAR(10g)(W/kg)	Power Drift (dB)
Ch.	MHz									
Ambient Temperature: 22.9°C      Liquid Temperature: 22.5°C										
11	2462	Front	10mm	14.88	15.50	0.029	<b>0.03</b>	0.064	<b>0.07</b>	-0.09
11	2462	Rear	10mm	14.88	15.50	0.085	<b>0.10</b>	0.194	<b>0.22</b>	0.06
11	2462	Rear	10mm/Unfold	14.88	15.50	0.079	<b>0.09</b>	0.175	<b>0.20</b>	-0.13
11	2462	Left	10mm	14.88	15.50	0.05	<b>0.06</b>	0.112	<b>0.13</b>	0.14
11	2462	Top	10mm	14.88	15.50	0.024	<b>0.03</b>	0.055	<b>0.06</b>	-0.17
11	2462	Rear	15mm	14.88	15.50	0.0435	<b>0.05</b>	0.091	<b>0.10</b>	-0.09

As shown above table, the initial test position for body is “Rear 10mm”. So the body SAR of WLAN is presented as below:

**Table 14.2-5: SAR Values (WLAN - Body)– 802.11b (Full SAR)**

Frequency		Test Position	Figure No./ Note	Conducted Power (dBm)	Max. tune-up Power (dBm)	Measured SAR(1g) (W/kg)	Reported SAR(1g)(W/kg)	Measured SAR(10g) (W/kg)	Reported SAR(10g)(W/kg)	Power Drift (dB)
Ch.	MHz									
Ambient Temperature: 22.9°C      Liquid Temperature: 22.5°C										
11	2462	Rear 10mm	Fig.39	14.88	15.50	0.088	<b>0.10</b>	0.199	<b>0.23</b>	0.06

Note1: When the reported SAR of the initial test position is > 0.4 W/kg, SAR is repeated for the 802.11 transmission mode configuration tested in the initial test position using subsequent highest estimated 1-g SAR conditions determined by area scans, on the highest maximum output power channel, until the reported SAR is ≤ 0.8 W/kg.

Note2: For all positions/configurations tested using the initial test position and subsequent test positions, when the reported SAR is > 0.8 W/kg, SAR is measured for these test positions/configurations on the subsequent next highest measured output power channel until the reported SAR is ≤ 1.2 W/kg or all required channels are tested.

According to the KDB248227 D01, The reported SAR must be scaled to 100% transmission duty factor to determine compliance at the maximum tune-up tolerance limit. The scaled reported SAR is presented as below.

**Table 14.2-6: SAR Values (WLAN - Body) – 802.11b (Scaled Reported SAR)**

Frequency		Test Position	Actual duty factor	maximum duty factor	Reported SAR (1g)(W/kg)	Scaled reported SAR (1g)(W/kg)
Ch.	MHz					
11	2462	Rear 10mm	100%	100%	<b>0.23</b>	<b>0.23</b>

SAR is not required for OFDM because the 802.11b adjusted SAR  $\leq 1.2$  W/kg.

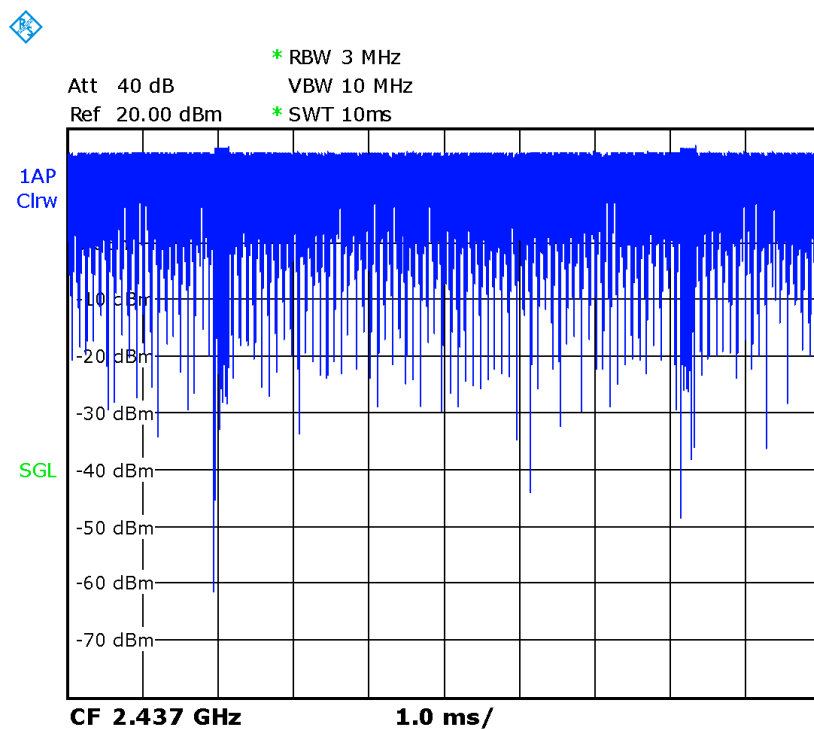

**Picture 14.2-2 Duty factor plot**

## 15 SAR Measurement Variability

SAR measurement variability must be assessed for each frequency band, which is determined by the SAR probe calibration point and tissue-equivalent medium used for the device measurements. When both head and body tissue-equivalent media are required for SAR measurements in a frequency band, the variability measurement procedures should be applied to the tissue medium with the highest measured SAR, using the highest measured SAR configuration for that tissue-equivalent medium.

The following procedures are applied to determine if repeated measurements are required.

- 1) Repeated measurement is not required when the original highest measured SAR is  $< 0.80$  W/kg; steps 2) through 4) do not apply.
- 2) When the original highest measured SAR is  $\geq 0.80$  W/kg, repeat that measurement once.
- 3) Perform a second repeated measurement only if the ratio of largest to smallest SAR for the original and first repeated measurements is  $> 1.20$  or when the original or repeated measurement is  $\geq 1.45$  W/kg ( $\sim 10\%$  from the 1-g SAR limit).
- 4) Perform a third repeated measurement only if the original, first or second repeated measurement is  $\geq 1.5$  W/kg and the ratio of largest to smallest SAR for the original, first and second repeated measurements is  $> 1.20$

**Table 15.1: SAR Measurement Variability for Body GSM1900 (1g)**

Frequency		Test Position	Spacing (mm)	Original SAR (W/kg)	First Repeated SAR (W/kg)	The Ratio	Second Repeated SAR (W/kg)
Ch.	MHz						
512	1850.2	Bottom	10	0.975	0.956	1.02	/

**Table 15.2: SAR Measurement Variability for Body WCDMA1700 (1g)**

Frequency		Test Position	Spacing (mm)	Original SAR (W/kg)	First Repeated SAR (W/kg)	The Ratio	Second Repeated SAR (W/kg)
Ch.	MHz						
1513	1752.6	Rear	15	0.934	0.921	1.01	/

**Table 15.3: SAR Measurement Variability for Body LTE B2 (1g)**

Frequency		Mode	Test Position	Spacing (mm)	Original SAR (W/kg)	First Repeated SAR (W/kg)	The Ratio	Second Repeated SAR (W/kg)
Ch.	MHz							
18700	1860	1RB-Mid	Rear	15	0.9	0.875	1.03	/
18700	1860	1RB-Mid	Rear unfold	15	0.864	0.853	1.01	/

**Table 15.4: SAR Measurement Variability for Body LTE B7 (1g)**

Frequency		Mode	Test Position	Spacing (mm)	Original SAR (W/kg)	First Repeated SAR (W/kg)	The Ratio	Second Repeated SAR (W/kg)
Ch.	MHz							
21100	2535	1RB-Mid	Bottom	10	1.04	1.01	1.03	/

**Table 15.5: SAR Measurement Variability for Body LTE B66 (1g)**

Frequency		Mode	Test Position	Spacing (mm)	Original SAR (W/kg)	First Repeated SAR (W/kg)	The Ratio	Second Repeated SAR (W/kg)
Ch.	MHz							
132322	1745	1RB-Mid	Rear	15	1.09	1.07	1.02	/



## 16 Measurement Uncertainty

### 16.1 Measurement Uncertainty for Normal SAR Tests (300MHz~3GHz)

No.	Error Description	Type	Uncertainty value	Probably Distribution	Div.	(Ci) 1g	(Ci) 10g	Std. Unc. (1g)	Std. Unc. (10g)	Degree of freedom
<b>Measurement system</b>										
1	Probe calibration	B	6.0	N	1	1	1	6.0	6.0	$\infty$
2	Isotropy	B	4.7	R	$\sqrt{3}$	0.7	0.7	1.9	1.9	$\infty$
3	Boundary effect	B	1.0	R	$\sqrt{3}$	1	1	0.6	0.6	$\infty$
4	Linearity	B	4.7	R	$\sqrt{3}$	1	1	2.7	2.7	$\infty$
5	Detection limit	B	1.0	N	1	1	1	0.6	0.6	$\infty$
6	Readout electronics	B	0.3	R	$\sqrt{3}$	1	1	0.3	0.3	$\infty$
7	Response time	B	0.8	R	$\sqrt{3}$	1	1	0.5	0.5	$\infty$
8	Integration time	B	2.6	R	$\sqrt{3}$	1	1	1.5	1.5	$\infty$
9	RF ambient conditions-noise	B	0	R	$\sqrt{3}$	1	1	0	0	$\infty$
10	RFambient conditions-reflection	B	0	R	$\sqrt{3}$	1	1	0	0	$\infty$
11	Probe positioned mech. restrictions	B	0.4	R	$\sqrt{3}$	1	1	0.2	0.2	$\infty$
12	Probe positioning with respect to phantom shell	B	2.9	R	$\sqrt{3}$	1	1	1.7	1.7	$\infty$
13	Post-processing	B	1.0	R	$\sqrt{3}$	1	1	0.6	0.6	$\infty$
<b>Test sample related</b>										
14	Test sample positioning	A	3.3	N	1	1	1	3.3	3.3	71
15	Device holder uncertainty	A	3.4	N	1	1	1	3.4	3.4	5
16	Drift of output power	B	5.0	R	$\sqrt{3}$	1	1	2.9	2.9	$\infty$
<b>Phantom and set-up</b>										
17	Phantom uncertainty	B	4.0	R	$\sqrt{3}$	1	1	2.3	2.3	$\infty$
18	Liquid conductivity (target)	B	5.0	R	$\sqrt{3}$	0.64	0.43	1.8	1.2	$\infty$
19	Liquid conductivity (meas.)	A	2.06	N	1	0.64	0.43	1.32	0.89	43
20	Liquid permittivity (target)	B	5.0	R	$\sqrt{3}$	0.6	0.49	1.7	1.4	$\infty$
21	Liquid permittivity (meas.)	A	1.6	N	1	0.6	0.49	1.0	0.8	521

Combined standard uncertainty	$u_c' = \sqrt{\sum_{i=1}^{21} c_i^2 u_i^2}$							9.55	9.43	257
Expanded uncertainty (confidence interval of 95 %)	$u_e = 2u_c$							19.1	18.9	

**16.2 Measurement Uncertainty for Fast SAR Tests (300MHz~3GHz)**

No.	Error Description	Type	Uncertainty value	Probably Distribution	Div.	(Ci) 1g	(Ci) 10g	Std. Unc. (1g)	Std. Unc. (10g)	Degree of freedom
<b>Measurement system</b>										
1	Probe calibration	B	6.0	N	1	1	1	6.0	6.0	$\infty$
2	Isotropy	B	4.7	R	$\sqrt{3}$	0.7	0.7	1.9	1.9	$\infty$
3	Boundary effect	B	1.0	R	$\sqrt{3}$	1	1	0.6	0.6	$\infty$
4	Linearity	B	4.7	R	$\sqrt{3}$	1	1	2.7	2.7	$\infty$
5	Detection limit	B	1.0	R	$\sqrt{3}$	1	1	0.6	0.6	$\infty$
6	Readout electronics	B	0.3	R	$\sqrt{3}$	1	1	0.3	0.3	$\infty$
7	Response time	B	0.8	R	$\sqrt{3}$	1	1	0.5	0.5	$\infty$
8	Integration time	B	2.6	R	$\sqrt{3}$	1	1	1.5	1.5	$\infty$
9	RF ambient conditions-noise	B	0	R	$\sqrt{3}$	1	1	0	0	$\infty$
10	RFambient conditions-reflection	B	0	R	$\sqrt{3}$	1	1	0	0	$\infty$
11	Probe positioned mech. Restrictions	B	0.4	R	$\sqrt{3}$	1	1	0.2	0.2	$\infty$
12	Probe positioning with respect to phantom shell	B	2.9	R	$\sqrt{3}$	1	1	1.7	1.7	$\infty$
13	Post-processing	B	1.0	R	$\sqrt{3}$	1	1	0.6	0.6	$\infty$
14	Fast SAR z-Approximation	B	7.0	R	$\sqrt{3}$	1	1	4.0	4.0	$\infty$
<b>Test sample related</b>										
15	Test sample positioning	A	3.3	N	1	1	1	3.3	3.3	71
16	Device holder uncertainty	A	3.4	N	1	1	1	3.4	3.4	5
17	Drift of output power	B	5.0	R	$\sqrt{3}$	1	1	2.9	2.9	$\infty$
<b>Phantom and set-up</b>										
18	Phantom uncertainty	B	4.0	R	$\sqrt{3}$	1	1	2.3	2.3	$\infty$
19	Liquid conductivity (target)	B	5.0	R	$\sqrt{3}$	0.64	0.43	1.8	1.2	$\infty$
20	Liquid conductivity (meas.)	A	2.06	N	1	0.64	0.43	1.32	0.89	43

21	Liquid permittivity (target)	B	5.0	R	$\sqrt{3}$	0.6	0.49	1.7	1.4	$\infty$
22	Liquid permittivity (meas.)	A	1.6	N	1	0.6	0.49	1.0	0.8	521
Combined standard uncertainty		$u_c = \sqrt{\sum_{i=1}^{22} c_i^2 u_i^2}$						10.4	10.3	257
Expanded uncertainty (confidence interval of 95 %)		$u_e = 2u_c$						20.8	20.6	

## 17 MAIN TEST INSTRUMENTS

**Table 17.1: List of Main Instruments**

No.	Name	Type	Serial Number	Calibration Date	Valid Period
01	Network analyzer	N5239A	MY55491241	May 31, 2021	One year
02	Power meter	NRP2	106276	May 11, 2021	One year
03	Power sensor	NRP6A	101369		
04	Signal Generator	E4438C	MY49071430	February 1, 2021	One Year
05	Amplifier	60S1G4	0331848	No Calibration Requested	
06	BTS	CMW500	159889	January 13, 2021	One year
07	E-field Probe	SPEAG EX3DV4	7548	June 25, 2021	One year
08	DAE	SPEAG DAE4	1331	September 1, 2021	One year
09	Dipole Validation Kit	SPEAG D750V3	1017	July 12,,2021	One year
10	Dipole Validation Kit	SPEAG D835V2	4d069	July 21,,2021	One year
11	Dipole Validation Kit	SPEAG D1750V2	1003	July 12,,2021	One year
12	Dipole Validation Kit	SPEAG D1900V2	5d101	July 15,2021	One year
13	Dipole Validation Kit	SPEAG D2450V2	853	July 26,2021	One year
14	Dipole Validation Kit	SPEAG D2600V2	1012	July 26,2021	One year

\*\*\*END OF REPORT BODY\*\*\*

## ANNEX A Graph Results

### GSM850\_CH190 Left Cheek

Date: 1/23/2022

Electronics: DAE4 Sn1331

Medium: head 835 MHz

Medium parameters used:  $f = 836.6$  MHz;  $\sigma = 0.858$  S/m;  $\epsilon_r = 44.681$ ;  $\rho = 1000$  kg/m<sup>3</sup>

Ambient Temperature: 22.9°C, Liquid Temperature: 22.5°C

Communication System: GSM850 836.6 MHz Duty Cycle: 1:8.3

Probe: EX3DV4 – SN7548 ConvF(10.36,10.36,10.36)

**Area Scan (81x141x1):** Interpolated grid: dx=1.500 mm, dy=1.500 mm

Maximum value of SAR (interpolated) = 0.563 W/kg

**Zoom Scan (5x6x7)/Cube 0:** Measurement grid: dx=8mm, dy=8mm, dz=5mm

Reference Value = 2.843 V/m; Power Drift = 0.07 dB

Peak SAR (extrapolated) = 0.744 W/kg

**SAR(1 g) = 0.458 W/kg; SAR(10 g) = 0.331 W/kg**

Maximum value of SAR (measured) = 0.591 W/kg

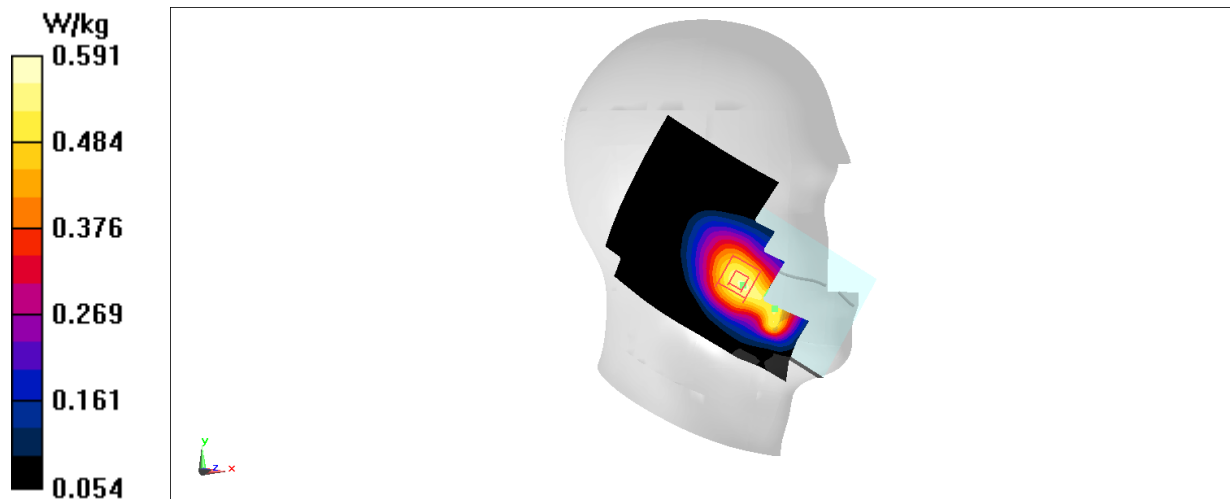

Fig A.1

**GSM850\_CH190 Rear 15mm**

Date: 1/23/2022

Electronics: DAE4 Sn1331

Medium: head 835 MHz

Medium parameters used:  $f = 836.6$  MHz;  $\sigma = 0.858$  S/m;  $\epsilon_r = 44.681$ ;  $\rho = 1000$  kg/m<sup>3</sup>

Ambient Temperature: 22.9°C, Liquid Temperature: 22.5°C

Communication System: GSM850 836.6 MHz Duty Cycle: 1:4

Probe: EX3DV4 – SN7548 ConvF(10.36,10.36,10.36)

**Area Scan (71x121x1):** Interpolated grid: dx=1.500 mm, dy=1.500 mm

Maximum value of SAR (interpolated) = 0.773 W/kg

**Zoom Scan (6x6x7)/Cube 0:** Measurement grid: dx=8mm, dy=8mm, dz=5mm

Reference Value = 24.58 V/m; Power Drift = -0.03 dB

Peak SAR (extrapolated) = 0.838 W/kg

**SAR(1 g) = 0.594 W/kg; SAR(10 g) = 0.429 W/kg**

Maximum value of SAR (measured) = 0.750 W/kg

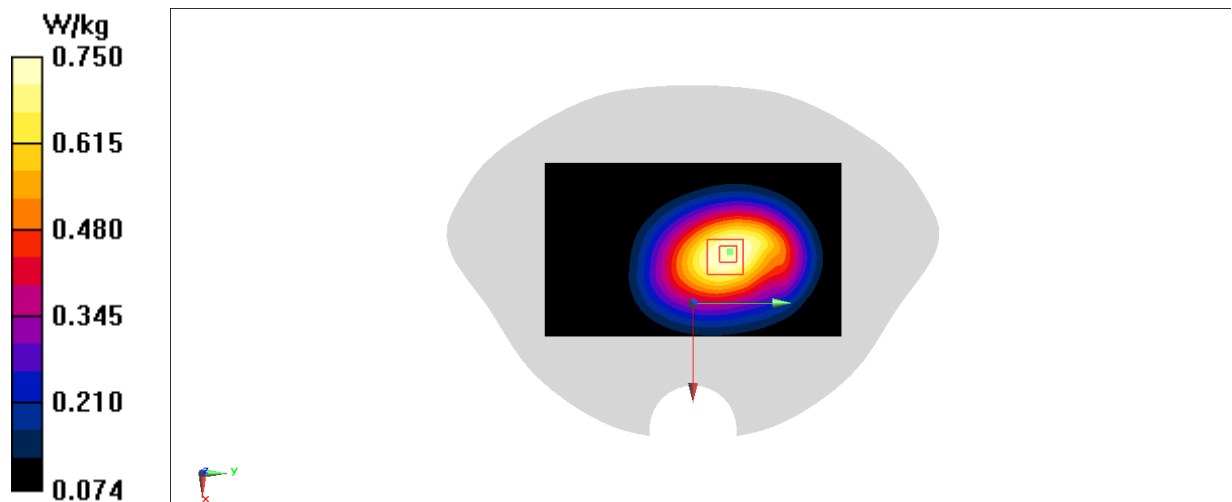

**Fig A.2**

**GSM850\_CH251 Rear 10mm**

Date:1/23/2022

Electronics: DAE4 Sn1331

Medium: head 835 MHz

Medium parameters used:  $f = 848.8$  MHz;  $\sigma = 0.863$  S/m;  $\epsilon_r = 44.639$ ;  $\rho = 1000$  kg/m<sup>3</sup>

Ambient Temperature: 22.9°C, Liquid Temperature: 22.5°C

Communication System: GSM850 848.8 MHz Duty Cycle: 1:4

Probe: EX3DV4 – SN7548 ConvF(10.36,10.36,10.36)

**Area Scan (71x121x1):** Interpolated grid: dx=1.500 mm, dy=1.500 mm

Maximum value of SAR (interpolated) = 0.480 W/kg

**Zoom Scan (6x6x7)/Cube 0:** Measurement grid: dx=8mm, dy=8mm, dz=5mm

Reference Value = 19.70 V/m; Power Drift = 0.06 dB

Peak SAR (extrapolated) = 0.579 W/kg

**SAR(1 g) = 0.404 W/kg; SAR(10 g) = 0.289 W/kg**

Maximum value of SAR (measured) = 0.509 W/kg

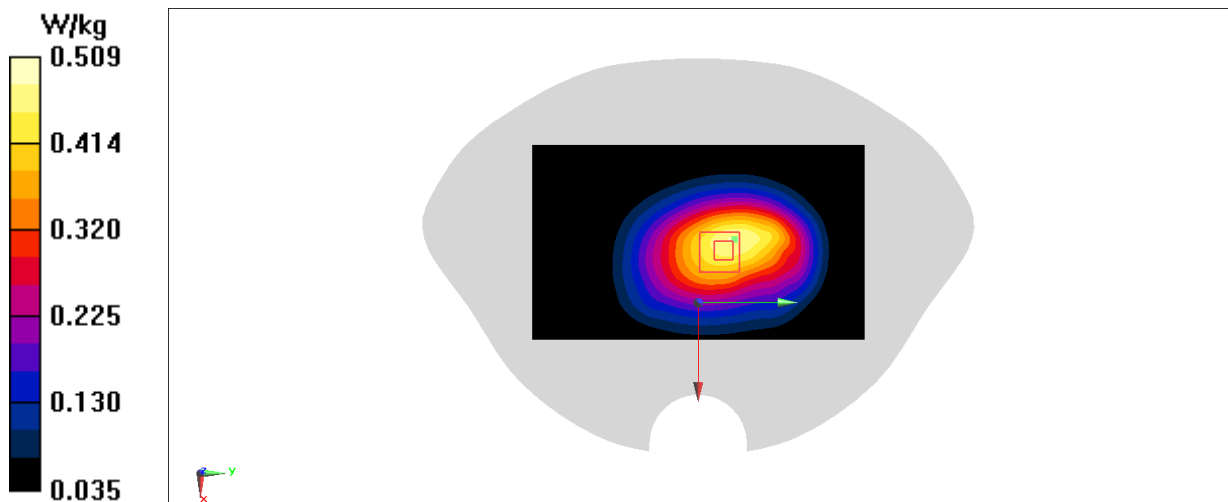
**Fig A.3**

**PCS1900\_CH512 Left Cheek**

Date: 1/25/2022

Electronics: DAE4 Sn1331

Medium: head 1900 MHz

Medium parameters used:  $f = 1850.2$  MHz;  $\sigma = 1.444$  S/m;  $\epsilon_r = 42.208$ ;  $\rho = 1000$  kg/m<sup>3</sup>

Ambient Temperature: 22.9°C, Liquid Temperature: 22.5°C

Communication System: PCS1900 1850.2 MHz Duty Cycle: 1:8.3

Probe: EX3DV4 – SN7548 ConvF(7.88,7.88,7.88)

**Area Scan (81x141x1):** Interpolated grid: dx=1.500 mm, dy=1.500 mm

Maximum value of SAR (interpolated) = 0.365 W/kg

**Zoom Scan (6x6x7)/Cube 0:** Measurement grid: dx=8mm, dy=8mm, dz=5mm

Reference Value = 0.8330 V/m; Power Drift = 0.09 dB

Peak SAR (extrapolated) = 0.420 W/kg

**SAR(1 g) = 0.274 W/kg; SAR(10 g) = 0.161 W/kg**

Maximum value of SAR (measured) = 0.374 W/kg

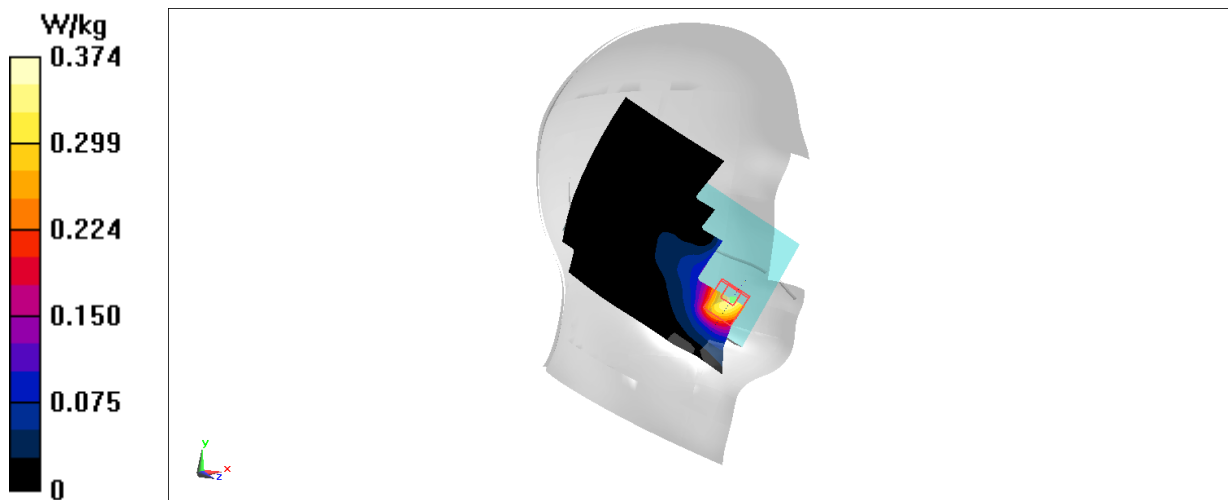
**Fig A.4**



**PCS1900\_CH512 Rear 15mm**

Date: 1/25/2022

Electronics: DAE4 Sn1331

Medium: head 1900 MHz

Medium parameters used:  $f = 1850.2$  MHz;  $\sigma = 1.444$  S/m;  $\epsilon_r = 42.208$ ;  $\rho = 1000$  kg/m<sup>3</sup>

Ambient Temperature: 22.9°C, Liquid Temperature: 22.5°C

Communication System: PCS1900 1850.2 MHz Duty Cycle: 1:2

Probe: EX3DV4 – SN7548 ConvF(7.88,7.88,7.88)

**Area Scan (81x141x1):** Interpolated grid: dx=1.500 mm, dy=1.500 mm

Maximum value of SAR (interpolated) = 0.812 W/kg

**Zoom Scan (5x5x7)/Cube 0:** Measurement grid: dx=8mm, dy=8mm, dz=5mm

Reference Value = 12.25 V/m; Power Drift = 0.02 dB

Peak SAR (extrapolated) = 0.915 W/kg

**SAR(1 g) = 0.551 W/kg; SAR(10 g) = 0.329 W/kg**

Maximum value of SAR (measured) = 0.780 W/kg

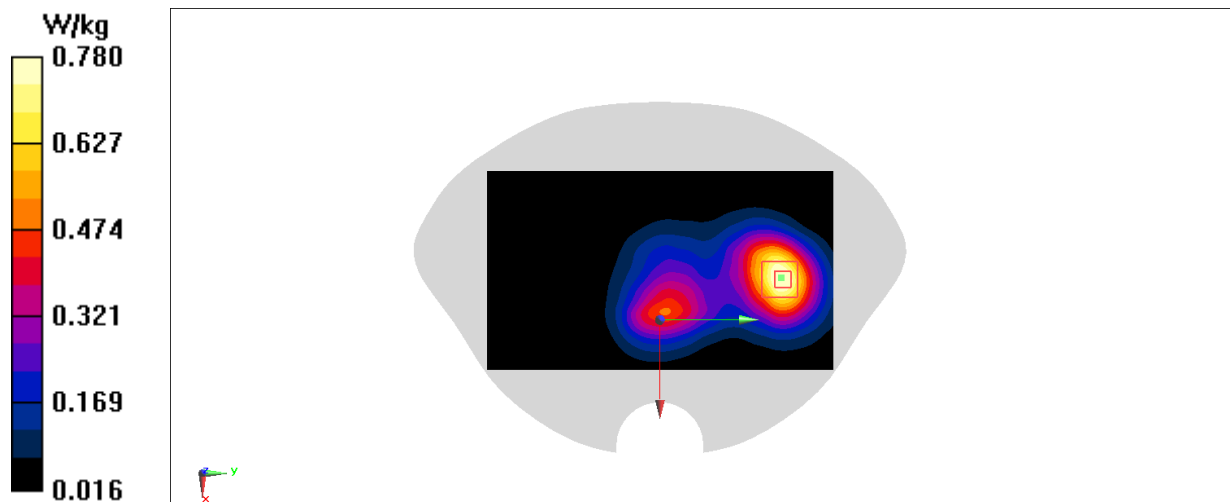
**Fig A.5**

**PCS1900\_CH512 Bottom 10mm**

Date: 1/25/2022

Electronics: DAE4 Sn1331

Medium: head 1900 MHz

Medium parameters used:  $f = 1850.2$  MHz;  $\sigma = 1.444$  S/m;  $\epsilon_r = 42.208$ ;  $\rho = 1000$  kg/m<sup>3</sup>

Ambient Temperature: 22.9°C, Liquid Temperature: 22.5°C

Communication System: PCS1900 1850.2 MHz Duty Cycle: 1:2.67

Probe: EX3DV4 – SN7548 ConvF(7.88,7.88,7.88)

**Area Scan (41x101x1):** Interpolated grid: dx=1.500 mm, dy=1.500 mm

Maximum value of SAR (interpolated) = 1.52 W/kg

**Zoom Scan (5x5x7)/Cube 0:** Measurement grid: dx=8mm, dy=8mm, dz=5mm

Reference Value = 26.94 V/m; Power Drift = -0.05 dB

Peak SAR (extrapolated) = 1.76 W/kg

**SAR(1 g) = 0.975 W/kg; SAR(10 g) = 0.526 W/kg**

Maximum value of SAR (measured) = 1.47 W/kg

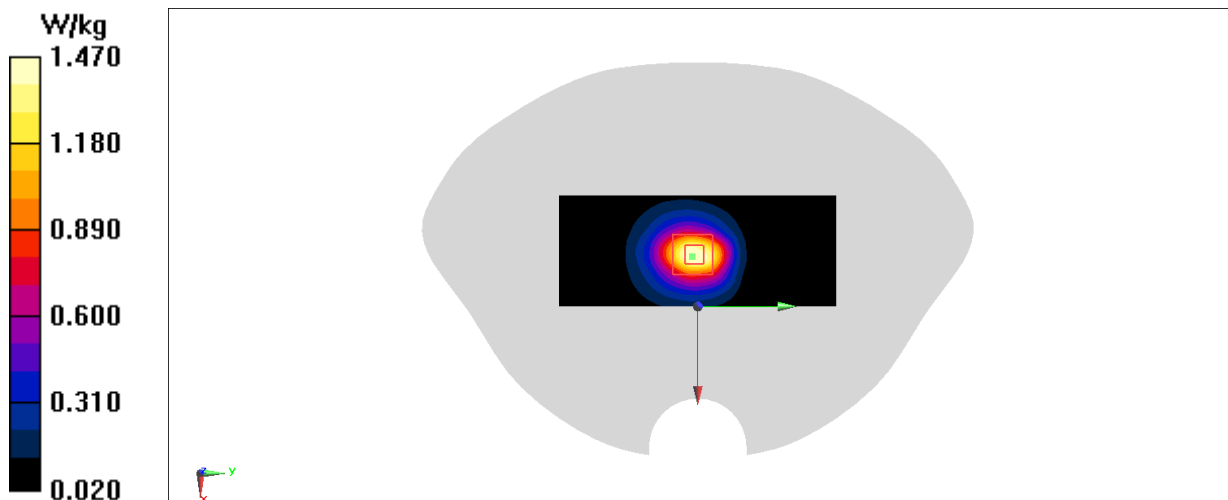
**Fig A.6**

**WCDMA1900-BII\_CH9262 Left Cheek**

Date: 1/25/2022

Electronics: DAE4 Sn1331

Medium: head 1900 MHz

Medium parameters used:  $f = 1852.4$  MHz;  $\sigma = 1.532$  S/m;  $\epsilon_r = 42.489$ ;  $\rho = 1000$  kg/m<sup>3</sup>

Ambient Temperature: 22.9°C, Liquid Temperature: 22.5°C

Communication System: WCDMA1900-BII 1852.4 MHz Duty Cycle: 1:1

Probe: EX3DV4 – SN7548 ConvF(7.88,7.88,7.88)

**Area Scan (81x141x1):** Interpolated grid: dx=1.500 mm, dy=1.500 mm

Maximum value of SAR (interpolated) = 0.468 W/kg

**Zoom Scan (6x5x7)/Cube 0:** Measurement grid: dx=8mm, dy=8mm, dz=5mm

Reference Value = 0.8650 V/m; Power Drift = 0.05 dB

Peak SAR (extrapolated) = 0.527 W/kg

**SAR(1 g) = 0.342 W/kg; SAR(10 g) = 0.213 W/kg**

Maximum value of SAR (measured) = 0.471 W/kg

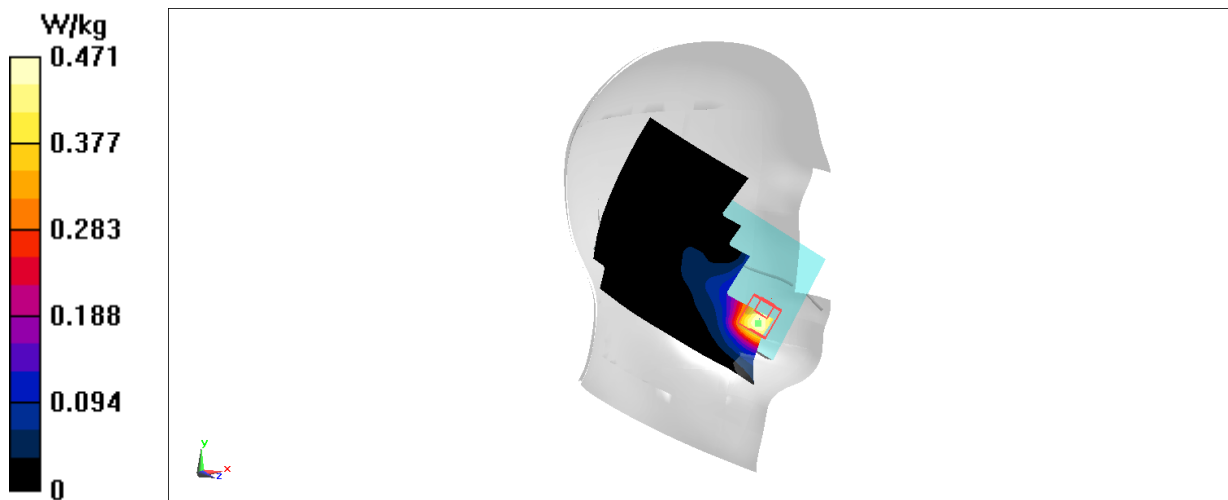
**Fig A.7**

**WCDMA1900-BII\_CH9262 Rear 15mm**

Date: 1/25/2022

Electronics: DAE4 Sn1331

Medium: head 1900 MHz

Medium parameters used:  $f = 1852.4$  MHz;  $\sigma = 1.532$  S/m;  $\epsilon_r = 42.489$ ;  $\rho = 1000$  kg/m<sup>3</sup>

Ambient Temperature: 22.9°C, Liquid Temperature: 22.5°C

Communication System: WCDMA1900-BII 1852.4 MHz Duty Cycle: 1:1

Probe: EX3DV4 – SN7548 ConvF(7.88,7.88,7.88)

**Area Scan (81x141x1):** Interpolated grid: dx=1.500 mm, dy=1.500 mm

Maximum value of SAR (interpolated) = 1.07 W/kg

**Zoom Scan (5x5x7)/Cube 0:** Measurement grid: dx=8mm, dy=8mm, dz=5mm

Reference Value = 11.53 V/m; Power Drift = -0.05 dB

Peak SAR (extrapolated) = 1.19 W/kg

**SAR(1 g) = 0.724 W/kg; SAR(10 g) = 0.444 W/kg**

Maximum value of SAR (measured) = 1.01 W/kg

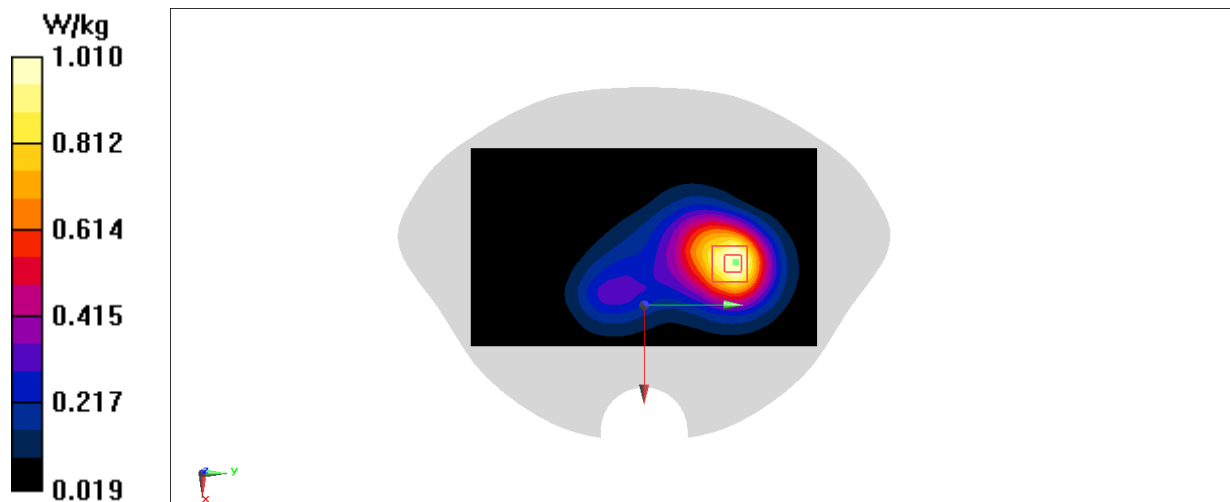
**Fig A.8**

**WCDMA1900-BII\_CH9400 Bottom 10mm**

Date: 1/25/2022

Electronics: DAE4 Sn1331

Medium: head 1900 MHz

Medium parameters used:  $f = 1880$  MHz;  $\sigma = 1.472$  S/m;  $\epsilon_r = 42.726$ ;  $\rho = 1000$  kg/m<sup>3</sup>

Ambient Temperature: 22.9°C, Liquid Temperature: 22.5°C

Communication System: WCDMA1900-BII 1880 MHz Duty Cycle: 1:1

Probe: EX3DV4 – SN7548 ConvF(7.88,7.88,7.88)

**Area Scan (81x141x1):** Interpolated grid: dx=1.500 mm, dy=1.500 mm

Maximum value of SAR (interpolated) = 0.914 W/kg

**Zoom Scan (6x8x7)/Cube 0:** Measurement grid: dx=8mm, dy=8mm, dz=5mm

Reference Value = 14.16 V/m; Power Drift = 0.12 dB

Peak SAR (extrapolated) = 1.10 W/kg

**SAR(1 g) = 0.611 W/kg; SAR(10 g) = 0.329 W/kg**

Maximum value of SAR (measured) = 0.920 W/kg

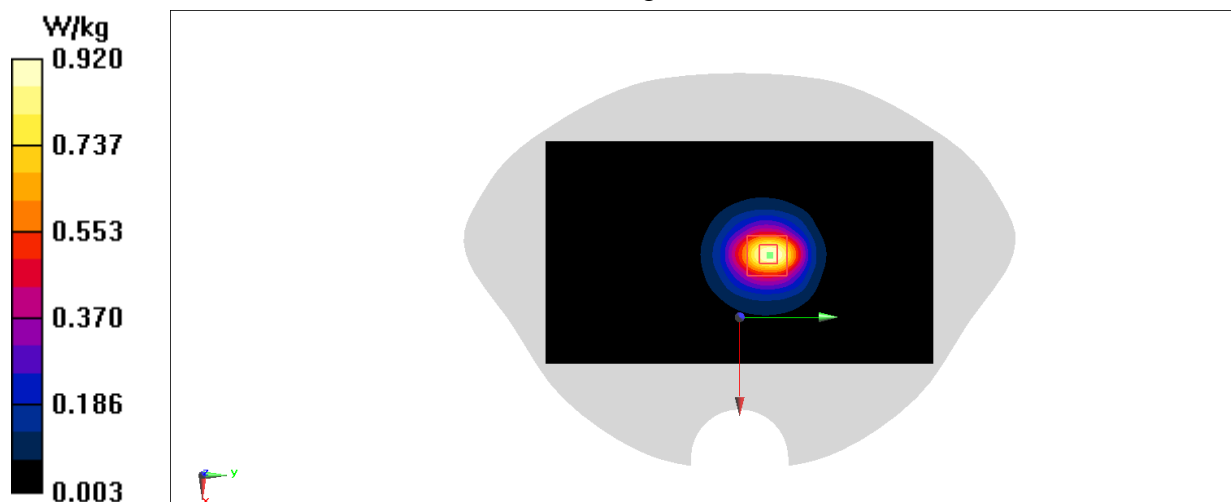

**Fig A.9**

**WCDMA1700-BIV\_CH1412 Right Cheek**

Date: 1/24/2022

Electronics: DAE4 Sn1331

Medium: head 1750 MHz

Medium parameters used:  $f = 1732.4$  MHz;  $\sigma = 1.369$  S/m;  $\epsilon_r = 43.058$ ;  $\rho = 1000$  kg/m<sup>3</sup>

Ambient Temperature: 22.9°C, Liquid Temperature: 22.5°C

Communication System: WCDMA1700-BIV 1732.4 MHz Duty Cycle: 1:1

Probe: EX3DV4 – SN7548 ConvF(8.14,8.14,8.14)

**Area Scan (71x141x1):** Interpolated grid: dx=1.500 mm, dy=1.500 mm

Maximum value of SAR (interpolated) = 0.613 W/kg

**Zoom Scan (5x5x7)/Cube 0:** Measurement grid: dx=8mm, dy=8mm, dz=5mm

Reference Value = 1.411 V/m; Power Drift = 0.03 dB

Peak SAR (extrapolated) = 0.688 W/kg

**SAR(1 g) = 0.440 W/kg; SAR(10 g) = 0.270 W/kg**

Maximum value of SAR (measured) = 0.590 W/kg

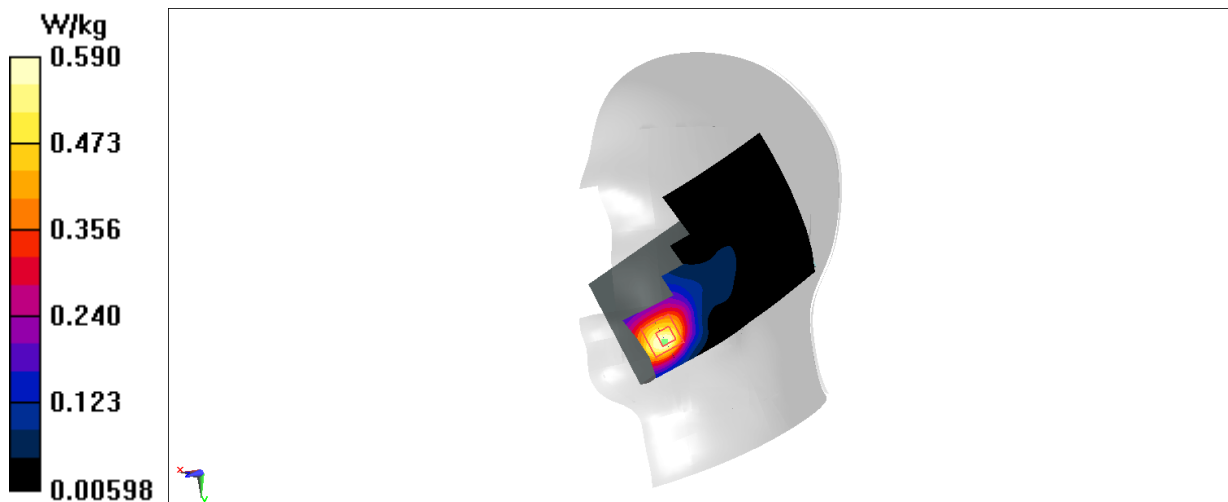
**Fig A.10**

**WCDMA1700-BIV\_CH1513 Rear 15mm**

Date: 1/24/2022

Electronics: DAE4 Sn1331

Medium: head 1750 MHz

Medium parameters used:  $f = 1752.6$  MHz;  $\sigma = 1.523$  S/m;  $\epsilon_r = 43.142$ ;  $\rho = 1000$  kg/m<sup>3</sup>

Ambient Temperature: 22.9°C, Liquid Temperature: 22.5°C

Communication System: WCDMA1700-BIV 1752.6 MHz Duty Cycle: 1:1

Probe: EX3DV4 – SN7548 ConvF(8.14,8.14,8.14)

**Area Scan (81x141x1):** Interpolated grid: dx=1.500 mm, dy=1.500 mm

Maximum value of SAR (interpolated) = 1.32 W/kg

**Zoom Scan (5x5x7)/Cube 0:** Measurement grid: dx=8mm, dy=8mm, dz=5mm

Reference Value = 10.38 V/m; Power Drift = 0.10 dB

Peak SAR (extrapolated) = 1.48 W/kg

**SAR(1 g) = 0.934 W/kg; SAR(10 g) = 0.581 W/kg**

Maximum value of SAR (measured) = 1.26 W/kg

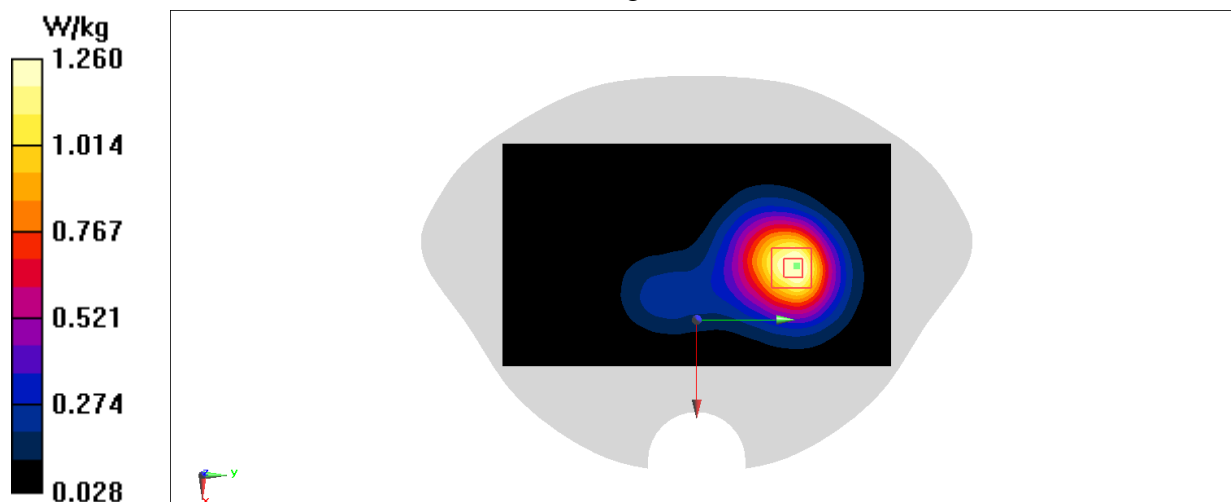

**Fig A.11**

**WCDMA1700-BIV\_CH1312 Bototm 10mm**

Date: 1/24/2022

Electronics: DAE4 Sn1331

Medium: head 1750 MHz

Medium parameters used:  $f = 1712.4$  MHz;  $\sigma = 1.355$  S/m;  $\epsilon_r = 43.106$ ;  $\rho = 1000$  kg/m<sup>3</sup>

Ambient Temperature: 22.9°C, Liquid Temperature: 22.5°C

Communication System: WCDMA1700-BIV 1712.4 MHz Duty Cycle: 1:1

Probe: EX3DV4 – SN7548 ConvF(8.14,8.14,8.14)

**Area Scan (81x141x1):** Interpolated grid: dx=1.500 mm, dy=1.500 mm

Maximum value of SAR (interpolated) = 1.03 W/kg

**Zoom Scan (6x8x7)/Cube 0:** Measurement grid: dx=8mm, dy=8mm, dz=5mm

Reference Value = 17.47 V/m; Power Drift = 0.02 dB

Peak SAR (extrapolated) = 1.25 W/kg

**SAR(1 g) = 0.718 W/kg; SAR(10 g) = 0.396 W/kg**

Maximum value of SAR (measured) = 1.04 W/kg

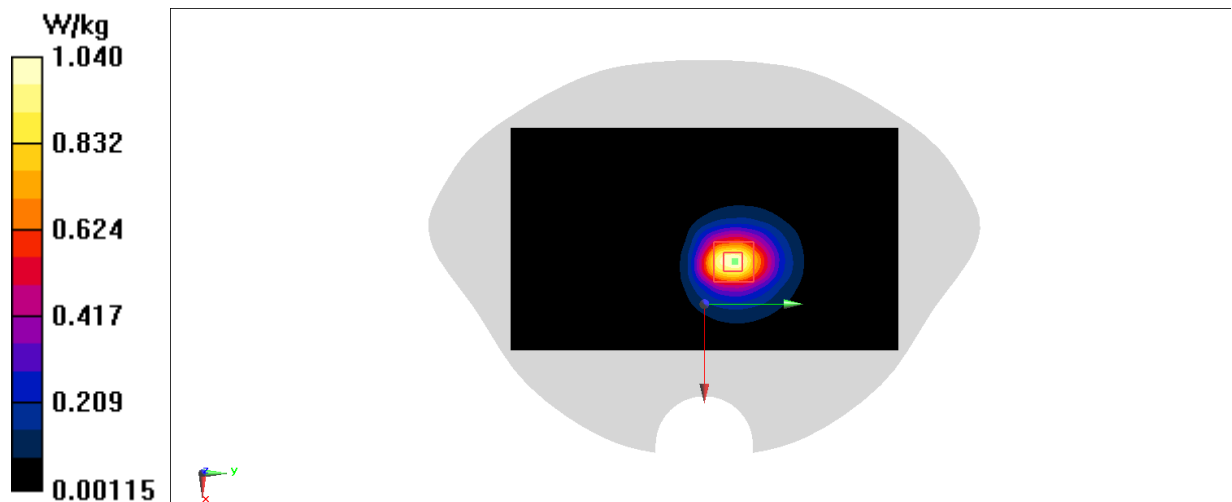

**Fig A.12**



**WCDMA850-BV\_CH4233 Left Cheek**

Date: 1/23/2022

Electronics: DAE4 Sn1331

Medium: head 835 MHz

Medium parameters used:  $f = 846.6$  MHz;  $\sigma = 0.862$  S/m;  $\epsilon_r = 45.37$ ;  $\rho = 1000$  kg/m<sup>3</sup>

Ambient Temperature: 22.9°C, Liquid Temperature: 22.5°C

Communication System: WCDMA850-BV 846.6 MHz Duty Cycle: 1:1

Probe: EX3DV4 – SN7548 ConvF(10.36,10.36,10.36)

**Area Scan (81x141x1):** Interpolated grid: dx=1.500 mm, dy=1.500 mm

Maximum value of SAR (interpolated) = 0.511 W/kg

**Zoom Scan (6x7x7)/Cube 0:** Measurement grid: dx=8mm, dy=8mm, dz=5mm

Reference Value = 3.235 V/m; Power Drift = -0.06 dB

Peak SAR (extrapolated) = 0.739 W/kg

**SAR(1 g) = 0.384 W/kg; SAR(10 g) = 0.282 W/kg**

Maximum value of SAR (measured) = 0.560 W/kg

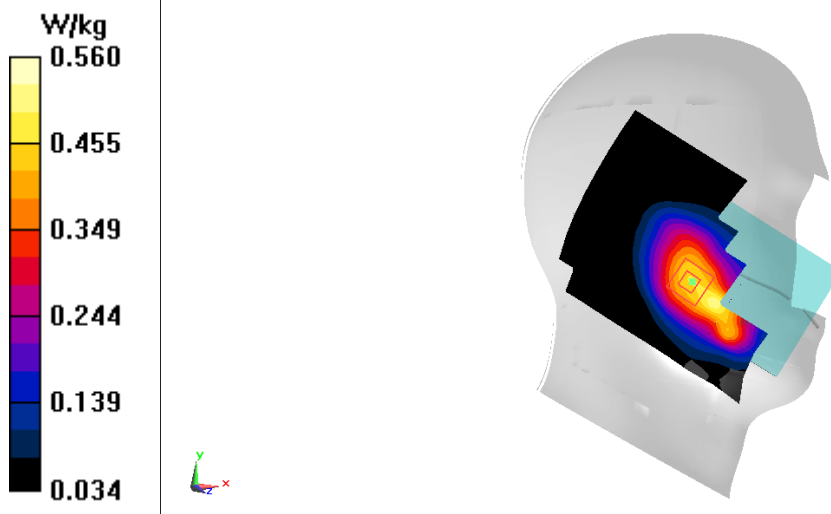

**Fig A.13**

**WCDMA850-BV\_CH4132 Rear 10mm**

Date: 9/16/2021

Electronics: DAE4 Sn1331

Medium: head 835 MHz

Medium parameters used:  $f = 826.4$  MHz;  $\sigma = 0.879$  S/m;  $\epsilon_r = 40.955$ ;  $\rho = 1000$  kg/m<sup>3</sup>

Ambient Temperature: 22.9°C, Liquid Temperature: 22.5°C

Communication System: WCDMA850-BV 826.4 MHz Duty Cycle: 1:1

Probe: EX3DV4 – SN7548 ConvF(10.36,10.36,10.36)

**Area Scan (81x141x1):** Interpolated grid: dx=1.500 mm, dy=1.500 mm

Maximum value of SAR (interpolated) = 1.21 W/kg

**Zoom Scan (6x6x7)/Cube 0:** Measurement grid: dx=8mm, dy=8mm, dz=5mm

Reference Value = 29.45 V/m; Power Drift = 0.07 dB

Peak SAR (extrapolated) = 1.38 W/kg

**SAR(1 g) = 0.971 W/kg; SAR(10 g) = 0.691 W/kg**

Maximum value of SAR (measured) = 1.23 W/kg

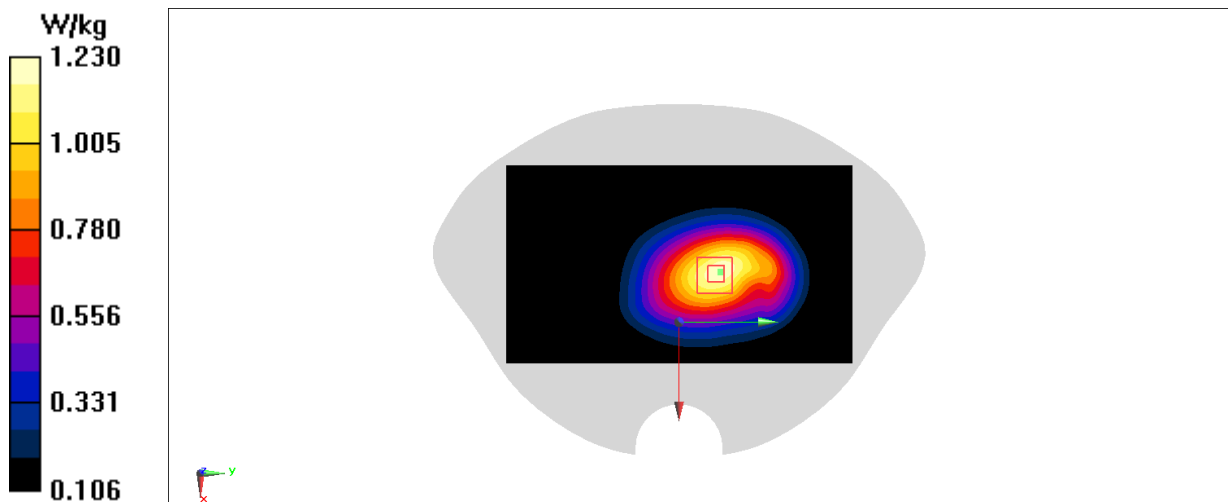
**Fig A.14**

**LTE1900-FDD2\_CH18900 Left Cheek**

Date: 1/25/2022

Electronics: DAE4 Sn1331

Medium: head 1900 MHz

Medium parameters used:  $f = 1880$  MHz;  $\sigma = 1.472$  S/m;  $\epsilon_r = 42.726$ ;  $\rho = 1000$  kg/m<sup>3</sup>

Ambient Temperature: 22.9°C, Liquid Temperature: 22.5°C

Communication System: LTE1900-FDD2 1880 MHz Duty Cycle: 1:1

Probe: EX3DV4 – SN7548 ConvF(7.88, 7.88, 7.88)

**Area Scan (81x141x1):** Interpolated grid: dx=1.500 mm, dy=1.500 mm

Maximum value of SAR (interpolated) = 0.502 W/kg

**Zoom Scan (6x7x7)/Cube 0:** Measurement grid: dx=8mm, dy=8mm, dz=5mm

Reference Value = 1.115 V/m; Power Drift = 0.87 dB

Peak SAR (extrapolated) = 0.568 W/kg

**SAR(1 g) = 0.343 W/kg; SAR(10 g) = 0.223 W/kg**

Maximum value of SAR (measured) = 0.470 W/kg

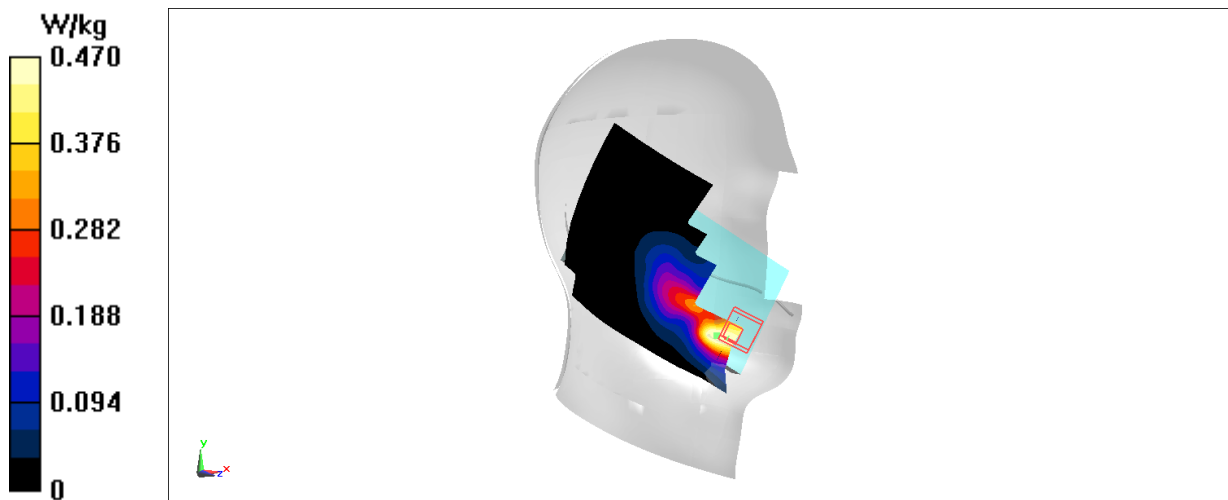

**Fig A.15**

**LTE1900-FDD2\_CH18700 Rear 15mm**

Date: 1/25/2022

Electronics: DAE4 Sn1331

Medium: head 1900 MHz

Medium parameters used:  $f = 1860$  MHz;  $\sigma = 1.532$  S/m;  $\epsilon_r = 42.448$ ;  $\rho = 1000$  kg/m<sup>3</sup>

Ambient Temperature: 22.9°C, Liquid Temperature: 22.5°C

Communication System: LTE1900-FDD2 1860 MHz Duty Cycle: 1:1

Probe: EX3DV4 – SN7548 ConvF(7.88, 7.88, 7.88)

**Area Scan (81x141x1):** Interpolated grid: dx=1.500 mm, dy=1.500 mm

Maximum value of SAR (interpolated) = 1.34 W/kg

**Zoom Scan (6x8x7)/Cube 0:** Measurement grid: dx=8mm, dy=8mm, dz=5mm

Reference Value = 11.87 V/m; Power Drift = 0.16 dB

Peak SAR (extrapolated) = 1.49 W/kg

**SAR(1 g) = 0.900 W/kg; SAR(10 g) = 0.540 W/kg**

Maximum value of SAR (measured) = 1.28 W/kg

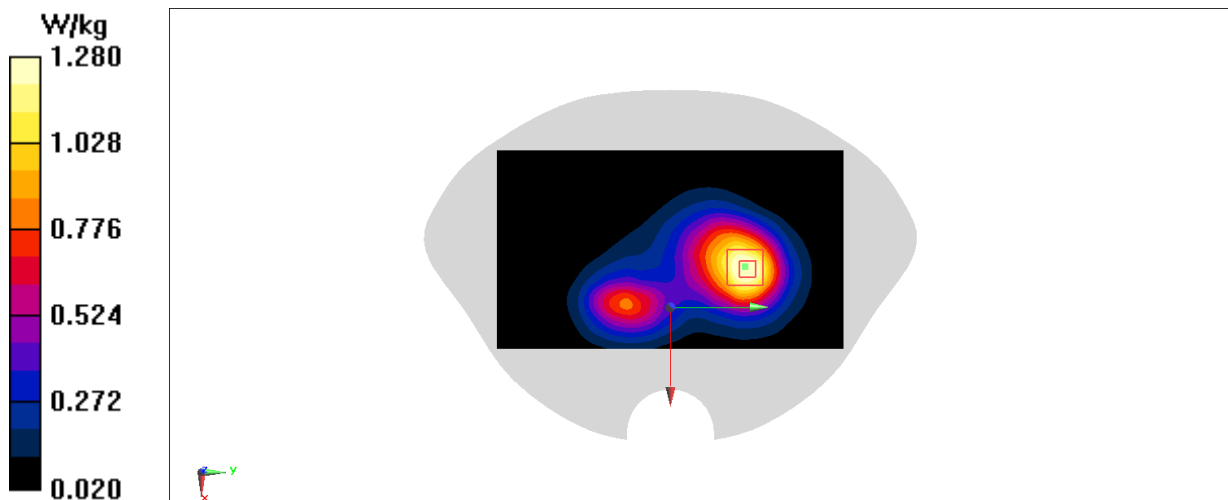

**Fig A.16**

**LTE1900-FDD2\_CH18900 Bottom 10mm**

Date: 1/25/2022

Electronics: DAE4 Sn1331

Medium: head 1900 MHz

Medium parameters used:  $f = 1880$  MHz;  $\sigma = 1.472$  S/m;  $\epsilon_r = 42.726$ ;  $\rho = 1000$  kg/m<sup>3</sup>

Ambient Temperature: 22.9°C, Liquid Temperature: 22.5°C

Communication System: LTE1900-FDD2 1880 MHz Duty Cycle: 1:1

Probe: EX3DV4 – SN7548 ConvF(7.88, 7.88, 7.88)

**Area Scan (41x101x1):** Interpolated grid: dx=1.500 mm, dy=1.500 mm

Maximum value of SAR (interpolated) = 0.951 W/kg

**Zoom Scan (5x5x7)/Cube 0:** Measurement grid: dx=8mm, dy=8mm, dz=5mm

Reference Value = 18.26 V/m; Power Drift = -0.01 dB

Peak SAR (extrapolated) = 1.04 W/kg

**SAR(1 g) = 0.576 W/kg; SAR(10 g) = 0.308 W/kg**

Maximum value of SAR (measured) = 0.867 W/kg

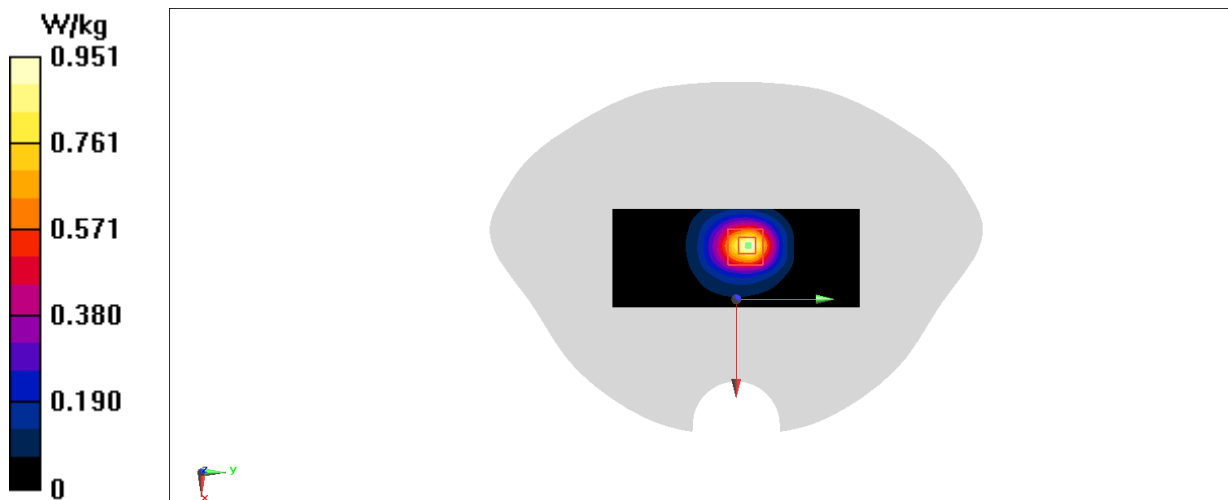

**Fig A.17**

**LTE850-FDD5\_CH20600 Left Cheek**

Date: 1/23/2022

Electronics: DAE4 Sn1331

Medium: head 835 MHz

Medium parameters used:  $f = 844 \text{ MHz}$ ;  $\sigma = 0.861 \text{ S/m}$ ;  $\epsilon_r = 45.38$ ;  $\rho = 1000 \text{ kg/m}^3$

Ambient Temperature:  $22.9^\circ\text{C}$ , Liquid Temperature:  $22.5^\circ\text{C}$

Communication System: LTE850-FDD5 844 MHz Duty Cycle: 1:1

Probe: EX3DV4 – SN7548 ConvF(10.36,10.36,10.36)

**Area Scan (81x141x1):** Interpolated grid:  $dx=1.500 \text{ mm}$ ,  $dy=1.500 \text{ mm}$

Maximum value of SAR (interpolated) =  $0.594 \text{ W/kg}$

**Zoom Scan (7x8x7)/Cube 0:** Measurement grid:  $dx=8\text{mm}$ ,  $dy=8\text{mm}$ ,  $dz=5\text{mm}$

Reference Value =  $3.097 \text{ V/m}$ ; Power Drift =  $0.05 \text{ dB}$

Peak SAR (extrapolated) =  $0.983 \text{ W/kg}$

**SAR(1 g) =  $0.489 \text{ W/kg}$ ; SAR(10 g) =  $0.324 \text{ W/kg}$**

Maximum value of SAR (measured) =  $0.717 \text{ W/kg}$

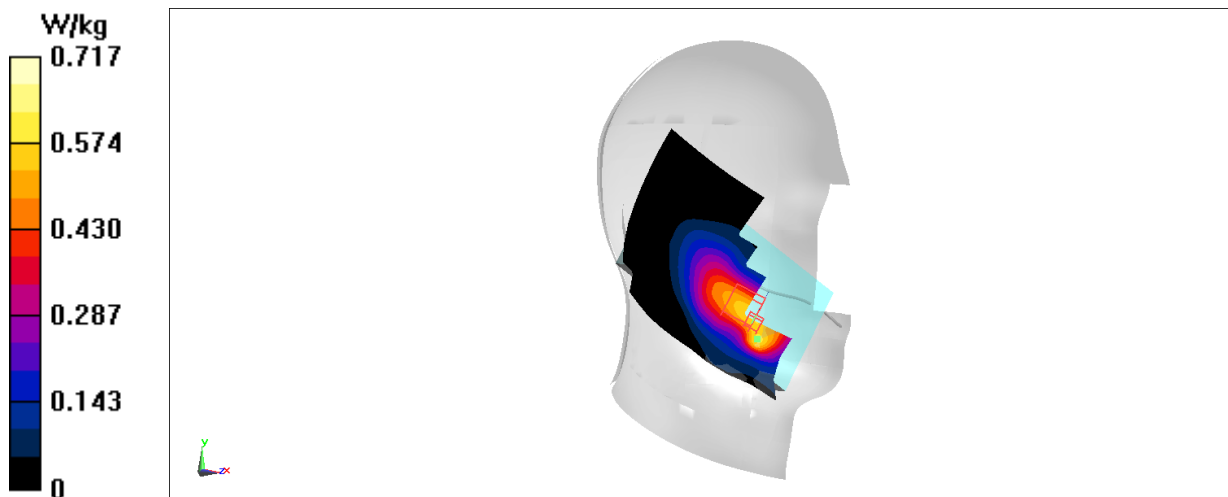

**Fig A.18**

**LTE850-FDD5\_CH20600 Rear 10mm**

Date: 1/23/2022

Electronics: DAE4 Sn1331

Medium: head 835 MHz

Medium parameters used:  $f = 844$  MHz;  $\sigma = 0.881$  S/m;  $\epsilon_r = 40.95$ ;  $\rho = 1000$  kg/m<sup>3</sup>

Ambient Temperature: 22.9°C, Liquid Temperature: 22.5°C

Communication System: LTE850-FDD5 844 MHz Duty Cycle: 1:1

Probe: EX3DV4 – SN7548 ConvF(10.36,10.36,10.36)

**Area Scan (81x141x1):** Interpolated grid: dx=1.500 mm, dy=1.500 mm

Maximum value of SAR (interpolated) = 1.12 W/kg

**Zoom Scan (6x8x7)/Cube 0:** Measurement grid: dx=8mm, dy=8mm, dz=5mm

Reference Value = 23.85 V/m; Power Drift = 0.04 dB

Peak SAR (extrapolated) = 1.26 W/kg

**SAR(1 g) = 0.752 W/kg; SAR(10 g) = 0.514 W/kg**

Maximum value of SAR (measured) = 1.04 W/kg

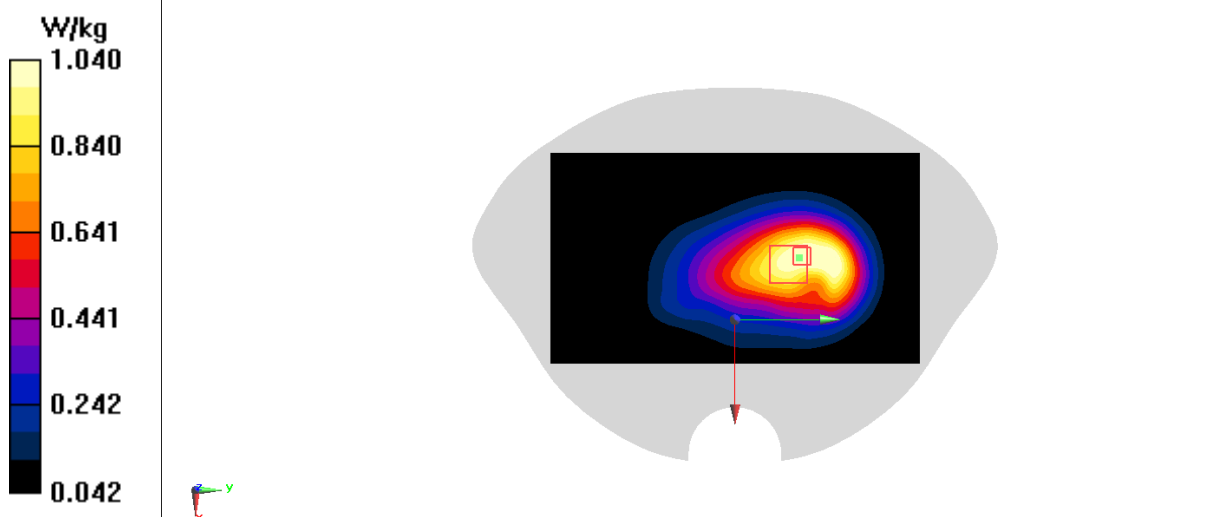
**Fig A.19**

**LTE2500-FDD7\_CH21350 Right Cheek**

Date: 1/27/2022

Electronics: DAE4 Sn1331

Medium: head 2600 MHz

Medium parameters used:  $f = 2560$  MHz;  $\sigma = 2.017$  S/m;  $\epsilon_r = 41.416$ ;  $\rho = 1000$  kg/m<sup>3</sup>

Ambient Temperature: 22.9°C, Liquid Temperature: 22.5°C

Communication System: LTE2500-FDD7 2560 MHz Duty Cycle: 1:1

Probe: EX3DV4 – SN7548 ConvF(7.11, 7.11, 7.11)

**Area Scan (91x171x1):** Interpolated grid: dx=1.200 mm, dy=1.200 mm

Maximum value of SAR (interpolated) = 1.17 W/kg

**Zoom Scan (7x7x7)/Cube 0:** Measurement grid: dx=5mm, dy=5mm, dz=5mm

Reference Value = 2.735 V/m; Power Drift = 0.07 dB

Peak SAR (extrapolated) = 1.46 W/kg

**SAR(1 g) = 0.662 W/kg; SAR(10 g) = 0.284 W/kg**

Maximum value of SAR (measured) = 1.12 W/kg

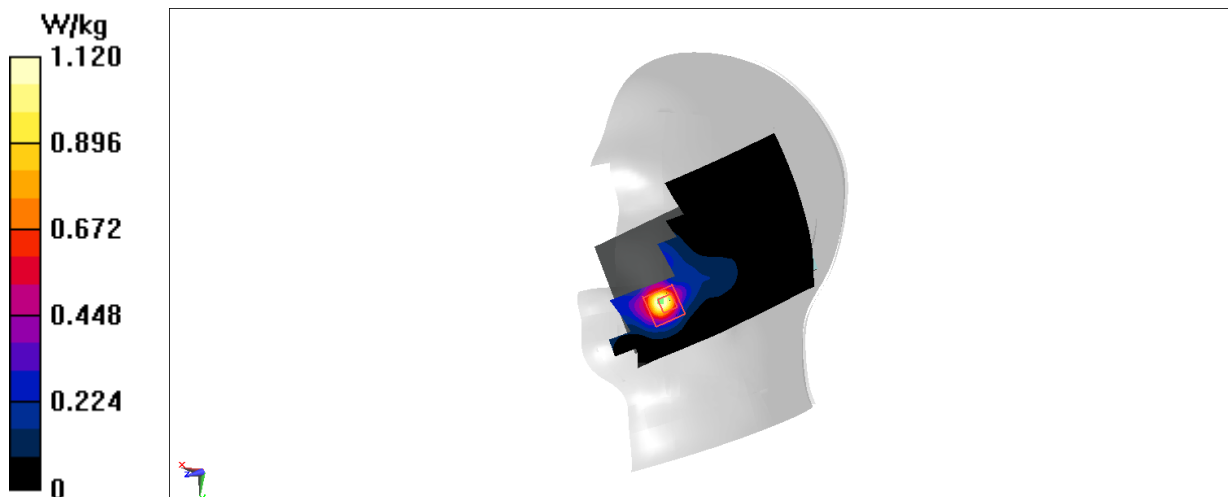

**Fig A.20**



**LTE2500-FDD7\_CH21350 Rear 15mm unfold**

Date: 1/27/2022

Electronics: DAE4 Sn1331

Medium: head 2600 MHz

Medium parameters used:  $f = 2560$  MHz;  $\sigma = 2.036$  S/m;  $\epsilon_r = 40.613$ ;  $\rho = 1000$  kg/m<sup>3</sup>

Ambient Temperature: 22.9°C, Liquid Temperature: 22.5°C

Communication System: LTE2500-FDD7 2560 MHz Duty Cycle: 1:1

Probe: EX3DV4 – SN7548 ConvF(7.11, 7.11, 7.11)

**Area Scan (101x171x1):** Interpolated grid: dx=1.200 mm, dy=1.200 mm

Maximum value of SAR (interpolated) = 1.33 W/kg

**Zoom Scan (8x10x7)/Cube 0:** Measurement grid: dx=5mm, dy=5mm, dz=5mm

Reference Value = 8.013 V/m; Power Drift = 0.03 dB

Peak SAR (extrapolated) = 1.60 W/kg

**SAR(1 g) = 0.827 W/kg; SAR(10 g) = 0.455 W/kg**

Maximum value of SAR (measured) = 1.28 W/kg

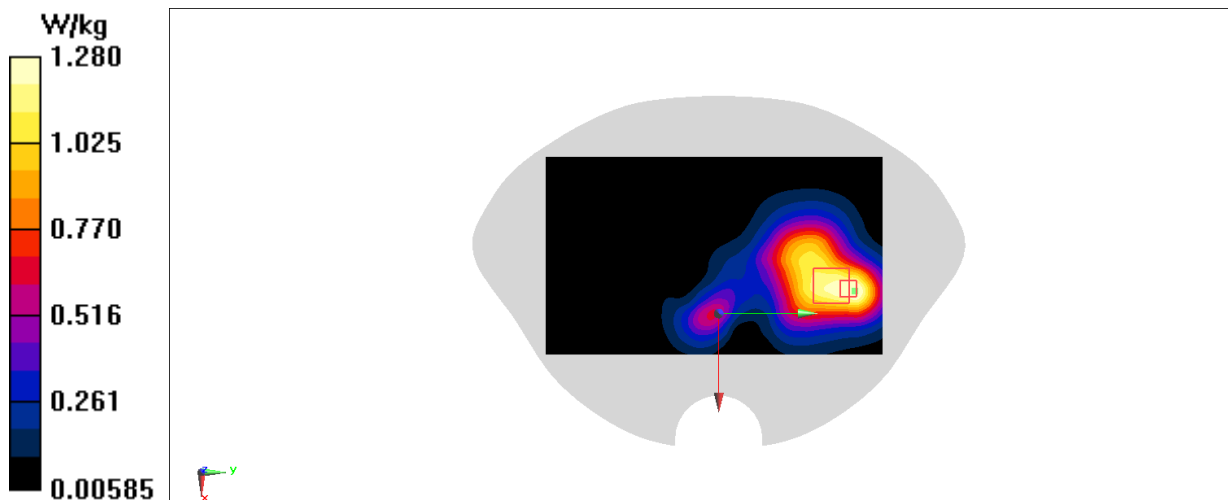

**Fig A.21**

**LTE2500-FDD7\_CH21100 Bottom 10mm**

Date: 1/27/2022

Electronics: DAE4 Sn1331

Medium: head 2600 MHz

Medium parameters used:  $f = 2535$  MHz;  $\sigma = 1.993$  S/m;  $\epsilon_r = 41.461$ ;  $\rho = 1000$  kg/m<sup>3</sup>

Ambient Temperature: 22.9°C, Liquid Temperature: 22.5°C

Communication System: LTE2500-FDD7 2535 MHz Duty Cycle: 1:1

Probe: EX3DV4 – SN7548 ConvF(7.11, 7.11, 7.11)

**Area Scan (51x121x1):** Interpolated grid: dx=1.200 mm, dy=1.200 mm

Maximum value of SAR (interpolated) = 1.81 W/kg

**Zoom Scan (7x7x7)/Cube 0:** Measurement grid: dx=5mm, dy=5mm, dz=5mm

Reference Value = 20.52 V/m; Power Drift = 0.12 dB

Peak SAR (extrapolated) = 2.24 W/kg

**SAR(1 g) = 1.04 W/kg; SAR(10 g) = 0.454 W/kg**

Maximum value of SAR (measured) = 1.77 W/kg

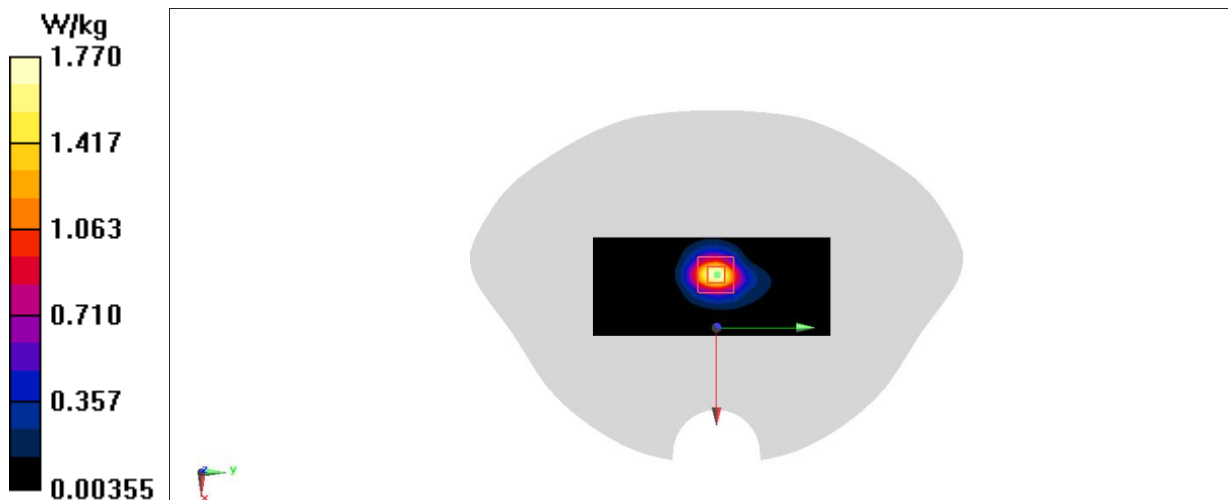
**Fig A.22**

**LTE700-FDD12\_CH23095 Left Cheek**

Date: 1/22/2022

Electronics: DAE4 Sn1331

Medium: head 750 MHz

Medium parameters used:  $f = 707.5$  MHz;  $\sigma = 0.845$  S/m;  $\epsilon_r = 41.663$ ;  $\rho = 1000$  kg/m<sup>3</sup>

Ambient Temperature: 22.9°C, Liquid Temperature: 22.5°C

Communication System: LTE700-FDD12 707.5 MHz Duty Cycle: 1:1

Probe: EX3DV4 – SN7548 ConvF(10.36,10.36,10.36)

**Area Scan (81x141x1):** Interpolated grid: dx=1.500 mm, dy=1.500 mm

Maximum value of SAR (interpolated) = 0.511 W/kg

**Zoom Scan (5x5x7)/Cube 0:** Measurement grid: dx=8mm, dy=8mm, dz=5mm

Reference Value = 3.759 V/m; Power Drift = -0.03 dB

Peak SAR (extrapolated) = 0.789 W/kg

**SAR(1 g) = 0.386 W/kg; SAR(10 g) = 0.246 W/kg**

Maximum value of SAR (measured) = 0.602 W/kg

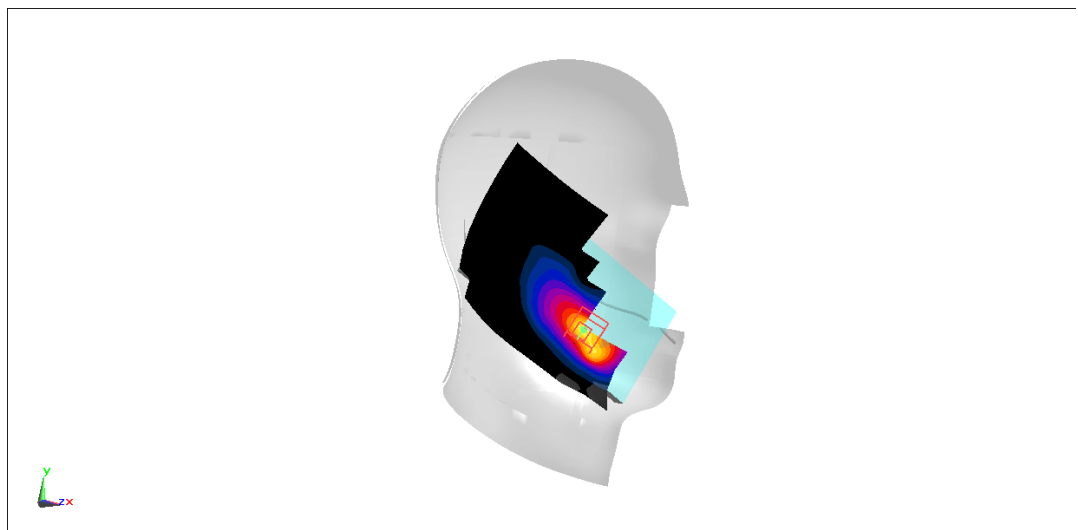
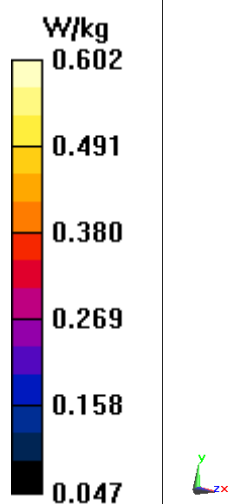

**Fig A.23**

**LTE700-FDD12\_CH23095 Rear 10mm**

Date: 1/22/2022

Electronics: DAE4 Sn1331

Medium: head 750 MHz

Medium parameters used:  $f = 707.5$  MHz;  $\sigma = 0.845$  S/m;  $\epsilon_r = 41.663$ ;  $\rho = 1000$  kg/m<sup>3</sup>

Ambient Temperature: 22.9°C, Liquid Temperature: 22.5°C

Communication System: LTE700-FDD12 707.5 MHz Duty Cycle: 1:1

Probe: EX3DV4 – SN7548 ConvF(10.36,10.36,10.36)

**Area Scan (81x141x1):** Interpolated grid: dx=1.500 mm, dy=1.500 mm

Maximum value of SAR (interpolated) = 0.742 W/kg

**Zoom Scan (6x8x7)/Cube 0:** Measurement grid: dx=8mm, dy=8mm, dz=5mm

Reference Value = 26.46 V/m; Power Drift = -0.19 dB

Peak SAR (extrapolated) = 0.820 W/kg

**SAR(1 g) = 0.575 W/kg; SAR(10 g) = 0.411 W/kg**

Maximum value of SAR (measured) = 0.729 W/kg

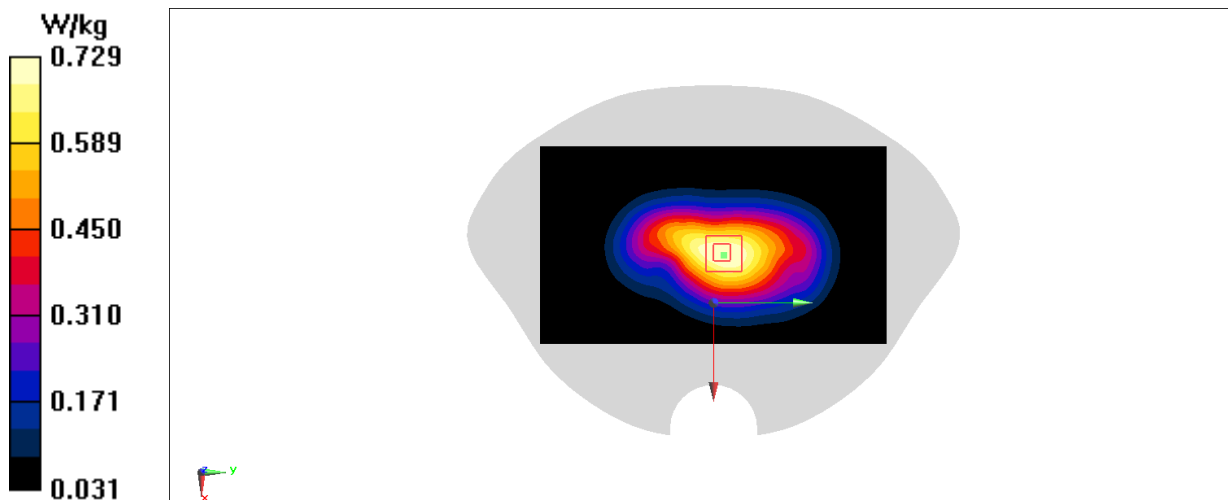

**Fig A.24**

**LTE750-FDD13\_CH23230 Left Cheek**

Date: 1/22/2022

Electronics: DAE4 Sn1331

Medium: head 750 MHz

Medium parameters used:  $f = 782 \text{ MHz}$ ;  $\sigma = 0.833 \text{ S/m}$ ;  $\epsilon_r = 45.604$ ;  $\rho = 1000 \text{ kg/m}^3$

Ambient Temperature: 22.9°C, Liquid Temperature: 22.5°C

Communication System: LTE750-FDD13 782 MHz Duty Cycle: 1:1

Probe: EX3DV4 – SN7548 ConvF(10.36,10.36,10.36)

**Area Scan (81x141x1):** Interpolated grid:  $dx=1.500 \text{ mm}$ ,  $dy=1.500 \text{ mm}$

Maximum value of SAR (interpolated) = 0.468 W/kg

**Zoom Scan (6x6x7)/Cube 0:** Measurement grid:  $dx=8\text{mm}$ ,  $dy=8\text{mm}$ ,  $dz=5\text{mm}$

Reference Value = 2.630 V/m; Power Drift = 0.12 dB

Peak SAR (extrapolated) = 0.627 W/kg

**SAR(1 g) = 0.343 W/kg; SAR(10 g) = 0.231 W/kg**

Maximum value of SAR (measured) = 0.508 W/kg

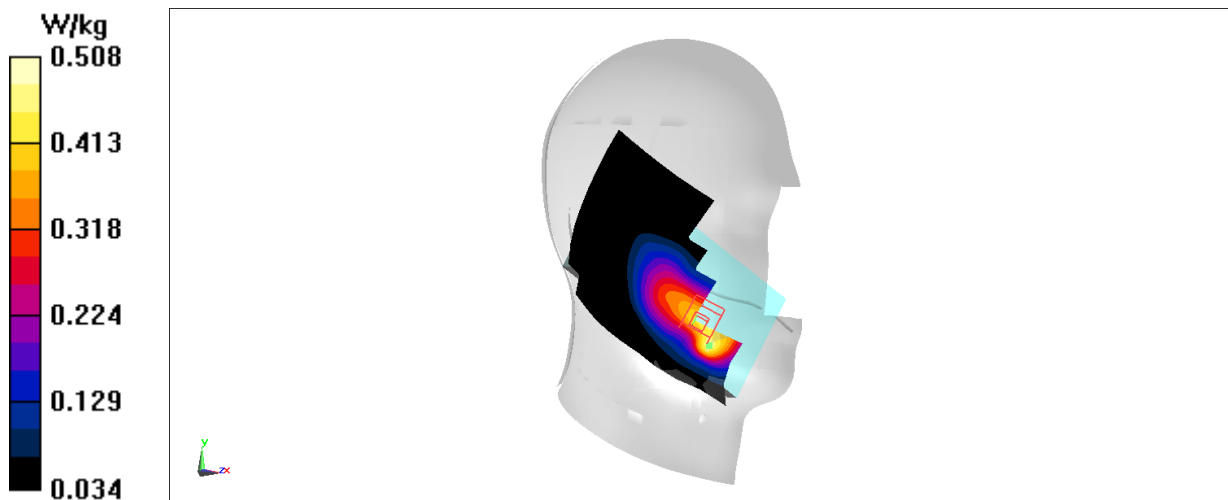

**Fig A.25**

**LTE750-FDD13\_CH23230 Rear 10mm**

Date: 1/22/2022

Electronics: DAE4 Sn1331

Medium: head 750 MHz

Medium parameters used:  $f = 782 \text{ MHz}$ ;  $\sigma = 0.871 \text{ S/m}$ ;  $\epsilon_r = 41.106$ ;  $\rho = 1000 \text{ kg/m}^3$

Ambient Temperature:  $22.9^\circ\text{C}$ , Liquid Temperature:  $22.5^\circ\text{C}$

Communication System: LTE750-FDD13 782 MHz Duty Cycle: 1:1

Probe: EX3DV4 – SN7548 ConvF(10.36,10.36,10.36)

**Area Scan (81x141x1):** Interpolated grid:  $dx=1.500 \text{ mm}$ ,  $dy=1.500 \text{ mm}$

Maximum value of SAR (interpolated) =  $0.552 \text{ W/kg}$

**Zoom Scan (6x8x7)/Cube 0:** Measurement grid:  $dx=8\text{mm}$ ,  $dy=8\text{mm}$ ,  $dz=5\text{mm}$

Reference Value =  $17.33 \text{ V/m}$ ; Power Drift =  $0.13 \text{ dB}$

Peak SAR (extrapolated) =  $0.655 \text{ W/kg}$

**SAR(1 g) =  $0.387 \text{ W/kg}$ ; SAR(10 g) =  $0.268 \text{ W/kg}$**

Maximum value of SAR (measured) =  $0.532 \text{ W/kg}$

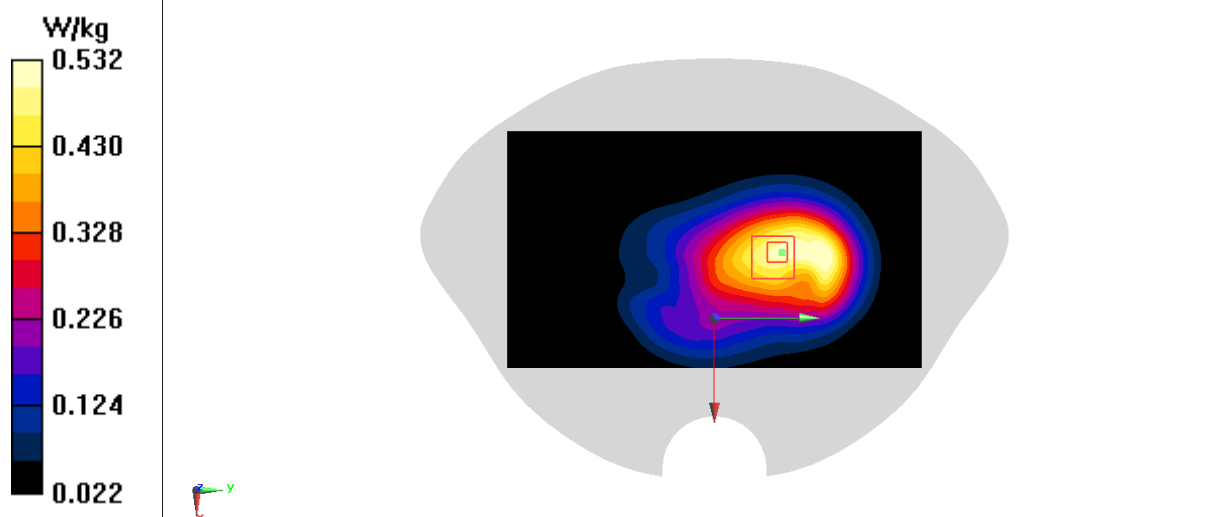

**Fig A.26**

**LTE2500-TDD41 PC3\_CH40185 Left Cheek**

Date: 1/27/2022

Electronics: DAE4 Sn1331

Medium: head 2600 MHz

Medium parameters used:  $f = 2550$  MHz;  $\sigma = 2.007$  S/m;  $\epsilon_r = 41.434$ ;  $\rho = 1000$  kg/m<sup>3</sup>

Ambient Temperature: 22.9°C, Liquid Temperature: 22.5°C

Communication System: LTE2500-TDD41 2550 MHz Duty Cycle: 1:1.58

Probe: EX3DV4 – SN7548 ConvF(7.11,7.11, 7.11)

**Area Scan (101x171x1):** Interpolated grid: dx=1.200 mm, dy=1.200 mm

Maximum value of SAR (interpolated) = 0.745 W/kg

**Zoom Scan (7x7x7)/Cube 0:** Measurement grid: dx=5mm, dy=5mm, dz=5mm

Reference Value = 2.339 V/m; Power Drift = 0.05 dB

Peak SAR (extrapolated) = 0.908 W/kg

**SAR(1 g) = 0.455 W/kg; SAR(10 g) = 0.236 W/kg**

Maximum value of SAR (measured) = 0.717 W/kg

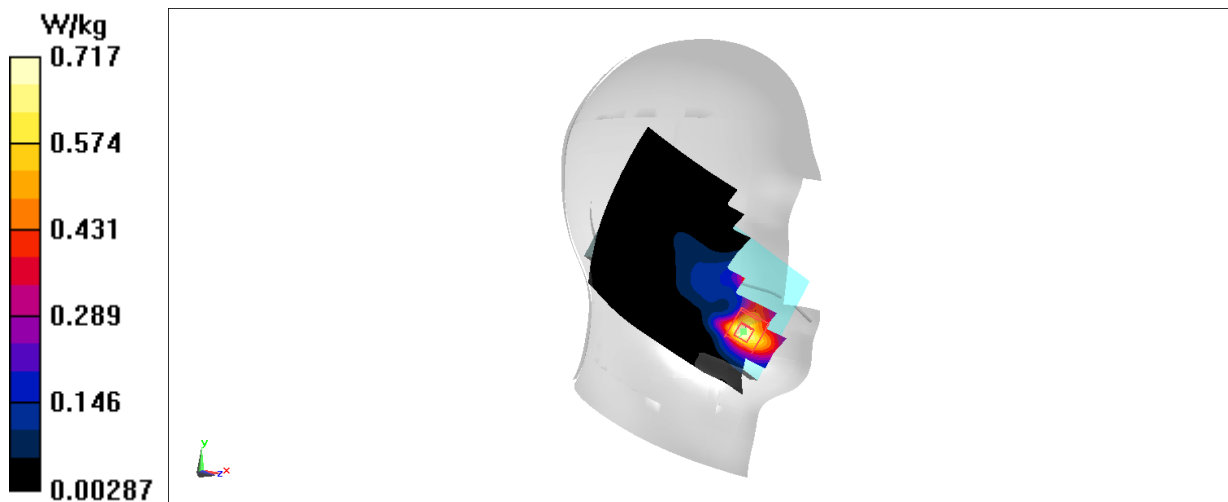
**Fig A.27**

**LTE2500-TDD41 PC3\_CH40185 Rear 15mm**

Date: 1/27/2022

Electronics: DAE4 Sn1331

Medium: head 2600 MHz

Medium parameters used:  $f = 2550$  MHz;  $\sigma = 2.007$  S/m;  $\epsilon_r = 41.434$ ;  $\rho = 1000$  kg/m<sup>3</sup>

Ambient Temperature: 22.9°C, Liquid Temperature: 22.5°C

Communication System: LTE2500-TDD41 2550 MHz Duty Cycle: 1:1.58

Probe: EX3DV4 – SN7548 ConvF(7.11,7.11, 7.11)

**Area Scan (101x171x1):** Interpolated grid: dx=1.200 mm, dy=1.200 mm

Maximum value of SAR (interpolated) = 0.730 W/kg

**Zoom Scan (8x7x7)/Cube 0:** Measurement grid: dx=5mm, dy=5mm, dz=5mm

Reference Value = 6.489 V/m; Power Drift = 0.09 dB

Peak SAR (extrapolated) = 0.876 W/kg

**SAR(1 g) = 0.472 W/kg; SAR(10 g) = 0.265 W/kg**

Maximum value of SAR (measured) = 0.723 W/kg

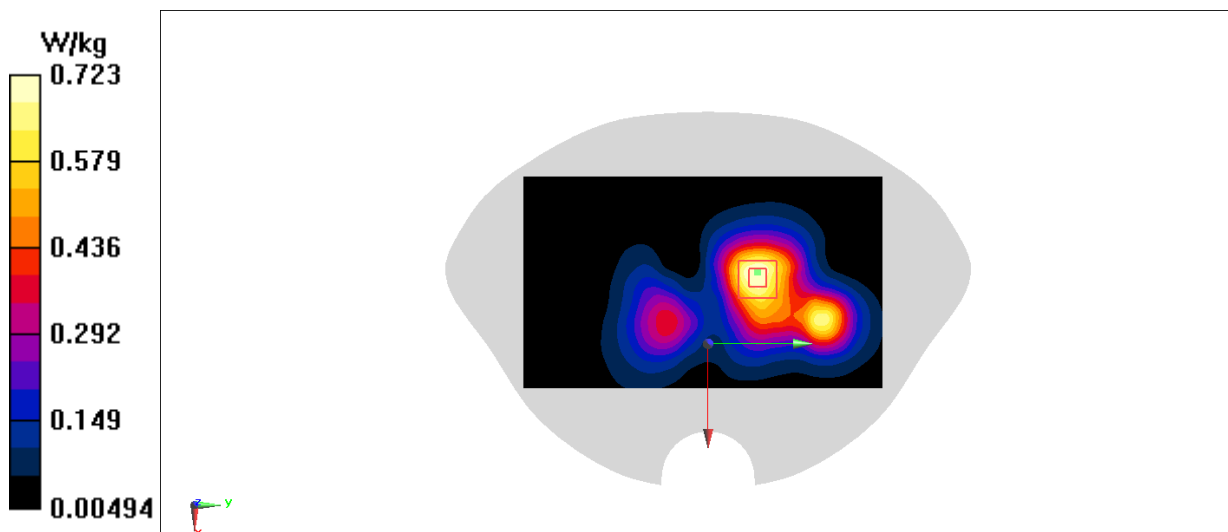

**Fig A.28**



**LTE2500-TDD41 PC3\_CH40185 Bottom 10mm**

Date: 1/27/2022

Electronics: DAE4 Sn1331

Medium: head 2600 MHz

Medium parameters used:  $f = 2550$  MHz;  $\sigma = 2.007$  S/m;  $\epsilon_r = 41.434$ ;  $\rho = 1000$  kg/m<sup>3</sup>

Ambient Temperature: 22.9°C, Liquid Temperature: 22.5°C

Communication System: LTE2500-TDD41 2550 MHz Duty Cycle: 1:1.58

Probe: EX3DV4 – SN7548 ConvF(7.11,7.11, 7.11)

**Area Scan (91x91x1):** Interpolated grid: dx=1.200 mm, dy=1.200 mm

Maximum value of SAR (interpolated) = 1.60 W/kg

**Zoom Scan (7x7x5)/Cube 0:** Measurement grid: dx=5mm, dy=5mm, dz=5mm

Reference Value = 10.85 V/m; Power Drift = -0.15 dB

Peak SAR (extrapolated) = 2.12 W/kg

**SAR(1 g) = 0.964 W/kg; SAR(10 g) = 0.425 W/kg**

Maximum value of SAR (measured) = 1.67 W/kg

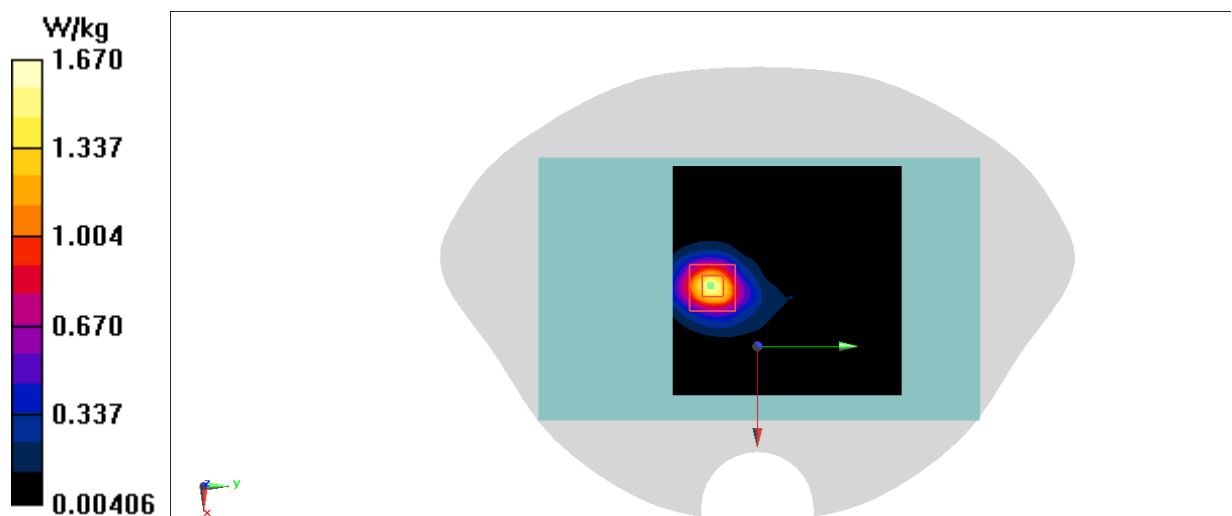

**Fig A.29**

**LTE2500-TDD41 PC2\_CH40620 Right Cheek**

Date: 1/27/2022

Electronics: DAE4 Sn1331

Medium: head 2600 MHz

Medium parameters used:  $f = 2593$  MHz;  $\sigma = 2.065$  S/m;  $\epsilon_r = 40.53$ ;  $\rho = 1000$  kg/m<sup>3</sup>

Ambient Temperature: 22.9°C, Liquid Temperature: 22.5°C

Communication System: LTE2500-TDD41 2593 MHz Duty Cycle: 1: 2.37

Probe: EX3DV4 – SN7548 ConvF(7.11,7.11,7.11)

**Area Scan (91x171x1):** Interpolated grid: dx=1.200 mm, dy=1.200 mm

Maximum value of SAR (interpolated) = 0.527 W/kg

**Zoom Scan (7x7x7)/Cube 0:** Measurement grid: dx=5mm, dy=5mm, dz=5mm

Reference Value = 1.517 V/m; Power Drift = 0.06 dB

Peak SAR (extrapolated) = 0.797 W/kg

**SAR(1 g) = 0.352 W/kg; SAR(10 g) = 0.147 W/kg**

Maximum value of SAR (measured) = 0.605 W/kg

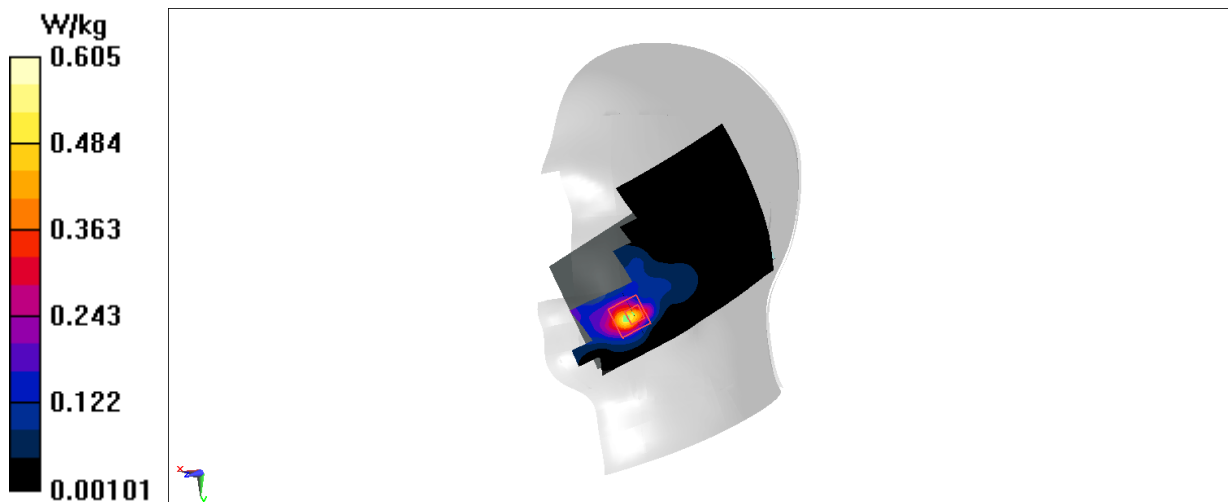

**Fig A.30**

**LTE2500-TDD41 PC2\_CH40620 Rear 15mm**

Date: 1/27/2022

Electronics: DAE4 Sn1331

Medium: head 2600 MHz

Medium parameters used:  $f = 2593$  MHz;  $\sigma = 2.065$  S/m;  $\epsilon_r = 40.53$ ;  $\rho = 1000$  kg/m<sup>3</sup>

Ambient Temperature: 22.9°C, Liquid Temperature: 22.5°C

Communication System: LTE2500-TDD41 2593 MHz Duty Cycle: 1: 2.37

Probe: EX3DV4 – SN7548 ConvF(7.11,7.11,7.11)

**Area Scan (101x171x1):** Interpolated grid: dx=1.200 mm, dy=1.200 mm

Maximum value of SAR (interpolated) = 1.15 W/kg

**Zoom Scan (7x7x7)/Cube 0:** Measurement grid: dx=5mm, dy=5mm, dz=5mm

Reference Value = 5.781 V/m; Power Drift = 0.06 dB

Peak SAR (extrapolated) = 1.40 W/kg

**SAR(1 g) = 0.699 W/kg; SAR(10 g) = 0.357 W/kg**

Maximum value of SAR (measured) = 1.13 W/kg

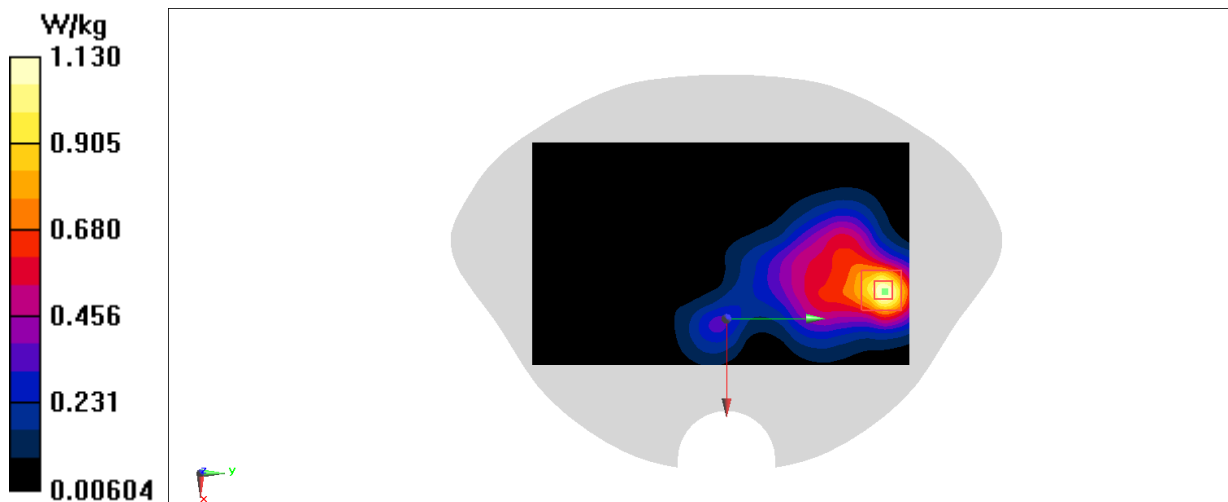

**Fig A.31**

**LTE2500-TDD41 PC2\_CH40620 Bottom 10mm**

Date: 1/27/2022

Electronics: DAE4 Sn1331

Medium: head 2600 MHz

Medium parameters used:  $f = 2593$  MHz;  $\sigma = 1.957$  S/m;  $\epsilon_r = 41.721$ ;  $\rho = 1000$  kg/m<sup>3</sup>

Ambient Temperature: 22.9°C, Liquid Temperature: 22.5°C

Communication System: LTE2500-TDD41 2593 MHz Duty Cycle: 1:2.37

Probe: EX3DV4 – SN7548 ConvF(7.11,7.11,7.11)

**Area Scan (51x121x1):** Interpolated grid: dx=1.200 mm, dy=1.200 mm

Maximum value of SAR (interpolated) = 0.797 W/kg

**Zoom Scan (7x7x7)/Cube 0:** Measurement grid: dx=5mm, dy=5mm, dz=5mm

Reference Value = 8.074 V/m; Power Drift = 0.02 dB

Peak SAR (extrapolated) = 0.983 W/kg

**SAR(1 g) = 0.451 W/kg; SAR(10 g) = 0.197 W/kg**

Maximum value of SAR (measured) = 0.775 W/kg

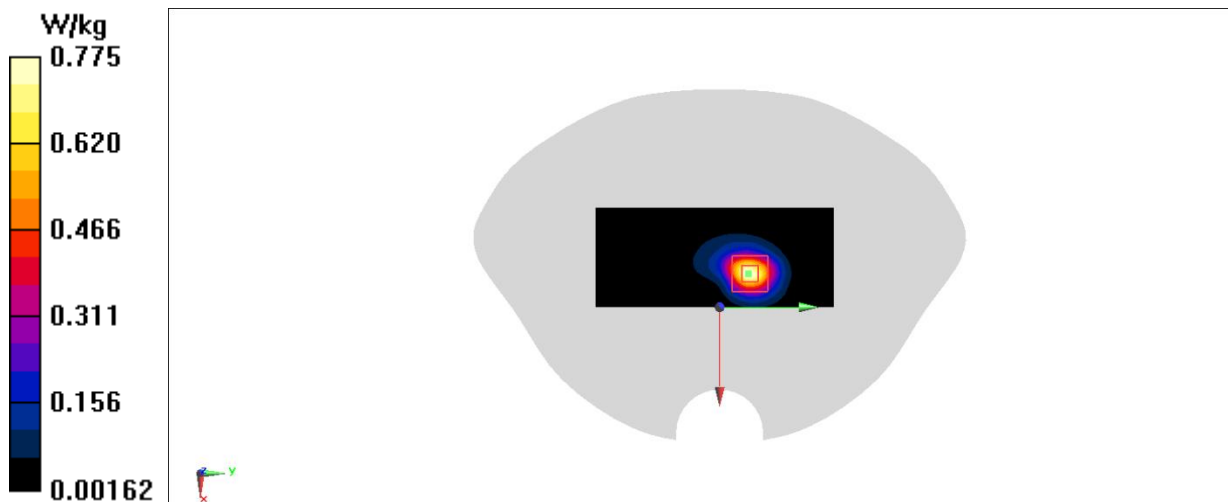

**Fig A.32**

**LTE1700-FDD66\_CH132322 Left Cheek**

Date:1/24/2022

Electronics: DAE4 Sn1331

Medium: head 1750 MHz

Medium parameters used:  $f = 1745$  MHz;  $\sigma = 1.378$  S/m;  $\epsilon_r = 43.029$ ;  $\rho = 1000$  kg/m<sup>3</sup>

Ambient Temperature: 22.9°C, Liquid Temperature: 22.5°C

Communication System: LTE1700-FDD66 1745 MHz Duty Cycle: 1:1

Probe: EX3DV4 – SN7548 ConvF(8.14,8.14,8.14)

**Area Scan (81x141x1):** Interpolated grid: dx=1.500 mm, dy=1.500 mm

Maximum value of SAR (interpolated) = 0.541 W/kg

**Zoom Scan (6x7x7)/Cube 0:** Measurement grid: dx=8mm, dy=8mm, dz=5mm

Reference Value = 1.622 V/m; Power Drift = 0.04 dB

Peak SAR (extrapolated) = 0.638 W/kg

**SAR(1 g) = 0.412 W/kg; SAR(10 g) = 0.267 W/kg**

Maximum value of SAR (measured) = 0.552 W/kg

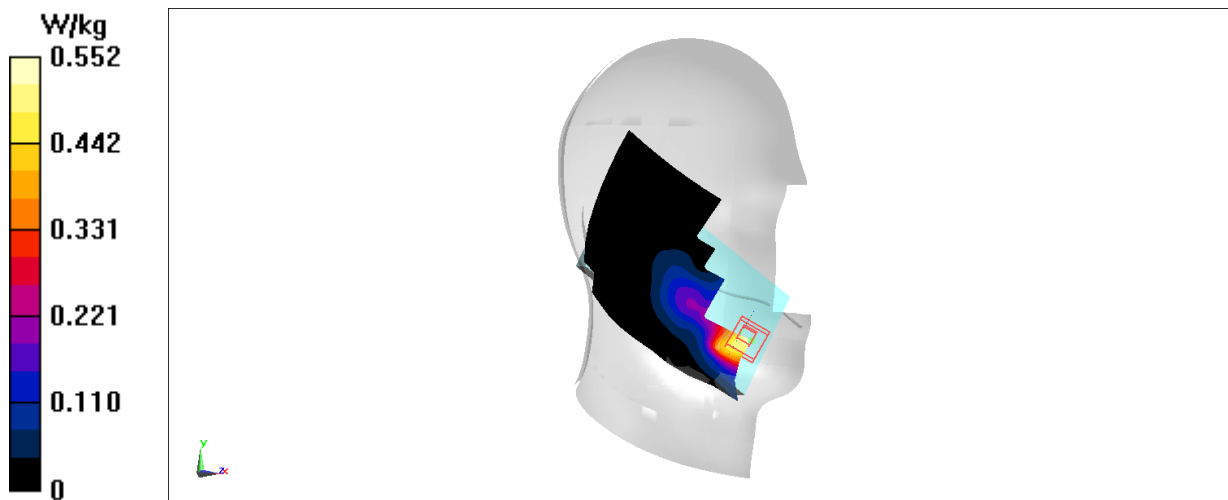

**Fig A.33**

**LTE1700-FDD66\_CH132322 Rear 15mm**

Date: 1/24/2022

Electronics: DAE4 Sn1331

Medium: head 1750 MHz

Medium parameters used:  $f = 1745$  MHz;  $\sigma = 1.378$  S/m;  $\epsilon_r = 43.029$ ;  $\rho = 1000$  kg/m<sup>3</sup>

Ambient Temperature: 22.9°C, Liquid Temperature: 22.5°C

Communication System: LTE1700-FDD66 1745 MHz Duty Cycle: 1:1

Probe: EX3DV4 – SN7548 ConvF(8.14,8.14,8.14)

**Area Scan (81x141x1):** Interpolated grid: dx=1.500 mm, dy=1.500 mm

Maximum value of SAR (interpolated) = 1.58 W/kg

**Zoom Scan (6x8x7)/Cube 0:** Measurement grid: dx=8mm, dy=8mm, dz=5mm

Reference Value = 8.214 V/m; Power Drift = 0.07 dB

Peak SAR (extrapolated) = 1.80 W/kg

**SAR(1 g) = 1.09 W/kg; SAR(10 g) = 0.677 W/kg**

Maximum value of SAR (measured) = 1.48 W/kg

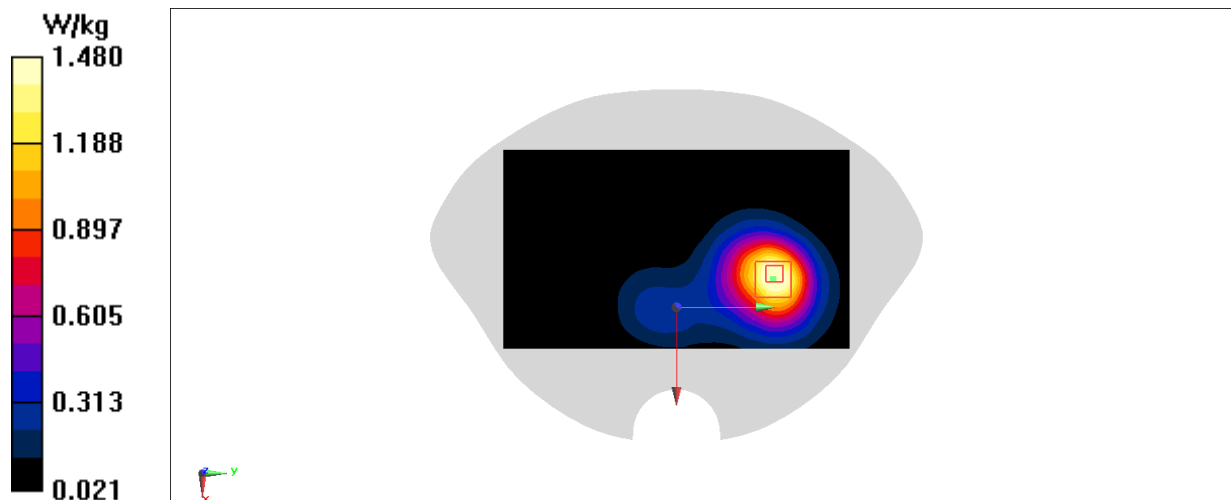

**Fig A.34**

**LTE1700-FDD66\_CH132322 Bottom 10mm**

Date: 1/24/2022

Electronics: DAE4 Sn1331

Medium: head 1750 MHz

Medium parameters used:  $f = 1745$  MHz;  $\sigma = 1.378$  S/m;  $\epsilon_r = 43.029$ ;  $\rho = 1000$  kg/m<sup>3</sup>

Ambient Temperature: 22.9°C, Liquid Temperature: 22.5°C

Communication System: LTE1700-FDD66 1745 MHz Duty Cycle: 1:1

Probe: EX3DV4 – SN7548 ConvF(8.14,8.14,8.14)

**Area Scan (81x141x1):** Interpolated grid: dx=1.500 mm, dy=1.500 mm

Maximum value of SAR (interpolated) = 1.01 W/kg

**Zoom Scan (5x5x7)/Cube 0:** Measurement grid: dx=8mm, dy=8mm, dz=5mm

Reference Value = 14.98 V/m; Power Drift = 0.02 dB

Peak SAR (extrapolated) = 1.15 W/kg

**SAR(1 g) = 0.656 W/kg; SAR(10 g) = 0.361 W/kg**

Maximum value of SAR (measured) = 0.968 W/kg

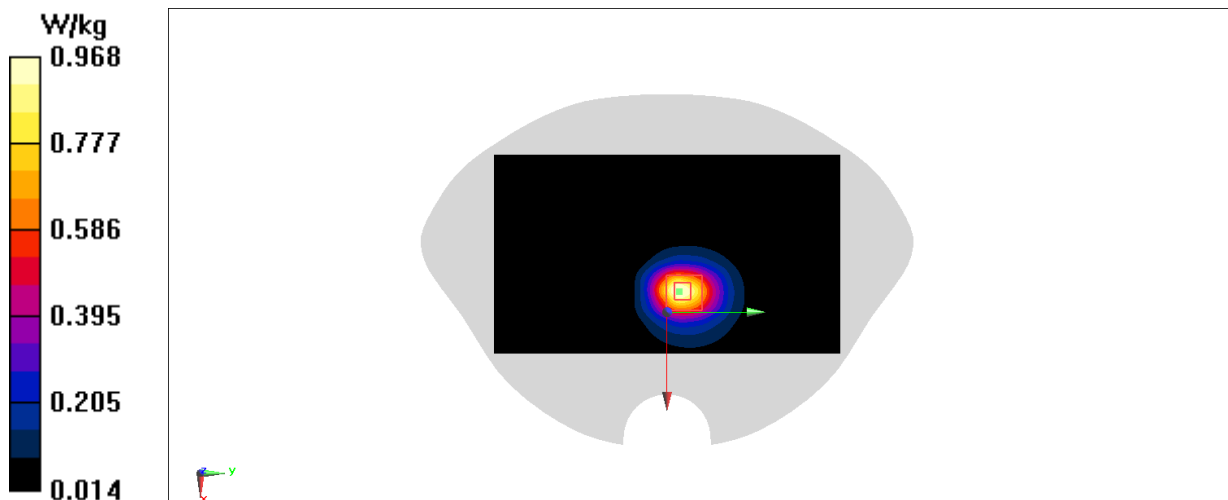
**Fig A.35**

**LTE700-FDD71\_CH133222 Left Cheek**

Date: 1/22/2022

Electronics: DAE4 Sn1331

Medium: head 750 MHz

Medium parameters used:  $f = 673 \text{ MHz}$ ;  $\sigma = 0.789 \text{ S/m}$ ;  $\epsilon_r = 45.987$ ;  $\rho = 1000 \text{ kg/m}^3$

Ambient Temperature: 22.9°C, Liquid Temperature: 22.5°C

Communication System: LTE700-FDD71 673 MHz Duty Cycle: 1:1

Probe: EX3DV4 – SN7548 ConvF(10.36,10.36,10.36)

**Area Scan (81x141x1):** Interpolated grid:  $dx=1.500 \text{ mm}$ ,  $dy=1.500 \text{ mm}$

Maximum value of SAR (interpolated) = 0.758 W/kg

**Zoom Scan (6x6x7)/Cube 0:** Measurement grid:  $dx=8\text{mm}$ ,  $dy=8\text{mm}$ ,  $dz=5\text{mm}$

Reference Value = 2.954 V/m; Power Drift = -0.01 dB

Peak SAR (extrapolated) = 1.28 W/kg

**SAR(1 g) = 0.562 W/kg; SAR(10 g) = 0.349 W/kg**

Maximum value of SAR (measured) = 0.897 W/kg

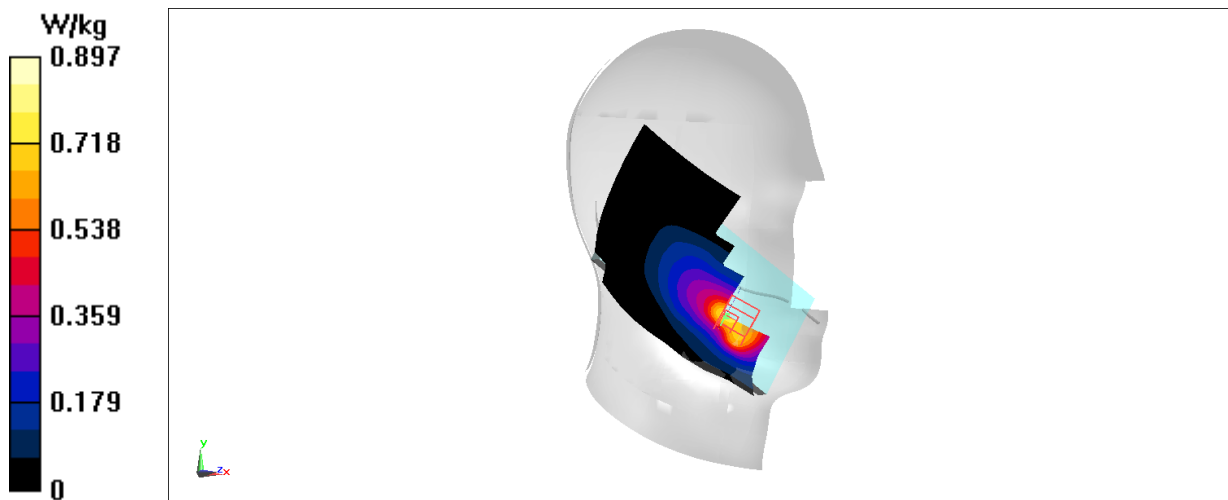

**Fig A.36**



**LTE700-FDD71\_CH133222 Rear 10mm**

Date: 1/22/2022

Electronics: DAE4 Sn1331

Medium: head 750 MHz

Medium parameters used:  $f = 673 \text{ MHz}$ ;  $\sigma = 0.789 \text{ S/m}$ ;  $\epsilon_r = 45.987$ ;  $\rho = 1000 \text{ kg/m}^3$

Ambient Temperature: 22.9°C, Liquid Temperature: 22.5°C

Communication System: LTE700-FDD71 673 MHz Duty Cycle: 1:1

Probe: EX3DV4 – SN7548 ConvF(10.36,10.36,10.36)

**Area Scan (81x141x1):** Interpolated grid:  $dx=1.500 \text{ mm}$ ,  $dy=1.500 \text{ mm}$

Maximum value of SAR (interpolated) = 0.507 W/kg

**Zoom Scan (6x6x7)/Cube 0:** Measurement grid:  $dx=8\text{mm}$ ,  $dy=8\text{mm}$ ,  $dz=5\text{mm}$

Reference Value = 20.66 V/m; Power Drift = -0.06 dB

Peak SAR (extrapolated) = 0.575 W/kg

**SAR(1 g) = 0.398 W/kg; SAR(10 g) = 0.285 W/kg**

Maximum value of SAR (measured) = 0.506 W/kg

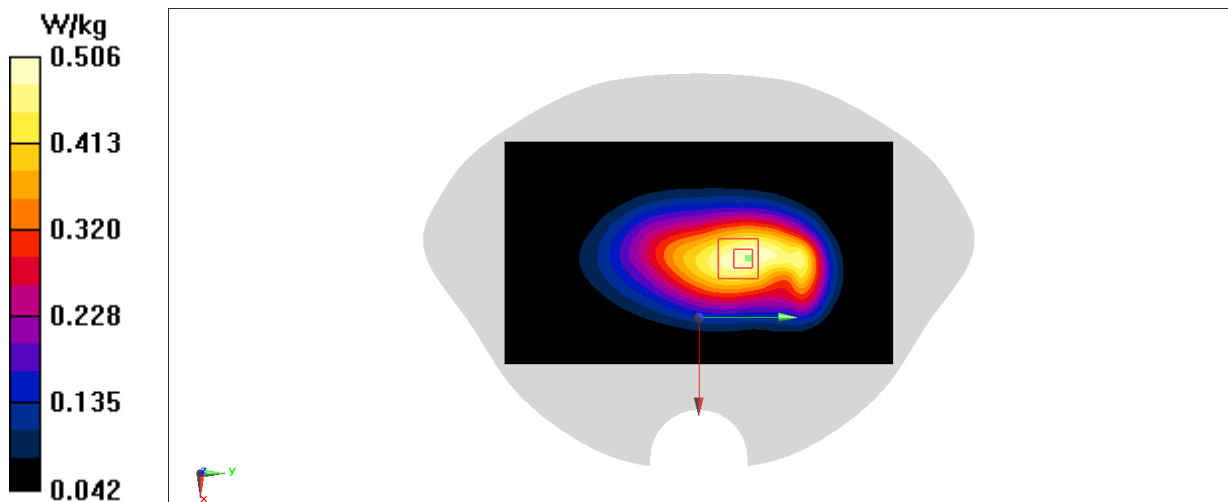

**Fig A.37**

**WLAN2450\_CH11 Left Cheek**

Date: 1/26/2022

Electronics: DAE4 Sn1331

Medium: head 2450 MHz

Medium parameters used:  $f = 2462$  MHz;  $\sigma = 1.919$  S/m;  $\epsilon_r = 40.63$ ;  $\rho = 1000$  kg/m<sup>3</sup>

Ambient Temperature: 22.9°C, Liquid Temperature: 22.5°C

Communication System: WLAN2450 2462 MHz Duty Cycle: 1:1

Probe: EX3DV4 – SN7548 ConvF(7.35,7.35,7.35)

**Area Scan (101x171x1):** Interpolated grid: dx=1.200 mm, dy=1.200 mm

Maximum value of SAR (interpolated) = 0.489 W/kg

**Zoom Scan (7x7x7)/Cube 0:** Measurement grid: dx=5mm, dy=5mm, dz=5mm

Reference Value = 0.7320 V/m; Power Drift = -0.01 dB

Peak SAR (extrapolated) = 0.631 W/kg

**SAR(1 g) = 0.296 W/kg; SAR(10 g) = 0.122 W/kg**

Maximum value of SAR (measured) = 0.481 W/kg

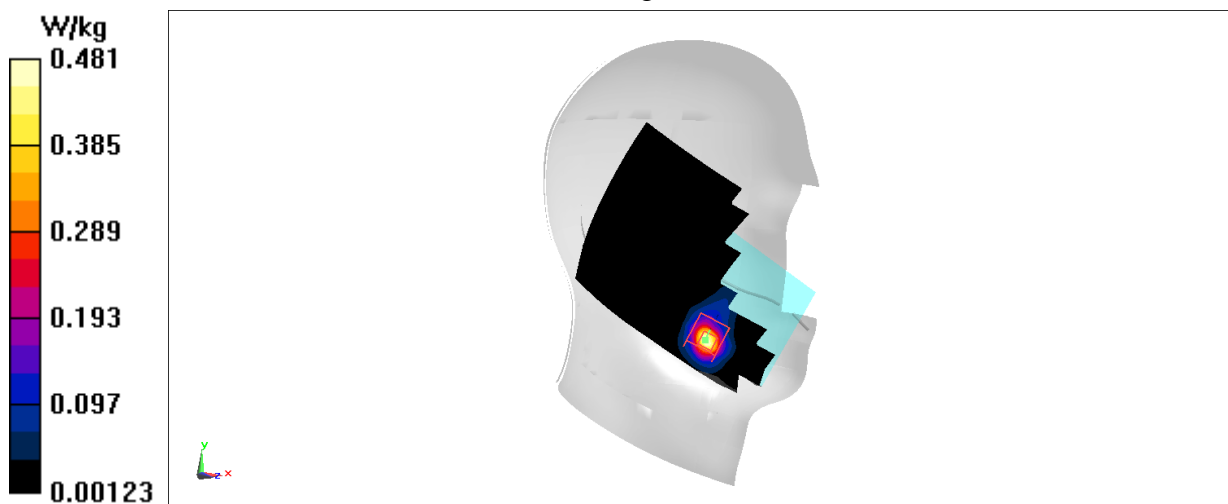

**Fig A.38**

**WLAN2450\_CH11 Rear 10mm**

Date: 1/26/2022

Electronics: DAE4 Sn1331

Medium: head 2450 MHz

Medium parameters used:  $f = 2462$  MHz;  $\sigma = 1.919$  S/m;  $\epsilon_r = 40.63$ ;  $\rho = 1000$  kg/m<sup>3</sup>

Ambient Temperature: 22.9°C, Liquid Temperature: 22.5°C

Communication System: WLAN2450 2462 MHz Duty Cycle: 1:1

Probe: EX3DV4 – SN7548 ConvF(7.35,7.35,7.35)

**Area Scan (101x171x1):** Interpolated grid:  $dx=1.200$  mm,  $dy=1.200$  mm

Maximum value of SAR (interpolated) = 0.349 W/kg

**Zoom Scan (7x7x7)/Cube 0:** Measurement grid:  $dx=5$ mm,  $dy=5$ mm,  $dz=5$ mm

Reference Value = 2.050 V/m; Power Drift = 0.66 dB

Peak SAR (extrapolated) = 0.424 W/kg

**SAR(1 g) = 0.199 W/kg; SAR(10 g) = 0.088 W/kg**

Maximum value of SAR (measured) = 0.340 W/kg

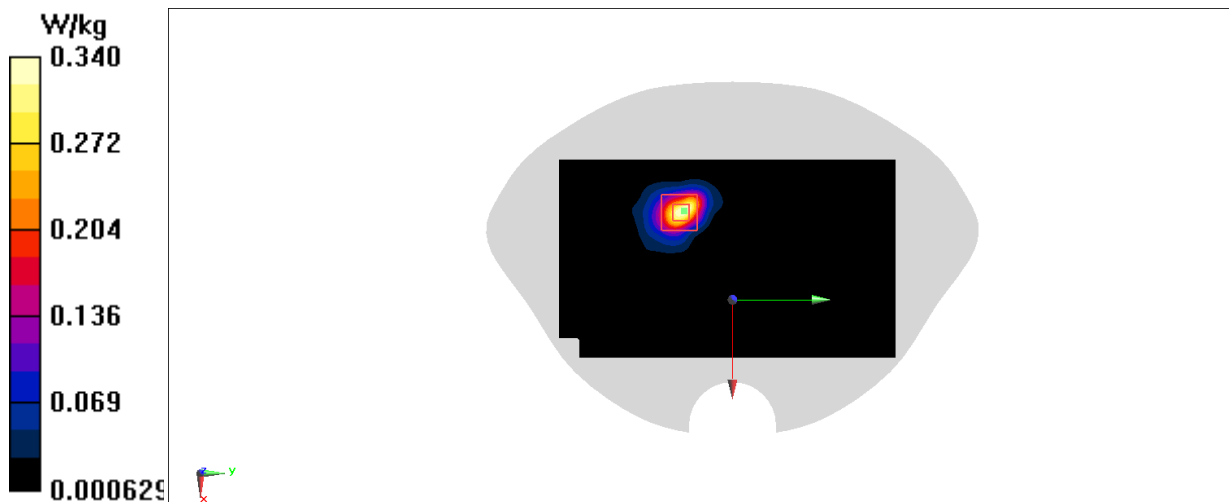

**Fig A.39**

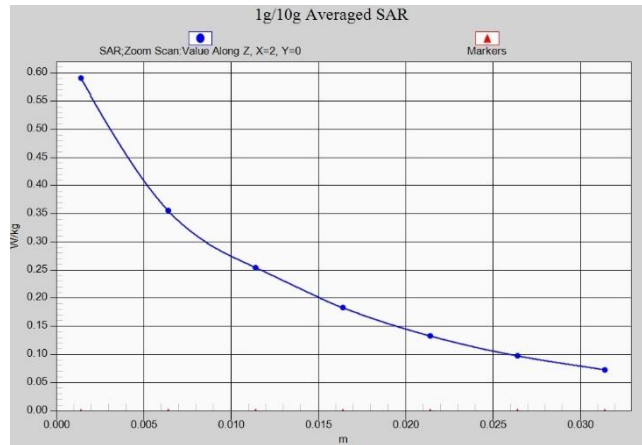

**Z-Scan at power reference point (GSM850)**

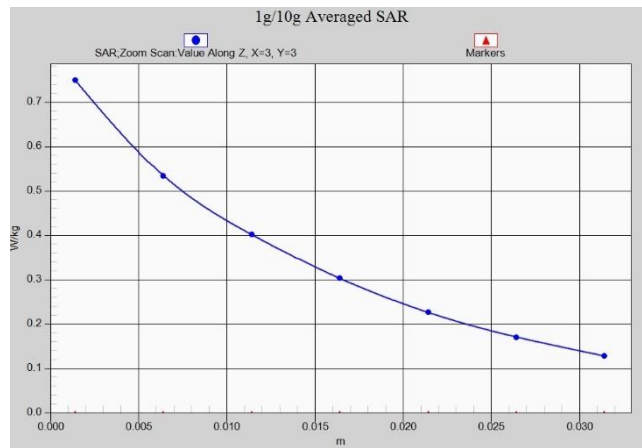

**Z-Scan at power reference point (GSM850)**

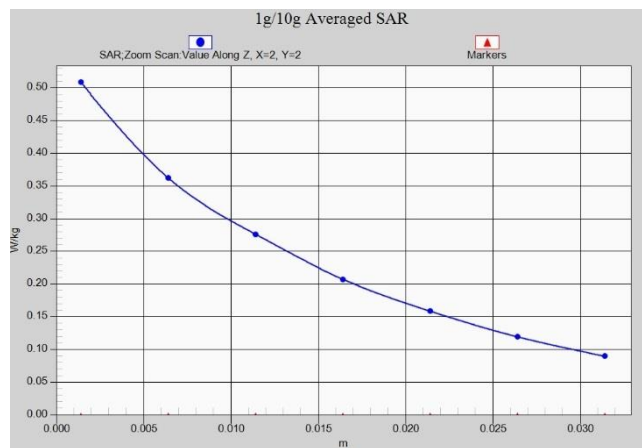

**Z-Scan at power reference point (GSM850)**

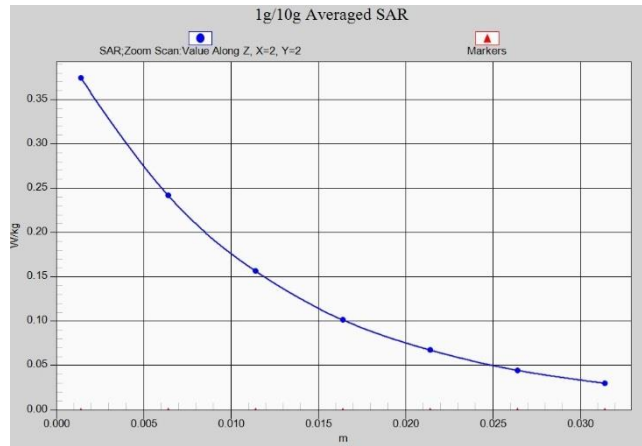

**Z-Scan at power reference point (GSM1900)**

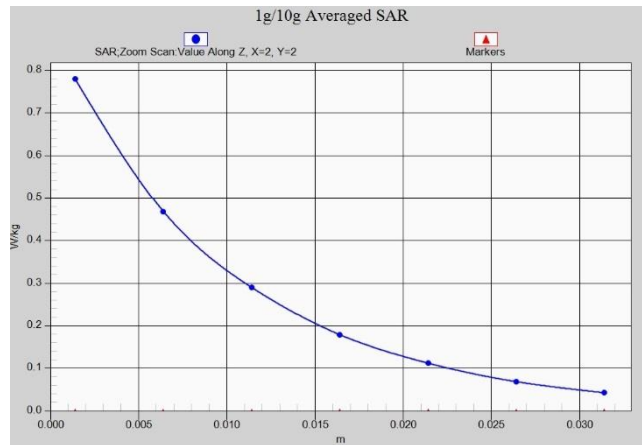

**Z-Scan at power reference point (GSM1900)**

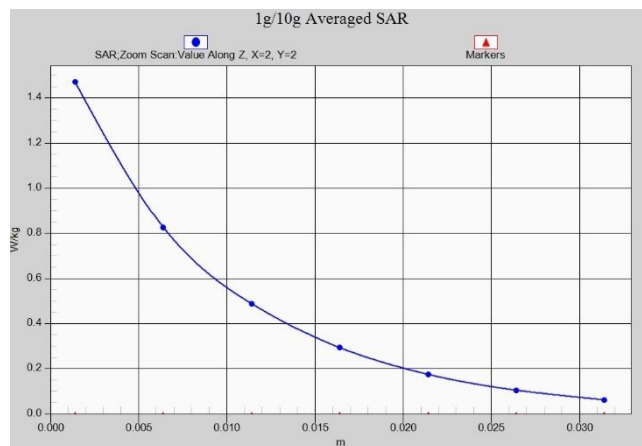

**Z-Scan at power reference point (GSM1900)**

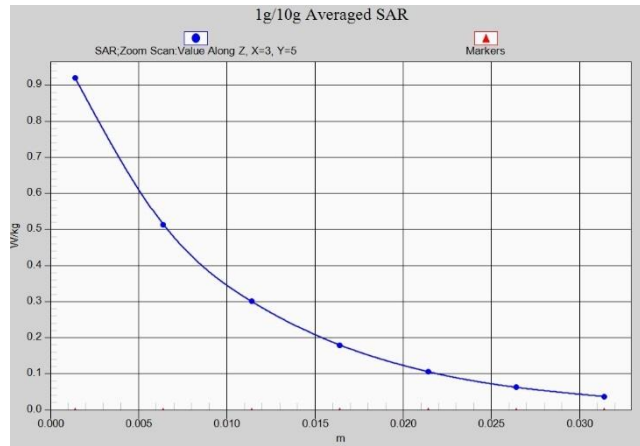

**Z-Scan at power reference point (WCDMA1900)**

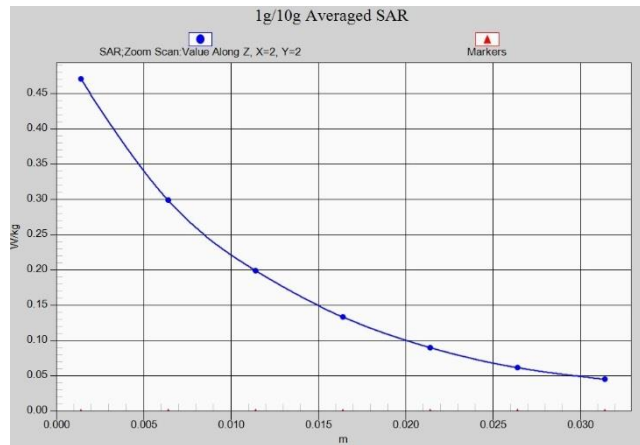

**Z-Scan at power reference point (WCDMA1900)**

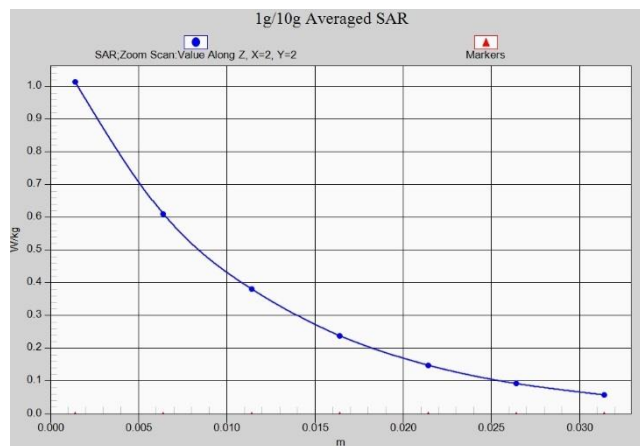

**Z-Scan at power reference point (WCDMA1900)**

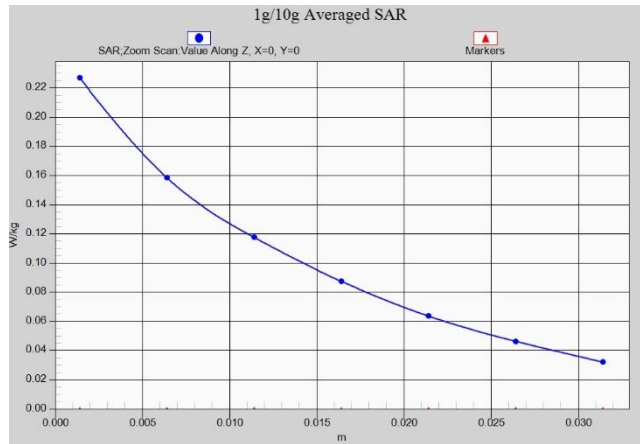

**Z-Scan at power reference point (WCDMA1700)**

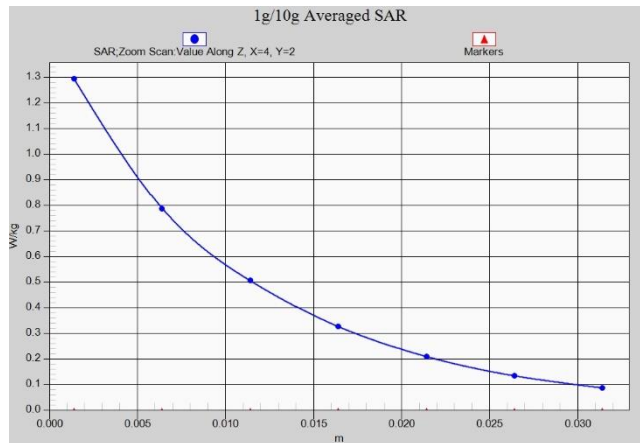

**Z-Scan at power reference point (WCDMA1700)**

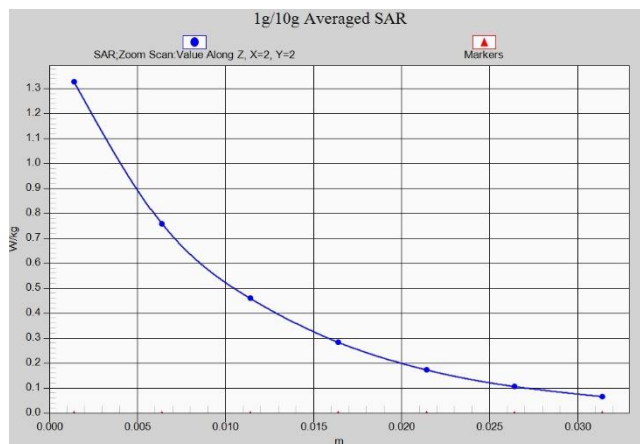

**Z-Scan at power reference point (WCDMA1700)**

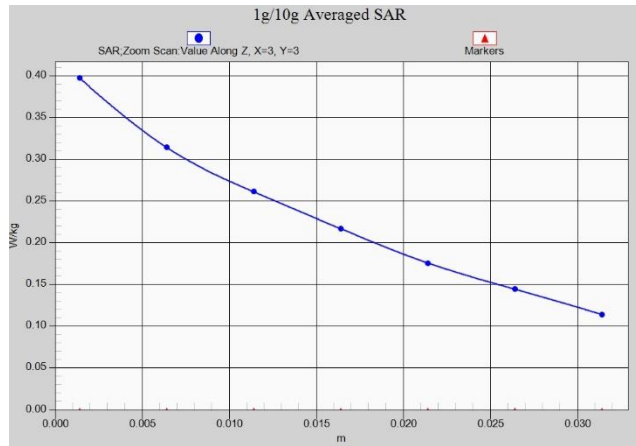

**Z-Scan at power reference point (WCDMA850)**

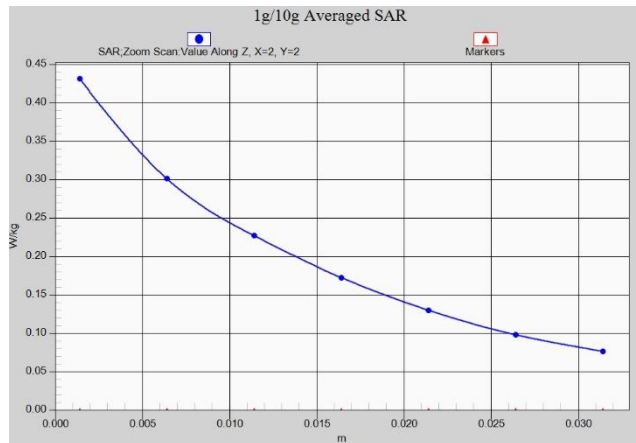

**Z-Scan at power reference point (WCDMA850)**

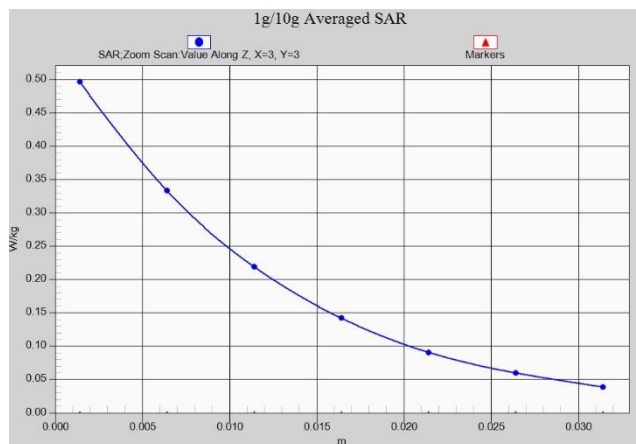

**Z-Scan at power reference point (LTEB2)**



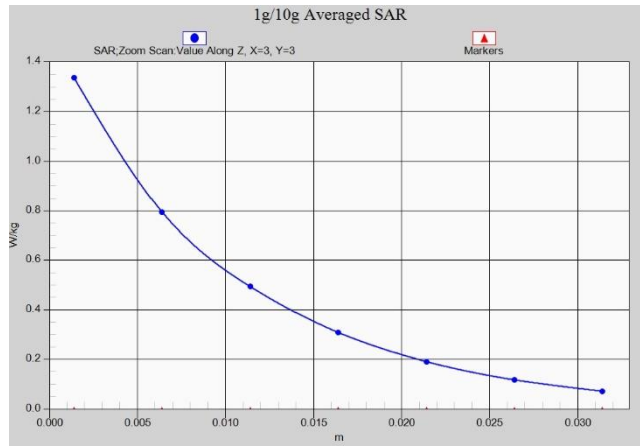

**Z-Scan at power reference point (LTEB2)**

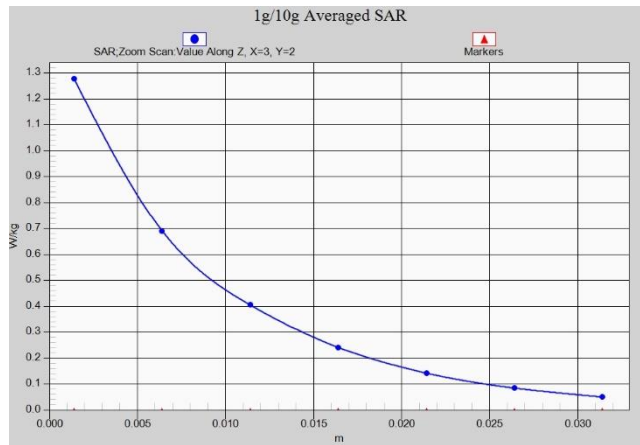

**Z-Scan at power reference point (LTEB2)**

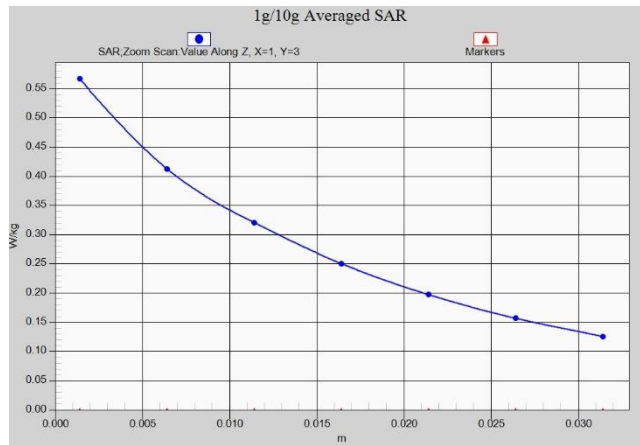

**Z-Scan at power reference point (LTEB5)**

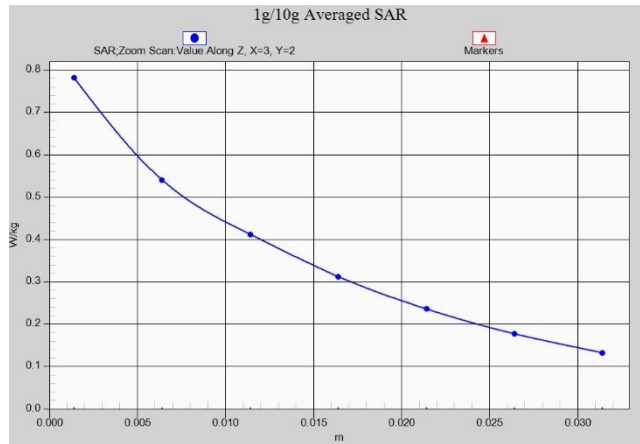

**Z-Scan at power reference point (LTEB5)**

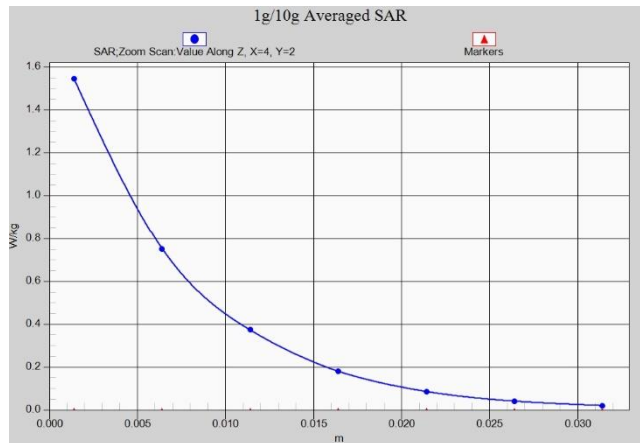

**Z-Scan at power reference point (LTEB7)**

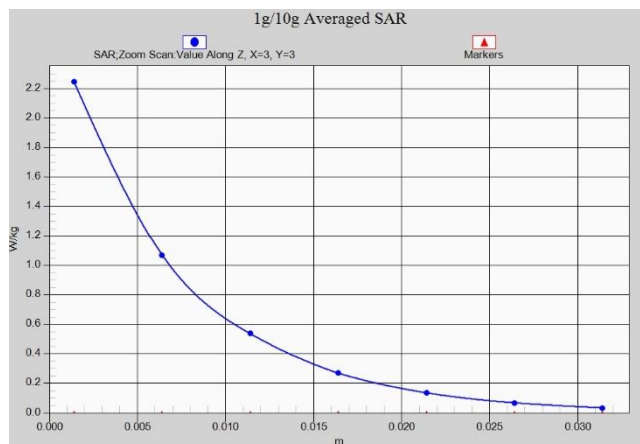

**Z-Scan at power reference point (LTEB7)**

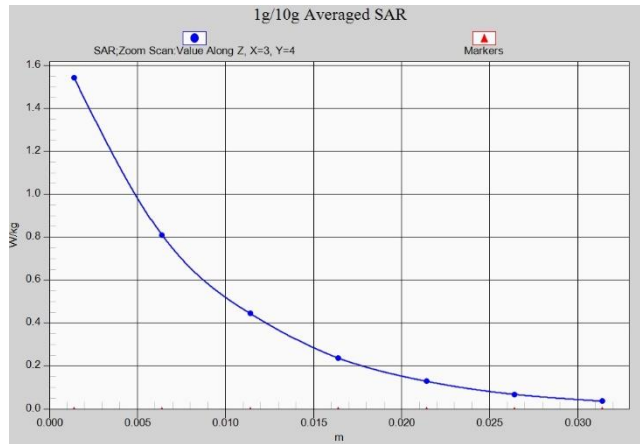

**Z-Scan at power reference point (LTEB7)**

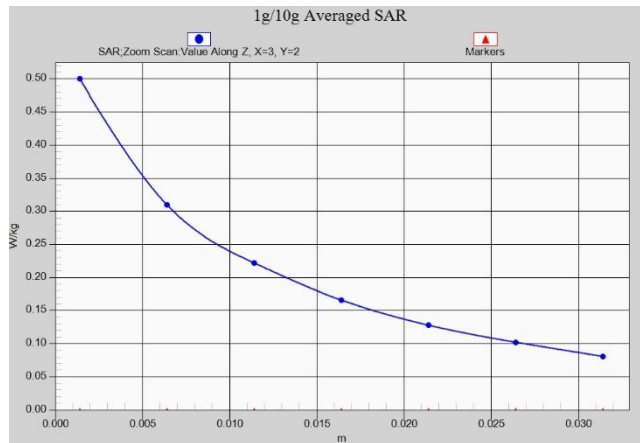

**Z-Scan at power reference point (LTEB12)**

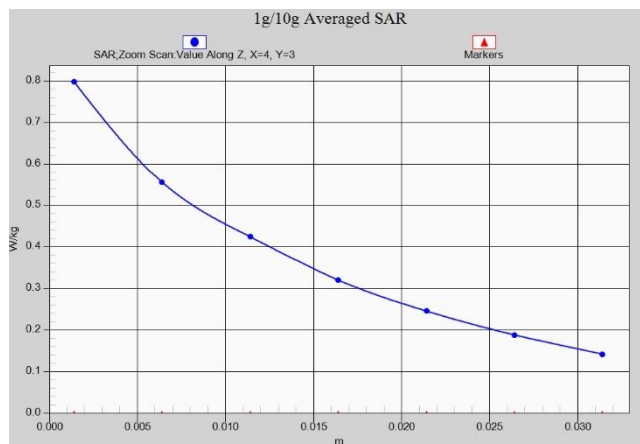

**Z-Scan at power reference point (LTEB12)**

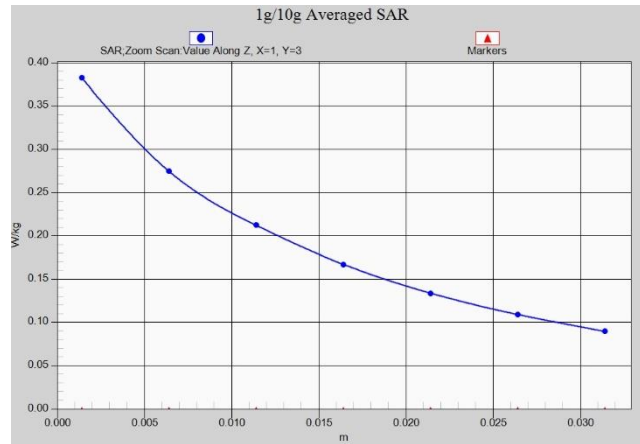

**Z-Scan at power reference point (LTEB13)**

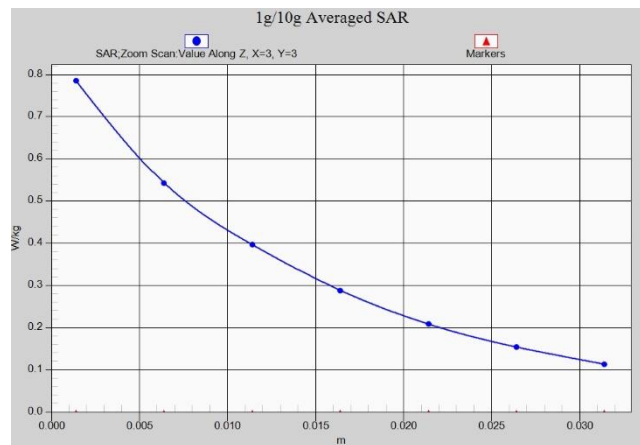

**Z-Scan at power reference point (LTEB13)**

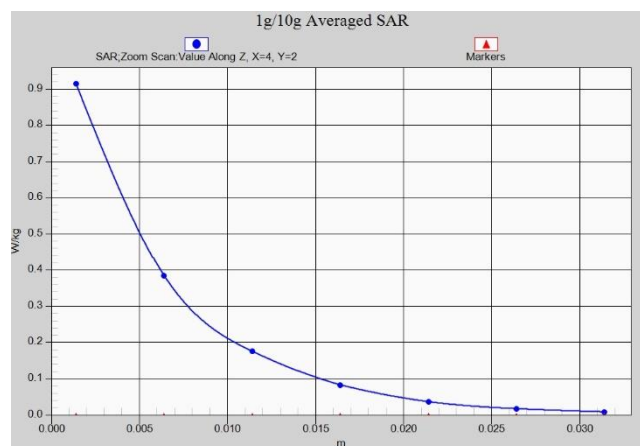

**Z-Scan at power reference point (LTEB41 PC3)**

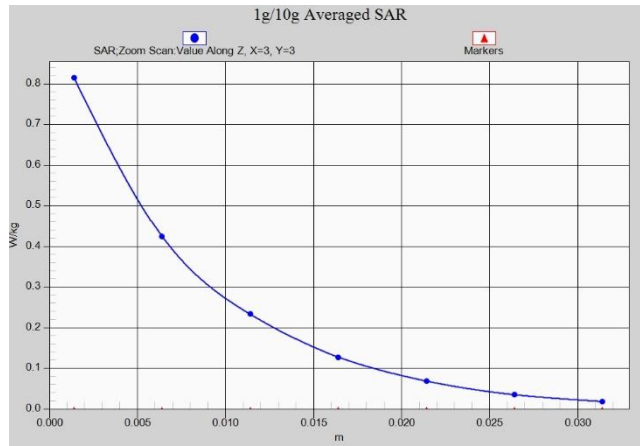

**Z-Scan at power reference point (LTEB41 PC3)**

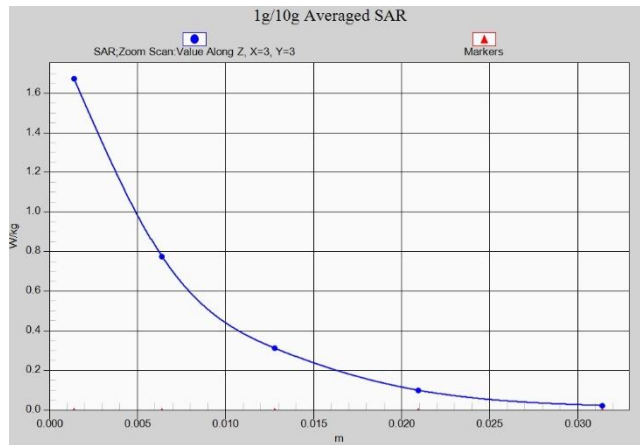

**Z-Scan at power reference point (LTEB41 PC3)**

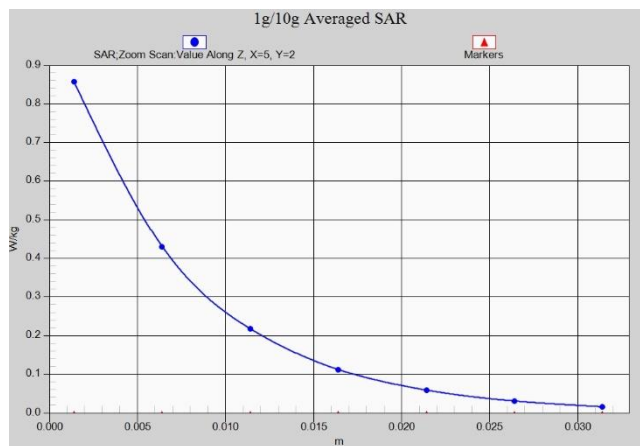

**Z-Scan at power reference point (LTEB41 PC2)**

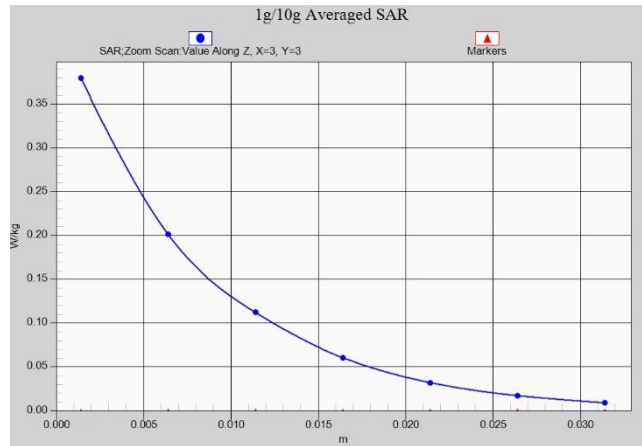

**Z-Scan at power reference point (LTEB41 PC2)**

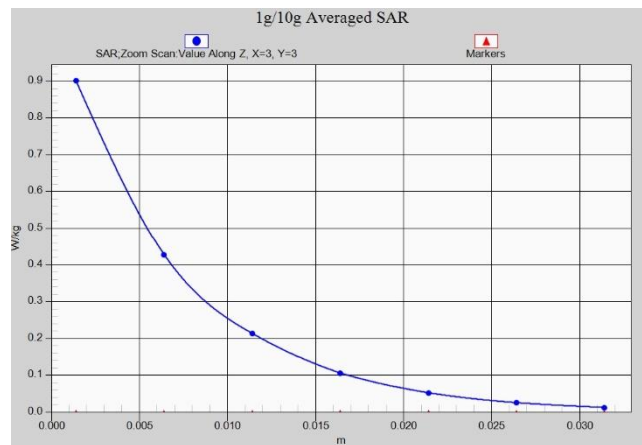

**Z-Scan at power reference point (LTEB41 PC2)**

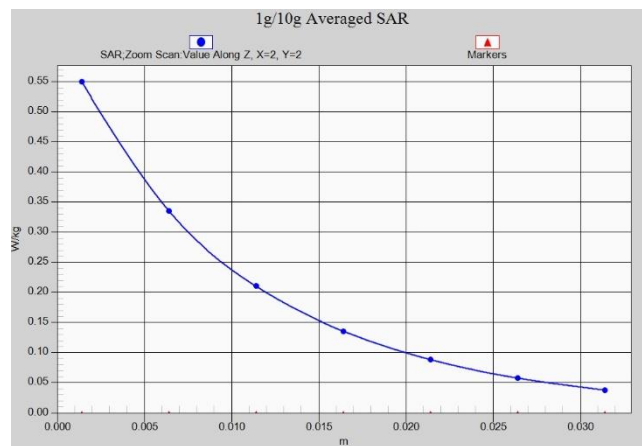

**Z-Scan at power reference point (LTEB66)**

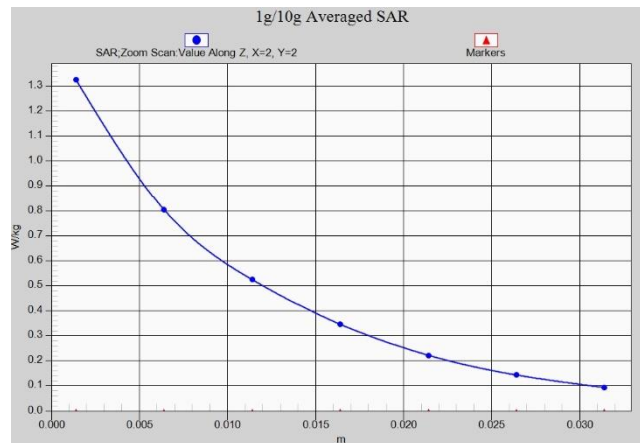

**Z-Scan at power reference point (LTEB66)**

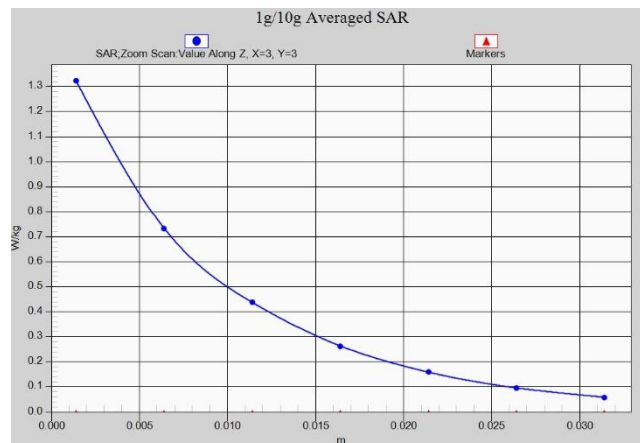

**Z-Scan at power reference point (LTEB66)**

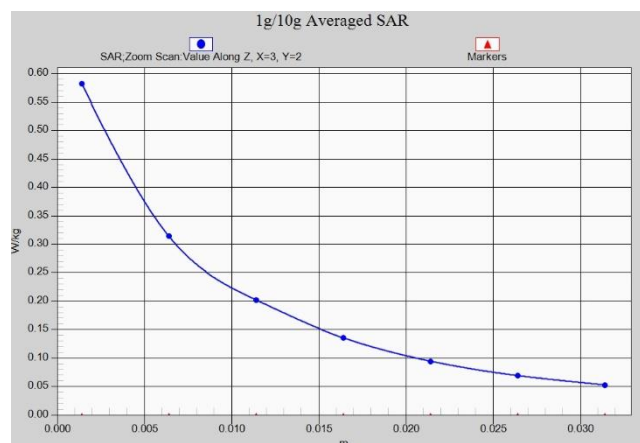

**Z-Scan at power reference point (LTEB71)**

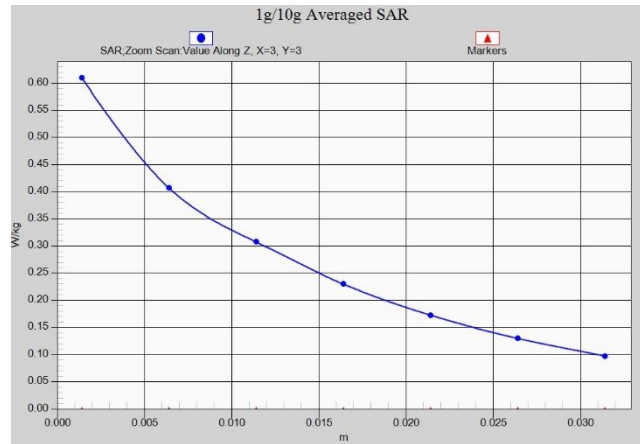

**Z-Scan at power reference point (LTEB71)**

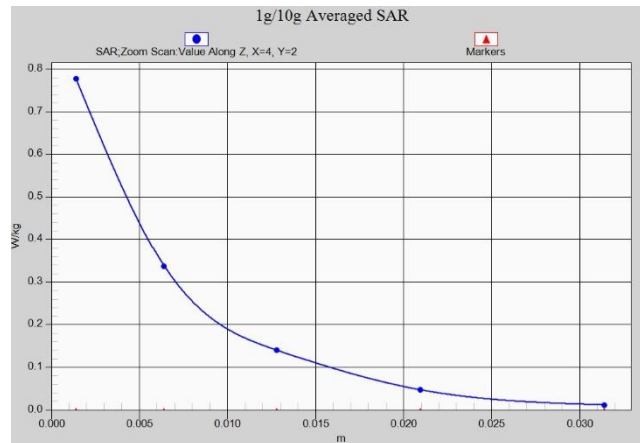

**Z-Scan at power reference point (WIFI2.4G)**

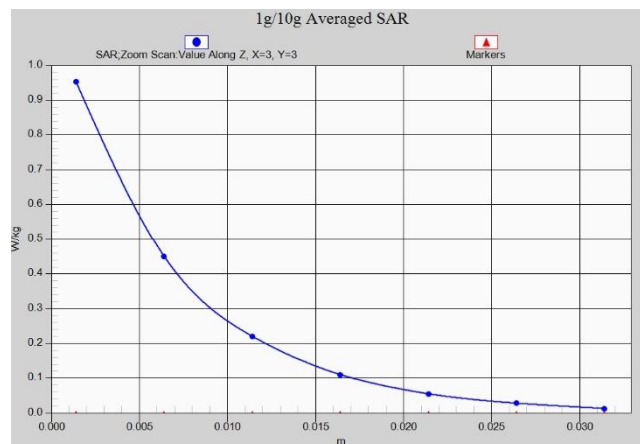

**Z-Scan at power reference point (WIFI2.4G)**



## ANNEX B System Verification Results

### 750 MHz

Date: 1/22/2022

Electronics: DAE4 Sn1331

Medium: Head 750 MHz

Medium parameters used:  $f = 750 \text{ MHz}$ ;  $\sigma = 0.8625 \text{ mho/m}$ ;  $\epsilon_r = 41.31$ ;  $\rho = 1000 \text{ kg/m}^3$

Ambient Temperature: 22.9°C Liquid Temperature: 22.5°C

Communication System: CW Frequency: 750 MHz Duty Cycle: 1:1

Probe: EX3DV4 – SN7548 ConvF(10.36,10.36,10.36)

**System Validation /Area Scan (81x191x1):** Interpolated grid:  $dx=1.000 \text{ mm}$ ,  $dy=1.000 \text{ mm}$

Reference Value = 60.76 V/m; Power Drift = 0.11

**Fast SAR: SAR(1 g) = 2.15 W/kg; SAR(10 g) = 1.43 W/kg**

Maximum value of SAR (interpolated) = 2.91 W/kg

**System Validation /Zoom Scan (7x7x7)/Cube 0:** Measurement grid:  $dx=5\text{mm}$ ,  $dy=5\text{mm}$ ,  $dz=5\text{mm}$

Reference Value = 60.76 V/m; Power Drift = 0.11

Peak SAR (extrapolated) = 3.55 W/kg

**SAR(1 g) = 2.12 W/kg; SAR(10 g) = 1.39 W/kg**

Maximum value of SAR (measured) = 2.67 W/kg

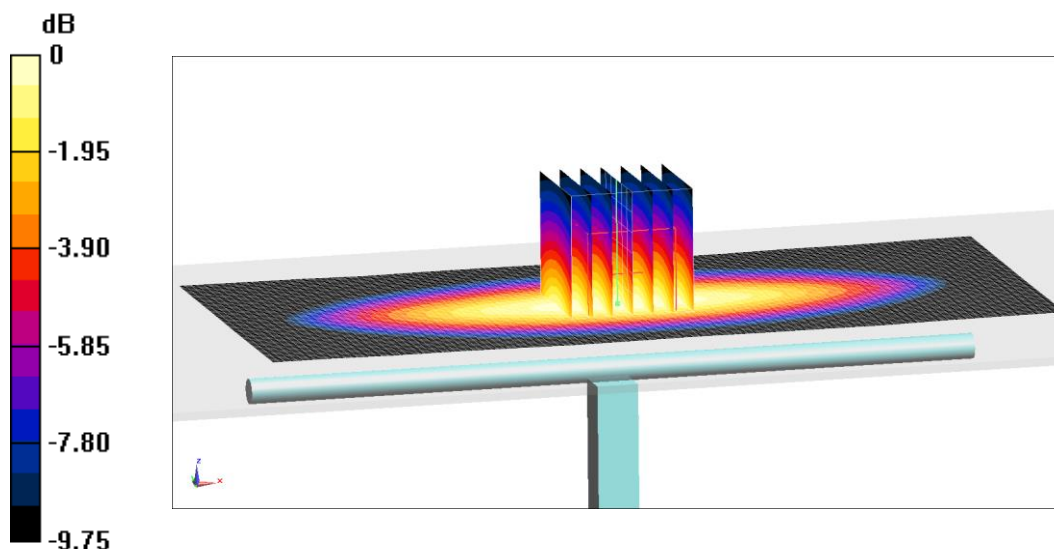

0 dB = 2.67 W/kg = 4.27 dB W/kg

**Fig.B.1 validation 750 MHz 250mW**

## 835 MHz

Date: 1/23/2022

Electronics: DAE4 Sn1331

Medium: Head 835 MHz

Medium parameters used:  $f = 835 \text{ MHz}$ ;  $\sigma = 0.8802 \text{ mho/m}$ ;  $\epsilon_r = 40.95$ ;  $\rho = 1000 \text{ kg/m}^3$

Ambient Temperature:  $22.9^\circ\text{C}$  Liquid Temperature:  $22.5^\circ\text{C}$

Communication System: CW Frequency: 835 MHz Duty Cycle: 1:1

Probe: EX3DV4 – SN7548 ConvF(10.36,10.36,10.36)

**System Validation /Area Scan (81x191x1):** Interpolated grid:  $dx=1.000 \text{ mm}$ ,  $dy=1.000 \text{ mm}$

Reference Value =  $63.23 \text{ V/m}$ ; Power Drift =  $0.15$

**Fast SAR: SAR(1 g) =  $2.41 \text{ W/kg}$ ; SAR(10 g) =  $1.55 \text{ W/kg}$**

Maximum value of SAR (interpolated) =  $3.56 \text{ W/kg}$

**System Validation /Zoom Scan (7x7x7)/Cube 0:** Measurement grid:  $dx=5\text{mm}$ ,  $dy=5\text{mm}$ ,  $dz=5\text{mm}$

Reference Value =  $63.23 \text{ V/m}$ ; Power Drift =  $0.15$

Peak SAR (extrapolated) =  $3.67 \text{ W/kg}$

**SAR(1 g) =  $2.43 \text{ W/kg}$ ; SAR(10 g) =  $1.58 \text{ W/kg}$**

Maximum value of SAR (measured) =  $3.11 \text{ W/kg}$

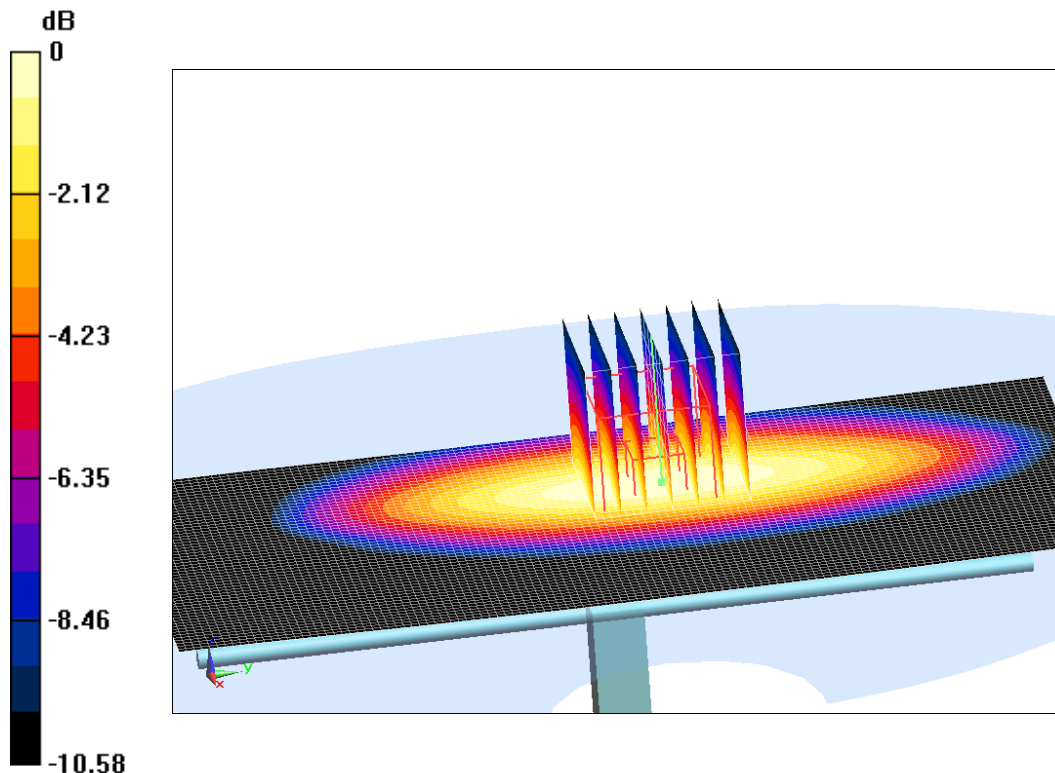

$0 \text{ dB} = 3.11 \text{ W/kg} = 4.93 \text{ dB W/kg}$

**Fig.B.2 validation 835 MHz 250mW**

## 1750 MHz

Date: 1/24/2022

Electronics: DAE4 Sn1331

Medium: Head 1750 MHz

Medium parameters used:  $f = 1750$  MHz;  $\sigma = 1.382$  mho/m;  $\epsilon_r = 43.02$ ;  $\rho = 1000$  kg/m<sup>3</sup>

Ambient Temperature: 22.9°C Liquid Temperature: 22.5°C

Communication System: CW Frequency: 1750 MHz Duty Cycle: 1:1

Probe: EX3DV4 – SN7548 ConvF(8.14,8.14,8.14)

**System Validation /Area Scan (81x191x1):** Interpolated grid: dx=1.000 mm, dy=1.000 mm

Reference Value = 105.99 V/m; Power Drift =0.07

**Fast SAR: SAR(1 g) = 9.27 W/kg; SAR(10 g) = 4.87 W/kg**

Maximum value of SAR (interpolated) = 14.56 W/kg

**System Validation /Zoom Scan (7x7x7)/Cube 0:** Measurement grid: dx=5mm, dy=5mm, dz=5mm

Reference Value = 105.99 V/m; Power Drift =0.07

Peak SAR (extrapolated) = 16.45 W/kg

**SAR(1 g) = 9.32 W/kg; SAR(10 g) = 4.91 W/kg**

Maximum value of SAR (measured) = 14.25 W/kg

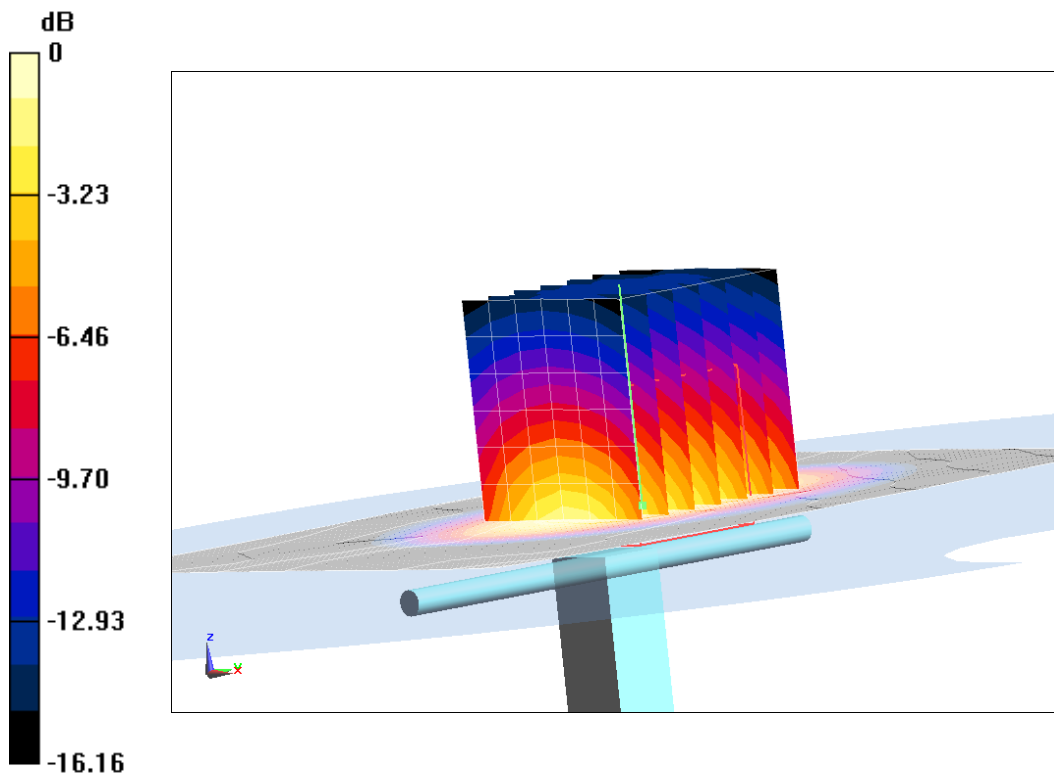

0 dB = 13.92 W/kg = 11.54 dB W/kg

**Fig.B.3 validation 1750 MHz 250mW**

## 1900 MHz

Date: 1/25/2022

Electronics: DAE4 Sn1331

Medium: Head 1900 MHz

Medium parameters used:  $f = 1900$  MHz;  $\sigma = 1.481$  mho/m;  $\epsilon_r = 42.08$ ;  $\rho = 1000$  kg/m<sup>3</sup>

Ambient Temperature: 22.9°C Liquid Temperature: 22.5°C

Communication System: CW Frequency: 1900 MHz Duty Cycle: 1:1

Probe: EX3DV4 – SN7548 ConvF(7.88,7.88,7.88)

**System Validation /Area Scan (81x191x1):** Interpolated grid: dx=1.000 mm, dy=1.000 mm

Reference Value = 108.79 V/m; Power Drift = 0.12

**Fast SAR: SAR(1 g) = 9.92 W/kg; SAR(10 g) = 5.17 W/kg**

Maximum value of SAR (interpolated) = 15.7 W/kg

**System Validation /Zoom Scan (7x7x7)/Cube 0:** Measurement grid: dx=5mm, dy=5mm, dz=5mm

Reference Value = 108.79 V/m; Power Drift = 0.12

Peak SAR (extrapolated) = 18.67 W/kg

**SAR(1 g) = 9.87 W/kg; SAR(10 g) = 5.14 W/kg**

Maximum value of SAR (measured) = 15.47 W/kg

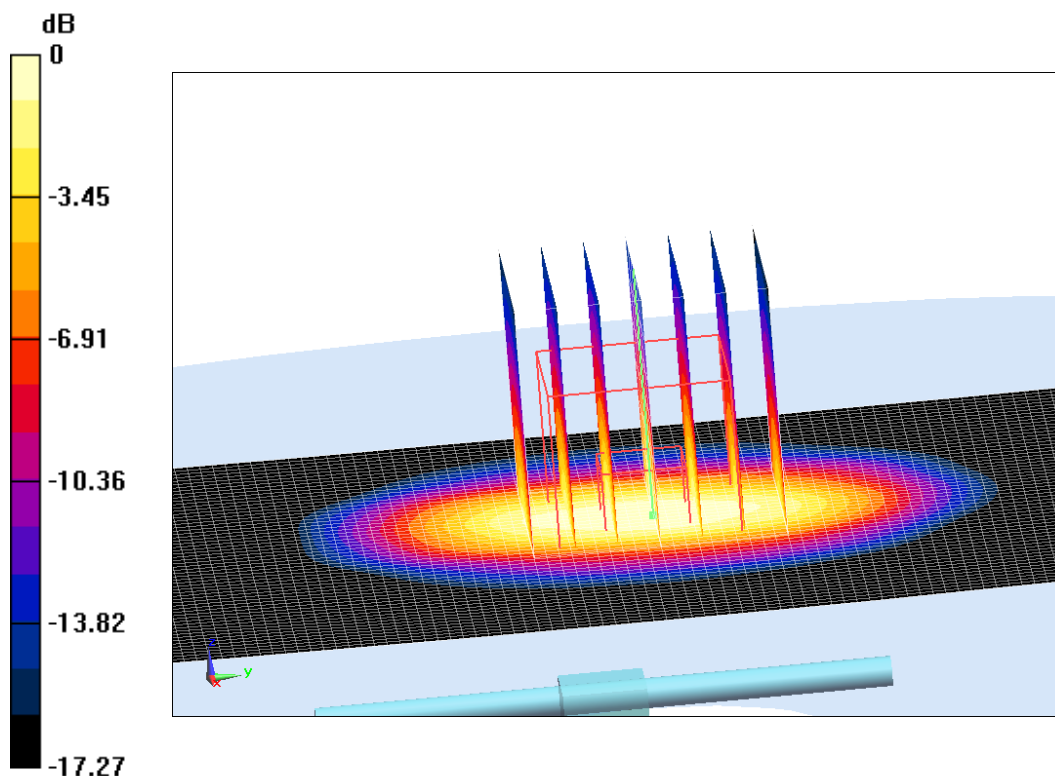

0 dB = 15.47 W/kg = 11.89 dB W/kg

**Fig.B.4 validation 1900 MHz 250mW**

## 2450 MHz

Date: 1/26/2022

Electronics: DAE4 Sn1331

Medium: Head 2450 MHz

Medium parameters used:  $f = 2450 \text{ MHz}$ ;  $\sigma = 1.915 \text{ mho/m}$ ;  $\epsilon_r = 41.6$ ;  $\rho = 1000 \text{ kg/m}^3$

Ambient Temperature:  $22.9^\circ\text{C}$  Liquid Temperature:  $22.5^\circ\text{C}$

Communication System: CW Frequency: 2450 MHz Duty Cycle: 1:1

Probe: EX3DV4 – SN7548 ConvF(7.35,7.35,7.35)

**System Validation /Area Scan (81x191x1):** Interpolated grid:  $dx=1.000 \text{ mm}$ ,  $dy=1.000 \text{ mm}$

Reference Value =  $116.25 \text{ V/m}$ ; Power Drift = 0.14

**Fast SAR: SAR(1 g) =  $13.27 \text{ W/kg}$ ; SAR(10 g) =  $6.2 \text{ W/kg}$**

Maximum value of SAR (interpolated) =  $21.33 \text{ W/kg}$

**System Validation /Zoom Scan (7x7x7)/Cube 0:** Measurement grid:  $dx=5\text{mm}$ ,  $dy=5\text{mm}$ ,  $dz=5\text{mm}$

Reference Value =  $116.25 \text{ V/m}$ ; Power Drift = 0.14

Peak SAR (extrapolated) =  $25.45 \text{ W/kg}$

**SAR(1 g) =  $13.21\text{W/kg}$ ; SAR(10 g) =  $6.16 \text{ W/kg}$**

Maximum value of SAR (measured) =  $22.14 \text{ W/kg}$

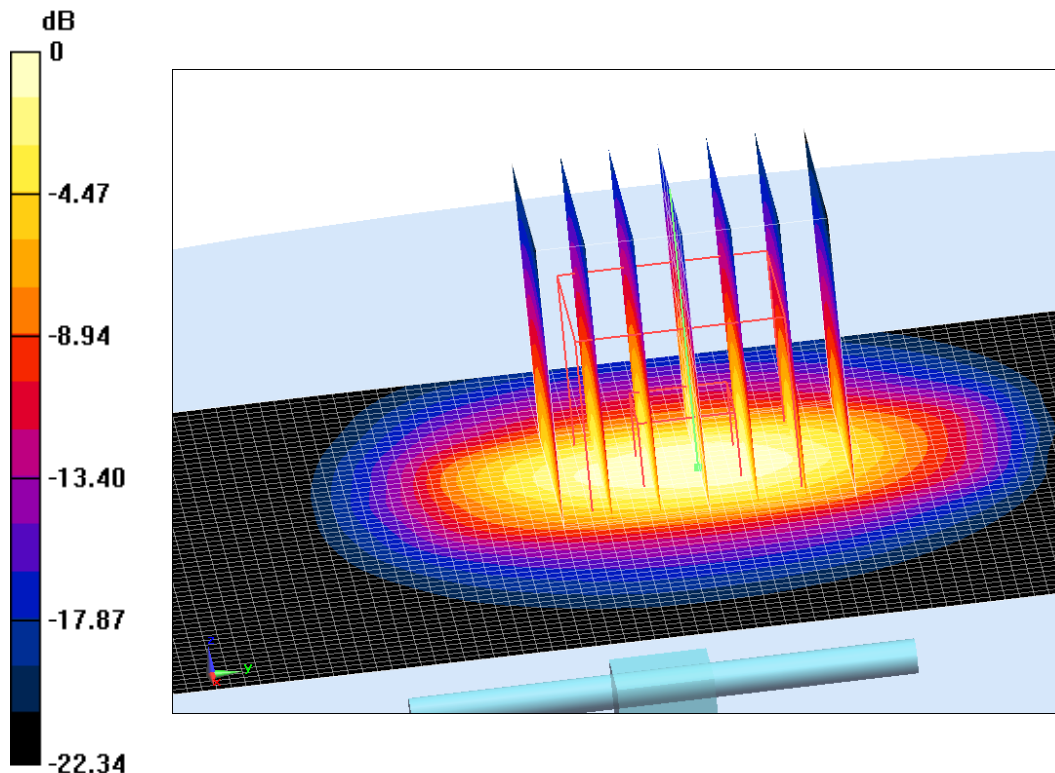

0 dB =  $22.14 \text{ W/kg} = 13.45 \text{ dB W/kg}$

**Fig.B.5 validation 2450 MHz 250mW**

## 2600 MHz

Date: 1/27/2022

Electronics: DAE4 Sn1331

Medium: Head 2600 MHz

Medium parameters used:  $f = 2600$  MHz;  $\sigma = 2.071$  mho/m;  $\epsilon_r = 40.51$ ;  $\rho = 1000$  kg/m<sup>3</sup>

Ambient Temperature: 22.9°C Liquid Temperature: 22.5°C

Communication System: CW Frequency: 2600 MHz Duty Cycle: 1:1

Probe: EX3DV4 – SN7548 ConvF(7.11,7.11,7.11)

**System Validation /Area Scan (81x191x1):** Interpolated grid: dx=1.000 mm, dy=1.000 mm

Reference Value = 123.5 V/m; Power Drift = 0.02

**Fast SAR: SAR(1 g) = 14.11 W/kg; SAR(10 g) = 6.27 W/kg**

Maximum value of SAR (interpolated) = 24.77 W/kg

**System Validation /Zoom Scan (7x7x7)/Cube 0:** Measurement grid: dx=5mm, dy=5mm, dz=5mm

Reference Value = 123.5 V/m; Power Drift = 0.02

Peak SAR (extrapolated) = 28.76 W/kg

**SAR(1 g) = 14.08 W/kg; SAR(10 g) = 6.22 W/kg**

Maximum value of SAR (measured) = 24.78 W/kg

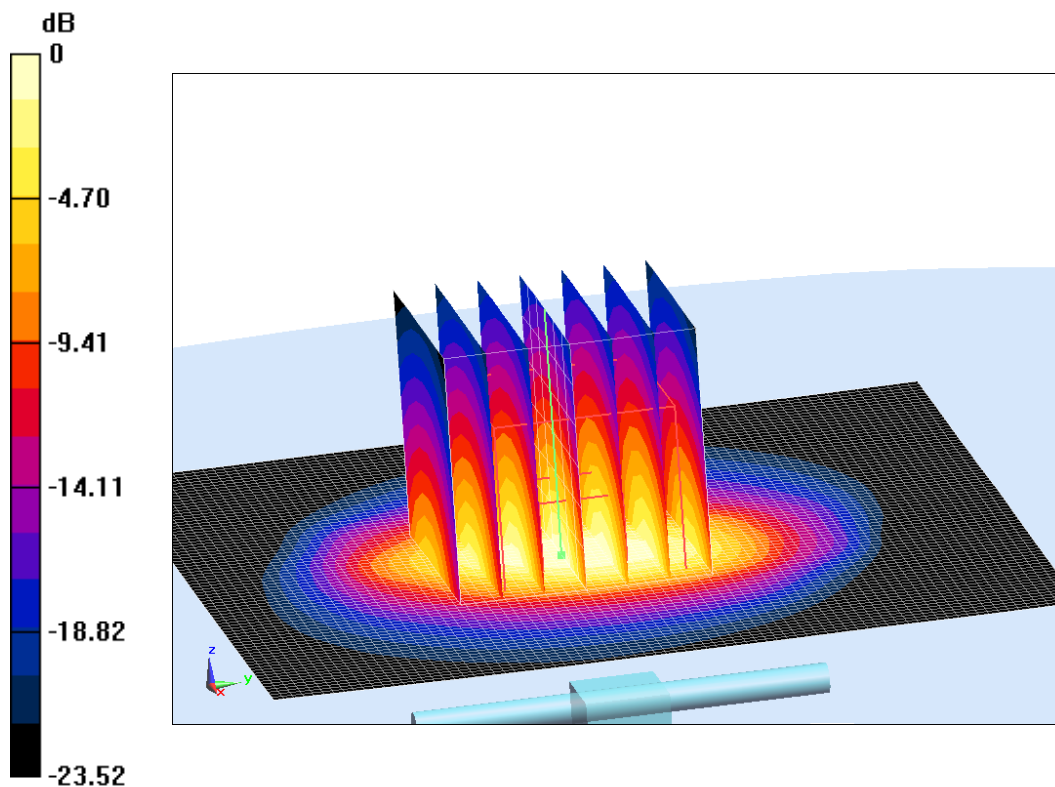

0 dB = 24.78 W/kg = 13.94 dB W/kg

**Fig.B.6 validation 2600 MHz 250mW**

The SAR system verification must be required that the area scan estimated 1-g SAR is within 3% of the zoom scan 1-g SAR.

**Table B.1 Comparison between area scan and zoom scan for system verification**

<b>Date</b>	<b>Band</b>	<b>Position</b>	<b>Area scan (1g)</b>	<b>Zoom scan (1g)</b>	<b>Drift (%)</b>
2022-1-22	750 MHz	Head	2.15	2.12	1.42%
2022-1-23	835 MHz	Head	2.41	2.43	-0.82%
2022-1-24	1750 MHz	Head	9.27	9.32	-0.54%
2022-1-25	1900 MHz	Head	9.92	9.87	0.51%
2022-1-26	2450 MHz	Head	13.27	13.21	0.45%
2022-1-27	2600 MHz	Head	14.11	14.08	0.21%



## ANNEX C SAR Measurement Setup

### C.1 Measurement Set-up

The Dasy4 or DASY5 system for performing compliance tests is illustrated above graphically. This system consists of the following items:

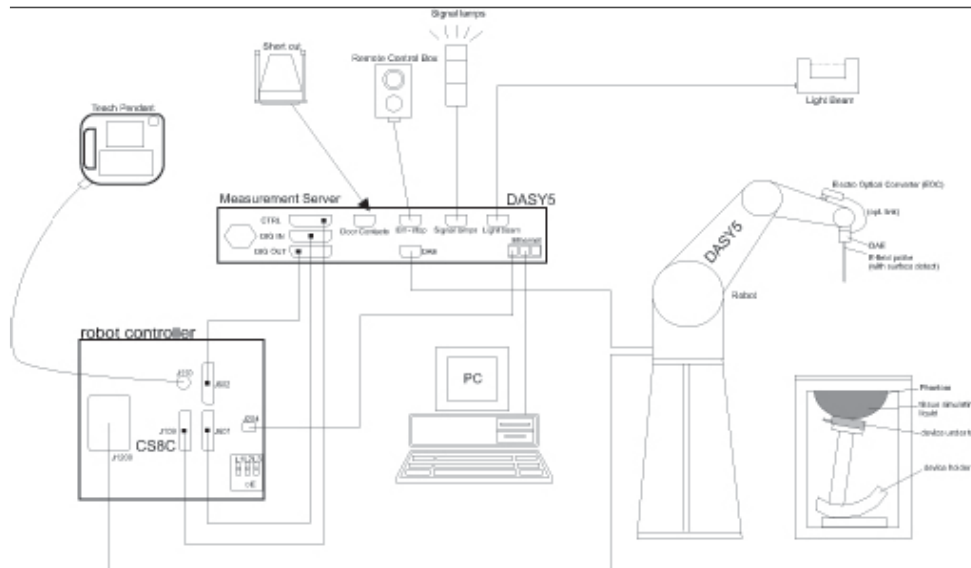

Picture C.1 SAR Lab Test Measurement Set-up

- A standard high precision 6-axis robot (Stäubli TX=RX family) with controller, teach pendant and software. An arm extension for accommodating the data acquisition electronics (DAE).
- An isotropic field probe optimized and calibrated for the targeted measurement.
- A data acquisition electronics (DAE) which performs the signal amplification, signal multiplexing, AD-conversion, offset measurements, mechanical surface detection, collision detection, etc. The unit is battery powered with standard or rechargeable batteries. The signal is optically transmitted to the EOC.
- The Electro-optical converter (EOC) performs the conversion from optical to electrical signals for the digital communication to the DAE. To use optical surface detection, a special version of the EOC is required. The EOC signal is transmitted to the measurement server.
- The function of the measurement server is to perform the time critical tasks such as signal filtering, control of the robot operation and fast movement interrupts.
- The Light Beam used is for probe alignment. This improves the (absolute) accuracy of the probe positioning.
- A computer running WinXP and the DASY4 or DASY5 software.
- Remote control and teach pendant as well as additional circuitry for robot safety such as
- warning lamps, etc.
- The phantom, the device holder and other accessories according to the targeted measurement.



## C.2 Dasy4 or DASY5 E-field Probe System

The SAR measurements were conducted with the dosimetric probe designed in the classical triangular configuration and optimized for dosimetric evaluation. The probe is constructed using the thick film technique; with printed resistive lines on ceramic substrates. The probe is equipped with an optical multifiber line ending at the front of the probe tip. It is connected to the EOC box on the robot arm and provides an automatic detection of the phantom surface. Half of the fibers are connected to a pulsed infrared transmitter, the other half to a synchronized receiver. As the probe approaches the surface, the reflection from the surface produces a coupling from the transmitting to the receiving fibers. This reflection increases first during the approach, reaches maximum and then decreases. If the probe is flatly touching the surface, the coupling is zero. The distance of the coupling maximum to the surface is independent of the surface reflectivity and largely independent of the surface to probe angle. The DASY4 or DASY5 software reads the reflection during a software approach and looks for the maximum using 2<sup>nd</sup> ord curve fitting. The approach is stopped at reaching the maximum.

### Probe Specifications:

<b>Model:</b>	<b>ES3DV3, EX3DV4</b>
<b>Frequency</b>	<b>10MHz — 6.0GHz(EX3DV4)</b>
<b>Range:</b>	<b>10MHz — 4GHz(ES3DV3)</b>
<b>Calibration:</b>	<b>In head and body simulating tissue at Frequencies from 835 up to 5800MHz</b>
<b>Linearity:</b>	<b>± 0.2 dB(30 MHz to 6 GHz) for EX3DV4 ± 0.2 dB(30 MHz to 4 GHz) for ES3DV3</b>
<b>DynamicRange:</b>	<b>10 mW/kg — 100W/kg</b>
<b>Probe Length:</b>	<b>330 mm</b>
<b>Probe Tip</b>	
<b>Length:</b>	<b>20 mm</b>
<b>Body Diameter:</b>	<b>12 mm</b>
<b>Tip Diameter:</b>	<b>2.5 mm (3.9 mm for ES3DV3)</b>
<b>Tip-Center:</b>	<b>1 mm (2.0mm for ES3DV3)</b>
<b>Application:</b>	<b>SAR Dosimetry Testing Compliance tests of mobile phones Dosimetry in strong gradient fields</b>



Picture C.2Near-field Probe



Picture C.3E-field Probe

## C.3 E-field Probe Calibration

Each E-Probe/Probe Amplifier combination has unique calibration parameters. A TEM cell calibration procedure is conducted to determine the proper amplifier settings to enter in the probe parameters. The amplifier settings are determined for a given frequency by subjecting the probe to a known E-field density (1 mW/cm<sup>2</sup>) using an RF Signal generator, TEM cell, and RF Power Meter.

The free space E-field from amplified probe outputs is determined in a test chamber. This calibration can be performed in a TEM cell if the frequency is below 1 GHz and in a waveguide or

other methodologies above 1 GHz for free space. For the free space calibration, the probe is placed in the volumetric center of the cavity and at the proper orientation with the field. The probe is then rotated 360 degrees until the three channels show the maximum reading. The power density readings equates to 1 mW/cm<sup>2</sup>.

E-field temperature correlation calibration is performed in a flat phantom filled with the appropriate simulated brain tissue. The E-field in the medium correlates with the temperature rise in the dielectric medium. For temperature correlation calibration a RF transparent thermistor-based temperature probe is used in conjunction with the E-field probe.

$$SAR = C \frac{\Delta T}{\Delta t}$$

Where:

$\Delta t$  = Exposure time (30 seconds),

C = Heat capacity of tissue (brain or muscle),

$\Delta T$  = Temperature increase due to RF exposure.

$$SAR = \frac{|E|^2 \cdot \sigma}{\rho}$$

Where:

$\sigma$  = Simulated tissue conductivity,

$\rho$  = Tissue density (kg/m<sup>3</sup>).

## C.4 Other Test Equipment

### C.4.1 Data Acquisition Electronics(DAE)

The data acquisition electronics consist of a highly sensitive electrometer-grade preamplifier with auto-zeroing, a channel and gain-switching multiplexer, a fast 16 bit AD-converter and a command decoder with a control logic unit. Transmission to the measurement server is accomplished through an optical downlink for data and status information, as well as an optical uplink for commands and the clock.

The mechanical probe mounting device includes two different sensor systems for frontal and sideways probe contacts. They are used for mechanical surface detection and probe collision detection.

The input impedance of the DAE is 200 MOhm; the inputs are symmetrical and floating. Common mode rejection is above 80 dB.



PictureC.4: DAE

### C.4.2 Robot

The SPEAG DASY system uses the high precision robots (DASY4: RX90XL; DASY5: RX160L) type from Stäubli SA (France). For the 6-axis controller system, the robot controller version from Stäubli is used. The Stäubli robot series have many features that are important for our application:

- High precision (repeatability 0.02mm)
- High reliability (industrial design)
- Low maintenance costs (virtually maintenance free due to direct drive gears; no belt drives)
- Jerk-free straight movements (brushless synchron motors; no stepper motors)
- Low ELF interference (motor control fields shielded via the closed metallic construction shields)



Picture C.5 DASY 4



Picture C.6 DASY 5

### C.4.3 Measurement Server

The Measurement server is based on a PC/104 CPU board with CPU (dasy4: 166 MHz, Intel Pentium; DASY5: 400 MHz, Intel Celeron), chipdisk (DASY4: 32 MB; DASY5: 128MB), RAM (DASY4: 64 MB, DASY5: 128MB). The necessary circuits for communication with the DAE electronic box, as well as the 16 bit AD converter system for optical detection and digital I/O interface are contained on the DASY I/O board, which is directly connected to the PC/104 bus of the CPU board.

The measurement server performs all real-time data evaluation of field measurements and surface detection, controls robot movements and handles safety operation. The PC operating system cannot interfere with these time critical processes. All connections are supervised by a watchdog, and disconnection of any of the cables to the measurement server will automatically disarm the robot and disable all program-controlled robot movements. Furthermore, the measurement server is equipped with an expansion port which is reserved for future applications. Please note that this expansion port does not have a standardized pinout, and therefore only devices provided by SPEAG can be connected. Devices from any other supplier could seriously damage the measurement server.



Picture C.7 Server for DASY 4



Picture C.8 Server for DASY 5

#### C.4.4 Device Holder for Phantom

The SAR in the phantom is approximately inversely proportional to the square of the distance between the source and the liquid surface. For a source at 5mm distance, a positioning uncertainty of  $\pm 0.5\text{mm}$  would produce a SAR uncertainty of  $\pm 20\%$ . Accurate device positioning is therefore crucial for accurate and repeatable measurements. The positions in which the devices must be measured are defined by the standards.

The DASY device holder is designed to cope with the different positions given in the standard. It has two scales for device rotation (with respect to the body axis) and device inclination (with respect to the line between the ear reference points). The rotation centers for both scales are the ear reference point (ERP). Thus the device needs no repositioning when changing the angles. The DASY device holder is constructed of low-loss POM material having the following dielectric parameters: relative permittivity  $\epsilon = 3$  and loss tangent  $\delta = 0.02$ . The amount of dielectric material has been reduced in the closest vicinity of the device, since measurements have suggested that the influence of the clamp on the test results could thus be lowered.

<Laptop Extension Kit>

The extension is lightweight and made of POM, acrylic glass and foam. It fits easily on the upper part of the Mounting Device in place of the phone positioner. The extension is fully compatible with the Twin-SAM and ELI phantoms.



Picture C.9-1: Device Holder

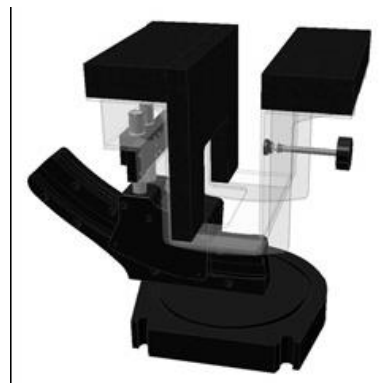

Picture C.9-2: Laptop Extension Kit

### C.4.5 Phantom

The SAM Twin Phantom V4.0 is constructed of a fiberglass shell integrated in a table. The shape of the shell is based on data from an anatomical study designed to

Represent the 90<sup>th</sup> percentile of the population. The phantom enables the dissymmetric evaluation of SAR for both left and right handed handset usage, as well as body-worn usage using the flat phantom region. Reference markings on the Phantom allow the complete setup of all predefined phantom positions and measurement grids by manually teaching three points in the robot. The shell phantom has a 2mm shell thickness (except the ear region where shell thickness increases to 6 mm).

Shell Thickness:  $2 \pm 0.2$  mm

Filling Volume: Approx. 25 liters

Dimensions: 810 x 1000 x 500 mm (H x L x W)

Available: Special



**Picture C.10: SAM Twin Phantom**

## ANNEX D Position of the wireless device in relation to the phantom

### D.1 General considerations

This standard specifies two handset test positions against the head phantom – the “cheek” position and the “tilt” position.

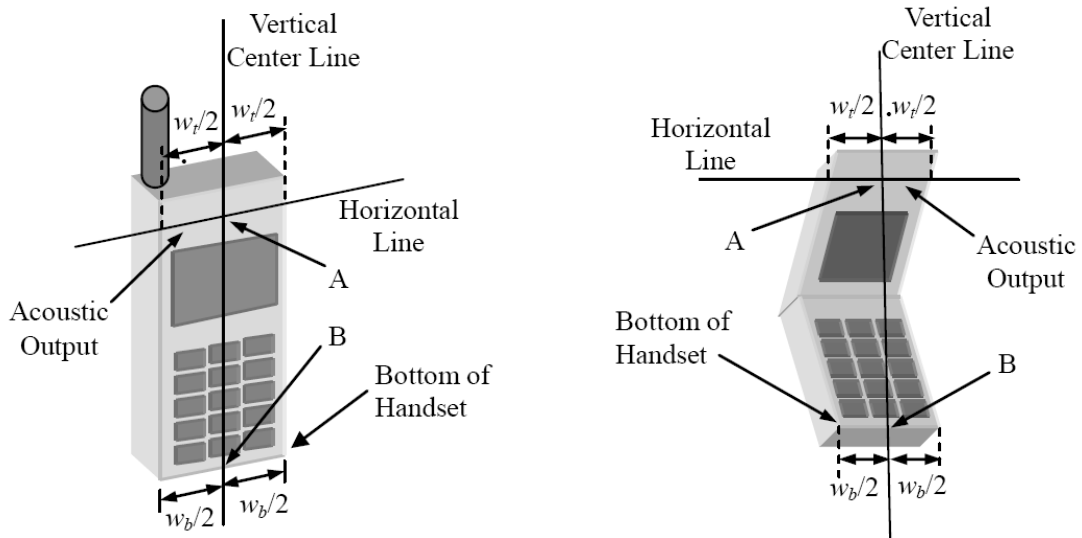

- $w_t$  Width of the handset at the level of the acoustic
- $w_b$  Width of the bottom of the handset
- A Midpoint of the width  $w_t$  of the handset at the level of the acoustic output
- B Midpoint of the width  $w_b$  of the bottom of the handset

Picture D.1-a Typical “fixed” case handset      Picture D.1-b Typical “clam-shell” case handset

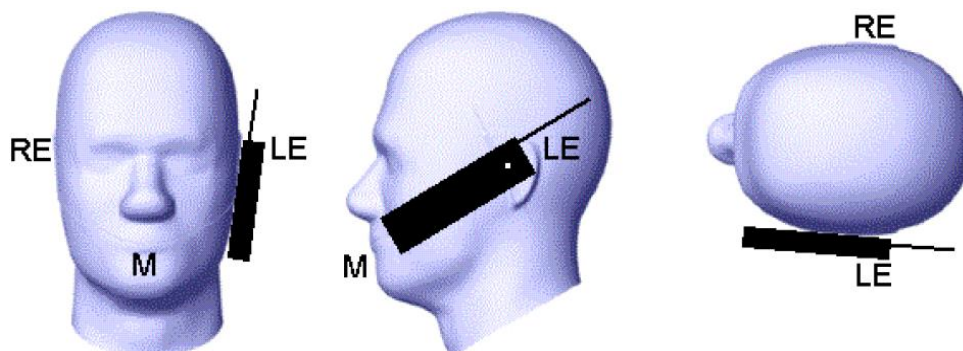

Picture D.2 Cheek position of the wireless device on the left side of SAM



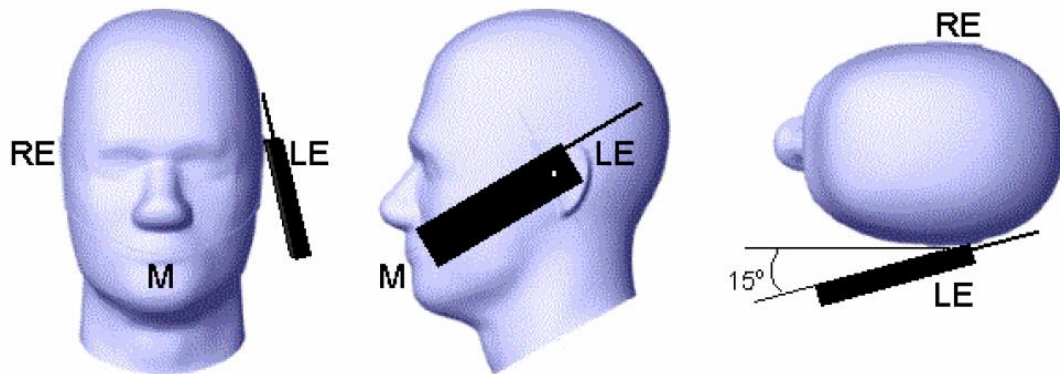

Picture D.3 Tilt position of the wireless device on the left side of SAM

## D.2 Body-worn device

A typical example of a body-worn device is a mobile phone, wireless enabled PDA or other battery operated wireless device with the ability to transmit while mounted on a person's body using a carry accessory approved by the wireless device manufacturer.

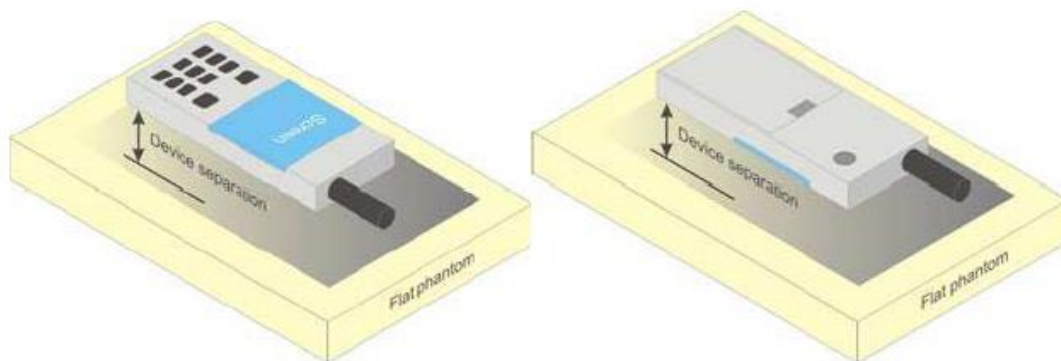

Picture D.4 Test positions for body-worn devices

## D.3 Desktop device

A typical example of a desktop device is a wireless enabled desktop computer placed on a table or desk when used.

The DUT shall be positioned at the distance and in the orientation to the phantom that corresponds to the intended use as specified by the manufacturer in the user instructions. For devices that employ an external antenna with variable positions, tests shall be performed for all antenna positions specified. Picture 8.5 show positions for desktop device SAR tests. If the intended use is not specified, the device shall be tested directly against the flat phantom.

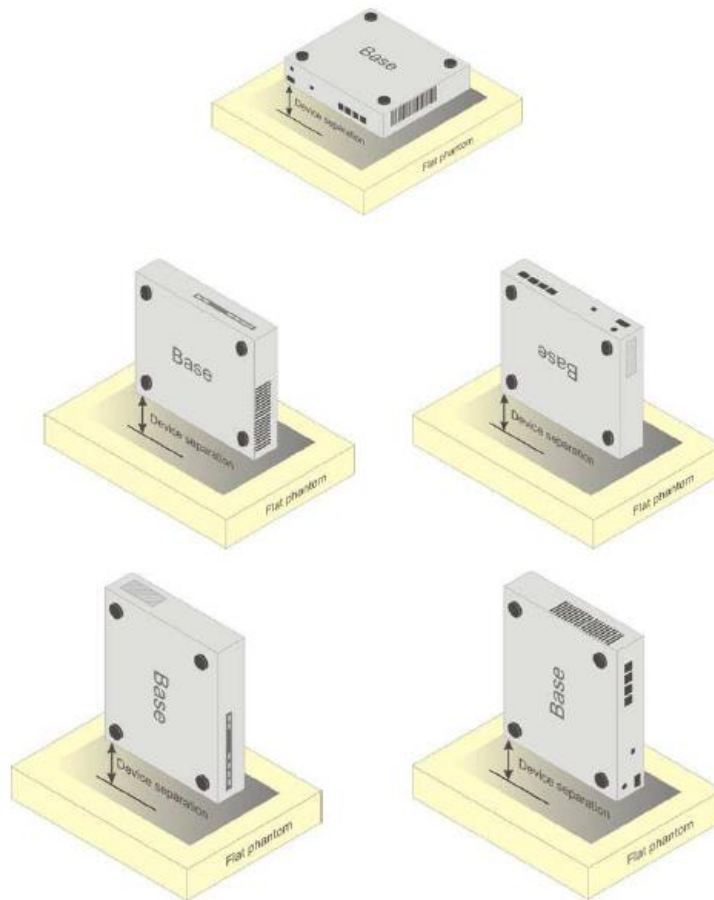

Picture D.5 Test positions for desktop devices

#### D.4 DUT Setup Photos



Picture D.6