

# RADIO TEST REPORT

## (FCC Part 15 Subpart E)



Applicant:	HMD Global Oy
Address:	Bertel Jungin aukio 9 Espoo 02600 Finland

Manufacturer:	HMD Global Oy
Address:	Bertel Jungin aukio 9 Espoo 02600 Finland
Product:	Smartphone
Brand Name:	HMD
Model Name:	N159V
FCC ID:	2AJOTTA-1590
Date of tests:	Jan. 02, 2024 ~ Jan. 30, 2024

The tests have been carried out according to the requirements of the following standard:

**Part 15 Subpart E §15. 407**

CONCLUSION: The submitted sample was found to COMPLY with the test requirement

Prepared by Hanwen Xu Engineer / Mobile Department	Approved by Peibo Sun Manager / Mobile Department
 Date: Jan. 30, 2024	 Date: Jan. 30, 2024

This report is governed by, and incorporates by reference, the Conditions of Testing as posted at the date of issuance of this report at <http://www.bureauveritas.com/home/about-us/our-business/cps/about-us/terms-conditions/> and is intended for your exclusive use. Any copying or replication of this report to or for any other person or entity, or use of our name or trademark, is permitted only with our prior written permission. This report sets forth our findings solely with respect to the test samples identified herein. The results set forth in this report are not indicative or representative of the quality or characteristics of the lot from which a test sample was taken or any similar or identical product unless specifically and expressly noted. Our report includes all of the tests requested by you and the results thereof based upon the information that you provided to us. Measurement uncertainty is only provided upon request for accredited tests. Statements of conformity are based on simple acceptance criteria without taking measurement uncertainty into account, unless otherwise requested in writing. You have 60 days from date of issuance of this report to notify us of any material error or omission caused by our negligence or if you require measurement uncertainty; provided, however, that such notice shall be in writing and shall specifically address the issue you wish to raise. A failure to raise such issue within the prescribed time shall constitute your unqualified acceptance of the completeness of this report, the tests conducted and the correctness of the report contents.



**BUREAU  
VERITAS**

Test Report No.: PSU-NQN2311090109RF08

## REPORT REVISE RECORD

ISSUE NO.	REASON FOR CHANGE	DATE ISSUED
PSU-NQN2311090109RF08	Original release	Jan. 30, 2024

## TABLE OF CONTENTS

<b>1</b>	<b>GENERAL DESCRIPTION.....</b>	<b>5</b>
1.1	GENERAL DESCRIPTION OF EUT.....	5
1.2	MODIFICATION OF EUT .....	7
1.3	APPLICABLE STANDARDS .....	8
<b>2</b>	<b>TEST CONFIGURATION OF EQUIPMENT UNDER TEST.....</b>	<b>9</b>
2.1	CARRIER FREQUENCY AND CHANNEL .....	9
2.2	TEST MODE .....	10
2.3	SUPPORT EQUIPMENT .....	10
2.4	TEST TOOL SOFTWARE VERSION .....	10
2.5	TEST SETUP.....	11
2.6	DFS DETECTION THRESHOLDS FOR MASTER DEVICES AND CLIENT DEVICES WITH RADAR DETECTION.....	12
<b>3</b>	<b>REQUIREMENTS AND PARAMETERS FOR DFS TEST.....</b>	<b>13</b>
3.1	APPLICABILITY OF DFS REQUIREMENTS .....	13
3.2	DFS RESPONSE REQUIREMENT VALUES .....	15
3.3	SHORT PULSE RADAR TEST WAVEFORMS.....	16
3.4	LONG PULSE RADAR TEST WAVEFORM.....	17
3.5	FREQUENCY HOPPING RADAR TEST WAVEFORM .....	17
<b>4</b>	<b>CALIBRATION SETUP AND DFS TEST RESULTS .....</b>	<b>18</b>
4.1	CALIBRATION OF RADAR WAVEFORM.....	18
4.2	IN-SERVICE MONITORING: CHANNEL MOVE TIME, CHANNEL CLOSING TRANSMISSION TIME AND NON-OCCUPANCY PERIOD .....	18
<b>5</b>	<b>LIST OF MEASURING EQUIPMENT .....</b>	<b>21</b>
<b>APPENDIX</b>	<b>.....</b>	<b>22</b>
	CHANNEL MOVE TIME AND CHANNEL CLOSING TRANSMISSION TIME.....	22
	NON-OCCUPANCY PERIOD .....	25

## SUMMARY OF DYNAMIC FREQUENCY SELECTION TEST

UNII	Bandwidth and Channel	Description	Measured	Limit	Result	Test Lab*
UNII Band 2-A 5250-5350MHz & UNII Band 2-C 5470-5725MHz	80MHz (CH58) 5290MHz	Channel Move Time	940.9ms	10 sec	Pass	A
		Channel Closing Transmission time	<200ms + 24.7ms (aggregate)	200 ms + aggregate of 60 ms over remaining 10 s period	Pass	A
		Non-Occupancy Period and Client Beacon Test	No transmission or Beacons occurred	30 minutes	Pass	A
UNII Band 2-A 5250-5350MHz & UNII Band 2-C 5470-5725MHz	80MHz (CH106) 5530MHz	Channel Move Time	864.2ms	10 sec	Pass	A
		Channel Closing Transmission time	<200ms + 22.1ms (aggregate)	200 ms + aggregate of 60 ms over remaining 10 s period	Pass	A
		Non-Occupancy Period and Client Beacon Test	No transmission or Beacons occurred	30 minutes	Pass	A

Note:

1. Since the product is client without radar detection function, only Channel Move Time, Channel Closing Transmission Time and Non-Occupancy Period Test are required to be performed.

**\*Test Lab Information Reference**

**Lab A:**

Huarui 7Layers High Technology (Suzhou) Co., Ltd.

**Lab Address:**

Tower N, Innovation Center, 88 Zhuyi Road, High-tech District, Suzhou City, Anhui Province

**Accredited Test Lab Cert 6613.01**

The FCC Site Registration No. is 434559; The Designation No. is CN1325.

# 1 GENERAL DESCRIPTION

## 1.1 GENERAL DESCRIPTION OF EUT

<b>PRODUCT*</b>	Smartphone
<b>BRAND NAME*</b>	HMD
<b>MODEL NAME*</b>	N159V
<b>Power Supply*</b>	5.0Vdc (adapter) 3.87Vdc (battery)
<b>HW Version*</b>	V 1.0
<b>SW Version*</b>	02US_0_101
<b>Modulation Technology</b>	64QAM,16QAM, QPSK, BPSK for OFDM
<b>Modulation Type</b>	802.11a/n/ac : OFDM
<b>Operating Frequency</b>	U-NII-2A:5250~5350MHz U-NII-2C:5500~5720MHz
<b>Antenna Type*</b>	PIFA Antenna
<b>Antenna Gain*</b>	<5250 MHz ~ 5350 MHz> -0.35 dBi <5500 MHz ~ 5720 MHz> -0.35 dBi
<b>I/O Ports*</b>	Refer to user's manual

### NOTE:

- \*Since the above data and/or information is provided by the client relevant results or conclusions of this report are only made for these data and/or information, Test Lab is not responsible for the authenticity, integrity and results of the data and information and/or the validity of the conclusion.
- For a more detailed features description, please refer to the manufacturer's specifications or the user's manual.
- For the test results, the EUT had been tested with all conditions. But only the worst case was shown in the test report.
- For the product of N159V(FCC ID 2AJOTTA-1590), the following components are different between the first and second supply, other parameters are the same.

Component		First supply		Second supply	
		Supplier	specificatons	Supplier	specificatons
PCBA	3GB LPDDR	Longsys	3GB	biwin	3GB
	64GB EMMC	Longsys	64GB	biwin	64GB

**BUREAU  
VERITAS****Test Report No.: PSU-NQN2311090109RF08**

	Charger IC	SGMICRO	3.78A Single Cell Switching Battery Charger IC	Unisemi	3.78A Single Cell Switching Battery Charger IC
LCM	LCD	TCL	LCD a-Si TFT;720*1612	icetron	LCD a-Si TFT;720*1612
Front camera	Camera	Union Image	5M;FF	Imaging	5M;FF
CAM	Camera	Union Image	13 AF	Sunwin	13 AF
	Camera	SEGA	2M	Imaging	2M
Acoustic	Vibrator	KunWang	0830	HONGZHIFA	0830
	FPC	XINYE	Speaker FPC : 32.1*11.46*0.15	Lat	Speaker FPC : 32.1*11.46*0.15
LED		Runlite	White LED;500mA;1500mA	latticepower	White LED;500mA;1500mA
Battery		gaoyuan	4000mAh;3.87V;4.45V	highpower	4000mAh;3.87V;4.45V
antenna		Haitong	Omni-directional, Linear, antenna shrapnel	Kexinhuacheng	Omni-directional, Linear, antenna shrapnel
MIC		Gettop	L2.75xW1.85xH0.9 mm	goertek	L2.75xW1.85xH0.9 mm
Data cable		Saibao	5V2A	TorchWay	5V2A

**List of Accessory:**

ACCESSORIES	BRAND	MANUFACTURER	MODEL	SPECIFICATION
Battery 1	Gaoyuan	N/A	CH426385	Power Rating: 15.48Wh
Battery 2	Highpower	N/A	CH426385	Power Rating: 15.48Wh
AC Adapter	BaiJunDa	BaiJunDa	HAD-010U	I/P: 100-240Vac, O/P: 4.8~5.4Vdc, 2.0A
USB Cable 1	Saibao	N/A	SZN-A036A	Signal Line, 1.0meter 5V 2A
USB Cable 2	TorchWay	N/A	JWUB1651-ZN01H	Signal Line, 1.0meter 5V 2A



Test Report No.: PSU-NQN2311090109RF08

## 1.2 MODIFICATION OF EUT

No modifications are made to the EUT during all test items.



Test Report No.: PSU-NQN2311090109RF08

### 1.3 APPLICABLE STANDARDS

According to the specifications of the manufacturer, the EUT must comply with the requirements of the following standards:

- ♦ FCC Part 15 Subpart E §15.407
- ♦ FCC KDB 905462 D02 UNII DFS Compliance Procedures New Rules v02
- ♦ FCC KDB 905462 D03 UNII Clients Without Radar Detection New Rules v01r02
- ♦ The FCC Site Registration No. is 55120; The Designation No. is CN1171.





## 2 TEST CONFIGURATION OF EQUIPMENT UNDER TEST

### 2.1 CARRIER FREQUENCY AND CHANNEL

#### U-NII-2A

CHANNEL	FREQUENCY	CHANNEL	FREQUENCY
52	5260 MHz	60	5300 MHz
54	5270 MHz	62	5310 MHz
56	5280 MHz	64	5320 MHz
58	5290 MHz		

#### U-NII-2C

CHANNEL	FREQUENCY	CHANNEL	FREQUENCY
100	5500 MHz	112	5560 MHz
102	5510 MHz	116	5580 MHz
104	5520 MHz	132	5660 MHz
106	5530 MHz	134	5670 MHz
108	5540 MHz	136	5680 MHz
110	5550 MHz	140	5700 MHz
144	5720 MHz		

#### TDWR

CHANNEL	FREQUENCY	CHANNEL	FREQUENCY
118	5590 MHz	124	5620 MHz
120	5600 MHz	126	5630 MHz
122	5610 MHz	128	5640 MHz

## 2.2 TEST MODE

Additional requirements for devices with multiple bandwidth modes	Master Device or Client with Radar Detection	Client Without Radar Detection
U-NII Detection Bandwidth and Statistical Performance Check	All BW modes must be tested	Not required
Channel Move Time and Channel Closing Transmission Time	Test using widest BW mode available	Test using the widest BW mode available for the link
All other tests	Any single BW mode	Not required

**Note:** Frequencies selected for statistical performance check (Section 7.8.4) should include several frequencies within the radar detection bandwidth and frequencies near the edge of the radar detection bandwidth. For 802.11 devices it is suggested to select frequencies in each of the bonded 20 MHz channels and the channel center frequency.

## 2.3 SUPPORT EQUIPMENT

Item	Equipment	Trade Name	Model Name	FCC ID	Data Cable	Power Cord
1.	Wireless Router	ASUS	RT-AX88U	N/A	N/A	Unshielded, 1.8 m
2.	Notebook	Lenovo	PC-8	N/A	N/A	shielded cable DC O/P 1.8 m unshielded AC I/P cable 1.2 m

## 2.4 TEST TOOL SOFTWARE VERSION

Item	Model Name	FW Version
1.	EMC32	11.60

## 2.5 TEST SETUP

### Master Modes

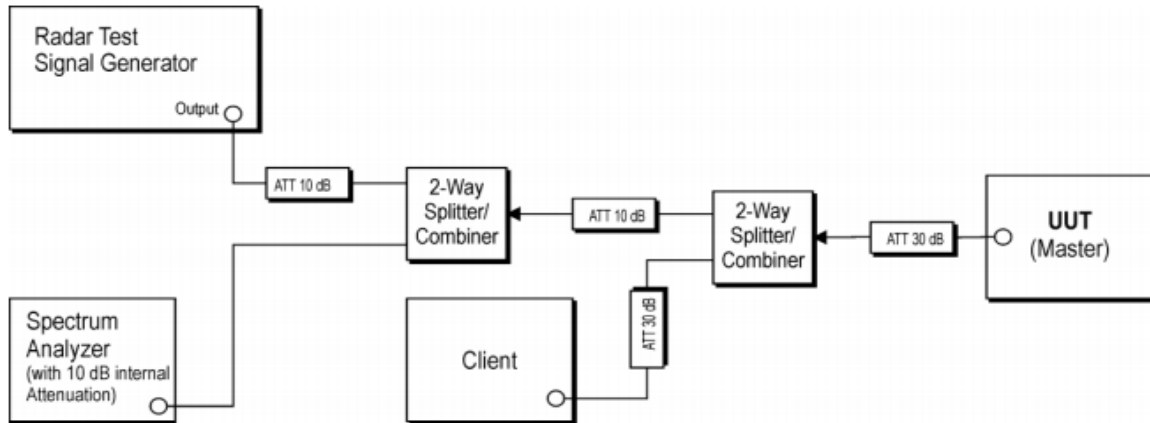

### Client with injection at the Client Modes

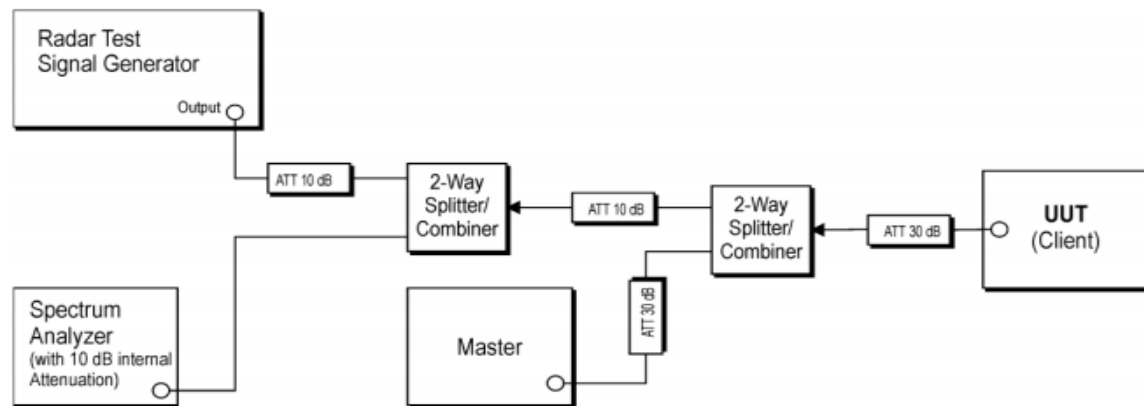

### Client with injection at the Master Modes

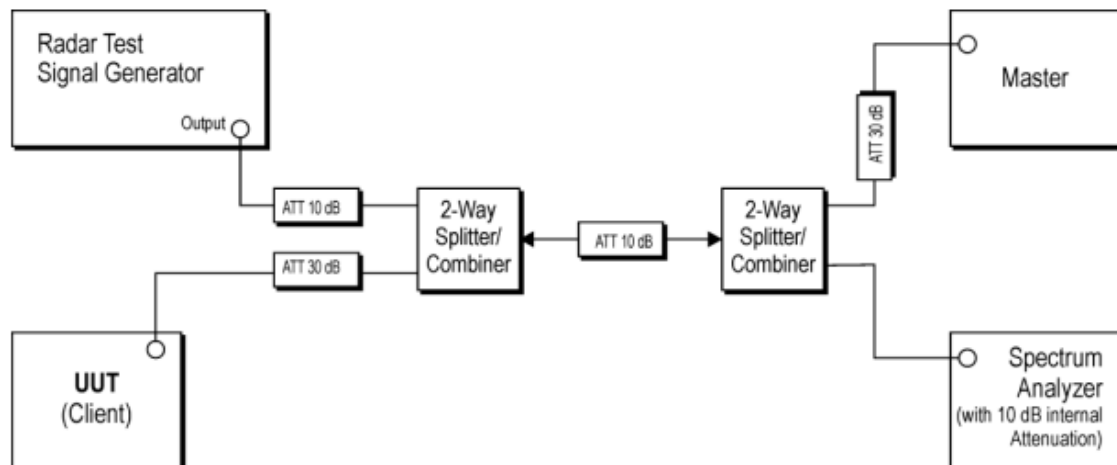

## 2.6 DFS DETECTION THRESHOLDS FOR MASTER DEVICES AND CLIENT DEVICES WITH RADAR DETECTION

Maximum Transmit Power	Value (See Notes 1, 2, and 3)
EIRP $\geq$ 200 milliwatt	-64 dBm
EIRP < 200 milliwatt and power spectral density < 10 dBm/MHz	-62 dBm
EIRP < 200 milliwatt that do not meet the power spectral density requirement	-64 dBm

Note 1: This is the level at the input of the receiver assuming a 0 dBi receive antenna.

Note 2: Throughout these test procedures an additional 1 dB has been added to the amplitude of the test transmission waveforms to account for variations in measurement equipment. This will ensure that the test signal is at or above the detection threshold level to trigger a DFS response.

Note3: EIRP is based on the highest antenna gain.

The radar Detection Threshold, lowest antenna gain is the parameter of Interference radar DFS detection threshold, The Interference Detection Threshold is the ( -62dBm) + (-0.35) [dBi]+ 1 dB= -61.35 dBm.

### 3 REQUIREMENTS AND PARAMETERS FOR DFS TEST

#### 3.1 APPLICABILITY OF DFS REQUIREMENTS

EUT is client and operates as client without radar detection function.

**Table 1: Applicability of DFS Requirements Prior to Use of a Channel**

Requirement	Operational Mode		
	Master	Client Without Radar Detection	Client With Radar Detection
Non-Occupancy Period	Yes	Not required	Yes
DFS Detection Threshold	Yes	Not required	Yes
Channel Availability Check Time	Yes	Not required	Not required
U-NII Detection Bandwidth	Yes	Not required	Yes

**Table 2: Applicability of DFS requirements during normal operation**

Requirement	Operational Mode		
	Master	Client Without Radar Detection	Client With Radar Detection
DFS Detection Threshold	Yes	Not required	Yes
Channel Closing Transmission Time	Yes	Yes	Yes
Channel Move Time	Yes	Yes	Yes
U-NII Detection Bandwidth	Yes	Not required	Yes
Client Beacon Test	N/A	Yes	Yes



BUREAU  
VERITAS

Test Report No.: PSU-NQN2311090109RF08

Additional requirements for devices with multiple bandwidth modes	Operational Mode	
	Master or Client With Radar Detection	Client Without Radar Detection
U-NII Detection Bandwidth and Statistical Performance Check	All BW modes must be tested	Not required
Channel Move Time and Channel Closing Transmission Time	Test using widest BW mode available	Test using the widest BW mode available for the link
All other tests	Any single BW mode	Not required

**Note**

Frequencies selected for statistical performance check should include several frequencies within the radar detection bandwidth and frequencies near the edge of the radar detection bandwidth. For 802.11 devices it is suggested to select frequencies in each of the bonded 20 MHz channels and the channel center frequency.

### 3.2 DFS RESPONSE REQUIREMENT VALUES

Parameter	Value
<i>Non-occupancy period</i>	Minimum 30 minutes
<i>Channel Availability Check Time</i>	60 seconds
<i>Channel Move Time</i>	10 seconds See Note 1.
<i>Channel Closing Transmission Time</i>	200 milliseconds + an aggregate of 60 milliseconds over remaining 10 second period. See Notes 1 and 2.
<i>U-NII Detection Bandwidth</i>	Minimum 100% of the 99% power bandwidth See Note 3.

**Note 1:** The instant that the *Channel Move Time* and the *Channel Closing Transmission Time* begins is as follows:

- For the Short pulse radar Test Signals this instant is the end of the *Burst*.
- For the Frequency Hopping radar Test Signal, this instant is the end of the last radar *Burst* generated.
- For the Long Pulse radar Test Signal this instant is the end of the 12 second period defining the radar transmission.

**Note 2:** The *Channel Closing Transmission Time* is comprised of 200 milliseconds starting at the beginning of the *Channel Move Time* plus any additional intermittent control signals required to facilitate *Channel* changes (an aggregate of 60 milliseconds) during the remainder of the 10 second period. The aggregate duration of control signals will not count quiet periods in between transmissions.

**Note 3:** During the *U-NII Detection Bandwidth* detection test, radar type 0 is used and for each frequency step the minimum percentage of detection is 90%. Measurements are performed with no data traffic.

### 3.3 SHORT PULSE RADAR TEST WAVEFORMS

As the EUT is a Client Device with no Radar Detection, only one type radar pulse is required for the testing. Radar Pulse type 0 was used in the evaluation of the Client device for the purpose of measuring the Channel Move Time and the Channel Closing Transmission Time.

Radar Type	Pulse Width (μsec)	PRI (μsec)	Number of Pulses	Minimum Percentage of Successful Detection	Minimum Trials
0	1	1428	18	60%	30
1	1	Test A Test B	Roundup $\left\{ \left( \frac{1}{360} \right) \cdot \left( \frac{19 \cdot 10^6}{\text{PRI}_{\mu\text{sec}}} \right) \right\}$	60%	30
2	1-5	150-230	23-29	60%	30
3	6-10	200-500	16-18	60%	30
4	11-20	200-500	12-16	60%	30
Aggregate (Radar Types 1-4)				80%	120
Note 1: Short Pulse Radar Type 0 should be used for the detection bandwidth test, channel move time, and channel closing time tests.					

Test A: 15 unique PRI values randomly selected from the list of 23 PRI values in Table 5a.

Test B: 15 unique PRI values randomly selected within the range of 518-3066 μsec, with a minimum increment of 1 μsec, excluding PRI values selected in Test A

A minimum of 30 unique waveforms are required for each of the short pulse radar types 2 through 4. For short pulse radar type 1, the same waveform is used a minimum of 30 times. If more than 30 waveforms are used for short pulse radar types 2 through 4, then each additional waveform must also be unique and not repeated from the previous waveforms.

If more than 30 waveforms are used for Short Pulse Radar Type 1, then each additional waveform is generated with Test B and must also be unique and not repeated from the previous waveforms in Tests A or B.

The aggregate is the average of the percentage of successful detections of short pulse radar types 1-4.





### 3.4 LONG PULSE RADAR TEST WAVEFORM

Radar Type	Pulse Width (μsec)	Chirp Width (MHz)	PRI (μsec)	Number of Pulses per Burst	Number of Bursts	Minimum Percentage of Successful Detection	Minimum Number of Trials
5	50-100	5-20	1000-2000	1-3	8-20	80%	30

The parameters for this waveform are randomly chosen. Thirty unique waveforms are required for the Long Pulse Radar Type waveforms. If more than 30 waveforms are used for the Long Pulse Radar Type waveforms, then each additional waveform must also be unique and not repeated from the previous waveforms.

### 3.5 FREQUENCY HOPPING RADAR TEST WAVEFORM

Radar Type	Pulse Width (μsec)	PRI (μsec)	Pulses per Hop	Hopping Rate (kHz)	Hopping Sequence Length (msec)	Minimum Percentage of Successful Detection	Minimum Number of Trials
6	1	333	9	0.333	300	70%	30

For the Frequency Hopping Radar Type, the same Burst parameters are used for each waveform. The hopping sequence is different for each waveform and a 100-length segment is selected from the hopping sequence defined by the following algorithm:

The first frequency in a hopping sequence is selected randomly from the group of 475 integer frequencies from 5250 – 5724 MHz Next, the frequency that was just chosen is removed from the group and a frequency is randomly selected from the remaining 474 frequencies in the group. This process continues until all 475 frequencies are chosen for the set. For selection of a random frequency, the frequencies remaining within the group are always treated as equally likely.

## 4 CALIBRATION SETUP AND DFS TEST RESULTS

### 4.1 CALIBRATION OF RADAR WAVEFORM

#### 4.1.1 RADAR WAVEFORM CALIBRATION PROCEDURE

The Interference **Radar Detection Threshold Level** is  $(-62dBm) + (-0.35) [dBi] + 1 dB = -61.35dBm$  that had been taken into account the output power range and antenna gain. The following equipment setup was used to calibrate the radiated Radar Waveform. A vector signal generator was utilized to establish the test signal level for radar type 0. During this process there were no transmissions by either the Master or Client Device. The spectrum analyzer was switched to the zero span (Time Domain) at the frequency of the Radar Waveform generator. Peak detection was used. The spectrum analyzer resolution bandwidth (RBW) and video bandwidth (VBW) were set to 3 MHz to measure the type 0 radar waveform. Capture the spectrum analyzer plots on short pulse radar waveform.

#### 4.1.2 RADAR WAVEFORM CALIBRATION RESULT

Please Refer to Appendix Of this test report.

### 4.2 IN-SERVICE MONITORING: CHANNEL MOVE TIME, CHANNEL CLOSING TRANSMISSION TIME AND NON-OCCUPANCY PERIOD

#### 4.2.1 LIMIT OF IN-SERVICE MONITORING

The EUT has an In-Service Monitoring function to continuously monitor the radar signals, If radar is detected, it must leave the channel (Shutdown). The Channel Move Time to cease all transmissions on the current Channel upon detection of a Radar Waveform above the DFS Detection Threshold within 10 sec. The total duration of Channel Closing Transmission Time is comprised of 200 milliseconds starting at the beginning of the Channel Move Time plus any additional intermittent control signals required to facilitate Channel changes (an aggregate of 60 milliseconds) during the remainder of the 10 second period. The aggregate duration of control signals will not count quiet periods in between transmissions.

Non-Occupancy Period time is 30 minute during which a Channel will not be utilized after a Radar Waveform is detected on that Channel. The non-associated Client Beacon Test is during the 30 minutes observation time. The EUT should not make any transmissions in the DFS band after EUT powers up.

## 4.2.2 TEST PROCEDURES

1. The radar pulse generator is set up to provide a pulse at frequency that the Master and Client are operating. A type 0 radar pulse with a 1us pulse width and a 1428 us PRI is used for the testing.
2. The vector signal generator is adjusted to provide the radar burst (18 pulses) at a level of approximately -62dBm at the antenna of the Master device.
3. A trigger is provided from the pulse generator to the DFS monitoring system in order to capture the traffic and the occurrence of the radar pulse.
4. A U-NII device operating as a Client Device will associate with the Master at Channel. The MPEG file "TestFile.mpg" specified by the FCC is streamed from the "file computer" through the Master to the Client Device and played in full motion video using Media Player Classic Ver. 6.4.8.6 in order to properly load the network for the entire period of the test.
5. When a radar Burst with a level equal to the DFS Detection Threshold + 1dB is generated on the Operating Channel of the U-NII device. At time T0 the Radar Waveform generator sends a Burst of pulse of the radar waveform at Detection Threshold + 1dB.
6. Observe the transmissions of the EUT at the end of the radar Burst on the Operating Channel. Measure and record the transmissions from the EUT during the observation time (Channel Move Time). One 12 second plot is reported for the Short Pulse Radar Types 1. The plot for the Short Pulse Radar Types starts at the end of the radar burst. The Channel Move Time will be calculated based on the zoom in 600ms plot of the Short Pulse Radar Type.
7. Measurement of the aggregate duration of the Channel Closing Transmission Time method. With the spectrum analyzer set to zero span tuned to the center frequency of the EUT operating channel at the radar simulated frequency, peak detection, and max hold, the dwell time per bin is given by: **Dwell (1.3ms) = S (13000ms) / B (10000)**; where Dwell is the dwell time per spectrum analyzer sampling bin, S is the sweep time and B is the number of spectrum analyzer sampling bins. An upper bound of the aggregate duration of the intermittent control signals of Channel Closing Transmission Time is calculated by: **C (ms) = N X Dwell (1.3 ms)**; where C is the Closing Time, N is the number of spectrum analyzer sampling bins (intermittent control signals) showing a U-NII transmission and Dwell is the dwell time per bin.
8. Measure the EUT for more than 30 minutes following the channel move time to verify that no transmissions or beacons occur on this Channel.



Test Report No.: PSU-NQN2311090109RF08

#### **4.2.3 RESULT OF CHANNEL MOVE TIME, CHANNEL CLOSING TRANSMISSION TIME AND NON-OCCUPANCY PERIOD FOR CLIENT BEACON TEST RESULT**

Please Refer to Appendix Of this test report.

## 5 LIST OF MEASURING EQUIPMENT

Instrument	Manufacturer	Model No.	Serial No.	Calibration Date	Due Date	Remark
Open Switch and Control Unit	Rohde&Schwarz	OSP-B157W8	100836	N/A	N/A	Conducted
Vector Signal Source	Rohde&Schwarz	SMW200A	110963	Jun. 12,23	Jun. 11,25	Conducted
Signal &Spectrum Analyzer	Rohde&Schwarz	FSV3044	101340	Jun. 12,23	Jun. 11,25	Conducted
Signal Source	Rohde&Schwarz	SMB100A	183313	Oct. 08,23	Oct. 07,25	Conducted
Test Software	Rohde&Schwarz	EMC32	N/A	N/A	N/A	Conducted



BUREAU  
VERITAS

Test Report No.: PSU-NQN2311090109RF08

## APPENDIX

### Channel Move Time and Channel Closing Transmission Time

#### Test Result

TestMode	Frequency[MHz]	CCTT[ms]	Limit[ms]	CMT[ms]	Limit[ms]	Verdict
11AC80SISO	5290	0.280	200+60	0.000	10000	PASS
	5530	0.000	200+60	0.000	10000	PASS

## Test Graphs

11AC80SISO\_5290

Channel Move Time

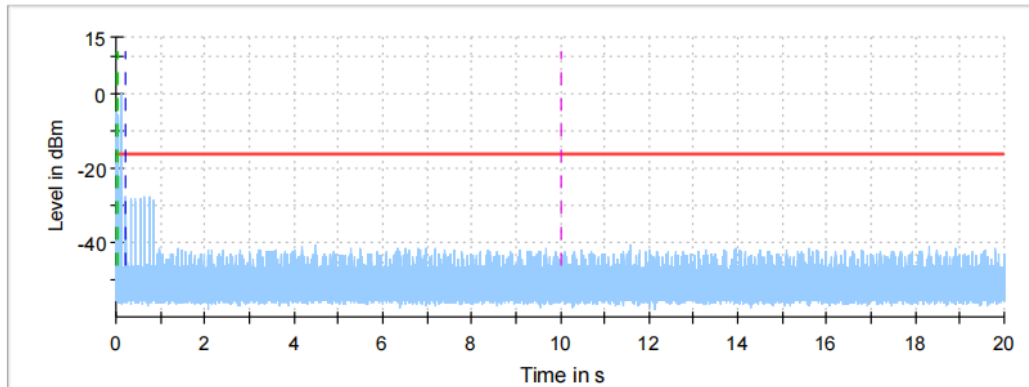

— Channel Move Time  
- - - Start of Radar  
- - - First 200ms of Channel Closing Tx Time  
— Threshold  
- - - Trigger at end of Radar  
- - - 10sec Channel Move Time Limit

Channel Move Time first 200ms

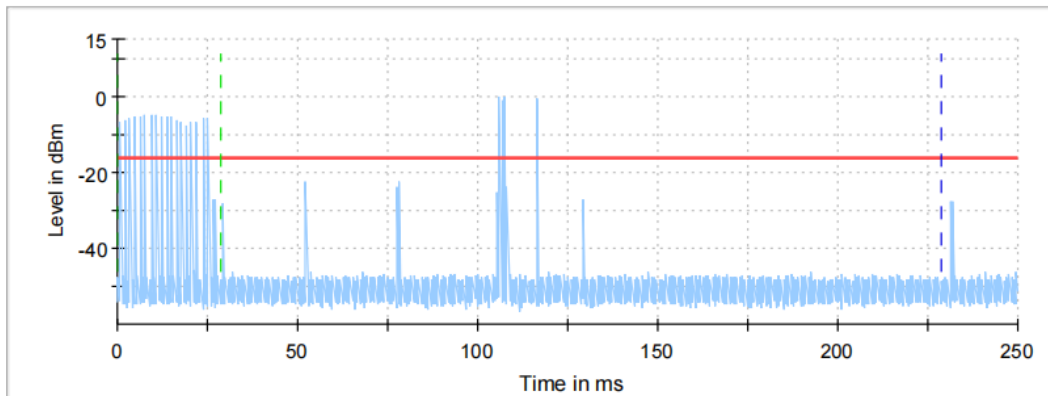

— Channel Move Time first 200ms  
- - - Start of Radar  
- - - First 200ms of Channel Closing Tx Time  
— Threshold  
- - - Trigger at end of Radar



11AC80SISO\_5530

Channel Move Time

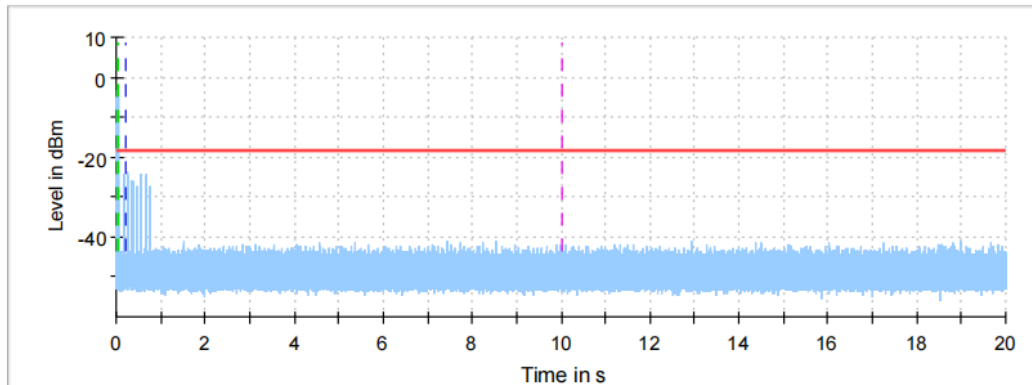

- Channel Move Time
- Start of Radar
- First 200ms of Channel Closing Tx Time
- Threshold
- Trigger at end of Radar
- 10sec Channel Move Time Limit

Channel Move Time first 200ms

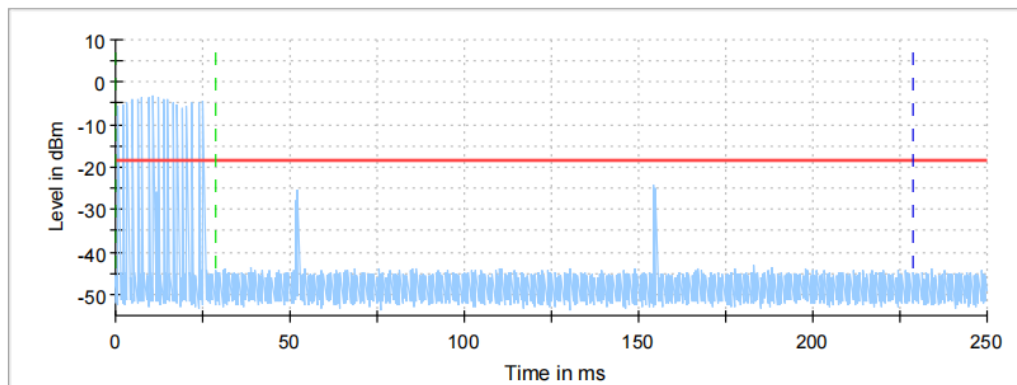

- Channel Move Time first 200ms
- Start of Radar
- First 200ms of Channel Closing Tx Time
- Threshold
- Trigger at end of Radar





BUREAU  
VERITAS

Test Report No.: PSU-NQN2311090109RF08

## Non-Occupancy Period

### Test Result

TestMode	Frequency[MHz]	Result	Limit[s]	Verdict
11AC80SISO	5290	see test graph	≥1800	PASS
	5530	see test graph	≥1800	PASS

## Test Graphs

11AC80SISO\_5290

Non-occupancy period

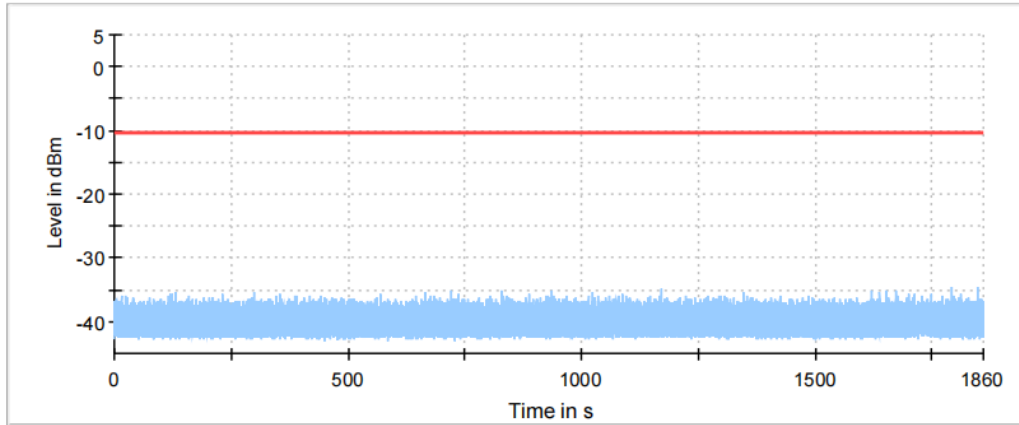

— Non-occupancy period    — Threshold

11AC80SISO\_5530

Non-occupancy period

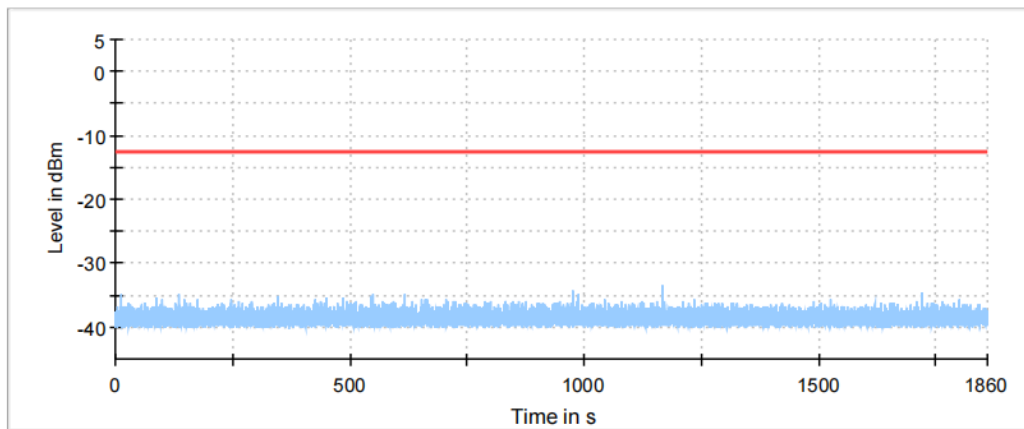

— Non-occupancy period    — Threshold

---END---