

HAC TEST REPORT

Applicant	HMD Global Oy
FCC ID	2AJOTTA-1584
Product	Smart Phone
Brand	NOKIA
Model	TA-1584
Report No.	R2305A0601-H1
Issue Date	June 14, 2023

TA Technology (Shanghai) Co., Ltd. tested the above equipment in accordance with the requirements in **ANSI C63.19-2011**. The test results show that the equipment tested is capable of demonstrating compliance with the requirements as documented in this report.



Prepared by: Wei Fangying

Approved by: Fan Guangchang

TA Technology (Shanghai) Co., Ltd.

Building 3, No.145, Jintang Rd, Pudong Shanghai, P.R.China

TEL: +86-021-50791141/2/3

FAX: +86-021-50791141/2/3-8000

Table of Contents

1	Test Laboratory.....	3
1.1	Notes of the Test Report.....	3
1.2	Test Facility.....	3
1.3	Testing Location.....	3
1.4	Laboratory Environment.....	4
2	Statement of Compliance.....	5
3	Description of Equipment under Test.....	6
4	Test Specification and Operational Conditions.....	9
4.1	Test Specification.....	9
5	Test Information.....	10
5.1	Operational Conditions during Test.....	10
5.1.1	General Description of Test Procedures.....	10
5.2	T-Coil Measurements System Configuration.....	10
5.2.1	T-coil Measurement Set-up.....	10
5.2.2	AM1D Probe.....	13
5.2.3	Audio Magnetic Measurement Instrument (AMMI).....	14
5.2.4	Helmholtz Calibration Coil (AMCC).....	15
5.2.5	Test Arch Phantom & Phone Positioner.....	15
5.3	T-Coil measurement points and reference plane.....	16
5.4	T-Coil Test Procedures.....	17
6	T-Coil Performance Requirements.....	19
6.1	T-Coil coupling field intensity.....	19
6.2	Frequency response.....	19
6.3	Signal quality.....	20
7	T-Coil testing for OTT.....	21
8	Summary Test Results.....	24
9	Measurement Uncertainty.....	26
10	Main Test Instruments.....	27
	ANNEX A: Test Layout.....	28
	ANNEX B: Graph Results.....	29
	ANNEX C: Probe Calibration Certificate.....	109
	ANNEX D: DAE4 Calibration Certificate.....	112
	ANNEX E: The EUT Appearances and Test Configuration.....	115

1 Test Laboratory

1.1 Notes of the Test Report

This report shall not be reproduced in full or partial, without the written approval of **TA Technology (Shanghai) Co., Ltd.** The results documented in this report apply only to the tested sample, under the conditions and modes of operation as described herein .Measurement Uncertainties were not taken into account and are published for informational purposes only. This report is written to support regulatory compliance of the applicable standards stated above.

1.2 Test Facility

FCC (Designation number: CN1179, Test Firm Registration Number: 446626)

TA Technology (Shanghai) Co., Ltd. has been listed on the US Federal Communications Commission list of test facilities recognized to perform measurements.

A2LA (Certificate Number: 3857.01)

TA Technology (Shanghai) Co., Ltd. has been listed by American Association for Laboratory Accreditation to perform measurement.

1.3 Testing Location

Company: TA Technology (Shanghai) Co., Ltd.
Address: Building 3, No.145, Jintang Rd, Pudong Shanghai, P.R.China
City: Shanghai
Post code: 201201
Country: P. R. China
Contact: Fan Guangchang
Telephone: +86-021-50791141/2/3
Fax: +86-021-50791141/2/3-8000
Website: <http://www.ta-shanghai.com>
E-mail: fanguangchang@ta-shanghai.com

1.4 Laboratory Environment

Temperature	Min. = 18°C, Max. = 28 °C
Relative humidity	Min. = 0%, Max. = 80%
Ground system resistance	< 0.5 Ω
Ambient noise is checked and found very low and in compliance with requirement of standards. Reflection of surrounding objects is minimized and in compliance with requirement of standards.	

2 Statement of Compliance

Table 2.1: T-Coil signal quality categories of each tested Mode

Band	Category (OTT VoIP)
GSM 850	T4
GSM 1900	T4
WCDMA Band II	T4
WCDMA Band IV	T4
WCDMA Band V	T4
LTE Band 2	T4
LTE Band 4	T4
LTE Band 5	T4
LTE Band 12	T4
LTE Band 25	T4
LTE Band 26	T4
LTE Band 41	T4
LTE Band 66	T4
LTE Band 71	T4
Wi-Fi 2.4G 802.11b	T4
Wi-Fi 2.4G 802.11g	T4
Wi-Fi 2.4G 802.11n	T4
Wi-Fi 5G (U-NII-1) 802.11a	T4
Wi-Fi 5G (U-NII-2A) 802.11a	T4
Wi-Fi 5G (U-NII-2C) 802.11a	T4
Wi-Fi 5G (U-NII-3) 802.11a	T4
The Total T-Coil rating for OTT is T4	
Date of Testing: May 30, 2023 ~ June 2, 2023	
Date of Sample Received: May 29, 2023	
Note: All indications of Pass/Fail in this report are opinions expressed by TA Technology (Shanghai) Co., Ltd. based on interpretations and/or observations of test results. Measurement Uncertainties were not taken into account and are published for informational purposes only.	

3 Description of Equipment under Test

Client Information

Applicant	HMD Global Oy
Applicant address	Bertel Jungin aukio 9 Espoo 02600 Finland
Manufacturer	HMD Global Oy
Manufacturer address	Bertel Jungin aukio 9 Espoo 02600 Finland

General Technologies

Device Type	Portable Device
EUT Stage	Production Unit
Model	TA-1584
IMEI	First supply: 354668350012676 Second supply: 354668350017121
HW Version	V1.0
SW Version	04US_0_023
Antenna Type	Internal Antenna
Power Class	GSM 850: 4 GSM 1900: 1 WCDMA Band II/IV/V: 3 LTE FDD 2/4/5/12/25/26/66/71:3 LTE TDD 41:3
Power Level	GSM 850: level 5 GSM 1900: level 0 WCDMA Band II/IV/V: All up bits LTE FDD 2/4/5/12/25/26/66/71:max power LTE TDD 41:max power
Tx Frequency Bands (Unit: MHz)	GSM 850: 824 ~ 849 GSM 1900: 1850 ~ 1910 WCDMA Band II: 1850 ~ 1910 WCDMA Band IV: 1710 ~ 1755 WCDMA Band V: 824 ~ 849 LTE FDD 2: 1850 ~ 1910 LTE FDD 4: 1710 ~ 1755 LTE FDD 5: 824 ~ 849 LTE FDD 12: 699 ~ 716 LTE FDD 25: 1850 ~ 1915 LTE FDD 26: 814 ~ 849 LTE TDD 41: 2496 ~ 2690 LTE FDD 66: 1710 ~ 1780 LTE FDD 71: 663 ~ 698 WLAN: 2412 ~ 2462, 5180 ~ 5240, 5260 ~ 5320, 5500 ~ 5720, 5745 ~ 5825 Bluetooth: 2402 ~ 2480

Uplink Modulations	GSM % GPRS & EDGE: GMSK, 8PSK WCDMA: QPSK; LTE: QPSK, 16QAM, 64QAM 802.11b: DSSS 802.11a/g/n/ac: OFDM
Accessory Equipment	
Battery 1	Manufacturer: Huizhou Highpower Technology Co., Ltd. Model: CH396078
Battery 2	Manufacturer: HUNAN GAOYUAN BATTERY CO.,LTD Model: CH396078
Note: The EUT is sent from the applicant to TA and the information of the EUT is declared by the applicant.	

Component		First supply		Second supply	
		Supplier	Spec	Supplier	Spec
PCBA	3GB LPDDR	Longsys	3GB	Samsung	RAM; DDR4; 3GB; 4266Mbps; FBGA-200; 10*15*0.9
	32GB EMMC	Longsys	32GB	biwin	32GB
	PCB	Huashen	105X131.6MM	SUNTAK	105X131.6MM
LCM	LCD	TCL	6.3"HKC incell, 720X1560 FocalTech: FT8006S-AN, GG3	Ice tron	6.3" HKC incell, 720X1560 Chipone:ICNL9911C
Front camera	Camera	Holitech	5M;FF	TXD	5M;FF
Macro CAM	Camera	Sunwin	13M;PDAF;	TXD	13M; PDAF;
	Camera	Imaging	2M;FF	Holitech	2M;FF
Acoustic	Vibrator	ChaoYing	Φ8*3mm	HONGZHIFA	Φ8*3mm
	FPC	ZRXD		XINYE	
Battery		Highpower	3000mAh	GAOYUAN	3000mAh
Glass		Dottone	30.09X12.02X0.50mm	Lesu	30.09X12.02X0.50mm
The customer declares that there are only the manufacturer of key parts is different between the first and second supply, other parameters are the same.					

Air-Interface	Band (MHz)	Type	ANSI C63.19 tested	Simultaneous Transmissions	Voice over Digital Transport OTT Capability	Name of Voice Service	Power Reduction
GSM	850	VO	Yes	Yes BT or Wi-Fi	N/A	CMRS Voice	N/A
	1900						
	GPRS/EDGE	VD	Yes		Yes	Google Duo	No
WCDMA	Band II	VO	Yes	Yes BT or Wi-Fi	N/A	CMRS Voice	N/A
	Band IV						
	Band V						
	HSPA	VD	Yes		Yes	Google Duo	No
LTE	Band 2	VD	Yes	Yes BT or Wi-Fi	Yes	VoLTE Google Duo	No
	Band 4						
	Band 5						
	Band 12						
	Band 25						
	Band 26						
	Band 41						
	Band 66						
	Band 71						
Wi-Fi	2450	VD	Yes	Yes GSM, WCDMA, LTE	Yes	VoWi-Fi Google Duo	No
	U-NII-1						
	U-NII-2A						
	U-NII-2C						
	U-NII-3						
Bluetooth (BT)	2450	DT	No	Yes GSM, WCDMA, LTE	N/A	NA	No

VO= legacy Cellular Voice Service from Table 7.1 in 7.4.2.1 of ANSI C63.19-2011

VD= IP voice service over digital transport.

DT= Digital Transport only (no voice)

#: Ref Lev in accordance with 7.4.2.1 of ANSI C63.19-2011

###: Ref Lev in accordance with the July 2012 VoLTE interpretation.

Remark:

- According to TCB workshop October, 2014 RF Exposure Procedures Update (Overlapping LTE Bands):
HAC for LTE Band 2 (Frequency range: 1850 ~ 1910 MHz) is covered by LTE Band 25 (Frequency range 1850 ~ 1915 MHz); LTE Band 4 (Frequency range 1710-1755 MHz) is covered by LTE Band 66 (Frequency range: 1710-1780 MHz); LTE Band 5 (Frequency range 824 ~ 849 MHz) is covered by LTE Band 26 (Frequency range: 814 ~ 849 MHz) due to similar frequency range, same maximum tune up limit and same channel bandwidth.
- This report only tests OTT VoIP mode.

4 Test Specification and Operational Conditions

4.1 Test Specification

The tests documented in this report were performed in accordance with the following:

FCC CFR47 Part 20.19

ANSI C63.19-2011

KDB 285076 D01 HAC Guidance v06

KDB 285076 D02 T-Coil testing for CMRS IP v04

5 Test Information

5.1 Operational Conditions during Test

5.1.1 General Description of Test Procedures

The phone was tested in all normal configurations for the ear use. The EUT is mounted in the device holder equivalent as for classic dosimeter measurements. The acoustic output of the EUT shall coincide with the center point of the area formed by the dielectric wire and the middle bar of the arch's top frame. The EUT shall be moved vertically upwards until it touches the frame. The fine adjustment is possible by sliding the complete EUT holder on the yellow base plate of the Test Arch phantom. During the test, the EUT is selected on T-Coil mode, the LCD backlight is turned off and volume is adjusted to maximum level.

A communication link is set up with a System Simulator (SS) by RF cable, and a call is established. The Absolute Radio Frequency Channel Number (ARFCN) is allocated to Ch Middle respectively in the case of Band. T-Coil configurations is measured using System Simulator (SS) of CMU200/ CMW 500, at the same time the EUT shall be operated at its maximum RF output power setting.

5.2 T-Coil Measurements System Configuration

5.2.1 T-coil Measurement Set-up

These measurements are performed using the DASY5 automated dosimetric assessment system. It is made by Schmid & Partner Engineering AG (SPEAG) in Zurich, Switzerland. It consists of high precision robotics system (Stäubli), robot controller, Intel Core computer, near-field probe, probe alignment sensor. The robot is a six-axis industrial robot performing precise movements. Cell controller systems contain the power supply, robot controller, teach pendant (Joystick) and remote control, and are used to drive the robot motors. The Stäubli Robot is connected to the cell controller to allow software manipulation of the robot. A data acquisition electronic (DAE) circuit performs the signal amplification; signal multiplexing, AD-conversion, offset measurements, mechanical surface detection, collision detection, etc. is connected to the Electro-optical coupler (EOC). The EOC performs the conversion from the optical into digital electric signal of the DAE and transfers data to the PC plug-in card.

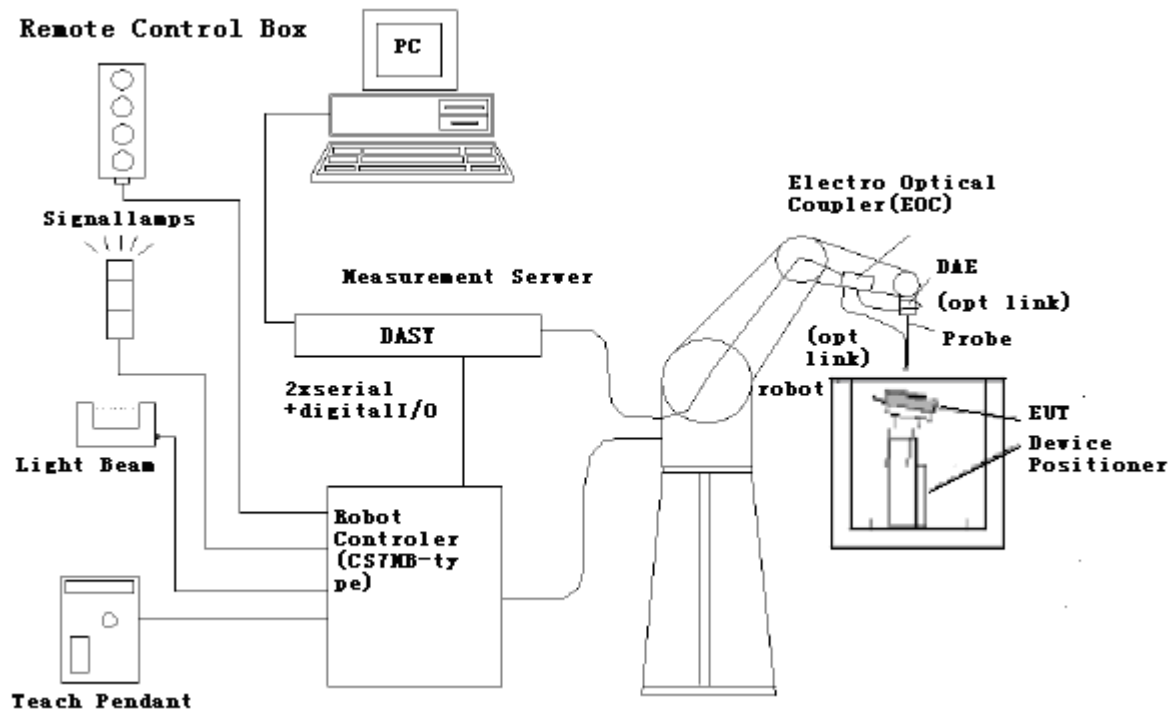

Figure 1 T-Coil Test Measurement Set-up

The DAE4 consists of a highly sensitive electrometer-grade preamplifier with auto-zeroing, a channel and gain-switching multiplexer, a fast 16 bit AD-converter and a command decoder and control logic unit. Transmission to the PC-card is accomplished through an optical downlink for data and status information and an optical uplink for commands and clock lines. The mechanical probe mounting device includes two different sensor systems for frontal and sidewise probe contacts. They are also used for mechanical surface detection and probe collision detection. The robot uses its own controller with a built in VME-bus computer.

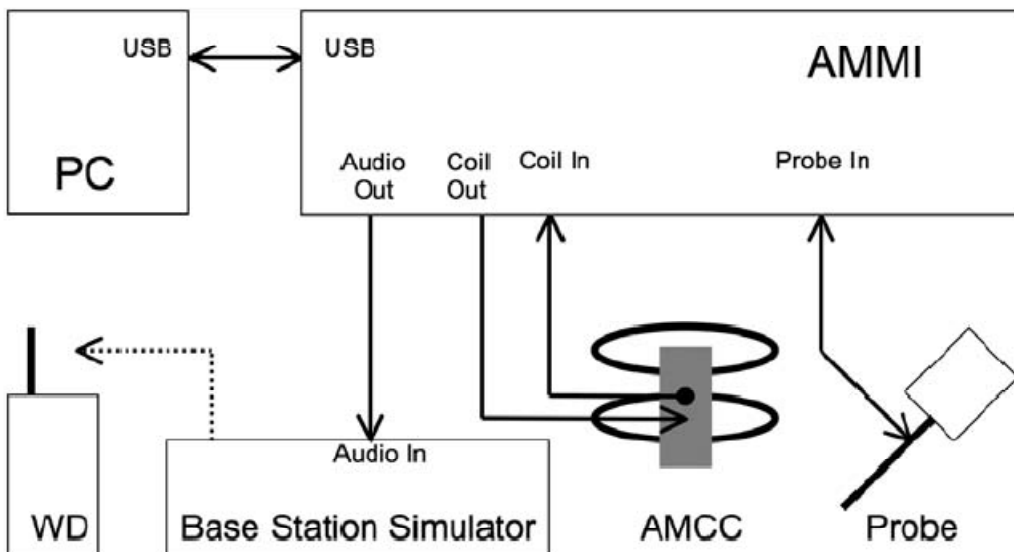

Figure 2 T-Coil Test Measurement Set-up

5.2.2 AM1D Probe

The AM1D probe is an active probe with a single sensor. It is fully RF-shielded and has a rounded tip 6mm in diameter incorporating a pickup coil with its center offset 3mm from the tip and the sides. The symmetric signal preamplifier in the probe is fed via the shielded symmetric output cable from the AMMI with a 48V “phantom” voltage supply. The 7-pin connector on the back in the axis of the probe does not carry any signals. It is mounted to the DAE for the correct orientation of the sensor. If the probe axis is tilted 54.7 degree from the vertical, the sensor is approximately vertical when the signal connector is at the underside of the probe (cable hanging downwards).

Specification

frequency range	0.1 - 20 kHz (RF sensitivity <-100 dB, fully RF shielded)
sensitivity	<-50 dB A/m @ 1 kHz
pre-amplifier	40 dB, symmetric
dimensions	tip diameter / length: 6 / 290 mm, sensor according to ANSI-C63.19



Figure 3 AM1D Probe

5.2.3 Audio Magnetic Measurement Instrument (AMMI)

The Audio Magnetic Measuring Instrument (AMMI) is a desktop 19-inch unit containing a sampling unit, a waveform generator for test and calibration signals, and a USB interface.



Figure 4 AMMI front panel

Port description:

Audio Out	BNC, audio signal to the base station simulator, for >500Ohm load
Coil Out	BNC, test and calibration signal to the AMCC (top connector), for 50Ohm load
Coil In	XLR, monitor signal from the AMCC BNO connector, 600 Ohm
Probe In	XLR, probe signal and phantom supply to the probe Lemo connector



Figure 5 AMMI rear side

Sampling rate	48 kHz / 24 bit
Dynamic range	85 dB
Test signal generation	User selectable and predefined (vis PC)
Calibration	Auto-calibration / full system calibration using AMCC with monitor output
Dimensions	482 x 65 x 270 mm

5.2.4 Helmholtz Calibration Coil (AMCC)

The Audio Magnetic Calibration coil is a Helmholtz Coil designed for calibration of the AM1D probe. The two horizontal coils generate a homogeneous magnetic field in the z direction. The DC input resistance is adjusted by a series resistor to approximately 50Ohm, and a shunt resistor of 100hm permits monitoring the current with a scale of 1:10

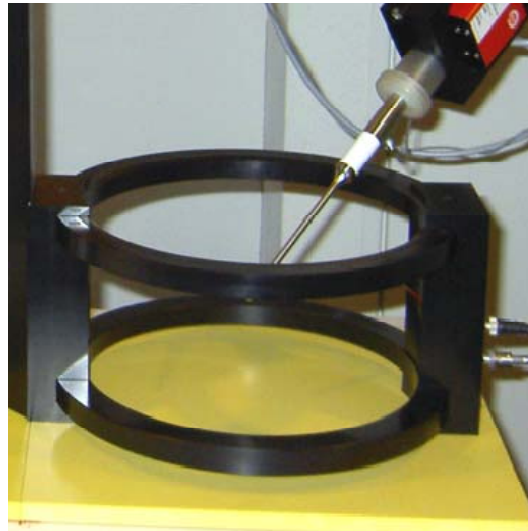

Figure 6 AMCC

Port description:

Signal	Connector	Resistance
Coil In	BNC	Typically 50Ohm
Coil Monitor	BNO	100hm ± 1% (100mV corresponding to 1 A/m)

Specification:

Dimensions	370 x 370 x 196 mm, according to ANSI-C63.19
-------------------	--

5.2.5 Test Arch Phantom & Phone Positioner

The Test Arch phantom should be positioned horizontally on a stable surface. Reference markings on the Phantom allow the complete setup of all predefined phantom positions and measurement grids by manually teaching three points in the robot. It enables easy and well defined positioning of the phone and validation dipoles as well as simple teaching of the robot (Dimensions: 370 x 370 x 370 mm).

The Device reference point is set for the EUT at 6.3 mm, the Grid reference point is on the upper surface at the origin of the coordinates, and the “user point \Height Check 0.5 mm” is 0.5mm above the center, allowing verification of the gap of 0.5mm while the probe is positioned there.

The Phone Positioner supports accurate and reliable positioning of any phone with effect on near field $\leq \pm 0.5 \text{ dB}$.



Figure 7 T-coil Phantom & Device Holder

5.3 T-Coil measurement points and reference plane

The following figure illustrates the standard probe orientations. Position 1 is the perpendicular orientation of the probe coil; orientation 2 is the transverse orientation. The space between the measurement positions is not fixed. It is recommended that a scan of the WD be performed for each probe coil orientation and that the maximum level recorded be used as the reading for that orientation of the probe coil.

- 1) The reference plane is the planar area that contains the highest point in the area of the phone that normally rests against the user's ear. It is parallel to the centerline of the receiver area of the phone and is defined by the points of the receiver-end of the EUT handset, which, in normal handset use, rest against the ear.
- 2) The measurement plane is parallel to, and 10 mm in front of, the reference plane.
- 3) The reference axis is normal to the reference plane and passes through the center of the receiver speaker section (or the center of the hole array); or may be centered on a secondary inductive source. The actual location of the measurement point shall be noted in the test report as the measurement reference point.
- 4) The measurement points may be located where the axial and radial field intensity measurements are optimum with regard to the requirements. However, the measurement points should be near the acoustic output of the EUT and shall be located in the same half of the phone as the EUT receiver. In a EUT handset with a centered receiver and a circularly symmetrical magnetic field, the measurement axis and the reference axis would coincide.

- 5) The relative spacing of each measurement orientation is not fixed. The axial and two radial orientations should be chosen to select the optimal position.
- 6) The measurement point for the axial position is located 10 mm from the reference plane on the measurement axis.
- 7) The actual location of the measurement point shall be noted in test reports and designated as the measurement reference point.

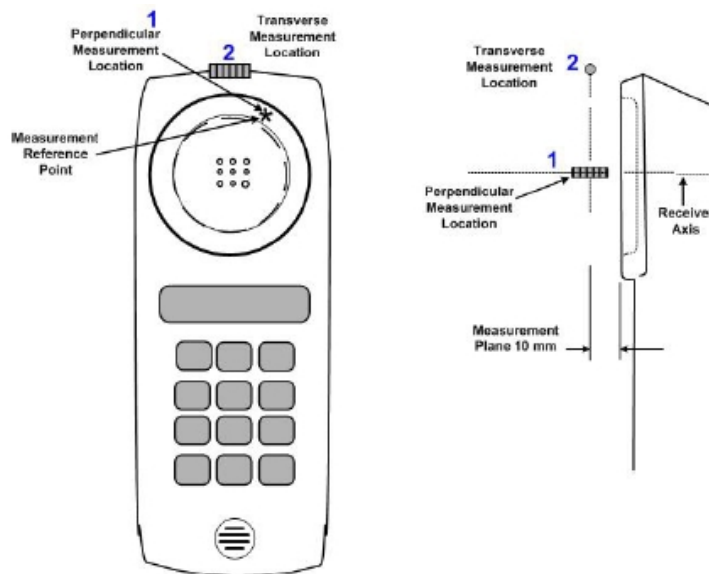

Figure 8 Axis and planes for EUT audio frequency magnetic field measurements

5.4 T-Coil Test Procedures

The following illustrate a typical test scan over a wireless communications device:

- 1) Geometry and signal check: system probe alignment, proper operation of the field probe, probe measurement system, other instrumentation, and the positioning system was confirmed. A surface calibration was performed before each setup change to ensure repeatable spacing and proper maintenance of the measurement plane using the test Arch.
- 2) Set the reference drive level of signal voice defined in C63.19 per 7.4.2.1.
- 3) The ambient and test system background noise (dB A/m) was measured as well as ABM2 over the full measurement. The maximum noise level must be at least 10dB below the limit of C63.19 per 8.3.2.
- 4) The EUT was positioned in its intended test position, acoustic output point of the device perpendicular to the field probe.
- 5) The EUT operation for maximum rated RF output power was configured and connected by using of coaxial cable connection to the base station simulator at the test channel and other normal operating parameters as intended for the test. The battery was ensured to be fully charged before each test. The center sub-grid was centered over the center of the acoustic output (also audio band magnetic output, if applicable). The EUT audio output was positioned tangent (as physically possible) to the measurement plane.
- 6) The EUT's RF emission field was eliminated from T-coil results by using a well RF-shielding of the probe, AM1D, and by using of coaxial cable connection to a Base Station Simulator. One test channel was pre-measurement to avoid this possibility.
- 7) Determined the optimal measurement locations for the EUT by following the three steps, coarse

resolution scan, fine resolution scans, and point measurement, as described in C63.19 per 7.4.4.2. At each measurement locations, samples in the measurement window duration were evaluated to get ABM1 and the signal spectrum. The noise measurement was performed after the scan with the signal, the same happened, just with the voice signal switched off. The ABM2 was calculated from this second scan.

8) All results resulting from a measurement point in a T-Coil job were calculated from the signal samples during this window interval. ABM values were averaged over the sequence of there samples.

9) At an optimal point measurement, the SNR (ABM1/ABM2) was calculated for axial,radial transverse and radial longitudinal orientation, and the frequency response was measured in axial axis.

10) Corrected for the frequency response after the EUT measurement since the DASY5 system had known the spectrum of the input signal by using a reference job.

11) In SEMCAD postprocessing, the spectral points are in addition scaled with the high-pass (half-band) and the A-weighting, bandwidth compensated factor (BWC) and those results are final as shown in this report.

6 T-Coil Performance Requirements

In order to be rated for T-Coil use, a EUT shall meet the requirements for signal level and signal quality contained in this part.

6.1 T-Coil coupling field intensity

When measured as specified in ANSI C63.19, the T-Coil signal shall be ≥ -18 dB (A/m) at 1 kHz, in a 1/3 octave band filter for all orientations.

6.2 Frequency response

The frequency response of the axial component of the magnetic field, measured in 1/3 octave bands, shall follow the response curve specified in this sub-clause, over the frequency range 300 Hz to 3000 Hz. The following figures provide the boundaries for the specified frequency. These response curves are for true field strength measurements of the T-Coil signal. Thus the 6 dB/octave probe response has been corrected from the raw readings.

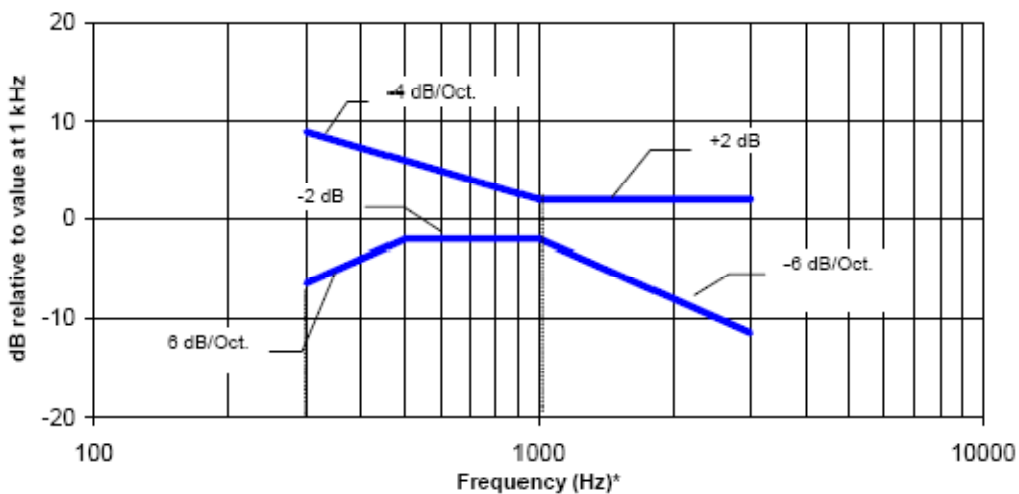

NOTE—Frequency response is between 300 Hz and 3000 Hz.

Figure 9 Magnetic field frequency response for EUTs with a field ≤ -15 dB (A/m) at 1 kHz

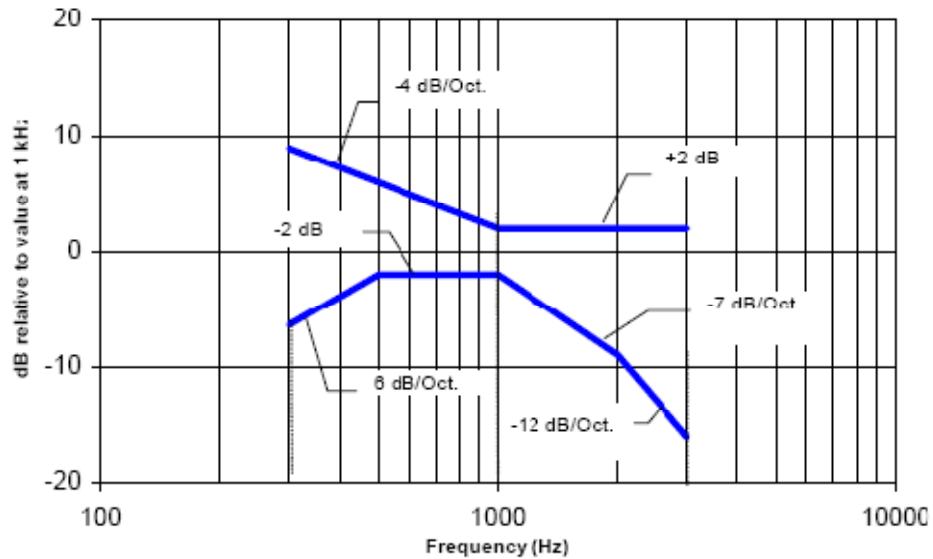

NOTE—Frequency response is between 300 Hz and 3000 Hz.

Figure 10 Magnetic field frequency response for EUTs with a field that exceeds -15 dB(A/m) at 1 kHz

6.3 Signal quality

This part provides the signal quality requirement for the intended T-Coil signal from a EUT. Only the RF immunity of the hearing aid is measured in T-Coil mode. It is assumed that a hearing aid can have no immunity to an interference signal in the audio band, which is the intended reception band for this mode. So, the only criteria that can be measured is the RF immunity in T-Coil mode. This is measured using the same procedure as for the audio coupling mode and at the same levels.

The worst signal quality of the two T-Coil signal measurements shall be used to determine the T-Coil mode category per Table 1

Table 1: T-Coil signal quality categories

Category	Telephone parameters WD signal quality [(signal + noise) – to – noise ratio in decibels]
Category T1	0 dB to 10 dB
Category T2	10 dB to 20 dB
Category T3	20 dB to 30 dB
Category T4	> 30 dB

7 T-Coil testing for OTT

This device supports VoIP via a preinstalled application that uses the Google Duo service, using OPUS as its only codec. VoIP capabilities require HAC assessment when voice calls are supported over the cellular data connection via preinstalled VoIP applications and the assessment is subject to Pre-Approval Guidance procedures.

The equipment is set up as shown below with a support device used to originate the call using the IP transport. The support device connects to the cloud-based Google Duo service via Wi-Fi access point and router, or RJ45. The DUT connects to the VoIP service via a cellular/unlicensed air interface to the call box and an Ethernet connection from call box to Internet. The various codec bit rate and air interface configurations are evaluated to determine the worst-case configuration

Test Setup configuration for OTT calls

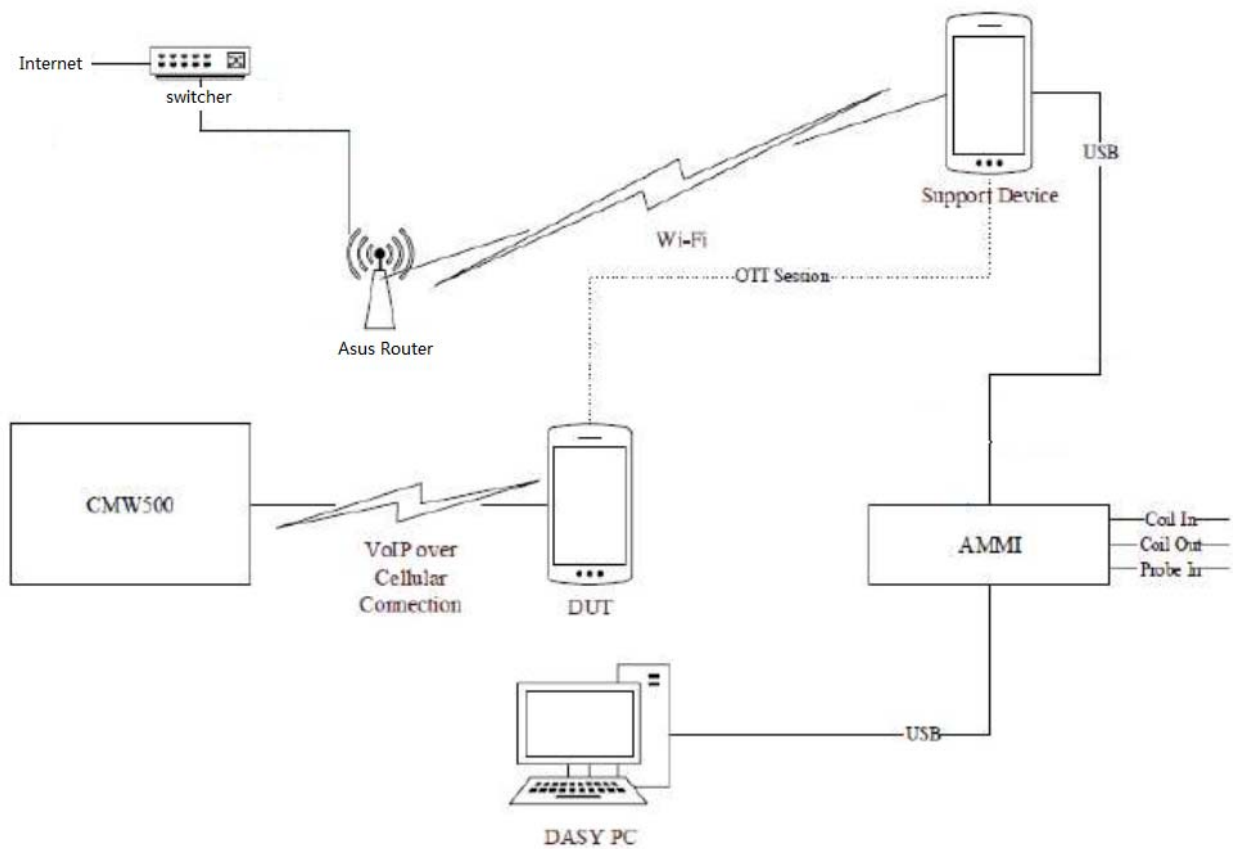

For the OTT call, the calibrated audio card within the CMW500 cannot be used so the AMMI is connected to an external Digital-Analog Converter (DAC) and the DAC is connected to the Support Device via USB. The test signal is sent from the DASY PC to the AMMI, from the AMMI to the DAC, from the DAC to the Support Device, and, via the VoIP call, to the DUT.

As this test set up uses an external DAC between the AMMI's audio output and support device, the appropriate gain factor for the OTT call needs be determined. This is done by connecting the DAC between the AMMI Audio output and Coil input as shown below.

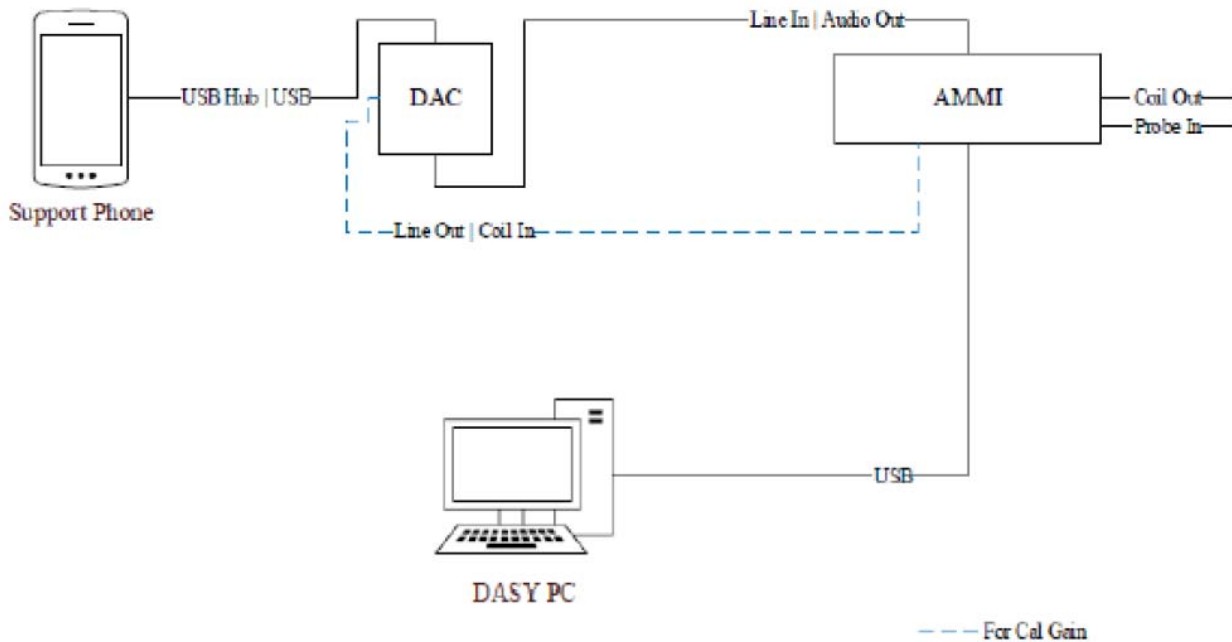

Using the metering function on the DAC, the DAC gain is adjusted until the volume reaches 0 dBFS (3.14 dBm0 based on TIA/EIA 810-A). SPEAG's "TN-LK-05042018-C-T-Coil_Levels" document (ANNEX E) steps E through H are then followed to determine the adjusted gain values so that the reference level is set to 23.14dB below full scale, i.e. at -20dBm0. A verification of the DAC's output is performed prior to testing.

Codec Investigation - OTT VoIP (EDGE)						
Codec Setting	75kbps	35kbps	6kbps	Orientation	Band	Channel
ABM1 (dBA/m)	8.07	4.55	5.43	z (Axial):	GSM 850	190
ABM2 (dBA/m)	-44.54	-49.27	-44.68			
Frequency Response	PASS	PASS	PASS			
Signal Quality (dB)	52.61	53.82	50.11			

Codec Investigation - OTT VoIP (HSPA)						
Codec Setting	75kbps	35kbps	6kbps	Orientation	Band	Channel
ABM1 (dBA/m)	3.49	3.48	2.59	z (Axial):	WCDMA Band 2	9400
ABM2 (dBA/m)	-49.73	-49.64	-50			
Frequency Response	PASS	PASS	PASS			
Signal Quality (dB)	53.22	53.12	52.59			

Codec Investigation - OTT VoIP (LTE)						
Codec Setting	75kbps	35kbps	6kbps	Orientation	Band	Channel
ABM1 (dBA/m)	3.75	2.37	2.59	z (Axial):	LTE Band 12	23095
ABM2 (dBA/m)	-49.64	-49.43	-48.72			
Frequency Response	PASS	PASS	PASS			
Signal Quality (dB)	53.39	51.8	51.31			

Codec Investigation - OTT VoIP (Wi-Fi)							
Codec Setting	75kbps	35kbps	6kbps	Orientation	Band	Standard	Channel
ABM1 (dBA/m)	7.47	5.74	2.38	z (Axial):	2.4GHz	IEEE802.11b	6
ABM2 (dBA/m)	-42.52	-46.59	-45.73				
Frequency Response	PASS	PASS	PASS				
Signal Quality (dB)	49.99	52.33	48.11				

8 Summary Test Results

Result For GSM & WCDMA & LTE & Wi-Fi (OTT VoIP)

Mode	Channel / Frequency (MHz)	Probe Orientation	ABM1≥-18 (dB A/m)	ABM2 [dB(A/m)]	Ambient Noise [dB (A/m)]	ABM SNR (dB)	Freq. Resp. Diff (dB)	Frequency Response	Category	Plot No.
GSM 850 Google Duo 6kbps	190/836.6	Y-axial	-1.07	-50.25	-58.31	49.18	/	/	T4	1
		Z-axial	5.43	-44.68	-58.87	50.11	0.35	Pass	T4	2
PCS 1900 Google Duo 6kbps	661/1880	Y-axial	-5.58	-45.79	-58.31	40.21	/	/	T4	3
		Z-axial	1.96	-49.76	-58.87	51.72	0.24	Pass	T4	4
WCDMA B2 Google Duo 6kbps	9400/1880	Y-axial	-6.36	-46.86	-58.31	40.50	/	/	T4	5
		Z-axial	2.59	-50.00	-58.87	52.59	0.06	Pass	T4	6
WCDMA B4 Google Duo 6kbps	1413/1732.6	Y-axial	-8.65	-47.63	-58.31	38.98	/	/	T4	7
		Z-axial	3.08	-48.54	-58.87	51.62	0.32	Pass	T4	8
WCDMA B5 Google Duo 6kbps	4183/836.6	Y-axial	-8.99	-48.32	-58.31	39.33	/	/	T4	9
		Z-axial	5.91	-50.07	-58.87	55.98	0.03	Pass	T4	10
LTE FDD B12 Google Duo 6kbps	23095/707.5 (QPSK_10M_Full RB_0 offset)	Y-axial	-4.71	-44.48	-58.31	39.77	/	/	T4	11
		Z-axial	2.59	-48.72	-58.87	51.31	0.78	Pass	T4	12
LTE FDD B25 Google Duo 6kbps	26365/1882.5 (QPSK_20M_Full RB_0 offset)	Y-axial	-5.47	-44.91	-58.31	39.44	/	/	T4	13
		Z-axial	-2.60	-46.43	-58.87	43.83	0.24	Pass	T4	14
LTE FDD B25 Google Duo 6kbps (Second supply)	26365/1882.5 (QPSK_20M_Full RB_0 offset)	Y-axial	-1.54	-46.51	-58.31	44.97	/	/	T4	15
		Z-axial	6.59	-45.94	-58.87	52.53	0.57	Pass	T4	16
LTE FDD B26 Google Duo 6kbps	26865/831.5 (QPSK_15M_Full RB_0 offset)	Y-axial	-5.53	-46.46	-58.31	40.93	/	/	T4	17
		Z-axial	2.14	-49.40	-58.87	51.54	0.97	pass	T4	18
LTE TDD B41 Google Duo 6kbps	40620/2593 (QPSK_20M_Full RB_0 offset)	Y-axial	-5.82	-45.22	-58.31	39.40	/	/	T4	19
		Z-axial	4.26	-42.04	-58.87	46.30	0.37	pass	T4	20
LTE FDD B66 Google Duo 6kbps	132322/1745 (QPSK_20M_Full RB_0 offset)	Y-axial	-3.48	-44.13	-58.31	40.65	/	/	T4	21
		Z-axial	1.51	-49.23	-58.87	50.74	0.52	pass	T4	22
LTE FDD B71 Google Duo 6kbps	133322/683 (QPSK_20M_Full RB_0 offset)	Y-axial	-4.32	-46.84	-58.31	42.52	/	/	T4	23
		Z-axial	1.68	-49.50	-58.87	51.18	0.12	pass	T4	24
Wi-Fi 2.4G: 802.11b Google Duo 6kbps	6/2437 (BW:20M_Rate:11M)	Y-axial	-5.31	-44.20	-58.31	38.89	/	/	T4	25
		Z-axial	2.38	-45.73	-58.87	48.11	0.20	pass	T4	26
Wi-Fi 2.4G: 802.11g Google Duo 6kbps	6/2437 (BW:20M_Rate:6M)	Y-axial	-6.09	-32.98	-58.31	38.97	/	/	T4	27
		Z-axial	5.99	-52.78	-58.87	48.55	0.08	pass	T4	28

Wi-Fi 2.4G: 802.11n Google Duo 6kbps	6/2437 (BW:20M_ Rate:MCS0)	Y-axial	-4.23	-42.53	-58.31	38.30	/	/	T4	29
		Z-axial	5.45	-43.50	-58.87	48.95	0.20	pass	T4	30
Wi-Fi 5G: 802.11a (U-NII-1) Google Duo 6kbps	40/5200 (BW:20M_ Rate:6M)	Y-axial	-6.47	-46.45	-58.31	39.98	/	/	T4	31
		Z-axial	2.65	-49.77	-58.87	52.42	0.38	pass	T4	32
Wi-Fi 5G: 802.11a (U-NII-2A) Google Duo 6kbps	60/5300 (BW:20M_ Rate:6M)	Y-axial	-9.62	-48.22	-58.31	38.60	/	/	T4	33
		Z-axial	6.53	-37.73	-58.87	44.26	0.67	pass	T4	34
Wi-Fi 5G: 802.11a (U-NII-2A) Google Duo 6kbps (Second supply)	60/5300 (BW:20M_ Rate:6M)	Y-axial	-0.99	-45.47	-58.31	44.48	/	/	T4	35
		Z-axial	3.13	-49.55	-58.87	52.68	0.87	pass	T4	36
Wi-Fi 5G: 802.11a (U-NII-2C) Google Duo 6kbps	116/5580 (BW:20M_ Rate:6M)	Y-axial	-5.58	-46.50	-58.31	40.92	/	/	T4	37
		Z-axial	2.81	-49.75	-58.87	52.56	0.10	pass	T4	38
Wi-Fi 5G: 802.11a (U-NII-3) Google Duo 6kbps	157/5785 (BW:20M_ Rate:6M)	Y-axial	-3.75	-44.39	-58.31	40.64	/	/	T4	39
		Z-axial	1.54	-49.59	-58.87	51.13	0.08	pass	T4	40

Note: 1. The LCD backlight is turn off and volume is adjusted to maximum level during T-Coil testing.

2. Signal strength measurement scan plots are presented in Annex B.

9 Measurement Uncertainty

Measurement uncertainty evaluation template for DUT HAC T-Coil test

Error source	Type	Uncertainty Value a_i (%)	Prob. Dist.	k	ABM1 c_i	ABM2 c_i	Std. Unc. ABM1 (\pm %)	Std. Unc. ABM2 (\pm %)	Degree of freedom V_{eff} or v_i
Probe Sensitivity									
Reference Level	B	3.0	N	1	1	1	3.0	3.0	∞
AMCC Geometry	B	0.4	R	1.732	1	1	0.2	0.2	∞
AMCC Current	B	0.6	R	1.732	1	1	0.3	0.3	∞
Probe Positioning during Calibration	B	0.1	R	1.732	1	1	0.1	0.1	∞
Noise Contribution	B	0.7	R	1.732	0.0143	1	0.0	0.4	∞
Frequency Slope	B	5.9	R	1.732	0.1	1	0.3	3.4	∞
Probe System									
Repeatability / Drift	B	1.0	R	1.732	1	1	0.6	0.6	∞
Linearity / Dynamic Range	B	0.6	R	1.732	1	1	0.3	0.3	∞
Acoustic Noise	B	1.0	R	1.732	0.1	1	0.1	0.6	∞
Probe Angle	B	2.3	R	1.732	1	1	1.3	1.3	∞
Spectral Processing	B	0.9	R	1.732	1	1	0.5	0.5	∞
Integration Time	B	0.6	N	1	1	5	0.6	3.0	∞
Field Distribution	B	0.2	R	1.732	1	1	0.1	0.1	∞
Test Signal									
Ref.Signal Spectral Response	B	0.6	R	1.732	0	1	0.0	0.3	∞
Positioning									
Probe Positioning	B	1.9	R	1.732	1	1	1.1	1.1	∞
Phantom Thickness	B	0.9	R	1.732	1	1	0.5	0.5	∞
EUT Positioning	B	1.9	R	1.732	1	1	1.1	1.1	∞
External Contributions									
RF Interference	B	0.0	R	1.732	1	0.3	0.0	0.0	∞
Test Signal Variation	B	2.0	R	1.732	1	1	1.2	1.2	∞
Combined Std. Uncertainty (ABM Field)							4.0	6.1	
Expanded Std. Uncertainty							8.0	12.2	

10 Main Test Instruments

Name	Manufacturer	Type	Serial Number	Last Cal.	Cal. Due Date
Audio Magnetic 1D Field Probe	SPEAG	AM1DV3	3082	2023-02-16	2024-02-15
DAE	SPEAG	DAE4	1347	2023-03-08	2024-03-07
Universal Radio Communication Tester	R&S	CMW 500	146734	2023-05-13	2024-05-12
Audio Magnetic Calibration Coil	SPEAG	AMCC	1101	/	/
Hygrothermograph	Anymetr	HTC - 1	TA2023A001	2023-05-13	2024-05-12
HAC Phantom	SPEAG	SD HAC P01 BB	1117	/	/
DAC	Sound Devices	USBPre 2	HB1420183010	/	/
Software for Test	Speag	DASY5	/	/	/

ANNEX A: Test Layout



Picture 1: HAC T-Coil System Layout

ANNEX B: Graph Results

Plot 1 T-Coil GSM 850 Y transversal

Date: 2023/6/1

Communication System: UID 10021 - DAC, GSM-FDD (TDMA, GMSK); Frequency: 836.6 MHz; Duty Cycle: 1:8.69961

Medium parameters used: $\sigma = 0$ S/m, $\epsilon_r = 1$; $\rho = 1$ kg/m³

Ambient Temperature: 22.3 °C Liquid Temperature: 21.5 °C

Phantom section: TCoil Section

DASY5 Configuration:

Sensor-Surface: 0mm (Mechanical Surface Detection)

Probe: AM1DV3 - 3082; Calibrated: 2023/2/16

Electronics: DAE4 Sn1347; Calibrated: 2023/3/8

Phantom: HAC Test Arch with AMCC; Type: SD HAC P01 BA; Serial

Measurement SW: DASY52, Version 52.10 (4); SEMCAD X Version 14.6.14 (7483)

GSM850 HAC_TCoil_WD_Emission - 6kbps/General Scans/y (transversal) 4.2mm 50 x 50/ABM

SNR(x,y,z) (13x13x1): Measurement grid: dx=10mm, dy=10mm

Signal Type: Audio File (.wav) 48k_voice_1kHz_1s.wav

Output Gain: 33.76

Measure Window Start: 300ms

Measure Window Length: 1000ms

BWC applied: 0.17 dB

Device Reference Point: 0, 0, -6.3 mm

Cursor:

ABM1/ABM2 = 49.18 dB

ABM1 comp = -1.07 dBA/m

BWC Factor = 0.17 dB

Location: 4.2, 16.7, 3.7 mm

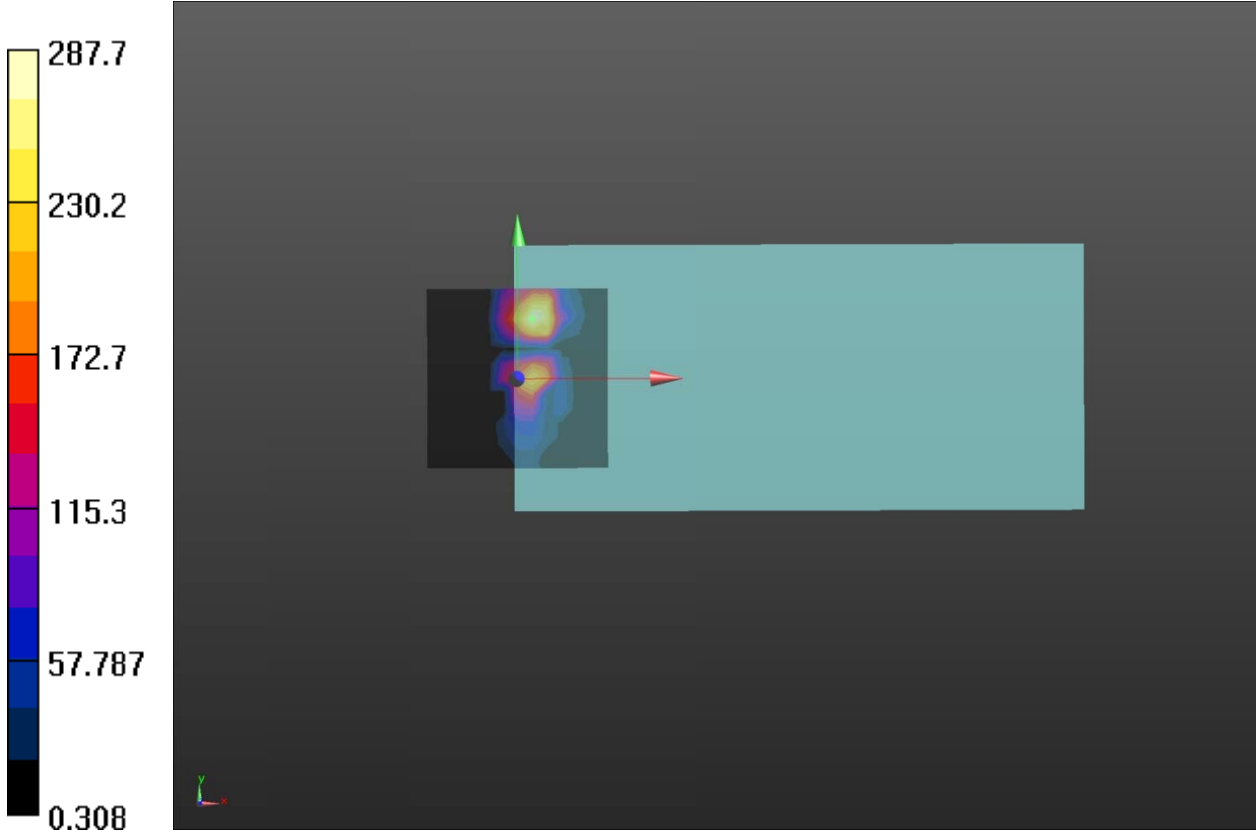

Plot 2 T-Coil GSM 850 Z Axial

Date: 2023/6/1

Communication System: UID 10021 - DAC, GSM-FDD (TDMA, GMSK); Frequency: 836.6 MHz; Duty Cycle: 1:8.69961

Medium parameters used: $\sigma = 0$ S/m, $\epsilon_r = 1$; $\rho = 1$ kg/m³

Ambient Temperature: 22.3 °C Liquid Temperature: 21.5 °C

Phantom section: TCoil Section

DASY5 Configuration:

Sensor-Surface: 0mm (Mechanical Surface Detection)

Probe: AM1DV3 - 3082; Calibrated: 2023/2/16

Electronics: DAE4 Sn1347; Calibrated: 2023/3/8

Phantom: HAC Test Arch with AMCC; Type: SD HAC P01 BA; Serial

Measurement SW: DASY52, Version 52.10 (4); SEMCAD X Version 14.6.14 (7483)

GSM850 HAC_TCoil_WD_Emission/General Scans/z (axial) 4.2mm 50 x 50/ABM SNR(x,y,z)

(13x13x1): Measurement grid: dx=10mm, dy=10mm

Signal Type: Audio File (.wav) 48k_voice_1kHz_1s.wav

Output Gain: 33.76

Measure Window Start: 300ms

Measure Window Length: 1000ms

BWC applied: 0.17 dB

Device Reference Point: 0, 0, -6.3 mm

Cursor:

ABM1/ABM2 = 50.11 dB

ABM1 comp = 5.43 dBA/m

BWC Factor = 0.17 dB

Location: 4.2, 8.3, 3.7 mm

GSM850 HAC_TCoil_WD_Emission/General Scans/z (axial) wideband at best S/N/ABM Freq

Resp(x,y,z,f) (1x1x1): Measurement grid: dx=10mm, dy=10mm

Signal Type: Audio File (.wav) 48k_voice_300-3000_2s.wav

Output Gain: 66.12

Measure Window Start: 300ms

Measure Window Length: 2000ms

BWC applied: 10.81 dB

Device Reference Point: 0, 0, -6.3 mm

Cursor:

Diff = 0.35 dB

BWC Factor = 10.81 dB

Location: 4.2, 8.3, 3.7 mm

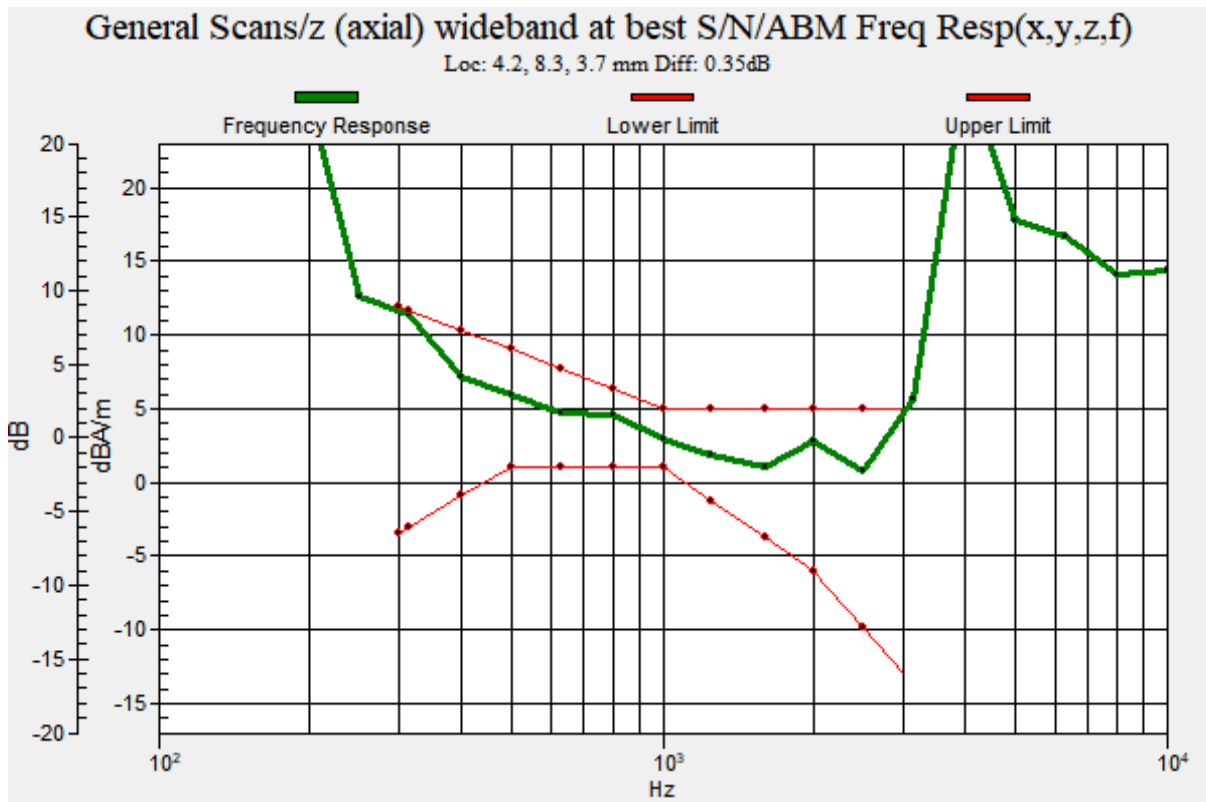
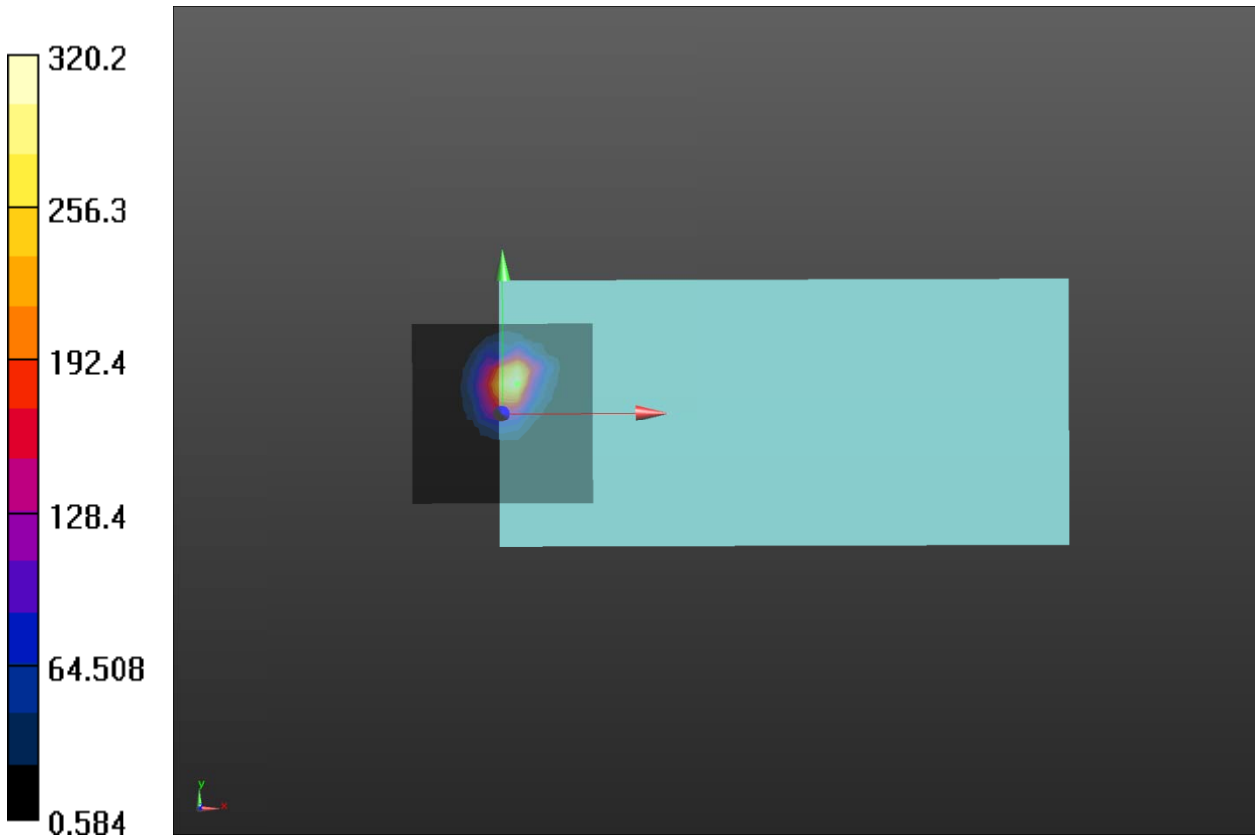

Plot 3 T-Coil GSM 1900 Y transversal

Date: 2023/6/1

Communication System: UID 10021 - DAC, GSM-FDD (TDMA, GMSK); Frequency: 1880 MHz; Duty Cycle: 1:8.69961

Medium parameters used: $\sigma = 0$ S/m, $\epsilon_r = 1$; $\rho = 1$ kg/m³

Ambient Temperature: 22.3 °C Liquid Temperature: 21.5 °C

Phantom section: TCoil Section

DASY5 Configuration:

Sensor-Surface: 0mm (Mechanical Surface Detection)

Probe: AM1DV3 - 3082; Calibrated: 2023/2/16

Electronics: DAE4 Sn1347; Calibrated: 2023/3/8

Phantom: HAC Test Arch with AMCC; Type: SD HAC P01 BA; Serial

Measurement SW: DASY52, Version 52.10 (4); SEMCAD X Version 14.6.14 (7483)

GSM1900 HAC_TCoil_WD_Emission/General Scans/y (transversal) 4.2mm 50 x 50/ABM

SNR(x,y,z) (13x13x1): Measurement grid: dx=10mm, dy=10mm

Signal Type: Audio File (.wav) 48k_voice_1kHz_1s.wav

Output Gain: 33.76

Measure Window Start: 300ms

Measure Window Length: 1000ms

BWC applied: 0.17 dB

Device Reference Point: 0, 0, -6.3 mm

Cursor:

ABM1/ABM2 = 40.21 dB

ABM1 comp = -5.58 dBA/m

BWC Factor = 0.17 dB

Location: 0, -4.2, 3.7 mm

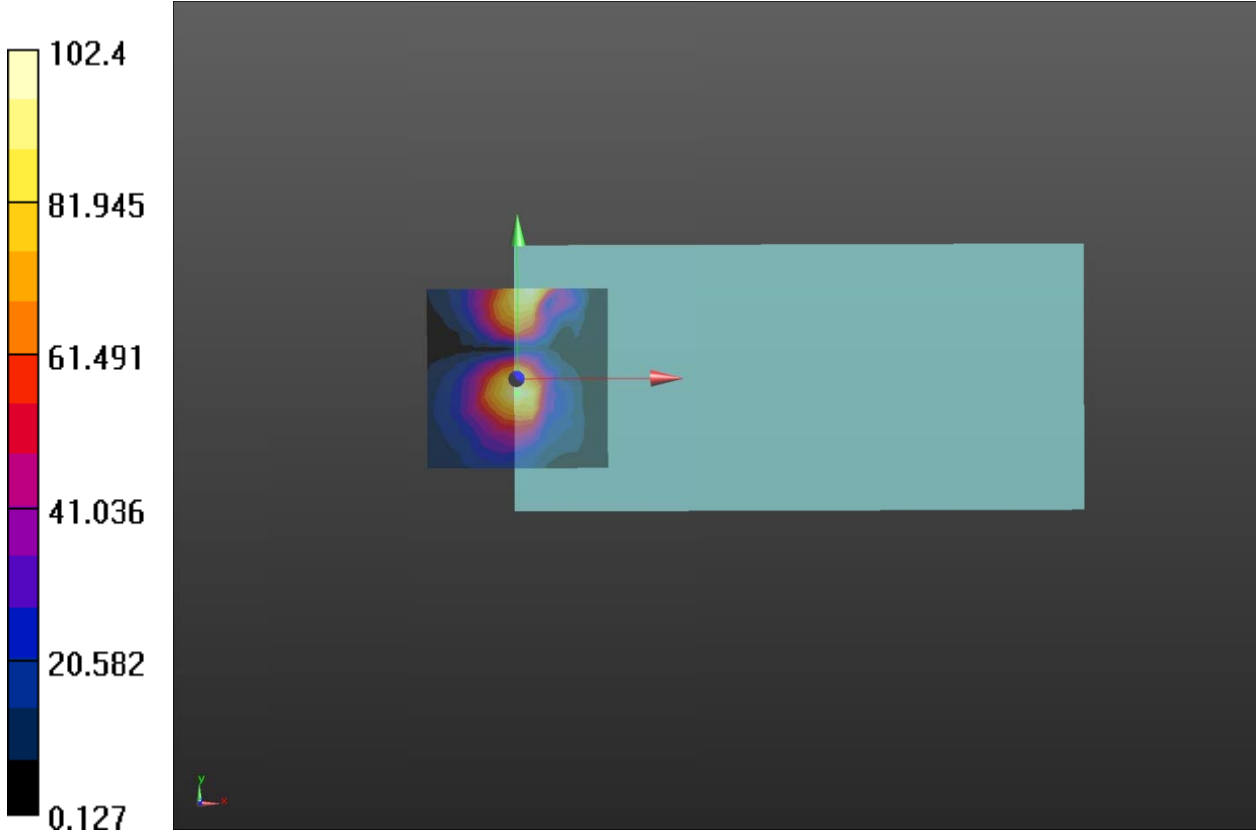

Plot 4 T-Coil GSM 1900 Z Axial

Date: 2023/6/1

Communication System: UID 10021 - DAC, GSM-FDD (TDMA, GMSK); Frequency: 1880 MHz; Duty Cycle: 1:8.69961

Medium parameters used: $\sigma = 0$ S/m, $\epsilon_r = 1$; $\rho = 1$ kg/m³

Ambient Temperature: 22.3 °C Liquid Temperature: 21.5 °C

Phantom section: TCoil Section

DASY5 Configuration:

Sensor-Surface: 0mm (Mechanical Surface Detection)

Probe: AM1DV3 - 3082; Calibrated: 2023/2/16

Electronics: DAE4 Sn1347; Calibrated: 2023/3/8

Phantom: HAC Test Arch with AMCC; Type: SD HAC P01 BA; Serial

Measurement SW: DASY52, Version 52.10 (4); SEMCAD X Version 14.6.14 (7483)

GSM1900 HAC_TCoil_WD_Emission/General Scans/z (axial) 4.2mm 50 x 50/ABM SNR(x,y,z)

(13x13x1): Measurement grid: dx=10mm, dy=10mm

Signal Type: Audio File (.wav) 48k_voice_1kHz_1s.wav

Output Gain: 33.76

Measure Window Start: 300ms

Measure Window Length: 1000ms

BWC applied: 0.17 dB

Device Reference Point: 0, 0, -6.3 mm

Cursor:

ABM1/ABM2 = 51.72 dB

ABM1 comp = 1.96 dBA/m

BWC Factor = 0.17 dB

Location: 0, 8.3, 3.7 mm

GSM1900 HAC_TCoil_WD_Emission/General Scans/z (axial) wideband at best S/N/ABM Freq

Resp(x,y,z,f) (1x1x1): Measurement grid: dx=10mm, dy=10mm

Signal Type: Audio File (.wav) 48k_voice_300-3000_2s.wav

Output Gain: 66.12

Measure Window Start: 300ms

Measure Window Length: 2000ms

BWC applied: 10.81 dB

Device Reference Point: 0, 0, -6.3 mm

Cursor:

Diff = 0.24 dB

BWC Factor = 10.81 dB

Location: 0, 8.3, 3.7 mm

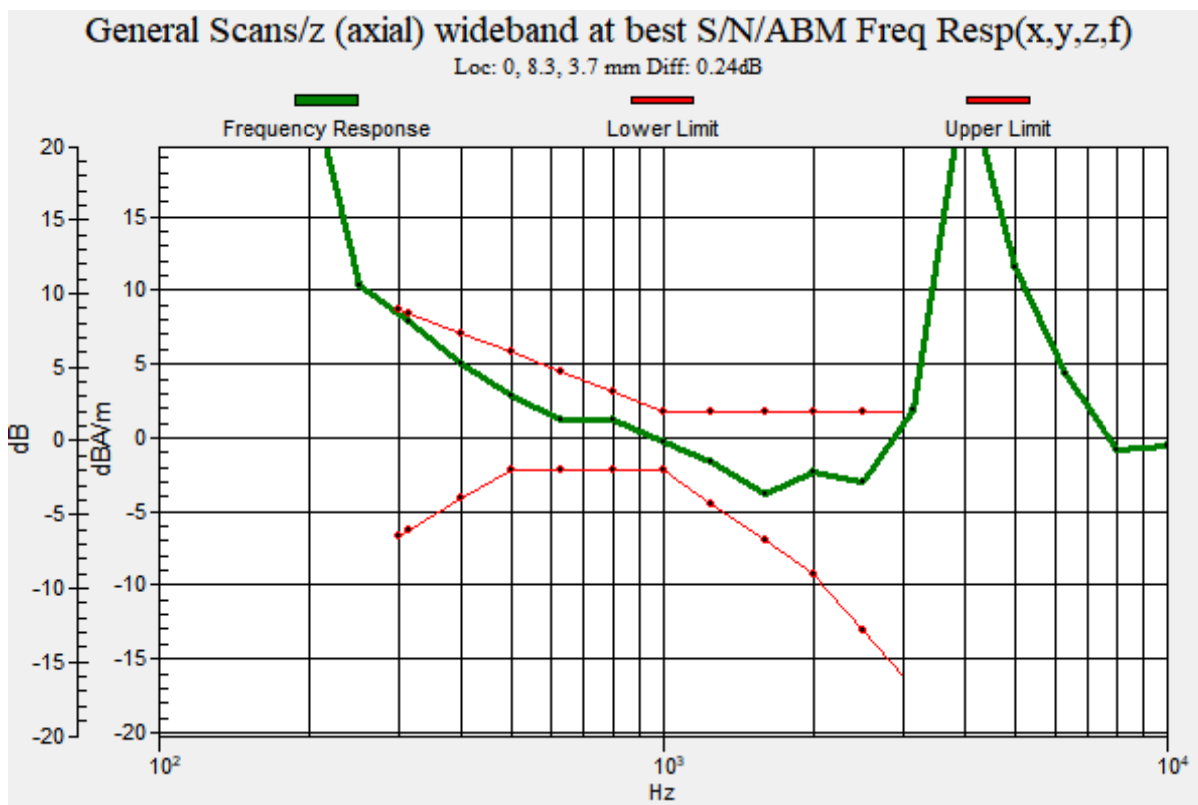
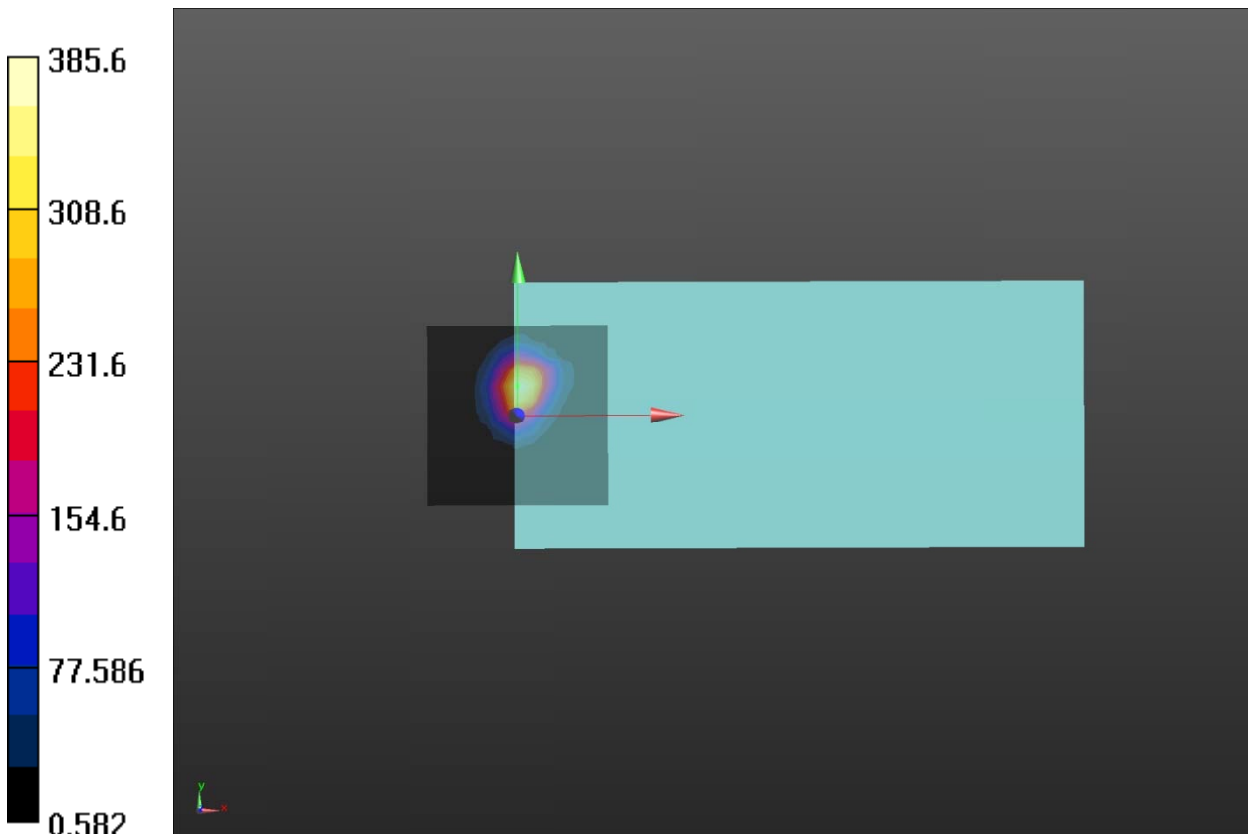

Plot 5 T-Coil WCDMA Band II Y transversal

Date: 2023/6/1

Communication System: UID 10011 - CAB, UMTS-FDD (WCDMA); Frequency: 1880 MHz; Duty Cycle: 1:1.95434

Medium parameters used: $\sigma = 0$ S/m, $\epsilon_r = 1$; $\rho = 1$ kg/m³

Ambient Temperature: 22.3 °C Liquid Temperature: 21.5 °C

Phantom section: TCoil Section

DASY5 Configuration:

Sensor-Surface: 0mm (Mechanical Surface Detection)

Probe: AM1DV3 - 3082; Calibrated: 2023/2/16

Electronics: DAE4 Sn1347; Calibrated: 2023/3/8

Phantom: HAC Test Arch with AMCC; Type: SD HAC P01 BA; Serial

Measurement SW: DASY52, Version 52.10 (4); SEMCAD X Version 14.6.14 (7483)

WCDMA B2 HAC_TCoil_WD_Emission/General Scans/y (transversal) 4.2mm 50 x 50/ABM

SNR(x,y,z) (13x13x1): Measurement grid: dx=10mm, dy=10mm

Signal Type: Audio File (.wav) 48k_voice_1kHz_1s.wav

Output Gain: 33.76

Measure Window Start: 300ms

Measure Window Length: 1000ms

BWC applied: 0.17 dB

Device Reference Point: 0, 0, -6.3 mm

Cursor:

ABM1/ABM2 = 40.50 dB

ABM1 comp = -6.36 dBA/m

BWC Factor = 0.17 dB

Location: 0, -4.2, 3.7 mm

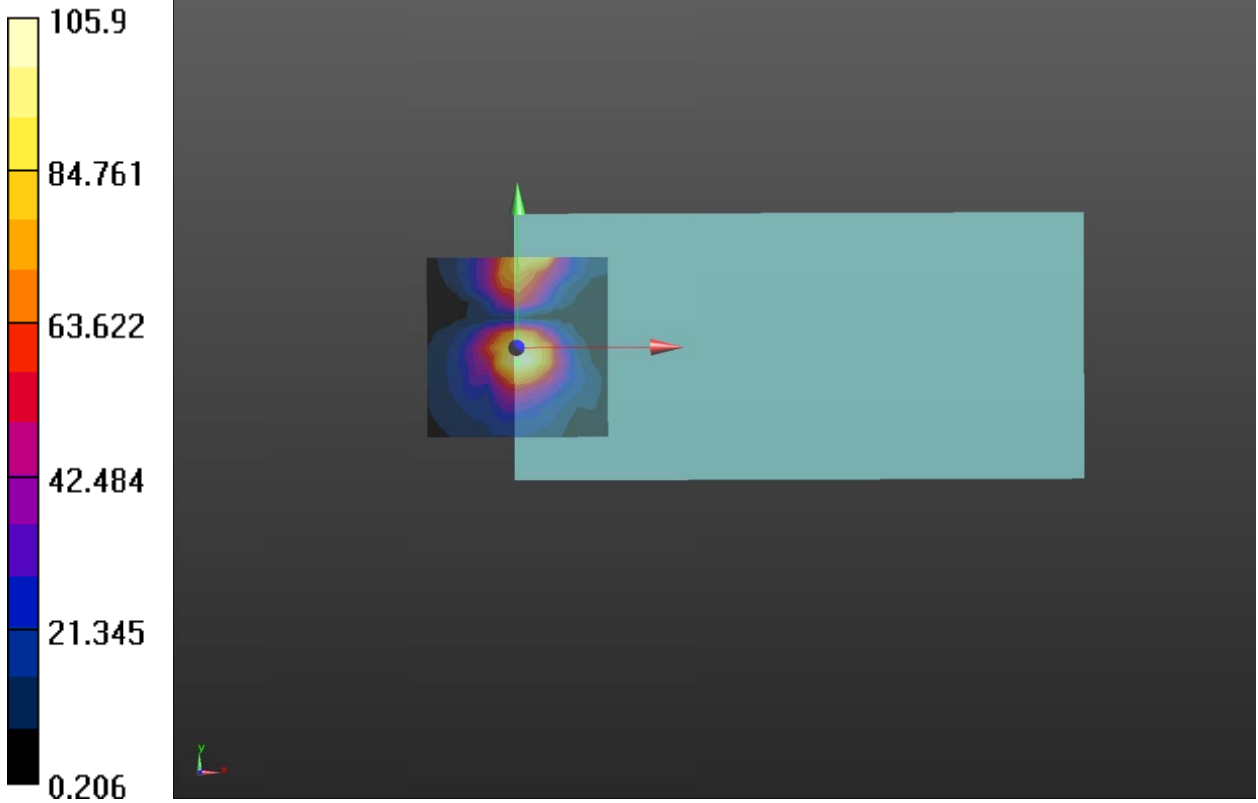

Plot 6 T-Coil WCDMA Band II Z Axial

Date: 2023/6/1

Communication System: UID 10011 - CAB, UMTS-FDD (WCDMA); Frequency: 1880 MHz; Duty Cycle: 1:1.95434

Medium parameters used: $\sigma = 0$ S/m, $\epsilon_r = 1$; $\rho = 1$ kg/m³

Ambient Temperature: 22.3 °C Liquid Temperature: 21.5 °C

Phantom section: TCoil Section

DASY5 Configuration:

Sensor-Surface: 0mm (Mechanical Surface Detection)

Probe: AM1DV3 - 3082; Calibrated: 2023/2/16

Electronics: DAE4 Sn1347; Calibrated: 2023/3/8

Phantom: HAC Test Arch with AMCC; Type: SD HAC P01 BA; Serial

Measurement SW: DASY52, Version 52.10 (4); SEMCAD X Version 14.6.14 (7483)

WCDMA B2 HAC_TCoil_WD_Emission/General Scans/z (axial) 4.2mm 50 x 50/ABM SNR(x,y,z)

(13x13x1): Measurement grid: dx=10mm, dy=10mm

Signal Type: Audio File (.wav) 48k_voice_1kHz_1s.wav

Output Gain: 33.76

Measure Window Start: 300ms

Measure Window Length: 1000ms

BWC applied: 0.17 dB

Device Reference Point: 0, 0, -6.3 mm

Cursor:

ABM1/ABM2 = 52.59 dB

ABM1 comp = 2.59 dBA/m

BWC Factor = 0.17 dB

Location: 0, 8.3, 3.7 mm

WCDMA B2 HAC_TCoil_WD_Emission/General Scans/z (axial) wideband at best S/N/ABM Freq

Resp(x,y,z,f) (1x1x1): Measurement grid: dx=10mm, dy=10mm

Signal Type: Audio File (.wav) 48k_voice_300-3000_2s.wav

Output Gain: 66.12

Measure Window Start: 300ms

Measure Window Length: 2000ms

BWC applied: 10.81 dB

Device Reference Point: 0, 0, -6.3 mm

Cursor:

Diff = 0.06 dB

BWC Factor = 10.81 dB

Location: 0, 8.3, 3.7 mm

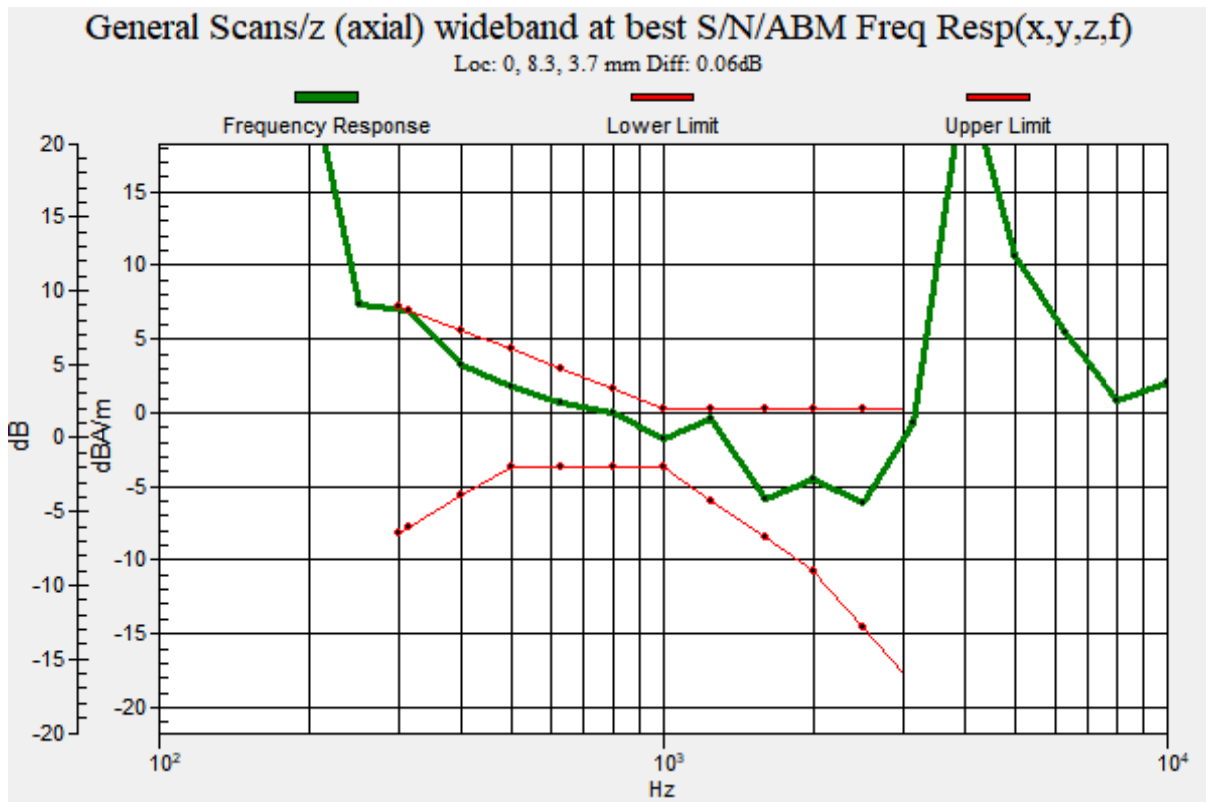
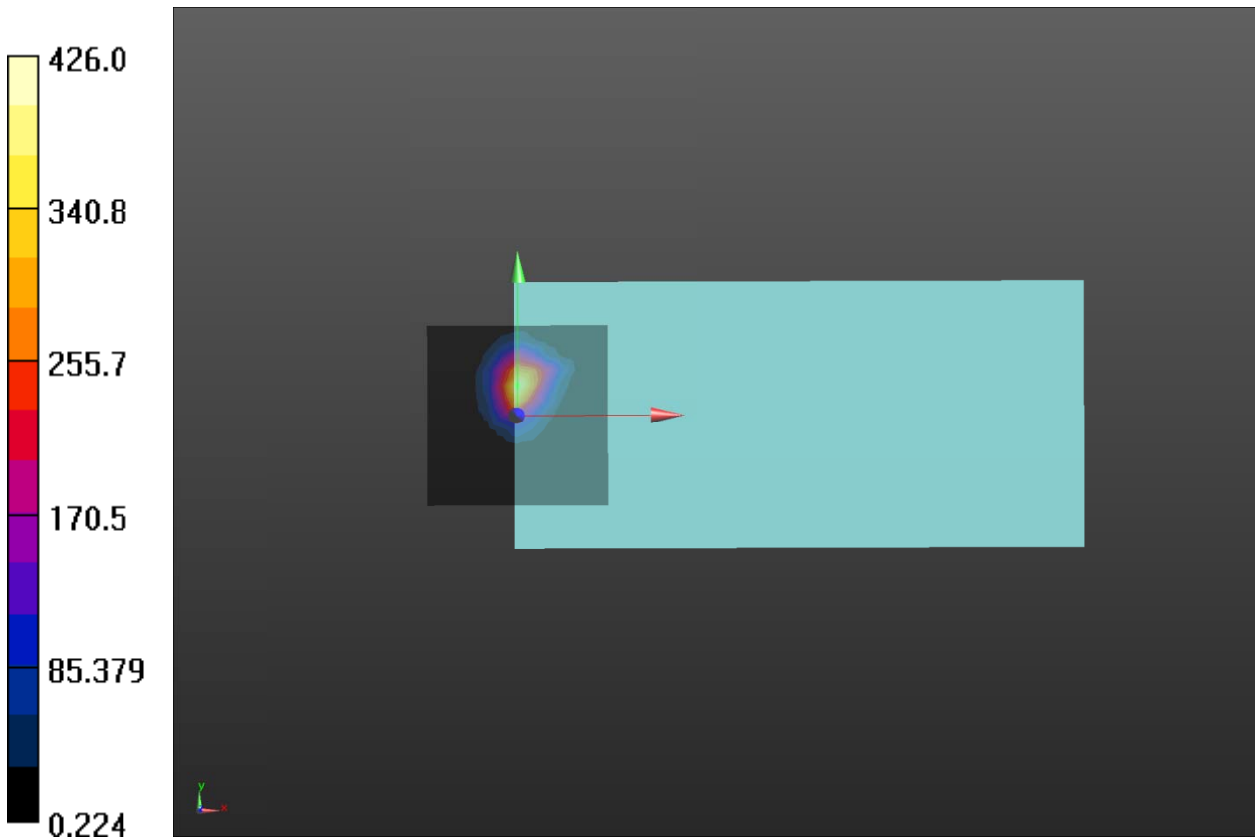

Plot 7 T-Coil WCDMA Band IV Y transversal

Date: 2023/6/1

Communication System: UID 10011 - CAB, UMTS-FDD (WCDMA); Frequency: 1732.6 MHz; Duty Cycle: 1:1.95434

Medium parameters used: $\sigma = 0 \text{ S/m}$, $\epsilon_r = 1$; $\rho = 1 \text{ kg/m}^3$

Ambient Temperature: 22.3 °C Liquid Temperature: 21.5 °C

Phantom section: TCoil Section

DASY5 Configuration:

Sensor-Surface: 0mm (Mechanical Surface Detection)

Probe: AM1DV3 - 3082; Calibrated: 2023/2/16

Electronics: DAE4 Sn1347; Calibrated: 2023/3/8

Phantom: HAC Test Arch with AMCC; Type: SD HAC P01 BA; Serial

Measurement SW: DASY52, Version 52.10 (4); SEMCAD X Version 14.6.14 (7483)

WCDMA B4 HAC_TCoil_WD_Emission/General Scans/y (transversal) 4.2mm 50 x 50/ABM

SNR(x,y,z) (13x13x1): Measurement grid: dx=10mm, dy=10mm

Signal Type: Audio File (.wav) 48k_voice_1kHz_1s.wav

Output Gain: 33.76

Measure Window Start: 300ms

Measure Window Length: 1000ms

BWC applied: 0.17 dB

Device Reference Point: 0, 0, -6.3 mm

Cursor:

ABM1/ABM2 = 38.98 dB

ABM1 comp = -8.65 dBA/m

BWC Factor = 0.17 dB

Location: 0, 25, 3.7 mm

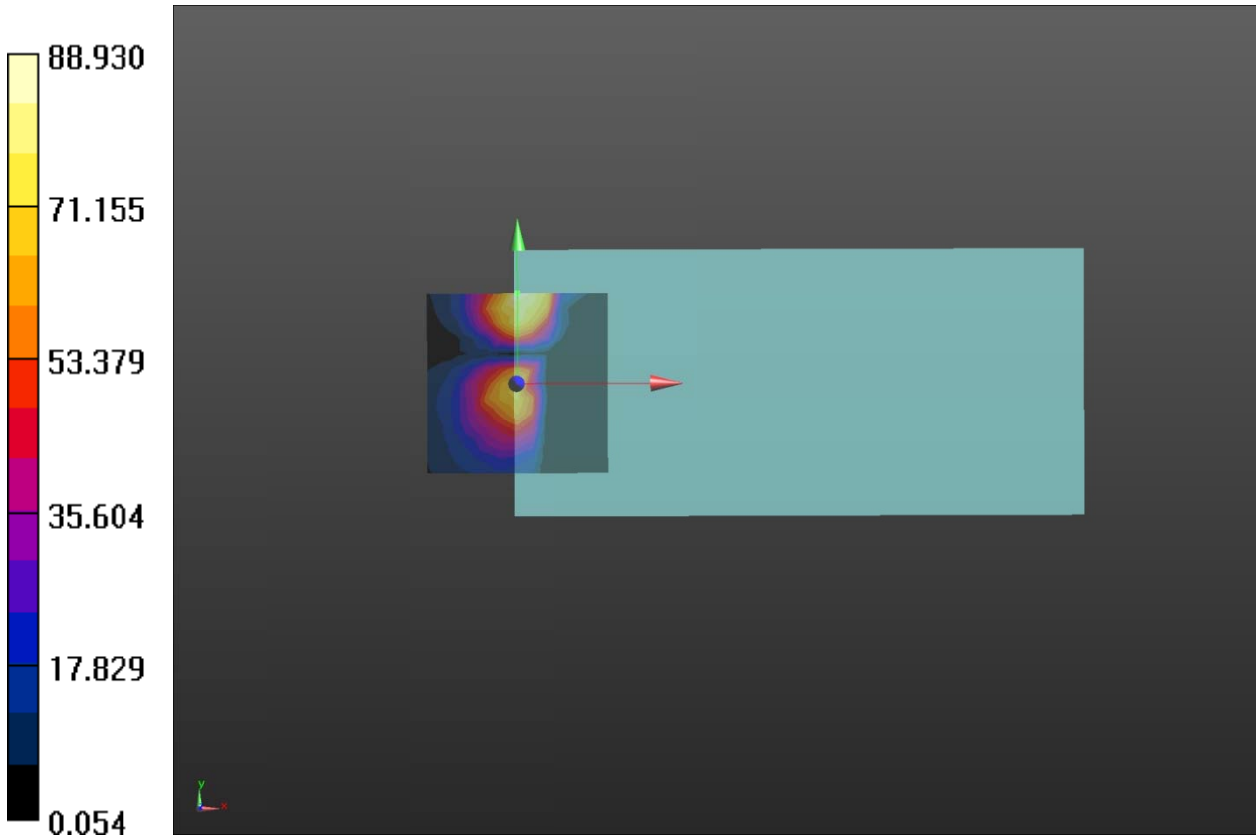

Plot 8 T-Coil WCDMA Band IV Z Axial

Date: 2023/6/1

Communication System: UID 10011 - CAB, UMTS-FDD (WCDMA); Frequency: 1732.6 MHz; Duty Cycle: 1:1.95434

Medium parameters used: $\sigma = 0$ S/m, $\epsilon_r = 1$; $\rho = 1$ kg/m³

Ambient Temperature: 22.3 °C Liquid Temperature: 21.5 °C

Phantom section: TCoil Section

DASY5 Configuration:

Sensor-Surface: 0mm (Mechanical Surface Detection)

Probe: AM1DV3 - 3082; Calibrated: 2023/2/16

Electronics: DAE4 Sn1347; Calibrated: 2023/3/8

Phantom: HAC Test Arch with AMCC; Type: SD HAC P01 BA; Serial

Measurement SW: DASY52, Version 52.10 (4); SEMCAD X Version 14.6.14 (7483)

WCDMA B4 HAC_TCoil_WD_Emission/General Scans/z (axial) 4.2mm 50 x 50/ABM SNR(x,y,z)

(13x13x1): Measurement grid: dx=10mm, dy=10mm

Signal Type: Audio File (.wav) 48k_voice_1kHz_1s.wav

Output Gain: 33.76

Measure Window Start: 300ms

Measure Window Length: 1000ms

BWC applied: 0.17 dB

Device Reference Point: 0, 0, -6.3 mm

Cursor:

ABM1/ABM2 = 51.62 dB

ABM1 comp = 3.08 dBA/m

BWC Factor = 0.17 dB

Location: 0, 8.3, 3.7 mm

WCDMA B4 HAC_TCoil_WD_Emission/General Scans/z (axial) wideband at best S/N/ABM Freq

Resp(x,y,z,f) (1x1x1): Measurement grid: dx=10mm, dy=10mm

Signal Type: Audio File (.wav) 48k_voice_300-3000_2s.wav

Output Gain: 66.12

Measure Window Start: 300ms

Measure Window Length: 2000ms

BWC applied: 10.81 dB

Device Reference Point: 0, 0, -6.3 mm

Cursor:

Diff = 0.32 dB

BWC Factor = 10.81 dB

Location: 0, 8.3, 3.7 mm

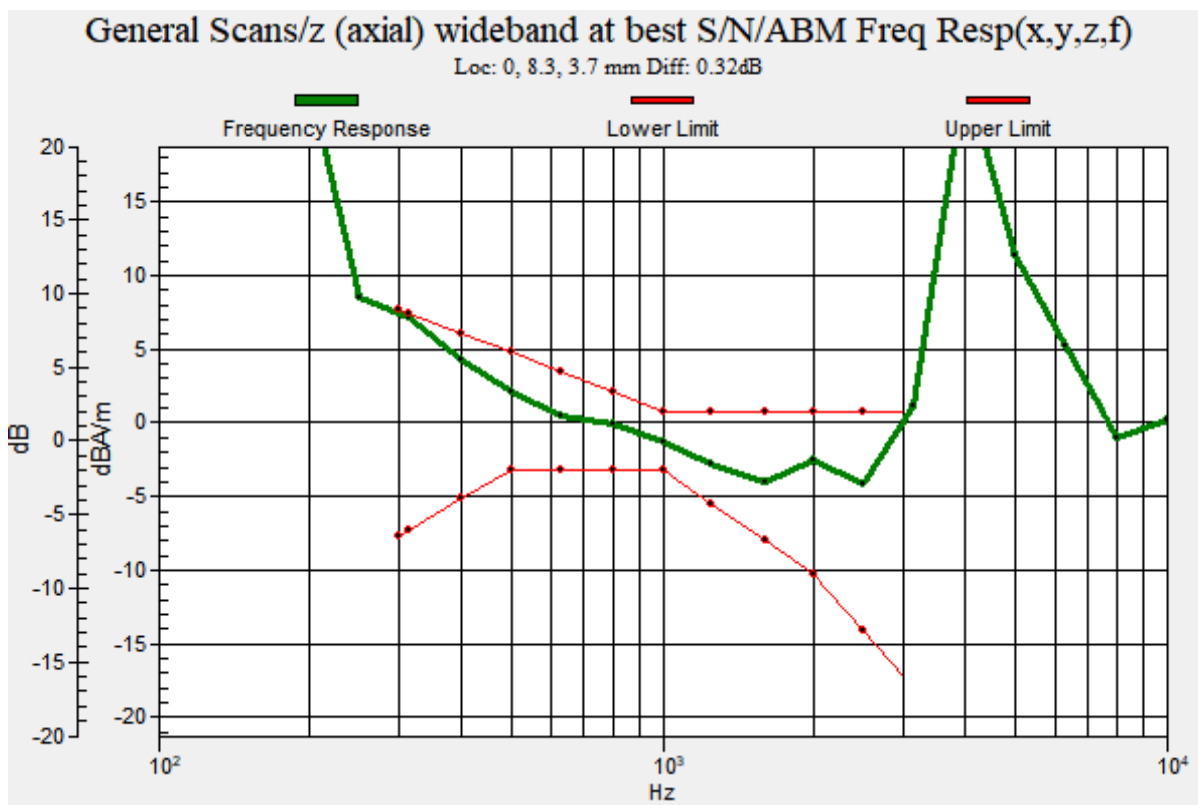
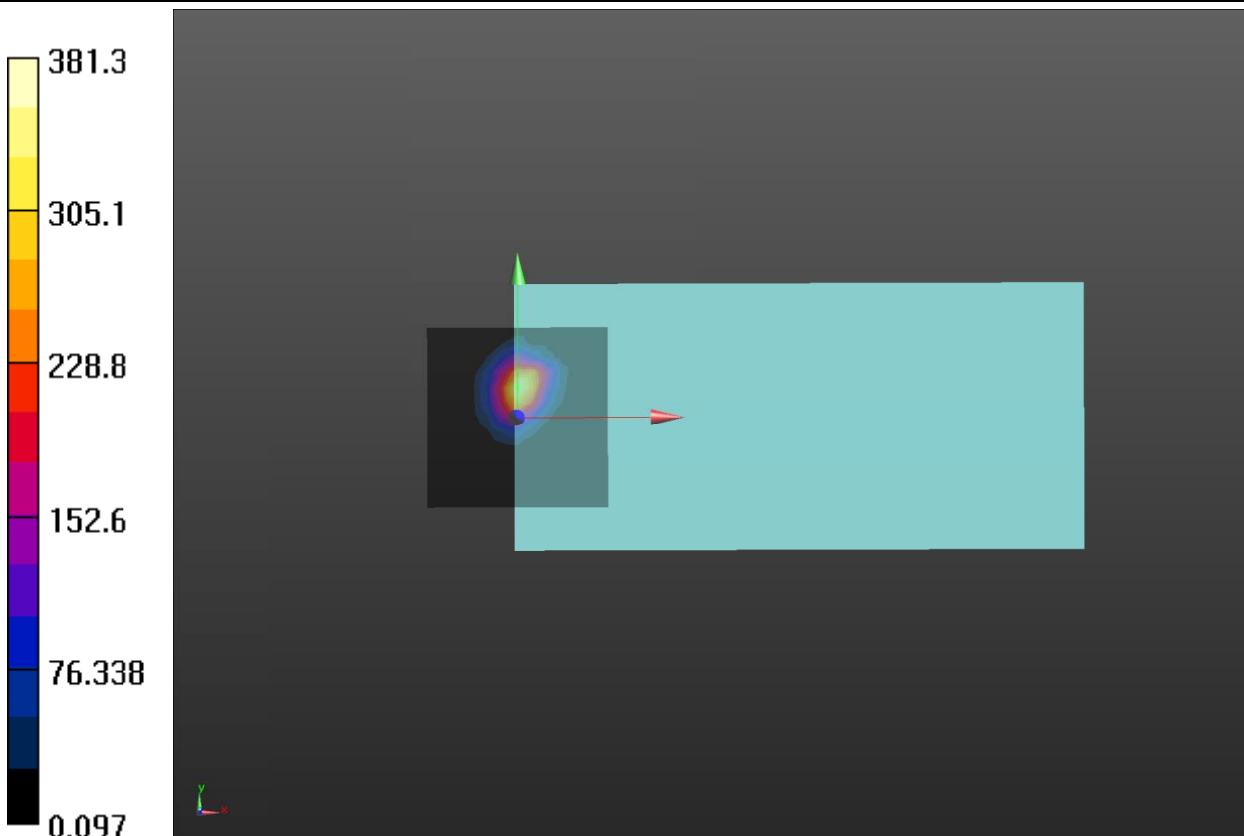

Plot 9 T-Coil WCDMA Band V Y transversal

Date: 2023/6/1

Communication System: UID 10011 - CAB, UMTS-FDD (WCDMA); Frequency: 836.6 MHz; Duty Cycle: 1:1.95434

Medium parameters used: $\sigma = 0$ S/m, $\epsilon_r = 1$; $\rho = 1$ kg/m³

Ambient Temperature: 22.3 °C Liquid Temperature: 21.5 °C

Phantom section: TCoil Section

DASY5 Configuration:

Sensor-Surface: 0mm (Mechanical Surface Detection)

Probe: AM1DV3 - 3082; Calibrated: 2023/2/16

Electronics: DAE4 Sn1347; Calibrated: 2023/3/8

Phantom: HAC Test Arch with AMCC; Type: SD HAC P01 BA; Serial

Measurement SW: DASY52, Version 52.10 (4); SEMCAD X Version 14.6.14 (7483)

WCDMA B5 HAC_TCoil_WD_Emission/General Scans/y (transversal) 4.2mm 50 x 50/ABM**SNR(x,y,z) (13x13x1):** Measurement grid: dx=10mm, dy=10mm

Signal Type: Audio File (.wav) 48k_voice_1kHz_1s.wav

Output Gain: 33.76

Measure Window Start: 300ms

Measure Window Length: 1000ms

BWC applied: 0.17 dB

Device Reference Point: 0, 0, -6.3 mm

Cursor:

ABM1/ABM2 = 39.33 dB

ABM1 comp = -8.99 dBA/m

BWC Factor = 0.17 dB

Location: 0, 25, 3.7 mm

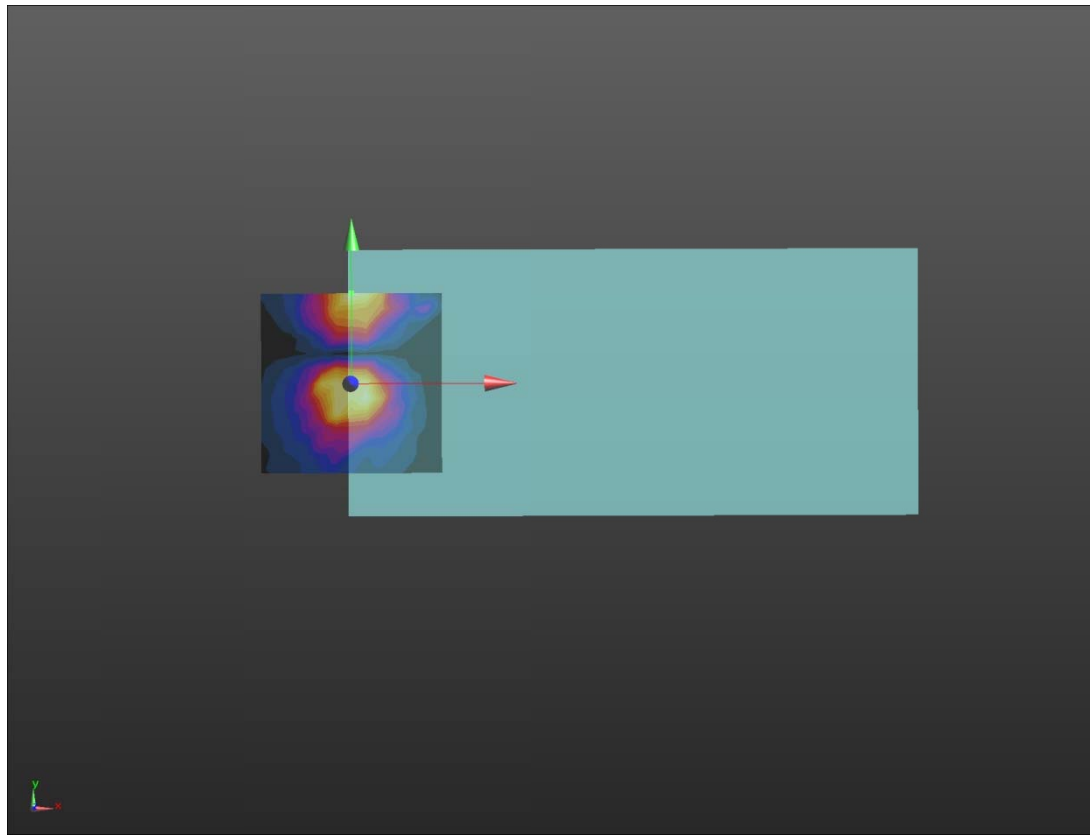
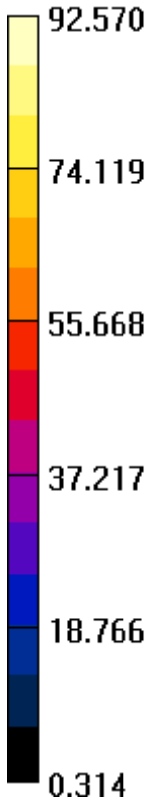

Plot 10 T-Coil WCDMA Band V Z Axial

Date: 2023/6/1

Communication System: UID 10011 - CAB, UMTS-FDD (WCDMA); Frequency: 836.6 MHz; Duty Cycle: 1:1.95434

Medium parameters used: $\sigma = 0$ S/m, $\epsilon_r = 1$; $\rho = 1$ kg/m³

Ambient Temperature: 22.3 °C Liquid Temperature: 21.5 °C

Phantom section: TCoil Section

DASY5 Configuration:

Sensor-Surface: 0mm (Mechanical Surface Detection)

Probe: AM1DV3 - 3082; Calibrated: 2023/2/16

Electronics: DAE4 Sn1347; Calibrated: 2023/3/8

Phantom: HAC Test Arch with AMCC; Type: SD HAC P01 BA; Serial

Measurement SW: DASY52, Version 52.10 (4); SEMCAD X Version 14.6.14 (7483)

WCDMA B5 HAC_TCoil_WD_Emission/General Scans/z (axial) 4.2mm 50 x 50/ABM SNR(x,y,z)

(13x13x1): Measurement grid: dx=10mm, dy=10mm

Signal Type: Audio File (.wav) 48k_voice_1kHz_1s.wav

Output Gain: 33.76

Measure Window Start: 300ms

Measure Window Length: 1000ms

BWC applied: 0.17 dB

Device Reference Point: 0, 0, -6.3 mm

Cursor:

ABM1/ABM2 = 55.98 dB

ABM1 comp = 5.91 dBA/m

BWC Factor = 0.17 dB

Location: 4.2, 8.3, 3.7 mm

WCDMA B5 HAC_TCoil_WD_Emission/General Scans/z (axial) wideband at best S/N/ABM Freq

Resp(x,y,z,f) (1x1x1): Measurement grid: dx=10mm, dy=10mm

Signal Type: Audio File (.wav) 48k_voice_300-3000_2s.wav

Output Gain: 66.12

Measure Window Start: 300ms

Measure Window Length: 2000ms

BWC applied: 10.81 dB

Device Reference Point: 0, 0, -6.3 mm

Cursor:

Diff = 0.03 dB

BWC Factor = 10.81 dB

Location: 4.2, 8.3, 3.7 mm

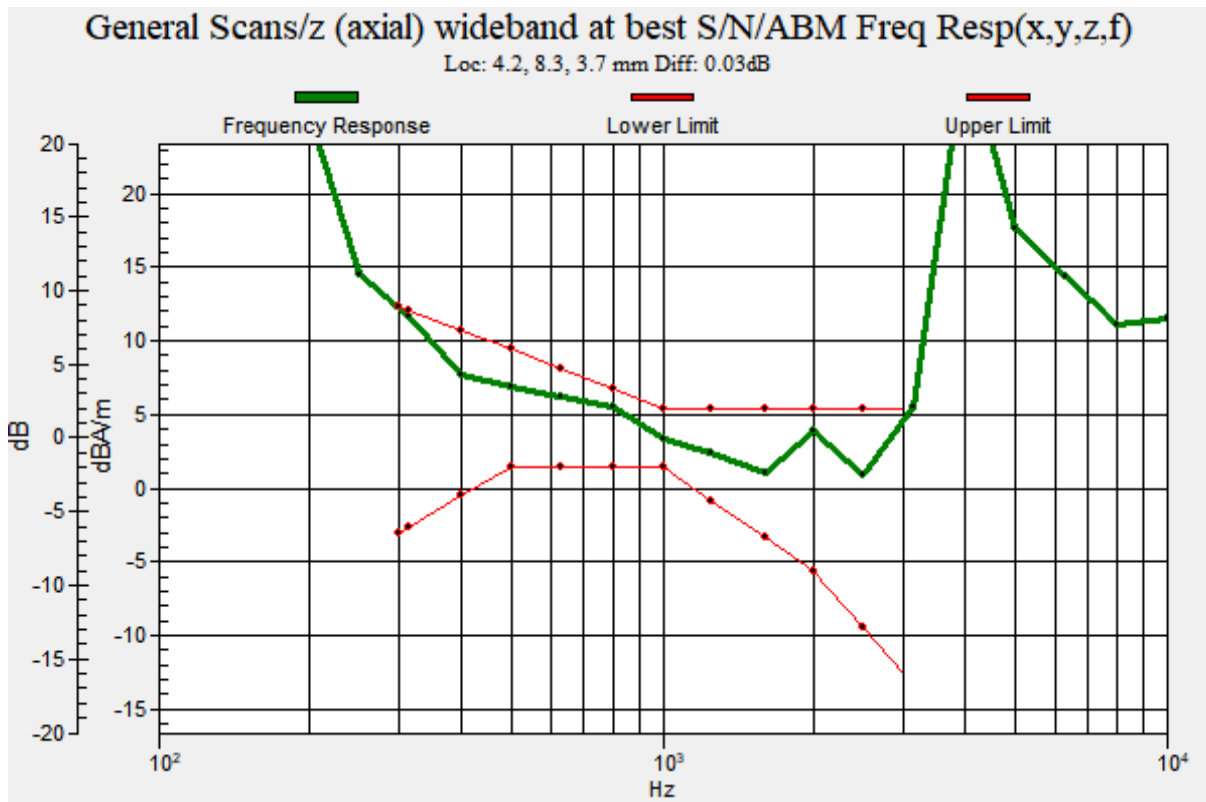
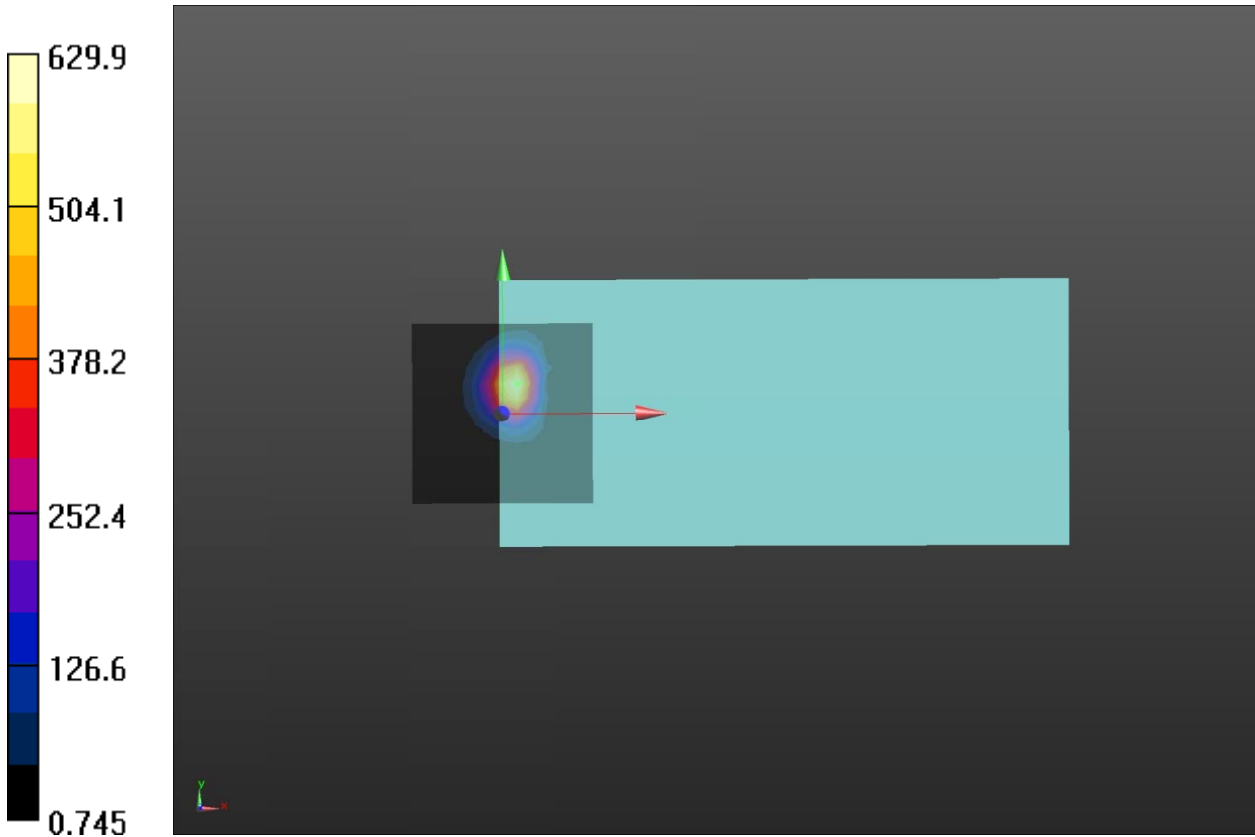

Plot 11 T-Coil LTE Band 12 Y transversal

Date: 2023/5/30

Communication System: UID 10108 - CAG, LTE-FDD (SC-FDMA, 100% RB, 10 MHz, QPSK);

Frequency: 707.5 MHz; Duty Cycle: 1:3.80102

Medium parameters used: $\sigma = 0$ S/m, $\epsilon_r = 1$; $\rho = 1$ kg/m³

Ambient Temperature: 22.3 °C Liquid Temperature: 21.5 °C

Phantom section: TCoil Section

DASY5 Configuration:

Sensor-Surface: 0mm (Mechanical Surface Detection)

Probe: AM1DV3 - 3082; Calibrated: 2023/2/16

Electronics: DAE4 Sn1347; Calibrated: 2023/3/8

Phantom: HAC Test Arch with AMCC; Type: SD HAC P01 BA; Serial

Measurement SW: DASY52, Version 52.10 (4); SEMCAD X Version 14.6.14 (7483)

LTE B12 100%RB HAC_TCoil_WD_Emission/General Scans/y (transversal) 4.2mm 50 x

50/ABM SNR(x,y,z) (13x13x1): Measurement grid: dx=10mm, dy=10mm

Signal Type: Audio File (.wav) 48k_voice_1kHz_1s.wav

Output Gain: 33.76

Measure Window Start: 300ms

Measure Window Length: 1000ms

BWC applied: 0.17 dB

Device Reference Point: 0, 0, -6.3 mm

Cursor:

ABM1/ABM2 = 39.77 dB

ABM1 comp = -4.71 dBA/m

BWC Factor = 0.17 dB

Location: 4.2, -4.2, 3.7 mm

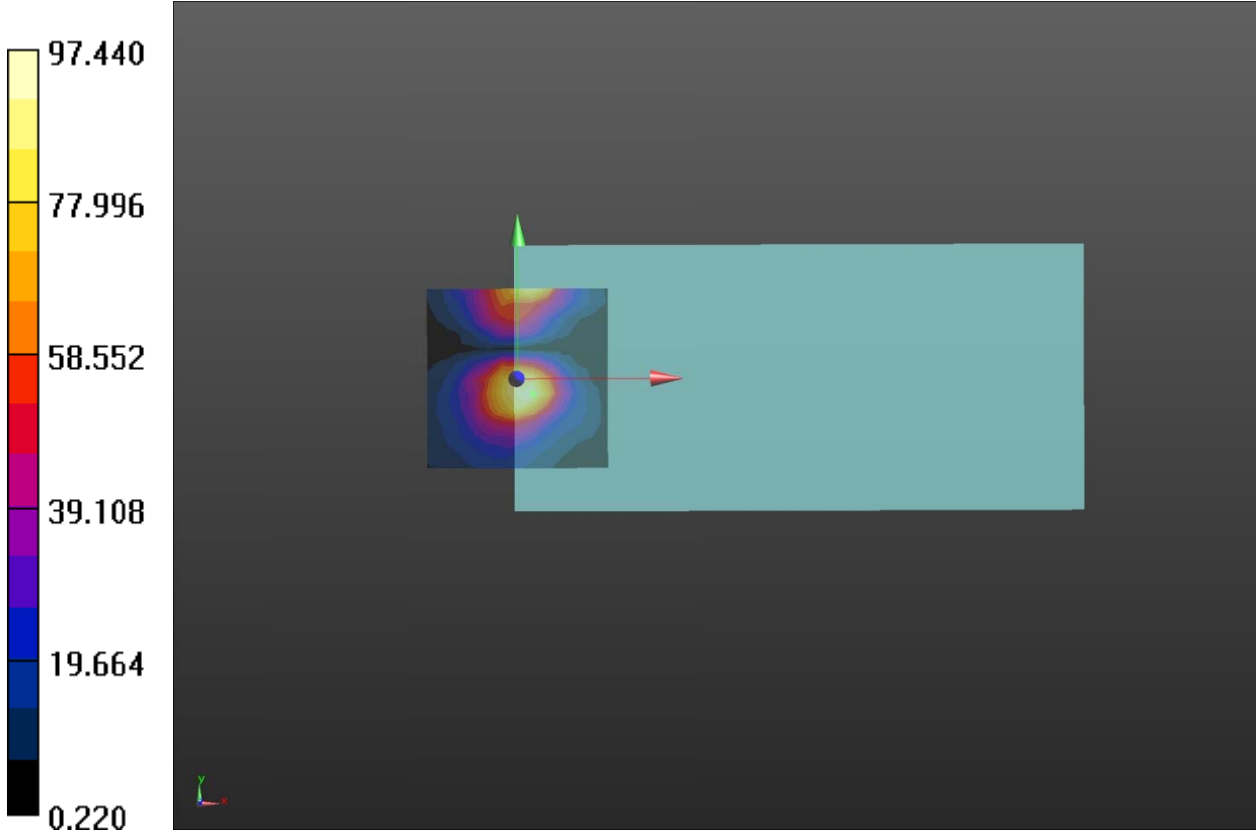

Plot 12 T-Coil LTE Band 12 Z Axial

Date: 2023/5/30

Communication System: UID 10108 - CAG, LTE-FDD (SC-FDMA, 100% RB, 10 MHz, QPSK);

Frequency: 707.5 MHz; Duty Cycle: 1:3.80102

Medium parameters used: $\sigma = 0$ S/m, $\epsilon_r = 1$; $\rho = 1$ kg/m³

Ambient Temperature: 22.3 °C Liquid Temperature: 21.5 °C

Phantom section: TCoil Section

DASY5 Configuration:

Sensor-Surface: 0mm (Mechanical Surface Detection)

Probe: AM1DV3 - 3082; Calibrated: 2023/2/16

Electronics: DAE4 Sn1347; Calibrated: 2023/3/8

Phantom: HAC Test Arch with AMCC; Type: SD HAC P01 BA; Serial

Measurement SW: DASY52, Version 52.10 (4); SEMCAD X Version 14.6.14 (7483)

LTE B12 100%RB HAC_TCoil_WD_Emission/General Scans/z (axial) 4.2mm 50 x 50/ABM

SNR(x,y,z) (13x13x1): Measurement grid: dx=10mm, dy=10mm

Signal Type: Audio File (.wav) 48k_voice_1kHz_1s.wav

Output Gain: 33.76

Measure Window Start: 300ms

Measure Window Length: 1000ms

BWC applied: 0.17 dB

Device Reference Point: 0, 0, -6.3 mm

Cursor:

ABM1/ABM2 = 51.31 dB

ABM1 comp = 2.59 dBA/m

BWC Factor = 0.17 dB

Location: 0, 8.3, 3.7 mm

LTE B12 100%RB HAC_TCoil_WD_Emission/General Scans/z (axial) wideband at best

S/N/ABM Freq Resp(x,y,z,f) (1x1x1): Measurement grid: dx=10mm, dy=10mm

Signal Type: Audio File (.wav) 48k_voice_300-3000_2s.wav

Output Gain: 66.12

Measure Window Start: 300ms

Measure Window Length: 2000ms

BWC applied: 10.81 dB

Device Reference Point: 0, 0, -6.3 mm

Cursor:

Diff = 0.78 dB

BWC Factor = 10.81 dB

Location: 0, 8.3, 3.7 mm

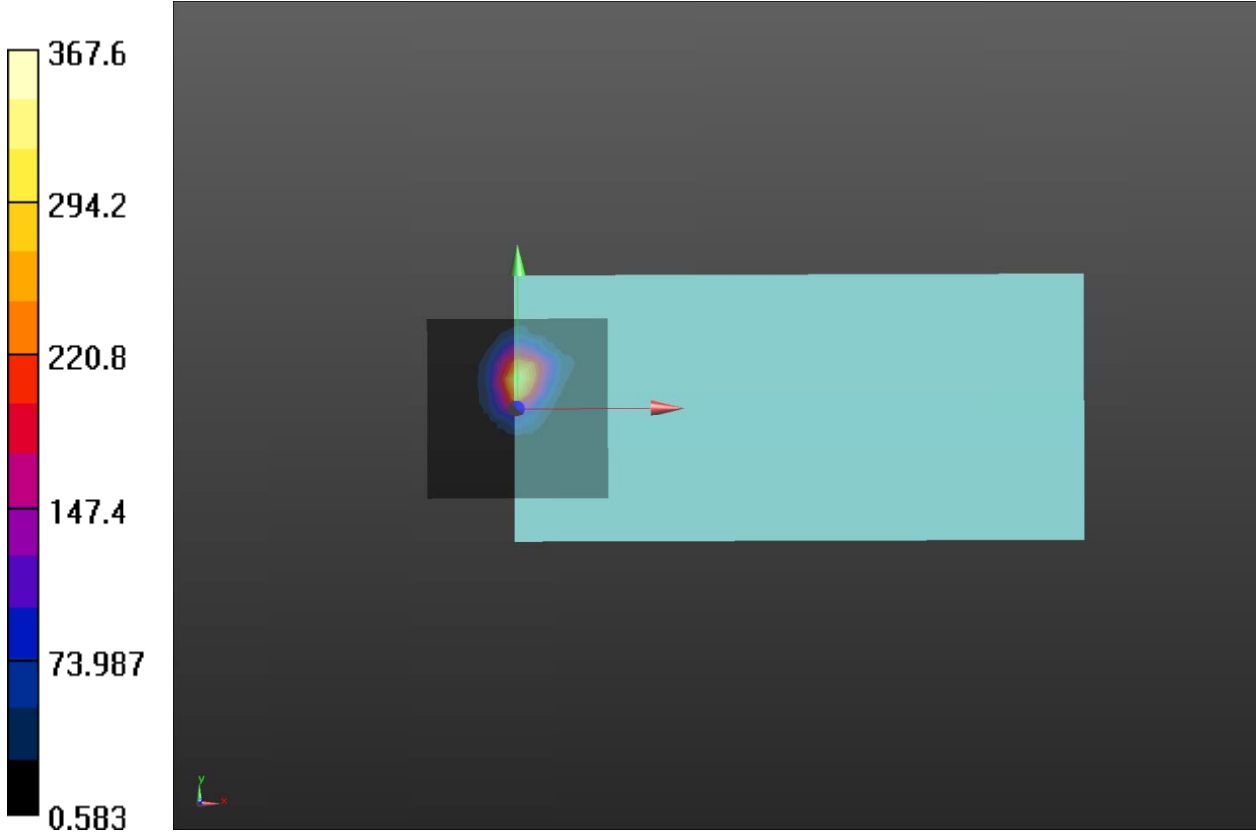

Plot 13 T-Coil LTE Band 25 Y transversal

Date: 2023/5/30

Communication System: UID 10100 - CAE, LTE-FDD (SC-FDMA, 100% RB, 20 MHz, QPSK);

Frequency: 1882.5 MHz; Duty Cycle: 1:3.68638

Medium parameters used: $\sigma = 0$ S/m, $\epsilon_r = 1$; $\rho = 1$ kg/m³

Ambient Temperature: 22.3 °C Liquid Temperature: 21.5 °C

Phantom section: TCoil Section

DASY5 Configuration:

Sensor-Surface: 0mm (Mechanical Surface Detection)

Probe: AM1DV3 - 3082; Calibrated: 2023/2/16

Electronics: DAE4 Sn1347; Calibrated: 2023/3/8

Phantom: HAC Test Arch with AMCC; Type: SD HAC P01 BA; Serial

Measurement SW: DASY52, Version 52.10 (4); SEMCAD X Version 14.6.14 (7483)

LTE B25 100%RB HAC_TCoil_WD_Emission/General Scans/y (transversal) 4.2mm 50 x

50/ABM SNR(x,y,z) (13x13x1): Measurement grid: dx=10mm, dy=10mm

Signal Type: Audio File (.wav) 48k_voice_1kHz_1s.wav

Output Gain: 33.76

Measure Window Start: 300ms

Measure Window Length: 1000ms

BWC applied: 0.17 dB

Device Reference Point: 0, 0, -6.3 mm

Cursor:

ABM1/ABM2 = 39.44 dB

ABM1 comp = -5.47 dBA/m

BWC Factor = 0.17 dB

Location: 0, 0, 3.7 mm

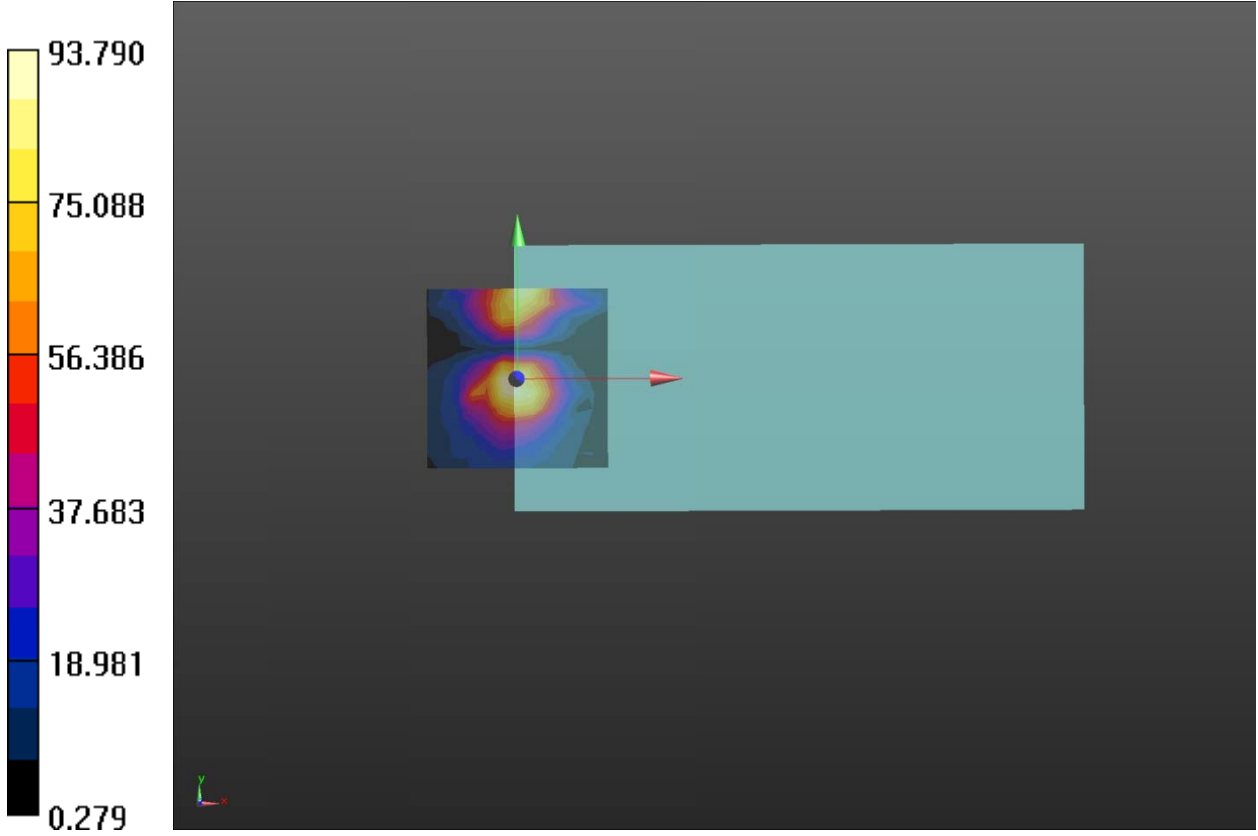

Plot 14 T-Coil LTE Band 25 Z Axial

Date: 2023/5/30

Communication System: UID 10100 - CAE, LTE-FDD (SC-FDMA, 100% RB, 20 MHz, QPSK);

Frequency: 1882.5 MHz; Duty Cycle: 1:3.68638

Medium parameters used: $\sigma = 0$ S/m, $\epsilon_r = 1$; $\rho = 1$ kg/m³

Ambient Temperature: 22.3 °C Liquid Temperature: 21.5 °C

Phantom section: TCoil Section

DASY5 Configuration:

Sensor-Surface: 0mm (Mechanical Surface Detection)

Probe: AM1DV3 - 3082; Calibrated: 2023/2/16

Electronics: DAE4 Sn1347; Calibrated: 2023/3/8

Phantom: HAC Test Arch with AMCC; Type: SD HAC P01 BA; Serial

Measurement SW: DASY52, Version 52.10 (4); SEMCAD X Version 14.6.14 (7483)

LTE B25 100%RB HAC_TCoil_WD_Emission/General Scans/z (axial) 4.2mm 50 x 50/ABM

SNR(x,y,z) (13x13x1): Measurement grid: dx=10mm, dy=10mm

Signal Type: Audio File (.wav) 48k_voice_1kHz_1s.wav

Output Gain: 33.76

Measure Window Start: 300ms

Measure Window Length: 1000ms

BWC applied: 0.17 dB

Device Reference Point: 0, 0, -6.3 mm

Cursor:

ABM1/ABM2 = 43.83 dB

ABM1 comp = -2.60 dBA/m

BWC Factor = 0.17 dB

Location: 4.2, 16.7, 3.7 mm

LTE B25 100%RB HAC_TCoil_WD_Emission/General Scans/z (axial) wideband at best

S/N/ABM Freq Resp(x,y,z,f) (1x1x1): Measurement grid: dx=10mm, dy=10mm

Signal Type: Audio File (.wav) 48k_voice_300-3000_2s.wav

Output Gain: 66.12

Measure Window Start: 300ms

Measure Window Length: 2000ms

BWC applied: 10.81 dB

Device Reference Point: 0, 0, -6.3 mm

Cursor:

Diff = 0.24 dB

BWC Factor = 10.81 dB

Location: 4.2, 16.7, 3.7 mm

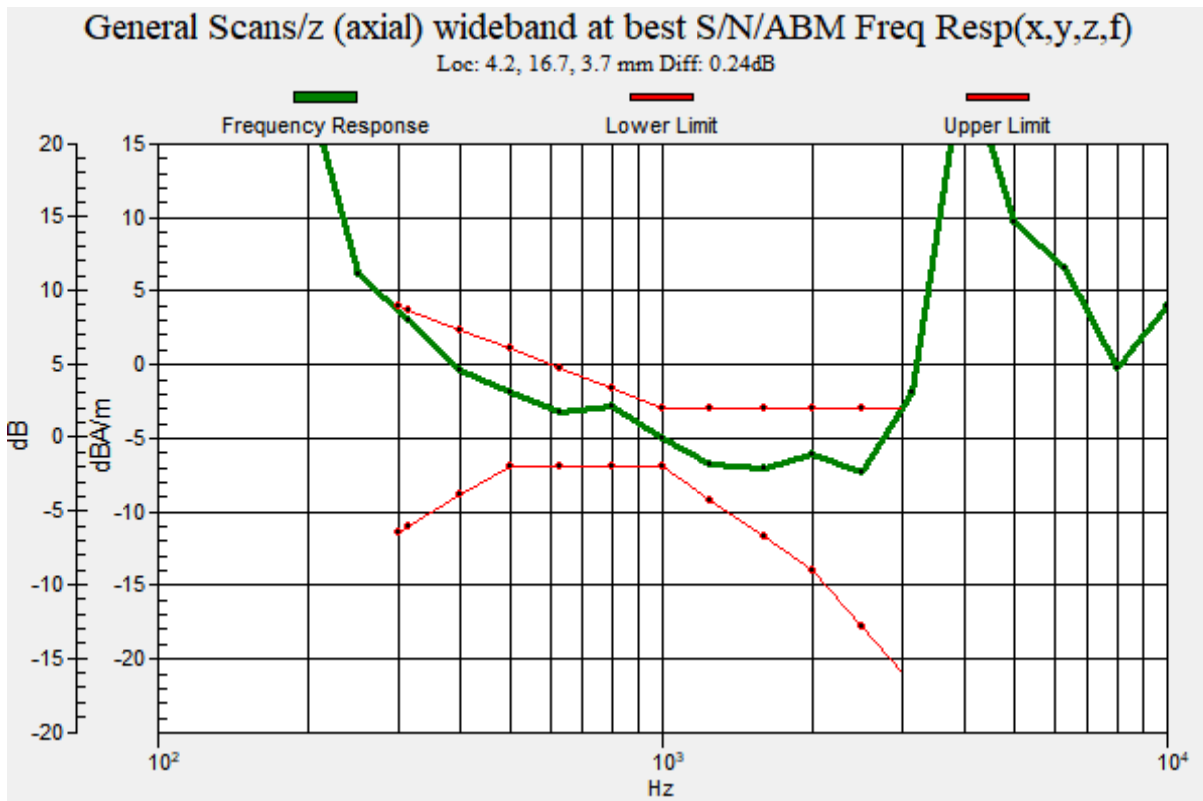
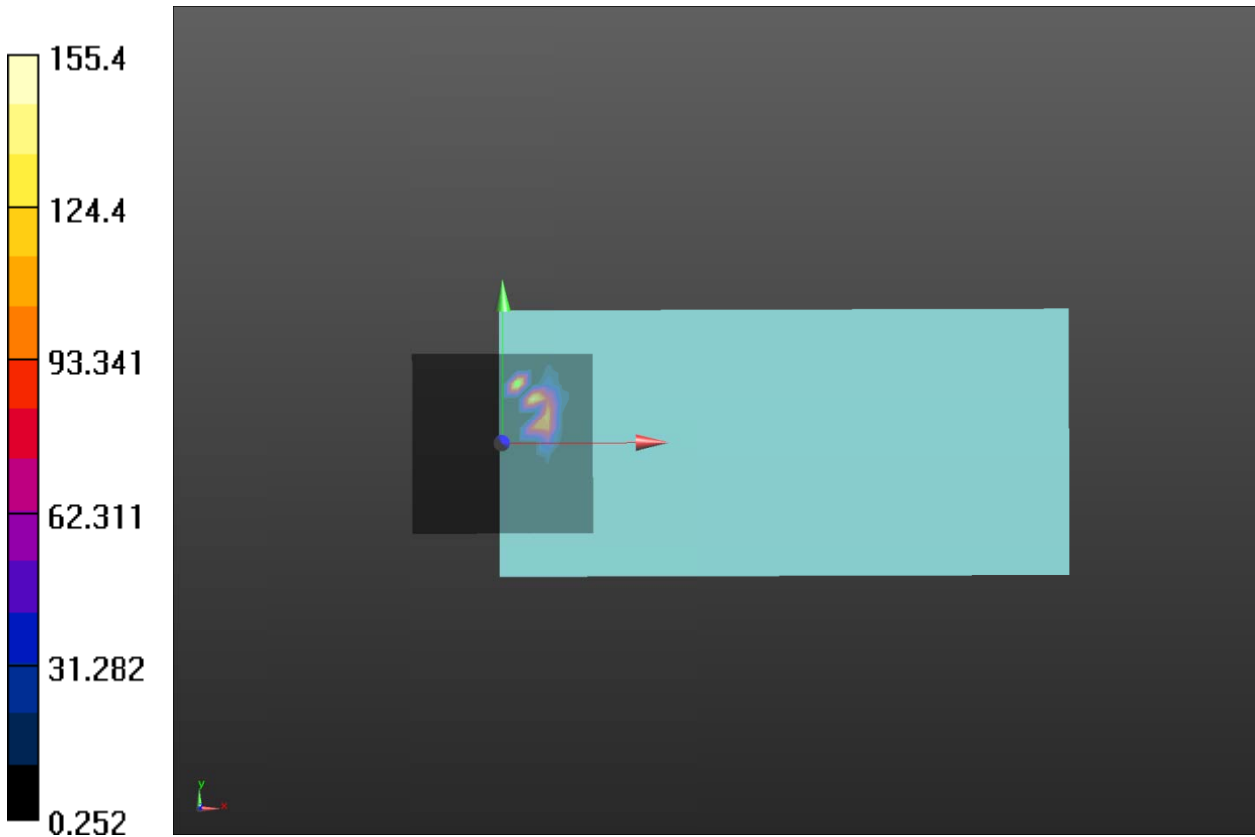

Plot 15 T-Coil LTE Band 25 Y transversal (Second supply)

Date: 2023/6/2

Communication System: UID 10100 - CAE, LTE-FDD (SC-FDMA, 100% RB, 20 MHz, QPSK);

Frequency: 1882.5 MHz; Duty Cycle: 1:3.68638

Medium parameters used: $\sigma = 0$ S/m, $\epsilon_r = 1$; $\rho = 1$ kg/m³

Ambient Temperature: 22.3 °C Liquid Temperature: 21.5 °C

Phantom section: TCoil Section

DASY5 Configuration:

Sensor-Surface: 0mm (Mechanical Surface Detection)

Probe: AM1DV3 - 3082; Calibrated: 2023/2/16

Electronics: DAE4 Sn1347; Calibrated: 2023/3/8

Phantom: HAC Test Arch with AMCC; Type: SD HAC P01 BA; Serial

Measurement SW: DASY52, Version 52.10 (4); SEMCAD X Version 14.6.14 (7483)

LTE B25 100%RB HAC_TCoil_WD_Emission/General Scans/y (transversal) 4.2mm 50 x

50/ABM SNR(x,y,z) (13x13x1): Measurement grid: dx=10mm, dy=10mm

Signal Type: Audio File (.wav) 48k_voice_1kHz_1s.wav

Output Gain: 33.76

Measure Window Start: 300ms

Measure Window Length: 1000ms

BWC applied: 0.17 dB

Device Reference Point: 0, 0, -6.3 mm

Cursor:

ABM1/ABM2 = 44.97 dB

ABM1 comp = -1.54 dBA/m

BWC Factor = 0.17 dB

Location: 4.2, 16.7, 3.7 mm

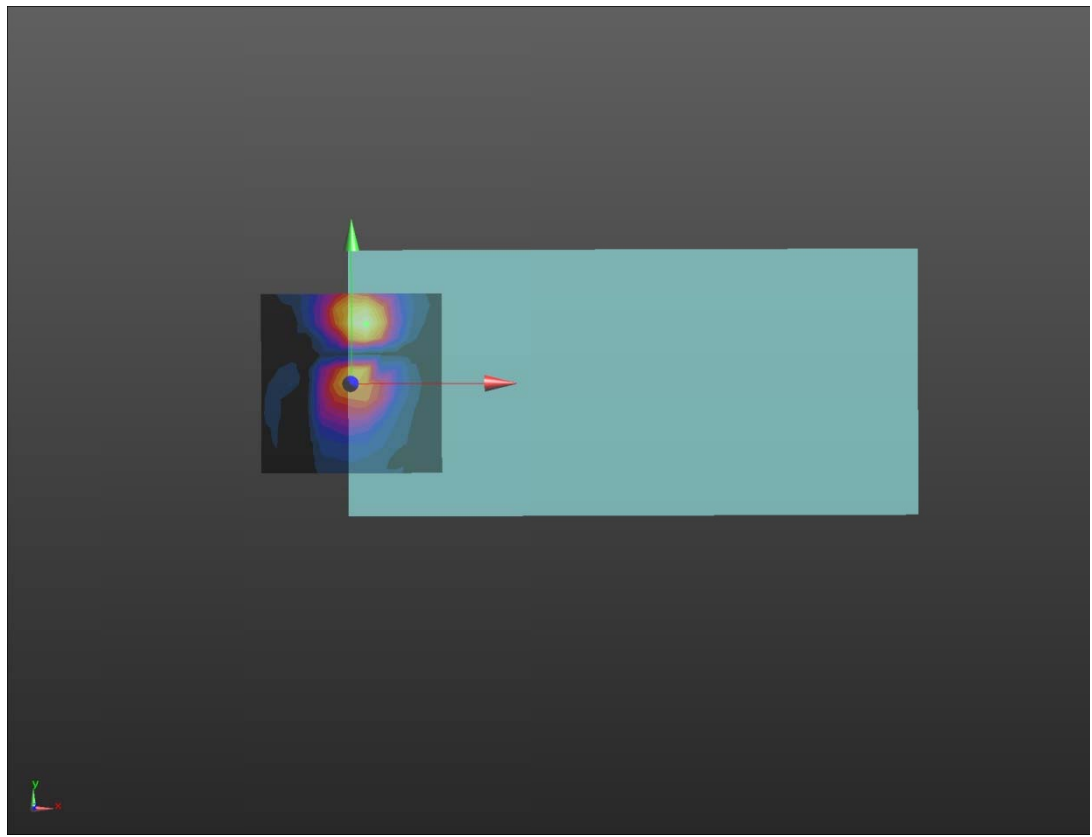
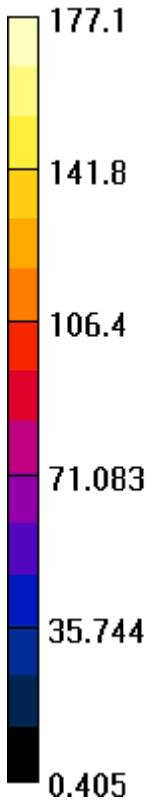

Plot 16 T-Coil LTE Band 25 Z Axial (Second supply)

Date: 2023/6/2

Communication System: UID 10100 - CAE, LTE-FDD (SC-FDMA, 100% RB, 20 MHz, QPSK);

Frequency: 1882.5 MHz; Duty Cycle: 1:3.68638

Medium parameters used: $\sigma = 0$ S/m, $\epsilon_r = 1$; $\rho = 1$ kg/m³

Ambient Temperature: 22.3 °C Liquid Temperature: 21.5 °C

Phantom section: TCoil Section

DASY5 Configuration:

Sensor-Surface: 0mm (Mechanical Surface Detection)

Probe: AM1DV3 - 3082; Calibrated: 2023/2/16

Electronics: DAE4 Sn1347; Calibrated: 2023/3/8

Phantom: HAC Test Arch with AMCC; Type: SD HAC P01 BA; Serial

Measurement SW: DASY52, Version 52.10 (4); SEMCAD X Version 14.6.14 (7483)

LTE B25 100%RB HAC_TCoil_WD_Emission/General Scans/z (axial) 4.2mm 50 x 50/ABM

SNR(x,y,z) (13x13x1): Measurement grid: dx=10mm, dy=10mm

Signal Type: Audio File (.wav) 48k_voice_1kHz_1s.wav

Output Gain: 33.76

Measure Window Start: 300ms

Measure Window Length: 1000ms

BWC applied: 0.17 dB

Device Reference Point: 0, 0, -6.3 mm

Cursor:

ABM1/ABM2 = 52.53 dB

ABM1 comp = 6.59 dBA/m

BWC Factor = 0.17 dB

Location: 4.2, 8.3, 3.7 mm

LTE B25 100%RB HAC_TCoil_WD_Emission/General Scans/z (axial) wideband at best

S/N/ABM Freq Resp(x,y,z,f) (1x1x1): Measurement grid: dx=10mm, dy=10mm

Signal Type: Audio File (.wav) 48k_voice_300-3000_2s.wav

Output Gain: 66.12

Measure Window Start: 300ms

Measure Window Length: 2000ms

BWC applied: 10.81 dB

Device Reference Point: 0, 0, -6.3 mm

Cursor:

Diff = 0.57 dB

BWC Factor = 10.81 dB

Location: 4.2, 8.3, 3.7 mm

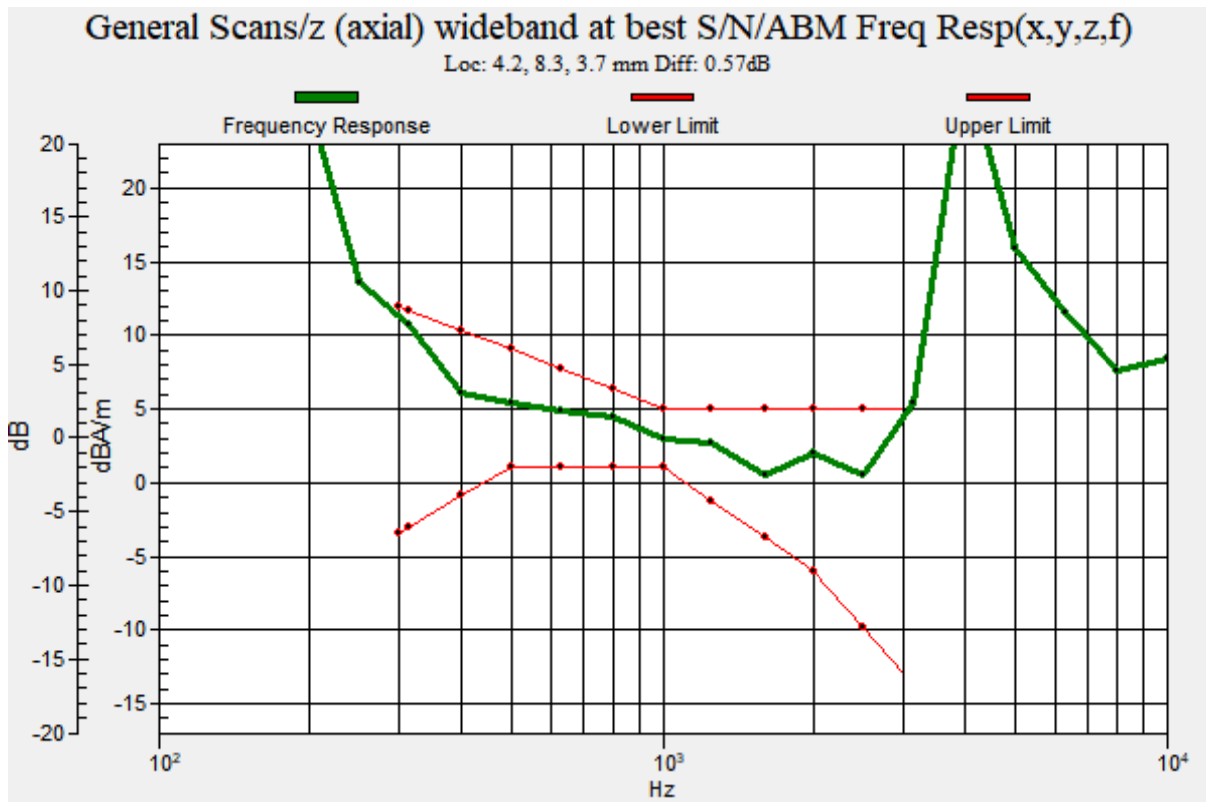
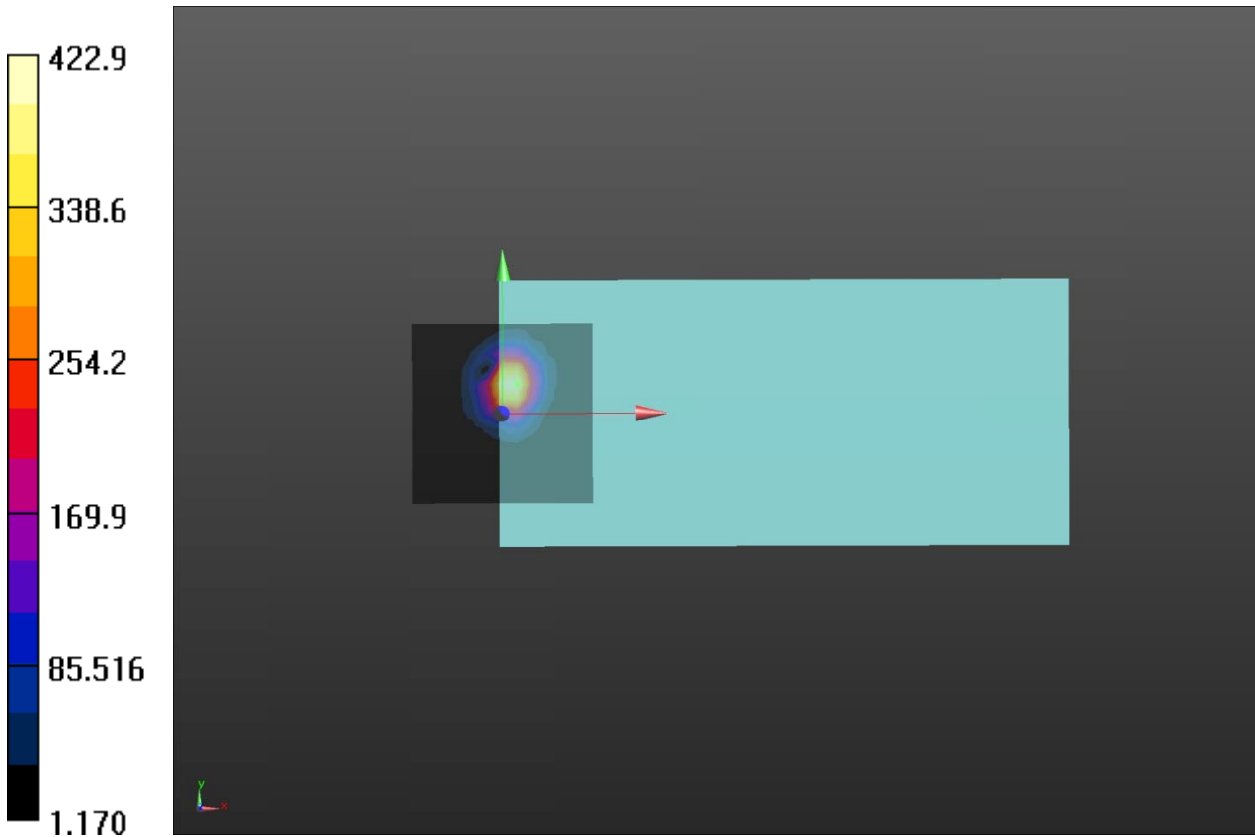

Plot 17 T-Coil LTE Band 26 Y transversal

Date: 2023/5/30

Communication System: UID 10311 - AAD, LTE-FDD (SC-FDMA, 100% RB, 15 MHz, QPSK);

Frequency: 831.5 MHz; Duty Cycle: 1:4.03738

Medium parameters used: $\sigma = 0$ S/m, $\epsilon_r = 1$; $\rho = 1$ kg/m³

Ambient Temperature: 22.3 °C Liquid Temperature: 21.5 °C

Phantom section: TCoil Section

DASY5 Configuration:

Sensor-Surface: 0mm (Mechanical Surface Detection)

Probe: AM1DV3 - 3082; Calibrated: 2023/2/16

Electronics: DAE4 Sn1347; Calibrated: 2023/3/8

Phantom: HAC Test Arch with AMCC; Type: SD HAC P01 BA; Serial

Measurement SW: DASY52, Version 52.10 (4); SEMCAD X Version 14.6.14 (7483)

LTE B26 100%RB HAC_TCoil_WD_Emission/General Scans/y (transversal) 4.2mm 50 x

50/ABM SNR(x,y,z) (13x13x1): Measurement grid: dx=10mm, dy=10mm

Signal Type: Audio File (.wav) 48k_voice_1kHz_1s.wav

Output Gain: 33.76

Measure Window Start: 300ms

Measure Window Length: 1000ms

BWC applied: 0.17 dB

Device Reference Point: 0, 0, -6.3 mm

Cursor:

ABM1/ABM2 = 40.93 dB

ABM1 comp = -5.53 dBA/m

BWC Factor = 0.17 dB

Location: 0, 0, 3.7 mm

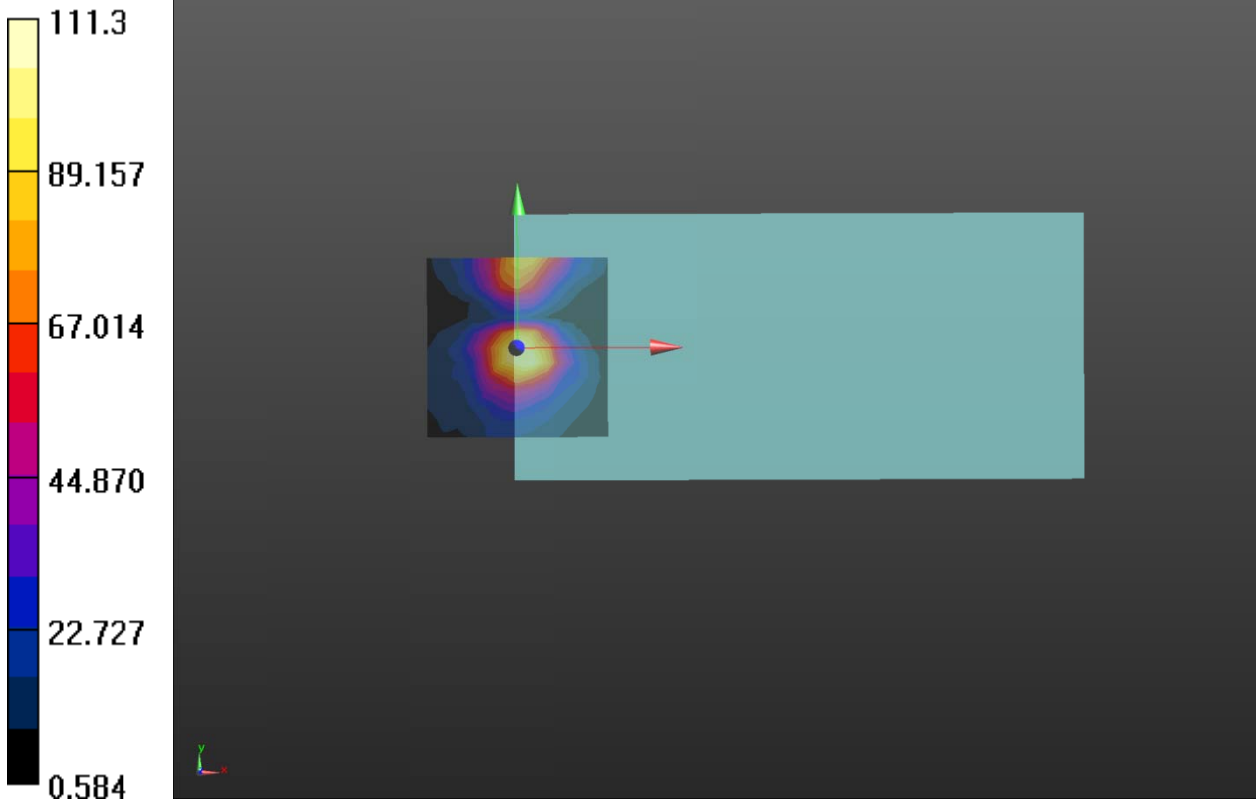

Plot 18 T-Coil LTE Band 26 Z Axial

Date: 2023/5/30

Communication System: UID 10311 - AAD, LTE-FDD (SC-FDMA, 100% RB, 15 MHz, QPSK);

Frequency: 831.5 MHz; Duty Cycle: 1:4.03738

Medium parameters used: $\sigma = 0$ S/m, $\epsilon_r = 1$; $\rho = 1$ kg/m³

Ambient Temperature: 22.3 °C Liquid Temperature: 21.5 °C

Phantom section: TCoil Section

DASY5 Configuration:

Sensor-Surface: 0mm (Mechanical Surface Detection)

Probe: AM1DV3 - 3082; Calibrated: 2023/2/16

Electronics: DAE4 Sn1347; Calibrated: 2023/3/8

Phantom: HAC Test Arch with AMCC; Type: SD HAC P01 BA; Serial

Measurement SW: DASY52, Version 52.10 (4); SEMCAD X Version 14.6.14 (7483)

LTE B26 100%RB HAC_TCoil_WD_Emission/General Scans/z (axial) 4.2mm 50 x 50/ABM

SNR(x,y,z) (13x13x1): Measurement grid: dx=10mm, dy=10mm

Signal Type: Audio File (.wav) 48k_voice_1kHz_1s.wav

Output Gain: 33.76

Measure Window Start: 300ms

Measure Window Length: 1000ms

BWC applied: 0.17 dB

Device Reference Point: 0, 0, -6.3 mm

Cursor:

ABM1/ABM2 = 51.54 dB

ABM1 comp = 2.14 dBA/m

BWC Factor = 0.17 dB

Location: 0, 8.3, 3.7 mm

LTE B26 100%RB HAC_TCoil_WD_Emission/General Scans/z (axial) wideband at best

S/N/ABM Freq Resp(x,y,z,f) (1x1x1): Measurement grid: dx=10mm, dy=10mm

Signal Type: Audio File (.wav) 48k_voice_300-3000_2s.wav

Output Gain: 66.12

Measure Window Start: 300ms

Measure Window Length: 2000ms

BWC applied: 10.81 dB

Device Reference Point: 0, 0, -6.3 mm

Cursor:

Diff = 0.97 dB

BWC Factor = 10.81 dB

Location: 0, 8.3, 3.7 mm

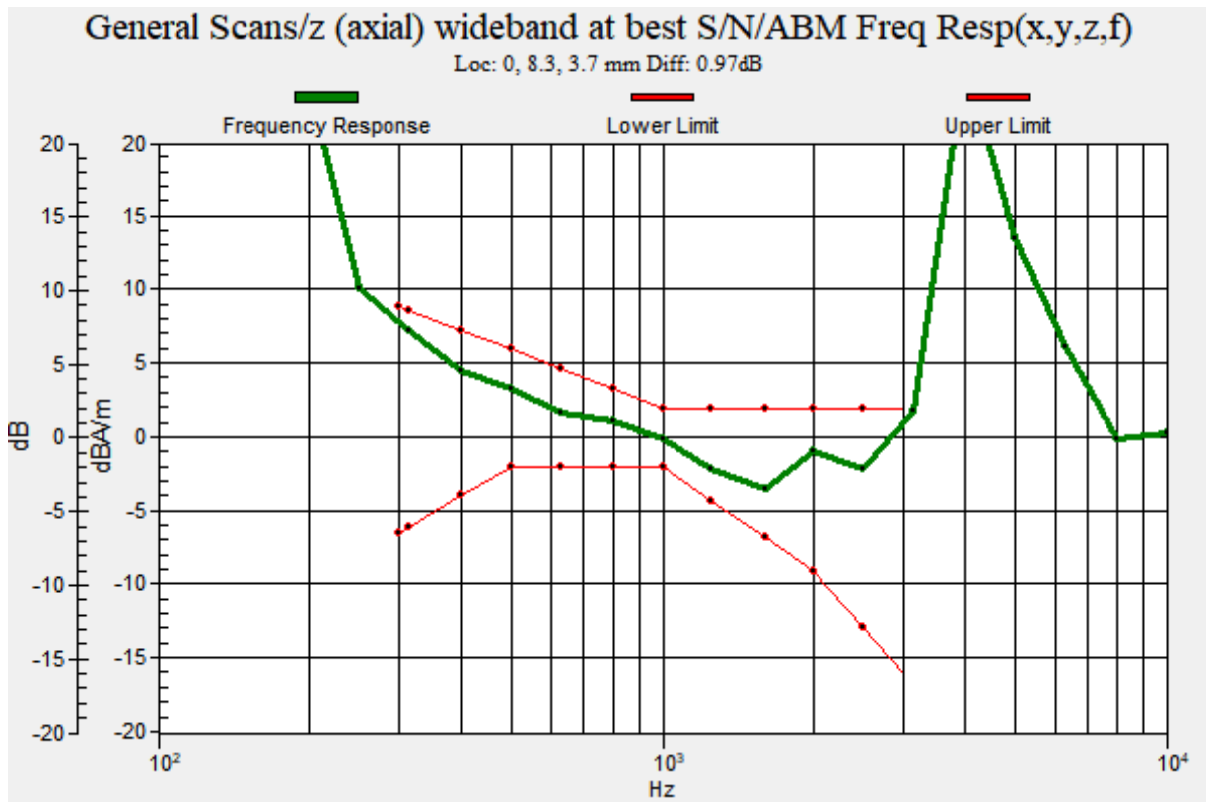
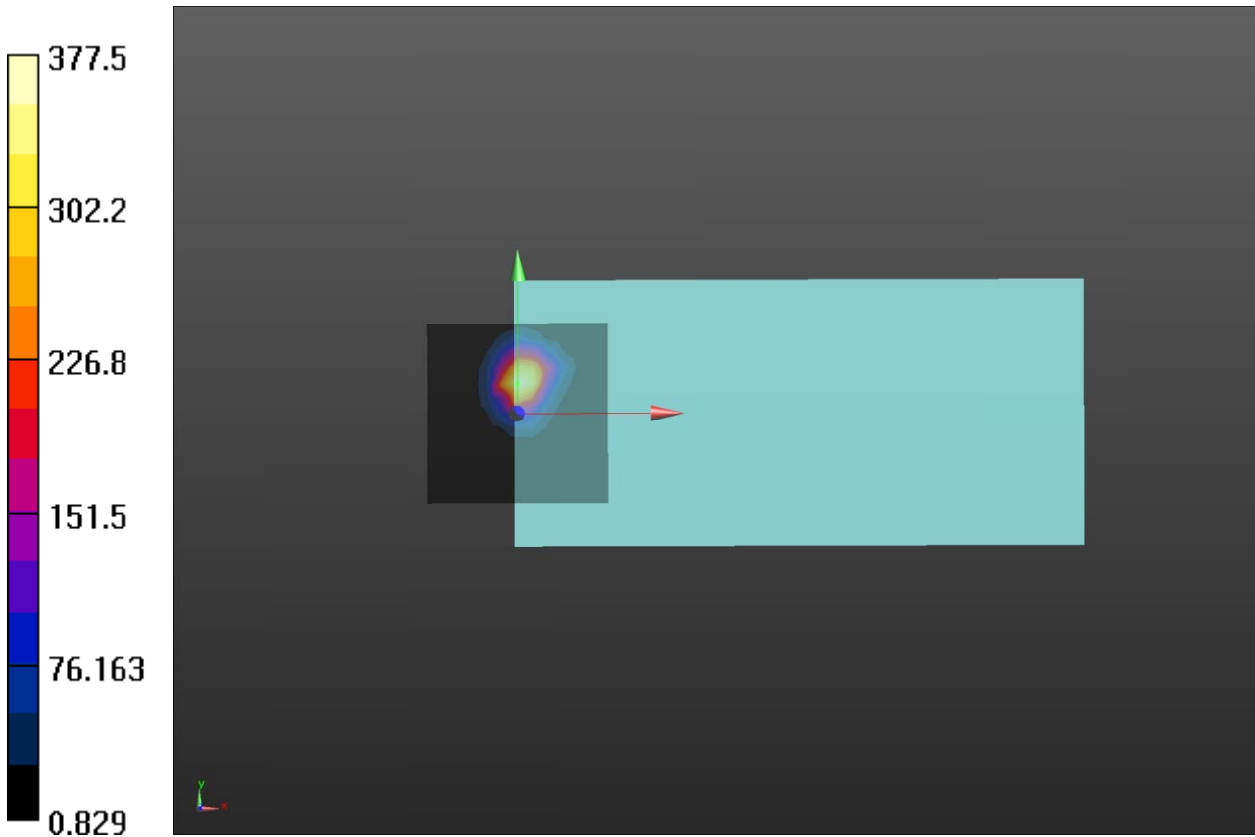

Plot 19 T-Coil LTE Band 41 Y transversal

Date: 2023/5/30

Communication System: UID 10103 - CAG, LTE-TDD (SC-FDMA, 100% RB, 20 MHz, QPSK);

Frequency: 2593 MHz; Duty Cycle: 1:8.4918

Medium parameters used: $\sigma = 0$ S/m, $\epsilon_r = 1$; $\rho = 1$ kg/m³

Ambient Temperature: 22.3 °C Liquid Temperature: 21.5 °C

Phantom section: TCoil Section

DASY5 Configuration:

Sensor-Surface: 0mm (Mechanical Surface Detection)

Probe: AM1DV3 - 3082; Calibrated: 2023/2/16

Electronics: DAE4 Sn1347; Calibrated: 2023/3/8

Phantom: HAC Test Arch with AMCC; Type: SD HAC P01 BA; Serial

Measurement SW: DASY52, Version 52.10 (4); SEMCAD X Version 14.6.14 (7483)

LTE B41 100%RB HAC_TCoil_WD_Emission/General Scans/y (transversal) 4.2mm 50 x

50/ABM SNR(x,y,z) (13x13x1): Measurement grid: dx=10mm, dy=10mm

Signal Type: Audio File (.wav) 48k_voice_1kHz_1s.wav

Output Gain: 33.76

Measure Window Start: 300ms

Measure Window Length: 1000ms

BWC applied: 0.17 dB

Device Reference Point: 0, 0, -6.3 mm

Cursor:

ABM1/ABM2 = 39.40 dB

ABM1 comp = -5.82 dBA/m

BWC Factor = 0.17 dB

Location: 0, 0, 3.7 mm

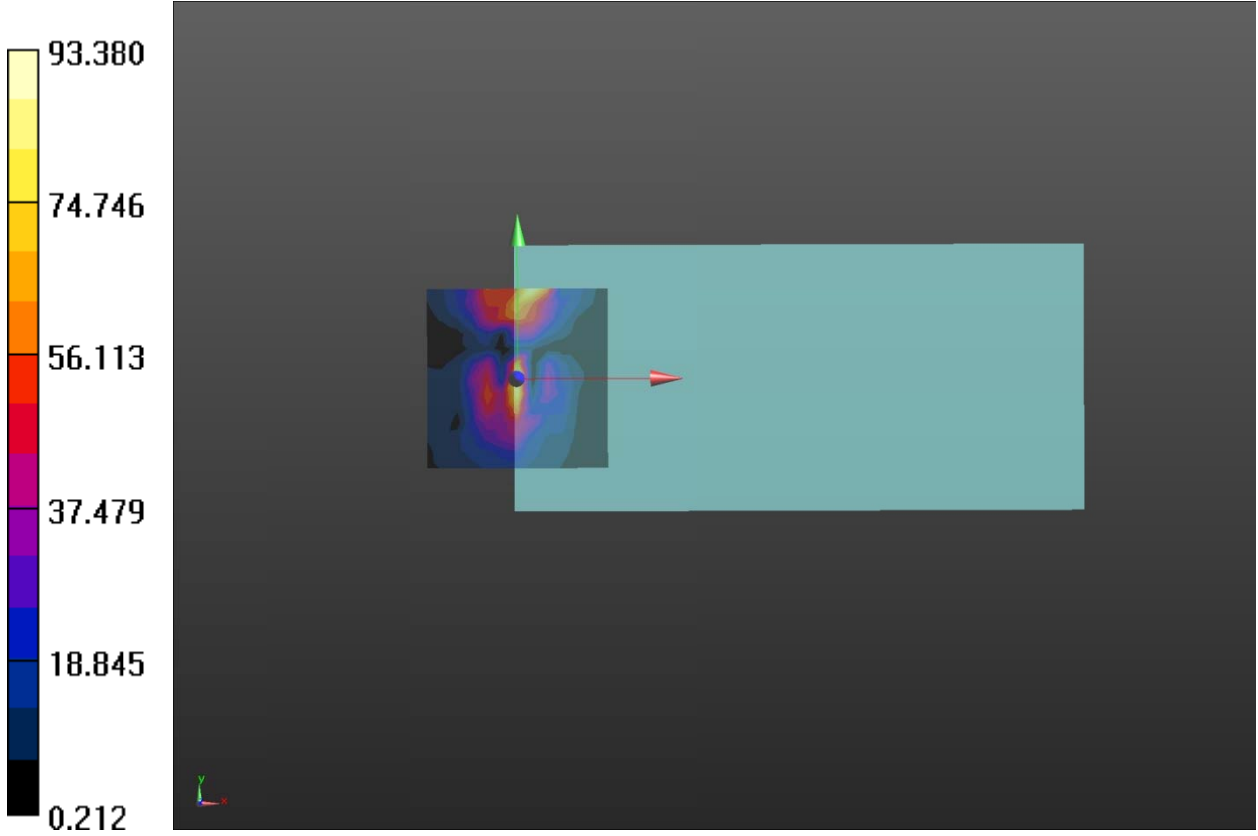

Plot 20 T-Coil LTE Band 41 Z Axial

Date: 2023/5/30

Communication System: UID 10103 - CAG, LTE-TDD (SC-FDMA, 100% RB, 20 MHz, QPSK);

Frequency: 2593 MHz; Duty Cycle: 1:8.4918

Medium parameters used: $\sigma = 0$ S/m, $\epsilon_r = 1$; $\rho = 1$ kg/m³

Ambient Temperature: 22.3 °C Liquid Temperature: 21.5 °C

Phantom section: TCoil Section

DASY5 Configuration:

Sensor-Surface: 0mm (Mechanical Surface Detection)

Probe: AM1DV3 - 3082; Calibrated: 2023/2/16

Electronics: DAE4 Sn1347; Calibrated: 2023/3/8

Phantom: HAC Test Arch with AMCC; Type: SD HAC P01 BA; Serial

Measurement SW: DASY52, Version 52.10 (4); SEMCAD X Version 14.6.14 (7483)

LTE B41 100%RB HAC_TCoil_WD_Emission/General Scans/z (axial) 4.2mm 50 x 50/ABM

SNR(x,y,z) (13x13x1): Measurement grid: dx=10mm, dy=10mm

Signal Type: Audio File (.wav) 48k_voice_1kHz_1s.wav

Output Gain: 33.76

Measure Window Start: 300ms

Measure Window Length: 1000ms

BWC applied: 0.17 dB

Device Reference Point: 0, 0, -6.3 mm

Cursor:

ABM1/ABM2 = 46.30 dB

ABM1 comp = 4.26 dBA/m

BWC Factor = 0.17 dB

Location: 4.2, 12.5, 3.7 mm

LTE B41 100%RB HAC_TCoil_WD_Emission/General Scans/z (axial) wideband at best

S/N/ABM Freq Resp(x,y,z,f) (1x1x1): Measurement grid: dx=10mm, dy=10mm

Signal Type: Audio File (.wav) 48k_voice_300-3000_2s.wav

Output Gain: 66.12

Measure Window Start: 300ms

Measure Window Length: 2000ms

BWC applied: 10.81 dB

Device Reference Point: 0, 0, -6.3 mm

Cursor:

Diff = 0.37 dB

BWC Factor = 10.81 dB

Location: 0, 8.3, 3.7 mm

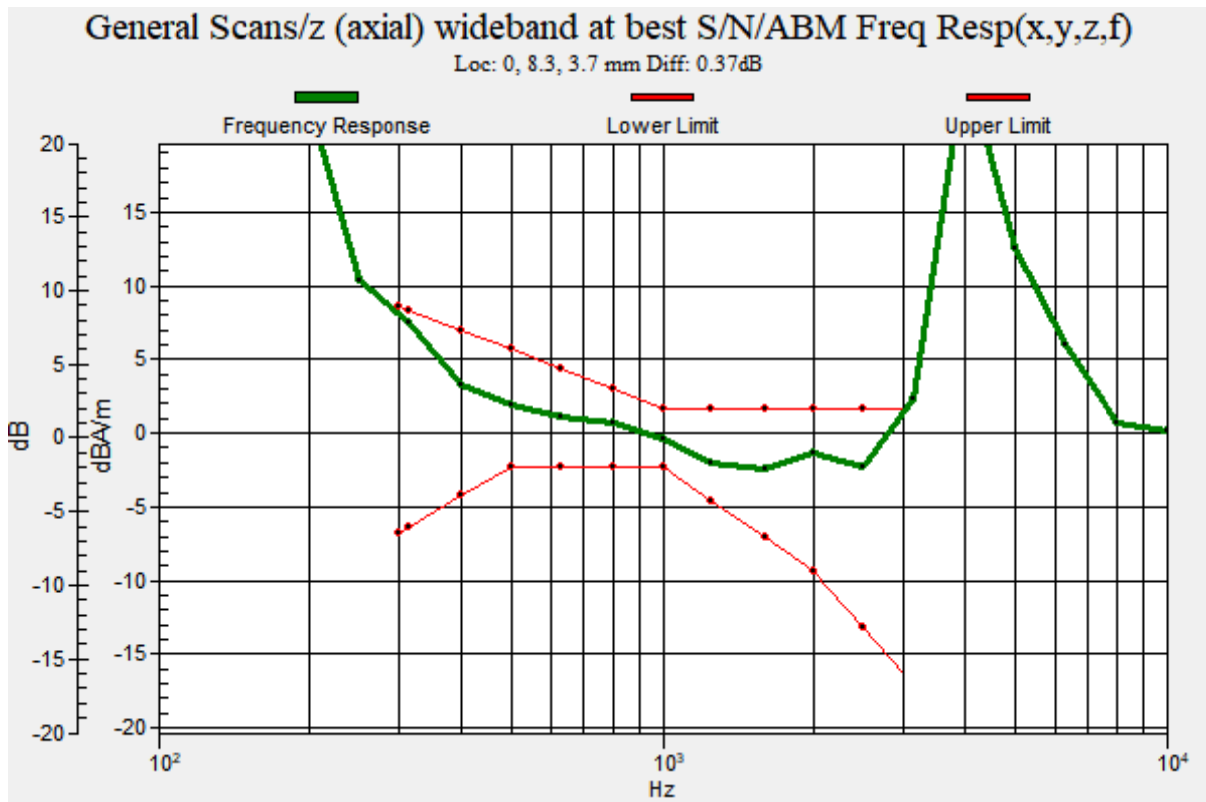
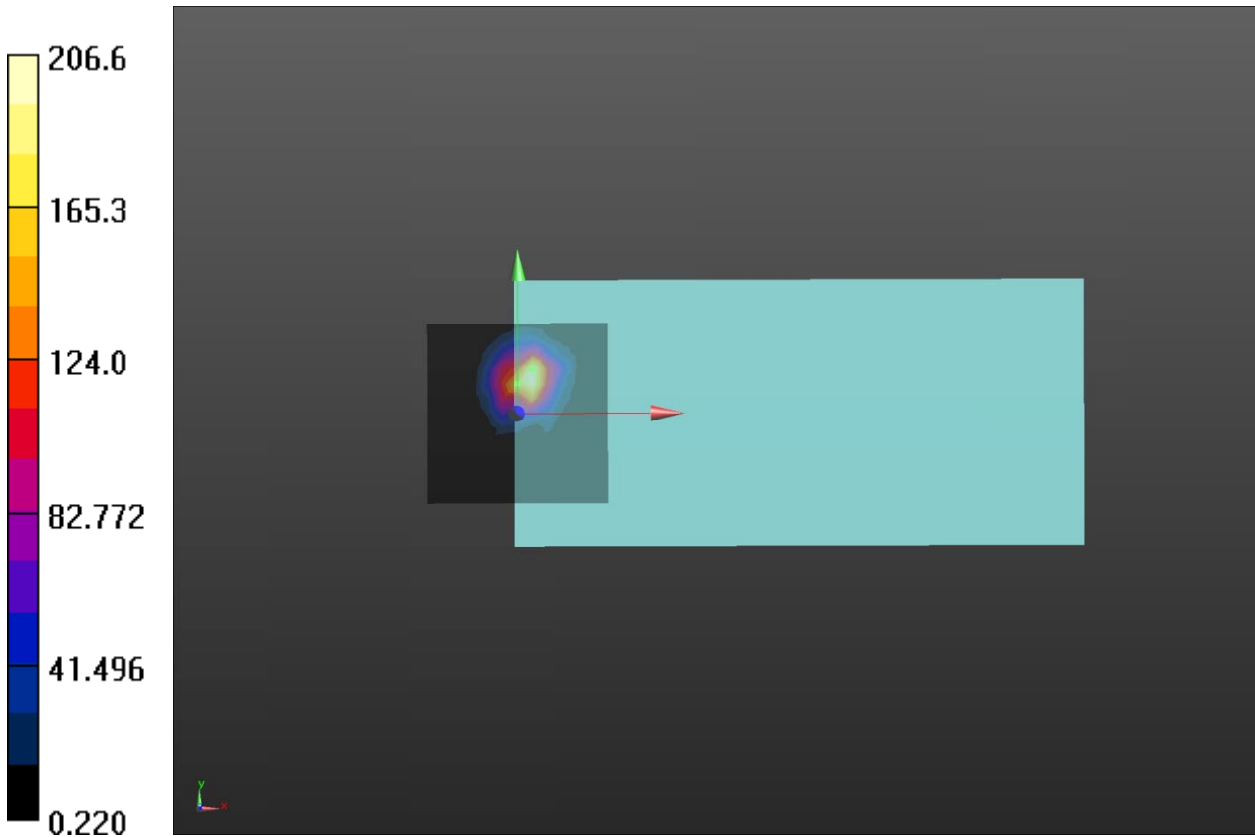

Plot 21 T-Coil LTE Band 66 Y transversal

Date: 2023/5/30

Communication System: UID 10100 - CAE, LTE-FDD (SC-FDMA, 100% RB, 20 MHz, QPSK);

Frequency: 1745 MHz; Duty Cycle: 1:3.68638

Medium parameters used: $\sigma = 0$ S/m, $\epsilon_r = 1$; $\rho = 1$ kg/m³

Ambient Temperature: 22.3 °C Liquid Temperature: 21.5 °C

Phantom section: TCoil Section

DASY5 Configuration:

Sensor-Surface: 0mm (Mechanical Surface Detection)

Probe: AM1DV3 - 3082; Calibrated: 2023/2/16

Electronics: DAE4 Sn1347; Calibrated: 2023/3/8

Phantom: HAC Test Arch with AMCC; Type: SD HAC P01 BA; Serial

Measurement SW: DASY52, Version 52.10 (4); SEMCAD X Version 14.6.14 (7483)

LTE B66 100%RB HAC_TCoil_WD_Emission/General Scans/y (transversal) 4.2mm 50 x

50/ABM SNR(x,y,z) (13x13x1): Measurement grid: dx=10mm, dy=10mm

Signal Type: Audio File (.wav) 48k_voice_1kHz_1s.wav

Output Gain: 33.76

Measure Window Start: 300ms

Measure Window Length: 1000ms

BWC applied: 0.17 dB

Device Reference Point: 0, 0, -6.3 mm

Cursor:

ABM1/ABM2 = 40.65 dB

ABM1 comp = -3.48 dBA/m

BWC Factor = 0.17 dB

Location: 4.2, 0, 3.7 mm

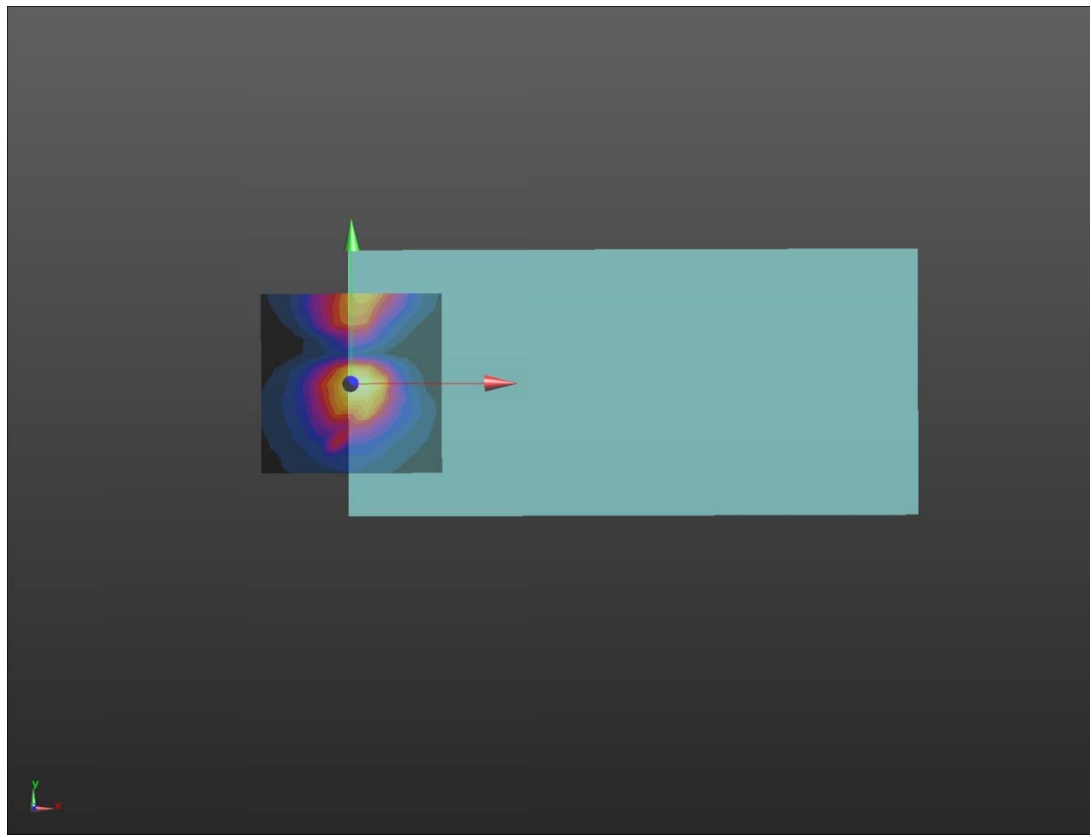
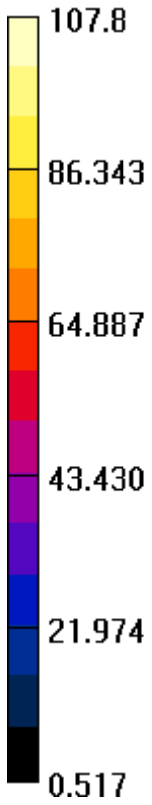

Plot 22 T-Coil LTE Band 66 Z Axial

Date: 2023/5/30

Communication System: UID 10100 - CAE, LTE-FDD (SC-FDMA, 100% RB, 20 MHz, QPSK);

Frequency: 1745 MHz; Duty Cycle: 1:3.68638

Medium parameters used: $\sigma = 0$ S/m, $\epsilon_r = 1$; $\rho = 1$ kg/m³

Ambient Temperature: 22.3 °C Liquid Temperature: 21.5 °C

Phantom section: TCoil Section

DASY5 Configuration:

Sensor-Surface: 0mm (Mechanical Surface Detection)

Probe: AM1DV3 - 3082; Calibrated: 2023/2/16

Electronics: DAE4 Sn1347; Calibrated: 2023/3/8

Phantom: HAC Test Arch with AMCC; Type: SD HAC P01 BA; Serial

Measurement SW: DASY52, Version 52.10 (4); SEMCAD X Version 14.6.14 (7483)

LTE B66 100%RB HAC_TCoil_WD_Emission/General Scans/z (axial) 4.2mm 50 x 50/ABM

SNR(x,y,z) (13x13x1): Measurement grid: dx=10mm, dy=10mm

Signal Type: Audio File (.wav) 48k_voice_1kHz_1s.wav

Output Gain: 33.76

Measure Window Start: 300ms

Measure Window Length: 1000ms

BWC applied: 0.17 dB

Device Reference Point: 0, 0, -6.3 mm

Cursor:

ABM1/ABM2 = 50.74 dB

ABM1 comp = 1.51 dBA/m

BWC Factor = 0.17 dB

Location: 0, 8.3, 3.7 mm

LTE B66 100%RB HAC_TCoil_WD_Emission/General Scans/z (axial) wideband at best

S/N/ABM Freq Resp(x,y,z,f) (1x1x1): Measurement grid: dx=10mm, dy=10mm

Signal Type: Audio File (.wav) 48k_voice_300-3000_2s.wav

Output Gain: 66.12

Measure Window Start: 300ms

Measure Window Length: 2000ms

BWC applied: 10.81 dB

Device Reference Point: 0, 0, -6.3 mm

Cursor:

Diff = 0.52 dB

BWC Factor = 10.81 dB

Location: 0, 8.3, 3.7 mm

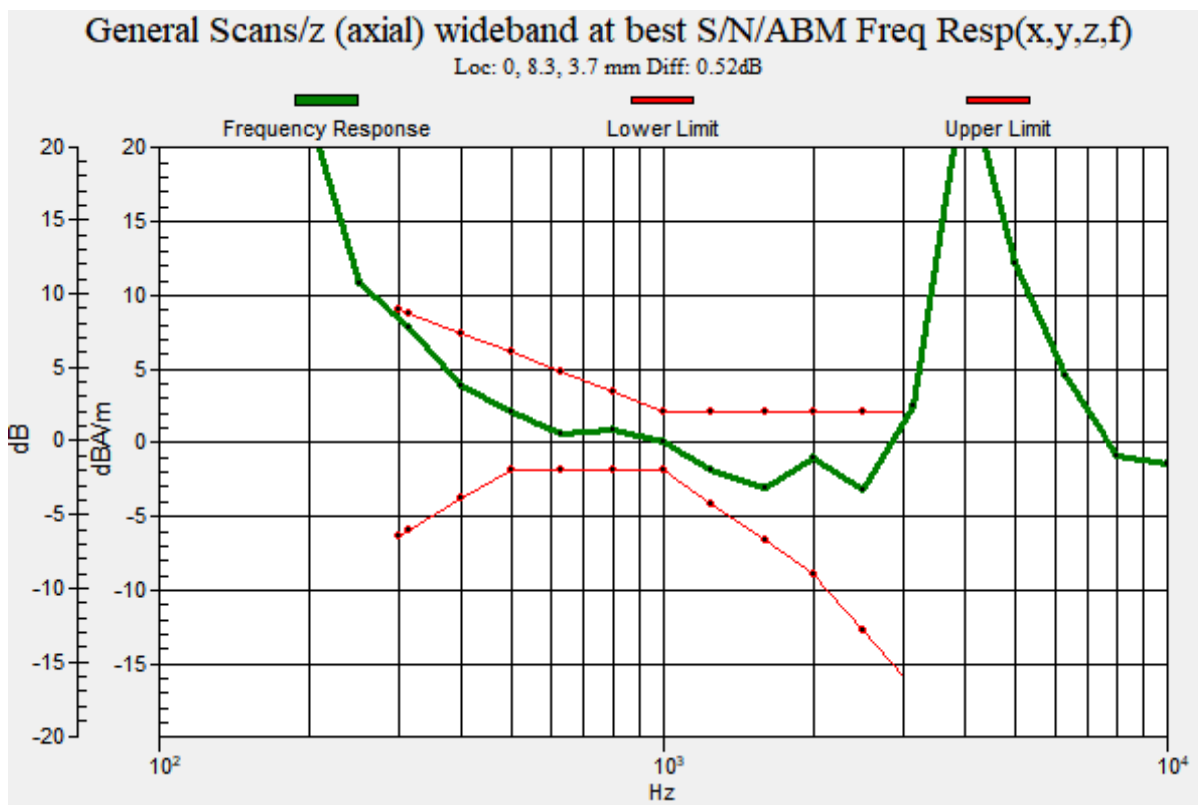
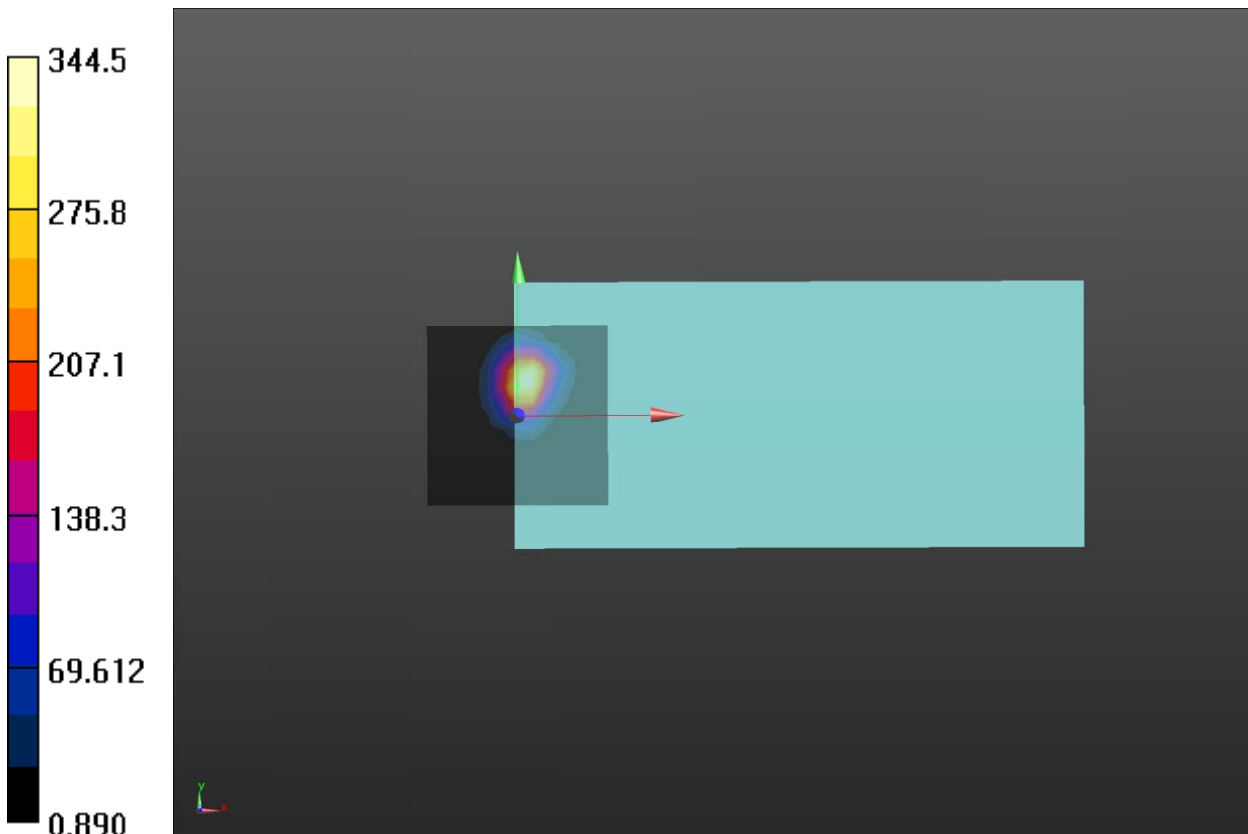

Plot 23 T-Coil LTE Band 71 Y transversal

Date: 2023/5/30

Communication System: UID 10100 - CAE, LTE-FDD (SC-FDMA, 100% RB, 20 MHz, QPSK);

Frequency: 683 MHz; Duty Cycle: 1:3.68638

Medium parameters used: $\sigma = 0$ S/m, $\epsilon_r = 1$; $\rho = 1$ kg/m³

Ambient Temperature: 22.3 °C Liquid Temperature: 21.5 °C

Phantom section: TCoil Section

DASY5 Configuration:

Sensor-Surface: 0mm (Mechanical Surface Detection)

Probe: AM1DV3 - 3082; Calibrated: 2023/2/16

Electronics: DAE4 Sn1347; Calibrated: 2023/3/8

Phantom: HAC Test Arch with AMCC; Type: SD HAC P01 BA; Serial

Measurement SW: DASY52, Version 52.10 (4); SEMCAD X Version 14.6.14 (7483)

LTE B71 100%RB HAC_TCoil_WD_Emission/General Scans/y (transversal) 4.2mm 50 x

50/ABM SNR(x,y,z) (13x13x1): Measurement grid: dx=10mm, dy=10mm

Signal Type: Audio File (.wav) 48k_voice_1kHz_1s.wav

Output Gain: 33.76

Measure Window Start: 300ms

Measure Window Length: 1000ms

BWC applied: 0.17 dB

Device Reference Point: 0, 0, -6.3 mm

Cursor:

ABM1/ABM2 = 42.52 dB

ABM1 comp = -4.32 dBA/m

BWC Factor = 0.17 dB

Location: -4.2, 20.8, 3.7 mm

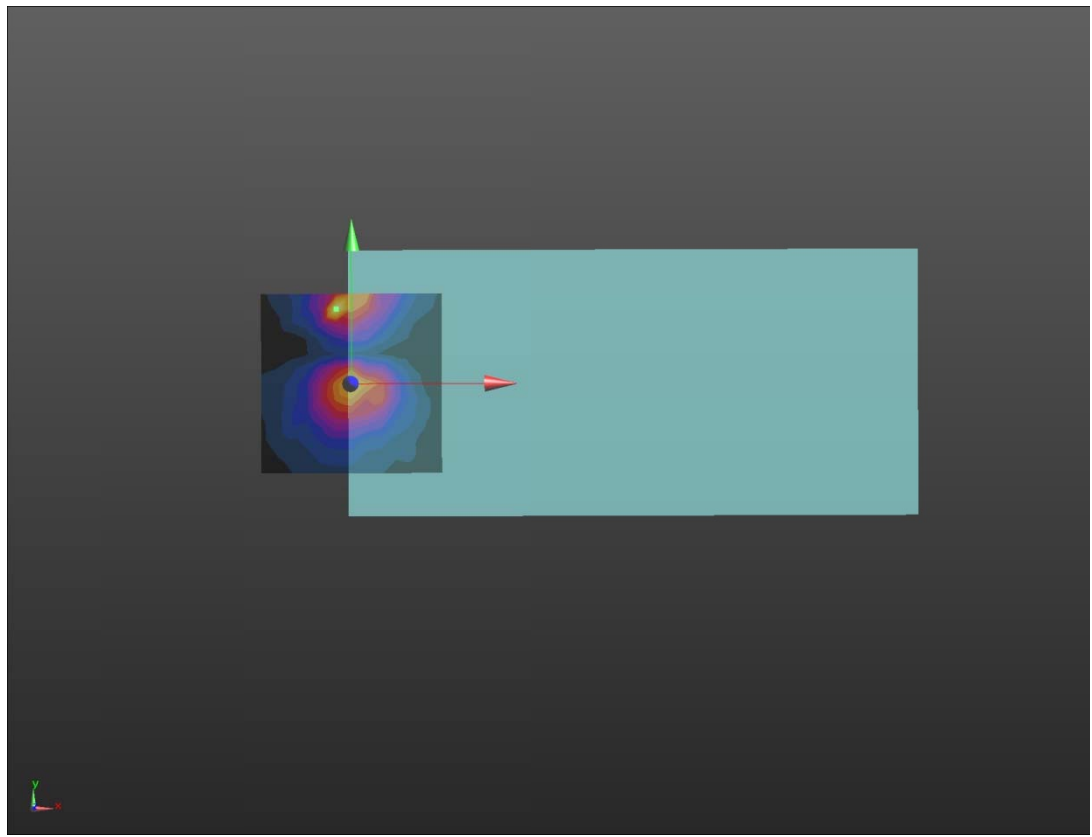
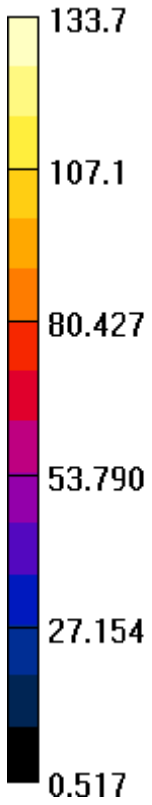

Plot 24 T-Coil LTE Band 71 Z Axial

Date: 2023/5/30

Communication System: UID 10100 - CAE, LTE-FDD (SC-FDMA, 100% RB, 20 MHz, QPSK);

Frequency: 683 MHz; Duty Cycle: 1:3.68638

Medium parameters used: $\sigma = 0$ S/m, $\epsilon_r = 1$; $\rho = 1$ kg/m³

Ambient Temperature: 22.3 °C Liquid Temperature: 21.5 °C

Phantom section: TCoil Section

DASY5 Configuration:

Sensor-Surface: 0mm (Mechanical Surface Detection)

Probe: AM1DV3 - 3082; Calibrated: 2023/2/16

Electronics: DAE4 Sn1347; Calibrated: 2023/3/8

Phantom: HAC Test Arch with AMCC; Type: SD HAC P01 BA; Serial

Measurement SW: DASY52, Version 52.10 (4); SEMCAD X Version 14.6.14 (7483)

LTE B71 100%RB HAC_TCoil_WD_Emission/General Scans/z (axial) 4.2mm 50 x 50/ABM

SNR(x,y,z) (13x13x1): Measurement grid: dx=10mm, dy=10mm

Signal Type: Audio File (.wav) 48k_voice_1kHz_1s.wav

Output Gain: 33.76

Measure Window Start: 300ms

Measure Window Length: 1000ms

BWC applied: 0.17 dB

Device Reference Point: 0, 0, -6.3 mm

Cursor:

ABM1/ABM2 = 51.18 dB

ABM1 comp = 1.68 dBA/m

BWC Factor = 0.17 dB

Location: 0, 8.3, 3.7 mm

LTE B71 100%RB HAC_TCoil_WD_Emission/General Scans/z (axial) wideband at best

S/N/ABM Freq Resp(x,y,z,f) (1x1x1): Measurement grid: dx=10mm, dy=10mm

Signal Type: Audio File (.wav) 48k_voice_300-3000_2s.wav

Output Gain: 66.12

Measure Window Start: 300ms

Measure Window Length: 2000ms

BWC applied: 10.81 dB

Device Reference Point: 0, 0, -6.3 mm

Cursor:

Diff = 0.12 dB

BWC Factor = 10.81 dB

Location: 0, 8.3, 3.7 mm

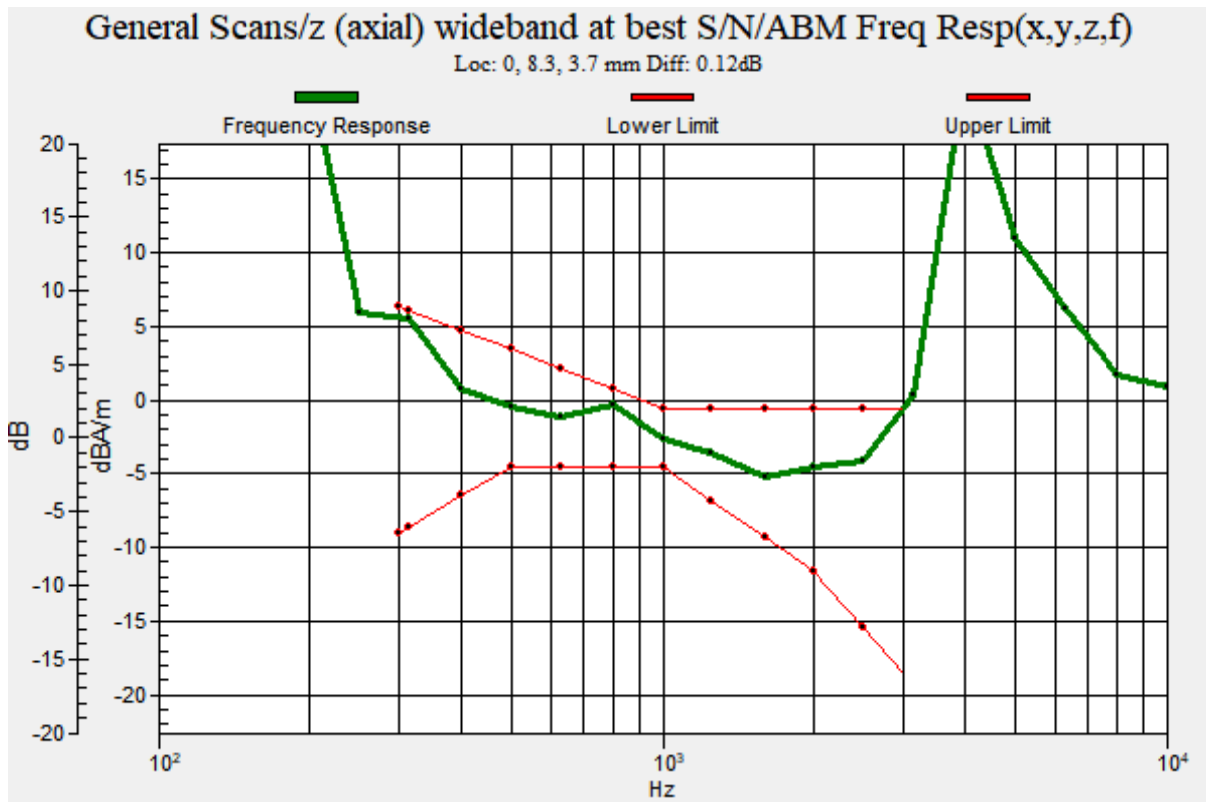
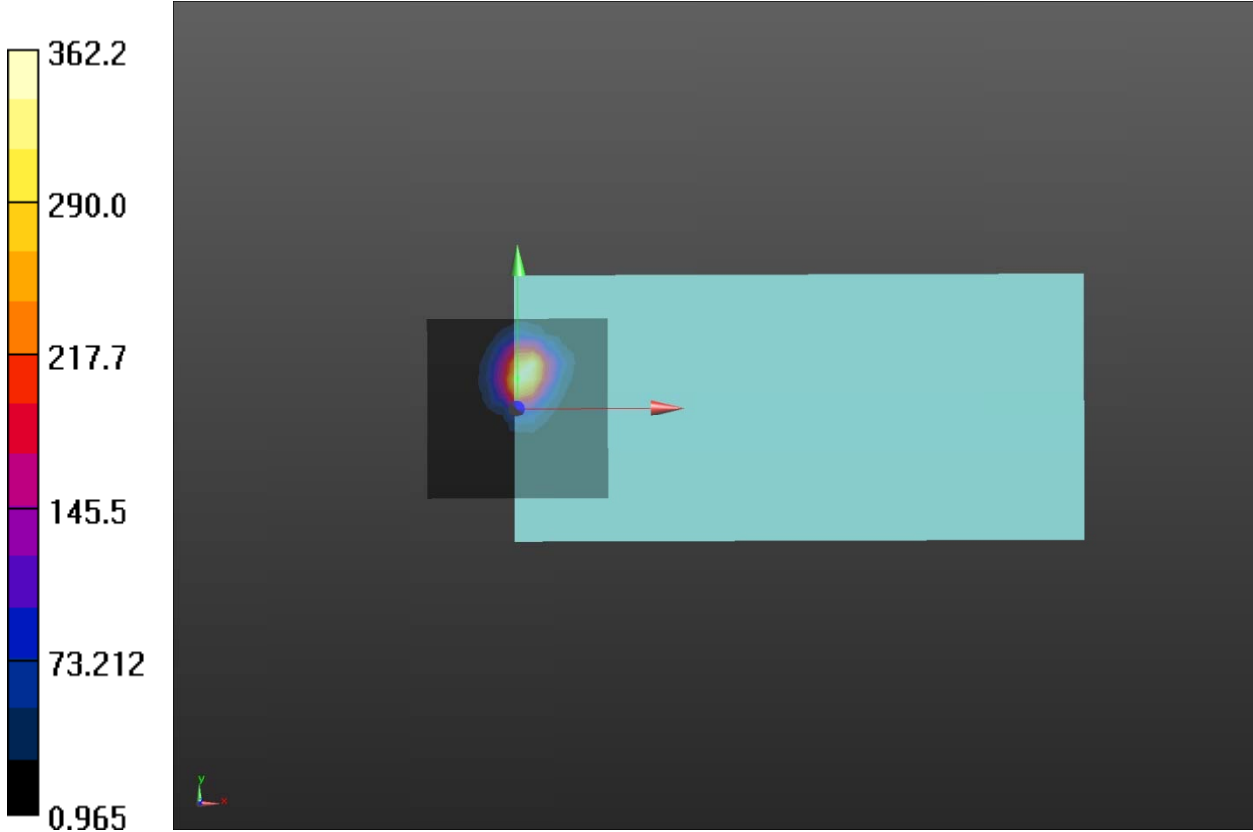

Plot 25 T-Coil Wi-Fi 2.4G 802.11b Y transversal

Date: 2023/5/30

Communication System: UID 10061 - CAB, IEEE 802.11b WiFi 2.4 GHz (DSSS, 11 Mbps);

Frequency: 2437 MHz; Duty Cycle: 1:2.29034

Medium parameters used: $\sigma = 0$ S/m, $\epsilon_r = 1$; $\rho = 1$ kg/m³

Ambient Temperature: 22.3 °C Liquid Temperature: 21.5 °C

Phantom section: TCoil Section

DASY5 Configuration:

Sensor-Surface: 0mm (Mechanical Surface Detection)

Probe: AM1DV3 - 3082; Calibrated: 2023/2/16

Electronics: DAE4 Sn1347; Calibrated: 2023/3/8

Phantom: HAC Test Arch with AMCC; Type: SD HAC P01 BA; Serial

Measurement SW: DASY52, Version 52.10 (4); SEMCAD X Version 14.6.14 (7483)

802.11b HAC_TCoil_WD_Emission/General Scans/y (transversal) 4.2mm 50 x 50/ABM

SNR(x,y,z) (13x13x1): Measurement grid: dx=10mm, dy=10mm

Signal Type: Audio File (.wav) 48k_voice_1kHz_1s.wav

Output Gain: 33.76

Measure Window Start: 300ms

Measure Window Length: 1000ms

BWC applied: 0.17 dB

Device Reference Point: 0, 0, -6.3 mm

Cursor:

ABM1/ABM2 = 38.89 dB

ABM1 comp = -5.31 dBA/m

BWC Factor = 0.17 dB

Location: 0, 20.8, 3.7 mm

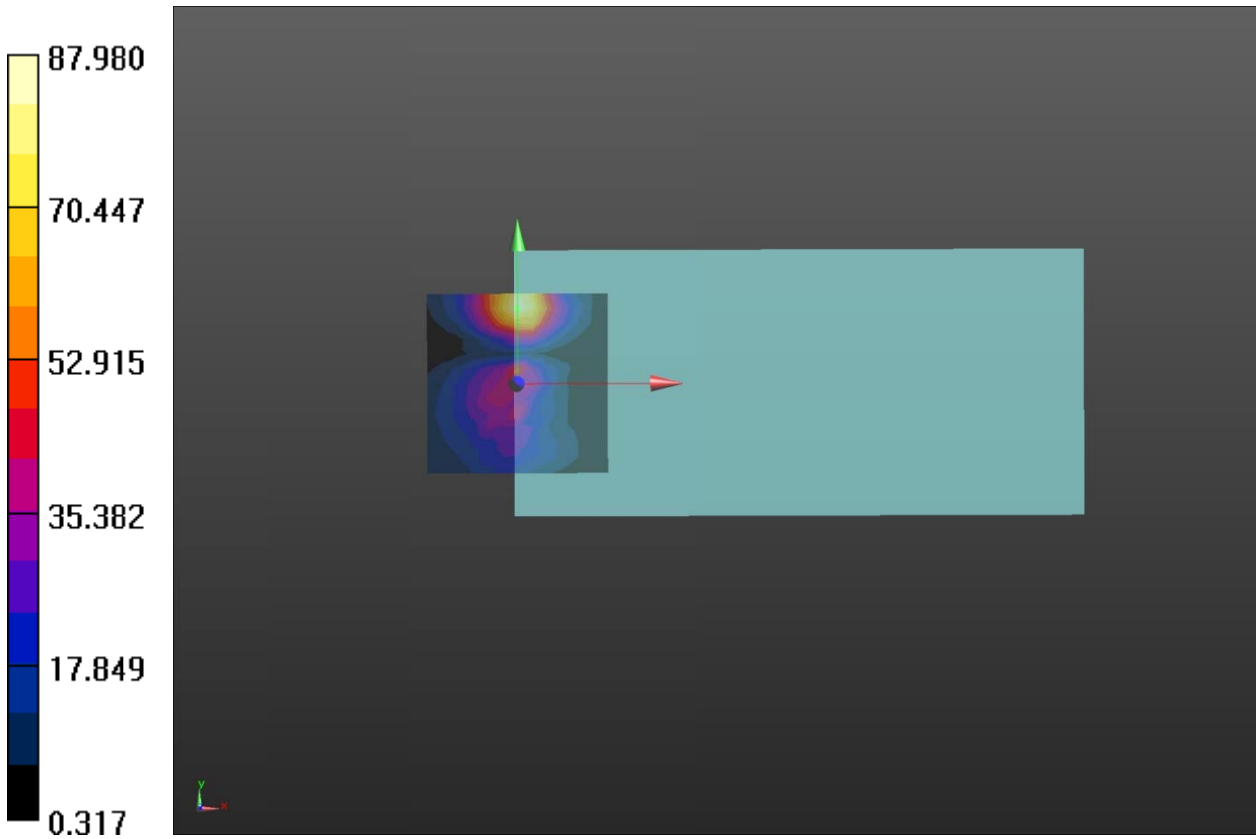

Plot 26 T-Coil Wi-Fi 2.4G 802.11b Z Axial

Date: 2023/5/30

Communication System: UID 10061 - CAB, IEEE 802.11b WiFi 2.4 GHz (DSSS, 11 Mbps);

Frequency: 2437 MHz; Duty Cycle: 1:2.29034

Medium parameters used: $\sigma = 0$ S/m, $\epsilon_r = 1$; $\rho = 1$ kg/m³

Ambient Temperature: 22.3 °C Liquid Temperature: 21.5 °C

Phantom section: TCoil Section

DASY5 Configuration:

Sensor-Surface: 0mm (Mechanical Surface Detection)

Probe: AM1DV3 - 3082; Calibrated: 2023/2/16

Electronics: DAE4 Sn1347; Calibrated: 2023/3/8

Phantom: HAC Test Arch with AMCC; Type: SD HAC P01 BA; Serial

Measurement SW: DASY52, Version 52.10 (4); SEMCAD X Version 14.6.14 (7483)

802.11b HAC_TCoil_WD_Emission/General Scans/z (axial) 4.2mm 50 x 50/ABM SNR(x,y,z)

(13x13x1): Measurement grid: dx=10mm, dy=10mm

Signal Type: Audio File (.wav) 48k_voice_1kHz_1s.wav

Output Gain: 33.76

Measure Window Start: 300ms

Measure Window Length: 1000ms

BWC applied: 0.17 dB

Device Reference Point: 0, 0, -6.3 mm

Cursor:

ABM1/ABM2 = 48.11 dB

ABM1 comp = 2.38 dBA/m

BWC Factor = 0.17 dB

Location: 0, 8.3, 3.7 mm

802.11b HAC_TCoil_WD_Emission/General Scans/z (axial) wideband at best S/N/ABM Freq

Resp(x,y,z,f) (1x1x1): Measurement grid: dx=10mm, dy=10mm

Signal Type: Audio File (.wav) 48k_voice_300-3000_2s.wav

Output Gain: 66.12

Measure Window Start: 300ms

Measure Window Length: 2000ms

BWC applied: 10.81 dB

Device Reference Point: 0, 0, -6.3 mm

Cursor:

Diff = 0.20 dB

BWC Factor = 10.81 dB

Location: 0, 8.3, 3.7 mm

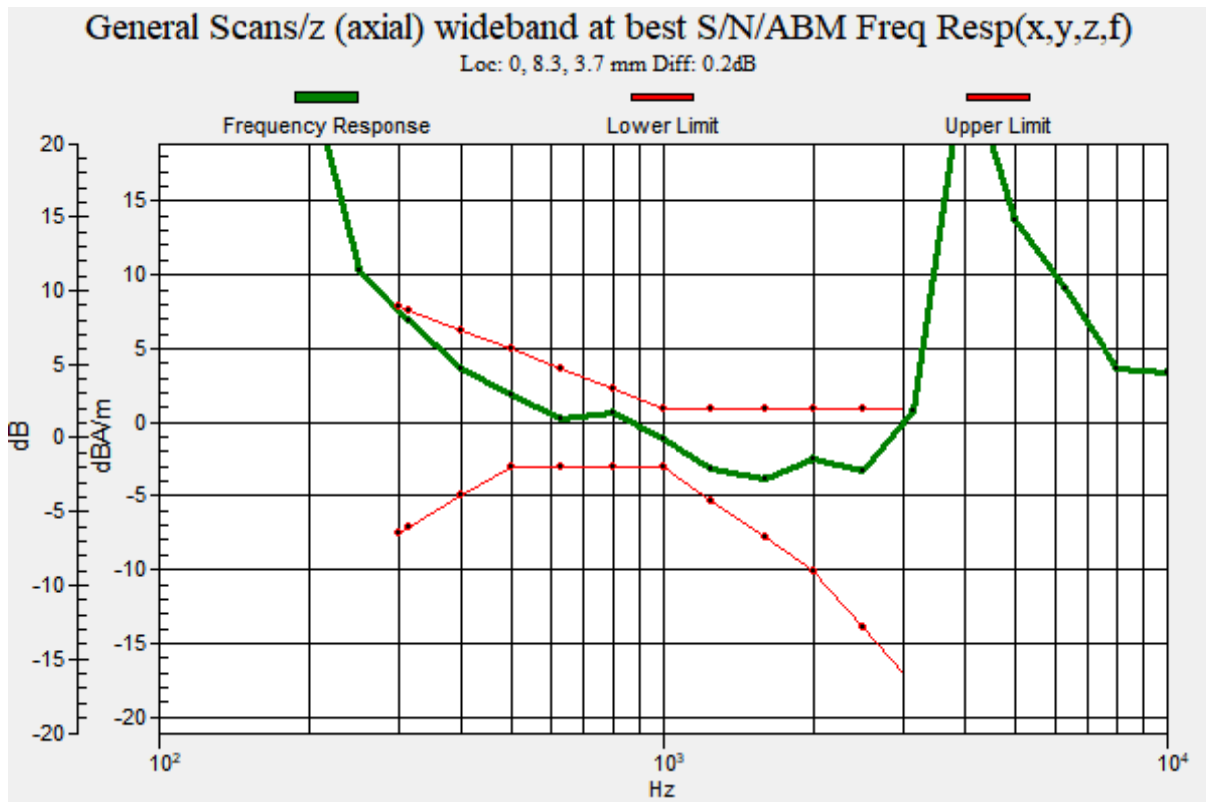
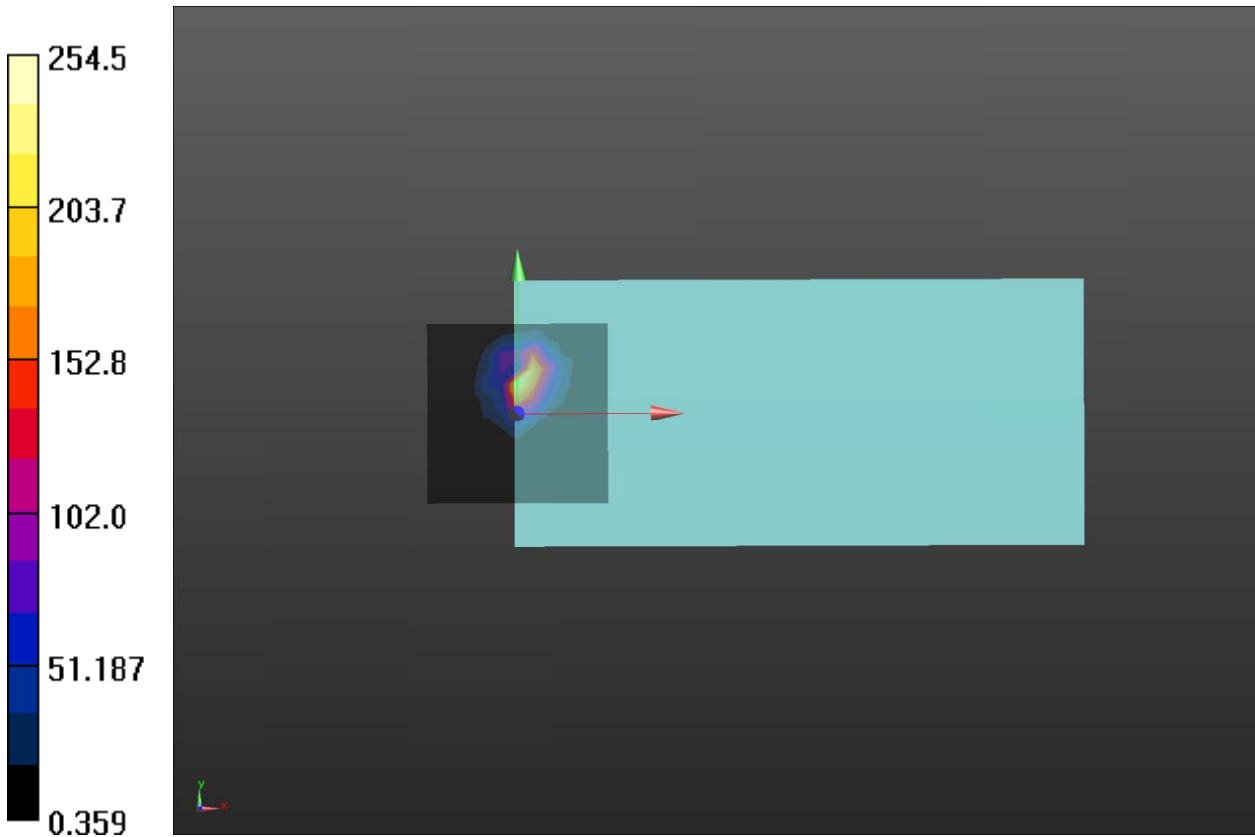

Plot 27 T-Coil Wi-Fi 2.4G 802.11g Y transversal

Date: 2023/5/30

Communication System: UID 10013 - CAB, IEEE 802.11g WiFi 2.4 GHz (DSSS-OFDM, 6 Mbps);

Frequency: 2437 MHz; Duty Cycle: 1:8.82673

Medium parameters used: $\sigma = 0$ S/m, $\epsilon_r = 1$; $\rho = 1$ kg/m³

Ambient Temperature: 22.3 °C Liquid Temperature: 21.5 °C

Phantom section: TCoil Section

DASY5 Configuration:

Sensor-Surface: 0mm (Mechanical Surface Detection)

Probe: AM1DV3 - 3082; Calibrated: 2023/2/16

Electronics: DAE4 Sn1347; Calibrated: 2023/3/8

Phantom: HAC Test Arch with AMCC; Type: SD HAC P01 BA; Serial

Measurement SW: DASY52, Version 52.10 (4); SEMCAD X Version 14.6.14 (7483)

802.11g HAC_TCoil_WD_Emission/General Scans/y (transversal) 4.2mm 50 x 50/ABM

SNR(x,y,z) (13x13x1): Measurement grid: dx=10mm, dy=10mm

Signal Type: Audio File (.wav) 48k_voice_1kHz_1s.wav

Output Gain: 33.76

Measure Window Start: 300ms

Measure Window Length: 1000ms

BWC applied: 0.17 dB

Device Reference Point: 0, 0, -6.3 mm

Cursor:

ABM1/ABM2 = 38.97 dB

ABM1 comp = -6.09 dBA/m

BWC Factor = 0.17 dB

Location: 0, 20.8, 3.7 mm

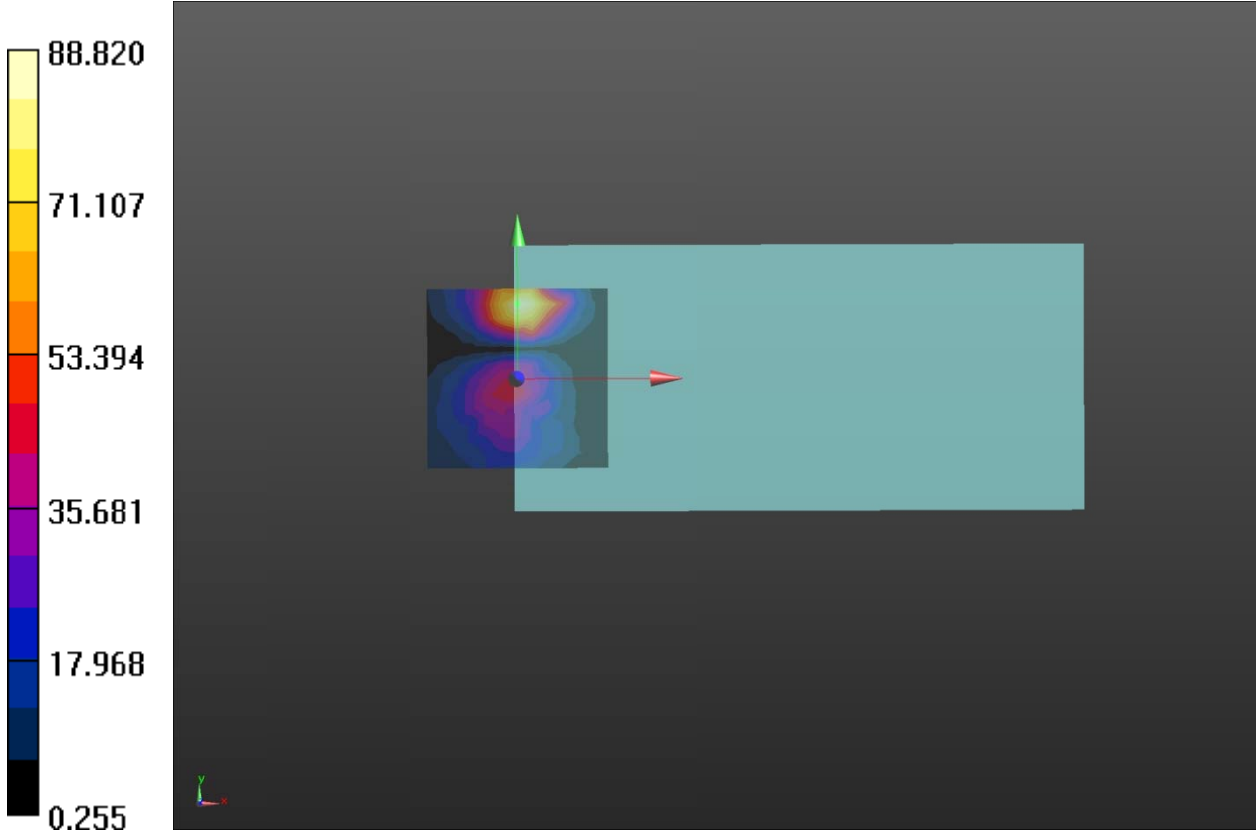

Plot 28 T-Coil Wi-Fi 2.4G 802.11g Z Axial

Date: 2023/5/30

Communication System: UID 10013 - CAB, IEEE 802.11g WiFi 2.4 GHz (DSSS-OFDM, 6 Mbps);

Frequency: 2437 MHz; Duty Cycle: 1:8.82673

Medium parameters used: $\sigma = 0$ S/m, $\epsilon_r = 1$; $\rho = 1$ kg/m³

Ambient Temperature: 22.3 °C Liquid Temperature: 21.5 °C

Phantom section: TCoil Section

DASY5 Configuration:

Sensor-Surface: 0mm (Mechanical Surface Detection)

Probe: AM1DV3 - 3082; Calibrated: 2023/2/16

Electronics: DAE4 Sn1347; Calibrated: 2023/3/8

Phantom: HAC Test Arch with AMCC; Type: SD HAC P01 BA; Serial

Measurement SW: DASY52, Version 52.10 (4); SEMCAD X Version 14.6.14 (7483)

802.11g HAC_TCoil_WD_Emission/General Scans/z (axial) 4.2mm 50 x 50/ABM SNR(x,y,z)

(13x13x1): Measurement grid: dx=10mm, dy=10mm

Signal Type: Audio File (.wav) 48k_voice_1kHz_1s.wav

Output Gain: 33.76

Measure Window Start: 300ms

Measure Window Length: 1000ms

BWC applied: 0.17 dB

Device Reference Point: 0, 0, -6.3 mm

Cursor:

ABM1/ABM2 = 48.55 dB

ABM1 comp = 5.99 dBA/m

BWC Factor = 0.17 dB

Location: 4.2, 8.3, 3.7 mm

802.11g HAC_TCoil_WD_Emission/General Scans/z (axial) wideband at best S/N/ABM Freq

Resp(x,y,z,f) (1x1x1): Measurement grid: dx=10mm, dy=10mm

Signal Type: Audio File (.wav) 48k_voice_300-3000_2s.wav

Output Gain: 66.12

Measure Window Start: 300ms

Measure Window Length: 2000ms

BWC applied: 10.81 dB

Device Reference Point: 0, 0, -6.3 mm

Cursor:

Diff = 0.08 dB

BWC Factor = 10.81 dB

Location: 4.2, 8.3, 3.7 mm

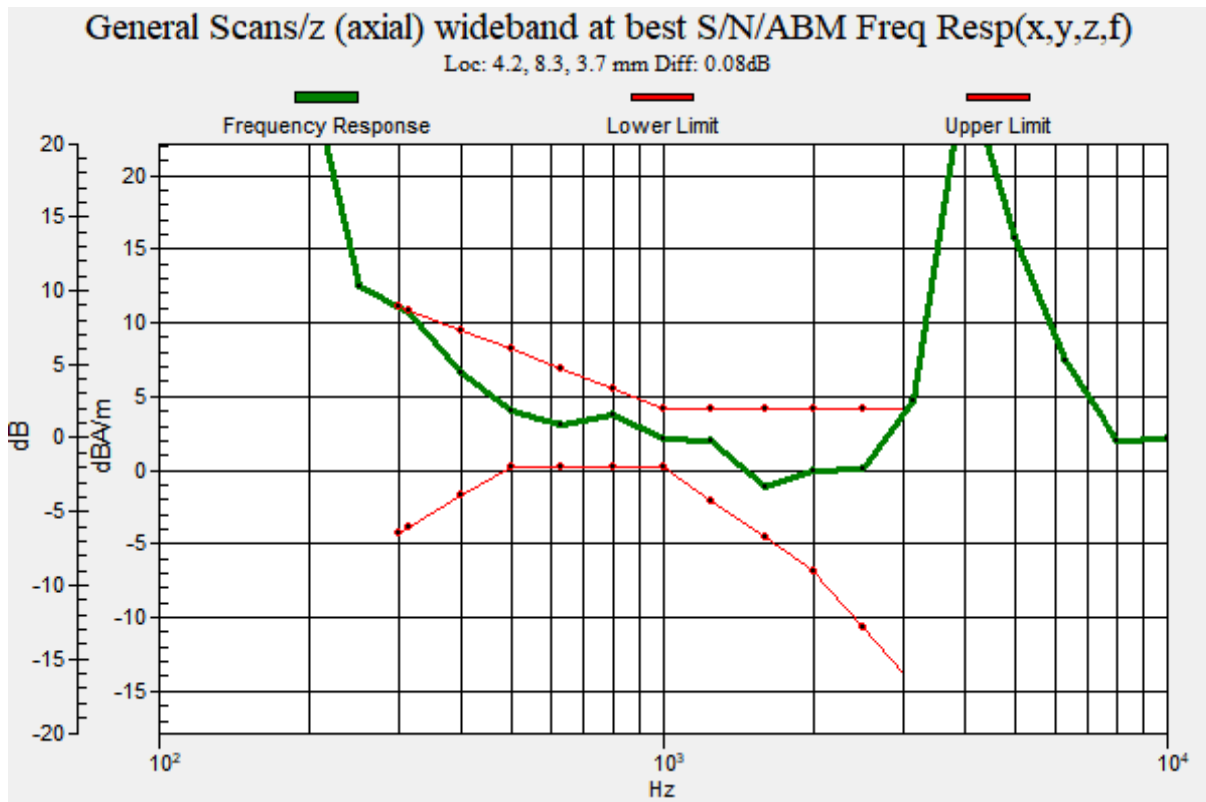
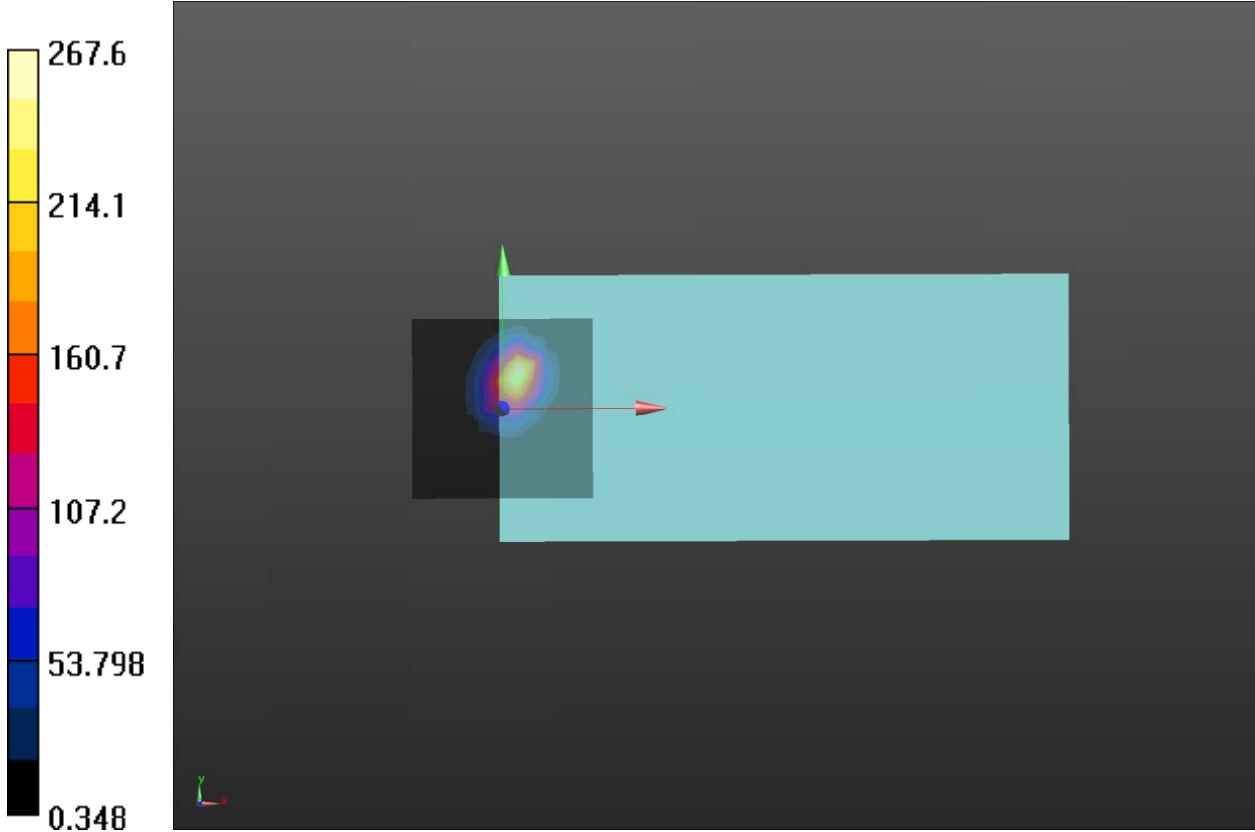

Plot 29 T-Coil Wi-Fi 2.4G 802.11n Y transversal

Date: 2023/5/30

Communication System: UID 10591 - AAB, IEEE 802.11n (HT Mixed, 20MHz, MCS0, 90pc duty cycle); Frequency: 2437 MHz; Duty Cycle: 1:7.29122

Medium parameters used: $\sigma = 0$ S/m, $\epsilon_r = 1$; $\rho = 1$ kg/m³

Ambient Temperature: 22.3 °C Liquid Temperature: 21.5 °C

Phantom section: TCoil Section

DASY5 Configuration:

Sensor-Surface: 0mm (Mechanical Surface Detection)

Probe: AM1DV3 - 3082; Calibrated: 2023/2/16

Electronics: DAE4 Sn1347; Calibrated: 2023/3/8

Phantom: HAC Test Arch with AMCC; Type: SD HAC P01 BA; Serial

Measurement SW: DASY52, Version 52.10 (4); SEMCAD X Version 14.6.14 (7483)

802.11n HAC_TCoil_WD_Emission/General Scans/y (transversal) 4.2mm 50 x 50/ABM**SNR(x,y,z) (13x13x1):** Measurement grid: dx=10mm, dy=10mm

Signal Type: Audio File (.wav) 48k_voice_1kHz_1s.wav

Output Gain: 33.76

Measure Window Start: 300ms

Measure Window Length: 1000ms

BWC applied: 0.17 dB

Device Reference Point: 0, 0, -6.3 mm

Cursor:

ABM1/ABM2 = 38.30 dB

ABM1 comp = -4.23 dBA/m

BWC Factor = 0.17 dB

Location: 4.2, 20.8, 3.7 mm

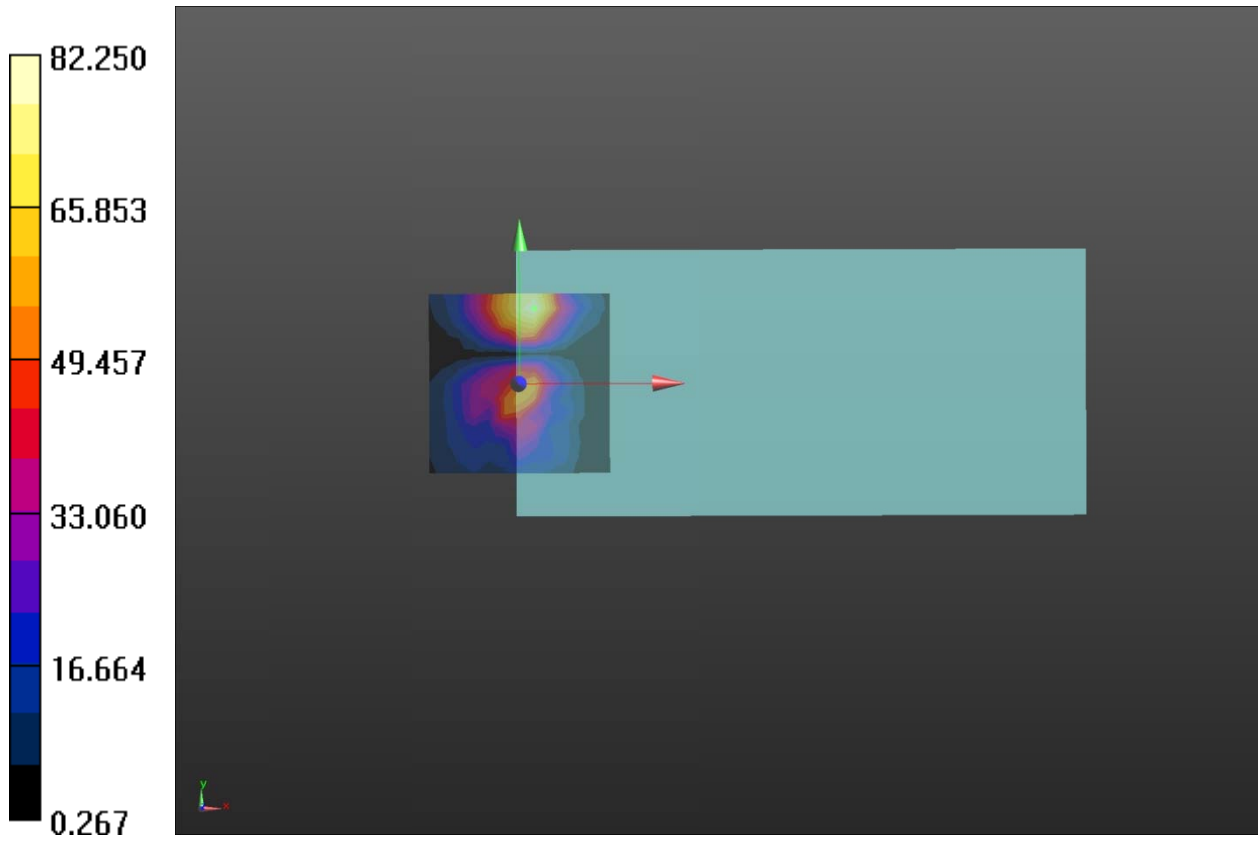

Plot 30 T-Coil Wi-Fi 2.4G 802.11n Z Axial

Date: 2023/5/30

Communication System: UID 10591 - AAB, IEEE 802.11n (HT Mixed, 20MHz, MCS0, 90pc duty cycle); Frequency: 2437 MHz; Duty Cycle: 1:7.29122

Medium parameters used: $\sigma = 0$ S/m, $\epsilon_r = 1$; $\rho = 1$ kg/m³

Ambient Temperature: 22.3 °C Liquid Temperature: 21.5 °C

Phantom section: TCoil Section

DASY5 Configuration:

Sensor-Surface: 0mm (Mechanical Surface Detection)

Probe: AM1DV3 - 3082; Calibrated: 2023/2/16

Electronics: DAE4 Sn1347; Calibrated: 2023/3/8

Phantom: HAC Test Arch with AMCC; Type: SD HAC P01 BA; Serial

Measurement SW: DASY52, Version 52.10 (4); SEMCAD X Version 14.6.14 (7483)

802.11n HAC_TCoil_WD_Emission/General Scans/z (axial) 4.2mm 50 x 50/ABM SNR(x,y,z)

(13x13x1): Measurement grid: dx=10mm, dy=10mm

Signal Type: Audio File (.wav) 48k_voice_1kHz_1s.wav

Output Gain: 33.76

Measure Window Start: 300ms

Measure Window Length: 1000ms

BWC applied: 0.17 dB

Device Reference Point: 0, 0, -6.3 mm

Cursor:

ABM1/ABM2 = 48.95 dB

ABM1 comp = 5.45 dBA/m

BWC Factor = 0.17 dB

Location: 4.2, 8.3, 3.7 mm

802.11n HAC_TCoil_WD_Emission/General Scans/z (axial) wideband at best S/N/ABM Freq

Resp(x,y,z,f) (1x1x1): Measurement grid: dx=10mm, dy=10mm

Signal Type: Audio File (.wav) 48k_voice_300-3000_2s.wav

Output Gain: 66.12

Measure Window Start: 300ms

Measure Window Length: 2000ms

BWC applied: 10.81 dB

Device Reference Point: 0, 0, -6.3 mm

Cursor:

Diff = 0.20 dB

BWC Factor = 10.81 dB

Location: 4.2, 8.3, 3.7 mm

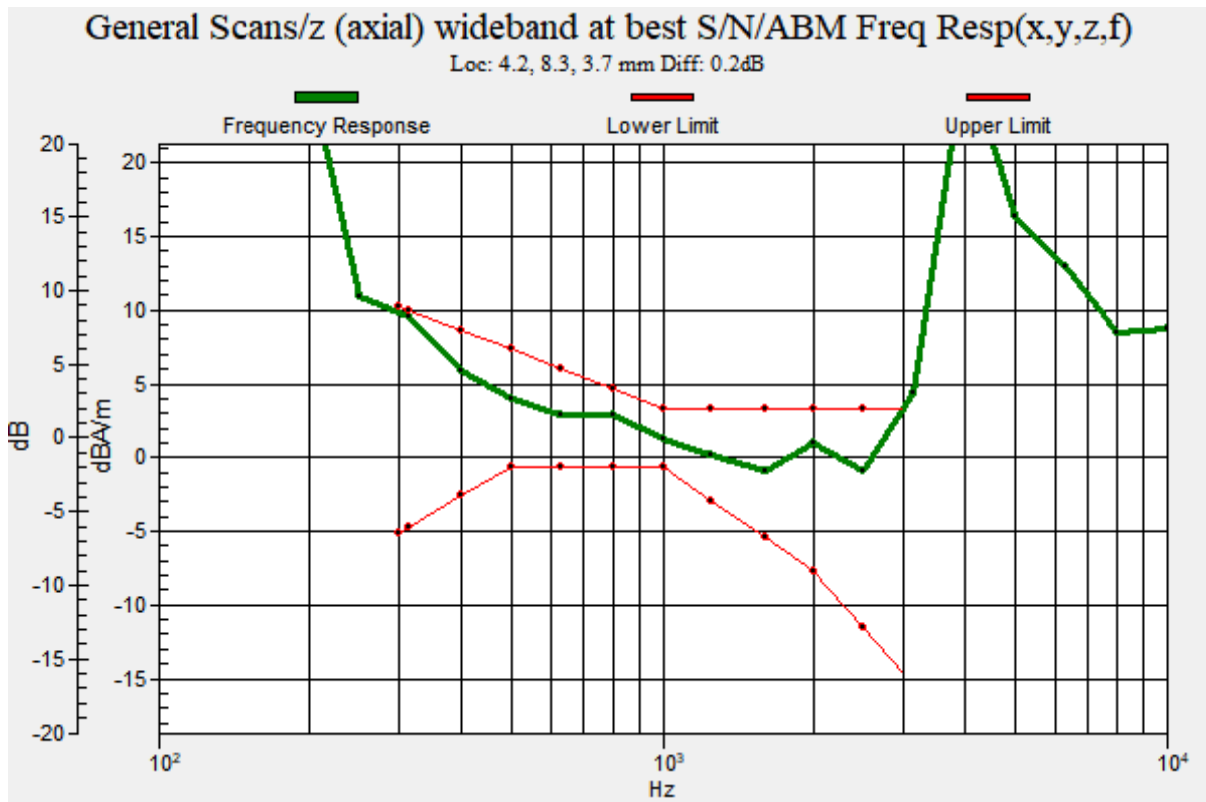
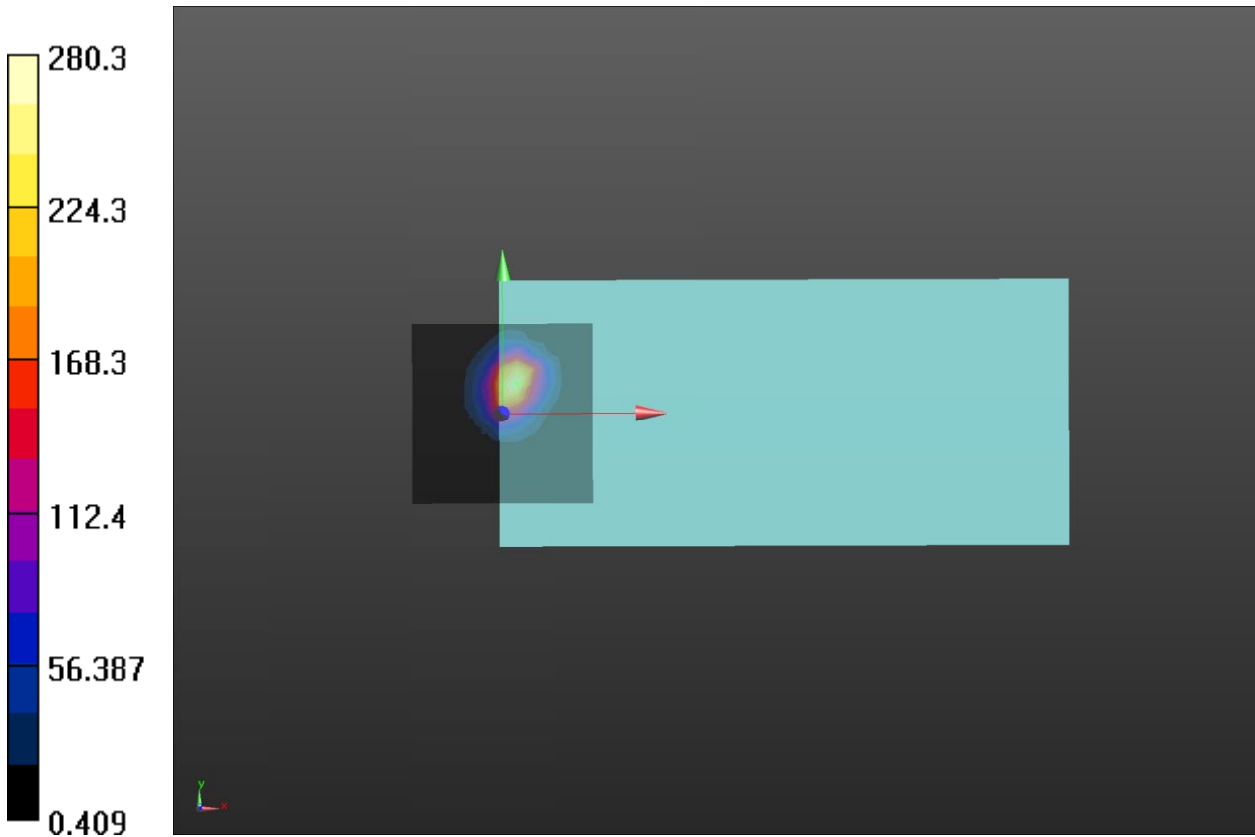

Plot 31 T-Coil Wi-Fi 5G U-NII-1 802.11a Y transversal

Date: 2023/5/31

Communication System: UID 10062 - CAC, IEEE 802.11a WiFi 5 GHz (OFDM, 6 Mbps); Frequency: 5200 MHz; Duty Cycle: 1:7.37564

Medium parameters used: $\sigma = 0$ S/m, $\epsilon_r = 1$; $\rho = 1$ kg/m³

Ambient Temperature: 22.3 °C Liquid Temperature: 21.5 °C

Phantom section: TCoil Section

DASY5 Configuration:

Sensor-Surface: 0mm (Mechanical Surface Detection)

Probe: AM1DV3 - 3082; Calibrated: 2023/2/16

Electronics: DAE4 Sn1347; Calibrated: 2023/3/8

Phantom: HAC Test Arch with AMCC; Type: SD HAC P01 BA; Serial

Measurement SW: DASY52, Version 52.10 (4); SEMCAD X Version 14.6.14 (7483)

802.11a HAC_TCoil_WD_Emission/General Scans/y (transversal) 4.2mm 50 x 50/ABM

SNR(x,y,z) (13x13x1): Measurement grid: dx=10mm, dy=10mm

Signal Type: Audio File (.wav) 48k_voice_1kHz_1s.wav

Output Gain: 33.76

Measure Window Start: 300ms

Measure Window Length: 1000ms

BWC applied: 0.17 dB

Device Reference Point: 0, 0, -6.3 mm

Cursor:

ABM1/ABM2 = 39.98 dB

ABM1 comp = -6.47 dBA/m

BWC Factor = 0.17 dB

Location: -4.2, 4.2, 3.7 mm

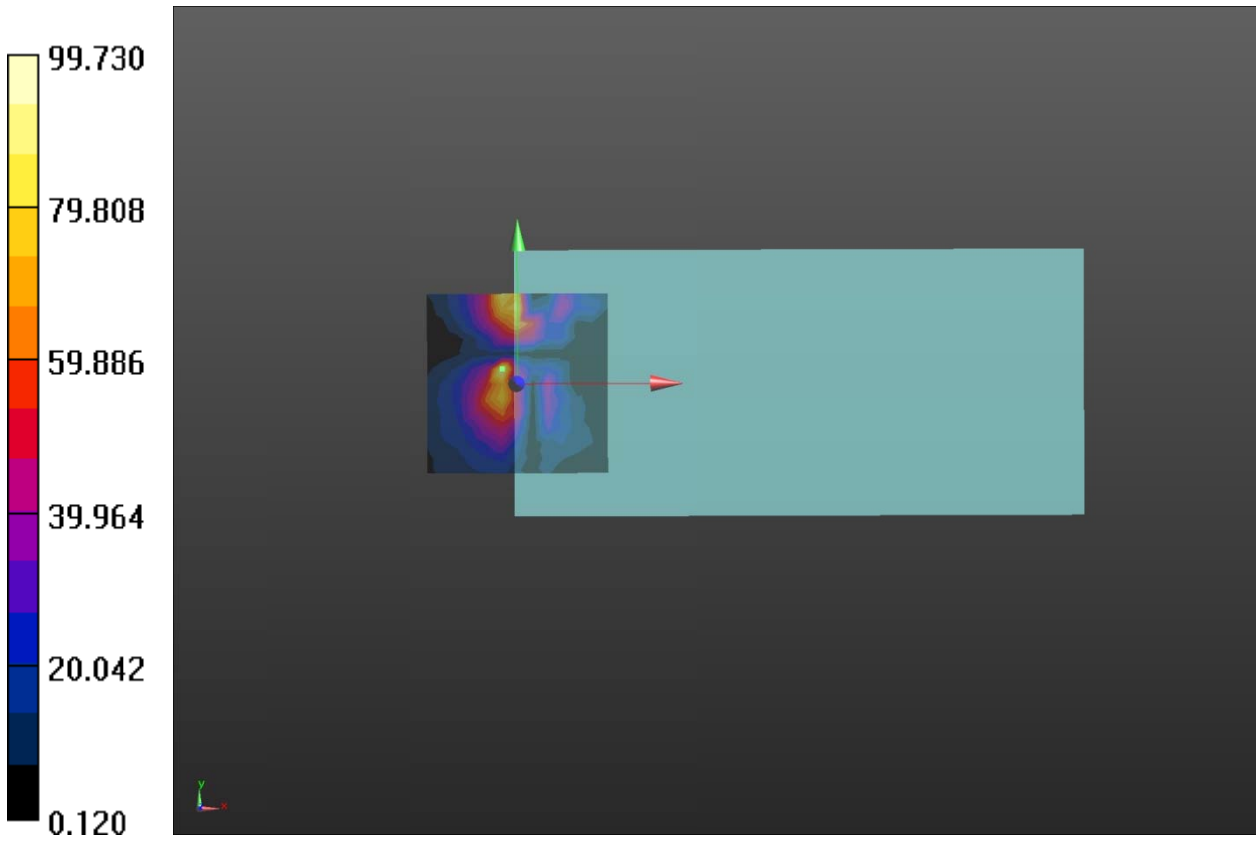

Plot 32 T-Coil Wi-Fi 5G U-NII-1 802.11a Z Axial

Date: 2023/5/31

Communication System: UID 10062 - CAC, IEEE 802.11a WiFi 5 GHz (OFDM, 6 Mbps); Frequency: 5200 MHz; Duty Cycle: 1:7.37564

Medium parameters used: $\sigma = 0$ S/m, $\epsilon_r = 1$; $\rho = 1$ kg/m³

Ambient Temperature: 22.3 °C Liquid Temperature: 21.5 °C

Phantom section: TCoil Section

DASY5 Configuration:

Sensor-Surface: 0mm (Mechanical Surface Detection)

Probe: AM1DV3 - 3082; Calibrated: 2023/2/16

Electronics: DAE4 Sn1347; Calibrated: 2023/3/8

Phantom: HAC Test Arch with AMCC; Type: SD HAC P01 BA; Serial

Measurement SW: DASY52, Version 52.10 (4); SEMCAD X Version 14.6.14 (7483)

802.11a HAC_TCoil_WD_Emission/General Scans/z (axial) 4.2mm 50 x 50/ABM SNR(x,y,z)

(13x13x1): Measurement grid: dx=10mm, dy=10mm

Signal Type: Audio File (.wav) 48k_voice_1kHz_1s.wav

Output Gain: 33.76

Measure Window Start: 300ms

Measure Window Length: 1000ms

BWC applied: 0.17 dB

Device Reference Point: 0, 0, -6.3 mm

Cursor:

ABM1/ABM2 = 52.42 dB

ABM1 comp = 2.65 dBA/m

BWC Factor = 0.17 dB

Location: 0, 8.3, 3.7 mm

802.11a HAC_TCoil_WD_Emission/General Scans/z (axial) wideband at best S/N/ABM Freq

Resp(x,y,z,f) (1x1x1): Measurement grid: dx=10mm, dy=10mm

Signal Type: Audio File (.wav) 48k_voice_300-3000_2s.wav

Output Gain: 66.12

Measure Window Start: 300ms

Measure Window Length: 2000ms

BWC applied: 10.81 dB

Device Reference Point: 0, 0, -6.3 mm

Cursor:

Diff = 0.38 dB

BWC Factor = 10.81 dB

Location: 0, 8.3, 3.7 mm

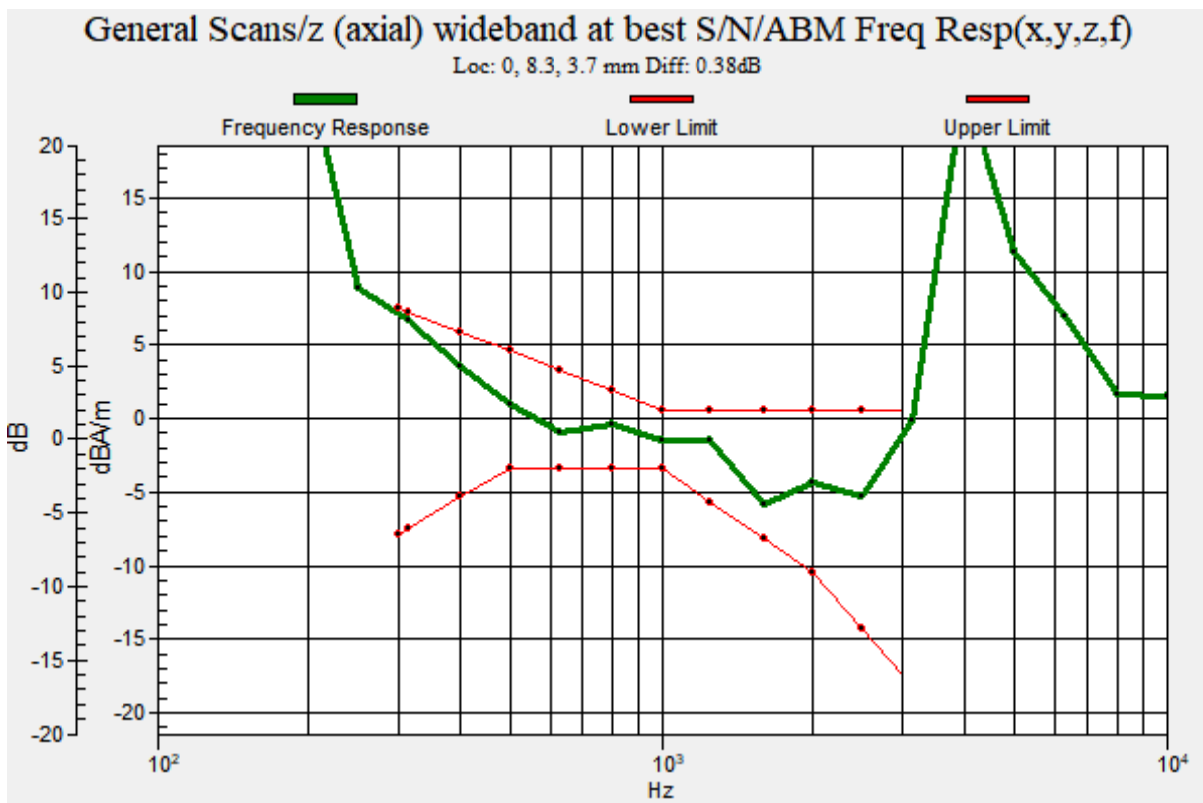
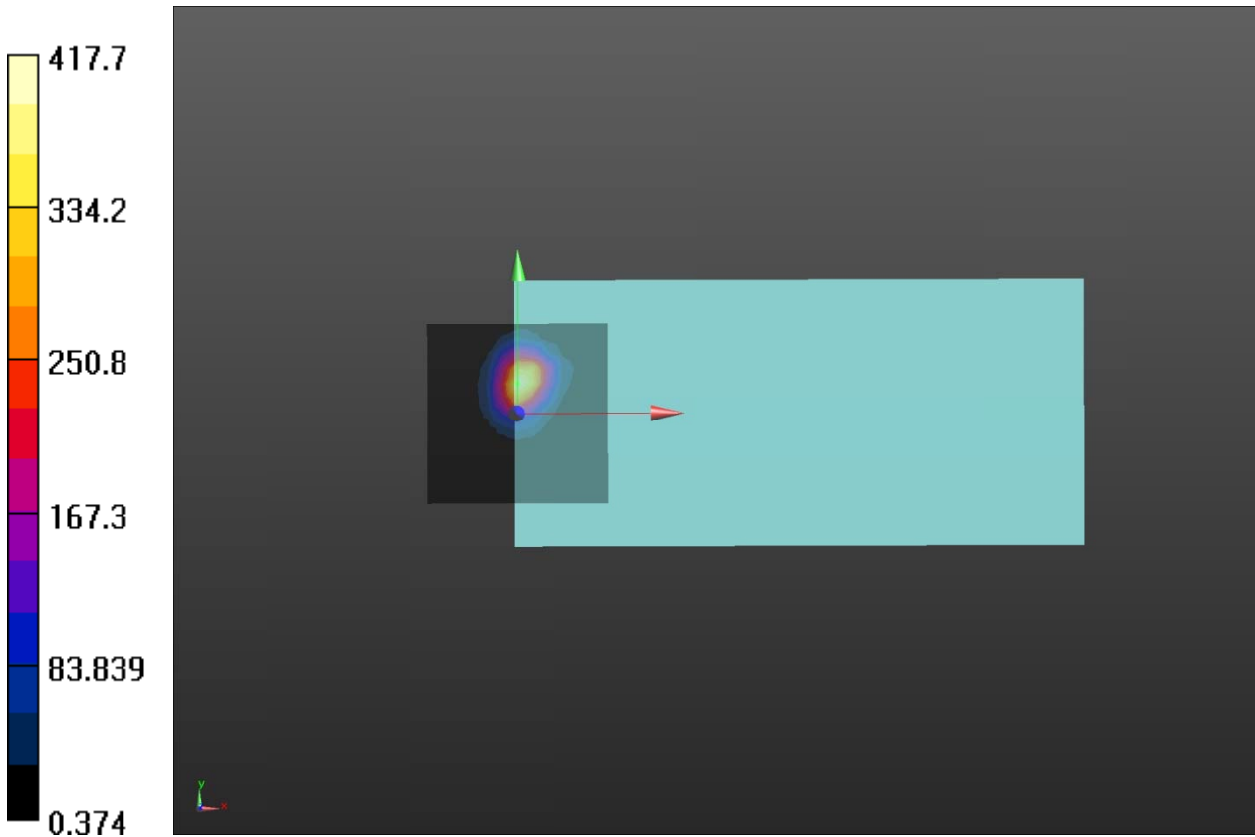

Plot 33 T-Coil Wi-Fi 5G U-NII-2A 802.11a Y transversal

Date: 2023/5/31

Communication System: UID 10062 - CAC, IEEE 802.11a WiFi 5 GHz (OFDM, 6 Mbps); Frequency: 5300 MHz; Duty Cycle: 1:7.37564

Medium parameters used: $\sigma = 0$ S/m, $\epsilon_r = 1$; $\rho = 1$ kg/m³

Ambient Temperature: 22.3 °C Liquid Temperature: 21.5 °C

Phantom section: TCoil Section

DASY5 Configuration:

Sensor-Surface: 0mm (Mechanical Surface Detection)

Probe: AM1DV3 - 3082; Calibrated: 2023/2/16

Electronics: DAE4 Sn1347; Calibrated: 2023/3/8

Phantom: HAC Test Arch with AMCC; Type: SD HAC P01 BA; Serial

Measurement SW: DASY52, Version 52.10 (4); SEMCAD X Version 14.6.14 (7483)

802.11a HAC_TCoil_WD_Emission/General Scans/y (transversal) 4.2mm 50 x 50/ABM

SNR(x,y,z) (13x13x1): Measurement grid: dx=10mm, dy=10mm

Signal Type: Audio File (.wav) 48k_voice_1kHz_1s.wav

Output Gain: 33.76

Measure Window Start: 300ms

Measure Window Length: 1000ms

BWC applied: 0.17 dB

Device Reference Point: 0, 0, -6.3 mm

Cursor:

ABM1/ABM2 = 38.60 dB

ABM1 comp = -9.62 dBA/m

BWC Factor = 0.17 dB

Location: 0, 25, 3.7 mm

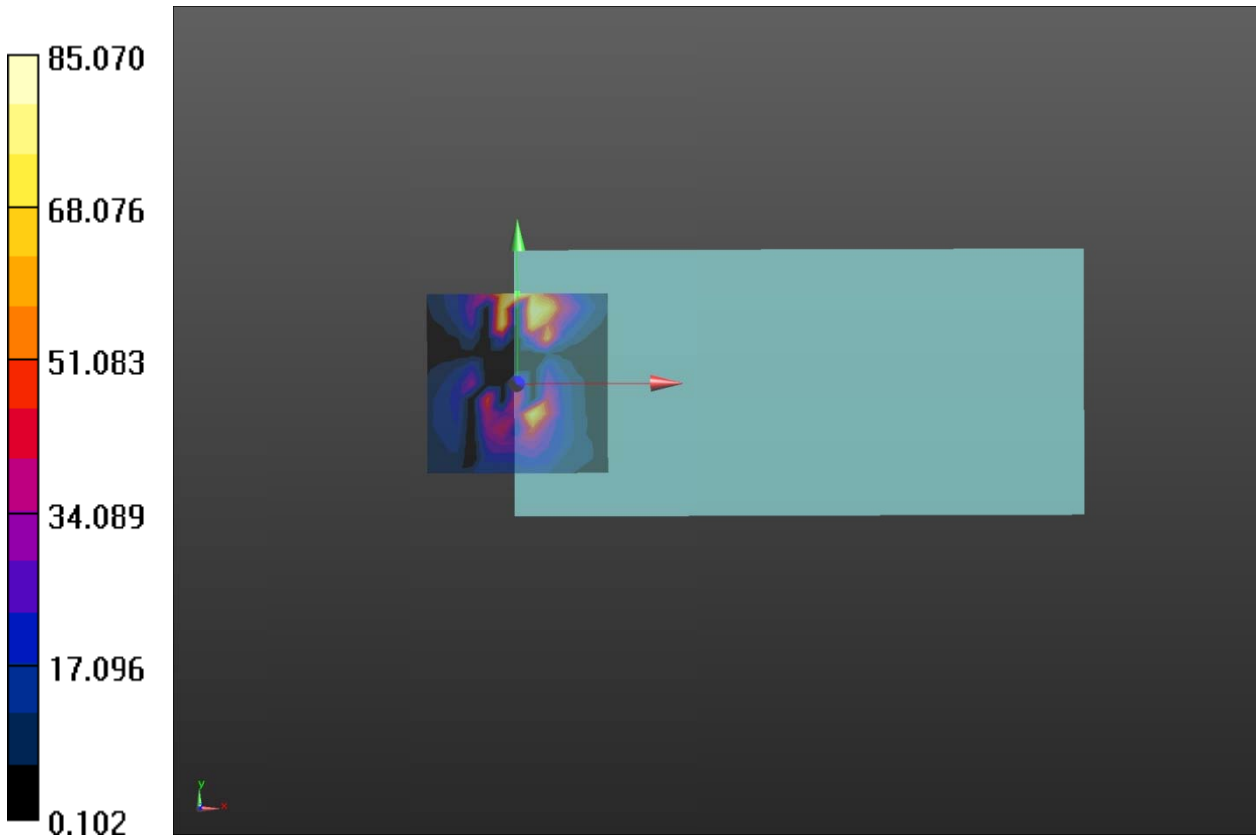

Plot 34 T-Coil Wi-Fi 5G U-NII-2A 802.11a Z Axial

Date: 2023/5/31

Communication System: UID 10062 - CAC, IEEE 802.11a WiFi 5 GHz (OFDM, 6 Mbps); Frequency: 5300 MHz; Duty Cycle: 1:7.37564

Medium parameters used: $\sigma = 0$ S/m, $\epsilon_r = 1$; $\rho = 1$ kg/m³

Ambient Temperature: 22.3 °C Liquid Temperature: 21.5 °C

Phantom section: TCoil Section

DASY5 Configuration:

Sensor-Surface: 0mm (Mechanical Surface Detection)

Probe: AM1DV3 - 3082; Calibrated: 2023/2/16

Electronics: DAE4 Sn1347; Calibrated: 2023/3/8

Phantom: HAC Test Arch with AMCC; Type: SD HAC P01 BA; Serial

Measurement SW: DASY52, Version 52.10 (4); SEMCAD X Version 14.6.14 (7483)

802.11a HAC_TCoil_WD_Emission/General Scans/z (axial) 4.2mm 50 x 50/ABM SNR(x,y,z)

(13x13x1): Measurement grid: dx=10mm, dy=10mm

Signal Type: Audio File (.wav) 48k_voice_1kHz_1s.wav

Output Gain: 33.76

Measure Window Start: 300ms

Measure Window Length: 1000ms

BWC applied: 0.17 dB

Device Reference Point: 0, 0, -6.3 mm

Cursor:

ABM1/ABM2 = 44.26 dB

ABM1 comp = 6.53 dBA/m

BWC Factor = 0.17 dB

Location: 8.3, 8.3, 3.7 mm

802.11a HAC_TCoil_WD_Emission/General Scans/z (axial) wideband at best S/N/ABM Freq

Resp(x,y,z,f) (1x1x1): Measurement grid: dx=10mm, dy=10mm

Signal Type: Audio File (.wav) 48k_voice_300-3000_2s.wav

Output Gain: 66.12

Measure Window Start: 300ms

Measure Window Length: 2000ms

BWC applied: 10.81 dB

Device Reference Point: 0, 0, -6.3 mm

Cursor:

Diff = 0.67 dB

BWC Factor = 10.81 dB

Location: 8.3, 8.3, 3.7 mm

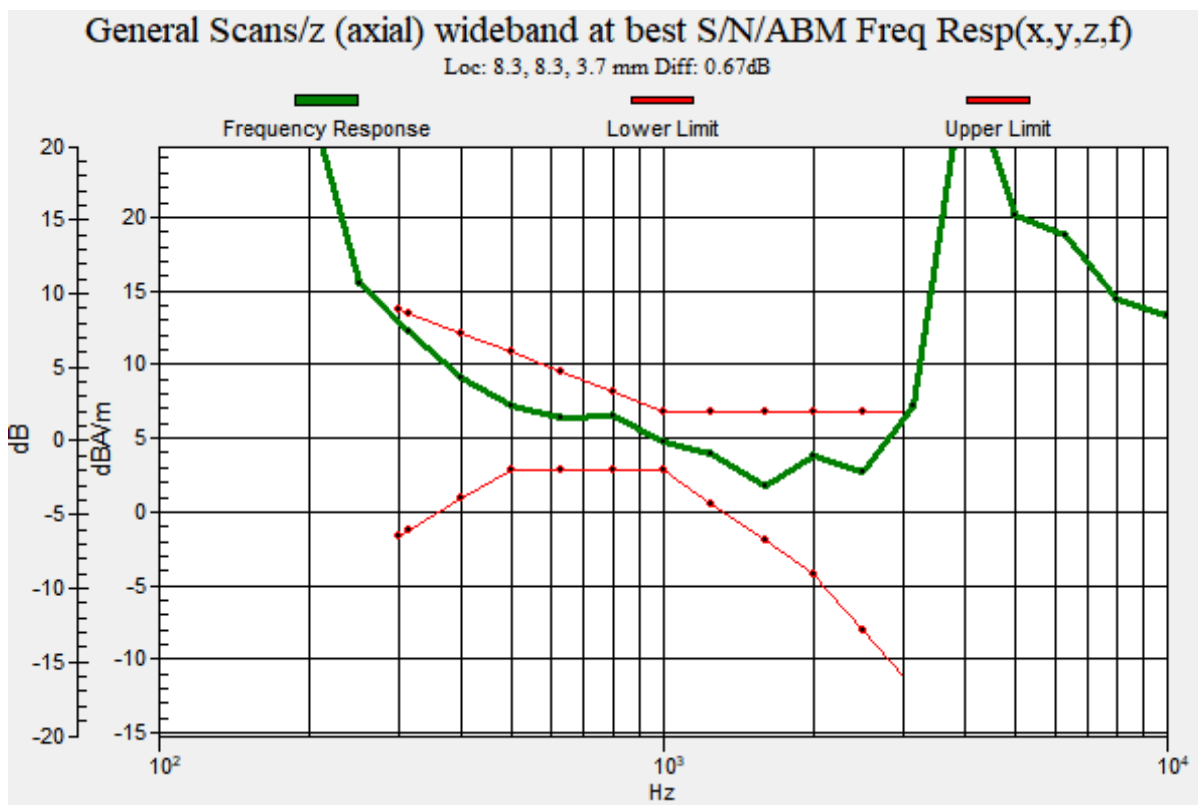
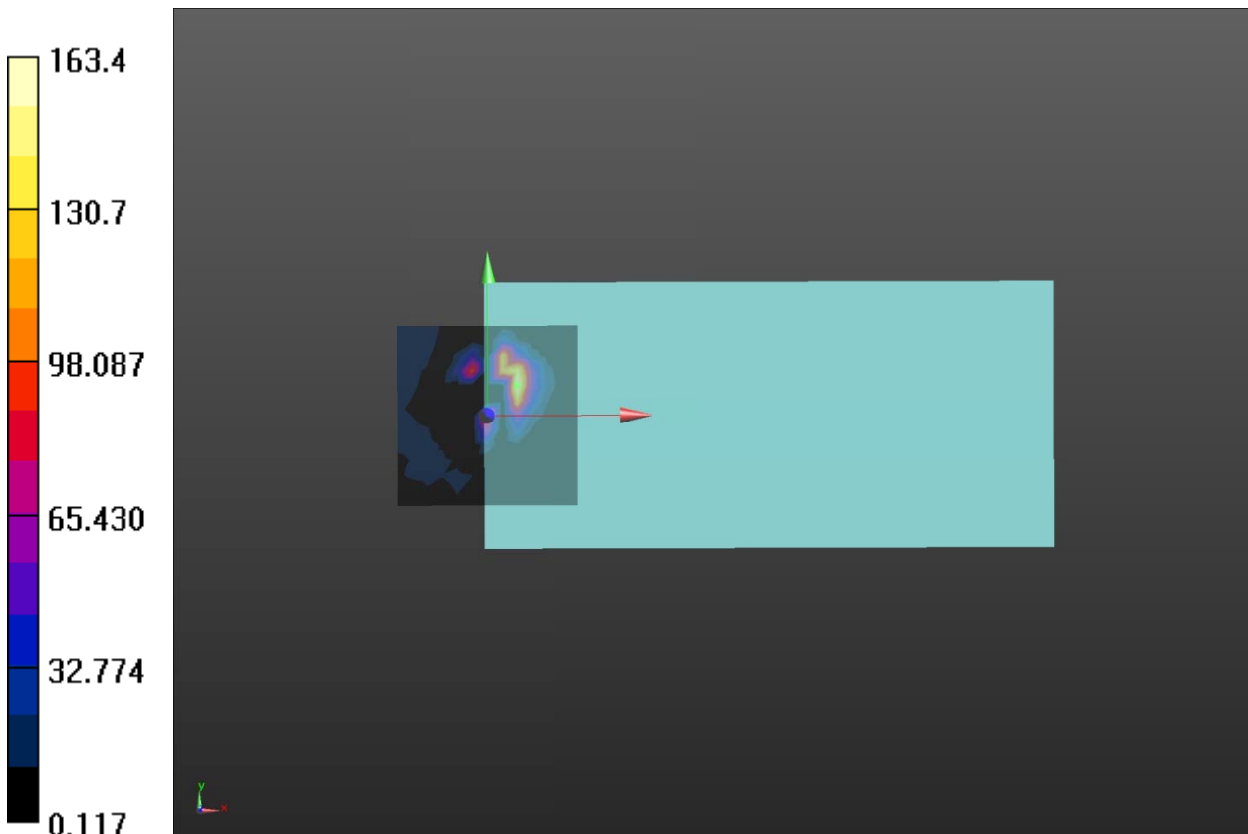

Plot 35 T-Coil Wi-Fi 5G U-NII-2A 802.11a Y transversal (Second supply)

Date: 2023/6/2

Communication System: UID 10062 - CAC, IEEE 802.11a/h WiFi 5 GHz (OFDM, 6 Mbps); Frequency: 5300 MHz; Duty Cycle: 1:7.37564

Medium parameters used: $\sigma = 0$ S/m, $\epsilon_r = 1$; $\rho = 1$ kg/m³

Ambient Temperature: 22.3 °C Liquid Temperature: 21.5 °C

Phantom section: TCoil Section

DASY5 Configuration:

Sensor-Surface: 0mm (Mechanical Surface Detection)

Probe: AM1DV3 - 3082; Calibrated: 2023/2/16

Electronics: DAE4 Sn1347; Calibrated: 2023/3/8

Phantom: HAC Test Arch with AMCC; Type: SD HAC P01 BA; Serial

Measurement SW: DASY52, Version 52.10 (4); SEMCAD X Version 14.6.14 (7483)

802.11a HAC_TCoil_WD_Emission/General Scans/y (transversal) 4.2mm 50 x 50/ABM

SNR(x,y,z) (13x13x1): Measurement grid: dx=10mm, dy=10mm

Signal Type: Audio File (.wav) 48k_voice_1kHz_1s.wav

Output Gain: 33.76

Measure Window Start: 300ms

Measure Window Length: 1000ms

BWC applied: 0.17 dB

Device Reference Point: 0, 0, -6.3 mm

Cursor:

ABM1/ABM2 = 44.48 dB

ABM1 comp = -0.99 dBA/m

BWC Factor = 0.17 dB

Location: 4.2, 16.7, 3.7 mm

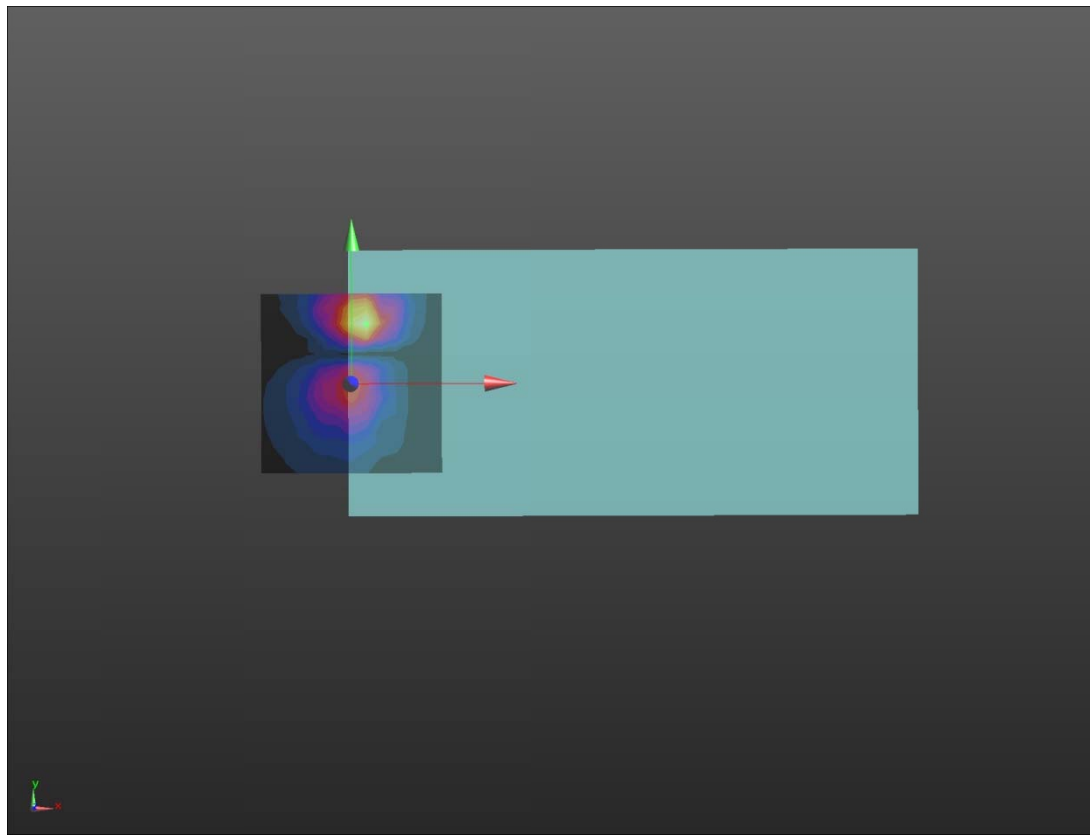
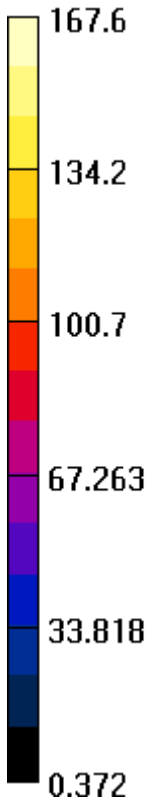

Plot 36 T-Coil Wi-Fi 5G U-NII-2A 802.11a Z Axial (Second supply)

Date: 2023/6/2

Communication System: UID 10062 - CAC, IEEE 802.11a/h WiFi 5 GHz (OFDM, 6 Mbps); Frequency: 5300 MHz; Duty Cycle: 1:7.37564

Medium parameters used: $\sigma = 0$ S/m, $\epsilon_r = 1$; $\rho = 1$ kg/m³

Ambient Temperature: 22.3 °C Liquid Temperature: 21.5 °C

Phantom section: TCoil Section

DASY5 Configuration:

Sensor-Surface: 0mm (Mechanical Surface Detection)

Probe: AM1DV3 - 3082; Calibrated: 2023/2/16

Electronics: DAE4 Sn1347; Calibrated: 2023/3/8

Phantom: HAC Test Arch with AMCC; Type: SD HAC P01 BA; Serial

Measurement SW: DASY52, Version 52.10 (4); SEMCAD X Version 14.6.14 (7483)

802.11a HAC_TCoil_WD_Emission/General Scans/z (axial) 4.2mm 50 x 50/ABM SNR(x,y,z)

(13x13x1): Measurement grid: dx=10mm, dy=10mm

Signal Type: Audio File (.wav) 48k_voice_1kHz_1s.wav

Output Gain: 33.76

Measure Window Start: 300ms

Measure Window Length: 1000ms

BWC applied: 0.17 dB

Device Reference Point: 0, 0, -6.3 mm

Cursor:

ABM1/ABM2 = 52.68 dB

ABM1 comp = 3.13 dBA/m

BWC Factor = 0.17 dB

Location: 0, 8.3, 3.7 mm

802.11a HAC_TCoil_WD_Emission/General Scans/z (axial) wideband at best S/N/ABM Freq

Resp(x,y,z,f) (1x1x1): Measurement grid: dx=10mm, dy=10mm

Signal Type: Audio File (.wav) 48k_voice_300-3000_2s.wav

Output Gain: 66.12

Measure Window Start: 300ms

Measure Window Length: 2000ms

BWC applied: 10.81 dB

Device Reference Point: 0, 0, -6.3 mm

Cursor:

Diff = 0.87 dB

BWC Factor = 10.81 dB

Location: 0, 8.3, 3.7 mm

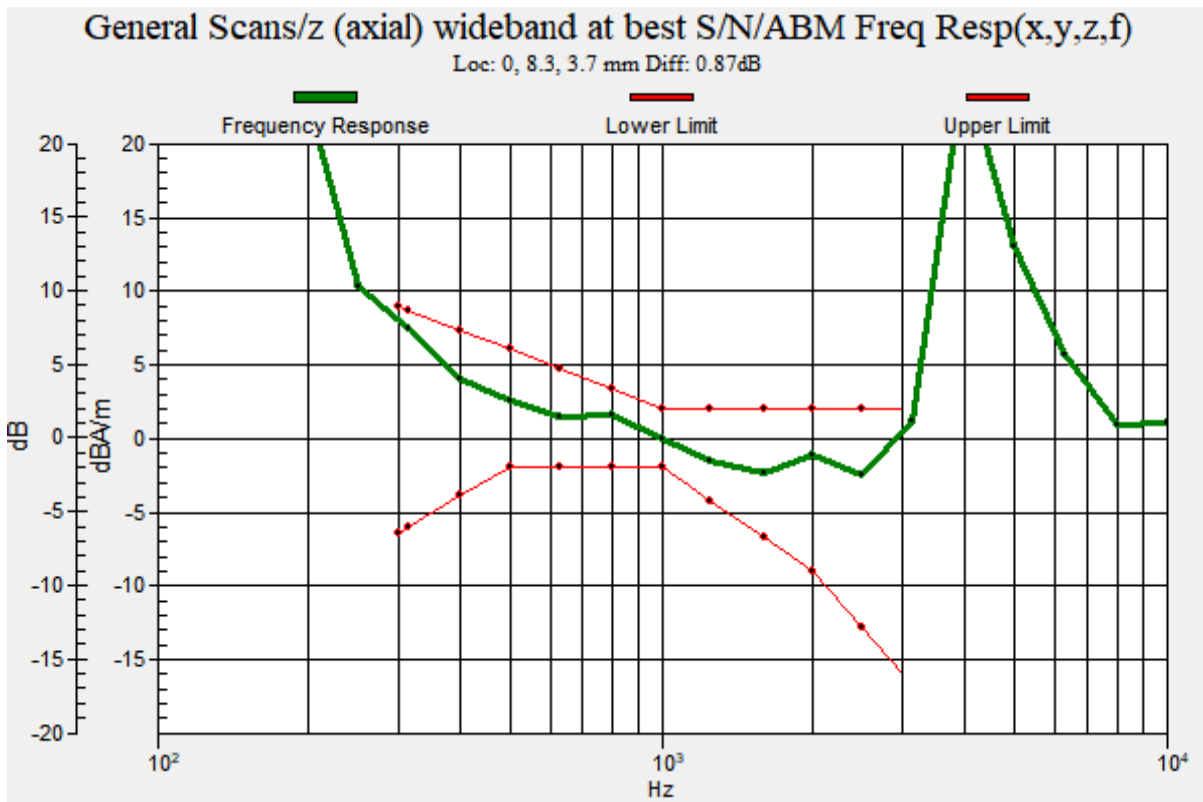
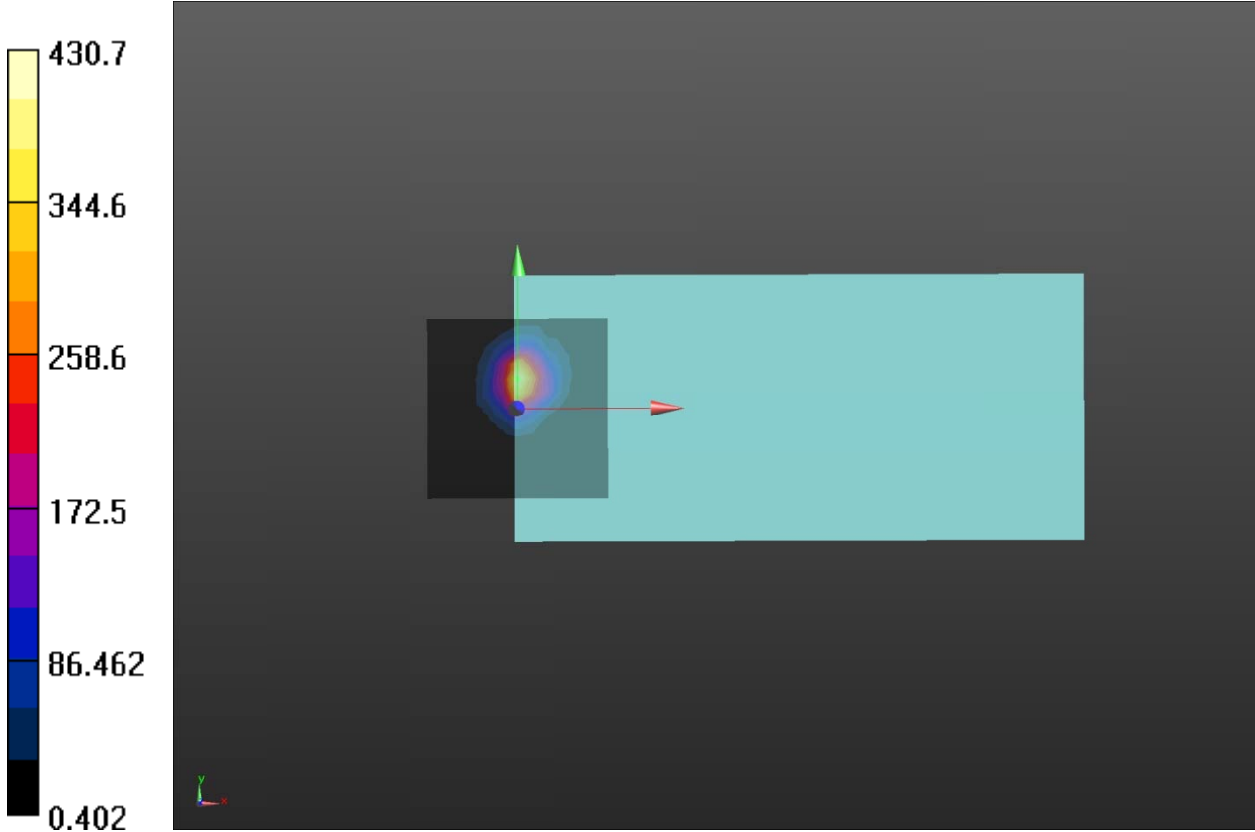

Plot 37 T-Coil Wi-Fi 5G U-NII-2C 802.11a Y transversal

Date: 2023/6/1

Communication System: UID 10062 - CAC, IEEE 802.11a WiFi 5 GHz (OFDM, 6 Mbps); Frequency: 5580 MHz; Duty Cycle: 1:7.37564

Medium parameters used: $\sigma = 0$ S/m, $\epsilon_r = 1$; $\rho = 1$ kg/m³

Ambient Temperature: 22.3 °C Liquid Temperature: 21.5 °C

Phantom section: TCoil Section

DASY5 Configuration:

Sensor-Surface: 0mm (Mechanical Surface Detection)

Probe: AM1DV3 - 3082; Calibrated: 2023/2/16

Electronics: DAE4 Sn1347; Calibrated: 2023/3/8

Phantom: HAC Test Arch with AMCC; Type: SD HAC P01 BA; Serial

Measurement SW: DASY52, Version 52.10 (4); SEMCAD X Version 14.6.14 (7483)

802.11a HAC_TCoil_WD_Emission/General Scans/y (transversal) 4.2mm 50 x 50/ABM

SNR(x,y,z) (13x13x1): Measurement grid: dx=10mm, dy=10mm

Signal Type: Audio File (.wav) 48k_voice_1kHz_1s.wav

Output Gain: 33.76

Measure Window Start: 300ms

Measure Window Length: 1000ms

BWC applied: 0.17 dB

Device Reference Point: 0, 0, -6.3 mm

Cursor:

ABM1/ABM2 = 40.92 dB

ABM1 comp = -5.58 dBA/m

BWC Factor = 0.17 dB

Location: 0, -8.3, 3.7 mm

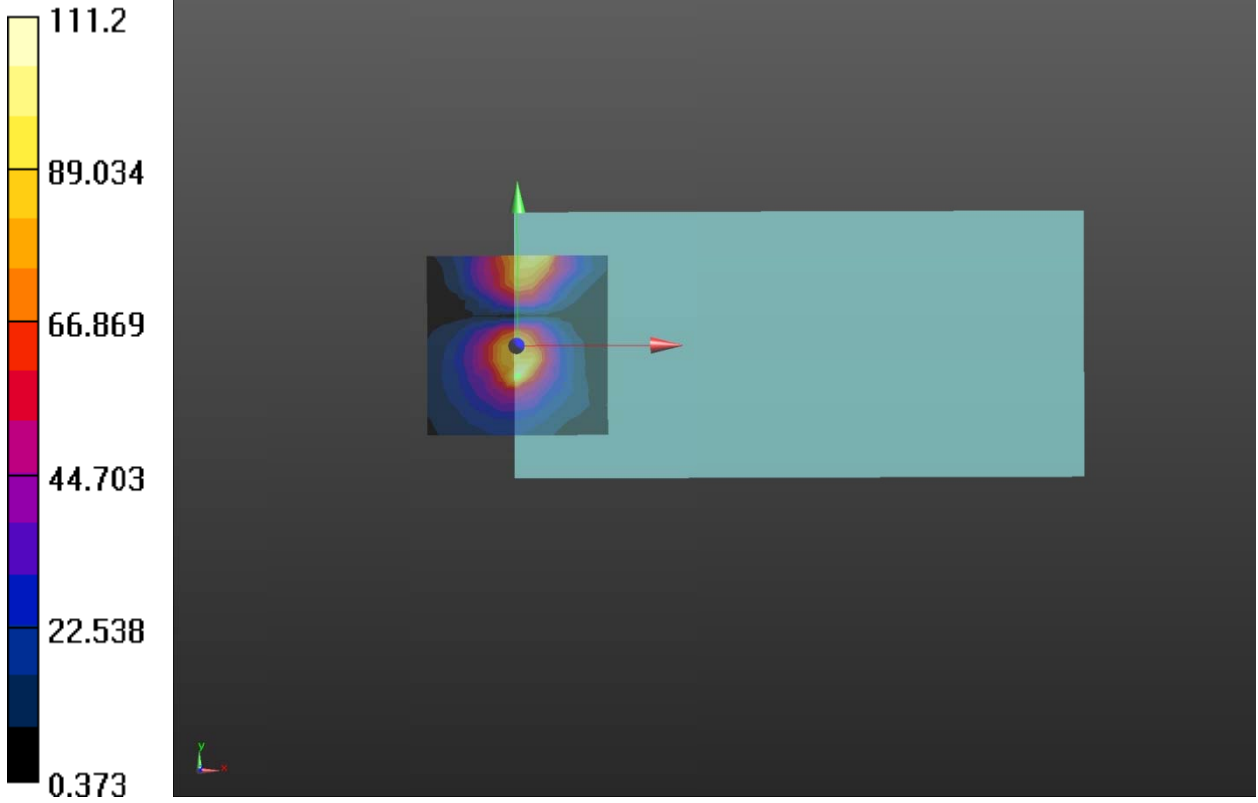

Plot 38 T-Coil Wi-Fi 5G U-NII-2C 802.11a Z Axial

Date: 2023/6/1

Communication System: UID 10062 - CAC, IEEE 802.11a WiFi 5 GHz (OFDM, 6 Mbps); Frequency: 5580 MHz; Duty Cycle: 1:7.37564

Medium parameters used: $\sigma = 0$ S/m, $\epsilon_r = 1$; $\rho = 1$ kg/m³

Ambient Temperature: 22.3 °C Liquid Temperature: 21.5 °C

Phantom section: TCoil Section

DASY5 Configuration:

Sensor-Surface: 0mm (Mechanical Surface Detection)

Probe: AM1DV3 - 3082; Calibrated: 2023/2/16

Electronics: DAE4 Sn1347; Calibrated: 2023/3/8

Phantom: HAC Test Arch with AMCC; Type: SD HAC P01 BA; Serial

Measurement SW: DASY52, Version 52.10 (4); SEMCAD X Version 14.6.14 (7483)

802.11a HAC_TCoil_WD_Emission/General Scans/z (axial) 4.2mm 50 x 50/ABM SNR(x,y,z)

(13x13x1): Measurement grid: dx=10mm, dy=10mm

Signal Type: Audio File (.wav) 48k_voice_1kHz_1s.wav

Output Gain: 33.76

Measure Window Start: 300ms

Measure Window Length: 1000ms

BWC applied: 0.17 dB

Device Reference Point: 0, 0, -6.3 mm

Cursor:

ABM1/ABM2 = 52.56 dB

ABM1 comp = 2.81 dBA/m

BWC Factor = 0.17 dB

Location: 0, 8.3, 3.7 mm

802.11a HAC_TCoil_WD_Emission/General Scans/z (axial) wideband at best S/N/ABM Freq

Resp(x,y,z,f) (1x1x1): Measurement grid: dx=10mm, dy=10mm

Signal Type: Audio File (.wav) 48k_voice_300-3000_2s.wav

Output Gain: 66.12

Measure Window Start: 300ms

Measure Window Length: 2000ms

BWC applied: 10.81 dB

Device Reference Point: 0, 0, -6.3 mm

Cursor:

Diff = 0.10 dB

BWC Factor = 10.81 dB

Location: 0, 8.3, 3.7 mm

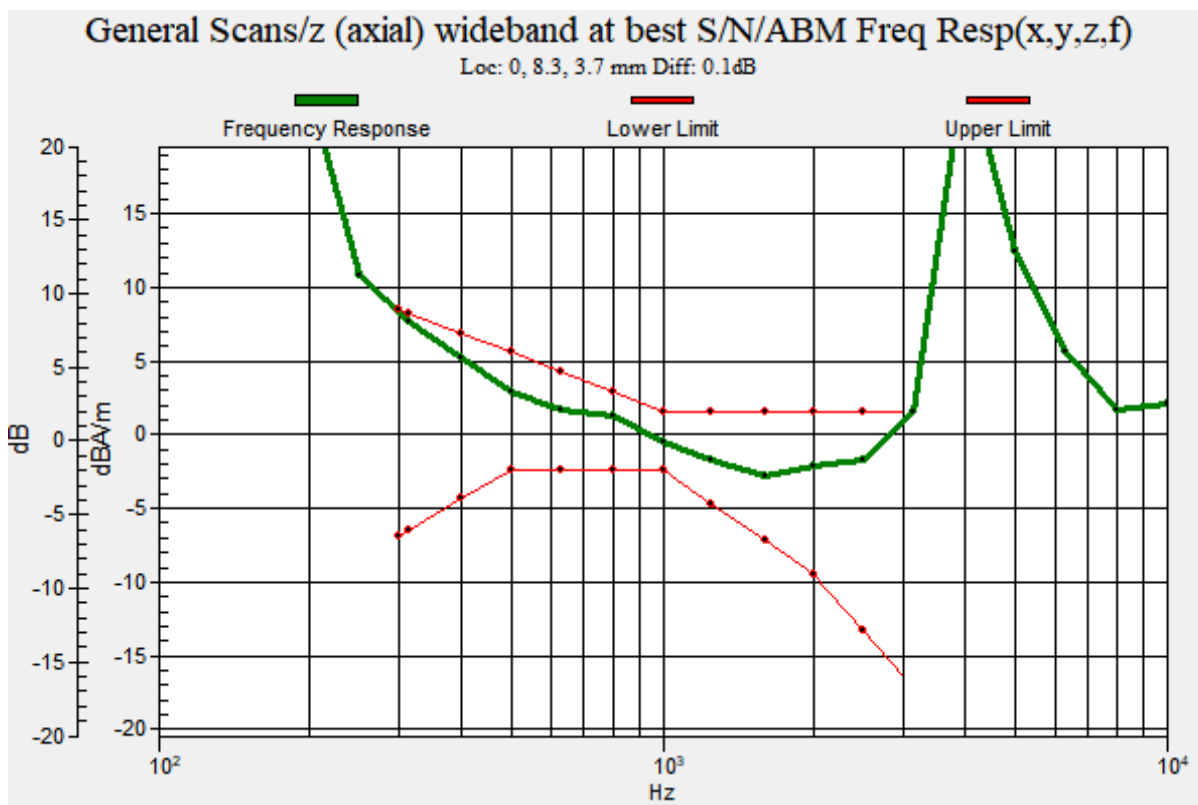
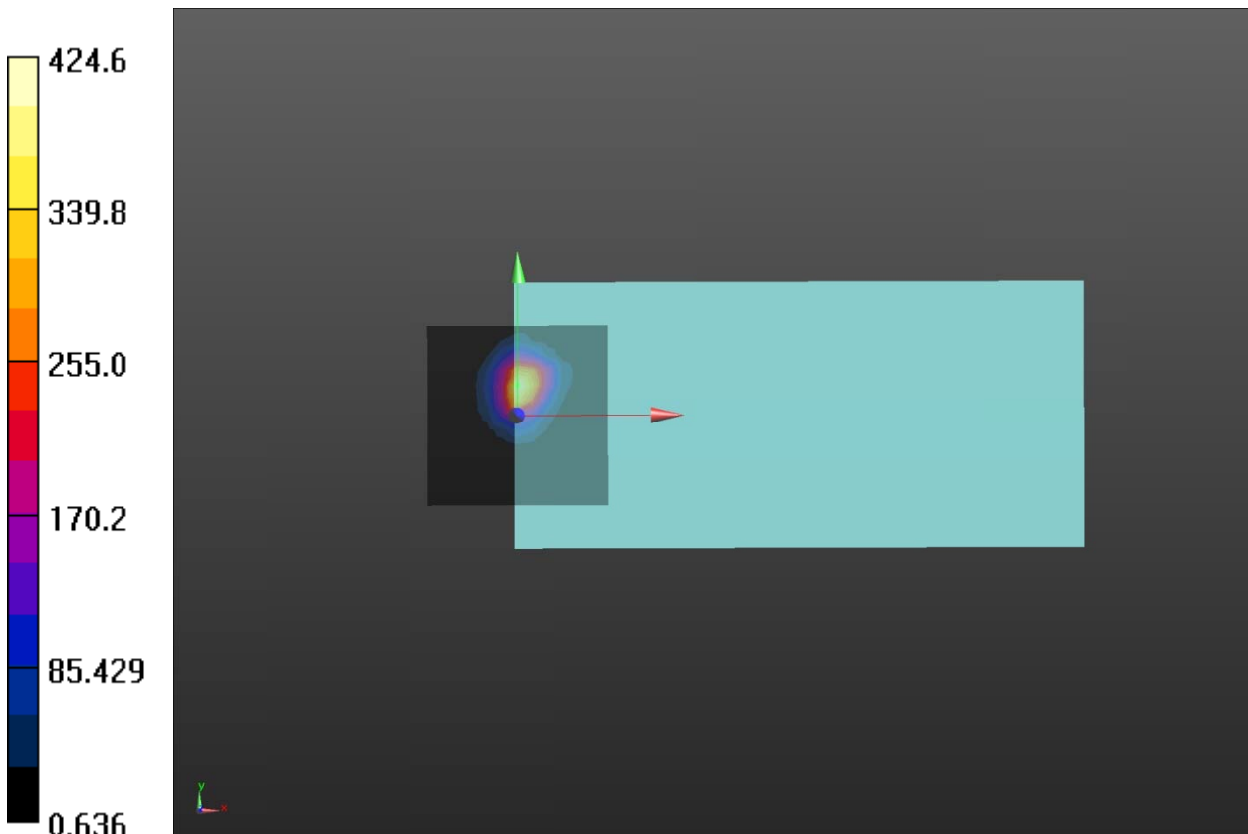

Plot 39 T-Coil Wi-Fi 5G U-NII-3 802.11a Y transversal

Date: 2023/5/31

Communication System: UID 10062 - CAC, IEEE 802.11a WiFi 5 GHz (OFDM, 6 Mbps); Frequency: 5785 MHz; Duty Cycle: 1:7.37564

Medium parameters used: $\sigma = 0$ S/m, $\epsilon_r = 1$; $\rho = 1$ kg/m³

Ambient Temperature: 22.3 °C Liquid Temperature: 21.5 °C

Phantom section: TCoil Section

DASY5 Configuration:

Sensor-Surface: 0mm (Mechanical Surface Detection)

Probe: AM1DV3 - 3082; Calibrated: 2023/2/16

Electronics: DAE4 Sn1347; Calibrated: 2023/3/8

Phantom: HAC Test Arch with AMCC; Type: SD HAC P01 BA; Serial

Measurement SW: DASY52, Version 52.10 (4); SEMCAD X Version 14.6.14 (7483)

802.11a HAC_TCoil_WD_Emission/General Scans/y (transversal) 4.2mm 50 x 50/ABM

SNR(x,y,z) (13x13x1): Measurement grid: dx=10mm, dy=10mm

Signal Type: Audio File (.wav) 48k_voice_1kHz_1s.wav

Output Gain: 33.76

Measure Window Start: 300ms

Measure Window Length: 1000ms

BWC applied: 0.17 dB

Device Reference Point: 0, 0, -6.3 mm

Cursor:

ABM1/ABM2 = 40.64 dB

ABM1 comp = -3.75 dBA/m

BWC Factor = 0.17 dB

Location: 8.3, 25, 3.7 mm

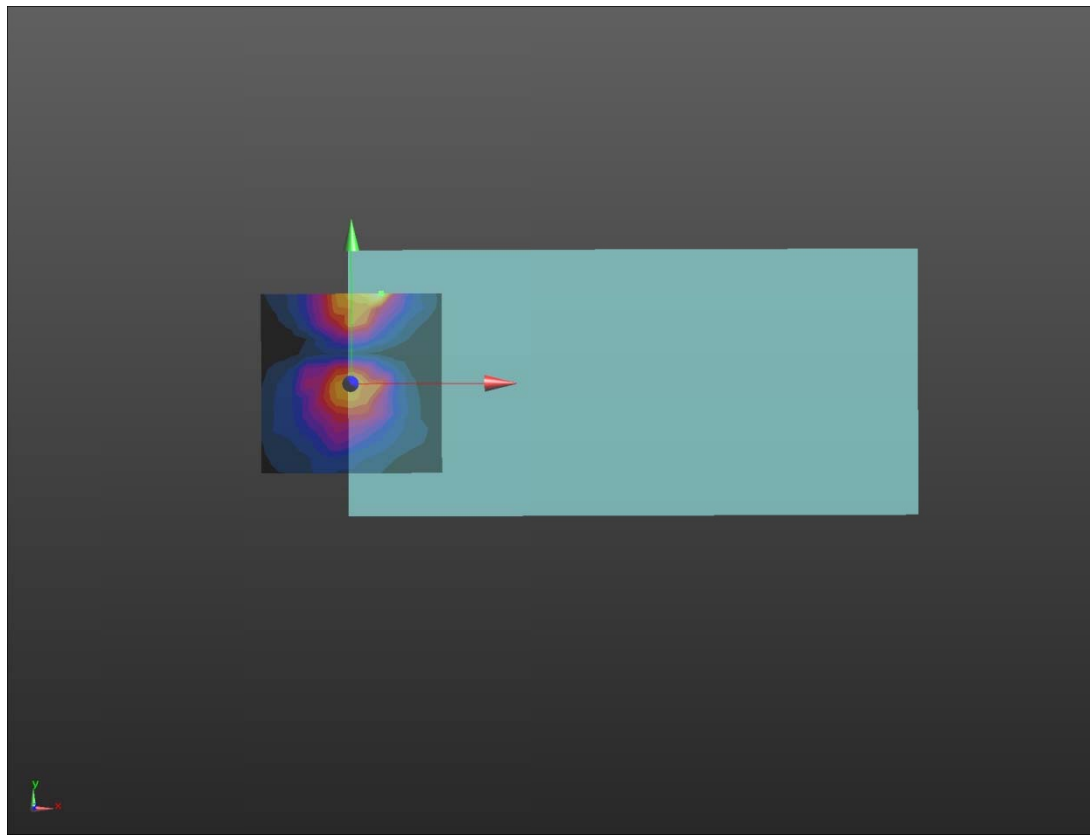
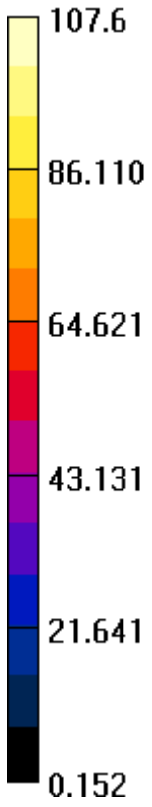

Plot 40 T-Coil Wi-Fi 5G U-NII-3 802.11a Z Axial

Date: 2023/5/31

Communication System: UID 10062 - CAC, IEEE 802.11a WiFi 5 GHz (OFDM, 6 Mbps); Frequency: 5785 MHz; Duty Cycle: 1:7.37564

Medium parameters used: $\sigma = 0$ S/m, $\epsilon_r = 1$; $\rho = 1$ kg/m³

Ambient Temperature: 22.3 °C Liquid Temperature: 21.5 °C

Phantom section: TCoil Section

DASY5 Configuration:

Sensor-Surface: 0mm (Mechanical Surface Detection)

Probe: AM1DV3 - 3082; Calibrated: 2023/2/16

Electronics: DAE4 Sn1347; Calibrated: 2023/3/8

Phantom: HAC Test Arch with AMCC; Type: SD HAC P01 BA; Serial

Measurement SW: DASY52, Version 52.10 (4); SEMCAD X Version 14.6.14 (7483)

802.11a HAC_TCoil_WD_Emission/General Scans/z (axial) 4.2mm 50 x 50/ABM SNR(x,y,z)

(13x13x1): Measurement grid: dx=10mm, dy=10mm

Signal Type: Audio File (.wav) 48k_voice_1kHz_1s.wav

Output Gain: 33.76

Measure Window Start: 300ms

Measure Window Length: 1000ms

BWC applied: 0.17 dB

Device Reference Point: 0, 0, -6.3 mm

Cursor:

ABM1/ABM2 = 51.13 dB

ABM1 comp = 1.54 dBA/m

BWC Factor = 0.17 dB

Location: 0, 8.3, 3.7 mm

802.11a HAC_TCoil_WD_Emission/General Scans/z (axial) wideband at best S/N/ABM Freq

Resp(x,y,z,f) (1x1x1): Measurement grid: dx=10mm, dy=10mm

Signal Type: Audio File (.wav) 48k_voice_300-3000_2s.wav

Output Gain: 66.12

Measure Window Start: 300ms

Measure Window Length: 2000ms

BWC applied: 10.81 dB

Device Reference Point: 0, 0, -6.3 mm

Cursor:

Diff = 0.08 dB

BWC Factor = 10.81 dB

Location: 0, 8.3, 3.7 mm

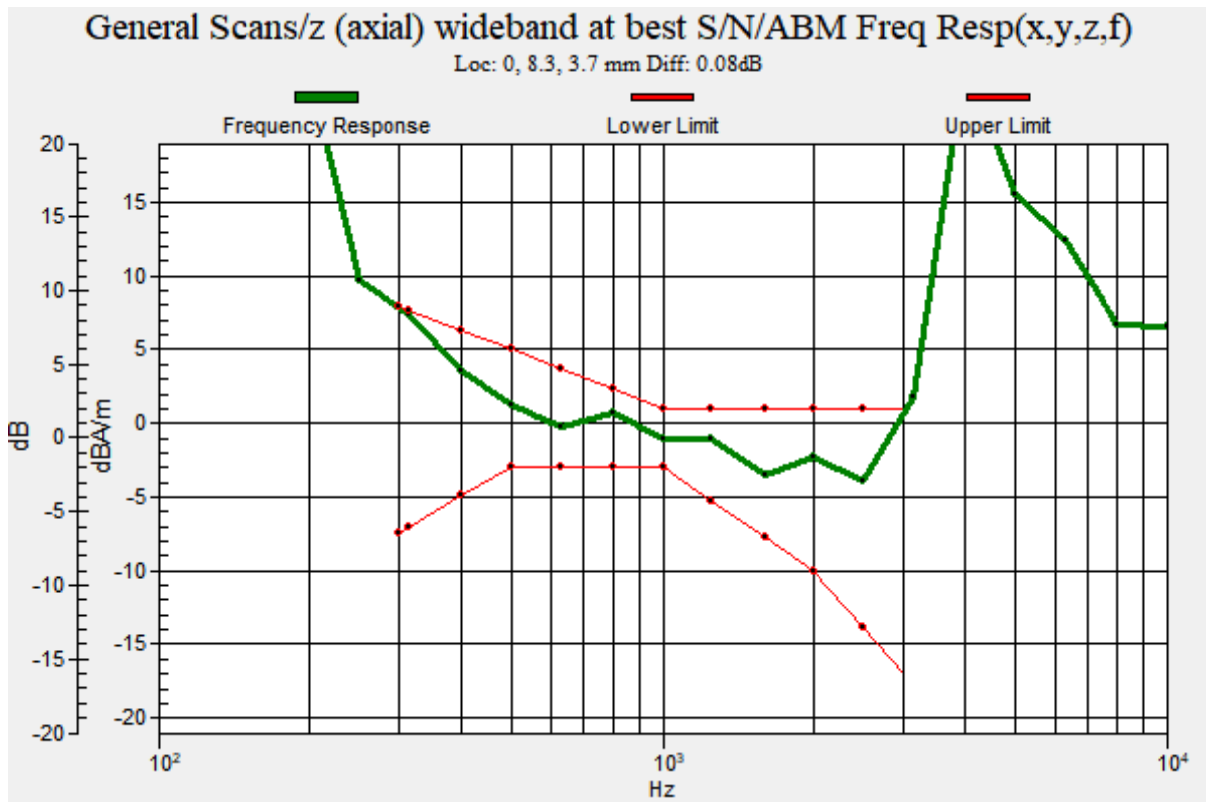
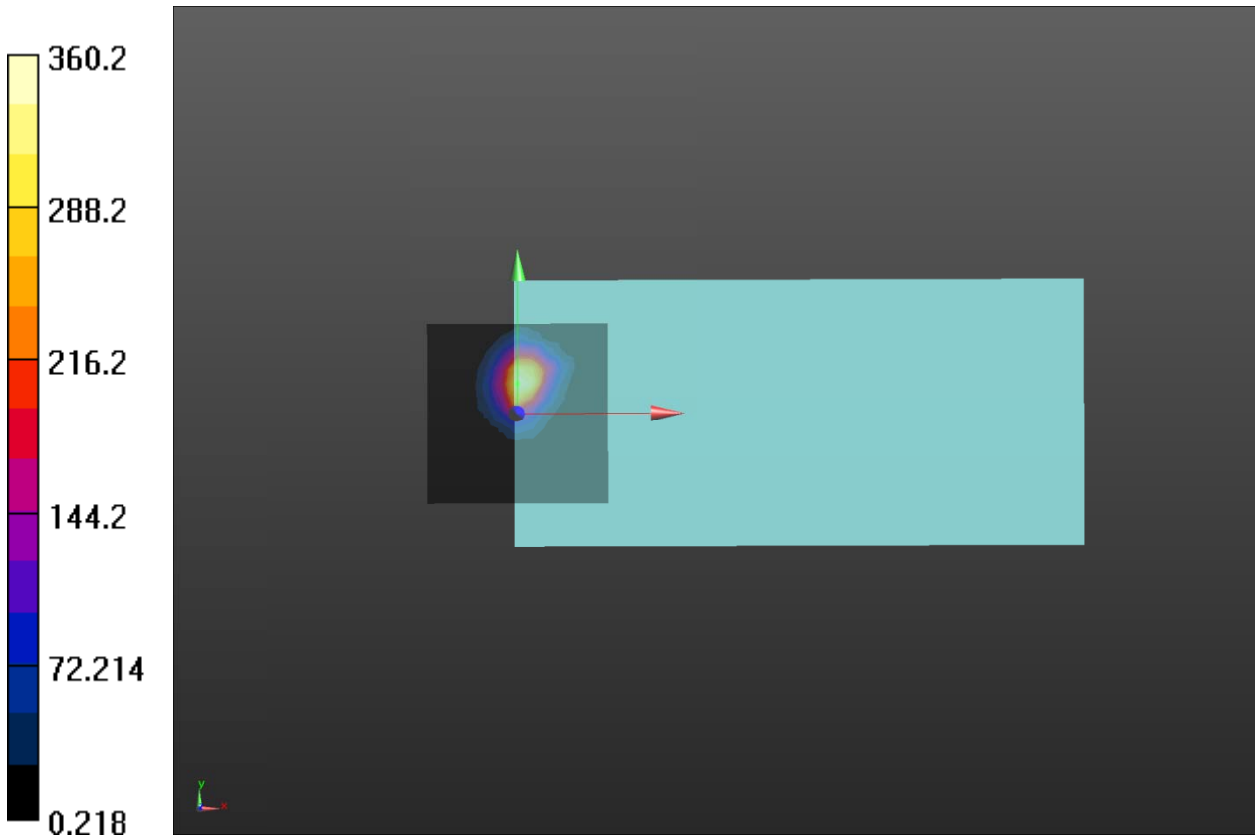

ANNEX C: Probe Calibration Certificate

**Calibration Laboratory of
Schmid & Partner
Engineering AG**
Zeughausstrasse 43, 8004 Zurich, Switzerland



S Schweizerischer Kalibrierdienst
C Service suisse d'étalonnage
S Servizio svizzero di taratura
S Swiss Calibration Service

Accredited by the Swiss Accreditation Service (SAS)
The Swiss Accreditation Service is one of the signatories to the EA
Multilateral Agreement for the recognition of calibration certificates

Accreditation No.: **SCS 0108**

Client **TA-SH**

Certificate No: **AM1DV3-3082_Feb23**

CALIBRATION CERTIFICATE																															
Object	AM1DV3 - SN: 3082																														
Calibration procedure(s)	QA CAL-24.v4 Calibration procedure for AM1D magnetic field probes and TMFS in the audio range																														
Calibration date:	February 16, 2023																														
<p>This calibration certificate documents the traceability to national standards, which realize the physical units of measurements (SI). The measurements and the uncertainties with confidence probability are given on the following pages and are part of the certificate.</p> <p>All calibrations have been conducted in the closed laboratory facility: environment temperature (22 ± 3)°C and humidity < 70%.</p> <p>Calibration Equipment used (M&TE critical for calibration)</p> <table border="1"> <thead> <tr> <th>Primary Standards</th> <th>ID #</th> <th>Cal Date (Certificate No.)</th> <th>Scheduled Calibration</th> </tr> </thead> <tbody> <tr> <td>Keithley Multimeter Type 2001</td> <td>SN: 0810278</td> <td>29-Aug-22 (No. 34389)</td> <td>Aug-23</td> </tr> <tr> <td>Reference Probe AM1DV2</td> <td>SN: 1008</td> <td>20-Dec-22 (No. AM1DV2-1008_Dec22)</td> <td>Dec-23</td> </tr> <tr> <td>DAE4</td> <td>SN: 781</td> <td>03-Jan-23 (No. DAE4-781_Jan23)</td> <td>Jan-24</td> </tr> </tbody> </table> <table border="1"> <thead> <tr> <th>Secondary Standards</th> <th>ID #</th> <th>Check Date (in house)</th> <th>Scheduled Check</th> </tr> </thead> <tbody> <tr> <td>AMCC</td> <td>SN: 1050</td> <td>01-Oct-13 (in house check Oct-20)</td> <td>Oct-23</td> </tr> <tr> <td>AMMI Audio Measuring Instrument</td> <td>SN: 1062</td> <td>26-Sep-12 (in house check Oct-20)</td> <td>Oct-23</td> </tr> </tbody> </table>				Primary Standards	ID #	Cal Date (Certificate No.)	Scheduled Calibration	Keithley Multimeter Type 2001	SN: 0810278	29-Aug-22 (No. 34389)	Aug-23	Reference Probe AM1DV2	SN: 1008	20-Dec-22 (No. AM1DV2-1008_Dec22)	Dec-23	DAE4	SN: 781	03-Jan-23 (No. DAE4-781_Jan23)	Jan-24	Secondary Standards	ID #	Check Date (in house)	Scheduled Check	AMCC	SN: 1050	01-Oct-13 (in house check Oct-20)	Oct-23	AMMI Audio Measuring Instrument	SN: 1062	26-Sep-12 (in house check Oct-20)	Oct-23
Primary Standards	ID #	Cal Date (Certificate No.)	Scheduled Calibration																												
Keithley Multimeter Type 2001	SN: 0810278	29-Aug-22 (No. 34389)	Aug-23																												
Reference Probe AM1DV2	SN: 1008	20-Dec-22 (No. AM1DV2-1008_Dec22)	Dec-23																												
DAE4	SN: 781	03-Jan-23 (No. DAE4-781_Jan23)	Jan-24																												
Secondary Standards	ID #	Check Date (in house)	Scheduled Check																												
AMCC	SN: 1050	01-Oct-13 (in house check Oct-20)	Oct-23																												
AMMI Audio Measuring Instrument	SN: 1062	26-Sep-12 (in house check Oct-20)	Oct-23																												
Calibrated by:	Name Aidonia Georgiadou	Function Laboratory Technician	Signature 																												
Approved by:	Name Niels Kuster	Function Quality Manager																													
			Issued: February 22, 2023																												
This calibration certificate shall not be reproduced except in full without written approval of the laboratory.																															

References

- [1] ANSI-C63.19-2007
American National Standard for Methods of Measurement of Compatibility between Wireless Communications Devices and Hearing Aids.
- [2] ANSI-C63.19-2019 (ANSI-C63.19-2011)
American National Standard, Methods of Measurement of Compatibility between Wireless Communications Devices and Hearing Aids.
- [3] DASY System Handbook

Description of the AM1D probe

The AM1D Audio Magnetic Field Probe is a fully shielded magnetic field probe for the frequency range from 100 Hz to 20 kHz. The pickup coil is compliant with the dimensional requirements of [1+2]. The probe includes a symmetric low noise amplifier for the signal available at the shielded 3 pin connector at the side. Power is supplied via the same connector (phantom power supply) and monitored via the LED near the connector. The 7 pin connector at the end of the probe does not carry any signals, but determines the angle of the sensor when mounted on the DAE. The probe supports mechanical detection of the surface.

The single sensor in the probe is arranged in a tilt angle allowing measurement of 3 orthogonal field components when rotating the probe by 120° around its axis. It is aligned with the perpendicular component of the field, if the probe axis is tilted nominally 35.3° above the measurement plane, using the connector rotation and sensor angle stated below.

The probe is fully RF shielded when operated with the matching signal cable (shielded) and allows measurement of audio magnetic fields in the close vicinity of RF emitting wireless devices according to [1+2] without additional shielding.

Handling of the item

The probe is manufactured from stainless steel. In order to maintain the performance and calibration of the probe, it must not be opened. The probe is designed for operation in air and shall not be exposed to humidity or liquids. For proper operation of the surface detection and emergency stop functions in a DASY system, the probe must be operated with the special probe cup provided (larger diameter).

Methods Applied and Interpretation of Parameters

- *Coordinate System:* The AM1D probe is mounted in the DASY system for operation with a HAC Test Arch phantom with AMCC Helmholtz calibration coil according to [3], with the tip pointing to "southwest" orientation.
- *Functional Test:* The functional test preceding calibration includes test of Noise level RF immunity (1kHz AM modulated signal). The shield of the probe cable must be well connected. Frequency response verification from 100 Hz to 10 kHz.
- *Connector Rotation:* The connector at the end of the probe does not carry any signals and is used for fixation to the DAE only. The probe is operated in the center of the AMCC Helmholtz coil using a 1 kHz magnetic field signal. Its angle is determined from the two minima at nominally +120° and -120° rotation, so the sensor in the tip of the probe is aligned to the vertical plane in z-direction, corresponding to the field maximum in the AMCC Helmholtz calibration coil.
- *Sensor Angle:* The sensor tilting in the vertical plane from the ideal vertical direction is determined from the two minima at nominally +120° and -120°. DASY system uses this angle to align the sensor for radial measurements to the x and y axis in the horizontal plane.
- *Sensitivity:* With the probe sensor aligned to the z-field in the AMCC, the output of the probe is compared to the magnetic field in the AMCC at 1 kHz. The field in the AMCC Helmholtz coil is given by the geometry and the current through the coil, which is monitored on the precision shunt resistor of the coil.

AM1D probe identification and configuration data

Item	AM1DV3 Audio Magnetic 1D Field Probe
Type No	SP AM1 001 BA
Serial No	3082

Overall length	296 mm
Tip diameter	6.0 mm (at the tip)
Sensor offset	3.0 mm (centre of sensor from tip)
Internal Amplifier	20 dB

Manufacturer / Origin	Schmid & Partner Engineering AG, Zurich, Switzerland
-----------------------	--

Calibration data

Connector rotation angle	(in DASYS system)	8.3 °	+/- 3.6 ° (k=2)
Sensor angle	(in DASYS system)	0.47 °	+/- 0.5 ° (k=2)
Sensitivity at 1 kHz	(in DASYS system)	0.00737 V/(A/m)	+/- 2.2 % (k=2)

The reported uncertainty of measurement is stated as the standard uncertainty of measurement multiplied by the coverage factor k=2, which for a normal distribution corresponds to a coverage probability of approximately 95%.

ANNEX D: DAE4 Calibration Certificate



In Collaboration with
TTL Speaq
 CALIBRATION LABORATORY
 Add: No.52 HuaYuanBei Road, Haidian District, Beijing, 100191, China
 Tel: +86-10-62304633-2117
 E-mail: cmf@caict.ac.cn <http://www.caict.ac.cn>



Client : **TA(Shanghai)**

Certificate No: **Z23-60111**

CALIBRATION CERTIFICATE

Object **DAE4 - SN: 1347**

Calibration Procedure(s) **FF-Z11-002-01**
Calibration Procedure for the Data Acquisition Electronics (DAEx)

Calibration date: **March 08, 2023**

This calibration Certificate documents the traceability to national standards, which realize the physical units of measurements(SI). The measurements and the uncertainties with confidence probability are given on the following pages and are part of the certificate.

All calibrations have been conducted in the closed laboratory facility: environment temperature(22±3)°C and humidity<70%.

Calibration Equipment used (M&TE critical for calibration)

Primary Standards	ID #	Cal Date(Calibrated by, Certificate No.)	Scheduled Calibration
Process Calibrator 753	1971018	14-Jun-22 (CTTL, No.J22X04180)	Jun-23

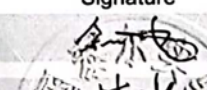
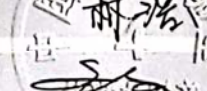
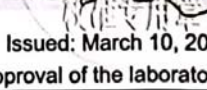
	Name	Function	Signature
Calibrated by:	Yu Zongying	SAR Test Engineer	
Reviewed by:	Lin Hao	SAR Test Engineer	
Approved by:	Qi Dianyuan	SAR Project Leader	

Issued: March 10, 2023

This calibration certificate shall not be reproduced except in full without written approval of the laboratory.



Add: No.52 HuaYuanBei Road, Haidian District, Beijing, 100191, China
Tel: +86-10-62304633-2117
E-mail: emf@caict.ac.cn <http://www.caict.ac.cn>

Glossary:

DAE data acquisition electronics
Connector angle information used in DASY system to align probe sensor X to the robot coordinate system.

Methods Applied and Interpretation of Parameters:

- *DC Voltage Measurement:* Calibration Factor assessed for use in DASY system by comparison with a calibrated instrument traceable to national standards. The figure given corresponds to the full scale range of the voltmeter in the respective range.
- *Connector angle:* The angle of the connector is assessed measuring the angle mechanically by a tool inserted. Uncertainty is not required.
- The report provide only calibration results for DAE, it does not contain other performance test results.

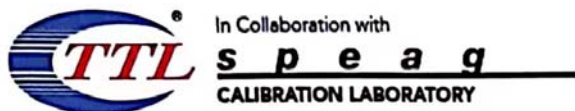

Add: No.52 HuaYuanBei Road, Haidian District, Beijing, 100191, China
 Tel: +86-10-62304633-2117
 E-mail: emf@caict.ac.cn <http://www.caict.ac.cn>

DC Voltage Measurement

A/D - Converter Resolution nominal
 High Range: 1LSB = 6.1μV, full range = -100...+300 mV
 Low Range: 1LSB = 61nV, full range = -1.....+3mV
 DASY measurement parameters: Auto Zero Time: 3 sec; Measuring time: 3 sec

Calibration Factors	X	Y	Z
High Range	404.759 ± 0.15% (k=2)	405.018 ± 0.15% (k=2)	404.517 ± 0.15% (k=2)
Low Range	3.96617 ± 0.7% (k=2)	4.00843 ± 0.7% (k=2)	3.98744 ± 0.7% (k=2)

Connector Angle

Connector Angle to be used in DASY system	255.5° ± 1 °
---	--------------

ANNEX E: The EUT Appearances and Test Configuration

The EUT Appearance and Test Configuration are submitted separately.

*******END OF REPORT *******