



Test Report No.: W7L-P22120012-1RF04



FCC TEST REPORT (PART 27)



Applicant:	HMD Global Oy
Address:	Bertel Jungin aukio 9,02600 Espoo,Finland

Manufacturer or Supplier:	HMD Global Oy
Address:	Bertel Jungin aukio 9,02600 Espoo,Finland
Product:	GSM/WCDMA/LTE Mobile Phone
Brand Name:	NOKIA
Model Name:	TA-1545
FCC ID:	2AJOTTA-1545
Date of tests:	Feb. 14, 2023 ~ Mar. 06, 2023

The tests have been carried out according to the requirements of the following standard:

- FCC Part 27 ANSI/TIA/EIA-603-D
- FCC Part 2 ANSI/TIA/EIA-603-E ANSI C63.26-2015

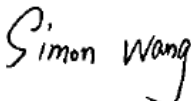
CONCLUSION: The submitted sample was found to COMPLY with the test requirement

Prepared by Simon Wang Engineer / Mobile Department	Approved by Luke Lu Manager / Mobile Department
 Date: Mar. 06, 2023	 Date: Mar. 06, 2023

This report is governed by, and incorporates by reference, the Conditions of Testing as posted at the date of issuance of this report at <http://www.bureauveritas.com/home/about-us/our-business/cps/about-us/terms-conditions/> and is intended for your exclusive use. Any copying or replication of this report to or for any other person or entity, or use of our name or trademark, is permitted only with our prior written permission. This report sets forth our findings solely with respect to the test samples identified herein. The results set forth in this report are not indicative or representative of the quality or characteristics of the lot from which a test sample was taken or any similar or identical product unless specifically and expressly noted. Our report includes all of the tests requested by you and the results thereof based upon the information that you provided to us. Measurement uncertainty is only provided upon request for accredited tests. Statements of conformity are based on simple acceptance criteria without taking measurement uncertainty into account, unless otherwise requested in writing. You have 60 days from date of issuance of this report to notify us of any material error or omission caused by our negligence or if you require measurement uncertainty; provided, however, that such notice shall be in writing and shall specifically address the issue you wish to raise. A failure to raise such issue within the prescribed time shall constitute your unqualified acceptance of the completeness of this report, the tests conducted and the correctness of the report contents.



TABLE OF CONTENTS

RELEASE CONTROL RECORD	4
1 SUMMARY OF TEST RESULTS	5
1.1 MEASUREMENT UNCERTAINTY	7
1.2 TEST SITE AND INSTRUMENTS	8
2 GENERAL INFORMATION	9
2.1 GENERAL DESCRIPTION OF EUT	9
2.2 CONFIGURATION OF SYSTEM UNDER TEST	14
2.3 DESCRIPTION OF SUPPORT UNITS	15
2.4 TEST ITEM AND TEST CONFIGURATION	15
2.5 GENERAL DESCRIPTION OF APPLIED STANDARDS	20
3 TEST TYPES AND RESULTS	21
3.1 OUTPUT POWER MEASUREMENT	21
3.1.1 LIMITS OF OUTPUT POWER MEASUREMENT	21
3.1.2 TEST PROCEDURES	21
3.1.3 TEST SETUP	22
3.1.4 TEST RESULTS	23
3.2 FREQUENCY STABILITY MEASUREMENT	48
3.2.1 LIMITS OF FREQUENCY STABILITY MEASUREMENT	48
3.2.2 TEST PROCEDURE	48
3.2.3 TEST SETUP	48
3.2.4 TEST RESULTS	49
3.3 OCCUPIED BANDWIDTH MEASUREMENT	50
3.3.1 LIMITS OF OCCUPIED BANDWIDTH MEASUREMENT	50
3.3.2 TEST SETUP	50
3.3.3 TEST PROCEDURES	50
3.3.4 TEST RESULTS	51
3.4 BAND EDGE MEASUREMENT	52
3.4.1 LIMITS OF BAND EDGE MEASUREMENT	52
3.4.2 TEST SETUP	52
3.4.3 TEST PROCEDURES	53
3.4.4 TEST RESULTS	54
3.5 CONDUCTED SPURIOUS EMISSIONS	55
3.5.1 LIMITS OF CONDUCTED SPURIOUS EMISSIONS MEASUREMENT	55
3.5.2 TEST PROCEDURE	55
3.5.3 TEST SETUP	55
3.5.4 TEST RESULTS	55
3.6 RADIATED EMISSION MEASUREMENT	56
3.6.1 LIMITS OF RADIATED EMISSION MEASUREMENT	56
3.6.2 TEST PROCEDURES	56
3.6.3 DEVIATION FROM TEST STANDARD	56
3.6.4 TEST SETUP	57
3.6.5 TEST RESULTS	59
3.7 PEAK TO AVERAGE RATIO	95
3.7.1 LIMITS OF PEAK TO AVERAGE RATIO MEASUREMENT	95
3.7.2 TEST SETUP	95
3.7.3 TEST PROCEDURES	95
3.7.4 TEST RESULTS	96
4 INFORMATION ON THE TESTING LABORATORIES	97



**BUREAU
VERITAS**

Test Report No.: W7L-P22120012-1RF04

5 MODIFICATIONS RECORDERS FOR ENGINEERING CHANGES TO THE EUT BY THE LAB... 98

6 APPENDIX..... 99

WCDMA BAND4 99

LTE BAND7 112

LTE BAND66(INCLUDING LTE BAND 4)..... 166



Test Report No.: W7L-P22120012-1RF04

RELEASE CONTROL RECORD

ISSUE NO.	REASON FOR CHANGE	DATE ISSUED
W7L-P22120012-1RF04	Original release	Mar. 06, 2023

1 SUMMARY OF TEST RESULTS

The EUT has been tested according to the following specifications:

APPLIED STANDARD: FCC PART 27 & PART 2			
STANDARD SECTION	TEST TYPE AND LIMIT	RESULT	TEST LAB*
§2.1046	Conducted Output Power	Compliance	A
§27.50(b)(10) §27.50(c)(10)	Effective Radiated Power	Compliance	A
§27.50(d)(4) §27.50(h)(2) §27.50(a)(3)	Equivalent Isotropically Radiated Power	Compliance	A
§2.1055 §27.54	Frequency Stability	Compliance	A
§2.1049	Occupied Bandwidth	Compliance	A
§2.1051 §27.53(c)(2)(4) §27.53(g) §27.53(h) §27.53(m)(4)(6) §27.53(a)(4)	Conducted Band Edge Measurements	Compliance	A
§2.1051 §27.53(c)(2)(4) §27.53(g) §27.53(h) §27.53(m)(4)(6) §27.53(a)(4)	Conducted Spurious Emissions	Compliance	A
§2.1053 §27.53(c)(2)(4) §27.53(f) §27.53(g) §27.53(h) §27.53(m)(4)(6) §27.53(a)(4)	Radiated Spurious Emissions	Compliance	A
NA	Peak to average ratio	Compliance	A



Test Report No.: W7L-P22120012-1RF04

Note : This report refers to the data of W7L-P22120012RF04 (model:TA-1563) , the difference of TA-1563 and TA-1545 is model , FCC ID and SW version. TA-1563 is double card, TA-1545 is single card. In this report only verify power and RSE worst case. The verify result of power is similar and lower. So this report only updated RSE worse case (LTE B7)

***Test Lab Information Reference**

Lab A:

BV 7Layers Communications Technology (Shenzhen) Co., Ltd

Lab Address:

No.B102, Dazu Chuangxin Mansion, North of Beihuan Avenue, North Area, Hi-Tech Industrial Park, Nanshan District, Shenzhen, Guangdong, China

Accredited Test Lab Cert 3939.01

The FCC Site Registration No. : 525120; Designation No. : CN1171;

1.1 MEASUREMENT UNCERTAINTY

Where relevant, the following measurement uncertainty levels have been estimated for tests performed on the EUT as specified in CISPR 16-4-2:

MEASUREMENT	UNCERTAINTY
Frequency Stability	±76.97Hz
Radiated emissions (9KHz~30MHz)	±2.68dB
Radiated emissions & Radiated Power (30MHz~1GHz)	±4.98dB
Radiated emissions & Radiated Power (1GHz ~6GHz)	±4.70dB
Radiated emissions (6GHz ~18GHz)	±4.60dB
Radiated emissions (18GHz ~40GHz)	±4.12dB
Conducted emissions	±4.01dB
Occupied Channel Bandwidth	±43.58KHz
Conducted Output power	±2.06dB
Band Edge Measurements	±4.70dB

This uncertainty represents an expanded uncertainty expressed at approximately the 95% confidence level using a coverage factor of k=2.

1.2 TEST SITE AND INSTRUMENTS

Equipment	Manufacturer	Model No.	Serial No.	Last Cal.	Next Cal.
MXE EMI Receiver	KEYSIGHT	N9038A-544	MY54450026	Feb. 21,22	Feb. 20,23
MXE EMI Receiver	KEYSIGHT	N9038A-544	MY54450026	Feb. 20,23	Feb. 19,24
EXA Signal Analyzer	KEYSIGHT	N9010A-544	MY54510355	May.15,22	May.14,23
Loop Antenna	Schwarzbeck	FMZB 1519B	00173	Sep.04,22	Sep.03,23
Bilog Antenna	ETS-LINDGRE N	3143B	00161965	Mar. 06,22	Mar. 05,23
Bilog Antenna	ETS-LINDGRE N	3143B	00161965	Mar. 05,23	Mar. 04,24
Horn Antenna	ETS-LINDGRE N	3117	00168692	Mar. 06,22	Mar. 05,23
Horn Antenna	ETS-LINDGRE N	3117	00168692	Mar. 05,23	Mar. 04,24
Horn Antenna (18GHz-40GHz)	N/A	QWH-SL-18-40-K- SG/QMS-00361	15433	Sep.04,22	Sep.03,23
Radio Communication Analyzer	ANRITSU	MT8820C	6201465426	Feb. 14,23	Feb. 13,24
Signal Pre-Amplifier	EMSI	EMC 9135	980249	May.12,22	May.11,23
Signal Pre-Amplifier	EMSI	EMC 012645B	980257	May.12,22	May.11,23
Signal Pre-Amplifier	EMSI	EMC 184045B	980259	Feb. 21,22	Feb.20,23
Signal Pre-Amplifier	EMSI	EMC 184045B	980259	Feb. 20,23	Feb.19,24
3m Semi-anechoic Chamber	ETS-LINDGRE N	9m*6m*6m	Euroshieldpn- CT0001143-121 6	May. 19,20	May. 18,23
Test Software	E3	V 9.160323	N/A	N/A	N/A
Test Software	JS1120	3.1.36	N/A	N/A	N/A
10dB Attenuator	JFW/USA	50HF-010-SMA	1505	May. 07,22	May. 06,23
Power Meter	Anritsu	ML2495A	1506002	Feb. 22,22	Feb. 21,23
Power Meter	Anritsu	ML2495A	1506002	Feb. 21,23	Feb. 20,24
Power Sensor	Anritsu	MA2411B	1339352	May. 07,22	May. 06,23
Temperature Chamber	ESPEC	SH-242	93000855	May. 12,22	May. 11,23
MXG Analog Microwave Signal Generator	KEYSIGHT	N5183A	MY50143024	Feb. 18,22	Feb. 17,23
MXG Analog Microwave Signal Generator	KEYSIGHT	N5183A	MY50143024	Feb. 17,23	Feb. 16,24
Base station R&S CMW500	Rohde&Schwa rz	CMW500	153085	May.12,22	May.11,23
DC Source	Kikusui/JP	PMX18-5A	0000001	Aug. 24,22	Aug. 23,23

- NOTE:**
1. The calibration interval of the above test instruments is 12 months or 36 months and the calibrations are traceable to CEPREI/CHINA, GRGT/CHINA and NIM/CHINA.
 2. The test was performed in 3m Semi-anechoic Chamber and RF Oven Room.
 3. The horn antenna is used only for the measurement of emission frequency above 1GHz if tested.
 4. The FCC Site Registration No. is 525120; The Designation No. is CN1171.

2 GENERAL INFORMATION

2.1 GENERAL DESCRIPTION OF EUT

PRODUCT	GSM/WCDMA/LTE Mobile Phone	
BRAND NAME	NOKIA	
MODEL NAME	TA-1545	
NOMINAL VOLTAGE	5.0Vdc(adapter or host equipment) 3.7Vdc (Li-ion, battery)	
MODULATION TECHNOLOGY	WCDMA IV	BPSK, QPSK
	LTE	QPSK, 16QAM
FREQUENCY RANGE	WCDMA IV	1712.4MHz ~ 1752.6MHz
	LTE Band 4 Channel Bandwidth: 1.4MHz	1710.7MHz ~ 1754.3MHz
	LTE Band 4 Channel Bandwidth: 3MHz	1711.5MHz ~ 1753.5MHz
	LTE Band 4 Channel Bandwidth: 5MHz	1712.5MHz ~ 1752.5MHz
	LTE Band 4 Channel Bandwidth: 10MHz	1715MHz ~ 1750MHz
	LTE Band 4 Channel Bandwidth: 15MHz	1717.5MHz ~ 1747.5 MHz
	LTE Band 4 Channel Bandwidth: 20MHz	1720MHz ~ 1745MHz
	LTE Band 7 Channel Bandwidth: 5MHz	2502.5MHz ~ 2567.5MHz
	LTE Band 7 Channel Bandwidth: 10MHz	2505MHz ~ 2565MHz
	LTE Band 7 Channel Bandwidth: 15MHz	2507.5MHz ~ 2562.5MHz
	LTE Band 7 Channel Bandwidth: 20MHz	2510MHz ~ 2560MHz
	LTE Band 66 Channel Bandwidth: 1.4MHz	1710.7MHz ~ 1779.3MHz
	LTE Band 66 Channel Bandwidth: 3MHz	1711.5MHz ~ 1778.5MHz
	LTE Band 66 Channel Bandwidth: 5MHz	1712.5MHz ~ 1777.5MHz
	LTE Band 66 Channel Bandwidth: 10MHz	1715MHz ~ 1775MHz
	LTE Band 66 Channel Bandwidth: 15MHz	1717.5MHz ~ 1772.5MHz
LTE Band 66 Channel Bandwidth: 20MHz	1720MHz ~ 1770MHz	



BUREAU
VERITAS

Test Report No.: W7L-P22120012-1RF04

MAX. EIRP POWER	WCDMA IV	262.42mW
	LTE Band 4 Channel Bandwidth: 1.4MHz	275.42mW
	LTE Band 4 Channel Bandwidth: 3MHz	272.27mW
	LTE Band 4 Channel Bandwidth: 5MHz	272.9mW
	LTE Band 4 Channel Bandwidth: 10MHz	271.02mW
	LTE Band 4 Channel Bandwidth: 15MHz	273.53mW
	LTE Band 4 Channel Bandwidth: 20MHz	276.06mW
	LTE Band 7 Channel Bandwidth: 5MHz	151.01mW
	LTE Band 7 Channel Bandwidth: 10MHz	149.62mW
	LTE Band 7 Channel Bandwidth: 15MHz	150.66mW
	LTE Band 7 Channel Bandwidth: 20MHz	151.36mW
	LTE Band 66 Channel Bandwidth: 1.4MHz	289.07mW
	LTE Band 66 Channel Bandwidth: 3MHz	287.08mW
	LTE Band 66 Channel Bandwidth: 5MHz	289.07mW
	LTE Band 66 Channel Bandwidth: 10MHz	289.73mW
	LTE Band 66 Channel Bandwidth: 15MHz	289.07mW
	LTE Band 66 Channel Bandwidth: 20MHz	290.4mW

EMISSION DESIGNATOR	WCDMA IV	4M17F9W
	LTE Band 7 Channel Bandwidth: 5MHz	QPSK: 4M49G7D
		16QAM: 4M50W7D
		64QAM: /
	LTE Band 7 Channel Bandwidth: 10MHz	QPSK:8M98G7D
		16QAM: 8M99W7D
		64QAM: /
	LTE Band 7 Channel Bandwidth: 15MHz	QPSK: 13M5G7D
		16QAM: 13M5W7D
		64QAM: /
	LTE Band 7 Channel Bandwidth: 20MHz	QPSK: 18M0G7D
		16QAM: 18M0W7D
		64QAM: /
	LTE Band 66 Channel Bandwidth: 1.4MHz	QPSK: 1M09G7D
16QAM: 1M09W7D		
64QAM: /		
LTE Band 66 Channel Bandwidth: 3MHz	QPSK: 2M70G7D	
	16QAM: 2M70W7D	
	64QAM: /	
LTE Band 66 Channel Bandwidth: 5MHz	QPSK: 4M50G7D	
	16QAM: 4M50W7D	
	64QAM: /	
LTE Band 66 Channel Bandwidth: 10MHz	QPSK: 8M99G7D	
	16QAM: 8M98W7D	
	64QAM: /	
LTE Band 66 Channel Bandwidth: 15MHz	QPSK: 13M5G7D	
	16QAM: 13M5W7D	
	64QAM: /	
LTE Band 66 Channel Bandwidth: 20MHz	QPSK: 18M0G7D	
	16QAM: 18M0W7D	
	64QAM: /	
ANTENNA TYPE	Fixed Internal Antenna with 1.55dBi gain for WCDMA IV Fixed Internal Antenna with 1.55dBi gain for LTE4 Fixed Internal Antenna with -1.56dBi gain for LTE7 Fixed Internal Antenna with 1.55dBi gain for LTE66	



**BUREAU
VERITAS**

Test Report No.: W7L-P22120012-1RF04

HW VERSION	V0.2
SW VERSION	HMDSW_TA-1545_0.2
I/O PORTS	Refer to user's manual
CABLE SUPPLIED	USB cable: non-shielded cable, with w/o ferrite core, 1.0 meter Earphone cable: non-shielded cable, with w/o ferrite core, 1.5 meter
EXTREME TEMPERATURE	-10-55 °C
EXTREME VOLTAGE	3.65V - 4.15V

NOTE:

1. For a more detailed features description, please refer to the manufacturer's specifications or the user's manual.
2. The EUT incorporates a SISO function. Physically, the EUT provides one completed transmitter and one receiver.

MODULATION MODE	TX FUNCTION
WCDMA	1TX/1RX
LTE	1TX/1RX

3. For the test results, the EUT had been tested with all conditions. But only the worst case was shown in test report.
4. There were Sample 1 and 2 for this project, the difference is as below:

SAMPLE	EUT CONFIGURATION INFORMATION
1	LCD Panel 1 (SICHUAN)+Photo Camera 1(Chengxiangtong) +PCB 1(Zhiboxin)+ Speaker 1 (Xingrongda)
2	LCD Panel 2 (Zhongxian intelligent)+Photo Camera 2(Union Image) + PCB (Honggao) + Speaker 2 (Guanyintai)



Test Report No.: W7L-P22120012-1RF04

List of Accessory:

ACCESSORIES	BRAND	MANUFACTURER	MODEL	SPECIFICATION
Battery 1	FHE	Guangdong Fenghua New Energy Co.,Ltd.	BL-L5H	Capacity: 3.7Vdc, 1400mAh
Battery 2	/	Shenzhen Aerospace Electronic Co., Ltd..	BL-L5H	Capacity: 3.7Vdc, 1400mAh
AC Adapter 1	/	Shenzhen BaiJunda Electronics Co., Ltd.	AC-18U	I/P: 100-240Vac, 0.1A, O/P: 5.0Vdc, 0.55A
AC Adapter 2	/	JIANGXI JIAN AOHA TECHNOLOGY CO.,LTD	AC-18U	I/P: 100-240Vac, 0.1A, O/P: 5.0Vdc, 0.55A
USB Cable	/	Saibao(Jiangxi) Communication Industrial Co.,Ltd	SAT-A002A	Signal Line,1.0meter
Earphone Cable	/	HUIZHOU JUWEI ELECTRONICS CO.,LTD	WH-108	Signal Line,1.5meter

2.2 CONFIGURATION OF SYSTEM UNDER TEST FOR RADIATION EMISSION TEST

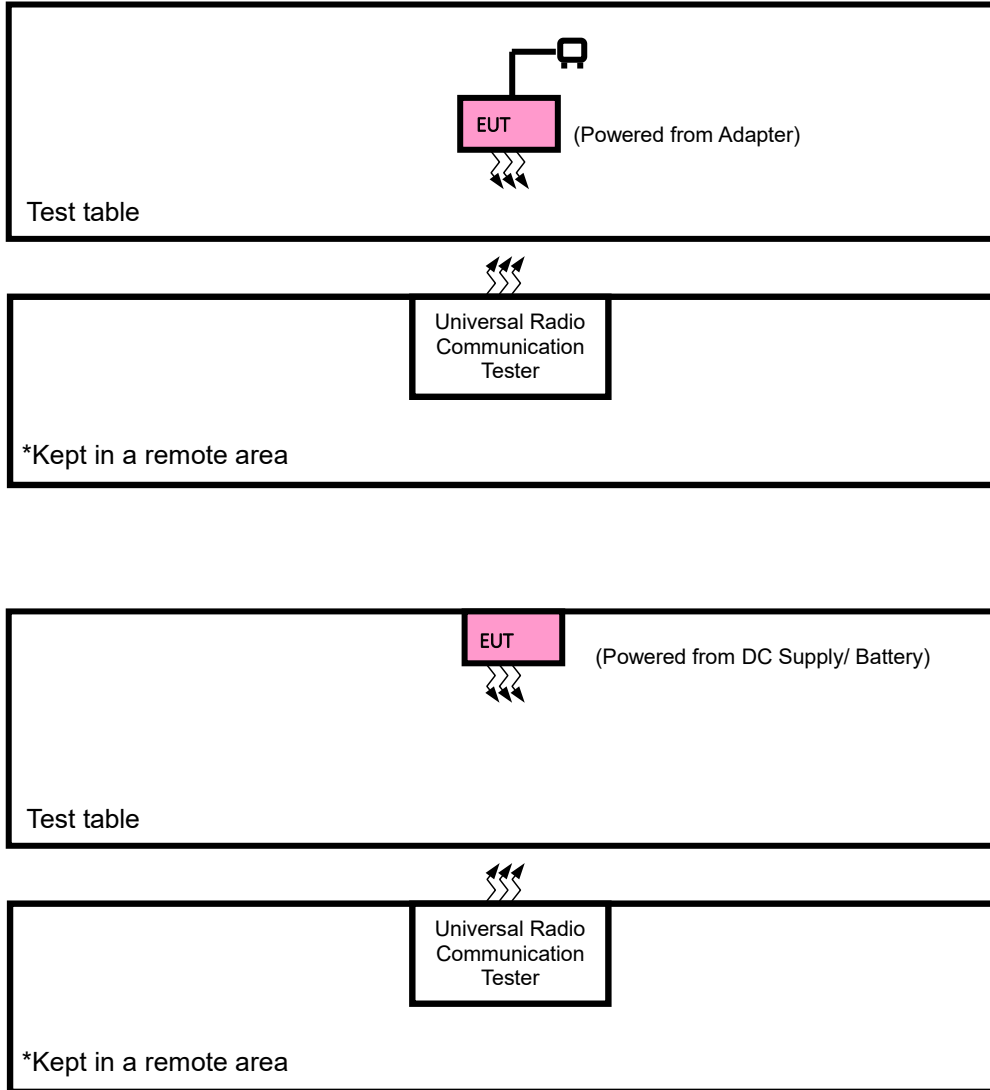

2.3 DESCRIPTION OF SUPPORT UNITS

The EUT has been tested as an independent unit together with other necessary accessories or support units. The following support units or accessories were used to form a representative test configuration during the tests.

NO.	PRODUCT	BRAND	MODEL NO.	SERIAL NO.	FCC ID
1	DC source	LONG WEI	PS-6403D	010934269	N/A

NO.	SIGNAL CABLE DESCRIPTION OF THE ABOVE SUPPORT UNITS
1	DC Line: Unshielded, Detachable 1.8m

2.4 TEST ITEM AND TEST CONFIGURATION

Pre-Scan has been conducted to determine the worst-case mode from all possible combinations between available modulations, data rates, XYZ axis and antenna ports. The worst case was found when positioned on Y-plane for EIRP and X-axis for radiated emission. Following channel(s) was (were) selected for the final test as listed below:

EUT CONFIGURE MODE	DESCRIPTION
A	EUT + Adapter + USB Cable with WCDMA or LTE link
B	EUT + DC Supply with WCDMA or LTE link

WCDMA MODE

EUT CONFIGURE MODE	TEST ITEM	AVAILABLE CHANNEL	TESTED CHANNEL	MODE
A	EIRP	1312 to 1513	1312, 1413, 1513	WCDMA
B	FREQUENCY STABILITY	1312 to 1513	1312, 1413, 1513	WCDMA
A	OCCUPIED BANDWIDTH	1312 to 1513	1312, 1413, 1513	WCDMA
A	BAND EDGE	1312 to 1513, 1312, 1413, 1513	1312, 1513	WCDMA
A	PEAK TO AVERAGE RATIO	1312 to 1513	1312, 1413, 1513	WCDMA
A	CONDUCTED EMISSION	1312 to 1513	1312, 1413, 1513	WCDMA
A	RADIATED EMISSION	1312 to 1513	1312, 1413, 1513	WCDMA



LTE BAND 4 MODE

EUT CONFIGURE MODE	TEST ITEM	AVAILABLE CHANNEL	TESTED CHANNEL	CHANNEL BANDWIDTH	MODULATION	MODE
A	EIRP	19957 to 20393	19957, 20175, 20393	1.4MHz	QPSK, 16QAM	1 RB / 0 RB Offset
		19965 to 20385	19965, 20175, 20385	3MHz	QPSK, 16QAM	1 RB / 0 RB Offset
		19975 to 20375	19975, 20175, 20375	5MHz	QPSK, 16QAM	1 RB / 0 RB Offset
		20000 to 20350	20000, 20175, 20350	10MHz	QPSK, 16QAM	1 RB / 0 RB Offset
		20025 to 20325	20025, 20175, 20325	15MHz	QPSK, 16QAM	1 RB / 0 RB Offset
		20050 to 20300	20050, 20175, 20300	20MHz	QPSK, 16QAM	1 RB / 0 RB Offset

Note: 1.This device was tested under all bandwidths, RB configurations and modulations. The worst case was found in QPSK modulation.

2. LTE Band 4 are covered by LTE Band 66, Because it is a subset of LTE Band 66 with the same output power and supported bandwidths, So the conducted test data and RSE test data please refer to LTE Band 66

LTE BAND 7 MODE

EUT CONFIGURE MODE	TEST ITEM	AVAILABLE CHANNEL	TESTED CHANNEL	CHANNEL BANDWIDTH	MODULATION	MODE		
A	EIRP	20775 to 21425	20775, 21100, 21425	5MHz	QPSK, 16QAM	1 RB / 0 RB Offset		
		20800 to 21400	20800, 21100, 21400	10MHz	QPSK, 16QAM	1 RB / 0RB Offset		
		20825 to 21375	20825, 21100, 21375	15MHz	QPSK, 16QAM	1 RB / 0 RB Offset		
		20850 to 21350	20850, 21100, 21350	20MHz	QPSK, 16QAM	1 RB / 0 RB Offset		
B	FREQUENCY STABILITY	20775 to 21425	20775, 21100, 21425	5MHz	QPSK	25 RB / 0 RB Offset		
		20800 to 21400	20800, 21100, 21400	10MHz	QPSK	50 RB / 0 RB Offset		
		20825 to 21375	20825, 21100, 21375	15MHz	QPSK	75 RB / 0 RB Offset		
		20850 to 21350	20850, 21100, 21350	20MHz	QPSK	100 RB / 0 RB Offset		
A	OCCUPIED BANDWIDTH	20775 to 21425	20775, 21100, 21425	5MHz	QPSK, 16QAM	25 RB / 0 RB Offset		
		20800 to 21400	20800, 21100, 21400	10MHz	QPSK, 16QAM	50 RB / 0 RB Offset		
		20825 to 21375	20825, 21100, 21375	15MHz	QPSK, 16QAM	75 RB / 0 RB Offset		
		20850 to 21350	20850, 21100, 21350	20MHz	QPSK, 16QAM	100 RB / 0 RB Offset		
A	PEAK TO AVERAGE RATIO	20775 to 21425	20775, 21100, 21425	5MHz	QPSK, 16QAM	1 RB / 0 RB Offset 25 RB / 0 RB Offset		
		20800 to 21400	20800, 21100, 21400	10MHz	QPSK, 16QAM	1 RB / 0 RB Offset 50 RB / 0 RB Offset		
		20825 to 21375	20825, 21100, 21375	15MHz	QPSK, 16QAM	1 RB / 0 RB Offset 75 RB / 0 RB Offset		
		20850 to 21350	20850, 21100, 21350	20MHz	QPSK, 16QAM	1 RB / 0 RB Offset 100 RB / 0 RB Offset		
A	BAND EDGE	20775 to 21425	20775	5MHz	QPSK, 16QAM	1 RB / 0 RB Offset 25 RB / 0 RB Offset		
			21425	5MHz	QPSK, 16QAM	1 RB / 24 RB Offset 25 RB / 0 RB Offset		
		20800 to 21400	20800	10MHz	QPSK, 16QAM	1 RB / 0 RB Offset 50 RB / 0 RB Offset		
			21400	10MHz	QPSK, 16QAM	1 RB / 49 RB Offset 50 RB / 0 RB Offset		
		20825 to 21375	20825	15MHz	QPSK, 16QAM	1 RB / 0 RB Offset 75 RB / 0 RB Offset		
			21375	15MHz	QPSK, 16QAM	1 RB / 74 RB Offset 75 RB / 0 RB Offset		
		20850 to 21350	20850	20MHz	QPSK, 16QAM	1 RB / 0 RB Offset 100 RB / 0 RB Offset		
			21350	20MHz	QPSK, 16QAM	1 RB / 99 RB Offset 100 RB / 0 RB Offset		
		A	CONDUCTED EMISSION	20775 to 21425	20775, 21100, 21425	5MHz	QPSK	1 RB / 0 RB Offset
				20800 to 21400	20800, 21100, 21400	10MHz	QPSK	1 RB / 0RB Offset
				20825 to 21375	20825, 21100, 21375	15MHz	QPSK	1 RB / 0 RB Offset
				20850 to 21350	20850, 21100, 21350	20MHz	QPSK	1 RB / 0 RB Offset
A	RADIATED EMISSION	20775 to 21425	21100	5MHz	QPSK	1 RB / 0 RB Offset		
		20800 to 21400	21100	10MHz	QPSK	1 RB / 0 RB Offset		
		20825 to 21375	20825, 21100, 21375	15MHz	QPSK	1 RB / 0 RB Offset		
		20850 to 21350	21100	20MHz	QPSK	1 RB / 0 RB Offset		

Note: This device was tested under all bandwidths, RB configurations and modulations. The worst case was found in QPSK modulation.



Test Report No.: W7L-P22120012-1RF04

LTE BAND 66 MODE

EUT CONFIGURE MODE	TEST ITEM	AVAILABLE CHANNEL	TESTED CHANNEL	CHANNEL BANDWIDTH	MODULATION	MODE
A	EIRP	131979 to 132665	131979,132322,132665	1.4MHz	QPSK, 16QAM	1 RB / 0 RB Offset
		131987 to 132657	131987, 132322,132657	3MHz	QPSK, 16QAM	1 RB / 0 RB Offset
		131997 to 132647	131997, 132322,132647	5MHz	QPSK, 16QAM	1 RB / 0 RB Offset
		132022 to 132622	132022,132322,132622	10MHz	QPSK, 16QAM	1 RB / 0 RB Offset
		132047 to 132597	132047,132322,132597	15MHz	QPSK, 16QAM	1 RB / 0 RB Offset
		132072 to 132572	132072,132322,132572	20MHz	QPSK, 16QAM	1 RB / 0 RB Offset
B	FREQUENCY STABILITY	131979 to 132665	131979,132322,132665	1.4MHz	QPSK	6 RB / 0 RB Offset
		131987 to 132657	131987,132322,132657	3MHz	QPSK	15 RB / 0 RB Offset
		131997 to 132647	131997,132322,132647	5MHz	QPSK	25 RB / 0 RB Offset
		132022 to 132622	132022,132322,132622	10MHz	QPSK	50 RB / 0 RB Offset
		132047 to 132597	132047,132322,132597	15MHz	QPSK	75 RB / 0 RB Offset
		132072 to 132572	132072,132322,132572	20MHz	QPSK	100 RB / 0 RB Offset
A	OCCUPIED BANDWIDTH	131979 to 132665	131979,132322,132665	1.4MHz	QPSK, 16QAM	6 RB / 0 RB Offset
		131987 to 132657	131987, 132322,132657	3MHz	QPSK, 16QAM	15 RB / 0 RB Offset
		131997 to 132647	131997, 132322,132647	5MHz	QPSK, 16QAM	25 RB / 0 RB Offset
		132022 to 132622	132022,132322,132622	10MHz	QPSK, 16QAM	50 RB / 0 RB Offset
		132047 to 132597	132047,132322,132597	15MHz	QPSK, 16QAM	75 RB / 0 RB Offset
		132072 to 132572	132072,132322,132572	20MHz	QPSK, 16QAM	100 RB / 0 RB Offset
A	BAND EDGE	131979 to 132322	131979	1.4MHz	QPSK, 16QAM	1 RB / 0 RB Offset 6 RB / 0 RB Offset
			132322	1.4MHz	QPSK, 16QAM	1 RB / 5 RB Offset 6 RB / 0 RB Offset
		131987 to 132657	131987	3MHz	QPSK, 16QAM	1 RB / 0 RB Offset 15 RB / 0 RB Offset
			132657	3MHz	QPSK, 16QAM	1 RB / 14 RB Offset 15 RB / 0 RB Offset
		131997 to 132647	131997	5MHz	QPSK, 16QAM	1 RB / 0 RB Offset 25 RB / 0 RB Offset
			132647	5MHz	QPSK, 16QAM	1 RB / 24 RB Offset 25 RB / 0 RB Offset
		132022 to 132622	132022	10MHz	QPSK, 16QAM	1 RB / 0 RB Offset 50 RB / 0 RB Offset
			132622	10MHz	QPSK, 16QAM	1 RB / 49 RB Offset 50 RB / 0 RB Offset
		132047 to 132597	132047	15MHz	QPSK, 16QAM	1 RB / 0 RB Offset 75 RB / 0 RB Offset
			132597	15MHz	QPSK, 16QAM	1 RB / 74 RB Offset 75 RB / 0 RB Offset
		132072 to 132572	132072	20MHz	QPSK, 16QAM	1 RB / 0 RB Offset 100 RB / 0 RB Offset
			132572	20MHz	QPSK, 16QAM	1 RB / 99 RB Offset



Test Report No.: W7L-P22120012-1RF04

						100 RB / 0 RB Offset
A	CONDCUDED EMISSION	131979 to 132665	131979,132322,132665	1.4MHz	QPSK	1 RB / 0 RB Offset
		131987 to 132657	131987,132322,132657	3MHz	QPSK	1 RB / 0 RB Offset
		131997 to 132647	131997,132322,132647	5MHz	QPSK	1 RB / 0 RB Offset
		132022 to 132622	132022,132322,132622	10MHz	QPSK	1 RB / 0 RB Offset
		132047 to 132597	132047,132322,132597	15MHz	QPSK	1 RB / 0 RB Offset
		132072 to 132572	132072,132322,132572	20MHz	QPSK	1 RB / 0 RB Offset
A	RADIATED EMISSION	131979 to 132665	132322	1.4MHz	QPSK	1 RB / 0 RB Offset
		131987 to 132657	132322	3MHz	QPSK	1 RB / 0 RB Offset
		131997 to 132647	132322	5MHz	QPSK	1 RB / 0 RB Offset
		132022 to 132622	132022,132322,132622	10MHz	QPSK	1 RB / 0 RB Offset
		132047 to 132597	132322	15MHz	QPSK	1 RB / 0 RB Offset
		132072 to 132572	132322	20MHz	QPSK	1 RB / 0 RB Offset

Note: This device was tested under all bandwidths, RB configurations and modulations. The worst case was found in QPSK modulation.

TEST CONDITION:

TEST ITEM	ENVIRONMENTAL CONDITIONS	INPUT POWER	TESTED BY
ERP&EIRP	23deg. C, 70%RH	DC 5V By Adapter	Jace Hu
FREQUENCY STABILITY	23deg. C, 70%RH	DC 3.65V/3.7V/4.15V By DC Supply	James Fu
OCCUPIED BANDWIDTH	23deg. C, 70%RH	DC5V By Adapter	James Fu
BAND EDGE	23deg. C, 70%RH	DC 5V By Adapter	James Fu
CONDCUDED EMISSION	23deg. C, 70%RH	DC5V By Adapter	James Fu
RADIATED EMISSION	23deg. C, 70%RH	DC5V By Adapter	Jace Hu
PEAK TO AVERAGE RATIO	23deg. C, 70%RH	DC5V By Adapter	James Fu



Test Report No.: W7L-P22120012-1RF04

2.5 GENERAL DESCRIPTION OF APPLIED STANDARDS

The EUT is a RF product. According to the specifications of the manufacturer, it must comply with the requirements of the following standards:

FCC 47 CFR Part 2

FCC 47 CFR Part 27

KDB 971168 D01 Power Meas License Digital Systems v03r01

ANSI/TIA/EIA-603-D

ANSI/TIA/EIA-603-E

ANSI C63.26-2015

NOTE: All test items have been performed and recorded as per the above standards.



3 TEST TYPES AND RESULTS

3.1 OUTPUT POWER MEASUREMENT

3.1.1 LIMITS OF OUTPUT POWER MEASUREMENT

The radiated peak output power shall be according to the specific rule Part 27.50(h)(2) that “User stations are limited to 2 watts” and 27.50(i) specific that “Peak transmit power must be measure over any interval of continuous transmission using instrumentation calibration in terms of rms-equivalent voltage.”

Fixed, mobile, and portable (hand-held) stations operating in the 1710-1755 MHz band and mobile and portable stations operating in the 1695-1710 MHz and 1755-1780 MHz bands are limited to 1 watt EIRP

3.1.2 TEST PROCEDURES

EIRP MEASUREMENT:

Per KDB 971168 D01 Power Meas License Digital Systems v03r01 or subclause 5.2.5.5 of ANSI C63.26-2015, the relevant equation for determining the ERP or EIRP from the conducted RF output power measured using the guidance provided above is:

$$\text{ERP or EIRP} = P_{\text{Meas}} + G_{\text{T}} - L_{\text{C}}$$

Where:

ERP or EIRP = effective radiated power or equivalent isotropically radiated power, respectively
(expressed in the same units as P_{Meas} , typically dBW or dBm);

P_{Meas} = measured transmitter output power or PSD, in dBm or dBW;

G_{T} = gain of the transmitting antenna, in dBd (ERP) or dBi (EIRP);

L_{C} = signal attenuation in the connecting cable between the transmitter and antenna, in dB.

CONDUCTED POWER MEASUREMENT:

- a. The EUT was set up for the maximum power with LTE link data modulation and link up with simulator.
- b. Set the EUT to transmit under low, middle and high channel and record the power level shown on simulator.



Test Report No.: W7L-P22120012-1RF04

3.1.3 TEST SETUP

CONDUCTED POWER MEASUREMENT:

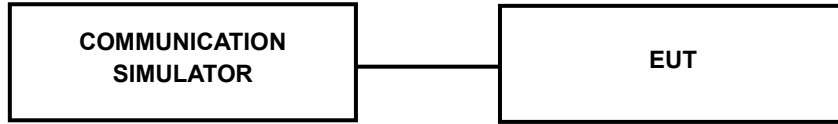

For the actual test configuration, please refer to the attached file (Test Setup Photo).



Test Report No.: W7L-P22120012-1RF04

3.1.4 TEST RESULTS

AVERAGE CONDUCTED OUTPUT POWER (dBm)

Band	WCDMA IV		
	1312	1413	1513
Channel	1712.4	1732.6	1752.6
Frequency (MHz)	1712.4	1732.6	1752.6
RMC 12.2K	22.53	22.56	22.64
HSDPA Subtest-1	21.49	21.51	21.59
HSDPA Subtest-2	21.45	21.55	21.59
HSDPA Subtest-3	20.91	21.00	21.08
HSDPA Subtest-4	20.93	20.99	21.04
HSUPA Subtest-1	21.47	21.54	21.58
HSUPA Subtest-2	19.46	19.51	19.62
HSUPA Subtest-3	20.40	20.44	20.57
HSUPA Subtest-4	19.39	19.46	19.60
HSUPA Subtest-5	21.39	21.52	21.52



BUREAU
VERITAS

Test Report No.: W7L-P22120012-1RF04

LTE Band 4

Band/BW	Modulation	RB Size	RB Offset	Low CH 19957	Mid CH 20175	High CH 20393
				Frequency 1710.7 MHz	Frequency 1732.5 MHz	Frequency 1754.3 MHz
4/ 1.4	QPSK	1	0	22.85	22.76	22.64
		1	2	22.76	22.69	22.57
		1	5	22.69	22.60	22.53
		3	0	22.39	22.31	22.21
		3	1	22.43	22.38	22.24
		3	3	22.48	22.37	22.27
		6	0	21.44	21.36	21.22
	16QAM	1	0	21.54	21.46	21.38
		1	2	21.50	21.43	21.35
		1	5	21.53	21.39	21.40
		3	0	21.49	21.47	21.33
		3	1	21.49	21.48	21.35
		3	3	21.54	21.44	21.32
		6	0	20.54	20.56	20.39

Band/BW	Modulation	RB Size	RB Offset	Low CH 19965	Mid CH 20175	High CH 20385
				Frequency 1711.5 MHz	Frequency 1732.5 MHz	Frequency 1753.5 MHz
4/3	QPSK	1	0	22.80	22.75	22.61
		1	7	22.72	22.70	22.57
		1	14	22.63	22.65	22.52
		8	0	21.37	21.38	21.21
		8	3	21.40	21.35	21.24
		8	7	21.45	21.44	21.31
		15	0	21.40	21.37	21.20
	16QAM	1	0	21.57	21.45	21.42
		1	7	21.44	21.47	21.32
		1	14	21.55	21.41	21.39
		8	0	20.51	20.45	20.33
		8	3	20.51	20.41	20.38
		8	7	20.57	20.47	20.25
		15	0	20.55	20.50	20.38



Test Report No.: W7L-P22120012-1RF04

Band/BW	Modulation	RB Size	RB Offset	Low CH 19975	Mid CH 20175	High CH 20375
				Frequency 1712.5 MHz	Frequency 1732.5 MHz	Frequency 1752.5 MHz
4/5	QPSK	1	0	22.81	22.74	22.65
		1	12	22.75	22.70	22.54
		1	24	22.63	22.66	22.53
		12	0	21.41	21.34	21.22
		12	6	21.38	21.38	21.27
		12	13	21.46	21.40	21.31
		25	0	21.37	21.40	21.19
	16QAM	1	0	21.57	21.45	21.41
		1	12	21.44	21.45	21.29
		1	24	21.52	21.45	21.35
		12	0	20.46	20.47	20.36
		12	6	20.51	20.42	20.35
		12	13	20.51	20.44	20.31
		25	0	20.52	20.56	20.38

Band/BW	Modulation	RB Size	RB Offset	Low CH 20000	Mid CH 20175	High CH 20350
				Frequency 1715 MHz	Frequency 1732.5 MHz	Frequency 1750 MHz
4/ 10	QPSK	1	0	22.78	22.78	22.61
		1	24	22.76	22.69	22.57
		1	49	22.69	22.60	22.53
		25	0	21.39	21.31	21.21
		25	12	21.43	21.38	21.24
		25	25	21.46	21.37	21.27
		50	0	21.42	21.36	21.22
	16QAM	1	0	21.57	21.46	21.38
		1	24	21.46	21.43	21.35
		1	49	21.56	21.39	21.40
		25	0	20.45	20.48	20.33
		25	12	20.55	20.41	20.39
		25	25	20.50	20.45	20.28
		50	0	20.57	20.52	20.42

Band/BW	Modulation	RB Size	RB Offset	Low CH 20025	Mid CH 20175	High CH 20325
				Frequency 1717.5 MHz	Frequency 1732.5 MHz	Frequency 1747.5 MHz
4/ 15	QPSK	1	0	22.82	22.79	22.60
		1	37	22.77	22.74	22.55
		1	74	22.65	22.62	22.57
		36	0	21.44	21.37	21.18
		36	19	21.36	21.33	21.30
		36	39	21.52	21.41	21.30
		75	0	21.42	21.41	21.18
	16QAM	1	0	21.55	21.48	21.41
		1	37	21.46	21.49	21.34
		1	74	21.56	21.39	21.40
		36	0	20.45	20.48	20.33
		36	19	20.54	20.43	20.38
		36	39	20.57	20.44	20.25
		75	0	20.54	20.55	20.40

Band/BW	Modulation	RB Size	RB Offset	Low CH 20050	Mid CH 20175	High CH 20300
				Frequency 1720 MHz	Frequency 1732.5 MHz	Frequency 1745 MHz
4/ 20	QPSK	1	0	22.86	22.82	22.66
		1	50	22.79	22.75	22.59
		1	99	22.71	22.67	22.58
		50	0	21.45	21.39	21.23
		50	25	21.44	21.40	21.32
		50	50	21.53	21.45	21.33
		100	0	21.45	21.42	21.24
	16QAM	1	0	21.59	21.53	21.43
		1	50	21.52	21.51	21.37
		1	99	21.58	21.47	21.41
		50	0	20.53	20.52	20.38
		50	25	20.57	20.49	20.40
		50	50	20.58	20.49	20.33
		100	0	20.60	20.58	20.44

LTE Band 7

Band/BW	Modulation	RB Size	RB Offset	Low CH 20775	Mid CH 21100	High CH 21425
				Frequency 2502.5 MHz	Frequency 2535 MHz	Frequency 2567.5 MHz
7/5	QPSK	1	0	22.25	22.65	22.94
		1	12	22.33	22.81	23.14
		1	24	22.54	22.92	23.35
		12	0	21.37	21.78	22.12
		12	6	21.31	21.73	22.17
		12	13	21.48	21.90	22.29
		25	0	21.44	21.84	22.24
	16QAM	1	0	22.03	22.41	22.81
		1	12	21.94	22.44	22.74
		1	24	22.00	22.41	22.83
		12	0	20.44	20.80	21.19
		12	6	20.45	20.87	21.31
		12	13	20.62	21.09	21.34
		25	0	20.55	21.01	21.37



Test Report No.: W7L-P22120012-1RF04

Band/BW	Modulation	RB Size	RB Offset	Low CH 20800	Mid CH 21100	High CH 21400
				Frequency 2505 MHz	Frequency 2535 MHz	Frequency 2565 MHz
7/ 10	QPSK	1	0	22.23	22.62	22.97
		1	24	22.39	22.74	23.18
		1	49	22.50	22.93	23.31
		25	0	21.41	21.72	22.16
		25	12	21.30	21.74	22.14
		25	25	21.53	21.86	22.32
		50	0	21.44	21.85	22.21
	16QAM	1	0	22.05	22.39	22.87
		1	24	21.99	22.44	22.72
		1	49	22.02	22.38	22.79
		25	0	20.49	20.81	21.22
		25	12	20.50	20.84	21.32
		25	25	20.62	21.07	21.35
		50	0	20.61	20.94	21.38



Test Report No.: W7L-P22120012-1RF04

Band/BW	Modulation	RB Size	RB Offset	Low CH 20825	Mid CH 21100	High CH 21375
				Frequency 2507.5 MHz	Frequency 2535 MHz	Frequency 2562.5 MHz
7/ 15	QPSK	1	0	22.28	22.68	22.91
		1	37	22.34	22.74	23.13
		1	74	22.55	22.91	23.34
		36	0	21.41	21.73	22.12
		36	19	21.32	21.70	22.17
		36	39	21.54	21.84	22.33
		75	0	21.38	21.88	22.21
	16QAM	1	0	22.09	22.39	22.88
		1	37	21.92	22.42	22.75
		1	74	22.04	22.40	22.83
		36	0	20.48	20.80	21.19
		36	19	20.46	20.84	21.31
		36	39	20.69	21.09	21.32
		75	0	20.58	20.94	21.33



Test Report No.: W7L-P22120012-1RF04

Band/BW	Modulation	RB Size	RB Offset	Low CH 20850	Mid CH 21100	High CH 21350
				Frequency 2510 MHz	Frequency 2535 MHz	Frequency 2560 MHz
7/ 20	QPSK	1	0	22.29	22.70	22.99
		1	50	22.41	22.82	23.19
		1	99	22.58	22.97	23.36
		50	0	21.43	21.80	22.17
		50	25	21.38	21.78	22.19
		50	50	21.56	21.92	22.34
		100	0	21.46	21.92	22.26
	16QAM	1	0	22.11	22.47	22.89
		1	50	22.00	22.46	22.80
		1	99	22.07	22.46	22.85
		50	0	20.50	20.87	21.24
		50	25	20.52	20.92	21.33
		50	50	20.70	21.11	21.40
		100	0	20.63	21.02	21.39

LTE Band 66

Band/BW	Modulation	RB Size	RB Offset	Low CH 131979	Mid CH 132322	High CH 132665
				Frequency 1710.7MHz	Frequency 1745MHz	Frequency 1779.3MHz
66/ 1.4	QPSK	1	0	22.69	22.67	22.98
		1	2	22.74	22.63	23.06
		1	5	22.71	22.55	22.95
		3	0	22.39	22.29	22.74
		3	1	22.36	22.31	22.57
		3	3	22.35	22.29	22.66
		6	0	21.51	21.35	21.72
	16QAM	1	0	21.46	21.41	21.78
		1	2	21.43	21.27	21.70
		1	5	21.49	21.30	21.80
		3	0	21.45	21.38	21.73
		3	1	21.48	21.42	21.78
		3	3	21.51	21.35	21.77
		6	0	20.48	20.40	20.79



Test Report No.: W7L-P22120012-1RF04

Band/BW	Modulation	RB Size	RB Offset	Low CH 131987	Mid CH 132322	High CH 132657
				Frequency 1711.5MHz	Frequency 1745MHz	Frequency 1778.5MHz
66/ 3	QPSK	1	0	22.71	22.66	23.02
		1	7	22.76	22.67	23.03
		1	14	22.65	22.55	22.98
		8	0	21.44	21.33	21.73
		8	3	21.34	21.32	21.59
		8	7	21.36	21.32	21.70
		15	0	21.46	21.39	21.71
	16QAM	1	0	21.49	21.40	21.82
		1	7	21.37	21.31	21.67
		1	14	21.51	21.32	21.79
		8	0	20.48	20.38	20.70
		8	3	20.50	20.40	20.79
		8	7	20.53	20.33	20.73
		15	0	20.48	20.34	20.82

Band/BW	Modulation	RB Size	RB Offset	Low CH 131997	Mid CH 132322	High CH 132647
				Frequency 1712.5MHz	Frequency 1745MHz	Frequency 1777.5MHz
66/ 5	QPSK	1	0	22.72	22.64	22.98
		1	12	22.75	22.61	23.06
		1	24	22.68	22.54	22.99
		12	0	21.41	21.32	21.71
		12	6	21.29	21.32	21.60
		12	13	21.36	21.32	21.71
		25	0	21.46	21.39	21.69
	16QAM	1	0	21.44	21.43	21.81
		1	12	21.37	21.33	21.67
		1	24	21.52	21.30	21.79
		12	0	20.41	20.37	20.70
		12	6	20.50	20.41	20.77
		12	13	20.48	20.35	20.76
		25	0	20.48	20.35	20.79

Band/BW	Modulation	RB Size	RB Offset	Low CH 132022	Mid CH 132322	High CH 132622
				Frequency 1715MHz	Frequency 1745MHz	Frequency 1775MHz
66/ 10	QPSK	1	0	22.74	22.65	23.01
		1	24	22.75	22.61	23.07
		1	49	22.65	22.58	22.95
		25	0	21.42	21.31	21.74
		25	12	21.35	21.26	21.60
		25	25	21.34	21.29	21.70
		50	0	21.51	21.39	21.66
	16QAM	1	0	21.44	21.40	21.77
		1	24	21.42	21.29	21.70
		1	49	21.52	21.31	21.76
		25	0	20.43	20.35	20.76
		25	12	20.54	20.35	20.82
		25	25	20.47	20.36	20.73
		50	0	20.52	20.34	20.83



Test Report No.: W7L-P22120012-1RF04

Band/BW	Modulation	RB Size	RB Offset	Low CH 132047	Mid CH 132322	High CH 132597
				Frequency 1717.5 MHz	Frequency 1745MHz	Frequency 1772.5 MHz
66/ 15	QPSK	1	0	22.71	22.69	22.97
		1	37	22.70	22.64	23.06
		1	74	22.67	22.55	22.95
		36	0	21.38	21.32	21.74
		36	19	21.29	21.31	21.59
		36	39	21.32	21.36	21.70
		75	0	21.48	21.36	21.66
	16QAM	1	0	21.43	21.47	21.81
		1	37	21.40	21.30	21.68
		1	74	21.52	21.30	21.80
		36	0	20.41	20.39	20.73
		36	19	20.53	20.37	20.81
		36	39	20.53	20.33	20.73
		75	0	20.48	20.34	20.82

Band/BW	Modulation	RB Size	RB Offset	Low CH 132072	Mid CH 132322	High CH 132572
				Frequency 1720MHz	Frequency 1745MHz	Frequency 1770MHz
66/ 20	QPSK	1	0	22.77	22.71	23.03
		1	50	22.77	22.69	23.08
		1	99	22.73	22.62	23.00
		50	0	21.45	21.37	21.76
		50	25	21.37	21.33	21.65
		50	50	21.40	21.37	21.72
		100	0	21.52	21.41	21.74
	16QAM	1	0	21.51	21.48	21.83
		1	50	21.45	21.35	21.72
		1	99	21.54	21.38	21.81
		50	0	20.49	20.43	20.78
		50	25	20.56	20.43	20.83
		50	50	20.55	20.40	20.78
		100	0	20.54	20.42	20.84



BUREAU
VERITAS

Test Report No.: W7L-P22120012-1RF04

EIRP

WCDMA IV

Channel	Frequency (MHz)	Conducted Power (dBm)	G _T -L _c (dB)	EIRP (dBm)	EIRP (mW)	Limit (W)
1312	1712.4	22.53	1.55	24.08	255.86	1
1413	1732.6	22.56	1.55	24.11	257.63	1
1513	1752.6	22.64	1.55	24.19	262.42	1

LTE BAND 4

CHANNEL BANDWIDTH: 1.4MHz QPSK

Channel	Frequency (MHz)	Conducted Power (dBm)	G _T -L _c (dB)	EIRP (dBm)	EIRP (mW)	Limit (W)
19957	1710.7	22.85	1.55	24.4	275.42	1
20175	1732.5	22.76	1.55	24.31	269.77	1
20393	1754.3	22.64	1.55	24.19	262.42	1

CHANNEL BANDWIDTH: 1.4MHz 16QAM

Channel	Frequency (MHz)	Conducted Power (dBm)	G _T -L _c (dB)	EIRP (dBm)	EIRP (mW)	Limit (W)
19957	1710.7	21.54	1.55	23.09	203.7	1
20175	1732.5	21.48	1.55	23.03	200.91	1
20393	1754.3	21.4	1.55	22.95	197.24	1

CHANNEL BANDWIDTH: 3MHz QPSK

Channel	Frequency (MHz)	Conducted Power (dBm)	G _T -L _c (dB)	EIRP (dBm)	EIRP (mW)	Limit (W)
19965	1711.5	22.8	1.55	24.35	272.27	1
20175	1732.5	22.75	1.55	24.3	269.15	1
20385	1753.5	22.61	1.55	24.16	260.62	1

CHANNEL BANDWIDTH: 3MHz 16QAM

Channel	Frequency (MHz)	Conducted Power (dBm)	G _T -L _c (dB)	EIRP (dBm)	EIRP (mW)	Limit (W)
19965	1711.5	21.57	1.55	23.12	205.12	1
20175	1732.5	21.55	1.55	23.1	204.17	1
20385	1753.5	21.55	1.55	23.1	204.17	1

CHANNEL BANDWIDTH: 5MHz QPSK

Channel	Frequency (MHz)	Conducted Power (dBm)	G _T -L _C (dB)	EIRP (dBm)	EIRP (mW)	Limit (W)
19975	1712.5	22.81	1.55	24.36	272.9	1
20175	1732.5	22.74	1.55	24.29	268.53	1
20375	1752.5	22.65	1.55	24.2	263.03	1

CHANNEL BANDWIDTH: 5MHz 16QAM

Channel	Frequency (MHz)	Conducted Power (dBm)	G _T -L _C (dB)	EIRP (dBm)	EIRP (mW)	Limit (W)
19975	1712.5	21.57	1.55	23.12	205.12	1
20175	1732.5	21.45	1.55	23	199.53	1
20375	1752.5	21.41	1.55	22.96	197.7	1

CHANNEL BANDWIDTH: 10MHz QPSK

Channel	Frequency (MHz)	Conducted Power (dBm)	G _T -L _C (dB)	EIRP (dBm)	EIRP (mW)	Limit (W)
20000	1715	22.78	1.55	24.33	271.02	1
20175	1732.5	22.78	1.55	24.33	271.02	1
20350	1750	22.61	1.55	24.16	260.62	1

CHANNEL BANDWIDTH: 10MHz 16QAM

Channel	Frequency (MHz)	Conducted Power (dBm)	G _T -L _C (dB)	EIRP (dBm)	EIRP (mW)	Limit (W)
20000	1715	21.57	1.55	23.12	205.12	1
20175	1732.5	21.46	1.55	23.01	199.99	1
20350	1750	21.4	1.55	22.95	197.24	1

CHANNEL BANDWIDTH: 15MHz QPSK

Channel	Frequency (MHz)	Conducted Power (dBm)	G _T -L _c (dB)	EIRP (dBm)	EIRP (mW)	Limit (W)
20025	1717.5	22.82	1.55	24.37	273.53	1
20175	1732.5	22.79	1.55	24.34	271.64	1
20325	1747.5	22.6	1.55	24.15	260.02	1

CHANNEL BANDWIDTH: 15MHz 16QAM

Channel	Frequency (MHz)	Conducted Power (dBm)	G _T -L _c (dB)	EIRP (dBm)	EIRP (mW)	Limit (W)
20025	1717.5	21.56	1.55	23.11	204.64	1
20175	1732.5	21.49	1.55	23.04	201.37	1
20325	1747.5	21.41	1.55	22.96	197.7	1

CHANNEL BANDWIDTH: 20MHz QPSK

Channel	Frequency (MHz)	Conducted Power (dBm)	G _T -L _c (dB)	EIRP (dBm)	EIRP (mW)	Limit (W)
20050	1720	22.86	1.55	24.41	276.06	1
20175	1732.5	22.82	1.55	24.37	273.53	1
20300	1745	22.66	1.55	24.21	263.63	1

CHANNEL BANDWIDTH: 20MHz 16QAM

Channel	Frequency (MHz)	Conducted Power (dBm)	G _T -L _c (dB)	EIRP (dBm)	EIRP (mW)	Limit (W)
20050	1720	21.59	1.55	23.14	206.06	1
20175	1732.5	21.53	1.55	23.08	203.24	1
20300	1745	21.43	1.55	22.98	198.61	1

LTE BAND 7

CHANNEL BANDWIDTH: 5MHz QPSK

Channel	Frequency (MHz)	Conducted Power (dBm)	G _T -L _c (dB)	EIRP (dBm)	EIRP (mW)	Limit (W)
20775	2502.5	22.54	-1.56	20.98	125.31	2
21100	2535.0	22.92	-1.56	21.36	136.77	2
21425	2567.5	23.35	-1.56	21.79	151.01	2

CHANNEL BANDWIDTH: 5MHz 16QAM

Channel	Frequency (MHz)	Conducted Power (dBm)	G _T -L _c (dB)	EIRP (dBm)	EIRP (mW)	Limit (W)
20775	2502.5	22.03	-1.56	20.47	111.43	2
21100	2535.0	22.44	-1.56	20.88	122.46	2
21425	2567.5	22.83	-1.56	21.27	133.97	2

CHANNEL BANDWIDTH: 10MHz QPSK

Channel	Frequency (MHz)	Conducted Power (dBm)	G _T -L _c (dB)	EIRP (dBm)	EIRP (mW)	Limit (W)
20800	2505.0	22.5	-1.56	20.94	124.17	2
21100	2535.0	22.93	-1.56	21.37	137.09	2
21400	2565.0	23.31	-1.56	21.75	149.62	2

CHANNEL BANDWIDTH: 10MHz 16QAM

Channel	Frequency (MHz)	Conducted Power (dBm)	G _T -L _c (dB)	EIRP (dBm)	EIRP (mW)	Limit (W)
20800	2505.0	22.05	-1.56	20.49	111.94	2
21100	2535.0	22.44	-1.56	20.88	122.46	2
21400	2565.0	22.87	-1.56	21.31	135.21	2

CHANNEL BANDWIDTH: 15MHz QPSK

Channel	Frequency (MHz)	Conducted Power (dBm)	G _T -L _c (dB)	EIRP (dBm)	EIRP (mW)	Limit (W)
20825	2507.5	22.55	-1.56	20.99	125.6	2
21100	2535.0	22.91	-1.56	21.35	136.46	2
21375	2562.5	23.34	-1.56	21.78	150.66	2

CHANNEL BANDWIDTH: 15MHz 16QAM

Channel	Frequency (MHz)	Conducted Power (dBm)	G _T -L _c (dB)	EIRP (dBm)	EIRP (mW)	Limit (W)
20825	2507.5	22.09	-1.56	20.53	112.98	2
21100	2535.0	22.42	-1.56	20.86	121.9	2
21375	2562.5	22.88	-1.56	21.32	135.52	2

CHANNEL BANDWIDTH: 20MHz QPSK

Channel	Frequency (MHz)	Conducted Power (dBm)	G _T -L _c (dB)	EIRP (dBm)	EIRP (mW)	Limit (W)
20850	2510.0	22.58	-1.56	21.02	126.47	2
21100	2535.0	22.97	-1.56	21.41	138.36	2
21350	2560.0	23.36	-1.56	21.8	151.36	2

CHANNEL BANDWIDTH: 20MHz 16QAM

Channel	Frequency (MHz)	Conducted Power (dBm)	G _T -L _c (dB)	EIRP (dBm)	EIRP (mW)	Limit (W)
20850	2510.0	22.11	-1.56	20.55	113.5	2
21100	2535.0	22.47	-1.56	20.91	123.31	2
21350	2560.0	22.89	-1.56	21.33	135.83	2

LTE BAND 66

CHANNEL BANDWIDTH: 1.4MHz QPSK

Channel	Frequency (MHz)	Conducted Power (dBm)	G _T -L _c (dB)	EIRP (dBm)	EIRP (mW)	Limit (W)
131979	1710.7	22.74	1.55	24.29	268.53	1
132322	1745	22.67	1.55	24.22	264.24	1
132665	1779.3	23.06	1.55	24.61	289.07	1

CHANNEL BANDWIDTH: 1.4MHz 16QAM

Channel	Frequency (MHz)	Conducted Power (dBm)	G _T -L _c (dB)	EIRP (dBm)	EIRP (mW)	Limit (W)
131979	1710.7	21.51	1.55	23.06	202.3	1
132322	1745	21.42	1.55	22.97	198.15	1
132665	1779.3	21.8	1.55	23.35	216.27	1

CHANNEL BANDWIDTH: 3MHz QPSK

Channel	Frequency (MHz)	Conducted Power (dBm)	G _T -L _c (dB)	EIRP (dBm)	EIRP (mW)	Limit (W)
131987	1711.5	22.76	1.55	24.31	269.77	1
132322	1745	22.67	1.55	24.22	264.24	1
132657	1778.5	23.03	1.55	24.58	287.08	1

CHANNEL BANDWIDTH: 3MHz 16QAM

Channel	Frequency (MHz)	Conducted Power (dBm)	G _T -L _c (dB)	EIRP (dBm)	EIRP (mW)	Limit (W)
131987	1711.5	21.51	1.55	23.06	202.3	1
132322	1745	21.4	1.55	22.95	197.24	1
132657	1778.5	21.82	1.55	23.37	217.27	1

CHANNEL BANDWIDTH: 5MHz QPSK

Channel	Frequency (MHz)	Conducted Power (dBm)	G _T -L _c (dB)	EIRP (dBm)	EIRP (mW)	Limit (W)
131997	1712.5	22.75	1.55	24.3	269.15	1
132322	1745	22.64	1.55	24.19	262.42	1
132647	1777.5	23.06	1.55	24.61	289.07	1

CHANNEL BANDWIDTH: 5MHz 16QAM

Channel	Frequency (MHz)	Conducted Power (dBm)	G _T -L _c (dB)	EIRP (dBm)	EIRP (mW)	Limit (W)
131997	1712.5	21.52	1.55	23.07	202.77	1
132322	1745	21.43	1.55	22.98	198.61	1
132647	1777.5	21.81	1.55	23.36	216.77	1

CHANNEL BANDWIDTH: 10MHz QPSK

Channel	Frequency (MHz)	Conducted Power (dBm)	G _T -L _c (dB)	EIRP (dBm)	EIRP (mW)	Limit (W)
132022	1715	22.75	1.55	24.3	269.15	1
132322	1745	22.65	1.55	24.2	263.03	1
132622	1775	23.07	1.55	24.62	289.73	1

CHANNEL BANDWIDTH: 10MHz 16QAM

Channel	Frequency (MHz)	Conducted Power (dBm)	G _T -L _c (dB)	EIRP (dBm)	EIRP (mW)	Limit (W)
132022	1715	21.52	1.55	23.07	202.77	1
132322	1745	21.4	1.55	22.95	197.24	1
132622	1775	21.77	1.55	23.32	214.78	1

CHANNEL BANDWIDTH: 15MHz QPSK

Channel	Frequency (MHz)	Conducted Power (dBm)	G _T -L _c (dB)	EIRP (dBm)	EIRP (mW)	Limit (W)
132047	1717.5	22.71	1.55	24.26	266.69	1
132322	1745	22.69	1.55	24.24	265.46	1
132597	1772.5	23.06	1.55	24.61	289.07	1

CHANNEL BANDWIDTH: 15MHz 16QAM

Channel	Frequency (MHz)	Conducted Power (dBm)	G _T -L _c (dB)	EIRP (dBm)	EIRP (mW)	Limit (W)
132047	1717.5	21.52	1.55	23.07	202.77	1
132322	1745	21.47	1.55	23.02	200.45	1
132597	1772.5	21.81	1.55	23.36	216.77	1

CHANNEL BANDWIDTH: 20MHz QPSK

Channel	Frequency (MHz)	Conducted Power (dBm)	G _T -L _c (dB)	EIRP (dBm)	EIRP (mW)	Limit (W)
132072	1720	22.77	1.55	24.32	270.4	1
132322	1745	22.71	1.55	24.26	266.69	1
132572	1770	23.08	1.55	24.63	290.4	1

CHANNEL BANDWIDTH: 20MHz 16QAM

Channel	Frequency (MHz)	Conducted Power (dBm)	G _T -L _c (dB)	EIRP (dBm)	EIRP (mW)	Limit (W)
132072	1720	21.54	1.55	23.09	203.7	1
132322	1745	21.48	1.55	23.03	200.91	1
132572	1770	21.83	1.55	23.38	217.77	1

3.2 FREQUENCY STABILITY MEASUREMENT

3.2.1 LIMITS OF FREQUENCY STABILITY MEASUREMENT

The frequency stability shall be sufficient to ensure that the fundamental emissions stay within the authorized bands of operation.

3.2.2 TEST PROCEDURE

- a. Device is placed at the oven room. The oven room could control the temperatures and humidity. Power warm up is at least 15 min and power applied should perform before recording frequency error.
- b. EUT is connected the external power supply to control the DC input power. The test voltage range is from minimum to maximum working voltage. Each step shall be record the frequency error rate.
- c. The temperature range step is 10 degrees in this test items. All temperature levels shall be hold the $\pm 0.5^{\circ}\text{C}$ during the measurement testing. The each temperature step shall be at least 0.5 hours, consider the EUT could be test under the stability condition.

NOTE: The frequency error was recorded frequency error from the communication simulator.

3.2.3 TEST SETUP

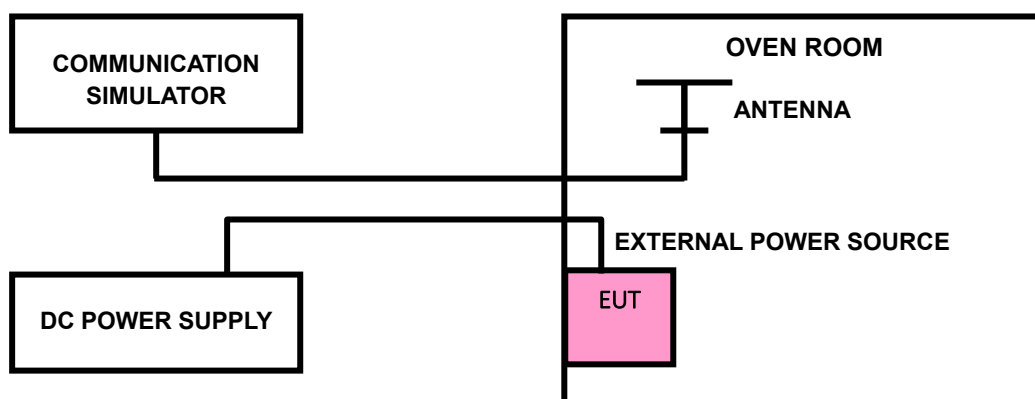



Test Report No.: W7L-P22120012-1RF04

3.2.4 TEST RESULTS

Please Refer to Appendix Of this test report.

Note: VL = Low voltage(3.65V); VN/NV = Normal voltage(3.7V); VH = High voltage(4.15V);
NT = Normal temperature (25°C)

3.3 OCCUPIED BANDWIDTH MEASUREMENT

3.3.1 LIMITS OF OCCUPIED BANDWIDTH MEASUREMENT

The width of a frequency band such that, below the lower and above the upper frequency limits, the mean powers emitted are each equal to a specified percentage 0.5 % of the total mean power of a given emission.

3.3.2 TEST SETUP

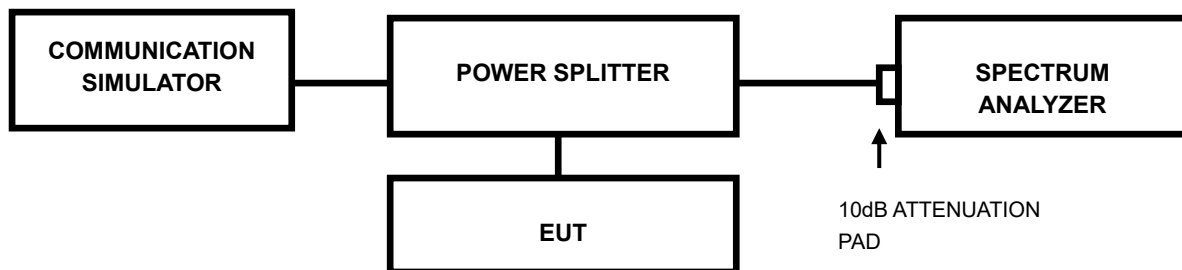

3.3.3 TEST PROCEDURES

- The conducted occupied bandwidth used the power splitter via EUT RF power connector between simulation base station and spectrum analyzer.
- Use OBW measurement function of Spectrum analyzer to measure 99 % occupied bandwidth.



Test Report No.: W7L-P22120012-1RF04

3.3.4 TEST RESULTS

Please Refer to Appendix Of this test report.

3.4 BAND EDGE MEASUREMENT

3.4.1 LIMITS OF BAND EDGE MEASUREMENT

According to FCC 27.53(h) specified that For operations in the 1710-1755 MHz band, the power of any emission outside a licensee's frequency band(s) of operation shall be attenuated below the transmitter power (P) within the licensed band(s) of operation, measured in watts, by at least $43 + 10 \log (P)$ dB. However, in the 1 megahertz bands immediately outside and adjacent to the licensee's frequency block, a resolution bandwidth of at least one percent of the emission bandwidth of the fundamental emission of the transmitter may be employed.

According to FCC 27.53(m)(4) specified that For mobile digital stations, the attenuation factor shall be not less than $40 + 10 \log (P)$ dB on all frequencies between the channel edge and 5 megahertz from the channel edge, $43 + 10 \log (P)$ dB on all frequencies between 5 megahertz and X megahertz from the channel edge, and $55 + 10 \log (P)$ dB on all frequencies more than X megahertz from the channel edge, where X is the greater of 6 megahertz or the actual emission bandwidth as defined in paragraph (m)(6) of this section. In addition, the attenuation factor shall not be less that $43 + 10 \log (P)$ dB on all frequencies between 2490.5 MHz and 2496 MHz and $55 + 10 \log (P)$ dB at or below 2490.5 MHz. Mobile Satellite Service licensees operating on frequencies below 2495 MHz may also submit a documented interference complaint against BRS licensees operating on channel BRS Channel 1 on the same terms and conditions as adjacent channel BRS or EBS licensees. For mobile digital stations, in the 1 megahertz bands immediately outside and adjacent to the frequency block a resolution bandwidth of at least two percent may be employed.

3.4.2 TEST SETUP

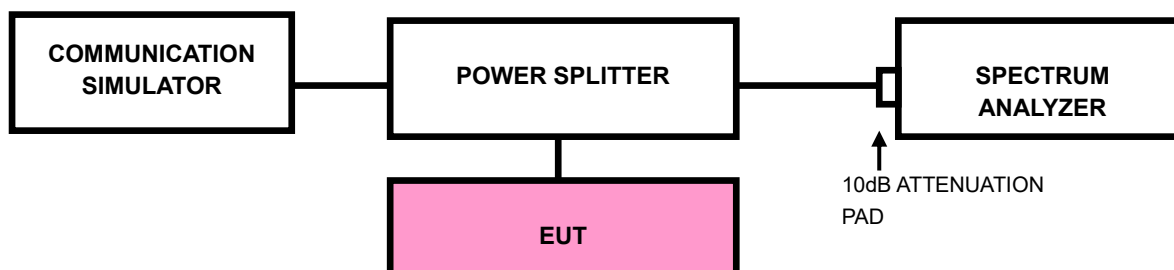



Test Report No.: W7L-P22120012-1RF04

3.4.3 TEST PROCEDURES

- a) All measurements were done at low and high operational frequency range
- b) Connect the transmitter to the spectrum analyzer via coaxial cable while ensuring proper impedance matching.
- c) Tune the analyzer to the nominal center frequency of the emission bandwidth
(EBW)
- d) .Set the resolution bandwidth (RBW) $\geq 1\%$ EBW in the 1MHz band immediately outside and adjacent to the band edge.
- e) Beyond the 1MHz band from the band edge, RBW=1MHz was used.
- f) Set the video bandwidth (VBW) to $\geq 3 \times$ RBW.
- g) Select the average power (RMS) display detector.
- h) Set the number of measurement points to ≥ 1001 .
- i) Use auto-coupled sweep time.
- j) Perform the measurement over an interval of time when the transmission is continuous and at its maximum power level.
- k) The RF fundamental frequency should be excluded against the limit line in the operating frequency band and use RBW is 10KHz or 100KHz.
- l) Record the max trace plot into the test report.



Test Report No.: W7L-P22120012-1RF04

3.4.4 TEST RESULTS

Please Refer to Appendix Of this test report.

3.5 CONDUCTED SPURIOUS EMISSIONS

3.5.1 LIMITS OF CONDUCTED SPURIOUS EMISSIONS MEASUREMENT

The power of any emission outside of the authorized operating frequency ranges must be attenuated below the transmitting power (P) by a factor of at least $43 + 10 \log(P)$ dB. The emission limit equal to -13dBm .

For: LTE Band7

The power of any emission outside a licensee's frequency block shall be attenuated below the transmitter power (P) by at least $55 + 10 \log_{10}(P)$ dB. The limit of emission is equal to -25dBm .

3.5.2 TEST PROCEDURE

- a. The EUT makes a phone call to the communication simulator. All measurements were done at low, middle and high operational frequency range.
- b. Measuring frequency range is from 9kHz up to a frequency including its 10th harmonic. 10dB attenuation pad is connected with spectrum. RBW=1MHz and VBW=3MHz is used for conducted emission measurement.

3.5.3 TEST SETUP

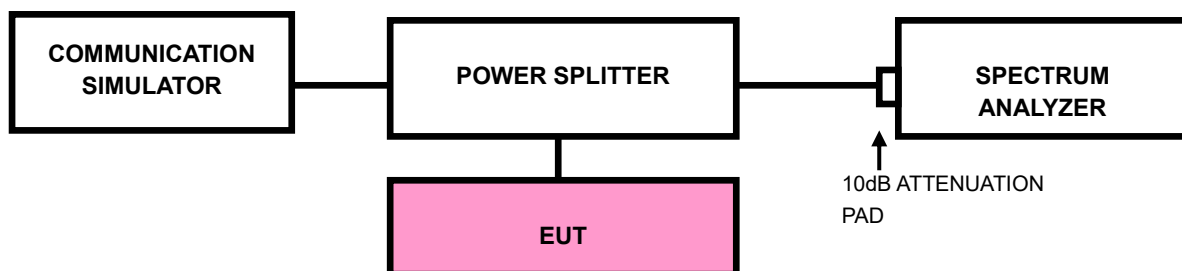

3.5.4 TEST RESULTS

NOTE : The 9K~30MHz amplitude of spurious emissions attenuated more than 20 dB below the permissible value is not required in the report.

Please Refer to Appendix Of this test report.



Test Report No.: W7L-P22120012-1RF04

3.6 RADIATED EMISSION MEASUREMENT

3.6.1 LIMITS OF RADIATED EMISSION MEASUREMENT

The power of any emission outside of the authorized operating frequency ranges must be attenuated below the transmitting power (P) by a factor of at least $43 + 10 \log(P)$ dB. The emission limit equal to -13dBm .

For: LTE Band7/ Band41

The power of any emission outside a licensee's frequency block shall be attenuated below the transmitter power (P) by at least $55 + 10 \log_{10}(P)$ dB. The limit of emission is equal to -25dBm .

3.6.2 TEST PROCEDURES

- a. Substitution method is used for E.I.R.P measurement. In the semi-anechoic chamber, EUT placed on the 0.8m height of Turn Table, rotated the table around 360 degrees to search the maximum radiation power and receiver antenna shall be rotated vertical and horizontal polarization and moved height from 1m to 4m to find the maximum polar radiated power. The "Read Value" is the spectrum reading the maximum power value.
- b. The substitution horn antenna is substituted for EUT at the same position and signals generator export the CW signal to the substitution antenna via a TX cable. Rotated the Turn Table and moved receiving antenna to find the maximum radiation power. Adjust output power level of S.G to get a Value of spectrum reading equal to "Read Value " of step a. Record the power level of S.G.
- c. EIRP = Output power level of S.G – TX cable loss + Antenna gain of substitution horn.
- d. E.R.P power can be calculated form E.I.R.P power by subtracting the gain of dipole, $E.R.P \text{ power} = E.I.P.R \text{ power} - 2.15\text{dBi}$.

NOTE: The resolution bandwidth of spectrum analyzer is 1 MHz and the video bandwidth is 3 MHz.

3.6.3 DEVIATION FROM TEST STANDARD

No deviation

3.6.4 TEST SETUP

< Frequency Range below 30MHz >

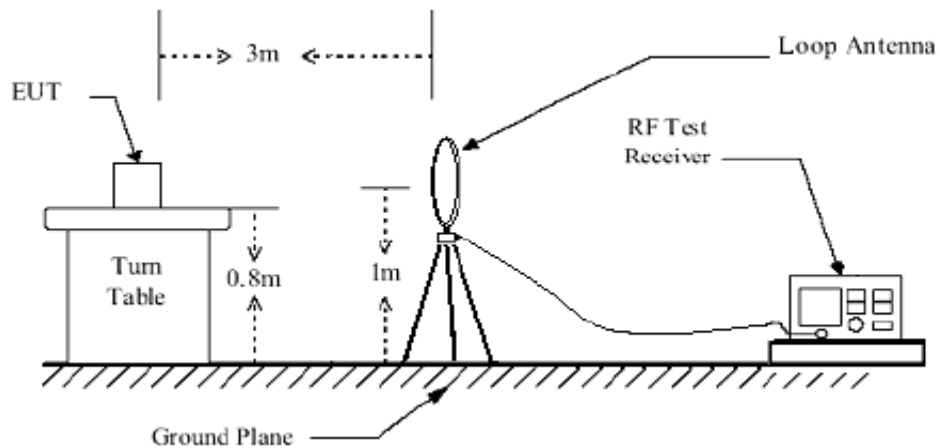

< Frequency Range 30MHz~1GHz >

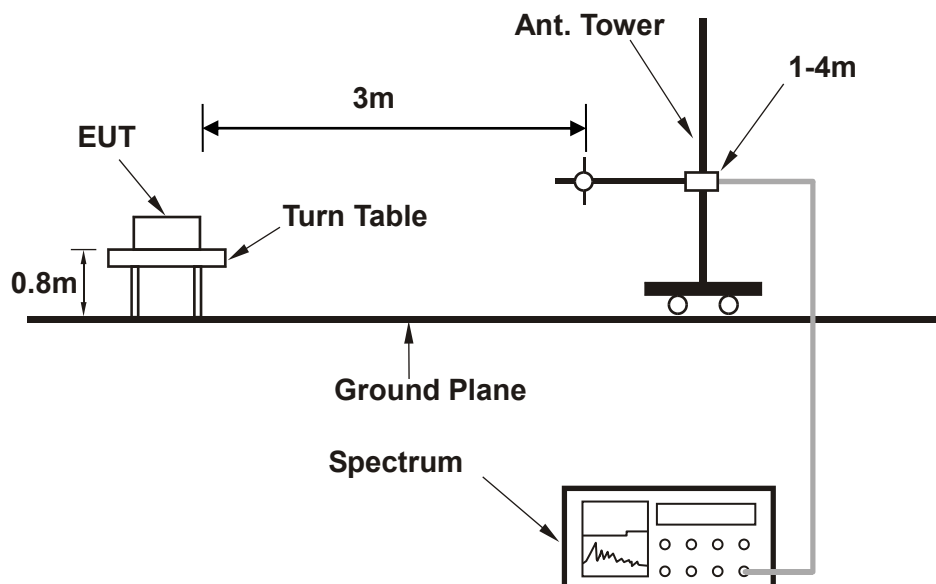

<Frequency Range above 1GHz>

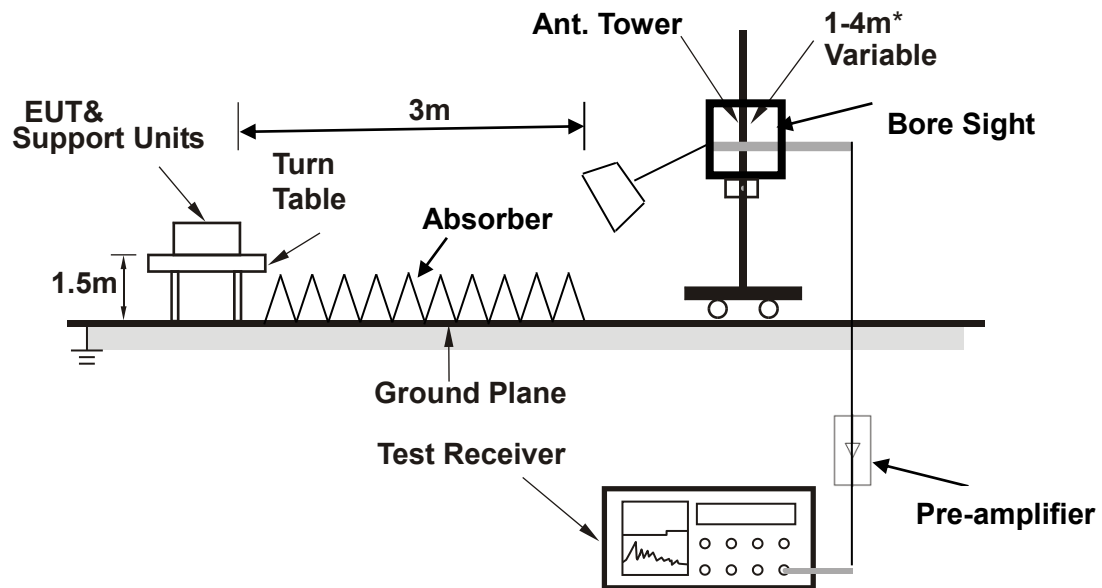

Note: Above 1G is a directional antenna depends on the EUT height and the antenna 3dB beamwidth both, refer to section 7.3 of CISPR 16-2-3.

For the actual test configuration, please refer to the attached file (Test Setup Photo).



3.6.5 TEST RESULTS

NOTE : The 9K~30MHz amplitude of spurious emissions attenuated more than 20 dB below the permissible value is not required in the report.

BELOW 1GHz WORST-CASE DATA

30 MHz – 1GHz data:

LTE Band 7

CHANNEL BANDWIDTH: 15MHz / QPSK

MODE	TX channel 21375	FREQUENCY RANGE	Below 1000MHz
ENVIRONMENTAL CONDITIONS	23deg. C, 70%RH	INPUT POWER	AC 120V/60HZ
TESTED BY	Jace Hu		
ANTENNA POLARITY & TEST DISTANCE: HORIZONTAL AT 3 M			

	Freq	Level	Read Level	Limit Line	Over Limit	Factor	Remark	Pol/Phase
	MHz	dBm/m	dBm	dBm/m	dB	dB/m		
1	61.040	-68.14	-49.12	-25.00	-43.14	-19.02	Peak	Horizontal
2	108.570	-59.40	-38.12	-25.00	-34.40	-21.28	Peak	Horizontal
3	162.890	-65.04	-49.03	-25.00	-40.04	-16.01	Peak	Horizontal
4 PP	281.230	-58.11	-46.03	-25.00	-33.11	-12.08	Peak	Horizontal
5	342.340	-63.43	-52.00	-25.00	-38.43	-11.43	Peak	Horizontal
6	484.930	-68.31	-59.80	-25.00	-43.31	-8.51	Peak	Horizontal

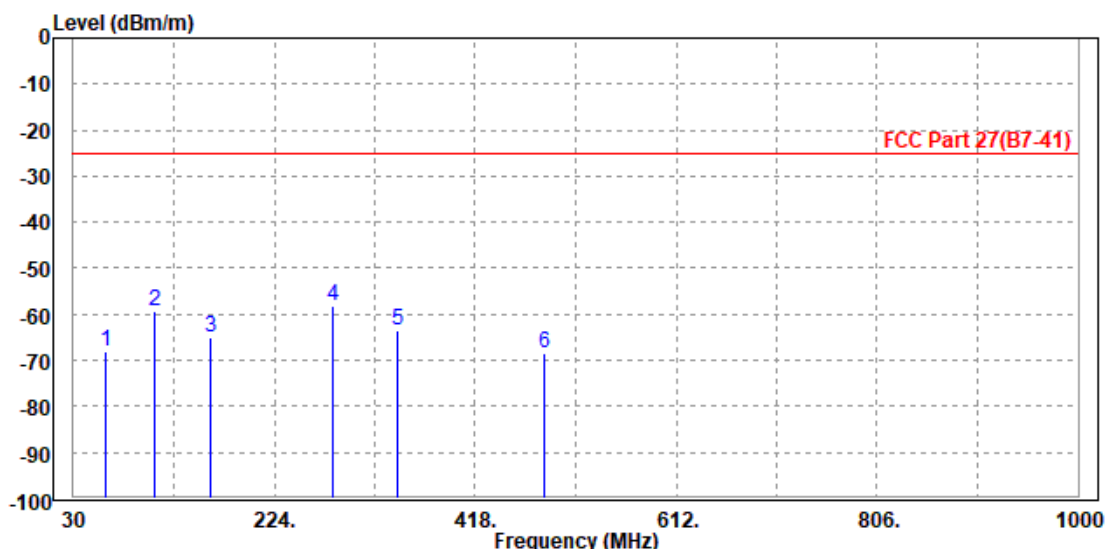



Test Report No.: W7L-P22120012-1RF04

MODE	TX channel 21375	FREQUENCY RANGE	Below 1000MHz
ENVIRONMENTAL CONDITIONS	23deg. C, 70%RH	INPUT POWER	AC 120V/60HZ
TESTED BY	Jace Hu		
ANTENNA POLARITY & TEST DISTANCE: VERTICAL AT 3 M			

	Freq	Level	Read Level	Limit Line	Over Limit	Factor	Remark	Pol/Phase
	MHz	dBm/m	dBm	dBm/m	dB	dB/m		
1	91.110	-49.00	-34.28	-25.00	-24.00	-14.72	Peak	Vertical
2	134.760	-58.51	-44.89	-25.00	-33.51	-13.62	Peak	Vertical
3	217.210	-64.71	-48.21	-25.00	-39.71	-16.50	Peak	Vertical
4	287.050	-64.68	-53.14	-25.00	-39.68	-11.54	Peak	Vertical
5	406.360	-70.39	-61.45	-25.00	-45.39	-8.94	Peak	Vertical
6	627.520	-66.98	-61.07	-25.00	-41.98	-5.91	Peak	Vertical

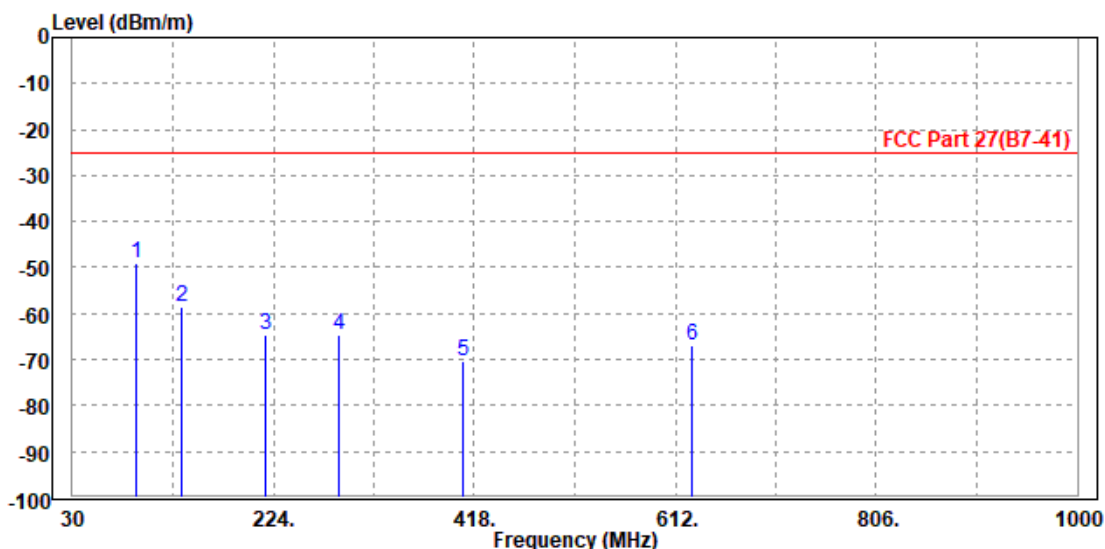



BUREAU VERITAS

Test Report No.: W7L-P22120012-1RF04

ABOVE 1GHz

Note: For higher frequency, the emission is too low to be detected.

WCDMA Band IV:

CH 1312

MODE	TX channel 1312	FREQUENCY RANGE	Above 1000MHz
ENVIRONMENTAL CONDITIONS	23deg. C, 70%RH	INPUT POWER	AC 120V/60HZ
TESTED BY	Jace Hu		
ANTENNA POLARITY & TEST DISTANCE: HORIZONTAL AT 3 M			

	Freq	Level	Read Level	Limit	Over Limit	Factor	Remark	Pol/Phase
	MHz	dBm/m	dBm	dBm/m	dB	dB/m		
1	3424.800	-51.95	-59.17	-13.00	-38.95	7.22	Peak	Horizontal
2 PP	5131.000	-50.40	-60.29	-13.00	-37.40	9.89	Peak	Horizontal

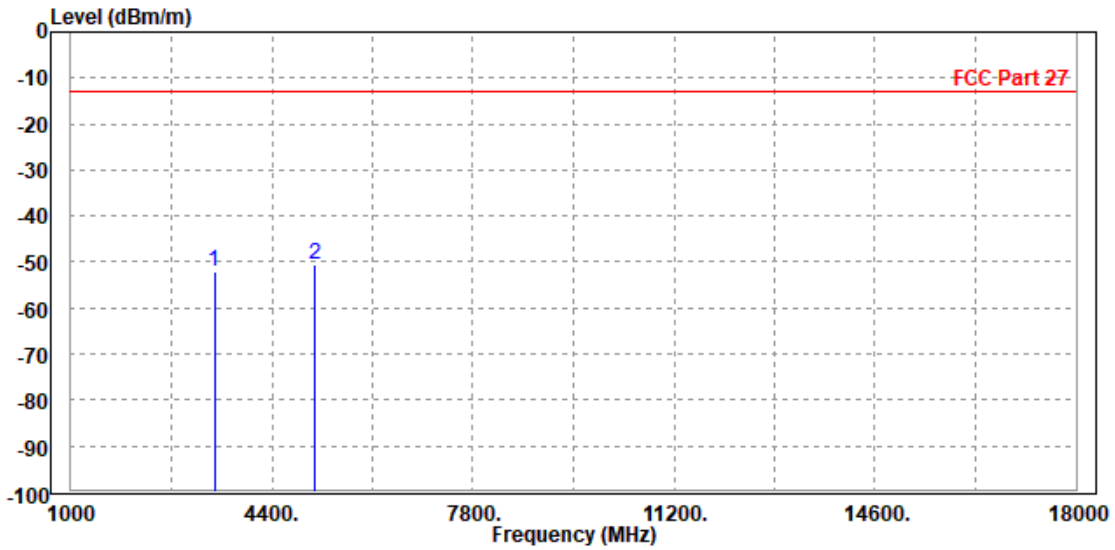



Test Report No.: W7L-P22120012-1RF04

MODE	TX channel 1312	FREQUENCY RANGE	Above 1000MHz
ENVIRONMENTAL CONDITIONS	23deg. C, 70%RH	INPUT POWER	AC 120V/60HZ
TESTED BY	Jace Hu		
ANTENNA POLARITY & TEST DISTANCE: VERTICAL AT 3 M			

	Freq	Level	Read Level	Limit Line	Over Limit	Factor	Remark	Pol/Phase
	MHz	dBm/m	dBm	dBm/m	dB	dB/m		
1	3431.000	-51.76	-58.97	-13.00	-38.76	7.21	Peak	Vertical
2 PP	5137.200	-50.76	-61.15	-13.00	-37.76	10.39	Peak	Vertical

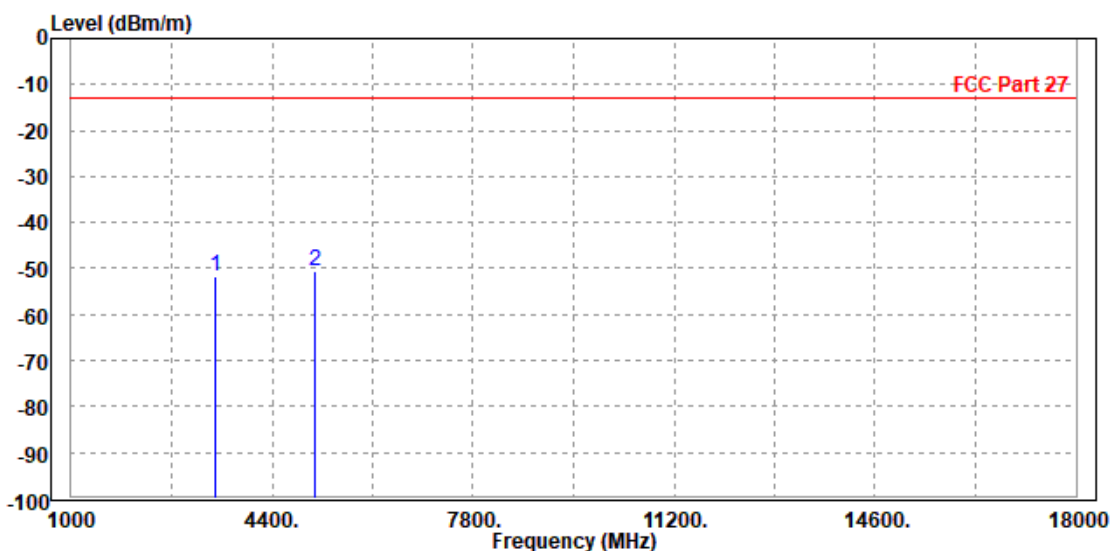



Test Report No.: W7L-P22120012-1RF04

CH 1413

MODE	TX channel 1413	FREQUENCY RANGE	Above 1000MHz
ENVIRONMENTAL CONDITIONS	23deg. C, 70%RH	INPUT POWER	AC 120V/60HZ
TESTED BY	Jace Hu		
ANTENNA POLARITY & TEST DISTANCE: HORIZONTAL AT 3 M			

	Freq	Level	Read Level	Limit Line	Over Limit	Factor	Remark	Pol/Phase
	MHz	dBm/m	dBm	dBm/m	dB	dB/m		
1	3465.200	-51.67	-58.94	-13.00	-38.67	7.27	Peak	Horizontal
2 PP	5199.000	-50.56	-60.56	-13.00	-37.56	10.00	Peak	Horizontal

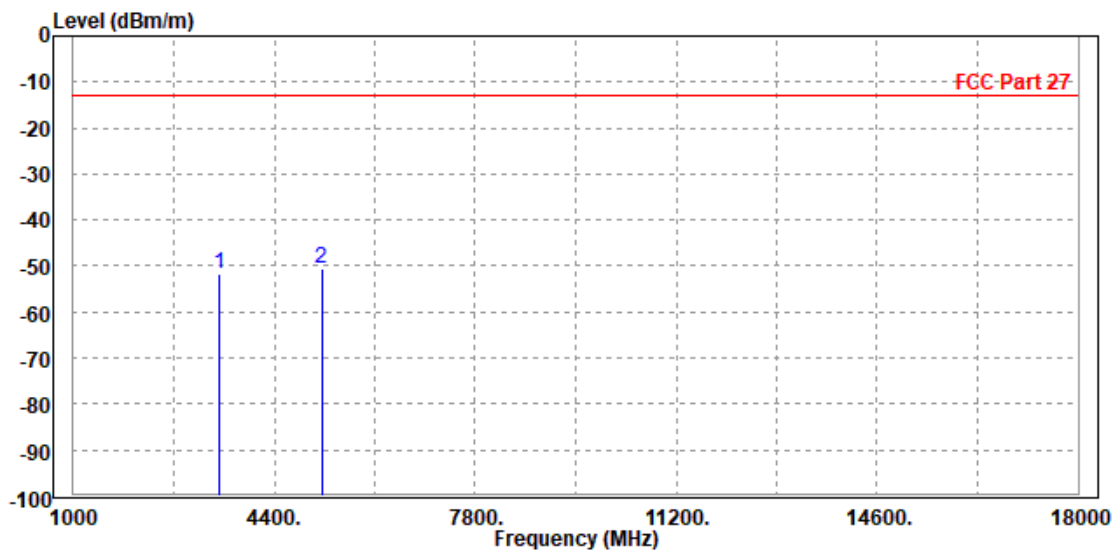



Test Report No.: W7L-P22120012-1RF04

MODE	TX channel 1413	FREQUENCY RANGE	Above 1000MHz
ENVIRONMENTAL CONDITIONS	23deg. C, 70%RH	INPUT POWER	AC 120V/60HZ
TESTED BY	Jace Hu		
ANTENNA POLARITY & TEST DISTANCE: VERTICAL AT 3 M			

	Freq	Level	Read Level	Limit Line	Over Limit	Factor	Remark	Pol/Phase
	MHz	dBm/m	dBm	dBm/m	dB	dB/m		
1	3465.000	-51.08	-58.34	-13.00	-38.08	7.26	Peak	Vertical
2 PP	5197.800	-50.07	-60.52	-13.00	-37.07	10.45	Peak	Vertical

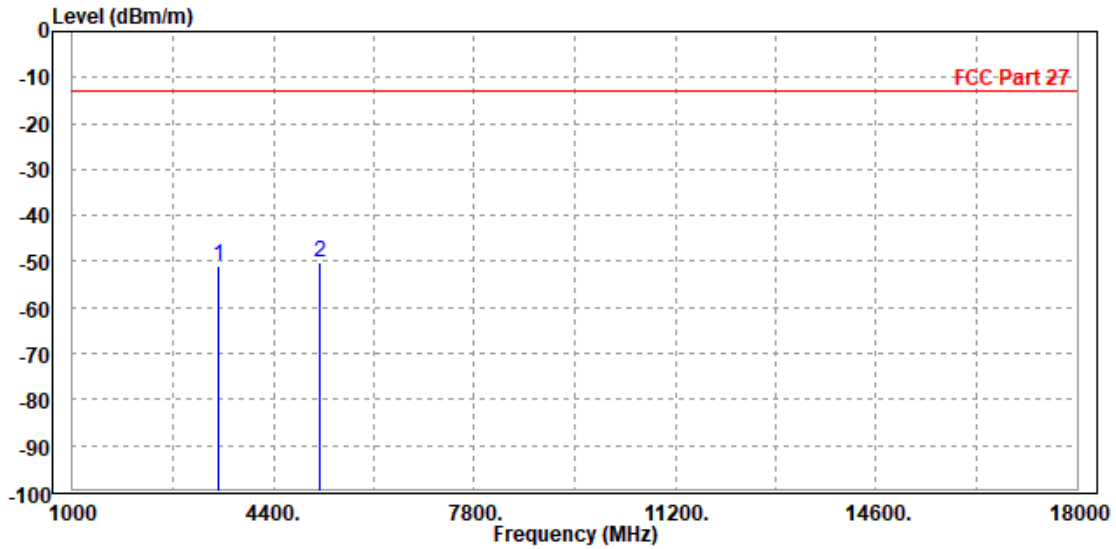



Test Report No.: W7L-P22120012-1RF04

CH 1513

MODE	TX channel 1513	FREQUENCY RANGE	Above 1000MHz
ENVIRONMENTAL CONDITIONS	23deg. C, 70%RH	INPUT POWER	AC 120V/60HZ
TESTED BY	Jace Hu		
ANTENNA POLARITY & TEST DISTANCE: HORIZONTAL AT 3 M			

	Freq	Level	Read Level	Limit Line	Over Limit	Factor	Remark	Pol/Phase
	MHz	dBm/m	dBm	dBm/m	dB	dB/m		
1	3499.000	-51.03	-58.35	-13.00	-38.03	7.32	Peak	Horizontal
2 PP	5257.800	-50.37	-60.46	-13.00	-37.37	10.09	Peak	Horizontal

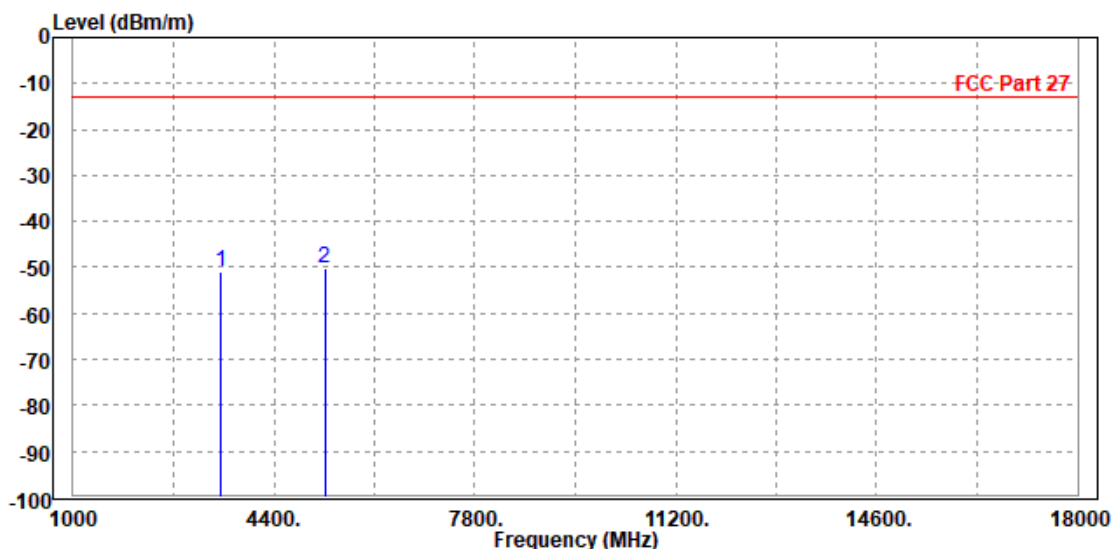



**BUREAU
VERITAS**

Test Report No.: W7L-P22120012-1RF04

MODE	TX channel 1513	FREQUENCY RANGE	Above 1000MHz
ENVIRONMENTAL CONDITIONS	23deg. C, 70%RH	INPUT POWER	AC 120V/60HZ
TESTED BY	Jace Hu		
ANTENNA POLARITY & TEST DISTANCE: VERTICAL AT 3 M			

	Freq	Level	Read Level	Limit Line	Over Limit	Factor	Remark	Pol/Phase
	MHz	dBm/m	dBm	dBm/m	dB	dB/m		
1	3505.200	-51.54	-58.87	-13.00	-38.54	7.33	Peak	Vertical
2 PP	5250.000	-49.93	-60.43	-13.00	-36.93	10.50	Peak	Vertical

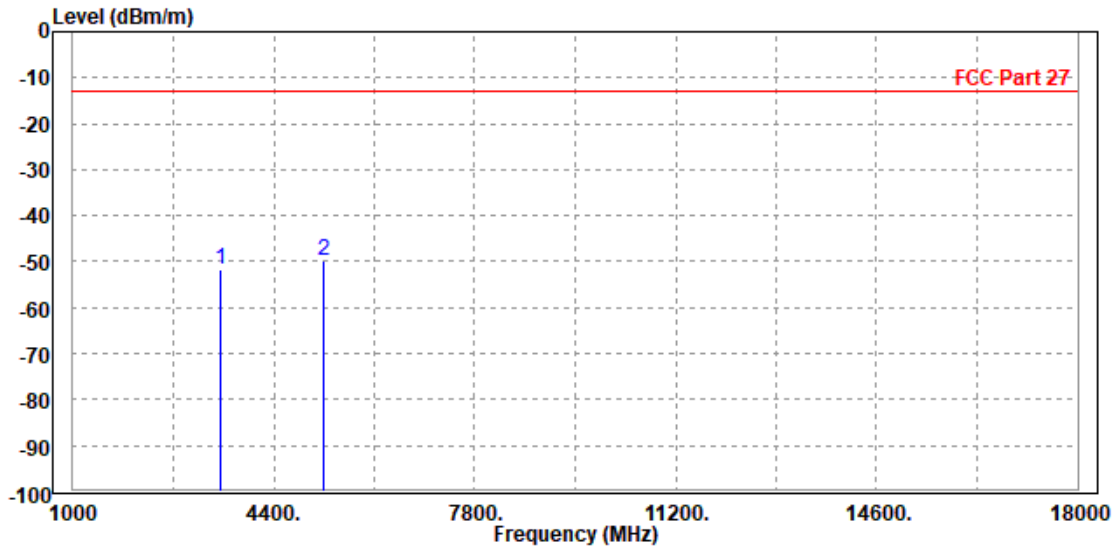



Test Report No.: W7L-P22120012-1RF04

LTE Band 7
CHANNEL BANDWIDTH: 5MHz / QPSK

MODE	TX channel 21100	FREQUENCY RANGE	Above 1000MHz
ENVIRONMENTAL CONDITIONS	23deg. C, 70%RH	INPUT POWER	AC 120V/60HZ
TESTED BY	Jace Hu		
ANTENNA POLARITY & TEST DISTANCE: HORIZONTAL AT 3 M			

	Freq	Level	Read Level	Limit Line	Over Limit	Factor	Remark	Pol/Phase
	MHz	dBm/m	dBm	dBm/m	dB	dB/m		
1	PP 5070.000	-50.17	-59.97	-25.00	-25.17	9.80	Peak	Horizontal
2	7604.000	-52.64	-64.81	-25.00	-27.64	12.17	Peak	Horizontal

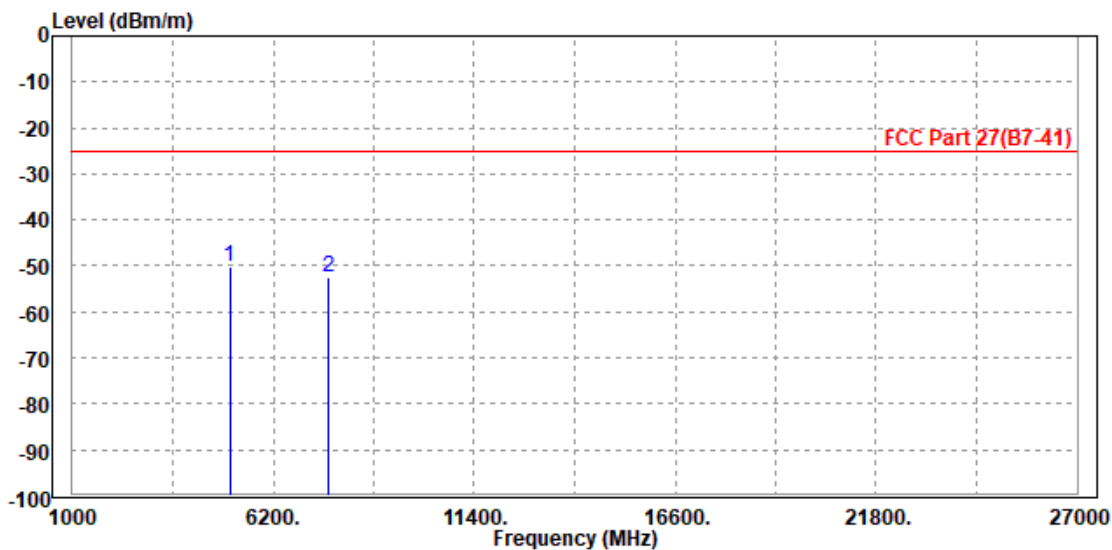



Test Report No.: W7L-P22120012-1RF04

MODE	TX channel 21100	FREQUENCY RANGE	Above 1000MHz
ENVIRONMENTAL CONDITIONS	23deg. C, 70%RH	INPUT POWER	AC 120V/60HZ
TESTED BY	Jace Hu		
ANTENNA POLARITY & TEST DISTANCE: VERTICAL AT 3 M			

	Freq	Level	Read Level	Limit Line	Over Limit	Factor	Remark	Pol/Phase
	MHz	dBm/m	dBm	dBm/m	dB	dB/m		
1	PP 5082.000	-49.76	-60.10	-25.00	-24.76	10.34	Peak	Vertical
2	7605.000	-49.81	-64.66	-25.00	-24.81	14.85	Peak	Vertical

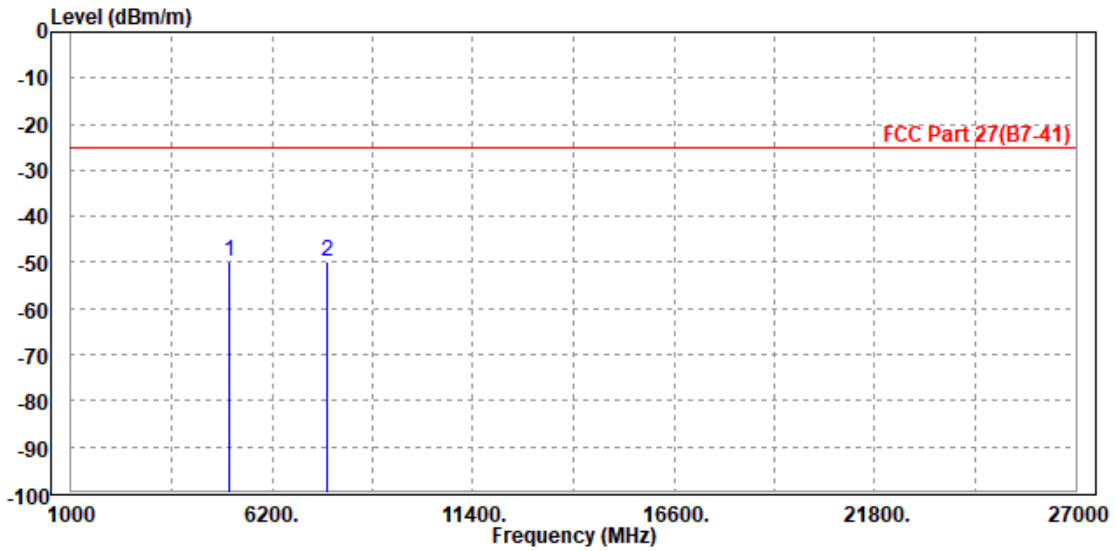



Test Report No.: W7L-P22120012-1RF04

CHANNEL BANDWIDTH: 10MHz / QPSK

MODE	TX channel 21100	FREQUENCY RANGE	Above 1000MHz
ENVIRONMENTAL CONDITIONS	23deg. C, 70%RH	INPUT POWER	AC 120V/60HZ
TESTED BY	Jace Hu		
ANTENNA POLARITY & TEST DISTANCE: HORIZONTAL AT 3 M			

	Freq	Level	Read Level	Limit Line	Over Limit	Factor	Remark	Pol/Phase
	MHz	dBm/m	dBm	dBm/m	dB	dB/m		
1	PP 5070.000	-51.17	-60.97	-25.00	-26.17	9.80	Peak	Horizontal
2	7604.000	-52.10	-64.27	-25.00	-27.10	12.17	Peak	Horizontal

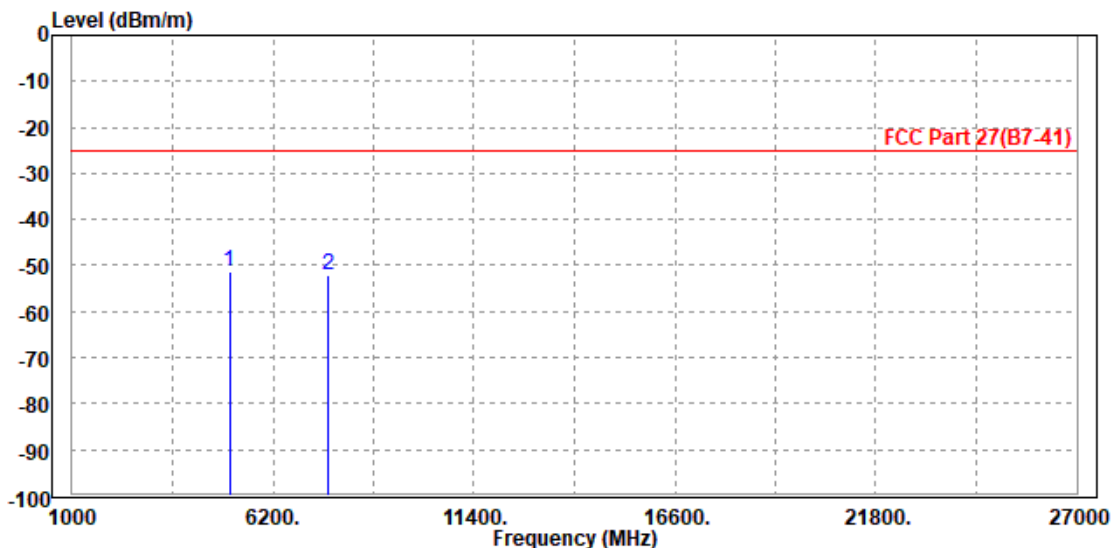



Test Report No.: W7L-P22120012-1RF04

MODE	TX channel 21100	FREQUENCY RANGE	Above 1000MHz
ENVIRONMENTAL CONDITIONS	23deg. C, 70%RH	INPUT POWER	AC 120V/60HZ
TESTED BY	Jace Hu		
ANTENNA POLARITY & TEST DISTANCE: VERTICAL AT 3 M			

	Freq	Level	Read Level	Limit Line	Over Limit	Factor	Remark	Pol/Phase
	MHz	dBm/m	dBm	dBm/m	dB	dB/m		
1	5082.000	-51.17	-61.51	-25.00	-26.17	10.34	Peak	Vertical
2 PP	7605.000	-49.01	-63.86	-25.00	-24.01	14.85	Peak	Vertical

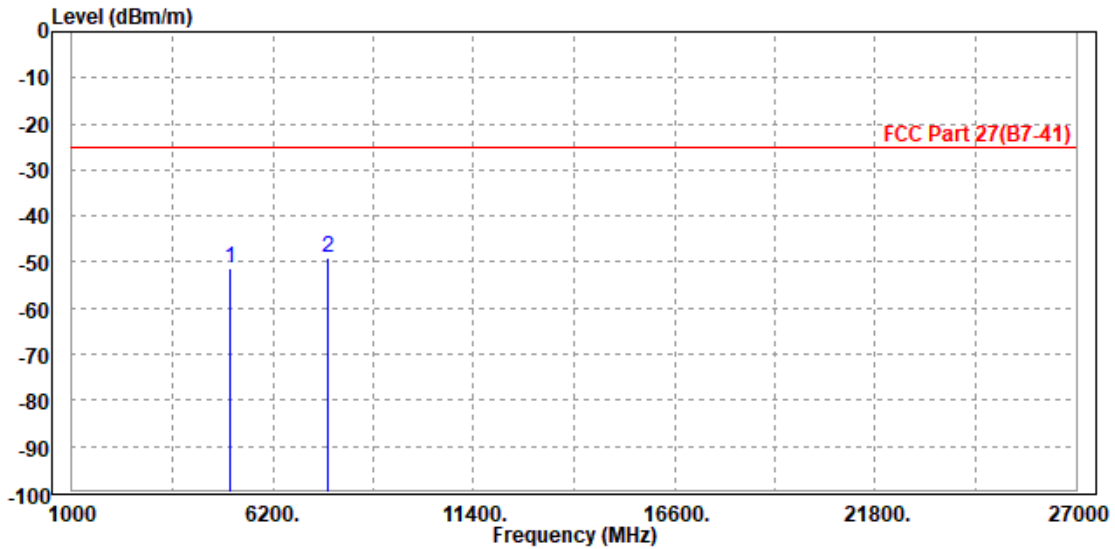



BUREAU VERITAS

Test Report No.: W7L-P22120012-1RF04

CHANNEL BANDWIDTH: 15MHz / QPSK

CH 20825

MODE	TX channel 20825	FREQUENCY RANGE	Above 1000MHz
ENVIRONMENTAL CONDITIONS	23deg. C, 70%RH	INPUT POWER	AC 120V/60HZ
TESTED BY	Jace Hu		
ANTENNA POLARITY & TEST DISTANCE: HORIZONTAL AT 3 M			

	Freq	Level	Read Level	Limit Line	Over Limit	Factor	Remark	Pol/Phase
	MHz	dBm/m	dBm	dBm/m	dB	dB/m		
1	PP 5004.000	-50.54	-60.24	-25.00	-25.54	9.70	Peak	Horizontal
2	7522.500	-52.35	-63.93	-25.00	-27.35	11.58	Peak	Horizontal

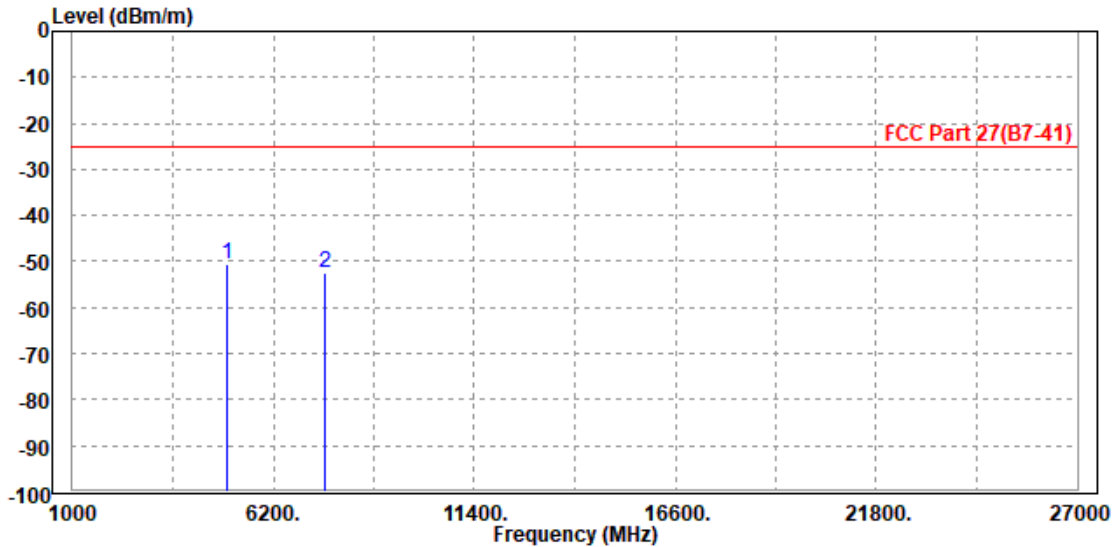



Test Report No.: W7L-P22120012-1RF04

MODE	TX channel 20825	FREQUENCY RANGE	Above 1000MHz
ENVIRONMENTAL CONDITIONS	23deg. C, 70%RH	INPUT POWER	AC 120V/60HZ
TESTED BY	Jace Hu		
ANTENNA POLARITY & TEST DISTANCE: VERTICAL AT 3 M			

	Freq	Level	Read Level	Limit	Over Limit	Factor	Remark	Pol/Phase
	MHz	dBm/m	dBm	dBm/m	dB	dB/m		
1	5004.000	-50.57	-60.84	-25.00	-25.57	10.27	Peak	Vertical
2 PP	7526.000	-49.76	-64.50	-25.00	-24.76	14.74	Peak	Vertical

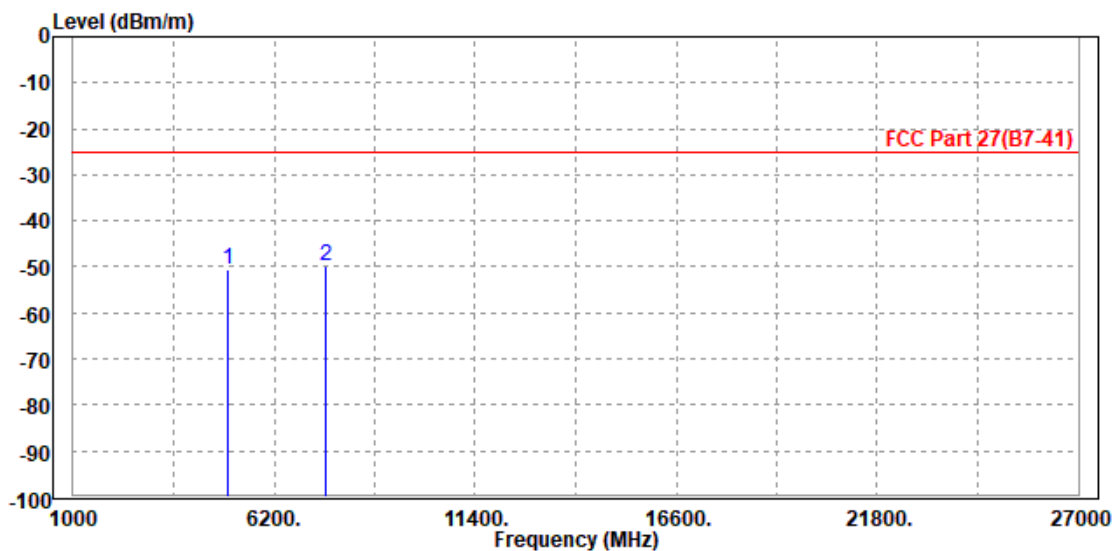



Test Report No.: W7L-P22120012-1RF04

CH 21100

MODE	TX channel 21100	FREQUENCY RANGE	Above 1000MHz
ENVIRONMENTAL CONDITIONS	23deg. C, 70%RH	INPUT POWER	AC 120V/60HZ
TESTED BY	Jace Hu		
ANTENNA POLARITY & TEST DISTANCE: HORIZONTAL AT 3 M			

	Freq	Level	Read Level	Limit Line	Over Limit	Factor	Remark	Pol/Phase
	MHz	dBm/m	dBm	dBm/m	dB	dB/m		
1	PP 5082.000	-50.95	-60.77	-25.00	-25.95	9.82	Peak	Horizontal
2	7605.000	-52.31	-64.49	-25.00	-27.31	12.18	Peak	Horizontal

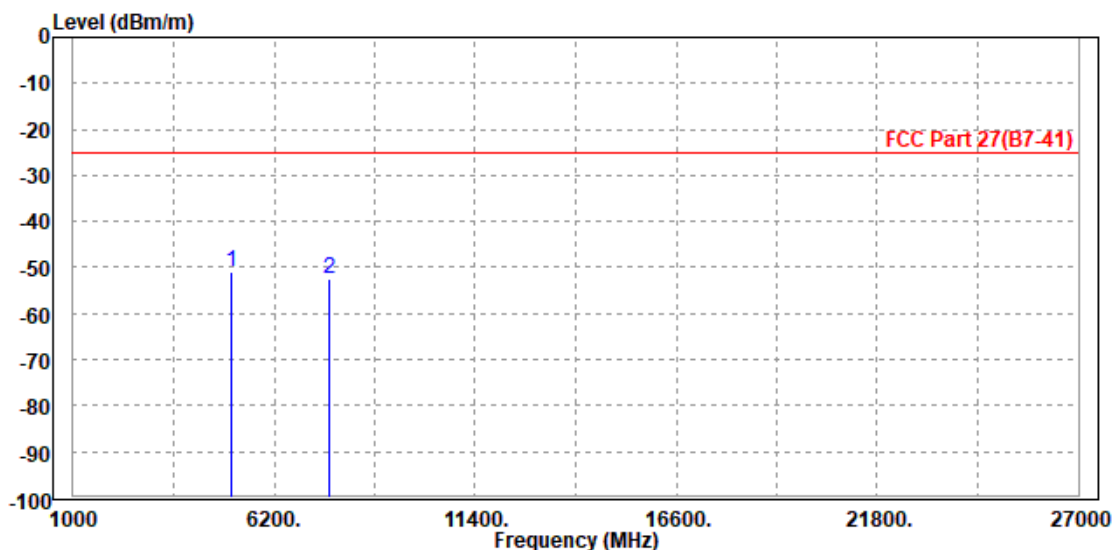



Test Report No.: W7L-P22120012-1RF04

MODE	TX channel 21100	FREQUENCY RANGE	Above 1000MHz
ENVIRONMENTAL CONDITIONS	23deg. C, 70%RH	INPUT POWER	AC 120V/60HZ
TESTED BY	Jace Hu		
ANTENNA POLARITY & TEST DISTANCE: VERTICAL AT 3 M			

	Freq	Level	Read Level	Limit Line	Over Limit	Factor	Remark	Pol/Phase
	MHz	dBm/m	dBm	dBm/m	dB	dB/m		
1	5070.000	-49.31	-59.64	-25.00	-24.31	10.33	Peak	Vertical
2	PP 7604.000	-48.68	-63.53	-25.00	-23.68	14.85	Peak	Vertical

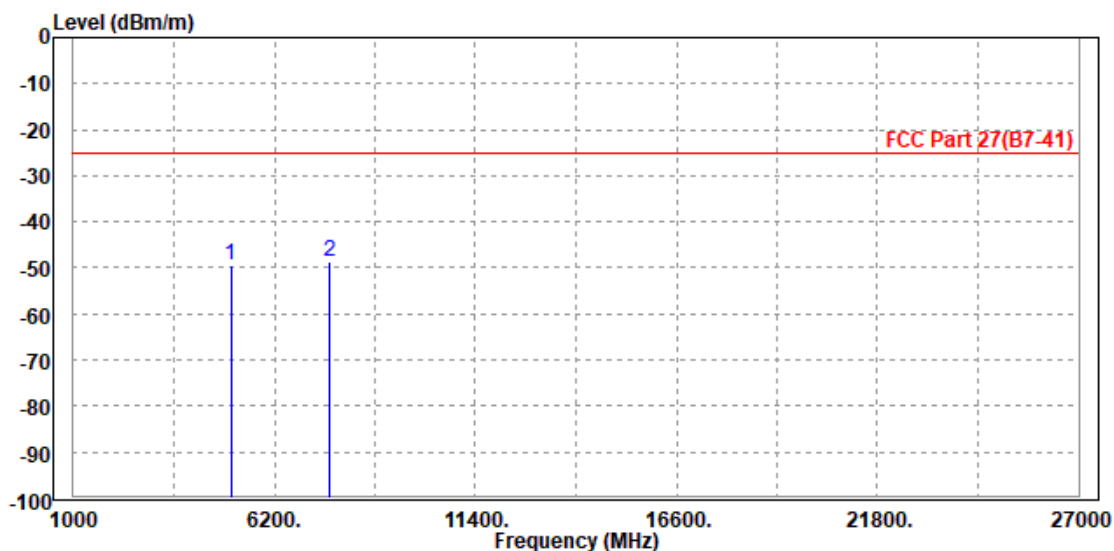



**BUREAU
VERITAS**

Test Report No.: W7L-P22120012-1RF04

CH 21375

MODE	TX channel 21375	FREQUENCY RANGE	Above 1000MHz
ENVIRONMENTAL CONDITIONS	23deg. C, 70%RH	INPUT POWER	AC 120V/60HZ
TESTED BY	Jace Hu		
ANTENNA POLARITY & TEST DISTANCE: HORIZONTAL AT 3 M			

	Freq	Level	Read Level	Limit Line	Over Limit	Factor	Remark	Pol/Phase
	MHz	dBm/m	dBm	dBm/m	dB	dB/m		
1	5125.000	-49.33	-59.22	-25.00	-24.33	9.89	Peak	Horizontal
2 PP	7687.500	-48.02	-60.80	-25.00	-23.02	12.78	Peak	Horizontal

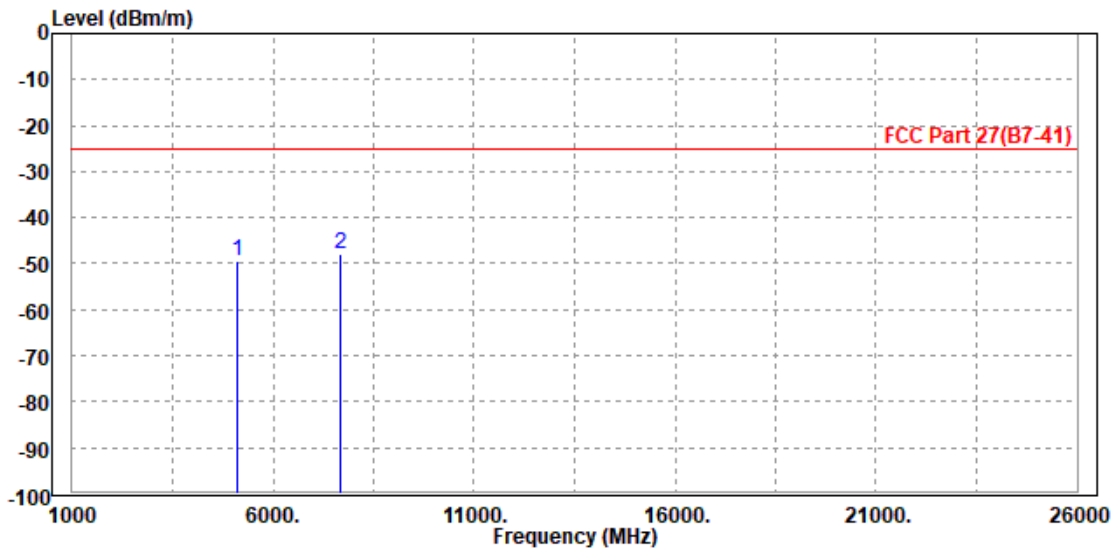



Test Report No.: W7L-P22120012-1RF04

MODE	TX channel 21375	FREQUENCY RANGE	Above 1000MHz
ENVIRONMENTAL CONDITIONS	23deg. C, 70%RH	INPUT POWER	AC 120V/60HZ
TESTED BY	Jace Hu		
ANTENNA POLARITY & TEST DISTANCE: VERTICAL AT 3 M			

	Freq	Level	Read Level	Limit	Over Limit	Factor	Remark	Pol/Phase
	MHz	dBm/m	dBm	dBm/m	dB	dB/m		
1	5125.000	-49.15	-59.53	-25.00	-24.15	10.38	Peak	Vertical
2 PP	7700.000	-45.15	-60.14	-25.00	-20.15	14.99	Peak	Vertical

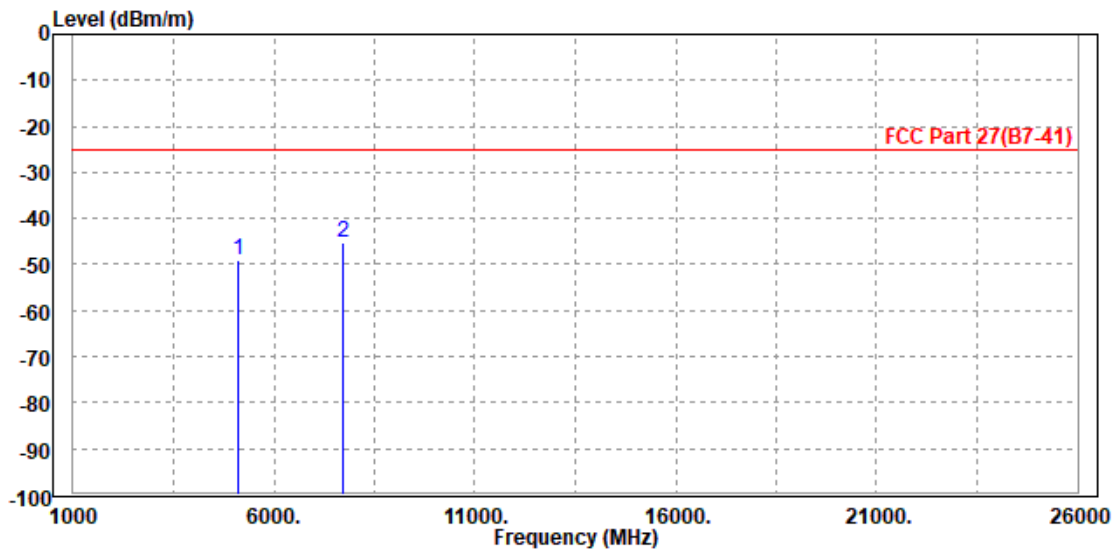



BUREAU VERITAS

Test Report No.: W7L-P22120012-1RF04

CHANNEL BANDWIDTH: 20MHz / QPSK

MODE	TX channel 21100	FREQUENCY RANGE	Above 1000MHz
ENVIRONMENTAL CONDITIONS	23deg. C, 70%RH	INPUT POWER	AC 120V/60HZ
TESTED BY	Jace Hu		
ANTENNA POLARITY & TEST DISTANCE: HORIZONTAL AT 3 M			

	Freq	Level	Read Level	Limit Line	Over Limit	Factor	Remark	Pol/Phase
	MHz	dBm/m	dBm	dBm/m	dB	dB/m		
1	PP 5070.000	-50.90	-60.70	-25.00	-25.90	9.80	Peak	Horizontal
2	7604.000	-51.99	-64.16	-25.00	-26.99	12.17	Peak	Horizontal

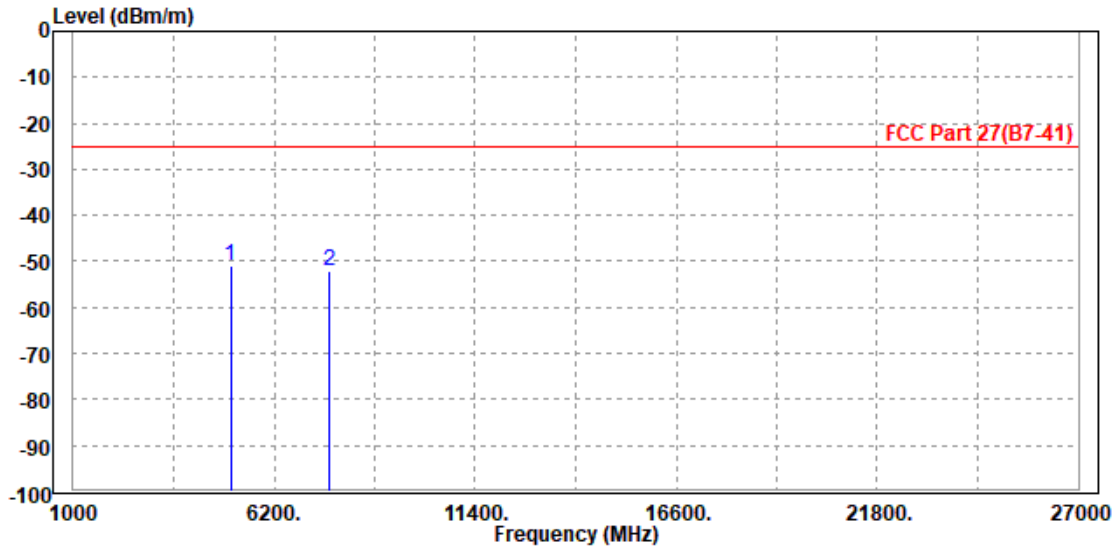



Test Report No.: W7L-P22120012-1RF04

MODE	TX channel 21100	FREQUENCY RANGE	Above 1000MHz
ENVIRONMENTAL CONDITIONS	23deg. C, 70%RH	INPUT POWER	AC 120V/60HZ
TESTED BY	Jace Hu		
ANTENNA POLARITY & TEST DISTANCE: VERTICAL AT 3 M			

	Freq	Read Level	Limit Level	Over Line	Over Limit	Factor	Remark	Pol/Phase
	MHz	dBm/m	dBm	dBm/m	dB	dB/m		
1	5082.000	-50.77	-61.11	-25.00	-25.77	10.34	Peak	Vertical
2	PP 7605.000	-49.50	-64.35	-25.00	-24.50	14.85	Peak	Vertical

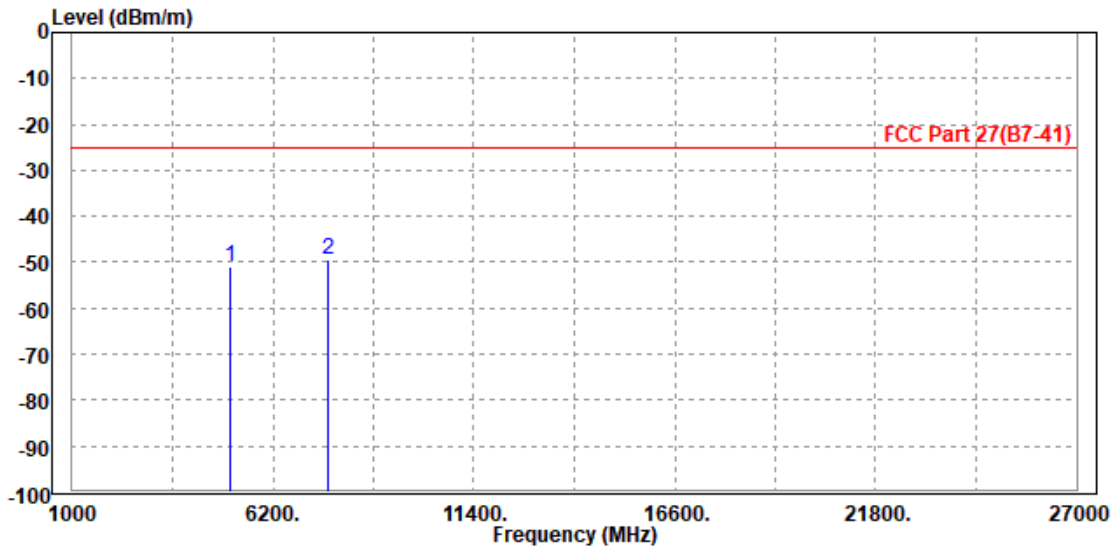



Test Report No.: W7L-P22120012-1RF04

LTE BAND 66

CHANNEL BANDWIDTH: 1.4MHz / QPSK

MODE	TX channel 132322	FREQUENCY RANGE	Above 1000MHz
ENVIRONMENTAL CONDITIONS	23deg. C, 70%RH	INPUT POWER	AC 120V/60HZ
TESTED BY	Jace Hu		
ANTENNA POLARITY & TEST DISTANCE: HORIZONTAL AT 3 M			

	Freq	Level	Read Level	Limit Line	Over Limit	Factor	Remark	Pol/Phase
	MHz	dBm/m	dBm	dBm/m	dB	dB/m		
1	3510.000	-51.94	-59.29	-13.00	-38.94	7.35	Peak	Horizontal
2 PP	5267.000	-51.13	-61.24	-13.00	-38.13	10.11	Peak	Horizontal

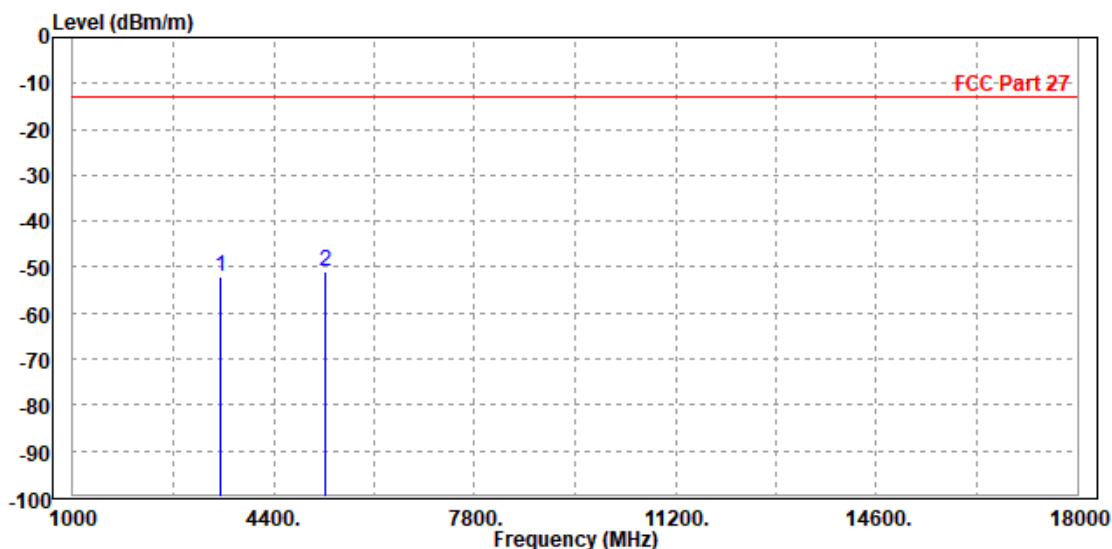



Test Report No.: W7L-P22120012-1RF04

MODE	TX channel 132322	FREQUENCY RANGE	Above 1000MHz
ENVIRONMENTAL CONDITIONS	23deg. C, 70%RH	INPUT POWER	AC 120V/60HZ
TESTED BY	Jace Hu		
ANTENNA POLARITY & TEST DISTANCE: VERTICAL AT 3 M			

	Freq	Level	Read Level	Limit Line	Over Limit	Factor	Remark	Pol/Phase
	MHz	dBm/m	dBm	dBm/m	dB	dB/m		
1	3516.000	-52.39	-59.73	-13.00	-39.39	7.34	Peak	Vertical
2	PP 5265.000	-51.11	-61.62	-13.00	-38.11	10.51	Peak	Vertical

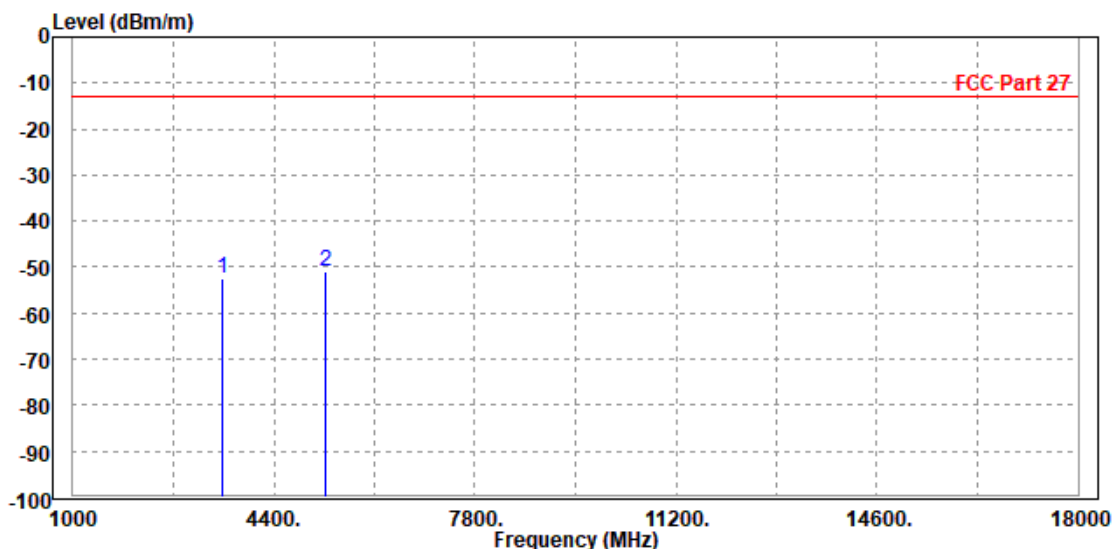



Test Report No.: W7L-P22120012-1RF04

CHANNEL BANDWIDTH: 3MHz / QPSK

MODE	TX channel 132322	FREQUENCY RANGE	Above 1000MHz
ENVIRONMENTAL CONDITIONS	23deg. C, 70%RH	INPUT POWER	AC 120V/60HZ
TESTED BY	Jace Hu		
ANTENNA POLARITY & TEST DISTANCE: HORIZONTAL AT 3 M			

	Freq	Level	Read Level	Limit Line	Over Limit	Factor	Remark	Pol/Phase
	MHz	dBm/m	dBm	dBm/m	dB	dB/m		
1	3516.000	-52.19	-59.55	-13.00	-39.19	7.36	Peak	Horizontal
2	PP 5265.000	-51.11	-61.22	-13.00	-38.11	10.11	Peak	Horizontal

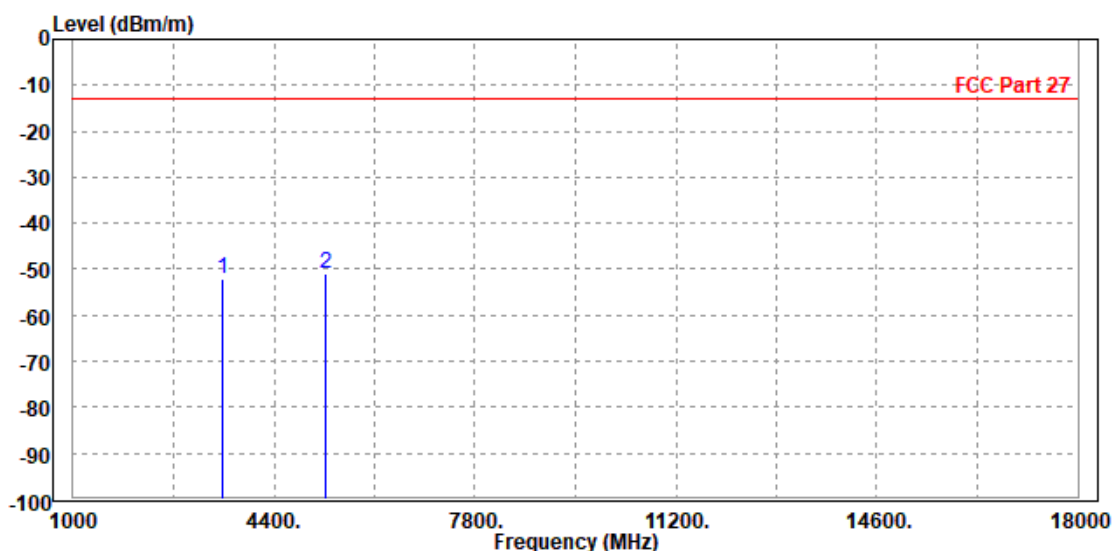



Test Report No.: W7L-P22120012-1RF04

MODE	TX channel 132322	FREQUENCY RANGE	Above 1000MHz
ENVIRONMENTAL CONDITIONS	23deg. C, 70%RH	INPUT POWER	AC 120V/60HZ
TESTED BY	Jace Hu		
ANTENNA POLARITY & TEST DISTANCE: VERTICAL AT 3 M			

	Freq	Level	Read Level	Limit Line	Over Limit	Factor	Remark	Pol/Phase
	MHz	dBm/m	dBm	dBm/m	dB	dB/m		
1	3510.000	-51.31	-58.64	-13.00	-38.31	7.33	Peak	Vertical
2 PP	5267.000	-50.64	-61.15	-13.00	-37.64	10.51	Peak	Vertical

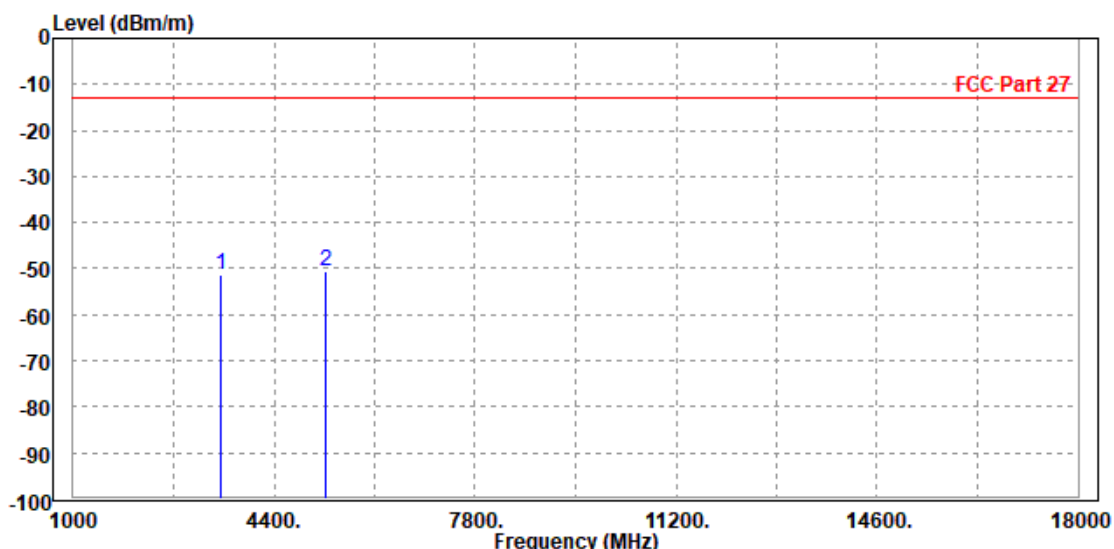



Test Report No.: W7L-P22120012-1RF04

CHANNEL BANDWIDTH: 5MHz / QPSK

MODE	TX channel 132322	FREQUENCY RANGE	Above 1000MHz
ENVIRONMENTAL CONDITIONS	23deg. C, 70%RH	INPUT POWER	AC 120V/60HZ
TESTED BY	Jace Hu		
ANTENNA POLARITY & TEST DISTANCE: HORIZONTAL AT 3 M			

	Freq	Level	Read Level	Limit Line	Over Limit	Factor	Remark	Pol/Phase
	MHz	dBm/m	dBm	dBm/m	dB	dB/m		
1	3510.000	-51.16	-58.51	-13.00	-38.16	7.35	Peak	Horizontal
2 PP	5267.000	-50.39	-60.50	-13.00	-37.39	10.11	Peak	Horizontal

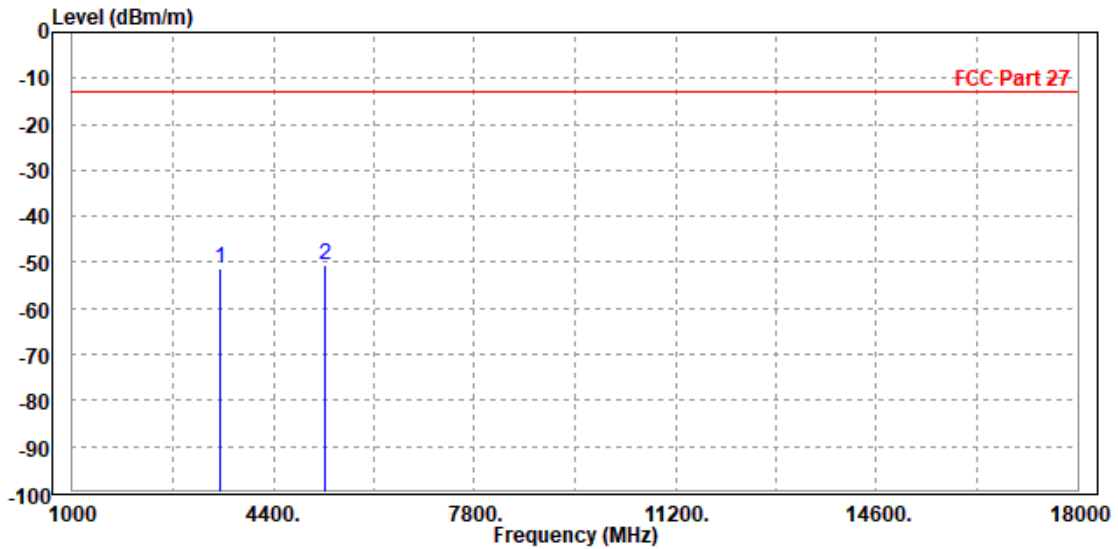



Test Report No.: W7L-P22120012-1RF04

MODE	TX channel 132322	FREQUENCY RANGE	Above 1000MHz
ENVIRONMENTAL CONDITIONS	23deg. C, 70%RH	INPUT POWER	AC 120V/60HZ
TESTED BY	Jace Hu		
ANTENNA POLARITY & TEST DISTANCE: VERTICAL AT 3 M			

	Freq	Level	Read Level	Limit Line	Over Limit	Factor	Remark	Pol/Phase
	MHz	dBm/m	dBm	dBm/m	dB	dB/m		
1	3516.000	-52.54	-59.88	-13.00	-39.54	7.34	Peak	Vertical
2 PP	5265.000	-50.46	-60.97	-13.00	-37.46	10.51	Peak	Vertical

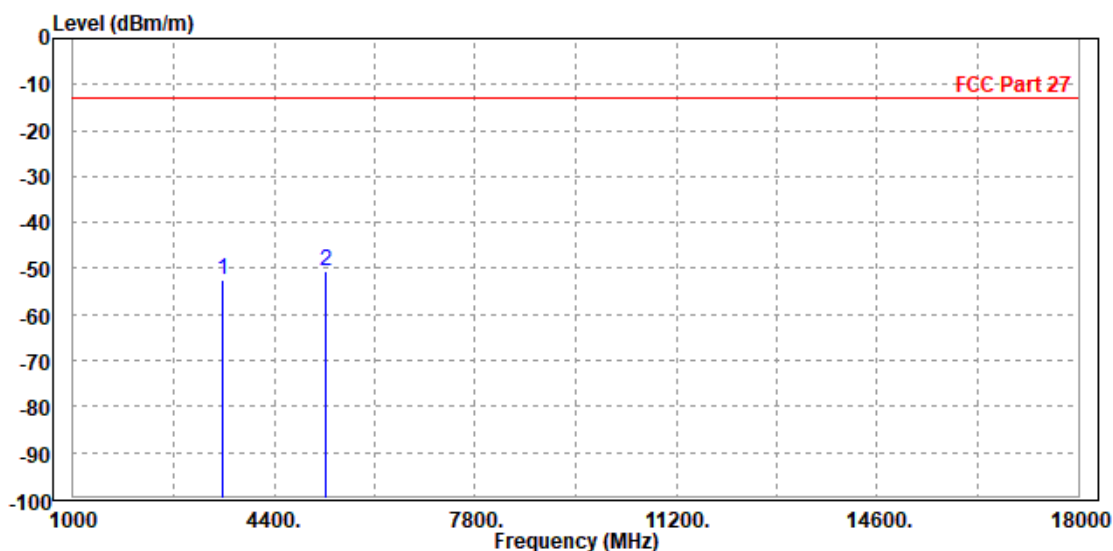



Test Report No.: W7L-P22120012-1RF04

CHANNEL BANDWIDTH: 10MHz / QPSK

CH132022

MODE	TX channel 132022	FREQUENCY RANGE	Above 1000MHz
ENVIRONMENTAL CONDITIONS	23deg. C, 70%RH	INPUT POWER	AC 120V/60HZ
TESTED BY	Jace Hu		
ANTENNA POLARITY & TEST DISTANCE: HORIZONTAL AT 3 M			

	Freq	Level	Read Level	Limit Line	Over Limit	Factor	Remark	Pol/Phase
	MHz	dBm/m	dBm	dBm/m	dB	dB/m		
1	3431.000	-52.30	-59.53	-13.00	-39.30	7.23	Peak	Horizontal
2 PP	5145.000	-49.55	-59.47	-13.00	-36.55	9.92	Peak	Horizontal

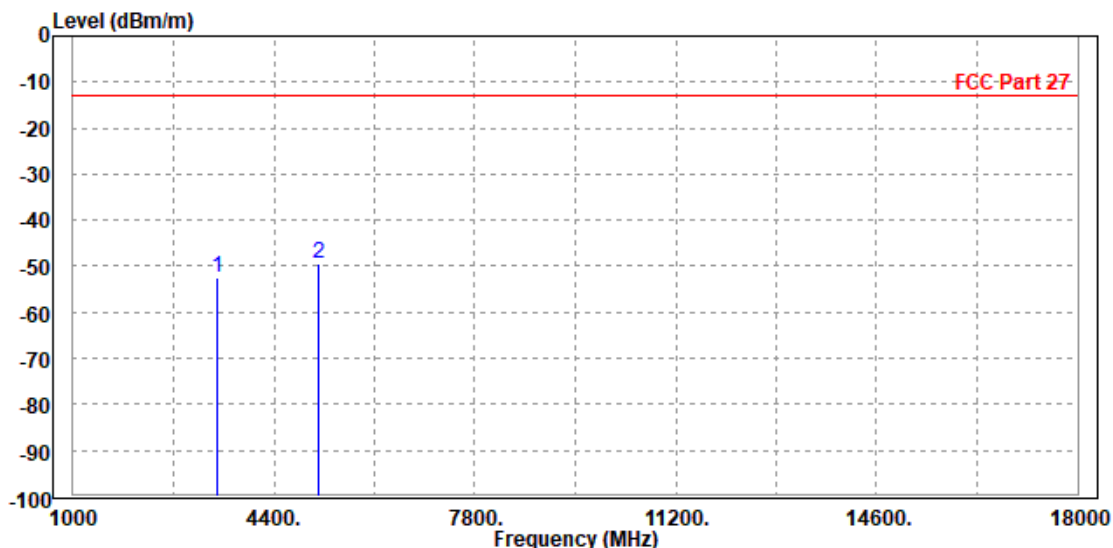



Test Report No.: W7L-P22120012-1RF04

MODE	TX channel 132022	FREQUENCY RANGE	Above 1000MHz
ENVIRONMENTAL CONDITIONS	23deg. C, 70%RH	INPUT POWER	AC 120V/60HZ
TESTED BY	Jace Hu		
ANTENNA POLARITY & TEST DISTANCE: VERTICAL AT 3 M			

	Freq	Level	Read Level	Limit Line	Over Limit	Factor	Remark	Pol/Phase
	MHz	dBm/m	dBm	dBm/m	dB	dB/m		
1	3430.000	-52.57	-59.78	-13.00	-39.57	7.21	Peak	Vertical
2 PP	5148.000	-51.29	-61.69	-13.00	-38.29	10.40	Peak	Vertical

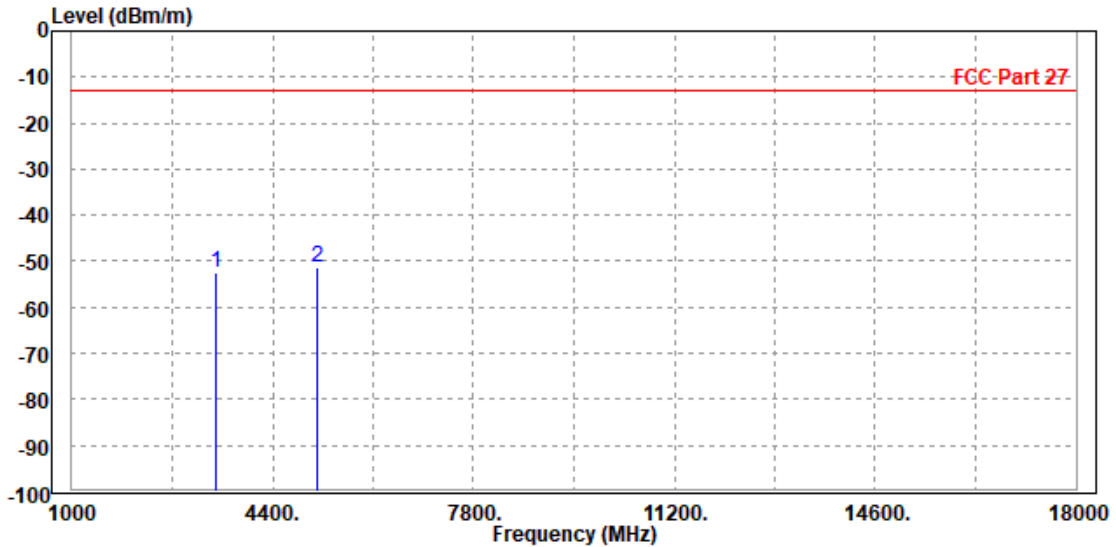



Test Report No.: W7L-P22120012-1RF04

CH132322

MODE	TX channel 132322	FREQUENCY RANGE	Above 1000MHz
ENVIRONMENTAL CONDITIONS	23deg. C, 70%RH	INPUT POWER	AC 120V/60HZ
TESTED BY	Jace Hu		
ANTENNA POLARITY & TEST DISTANCE: HORIZONTAL AT 3 M			

	Freq	Level	Read Level	Limit Line	Over Limit	Factor	Remark	Pol/Phase
	MHz	dBm/m	dBm	dBm/m	dB	dB/m		
1	3516.000	-51.21	-58.57	-13.00	-38.21	7.36	Peak	Horizontal
2	PP 5265.000	-50.14	-60.25	-13.00	-37.14	10.11	Peak	Horizontal

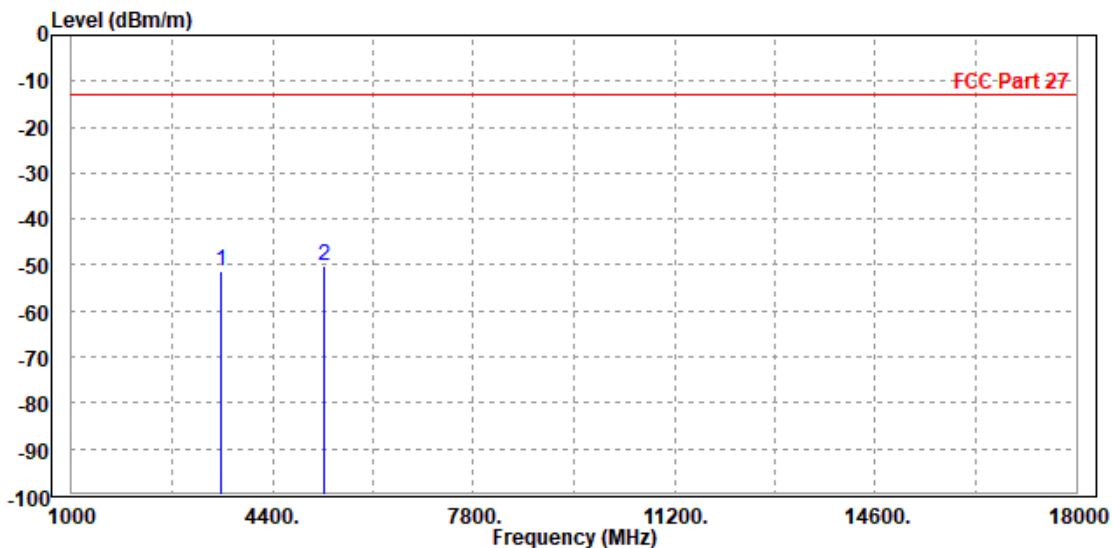



Test Report No.: W7L-P22120012-1RF04

MODE	TX channel 132322	FREQUENCY RANGE	Above 1000MHz
ENVIRONMENTAL CONDITIONS	23deg. C, 70%RH	INPUT POWER	AC 120V/60HZ
TESTED BY	Jace Hu		
ANTENNA POLARITY & TEST DISTANCE: VERTICAL AT 3 M			

	Freq	Level	Read Level	Limit Line	Over Limit	Factor	Remark	Pol/Phase
	MHz	dBm/m	dBm	dBm/m	dB	dB/m		
1	3510.000	-50.70	-58.03	-13.00	-37.70	7.33	Peak	Vertical
2 PP	5267.000	-49.55	-60.06	-13.00	-36.55	10.51	Peak	Vertical

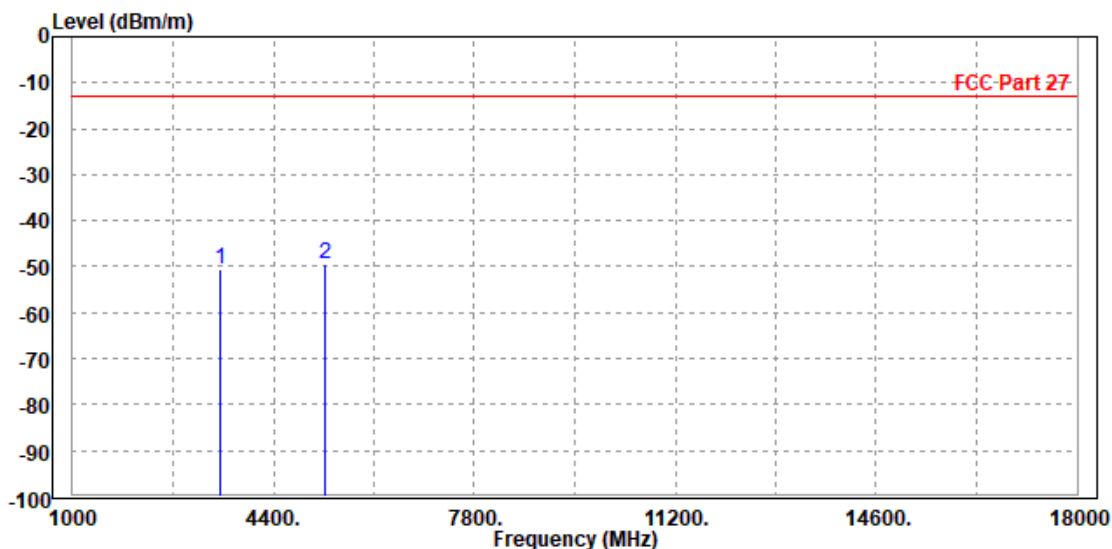



**BUREAU
VERITAS**

Test Report No.: W7L-P22120012-1RF04

CH132622

MODE	TX channel 132622	FREQUENCY RANGE	Above 1000MHz
ENVIRONMENTAL CONDITIONS	23deg. C, 70%RH	INPUT POWER	AC 120V/60HZ
TESTED BY	Jace Hu		
ANTENNA POLARITY & TEST DISTANCE: HORIZONTAL AT 3 M			

	Freq	Level	Read Level	Limit Line	Over Limit	Factor	Remark	Pol/Phase
	MHz	dBm/m	dBm	dBm/m	dB	dB/m		
1	PP 3550.000	-50.58	-58.03	-13.00	-37.58	7.45	Peak	Horizontal
2	5318.000	-51.50	-61.69	-13.00	-38.50	10.19	Peak	Horizontal

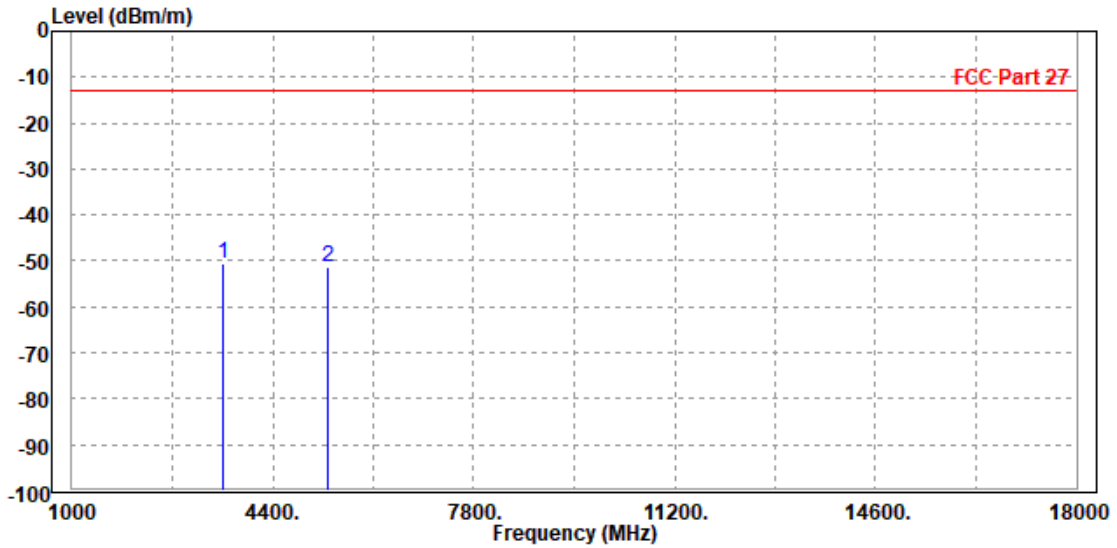



Test Report No.: W7L-P22120012-1RF04

MODE	TX channel 132622	FREQUENCY RANGE	Above 1000MHz
ENVIRONMENTAL CONDITIONS	23deg. C, 70%RH	INPUT POWER	AC 120V/60HZ
TESTED BY	Jace Hu		
ANTENNA POLARITY & TEST DISTANCE: VERTICAL AT 3 M			

	Freq	Level	Read Level	Limit Line	Over Limit	Factor	Remark	Pol/Phase
	MHz	dBm/m	dBm	dBm/m	dB	dB/m		
1	3550.000	-51.48	-58.87	-13.00	-38.48	7.39	Peak	Vertical
2 PP	5325.000	-50.48	-61.05	-13.00	-37.48	10.57	Peak	Vertical

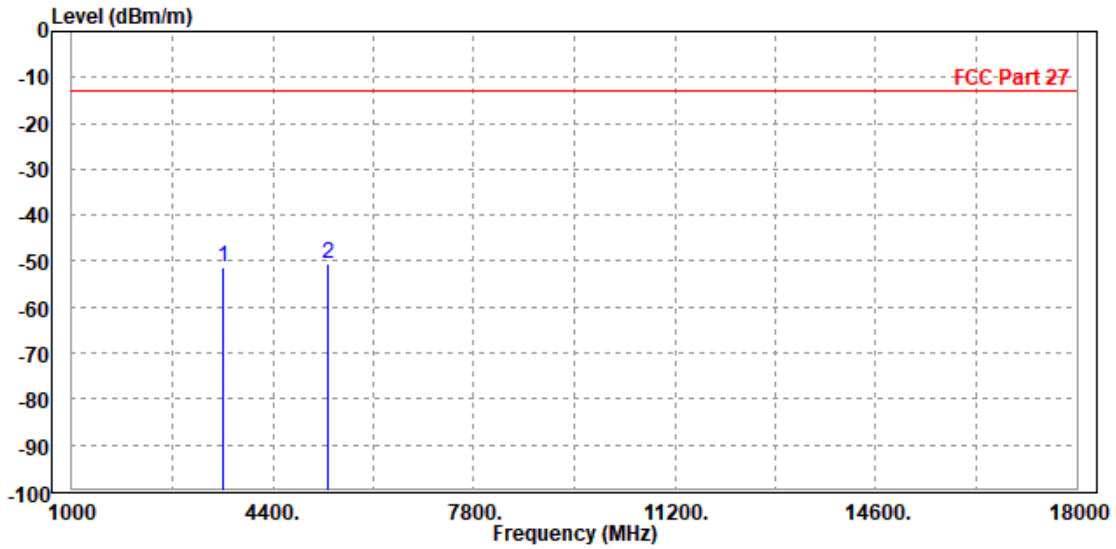



Test Report No.: W7L-P22120012-1RF04

CHANNEL BANDWIDTH: 15MHz / QPSK

MODE	TX channel 132322	FREQUENCY RANGE	Above 1000MHz
ENVIRONMENTAL CONDITIONS	23deg. C, 70%RH	INPUT POWER	AC 120V/60HZ
TESTED BY	Jace Hu		
ANTENNA POLARITY & TEST DISTANCE: HORIZONTAL AT 3 M			

	Freq	Level	Read Level	Limit Line	Over Limit	Factor	Remark	Pol/Phase
	MHz	dBm/m	dBm	dBm/m	dB	dB/m		
1	PP 3516.000	-51.67	-59.03	-13.00	-38.67	7.36	Peak	Horizontal
2	5265.000	-51.93	-62.04	-13.00	-38.93	10.11	Peak	Horizontal

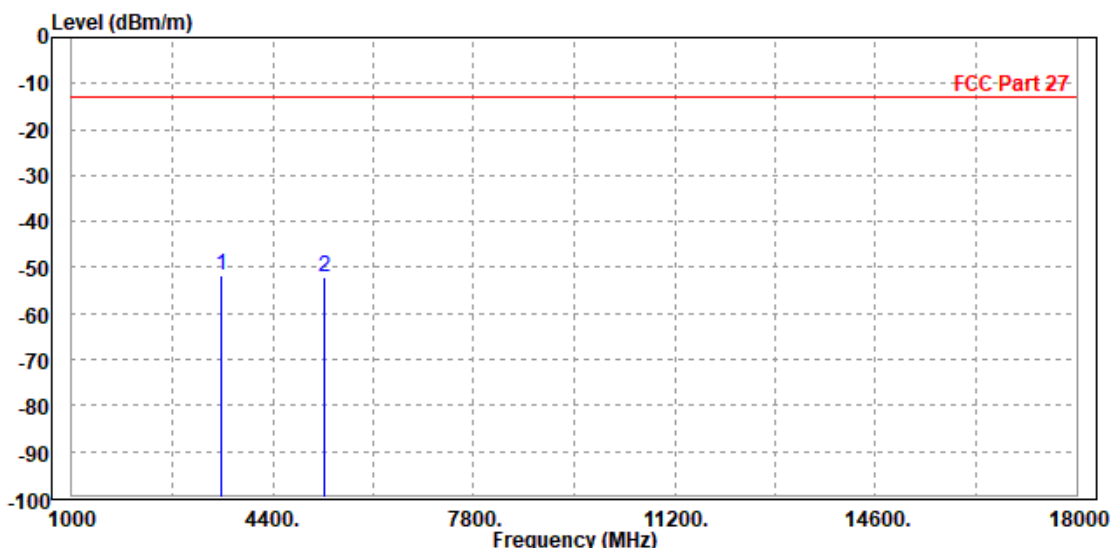



Test Report No.: W7L-P22120012-1RF04

MODE	TX channel 132322	FREQUENCY RANGE	Above 1000MHz
ENVIRONMENTAL CONDITIONS	23deg. C, 70%RH	INPUT POWER	AC 120V/60HZ
TESTED BY	Jace Hu		
ANTENNA POLARITY & TEST DISTANCE: VERTICAL AT 3 M			

	Freq	Level	Read Level	Limit Line	Over Limit	Factor	Remark	Pol/Phase
	MHz	dBm/m	dBm	dBm/m	dB	dB/m		
1	3510.000	-51.48	-58.81	-13.00	-38.48	7.33	Peak	Vertical
2 PP	5267.000	-50.26	-60.77	-13.00	-37.26	10.51	Peak	Vertical

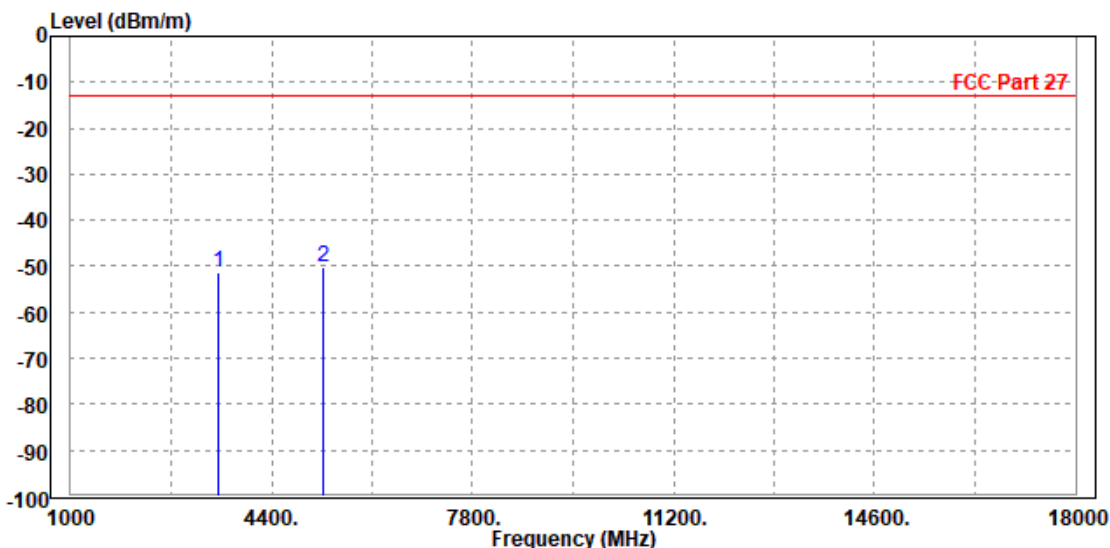



Test Report No.: W7L-P22120012-1RF04

CHANNEL BANDWIDTH: 20MHz / QPSK

MODE	TX channel 132322	FREQUENCY RANGE	Above 1000MHz
ENVIRONMENTAL CONDITIONS	23deg. C, 70%RH	INPUT POWER	AC 120V/60HZ
TESTED BY	Jace Hu		
ANTENNA POLARITY & TEST DISTANCE: HORIZONTAL AT 3 M			

	Freq	Level	Read Level	Limit Line	Over Limit	Factor	Remark	Pol/Phase
	MHz	dBm/m	dBm	dBm/m	dB	dB/m		
1	3510.000	-51.45	-58.80	-13.00	-38.45	7.35	Peak	Horizontal
2 PP	5267.000	-51.15	-61.26	-13.00	-38.15	10.11	Peak	Horizontal

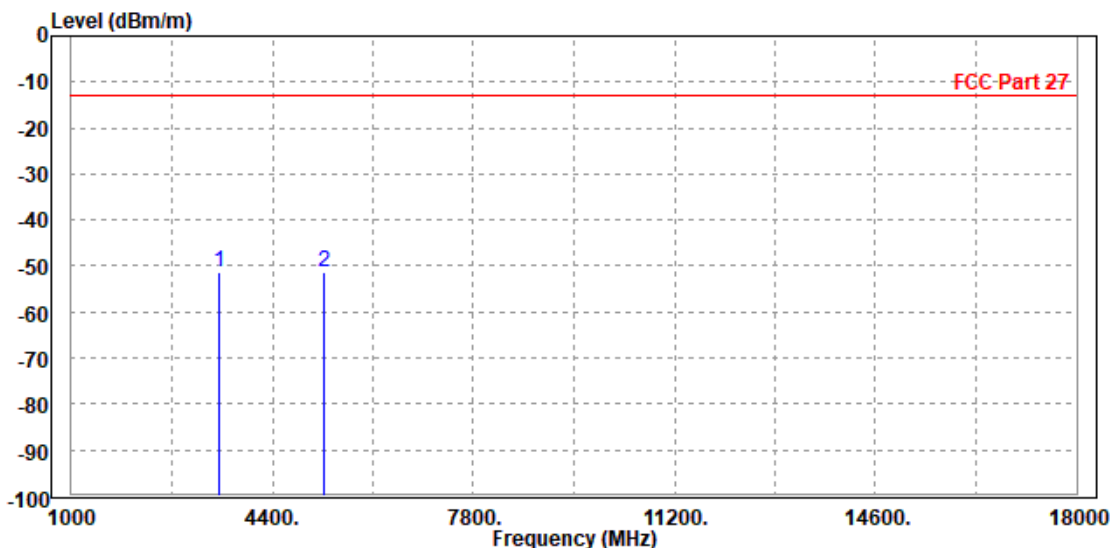



Test Report No.: W7L-P22120012-1RF04

MODE	TX channel 132322	FREQUENCY RANGE	Above 1000MHz
ENVIRONMENTAL CONDITIONS	23deg. C, 70%RH	INPUT POWER	AC 120V/60HZ
TESTED BY	Jace Hu		
ANTENNA POLARITY & TEST DISTANCE: VERTICAL AT 3 M			

	Freq	Level	Read Level	Limit Line	Over Limit	Factor	Remark	Pol/Phase
	MHz	dBm/m	dBm	dBm/m	dB	dB/m		
1	3516.000	-51.85	-59.19	-13.00	-38.85	7.34	Peak	Vertical
2 PP	5265.000	-50.45	-60.96	-13.00	-37.45	10.51	Peak	Vertical

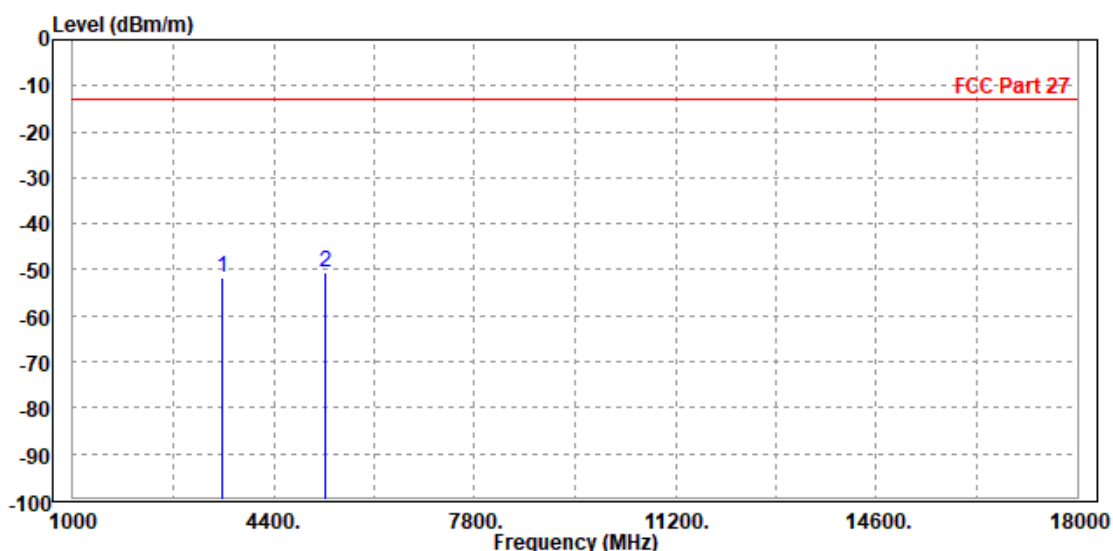

3.7 PEAK TO AVERAGE RATIO

3.7.1 LIMITS OF PEAK TO AVERAGE RATIO MEASUREMENT

In measuring transmissions in this band using an average power technique, the peak to-average ratio (PAR) of the transmission may not exceed 13 dB

3.7.2 TEST SETUP

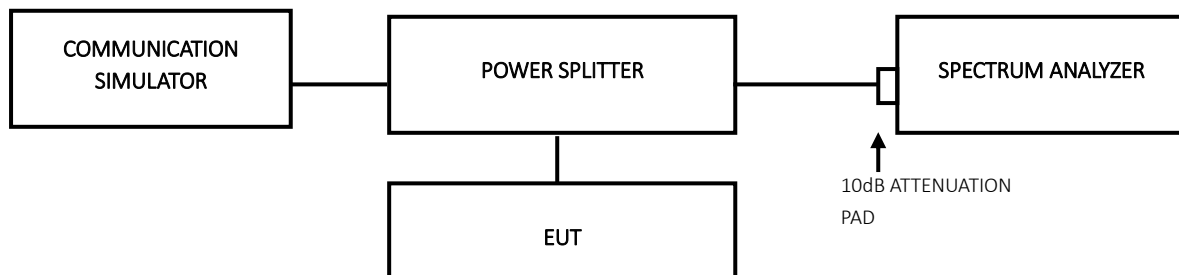

3.7.3 TEST PROCEDURES

1. Set resolution/measurement bandwidth \geq signal's occupied bandwidth;
2. Set the number of counts to a value that stabilizes the measured CCDF curve;
3. Record the maximum PAPR level associated with a probability of 0.1%.



Test Report No.: W7L-P22120012-1RF04

3.7.4 TEST RESULTS

Please Refer to Appendix Of this test report.



Test Report No.: W7L-P22120012-1RF04

4 INFORMATION ON THE TESTING LABORATORIES

We, BV 7LAYERS COMMUNICATIONS TECHNOLOGY (SHENZHEN) CO. LTD., were founded in 2015 to provide our best service in EMC, Radio, Telecom and Safety consultation. Our laboratories are accredited and approved according to ISO/IEC 17025.

If you have any comments, please feel free to contact us at the following:

Shenzhen EMC/RF Lab:

Tel: +86-755-88696566

Fax: +86-755-88696577

Email: customerservice.sw@cn.bureauveritas.com

Web Site: www.adt.com.tw

The address and road map of all our labs can be found in our web site also.



Test Report No.: W7L-P22120012-1RF04

5 MODIFICATIONS RECORDERS FOR ENGINEERING CHANGES TO THE EUT BY THE LAB

No any modifications are made to the EUT by the lab during the test.



Test Report No.: W7L-P22120012-1RF04

6 APPENDIX

WCDMA BAND4

PEAK-TO-AVERAGE RATIO

Test Result

Band	Channel	Peak-to-Average Ratio(dB)	Limit(dBm)	Verdict
Band4	1312	2.84	13	PASS
Band4	1413	3.03	13	PASS
Band4	1513	2.73	13	PASS

Test Graphs





BUREAU
VERITAS

Test Report No.: W7L-P22120012-1RF04

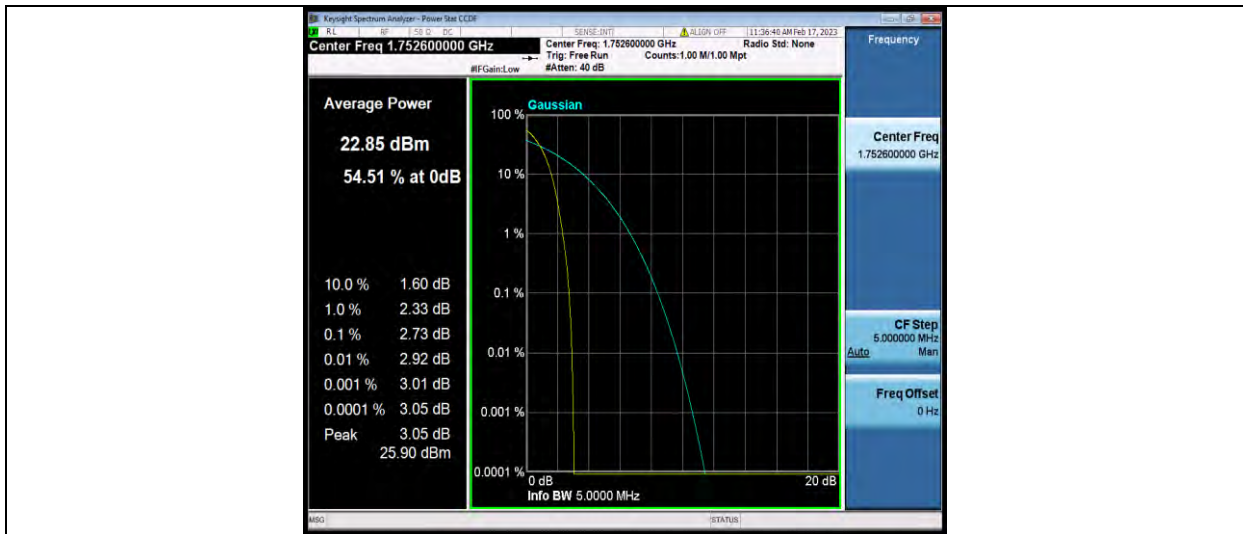



Test Report No.: W7L-P22120012-1RF04

26DB BANDWIDTH AND OCCUPIED BANDWIDTH

Test Result

Band	Channel	Occupied Bandwidth (kHz)	26dB Bandwidth (kHz)	Limit(kHz)	Verdict
Band4	1312	4.1620	4.701	---	PASS
Band4	1413	4.1607	4.678	---	PASS
Band4	1513	4.1709	4.701	---	PASS

Test Graphs

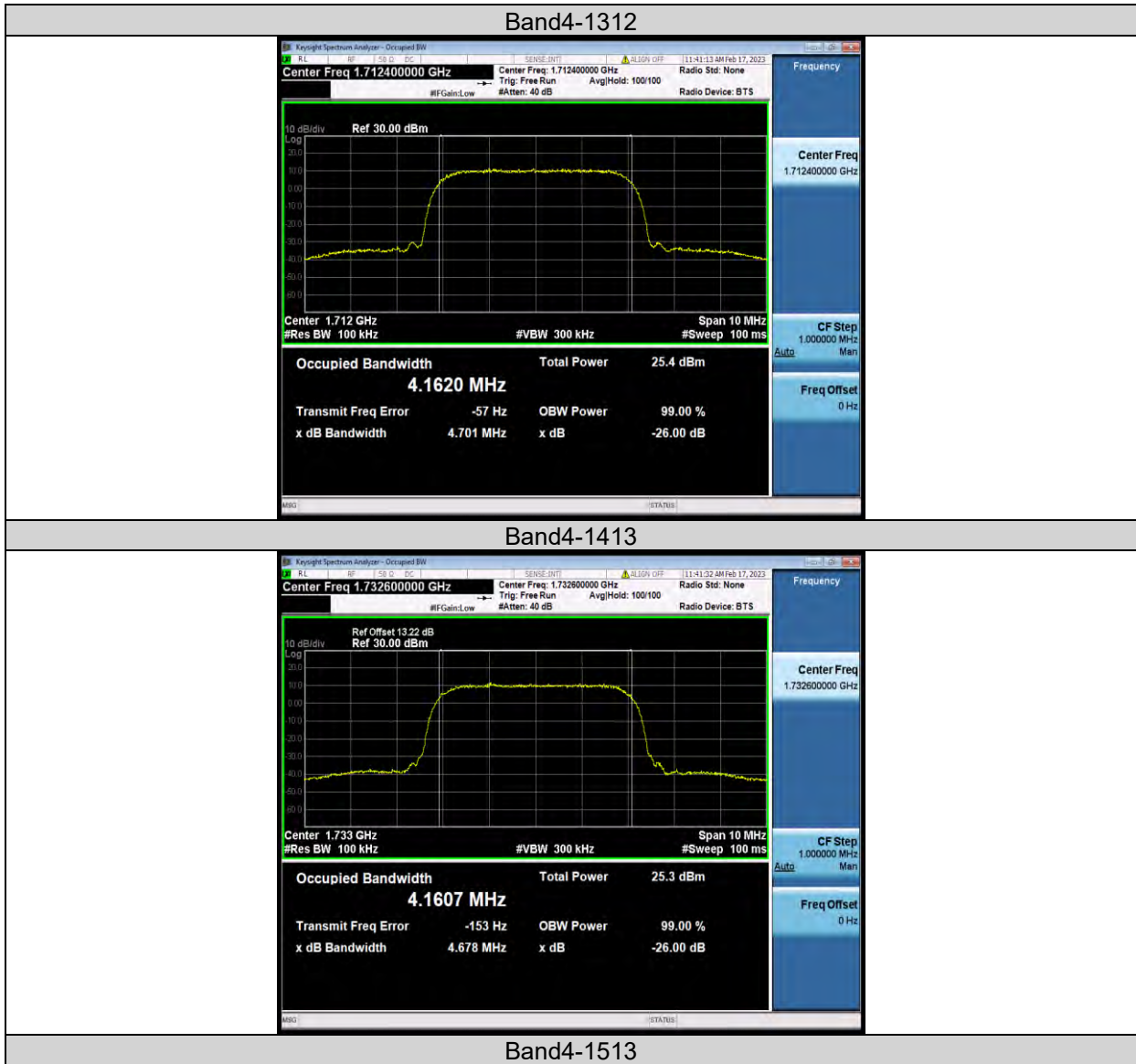



BUREAU VERITAS

Test Report No.: W7L-P22120012-1RF04





Test Report No.: W7L-P22120012-1RF04

BAND EDGE

Test Result

Band	Channel	Frequency (MHz)	Result (dBm)	Limit(dBm)	Verdict
Band4	1312	1710.00	-31.58	-13	PASS
Band4	1513	1755.00	-29.02	-13	PASS

Test Graphs





Test Report No.: W7L-P22120012-1RF04

CONDUCTED SPURIOUS EMISSION

Test Result

Band	Channel	Frequency Range (Mhz)	Frequency (dBm)	Result (dBm)	Limit (dBm)	Verdict
Band4	1312	30~1000MHz	747.93	-40.69	-13	PASS
Band4	1312	1000~20000MHz	19994.93	-32.45	-13	PASS
Band4	1413	30~1000MHz	796.91	-40.11	-13	PASS
Band4	1413	1000~20000MHz	19481.3	-32.76	-13	PASS
Band4	1513	30~1000MHz	880.88	-40.75	-13	PASS
Band4	1513	1000~20000MHz	19225.43	-32.27	-13	PASS

Test Graphs

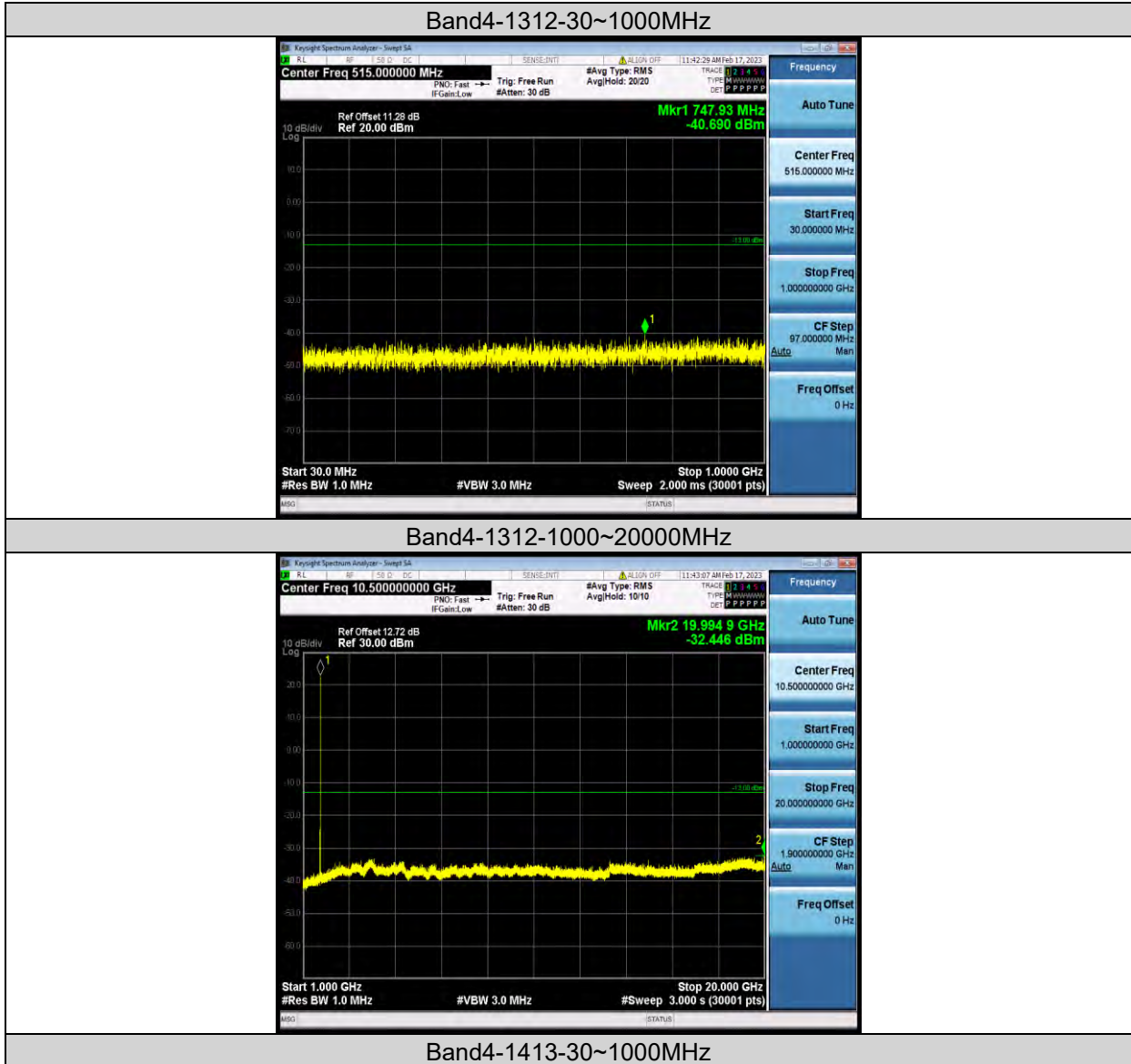



BUREAU VERITAS

Test Report No.: W7L-P22120012-1RF04

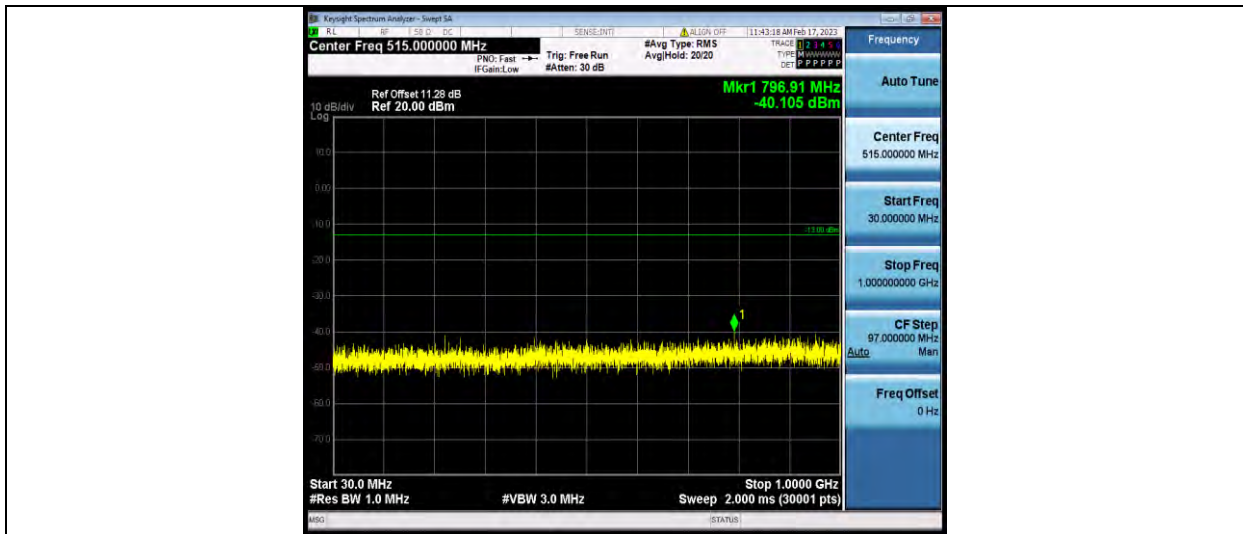

Band4-1413-1000~20000MHz



Band4-1513-30~1000MHz

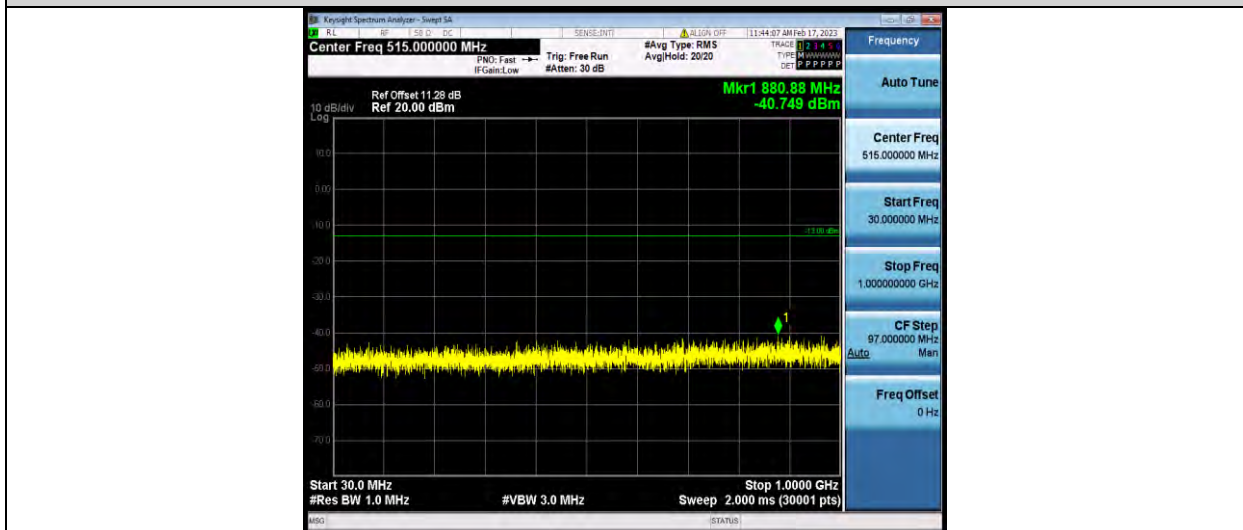

Band4-1513-1000~20000MHz



BUREAU
VERITAS

Test Report No.: W7L-P22120012-1RF04





Test Report No.: W7L-P22120012-1RF04

FREQUENCY STABILITY

Test Result

Voltage							
Band	Channel	Voltage (Vdc)	Temperature (°C)	Deviation (Hz)	Deviation (ppm)	Limit (ppm)	Verdict
Band4	1312	VL	NT	-1.84	-0.001075	±2.5	PASS
Band4	1312	VN	NT	1.92	0.001121	±2.5	PASS
Band4	1312	VH	NT	-0.86	-0.000502	±2.5	PASS
Band4	1413	VL	NT	-1.47	-0.000848	±2.5	PASS
Band4	1413	VN	NT	-1.74	-0.001004	±2.5	PASS
Band4	1413	VH	NT	1.86	0.001074	±2.5	PASS
Band4	1513	VL	NT	-2.62	-0.001495	±2.5	PASS
Band4	1513	VN	NT	-0.89	-0.000508	±2.5	PASS
Band4	1513	VH	NT	-2.84	-0.001620	±2.5	PASS

Temperature							
Band	Channel	Voltage (Vdc)	Temperature (°C)	Deviation (Hz)	Deviation (ppm)	Limit (ppm)	Verdict
Band4	1312	NV	-30	3.35	0.001956	±2.5	PASS
Band4	1312	NV	-20	-0.67	-0.000391	±2.5	PASS
Band4	1312	NV	-10	-5.87	-0.003428	±2.5	PASS
Band4	1312	NV	0	5.70	0.003329	±2.5	PASS
Band4	1312	NV	10	0.72	0.000420	±2.5	PASS
Band4	1312	NV	20	-4.04	-0.002359	±2.5	PASS
Band4	1312	NV	30	-4.01	-0.002342	±2.5	PASS
Band4	1312	NV	40	3.79	0.002213	±2.5	PASS
Band4	1312	NV	50	3.51	0.002050	±2.5	PASS
Band4	1413	NV	-30	-1.89	-0.001091	±2.5	PASS
Band4	1413	NV	-20	-2.81	-0.001622	±2.5	PASS
Band4	1413	NV	-10	2.76	0.001593	±2.5	PASS
Band4	1413	NV	0	-0.24	-0.000139	±2.5	PASS
Band4	1413	NV	10	-3.88	-0.002239	±2.5	PASS
Band4	1413	NV	20	-3.32	-0.001916	±2.5	PASS
Band4	1413	NV	30	2.78	0.001605	±2.5	PASS
Band4	1413	NV	40	2.44	0.001408	±2.5	PASS
Band4	1413	NV	50	2.45	0.001414	±2.5	PASS
Band4	1513	NV	-30	-1.70	-0.000970	±2.5	PASS
Band4	1513	NV	-20	-1.23	-0.000702	±2.5	PASS
Band4	1513	NV	-10	-4.33	-0.002471	±2.5	PASS
Band4	1513	NV	0	-1.52	-0.000867	±2.5	PASS
Band4	1513	NV	10	-5.49	-0.003132	±2.5	PASS
Band4	1513	NV	20	0.67	0.000382	±2.5	PASS
Band4	1513	NV	30	5.21	0.002973	±2.5	PASS
Band4	1513	NV	40	6.96	0.003971	±2.5	PASS
Band4	1513	NV	50	1.85	0.001056	±2.5	PASS



Test Report No.: W7L-P22120012-1RF04

LTE BAND7

PEAK-TO-AVERAGE RATIO(CCDF)

Test Result

Band	Bandwidth	Modulation	Channel	RB Configuration	Result(dB)	Limit(dB)	Verdict
Band7	5MHz	QPSK	20775	1RB#0	4.97	13	PASS
Band7	5MHz	QPSK	20775	25RB#0	5.52	13	PASS
Band7	5MHz	QPSK	21100	1RB#0	4.67	13	PASS
Band7	5MHz	QPSK	21100	25RB#0	5.42	13	PASS
Band7	5MHz	QPSK	21425	1RB#0	4.42	13	PASS
Band7	5MHz	QPSK	21425	25RB#0	5.25	13	PASS
Band7	5MHz	16QAM	20775	1RB#0	5.83	13	PASS
Band7	5MHz	16QAM	20775	25RB#0	6.37	13	PASS
Band7	5MHz	16QAM	21100	1RB#0	5.60	13	PASS
Band7	5MHz	16QAM	21100	25RB#0	6.25	13	PASS
Band7	5MHz	16QAM	21425	1RB#0	5.39	13	PASS
Band7	5MHz	16QAM	21425	25RB#0	5.94	13	PASS
Band7	10MHz	QPSK	20800	1RB#0	4.82	13	PASS
Band7	10MHz	QPSK	20800	50RB#0	5.60	13	PASS
Band7	10MHz	QPSK	21100	1RB#0	4.72	13	PASS
Band7	10MHz	QPSK	21100	50RB#0	5.45	13	PASS
Band7	10MHz	QPSK	21400	1RB#0	3.96	13	PASS
Band7	10MHz	QPSK	21400	50RB#0	5.08	13	PASS
Band7	10MHz	16QAM	20800	1RB#0	5.38	13	PASS
Band7	10MHz	16QAM	20800	50RB#0	6.44	13	PASS
Band7	10MHz	16QAM	21100	1RB#0	5.28	13	PASS
Band7	10MHz	16QAM	21100	50RB#0	6.29	13	PASS
Band7	10MHz	16QAM	21400	1RB#0	4.24	13	PASS
Band7	10MHz	16QAM	21400	50RB#0	5.87	13	PASS
Band7	15MHz	QPSK	20825	1RB#0	4.87	13	PASS
Band7	15MHz	QPSK	20825	75RB#0	5.83	13	PASS
Band7	15MHz	QPSK	21100	1RB#0	4.57	13	PASS
Band7	15MHz	QPSK	21100	75RB#0	5.69	13	PASS
Band7	15MHz	QPSK	21375	1RB#0	3.75	13	PASS
Band7	15MHz	QPSK	21375	75RB#0	5.26	13	PASS
Band7	15MHz	16QAM	20825	1RB#0	5.00	13	PASS
Band7	15MHz	16QAM	20825	75RB#0	6.39	13	PASS
Band7	15MHz	16QAM	21100	1RB#0	4.49	13	PASS
Band7	15MHz	16QAM	21100	75RB#0	6.32	13	PASS
Band7	15MHz	16QAM	21375	1RB#0	3.96	13	PASS
Band7	15MHz	16QAM	21375	75RB#0	5.87	13	PASS
Band7	20MHz	QPSK	20850	1RB#0	4.73	13	PASS
Band7	20MHz	QPSK	20850	100RB#0	5.52	13	PASS
Band7	20MHz	QPSK	21100	1RB#0	4.24	13	PASS
Band7	20MHz	QPSK	21100	100RB#0	5.54	13	PASS
Band7	20MHz	QPSK	21350	1RB#0	4.05	13	PASS



BUREAU
VERITAS

Test Report No.: W7L-P22120012-1RF04

Band7	20MHz	QPSK	21350	100RB#0	5.10	13	PASS
Band7	20MHz	16QAM	20850	1RB#0	5.71	13	PASS
Band7	20MHz	16QAM	20850	100RB#0	6.30	13	PASS
Band7	20MHz	16QAM	21100	1RB#0	4.53	13	PASS
Band7	20MHz	16QAM	21100	100RB#0	6.22	13	PASS
Band7	20MHz	16QAM	21350	1RB#0	5.11	13	PASS
Band7	20MHz	16QAM	21350	100RB#0	5.82	13	PASS

Test Graphs

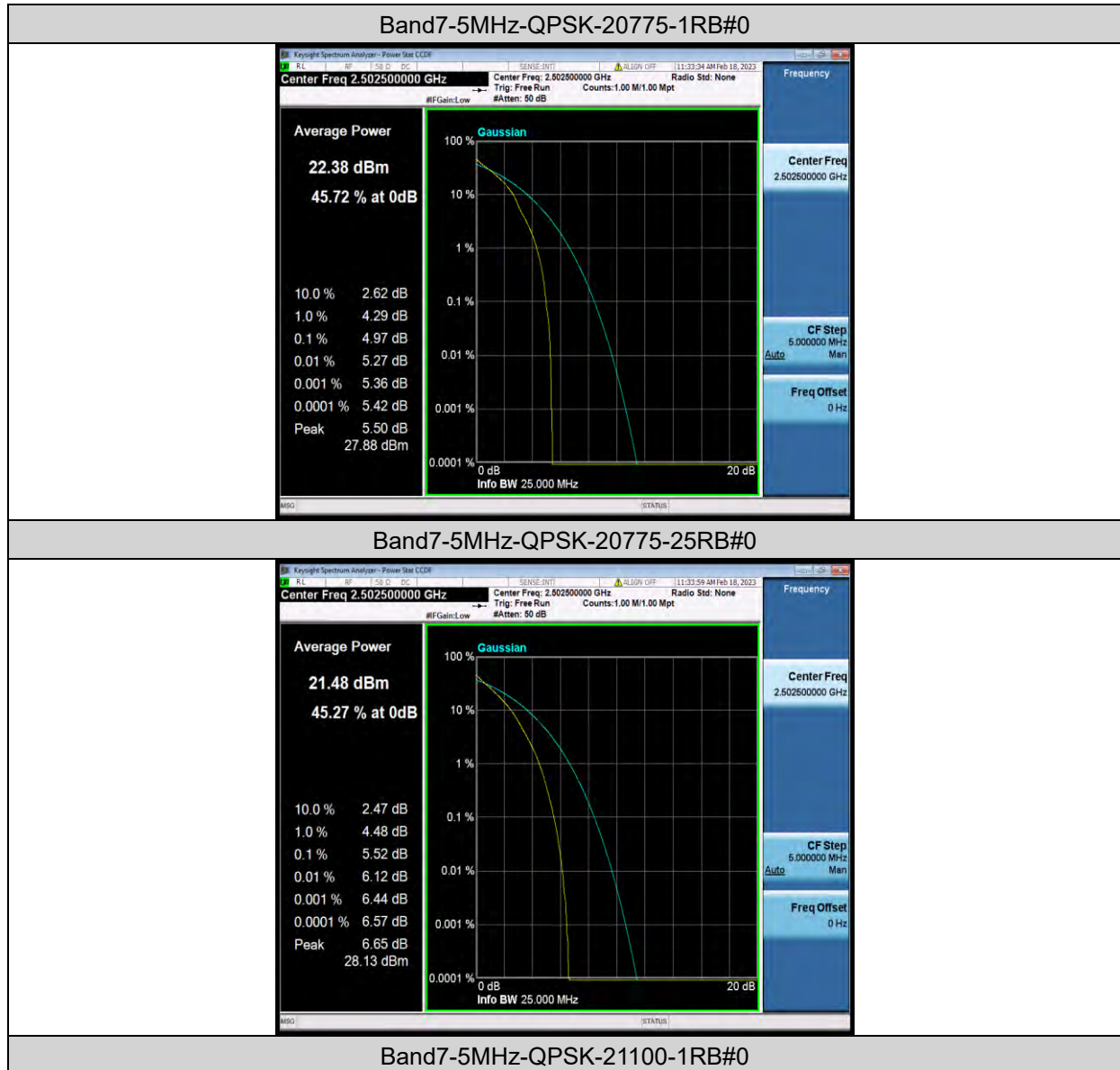



BUREAU
VERITAS

Test Report No.: W7L-P22120012-1RF04

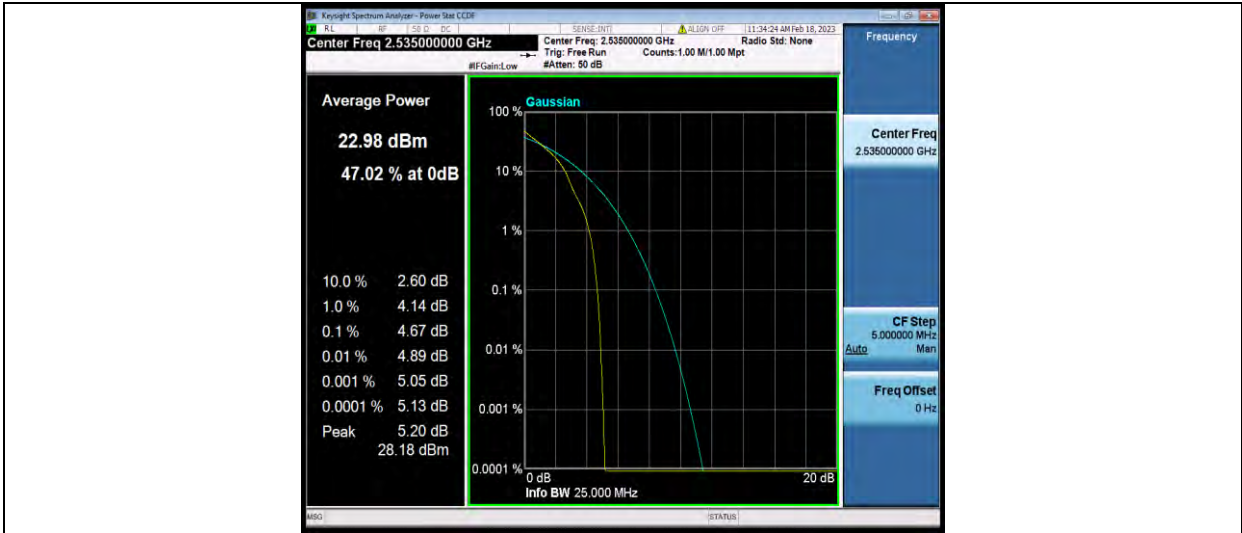

Band7-5MHz-QPSK-21100-25RB#0

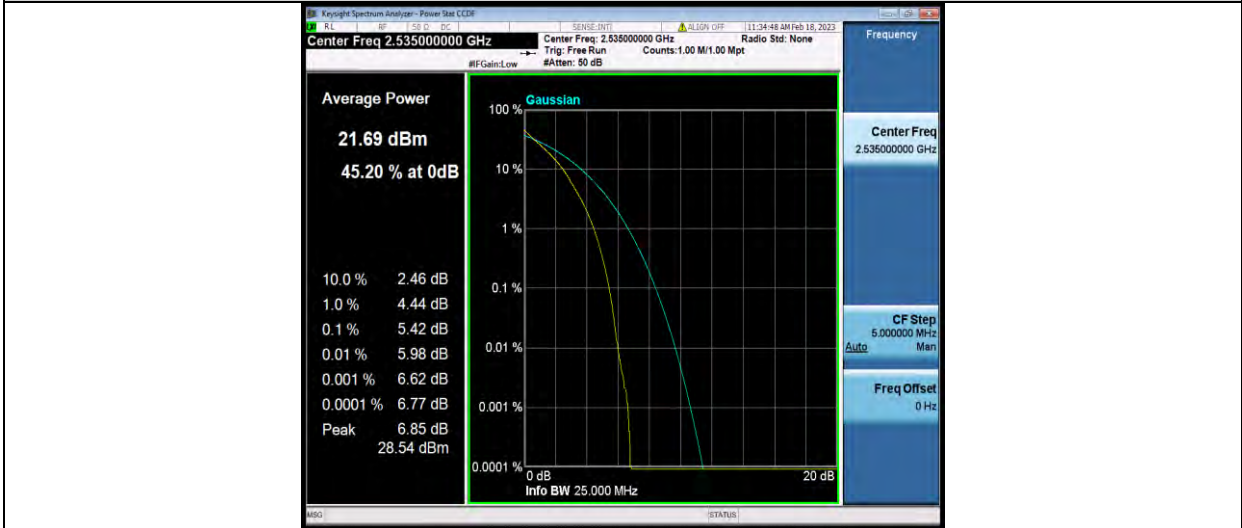

Band7-5MHz-QPSK-21425-1RB#0

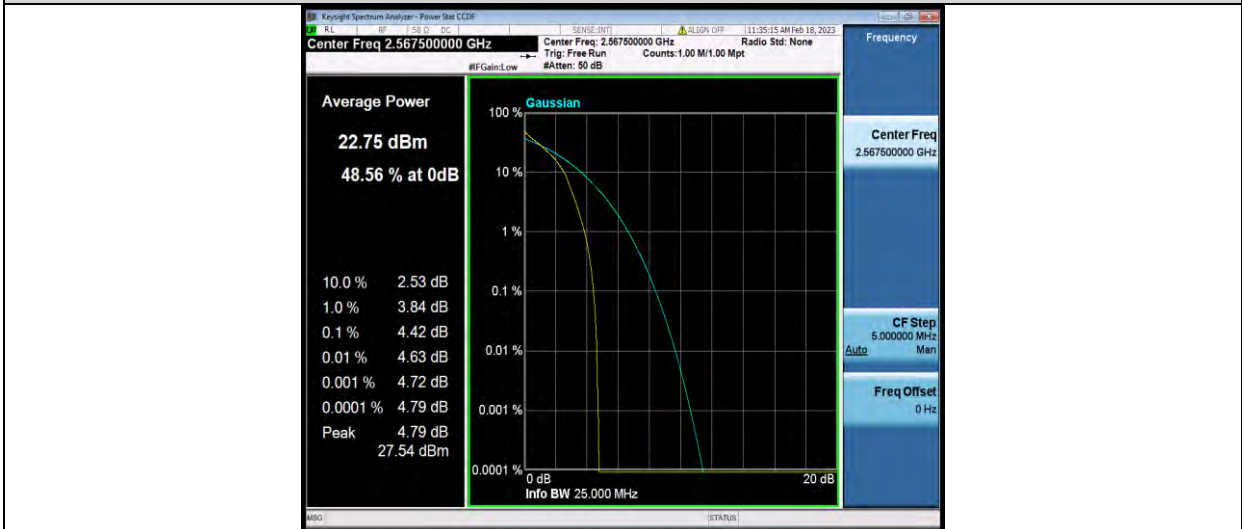

Band7-5MHz-QPSK-21425-25RB#0



BUREAU VERITAS

Test Report No.: W7L-P22120012-1RF04

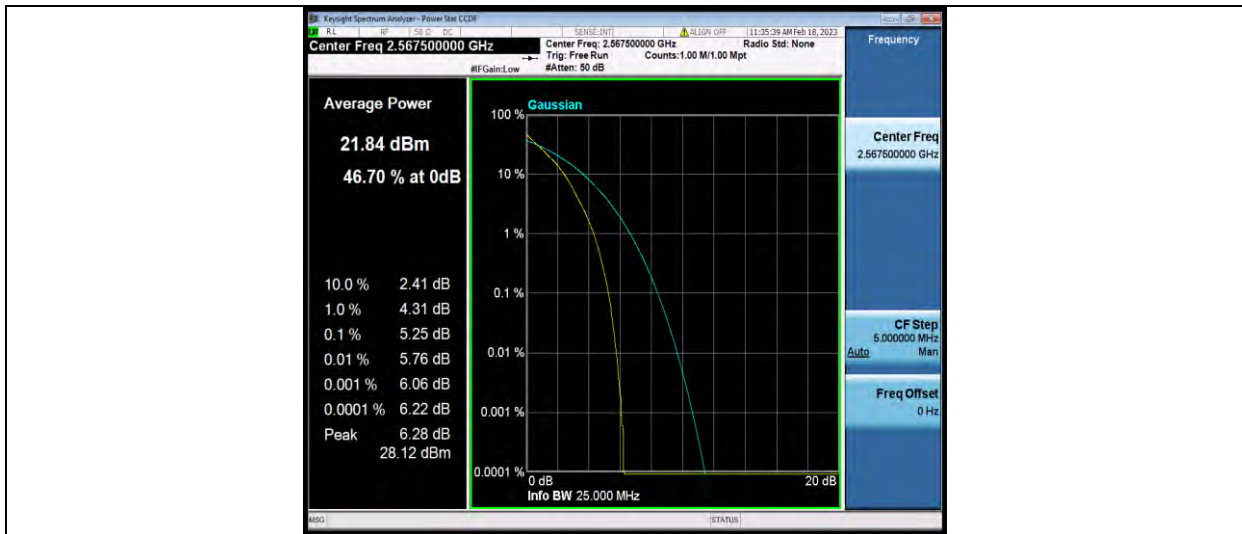

Band7-5MHz-16QAM-20775-1RB#0

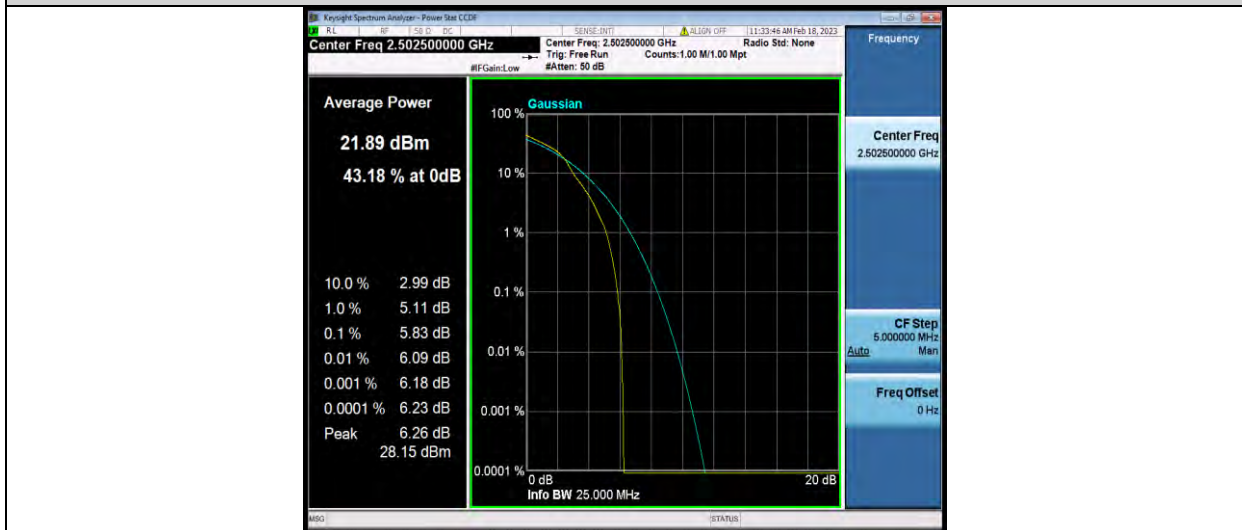

Band7-5MHz-16QAM-20775-25RB#0

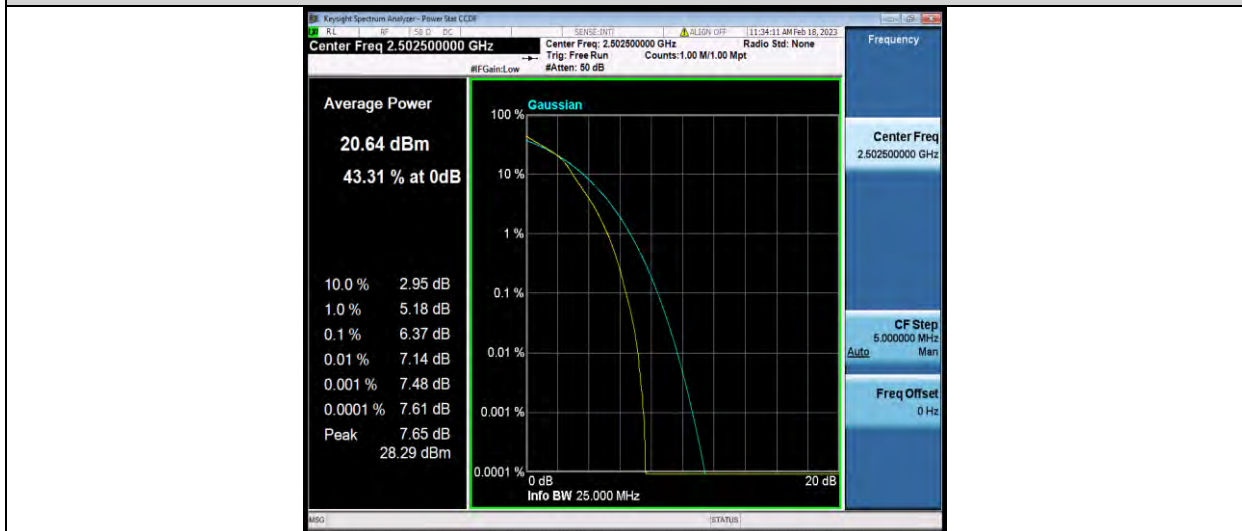

Band7-5MHz-16QAM-21100-1RB#0



BUREAU VERITAS

Test Report No.: W7L-P22120012-1RF04

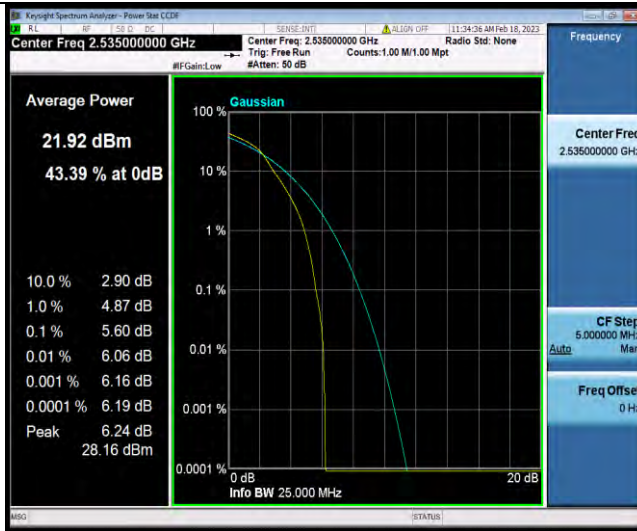

Band7-5MHz-16QAM-21100-25RB#0

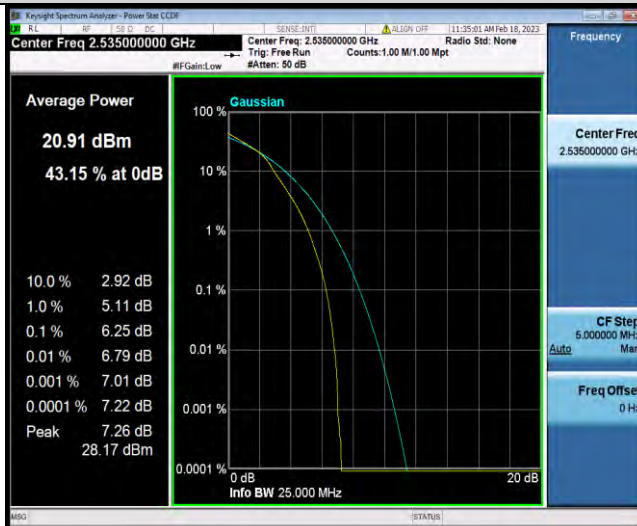

Band7-5MHz-16QAM-21425-1RB#0

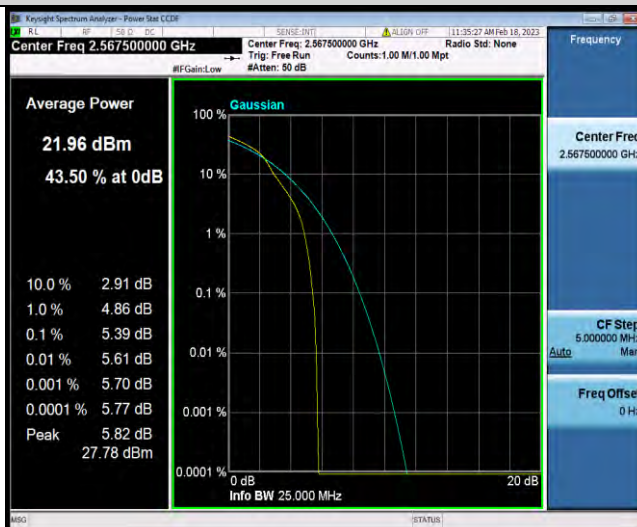

Band7-5MHz-16QAM-21425-25RB#0



BUREAU VERITAS

Test Report No.: W7L-P22120012-1RF04

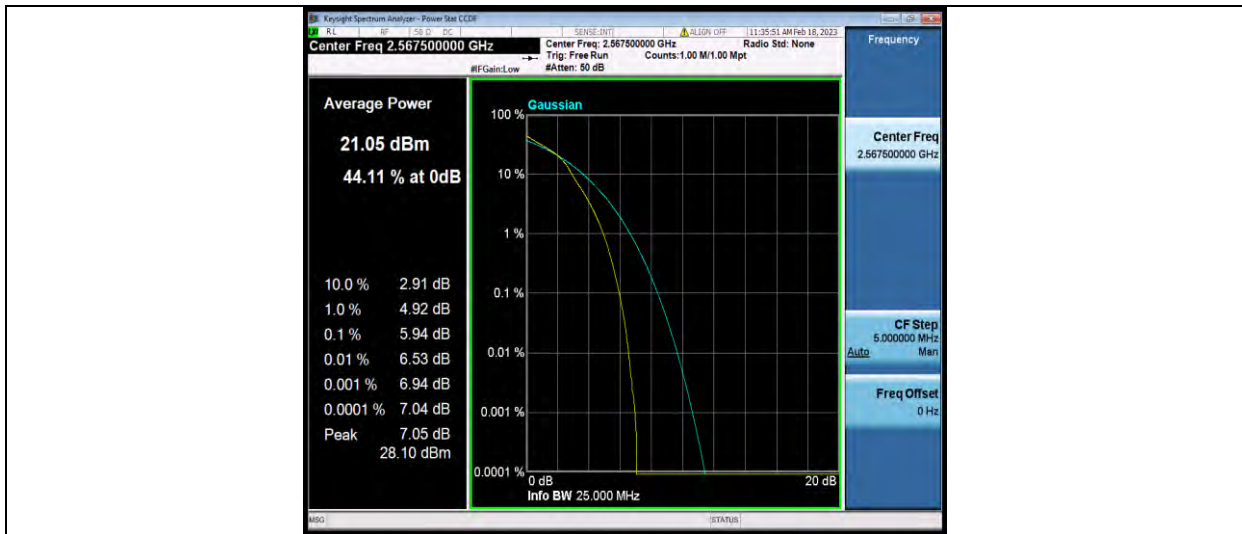

Band7-10MHz-QPSK-20800-1RB#0

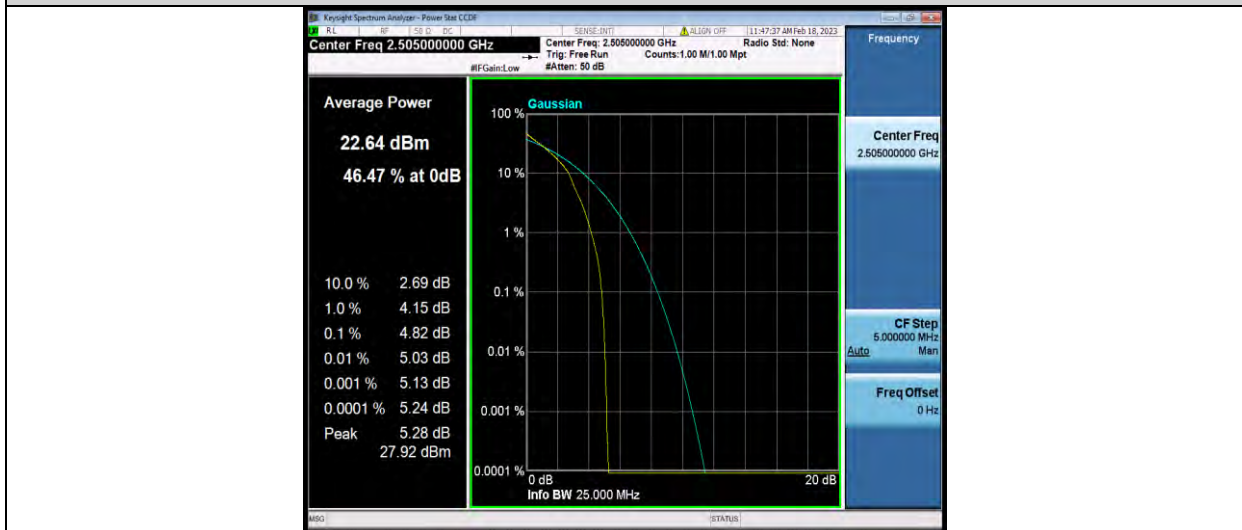

Band7-10MHz-QPSK-20800-50RB#0

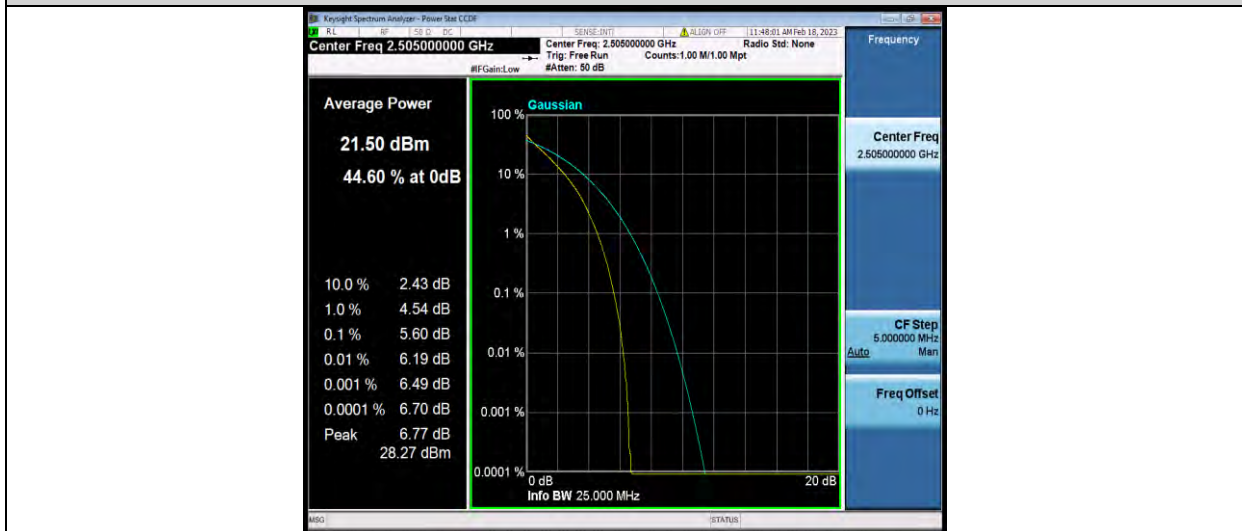

Band7-10MHz-QPSK-21100-1RB#0



BUREAU VERITAS

Test Report No.: W7L-P22120012-1RF04

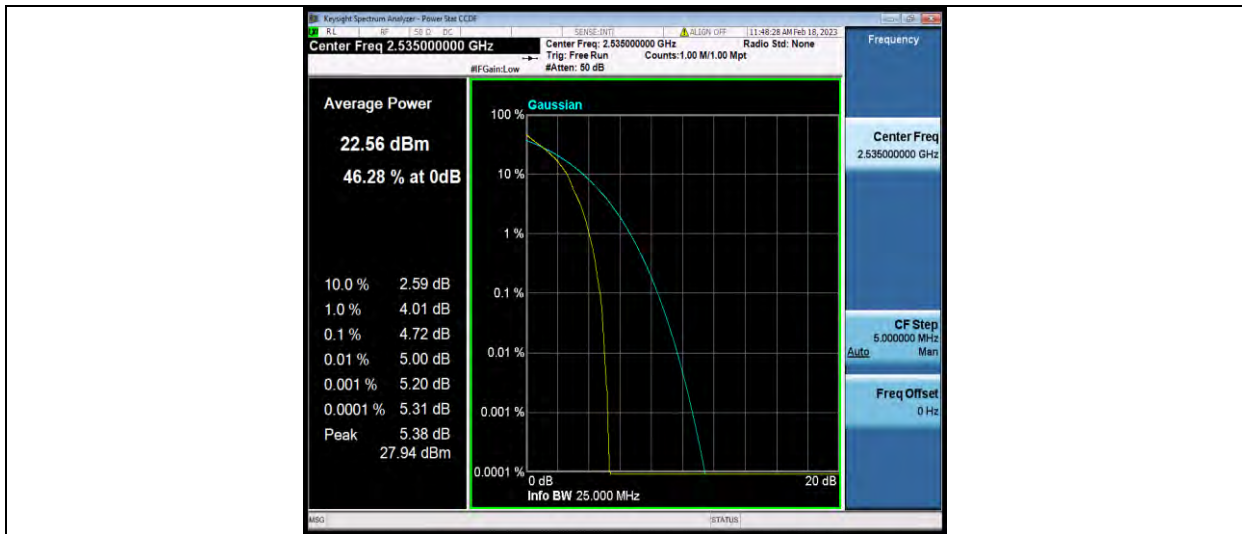

Band7-10MHz-QPSK-21100-50RB#0

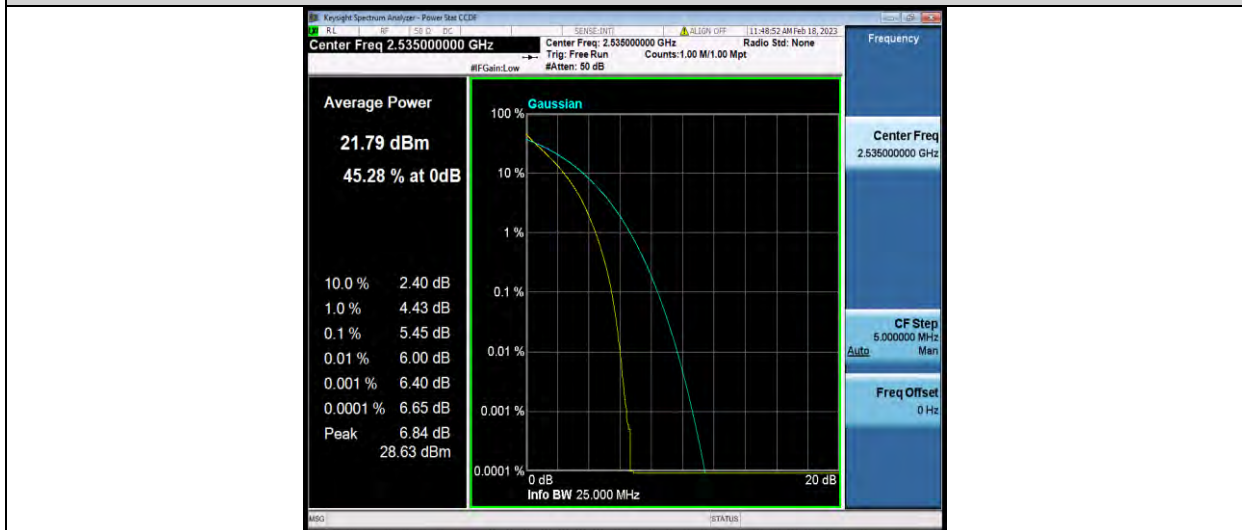

Band7-10MHz-QPSK-21400-1RB#0



Band7-10MHz-QPSK-21400-50RB#0



BUREAU
VERITAS

Test Report No.: W7L-P22120012-1RF04

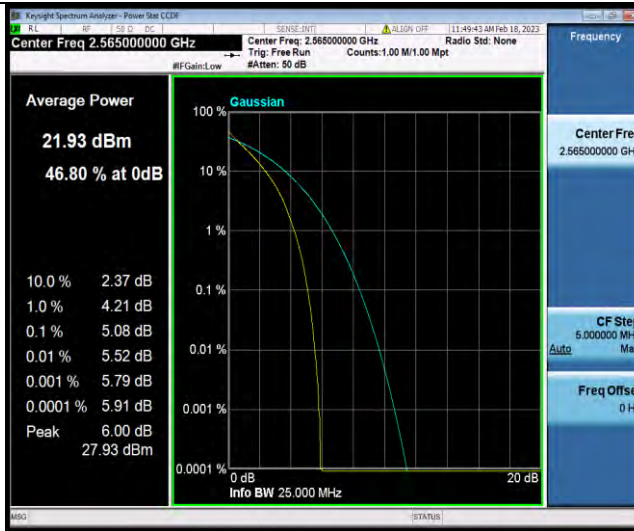

Band7-10MHz-16QAM-20800-1RB#0

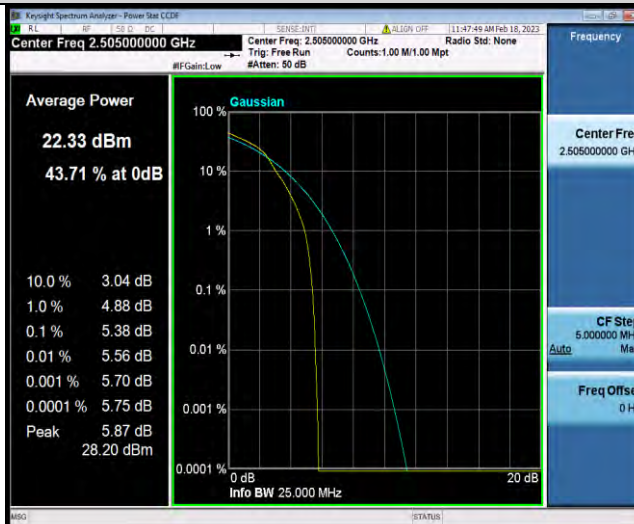

Band7-10MHz-16QAM-20800-50RB#0

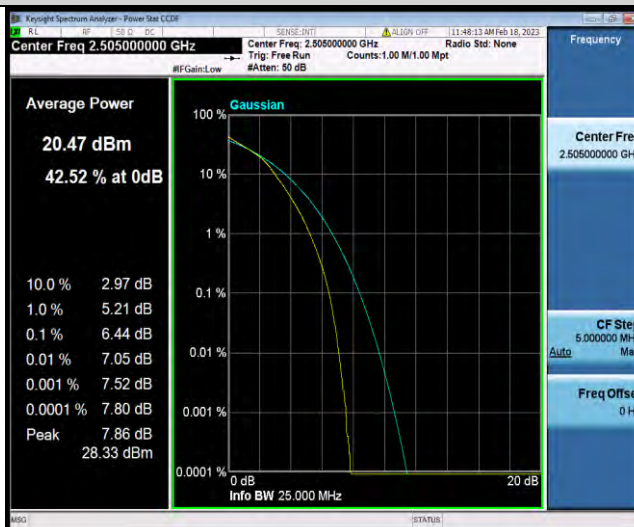

Band7-10MHz-16QAM-21100-1RB#0



BUREAU VERITAS

Test Report No.: W7L-P22120012-1RF04

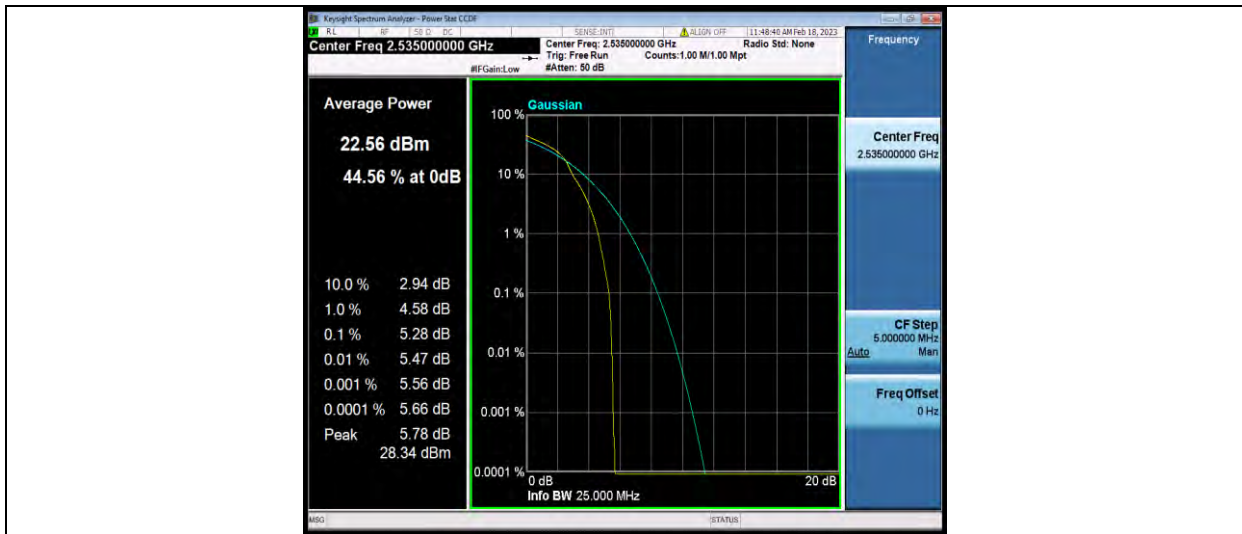

Band7-10MHz-16QAM-21100-50RB#0

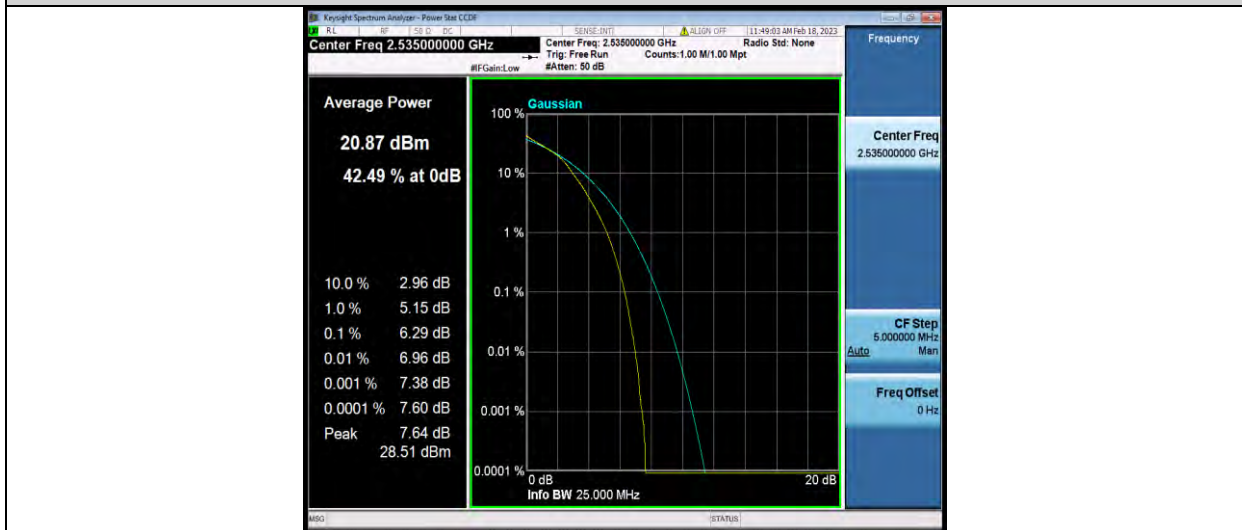

Band7-10MHz-16QAM-21400-1RB#0

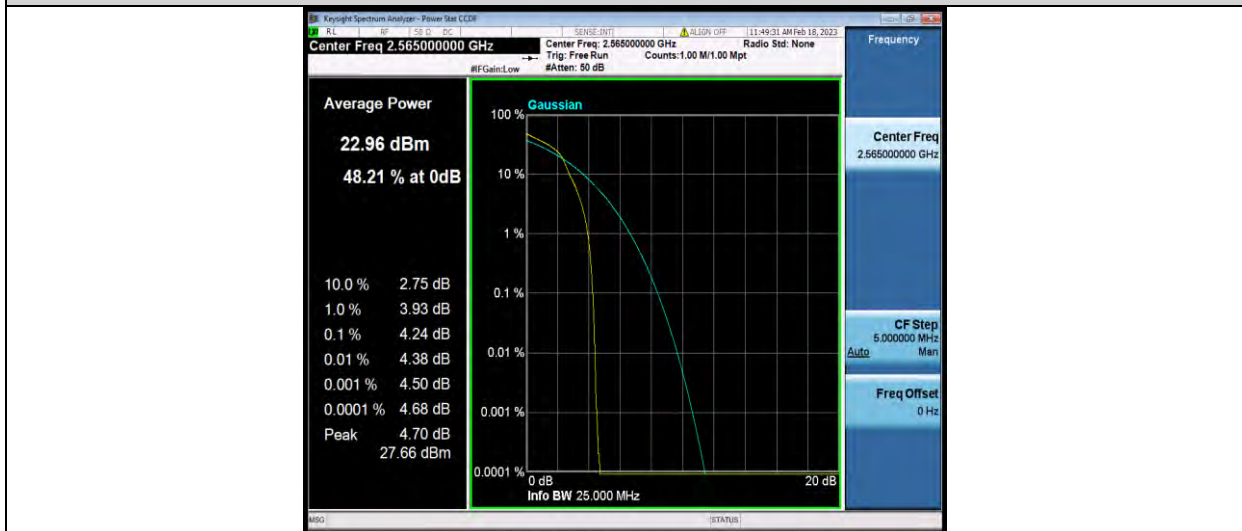

Band7-10MHz-16QAM-21400-50RB#0



BUREAU
VERITAS

Test Report No.: W7L-P22120012-1RF04

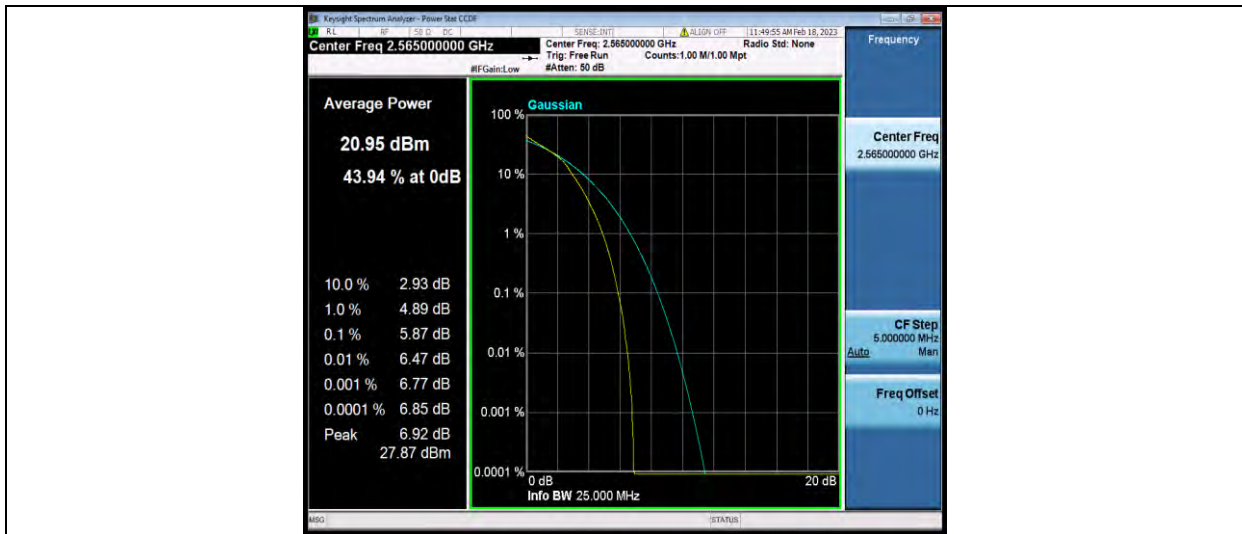

Band7-15MHz-QPSK-20825-1RB#0

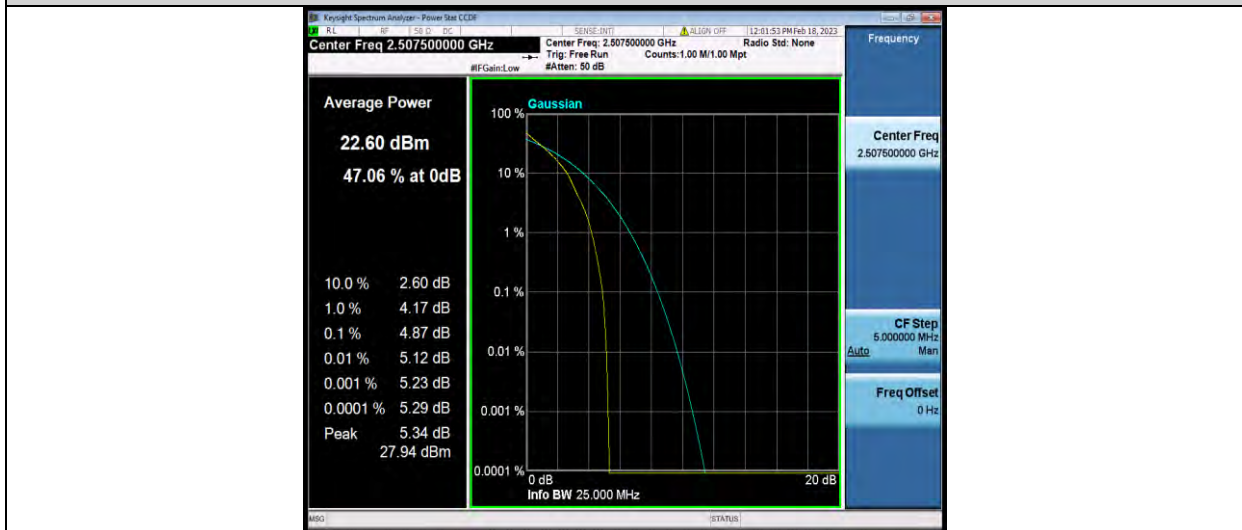

Band7-15MHz-QPSK-20825-75RB#0

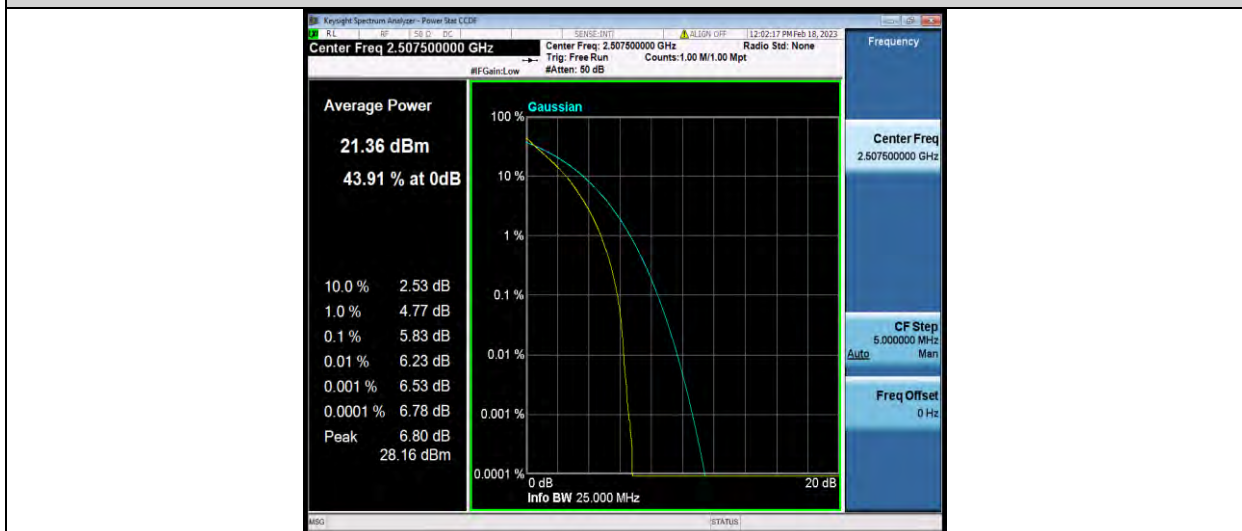

Band7-15MHz-QPSK-21100-1RB#0



BUREAU VERITAS

Test Report No.: W7L-P22120012-1RF04

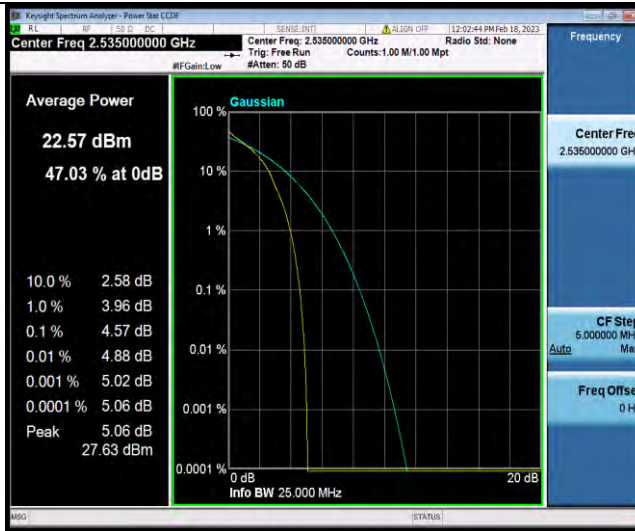

Band7-15MHz-QPSK-21100-75RB#0



Band7-15MHz-QPSK-21375-1RB#0

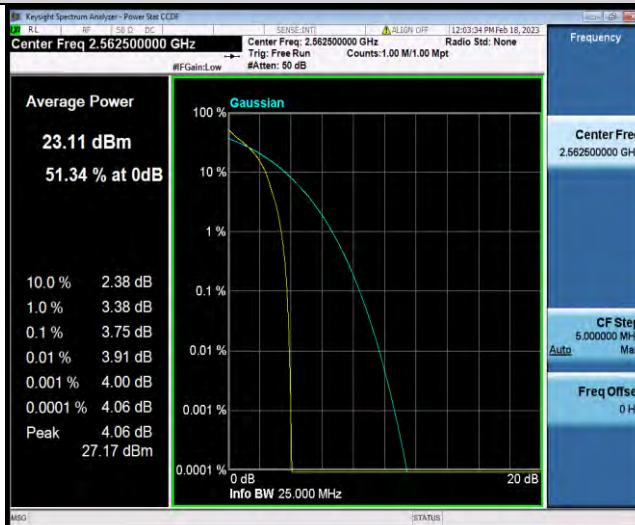

Band7-15MHz-QPSK-21375-75RB#0