



BUREAU
VERITAS



FCC SAR Test Report

Report No. : PSU-QSU2309010210SA01
Applicant : HMD Global Oy
Address : Bertel Jungin aukio 9, 02600 Espoo, Finland
Manufacturer : HMD Global Oy
Address : Bertel Jungin aukio 9, 02600 Espoo, Finland
Product : Mobile Phone
FCC ID : 2AJOTTA-1541
Brand : NOKIA
Model No. : TA-1541
Standards : FCC 47 CFR Part 2 (2.1093) / IEEE C95.1:1992 / IEEE 1528:2013
KDB 865664 D01 v01r04 / KDB 865664 D02 v01r02 / KDB 248227 D01 v02r02
KDB 447498 D04 v01 / KDB 648474 D04 v01r03 / KDB 941225 D01 v03r01
KDB 941225 D05 v02r05 / KDB 941225 D06 v02r01
Sample Received Date : Sep. 08, 2023
Date of Testing : Sep. 17, 2023 ~ Sep. 18, 2023
FCC Designation No. : CN1325 FCC Site Registration No. : 434559

CERTIFICATION: The above equipment have been tested by **Huarui 7layers High Technology (Suzhou) Co., Ltd.**, and found compliance with the requirement of the above standards. The test record, data evaluation & Equipment Under Test (EUT) configurations represented herein are true and accurate accounts of the measurements of the sample's SAR characteristics under the conditions specified in this report. It should not be reproduced except in full, without the written approval of our laboratory. The client should not use it to claim product certification, approval, or endorsement by A2LA or any government agencies.

Prepared By :

Chao Wu

Chao Wu / Engineer

Approved By :

Peibo Sun

Peibo Sun / Manager

This report is governed by, and incorporates by reference, CPS Conditions of Service as posted at the date of issuance of this report at <http://www.bureauveritas.com/home/about-us/our-business/cps/about-us/terms-conditions> and is intended for your exclusive use. Any copying or replication of this report to or for any other person or entity, or use of our name or trademark, is permitted only with our prior written permission. This report sets forth our findings solely with respect to the test samples identified herein. The results set forth in this report are not indicative or representative of the quality or characteristics of the lot from which a test sample was taken or any similar or identical product unless specifically and expressly noted. Our report includes all of the tests requested by you and the results thereof based upon the information that you provided to us. Measurement uncertainty is only provided upon request for accredited tests. You have 60 days from date of issuance of this report to notify us of any material error or omission caused by our negligence or if you require measurement uncertainty; provided, however, that such notice shall be in writing and shall specifically address the issue you wish to raise. A failure to raise such issue within the prescribed time shall constitute your unqualified acceptance of the completeness of this report, the tests conducted and the correctness of the report contents.



BUREAU
VERITAS



Table of Contents

Release Control Record	3
1. Summary of Maximum SAR Value	4
2. Description of Equipment Under Test	5
3. SAR Measurement System	7
3.1 Definition of Specific Absorption Rate (SAR)	7
3.2 SPEAG DASY System	7
3.2.1 Robot.....	8
3.2.2 Probes.....	9
3.2.3 Data Acquisition Electronics (DAE)	9
3.2.4 Phantoms	10
3.2.5 Device Holder.....	11
3.2.6 System Validation Dipoles.....	11
3.2.7 Tissue Simulating Liquids.....	12
3.3 SAR System Verification	14
3.4 SAR Measurement Procedure	15
3.4.1 Area & Zoom Scan Procedure	15
3.4.2 Volume Scan Procedure.....	15
3.4.3 Power Drift Monitoring.....	16
3.4.4 Spatial Peak SAR Evaluation	16
3.4.5 SAR Averaged Methods	16
4. SAR Measurement Evaluation	17
4.1 EUT Configuration and Setting.....	17
4.2 EUT Testing Position.....	22
4.2.1 Head Exposure Conditions.....	22
4.2.2 Body-worn Accessory Exposure Conditions	24
4.2.3 Hotspot Mode Exposure Conditions	25
4.2.4 Extremity Exposure Conditions	26
4.2.5 Simultaneous Transmission Possibilities.....	26
4.2 Tissue Verification	27
4.3 System Verification.....	27
4.4 Maximum Output Power.....	28
4.5.1 Maximum Conducted Power	28
4.5.2 Measured Conducted Power Result.....	28
4.5 SAR Testing Results	28
4.6.1 SAR Test Reduction Considerations	28
4.6.2 SAR Results for Head Exposure Condition	30
4.6.3 SAR Results for Body-worn Exposure Condition (Separation Distance is 1.0 cm Gap).....	30
4.6.4 SAR Results for Hotspot Exposure Condition (Separation Distance is 1.0 cm Gap).....	30
4.6.5 SAR Results for Extremity Exposure Condition (Separation Distance is 0 cm Gap).....	31
4.6.6 SAR Measurement Variability.....	32
4.6.7 Simultaneous Multi-band Transmission Evaluation	33
5. Calibration of Test Equipment.....	39
6. Measurement Uncertainty.....	40
7. Information on the Testing Laboratories	41
Appendix A. SAR Plots of System Verification	
Appendix B. SAR Plots of SAR Measurement	
Appendix C. Calibration Certificate for Probe and Dipole	
Appendix D. Conducted Power Result	
Appendix E. Photographs of EUT and Setup	



Certificate #6613.01

Release Control Record

Report No.	Reason for Change	Date Issued
PSU-QSU2309010210SA01	Initial release	Sep. 23, 2023



BUREAU VERITAS



1. Summary of Maximum SAR Value

Equipment Class	Mode	Highest Reported Head SAR _{1g} (W/kg)	Highest Reported Body-worn SAR _{1g} (1.0 cm Gap) (W/kg)	Highest Reported Hotspot SAR _{1g} (1.0 cm Gap) (W/kg)	Highest Reported Extremity SAR _{10g} (0 cm Gap) (W/kg)
PCE	GSM850	0.24	0.41	0.33	N/A
	GSM1900	0.04	0.61	1.00	2.35
	WCDMA II	0.04	0.79	1.33	2.84
	WCDMA IV	0.18	1.12	1.26	2.55
	WCDMA V	0.24	0.25	0.20	N/A
	LTE 2	0.15	0.94	1.25	2.95
	LTE 5	0.24	0.26	0.10	N/A
	LTE 7	0.05	0.73	1.05	N/A
	LTE 12 / 17	0.13	0.18	0.18	N/A
	LTE 13	0.06	0.07	0.07	N/A
LTE 66 / 4	0.05	0.59	1.20	2.40	
DTS	2.4G WLAN	0.60	0.41	0.41	N/A
DSS	Bluetooth	0.14	0.05	0.05	N/A
Highest Simultaneous Transmission SAR		Head (W/kg)	Body-worn (W/kg)	Hotspot (W/kg)	Extremity (W/kg)
		0.90	1.53	1.53	2.95

Note:

- The SAR limit (Head & Body: SAR_{1g} 1.6 W/kg, Extremity: SAR_{10g} 4.0 W/kg) for general population / uncontrolled exposure is specified in FCC 47 CFR part 2 (2.1093) and ANSI/IEEE C95.1-1992.



2. Description of Equipment Under Test

EUT Type	Mobile Phone
FCC ID	2AJOTTA-1541
Brand Name	NOKIA
Model Name	TA-1541
IMEI Code	Sample1 IMEI 1:359190990118032
HW Version	SPR_S63Q0
SW Version	00WW_0_090
Tx Frequency Bands (Unit: MHz)	GSM850 : 824 ~ 849 GSM1900 : 1850 ~ 1910 WCDMA Band II : 1850 ~ 1910 WCDMA Band IV : 1719 ~ 1755 WCDMA Band V : 824 ~ 849 LTE Band 2 : 1850 ~ 1910 LTE Band 4 : 1710 ~ 1755 LTE Band 5 : 824 ~ 849 LTE Band 7 : 2500 ~ 2570 LTE Band 12 : 699 ~ 716 LTE Band 13 : 777 ~ 787 LTE Band 17 : 704 ~ 716 LTE Band 66 : 1710 ~ 1780 WLAN : 2412 ~ 2462 Bluetooth : 2402 ~ 2480
Uplink Modulations	GSM & GPRS & EDGE : GMSK, 8PSK WCDMA : QPSK LTE : QPSK, 16QAM, 64QAM 802.11b : DSSS Bluetooth : GFSK, $\pi/4$ -DQPSK, 8-DPSK
Maximum Tune-up Conducted Power (Unit: dBm)	Please refer to section 4.5.1 of this report.
Antenna Type	WWAN: Fixed Internal Antenna WLAN: PIFA Antenna
EUT Stage	Identical Prototype

Note:

1. The above EUT information is declared by manufacturer and for more detailed features description please refers to the manufacturer's specifications or User's Manual.
2. According to the product equality declaration provided by the manufacturer, the model TA-1541 adds 2G PA second supply, other changes do not affect RF performance. Therefore, verify the worst case of the original report. (Report No:PSU-NQN2302240313SA02, issued by: Huarui 7layers High Technology (Suzhou) Co., Ltd.)

BUREAU
VERITAS

FCC SAR Test Report



Certificate #6613.01

component		First supply		Second supply	
		Supplier	Spec	Supplier	Spec
PCBA	64GB EMMC	Longsys	FEMDNN064G-A3A56 BWCTARV11X64G	Biwin	FEMDNN064G-A3A56 BWCTARV11X64G
	2GB LPDDR	Longsys	FLXC2002G-N2 BWMZEX32H2A-16G-X	Biwin	FLXC2002G-N2 BWMZEX32H2A-16G-X
	3GB LPDDR	Longsys	FLXC4003G-50 BWMEXX32H2A-24Gb-X	Biwin	FLXC4003G-50 BWMEXX32H2A-24Gb-X
	4GB LPDDR	Longsys	FLXC2004G-30 BWMZCX32H2A-32G-X	Biwin	FLXC2004G-30 BWMZCX32H2A-32G-X
	PCB	KINGSHINE	/	WUZHU	/
LCM	LCD	TCL	6.517 HKC · 360min,400typ, 2.5D	Lian Chuang	6.517 BOE (B8) · 360min,400typ, 2.5D
Front camera	Camera	Lian Heyingxiang	8M FF COM	Shijia	8M FF COM
Rear camera	Camera	Lian Heyingxiang	13M-AF COB	Ruicheng	13M-AF COB
Macro CAM	Camera	Shijia	2M FF	Lian Heyingxiang	2M FF
fingerprint	module	Hedayuan	Back fingerprint	Sanyingxin	Back fingerprint
Speaker		Dong Sheng	1712 1W	Xin Rongda	1712 1W
Vibrator		Kai Long	1027 FPC	Chao Yin	1027 FPC
Receiver		Dong Sheng	0809	Xin Rongda	0809
FPC		Lante	/	Kaihongxing	/
Battery		Gaoyuan	5000MAH	Feng Hua	5000MAH
Data cable		Yuwei	2A typeC ·	Juwei	2A typeC ·



3. SAR Measurement System

3.1 Definition of Specific Absorption Rate (SAR)

SAR is related to the rate at which energy is absorbed per unit mass in an object exposed to a radio field. The SAR distribution in a biological body is complicated and is usually carried out by experimental techniques or numerical modeling. The standard recommends limits for two tiers of groups, occupational/controlled and general population/uncontrolled, based on a person's awareness and ability to exercise control over his or her exposure. In general, occupational/controlled exposure limits are higher than the limits for general population/uncontrolled.

The SAR definition is the time derivative (rate) of the incremental energy (dW) absorbed by (dissipated in) an incremental mass (dm) contained in a volume element (dv) of a given density (ρ). The equation description is as below:

$$SAR = \frac{d}{dt} \left(\frac{dW}{dm} \right) = \frac{d}{dt} \left(\frac{dW}{\rho dv} \right)$$

SAR is expressed in units of Watts per kilogram (W/kg)

SAR measurement can be related to the electrical field in the tissue by

$$SAR = \frac{\sigma |E|^2}{\rho}$$

Where: σ is the conductivity of the tissue, ρ is the mass density of the tissue and E is the RMS electrical field strength.

3.2 SPEAG DASY System

DASY system consists of high precision robot, probe alignment sensor, phantom, robot controller, controlled measurement server and near-field probe. The robot includes six axes that can move to the precision position of the DASY5 software defined. The DASY software can define the area that is detected by the probe. The robot is connected to controlled box. Controlled measurement server is connected to the controlled robot box. The DAE includes amplifier, signal multiplexing, AD converter, offset measurement and surface detection. It is connected to the Electro-optical coupler (ECO). The ECO performs the conversion from the optical into digital electric signal of the DAE and transfers data to the PC.

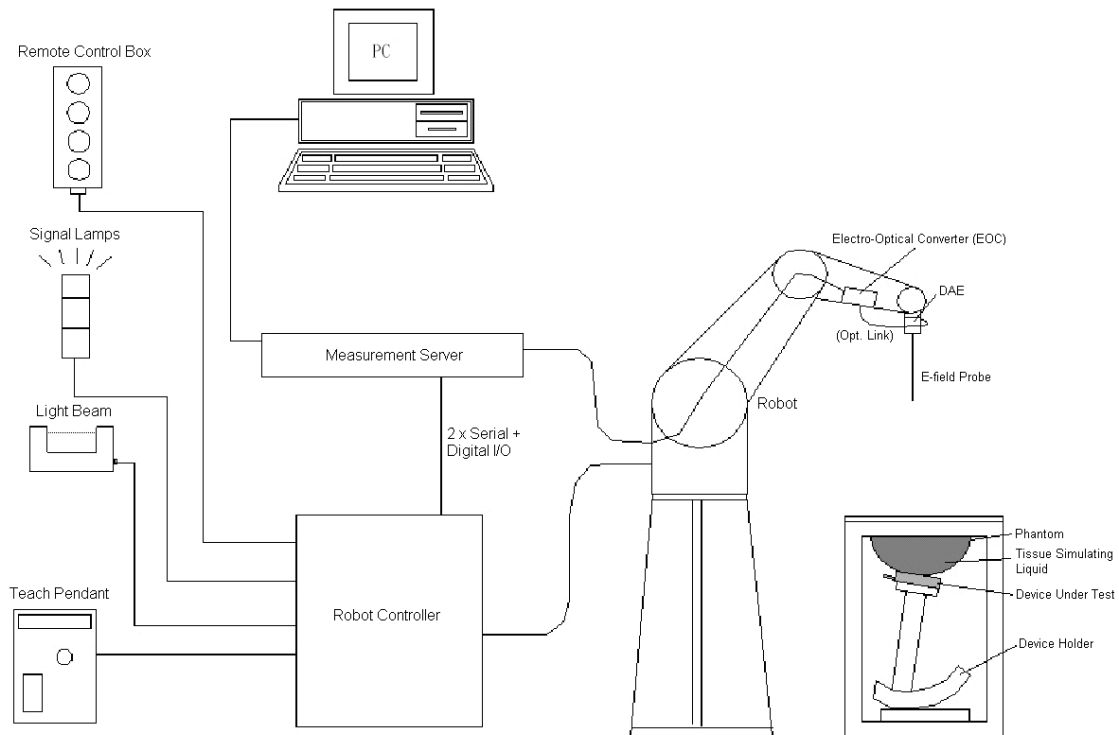
**Fig-3.1 DASY System Setup**

3.2.1 Robot

The DASY system uses the high precision robots from Stäubli SA (France). For the 6-axis controller system, the robot controller version (DASY6 : CS8c) from Stäubli is used. The Stäubli robot series have many features that are important for our application:

- High precision (repeatability ± 0.035 mm)
- High reliability (industrial design)
- Jerk-free straight movements
- Low ELF interference (the closed metallic construction shields against motor control fields)

**Fig-3.2 DASY6**

3.2.2 Probes

The SAR measurement is conducted with the dosimetric probe. The probe is specially designed and calibrated for use in liquid with high permittivity. The dosimetric probe has special calibration in liquid at different frequency.

Model	EX3DV4	
Construction	Symmetrical design with triangular core. Built-in shielding against static charges. PEEK enclosure material (resistant to organic solvents, e.g., DGBE).	
Frequency	10 MHz to 6 GHz Linearity: ± 0.2 dB	
Directivity	± 0.3 dB in HSL (rotation around probe axis) ± 0.5 dB in tissue material (rotation normal to probe axis)	
Dynamic Range	10 μ W/g to 100 mW/g Linearity: ± 0.2 dB (noise: typically < 1 μ W/g)	
Dimensions	Overall length: 337 mm (Tip: 20 mm) Tip diameter: 2.5 mm (Body: 12 mm) Typical distance from probe tip to dipole centers: 1 mm	

Model	ES3DV3	
Construction	Symmetrical design with triangular core. Interleaved sensors. Built-in shielding against static charges. PEEK enclosure material (resistant to organic solvents, e.g., DGBE).	
Frequency	10 MHz to 4 GHz Linearity: ± 0.2 dB	
Directivity	± 0.2 dB in HSL (rotation around probe axis) ± 0.3 dB in tissue material (rotation normal to probe axis)	
Dynamic Range	5 μ W/g to 100 mW/g Linearity: ± 0.2 dB	
Dimensions	Overall length: 337 mm (Tip: 20 mm) Tip diameter: 3.9 mm (Body: 12 mm) Distance from probe tip to dipole centers: 2.0 mm	

3.2.3 Data Acquisition Electronics (DAE)

Model	DAE3, DAE4	
Construction	Signal amplifier, multiplexer, A/D converter and control logic. Serial optical link for communication with DASY embedded system (fully remote controlled). Two step probe touch detector for mechanical surface detection and emergency robot stop.	
Measurement Range	-100 to +300 mV (16 bit resolution and two range settings: 4mV, 400mV)	
Input Offset Voltage	$< 5\mu$ V (with auto zero)	
Input Bias Current	< 50 fA	
Dimensions	60 x 60 x 68 mm	

3.2.4 Phantoms

Model	Twin SAM	
Construction	The shell corresponds to the specifications of the Specific Anthropomorphic Mannequin (SAM) phantom defined in IEEE 1528 and IEC 62209-1. It enables the dosimetric evaluation of left and right hand phone usage as well as body mounted usage at the flat phantom region. A cover prevents evaporation of the liquid. Reference markings on the phantom allow the complete setup of all predefined phantom positions and measurement grids by teaching three points with the robot.	
Material	Vinylester, glass fiber reinforced (VE-GF)	
Shell Thickness	2 ± 0.2 mm (6 ± 0.2 mm at ear point)	
Dimensions	Length: 1000 mm Width: 500 mm Height: adjustable feet	
Filling Volume	approx. 25 liters	

Model	ELI	
Construction	Phantom for compliance testing of handheld and body-mounted wireless devices in the frequency range of 30 MHz to 6 GHz. ELI is fully compatible with the IEC 62209-2 standard and all known tissue simulating liquids. ELI has been optimized regarding its performance and can be integrated into our standard phantom tables. A cover prevents evaporation of the liquid. Reference markings on the phantom allow installation of the complete setup, including all predefined phantom positions and measurement grids, by teaching three points. The phantom is compatible with all SPEAG dosimetric probes and dipoles.	
Material	Vinylester, glass fiber reinforced (VE-GF)	
Shell Thickness	2.0 ± 0.2 mm (bottom plate)	
Dimensions	Major axis: 600 mm Minor axis: 400 mm	
Filling Volume	approx. 30 liters	

3.2.5 Device Holder

Model	Mounting Device	
Construction	In combination with the Twin SAM Phantom or ELI4, the Mounting Device enables the rotation of the mounted transmitter device in spherical coordinates. Rotation point is the ear opening point. Transmitter devices can be easily and accurately positioned according to IEC, IEEE, FCC or other specifications. The device holder can be locked for positioning at different phantom sections (left head, right head, flat).	
Material	POM	

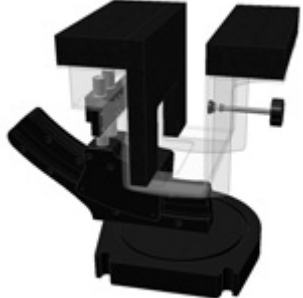
Model	Laptop Extensions Kit	
Construction	Simple but effective and easy-to-use extension for Mounting Device that facilitates the testing of larger devices according to IEC 62209-2 (e.g., laptops, cameras, etc.). It is lightweight and fits easily on the upper part of the Mounting Device in place of the phone positioner.	
Material	POM, Acrylic glass, Foam	

3.2.6 System Validation Dipoles

Model	D-Serial	
Construction	Symmetrical dipole with 1/4 balun. Enables measurement of feed point impedance with NWA. Matched for use near flat phantoms filled with tissue simulating solutions.	
Frequency	750 MHz to 5800 MHz	
Return Loss	> 20 dB	
Power Capability	> 100 W (f < 1GHz), > 40 W (f > 1GHz)	

3.2.7 Tissue Simulating Liquids

For SAR measurement of the field distribution inside the phantom, the phantom must be filled with homogeneous tissue simulating liquid to a depth of at least 15 cm. For head SAR testing, the liquid height from the ear reference point (ERP) of the phantom to the liquid top surface is larger than 15 cm. For body SAR testing, the liquid height from the center of the flat phantom to the liquid top surface is larger than 15 cm. The nominal dielectric values of the tissue simulating liquids in the phantom and the tolerance of 5% are listed in Table-3.1.

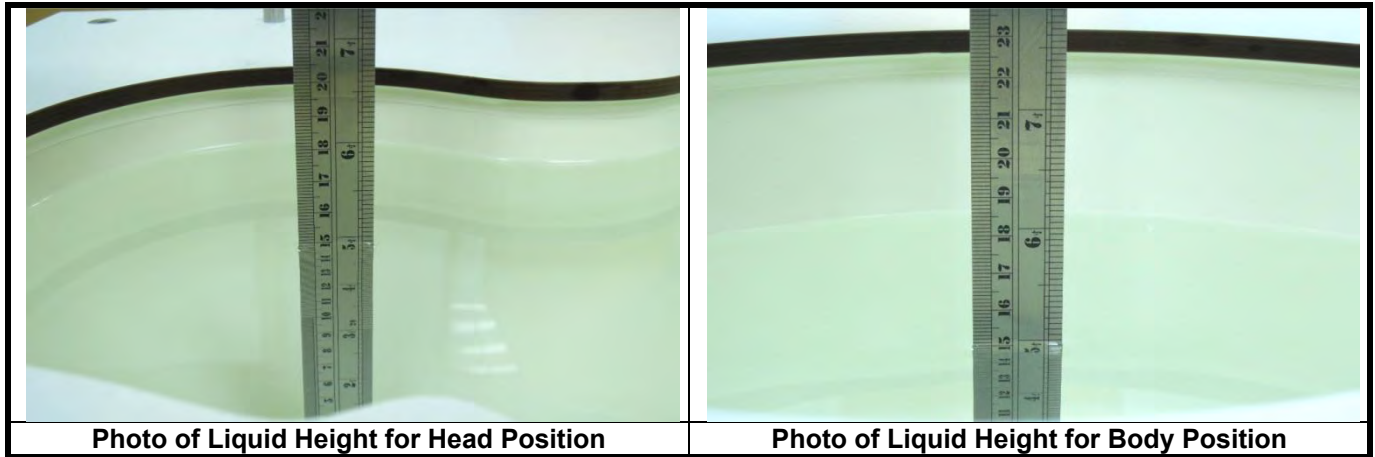

The dielectric properties of the head tissue simulating liquids are defined in IEEE 1528, and KDB 865664 D01 Appendix A. For the body tissue simulating liquids, the dielectric properties are defined in KDB 865664 D01 Appendix A. The dielectric properties of the tissue simulating liquids were verified prior to the SAR evaluation using a dielectric assessment kit and a network analyzer.



Table-3.1 Targets of Tissue Simulating Liquid

Frequency (MHz)	Target Permittivity	Range of $\pm 5\%$	Target Conductivity	Range of $\pm 5\%$
For Head				
750	41.9	39.8 ~ 44.0	0.89	0.85 ~ 0.93
835	41.5	39.4 ~ 43.6	0.90	0.86 ~ 0.95
900	41.5	39.4 ~ 43.6	0.97	0.92 ~ 1.02
1450	40.5	38.5 ~ 42.5	1.20	1.14 ~ 1.26
1640	40.3	38.3 ~ 42.3	1.29	1.23 ~ 1.35
1750	40.1	38.1 ~ 42.1	1.37	1.30 ~ 1.44
1800	40.0	38.0 ~ 42.0	1.40	1.33 ~ 1.47
1900	40.0	38.0 ~ 42.0	1.40	1.33 ~ 1.47
2000	40.0	38.0 ~ 42.0	1.40	1.33 ~ 1.47
2300	39.5	37.5 ~ 41.5	1.67	1.59 ~ 1.75
2450	39.2	37.2 ~ 41.2	1.80	1.71 ~ 1.89
2600	39.0	37.1 ~ 41.0	1.96	1.86 ~ 2.06
3500	37.9	36.0 ~ 39.8	2.91	2.76 ~ 3.06
5200	36.0	34.2 ~ 37.8	4.66	4.43 ~ 4.89
5300	35.9	34.1 ~ 37.7	4.76	4.52 ~ 5.00
5500	35.6	33.8 ~ 37.4	4.96	4.71 ~ 5.21
5600	35.5	33.7 ~ 37.3	5.07	4.82 ~ 5.32
5800	35.3	33.5 ~ 37.1	5.27	5.01 ~ 5.53

The following table gives the recipes for tissue simulating liquids.

Table-3.2 Recipes of Tissue Simulating Liquid

Tissue Type	Bactericide	DGBE	HEC	NaCl	Sucrose	Triton X-100	Water	Diethylene Glycol Mono-hexylether
H750	0.2	-	0.2	1.5	56.0	-	42.1	-
H835	0.2	-	0.2	1.5	57.0	-	41.1	-
H900	0.2	-	0.2	1.4	58.0	-	40.2	-
H1450	-	43.3	-	0.6	-	-	56.1	-
H1640	-	45.8	-	0.5	-	-	53.7	-
H1750	-	47.0	-	0.4	-	-	52.6	-
H1800	-	44.5	-	0.3	-	-	55.2	-
H1900	-	44.5	-	0.2	-	-	55.3	-
H2000	-	44.5	-	0.1	-	-	55.4	-
H2300	-	44.9	-	0.1	-	-	55.0	-
H2450	-	45.0	-	0.1	-	-	54.9	-
H2600	-	45.1	-	0.1	-	-	54.8	-
H3500	-	28.0	-	0.2	-	20.0	71.8	-
H5G	-	-	-	-	-	17.2	65.5	17.3

3.3 SAR System Verification

The system check verifies that the system operates within its specifications. It is performed daily or before every SAR measurement. The system check uses normal SAR measurements in the flat section of the phantom with a matched dipole at a specified distance. The system verification setup is shown as below.

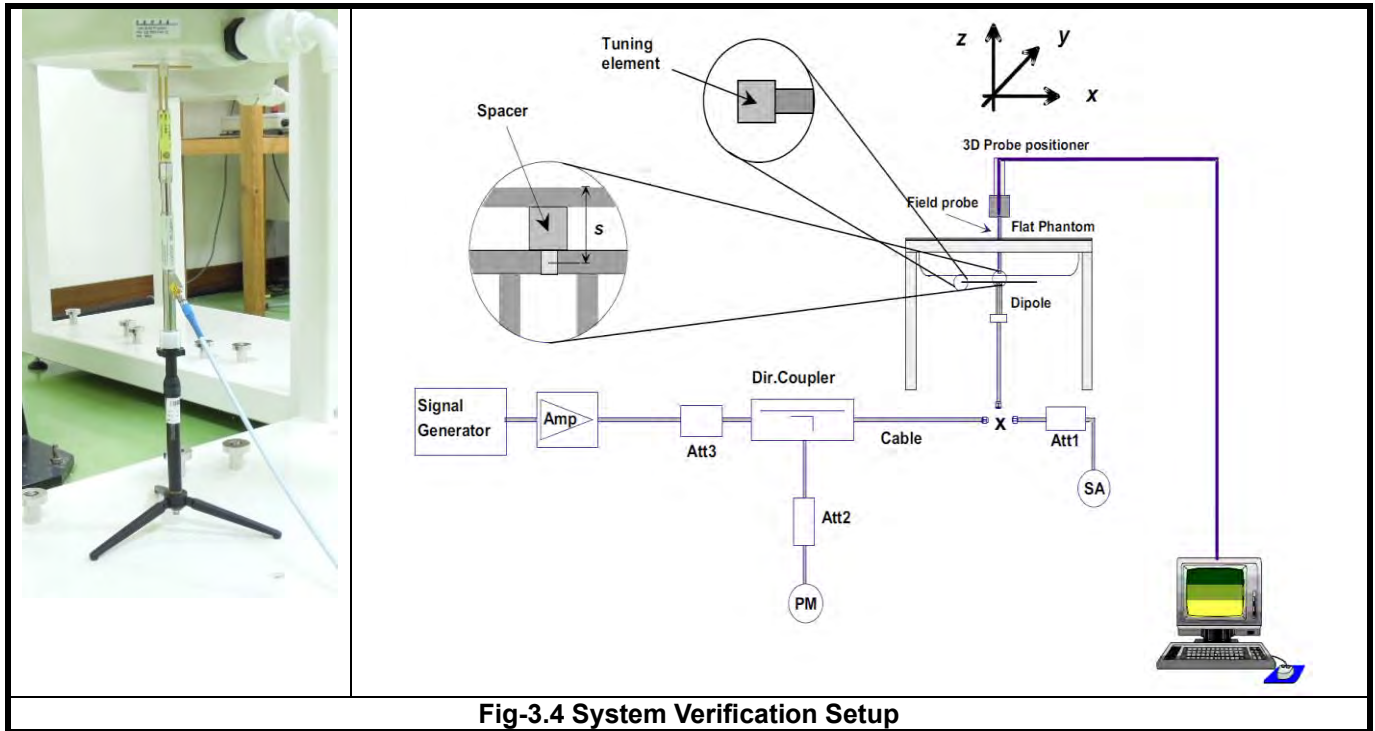

Fig-3.4 System Verification Setup

The validation dipole is placed beneath the flat phantom with the specific spacer in place. The distance spacer is touch the phantom surface with a light pressure at the reference marking and be oriented parallel to the long side of the phantom. The spectrum analyzer measures the forward power at the location of the system check dipole connector. The signal generator is adjusted for the desired forward power (250 mW is used for 700 MHz to 3 GHz, 100 mW is used for 3.5 GHz to 6 GHz) at the dipole connector and the power meter is read at that level. After connecting the cable to the dipole, the signal generator is readjusted for the same reading at power meter.

After system check testing, the SAR result will be normalized to 1W forward input power and compared with the reference SAR value derived from validation dipole certificate report. The deviation of system check should be within 10 %.



3.4 SAR Measurement Procedure

According to the SAR test standard, the recommended procedure for assessing the peak spatial-average SAR value consists of the following steps:

- (a) Power reference measurement
- (b) Area scan
- (c) Zoom scan
- (d) Power drift measurement

The SAR measurement procedures for each of test conditions are as follows:

- (a) Make EUT to transmit maximum output power
- (b) Measure conducted output power through RF cable
- (c) Place the EUT in the specific position of phantom
- (d) Perform SAR testing steps on the DASY system
- (e) Record the SAR value

3.4.1 Area & Zoom Scan Procedure

First Area Scan is used to locate the approximate location(s) of the local peak SAR value(s). The measurement grid within an Area Scan is defined by the grid extent, grid step size and grid offset. Next, in order to determine the EM field distribution in a three-dimensional spatial extension, Zoom Scan is required. The Zoom Scan is performed around the highest E-field value to determine the averaged SAR-distribution over 10 g. According to KDB 865664 D01, the resolution for Area and Zoom scan is specified in the table below.

Items	<= 2 GHz	2-3 GHz	3-4 GHz	4-5 GHz	5-6 GHz
Area Scan ($\Delta x, \Delta y$)	<= 15 mm	<= 12 mm	<= 12 mm	<= 10 mm	<= 10 mm
Zoom Scan ($\Delta x, \Delta y$)	<= 8 mm	<= 5 mm	<= 5 mm	<= 4 mm	<= 4 mm
Zoom Scan (Δz)	<= 5 mm	<= 5 mm	<= 4 mm	<= 3 mm	<= 2 mm
Zoom Scan Volume	>= 30 mm	>= 30 mm	>= 28 mm	>= 25 mm	>= 22 mm

Note:

When zoom scan is required and report SAR is <= 1.4 W/kg, the zoom scan resolution of $\Delta x / \Delta y$ (2-3GHz: <= 8 mm, 3-4GHz: <= 7 mm, 4-6GHz: <= 5 mm) may be applied.

3.4.2 Volume Scan Procedure

The volume scan is used for assess overlapping SAR distributions for antennas transmitting in different frequency bands. It is equivalent to an oversized zoom scan used in standalone measurements. The measurement volume will be used to enclose all the simultaneous transmitting antennas. For antennas transmitting simultaneously in different frequency bands, the volume scan is measured separately in each frequency band. In order to sum correctly to compute the 1g aggregate SAR, the EUT remain in the same test position for all measurements and all volume scan use the same spatial resolution and grid spacing. When all volume scan were completed, the software, SEMCAD postprocessor can combine and subsequently superpose these measurement data to calculating the multiband SAR.

3.4.3 Power Drift Monitoring

All SAR testing is under the EUT install full charged battery and transmit maximum output power. In DASY measurement software, the power reference measurement and power drift measurement procedures are used for monitoring the power drift of EUT during SAR test. Both these procedures measure the field at a specified reference position before and after the SAR testing. The software will calculate the field difference in dB. If the power drift more than 5%, the SAR will be retested.

3.4.4 Spatial Peak SAR Evaluation

The procedure for spatial peak SAR evaluation has been implemented according to the test standard. It can be conducted for 1g and 10g, as well as for user-specific masses. The DASY software includes all numerical procedures necessary to evaluate the spatial peak SAR value.

The base for the evaluation is a "cube" measurement. The measured volume must include the 1g and 10g cubes with the highest averaged SAR values. For that purpose, the center of the measured volume is aligned to the interpolated peak SAR value of a previously performed area scan.

The entire evaluation of the spatial peak values is performed within the post-processing engine (SEMCAD). The system always gives the maximum values for the 1g and 10g cubes. The algorithm to find the cube with highest averaged SAR is divided into the following stages:

- (a) Extraction of the measured data (grid and values) from the Zoom Scan
- (b) Calculation of the SAR value at every measurement point based on all stored data (A/D values and measurement parameters)
- (c) Generation of a high-resolution mesh within the measured volume
- (d) Interpolation of all measured values from the measurement grid to the high-resolution grid
- (e) Extrapolation of the entire 3-D field distribution to the phantom surface over the distance from sensor to surface
- (f) Calculation of the averaged SAR within masses of 1g and 10g

3.4.5 SAR Averaged Methods

In DASY, the interpolation and extrapolation are both based on the modified Quadratic Shepard's method. The interpolation scheme combines a least-square fitted function method and a weighted average method which are the two basic types of computational interpolation and approximation.

Extrapolation routines are used to obtain SAR values between the lowest measurement points and the inner phantom surface. The extrapolation distance is determined by the surface detection distance and the probe sensor offset. The uncertainty increases with the extrapolation distance. To keep the uncertainty within 1% for the 1 g and 10 g cubes, the extrapolation distance should not be larger than 5 mm.



4. SAR Measurement Evaluation

4.1 EUT Configuration and Setting

<Connections between EUT and System Simulator>

For WWAN SAR testing, the EUT was linked and controlled by base station emulator (CMW500 is used for GSM/WCDMA/and LTE). Communication between the EUT and the emulator was established by air link. The distance between the EUT and the communicating antenna of the emulator is larger than 50 cm and the output power radiated from the emulator antenna is at least 30 dB smaller than the output power of EUT. The EUT was set from the emulator to radiate maximum output power during SAR testing.

<Considerations Related to GSM / GPRS / EDGE for Setup and Testing>

The maximum multi-slot capability supported by this device is as below.

1. This EUT is class B device
2. This EUT supports GPRS multi-slot class 12 (max. uplink: 4, max. downlink: 4, total timeslots: 5)
3. This EUT supports EDGE multi-slot class 12 (max. uplink: 4, max. downlink: 4, total timeslots: 5)

For GSM850 frequency band, the power control level is set to 5 for GSM mode and GPRS (GMSK: CS1), and set to 8 for EDGE (GMSK: MCS1, 8PSK: MCS9). For GSM1900 frequency band, the power control level is set to 0 for GSM mode and GPRS (GMSK: CS1), and set to 2 for EDGE (GMSK: MCS1, 8PSK: MCS9).

SAR test reduction for GPRS and EDGE modes is determined by the source-based time-averaged output power specified for production units, including tune-up tolerance. The data mode with highest specified time-averaged output power should be tested for SAR compliance in the applicable exposure conditions. For modes with the same specified maximum output power and tolerance, the higher number time-slot configuration should be tested.

<Considerations Related to WCDMA for Setup and Testing>

WCDMA Handsets Head SAR

SAR for next to the ear head exposure is measured using a 12.2 kbps RMC with TPC bits configured to all "1's". The 3G SAR test reduction procedure is applied to AMR configurations with 12.2 kbps RMC as the primary mode.

WCDMA Handsets Body-worn SAR

SAR for body-worn configurations is measured using a 12.2 kbps RMC with TPC bits configured to all "1's". The 3G SAR test reduction procedure is applied to other spreading codes and multiple DPDCH_n configurations supported by the handset with 12.2 kbps RMC as the primary mode.

Handsets with Release 5 HSDPA

The 3G SAR test reduction procedure is applied to HSDPA body-worn configurations with 12.2 kbps RMC as the primary mode. Otherwise, SAR is measured for HSDPA using the HSDPA body SAR procedures in the "Release 5 HSDPA Data Devices", for the highest reported SAR body-worn exposure configuration in 12.2 kbps RMC. Handsets with both HSDPA and HSUPA are tested according to Release 6 HSPA test procedures.

Handsets with Release 6 HSUPA

The 3G SAR test reduction procedure is applied to HSPA (HSUPA/HSDPA with RMC) body-worn configurations with

BUREAU
VERITAS

12.2 kbps RMC as the primary mode. Otherwise, SAR is measured for HSPA using the HSPA body SAR procedures in the “Release 6 HSPA Data Devices”, for the highest reported body-worn exposure SAR configuration in 12.2 kbps RMC. When VOIP is applicable for next to the ear head exposure in HSPA, the 3G SAR test reduction procedure is applied to HSPA with 12.2 kbps RMC as the primary mode; otherwise, the same HSPA configuration used for body-worn measurements is tested for next to the ear head exposure.

Release 5 HSDPA Data Devices

The 3G SAR test reduction procedure is applied to body SAR with 12.2 kbps RMC as the primary mode. Otherwise, body SAR for HSDPA is measured using an FRC with H-Set 1 in Sub-test 1 and a 12.2 kbps RMC configured in Test Loop Mode 1, for the highest reported SAR configuration in 12.2 kbps RMC without HSDPA. HSDPA is configured according to the applicable UE category of a test device. The number of HS-DSCH / HS-PDSCHs, HARQ processes, minimum inter-TTI interval, transport block sizes and RV coding sequence are defined by the H-set. To maintain a consistent test configuration and stable transmission conditions, QPSK is used in the H-set for SAR testing. HS-DPCCH should be configured with a CQI feedback cycle of 4 ms and a CQI repetition factor of 2 to maintain a constant rate of active CQI slots. DPCCH and DPDCH gain factors (β_c , β_d), and HS-DPCCH power offset parameters (Δ_{ACK} , Δ_{NACK} , Δ_{CQI}) are set according to values indicated in below. The CQI value is determined by the UE category, transport block size, number of HS-PDSCHs and modulation used in the H-set.

Sub-test	β_c	β_d	β_d (SF)	β_c / β_d	$\beta_{hs}^{(1)}$	CM (dB) ⁽²⁾	MPR
1	2 / 15	15 / 15	64	2 / 15	4 / 15	0.0	0
2	12 / 15 ⁽³⁾	15 / 15 ⁽³⁾	64	12 / 15 ⁽³⁾	24 / 15	1.0	0
3	15 / 15	8 / 15	64	15 / 8	30 / 15	1.5	0.5
4	15 / 15	4 / 15	64	15 / 4	30 / 15	1.5	0.5

Note 1: Δ_{ACK} , Δ_{NACK} and $\Delta_{CQI} = 8 \Leftrightarrow A_{hs} = \beta_{hs} / \beta_c = 30 / 15 \Leftrightarrow \beta_{hs} = 30 / 15 * \beta_c$
Note 2: CM = 1 for $\beta_c / \beta_d = 12 / 15$, $\beta_{hs} / \beta_c = 24 / 15$
Note 3: For subtest 2 the β_c / β_d ratio of 12 / 15 for the TFC during the measurement period (TF1, TF0) is achieved by setting the signaled gain factors for the reference TFC (TF1, TF1) to $\beta_c = 11 / 15$ and $\beta_d = 15 / 15$.

Release 6 HSUPA Data Devices

The 3G SAR test reduction procedure is applied to body SAR with 12.2 kbps RMC as the primary mode. Otherwise, body SAR for HSPA is measured with E-DCH Sub-test 5, using H-Set 1 and QPSK for FRC and a 12.2 kbps RMC configured in Test Loop Mode 1 and power control algorithm 2, according to the highest reported body SAR configuration in 12.2 kbps RMC without HSPA. When VOIP applies to head exposure, the 3G SAR test reduction procedure is applied with 12.2 kbps RMC as the primary mode. Otherwise, the same HSPA configuration used for body SAR measurements are applied to head exposure testing. Due to inner loop power control requirements in HSPA, a communication test set is required for output power and SAR tests. The 12.2 kbps RMC, FRC H-set 1 and E-DCH configurations for HSPA are configured according to the β values indicated in below.

Sub-test	β_c	β_d	β_d (SF)	β_c / β_d	$\beta_{hs}^{(1)}$	β_{ec}	β_{ed}	β_{ed} (SF)	β_{ed} (codes)	CM ⁽²⁾ (dB)	MPR (dB)	AG ⁽⁴⁾ Index	E-TFCI
1	11 / 15 ⁽³⁾	15 / 15 ⁽³⁾	64	11 / 15 ⁽³⁾	22 / 15	209 / 225	1039 / 225	4	1	1.0	0.0	20	75
2	6 / 15	15 / 15	64	6 / 15	12 / 15	12 / 15	94 / 75	4	1	3.0	2.0	12	67
3	15 / 15	9 / 15	64	15 / 9	30 / 15	30 / 15	$\beta_{ed1}: 47/15$ $\beta_{ed2}: 47/15$	4	2	2.0	1.0	15	92
4	2 / 15	15 / 15	64	2 / 15	4 / 15	2 / 15	56 / 75	4	1	3.0	2.0	17	71



BUREAU VERITAS

FCC SAR Test Report



Certificate #6613.01

5	15 / 15 (4)	15 / 15 (4)	64	15 / 15 (4)	30 / 15	24 / 15	134 / 15	4	1	1.0	0.0	21	81
<p>Note 1: $\Delta_{ACK}, \Delta_{NACK}$ and $\Delta_{COI} = 8 \Leftrightarrow A_{HS} = \beta_{HS} / \beta_C = 30 / 15 \Leftrightarrow \beta_{HS} = 30 / 15 * \beta_C$</p> <p>Note 2: CM = 1 for $\beta_C / \beta_d = 12 / 15, \beta_{HS} / \beta_C = 24 / 15$. For all other combinations of DPDCH, DPCCH, HS-DPCCH, E-DPDCH and E-DPCCH the MPR is based on the relative CM difference.</p> <p>Note 3: For subtest 1 the β_C / β_d ratio of 11 / 15 for the TFC during the measurement period (TF1, TF0) is achieved by setting the signaled gain factors for the reference TFC (TF1, TF1) to $\beta_C = 10 / 15$ and $\beta_d = 15 / 15$.</p> <p>Note 4: For subtest 5 the β_C / β_d ratio of 15 / 15 for the TFC during the measurement period (TF1, TF0) is achieved by setting the signaled gain factors for the reference TFC (TF1, TF1) to $\beta_C = 14 / 15$ and $\beta_d = 15 / 15$.</p> <p>Note 5: Testing UE using E-DPDCH Physical Layer category 1 Sub-test 3 is not required according to TS 25.306 Table 5.1g.</p> <p>Note 6: β_{sd} cannot be set directly: it is set by Absolute Grant Value.</p>													

HSPA+ SAR Guidance

The 3G SAR test reduction procedure is applied to HSPA+ (uplink) with 12.2 kbps RMC as the primary mode. Otherwise, when SAR is required for Rel. 6 HSPA, SAR is required for Rel. 7 HSPA+. Power is measured for HSPA+ that supports uplink 16QAM according to configurations in Table C.11.1.4 of 3GPP TS 34.121-1 to determine SAR test reduction.

DC-HSDPA SAR Guidance

The 3G SAR test reduction procedure is applied to DC-HSDPA with 12.2 kbps RMC as the primary mode. Otherwise, when SAR is required for Rel. 5 HSDPA, SAR is required for Rel. 8 DC-HSDPA. Power is measured for DC-HSDPA according to the H-Set 12, FRC configuration in Table C.8.1.12 of 3GPP TS 34.121-1 to determine SAR test reduction. A primary and a secondary serving HS-DSCH Cell are required to perform the power measurement and for the results to be acceptable.

<Considerations Related to LTE for Setup and Testing>

This device contains LTE transmitter which follows 3GPP standards, supports both QPSK 16QAM and 64QAM modulations, and supported LTE band and channel bandwidth is listed in below. The output power was tested per 3GPP TS 36.521-1 maximum transmit procedures for both QPSK 16QAM and 64QAM modulation. The results please refer to section 4.6 of this report.

EUT Supported LTE Band and Channel Bandwidth						
LTE Band	BW 1.4 MHz	BW 3 MHz	BW 5 MHz	BW 10 MHz	BW 15 MHz	BW 20 MHz
2	V	V	V	V	V	V
4	V	V	V	V	V	V
5	V	V	V	V		
7			V	V	V	V
12	V	V	V	V		
13			V	V		
17			V	V		
66	V	V	V	V	V	V

The LTE maximum power reduction (MPR) in accordance with 3GPP TS 36.101 is active all times during LTE operation. The allowed MPR for the maximum output power is specified in below.

Modulation	Channel Bandwidth / RB Configurations						LTE MPR Setting (dB)
	BW 1.4 MHz	BW 3 MHz	BW 5 MHz	BW 10 MHz	BW 15 MHz	BW 20 MHz	
QPSK	> 5	> 4	> 8	> 12	> 16	> 18	1
16QAM	<= 5	<= 4	<= 8	<= 12	<= 16	<= 18	1
16QAM	> 5	> 4	> 8	> 12	> 16	> 18	2
64QAM	<= 5	<= 4	<= 8	<= 12	<= 16	<= 18	2



BUREAU
VERITAS



64QAM	> 5	> 4	> 8	> 12	> 16	> 18	3
-------	-----	-----	-----	------	------	------	---

Note: MPR is according to the standard and implemented in the circuit (mandatory).

In addition, the device is compliant with additional maximum power reduction (A-MPR) requirements defined in 3GPP TS 36.101 section 6.2.4 that was disabled for all FCC compliance testing.

During LTE SAR testing, the related parameters of operating band, channel bandwidth, uplink channel number, modulation type, and RB was set in base station simulator. When the EUT has registered and communicated to base station simulator, the simulator set to make EUT transmitting the maximum radiated power.

<Considerations Related to WLAN for Setup and Testing>

In general, various vendor specific external test software and chipset based internal test modes are typically used for SAR measurement. These chipset based test mode utilities are generally hardware and manufacturer dependent, and often include substantial flexibility to reconfigure or reprogram a device. A Wi-Fi device must be configured to transmit continuously at the required data rate, channel bandwidth and signal modulation, using the highest transmission duty factor supported by the test mode tools for SAR measurement. The test frequencies established using test mode must correspond to the actual channel frequencies. When 802.11 frame gaps are accounted for in the transmission, a maximum transmission duty factor of 92 - 96% is typically achievable in most test mode configurations. A minimum transmission duty factor of 85% is required to avoid certain hardware and device implementation issues related to wide range SAR scaling. In addition, a periodic transmission duty factor is required for current generation SAR systems to measure SAR correctly. The reported SAR must be scaled to 100% transmission duty factor to determine compliance at the maximum tune-up tolerance limit.

According to KDB 248227 D01, this device has installed WLAN engineering testing software which can provide continuous transmitting RF signal. During WLAN SAR testing, this device was operated to transmit continuously at the maximum transmission duty with specified transmission mode, operating frequency, lowest data rate, and maximum output power.

Initial Test Configuration

An initial test configuration is determined for OFDM transmission modes in 2.4 GHz and 5 GHz bands according to the channel bandwidth, modulation and data rate combination(s) with the highest maximum output power specified for production units in each standalone and aggregated frequency band. When the same maximum power is specified for multiple transmission modes in a frequency band, the largest channel bandwidth, lowest order modulation, lowest data rate and lowest order 802.11a/g/n/ac mode is used for SAR measurement, on the highest measured output power channel in the initial test configuration, for each frequency band.

Subsequent Test Configuration

SAR measurement requirements for the remaining 802.11 transmission mode configurations that have not been tested in the initial test configuration are determined separately for each standalone and aggregated frequency band, in each exposure condition, according to the maximum output power specified for production units. Additional power measurements may be required to determine if SAR measurements are required for subsequent highest output power channels in a subsequent test configuration. When the highest reported SAR for the initial test configuration according to the initial test position or fixed exposure position requirements, is adjusted by the ratio of the



BUREAU
VERITAS



subsequent test configuration to initial test configuration specified maximum output power and the adjusted SAR is ≤ 1.2 W/kg, SAR is not required for that subsequent test configuration.

SAR Test Configuration and Channel Selection

When multiple channel bandwidth configurations in a frequency band have the same specified maximum output power, the initial test configuration is using largest channel bandwidth, lowest order modulation, lowest data rate, and lowest order 802.11 mode (i.e., 802.11a is chosen over 802.11n then 802.11ac or 802.11g is chosen over 802.11n). After an initial test configuration is determined, if multiple test channels have the same measured maximum output power, the channel chosen for SAR measurement is determined according to the following.

- 1) The channel closest to mid-band frequency is selected for SAR measurement.
- 2) For channels with equal separation from mid-band frequency; for example, high and low channels or two mid-band channels, the higher frequency (number) channel is selected for SAR measurement.

<Considerations Related to Bluetooth for Setup and Testing>

This device has installed Bluetooth engineering testing software which can provide continuous transmitting RF signal. During Bluetooth SAR testing, this device was operated to transmit continuously at the maximum transmission duty with specified transmission mode, operating frequency, lowest data rate, and maximum output power

4.2 EUT Testing Position

According to KDB 648474 D04, handsets are tested for SAR compliance in head, body-worn accessory and other use configurations described in the following subsections.

4.2.1 Head Exposure Conditions

Head exposure is limited to next to the ear voice mode operations. Head SAR compliance is tested according to the test positions defined in IEEE Std 1528-2013 using the SAM phantom illustrated as below.

1. Define two imaginary lines on the handset

- (a) The vertical centerline passes through two points on the front side of the handset - the midpoint of the width w_t of the handset at the level of the acoustic output, and the midpoint of the width w_b of the bottom of the handset.
- (b) The horizontal line is perpendicular to the vertical centerline and passes through the center of the acoustic output. The horizontal line is also tangential to the face of the handset at point A.
- (c) The two lines intersect at point A. Note that for many handsets, point A coincides with the center of the acoustic output; however, the acoustic output may be located elsewhere on the horizontal line. Also note that the vertical centerline is not necessarily parallel to the front face of the handset, especially for clamshell handsets, handsets with flip covers, and other irregularly shaped handsets.

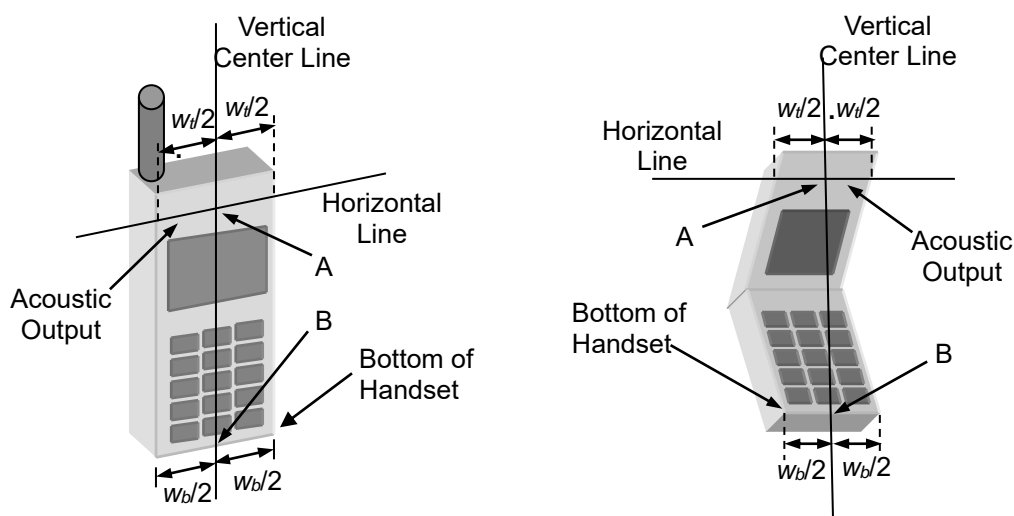

Fig-4.1 Illustration for Handset Vertical and Horizontal Reference Lines

2. Cheek Position

- (a) To position the device with the vertical center line of the body of the device and the horizontal line crossing the center piece in a plane parallel to the sagittal plane of the phantom. While maintaining the device in this plane, align the vertical center line with the reference plane containing the three ear and mouth reference point (M: Mouth, RE: Right Ear, and LE: Left Ear) and align the center of the ear piece with the line RE-LE.
- (b) To move the device towards the phantom with the ear piece aligned with the line LE-RE until the phone touched the ear. While maintaining the device in the reference plane and maintaining the phone contact with the ear, move the bottom of the phone until any point on the front side is in contact with the cheek of the phantom or until contact with the ear is lost (see Fig-4.2).

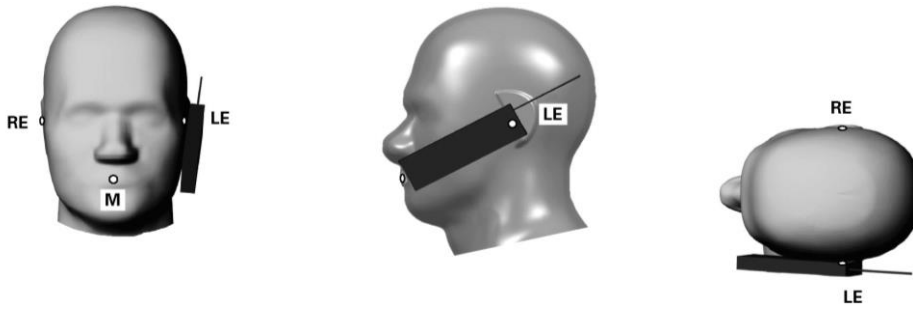

Fig-4.2 Illustration for Cheek Position

3. Tilted Position

- (a) To position the device in the “cheek” position described above.
- (b) While maintaining the device the reference plane described above and pivoting against the ear, moves it outward away from the mouth by an angle of 15 degrees or until contact with the ear is lost (see Fig-4.3).

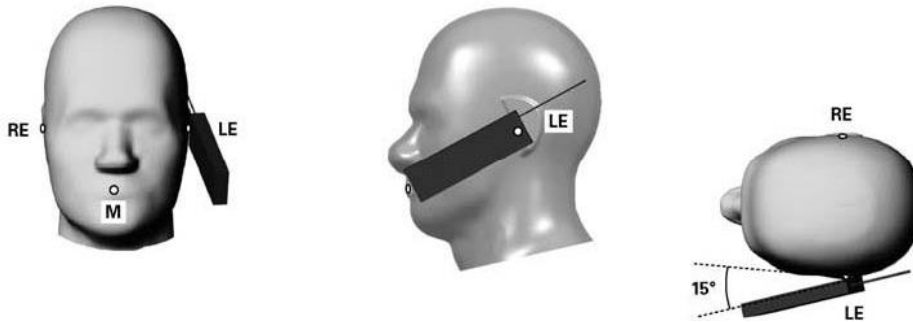

Fig-4.3 Illustration for Tilted Position

4.2.2 Body-worn Accessory Exposure Conditions

Body-worn accessory exposure is typically related to voice mode operations when handsets are carried in body-worn accessories. The body-worn accessory procedures in KDB 447498 D01 are used to test for body-worn accessory SAR compliance, without a headset connected to it. This enables the test results for such configuration to be compatible with that required for hotspot mode when the body-worn accessory test separation distance is greater than or equal to that required for hotspot mode. When the reported SAR for a body-worn accessory, measured without a headset connected to the handset, is $> 1.2 \text{ W/kg}$, the highest reported SAR configuration for that wireless mode and frequency band should be repeated for that body-worn accessory with a headset attached to the handset.

Body-worn accessories that do not contain metallic or conductive components may be tested according to worst-case exposure configurations, typically according to the smallest test separation distance required for the group of body-worn accessories with similar operating and exposure characteristics. All body-worn accessories containing metallic components are tested in conjunction with the host device.

Body-worn accessory SAR compliance is based on a single minimum test separation distance for all wireless and operating modes applicable to each body-worn accessory used by the host, and according to the relevant voice and/or data mode transmissions and operations. If a body-worn accessory supports voice only operations in its normal and expected use conditions, testing of data mode for body-worn compliance is not required.

A conservative minimum test separation distance for supporting off-the-shelf body-worn accessories that may be acquired by users of consumer handsets is used to test for body-worn accessory SAR compliance. This distance is determined by the handset manufacturer, according to the requirements of Supplement C 01-01. Devices that are designed to operate on the body of users using lanyards and straps, or without requiring additional body-worn accessories, will be tested using a conservative minimum test separation distance $\leq 5 \text{ mm}$ to support compliance.

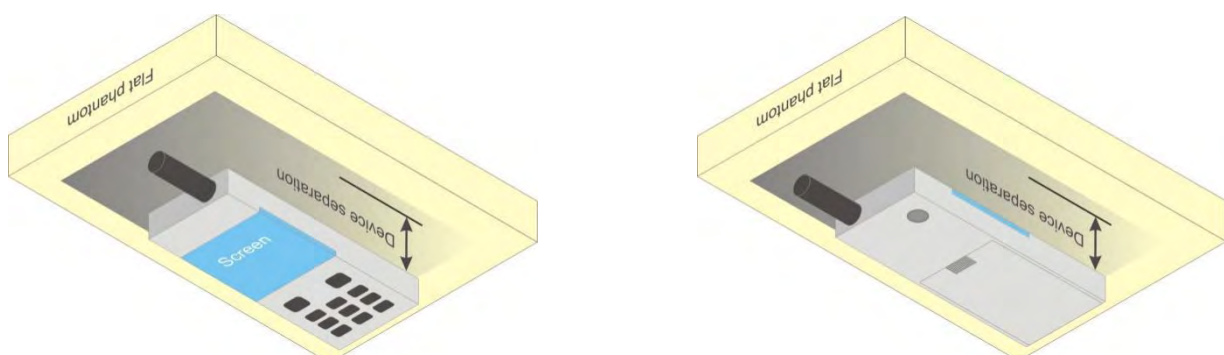
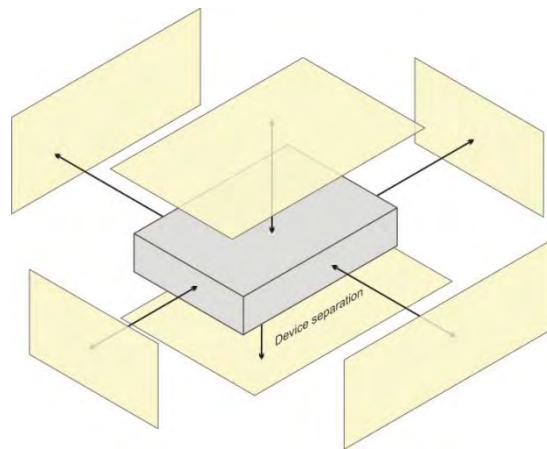

Fig-4.4 Illustration for Body Worn Position

4.2.3 Hotspot Mode Exposure Conditions

For handsets that support hotspot mode operations, with wireless router capabilities and various web browsing functions, the relevant hand and body exposure conditions are tested according to the hotspot SAR procedures in KDB 941225 D06. A test separation distance of 10 mm is required between the phantom and all surfaces and edges with a transmitting antenna located within 25 mm from that surface or edge. When the form factor of a handset is smaller than 9 cm x 5 cm, a test separation distance of 5 mm (instead of 10 mm) is required for testing hotspot mode. When the separation distance required for body-worn accessory testing is larger than or equal to that tested for hotspot mode, in the same wireless mode and for the same surface of the phone, the hotspot mode SAR data may be used to support body-worn accessory SAR compliance for that particular configuration (surface).



Based on the antenna location shown on appendix E of this report, the SAR testing required for hotspot mode is listed as below.

Antenna	Front Face	Rear Face	Left Side	Right Side	Top Side	Bottom Side
WWAN	V	V	V	V		V
WLAN / BT	V	V		V	V	



4.2.4 Extremity Exposure Conditions

For smart phones with a display diagonal dimension > 15 cm or an overall diagonal dimension > 16 cm that provide similar mobile web access and multimedia support found in mini-tablets or UMPC mini-tablets that support voice calls next to the ear, the following phablet procedures should be applied to evaluate SAR compliance for each applicable wireless modes and frequency band. Devices marketed as phablets, regardless of form factors and operating characteristics must be tested as a phablet to determine SAR compliance.

1. The normally required head and body-worn accessory SAR test procedures for handsets, including hotspot mode, must be applied.
2. The UMPC mini-tablet procedures must also be applied to test the SAR of all surfaces and edges with an antenna located at <= 25 mm from that surface or edge, in direct contact with a flat phantom, for 10-g extremity SAR according to the body-equivalent tissue dielectric parameters in KDB 865664 to address interactive hand use exposure conditions. The UMPC mini-tablet 1-g SAR at 5 mm is not required. When hotspot mode applies, 10-g extremity SAR is required only for the surfaces and edges with hotspot mode 1-g SAR > 1.2 W/kg. The normal tablet procedures in KDB 616217 are required when the over diagonal dimension of the device is > 20 cm. Hotspot mode SAR is not required when normal tablet procedures are applied. Extremity 10-g SAR is also not required for the front (top) surface of large form factor full size tablets. The more conservative tablet SAR results can be used to support the 10-g extremity SAR for phablet mode.
3. The simultaneous transmission operating configurations applicable to voice and data transmissions for both phone and mini-tablet modes must be taken into consideration separately for 1-g and 10-g SAR to determine the simultaneous transmission SAR test exclusion and measurement requirements for the relevant wireless modes and exposure conditions.

4.2.5 Simultaneous Transmission Possibilities

The simultaneous transmission possibilities for this device are listed as below.

Simultaneous TX Combination	Capable Transmit Configurations	Head	Body-worn	Hotspot	Extremity
1	WWAN + WLAN2.4G			Yes	
2	WWAN + BT			Yes	
3	WLAN2.4G + BT			Yes	



4.2 Tissue Verification

The measuring results for tissue simulating liquid are shown as below.

Test Date	Tissue Type	Frequency (MHz)	Liquid Temp. (°C)	Measured Conductivity (σ)	Measured Permittivity (ε _r)	Target Conductivity (σ)	Target Permittivity (ε _r)	Conductivity Deviation (%)	Permittivity Deviation (%)
Sep.18, 2023	Head	750	22.6	0.902	43.239	0.89	41.90	1.35	3.20
Sep.18, 2023	Head	835	22.6	0.931	42.981	0.90	41.50	3.44	3.57
Sep.18, 2023	Head	1750	22.6	1.421	40.782	1.37	40.10	3.72	1.70
Sep.18, 2023	Head	1900	22.6	1.403	39.730	1.40	40.00	0.21	-0.68
Sep.18, 2023	Head	2450	22.7	1.815	39.160	1.80	39.20	0.83	-0.10
Sep.18, 2023	Head	2600	22.7	1.930	38.938	1.96	39.00	-1.53	-0.16

Note:

The dielectric properties of the tissue simulating liquid must be measured within 24 hours before the SAR testing and within ±5% of the target values. Liquid temperature during the SAR testing must be within ±2 °C.

4.3 System Verification

The measuring result for system verification is tabulated as below.

Test Date	Mode	Frequency (MHz)	1W Target SAR-1g (W/kg)	Measured SAR-1g (W/kg)	Normalized to 1W SAR-1g (W/kg)	Deviation (%)	Dipole S/N	Probe S/N	DAE S/N
Sep.18, 2023	Head	750	8.45	2.11	8.44	-0.12	1200	7612	1633
Sep.18, 2023	Head	835	9.60	2.51	10.04	4.58	4d265	7612	1633
Sep.18, 2023	Head	1750	36.60	9.39	37.56	2.62	1176	7612	1633
Sep.18, 2023	Head	1900	39.70	9.56	38.24	-3.68	5d159	7612	1633
Sep.18, 2023	Head	2450	52.80	12.50	50.00	-5.30	1048	7612	1633
Sep.18, 2023	Head	2600	55.80	14.20	56.80	1.79	1110	7612	1633

Note:

Comparing to the reference SAR value provided by SPEAG, the validation data should be within its specification of 10 %. The result indicates the system check can meet the variation criterion and the plots can be referred to Appendix A of this report.



4.4 Maximum Output Power

4.5.1 Maximum Conducted Power

The maximum conducted average power (Unit: dBm) including tune-up tolerance please refer to Appendix D.

4.5.2 Measured Conducted Power Result

The measuring conducted average power (Unit: dBm) please refer to Appendix D.

4.5 SAR Testing Results

4.6.1 SAR Test Reduction Considerations

<KDB 447498 D04, General RF Exposure Guidance>

Testing of other required channels within the operating mode of a frequency band is not required when the reported SAR for the mid-band or highest output power channel is:

- (1) ≤ 0.8 W/kg or 2.0 W/kg, for 1-g or 10-g respectively, when the transmission band is ≤ 100 MHz
- (2) ≤ 0.6 W/kg or 1.5 W/kg, for 1-g or 10-g respectively, when the transmission band is between 100 MHz and 200 MHz
- (3) ≤ 0.4 W/kg or 1.0 W/kg, for 1-g or 10-g respectively, when the transmission band is ≥ 200 MHz

<KDB 941225 D01, 3G SAR Measurement Procedures>

The mode tested for SAR is referred to as the primary mode. The equivalent modes considered for SAR test reduction are denoted as secondary modes. Both primary and secondary modes must be in the same frequency band. When the maximum output power and tune-up tolerance specified for production units in a secondary mode is $\leq 1/4$ dB higher than the primary mode or when the highest reported SAR of the primary mode is scaled by the ratio of specified maximum output power and tune-up tolerance of secondary to primary mode and the adjusted SAR is ≤ 1.2 W/kg, SAR measurement is not required for the secondary mode.

<KDB 941225 D05, SAR Evaluation Considerations for LTE Devices>

(1) QPSK with 1 RB and 50% RB allocation

Start with the largest channel bandwidth and measure SAR, using the RB offset and required test channel combination with the highest maximum output power among RB offsets at the upper edge, middle and lower edge of each required test channel. When the reported SAR is ≤ 0.8 W/kg, testing of the remaining RB offset configurations and required test channels is not required; otherwise, SAR is required for the remaining required test channels and only for the RB offset configuration with the highest output power for that channel. When the reported SAR of a required test channel is > 1.45 W/kg, SAR is required for all three RB offset configurations for that required test channel.

(2) QPSK with 100% RB allocation

SAR is not required when the highest maximum output power for 100% RB allocation is less than the highest maximum output power in 50% and 1 RB allocations and the highest reported SAR for 1 RB and 50% RB allocation are ≤ 0.8 W/kg. Otherwise, SAR is measured for the highest output power channel; and if the reported SAR is > 1.45 W/kg, the remaining required test channels must also be tested.

(3) Higher order modulations

SAR is required only when the highest maximum output power for the configuration in the higher order modulation is $> 1/2$ dB higher than the same configuration in QPSK or when the reported SAR for the QPSK configuration is $>$



BUREAU
VERITAS



1.45 W/kg.

(4) Other channel bandwidth

SAR is required when the highest maximum output power of the smaller channel bandwidth is $> 1/2$ dB higher than the equivalent channel configurations in the largest channel bandwidth configuration or the reported SAR of a configuration for the largest channel bandwidth is > 1.45 W/kg.

<KDB 248227 D01, SAR Guidance for Wi-Fi Transmitters>

- (1) For handsets operating next to ear, hotspot mode or mini-tablet configurations, the initial test position procedures were applied. The test position with the highest extrapolated peak SAR will be used as the initial test position. When the reported SAR of initial test position is ≤ 0.4 W/kg, SAR testing for remaining test positions is not required. Otherwise, SAR is evaluated at the subsequent highest peak SAR positions until the reported SAR result is ≤ 0.8 W/kg or all test positions are measured.
- (2) For WLAN 2.4 GHz, the highest measured maximum output power channel for DSSS was selected for SAR measurement. When the reported SAR is ≤ 0.8 W/kg, no further SAR testing is required. Otherwise, SAR is evaluated at the next highest measured output power channel. When any reported SAR is > 1.2 W/kg, SAR is required for the third channel. For OFDM modes (802.11g/n), SAR is not required when the highest reported SAR for DSSS is adjusted by the ratio of OFDM to DSSS specified maximum output power and it is ≤ 1.2 W/kg.



4.6.2 SAR Results for Head Exposure Condition

Plot No.	Band	Mode	Test Position	Ch.	Sample	RB#	RB Offset	Duty Cycle %	Max. Tune-up Power (dBm)	Measured Conducted Power (dBm)	Power Drift (dB)	Measured SAR-1g (W/kg)	Duty Cycle Scaling Factor	Tune-up Scaling	Scaled SAR-1g (W/kg)
P01	GSM850	GPRS(3Tx-slot)	Right Cheek	128	1	-	-	-	29.00	28.18	-0.09	0.200	-	1.21	0.24
P02	GSM1900	GPRS(3Tx-slot)	Right Cheek	512	1	-	-	-	26.00	25.21	0.01	0.037	-	1.20	0.04
P03	WCDMA II	RMC12.2K	Right Cheek	9262	1	-	-	-	22.50	21.70	0.06	0.029	-	1.20	0.04
P04	WCDMA IV	RMC12.2K	Right Cheek	1413	1	-	-	-	21.50	20.89	0.06	0.155	-	1.15	0.18
P05	WCDMA V	RMC12.2K	Right Cheek	4233	1	-	-	-	24.50	23.74	0.04	0.201	-	1.19	0.24
P06	LTE 2	QPSK20M	Right Cheek	18900	1	1	50	-	23.00	22.23	0.06	0.126	-	1.19	0.15
P07	LTE 5	QPSK10M	Right Cheek	20450	1	1	24	-	24.50	23.44	0.02	0.189	-	1.28	0.24
P08	LTE 7	QPSK20M	Right Cheek	20850	1	1	0	-	20.50	19.71	0.05	0.042	-	1.20	0.05
P09	LTE 12	QPSK10M	Right Cheek	23130	1	1	0	-	24.00	23.34	0.09	0.109	-	1.16	0.13
P10	LTE 13	QPSK10M	Right Cheek	23230	1	1	49	-	24.00	23.28	0.05	0.049	-	1.18	0.06
P11	LTE 66	QPSK20M	Right Cheek	132572	1	1	50	-	21.50	20.95	0.05	0.040	-	1.14	0.05
P12	WLAN2.4G	802.11b	Left Cheek	11	1	18	-	100	17.00	16.11	0.12	0.492	1.00	1.23	0.60
P13	BT	GFSK	Left Cheek	0	1	4	-	77.33	9.00	8.48	0.03	0.098	1.29	1.13	0.14

4.6.3 SAR Results for Body-worn Exposure Condition (Separation Distance is 1.0 cm Gap)

Plot No.	Band	Mode	Test Position	Ch.	Sample	RB#	RB Offset	Duty Cycle %	Max. Tune-up Power (dBm)	Measured Conducted Power (dBm)	Power Drift (dB)	Measured SAR-1g (W/kg)	Duty Cycle Scaling Factor	Tune-up Scaling	Scaled SAR-1g (W/kg)
P14	GSM850	GPRS(3Tx-slot)	Rear Face	128	1	-	-	-	29.00	28.18	0.09	0.343	-	1.21	0.41
P15	GSM1900	GPRS(3Tx-slot)	Rear Face	512	1	-	-	-	26.00	25.21	0.18	0.508	-	1.20	0.61
P16	WCDMA II	RMC12.2K	Rear Face	9538	1	-	-	-	22.50	21.66	0.01	0.651	-	1.21	0.79
P17	WCDMA IV	RMC12.2K	Rear Face	1312	1	-	-	-	21.50	20.88	0.04	0.968	-	1.15	1.12
	WCDMA IV	RMC12.2K	Rear Face	1413	1	-	-	-	21.50	20.89	0.03	0.833	-	1.15	0.96
	WCDMA IV	RMC12.2K	Rear Face	1513	1	-	-	-	21.50	20.86	0.06	0.718	-	1.16	0.83
P18	WCDMA V	RMC12.2K	Rear Face	4233	1	-	-	-	24.50	23.74	0.04	0.213	-	1.19	0.25
P19	LTE 2	QPSK20M	Rear Face	19100	1	1	50	-	23.00	22.07	0.19	0.760	-	1.24	0.94
	LTE 2	QPSK20M	Rear Face	18900	1	1	50	-	23.00	22.23	0.09	0.781	-	1.19	0.93
	LTE 2	QPSK20M	Rear Face	18700	1	1	50	-	23.00	22.15	0.14	0.739	-	1.22	0.90
P20	LTE 5	QPSK10M	Rear Face	20450	1	1	24	-	24.50	23.44	0.07	0.203	-	1.28	0.26
P21	LTE 7	QPSK20M	Rear Face	20850	1	1	0	-	20.50	19.71	0.04	0.612	-	1.20	0.73
P22	LTE 12	QPSK10M	Rear Face	23130	1	1	0	-	24.00	23.34	0.01	0.151	-	1.16	0.18
P23	LTE 13	QPSK10M	Rear Face	23230	1	1	49	-	24.00	23.28	-0.09	0.055	-	1.18	0.07
P24	LTE 66	QPSK20M	Rear Face	132322	1	1	50	-	21.50	20.94	0.07	0.523	-	1.14	0.59
P25	WLAN2.4G	802.11b	Rear Face	11	1	18	-	100	17.00	16.11	-0.07	0.334	1.00	1.23	0.41
P26	BT	GFSK	Rear Face	0	1	4	-	77.33	9.00	8.48	-0.01	0.035	1.29	1.13	0.05

4.6.4 SAR Results for Hotspot Exposure Condition (Separation Distance is 1.0 cm Gap)

Plot No.	Band	Mode	Test Position	Ch.	Sample	RB#	RB Offset	Duty Cycle %	Max. Tune-up Power (dBm)	Measured Conducted Power (dBm)	Power Drift (dB)	Measured SAR-1g (W/kg)	Duty Cycle Scaling Factor	Tune-up Scaling	Scaled SAR-1g (W/kg)
P27	GSM850	GPRS(3Tx-slot)	Bottom Side	128	1	-	-	-	29.00	28.18	0.12	0.276	-	1.21	0.33
P28	GSM1900	GPRS(3Tx-slot)	Bottom Side	512	1	-	-	-	26.00	25.21	0.01	0.831	-	1.20	1.00
	GSM1900	GPRS(3Tx-slot)	Bottom Side	661	1	-	-	-	26.00	25.19	0.09	0.807	-	1.21	0.97
	GSM1900	GPRS(3Tx-slot)	Bottom Side	810	1	-	-	-	26.00	25.04	0.17	0.789	-	1.25	0.98
P29	WCDMA II	RMC12.2K	Bottom Side	9400	1	-	-	-	22.50	21.68	0.04	1.100	-	1.21	1.33
	WCDMA II	RMC12.2K	Bottom Side	9538	1	-	-	-	22.50	21.66	0.19	1.080	-	1.21	1.31
	WCDMA II	RMC12.2K	Bottom Side	9262	1	-	-	-	22.50	21.70	0.06	1.040	-	1.20	1.25
P30	WCDMA IV	RMC12.2K	Bottom Side	1312	1	-	-	-	21.50	20.88	0.04	1.090	-	1.15	1.26
	WCDMA IV	RMC12.2K	Bottom Side	1413	1	-	-	-	21.50	20.89	0.05	1.030	-	1.15	1.19



Plot No.	Band	Mode	Test Position	Ch.	Sample	RB#	RB Offset	Duty Cycle %	Max. Tune-up Power (dBm)	Measured Conducted Power (dBm)	Power Drift (dB)	Measured SAR-1g (W/kg)	Duty Cycle Scaling Factor	Tune-up Scaling	Scaled SAR-1g (W/kg)
	WCDMA IV	RMC12.2K	Bottom Side	1513	1	-	-	-	21.50	20.86	0.09	1.020	-	1.16	1.18
P31	WCDMA V	RMC12.2K	Bottom Side	4233	1	-	-	-	24.50	23.74	0.10	0.164	-	1.19	0.20
P32	LTE 2	QPSK20M	Bottom Side	19100	1	1	50	-	23.00	22.07	0.08	1.010	-	1.24	1.25
	LTE 2	QPSK20M	Bottom Side	18700	1	1	50	-	23.00	22.15	0.15	0.998	-	1.22	1.21
	LTE 2	QPSK20M	Bottom Side	18900	1	1	50	-	23.00	22.23	0.07	1.030	-	1.19	1.23
P33	LTE 5	QPSK10M	Bottom Side	20450	1	1	24	-	24.50	23.44	0.19	0.075	-	1.28	0.10
P34	LTE 7	QPSK20M	Bottom Side	21350	1	1	0	-	20.50	19.51	0.05	0.835	-	1.26	1.05
	LTE 7	QPSK20M	Bottom Side	21100	1	1	0	-	20.50	19.67	0.02	0.825	-	1.21	1.00
	LTE 7	QPSK20M	Bottom Side	20850	1	1	0	-	20.50	19.71	0.16	0.814	-	1.20	0.98
P35	LTE 12	QPSK10M	Rear Face	23130	1	1	0	-	24.00	23.34	0.01	0.151	-	1.16	0.18
P36	LTE 13	QPSK10M	Rear Face	23230	1	1	49	-	24.00	23.28	-0.09	0.055	-	1.18	0.07
P37	LTE 66	QPSK20M	Bottom Side	132072	1	1	50	-	21.50	20.87	0.05	1.040	-	1.16	1.20
	LTE 66	QPSK20M	Bottom Side	132322	1	1	50	-	21.50	20.94	0.19	1.000	-	1.14	1.14
	LTE 66	QPSK20M	Bottom Side	132572	1	1	50	-	21.50	20.95	0.06	0.937	-	1.14	1.06
P38	WLAN2.4G	802.11b	Rear Face	11	1	18	-	100	17.00	16.11	-0.07	0.334	1.00	1.23	0.41
P39	BT	GFSK	Rear Face	0	1	4	-	77.33	9.00	8.48	-0.01	0.035	1.29	1.13	0.05

4.6.5 SAR Results for Extremity Exposure Condition (Separation Distance is 0 cm Gap)

Plot No.	Band	Mode	Test Position	Ch.	Sample	RB#	RB Offset	Duty Cycle %	Max. Tune-up Power (dBm)	Measured Conducted Power (dBm)	Power Drift (dB)	Measured SAR-1g (W/kg)	Duty Cycle Scaling Factor	Tune-up Scaling	Scaled SAR-1g (W/kg)
P40	GSM1900	GPRS(3Tx-slot)	Bottom Side	512	1	-	-	-	26.00	25.21	0.05	1.960	-	1.20	2.35
	GSM1900	GPRS(3Tx-slot)	Bottom Side	661	1	-	-	-	26.00	25.19	0.09	1.510	-	1.21	1.82
	GSM1900	GPRS(3Tx-slot)	Bottom Side	810	1	-	-	-	26.00	25.04	0.17	1.530	-	1.25	1.91
P41	WCDMA II	RMC12.2K	Bottom Side	9538	1	-	-	-	22.50	21.66	0.06	2.340	-	1.21	2.84
	WCDMA II	RMC12.2K	Bottom Side	9262	1	-	-	-	22.50	21.70	0.13	1.980	-	1.20	2.38
	WCDMA II	RMC12.2K	Bottom Side	9400	1	-	-	-	22.50	21.68	0.12	1.910	-	1.21	2.31
P42	WCDMA IV	RMC12.2K	Bottom Side	1312	1	-	-	-	21.50	20.88	0.01	2.210	-	1.15	2.55
	WCDMA IV	RMC12.2K	Bottom Side	1413	1	-	-	-	21.50	20.89	0.12	1.760	-	1.15	2.03
	WCDMA IV	RMC12.2K	Bottom Side	1513	1	-	-	-	21.50	20.86	0.09	1.740	-	1.16	2.02
P43	LTE 2	QPSK20M	Bottom Side	18900	1	1	50	-	23.00	22.23	-0.03	2.380	-	1.24	2.95
	LTE 2	QPSK20M	Bottom Side	19100	1	1	50	-	23.00	22.07	-0.01	2.100	-	1.24	2.60
	LTE 2	QPSK20M	Bottom Side	18700	1	1	50	-	23.00	22.15	-0.10	2.090	-	1.24	2.59
P44	LTE 66	QPSK20M	Bottom Side	132072	1	1	50	-	21.50	20.87	-0.02	2.080	-	1.16	2.40
	LTE 66	QPSK20M	Bottom Side	132322	1	1	50	-	21.50	20.94	0.11	1.620	-	1.14	1.84
	LTE 66	QPSK20M	Bottom Side	132572	1	1	50	-	21.50	20.95	0.01	1.570	-	1.14	1.78



4.6.6 SAR Measurement Variability

According to KDB 865664 D01, SAR measurement variability was assessed for each frequency band, which is determined by the SAR probe calibration point and tissue-equivalent medium used for the device measurements. When both head and body tissue-equivalent media are required for SAR measurements in a frequency band, the variability measurement procedures should be applied to the tissue medium with the highest measured SAR, using the highest measured SAR configuration for that tissue-equivalent medium. Alternatively, if the highest measured SAR for both head and body tissue-equivalent media are ≤ 1.45 W/kg and the ratio of these highest SAR values, i.e., largest divided by smallest value, is ≤ 1.10 , the highest SAR configuration for either head or body tissue-equivalent medium may be used to perform the repeated measurement. These additional measurements are repeated after the completion of all measurements requiring the same head or body tissue-equivalent medium in a frequency band. The test device should be returned to ambient conditions (normal room temperature) with the battery fully charged before it is re-mounted on the device holder for the repeated measurement(s) to minimize any unexpected variations in the repeated results.

SAR repeated measurement procedure:

1. When the highest measured SAR is < 0.80 W/kg, repeated measurement is not required.
2. When the highest measured SAR is ≥ 0.80 W/kg, repeat that measurement once.
3. If the ratio of largest to smallest SAR for the original and first repeated measurements is > 1.20 , or when the original or repeated measurement is ≥ 1.45 W/kg, perform a second repeated measurement.
4. If the ratio of largest to smallest SAR for the original, first and second repeated measurements is > 1.20 , and the original, first or second repeated measurement is ≥ 1.5 W/kg, perform a third repeated measurement.

Band	Test Position	Ch.	Original Measured SAR-1g (W/kg)	1st Repeated SAR-1g (W/kg)	L/S Ratio	2nd Repeated SAR-1g (W/kg)	L/S Ratio	3rd Repeated SAR-1g (W/kg)	L/S Ratio
WCDMA II	Bottom Side	9400	1.100	1.050	1.048	N/A	N/A	N/A	N/A
WCDMA IV	Bottom Side	1312	1.090	1.020	1.069	N/A	N/A	N/A	N/A
LTE 7	Bottom Side	21350	0.835	0.802	1.041	N/A	N/A	N/A	N/A

Band	Test Position	Ch.	Original Measured SAR-10g (W/kg)	1st Repeated SAR-10g (W/kg)	L/S Ratio	2nd Repeated SAR-1g (W/kg)	L/S Ratio	3rd Repeated SAR-1g (W/kg)	L/S Ratio
WCDMA IV	Bottom Side	1312	2.210	2.090	1.057	N/A	N/A	N/A	N/A
LTE 2	Bottom Side	18900	2.380	2.310	1.030	N/A	N/A	N/A	N/A



4.6.7 Simultaneous Multi-band Transmission Evaluation

<SAR Summation Analysis>

Simultaneous transmission SAR test exclusion is determined for each operating configuration and exposure condition according to the reported standalone SAR of each applicable simultaneous transmitting antenna. When the sum of SAR_{1g} of all simultaneously transmitting antennas in an operating mode and exposure condition combination is within the SAR limit (SAR_{1g} 1.6 W/kg), the simultaneous transmission SAR is not required. When the sum of SAR_{1g} is greater than the SAR limit (SAR_{1g} 1.6 W/kg), SAR test exclusion is determined by the SPLSR.

<Head Exposure condition>

WWAN Band	Exposure Position	1	2	3	1+2 Summed 1g SAR (W/kg)	1+3 Summed 1g SAR (W/kg)	2+3 Summed 1g SAR (W/kg)	SPLSR Analysis
		WWAN	2.4GHz WLAN	BT				
		1g SAR (W/kg)	1g SAR (W/kg)	1g SAR (W/kg)				
GSM 850	Right Cheek	0.242	0.180	0.051	0.42	0.29	0.23	Σ SAR < 1.6, Not required
	Right Tilted	0.150	0.142	0.050	0.29	0.20	0.19	Σ SAR < 1.6, Not required
	Left Cheek	0.292	0.604	0.143	0.90	0.43	0.75	Σ SAR < 1.6, Not required
	Left Tilted	0.156	0.336	0.120	0.49	0.28	0.46	Σ SAR < 1.6, Not required
GSM 1900	Right Cheek	0.045	0.180	0.051	0.23	0.10	0.23	Σ SAR < 1.6, Not required
	Right Tilted	0.053	0.142	0.050	0.20	0.10	0.19	Σ SAR < 1.6, Not required
	Left Cheek	0.086	0.604	0.143	0.69	0.23	0.75	Σ SAR < 1.6, Not required
	Left Tilted	0.073	0.336	0.120	0.41	0.19	0.46	Σ SAR < 1.6, Not required
WCDMA II	Right Cheek	0.035	0.180	0.051	0.22	0.09	0.23	Σ SAR < 1.6, Not required
	Right Tilted	0.095	0.142	0.050	0.24	0.14	0.19	Σ SAR < 1.6, Not required
	Left Cheek	0.142	0.604	0.143	0.75	0.28	0.75	Σ SAR < 1.6, Not required
	Left Tilted	0.132	0.336	0.120	0.47	0.25	0.46	Σ SAR < 1.6, Not required
WCDMA IV	Right Cheek	0.178	0.180	0.051	0.36	0.23	0.23	Σ SAR < 1.6, Not required
	Right Tilted	0.148	0.142	0.050	0.29	0.20	0.19	Σ SAR < 1.6, Not required
	Left Cheek	0.163	0.604	0.143	0.77	0.31	0.75	Σ SAR < 1.6, Not required
	Left Tilted	0.139	0.336	0.120	0.48	0.26	0.46	Σ SAR < 1.6, Not required
WCDMA V	Right Cheek	0.239	0.180	0.051	0.42	0.29	0.23	Σ SAR < 1.6, Not required
	Right Tilted	0.108	0.142	0.050	0.25	0.16	0.19	Σ SAR < 1.6, Not required
	Left Cheek	0.181	0.604	0.143	0.78	0.32	0.75	Σ SAR < 1.6, Not required
	Left Tilted	0.094	0.336	0.120	0.43	0.21	0.46	Σ SAR < 1.6, Not required
LTE 2	Right Cheek	0.150	0.180	0.051	0.33	0.20	0.23	Σ SAR < 1.6, Not required
	Right Tilted	0.081	0.142	0.050	0.22	0.13	0.19	Σ SAR < 1.6, Not required
	Left Cheek	0.134	0.604	0.143	0.74	0.28	0.75	Σ SAR < 1.6, Not required
	Left Tilted	0.113	0.336	0.120	0.45	0.23	0.46	Σ SAR < 1.6, Not required



BUREAU VERITAS

FCC SAR Test Report



Certificate #6613.01

WWAN Band	Exposure Position	1	2	3	1+2 Summed 1g SAR (W/kg)	1+3 Summed 1g SAR (W/kg)	2+3 Summed 1g SAR (W/kg)	SPLSR Analysis
		WWAN	2.4GHz WLAN	BT				
		1g SAR (W/kg)	1g SAR (W/kg)	1g SAR (W/kg)				
LTE 5	Right Cheek	0.241	0.180	0.051	0.42	0.29	0.23	Σ SAR < 1.6, Not required
	Right Tilted	0.102	0.142	0.050	0.24	0.15	0.19	Σ SAR < 1.6, Not required
	Left Cheek	0.186	0.604	0.143	0.79	0.33	0.75	Σ SAR < 1.6, Not required
	Left Tilted	0.106	0.336	0.120	0.44	0.23	0.46	Σ SAR < 1.6, Not required
LTE 7	Right Cheek	0.050	0.180	0.051	0.23	0.10	0.23	Σ SAR < 1.6, Not required
	Right Tilted		0.142	0.050	0.14	0.05	0.19	Σ SAR < 1.6, Not required
	Left Cheek	0.027	0.604	0.143	0.63	0.17	0.75	Σ SAR < 1.6, Not required
	Left Tilted		0.336	0.120	0.34	0.12	0.46	Σ SAR < 1.6, Not required
LTE 12	Right Cheek	0.127	0.180	0.051	0.31	0.18	0.23	Σ SAR < 1.6, Not required
	Right Tilted	0.059	0.142	0.050	0.20	0.11	0.19	Σ SAR < 1.6, Not required
	Left Cheek	0.107	0.604	0.143	0.71	0.25	0.75	Σ SAR < 1.6, Not required
	Left Tilted	0.051	0.336	0.120	0.39	0.17	0.46	Σ SAR < 1.6, Not required
LTE 13	Right Cheek	0.058	0.180	0.051	0.24	0.11	0.23	Σ SAR < 1.6, Not required
	Right Tilted		0.142	0.050	0.14	0.05	0.19	Σ SAR < 1.6, Not required
	Left Cheek	0.039	0.604	0.143	0.64	0.18	0.75	Σ SAR < 1.6, Not required
	Left Tilted		0.336	0.120	0.34	0.12	0.46	Σ SAR < 1.6, Not required
LTE 66	Right Cheek	0.046	0.180	0.051	0.23	0.10	0.23	Σ SAR < 1.6, Not required
	Right Tilted	0.124	0.142	0.050	0.27	0.17	0.19	Σ SAR < 1.6, Not required
	Left Cheek	0.184	0.604	0.143	0.79	0.33	0.75	Σ SAR < 1.6, Not required
	Left Tilted	0.131	0.336	0.120	0.47	0.25	0.46	Σ SAR < 1.6, Not required

BUREAU
VERITAS

FCC SAR Test Report



Certificate #6613.01

<Body Worn Exposure condition>

WWAN Band	Exposure Position	1	2	3	1+2 Summed 1g SAR (W/kg)	1+3 Summed 1g SAR (W/kg)	2+3 Summed 1g SAR (W/kg)	SPLSR Analysis
		WWAN	2.4GHz WLAN	BT				
		1g SAR (W/kg)	1g SAR (W/kg)	1g SAR (W/kg)				
GSM 850	Front at 1.0cm	0.300	0.091	0.028	0.39	0.33	0.12	Σ SAR < 1.6, Not required
	Back at 1.0cm	0.414	0.410	0.050	0.82	0.46	0.46	Σ SAR < 1.6, Not required
GSM 1900	Front at 1.0cm	0.380	0.091	0.028	0.47	0.41	0.12	Σ SAR < 1.6, Not required
	Back at 1.0cm	0.609	0.410	0.050	1.02	0.66	0.46	Σ SAR < 1.6, Not required
WCDMA II	Front at 1.0cm	0.374	0.091	0.028	0.46	0.40	0.12	Σ SAR < 1.6, Not required
	Back at 1.0cm	0.790	0.410	0.050	1.20	0.84	0.46	Σ SAR < 1.6, Not required
WCDMA IV	Front at 1.0cm	0.410	0.091	0.028	0.50	0.44	0.12	Σ SAR < 1.6, Not required
	Back at 1.0cm	1.117	0.410	0.050	1.53	1.17	0.46	Σ SAR < 1.6, Not required
WCDMA V	Front at 1.0cm	0.136	0.091	0.028	0.23	0.16	0.12	Σ SAR < 1.6, Not required
	Back at 1.0cm	0.254	0.410	0.050	0.66	0.30	0.46	Σ SAR < 1.6, Not required
LTE 2	Front at 1.0cm	0.393	0.091	0.028	0.48	0.42	0.12	Σ SAR < 1.6, Not required
	Back at 1.0cm	0.941	0.410	0.050	1.35	0.99	0.46	Σ SAR < 1.6, Not required
LTE 5	Front at 1.0cm	0.152	0.091	0.028	0.24	0.18	0.12	Σ SAR < 1.6, Not required
	Back at 1.0cm	0.259	0.410	0.050	0.67	0.31	0.46	Σ SAR < 1.6, Not required
LTE 7	Front at 1.0cm	0.103	0.091	0.028	0.19	0.13	0.12	Σ SAR < 1.6, Not required
	Back at 1.0cm	0.734	0.410	0.050	1.14	0.78	0.46	Σ SAR < 1.6, Not required
LTE 12	Front at 1.0cm	0.127	0.091	0.028	0.22	0.15	0.12	Σ SAR < 1.6, Not required
	Back at 1.0cm	0.176	0.410	0.050	0.59	0.23	0.46	Σ SAR < 1.6, Not required
LTE 23	Front at 1.0cm	0.048	0.091	0.028	0.14	0.08	0.12	Σ SAR < 1.6, Not required
	Back at 1.0cm	0.065	0.410	0.050	0.48	0.12	0.46	Σ SAR < 1.6, Not required
LTE 66	Front at 1.0cm	0.185	0.091	0.028	0.28	0.21	0.12	Σ SAR < 1.6, Not required
	Back at 1.0cm	0.595	0.410	0.050	1.00	0.65	0.46	Σ SAR < 1.6, Not required

BUREAU
VERITAS

FCC SAR Test Report



Certificate #6613.01

<Hotspot Exposure condition>

WWAN Band	Exposure Position	1	2	3	1+2 Summed 1g SAR (W/kg)	1+3 Summed 1g SAR (W/kg)	2+3 Summed 1g SAR (W/kg)	SPLSR Analysis
		WWAN	2.4GHz WLAN	BT				
		1g SAR (W/kg)	1g SAR (W/kg)	1g SAR (W/kg)				
GSM 850	Front at 1.0cm	0.300	0.091	0.028	0.39	0.33	0.12	Σ SAR < 1.6, Not required
	Back at 1.0cm	0.414	0.410	0.050	0.82	0.46	0.46	Σ SAR < 1.6, Not required
	Left side at 1.0cm	0.191			0.19	0.19	0.00	Σ SAR < 1.6, Not required
	Right side at 1.0cm	0.248	0.102	0.029	0.35	0.28	0.13	Σ SAR < 1.6, Not required
	Top side at 1.0cm		0.074	0.017	0.07	0.02	0.09	Σ SAR < 1.6, Not required
	Bottom side at 1.0cm	0.333			0.33	0.33	0.00	Σ SAR < 1.6, Not required
GSM 1900	Front at 1.0cm	0.380	0.091	0.028	0.47	0.41	0.12	Σ SAR < 1.6, Not required
	Back at 1.0cm	0.609	0.410	0.050	1.02	0.66	0.46	Σ SAR < 1.6, Not required
	Left side at 1.0cm	0.174			0.17	0.17	0.00	Σ SAR < 1.6, Not required
	Right side at 1.0cm	0.062	0.102	0.029	0.16	0.09	0.13	Σ SAR < 1.6, Not required
	Top side at 1.0cm		0.074	0.017	0.07	0.02	0.09	Σ SAR < 1.6, Not required
	Bottom side at 1.0cm	0.997			1.00	1.00	0.00	Σ SAR < 1.6, Not required
WCDMA II	Front at 1.0cm	0.374	0.091	0.028	0.46	0.40	0.12	Σ SAR < 1.6, Not required
	Back at 1.0cm	0.790	0.410	0.050	1.20	0.84	0.46	Σ SAR < 1.6, Not required
	Left side at 1.0cm	0.178			0.18	0.18	0.00	Σ SAR < 1.6, Not required
	Right side at 1.0cm	0.059	0.102	0.029	0.16	0.09	0.13	Σ SAR < 1.6, Not required
	Top side at 1.0cm		0.074	0.017	0.07	0.02	0.09	Σ SAR < 1.6, Not required
	Bottom side at 1.0cm	1.329			1.33	1.33	0.00	Σ SAR < 1.6, Not required
WCDMA IV	Front at 1.0cm	0.410	0.091	0.028	0.50	0.44	0.12	Σ SAR < 1.6, Not required
	Back at 1.0cm	1.117	0.410	0.050	1.53	1.17	0.46	Σ SAR < 1.6, Not required
	Left side at 1.0cm	0.055			0.06	0.06	0.00	Σ SAR < 1.6, Not required
	Right side at 1.0cm	0.062	0.102	0.029	0.16	0.09	0.13	Σ SAR < 1.6, Not required
	Top side at 1.0cm		0.074	0.017	0.07	0.02	0.09	Σ SAR < 1.6, Not required
	Bottom side at 1.0cm	1.257			1.26	1.26	0.00	Σ SAR < 1.6, Not required
WCDMA V	Front at 1.0cm	0.136	0.091	0.028	0.23	0.16	0.12	Σ SAR < 1.6, Not required
	Back at 1.0cm	0.254	0.410	0.050	0.66	0.30	0.46	Σ SAR < 1.6, Not required
	Left side at 1.0cm	0.105			0.10	0.10	0.00	Σ SAR < 1.6, Not required
	Right side at 1.0cm	0.175	0.102	0.029	0.28	0.20	0.13	Σ SAR < 1.6, Not required
	Top side at 1.0cm		0.074	0.017	0.07	0.02	0.09	Σ SAR < 1.6, Not required
	Bottom side at 1.0cm	0.195			0.20	0.20	0.00	Σ SAR < 1.6, Not required

BUREAU VERITAS FCC SAR Test Report

WWAN Band	Exposure Position	1	2	3	1+2 Summed 1g SAR (W/kg)	1+3 Summed 1g SAR (W/kg)	2+3 Summed 1g SAR (W/kg)	SPLSR Analysis
		WWAN	2.4GHz WLAN	BT				
		1g SAR (W/kg)	1g SAR (W/kg)	1g SAR (W/kg)				
LTE 2	Front at 1.0cm	0.393	0.091	0.028	0.48	0.42	0.12	Σ SAR < 1.6, Not required
	Back at 1.0cm	0.941	0.410	0.050	1.35	0.99	0.46	Σ SAR < 1.6, Not required
	Left side at 1.0cm	0.160			0.16	0.16	0.00	Σ SAR < 1.6, Not required
	Right side at 1.0cm	0.053	0.102	0.029	0.15	0.08	0.13	Σ SAR < 1.6, Not required
	Top side at 1.0cm		0.074	0.017	0.07	0.02	0.09	Σ SAR < 1.6, Not required
	Bottom side at 1.0cm	1.251			1.25	1.25	0.00	Σ SAR < 1.6, Not required
LTE 5	Front at 1.0cm	0.152	0.091	0.028	0.24	0.18	0.12	Σ SAR < 1.6, Not required
	Back at 1.0cm	0.259	0.410	0.050	0.67	0.31	0.46	Σ SAR < 1.6, Not required
	Left side at 1.0cm				0.00	0.00	0.00	Σ SAR < 1.6, Not required
	Right side at 1.0cm	0.074	0.102	0.029	0.18	0.10	0.13	Σ SAR < 1.6, Not required
	Top side at 1.0cm		0.074	0.017	0.07	0.02	0.09	Σ SAR < 1.6, Not required
	Bottom side at 1.0cm	0.095			0.10	0.10	0.00	Σ SAR < 1.6, Not required
LTE 7	Front at 1.0cm	0.103	0.091	0.028	0.19	0.13	0.12	Σ SAR < 1.6, Not required
	Back at 1.0cm	0.734	0.410	0.050	1.14	0.78	0.46	Σ SAR < 1.6, Not required
	Left side at 1.0cm				0.00	0.00	0.00	Σ SAR < 1.6, Not required
	Right side at 1.0cm	0.058	0.102	0.029	0.16	0.09	0.13	Σ SAR < 1.6, Not required
	Top side at 1.0cm		0.074	0.017	0.07	0.02	0.09	Σ SAR < 1.6, Not required
	Bottom side at 1.0cm	1.049			1.05	1.05	0.00	Σ SAR < 1.6, Not required
LTE 12	Front at 1.0cm	0.127	0.091	0.028	0.22	0.15	0.12	Σ SAR < 1.6, Not required
	Back at 1.0cm	0.176	0.410	0.050	0.59	0.23	0.46	Σ SAR < 1.6, Not required
	Left side at 1.0cm				0.00	0.00	0.00	Σ SAR < 1.6, Not required
	Right side at 1.0cm	0.055	0.102	0.029	0.16	0.08	0.13	Σ SAR < 1.6, Not required
	Top side at 1.0cm		0.074	0.017	0.07	0.02	0.09	Σ SAR < 1.6, Not required
	Bottom side at 1.0cm	0.126			0.13	0.13	0.00	Σ SAR < 1.6, Not required
LTE 13	Front at 1.0cm	0.048	0.091	0.028	0.14	0.08	0.12	Σ SAR < 1.6, Not required
	Back at 1.0cm	0.065	0.410	0.050	0.48	0.12	0.46	Σ SAR < 1.6, Not required
	Left side at 1.0cm				0.00	0.00	0.00	Σ SAR < 1.6, Not required
	Right side at 1.0cm		0.102	0.029	0.10	0.03	0.13	Σ SAR < 1.6, Not required
	Top side at 1.0cm		0.074	0.017	0.07	0.02	0.09	Σ SAR < 1.6, Not required
	Bottom side at 1.0cm	0.081			0.08	0.08	0.00	Σ SAR < 1.6, Not required
LTE 66	Front at 1.0cm	0.185	0.091	0.028	0.28	0.21	0.12	Σ SAR < 1.6, Not required
	Back at 1.0cm	0.595	0.410	0.050	1.00	0.65	0.46	Σ SAR < 1.6, Not required



BUREAU
VERITAS

FCC SAR Test Report



Certificate #6613.01

WWAN Band	Exposure Position	1	2	3	1+2 Summed 1g SAR (W/kg)	1+3 Summed 1g SAR (W/kg)	2+3 Summed 1g SAR (W/kg)	SPLSR Analysis
		WWAN	2.4GHz WLAN	BT				
		1g SAR (W/kg)	1g SAR (W/kg)	1g SAR (W/kg)				
	Left side at 1.0cm	0.030			0.03	0.03	0.00	Σ SAR < 1.6, Not required
	Right side at 1.0cm	0.047	0.102	0.029	0.15	0.08	0.13	Σ SAR < 1.6, Not required
	Top side at 1.0cm		0.074	0.017	0.07	0.02	0.09	Σ SAR < 1.6, Not required
	Bottom side at 1.0cm	1.202			1.20	1.20	0.00	Σ SAR < 1.6, Not required

Note:

1. Except for verified data, all of the data use for the simultaneous transmission analysis on this report was copied from the original report. (Report No: PSU-NQN2302240313SA02, issued by: Huarui 7layers High Technology (Suzhou) Co., Ltd.)
2. The SAR summation of maximum SAR of WWAN and WLAN/BT for each position is under the SAR limitation (**Head & Body: SAR1g 1.6 W/kg, Extremity: SAR10g 4.0 W/kg**). Therefore, the simultaneous transmission condition is compliance with the SAR criterion

Test Engineer : ZiXiao Xia, and RenJie Liu



5. Calibration of Test Equipment

Equipment	Manufacturer	Model	SN	Cal. Date	Cal. Interval
System Validation Dipole	SPEAG	D750V3	1200	Oct. 27, 2021	3 Years
System Validation Dipole	SPEAG	D835V2	4d265	Oct. 18, 2021	3 Years
System Validation Dipole	SPEAG	D1750V2	1176	Oct. 19, 2021	3 Years
System Validation Dipole	SPEAG	D1900V2	5d159	Sep. 16, 2021	3 Years
System Validation Dipole	SPEAG	D2450V2	1048	Oct. 21, 2021	3 Years
System Validation Dipole	SPEAG	D2600V2	1110	Sep. 16, 2021	3 Years
Data Acquisition Electronics	SPEAG	DAE4	1633	Feb. 08, 2023	1 Year
Dosimetric E-field Probe	SPEAG	EX3DV4	7612	Feb. 28, 2023	1 Year
Magnetic Field Probe	SPEAG	DAKS-3.5	1119	Feb. 20, 2023	1 Year
Radio Communication Analyzer	ANRITSU	MT8821C	6272416925	Aug. 26, 2022	2 Years
Power Amplifier	Mimi-Circuits	ZHL-42w	ZHL-42w	N/A	N/A
Power Amplifier	Mimi-Circuits	ZVE-8G+	ZVE-8G+	N/A	N/A
Power Meter	Rohde&Schwarz	NRX	NRX	Feb. 14, 2022	2 Year
Power Sensor	Rohde&Schwarz	NRP6A	NRP6A	Feb. 14, 2022	2 Year
Power Sensor	Rohde&Schwarz	NRP6A	NRP6A	Feb. 14, 2022	2 Year
ESG Analog Signal Generator	Rohde&Schwarz	SMB100A03	SMB100A03	Feb. 15, 2022	2 Year
Coupler	Woken	0110A056020-10	COM27RW1A3	May. 10, 2023	1 Year
Temp.&Humi.Recorder	ANYMETER	JR912	SZ01	Jun.19,2022	2 Year

Note:

- Referring to KDB 865664 D01 v01r04, the dipole calibration interval can be extended to 3 years with justification. The dipole are also not physically damaged, or repaired during the interval. The dipole justification can be found in appendix C.
The return loss is < -20dB, within 20% of prior calibration, the impedance is with 5ohm of prior calibration.



6. Measurement Uncertainty

DASY6 Uncertainty Budget								
Error Description	Uncertainty Value (±%)	Probability	Divisor	(Ci) 1g	(Ci) 10g	Standard Uncertainty (1g) (±%)	Standard Uncertainty (10g) (±%)	(Vi) Veff
Measurement System								
Probe Calibration	6.05	N	1	1	1	6.1	6.1	∞
Axial Isotropy	4.7	R	1.732	0.7	0.7	1.9	1.9	∞
Hemispherical Isotropy	9.6	R	1.732	0.7	0.7	3.9	3.9	∞
Boundary Effects	2.0	R	1.732	1	1	1.2	1.2	∞
Linearity	4.7	R	1.732	1	1	2.7	2.7	∞
System Detection Limits	1.0	R	1.732	1	1	0.6	0.6	∞
Modulation Response	3.2	R	1.732	1	1	1.8	1.8	∞
Readout Electronics	0.3	N	1	1	1	0.3	0.3	∞
Response Time	0.0	R	1.732	1	1	0.0	0.0	∞
Integration Time	2.6	R	1.732	1	1	1.5	1.5	∞
RF Ambient Noise	3.0	R	1.732	1	1	1.7	1.7	∞
RF Ambient Reflections	3.0	R	1.732	1	1	1.7	1.7	∞
Probe Positioner	0.4	R	1.732	1	1	0.2	0.2	∞
Probe Positioning	6.7	R	1.732	1	1	3.9	3.9	∞
Max. SAR Eval.	4.0	R	1.732	1	1	2.3	2.3	∞
Test Sample Related								
Device Positioning	4.0	N	1	1	1	4.0	4.0	35
Device Holder	4.9	N	1	1	1	4.9	4.9	12
Power Drift	5.0	R	1.732	1	1	2.9	2.9	∞
Power Scaling	0.0	R	1.732	1	1	0.0	0.0	∞
Phantom and Setup								
Phantom Uncertainty	6.6	R	1.732	1	1	3.8	3.8	∞
SAR correction	0.0	R	1.732	1	0.84	0.0	0.0	∞
Liquid Conductivity Repeatability	0.14	N	1	0.78	0.71	0.1	0.1	5
Liquid Conductivity (target)	10.0	R	1.732	0.78	0.71	4.5	4.1	∞
Liquid Conductivity (mea.)	2.5	R	1.732	0.78	0.71	1.1	1.0	∞
Temp. unc. - Conductivity	2.61	R	1.732	0.78	0.71	1.2	1.1	∞
Liquid Permittivity Repeatability	0.03	N	1	0.23	0.26	0.0	0.0	5
Liquid Permittivity (target)	10.0	R	1.732	0.23	0.26	1.3	1.5	∞
Liquid Permittivity (mea.)	2.5	R	1.732	0.23	0.26	0.3	0.4	∞
Temp. unc. - Permittivity	1.78	R	1.732	0.23	0.26	0.2	0.3	∞
Combined Std. Uncertainty						13.6%	13.5%	578
Coverage Factor for 95 %						K=2	K=2	
Expanded STD Uncertainty						27.2%	26.9%	

Uncertainty budget for frequency range 300 MHz to 3 GHz



7. Information on the Testing Laboratories

We, Huarui Saiwei (Suzhou) Technology Co., LTD., were founded in 2020 to provide our best service in EMC, Radio, Telecom and Safety consultation.

If you have any comments, please feel free to contact us at the following:

Add: Tower N, Innovation Center, 88 Zuyi Road, High-tech District, Suzhou City, Anhui Province

Tel: [+86 \(0557\) 368 1008](tel:+86(0557)3681008)

The road map of all our labs can be found in our web site also

Web: <http://www.7Layers.com>

---END---



BUREAU
VERITAS



Appendix A. SAR Plots of System Verification

The plots for system verification with largest deviation for each SAR system combination are shown as follows.

System Check_HSL750_230918

DUT: Dipole 750 MHz; Type: D750V3

Communication System: CW; Frequency: 750 MHz; Duty Cycle: 1:1

Medium: HSL750_0918 Medium parameters used: $f = 750$ MHz; $\sigma = 0.902$ S/m; $\epsilon_r = 43.239$; $\rho = 1000$ kg/m³

Ambient Temperature : 23.2°C; Liquid Temperature : 22.6°C

DASY5 Configuration:

- Probe: EX3DV4 - SN7612; ConvF(11.35, 11.35, 11.35) @ 750 MHz; Calibrated: 2023/02/28
- Sensor-Surface: 1.4mm (Mechanical Surface Detection)
- Electronics: DAE4 Sn1633; Calibrated: 2023/02/08
- Phantom: Right v5.0; Type: QD000P40CD; Serial: TP:1502
- Measurement SW: DASY52, Version 52.10 (2); SEMCAD X Version 14.6.12 (7450)

Pin=250mW/Area Scan (81x141x1): Interpolated grid: dx=1.500 mm, dy=1.500 mm
Maximum value of SAR (interpolated) = 2.27 W/kg

Pin=250mW/Zoom Scan (5x5x7)/Cube 0: Measurement grid: dx=8mm, dy=8mm, dz=5mm
Reference Value = 41.85 V/m; Power Drift = 0.02 dB
Peak SAR (extrapolated) = 3.08 W/kg
SAR(1 g) = 2.11 W/kg; SAR(10 g) = 1.39 W/kg
Maximum value of SAR (measured) = 2.28 W/kg

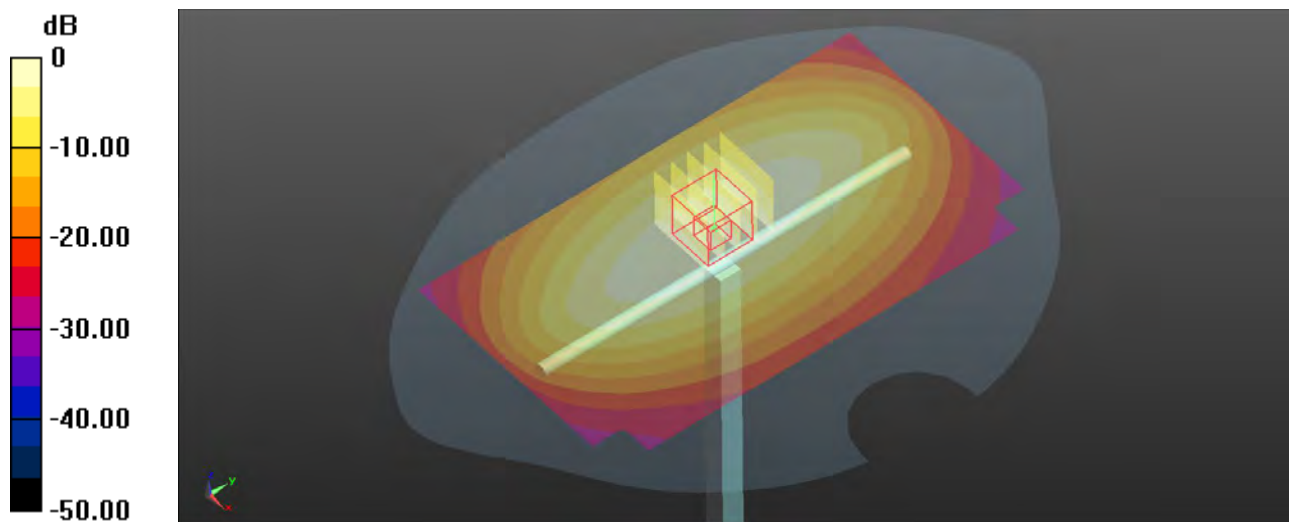

0 dB = 2.28 W/kg

System Check_HSL835_230918

DUT: Dipole 835 MHz; Type: D835V2

Communication System: CW; Frequency: 835 MHz; Duty Cycle: 1:1

Medium: HSL835_0918 Medium parameters used: $f = 835 \text{ MHz}$; $\sigma = 0.931 \text{ S/m}$; $\epsilon_r = 42.981$; $\rho = 1000 \text{ kg/m}^3$

Ambient Temperature : 23.2°C ; Liquid Temperature : 22.6°C

DASY5 Configuration:

- Probe: EX3DV4 - SN7612; ConvF(10.88, 10.88, 10.88) @ 835 MHz; Calibrated: 2023/02/28
- Sensor-Surface: 1.4mm (Mechanical Surface Detection)
- Electronics: DAE4 Sn1633; Calibrated: 2023/02/08
- Phantom: Right v5.0; Type: QD000P40CD; Serial: TP:1502
- Measurement SW: DASY52, Version 52.10 (2); SEMCAD X Version 14.6.12 (7450)

Pin=250mW/Area Scan (81x81x1): Interpolated grid: $dx=1.500 \text{ mm}$, $dy=1.500 \text{ mm}$
Maximum value of SAR (interpolated) = 2.71 W/kg

Pin=250mW/Zoom Scan (5x5x7)/Cube 0: Measurement grid: $dx=8\text{mm}$, $dy=8\text{mm}$, $dz=5\text{mm}$
Reference Value = 44.90 V/m ; Power Drift = 0.02 dB
Peak SAR (extrapolated) = 3.69 W/kg
SAR(1 g) = 2.51 W/kg ; SAR(10 g) = 1.64 W/kg
Maximum value of SAR (measured) = 2.72 W/kg

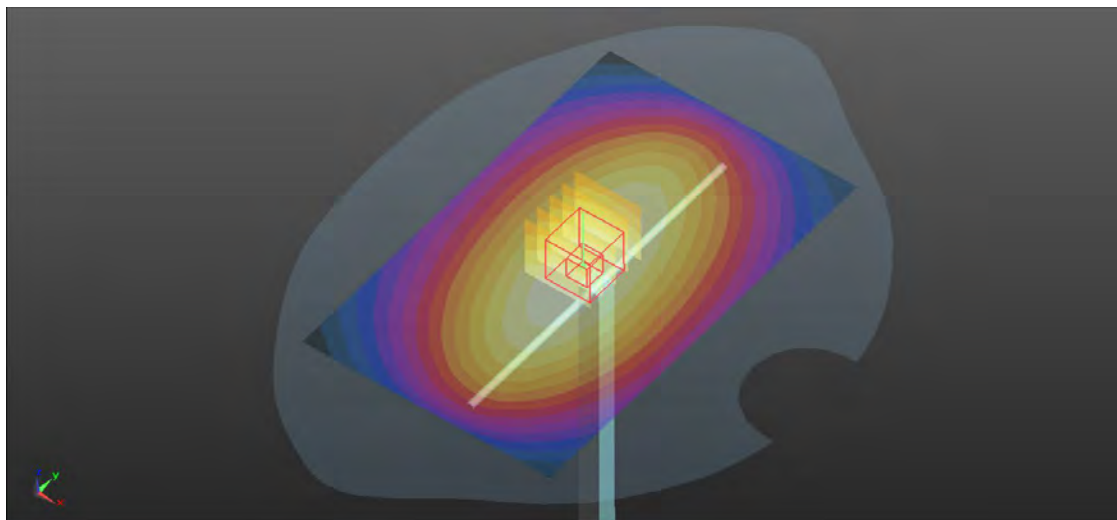
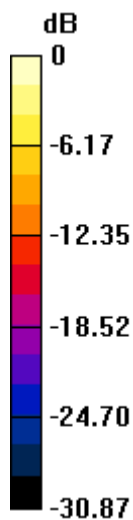

0 dB = 2.72 W/kg

System Check_HSL1750_230918

DUT: Dipole 1750 MHz; Type: D1750V2

Communication System: CW; Frequency: 1750 MHz; Duty Cycle: 1:1

Medium: HSL1750_0918 Medium parameters used: $f = 1750$ MHz; $\sigma = 1.421$ S/m; $\epsilon_r = 40.782$; $\rho = 1000$ kg/m³

Ambient Temperature : 23.3°C; Liquid Temperature : 22.6°C

DASY5 Configuration:

- Probe: EX3DV4 - SN7612; ConvF(9.05, 9.05, 9.05) @ 1750 MHz; Calibrated: 2023/02/28
- Sensor-Surface: 1.4mm (Mechanical Surface Detection)
- Electronics: DAE4 Sn1633; Calibrated: 2023/02/08
- Phantom: Right v5.0; Type: QD000P40CD; Serial: TP:1502
- Measurement SW: DASY52, Version 52.10 (2); SEMCAD X Version 14.6.12 (7450)

Pin=250mW/Area Scan (51x81x1): Interpolated grid: dx=1.500 mm, dy=1.500 mm
Maximum value of SAR (interpolated) = 10.6 W/kg

Pin=250mW/Zoom Scan (5x5x7)/Cube 0: Measurement grid: dx=8mm, dy=8mm, dz=5mm
Reference Value = 85.66 V/m; Power Drift = -0.16 dB
Peak SAR (extrapolated) = 18.1 W/kg
SAR(1 g) = 9.39 W/kg; SAR(10 g) = 4.91 W/kg
Maximum value of SAR (measured) = 10.7 W/kg

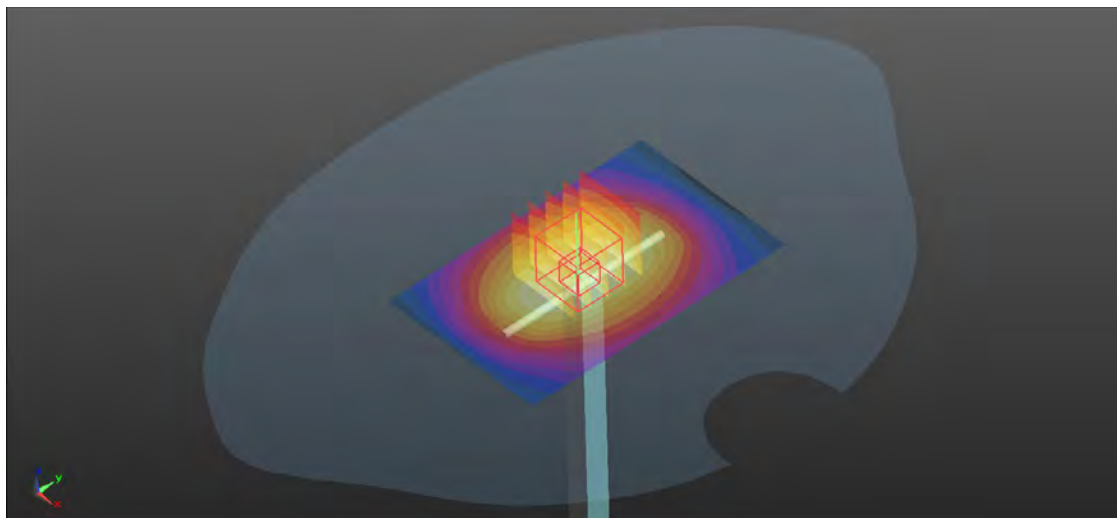
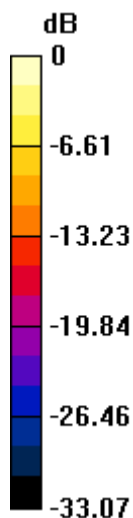

0 dB = 10.7 W/kg

System Check_HSL1900_230918

DUT: Dipole 1900 MHz; Type: D1900V2

Communication System: CW; Frequency: 1900 MHz; Duty Cycle: 1:1

Medium: HSL1900_0918 Medium parameters used: $f = 1900$ MHz; $\sigma = 1.403$ S/m; $\epsilon_r = 39.73$; $\rho = 1000$ kg/m³

Ambient Temperature : 23.4°C; Liquid Temperature : 22.6°C

DASY5 Configuration:

- Probe: EX3DV4 - SN7612; ConvF(8.68, 8.68, 8.68) @ 1900 MHz; Calibrated: 2023/02/28
- Sensor-Surface: 1.4mm (Mechanical Surface Detection)
- Electronics: DAE4 Sn1633; Calibrated: 2023/02/08
- Phantom: Right v5.0; Type: QD000P40CD; Serial: TP:1502
- Measurement SW: DASY52, Version 52.10 (2); SEMCAD X Version 14.6.12 (7450)

Pin=250mW/Area Scan (71x71x1): Interpolated grid: dx=1.500 mm, dy=1.500 mm
Maximum value of SAR (interpolated) = 11.1 W/kg

Pin=250mW/Zoom Scan (5x5x7)/Cube 0: Measurement grid: dx=8mm, dy=8mm, dz=5mm
Reference Value = 84.41 V/m; Power Drift = 0.13 dB
Peak SAR (extrapolated) = 17.8 W/kg
SAR(1 g) = 9.56 W/kg; SAR(10 g) = 4.96 W/kg
Maximum value of SAR (measured) = 10.7 W/kg

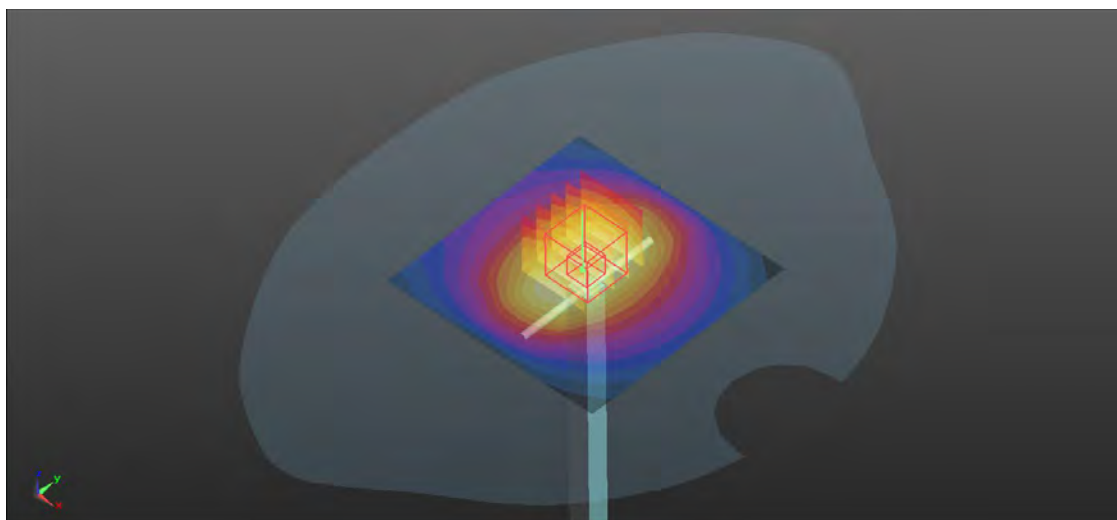
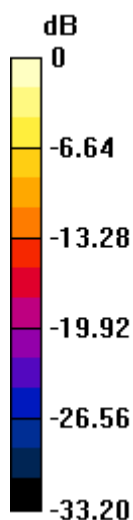

0 dB = 10.7 W/kg

System Check_HSL2450_230918

DUT: Dipole 2450 MHz; Type: D2450V2

Communication System: CW; Frequency: 2450 MHz; Duty Cycle: 1:1

Medium: HSL2450_0918 Medium parameters used: $f = 2450$ MHz; $\sigma = 1.815$ S/m; $\epsilon_r = 39.16$; $\rho = 1000$ kg/m³

Ambient Temperature : 23.4°C; Liquid Temperature : 22.7°C

DASY5 Configuration:

- Probe: EX3DV4 - SN7612; ConvF(8.11, 8.11, 8.11) @ 2450 MHz; Calibrated: 2023/02/28
- Sensor-Surface: 1.4mm (Mechanical Surface Detection)
- Electronics: DAE4 Sn1633; Calibrated: 2023/02/08
- Phantom: Right v5.0; Type: QD000P40CD; Serial: TP:1502
- Measurement SW: DASY52, Version 52.10 (2); SEMCAD X Version 14.6.12 (7450)

Pin=250mW/Area Scan (101x101x1): Interpolated grid: dx=1.200 mm, dy=1.200 mm
Maximum value of SAR (interpolated) = 21.2 W/kg

Pin=250mW/Zoom Scan (7x7x7)/Cube 0: Measurement grid: dx=5mm, dy=5mm, dz=5mm

Reference Value = 51.96 V/m; Power Drift = 0.07 dB

Peak SAR (extrapolated) = 26.1 W/kg

SAR(1 g) = 12.5 W/kg; SAR(10 g) = 5.79 W/kg

Maximum value of SAR (measured) = 21.1 W/kg

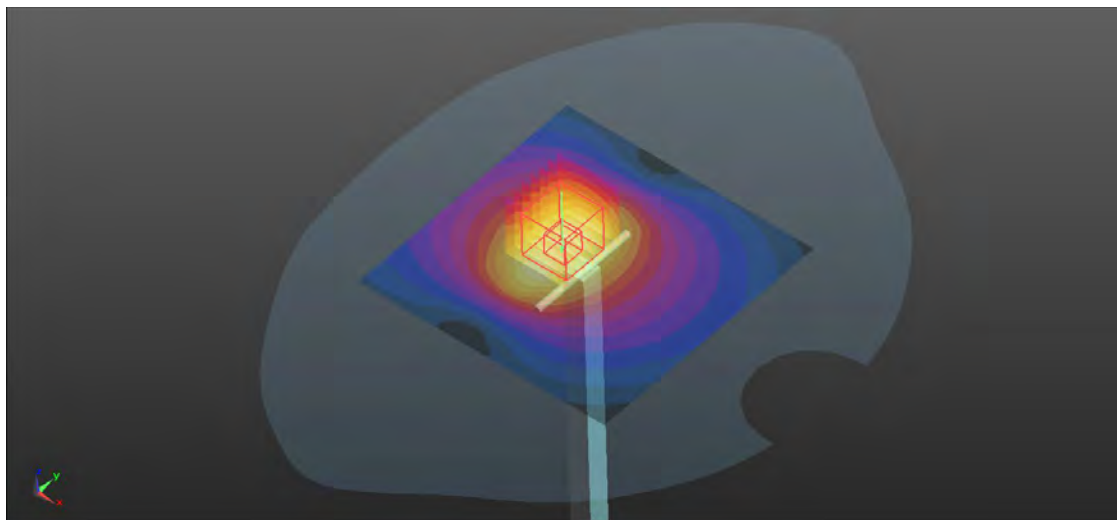
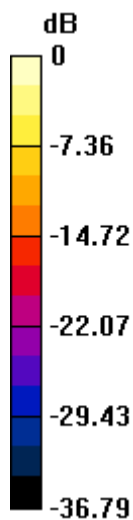

0 dB = 21.1 W/kg

System Check_HSL2600_230918

DUT: Dipole 2600 MHz; Type: D2600V2

Communication System: CW; Frequency: 2600 MHz; Duty Cycle: 1:1

Medium: HSL2600_0918 Medium parameters used: $f = 2600$ MHz; $\sigma = 1.93$ S/m; $\epsilon_r = 38.938$; $\rho = 1000$ kg/m³

Ambient Temperature : 23.4°C; Liquid Temperature : 22.7°C

DASY5 Configuration:

- Probe: EX3DV4 - SN7612; ConvF(7.85, 7.85, 7.85) @ 2600 MHz; Calibrated: 2023/02/28
- Sensor-Surface: 1.4mm (Mechanical Surface Detection)
- Electronics: DAE4 Sn1633; Calibrated: 2023/02/08
- Phantom: Right v5.0; Type: QD000P40CD; Serial: TP:1502
- Measurement SW: DASY52, Version 52.10 (2); SEMCAD X Version 14.6.12 (7450)

Pin=250mW/Area Scan (71x81x1): Interpolated grid: dx=1.200 mm, dy=1.200 mm
Maximum value of SAR (interpolated) = 24.9 W/kg

Pin=250mW/Zoom Scan (7x7x7)/Cube 0: Measurement grid: dx=5mm, dy=5mm, dz=5mm
Reference Value = 106.9 V/m; Power Drift = 0.11 dB
Peak SAR (extrapolated) = 31.1 W/kg
SAR(1 g) = 14.2 W/kg; SAR(10 g) = 6.2 W/kg
Maximum value of SAR (measured) = 24.7 W/kg

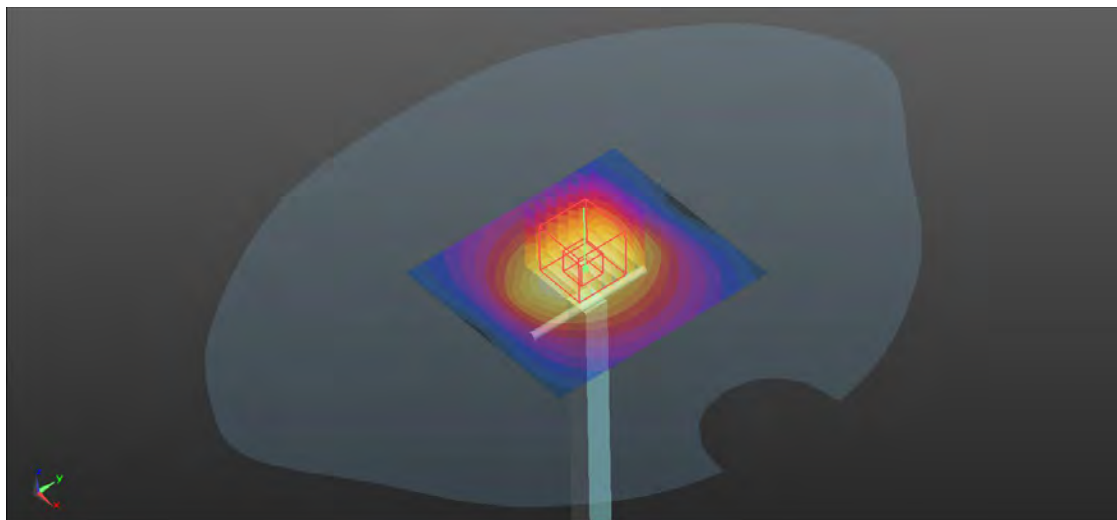
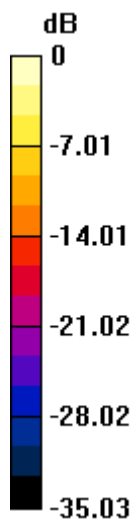

0 dB = 24.7 W/kg



BUREAU
VERITAS



Appendix B. SAR Plots of SAR Measurement

The SAR plots for highest measured SAR in each exposure configuration, wireless mode and frequency band combination, and measured SAR > 1.5 W/kg are shown as follows.

P01 GSM850_GPRS(3Tx slot)_Right Cheek_Ch128

Communication System: GPRS(3Tx-slot); Frequency: 824.2 MHz; Duty Cycle: 1:2.77
Medium: HSL835_0918 Medium parameters used: $f = 824.2$ MHz; $\sigma = 0.926$ S/m; $\epsilon_r = 43.058$; $\rho = 1000$ kg/m³
Ambient Temperature : 23.2°C; Liquid Temperature : 22.6°C

DASY5 Configuration:

- Probe: EX3DV4 - SN7612; ConvF(10.88, 10.88, 10.88) @ 824.2 MHz; Calibrated: 2023/02/28
- Sensor-Surface: 1.4mm (Mechanical Surface Detection)
- Electronics: DAE4 Sn1633; Calibrated: 2023/02/08
- Phantom: Right v5.0; Type: QD000P40CD; Serial: TP:1502
- Measurement SW: DASY52, Version 52.10 (2); SEMCAD X Version 14.6.12 (7450)

-Area Scan (71x131x1): Interpolated grid: dx=1.500 mm, dy=1.500 mm
Maximum value of SAR (interpolated) = 0.221 W/kg

-Zoom Scan (5x5x7)/Cube 0: Measurement grid: dx=8mm, dy=8mm, dz=5mm
Reference Value = 4.276 V/m; Power Drift = -0.09 dB
Peak SAR (extrapolated) = 0.259 W/kg
SAR(1 g) = 0.200 W/kg; SAR(10 g) = 0.151 W/kg
Maximum value of SAR (measured) = 0.221 W/kg

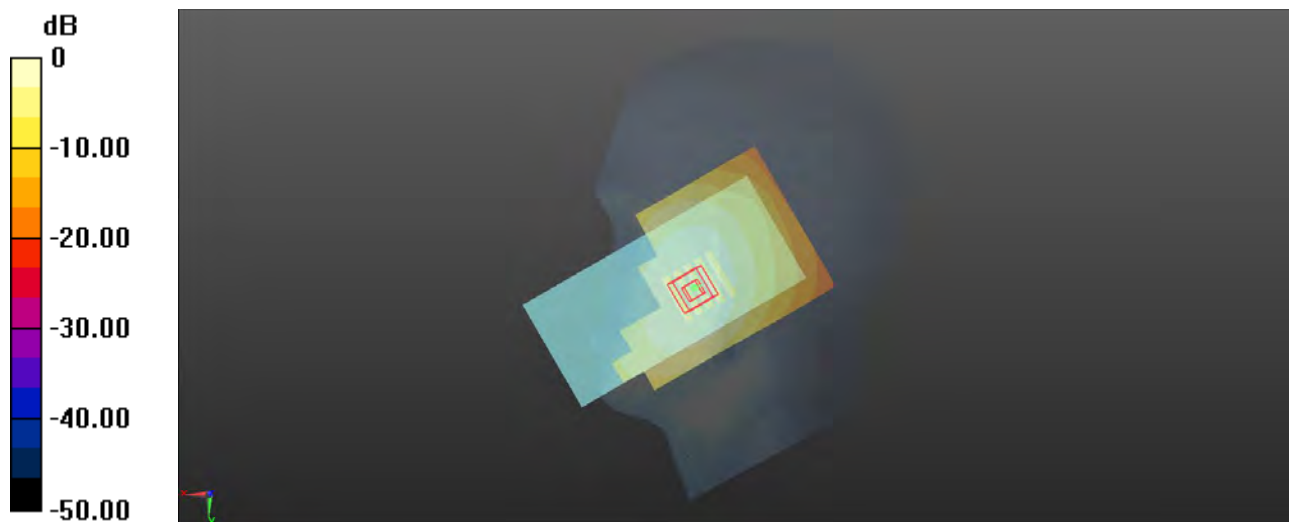

0 dB = 0.221 W/kg

P02 GSM1900_GPRS(3Tx slot)_Right Cheek_Ch512

Communication System: GPRS(3Tx-slot); Frequency: 1850.2 MHz; Duty Cycle: 1:2.77
Medium: HSL1900_0918 Medium parameters used: $f = 1850.2$ MHz; $\sigma = 1.376$ S/m; $\epsilon_r = 39.777$; $\rho = 1000$ kg/m³
Ambient Temperature : 23.4°C; Liquid Temperature : 22.6°C

DASY5 Configuration:

- Probe: EX3DV4 - SN7612; ConvF(10.88, 10.88, 10.88) @ 1850.2 MHz; Calibrated: 2023/02/28
- Sensor-Surface: 1.4mm (Mechanical Surface Detection)
- Electronics: DAE4 Sn1633; Calibrated: 2023/02/08
- Phantom: Right v5.0; Type: QD000P40CD; Serial: TP:1502
- Measurement SW: DASY52, Version 52.10 (2); SEMCAD X Version 14.6.12 (7450)

-Area Scan (71x131x1): Interpolated grid: dx=1.500 mm, dy=1.500 mm
Maximum value of SAR (interpolated) = 0.0428 W/kg

-Zoom Scan (5x5x7)/Cube 0: Measurement grid: dx=8mm, dy=8mm, dz=5mm
Reference Value = 1.289 V/m; Power Drift = 0.01 dB
Peak SAR (extrapolated) = 0.0560 W/kg
SAR(1 g) = 0.037 W/kg; SAR(10 g) = 0.024 W/kg
Maximum value of SAR (measured) = 0.0430 W/kg

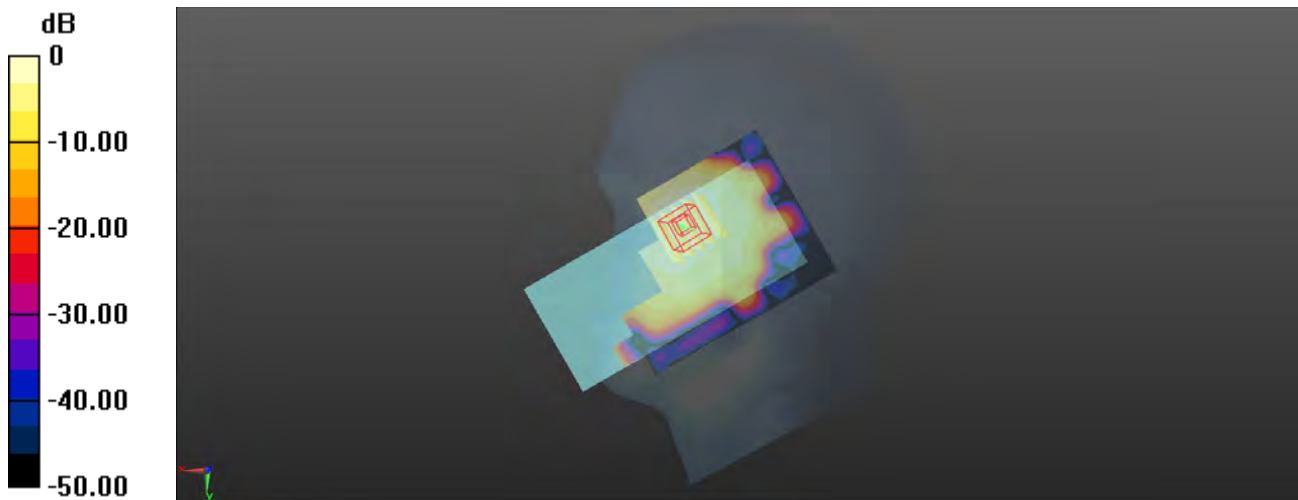

P03 WCDMA II_RMC12.2K_Right Cheek_Ch9262

Communication System: WCDMA; Frequency: 1852.4 MHz; Duty Cycle: 1:1

Medium: HSL1900_0918 Medium parameters used: $f = 1852.4$ MHz; $\sigma = 1.377$ S/m; $\epsilon_r = 39.773$; $\rho = 1000$ kg/m³

Ambient Temperature : 23.4°C; Liquid Temperature : 22.6°C

DASY5 Configuration:

- Probe: EX3DV4 - SN7612; ConvF(8.68, 8.68, 8.68) @ 1852.4 MHz; Calibrated: 2023/02/28
- Sensor-Surface: 1.4mm (Mechanical Surface Detection)
- Electronics: DAE4 Sn1633; Calibrated: 2023/02/08
- Phantom: Right v5.0; Type: QD000P40CD; Serial: TP:1502
- Measurement SW: DASY52, Version 52.10 (2); SEMCAD X Version 14.6.12 (7450)

-Area Scan (71x131x1): Interpolated grid: dx=1.500 mm, dy=1.500 mm
Maximum value of SAR (interpolated) = 0.0332 W/kg

-Zoom Scan (5x5x7)/Cube 0: Measurement grid: dx=8mm, dy=8mm, dz=5mm
Reference Value = 1.217 V/m; Power Drift = 0.06 dB
Peak SAR (extrapolated) = 0.0460 W/kg
SAR(1 g) = 0.029 W/kg; SAR(10 g) = 0.018 W/kg
Maximum value of SAR (measured) = 0.0343 W/kg

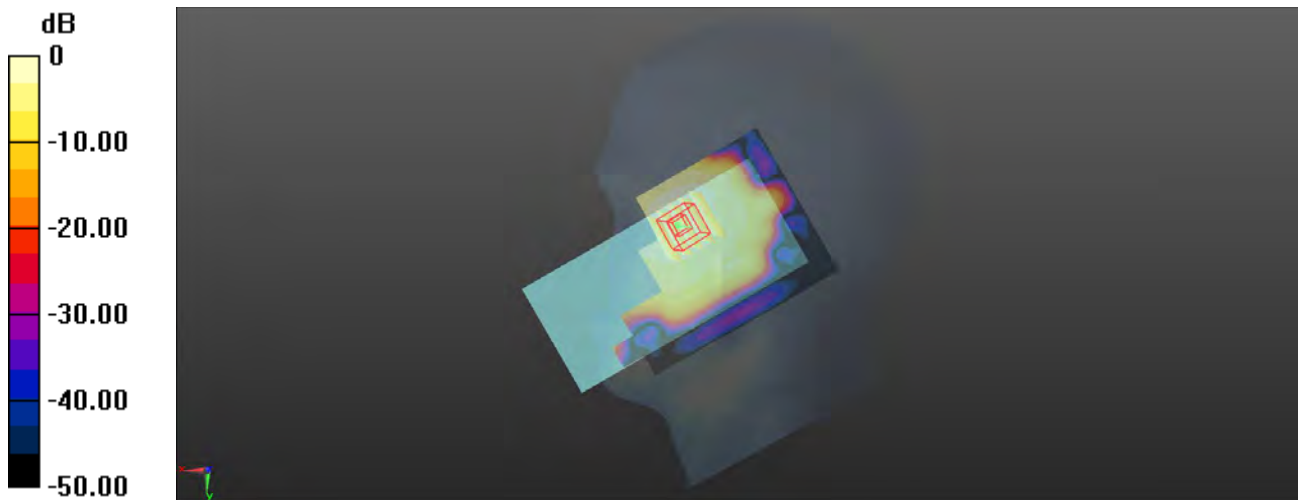

0 dB = 0.0343 W/kg

P04 WCDMA IV_RMC12.2K_Right Cheek_Ch1413

Communication System: WCDMA; Frequency: 1732.6 MHz; Duty Cycle: 1:1
Medium: HSL1750_0918 Medium parameters used: $f = 1733$ MHz; $\sigma = 1.41$ S/m; $\epsilon_r = 40.804$; $\rho = 1000$ kg/m³
Ambient Temperature : 23.3°C; Liquid Temperature : 22.6°C

DASY5 Configuration:

- Probe: EX3DV4 - SN7612; ConvF(9.05, 9.05, 9.05) @ 1732.6 MHz; Calibrated: 2023/02/28
- Sensor-Surface: 1.4mm (Mechanical Surface Detection)
- Electronics: DAE4 Sn1633; Calibrated: 2023/02/08
- Phantom: Right v5.0; Type: QD000P40CD; Serial: TP:1502
- Measurement SW: DASY52, Version 52.10 (2); SEMCAD X Version 14.6.12 (7450)

-Area Scan (71x131x1): Interpolated grid: dx=1.500 mm, dy=1.500 mm
Maximum value of SAR (interpolated) = 0.201 W/kg

-Zoom Scan (5x5x7)/Cube 0: Measurement grid: dx=8mm, dy=8mm, dz=5mm
Reference Value = 1.77 V/m; Power Drift = 0.06 dB
Peak SAR (extrapolated) = 0.198 W/kg
SAR(1 g) = 0.155 W/kg; SAR(10 g) = 0.502 W/kg
Maximum value of SAR (measured) = 0.199 W/kg

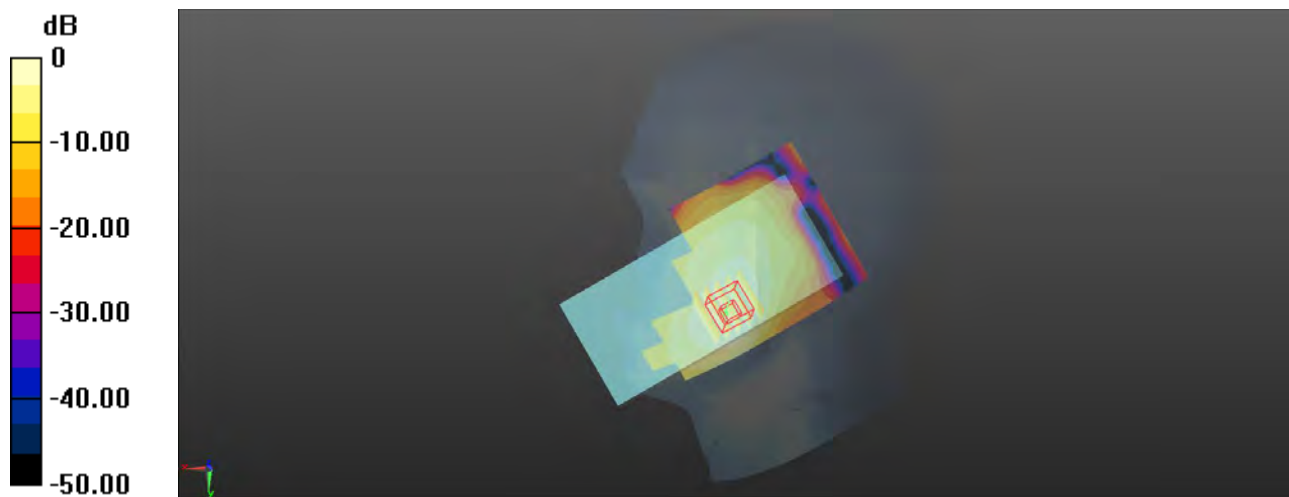

0 dB = 0.199 W/kg

P05 WCDMA V_RMC12.2K_Right Cheek_Ch4233

Communication System: WCDMA; Frequency: 846.6 MHz; Duty Cycle: 1:1

Medium: HSL835_0918 Medium parameters used: $f = 847$ MHz; $\sigma = 0.936$ S/m; $\epsilon_r = 42.914$; $\rho = 1000$ kg/m³

Ambient Temperature : 23.2°C; Liquid Temperature : 22.6°C

DASY5 Configuration:

- Probe: EX3DV4 - SN7612; ConvF(10.88, 10.88, 10.88) @ 846.6 MHz; Calibrated: 2023/02/28
- Sensor-Surface: 1.4mm (Mechanical Surface Detection)
- Electronics: DAE4 Sn1633; Calibrated: 2023/02/08
- Phantom: Right v5.0; Type: QD000P40CD; Serial: TP:1502
- Measurement SW: DASY52, Version 52.10 (2); SEMCAD X Version 14.6.12 (7450)

-Area Scan (71x131x1): Interpolated grid: dx=1.500 mm, dy=1.500 mm

Maximum value of SAR (interpolated) = 0.220 W/kg

-Zoom Scan (5x5x7)/Cube 0: Measurement grid: dx=8mm, dy=8mm, dz=5mm

Reference Value = 3.221 V/m; Power Drift = 0.04 dB

Peak SAR (extrapolated) = 0.259 W/kg

SAR(1 g) = 0.201 W/kg; SAR(10 g) = 0.153 W/kg

Maximum value of SAR (measured) = 0.222 W/kg

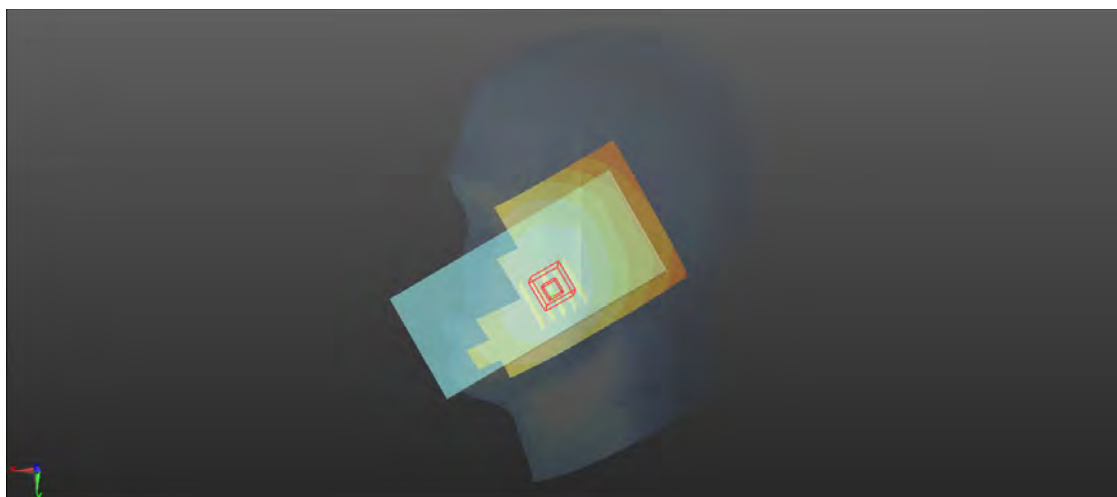
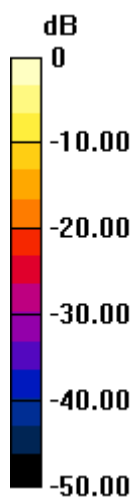

0 dB = 0.222 W/kg

P06 LTE 2_QPSK20M_Right Cheek_Ch18900_1RB_OS50

Communication System: LTE_FDD; Frequency: 1880 MHz; Duty Cycle: 1:1

Medium: HSL1900_0918 Medium parameters used: $f = 1880$ MHz; $\sigma = 1.39$ S/m; $\epsilon_r = 39.746$; $\rho = 1000$ kg/m³

Ambient Temperature : 23.4°C; Liquid Temperature : 22.6°C

DASY5 Configuration:

- Probe: EX3DV4 - SN7612; ConvF(8.68, 8.68, 8.68) @ 1880 MHz; Calibrated: 2023/02/28
- Sensor-Surface: 1.4mm (Mechanical Surface Detection)
- Electronics: DAE4 Sn1633; Calibrated: 2023/02/08
- Phantom: Right v5.0; Type: QD000P40CD; Serial: TP:1502
- Measurement SW: DASY52, Version 52.10 (2); SEMCAD X Version 14.6.12 (7450)

-Area Scan (71x131x1): Interpolated grid: dx=1.500 mm, dy=1.500 mm
Maximum value of SAR (interpolated) = 0.159 W/kg

-Zoom Scan (5x5x7)/Cube 0: Measurement grid: dx=8mm, dy=8mm, dz=5mm
Reference Value = 2.582 V/m; Power Drift = 0.06 dB
Peak SAR (extrapolated) = 0.166 W/kg
SAR(1 g) = 0.126 W/kg; SAR(10 g) = 0.077 W/kg
Maximum value of SAR (measured) = 0.154 W/kg

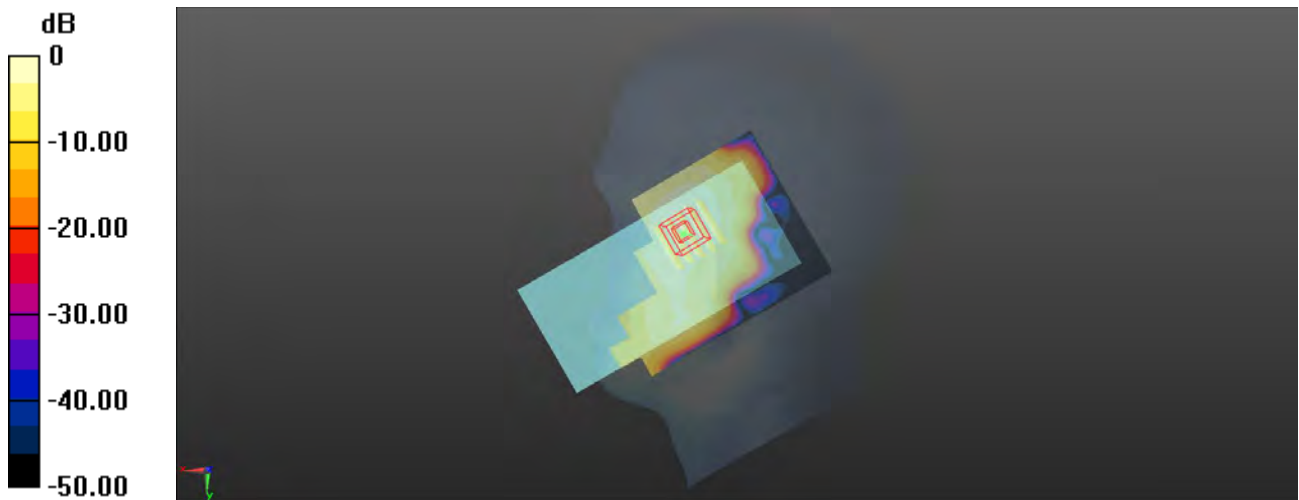

0 dB = 0.154 W/kg

P07 LTE 5_QPSK10M_Right Cheek_Ch20450_1RB_OS24

Communication System: LTE_FDD; Frequency: 829 MHz; Duty Cycle: 1:1
Medium: HSL835_0918 Medium parameters used: $f = 829 \text{ MHz}$; $\sigma = 0.928 \text{ S/m}$; $\epsilon_r = 43.035$; $\rho = 1000 \text{ kg/m}^3$
Ambient Temperature : 23.2°C ; Liquid Temperature : 22.6°C

DASY5 Configuration:

- Probe: EX3DV4 - SN7612; ConvF(10.88, 10.88, 10.88) @ 829 MHz; Calibrated: 2023/02/28
- Sensor-Surface: 1.4mm (Mechanical Surface Detection)
- Electronics: DAE4 Sn1633; Calibrated: 2023/02/08
- Phantom: Right v5.0; Type: QD000P40CD; Serial: TP:1502
- Measurement SW: DASY52, Version 52.10 (2); SEMCAD X Version 14.6.12 (7450)

-Area Scan (71x131x1): Interpolated grid: $dx=1.500 \text{ mm}$, $dy=1.500 \text{ mm}$
Maximum value of SAR (interpolated) = 0.204 W/kg

-Zoom Scan (5x5x7)/Cube 0: Measurement grid: $dx=8\text{mm}$, $dy=8\text{mm}$, $dz=5\text{mm}$
Reference Value = 3.736 V/m ; Power Drift = 0.02 dB
Peak SAR (extrapolated) = 0.240 W/kg
SAR(1 g) = 0.189 W/kg ; SAR(10 g) = 0.143 W/kg
Maximum value of SAR (measured) = 0.206 W/kg

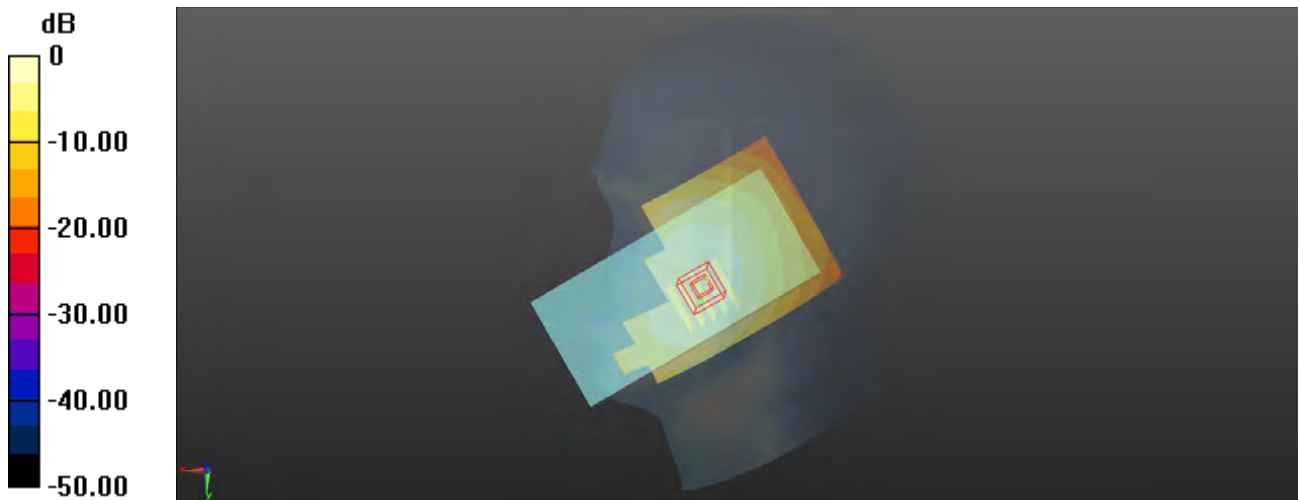

0 dB = 0.206 W/kg

P08 LTE 7_QPSK20M_Right Cheek_Ch20850_1RB_OS0

Communication System: LTE_FDD; Frequency: 2510 MHz; Duty Cycle: 1:1

Medium: HSL2600_0918 Medium parameters used: $f = 2510$ MHz; $\sigma = 1.859$ S/m; $\epsilon_r = 39.071$; $\rho = 1000$ kg/m³

Ambient Temperature : 23.4°C; Liquid Temperature : 22.7°C

DASY5 Configuration:

- Probe: EX3DV4 - SN7612; ConvF(7.85, 7.85, 7.85) @ 2510 MHz; Calibrated: 2023/02/28
- Sensor-Surface: 1.4mm (Mechanical Surface Detection)
- Electronics: DAE4 Sn1633; Calibrated: 2023/02/08
- Phantom: Right v5.0; Type: QD000P40CD; Serial: TP:1502
- Measurement SW: DASY52, Version 52.10 (2); SEMCAD X Version 14.6.12 (7450)

-Area Scan (81x161x1): Interpolated grid: dx=1.200 mm, dy=1.200 mm

Maximum value of SAR (interpolated) = 0.0534 W/kg

-Zoom Scan (7x7x7)/Cube 0: Measurement grid: dx=5mm, dy=5mm, dz=5mm

Reference Value = 0.1360 V/m; Power Drift = 0.05 dB

Peak SAR (extrapolated) = 0.0740 W/kg

SAR(1 g) = 0.042 W/kg; SAR(10 g) = 0.023 W/kg

Maximum value of SAR (measured) = 0.0516 W/kg

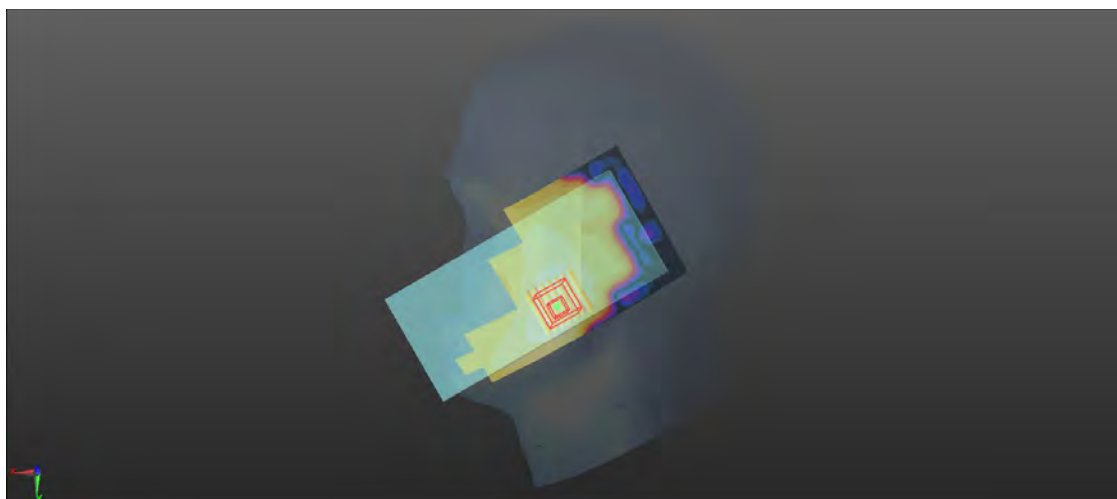
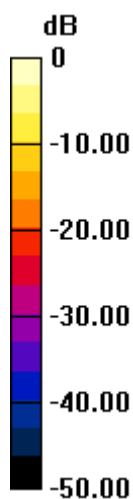

0 dB = 0.0516 W/kg

P09 LTE 12_QPSK10M_Right Cheek_Ch23130_1RB_OS0

Communication System: LTE_FDD; Frequency: 711 MHz; Duty Cycle: 1:1
Medium: HSL750_0918 Medium parameters used: $f = 711$ MHz; $\sigma = 0.89$ S/m; $\epsilon_r = 43.344$; $\rho = 1000$ kg/m³
Ambient Temperature : 23.2°C; Liquid Temperature : 22.6°C

DASY5 Configuration:

- Probe: EX3DV4 - SN7612; ConvF(11.35, 11.35, 11.35) @ 711 MHz; Calibrated: 2023/02/28
- Sensor-Surface: 1.4mm (Mechanical Surface Detection)
- Electronics: DAE4 Sn1633; Calibrated: 2023/02/08
- Phantom: Right v5.0; Type: QD000P40CD; Serial: TP:1502
- Measurement SW: DASY52, Version 52.10 (2); SEMCAD X Version 14.6.12 (7450)

-Area Scan (71x131x1): Interpolated grid: dx=1.500 mm, dy=1.500 mm
Maximum value of SAR (interpolated) = 0.119 W/kg

-Zoom Scan (5x5x7)/Cube 0: Measurement grid: dx=8mm, dy=8mm, dz=5mm
Reference Value = 2.763 V/m; Power Drift = 0.09 dB
Peak SAR (extrapolated) = 0.141 W/kg
SAR(1 g) = 0.109 W/kg; SAR(10 g) = 0.084 W/kg
Maximum value of SAR (measured) = 0.121 W/kg

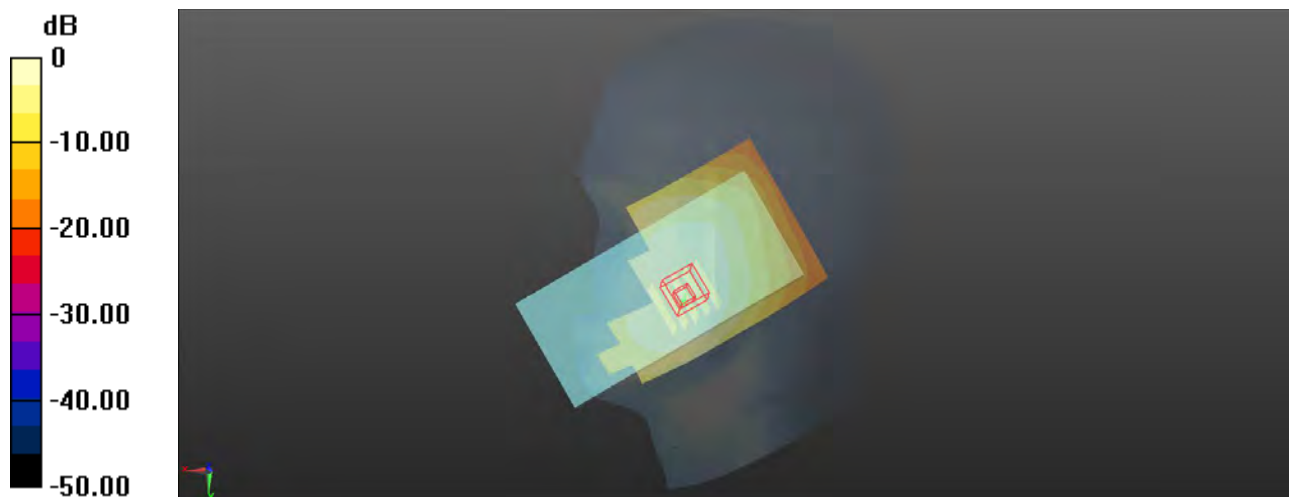

0 dB = 0.121 W/kg

P10 LTE 13_QPSK10M_Right Cheek_Ch23230_1RB_OS49

Communication System: LTE_FDD; Frequency: 782 MHz; Duty Cycle: 1:1
Medium: HSL750_0918 Medium parameters used: $f = 782 \text{ MHz}$; $\sigma = 0.915 \text{ S/m}$; $\epsilon_r = 43.118$; $\rho = 1000 \text{ kg/m}^3$
Ambient Temperature : 23.2°C; Liquid Temperature : 22.6°C

DASY5 Configuration:

- Probe: EX3DV4 - SN7612; ConvF(11.35, 11.35, 11.35) @ 782 MHz; Calibrated: 2023/02/28
- Sensor-Surface: 1.4mm (Mechanical Surface Detection)
- Electronics: DAE4 Sn1633; Calibrated: 2023/02/08
- Phantom: Right v5.0; Type: QD000P40CD; Serial: TP:1502
- Measurement SW: DASY52, Version 52.10 (2); SEMCAD X Version 14.6.12 (7450)

-Area Scan (71x131x1): Interpolated grid: $dx=1.500 \text{ mm}$, $dy=1.500 \text{ mm}$
Maximum value of SAR (interpolated) = 0.0540 W/kg

-Zoom Scan (5x5x7)/Cube 0: Measurement grid: $dx=8\text{mm}$, $dy=8\text{mm}$, $dz=5\text{mm}$
Reference Value = 1.693 V/m; Power Drift = 0.05 dB
Peak SAR (extrapolated) = 0.0640 W/kg
SAR(1 g) = 0.049 W/kg; SAR(10 g) = 0.037 W/kg
Maximum value of SAR (measured) = 0.0536 W/kg

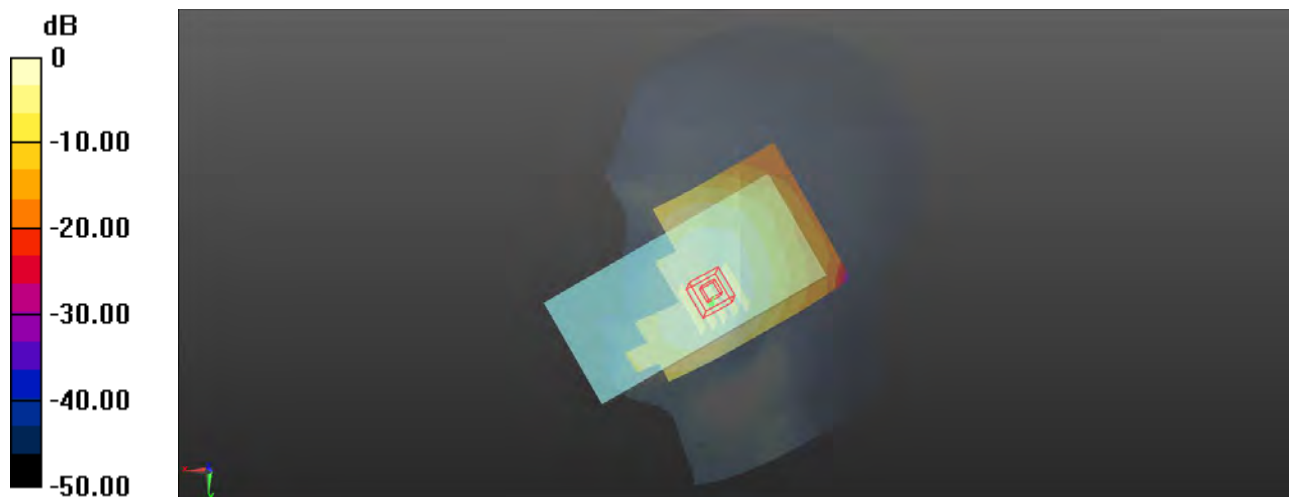

0 dB = 0.0536 W/kg

P11 LTE 66_QPSK20M_Right Cheek_Ch132572_1RB_OS50

Communication System: LTE_FDD; Frequency: 1770 MHz; Duty Cycle: 1:1

Medium: HSL1750_0918 Medium parameters used: $f = 1770$ MHz; $\sigma = 1.429$ S/m; $\epsilon_r = 40.74$; $\rho = 1000$ kg/m³

Ambient Temperature : 23.3°C; Liquid Temperature : 22.6°C

DASY5 Configuration:

- Probe: EX3DV4 - SN7612; ConvF(9.05, 9.05, 9.05) @ 1770 MHz; Calibrated: 20223/02/28
- Sensor-Surface: 1.4mm (Mechanical Surface Detection)
- Electronics: DAE4 Sn1633; Calibrated: 2023/02/08
- Phantom: Right v5.0; Type: QD000P40CD; Serial: TP:1502
- Measurement SW: DASY52, Version 52.10 (2); SEMCAD X Version 14.6.12 (7450)

-Area Scan (71x131x1): Interpolated grid: dx=1.500 mm, dy=1.500 mm
Maximum value of SAR (interpolated) = 0.0479 W/kg

-Zoom Scan (5x5x7)/Cube 0: Measurement grid: dx=8mm, dy=8mm, dz=5mm
Reference Value = 0.6740 V/m; Power Drift = 0.05 dB
Peak SAR (extrapolated) = 0.0610 W/kg
SAR(1 g) = 0.040 W/kg; SAR(10 g) = 0.026 W/kg
Maximum value of SAR (measured) = 0.0459 W/kg

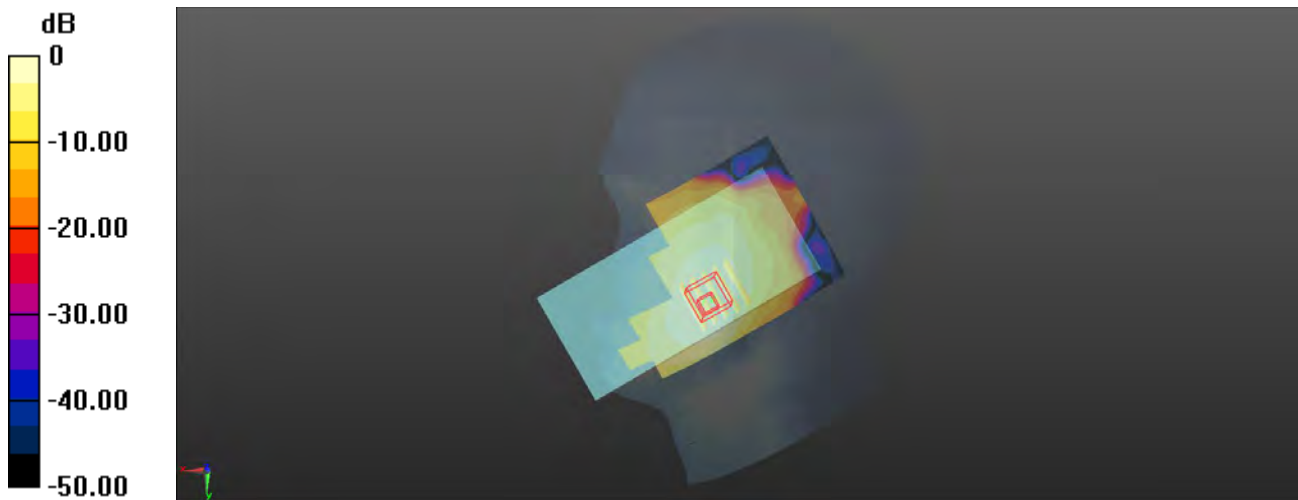

0 dB = 0.0459 W/kg

P12 WLAN2.4G_802.11b_Left Cheek_Ch11

Communication System: 802.11b; Frequency: 2462 MHz; Duty Cycle: 1:1

Medium: HSL2450_0918 Medium parameters used: $f = 2462$ MHz; $\sigma = 1.825$ S/m; $\epsilon_r = 39.151$; $\rho = 1000$ kg/m³

Ambient Temperature : 23.4°C; Liquid Temperature : 22.7°C

DASY5 Configuration:

- Probe: EX3DV4 - SN7612; ConvF(8.11, 8.11, 8.11) @ 2462 MHz; Calibrated: 2023/02/28
- Sensor-Surface: 1.4mm (Mechanical Surface Detection)
- Electronics: DAE4 Sn1633; Calibrated: 2023/02/08
- Phantom: Right v5.0; Type: QD000P40CD; Serial: TP:1502
- Measurement SW: DASY52, Version 52.10 (2); SEMCAD X Version 14.6.12 (7450)

-Area Scan (81x81x1): Interpolated grid: dx=1.200 mm, dy=1.200 mm

Maximum value of SAR (interpolated) = 0.622 W/kg

-Zoom Scan (7x7x7)/Cube 0: Measurement grid: dx=5mm, dy=5mm, dz=5mm

Reference Value = 8.184 V/m; Power Drift = 0.12 dB

Peak SAR (extrapolated) = 0.935 W/kg

SAR(1 g) = 0.492 W/kg; SAR(10 g) = 0.256 W/kg

Maximum value of SAR (measured) = 0.619 W/kg

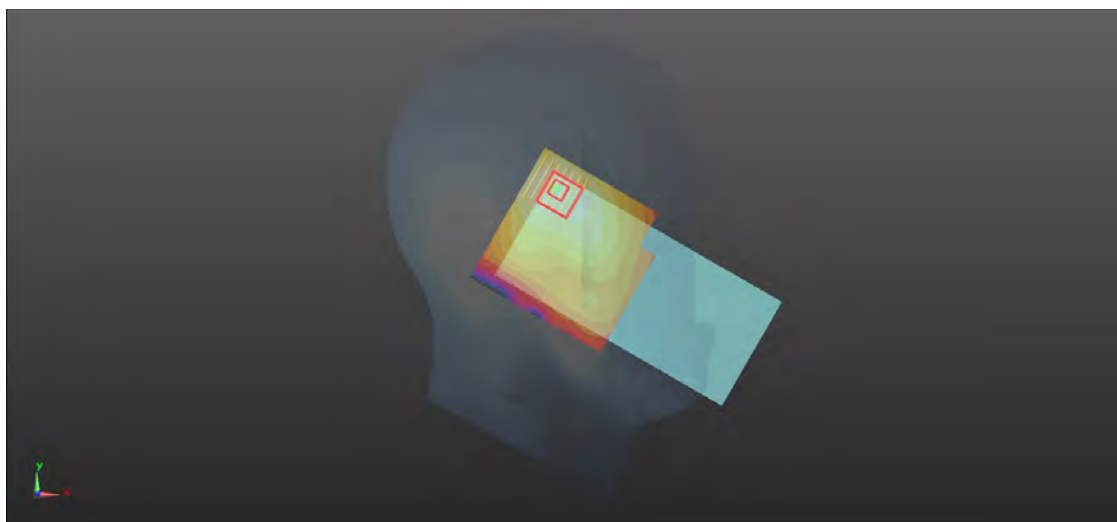
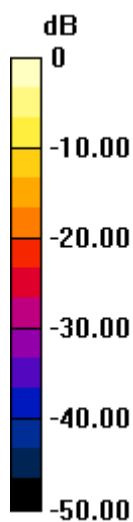

0 dB = 0.619 W/kg

P13 BT_GFSK_Left Cheek_Ch0

Communication System: Bluetooth; Frequency: 2402 MHz; Duty Cycle: 1:1.29

Medium: HSL2450_0918 Medium parameters used: $f = 2402$ MHz; $\sigma = 1.778$ S/m; $\epsilon_r = 39.25$; $\rho = 1000$ kg/m³

Ambient Temperature : 23.4°C; Liquid Temperature : 22.7°C

DASY5 Configuration:

- Probe: EX3DV4 - SN7612; ConvF(8.11, 8.11, 8.11) @ 2402 MHz; Calibrated: 2023/02/28
- Sensor-Surface: 1.4mm (Mechanical Surface Detection)
- Electronics: DAE4 Sn1633; Calibrated: 2023/02/08
- Phantom: Right v5.0; Type: QD000P40CD; Serial: TP:1502
- Measurement SW: DASY52, Version 52.10 (2); SEMCAD X Version 14.6.12 (7450)

-Area Scan (81x81x1): Interpolated grid: dx=1.200 mm, dy=1.200 mm

Maximum value of SAR (interpolated) = 0.142 W/kg

-Zoom Scan (7x7x7)/Cube 0: Measurement grid: dx=5mm, dy=5mm, dz=5mm

Reference Value = 4.594 V/m; Power Drift = 0.03 dB

Peak SAR (extrapolated) = 0.198 W/kg

SAR(1 g) = 0.098 W/kg; SAR(10 g) = 0.051 W/kg

Maximum value of SAR (measured) = 0.124 W/kg

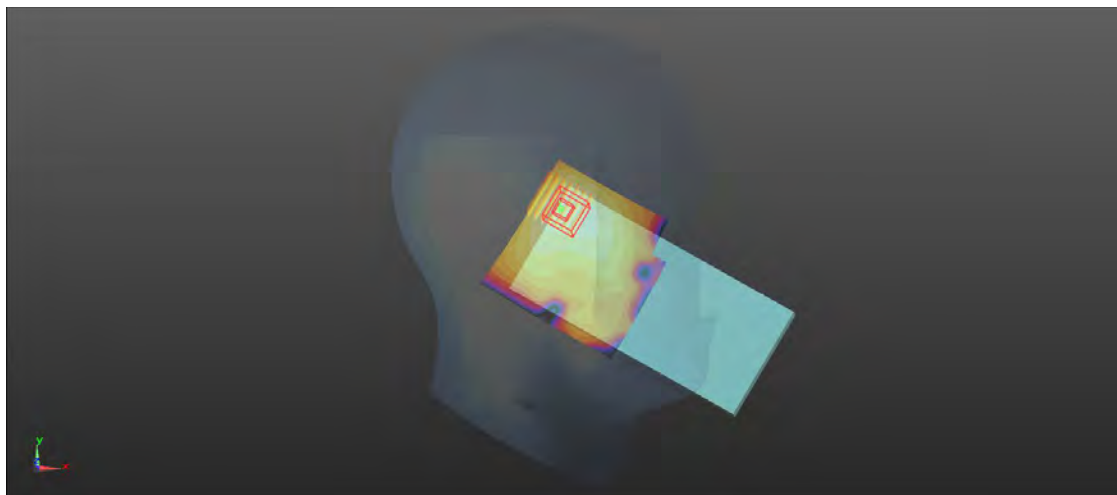
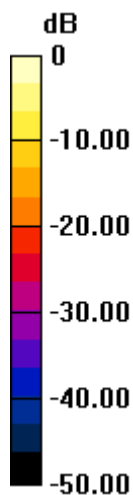

0 dB = 0.124 W/kg

P14 GSM850_GPRS(3Tx-slot)_Rear Face_1cm_Ch128

Communication System: GPRS(3Tx-slot); Frequency: 824.2 MHz; Duty Cycle: 1:2.77

Medium: HSL835_0918 Medium parameters used: $f = 824.2$ MHz; $\sigma = 0.926$ S/m; $\epsilon_r = 43.058$; $\rho = 1000$ kg/m³

Ambient Temperature : 23.4°C; Liquid Temperature : 22.6°C

DASY5 Configuration:

- Probe: EX3DV4 - SN7612; ConvF(10.88, 10.88, 10.88) @ 824.2 MHz; Calibrated: 2023/02/28
- Sensor-Surface: 1.4mm (Mechanical Surface Detection)
- Electronics: DAE4 Sn1633; Calibrated: 2023/02/08
- Phantom: Right v5.0; Type: QD000P40CD; Serial: TP:1502
- Measurement SW: DASY52, Version 52.10 (2); SEMCAD X Version 14.6.12 (7450)

-Area Scan (71x71x1): Interpolated grid: dx=1.500 mm, dy=1.500 mm
 Maximum value of SAR (interpolated) = 0.398 W/kg

-Zoom Scan (5x5x7)/Cube 0: Measurement grid: dx=8mm, dy=8mm, dz=5mm
 Reference Value = 16.90 V/m; Power Drift = 0.09 dB
 Peak SAR (extrapolated) = 0.513 W/kg
SAR(1 g) = 0.343 W/kg; SAR(10 g) = 0.149 W/kg
 Maximum value of SAR (measured) = 0.385 W/kg

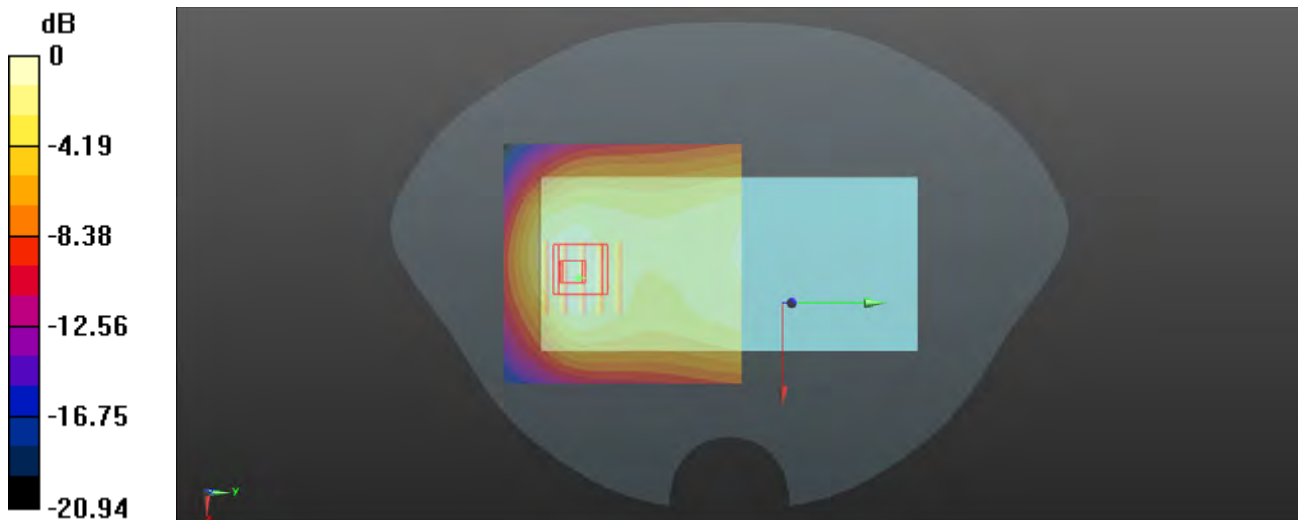

0 dB = 0.385 W/kg

P15 GSM1900_GPRS(3Tx-slot)_Rear Face_1cm_Ch512

Communication System: GPRS(3Tx-slot); Frequency: 1850.2 MHz; Duty Cycle: 1:2.77
Medium: HSL1900_0918 Medium parameters used: $f = 1850.2$ MHz; $\sigma = 1.376$ S/m; $\epsilon_r = 39.777$; $\rho = 1000$ kg/m³
Ambient Temperature : 23.4°C; Liquid Temperature : 22.6°C

DASY5 Configuration:

- Probe: EX3DV4 - SN7612; ConvF(8.68, 8.68, 8.68) @ 1850.2 MHz; Calibrated: 2023/02/28
- Sensor-Surface: 1.4mm (Mechanical Surface Detection)
- Electronics: DAE4 Sn1633; Calibrated: 2023/02/08
- Phantom: Right v5.0; Type: QD000P40CD; Serial: TP:1502
- Measurement SW: DASY52, Version 52.10 (2); SEMCAD X Version 14.6.12 (7450)

-Area Scan (71x71x1): Interpolated grid: dx=1.500 mm, dy=1.500 mm
Maximum value of SAR (interpolated) = 0.630 W/kg

-Zoom Scan (5x5x7)/Cube 0: Measurement grid: dx=8mm, dy=8mm, dz=5mm
Reference Value = 4.457 V/m; Power Drift = 0.18 dB
Peak SAR (extrapolated) = 0.864 W/kg
SAR(1 g) = 0.508 W/kg; SAR(10 g) = 0.276 W/kg
Maximum value of SAR (measured) = 0.626 W/kg

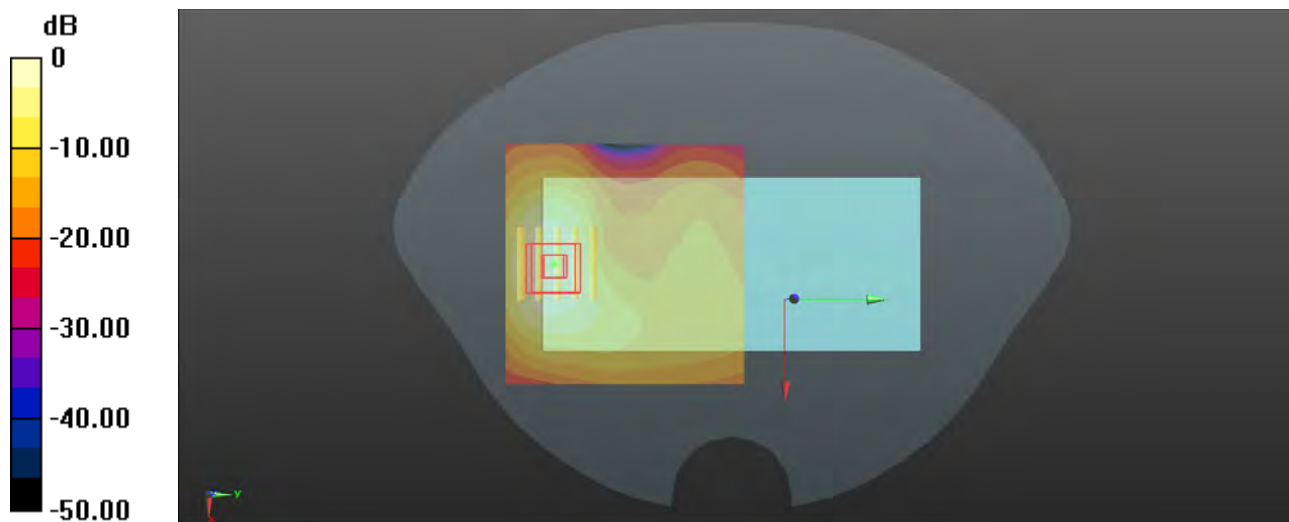

0 dB = 0.626 W/kg

P16 WCDMA II_RMC12.2K_Rear Face_1cm_Ch9538

Communication System: WCDMA; Frequency: 1907.6 MHz; Duty Cycle: 1:1

Medium: HSL1900_0918 Medium parameters used: $f = 1908$ MHz; $\sigma = 1.408$ S/m; $\epsilon_r = 39.723$; $\rho = 1000$ kg/m³

Ambient Temperature : 23.4°C; Liquid Temperature : 22.6°C

DASY5 Configuration:

- Probe: EX3DV4 - SN7612; ConvF(8.68, 8.68, 8.68) @ 1907.6 MHz; Calibrated: 2023/02/28
- Sensor-Surface: 1.4mm (Mechanical Surface Detection)
- Electronics: DAE4 Sn1633; Calibrated: 2023/02/08
- Phantom: Right v5.0; Type: QD000P40CD; Serial: TP:1502
- Measurement SW: DASY52, Version 52.10 (2); SEMCAD X Version 14.6.12 (7450)

-Area Scan (71x71x1): Interpolated grid: dx=1.500 mm, dy=1.500 mm

Maximum value of SAR (interpolated) = 0.795 W/kg

-Zoom Scan (5x5x7)/Cube 0: Measurement grid: dx=8mm, dy=8mm, dz=5mm

Reference Value = 4.928 V/m; Power Drift = 0.01 dB

Peak SAR (extrapolated) = 1.16 W/kg

SAR(1 g) = 0.651 W/kg; SAR(10 g) = 0.343 W/kg

Maximum value of SAR (measured) = 0.816 W/kg

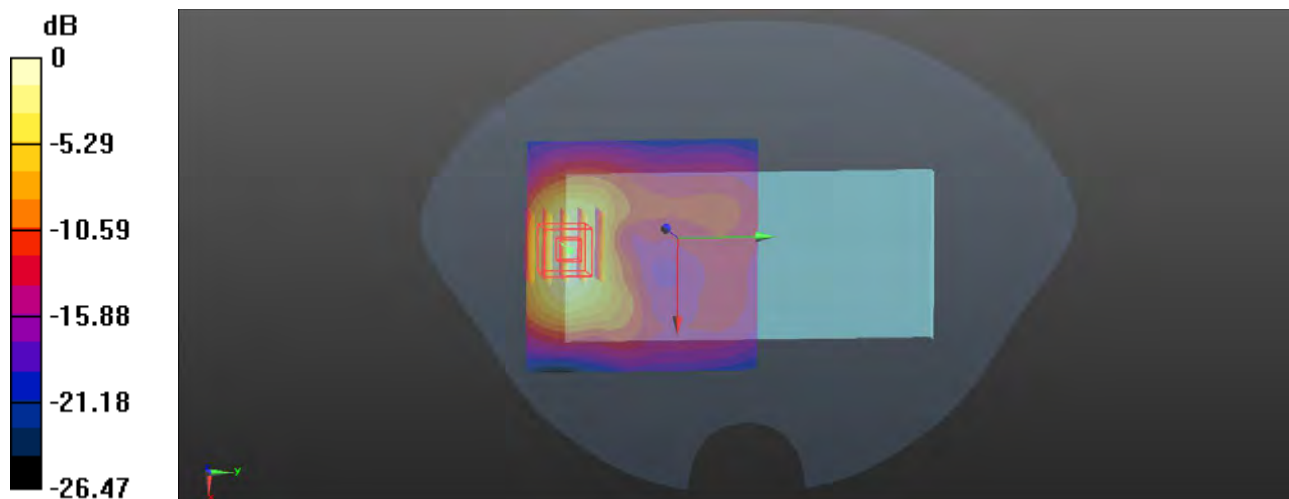

0 dB = 0.816 W/kg

P17 WCDMA IV_RMC12.2K_Rear Face_1cm_Ch1312

Communication System: WCDMA; Frequency: 1712.4 MHz; Duty Cycle: 1:1

Medium: HSL1750_0918 Medium parameters used: $f = 1712.4$ MHz; $\sigma = 1.393$ S/m; $\epsilon_r = 40.829$; $\rho = 1000$ kg/m³

Ambient Temperature : 23.3°C; Liquid Temperature : 22.6°C

DASY5 Configuration:

- Probe: EX3DV4 - SN7612; ConvF(9.05, 9.05, 9.05) @ 1712.4 MHz; Calibrated: 2023/02/28
- Sensor-Surface: 1.4mm (Mechanical Surface Detection)
- Electronics: DAE4 Sn1633; Calibrated: 2023/02/08
- Phantom: Right v5.0; Type: QD000P40CD; Serial: TP:1502
- Measurement SW: DASY52, Version 52.10 (2); SEMCAD X Version 14.6.12 (7450)

-Area Scan (71x71x1): Interpolated grid: dx=1.500 mm, dy=1.500 mm

Maximum value of SAR (interpolated) = 1.16 W/kg

-Zoom Scan (5x5x7)/Cube 0: Measurement grid: dx=8mm, dy=8mm, dz=5mm

Reference Value = 3.932 V/m; Power Drift = 0.04 dB

Peak SAR (extrapolated) = 1.73 W/kg

SAR(1 g) = 0.968 W/kg; SAR(10 g) = 0.507 W/kg

Maximum value of SAR (measured) = 1.19 W/kg

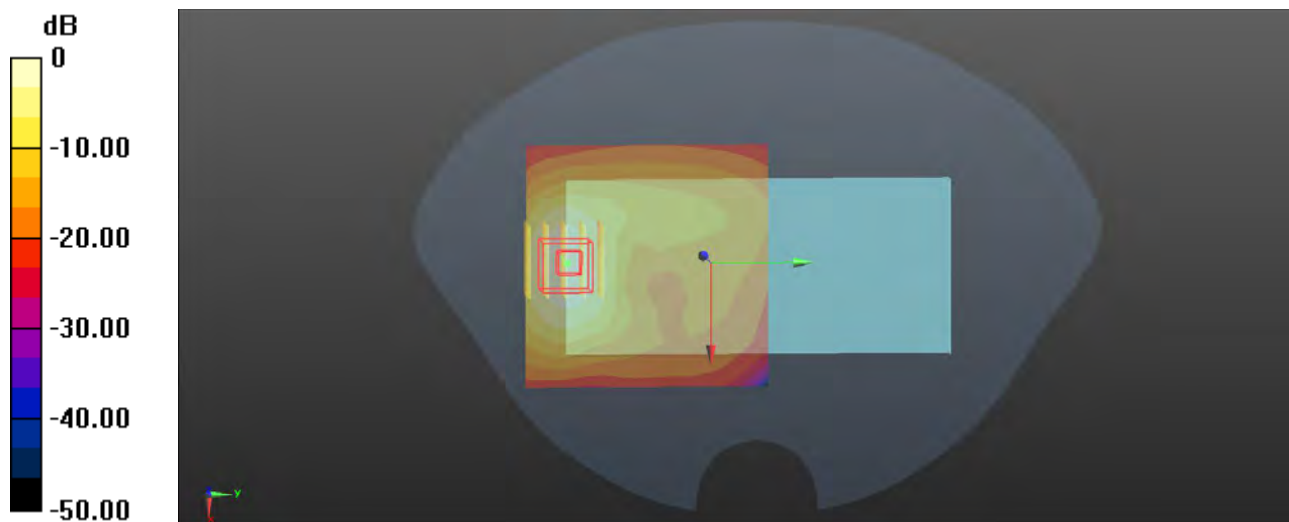

0 dB = 1.19 W/kg

P18 WCDMA V_RMC12.2K_Rear Face_1cm_Ch4233

Communication System: WCDMA; Frequency: 846.6 MHz; Duty Cycle: 1:1

Medium: HSL835_0918 Medium parameters used: $f = 847$ MHz; $\sigma = 0.936$ S/m; $\epsilon_r = 42.914$; $\rho = 1000$ kg/m³

Ambient Temperature : 23.2°C; Liquid Temperature : 22.6°C

DASY5 Configuration:

- Probe: EX3DV4 - SN7612; ConvF(10.88, 10.88, 10.88) @ 846.6 MHz; Calibrated: 2023/02/28
- Sensor-Surface: 1.4mm (Mechanical Surface Detection)
- Electronics: DAE4 Sn1633; Calibrated: 2023/02/08
- Phantom: Right v5.0; Type: QD000P40CD; Serial: TP:1502
- Measurement SW: DASY52, Version 52.10 (2); SEMCAD X Version 14.6.12 (7450)

-Area Scan (71x71x1): Interpolated grid: dx=1.500 mm, dy=1.500 mm

Maximum value of SAR (interpolated) = 0.264 W/kg

-Zoom Scan (5x5x7)/Cube 0: Measurement grid: dx=8mm, dy=8mm, dz=5mm

Reference Value = 14.96 V/m; Power Drift = 0.04 dB

Peak SAR (extrapolated) = 0.367 W/kg

SAR(1 g) = 0.213 W/kg; SAR(10 g) = 0.129 W/kg

Maximum value of SAR (measured) = 0.251 W/kg

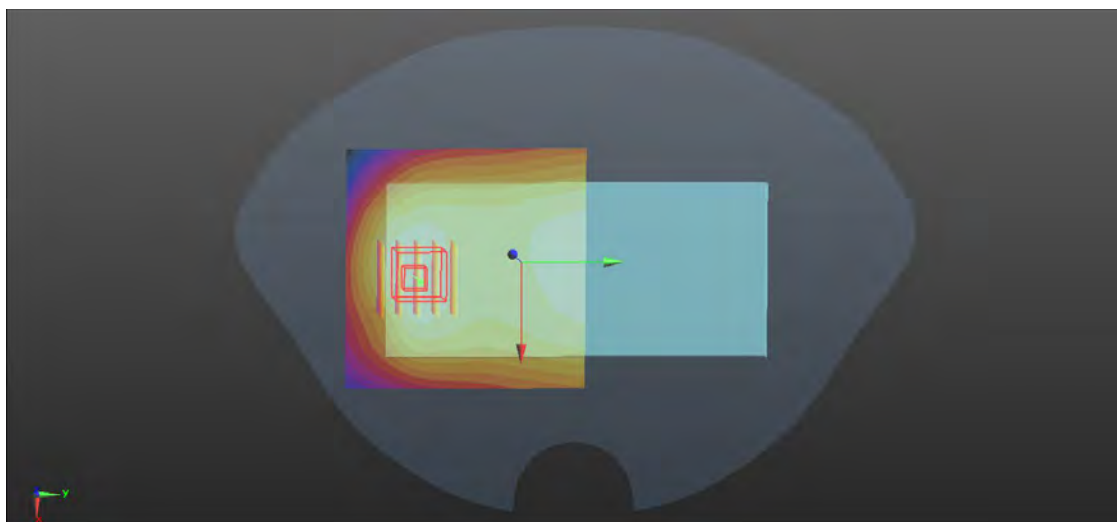
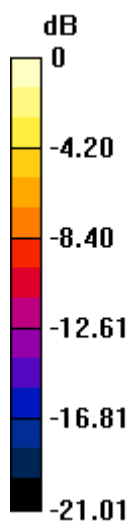

0 dB = 0.251 W/kg

P19 LTE 2_QPSK20M_Rear Face_1cm_Ch19100_1RB_OS50

Communication System: LTE_FDD; Frequency: 1900 MHz; Duty Cycle: 1:1
Medium: HSL1900_0918 Medium parameters used: $f = 1900$ MHz; $\sigma = 1.403$ S/m; $\epsilon_r = 39.73$; $\rho = 1000$ kg/m³
Ambient Temperature : 23.4°C; Liquid Temperature : 22.6°C

DASY5 Configuration:

- Probe: EX3DV4 - SN7612; ConvF(8.68, 8.68, 8.68) @ 1900 MHz; Calibrated: 2023/02/28
- Sensor-Surface: 1.4mm (Mechanical Surface Detection)
- Electronics: DAE4 Sn1633; Calibrated: 2023/02/08
- Phantom: Right v5.0; Type: QD000P40CD; Serial: TP:1502
- Measurement SW: DASY52, Version 52.10 (2); SEMCAD X Version 14.6.12 (7450)

-Area Scan (71x71x1): Interpolated grid: dx=1.500 mm, dy=1.500 mm
Maximum value of SAR (interpolated) = 0.950 W/kg

-Zoom Scan (5x5x7)/Cube 0: Measurement grid: dx=8mm, dy=8mm, dz=5mm
Reference Value = 4.113 V/m; Power Drift = 0.19 dB
Peak SAR (extrapolated) = 1.34 W/kg
SAR(1 g) = 0.760 W/kg; SAR(10 g) = 0.403 W/kg
Maximum value of SAR (measured) = 0.932 W/kg

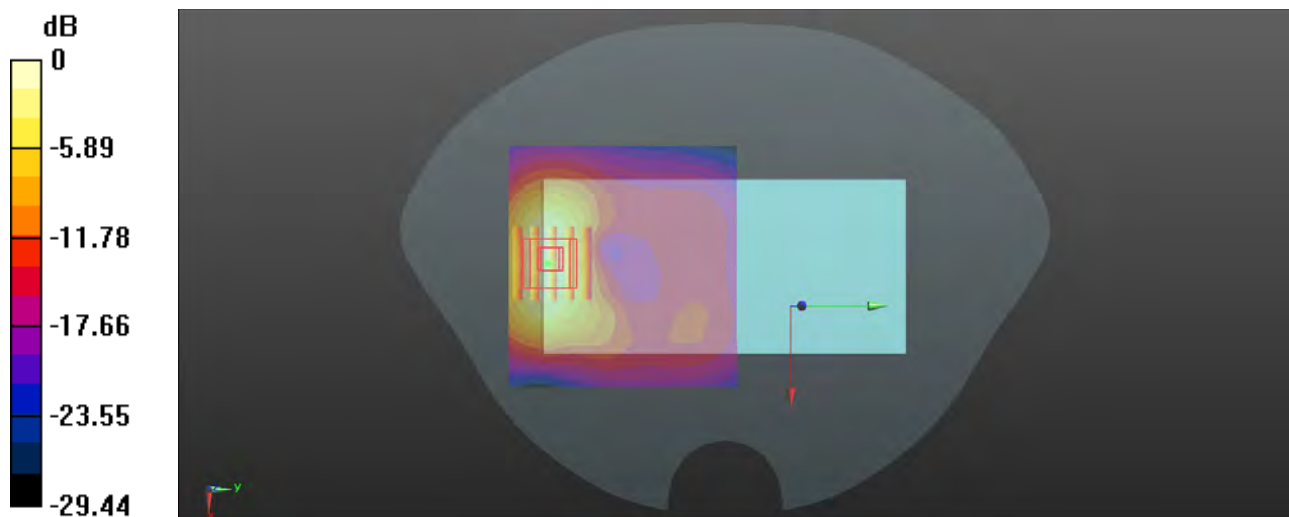

0 dB = 0.932 W/kg

P20 LTE 5_QPSK10M_Rear Face_1cm_Ch20450_1RB_OS24

Communication System: LTE_FDD; Frequency: 829 MHz; Duty Cycle: 1:1
Medium: HSL835_0918 Medium parameters used: $f = 829$ MHz; $\sigma = 0.928$ S/m; $\epsilon_r = 43.035$; $\rho = 1000$ kg/m³
Ambient Temperature : 23.2°C; Liquid Temperature : 22.6°C

DASY5 Configuration:

- Probe: EX3DV4 - SN7612; ConvF(10.88, 10.88, 10.88) @ 829 MHz; Calibrated: 2023/02/28
- Sensor-Surface: 1.4mm (Mechanical Surface Detection)
- Electronics: DAE4 Sn1633; Calibrated: 2023/02/08
- Phantom: Right v5.0; Type: QD000P40CD; Serial: TP:1502
- Measurement SW: DASY52, Version 52.10 (2); SEMCAD X Version 14.6.12 (7450)

-Area Scan (71x71x1): Interpolated grid: dx=1.500 mm, dy=1.500 mm
Maximum value of SAR (interpolated) = 0.250 W/kg

-Zoom Scan (5x5x7)/Cube 0: Measurement grid: dx=8mm, dy=8mm, dz=5mm
Reference Value = 12.34 V/m; Power Drift = 0.07 dB
Peak SAR (extrapolated) = 0.346 W/kg
SAR(1 g) = 0.203 W/kg; SAR(10 g) = 0.125 W/kg
Maximum value of SAR (measured) = 0.238 W/kg

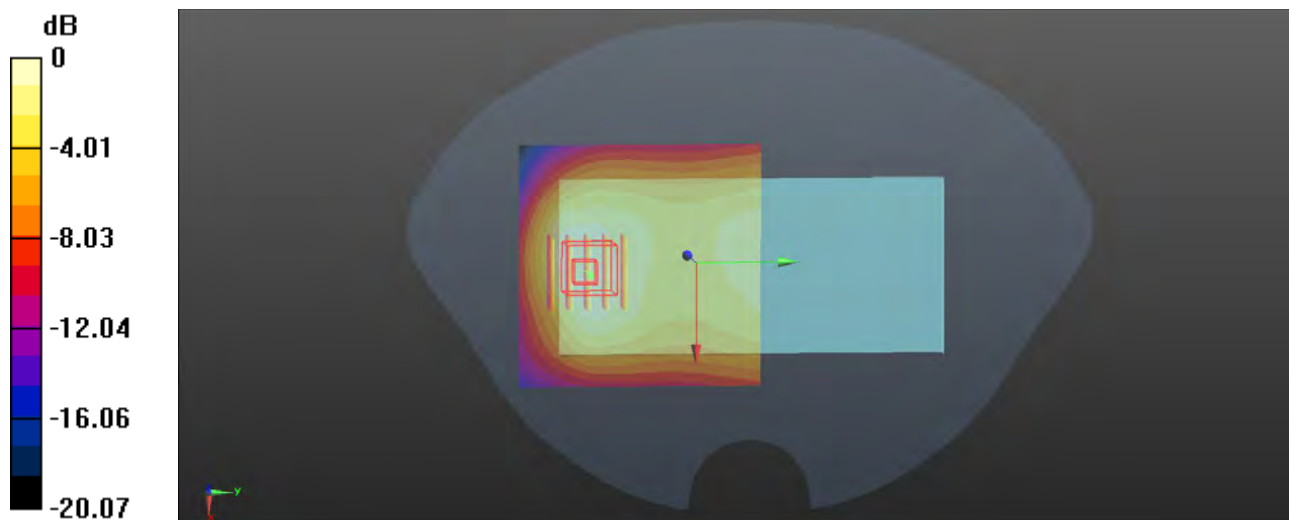

0 dB = 0.238 W/kg

P21 LTE 7_QPSK20M_Rear Face_1cm_Ch20850_1RB_OS0

Communication System: LTE_FDD; Frequency: 2510 MHz; Duty Cycle: 1:1

Medium: HSL2600_0918 Medium parameters used: $f = 2510$ MHz; $\sigma = 1.859$ S/m; $\epsilon_r = 39.071$; $\rho = 1000$ kg/m³

Ambient Temperature : 23.4°C; Liquid Temperature : 22.7°C

DASY5 Configuration:

- Probe: EX3DV4 - SN7612; ConvF(7.85, 7.85, 7.85) @ 2510 MHz; Calibrated: 2023/02/28
- Sensor-Surface: 1.4mm (Mechanical Surface Detection)
- Electronics: DAE4 Sn1633; Calibrated: 2023/02/08
- Phantom: Right v5.0; Type: QD000P40CD; Serial: TP:1502
- Measurement SW: DASY52, Version 52.10 (2); SEMCAD X Version 14.6.12 (7450)

-Area Scan (91x101x1): Interpolated grid: dx=1.200 mm, dy=1.200 mm

Maximum value of SAR (interpolated) = 0.888 W/kg

-Zoom Scan (7x7x7)/Cube 0: Measurement grid: dx=5mm, dy=5mm, dz=5mm

Reference Value = 2.085 V/m; Power Drift = 0.04 dB

Peak SAR (extrapolated) = 1.32 W/kg

SAR(1 g) = 0.612 W/kg; SAR(10 g) = 0.333 W/kg

Maximum value of SAR (measured) = 0.873 W/kg

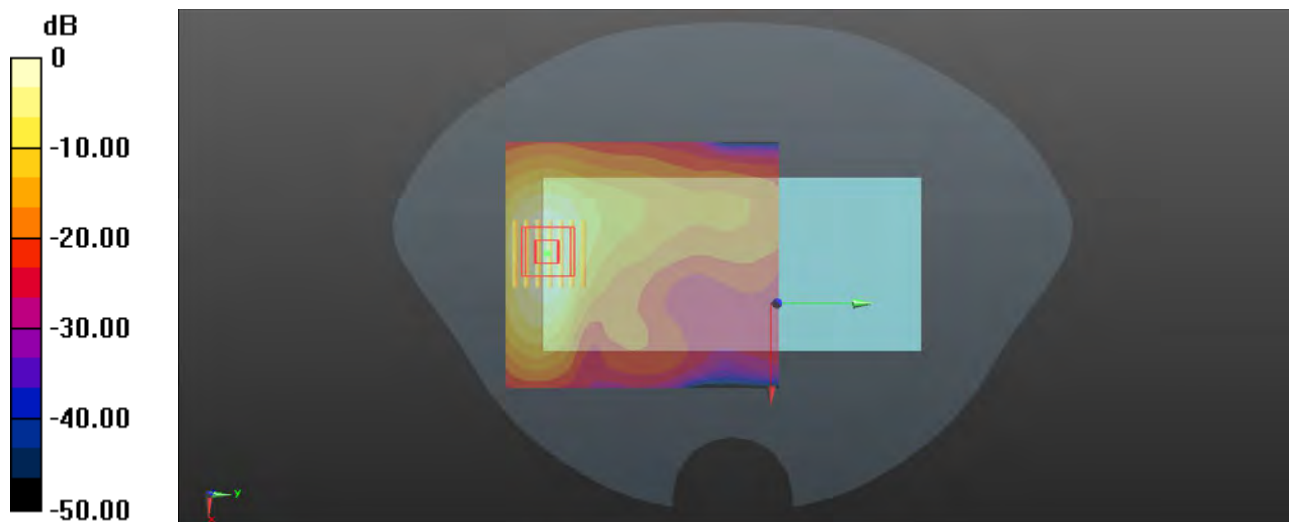

0 dB = 0.873 W/kg

P22 LTE 12_QPSK10M_Rear Face_1cm_Ch23130_1RB_OS0

Communication System: LTE_FDD; Frequency: 711 MHz; Duty Cycle: 1:1
Medium: HSL750_0918 Medium parameters used: $f = 711 \text{ MHz}$; $\sigma = 0.89 \text{ S/m}$; $\epsilon_r = 43.344$; $\rho = 1000 \text{ kg/m}^3$
Ambient Temperature : 23.2°C ; Liquid Temperature : 22.6°C

DASY5 Configuration:

- Probe: EX3DV4 - SN7612; ConvF(11.35, 11.35, 11.35) @ 711 MHz; Calibrated: 2023/02/28
- Sensor-Surface: 1.4mm (Mechanical Surface Detection)
- Electronics: DAE4 Sn1633; Calibrated: 2023/02/08
- Phantom: Right v5.0; Type: QD000P40CD; Serial: TP:1502
- Measurement SW: DASY52, Version 52.10 (2); SEMCAD X Version 14.6.12 (7450)

-Area Scan (71x71x1): Interpolated grid: $dx=1.500 \text{ mm}$, $dy=1.500 \text{ mm}$
Maximum value of SAR (interpolated) = 0.167 W/kg

-Zoom Scan (5x5x7)/Cube 0: Measurement grid: $dx=8\text{mm}$, $dy=8\text{mm}$, $dz=5\text{mm}$
Reference Value = 13.33 V/m ; Power Drift = 0.01 dB
Peak SAR (extrapolated) = 0.192 W/kg
SAR(1 g) = 0.151 W/kg ; SAR(10 g) = 0.116 W/kg
Maximum value of SAR (measured) = 0.166 W/kg

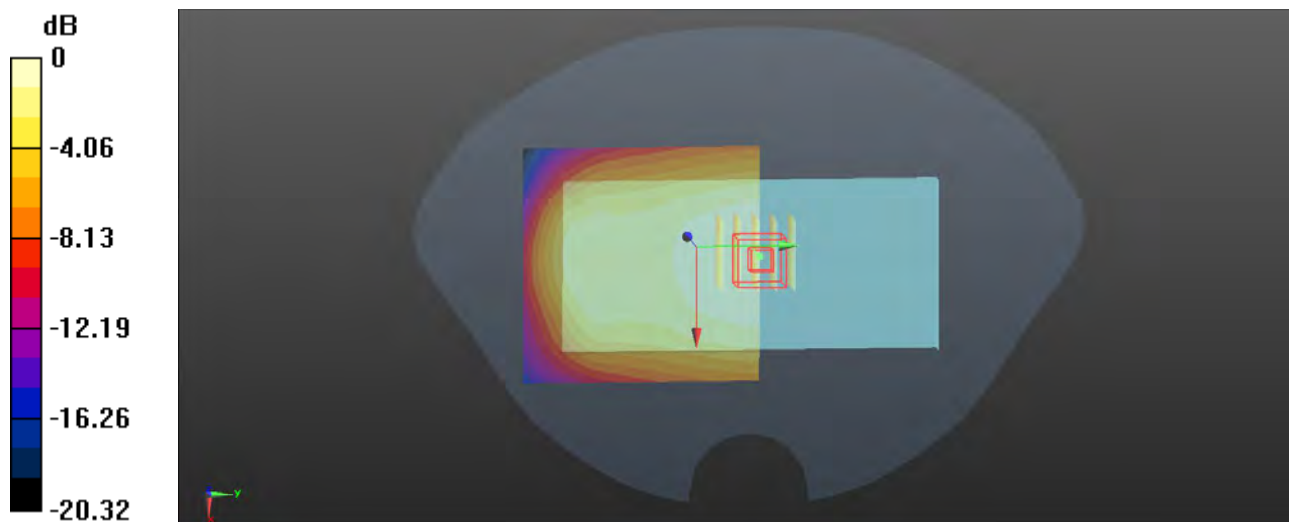

0 dB = 0.166 W/kg

P23 LTE 13_QPSK10M_Rear Face_1cm_Ch23230_1RB_OS49

Communication System: LTE_FDD; Frequency: 782 MHz; Duty Cycle: 1:1

Medium: HSL750_0918 Medium parameters used: $f = 782 \text{ MHz}$; $\sigma = 0.915 \text{ S/m}$; $\epsilon_r = 43.118$; $\rho = 1000 \text{ kg/m}^3$

Ambient Temperature : 23.2°C ; Liquid Temperature : 22.6°C

DASY5 Configuration:

- Probe: EX3DV4 - SN7612; ConvF(11.35, 11.35, 11.35) @ 782 MHz; Calibrated: 2023/02/28
- Sensor-Surface: 1.4mm (Mechanical Surface Detection)
- Electronics: DAE4 Sn1633; Calibrated: 2023/02/08
- Phantom: Right v5.0; Type: QD000P40CD; Serial: TP:1502
- Measurement SW: DASY52, Version 52.10 (2); SEMCAD X Version 14.6.12 (7450)

-Area Scan (71x71x1): Interpolated grid: $dx=1.500 \text{ mm}$, $dy=1.500 \text{ mm}$
 Maximum value of SAR (interpolated) = 0.0654 W/kg

-Zoom Scan (5x5x7)/Cube 0: Measurement grid: $dx=8\text{mm}$, $dy=8\text{mm}$, $dz=5\text{mm}$
 Reference Value = 7.673 V/m ; Power Drift = -0.09 dB
 Peak SAR (extrapolated) = 0.0980 W/kg
SAR(1 g) = 0.055 W/kg ; SAR(10 g) = 0.033 W/kg
 Maximum value of SAR (measured) = 0.0646 W/kg

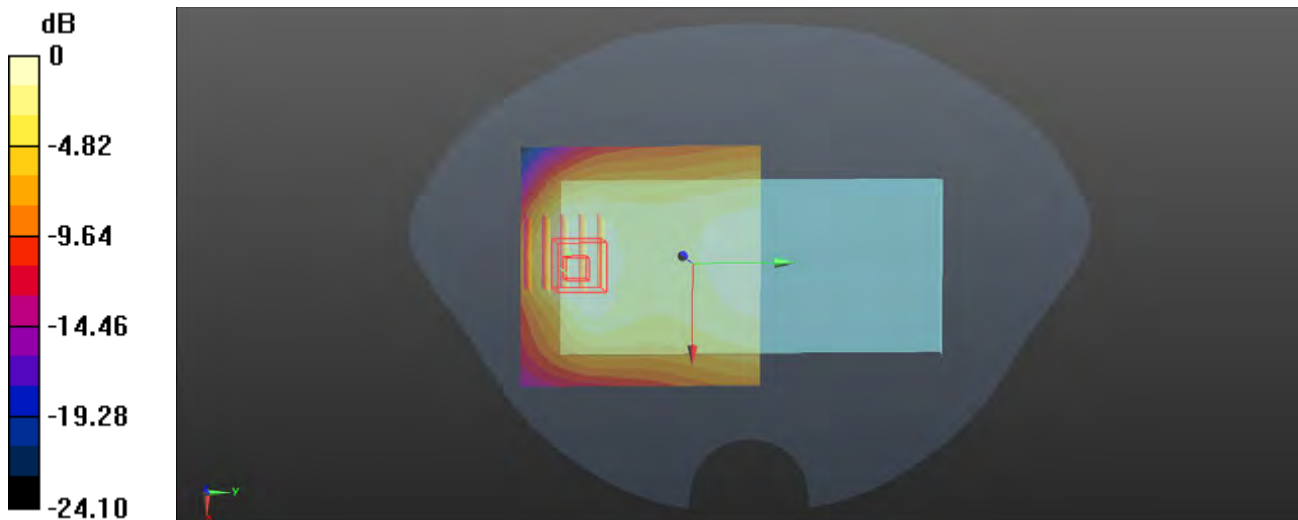

0 dB = 0.0646 W/kg

P24 LTE 66_QPSK20M_Rear Face_1cm_Ch132322_1RB_OS50

Communication System: LTE_FDD; Frequency: 1745 MHz; Duty Cycle: 1:1

Medium: HSL1750_0918 Medium parameters used: $f = 1745$ MHz; $\sigma = 1.418$ S/m; $\epsilon_r = 40.792$; $\rho = 1000$ kg/m³

Ambient Temperature : 23.3°C; Liquid Temperature : 22.6°C

DASY5 Configuration:

- Probe: EX3DV4 - SN7612; ConvF(9.05, 9.05, 9.05) @ 1745 MHz; Calibrated: 2023/02/28
- Sensor-Surface: 1.4mm (Mechanical Surface Detection)
- Electronics: DAE4 Sn1633; Calibrated: 2023/02/08
- Phantom: Right v5.0; Type: QD000P40CD; Serial: TP:1502
- Measurement SW: DASY52, Version 52.10 (2); SEMCAD X Version 14.6.12 (7450)

-Area Scan (71x71x1): Interpolated grid: dx=1.500 mm, dy=1.500 mm

Maximum value of SAR (interpolated) = 0.634 W/kg

-Zoom Scan (5x5x7)/Cube 0: Measurement grid: dx=8mm, dy=8mm, dz=5mm

Reference Value = 3.860 V/m; Power Drift = 0.07 dB

Peak SAR (extrapolated) = 0.929 W/kg

SAR(1 g) = 0.523 W/kg; SAR(10 g) = 0.276 W/kg

Maximum value of SAR (measured) = 0.647 W/kg

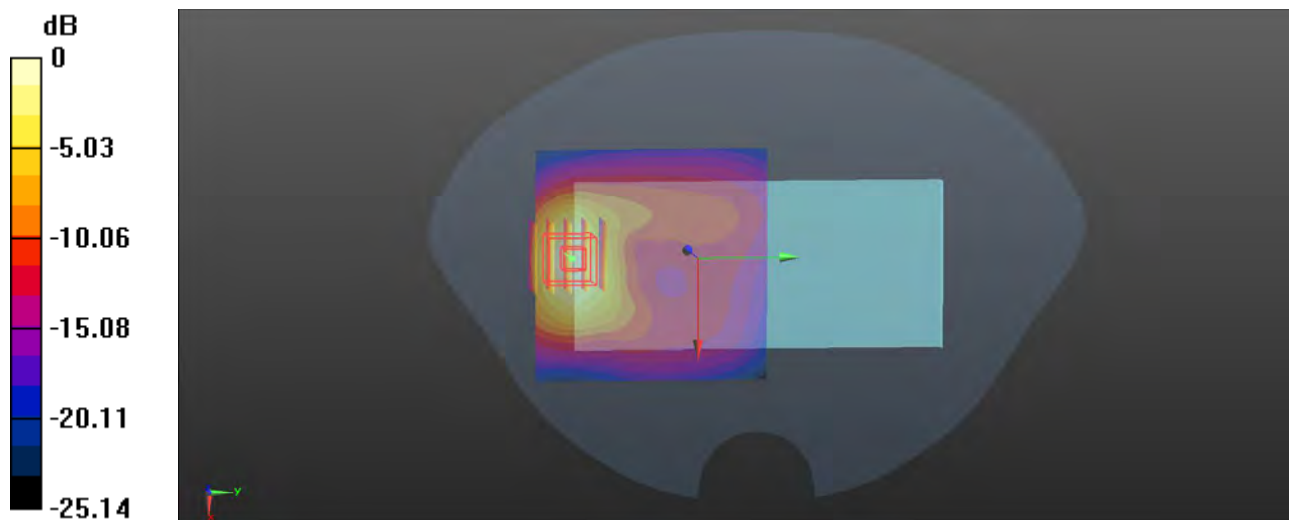

0 dB = 0.647 W/kg

P25 WLAN2.4G_802.11b_Rear Face_1cm_Ch11

Communication System: 802.11b; Frequency: 2462 MHz; Duty Cycle: 1:1

Medium: HSL2450_0918 Medium parameters used: $f = 2462$ MHz; $\sigma = 1.825$ S/m; $\epsilon_r = 39.151$; $\rho = 1000$ kg/m³

Ambient Temperature : 23.4°C; Liquid Temperature : 22.7°C

DASY5 Configuration:

- Probe: EX3DV4 - SN7612; ConvF(8.11, 8.11, 8.11) @ 2462 MHz; Calibrated: 2023/02/28
- Sensor-Surface: 1.4mm (Mechanical Surface Detection)
- Electronics: DAE4 Sn1633; Calibrated: 2023/02/08
- Phantom: Right v5.0; Type: QD000P40CD; Serial: TP:1502
- Measurement SW: DASY52, Version 52.10 (2); SEMCAD X Version 14.6.12 (7450)

-Area Scan (81x81x1): Interpolated grid: dx=1.200 mm, dy=1.200 mm
Maximum value of SAR (interpolated) = 0.421 W/kg

-Zoom Scan (7x7x7)/Cube 0: Measurement grid: dx=5mm, dy=5mm, dz=5mm
Reference Value = 5.105 V/m; Power Drift = -0.07 dB
Peak SAR (extrapolated) = 0.738 W/kg
SAR(1 g) = 0.334 W/kg; SAR(10 g) = 0.166 W/kg
Maximum value of SAR (measured) = 0.423 W/kg

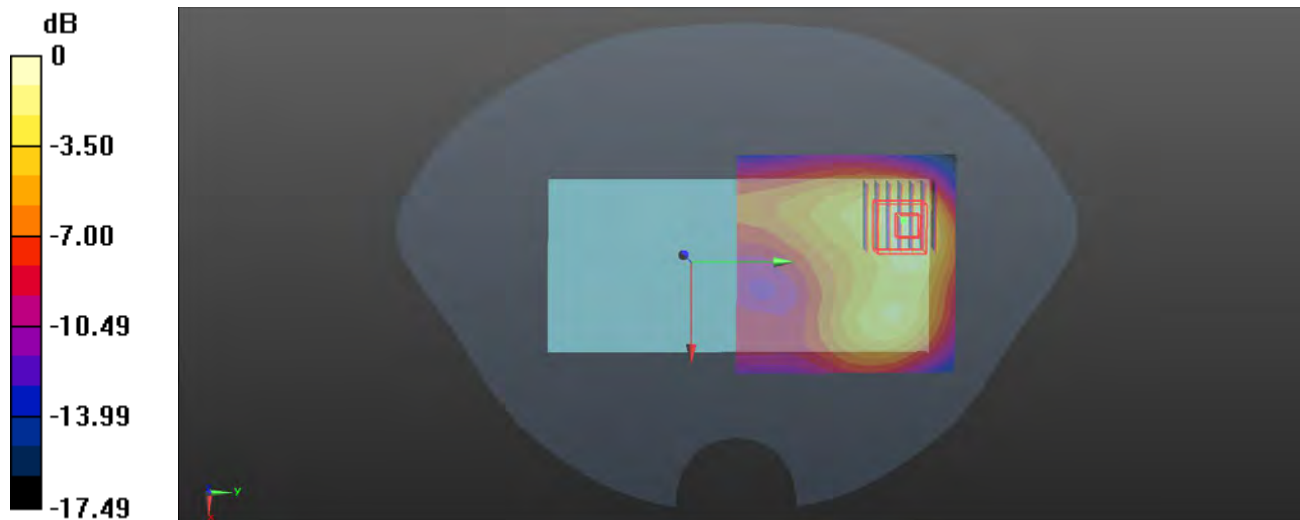

0 dB = 0.423 W/kg

P26 BT_GFSK_Rear Face_1cm_Ch0

Communication System: Bluetooth; Frequency: 2402 MHz; Duty Cycle: 1:1.29

Medium: HSL2450_0918 Medium parameters used: $f = 2402$ MHz; $\sigma = 1.778$ S/m; $\epsilon_r = 39.25$; $\rho = 1000$ kg/m³

Ambient Temperature : 23.4°C; Liquid Temperature : 22.7°C

DASY5 Configuration:

- Probe: EX3DV4 - SN7612; ConvF(8.11, 8.11, 8.11) @ 2402 MHz; Calibrated: 2023/02/28
- Sensor-Surface: 1.4mm (Mechanical Surface Detection)
- Electronics: DAE4 Sn1633; Calibrated: 2023/02/08
- Phantom: Right v5.0; Type: QD000P40CD; Serial: TP:1502
- Measurement SW: DASY52, Version 52.10 (2); SEMCAD X Version 14.6.12 (7450)

-Area Scan (81x81x1): Interpolated grid: dx=1.200 mm, dy=1.200 mm

Maximum value of SAR (interpolated) = 0.0419 W/kg

-Zoom Scan (7x7x7)/Cube 0: Measurement grid: dx=5mm, dy=5mm, dz=5mm

Reference Value = 1.507 V/m; Power Drift = -0.01 dB

Peak SAR (extrapolated) = 0.0760 W/kg

SAR(1 g) = 0.035 W/kg; SAR(10 g) = 0.017 W/kg

Maximum value of SAR (measured) = 0.0447 W/kg

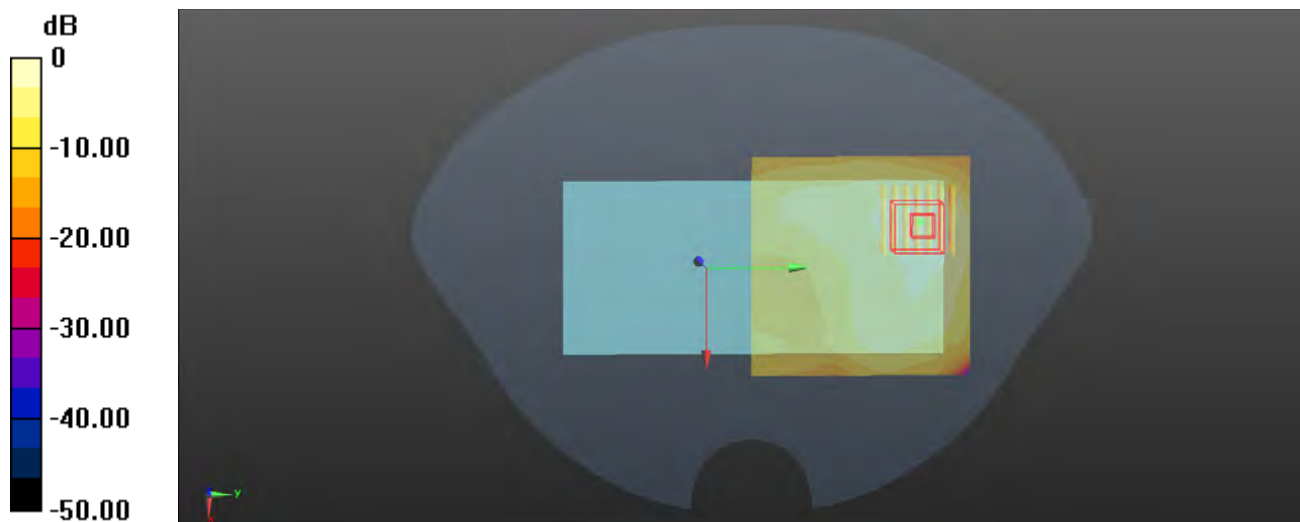

0 dB = 0.0447 W/kg

P27 GSM850_GPRS(3Tx Slot)_Bottom Side_1cm_Ch128

Communication System: GPRS(3Tx-slot); Frequency: 824.2 MHz; Duty Cycle: 1:2.77013
Medium: HSL835_0918 Medium parameters used (interpolated): $f = 824.2$ MHz; $\sigma = 0.926$ S/m; $\epsilon_r = 43.058$; $\rho = 1000$ kg/m³
Ambient Temperature : 23.4°C; Liquid Temperature : 22.6°C

DASY5 Configuration:

- Probe: EX3DV4 - SN7612; ConvF(10.88, 10.88, 10.88) @ 824.2 MHz; Calibrated: 2023/02/28
- Sensor-Surface: 1.4mm (Mechanical Surface Detection)
- Electronics: DAE4 Sn1633; Calibrated: 2023/02/08
- Phantom: Right v5.0; Type: QD000P40CD; Serial: TP:1502
- Measurement SW: DASY52, Version 52.10 (2); SEMCAD X Version 14.6.12 (7450)

-Area Scan (31x81x1): Interpolated grid: dx=1.500 mm, dy=1.500 mm
Maximum value of SAR (interpolated) = 0.297 W/kg

-Zoom Scan (5x5x7)/Cube 0: Measurement grid: dx=8mm, dy=8mm, dz=5mm
Reference Value = 10.72 V/m; Power Drift = 0.12 dB
Peak SAR (extrapolated) = 0.378 W/kg
SAR(1 g) = 0.276 W/kg; SAR(10 g) = 0.040 W/kg
Maximum value of SAR (measured) = 0.299 W/kg

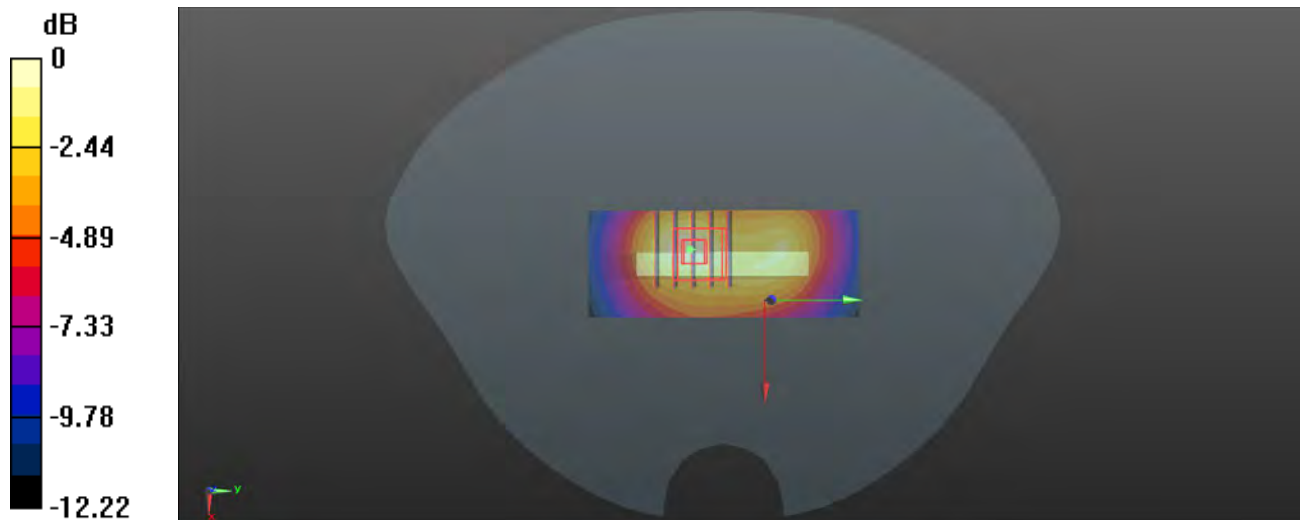

0 dB = 0.299 W/kg

P28 GSM1900_GPRS(3Tx Slot)_Bottom Side_1cm_Ch512

Communication System: GPRS(3Tx-slot); Frequency: 1850.2 MHz; Duty Cycle: 1:2.77
Medium: HSL1900_0918 Medium parameters used: $f = 1850.2$ MHz; $\sigma = 1.376$ S/m; $\epsilon_r = 39.777$; $\rho = 1000$ kg/m³
Ambient Temperature : 23.4°C; Liquid Temperature : 22.6°C

DASY5 Configuration:

- Probe: EX3DV4 - SN7612; ConvF(8.68, 8.68, 8.68) @ 1850.2 MHz; Calibrated: 2023/02/28
- Sensor-Surface: 1.4mm (Mechanical Surface Detection)
- Electronics: DAE4 Sn1633; Calibrated: 2023/02/08
- Phantom: Right v5.0; Type: QD000P40CD; Serial: TP:1502
- Measurement SW: DASY52, Version 52.10 (2); SEMCAD X Version 14.6.12 (7450)

-Area Scan (31x81x1): Interpolated grid: dx=1.500 mm, dy=1.500 mm
Maximum value of SAR (interpolated) = 1.05 W/kg

-Zoom Scan (5x5x7)/Cube 0: Measurement grid: dx=8mm, dy=8mm, dz=5mm
Reference Value = 23.42 V/m; Power Drift = 0.01 dB
Peak SAR (extrapolated) = 1.51 W/kg
SAR(1 g) = 0.831 W/kg; SAR(10 g) = 0.428 W/kg
Maximum value of SAR (measured) = 1.04 W/kg

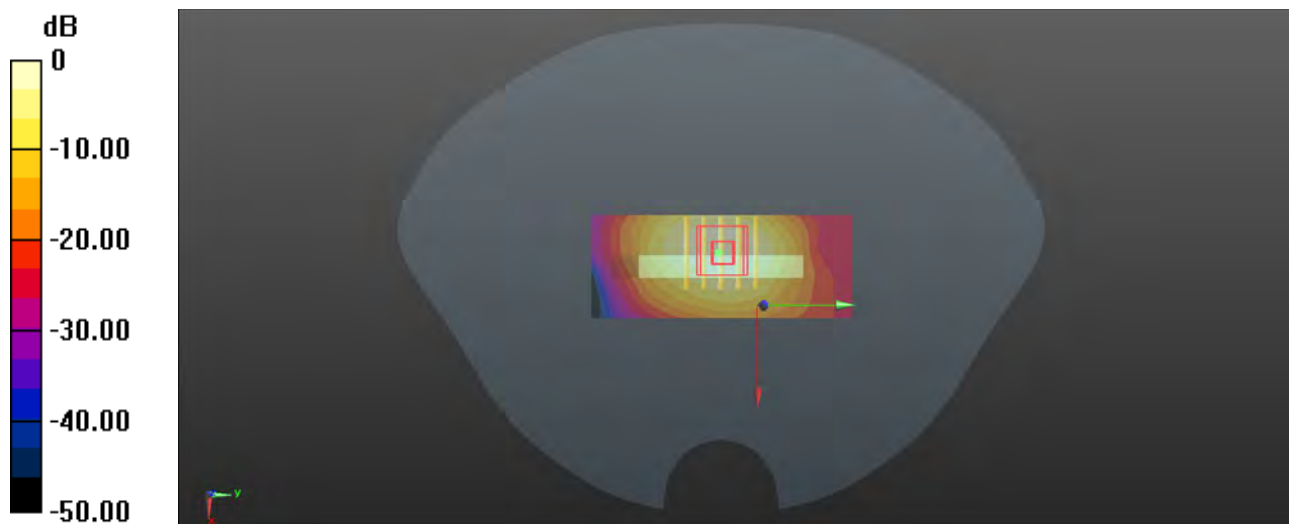

0 dB = 1.04 W/kg

P29 WCDMA II_RMC12.2K_Bottom Side_1cm_Ch9400

Communication System: WCDMA; Frequency: 1880 MHz; Duty Cycle: 1:1
Medium: HSL1900_0918 Medium parameters used: $f = 1880$ MHz; $\sigma = 1.39$ S/m; $\epsilon_r = 39.746$; $\rho = 1000$ kg/m³
Ambient Temperature : 23.4°C; Liquid Temperature : 22.6°C

DASY5 Configuration:

- Probe: EX3DV4 - SN7612; ConvF(8.68, 8.68, 8.68) @ 1880 MHz; Calibrated: 2023/02/28
- Sensor-Surface: 1.4mm (Mechanical Surface Detection)
- Electronics: DAE4 Sn1633; Calibrated: 2023/02/08
- Phantom: Right v5.0; Type: QD000P40CD; Serial: TP:1502
- Measurement SW: DASY52, Version 52.10 (2); SEMCAD X Version 14.6.12 (7450)

-Area Scan (31x81x1): Interpolated grid: dx=1.500 mm, dy=1.500 mm
Maximum value of SAR (interpolated) = 1.46 W/kg

-Zoom Scan (5x5x7)/Cube 0: Measurement grid: dx=8mm, dy=8mm, dz=5mm
Reference Value = 27.12 V/m; Power Drift = 0.04 dB
Peak SAR (extrapolated) = 1.99 W/kg
SAR(1 g) = 1.1 W/kg; SAR(10 g) = 0.567 W/kg
Maximum value of SAR (measured) = 1.37 W/kg

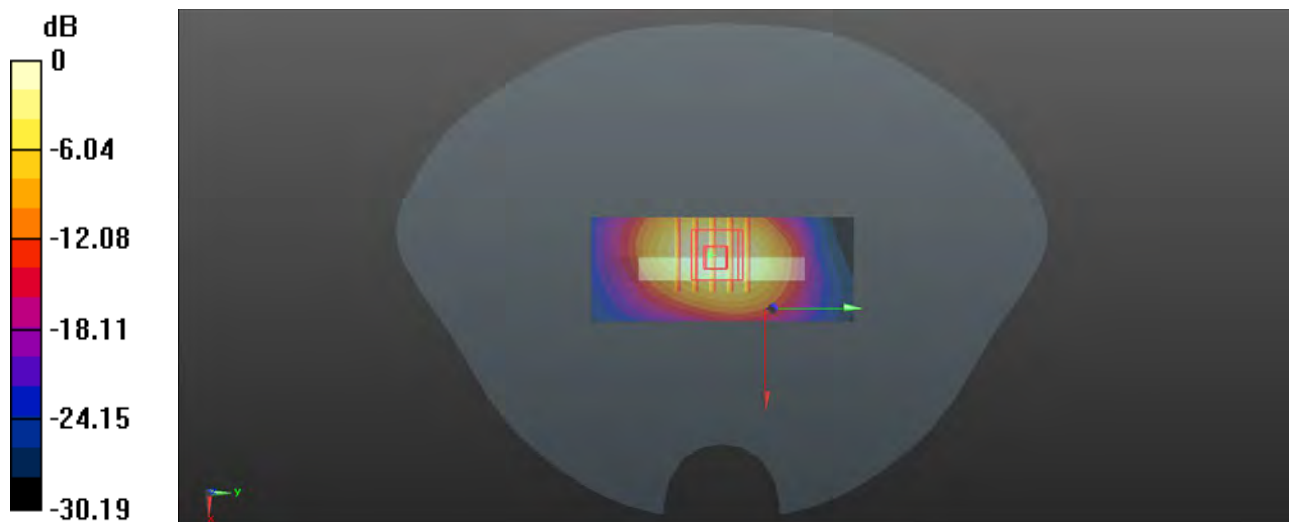

0 dB = 1.37 W/kg

P30 WCDMA IV_RMC12.2K_Bottom Side_1cm_Ch1312

Communication System: WCDMA; Frequency: 1712.4 MHz; Duty Cycle: 1:1

Medium: HSL1750_0918 Medium parameters used: $f = 1712.4$ MHz; $\sigma = 1.393$ S/m; $\epsilon_r = 40.829$; $\rho = 1000$ kg/m³

Ambient Temperature : 23.3°C; Liquid Temperature : 22.6°C

DASY5 Configuration:

- Probe: EX3DV4 - SN7612; ConvF(9.05, 9.05, 9.05) @ 1712.4 MHz; Calibrated: 2023/02/28
- Sensor-Surface: 1.4mm (Mechanical Surface Detection)
- Electronics: DAE4 Sn1633; Calibrated: 2023/02/08
- Phantom: Right v5.0; Type: QD000P40CD; Serial: TP:1502
- Measurement SW: DASY52, Version 52.10 (2); SEMCAD X Version 14.6.12 (7450)

-Area Scan (31x81x1): Interpolated grid: dx=1.500 mm, dy=1.500 mm

Maximum value of SAR (interpolated) = 1.56 W/kg

-Zoom Scan (5x5x7)/Cube 0: Measurement grid: dx=8mm, dy=8mm, dz=5mm

Reference Value = 30.47 V/m; Power Drift = 0.04 dB

Peak SAR (extrapolated) = 2.18 W/kg

SAR(1 g) = 1.09 W/kg; SAR(10 g) = 0.633 W/kg

Maximum value of SAR (measured) = 1.45 W/kg

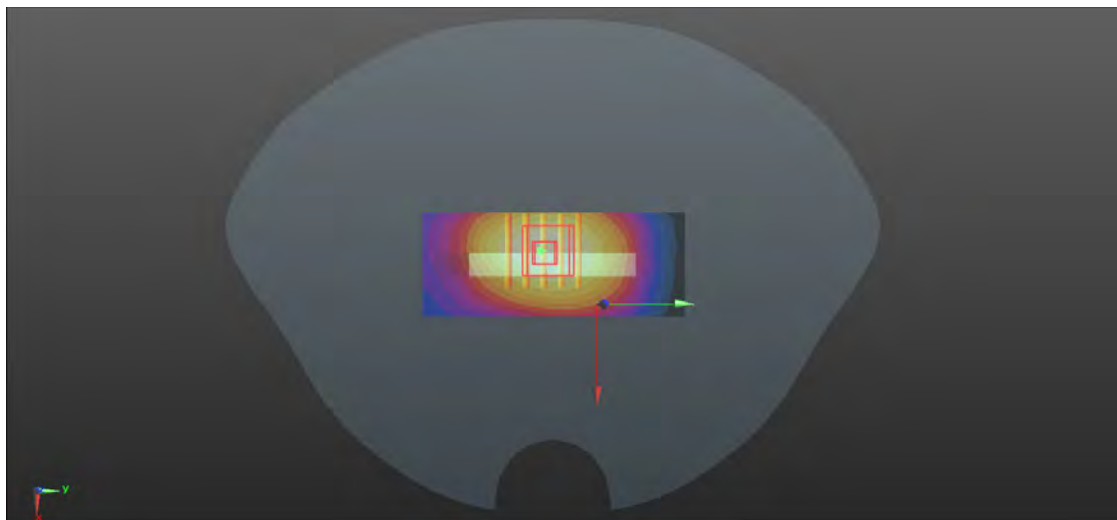
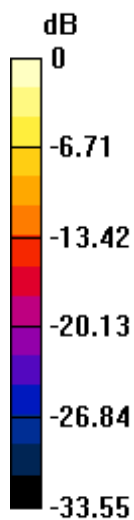

0 dB = 1.45 W/kg

P31 WCDMA V_RMC12.2K_Bottom Side_1cm_Ch4233

Communication System: WCDMA; Frequency: 846.6 MHz; Duty Cycle: 1:1

Medium: HSL835_0918 Medium parameters used: $f = 847$ MHz; $\sigma = 0.936$ S/m; $\epsilon_r = 42.914$; $\rho = 1000$ kg/m³

Ambient Temperature : 23.2°C; Liquid Temperature : 22.6°C

DASY5 Configuration:

- Probe: EX3DV4 - SN7612; ConvF(10.88, 10.88, 10.88) @ 846.6 MHz; Calibrated: 2023/02/28
- Sensor-Surface: 1.4mm (Mechanical Surface Detection)
- Electronics: DAE4 Sn1633; Calibrated: 2023/02/08
- Phantom: Right v5.0; Type: QD000P40CD; Serial: TP:1502
- Measurement SW: DASY52, Version 52.10 (2); SEMCAD X Version 14.6.12 (7450)

-Area Scan (31x81x1): Interpolated grid: dx=1.500 mm, dy=1.500 mm

Maximum value of SAR (interpolated) = 0.182 W/kg

-Zoom Scan (5x5x7)/Cube 0: Measurement grid: dx=8mm, dy=8mm, dz=5mm

Reference Value = 9.052 V/m; Power Drift = 0.10 dB

Peak SAR (extrapolated) = 0.252 W/kg

SAR(1 g) = 0.164 W/kg; SAR(10 g) = 0.094 W/kg

Maximum value of SAR (measured) = 0.186 W/kg

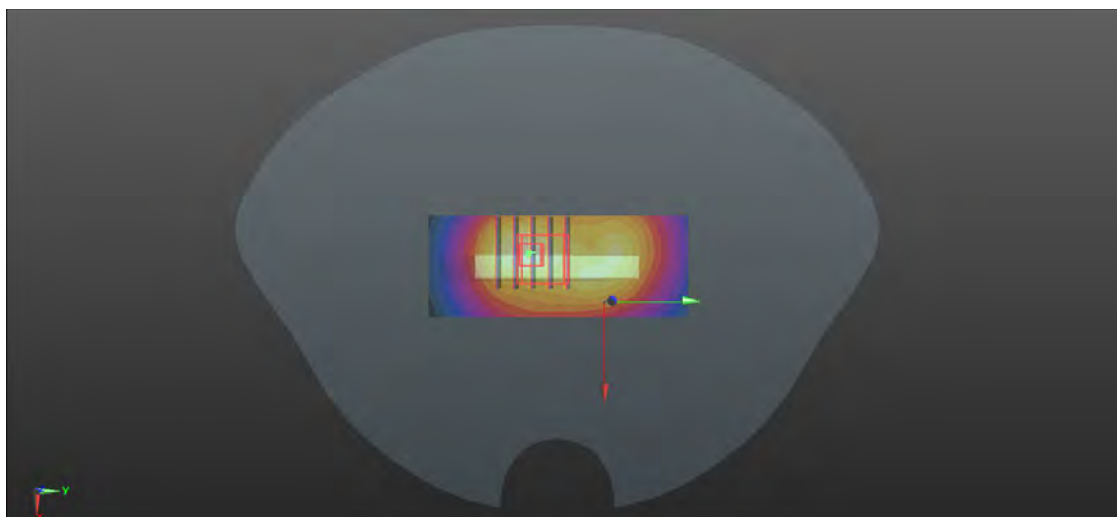
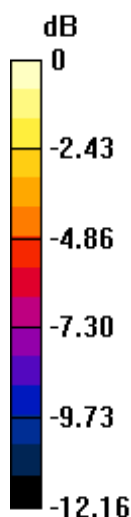

0 dB = 0.186 W/kg

P32 LTE 2_QPSK20M_Bottom Side_1cm_Ch19100_1RB_OS50

Communication System: LTE_FDD; Frequency: 1900 MHz; Duty Cycle: 1:1
Medium: HSL1900_0918 Medium parameters used: $f = 1900$ MHz; $\sigma = 1.403$ S/m; $\epsilon_r = 39.73$; $\rho = 1000$ kg/m³
Ambient Temperature : 23.4°C; Liquid Temperature : 22.6°C

DASY5 Configuration:

- Probe: EX3DV4 - SN7612; ConvF(8.68, 8.68, 8.68) @ 1900 MHz; Calibrated: 2023/02/28
- Sensor-Surface: 1.4mm (Mechanical Surface Detection)
- Electronics: DAE4 Sn1633; Calibrated: 2023/02/08
- Phantom: Right v5.0; Type: QD000P40CD; Serial: TP:1502
- Measurement SW: DASY52, Version 52.10 (2); SEMCAD X Version 14.6.12 (7450)

-Area Scan (31x81x1): Interpolated grid: dx=1.500 mm, dy=1.500 mm
Maximum value of SAR (interpolated) = 1.88 W/kg

-Zoom Scan (5x5x7)/Cube 0: Measurement grid: dx=8mm, dy=8mm, dz=5mm
Reference Value = 31.96 V/m; Power Drift = 0.08 dB
Peak SAR (extrapolated) = 2.46 W/kg
SAR(1 g) = 1.01 W/kg; SAR(10 g) = 0.695 W/kg
Maximum value of SAR (measured) = 1.78 W/kg

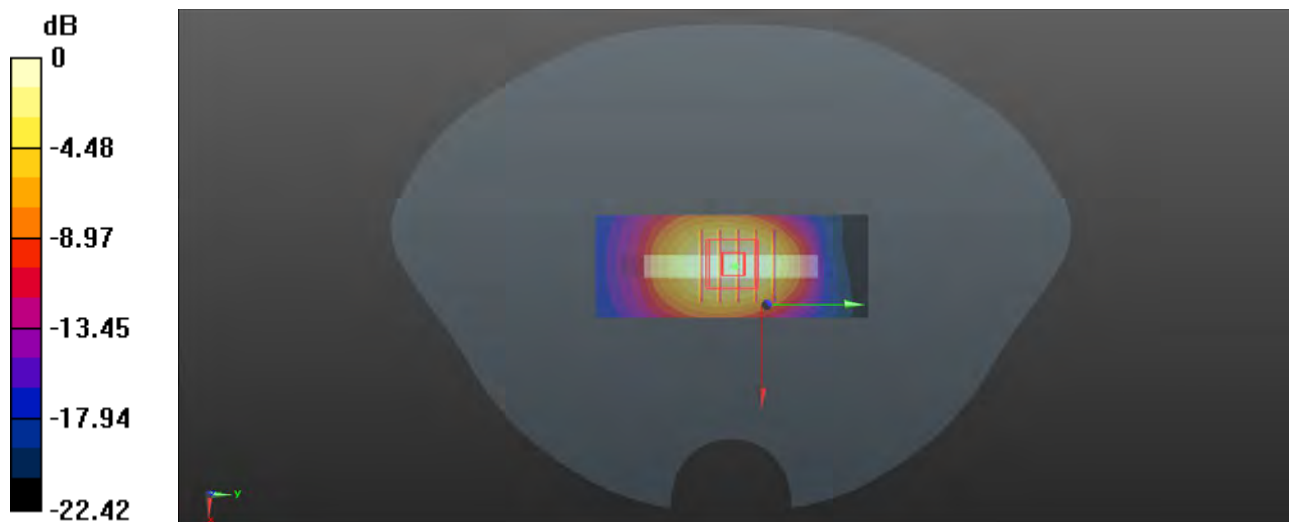

0 dB = 1.78 W/kg

P33 LTE 5_QPSK10M_Bottom Side_1cm_Ch20450_1RB_OS24

Communication System: LTE_FDD; Frequency: 829 MHz; Duty Cycle: 1:1
Medium: HSL835_0918 Medium parameters used: $f = 829$ MHz; $\sigma = 0.928$ S/m; $\epsilon_r = 43.035$; $\rho = 1000$ kg/m³
Ambient Temperature : 23.2°C; Liquid Temperature : 22.6°C

DASY5 Configuration:

- Probe: EX3DV4 - SN7612; ConvF(10.88, 10.88, 10.88) @ 829 MHz; Calibrated: 2023/02/28
- Sensor-Surface: 1.4mm (Mechanical Surface Detection)
- Electronics: DAE4 Sn1633; Calibrated: 2023/02/08
- Phantom: Right v5.0; Type: QD000P40CD; Serial: TP:1502
- Measurement SW: DASY52, Version 52.10 (2); SEMCAD X Version 14.6.12 (7450)

-Area Scan (31x81x1): Interpolated grid: dx=1.500 mm, dy=1.500 mm
Maximum value of SAR (interpolated) = 0.0980 W/kg

-Zoom Scan (5x5x7)/Cube 0: Measurement grid: dx=8mm, dy=8mm, dz=5mm
Reference Value = 8.587 V/m; Power Drift = 0.19 dB
Peak SAR (extrapolated) = 0.178 W/kg
SAR(1 g) = 0.075 W/kg; SAR(10 g) = 0.039 W/kg
Maximum value of SAR (measured) = 0.100 W/kg

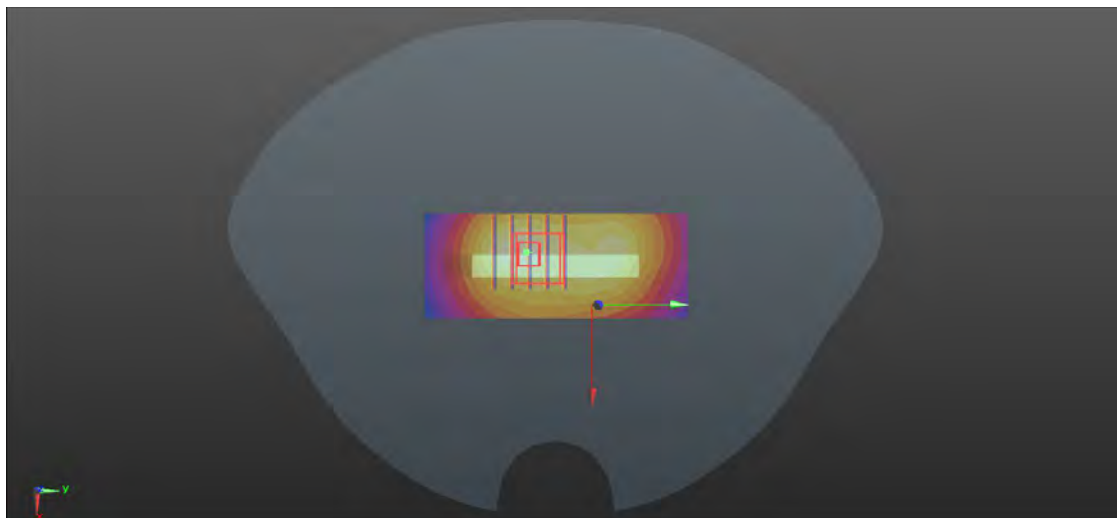
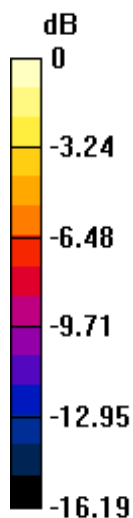

0 dB = 0.100 W/kg

P34 LTE 7_QPSK20M_Bottom Side_1cm_Ch21350_1RB_OS0

Communication System: LTE_FDD; Frequency: 2560 MHz; Duty Cycle: 1:1

Medium: HSL2600_0918 Medium parameters used: $f = 2560$ MHz; $\sigma = 1.9$ S/m; $\epsilon_r = 39.005$; $\rho = 1000$ kg/m³

Ambient Temperature : 23.4°C; Liquid Temperature : 22.7°C

DASY5 Configuration:

- Probe: EX3DV4 - SN7612; ConvF(7.85, 7.85, 7.85) @ 2560 MHz; Calibrated: 2023/02/28
- Sensor-Surface: 1.4mm (Mechanical Surface Detection)
- Electronics: DAE4 Sn1633; Calibrated: 2023/02/08
- Phantom: Right v5.0; Type: QD000P40CD; Serial: TP:1502
- Measurement SW: DASY52, Version 52.10 (2); SEMCAD X Version 14.6.12 (7450)

-Area Scan (41x101x1): Interpolated grid: dx=1.200 mm, dy=1.200 mm

Maximum value of SAR (interpolated) = 1.11 W/kg

-Zoom Scan (7x7x7)/Cube 0: Measurement grid: dx=5mm, dy=5mm, dz=5mm

Reference Value = 16.92 V/m; Power Drift = 0.05 dB

Peak SAR (extrapolated) = 1.69 W/kg

SAR(1 g) = 0.835 W/kg; SAR(10 g) = 0.387 W/kg

Maximum value of SAR (measured) = 1.10 W/kg

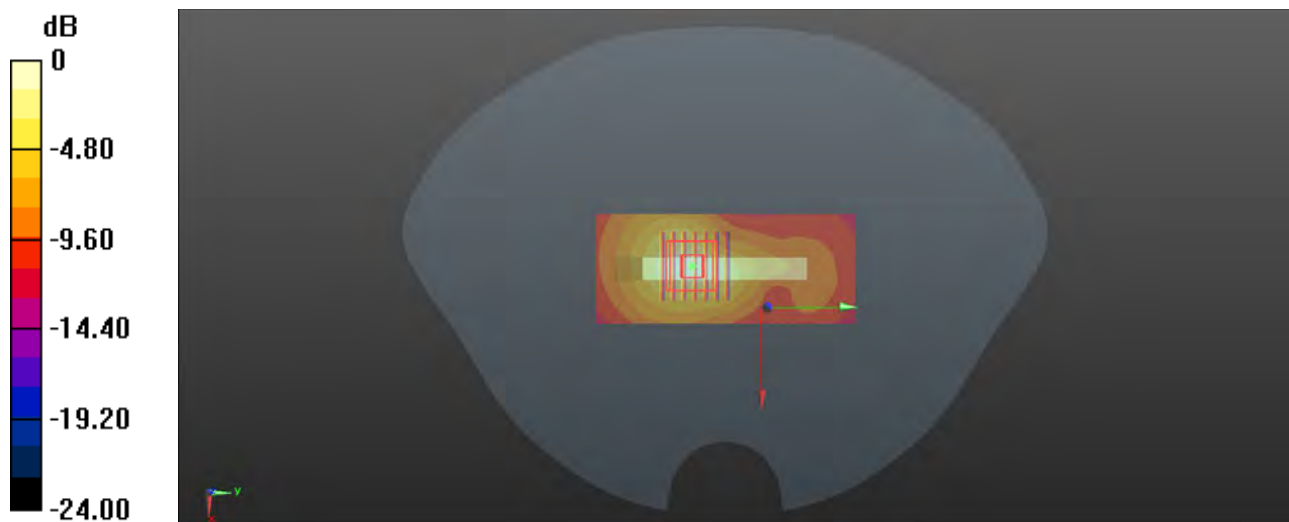

0 dB = 1.10 W/kg

P35 LTE 12_QPSK10M_Rear Face_1cm_Ch23130_1RB_OS0

Communication System: LTE_FDD; Frequency: 711 MHz; Duty Cycle: 1:1
Medium: HSL750_0918 Medium parameters used: $f = 711 \text{ MHz}$; $\sigma = 0.89 \text{ S/m}$; $\epsilon_r = 43.344$; $\rho = 1000 \text{ kg/m}^3$
Ambient Temperature : 23.2°C ; Liquid Temperature : 22.6°C

DASY5 Configuration:

- Probe: EX3DV4 - SN7612; ConvF(11.35, 11.35, 11.35) @ 711 MHz; Calibrated: 2023/02/28
- Sensor-Surface: 1.4mm (Mechanical Surface Detection)
- Electronics: DAE4 Sn1633; Calibrated: 2023/02/08
- Phantom: Right v5.0; Type: QD000P40CD; Serial: TP:1502
- Measurement SW: DASY52, Version 52.10 (2); SEMCAD X Version 14.6.12 (7450)

-Area Scan (71x71x1): Interpolated grid: $dx=1.500 \text{ mm}$, $dy=1.500 \text{ mm}$
Maximum value of SAR (interpolated) = 0.167 W/kg

-Zoom Scan (5x5x7)/Cube 0: Measurement grid: $dx=8\text{mm}$, $dy=8\text{mm}$, $dz=5\text{mm}$
Reference Value = 13.33 V/m ; Power Drift = 0.01 dB
Peak SAR (extrapolated) = 0.192 W/kg
SAR(1 g) = 0.151 W/kg ; SAR(10 g) = 0.116 W/kg
Maximum value of SAR (measured) = 0.166 W/kg

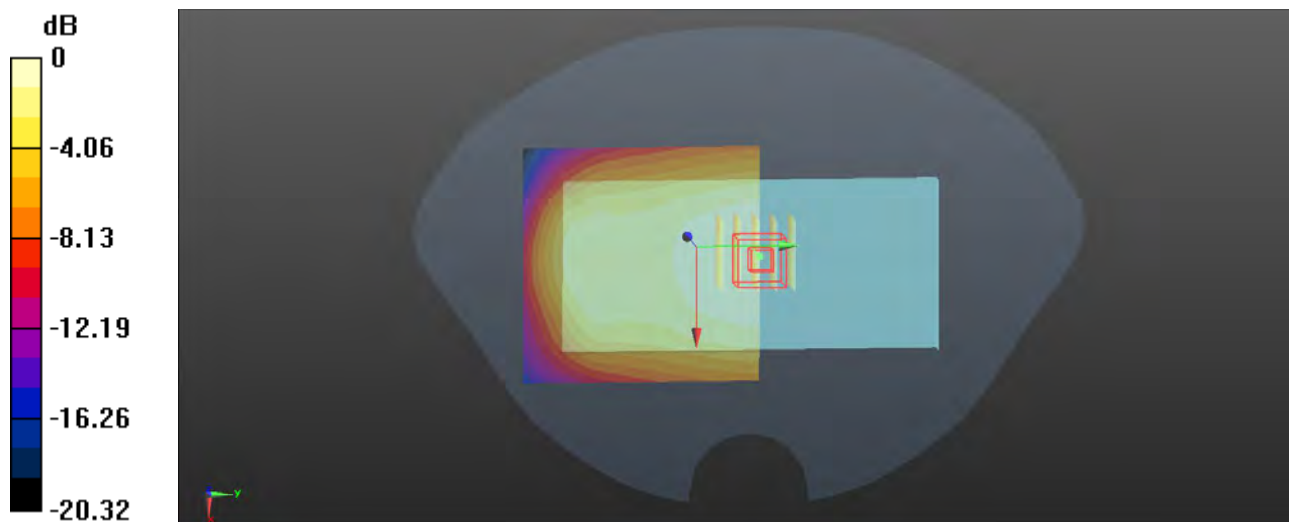

0 dB = 0.166 W/kg

P36 LTE 13_QPSK10M_Rear Face_1cm_Ch23230_1RB_OS49

Communication System: LTE_FDD; Frequency: 782 MHz; Duty Cycle: 1:1
 Medium: HSL750_0918 Medium parameters used: $f = 782 \text{ MHz}$; $\sigma = 0.915 \text{ S/m}$; $\epsilon_r = 43.118$; $\rho = 1000 \text{ kg/m}^3$
 Ambient Temperature : 23.2°C ; Liquid Temperature : 22.6°C

DASY5 Configuration:

- Probe: EX3DV4 - SN7612; ConvF(11.35, 11.35, 11.35) @ 782 MHz; Calibrated: 2023/02/28
- Sensor-Surface: 1.4mm (Mechanical Surface Detection)
- Electronics: DAE4 Sn1633; Calibrated: 2023/02/08
- Phantom: Right v5.0; Type: QD000P40CD; Serial: TP:1502
- Measurement SW: DASY52, Version 52.10 (2); SEMCAD X Version 14.6.12 (7450)

-Area Scan (71x71x1): Interpolated grid: $dx=1.500 \text{ mm}$, $dy=1.500 \text{ mm}$
 Maximum value of SAR (interpolated) = 0.0654 W/kg

-Zoom Scan (5x5x7)/Cube 0: Measurement grid: $dx=8\text{mm}$, $dy=8\text{mm}$, $dz=5\text{mm}$
 Reference Value = 7.673 V/m ; Power Drift = -0.09 dB
 Peak SAR (extrapolated) = 0.0980 W/kg
SAR(1 g) = 0.055 W/kg ; SAR(10 g) = 0.033 W/kg
 Maximum value of SAR (measured) = 0.0646 W/kg

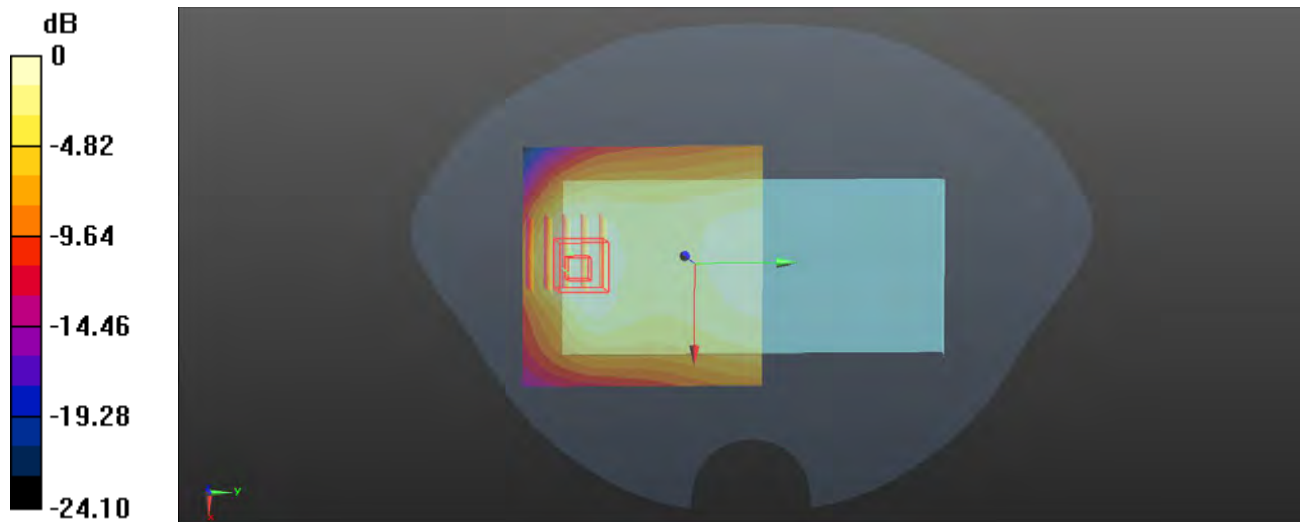

0 dB = 0.0646 W/kg

P37 LTE 66_QPSK20M_Bottom Side_1cm_Ch132072_1RB_OS50

Communication System: LTE_FDD; Frequency: 1720 MHz; Duty Cycle: 1:1

Medium: HSL1750_0918 Medium parameters used: $f = 1720$ MHz; $\sigma = 1.399$ S/m; $\epsilon_r = 40.822$; $\rho = 1000$ kg/m³

Ambient Temperature : 23.4°C; Liquid Temperature : 22.6°C

DASY5 Configuration:

- Probe: EX3DV4 - SN7612; ConvF(9.05, 9.05, 9.05) @ 1720 MHz; Calibrated: 2023/02/28
- Sensor-Surface: 1.4mm (Mechanical Surface Detection)
- Electronics: DAE4 Sn1633; Calibrated: 2023/02/08
- Phantom: Right v5.0; Type: QD000P40CD; Serial: TP:1502
- Measurement SW: DASY52, Version 52.10 (2); SEMCAD X Version 14.6.12 (7450)

-Area Scan (31x81x1): Interpolated grid: dx=1.500 mm, dy=1.500 mm
Maximum value of SAR (interpolated) = 1.60 W/kg

-Zoom Scan (5x5x7)/Cube 0: Measurement grid: dx=8mm, dy=8mm, dz=5mm
Reference Value = 31.73 V/m; Power Drift = 0.05 dB
Peak SAR (extrapolated) = 2.07 W/kg
SAR(1 g) = 1.04 W/kg; SAR(10 g) = 0.694 W/kg
Maximum value of SAR (measured) = 1.54 W/kg

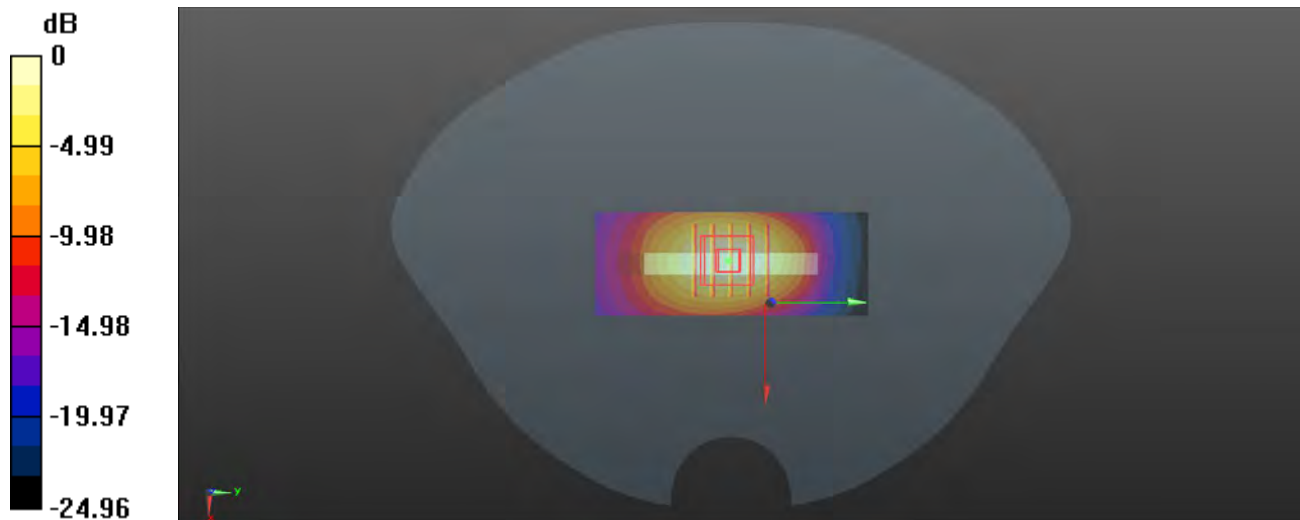

0 dB = 1.54 W/kg

P38 WLAN2.4G_802.11b_Rear Face_1cm_Ch11

Communication System: 802.11b; Frequency: 2462 MHz; Duty Cycle: 1:1

Medium: HSL2450_0918 Medium parameters used: $f = 2462$ MHz; $\sigma = 1.825$ S/m; $\epsilon_r = 39.151$; $\rho = 1000$ kg/m³

Ambient Temperature : 23.4°C; Liquid Temperature : 22.7°C

DASY5 Configuration:

- Probe: EX3DV4 - SN7612; ConvF(8.11, 8.11, 8.11) @ 2462 MHz; Calibrated: 2023/02/28
- Sensor-Surface: 1.4mm (Mechanical Surface Detection)
- Electronics: DAE4 Sn1633; Calibrated: 2023/02/08
- Phantom: Right v5.0; Type: QD000P40CD; Serial: TP:1502
- Measurement SW: DASY52, Version 52.10 (2); SEMCAD X Version 14.6.12 (7450)

-Area Scan (81x81x1): Interpolated grid: dx=1.200 mm, dy=1.200 mm

Maximum value of SAR (interpolated) = 0.421 W/kg

-Zoom Scan (7x7x7)/Cube 0: Measurement grid: dx=5mm, dy=5mm, dz=5mm

Reference Value = 5.105 V/m; Power Drift = -0.07 dB

Peak SAR (extrapolated) = 0.738 W/kg

SAR(1 g) = 0.334 W/kg; SAR(10 g) = 0.166 W/kg

Maximum value of SAR (measured) = 0.423 W/kg

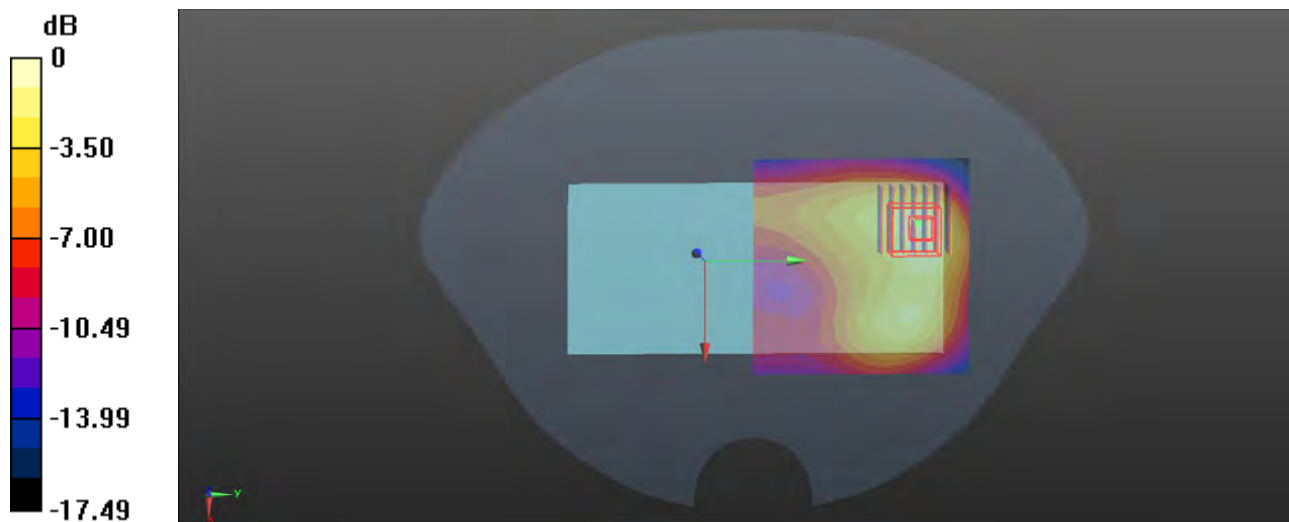

0 dB = 0.423 W/kg

P39 BT_GFSK_Rear Face_1cm_Ch0

Communication System: Bluetooth; Frequency: 2402 MHz; Duty Cycle: 1:1.29
Medium: HSL2450_0918 Medium parameters used: $f = 2402$ MHz; $\sigma = 1.778$ S/m; $\epsilon_r = 39.25$; $\rho = 1000$ kg/m³
Ambient Temperature : 23.4°C; Liquid Temperature : 22.7°C

DASY5 Configuration:

- Probe: EX3DV4 - SN7612; ConvF(8.11, 8.11, 8.11) @ 2402 MHz; Calibrated: 2023/02/28
- Sensor-Surface: 1.4mm (Mechanical Surface Detection)
- Electronics: DAE4 Sn1633; Calibrated: 2023/02/08
- Phantom: Right v5.0; Type: QD000P40CD; Serial: TP:1502
- Measurement SW: DASY52, Version 52.10 (2); SEMCAD X Version 14.6.12 (7450)

-Area Scan (81x81x1): Interpolated grid: dx=1.200 mm, dy=1.200 mm
Maximum value of SAR (interpolated) = 0.0419 W/kg

-Zoom Scan (7x7x7)/Cube 0: Measurement grid: dx=5mm, dy=5mm, dz=5mm
Reference Value = 1.507 V/m; Power Drift = -0.01 dB
Peak SAR (extrapolated) = 0.0760 W/kg
SAR(1 g) = 0.035 W/kg; SAR(10 g) = 0.017 W/kg
Maximum value of SAR (measured) = 0.0447 W/kg

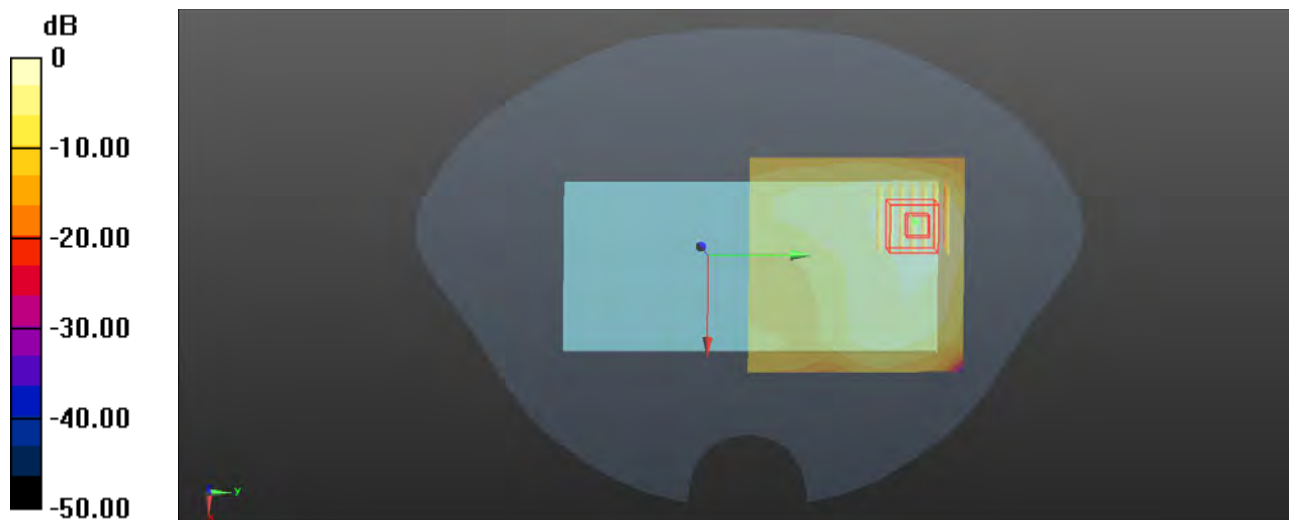

0 dB = 0.0447 W/kg

P40 GSM1900_GPRS(3Tx Slot)_Bottom Side_0cm_Ch512

Communication System: GPRS(3Tx-slot); Frequency: 1850.2 MHz; Duty Cycle: 1:2.77
Medium: HSL1900_0918 Medium parameters used: $f = 1850.2$ MHz; $\sigma = 1.376$ S/m; $\epsilon_r = 39.777$; $\rho = 1000$ kg/m³
Ambient Temperature : 23.4°C; Liquid Temperature : 22.6°C

DASY5 Configuration:

- Probe: EX3DV4 - SN7612; ConvF(8.68, 8.68, 8.68) @ 1850.2 MHz; Calibrated: 2023/02/28
- Sensor-Surface: 1.4mm (Mechanical Surface Detection)
- Electronics: DAE4 Sn1633; Calibrated: 2023/02/08
- Phantom: Right v5.0; Type: QD000P40CD; Serial: TP:1502
- Measurement SW: DASY52, Version 52.10 (2); SEMCAD X Version 14.6.12 (7450)

-Area Scan (31x81x1): Interpolated grid: dx=1.500 mm, dy=1.500 mm
Maximum value of SAR (interpolated) = 5.64 W/kg

-Zoom Scan (5x5x7)/Cube 0: Measurement grid: dx=8mm, dy=8mm, dz=5mm
Reference Value = 59.78 V/m; Power Drift = 0.05 dB
Peak SAR (extrapolated) = 9.12 W/kg
SAR(1 g) = 4.25 W/kg; SAR(10 g) = 1.96 W/kg
Maximum value of SAR (measured) = 6.13 W/kg

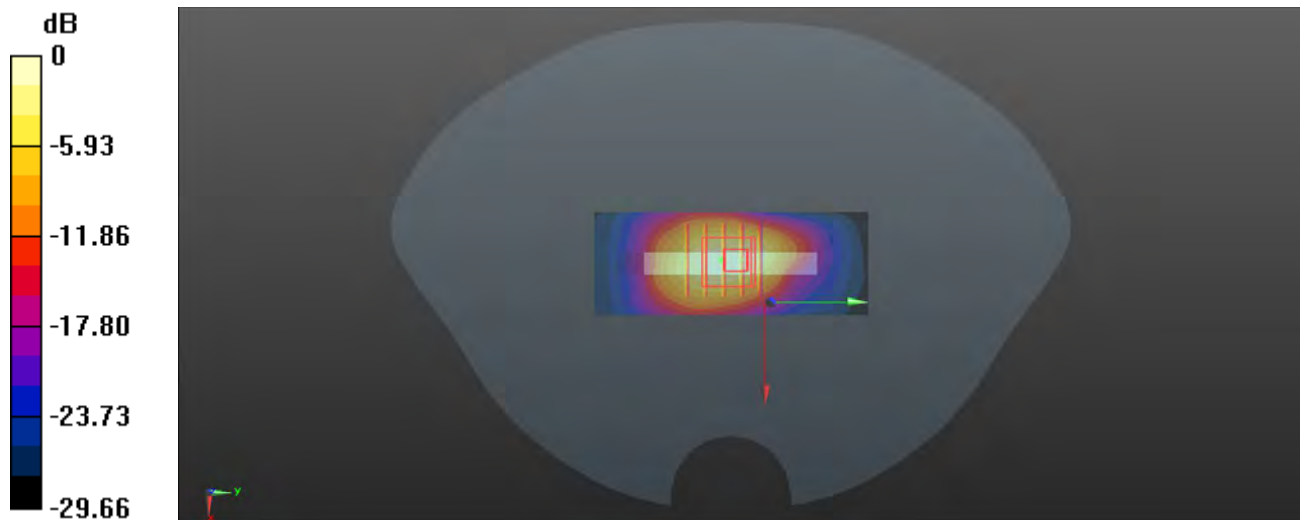

0 dB = 6.13 W/kg

P41 WCDMA II_RMC12.2K_Bottom Side_0cm_Ch9538

Communication System: WCDMA; Frequency: 1907.6 MHz; Duty Cycle: 1:1

Medium: HSL1900_0918 Medium parameters used: $f = 1908$ MHz; $\sigma = 1.408$ S/m; $\epsilon_r = 39.723$; $\rho = 1000$ kg/m³

Ambient Temperature : 23.4°C; Liquid Temperature : 22.6°C

DASY5 Configuration:

- Probe: EX3DV4 - SN7612; ConvF(8.68, 8.68, 8.68) @ 1907.6 MHz; Calibrated: 2023/02/28
- Sensor-Surface: 1.4mm (Mechanical Surface Detection)
- Electronics: DAE4 Sn1633; Calibrated: 2023/02/08
- Phantom: Right v5.0; Type: QD000P40CD; Serial: TP:1502
- Measurement SW: DASY52, Version 52.10 (2); SEMCAD X Version 14.6.12 (7450)

-Area Scan (31x81x1): Interpolated grid: dx=1.500 mm, dy=1.500 mm

Maximum value of SAR (interpolated) = 7.04 W/kg

-Zoom Scan (5x5x7)/Cube 0: Measurement grid: dx=8mm, dy=8mm, dz=5mm

Reference Value = 64.87 V/m; Power Drift = 0.06 dB

Peak SAR (extrapolated) = 10.6 W/kg

SAR(1 g) = 4.98 W/kg; SAR(10 g) = 2.34 W/kg

Maximum value of SAR (measured) = 7.04 W/kg

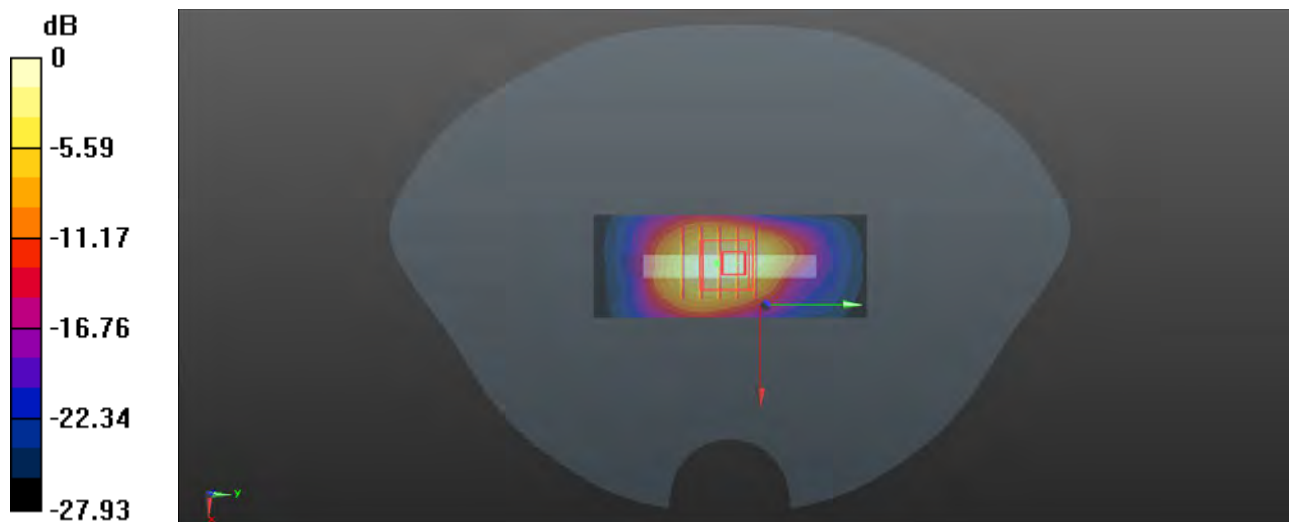

0 dB = 7.04 W/kg

P42 WCDMA IV_RMC12.2K_Bottom Side_0cm_Ch1312

Communication System: WCDMA; Frequency: 1712.4 MHz; Duty Cycle: 1:1

Medium: HSL1750_0918 Medium parameters used: $f = 1712.4$ MHz; $\sigma = 1.393$ S/m; $\epsilon_r = 40.829$; $\rho = 1000$ kg/m³

Ambient Temperature : 23.4°C; Liquid Temperature : 22.6°C

DASY5 Configuration:

- Probe: EX3DV4 - SN7612; ConvF(9.05, 9.05, 9.05) @ 1712.4 MHz; Calibrated: 2023/02/28
- Sensor-Surface: 1.4mm (Mechanical Surface Detection)
- Electronics: DAE4 Sn1633; Calibrated: 2023/02/08
- Phantom: Right v5.0; Type: QD000P40CD; Serial: TP:1502
- Measurement SW: DASY52, Version 52.10 (2); SEMCAD X Version 14.6.12 (7450)

-Area Scan (31x81x1): Interpolated grid: dx=1.500 mm, dy=1.500 mm
Maximum value of SAR (interpolated) = 6.42 W/kg

-Zoom Scan (5x5x7)/Cube 0: Measurement grid: dx=8mm, dy=8mm, dz=5mm
Reference Value = 64.76 V/m; Power Drift = 0.01 dB
Peak SAR (extrapolated) = 11.0 W/kg
SAR(1 g) = 5.08 W/kg; SAR(10 g) = 2.21 W/kg
Maximum value of SAR (measured) = 7.36 W/kg

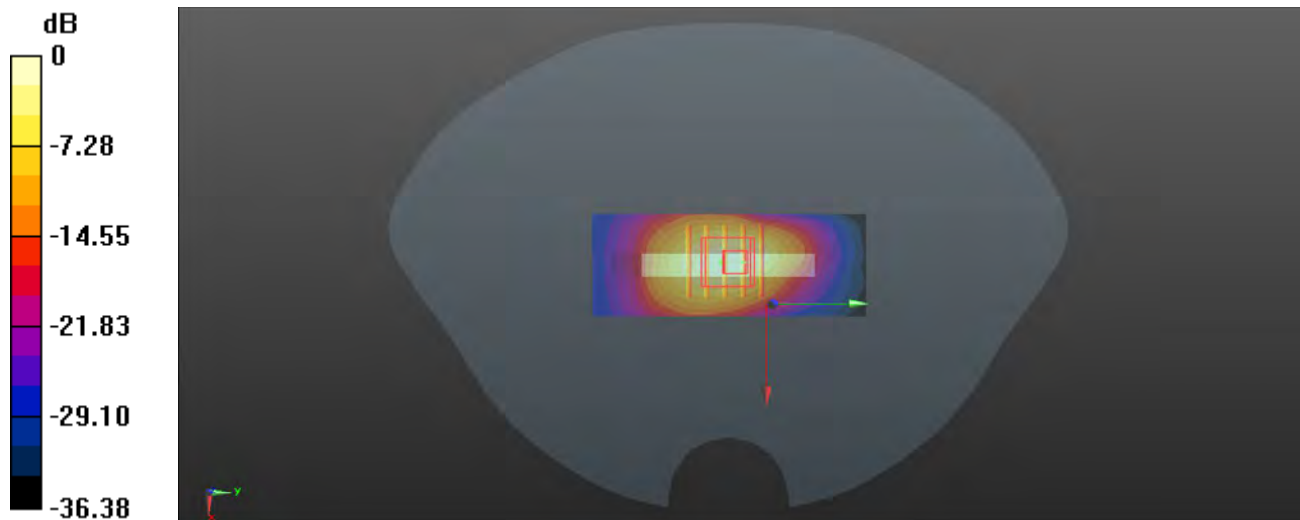

0 dB = 7.36 W/kg

P43 LTE 2_QPSK20M_Bottom Side_0cm_Ch18900_1RB_OS50

Communication System: LTE_FDD (0); Frequency: 1880 MHz; Duty Cycle: 1:1
Medium: HSL1900_0918 Medium parameters used: $f = 1880$ MHz; $\sigma = 1.39$ S/m; $\epsilon_r = 39.746$; $\rho = 1000$ kg/m³
Ambient Temperature : 23.4°C; Liquid Temperature : 22.6°C

DASY5 Configuration:

- Probe: EX3DV4 - SN7612; ConvF(8.68, 8.68, 8.68) @ 1880 MHz; Calibrated: 2023/02/28
- Sensor-Surface: 1.4mm (Mechanical Surface Detection)
- Electronics: DAE4 Sn1633; Calibrated: 2023/02/08
- Phantom: Right v5.0; Type: QD000P40CD; Serial: TP:1502
- Measurement SW: DASY52, Version 52.10 (2); SEMCAD X Version 14.6.12 (7450)

-Area Scan (31x81x1): Interpolated grid: dx=1.500 mm, dy=1.500 mm
Maximum value of SAR (interpolated) = 7.78 W/kg

-Zoom Scan (5x5x7)/Cube 0: Measurement grid: dx=8mm, dy=8mm, dz=5mm
Reference Value = 67.81 V/m; Power Drift = -0.03 dB
Peak SAR (extrapolated) = 11.6 W/kg
SAR(1 g) = 5.54 W/kg; SAR(10 g) = 2.38 W/kg
Maximum value of SAR (measured) = 7.73 W/kg

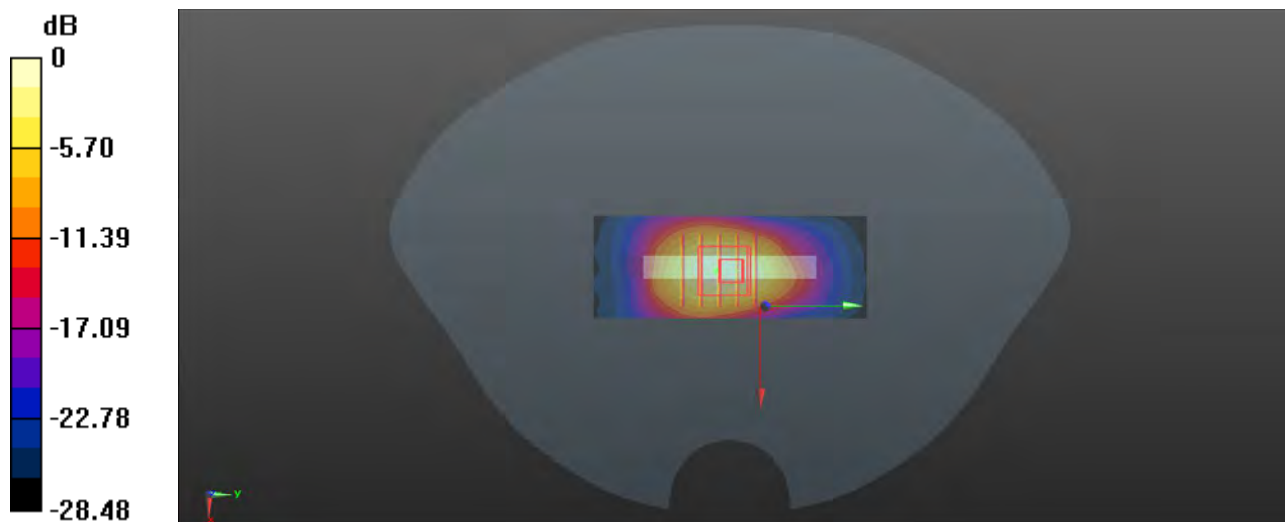

0 dB = 7.73 W/kg

P44 LTE 66_QPSK20M_Bottom Side_0cm_Ch132072_1RB_OS50

Communication System: LTE_FDD; Frequency: 1720 MHz; Duty Cycle: 1:1

Medium: HSL1750_0918 Medium parameters used: $f = 1720$ MHz; $\sigma = 1.399$ S/m; $\epsilon_r = 40.822$; $\rho = 1000$ kg/m³

Ambient Temperature : 23.4°C; Liquid Temperature : 22.6°C

DASY5 Configuration:

- Probe: EX3DV4 - SN7612; ConvF(9.05, 9.05, 9.05) @ 1720 MHz; Calibrated: 2023/02/28
- Sensor-Surface: 1.4mm (Mechanical Surface Detection)
- Electronics: DAE4 Sn1633; Calibrated: 2023/02/08
- Phantom: Right v5.0; Type: QD000P40CD; Serial: TP:1502
- Measurement SW: DASY52, Version 52.10 (2); SEMCAD X Version 14.6.12 (7450)

-Area Scan (31x81x1): Interpolated grid: dx=1.500 mm, dy=1.500 mm

Maximum value of SAR (interpolated) = 6.33 W/kg

-Zoom Scan (5x5x7)/Cube 0: Measurement grid: dx=8mm, dy=8mm, dz=5mm

Reference Value = 64.51 V/m; Power Drift = -0.02 dB

Peak SAR (extrapolated) = 10.2 W/kg

SAR(1 g) = 4.88 W/kg; SAR(10 g) = 2.08 W/kg

Maximum value of SAR (measured) = 6.89 W/kg

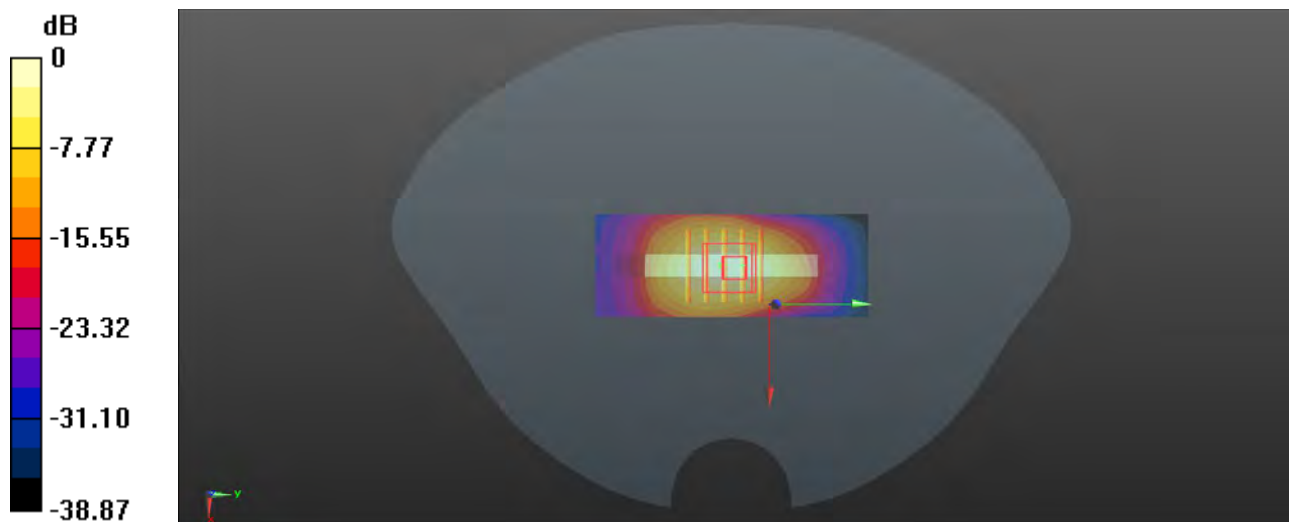

0 dB = 6.89 W/kg



BUREAU
VERITAS



Appendix C. Calibration Certificate for Probe and Dipole

The SPEAG calibration certificates are shown as follows.

Client : **7layers**

Certificate No: **Z23-60064**

CALIBRATION CERTIFICATE

Object: DAE4 - SN: 1633

Calibration Procedure(s): FF-Z11-002-01
Calibration Procedure for the Data Acquisition Electronics (DAEx)

Calibration date: February 08, 2023

This calibration Certificate documents the traceability to national standards, which realize the physical units of measurements(SI). The measurements and the uncertainties with confidence probability are given on the following pages and are part of the certificate.

All calibrations have been conducted in the closed laboratory facility: environment temperature(22±3)°C and humidity<70%.

Calibration Equipment used (M&TE critical for calibration)

Primary Standards	ID #	Cal Date(Calibrated by, Certificate No.)	Scheduled Calibration
Process Calibrator 753	1971018	14-Jun-22 (CTTL, No.J22X04180)	Jun-23

	Name	Function	Signature
Calibrated by:	Yu Zongying	SAR Test Engineer	
Reviewed by:	Lin Hao	SAR Test Engineer	
Approved by:	Qi Dianyuan	SAR Project Leader	

Issued: February 14, 2023

This calibration certificate shall not be reproduced except in full without written approval of the laboratory.



In Collaboration with

s p e a g
CALIBRATION LABORATORY



Add: No.52 HuaYuanBei Road, Haidian District, Beijing, 100191, China

Tel: +86-10-62304633-2117

E-mail: emf@caict.ac.cn

<http://www.caict.ac.cn>

Glossary:

DAE data acquisition electronics
Connector angle information used in DASY system to align probe sensor X to the robot coordinate system.

Methods Applied and Interpretation of Parameters:

- *DC Voltage Measurement:* Calibration Factor assessed for use in DASY system by comparison with a calibrated instrument traceable to national standards. The figure given corresponds to the full scale range of the voltmeter in the respective range.
- *Connector angle:* The angle of the connector is assessed measuring the angle mechanically by a tool inserted. Uncertainty is not required.
- The report provide only calibration results for DAE, it does not contain other performance test results.



Add: No.52 HuaYuanBei Road, Haidian District, Beijing, 100191, China
 Tel: +86-10-62304633-2117
 E-mail: emf@caict.ac.cn <http://www.caict.ac.cn>

DC Voltage Measurement

A/D - Converter Resolution nominal

High Range: 1LSB = 6.1μV, full range = -100...+300 mV

Low Range: 1LSB = 61nV, full range = -1.....+3mV

DASY measurement parameters: Auto Zero Time: 3 sec; Measuring time: 3 sec

Calibration Factors	X	Y	Z
High Range	405.258 ± 0.15% (k=2)	405.540 ± 0.15% (k=2)	405.038 ± 0.15% (k=2)
Low Range	4.00096 ± 0.7% (k=2)	4.00014 ± 0.7% (k=2)	4.01156 ± 0.7% (k=2)

Connector Angle

Connector Angle to be used in DASY system	318° ± 1 °
---	------------

Client **7layers**

Certificate No: **Z23-60063**

CALIBRATION CERTIFICATE

Object EX3DV4 - SN : 7612

Calibration Procedure(s)
FF-Z11-004-02
Calibration Procedures for Dosimetric E-field Probes

Calibration date: February 28, 2023



This calibration Certificate documents the traceability to national standards, which realize the physical units of measurements(SI). The measurements and the uncertainties with confidence probability are given on the following pages and are part of the certificate.

All calibrations have been conducted in the closed laboratory facility: environment temperature(22±3)°C and humidity<70%.

Calibration Equipment used (M&TE critical for calibration)

Primary Standards	ID #	Cal Date(Calibrated by, Certificate No.)	Scheduled Calibration
Power Meter NRP2	101919	14-Jun-22(CTTL, No.J22X04181)	Jun-23
Power sensor NRP-Z91	101547	14-Jun-22(CTTL, No.J22X04181)	Jun-23
Power sensor NRP-Z91	101548	14-Jun-22(CTTL, No.J22X04181)	Jun-23
Reference 10dBAttenuator	18N50W-10dB	19-Jan-23(CTTL, No.J23X00212)	Jan-25
Reference 20dBAttenuator	18N50W-20dB	19-Jan-23(CTTL, No.J23X00211)	Jan-25
Reference Probe EX3DV4	SN 3846	20-May-22(SPEAG, No.EX3-3846_May22)	May-23
DAE4	SN 1555	25-Aug-22(SPEAG, No.DAE4-1555_Aug22)	Aug-23

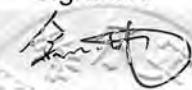
Secondary Standards	ID #	Cal Date(Calibrated by, Certificate No.)	Scheduled Calibration
SignalGenerator MG3700A	6201052605	14-Jun-22(CTTL, No.J22X04182)	Jun-23
Network Analyzer E5071C	MY46110673	10-Jan-23(CTTL, No.J23X00104)	Jan-24

	Name	Function	Signature
Calibrated by:	Yu Zongying	SAR Test Engineer	
Reviewed by:	Lin Hao	SAR Test Engineer	
Approved by:	Qi Dianyuan	SAR Project Leader	

Issued: March 06, 2023

This calibration certificate shall not be reproduced except in full without written approval of the laboratory.

**Glossary:**

TSL	tissue simulating liquid
NORM _{x,y,z}	sensitivity in free space
ConvF	sensitivity in TSL / NORM _{x,y,z}
DCP	diode compression point
CF	crest factor (1/duty_cycle) of the RF signal
A,B,C,D	modulation dependent linearization parameters
Polarization Φ	Φ rotation around probe axis
Polarization θ	θ rotation around an axis that is in the plane normal to probe axis (at measurement center), i $\theta=0$ is normal to probe axis
Connector Angle	information used in DASY system to align probe sensor X to the robot coordinate system

Calibration is Performed According to the Following Standards:

- IEEE Std 1528-2013, "IEEE Recommended Practice for Determining the Peak Spatial-Averaged Specific Absorption Rate (SAR) in the Human Head from Wireless Communications Devices: Measurement Techniques", June 2013
- IEC 62209-1, "Measurement procedure for the assessment of Specific Absorption Rate (SAR) from hand-held and body-mounted devices used next to the ear (frequency range of 300 MHz to 6 GHz)", July 2016
- IEC 62209-2, "Procedure to determine the Specific Absorption Rate (SAR) for wireless communication devices used in close proximity to the human body (frequency range of 30 MHz to 6 GHz)", March 2010
- KDB 865664, "SAR Measurement Requirements for 100 MHz to 6 GHz"

Methods Applied and Interpretation of Parameters:

- NORM_{x,y,z}**: Assessed for E-field polarization $\theta=0$ ($f \leq 900\text{MHz}$ in TEM-cell; $f > 1800\text{MHz}$: waveguide). NORM_{x,y,z} are only intermediate values, i.e., the uncertainties of NORM_{x,y,z} does not effect the E^2 -field uncertainty inside TSL (see below ConvF).
- NORM(f)_{x,y,z}** = NORM_{x,y,z} * frequency_response (see Frequency Response Chart). This linearization is implemented in DASY4 software versions later than 4.2. The uncertainty of the frequency response is included in the stated uncertainty of ConvF.
- DCP_{x,y,z}**: DCP are numerical linearization parameters assessed based on the data of power sweep (no uncertainty required). DCP does not depend on frequency nor media.
- PAR**: PAR is the Peak to Average Ratio that is not calibrated but determined based on the signal characteristics.
- A_{x,y,z}; B_{x,y,z}; C_{x,y,z}; VR_{x,y,z}**: A,B,C are numerical linearization parameters assessed based on the data of power sweep for specific modulation signal. The parameters do not depend on frequency nor media. VR is the maximum calibration range expressed in RMS voltage across the diode.
- ConvF and Boundary Effect Parameters**: Assessed in flat phantom using E-field (or Temperature Transfer Standard for $f \leq 800\text{MHz}$) and inside waveguide using analytical field distributions based on power measurements for $f > 800\text{MHz}$. The same setups are used for assessment of the parameters applied for boundary compensation (alpha, depth) of which typical uncertainty valued are given. These parameters are used in DASY4 software to improve probe accuracy close to the boundary. The sensitivity in TSL corresponds to NORM_{x,y,z} * ConvF whereby the uncertainty corresponds to that given for ConvF. A frequency dependent ConvF is used in DASY version 4.4 and higher which allows extending the validity from $\pm 50\text{MHz}$ to $\pm 100\text{MHz}$.
- Spherical isotropy (3D deviation from isotropy)**: in a field of low gradients realized using a flat phantom exposed by a patch antenna.
- Sensor Offset**: The sensor offset corresponds to the offset of virtual measurement center from the probe tip (on probe axis). No tolerance required.
- Connector Angle**: The angle is assessed using the information gained by determining the NORM_x (no uncertainty required).



Add: No.52 HuaYuanBei Road, Haidian District, Beijing, 100191, China
Tel: +86-10-62304633-2117
E-mail: emf@caict.ac.cn <http://www.caict.ac.cn>

DASY/EASY – Parameters of Probe: EX3DV4 – SN: 7612

Basic Calibration Parameters

	Sensor X	Sensor Y	Sensor Z	Unc (k=2)
Norm($\mu\text{V}/(\text{V}/\text{m})^2$) ^A	0.67	0.62	0.82	±10.0%
DCP(mV) ^B	112.3	109.6	113.2	

Calibration Results for Modulation Response

UID	Communication System Name		A dB	B dB $\sqrt{\mu\text{V}}$	C	D dB	VR mV	Max Dev.	Max Unc ^E (k=2)
0	CW	X	0.0	0.0	1.0	0.00	220.2	±2.3%	±4.7%
		Y	0.0	0.0	1.0		204.9		
		Z	0.0	0.0	1.0		249.9		
10352-AAA	Pulse Waveform (200Hz, 10%)	X	1.52	60.17	5.75	10.00	60	±3.5%	±9.6%
		Y	1.50	60.00	5.62		60		
		Z	1.69	60.00	5.91		60		
10353-AAA	Pulse Waveform (200Hz, 20%)	X	6.00	68.00	7.00	6.99	80	±4.1%	±9.6%
		Y	0.89	60.00	4.44		80		
		Z	1.15	60.00	4.91		80		
10354-AAA	Pulse Waveform (200Hz, 40%)	X	0.00	127.35	0.97	3.98	95	±3.5%	±9.6%
		Y	0.89	159.99	20.66		95		
		Z	0.69	60.00	3.86		95		
10355-AAA	Pulse Waveform (200Hz, 60%)	X	1.08	159.17	4.39	2.22	120	±2.1%	±9.6%
		Y	10.60	158.13	17.10		120		
		Z	0.46	60.00	2.96		120		
10387-AAA	QPSK Waveform, 1 MHz	X	0.66	62.07	9.72	1.00	150	±5.5%	±9.6%
		Y	0.84	63.77	11.09		150		
		Z	0.85	64.58	11.39		150		
10388-AAA	QPSK Waveform, 10 MHz	X	1.34	63.81	12.24	0.00	150	±1.7%	±9.6%
		Y	1.49	65.09	13.41		150		
		Z	1.52	65.84	13.80		150		
10396-AAA	64-QAM Waveform, 100 kHz	X	1.96	66.68	17.13	3.01	150	±1.0%	±9.6%
		Y	2.06	68.23	18.99		150		
		Z	2.31	70.69	20.00		150		
10414-AAA	WLAN CCDF, 64-QAM, 40MHz	X	4.01	65.50	14.75	0.00	150	±5.6%	±9.6%
		Y	4.29	66.06	15.34		150		
		Z	4.19	65.98	15.28		150		

Note: For details on UID parameters see Appendix

The reported uncertainty of measurement is stated as the standard uncertainty of Measurement multiplied by the coverage factor $k=2$, which for a normal distribution Corresponds to a coverage probability of approximately 95%.

^A The uncertainties of Norm X, Y, Z do not affect the E²-field uncertainty inside TSL (see Page 5).

^B Numerical linearization parameter: uncertainty not required.

^E Uncertainty is determined using the max. deviation from linear response applying rectangular distribution and is expressed for the square of the field value.



Add: No.52 HuaYuanBei Road, Haidian District, Beijing, 100191, China
 Tel: +86-10-62304633-2117
 E-mail: emf@caict.ac.cn <http://www.caict.ac.cn>

DASY/EASY – Parameters of Probe: EX3DV4 – SN: 7612

Sensor Model Parameters

	C1 fF	C2 fF	α V ⁻¹	T1 ms.V ⁻²	T2 ms.V ⁻¹	T3 ms	T4 V ⁻²	T5 V ⁻¹	T6
X	14.21	101.46	32.36	2.36	0.00	4.90	0.65	0.00	1.02
Y	17.81	130.11	33.90	5.13	0.00	4.90	0.35	0.03	1.02
Z	17.10	122.92	33.01	12.07	0.00	4.90	0.76	0.00	1.02

Other Probe Parameters

Sensor Arrangement	Triangular
Connector Angle (°)	16.2
Mechanical Surface Detection Mode	enabled
Optical Surface Detection Mode	disable
Probe Overall Length	337mm
Probe Body Diameter	10mm
Tip Length	9mm
Tip Diameter	2.5mm
Probe Tip to Sensor X Calibration Point	1mm
Probe Tip to Sensor Y Calibration Point	1mm
Probe Tip to Sensor Z Calibration Point	1mm
Recommended Measurement Distance from Surface	1.4mm

DASY/EASY – Parameters of Probe: EX3DV4 – SN:7612

Calibration Parameter Determined in Head Tissue Simulating Media

f [MHz] ^C	Relative Permittivity ^F	Conductivity (S/m) ^F	ConvF X	ConvF Y	ConvF Z	Alpha ^G	Depth ^G (mm)	Unct. (k=2)
750	41.9	0.89	11.35	11.35	11.35	0.17	1.22	± 12.7%
835	41.5	0.90	10.88	10.88	10.88	0.16	1.35	± 12.7%
900	41.5	0.97	10.81	10.81	10.81	0.16	1.41	± 12.7%
1450	40.5	1.20	9.77	9.77	9.77	0.10	1.20	± 12.7%
1750	40.1	1.37	9.05	9.05	9.05	0.25	1.01	± 12.7%
1900	40.0	1.40	8.68	8.68	8.68	0.25	1.09	± 12.7%
2100	39.8	1.49	8.72	8.72	8.72	0.24	1.16	± 12.7%
2300	39.5	1.67	8.41	8.41	8.41	0.65	0.67	± 12.7%
2450	39.2	1.80	8.11	8.11	8.11	0.65	0.67	± 12.7%
2600	39.0	1.96	7.85	7.85	7.85	0.50	0.79	± 12.7%
3300	38.2	2.71	7.45	7.45	7.45	0.39	0.95	± 13.9%
3500	37.9	2.91	7.30	7.30	7.30	0.39	0.92	± 13.9%
3700	37.7	3.12	7.10	7.10	7.10	0.35	1.01	± 13.9%
3900	37.5	3.32	6.95	6.95	6.95	0.30	1.50	± 13.9%
4100	37.2	3.53	6.90	6.90	6.90	0.30	1.40	± 13.9%
4200	37.1	3.63	6.85	6.85	6.85	0.30	1.50	± 13.9%
4400	36.9	3.84	6.75	6.75	6.75	0.35	1.35	± 13.9%
4600	36.7	4.04	6.65	6.65	6.65	0.40	1.30	± 13.9%
4800	36.4	4.25	6.55	6.55	6.55	0.40	1.38	± 13.9%
4950	36.3	4.40	6.35	6.35	6.35	0.40	1.38	± 13.9%
5250	35.9	4.71	5.70	5.70	5.70	0.45	1.30	± 13.9%
5600	35.5	5.07	5.10	5.10	5.10	0.50	1.30	± 13.9%
5750	35.4	5.22	5.21	5.21	5.21	0.50	1.30	± 13.9%

^C Frequency validity above 300 MHz of ±100MHz only applies for DASY v4.4 and higher (Page 2), else it is restricted to ±50MHz. The uncertainty is the RSS of ConvF uncertainty at calibration frequency and the uncertainty for the indicated frequency band. Frequency validity below 300 MHz is ± 10, 25, 40, 50 and 70 MHz for ConvF assessments at 30, 64, 128, 150 and 220 MHz respectively. Above 5 GHz frequency validity can be extended to ± 110 MHz.

^F At frequency up to 6 GHz, the validity of tissue parameters (ϵ and σ) can be relaxed to ±10% if liquid compensation formula is applied to measured SAR values. The uncertainty is the RSS of the ConvF uncertainty for indicated target tissue parameters.

^G Alpha/Depth are determined during calibration. SPEAG warrants that the remaining deviation due to the boundary effect after compensation is always less than ± 1% for frequencies below 3 GHz and below ± 2% for the frequencies between 3-6 GHz at any distance larger than half the probe tip diameter from the boundary.

Add: No.52 HuaYuanBei Road, Haidian District, Beijing, 100191, China
Tel: +86-10-62304633-2117
E-mail: emf@caict.ac.cn <http://www.caict.ac.cn>

Frequency Response of E-Field (TEM-Cell: ifi110 EXX, Waveguide: R22)

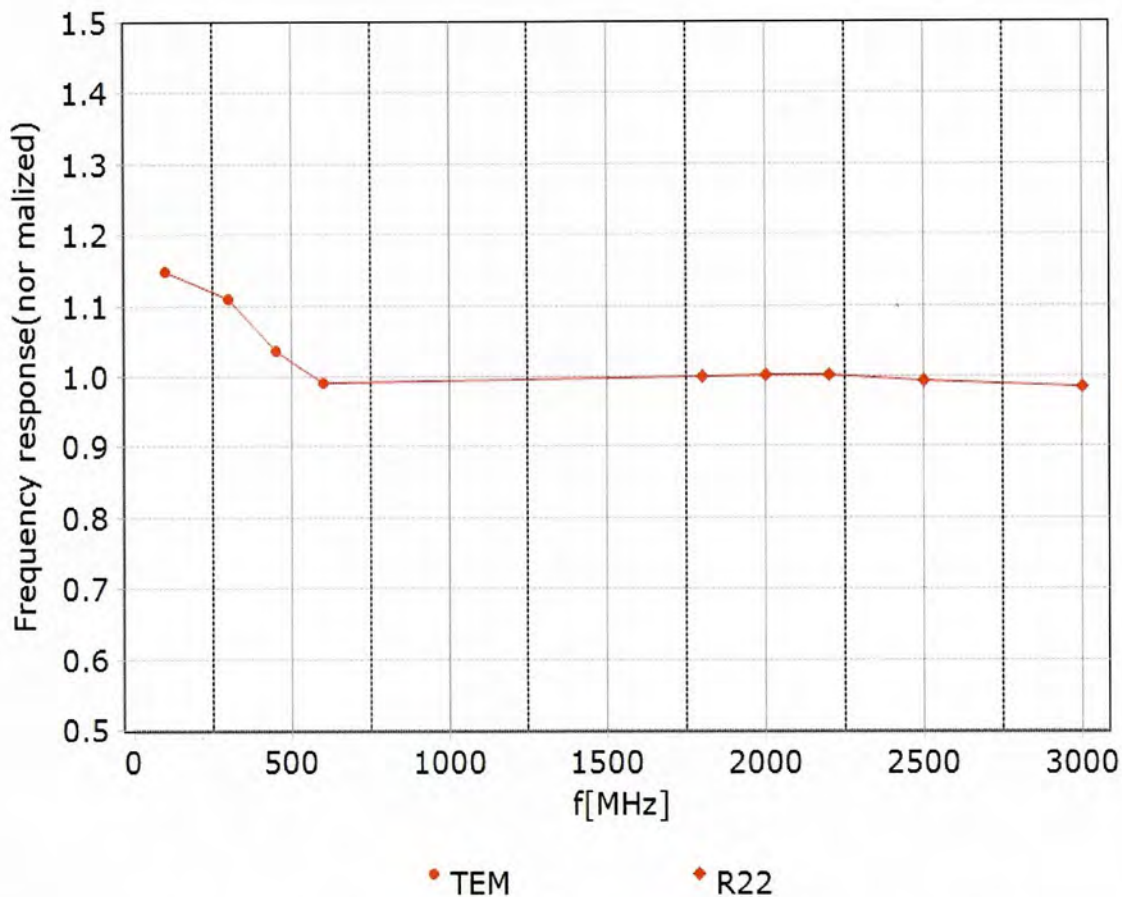

Uncertainty of Frequency Response of E-field: $\pm 7.4\%$ ($k=2$)

Add: No.52 HuaYuanBei Road, Haidian District, Beijing, 100191, China
 Tel: +86-10-62304633-2117
 E-mail: emf@caict.ac.cn <http://www.caict.ac.cn>

Receiving Pattern (Φ), $\theta=0^\circ$

f=600 MHz, TEM

f=1800 MHz, R22

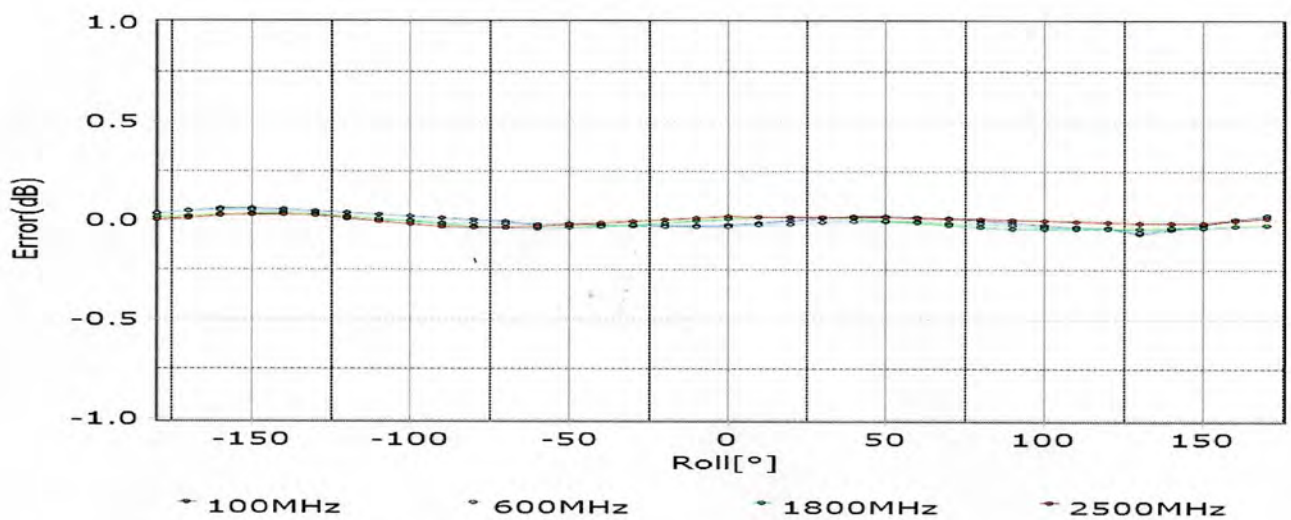
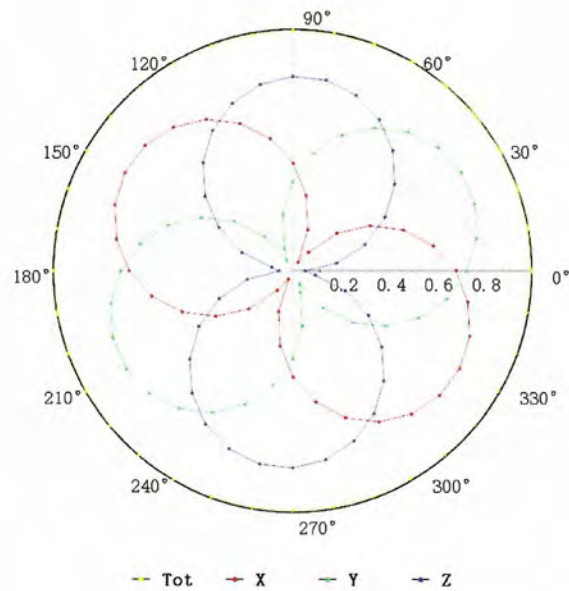
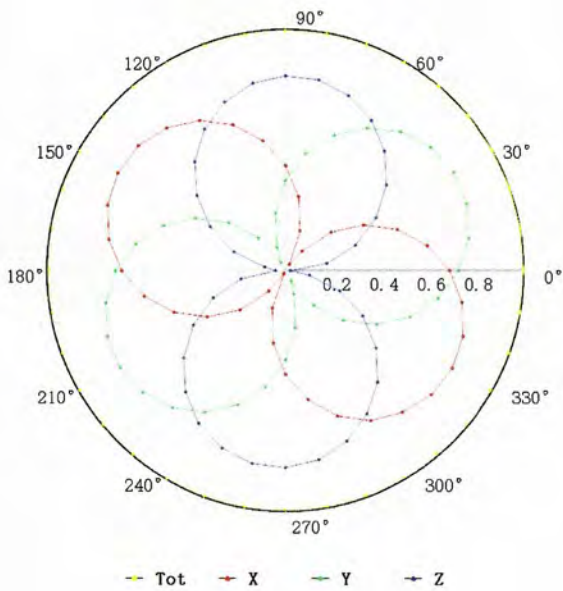

Uncertainty of Axial Isotropy Assessment: $\pm 1.2\%$ ($k=2$)

Add: No.52 HuaYuanBei Road, Haidian District, Beijing, 100191, China
 Tel: +86-10-62304633-2117
 E-mail: emf@caict.ac.cn <http://www.caict.ac.cn>

Dynamic Range f(SAR_{head}) (TEM cell, f = 900 MHz)

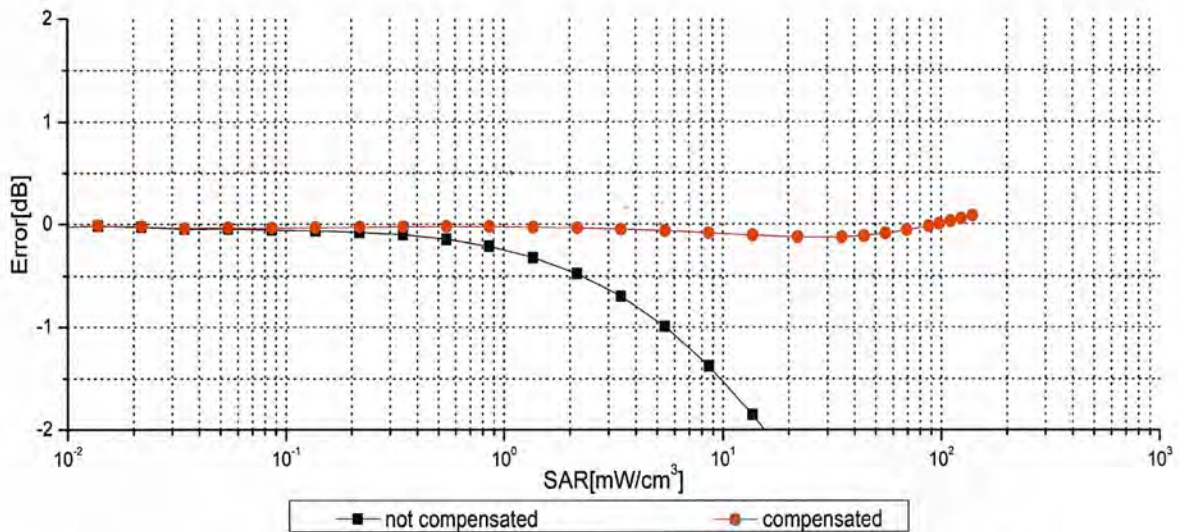
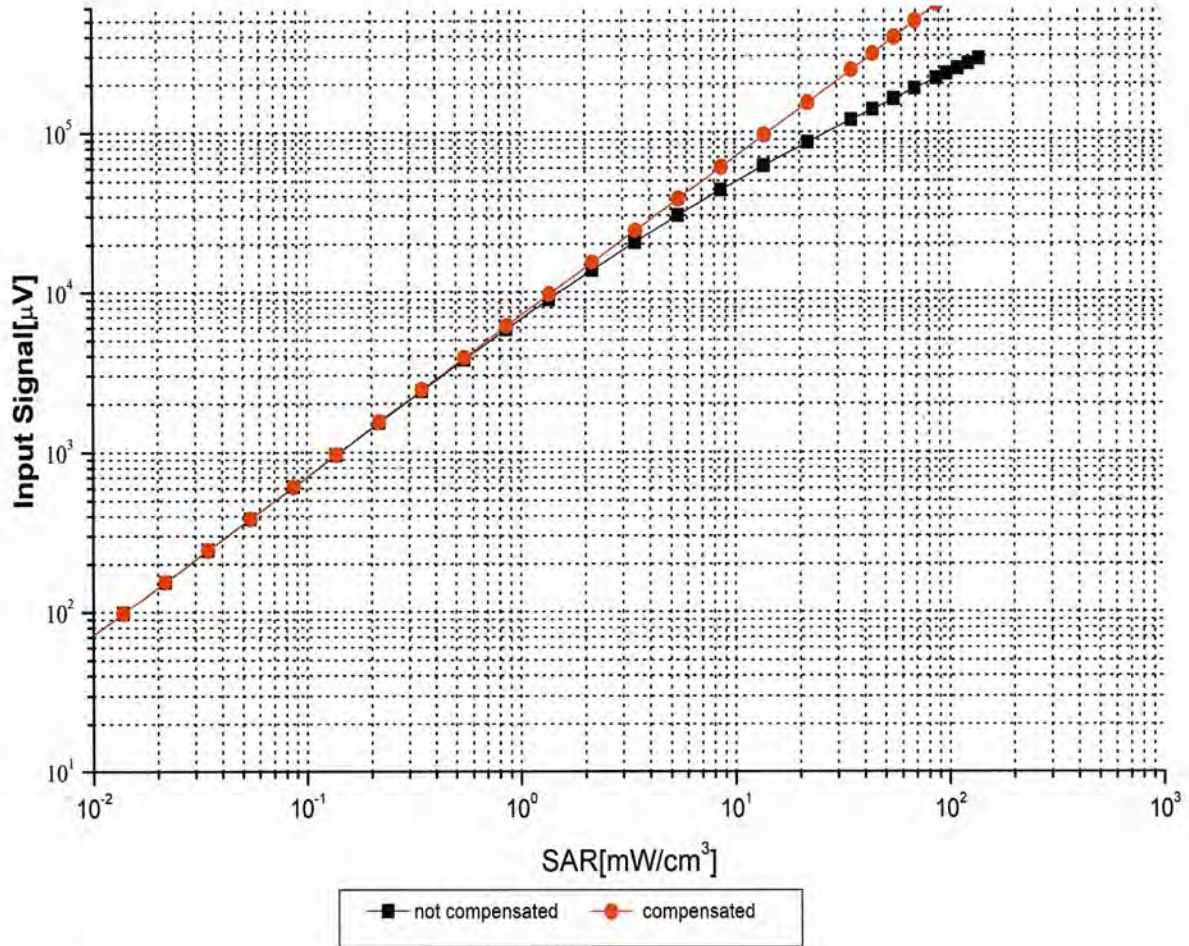

Uncertainty of Linearity Assessment: $\pm 0.9\%$ ($k=2$)

Add: No.52 HuaYuanBei Road, Haidian District, Beijing, 100191, China
 Tel: +86-10-62304633-2117
 E-mail: emf@caict.ac.cn <http://www.caict.ac.cn>

Conversion Factor Assessment

f=750 MHz,WGLS R9(H_convF)

f=1750 MHz,WGLS R22(H_convF)

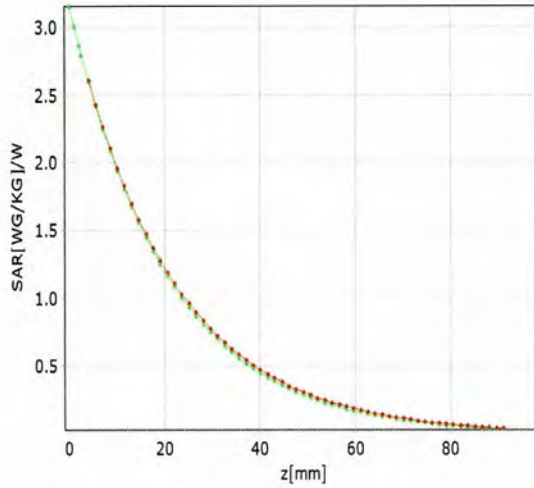

* analytical * measured

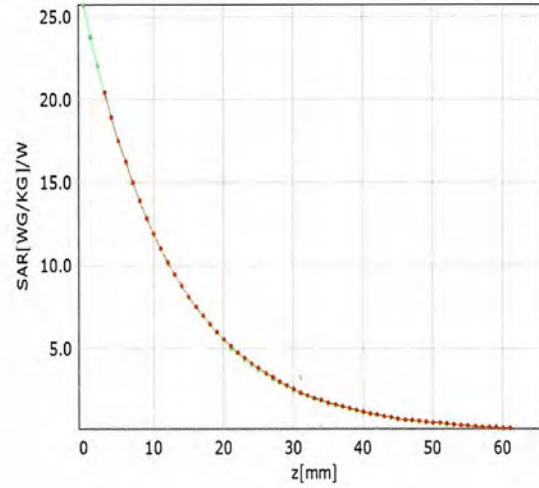

* analytical * measured

Deviation from Isotropy in Liquid

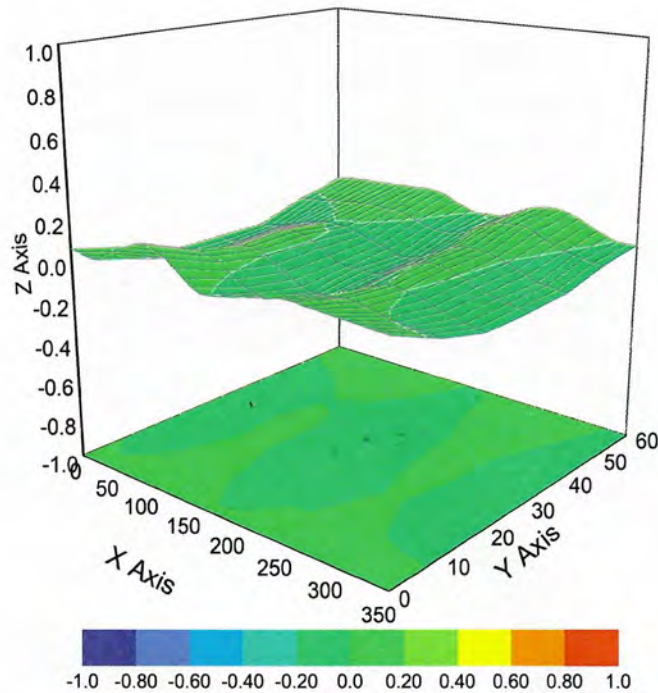

Uncertainty of Spherical Isotropy Assessment: $\pm 3.2\%$ ($k=2$)



Add: No.52 HuaYuanBei Road, Haidian District, Beijing, 100191, China
Tel: +86-10-62304633-2117
E-mail: emf@caict.ac.cn <http://www.caict.ac.cn>

Appendix: Modulation Calibration Parameters

UID	Rev	Communication System Name	Group	PAR (dB)	UncE (k=2)
0		CW	CW	0.00	± 4.7 %
10010	CAA	SAR Validation (Square, 100ms, 10ms)	Test	10.00	± 9.6 %
10011	CAB	UMTS-FDD (WCDMA)	WCDMA	2.91	± 9.6 %
10012	CAB	IEEE 802.11b WiFi 2.4 GHz (DSSS, 1 Mbps)	WLAN	1.87	± 9.6 %
10013	CAB	IEEE 802.11g WiFi 2.4 GHz (DSSS-OFDM, 6 Mbps)	WLAN	9.46	± 9.6 %
10021	DAC	GSM-FDD (TDMA, GMSK)	GSM	9.39	± 9.6 %
10023	DAC	GPRS-FDD (TDMA, GMSK, TN 0)	GSM	9.57	± 9.6 %
10024	DAC	GPRS-FDD (TDMA, GMSK, TN 0-1)	GSM	6.56	± 9.6 %
10025	DAC	EDGE-FDD (TDMA, 8PSK, TN 0)	GSM	12.62	± 9.6 %
10026	DAC	EDGE-FDD (TDMA, 8PSK, TN 0-1)	GSM	9.55	± 9.6 %
10027	DAC	GPRS-FDD (TDMA, GMSK, TN 0-1-2)	GSM	4.80	± 9.6 %
10028	DAC	GPRS-FDD (TDMA, GMSK, TN 0-1-2-3)	GSM	3.55	± 9.6 %
10029	DAC	EDGE-FDD (TDMA, 8PSK, TN 0-1-2)	GSM	7.78	± 9.6 %
10030	CAA	IEEE 802.15.1 Bluetooth (GFSK, DH1)	Bluetooth	5.30	± 9.6 %
10031	CAA	IEEE 802.15.1 Bluetooth (GFSK, DH3)	Bluetooth	1.87	± 9.6 %
10032	CAA	IEEE 802.15.1 Bluetooth (GFSK, DH5)	Bluetooth	1.16	± 9.6 %
10033	CAA	IEEE 802.15.1 Bluetooth (PI/4-DQPSK, DH1)	Bluetooth	7.74	± 9.6 %
10034	CAA	IEEE 802.15.1 Bluetooth (PI/4-DQPSK, DH3)	Bluetooth	4.53	± 9.6 %
10035	CAA	IEEE 802.15.1 Bluetooth (PI/4-DQPSK, DH5)	Bluetooth	3.83	± 9.6 %
10036	CAA	IEEE 802.15.1 Bluetooth (8-DPSK, DH1)	Bluetooth	8.01	± 9.6 %
10037	CAA	IEEE 802.15.1 Bluetooth (8-DPSK, DH3)	Bluetooth	4.77	± 9.6 %
10038	CAA	IEEE 802.15.1 Bluetooth (8-DPSK, DH5)	Bluetooth	4.10	± 9.6 %
10039	CAB	CDMA2000 (1xRTT, RC1)	CDMA2000	4.57	± 9.6 %
10042	CAB	IS-54 / IS-136 FDD (TDMA/FDM, PI/4-DQPSK, Halfrate)	AMPS	7.78	± 9.6 %
10044	CAA	IS-91/EIA/TIA-553 FDD (FDMA, FM)	AMPS	0.00	± 9.6 %
10048	CAA	DECT (TDD, TDMA/FDM, GFSK, Full Slot, 24)	DECT	13.80	± 9.6 %
10049	CAA	DECT (TDD, TDMA/FDM, GFSK, Double Slot, 12)	DECT	10.79	± 9.6 %
10056	CAA	UMTS-TDD (TD-SCDMA, 1.28 Mcps)	TD-SCDMA	11.01	± 9.6 %
10058	DAC	EDGE-FDD (TDMA, 8PSK, TN 0-1-2-3)	GSM	6.52	± 9.6 %
10059	CAB	IEEE 802.11b WiFi 2.4 GHz (DSSS, 2 Mbps)	WLAN	2.12	± 9.6 %
10060	CAB	IEEE 802.11b WiFi 2.4 GHz (DSSS, 5.5 Mbps)	WLAN	2.83	± 9.6 %
10061	CAB	IEEE 802.11b WiFi 2.4 GHz (DSSS, 11 Mbps)	WLAN	3.60	± 9.6 %
10062	CAD	IEEE 802.11a/h WiFi 5 GHz (OFDM, 6 Mbps)	WLAN	8.68	± 9.6 %
10063	CAD	IEEE 802.11a/h WiFi 5 GHz (OFDM, 9 Mbps)	WLAN	8.63	± 9.6 %
10064	CAD	IEEE 802.11a/h WiFi 5 GHz (OFDM, 12 Mbps)	WLAN	9.09	± 9.6 %
10065	CAD	IEEE 802.11a/h WiFi 5 GHz (OFDM, 18 Mbps)	WLAN	9.00	± 9.6 %
10066	CAD	IEEE 802.11a/h WiFi 5 GHz (OFDM, 24 Mbps)	WLAN	9.38	± 9.6 %
10067	CAD	IEEE 802.11a/h WiFi 5 GHz (OFDM, 36 Mbps)	WLAN	10.12	± 9.6 %
10068	CAD	IEEE 802.11a/h WiFi 5 GHz (OFDM, 48 Mbps)	WLAN	10.24	± 9.6 %
10069	CAD	IEEE 802.11a/h WiFi 5 GHz (OFDM, 54 Mbps)	WLAN	10.56	± 9.6 %
10071	CAB	IEEE 802.11g WiFi 2.4 GHz (DSSS/OFDM, 9 Mbps)	WLAN	9.83	± 9.6 %
10072	CAB	IEEE 802.11g WiFi 2.4 GHz (DSSS/OFDM, 12 Mbps)	WLAN	9.62	± 9.6 %
10073	CAB	IEEE 802.11g WiFi 2.4 GHz (DSSS/OFDM, 18 Mbps)	WLAN	9.94	± 9.6 %
10074	CAB	IEEE 802.11g WiFi 2.4 GHz (DSSS/OFDM, 24 Mbps)	WLAN	10.30	± 9.6 %
10075	CAB	IEEE 802.11g WiFi 2.4 GHz (DSSS/OFDM, 36 Mbps)	WLAN	10.77	± 9.6 %
10076	CAB	IEEE 802.11g WiFi 2.4 GHz (DSSS/OFDM, 48 Mbps)	WLAN	10.94	± 9.6 %
10077	CAB	IEEE 802.11g WiFi 2.4 GHz (DSSS/OFDM, 54 Mbps)	WLAN	11.00	± 9.6 %
10081	CAB	CDMA2000 (1xRTT, RC3)	CDMA2000	3.97	± 9.6 %
10082	CAB	IS-54 / IS-136 FDD (TDMA/FDM, PI/4-DQPSK, Fullrate)	AMPS	4.77	± 9.6 %
10090	DAC	GPRS-FDD (TDMA, GMSK, TN 0-4)	GSM	6.56	± 9.6 %
10097	CAC	UMTS-FDD (HSDPA)	WCDMA	3.98	± 9.6 %
10098	DAC	UMTS-FDD (HSUPA, Subtest 2)	WCDMA	3.98	± 9.6 %
10099	CAC	EDGE-FDD (TDMA, 8PSK, TN 0-4)	GSM	9.55	± 9.6 %
10100	CAC	LTE-FDD (SC-FDMA, 100% RB, 20 MHz, QPSK)	LTE-FDD	5.67	± 9.6 %
10101	CAB	LTE-FDD (SC-FDMA, 100% RB, 20 MHz, 16-QAM)	LTE-FDD	6.42	± 9.6 %



Add: No.52 HuaYuanBei Road, Haidian District, Beijing, 100191, China
Tel: +86-10-62304633-2117
E-mail: emf@caict.ac.cn <http://www.caict.ac.cn>

10102	CAB	LTE-FDD (SC-FDMA, 100% RB, 20 MHz, 64-QAM)	LTE-FDD	6.60	± 9.6 %
10103	DAC	LTE-TDD (SC-FDMA, 100% RB, 20 MHz, QPSK)	LTE-TDD	9.29	± 9.6 %
10104	CAE	LTE-TDD (SC-FDMA, 100% RB, 20 MHz, 16-QAM)	LTE-TDD	9.97	± 9.6 %
10105	CAE	LTE-TDD (SC-FDMA, 100% RB, 20 MHz, 64-QAM)	LTE-TDD	10.01	± 9.6 %
10108	CAE	LTE-FDD (SC-FDMA, 100% RB, 10 MHz, QPSK)	LTE-FDD	5.80	± 9.6 %
10109	CAG	LTE-FDD (SC-FDMA, 100% RB, 10 MHz, 16-QAM)	LTE-FDD	6.43	± 9.6 %
10110	CAG	LTE-FDD (SC-FDMA, 100% RB, 5 MHz, QPSK)	LTE-FDD	5.75	± 9.6 %
10111	CAG	LTE-FDD (SC-FDMA, 100% RB, 5 MHz, 16-QAM)	LTE-FDD	6.44	± 9.6 %
10112	CAG	LTE-FDD (SC-FDMA, 100% RB, 10 MHz, 64-QAM)	LTE-FDD	6.59	± 9.6 %
10113	CAG	LTE-FDD (SC-FDMA, 100% RB, 5 MHz, 64-QAM)	LTE-FDD	6.62	± 9.6 %
10114	CAG	IEEE 802.11n (HT Greenfield, 13.5 Mbps, BPSK)	WLAN	8.10	± 9.6 %
10115	CAG	IEEE 802.11n (HT Greenfield, 81 Mbps, 16-QAM)	WLAN	8.46	± 9.6 %
10116	CAG	IEEE 802.11n (HT Greenfield, 135 Mbps, 64-QAM)	WLAN	8.15	± 9.6 %
10117	CAG	IEEE 802.11n (HT Mixed, 13.5 Mbps, BPSK)	WLAN	8.07	± 9.6 %
10118	CAD	IEEE 802.11n (HT Mixed, 81 Mbps, 16-QAM)	WLAN	8.59	± 9.6 %
10119	CAD	IEEE 802.11n (HT Mixed, 135 Mbps, 64-QAM)	WLAN	8.13	± 9.6 %
10140	CAD	LTE-FDD (SC-FDMA, 100% RB, 15 MHz, 16-QAM)	LTE-FDD	6.49	± 9.6 %
10141	CAD	LTE-FDD (SC-FDMA, 100% RB, 15 MHz, 64-QAM)	LTE-FDD	6.53	± 9.6 %
10142	CAD	LTE-FDD (SC-FDMA, 100% RB, 3 MHz, QPSK)	LTE-FDD	5.73	± 9.6 %
10143	CAD	LTE-FDD (SC-FDMA, 100% RB, 3 MHz, 16-QAM)	LTE-FDD	6.35	± 9.6 %
10144	CAC	LTE-FDD (SC-FDMA, 100% RB, 3 MHz, 64-QAM)	LTE-FDD	6.65	± 9.6 %
10145	CAC	LTE-FDD (SC-FDMA, 100% RB, 1.4 MHz, QPSK)	LTE-FDD	5.76	± 9.6 %
10146	CAC	LTE-FDD (SC-FDMA, 100% RB, 1.4 MHz, 16-QAM)	LTE-FDD	6.41	± 9.6 %
10147	CAC	LTE-FDD (SC-FDMA, 100% RB, 1.4 MHz, 64-QAM)	LTE-FDD	6.72	± 9.6 %
10149	CAE	LTE-FDD (SC-FDMA, 50% RB, 20 MHz, 16-QAM)	LTE-FDD	6.42	± 9.6 %
10150	CAE	LTE-FDD (SC-FDMA, 50% RB, 20 MHz, 64-QAM)	LTE-FDD	6.60	± 9.6 %
10151	CAE	LTE-TDD (SC-FDMA, 50% RB, 20 MHz, QPSK)	LTE-TDD	9.28	± 9.6 %
10152	CAE	LTE-TDD (SC-FDMA, 50% RB, 20 MHz, 16-QAM)	LTE-TDD	9.92	± 9.6 %
10153	CAE	LTE-TDD (SC-FDMA, 50% RB, 20 MHz, 64-QAM)	LTE-TDD	10.05	± 9.6 %
10154	CAF	LTE-FDD (SC-FDMA, 50% RB, 10 MHz, QPSK)	LTE-FDD	5.75	± 9.6 %
10155	CAF	LTE-FDD (SC-FDMA, 50% RB, 10 MHz, 16-QAM)	LTE-FDD	6.43	± 9.6 %
10156	CAF	LTE-FDD (SC-FDMA, 50% RB, 5 MHz, QPSK)	LTE-FDD	5.79	± 9.6 %
10157	CAE	LTE-FDD (SC-FDMA, 50% RB, 5 MHz, 16-QAM)	LTE-FDD	6.49	± 9.6 %
10158	CAE	LTE-FDD (SC-FDMA, 50% RB, 10 MHz, 64-QAM)	LTE-FDD	6.62	± 9.6 %
10159	CAG	LTE-FDD (SC-FDMA, 50% RB, 5 MHz, 64-QAM)	LTE-FDD	6.56	± 9.6 %
10160	CAG	LTE-FDD (SC-FDMA, 50% RB, 15 MHz, QPSK)	LTE-FDD	5.82	± 9.6 %
10161	CAG	LTE-FDD (SC-FDMA, 50% RB, 15 MHz, 16-QAM)	LTE-FDD	6.43	± 9.6 %
10162	CAG	LTE-FDD (SC-FDMA, 50% RB, 15 MHz, 64-QAM)	LTE-FDD	6.58	± 9.6 %
10166	CAG	LTE-FDD (SC-FDMA, 50% RB, 1.4 MHz, QPSK)	LTE-FDD	5.46	± 9.6 %
10167	CAG	LTE-FDD (SC-FDMA, 50% RB, 1.4 MHz, 16-QAM)	LTE-FDD	6.21	± 9.6 %
10168	CAG	LTE-FDD (SC-FDMA, 50% RB, 1.4 MHz, 64-QAM)	LTE-FDD	6.79	± 9.6 %
10169	CAG	LTE-FDD (SC-FDMA, 1 RB, 20 MHz, QPSK)	LTE-FDD	5.73	± 9.6 %
10170	CAG	LTE-FDD (SC-FDMA, 1 RB, 20 MHz, 16-QAM)	LTE-FDD	6.52	± 9.6 %
10171	CAE	LTE-FDD (SC-FDMA, 1 RB, 20 MHz, 64-QAM)	LTE-FDD	6.49	± 9.6 %
10172	CAE	LTE-TDD (SC-FDMA, 1 RB, 20 MHz, QPSK)	LTE-TDD	9.21	± 9.6 %
10173	CAE	LTE-TDD (SC-FDMA, 1 RB, 20 MHz, 16-QAM)	LTE-TDD	9.48	± 9.6 %
10174	CAF	LTE-TDD (SC-FDMA, 1 RB, 20 MHz, 64-QAM)	LTE-TDD	10.25	± 9.6 %
10175	CAF	LTE-FDD (SC-FDMA, 1 RB, 10 MHz, QPSK)	LTE-FDD	5.72	± 9.6 %
10176	CAF	LTE-FDD (SC-FDMA, 1 RB, 10 MHz, 16-QAM)	LTE-FDD	6.52	± 9.6 %
10177	CAE	LTE-FDD (SC-FDMA, 1 RB, 5 MHz, QPSK)	LTE-FDD	5.73	± 9.6 %
10178	CAE	LTE-FDD (SC-FDMA, 1 RB, 5 MHz, 16-QAM)	LTE-FDD	6.52	± 9.6 %
10179	AAE	LTE-FDD (SC-FDMA, 1 RB, 10 MHz, 64-QAM)	LTE-FDD	6.50	± 9.6 %
10180	CAG	LTE-FDD (SC-FDMA, 1 RB, 5 MHz, 64-QAM)	LTE-FDD	6.50	± 9.6 %
10181	CAG	LTE-FDD (SC-FDMA, 1 RB, 15 MHz, QPSK)	LTE-FDD	5.72	± 9.6 %
10182	CAG	LTE-FDD (SC-FDMA, 1 RB, 15 MHz, 16-QAM)	LTE-FDD	6.52	± 9.6 %
10183	CAG	LTE-FDD (SC-FDMA, 1 RB, 15 MHz, 64-QAM)	LTE-FDD	6.50	± 9.6 %
10184	CAG	LTE-FDD (SC-FDMA, 1 RB, 3 MHz, QPSK)	LTE-FDD	5.73	± 9.6 %
10185	CAI	LTE-FDD (SC-FDMA, 1 RB, 3 MHz, 16-QAM)	LTE-FDD	6.51	± 9.6 %
10186	CAG	LTE-FDD (SC-FDMA, 1 RB, 3 MHz, 64-QAM)	LTE-FDD	6.50	± 9.6 %