



SAR TEST REPORT

No. I22Z60452-SEM07

For

HMD Global Oy

Smart Phone

Model Name: N1530DL

with

Hardware Version: v1.0

Software Version: 02US_1_110

FCC ID: 2AJOTTA-1530

Issued Date: 2022-6-29

Note:

The test results in this test report relate only to the devices specified in this report. This report shall not be reproduced except in full without the written approval of CTTL.

Test Laboratory:

CTTL, Telecommunication Technology Labs, CAICT

No. 51, Xueyuan Road, Haidian District, Beijing, P. R. China 100191.

Tel:+86(0)10-62304633-2512, Fax:+86(0)10-62304633-2504

Email: ctl_terminals@caict.ac.cn, website: www.caict.ac.cn

**REPORT HISTORY**

Report Number	Revision	Issue Date	Description
I22Z60452-SEM07	Rev.0	2022-6-1	Initial creation of test report
I22Z60452-SEM07	Rev.1	2022-6-29	Updated 2.4g /5G WIFI&BT measurement results on page 275. Page 9, GPRS/EGPRS multislot class 12 is updated to class 33. Updated Tune up power of WCDMA 1900 on page 33. Add N5 Conducted Output Power on page 278. CA_2A-2A-13A-66A measured with downlink carrier aggregation on page 77.

TABLE OF CONTENT

1 TEST LABORATORY	5
1.1 TESTING LOCATION	5
1.2 TESTING ENVIRONMENT.....	5
1.3 PROJECT DATA	5
1.4 SIGNATURE.....	5
2 STATEMENT OF COMPLIANCE	6
3 CLIENT INFORMATION	8
3.1 APPLICANT INFORMATION	8
3.2 MANUFACTURER INFORMATION	8
4 EQUIPMENT UNDER TEST (EUT) AND ANCILLARY EQUIPMENT (AE)	9
4.1 ABOUT EUT	9
4.2 INTERNAL IDENTIFICATION OF EUT USED DURING THE TEST	10
4.3 INTERNAL IDENTIFICATION OF AE USED DURING THE TEST	10
5 TEST METHODOLOGY	11
5.1 APPLICABLE LIMIT REGULATIONS	11
5.2 APPLICABLE MEASUREMENT STANDARDS.....	11
6 SPECIFIC ABSORPTION RATE (SAR).....	12
6.1 INTRODUCTION.....	12
6.2 SAR DEFINITION.....	12
7 TISSUE SIMULATING LIQUIDS	13
7.1 TARGETS FOR TISSUE SIMULATING LIQUID	13
7.2 DIELECTRIC PERFORMANCE	13
8 SYSTEM VERIFICATION	19
8.1 SYSTEM SETUP.....	19
8.2 SYSTEM VERIFICATION.....	20
9 GENERAL MEASUREMENT PROCEDURE	21
9.1 <i>POWER REFERENCE MEASUREMENT</i>	21
9.2 <i>AREA SCAN</i>	21
9.3 <i>ZOOM SCAN</i>	22
9.4 <i>POWER DRIFT MEASUREMENT</i>	22
9.5 <i>AREA SCAN BASED I-G SAR</i>	24
10 MEASUREMENT PROCEDURE FOR DIFFERENT TECHNOLOGIES	25
10.1 GSM/GPRS MEASUREMENT PROCEDURES FOR SAR	25
10.2 WCDMA MEASUREMENT PROCEDURES FOR SAR	25
10.3 LTE MEASUREMENT PROCEDURES FOR SAR.....	27
10.4 BLUETOOTH & WI-FI MEASUREMENT PROCEDURES FOR SAR	29
10.5 SAR MEASUREMENT FOR ENDC	29
11 CONDUCTED OUTPUT POWER.....	30
11.1 GSM MEASUREMENT RESULT	31
11.2 WCDMA MEASUREMENT RESULT.....	33



11.3 LTE MEASUREMENT RESULT	36
LTE CARRIER AGGREGATION CONDUCTED POWER (DOWNLINK).....	73
11.4 NR 5G MEASUREMENT RESULT.....	78
11.5 WI-FI AND BT MEASUREMENT RESULT	87
12 ANTENNA LOCATION	91
12.1 SAR MEASUREMENT POSITIONS.....	92
12.2 STANDALONE SAR TEST EXCLUSION CONSIDERATIONS	93
13 SAR TEST RESULT	95
13.1 SAR RESULTS.....	98
13.2 SAR RESULTS FOR 5G NR.....	105
13.3 SAR RESULTS FOR WLAN	106
13.4 SAR RESULTS FOR BT.....	109
14 SAR MEASUREMENT VARIABILITY.....	110
15 MEASUREMENT UNCERTAINTY	110
16 MAIN TEST INSTRUMENTS.....	111
ANNEX A GRAPH RESULTS.....	113
ANNEX B SYSTEM VERIFICATION RESULTS	161
ANNEX C SAR MEASUREMENT SETUP	182
ANNEX D POSITION OF THE WIRELESS DEVICE IN RELATION TO THE PHANTOM	189
ANNEX E EQUIVALENT MEDIA RECIPES	192
ANNEX F SYSTEM VALIDATION	193
ANNEX G PROBE CALIBRATION CERTIFICATE.....	194
ANNEX H DIPOLE CALIBRATION CERTIFICATE	203
ANNEX I SENSOR TRIGGERING DATA SUMMARY.....	269
ANNEX J SPOT CHECK	275
ANNEX K ACCREDITATION CERTIFICATE	356

1 Test Laboratory

1.1 Testing Location

Company Name:	CTTL(Shouxiang)
Address:	No. 51 Shouxiang Science Building, Xueyuan Road, Haidian District, Beijing, P. R. China100191

1.2 Testing Environment

Temperature:	18°C~25°C,
Relative humidity:	30%~ 70%
Ground system resistance:	< 0.5 Ω
Ambient noise & Reflection:	< 0.012 W/kg

1.3 Project Data

Project Leader:	Qi Dianyuan
Test Engineer:	Lin Xiaojun
Testing Start Date:	May 5, 2022
Testing End Date:	May 28, 2022

1.4 Signature



Lin Xiaojun

(Prepared this test report)

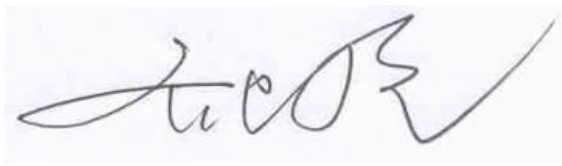

Qi Dianyuan

(Reviewed this test report)



Lu Bingsong

Deputy Director of the laboratory

(Approved this test report)

2 Statement of Compliance

The maximum results of Specific Absorption Rate (SAR) found during testing for HMD Global Oy Smart Phone N1530DL are as follows:

Table 2.1: Highest Reported SAR -Standalone(1g)

		Antenna	Highest Reported SAR (1g)	
			Head SAR	Body-worn SAR
GSM	GSM 850	0	0.32	0.71
	PCS 1900	2	0.46	0.43
WCDMA	UMTS FDD 2	2	0.96	0.65
	UMTS FDD 4	2	0.71	0.46
	UMTS FDD 5	0	0.42	0.62
LTE	LTE Band 2	0	0.13	0.18
	LTE Band 12	0	0.10	0.51
	LTE Band 13	0	0.13	0.45
	LTE Band 25	2	0.77	0.54
	LTE Band 26	0	0.23	0.35
	LTE Band 41 PC3	4	0.38	0.77
	LTE Band 41 PC2	4	0.31	0.60
	LTE Band 66	2	0.50	0.39
	LTE Band 66	0	0.25	0.22
NR SA/NSA	LTE Band 71	0	0.11	0.55
	N25	2	0.67	0.37
	N41PC2	4	0.79	0.60
	N41PC3	4	0.73	0.75
	N66	2	0.48	0.27
	N77 3450M-3550M PC2	5	0.77	0.76
	N77 3700M-3980M PC2	5	1.05	0.88
	N77 3450M-3550M PC3	5	0.61	0.69
	N77 3700M-3980M PC3	5	1.05	0.88
N71	0	0.23	0.47	
N5	0	0.24	0.49	
WLAN 2.4 GHz		9	0.20	0.25
WLAN 5 GHz		9	0.17	0.44
BT		9	<0.01	<0.01

The SAR values found for the Mobile Phone are below the maximum recommended levels of 1.6 W/kg as averaged over any 1g tissue according to the ANSI C95.1-1992.

For body operation, this device has been tested and meets FCC RF exposure guidelines when used with any accessory that contains no metal and which provides a minimum separation distance of 10 mm for body worn between this device and the body of the user. Use of other accessories may not ensure compliance with FCC RF exposure guidelines.

The EUT battery must be fully charged and checked periodically during the test to ascertain uniform power output.

The measurement together with the test system set-up is described in annex C. A detailed description of the equipment under test can be found in chapter 4 of this test report. **The highest**

reported SAR for Head, Body Worn are 1.05W/kg, 0.88W/kg.

Table 2.2: Highest Reported SAR -Simultaneous transmission

reported SAR 1g (W/kg)					
Body	WWAN		WIFI5G	BT	WWAN+WiFi2.4G +BT
	LTE Band66 ANT0	N71			
Right Edge 10mm	0.22	0.47	0.44	<0.01	1.13

According to the above tables, the highest sum of reported SAR values is **1.13 W/kg (1g)**. The detail for simultaneous transmission consideration is described in chapter 13.

3 Client Information

3.1 Applicant Information

Company Name:	HMD Global Oy
Address/Post:	Bertel Jungin aukio 9 02600 Espoo Finland
Contact Person:	/
E-mail:	/
Telephone:	/
Fax:	/

3.2 Manufacturer Information

Company Name:	HMD Global Oy
Address/Post:	Bertel Jungin aukio 9 02600 Espoo Finland
Contact Person:	/
E-mail:	/
Telephone:	/
Fax:	/

4 Equipment Under Test (EUT) and Ancillary Equipment (AE)

This EUT is a variant product and the report of original sample is No.I22Z60412-SEM014. According to the client request, we share the test results of original sample directly. This EUT add the measurement of NR n2/n5 and remove the values of LTE Band7. The results of spot check are presented in the annex I.

4.1 About EUT

Description:	Smart Phone
Model name:	N1530DL
Tested mode(s):	GSM850/1900, WCDMA1900/1700/850, LTE Band 2/7/12/13/25/26/40/41/66/71 n5//n25/n41/n66/n71/n77, BT, Wi-Fi (2.4G/5G),
Tested Tx Frequency:	824 – 849 MHz (GSM 850)
	1850 – 1910 MHz (GSM 1900)
	824–849 MHz (WCDMA 850 Band V)
	1710 – 1755 MHz (WCDMA 1700 Band IV)
	1850–1910 MHz (WCDMA1900 Band II)
	1850 – 1910 MHz (LTE Band 2)
	699 – 716 MHz (LTE Band 12)
	777 –787 MHz (LTE Band 13)
	1850.7 – 1914.3 MHz (LTE Band 25)
	814 – 849 MHz (LTE Band 26)
	2496 – 2690 MHz (LTE Band 41)
	1710 – 1780 MHz (LTE Band 66)
	665.5 – 695.5 MHz (LTE Band 71)
	824 MHz - 849 MHz (NR n5)
	1852.5 – 1912.5 MHz (NR n25)
	2506.02 – 2679.99 MHz (NR n41)
	2570 – 2620 MHz (NR n66)
665.5 – 695.5 MHz (NR n71)	
3450 – 3550 MHz (NR n77L)	
3700 – 3980 MHz (NR n77H)	
2402 – 2480 MHz (Bluetooth)	
2412 – 2462 MHz (Wi-Fi 2.4G)	
5150-5825 MHz (Wi-Fi 5G)	
GPRS/EGPRS Multislot Class:	33
GPRS capability Class:	B
Antenna type:	Integrated antenna
Hotspot mode:	Support
Note:	<p>1. The n77 frequency is divided into two parts. The first part of the frequency range is 3700-3900MHz, represented by n77H, and the second part of the frequency range is 3450-3550 MHz, represented by n77L.</p> <p>2. For 5G NR test, using FTM (Factory Test Mode) to perform SAR with default 100% transmission.</p>

4.2 Internal Identification of EUT used during the test

EUT ID*	IMEI/SN	HW	SW Version
EUT1	358503170026208	v1.0	02US_1_110
EUT2	358503170026166	v1.0	02US_1_110
EUT3	358503170001862	v1.0	02US_1_110
EUT4	358503170001870	v1.0	02US_1_110

*EUT ID: is used to identify the test sample in the lab internally.

Note: It is performed to test SAR with the EUT1-2 and conducted power with the EUT3-4.

4.3 Internal Identification of AE used during the test

AE ID*	Description	Model	SN	Manufacturer
AE1	Battery	HQ610	/	Ningde Amperex Technology Limited
AE2	Battery	HQ610	/	GUANGDONG FENGHUA NEW ENERGY CO., LTD
AE3	Headset	JWEP239-H17H	/	JUWEI ELECTRONICS CO.,LTD

*AE ID: is used to identify the test sample in the lab internally.

5 TEST METHODOLOGY

5.1 Applicable Limit Regulations

ANSI C95.1–1992: IEEE Standard for Safety Levels with Respect to Human Exposure to Radio Frequency Electromagnetic Fields, 3 kHz to 300 GHz.

It specifies the maximum exposure limit of **1.6 W/kg** as averaged over any 1 gram of tissue for portable devices being used within 20 cm of the user in the uncontrolled environment.

5.2 Applicable Measurement Standards

IEEE 1528–2013: Recommended Practice for Determining the Peak Spatial-Average Specific Absorption Rate (SAR) in the Human Head from Wireless Communications Devices: Measurement Techniques.

KDB447498 D01: General RF Exposure Guidance v06: Mobile and Portable Devices RF Exposure Procedures and Equipment Authorization Policies.

KDB648474 D04 Handset SAR v01r03: SAR Evaluation Considerations for Wireless Handsets.

KDB941225 D01 SAR test for 3G devices v03r01: SAR Measurement Procedures for 3G Devices

KDB941225 D05 SAR for LTE Devices v02r05: SAR Evaluation Considerations for LTE Devices

KDB941225 D06 Hotspot Mode SAR v02r01: SAR Evaluation Procedures for Portable Devices with Wireless Router Capabilities

KDB248227 D01 802.11 Wi-Fi SAR v02r02: SAR GUIDANCE FOR IEEE 802.11 (Wi-Fi) TRANSMITTERS

KDB865664 D01 SAR measurement 100 MHz to 6 GHz v01r04: SAR Measurement Requirements for 100 MHz to 6 GHz.

KDB865664 D02 RF Exposure Reporting v01r02: RF Exposure Compliance Reporting and Documentation Considerations

6 Specific Absorption Rate (SAR)

6.1 Introduction

SAR is related to the rate at which energy is absorbed per unit mass in an object exposed to a radio field. The SAR distribution in a biological body is complicated and is usually carried out by experimental techniques or numerical modeling. The standard recommends limits for two tiers of groups, occupational/controlled and general population/uncontrolled, based on a person's awareness and ability to exercise control over his or her exposure. In general, occupational/controlled exposure limits are higher than the limits for general population/uncontrolled.

6.2 SAR Definition

The SAR definition is the time derivative (rate) of the incremental energy (dW) absorbed by (dissipated in) an incremental mass (dm) contained in a volume element (dv) of a given density (ρ). The equation description is as below:

$$SAR = \frac{d}{dt} \left(\frac{dW}{dm} \right) = \frac{d}{dt} \left(\frac{dW}{\rho dv} \right)$$

SAR is expressed in units of Watts per kilogram (W/kg)

SAR measurement can be either related to the temperature elevation in tissue by

$$SAR = c \left(\frac{\delta T}{\delta t} \right)$$

Where: C is the specific heat capacity, δT is the temperature rise and δt is the exposure duration, or related to the electrical field in the tissue by

$$SAR = \frac{\sigma |E|^2}{\rho}$$

Where: σ is the conductivity of the tissue, ρ is the mass density of tissue and E is the RMS electrical field strength.

However for evaluating SAR of low power transmitter, electrical field measurement is typically applied.

7 Tissue Simulating Liquids

The temperature of the tissue-equivalent medium used during measurement must also be within 18 °C to 25 °C and within ± 2 °C of the temperature when the tissue parameters are characterized. The dielectric parameters must be measured before the tissue-equivalent medium is used in a series of SAR measurements. The parameters should be re-measured after each 3 – 4 days of use; or earlier if the dielectric parameters can become out of tolerance; for example, when the parameters are marginal at the beginning of the measurement series.

The dielectric constant (ϵ_r) and conductivity (σ) of typical tissue-equivalent media recipes are expected to be within $\pm 5\%$ of the required target values; but for SAR measurement systems that have implemented the SAR error compensation algorithms documented in IEEE Std 1528-2013, to automatically compensate the measured SAR results for deviations between the measured and required tissue dielectric parameters, the tolerance for ϵ_r and σ may be relaxed to $\pm 10\%$. This is limited to frequencies ≤ 3 GHz.

7.1 Targets for tissue simulating liquid

Table 7.1: Targets for tissue simulating liquid

Frequency(MHz)	Liquid Type	Conductivity(σ)	$\pm 10\%$ Range	Permittivity(ϵ)	$\pm 10\%$ Range
750	Head	0.89	0.80~0.98	41.94	37.75~46.13
835	Head	0.90	0.81~0.99	41.5	37.35~45.65
1750	Head	1.40	1.26~1.54	40.0	36~44
1900	Head	1.40	1.26~1.54	40.0	36~44
2450	Head	1.80	1.62~1.98	39.2	35.28~43.12
2600	Head	1.96	1.76~2.16	39.01	35.11~42.91

Table 7.2: Targets for tissue simulating liquid

Frequency(MHz)	Liquid Type	Conductivity(σ)	$\pm 5\%$ Range	Permittivity(ϵ)	$\pm 5\%$ Range
3700	Head	3.12	2.96~3.28	37.70	35.82~39.59
3900	Head	3.32	3.15~3.49	37.47	35.6~39.34
5250	Head	4.71	4.47~4.95	35.93	34.13~37.73
5600	Head	5.07	4.82~5.32	35.53	33.8~37.3
5750	Head	5.22	4.96~5.48	35.36	33.59~37.13

7.2 Dielectric Performance

Table 7.3: Dielectric Performance of Tissue Simulating Liquid

Measurement Date yyyy/mm/dd	Frequency	Type	Permittivity ϵ	Drift (%)	Conductivity σ (S/m)	Drift (%)
2022/5/5	750 MHz	Head	42.07	0.31	0.897	0.79
2022/5/6	750 MHz	Head	41.89	-0.12	0.874	-1.80
2022/5/7	835 MHz	Head	40.84	-1.59	0.903	0.33
2022/5/8	835 MHz	Head	40.8	-1.69	0.889	-1.22
2022/5/9	1750 MHz	Head	40.1	0.05	1.38	0.73
2022/5/10	1750 MHz	Head	39.45	-1.57	1.37	0.00

2022/5/11	1900 MHz	Head	39.44	-1.40	1.397	-0.21
2022/5/12	1900 MHz	Head	39.61	-0.98	1.387	-0.93
2022/5/13	2600 MHz	Head	39.73	1.85	1.971	0.56
2022/5/14	2600 MHz	Head	39	-0.03	1.999	1.99
2022/5/15	2450 MHz	Head	39.32	0.31	1.815	0.83
2022/5/16	5250 MHz	Head	35.89	-0.11	4.626	-1.78
2022/5/17	5600 MHz	Head	34.97	-1.58	5.085	0.30
2022/5/18	5750 MHz	Head	34.77	-1.67	5.154	-1.26
2022/5/18	750 MHz	Head	42.07	0.31	0.897	0.79
2022/5/19	1750 MHz	Head	40.03	-0.12	1.346	-1.75
2022/5/20	1900 MHz	Head	39.36	-1.60	1.404	0.29
2022/5/21	2600 MHz	Head	38.36	-1.67	1.935	-1.28
2022/5/22	3500 MHz	Head	37.72	0.05	3.142	0.71
2022/5/23	3900 MHz	Head	36.88	-1.57	3.321	0.03
2022/5/19	1750 MHz	Head	40.21	0.32	1.381	0.80
2022/5/20	1900 MHz	Head	39.95	-0.12	1.375	-1.79

Note: The liquid temperature is (22.0 -23.0)°C

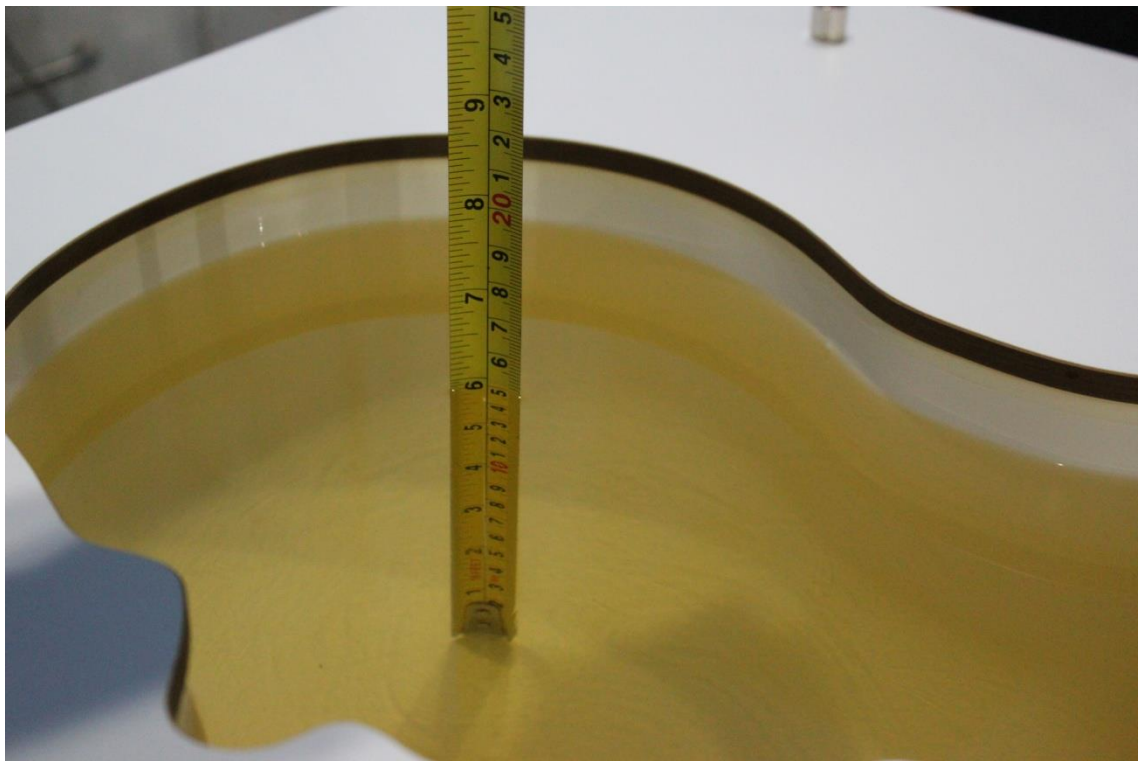

Picture 7-1 Liquid depth in the Head Phantom (750MHz)

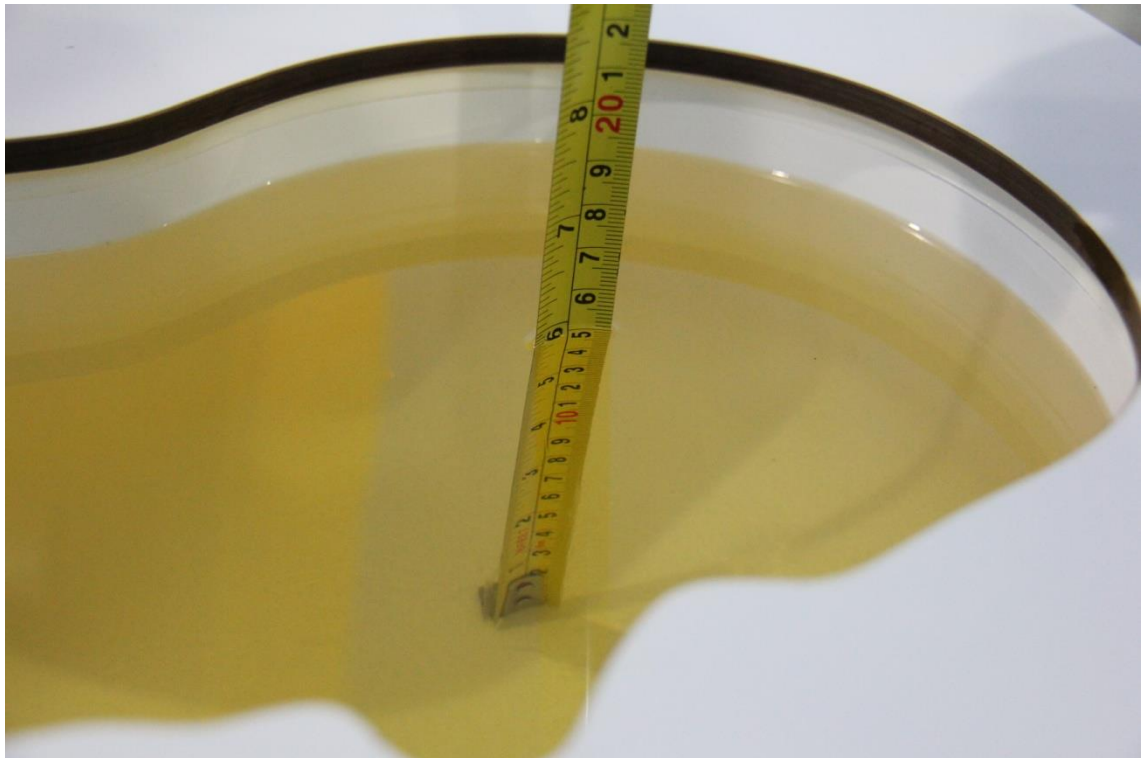

Picture 7-2 Liquid depth in the Head Phantom (835 MHz)



Picture 7-3 Liquid depth in the Head Phantom (1750 MHz)

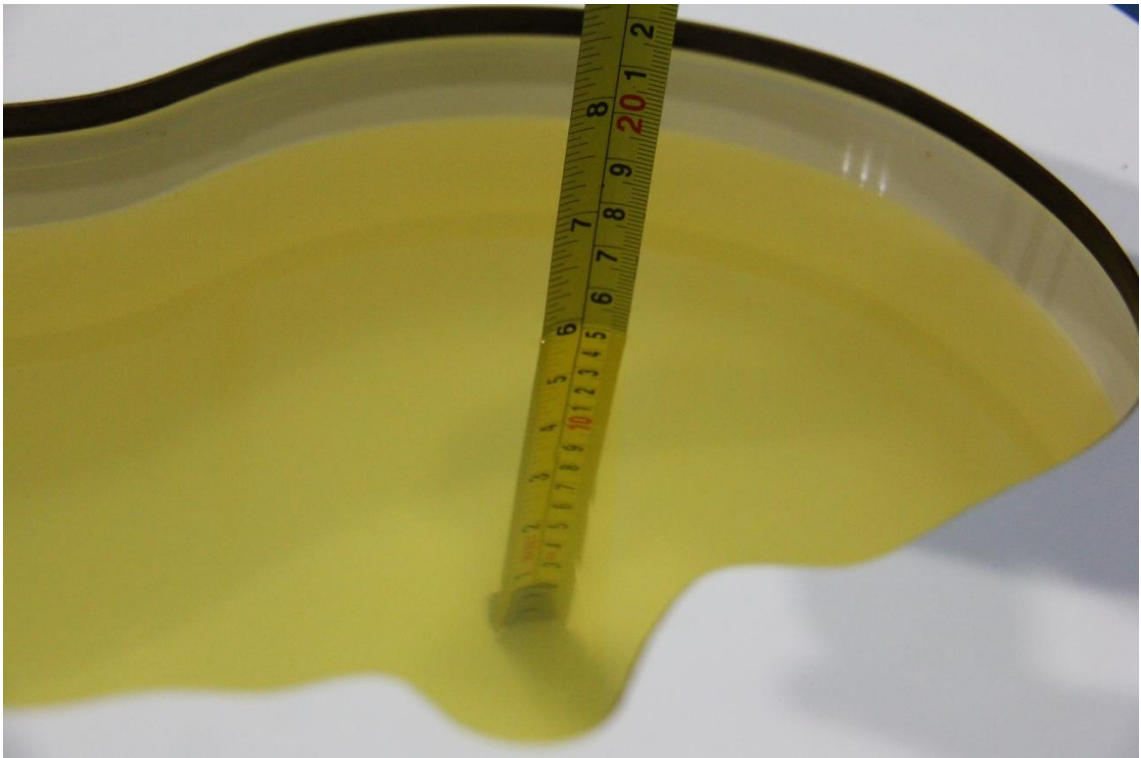

Picture 7-4 Liquid depth in the Head Phantom (1900 MHz)

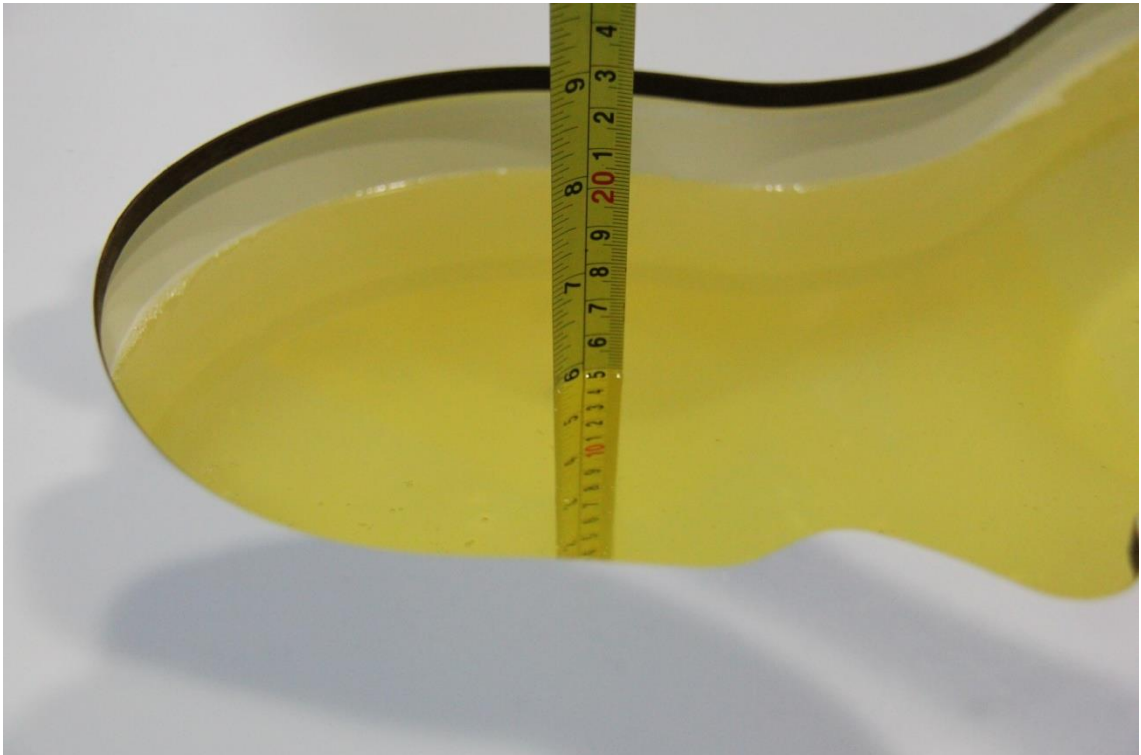

Picture 7-5 Liquid depth in the Head Phantom (2450MHz)



Picture 7-6 Liquid depth in the Head Phantom (2600 MHz)



Picture 7-7 Liquid depth in the Head Phantom (3500-3900 MHz)



Picture 7-8 Liquid depth in the Head Phantom (5GHz)

8 System verification

8.1 System Setup

In the simplified setup for system evaluation, the DUT is replaced by a calibrated dipole and the power source is replaced by a continuous wave that comes from a signal generator. The calibrated dipole must be placed beneath the flat phantom section of the SAM twin phantom with the correct distance holder. The distance holder should touch the phantom surface with a light pressure at the reference marking and be oriented parallel to the long side of the phantom. The equipment setup is shown below:

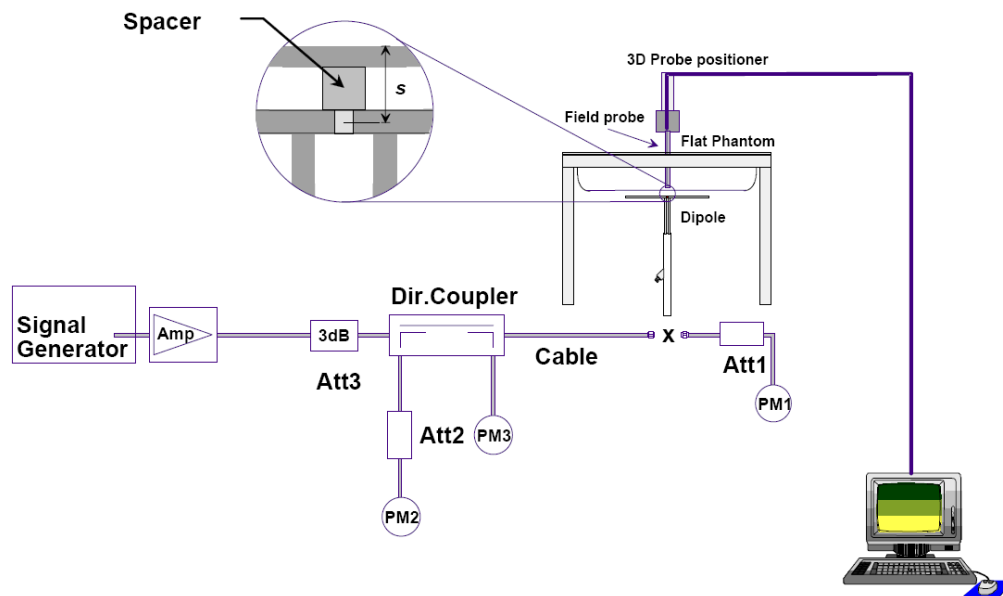

Picture 8.1 System Setup for System Evaluation



Picture 8.2 Photo of Dipole Setup

8.2 System Verification

SAR system verification is required to confirm measurement accuracy, according to the tissue dielectric media, probe calibration points and other system operating parameters required for measuring the SAR of a test device. The system verification must be performed for each frequency band and within the valid range of each probe calibration point required for testing the device.

Table 8.1: System Verification of Head

Calibration Date	Frequency	Target value (W/kg)		Measured value (W/kg)		Deviation	
		10 g Average	1 g Average	10 g Average	1 g Average	10 g Average	1 g Average
2022/5/5	750 MHz	5.53	8.47	5.6	8.44	1.27%	-0.35%
2022/5/6	750 MHz	5.53	8.47	5.48	8.52	-0.90%	0.59%
2022/5/7	835 MHz	6.25	9.60	6.24	9.48	-0.16%	-1.25%
2022/5/8	835 MHz	6.25	9.60	6.36	9.64	1.76%	0.42%
2022/5/9	1750 MHz	19.1	36.5	18.92	36	-0.94%	-1.37%
2022/5/10	1750 MHz	19.1	36.5	19.2	35.76	0.52%	-2.03%
2022/5/11	1900 MHz	20.6	39.6	20.96	39.76	1.75%	0.40%
2022/5/12	1900 MHz	20.6	39.6	20.68	39.12	0.39%	-1.21%
2022/5/13	2600 MHz	25.3	57.0	25.32	57.12	0.08%	0.21%
2022/5/14	2600 MHz	25.3	57.0	25.68	56.96	1.50%	-0.07%
2022/5/15	2450 MHz	24.5	52.5	24.88	52.24	1.55%	-0.50%
2022/5/16	5250 MHz	22.9	80.5	22.7	81.1	-0.96%	0.77%
2022/5/17	5600 MHz	23.6	83.3	23.5	82.2	-0.34%	-1.37%
2022/5/18	5750 MHz	22.7	80.4	23.1	80.6	1.67%	0.25%
2022/5/18	750 MHz	5.53	8.47	5.6	8.44	1.27%	-0.35%
2022/5/19	1750 MHz	19.1	36.5	18.92	36.8	-0.94%	0.82%
2022/5/20	1900 MHz	20.6	39.6	20.52	39.08	-0.39%	-1.31%
2022/5/21	2600 MHz	25.3	57.0	25.72	57.12	1.66%	0.21%
2022/5/22	3500 MHz	25.2	67.3	25.0	66.4	-0.95%	-1.40%
2022/5/23	3900 MHz	24.1	69.3	24.2	67.9	0.58%	-1.99%
2022/5/19	1750 MHz	19.1	36.5	19.4	36.32	1.57%	-0.49%
2022/5/20	1900 MHz	20.6	39.6	20.4	39.92	-0.97%	0.81%

9 General Measurement Procedure

9.1 Power Reference Measurement

The Power Reference Measurement and Power Drift Measurements are for monitoring the power drift of the device under test in the batch process. The minimum distance of probe sensors to surface determines the closest measurement point to phantom surface. This distance cannot be smaller than the distance of sensor calibration points to probe tip as defined in the probe properties.

9.2 Area Scan

The area scan is used as a fast scan in two dimensions to find the area of high field values, before doing a fine measurement around the hot spot. The sophisticated interpolation routines implemented in DASY software can find the maximum found in the scanned area, within a range of the global maximum. The range (in dB) is specified in the standards for compliance testing. For example, a 2 dB range is required in IEEE standard 1528 and IEC 62209 standards, whereby 3 dB is a requirement when compliance is assessed in accordance with the ARIB standard (Japan), if only one zoom scan follows the area scan, then only the absolute maximum will be taken as reference. For cases where multiple maximums are detected, the number of zoom scans has to be increased accordingly.

Area scan parameters extracted from FCC KDB 865664 D01v01r04 SAR measurement 100 MHz to 6 GHz.

	≤ 3 GHz	> 3 GHz
Maximum distance from closest measurement point (geometric center of probe sensors) to phantom surface	5 ± 1 mm	$\frac{1}{2} \cdot \delta \cdot \ln(2) \pm 0.5$ mm
Maximum probe angle from probe axis to phantom surface normal at the measurement location	30° ± 1°	20° ± 1°
Maximum area scan spatial resolution: Δx_{Area} , Δy_{Area}	≤ 2 GHz: ≤ 15 mm 2 – 3 GHz: ≤ 12 mm	3 – 4 GHz: ≤ 12 mm 4 – 6 GHz: ≤ 10 mm
	When the x or y dimension of the test device, in the measurement plane orientation, is smaller than the above, the measurement resolution must be ≤ the corresponding x or y dimension of the test device with at least one measurement point on the test device.	

9.3 Zoom Scan

Zoom Scans are used to assess the peak spatial SAR values within a cubic averaging volume containing 1 g and 10g of simulated tissue. The Zoom Scan measures points (refer to table below) within a cube whose base faces are centered on the maxima found in a preceding area scan job within the same procedure. When the measurement is done, the Zoom Scan evaluates the averaged SAR for 1 g and 10 g and displays these values next to the job' s label.

Zoom Scan Parameters extracted from KDB 865664 D01 SAR Measurement 100 MHz to 6 GHz

Maximum zoom scan spatial resolution: $\Delta x_{Zoom}, \Delta y_{Zoom}$		≤ 2 GHz: ≤ 8 mm 2 – 3 GHz: ≤ 5 mm*	3 – 4 GHz: ≤ 5 mm* 4 – 6 GHz: ≤ 4 mm*
Maximum zoom scan spatial resolution, normal to phantom surface	uniform grid: $\Delta z_{Zoom}(n)$	≤ 5 mm	3 – 4 GHz: ≤ 4 mm 4 – 5 GHz: ≤ 3 mm 5 – 6 GHz: ≤ 2 mm
	graded grid	$\Delta z_{Zoom}(1)$: between 1 st two points closest to phantom surface	≤ 4 mm
		$\Delta z_{Zoom}(n>1)$: between subsequent points	$\leq 1.5 \cdot \Delta z_{Zoom}(n-1)$
Minimum zoom scan volume	x, y, z	≥ 30 mm	3 – 4 GHz: ≥ 28 mm 4 – 5 GHz: ≥ 25 mm 5 – 6 GHz: ≥ 22 mm
Note: δ is the penetration depth of a plane-wave at normal incidence to the tissue medium; see draft standard IEEE P1528-2011 for details. * When zoom scan is required and the <i>reported</i> SAR from the <i>area scan based 1-g SAR estimation</i> procedures of KDB 447498 is ≤ 1.4 W/kg, ≤ 8 mm, ≤ 7 mm and ≤ 5 mm zoom scan resolution may be applied, respectively, for 2 GHz to 3 GHz, 3 GHz to 4 GHz and 4 GHz to 6 GHz.			

9.4 Power drift measurement

The Power Drift Measurement measures the field at the same location as the most recent power reference measurement within the same procedure, and with the same settings. The Power Drift Measurement gives the field difference in dB from the reading conducted within the last Power Reference Measurement. This allows a user to monitor the power drift of the device under test within a batch process. The measurement procedure is the same as 10.1.

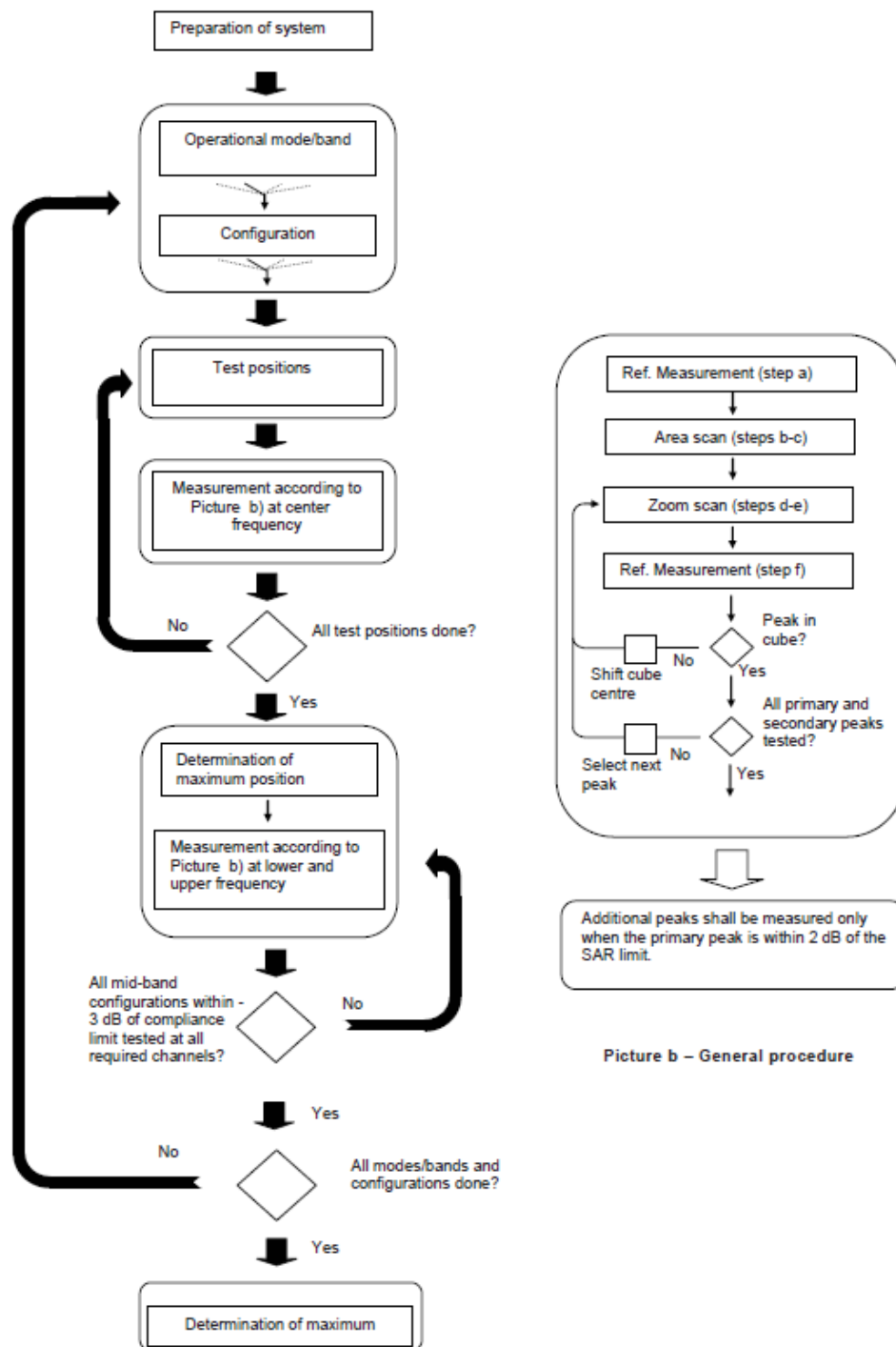

Picture a – Tests to be performed
 Picture 9.1 Block diagram of the tests to be performed

9.5 Area Scan Based 1-g SAR

9.5-1 Requirement of KDB

According to the KDB447498 D01 v06, when the implementation is based the specific polynomial fit algorithm as presented at the 29th Bioelectromagnetics Society meeting (2007) and the estimated 1-gSAR is ≤ 1.2 W/kg, a zoom scan measurement is not required provided it is also not needed for any other purpose; for example, if the peak SAR location required for simultaneous transmission SAR test exclusion can be determined accurately by the SAR system or manually to discriminate between distinctive peaks and scattered noisy SAR distributions from area scans.

There must not be any warning or alert messages due to various measurement concerns identified by the SAR system; for example, noise in measurements, peaks too close to scan boundary, peaks are too sharp, spatial resolution and uncertainty issues etc. The SAR system verification must also demonstrate that the area scan estimated 1-g SAR is within 3% of the zoom scan 1-g SAR (See Annex B). When all the SAR results for each exposure condition in a frequency band and wireless mode are based on estimated 1-g SAR, the 1-g SAR for the highest SAR configuration must be determined by a zoom scan.

9.5-2 Fast SAR Algorithms

The approach is based on the area scan measurement applying a frequency dependent attenuation parameter. This attenuation parameter was empirically determined by analyzing a large number of phones. The MOTOROLA FAST SAR was developed and validated by the MOTOROLA Research Group in Ft. Lauderdale.

In the initial study, an approximation algorithm based on Linear fit was developed. The accuracy of the algorithm has been demonstrated across a broad frequency range (136-2450 MHz) and for both 1- and 10-g averaged SAR using a sample of 264 SAR measurements from 55 wireless handsets. For the sample size studied, the root-mean-squared errors of the algorithm are 1.2% and 5.8% for 1- and 10-g averaged SAR, respectively. The paper describing the algorithm in detail is expected to be published in August 2004 within the Special Issue of Transactions on MTT.

In the second step, the same research group optimized the fitting algorithm to an Polynomial fit whereby the frequency validity was extended to cover the range 30-6000MHz. Details of this study can be found in the BEMS 2007 Proceedings.

Both algorithms are implemented in DASY software.

10 Measurement Procedure for different technologies

10.1 GSM/GPRS Measurement Procedures for SAR

GSM / GPRS / EDGE modes is determined by the source-based time-averaged output power including tune-up tolerance. The mode with highest specified time-averaged output power should be tested for SAR compliance in the applicable exposure conditions. For modes with the same specified maximum output power and tolerance, the higher number time-slot configuration should be tested. Other configurations of GSM / GPRS / EDGE are considered as secondary modes. The 3G SAR test reduction procedure is applied, when the maximum output power and tune-up tolerance specified for production units in a secondary mode is $\leq 1/4$ dB higher than the primary mode, SAR measurement is not required for the secondary mode.

10.2 WCDMA Measurement Procedures for SAR

The following procedures are applicable to WCDMA handsets operating under 3GPP Release99, Release 5 and Release 6. The default test configuration is to measure SAR with an established radio link between the DUT and a communication test set using a 12.2kbps RMC (reference measurement channel) configured in Test Loop Mode 1. SAR is selectively confirmed for other physical channel configurations (DPCCH & DPDCH_n), HSDPA and HSPA (HSUPA/HSDPA) modes according to output power, exposure conditions and device operating capabilities. Both uplink and downlink should be configured with the same RMC or AMR, when required. SAR for Release 5 HSDPA and Release 6 HSPA are measured using the applicable FRC (fixed reference channel) and E-DCH reference channel configurations. Maximum output power is verified according to applicable versions of 3GPP TS 34.121 and SAR must be measured according to these maximum output conditions. When Maximum Power Reduction (MPR) is not implemented according to Cubic Metric (CM) requirements for Release 6 HSPA, the following procedures do not apply.

For Release 5 HSDPA Data Devices:

Sub-test	β_c	β_d	β_d (SF)	β_c / β_d	β_{hs}	CM/dB
1	2/15	15/15	64	2/15	4/15	0.0
2	12/15	15/15	64	12/15	24/25	1.0
3	15/15	8/15	64	15/8	30/15	1.5
4	15/15	4/15	64	15/4	30/15	1.5

For Release 6 HSPA Data Devices

Sub-test	β_c	β_d	β_d (SF)	β_c / β_d	β_{hs}	β_{ec}	β_{ed}	β_{ed} (SF)	β_{ed} (codes)	CM (dB)	MPR (dB)	AG Index	E-TFCI
1	11/15	15/15	64	11/15	22/15	209/225	1039/225	4	1	1.5	1.5	20	75
2	6/15	15/15	64	6/15	12/15	12/15	12/15	4	1	1.5	1.5	12	67
3	15/15	9/15	64	15/9	30/15	30/15	$\beta_{ed1}:47/15$	4	2	1.5	1.5	15	92

							$\beta_{ed2}:47/15$						
4	2/15	15/15	64	2/15	4/15	4/15	56/75	4	1	1.5	1.5	17	71
5	15/15	15/15	64	15/15	24/15	30/15	134/15	4	1	1.5	1.5	21	81

Rel.7 Release 7 HSPA+ Data Devices

Table C.11.1.4: β values for transmitter characteristics tests with HS-DPCCH and E-DCH with 16QAM

Sub-test	β_c (Note 3)	β_d	β_{HS} (Note 1)	β_{ec}	β_{ed} (2xSF2) (Note 4)	β_{ed} (2xSF4) (Note 4)	CM (dB) (Note 2)	MPR (dB) (Note 2)	AG Index (Note 4)	E-TFCI (Note 5)	E-TFCI (boost)
1	1	0	30/15	30/15	$\beta_{ed1}: 30/15$ $\beta_{ed2}: 30/15$	$\beta_{ed3}: 24/15$ $\beta_{ed4}: 24/15$	3.5	2.5	14	105	105
<p>Note 1: $\Delta_{ACK}, \Delta_{NACK}$ and $\Delta_{CQI} = 30/15$ with $\beta_{hs} = 30/15 * \beta_c$.</p> <p>Note 2: CM = 3.5 and the MPR is based on the relative CM difference, MPR = MAX(CM-1,0).</p> <p>Note 3: DPDCH is not configured, therefore the β_c is set to 1 and $\beta_d = 0$ by default.</p> <p>Note 4: β_{ed} can not be set directly; it is set by Absolute Grant Value.</p> <p>Note 5: All the sub-tests require the UE to transmit 2SF2+2SF4 16QAM EDCH and they apply for UE using E-DPDCH category 7. E-DCH TTI is set to 2ms TTI and E-DCH table index = 2. To support these E-DCH configurations DPDCH is not allocated. The UE is signalled to use the extrapolation algorithm.</p>											

Rel.8 DC-HSDPA (Cat 24)

SAR test exclusion for Rel.8 DC-HSDPA must satisfy the SAR test exclusion requirements of Rel.5 HSDPA. SAR test exclusion for DC-HSDPA devices is determined by power measurements according to the H-Set 12, Fixed Reference Channel (FRC) configuration in Table C.8.1.12 of 3GPP TS 34.121-1. A primary and a secondary serving HS-DSCH Cell are required to perform the power measurement and for the results to qualify for SAR test exclusion.

Table C.8.1.12: Fixed Reference Channel H-Set 12

Parameter	Unit	Value
Nominal Avg. Inf. Bit Rate	kbps	60
Inter-TTI Distance	TTI's	1
Number of HARQ Processes	Processes	6
Information Bit Payload (N_{INF})	Bits	120
Number Code Blocks	Blocks	1
Binary Channel Bits Per TTI	Bits	960
Total Available SML's in UE	SML's	19200
Number of SML's per HARQ Proc.	SML's	3200
Coding Rate		0.15
Number of Physical Channel Codes	Codes	1
Modulation		QPSK
<p>Note 1: The RMC is intended to be used for DC-HSDPA mode and both cells shall transmit with identical parameters as listed in the table.</p> <p>Note 2: Maximum number of transmission is limited to 1, i.e., retransmission is not allowed. The redundancy and constellation version 0 shall be used.</p>		

10.3 LTE Measurement Procedures for SAR

SAR tests for LTE are performed with a base station simulator, Rohde & Schwarz CMW500 or Anritsu MT8821C Closed loop power control was used so the UE transmits with maximum output power during SAR testing.

It is performed for conducted power and SAR based on the KDB941225 D05.

SAR is evaluated separately according to the following procedures for the different test positions in each exposure condition – head, body, body-worn accessories and other use conditions. The procedures in the following subsections are applied separately to test each LTE frequency band.

1) QPSK with 1 RB allocation

Start with the largest channel bandwidth and measure SAR for QPSK with 1 RB allocation, using the RB offset and required test channel combination with the highest maximum output power among RB offsets at the upper edge, middle and lower edge of each required test channel. When the reported SAR is ≤ 0.8 W/kg, testing of the remaining RB offset configurations and required test channels is not required for 1 RB allocation; otherwise, SAR is required for the remaining required test channels and only for the RB offset configuration with the highest output power for that channel. When the reported SAR of a required test channel is > 1.45 W/kg, SAR is required for all three RB offset configurations for that required test channel.

2) QPSK with 50% RB allocation

The procedures required for 1 RB allocation in 1) are applied to measure the SAR for QPSK with 50% RB allocation.

3) QPSK with 100% RB allocation

For QPSK with 100% RB allocation, SAR is not required when the highest maximum output power for 100 % RB allocation is less than the highest maximum output power in 50% and 1 RB allocations and the highest reported SAR for 1 RB and 50% RB allocation in 1) and 2) are ≤ 0.8 W/kg. Otherwise, SAR is measured for the highest output power channel; and if the reported SAR is > 1.45 W/kg, the remaining required test channels must also be tested.

TDD test:

TDD testing is performed using guidance from FCC KDB 941225 D05 v02r05 and the SAR test guidance provided in April 2013 TCB works hop notes. TDD is tested at the highest duty factor using UL-DL configuration 0 with special subframe configuration 6 and applying the FDD LTE procedures in KDB 941225 D05 v02r05. SAR testing is performed using the extended cyclic prefix listed in 3GPP TS 36.211.

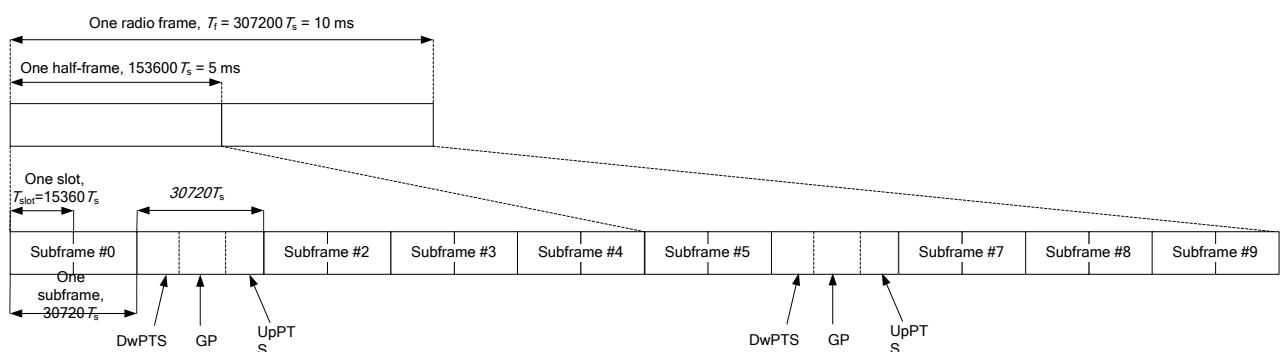

Figure 10.2: Frame structure type 2 (for 5 ms switch-point periodicity)

Table 10.1: Configuration of special subframe (lengths of DwPTS/GP/UpPTS)

Special subframe configuration	Normal cyclic prefix in downlink			Extended cyclic prefix in downlink		
	DwPTS	UpPTS		DwPTS	UpPTS	
		Normal cyclic prefix in uplink	Extended cyclic prefix in uplink		Normal cyclic prefix in uplink	Extended cyclic prefix in uplink
0	$6592 \cdot T_s$	$2192 \cdot T_s$	$2560 \cdot T_s$	$7680 \cdot T_s$	$2192 \cdot T_s$	$2560 \cdot T_s$
1	$19760 \cdot T_s$			$20480 \cdot T_s$		
2	$21952 \cdot T_s$			$23040 \cdot T_s$		
3	$24144 \cdot T_s$			$25600 \cdot T_s$		
4	$26336 \cdot T_s$	$4384 \cdot T_s$	$5120 \cdot T_s$	$7680 \cdot T_s$	$4384 \cdot T_s$	$5120 \cdot T_s$
5	$6592 \cdot T_s$			$20480 \cdot T_s$		
6	$19760 \cdot T_s$			$23040 \cdot T_s$		
7	$21952 \cdot T_s$			$12800 \cdot T_s$		
8	$24144 \cdot T_s$			-	-	-
9	$13168 \cdot T_s$			-	-	-

Table 10.2: Uplink-downlink configurations

Uplink-downlink configuration	Downlink-to-Uplink Switch-point periodicity	Subframe number										
		0	1	2	3	4	5	6	7	8	9	
0	5 ms	D	S	U	U	U	D	S	U	U	U	
1	5 ms	D	S	U	U	D	D	S	U	U	D	
2	5 ms	D	S	U	D	D	D	S	U	D	D	
3	10 ms	D	S	U	U	U	D	D	D	D	D	
4	10 ms	D	S	U	U	D	D	D	D	D	D	
5	10 ms	D	S	U	D	D	D	D	D	D	D	
6	5 ms	D	S	U	U	U	D	S	U	U	D	

Duty factor is calculated by:

$$\begin{aligned}
 \text{Duty factor} &= \text{uplink frame} \cdot 6 + \text{UpPTS} \cdot 2 / \text{one frame length} \\
 &= (30720 \cdot T_s \cdot 6 + 5120 \cdot T_s \cdot 2) / 307200 \cdot T_s \\
 &= 0.633
 \end{aligned}$$

According to the KDB 447498 D01, SAR should be evaluated at more than 3 frequencies for devices supporting transmit bands wider than 100MHz. Oct.2014 FCC-TCB conference notes (Dec. 2014 rev.) specifies the 5 test channels to use for 3GPP band 38/41 SAR evaluation.

10.4 Bluetooth & Wi-Fi Measurement Procedures for SAR

Normal network operating configurations are not suitable for measuring the SAR of 802.11 transmitters in general. Unpredictable fluctuations in network traffic and antenna diversity conditions can introduce undesirable variations in SAR results. The SAR for these devices should be measured using chipset based test mode software to ensure that the results are consistent and reliable.

Chipset based test mode software is hardware dependent and generally varies among manufacturers. The device operating parameters established in a test mode for SAR measurements must be identical to those programmed in production units, including output power levels, amplifier gain settings and other RF performance tuning parameters. The test frequencies should correspond to actual channel frequencies defined for domestic use. SAR for devices with switched diversity should be measured with only one antenna transmitting at a time during each SAR measurement, according to a fixed modulation and data rate. The same data pattern should be used for all measurements.

10.5 SAR Measurement for ENDC

1. Test LTE SAR with single uplink at maximum power following LTE SAR test procedure.
2. Test conducted power of 5G NR sub-carrier under EN-DC at maximum power (FDD and TDD)[1] and change the different parameters to find the worst-case configuration, see detail procedure as attached.
[1] For TDD band (n41), PC2 mode is only tested, because the duty cycle of both PC2 and PC3 are the same and PC2 has higher power than PC3.
3. Test SAR in worst case configuration for 5G NR in single uplink (test mode).
4. If the single uplink 1g SAR values for 5G NR and LTE are both less than 0.8W/kg and the algebraic summation of the 1g SAR values are less than 1.45W/kg, no additional measurements need to be performed.

11 Conducted Output Power

Antenna	Receiver ON (Head scenario)	Receiver OFF/ Sensor On (Body scenario)	Receiver OFF/ Sensor Off (Body scenario)
Standalone	Low Power	Low Power	Normal Power

11.1 GSM Measurement result

GSM850(Normal Power)

GSM 850 Speech (GMSK)	Measured timeslot-averaged output power (dBm)			Tune up	calculation	Source-based time-averaged output power (dBm)		
	251	190	128			251	190	128
1Txslot	32.73	32.96	32.83	33.50	/	/	/	/
GSM 850 GPRS (GMSK)	Measured timeslot-averaged output power (dBm)			Tune up	calculation	Source-based time-averaged output power (dBm)		
	251	190	128			251	190	128
1Txslot	32.91	32.91	32.93	33.50	-9.03	23.88	23.88	23.90
2Txslots	31.20	31.14	31.04	32.00	-6.02	25.18	25.12	25.02
3Txslots	29.07	29.06	28.99	30.00	-4.26	24.81	24.80	24.73
4Txslots	27.05	27.04	27.08	28.00	-3.01	24.04	24.03	24.07
GSM 850 EGPRS (GMSK)	Measured timeslot-averaged output power (dBm)					Source-based time-averaged output power (dBm)		
	251	190	128			251	190	128
1Txslot	32.86	32.88	32.86	33.50	-9.03	23.83	23.85	23.83
2Txslots	31.13	31.09	30.98	32.00	-6.02	25.11	25.07	24.96
3Txslots	29.00	29.01	28.93	30.00	-4.26	24.74	24.75	24.67
4Txslots	26.97	26.98	27.02	28.00	-3.01	23.96	23.97	24.01
GSM 850 EGPRS(8PSK)	Measured timeslot-averaged output power (dBm)					Source-based time-averaged output power (dBm)		
	251	190	128			251	190	128
1Txslot	26.84	26.88	26.90	28.00	-9.03	17.81	17.85	17.87
2Txslots	24.83	25.10	24.86	26.00	-6.02	18.81	19.08	18.84
3Txslots	23.73	22.82	23.58	24.00	-4.26	19.47	18.56	19.32
4Txslots	21.00	20.99	21.01	22.00	-3.01	17.99	17.98	18.00
GSM 1900 Speech (GMSK)	Measured timeslot-averaged output power (dBm)			Tune up	calculation	Source-based time-averaged output power (dBm)		
	810	661	512			810	661	512
1Txslot	29.72	29.75	29.49	30.50	/	/	/	/
GSM 1900 GPRS (GMSK)	Measured timeslot-averaged output power (dBm)			Tune up	calculation	Source-based time-averaged output power (dBm)		
	810	661	512			810	661	512
1Txslot	29.83	29.98	29.67	30.50	-9.03	20.80	20.95	20.64
2Txslots	28.05	28.00	27.89	29.00	-6.02	22.03	21.98	21.87
3Txslots	25.89	25.95	25.96	27.00	-4.26	21.63	21.69	21.70
4Txslots	24.13	24.14	24.11	25.00	-3.01	21.12	21.13	21.10
GSM 1900 EGPRS (GMSK)	Measured timeslot-averaged output power (dBm)					Source-based time-averaged output power (dBm)		
	810	661	512			810	661	512
1Txslot	29.96	29.84	29.60	30.50	-9.03	20.93	20.81	20.57

2Txslots	28.02	27.86	27.81	29.00	-6.02	22.00	21.84	21.79
3Txslots	26.00	25.82	25.87	27.00	-4.26	21.74	21.56	21.61
4Txslots	23.98	23.99	24.01	25.00	-3.01	20.97	20.98	21.00
GSM 1900 EGPRS(8PSK)	Measured timeslot-averaged output power (dBm)					Source-based time-averaged output power (dBm)		
	810	661	512			810	661	512
1Txslot	26.10	26.16	26.12	27.00	-9.03	17.07	17.13	17.09
2Txslots	24.22	23.73	24.08	25.00	-6.02	18.20	17.71	18.06
3Txslots	21.77	21.73	21.65	23.00	-4.26	17.51	17.47	17.39
4Txslots	19.73	19.86	19.48	21.00	-3.01	16.72	16.85	16.47

GSM1900(Low Power)

GSM 1900 Speech (GMSK)	Measured timeslot-averaged output power (dBm)			Tune up	calculation	Source-based time-averaged output power (dBm)		
	810	661	512			810	661	512
1Txslot	21.91	21.89	21.87	22.50	/	/	/	/
GSM 1900 GPRS (GMSK)	Measured timeslot-averaged output power (dBm)			Tune up	calculation	Source-based time-averaged output power (dBm)		
	810	661	512			810	661	512
1Txslot	21.92	21.92	21.91	22.50	-9.03	12.89	12.89	12.88
2Txslots	18.01	17.97	17.91	18.50	-6.02	11.99	11.95	11.89
3Txslots	16.52	16.47	16.45	17.00	-4.26	12.26	12.21	12.19
4Txslots	15.05	14.95	15.06	15.50	-3.01	12.04	11.94	12.05
GSM 1900 EGPRS (GMSK)	Measured timeslot-averaged output power (dBm)					Source-based time-averaged output power (dBm)		
	810	661	512			810	661	512
1Txslot	21.85	21.81	21.77	22.50	-9.03	12.82	12.78	12.74
2Txslots	17.96	17.87	17.80	18.50	-6.02	11.94	11.85	11.78
3Txslots	16.48	16.39	16.38	17.00	-4.26	12.22	12.13	12.12
4Txslots	15.01	14.87	14.98	15.50	-3.01	12.00	11.86	11.97
GSM 1900 EGPRS(8PSK)	Measured timeslot-averaged output power (dBm)					Source-based time-averaged output power (dBm)		
	810	661	512			810	661	512
1Txslot	18.73	18.66	18.66	19.50	-9.03	9.70	9.63	9.63
2Txslots	15.42	15.45	15.26	16.50	-6.02	9.40	9.43	9.24
3Txslots	14.54	14.33	14.24	15.50	-4.26	10.28	10.07	9.98
4Txslots	13.91	13.86	13.83	14.50	-3.01	10.90	10.85	10.82

11.2 WCDMA Measurement result

WCDMA1900(Normal Power)

Item	band	FDDII result			
	ARFCN	9538 (1907.6MHz)	9400 (1880MHz)	9262 (1852.4MHz)	Tune up
WCDMA	\	24.15	24.22	24.29	25.00
HSUPA	1	23.71	23.76	23.75	24.00
	2	21.71	21.75	21.67	22.00
	3	22.7	22.72	22.66	23.00
	4	21.73	21.77	21.67	22.00
	5	23.69	23.71	23.73	24.00
DC-HSDPA	1	22.86	22.89	22.83	24.00
	2	22.83	22.87	22.86	24.00
	3	21.93	22.01	21.99	23.50
	4	22.35	22.41	22.38	23.50

WCDMA1900(Low Power)

Item	band	FDDII result			
	ARFCN	9538 (1907.6MHz)	9400 (1880MHz)	9262 (1852.4MHz)	Tune up
WCDMA	\	16.22	16.26	16.21	17.00
HSUPA	1	14.21	14.39	14.22	16.00
	2	12.21	12.34	12.27	14.00
	3	13.32	13.37	13.27	15.00
	4	12.43	12.31	12.34	14.00
	5	14.3	14.32	14.27	16.00
DC-HSDPA	1	14.35	14.39	14.34	16.00
	2	14.37	14.40	14.44	16.00
	3	13.89	13.87	13.83	15.50
	4	15.42	15.36	15.29	15.50

WCDMA1700(Normal Power)

Item	band	FDDIV result			
	ARFCN	1513 (1752.6MHz)	1412 (1732.4MHz)	1312 (1712.4MHz)	Tune up
WCDMA	\	24.06	24.02	24.12	25.00
HSUPA	1	23.86	23.82	23.77	24.00
	2	21.81	21.86	21.84	22.00
	3	22.87	22.83	22.85	23.00
	4	21.76	21.88	21.80	22.00
	5	23.76	23.82	23.78	24.00
DC-HSDPA	1	22.88	22.97	22.83	24.00
	2	22.85	22.86	22.87	24.00
	3	21.97	22.42	22.46	23.50
	4	22.38	22.46	22.39	23.50

WCDMA1700(Low Power)

Item	band	FDDIV result			
	ARFCN	1513 (1752.6MHz)	1412 (1732.4MHz)	1312 (1712.4MHz)	Tune up
WCDMA	\	16.09	16.15	16.04	17.00
HSUPA	1	14.37	14.38	14.39	16.00
	2	12.45	12.42	12.41	14.00
	3	13.35	13.34	13.37	15.00
	4	12.4	12.43	12.45	14.00
	5	14.35	14.48	14.44	16.00
DC-HSDPA	1	14.37	14.43	14.39	16.00
	2	14.39	14.41	14.46	16.00
	3	14.39	14.42	14.45	15.50
	4	13.96	13.85	13.90	15.50

WCDMA850

Item	band	FDDV result			
	ARFCN	4233 (846.6MHz)	4183 (836.6MHz)	4132 (826.4MHz)	Tune up
WCDMA	\	24.46	24.58	24.57	25.00
HSUPA	1	23.53	23.56	23.51	24.00
	2	21.55	21.51	21.46	22.00
	3	22.6	22.61	22.52	23.00
	4	21.54	21.57	21.46	22.00
	5	23.56	23.57	23.46	24.00
DC-HSDPA	1	23.28	23.22	23.18	24.00
	2	23.24	23.21	23.18	24.00
	3	22.81	22.73	22.70	23.50
	4	22.78	22.66	22.71	23.50

11.3 LTE Measurement result

Table 11.3-1: Maximum Power Reduction (MPR) for LTE-Normal Power

Modulation	Channel bandwidth / Transmission bandwidth configuration [RB]						MPR (dB)
	1.4	3	5	10	15	20	
	MHz	MHz	MHz	MHz	MHz	MHz	
QPSK	> 5	> 4	> 8	> 12	> 16	> 18	1
16 QAM	≤ 5	≤ 4	≤ 8	≤ 12	≤ 16	≤ 18	1
16 QAM	> 5	> 4	> 8	> 12	> 16	> 18	2
64 QAM	≤ 5	≤ 4	≤ 8	≤ 12	≤ 16	≤ 18	2
64 QAM	> 5	> 4	> 8	> 12	> 16	> 18	3

Table 11.3-2: Maximum Power Reduction (MPR) for LTE- Low Power

Modulation	Channel bandwidth / Transmission bandwidth configuration [RB]						MPR (dB)
	1.4	3	5	10	15	20	
	MHz	MHz	MHz	MHz	MHz	MHz	
QPSK	> 5	> 4	> 8	> 12	> 16	> 18	1
16 QAM	≤ 5	≤ 4	≤ 8	≤ 12	≤ 16	≤ 18	1
16 QAM	> 5	> 4	> 8	> 12	> 16	> 18	2
64 QAM	≤ 5	≤ 4	≤ 8	≤ 12	≤ 16	≤ 18	2
64 QAM	> 5	> 4	> 8	> 12	> 16	> 18	3

Table 11.3-3: The tune up for LTE

Mode/Band	Normal Power	Low Power
FDD Band 2 ANT0	25	25
FDD Band 7	24	15
FDD Band 12	25	25
FDD Band 13	25	25
FDD Band 25	22	17
FDD Band 26	25	25
TDD Band 41(PC3)	25	15
TDD Band 41(PC2)	27.5	17.5
FDD Band 66 ANT2	25	17
FDD Band 66 ANT0	25	25
FDD Band 71	25	25

LTE Band2(Normal Power)

Band 2						
Bandwidth (MHz)	RB allocation	Frequency (MHz)	Actual output power (dBm)			
	RB offset		QPSK	16QAM	64QAM	
1.4MHz	1RB-High	1909.3	24.15	23.54	23.56	
		1880	24.31	23.67	23.43	
		1850.7	24.28	23.69	23.42	
	1RB-Middle	1909.3	24.39	23.66	23.63	
		1880	24.55	23.58	23.62	
		1850.7	24.61	23.63	23.68	
	1RB-Low	1909.3	24.30	23.83	23.64	
		1880	24.34	23.67	23.76	
		1850.7	24.41	23.68	23.49	
	3RB-High	1909.3	24.35	23.39	23.57	
		1880	24.35	23.41	23.53	
		1850.7	24.39	23.45	23.50	
	3RB-Middle	1909.3	24.49	23.25	23.43	
		1880	24.39	23.54	23.50	
		1850.7	24.42	23.33	23.57	
	3RB-Low	1909.3	24.38	23.25	23.60	
		1880	24.39	23.49	23.50	
		1850.7	24.42	23.46	23.54	
	6RB	1909.3	23.49	22.57	22.43	
		1880	23.44	22.52	22.44	
		1850.7	23.44	22.44	22.51	
	3MHz	1RB-High	1908.5	24.31	23.72	23.59
			1880	24.34	23.76	23.54
			1851.5	24.38	23.64	23.73
1RB-Middle		1908.5	24.34	23.93	23.41	
		1880	24.46	23.76	23.52	
		1851.5	24.41	23.76	23.62	
1RB-Low		1908.5	24.56	23.95	23.62	
		1880	24.53	23.91	23.67	
		1851.5	24.57	23.92	23.68	
8RB-High		1908.5	23.52	22.41	22.60	
		1880	23.48	22.43	22.50	
		1851.5	23.50	22.51	22.57	
8RB-Middle		1908.5	23.51	22.62	22.53	
		1880	23.59	22.64	22.61	
		1851.5	23.48	22.56	22.44	
8RB-Low		1908.5	23.61	22.64	22.61	
		1880	23.61	22.65	22.67	
		1851.5	23.54	22.68	22.64	
15RB		1908.5	23.45	22.56	22.54	
		1880	23.57	22.62	22.56	
		1851.5	23.48	22.53	22.53	
5MHz		1RB-High	1907.5	24.31	23.82	23.59
			1880	24.36	23.69	23.53
			1852.5	24.39	23.67	23.65
	1RB-Middle	1907.5	24.37	23.85	23.36	
		1880	24.39	23.48	23.62	
		1852.5	24.41	23.81	23.68	
	1RB-Low	1907.5	24.44	23.70	23.63	
		1880	24.49	23.82	23.61	
		1852.5	24.44	23.74	23.69	

	12RB-High	1907.5	23.43	22.53	22.45	
		1880	23.46	22.24	22.42	
		1852.5	23.42	22.47	22.51	
	12RB-Middle	1907.5	23.64	22.57	22.59	
		1880	23.56	22.64	22.44	
		1852.5	23.69	22.66	22.63	
	12RB-Low	1907.5	23.55	22.65	22.65	
		1880	23.62	22.55	22.61	
		1852.5	23.63	22.58	22.46	
	25RB	1907.5	23.51	22.58	22.61	
		1880	23.45	22.46	22.45	
		1852.5	23.53	22.58	22.58	
10MHz	1RB-High	1905	24.57	23.63	23.51	
		1880	24.44	23.69	23.58	
		1855	24.47	23.78	23.42	
	1RB-Middle	1905	24.36	23.77	23.59	
		1880	24.42	23.67	23.59	
		1855	24.43	23.69	23.74	
	1RB-Low	1905	24.38	24.00	23.71	
		1880	24.38	23.93	23.61	
		1855	24.47	23.96	23.62	
	25RB-High	1905	23.51	22.63	22.55	
		1880	23.34	22.50	22.48	
		1855	23.54	22.58	22.59	
	25RB-Middle	1905	23.53	22.62	22.59	
		1880	23.52	22.60	22.60	
		1855	23.64	22.68	22.69	
	25RB-Low	1905	23.57	22.64	22.55	
		1880	23.57	22.53	22.70	
		1855	23.50	22.63	22.53	
	50RB	1905	23.60	22.68	22.67	
		1880	23.43	22.50	22.49	
		1855	23.56	22.62	22.62	
	15MHz	1RB-High	1902.5	24.19	23.68	23.55
			1880	24.29	23.62	23.53
			1857.5	24.27	23.61	23.56
1RB-Middle		1902.5	24.22	23.76	23.49	
		1880	24.32	23.65	23.62	
		1857.5	24.32	23.74	23.53	
1RB-Low		1902.5	24.23	23.55	23.59	
		1880	24.28	23.69	23.66	
		1857.5	24.30	23.70	23.47	
36RB-High		1902.5	23.51	22.39	22.50	
		1880	23.37	22.35	22.44	
		1857.5	23.37	22.47	22.41	
36RB-Middle		1902.5	23.42	22.43	22.52	
		1880	23.40	22.34	22.43	
		1857.5	23.47	22.50	22.47	
36RB-Low		1902.5	23.46	22.42	22.38	
		1880	23.52	22.49	22.39	
		1857.5	23.50	22.43	22.42	
75RB		1902.5	23.43	22.52	22.53	
		1880	23.48	22.34	22.36	
		1857.5	23.47	22.41	22.32	
20MHz		1RB-High	1900	24.19	23.56	23.49

	1RB-Middle	1880	24.19	23.69	23.51	
		1860	24.25	23.63	23.51	
		1900	24.22	23.56	23.5	
	1RB-Low	1880	24.26	23.53	23.47	
		1860	24.26	23.70	23.5	
		1900	24.28	23.60	23.5	
	50RB-High	1880	24.29	23.62	23.56	
		1860	24.50	23.65	23.54	
		1900	23.47	22.48	22.49	
	50RB-Middle	1880	23.32	22.39	22.44	
		1860	23.42	22.38	22.37	
		1900	23.42	22.43	22.44	
	50RB-Low	1880	23.31	22.37	22.44	
		1860	23.43	22.42	22.37	
		1900	23.46	22.49	22.38	
	100RB	1880	23.46	22.43	22.47	
		1860	23.48	22.48	22.46	
		1900	23.45	22.35	22.45	
			1880	23.41	22.34	22.31
			1860	23.41	22.39	22.47
1860			23.41	22.39	22.47	

LTE Band7(Normal Power)

Band 7					
Bandwidth (MHz)	RB allocation RB offset	Frequency (MHz)	Actual output power (dBm)		
			QPSK	16QAM	64QAM
5MHz	1RB-High	2567.5	23.11	22.41	21.28
		2535	23.11	22.47	21.33
		2502.5	23.20	22.61	21.34
	1RB-Middle	2567.5	23.19	22.55	21.35
		2535	23.09	22.80	21.43
		2502.5	23.21	22.83	21.06
	1RB-Low	2567.5	23.04	22.51	21.19
		2535	23.14	22.44	21.31
		2502.5	23.05	22.54	21.23
	12RB-High	2567.5	22.29	21.22	20.39
		2535	22.25	21.32	20.28
		2502.5	22.34	21.41	20.49
	12RB-Middle	2567.5	22.26	21.34	20.34
		2535	22.27	21.28	20.27
		2502.5	22.35	21.41	20.38
	12RB-Low	2567.5	22.18	21.31	20.33
		2535	22.17	21.26	20.16
		2502.5	22.23	21.36	20.29
	25RB	2567.5	22.19	21.30	20.30
		2535	22.16	21.20	20.28
		2502.5	22.30	21.35	20.40
10MHz	1RB-High	2565	23.09	22.78	21.52
		2535	23.19	22.66	21.34
		2505	23.14	22.53	21.40
	1RB-Middle	2565	23.11	22.37	21.24
		2535	23.01	22.30	21.30
		2505	23.08	22.42	21.34
	1RB-Low	2565	23.03	22.70	21.23
		2535	22.99	22.51	21.38
		2535	22.99	22.51	21.38

	25RB-High	2505	23.16	22.75	21.43	
		2565	22.18	21.35	20.36	
		2535	22.22	21.26	20.27	
	25RB-Middle	2505	22.33	21.42	20.42	
		2565	22.23	21.26	20.24	
		2535	22.25	21.30	20.31	
	25RB-Low	2505	22.35	21.41	20.42	
		2565	22.14	21.31	20.20	
		2535	22.17	21.25	20.23	
	50RB	2505	22.32	21.42	20.33	
		2565	22.13	21.22	20.22	
		2535	22.22	21.28	20.18	
15MHz	1RB-High	2505	22.28	21.33	20.36	
		2562.5	22.84	22.22	21.46	
		2535	22.78	22.22	21.20	
	1RB-Middle	2507.5	22.87	22.24	21.37	
		2562.5	22.83	22.21	21.36	
		2535	22.92	22.28	21.18	
	1RB-Low	2507.5	22.97	22.36	21.26	
		2562.5	22.86	22.18	21.33	
		2535	22.87	22.27	21.15	
	36RB-High	2507.5	22.89	22.35	21.42	
		2562.5	22.11	21.12	20.14	
		2535	22.09	21.12	20.09	
	36RB-Middle	2507.5	22.13	21.18	20.17	
		2562.5	22.06	21.11	20.09	
		2535	22.04	21.14	20.20	
	36RB-Low	2507.5	22.19	21.28	20.21	
		2562.5	22.00	21.02	20.03	
		2535	22.01	21.06	20.04	
	75RB	2507.5	22.18	21.15	20.27	
		2562.5	22.02	21.15	20.17	
		2535	22.08	21.14	20.09	
	20MHz	1RB-High	2507.5	22.17	21.27	20.24
			2560	23.07	22.50	21.27
			2535	23.04	22.28	21.23
		1RB-Middle	2510	23.04	22.44	21.32
			2560	23.09	22.44	21.33
			2535	23.05	22.33	21.13
1RB-Low		2510	22.97	22.39	21.18	
		2560	23.05	22.43	21.33	
		2535	23.03	22.30	21.28	
50RB-High		2510	22.97	22.35	21.25	
		2560	22.24	21.34	20.29	
		2535	22.22	21.16	20.14	
50RB-Middle		2510	22.17	21.23	20.21	
		2560	22.20	21.18	20.26	
		2535	22.18	21.22	20.19	
50RB-Low		2510	22.19	21.25	20.23	
		2560	22.23	21.19	20.20	
		2535	22.14	21.12	20.05	
100RB		2510	22.19	21.19	20.25	
		2560	22.21	21.20	20.15	
		2535	22.16	21.12	20.16	
			2510	22.23	21.20	20.20

LTE Band7(Normal Power)

Band 7					
Bandwidth (MHz)	RB allocation RB offset	Frequency (MHz)	Actual output power (dBm)		
			QPSK	16QAM	64QAM
5MHz	1RB-High	2567.5	14.36	13.79	13.71
		2535	14.51	13.72	13.54
		2502.5	14.46	13.80	13.54
	1RB-Middle	2567.5	14.30	13.63	13.90
		2535	14.29	13.63	13.16
		2502.5	14.32	13.65	13.51
	1RB-Low	2567.5	14.45	13.67	13.76
		2535	14.42	13.55	13.47
		2502.5	14.42	13.78	13.61
	12RB-High	2567.5	13.43	12.32	12.43
		2535	13.44	12.46	12.44
		2502.5	13.50	12.62	12.57
	12RB-Middle	2567.5	13.55	12.43	12.45
		2535	13.48	12.48	12.44
		2502.5	13.48	12.48	12.47
	12RB-Low	2567.5	13.44	12.41	12.42
		2535	13.26	12.28	12.24
		2502.5	13.45	12.47	12.39
	25RB	2567.5	13.48	12.37	12.49
		2535	13.41	12.40	12.40
		2502.5	13.43	12.51	12.43
10MHz	1RB-High	2565	14.45	13.68	13.85
		2535	14.37	13.94	13.59
		2505	14.41	13.66	13.30
	1RB-Middle	2565	14.38	13.50	13.61
		2535	14.44	13.73	13.61
		2505	14.42	13.83	13.63
	1RB-Low	2565	14.48	13.66	13.55
		2535	14.30	13.73	13.45
		2505	14.48	13.64	13.63
	25RB-High	2565	13.53	12.51	12.50
		2535	13.43	12.42	12.41
		2505	13.50	12.47	12.48
	25RB-Middle	2565	13.48	12.47	12.45
		2535	13.45	12.43	12.43
		2505	13.53	12.54	12.52
	25RB-Low	2565	13.42	12.52	12.44
		2535	13.39	12.38	12.37
		2505	13.54	12.52	12.54
50RB	2565	13.47	12.45	12.33	
	2535	13.45	12.44	12.42	
	2505	13.47	12.56	12.34	
15MHz	1RB-High	2562.5	14.15	13.31	13.38
		2535	14.05	13.39	13.25
		2507.5	14.19	13.46	13.40
	1RB-Middle	2562.5	14.19	13.57	13.26
		2535	14.13	13.39	13.20
		2507.5	14.10	13.47	13.34
	1RB-Low	2562.5	14.09	13.44	13.28

	36RB-High	2535	14.10	13.38	13.27	
		2507.5	14.10	13.43	13.20	
		2562.5	13.31	12.30	12.30	
	36RB-Middle	2535	13.30	12.25	12.31	
		2507.5	13.31	12.28	12.40	
		2562.5	13.29	12.32	12.30	
	36RB-Low	2535	13.27	12.32	12.25	
		2507.5	13.33	12.44	12.31	
		2562.5	13.30	12.31	12.31	
	75RB	2535	13.28	12.23	12.23	
		2507.5	13.30	12.26	12.28	
		2562.5	13.33	12.19	12.27	
	20MHz	1RB-High	2560	14.28	13.47	13.37
			2535	14.10	13.45	13.32
			2510	14.20	13.36	13.31
1RB-Middle		2560	14.21	13.49	13.23	
		2535	14.12	13.42	13.33	
		2510	14.16	13.41	13.23	
1RB-Low		2560	14.16	13.38	13.31	
		2535	14.16	13.48	13.29	
		2510	14.24	13.29	13.30	
50RB-High		2560	13.38	12.39	12.31	
		2535	13.32	12.32	12.30	
		2510	13.30	12.30	12.30	
50RB-Middle		2560	13.36	12.37	12.35	
		2535	13.32	12.33	12.30	
		2510	13.34	12.32	12.32	
50RB-Low		2560	13.39	12.29	12.28	
		2535	13.29	12.30	12.27	
		2510	13.33	12.42	12.33	
100RB		2560	13.29	12.37	12.27	
		2535	13.36	12.34	12.23	
		2510	13.42	12.32	12.30	

LTE Band12(Normal Power)

		Band 12			
Bandwidth (MHz)	RB allocation RB offset	Frequency (MHz)	Actual output power (dBm)		
			QPSK	16QAM	64QAM
1.4MHz	1RB-High	715.3	23.93	22.91	22.04
		707.5	24.01	23.31	22.33
		699.7	23.99	23.23	22.48
	1RB-Middle	715.3	24.04	23.08	22.06
		707.5	24.25	23.38	22.38
		699.7	24.25	23.35	22.53
	1RB-Low	715.3	23.87	23.50	22.36
		707.5	24.10	23.26	22.29
		699.7	24.08	23.30	22.48
	3RB-High	715.3	23.84	22.80	21.85
		707.5	24.13	23.17	22.28
		699.7	24.02	23.18	22.23
	3RB-Middle	715.3	24.00	23.07	22.08
		707.5	24.17	23.30	22.27

	3RB-Low	699.7	24.15	23.29	22.22	
		715.3	24.08	23.15	22.17	
		707.5	24.12	23.24	22.27	
	6RB	699.7	24.20	23.20	22.32	
		715.3	23.13	22.21	21.13	
		707.5	23.19	22.28	21.13	
3MHz	1RB-High	699.7	23.22	22.30	21.31	
		714.5	23.77	22.96	22.03	
		707.5	24.08	23.47	22.33	
	1RB-Middle	700.5	24.06	23.33	22.32	
		714.5	24.12	23.44	22.34	
		707.5	24.10	23.53	22.32	
	1RB-Low	700.5	24.12	23.38	22.33	
		714.5	24.03	23.48	22.27	
		707.5	24.13	23.54	22.42	
	8RB-High	700.5	24.26	23.62	22.48	
		714.5	23.11	22.28	21.27	
		707.5	23.27	22.37	21.32	
	8RB-Middle	700.5	23.27	22.28	21.34	
		714.5	23.20	22.37	21.18	
		707.5	23.24	22.32	21.22	
	8RB-Low	700.5	23.38	22.38	21.28	
		714.5	23.17	22.28	21.22	
		707.5	23.21	22.38	21.44	
	15RB	700.5	23.34	22.43	21.51	
		714.5	23.06	22.22	21.22	
		707.5	23.18	22.39	21.22	
	5MHz	1RB-High	700.5	23.28	22.25	21.34
			713.5	23.65	22.99	22.09
			707.5	24.14	23.47	22.32
1RB-Middle		701.5	24.12	23.54	22.24	
		713.5	24.13	23.92	22.35	
		707.5	24.33	23.25	22.47	
1RB-Low		701.5	24.21	23.64	22.11	
		713.5	24.16	23.62	22.34	
		707.5	24.23	23.66	22.26	
12RB-High		701.5	24.12	23.43	22.33	
		713.5	23.13	22.20	21.36	
		707.5	23.21	22.31	21.24	
12RB-Middle		701.5	23.24	22.23	21.35	
		713.5	23.13	22.30	21.31	
		707.5	23.30	22.33	21.29	
12RB-Low		701.5	23.28	22.42	21.33	
		713.5	23.18	22.28	21.26	
		707.5	23.23	22.39	21.33	
25RB		701.5	23.32	22.44	21.31	
		713.5	23.06	22.25	21.16	
		707.5	23.22	22.22	21.26	
10MHz		1RB-High	701.5	23.30	22.33	21.29
			711	23.97	23.56	22.11
			707.5	24.14	23.64	22.30
	1RB-Middle	704	24.26	23.57	22.44	
		711	24.23	23.48	22.46	
		707.5	24.30	23.56	22.46	
704	24.27	23.39	22.58			

	1RB-Low	711	24.46	23.78	22.62
		707.5	24.24	23.73	22.56
		704	24.30	23.72	22.48
	25RB-High	711	23.26	22.38	21.34
		707.5	23.29	22.32	21.40
		704	23.30	22.24	21.39
	25RB-Middle	711	23.30	22.33	21.37
		707.5	23.35	22.35	21.25
		704	23.34	22.48	21.43
	25RB-Low	711	23.37	22.42	21.40
		707.5	23.31	22.27	21.40
		704	23.36	22.40	21.44
50RB	711	23.31	22.27	21.33	
	707.5	23.32	22.29	21.30	
	704	23.34	22.45	21.45	

LTE Band13(Normal Power)

Band 13					
Bandwidth (MHz)	RB allocation	Frequency (MHz)	Actual output power (dBm)		
	RB offset (Start RB)		QPSK	16QAM	64QAM
5 MHz	1RB-High	784.5	24.13	23.37	22.74
		782	24.18	23.76	22.66
		779.5	24.17	23.67	22.61
	1RB-Middle	784.5	24.54	23.90	22.96
		782	24.47	23.48	22.65
		779.5	24.45	23.20	22.70
	1RB-Low	784.5	24.26	23.68	22.73
		782	24.14	23.79	22.86
		779.5	23.92	23.37	22.63
	12RB-High	784.5	23.38	22.54	21.84
		782	23.40	22.58	21.92
		779.5	23.42	22.54	21.95
	12RB-Middle	784.5	23.41	22.59	21.77
		782	23.44	22.54	21.83
		779.5	23.48	22.49	21.92
	12RB-Low	784.5	23.35	22.43	21.80
		782	23.39	22.42	21.90
		779.5	23.32	22.55	21.91
25RB	784.5	23.36	22.44	21.73	
	782	23.37	22.51	21.74	
	779.5	23.39	22.57	21.83	
10 MHz	1RB-High	782	24.27	23.57	22.52
	1RB-Middle	782	24.37	23.65	22.98
	1RB-Low	782	24.21	23.94	22.28
	25RB-High	782	23.45	22.45	21.46
	25RB-Middle	782	23.48	22.47	21.49
	25RB-Low	782	23.43	22.47	21.53
	50RB	782	23.48	22.40	21.51

LTE Band25(Normal Power)

Band 25					
Bandwidth (MHz)	RB allocation	Frequency (MHz)	QPSK	16QAM	64QAM
	RB offset (Start RB)		Actual output power (dBm)	Actual output power (dBm)	Actual output power (dBm)

1.4 MHz	1RB High (5)	1914.3	24.12	23.48	22.57	
		1882.5	24.24	23.58	22.76	
		1850.7	23.58	23.04	22.31	
	1RB Middle (3)	1914.3	24.16	23.47	22.67	
		1882.5	24.32	23.70	22.95	
		1850.7	23.60	23.02	22.32	
	1RB Low (0)	1914.3	23.95	23.46	22.58	
		1882.5	24.27	23.50	22.75	
		1850.7	23.54	22.96	22.19	
	3RB High (3)	1914.3	24.13	23.37	22.69	
		1882.5	24.33	23.44	22.83	
		1850.7	23.58	22.81	22.17	
	3RB Middle (1)	1914.3	24.31	23.35	22.73	
		1882.5	24.37	23.29	22.77	
		1850.7	23.59	22.86	22.19	
	3RB Low (0)	1914.3	24.18	23.38	22.64	
		1882.5	24.34	23.46	22.78	
		1850.7	23.54	22.78	22.15	
	6RB (0)	1914.3	23.28	22.42	21.54	
		1882.5	23.45	22.52	21.64	
		1850.7	22.78	22.05	21.32	
	3 MHz	1RB High (14)	1913.5	24.30	23.71	22.57
			1882.5	24.38	23.76	22.81
			1851.5	23.82	23.30	22.50
1RB Middle (7)		1913.5	24.35	23.56	22.77	
		1882.5	24.50	23.76	22.86	
		1851.5	23.65	23.10	22.33	
1RB Low (0)		1913.5	24.14	23.68	22.71	
		1882.5	24.39	23.90	22.82	
		1851.5	23.69	23.11	22.34	
8RB High (7)		1913.5	23.38	22.41	21.80	
		1882.5	23.50	22.57	21.95	
		1851.5	22.96	22.21	21.46	
8RB Middle (4)		1913.5	23.44	22.50	21.73	
		1882.5	23.50	22.65	21.90	
		1851.5	22.94	22.20	21.49	
8RB Low (0)		1913.5	23.41	22.39	21.78	
		1882.5	23.43	22.52	21.86	
		1851.5	22.89	22.16	21.37	
15RB (0)		1913.5	23.41	22.50	21.78	
		1882.5	23.49	22.56	21.86	
		1851.5	22.94	22.14	21.44	
5 MHz		1RB High (24)	1912.5	24.28	23.52	22.62
			1882.5	24.41	23.66	22.86
			1852.5	23.96	23.45	22.54
	1RB Middle (12)	1912.5	24.29	23.17	22.80	
		1882.5	24.54	23.79	22.81	
		1852.5	23.71	23.05	22.46	

	1RB Low (0)	1912.5	24.23	23.57	22.65	
		1882.5	24.30	23.85	22.79	
		1852.5	23.73	23.22	22.43	
	12RB High (13)	1912.5	23.41	22.57	21.74	
		1882.5	23.55	22.65	21.91	
		1852.5	23.07	22.28	21.59	
	12RB Middle (6)	1912.5	23.37	22.54	21.86	
		1882.5	23.48	22.50	21.79	
		1852.5	23.01	22.22	21.49	
	12RB Low (0)	1912.5	23.46	22.41	21.88	
		1882.5	23.48	22.53	21.81	
		1852.5	22.96	22.16	21.48	
25RB (0)	1912.5	23.37	22.49	21.81		
	1882.5	23.45	22.52	21.77		
	1852.5	23.03	22.22	21.54		
10 MHz	1RB High (49)	1910	24.23	23.85	22.76	
		1882.5	24.37	24.01	22.98	
		1855	24.32	23.86	22.99	
	1RB Middle (24)	1910	24.22	23.54	22.73	
		1882.5	24.37	23.74	22.85	
		1855	23.82	23.23	22.40	
	1RB Low (0)	1910	24.30	23.83	22.89	
		1882.5	24.35	23.93	22.82	
		1855	23.86	23.32	22.52	
	25RB High (25)	1910	23.42	22.48	21.81	
		1882.5	23.59	22.62	21.97	
		1855	23.50	22.58	21.81	
	25RB Middle (12)	1910	23.42	22.50	21.72	
		1882.5	23.52	22.61	21.81	
		1855	23.18	22.35	21.65	
	25RB Low (0)	1910	23.40	22.37	21.73	
		1882.5	23.50	22.59	21.90	
		1855	23.10	22.27	21.58	
	50RB (0)	1910	23.41	22.47	21.77	
		1882.5	23.45	22.62	21.76	
		1855	23.26	22.45	21.74	
	15 MHz	1RB High (74)	1907.5	24.11	23.37	22.41
			1882.5	24.19	23.64	22.46
			1857.5	24.09	23.59	22.44
1RB Middle (37)		1907.5	24.06	23.63	22.48	
		1882.5	24.13	23.56	22.68	
		1857.5	24.02	23.40	21.71	
1RB Low (0)		1907.5	24.09	23.80	22.42	
		1882.5	24.18	23.70	22.39	
		1857.5	23.80	23.17	21.42	
36RB High (38)		1907.5	23.36	22.43	21.52	
		1882.5	23.47	22.49	21.56	
		1857.5	23.46	22.43	21.54	

	36RB Middle (19)	1907.5	23.41	22.49	21.58
		1882.5	23.39	22.43	21.61
		1857.5	23.40	22.46	21.40
	36RB Low (0)	1907.5	23.33	22.45	21.45
		1882.5	23.38	22.44	21.50
		1857.5	23.12	22.26	20.56
	75RB (0)	1907.5	23.39	22.40	21.51
		1882.5	23.41	22.46	21.52
		1857.5	23.37	22.44	21.44
20 MHz	1RB High (99)	1905	24.17	23.70	22.24
		1882.5	24.27	23.65	22.67
		1860	24.25	23.91	22.42
	1RB Middle (50)	1905	24.31	23.64	22.65
		1882.5	24.18	23.65	22.67
		1860	24.20	23.72	22.75
	1RB Low (0)	1905	24.27	23.78	22.48
		1882.5	24.24	23.76	22.46
		1860	24.30	23.91	22.28
	50RB High (50)	1905	23.41	22.54	21.47
		1882.5	23.49	22.49	21.54
		1860	23.45	22.42	21.46
	50RB Middle (25)	1905	23.49	22.47	21.58
		1882.5	23.40	22.48	21.43
		1860	23.51	22.48	21.53
	50RB Low (0)	1905	23.46	22.40	21.54
		1882.5	23.36	22.43	21.45
		1860	23.48	22.55	21.53
	100RB (0)	1905	23.36	22.47	21.51
		1882.5	23.37	22.41	21.43
		1860	23.51	22.50	21.50

LTE Band25(Low Power)

Band 25					
Bandwidth (MHz)	RB allocation	Frequency (MHz)	QPSK	16QAM	64QAM
	RB offset (Start RB)		Actual output power (dBm)	Actual output power (dBm)	Actual output power (dBm)
1.4 MHz	1RB High (5)	1914.3	16.21	15.37	14.89
		1882.5	16.24	15.51	15.00
		1850.7	16.23	15.51	14.67
	1RB Middle (3)	1914.3	16.16	15.56	14.77
		1882.5	16.40	15.53	14.89
		1850.7	16.38	15.61	14.82
	1RB Low (0)	1914.3	16.07	15.39	14.67
		1882.5	16.18	15.48	14.80
		1850.7	16.16	15.58	14.92
	3RB High (3)	1914.3	16.17	15.09	14.54
		1882.5	16.22	15.29	14.65
		1850.7	16.23	15.24	14.65

	3RB Middle (1)	1914.3	16.21	15.21	14.60	
		1882.5	16.21	14.93	14.57	
		1850.7	16.28	14.86	14.48	
	3RB Low (0)	1914.3	16.13	15.29	14.56	
		1882.5	16.17	15.36	14.54	
		1850.7	16.22	15.48	14.64	
	6RB (0)	1914.3	15.29	14.29	13.59	
		1882.5	15.28	14.46	13.68	
		1850.7	15.42	14.39	13.65	
3 MHz	1RB High (14)	1913.5	16.16	15.45	14.92	
		1882.5	16.38	15.53	14.78	
		1851.5	16.39	15.58	14.79	
	1RB Middle (7)	1913.5	16.16	15.40	14.62	
		1882.5	16.14	15.54	14.65	
		1851.5	16.23	15.55	14.92	
	1RB Low (0)	1913.5	16.32	15.61	14.86	
		1882.5	16.23	15.40	14.88	
		1851.5	16.39	15.66	14.85	
	8RB High (7)	1913.5	15.41	14.46	13.81	
		1882.5	15.44	14.37	13.84	
		1851.5	15.51	14.50	13.79	
	8RB Middle (4)	1913.5	15.37	14.50	13.55	
		1882.5	15.46	14.50	13.78	
		1851.5	15.40	14.53	13.76	
	8RB Low (0)	1913.5	15.37	14.42	13.69	
		1882.5	15.38	14.46	13.71	
		1851.5	15.43	14.50	13.78	
	15RB (0)	1913.5	15.44	14.58	13.66	
		1882.5	15.45	14.45	13.74	
		1851.5	15.49	14.50	13.87	
	5 MHz	1RB High (24)	1912.5	16.29	15.60	14.74
			1882.5	16.23	15.57	15.24
			1852.5	16.38	15.62	14.81
1RB Middle (12)		1912.5	16.16	15.58	14.49	
		1882.5	16.15	15.71	14.50	
		1852.5	16.23	15.60	14.97	
1RB Low (0)		1912.5	16.21	15.57	14.78	
		1882.5	16.37	15.65	14.96	
		1852.5	16.40	15.68	14.88	
12RB High (13)		1912.5	15.36	14.32	13.67	
		1882.5	15.47	14.52	13.63	
		1852.5	15.47	14.47	13.75	
12RB Middle (6)		1912.5	15.42	14.42	13.69	
		1882.5	15.40	14.40	13.71	
		1852.5	15.47	14.47	13.74	
12RB Low (0)		1912.5	15.44	14.46	13.64	
		1882.5	15.42	14.21	13.79	
		1852.5	15.42	14.53	13.75	

	25RB (0)	1912.5	15.40	14.45	13.69
		1882.5	15.46	14.57	13.75
		1852.5	15.50	14.48	13.79
10 MHz	1RB High (49)	1910	16.27	15.57	14.92
		1882.5	16.27	15.42	14.62
		1855	16.27	15.51	14.80
	1RB Middle (24)	1910	16.16	15.39	14.73
		1882.5	16.21	15.63	14.84
		1855	16.23	15.73	14.86
	1RB Low (0)	1910	16.34	15.47	14.69
		1882.5	16.25	15.50	14.74
		1855	16.35	15.65	14.66
	25RB High (25)	1910	15.48	14.48	13.76
		1882.5	15.42	14.55	13.73
		1855	15.47	14.47	13.77
	25RB Middle (12)	1910	15.45	14.41	13.72
		1882.5	15.43	14.49	13.78
		1855	15.53	14.54	13.72
	25RB Low (0)	1910	15.34	14.43	13.69
		1882.5	15.30	14.41	13.70
		1855	15.58	14.58	13.88
	50RB (0)	1910	15.43	14.45	13.62
		1882.5	15.51	14.51	13.78
		1855	15.53	14.55	13.75
15 MHz	1RB High (74)	1907.5	16.12	15.42	14.50
		1882.5	16.18	15.45	14.60
		1857.5	16.10	15.28	14.52
	1RB Middle (37)	1907.5	16.12	15.55	14.47
		1882.5	16.12	15.54	14.55
		1857.5	16.13	15.49	14.54
	1RB Low (0)	1907.5	16.12	15.44	14.58
		1882.5	16.17	15.53	14.56
		1857.5	16.20	15.40	14.63
	36RB High (38)	1907.5	15.39	14.38	13.67
		1882.5	15.39	14.35	13.73
		1857.5	15.36	14.35	13.71
	36RB Middle (19)	1907.5	15.31	14.39	13.56
		1882.5	15.35	14.42	13.58
		1857.5	15.39	14.38	13.67
	36RB Low (0)	1907.5	15.33	14.30	13.58
		1882.5	15.31	14.38	13.64
		1857.5	15.44	14.41	13.61
	75RB (0)	1907.5	15.32	14.37	13.56
		1882.5	15.38	14.42	13.66
		1857.5	15.40	14.43	13.67
20 MHz	1RB High (99)	1905	16.03	15.31	14.46
		1882.5	15.96	15.27	14.48
		1860	16.03	15.36	14.43

	1RB Middle (50)	1905	16.03	15.33	14.57
		1882.5	16.04	15.28	14.49
		1860	15.98	15.26	14.53
	1RB Low (0)	1905	16.48	15.33	14.47
		1882.5	16.04	15.48	14.42
		1860	16.00	15.46	14.56
	50RB High (50)	1905	15.26	14.29	13.66
		1882.5	15.28	14.30	13.6
		1860	15.33	14.35	13.6
	50RB Middle (25)	1905	15.22	14.30	13.55
		1882.5	15.35	14.27	13.58
		1860	15.34	14.34	13.61
	50RB Low (0)	1905	15.21	14.28	13.57
		1882.5	15.25	14.23	13.55
		1860	15.31	14.33	13.61
100RB (0)	1905	15.29	14.30	13.52	
	1882.5	15.30	14.27	13.6	
	1860	15.25	14.23	13.54	

LTE Band26

Band 26						
Bandwidth (MHz)	RB allocation RB offset (Start RB)	Frequency (MHz)	QPSK	16QAM	64QAM	
			Actual output power (dBm)	Actual output power (dBm)	Actual output power (dBm)	
1.4 MHz	1RB High (5)	848.3	23.24	22.53	22.57	
		831.5	23.40	22.69	22.62	
		814.7	23.36	22.63	22.59	
	1RB Middle (3)	848.3	23.33	22.64	22.66	
		831.5	23.31	22.75	22.57	
		814.7	23.55	22.76	22.64	
	1RB Low (0)	848.3	23.23	22.40	22.47	
		831.5	23.29	22.61	22.61	
		814.7	23.33	22.59	22.65	
	3RB High (3)	848.3	23.35	22.36	22.33	
		831.5	23.37	22.41	22.47	
		814.7	23.43	22.56	22.64	
	3RB Middle (1)	848.3	23.26	22.33	22.46	
		831.5	23.43	22.53	22.48	
		814.7	23.51	22.51	22.54	
	3RB Low (0)	848.3	23.25	22.28	22.46	
		831.5	23.36	22.45	22.49	
		814.7	23.45	22.62	22.62	
	6RB (0)	848.3	22.29	21.47	21.25	
		831.5	22.41	21.52	21.27	
		814.7	22.44	21.63	21.50	
	3 MHz	1RB High (14)	847.5	23.33	22.61	21.56
			831.5	23.48	22.75	21.63
			815.5	23.46	22.72	22.49

	1RB Middle (7)	847.5	23.29	22.91	21.53	
		831.5	23.35	23.02	21.54	
		815.5	23.45	22.42	22.51	
	1RB Low (0)	847.5	23.44	22.77	21.62	
		831.5	23.39	22.79	21.47	
		815.5	23.47	22.54	22.47	
	8RB High (7)	847.5	22.44	21.58	20.48	
		831.5	22.47	21.42	20.58	
		815.5	22.46	21.51	20.60	
	8RB Middle (4)	847.5	22.46	21.52	20.59	
		831.5	22.48	21.65	20.64	
		815.5	22.53	21.49	20.68	
	8RB Low (0)	847.5	22.44	21.53	20.49	
		831.5	22.40	21.45	20.59	
		815.5	22.32	21.53	20.67	
	15RB (0)	847.5	22.50	21.57	20.55	
		831.5	22.49	21.49	20.44	
		815.5	22.40	21.50	20.41	
	5 MHz	1RB High (24)	846.5	23.45	22.64	22.42
			831.5	23.45	22.84	22.64
			816.5	23.45	22.76	22.74
		1RB Middle (12)	846.5	23.39	22.80	22.57
			831.5	23.41	22.82	22.61
			816.5	23.40	23.25	22.69
		1RB Low (0)	846.5	23.39	22.80	22.58
			831.5	23.51	22.78	22.64
			816.5	23.58	22.86	22.58
12RB High (13)		846.5	22.44	21.56	21.53	
		831.5	22.52	21.60	21.53	
		816.5	22.52	21.55	21.62	
12RB Middle (6)		846.5	22.44	21.55	21.56	
		831.5	22.49	21.55	21.53	
		816.5	22.62	21.59	21.60	
12RB Low (0)		846.5	22.52	21.56	21.48	
		831.5	22.45	21.50	21.51	
		816.5	22.60	21.65	21.64	
25RB (0)		846.5	22.47	21.54	21.54	
		831.5	22.47	21.54	21.53	
		816.5	22.61	21.53	21.54	
10 MHz		1RB High (49)	844	23.38	22.80	21.39
			831.5	23.38	22.71	21.70
			820	23.36	22.89	21.62
		1RB Middle (24)	844	23.37	22.57	21.72
			831.5	23.37	22.58	21.55
			820	23.38	22.68	21.70
	1RB Low (0)	844	23.49	22.95	21.56	
		831.5	23.44	22.85	21.77	
		820	23.42	23.10	21.54	

	25RB High (25)	844	22.54	21.58	20.57
		831.5	22.53	21.46	20.51
		820	22.57	21.59	20.54
	25RB Middle (12)	844	22.55	21.50	20.55
		831.5	22.40	21.50	20.50
		820	22.59	21.64	20.59
	25RB Low (0)	844	22.45	21.53	20.59
		831.5	22.54	21.53	20.53
		820	22.56	21.55	20.59
	50RB (0)	844	22.51	21.45	20.54
		831.5	22.44	21.48	20.48
		820	22.54	21.62	20.66
15 MHz	1RB High (74)	841.5	23.12	22.53	21.29
		831.5	23.24	22.54	21.41
		822.5	23.26	22.59	21.48
	1RB Middle (37)	841.5	23.20	22.59	21.44
		831.5	23.14	22.55	21.40
		822.5	23.31	22.69	21.51
	1RB Low (0)	841.5	23.34	22.74	21.47
		831.5	23.34	22.71	21.47
		822.5	23.36	22.92	21.58
	36RB High (38)	841.5	22.36	21.40	20.37
		831.5	22.39	21.41	20.44
		822.5	22.34	21.39	20.41
	36RB Middle (19)	841.5	22.29	21.33	20.36
		831.5	22.31	21.30	20.34
		822.5	22.37	21.34	20.44
	36RB Low (0)	841.5	22.39	21.26	20.32
		831.5	22.33	21.34	20.38
		822.5	22.40	21.34	20.45
	75RB (0)	841.5	22.34	21.43	20.42
		831.5	22.33	21.35	20.35
		822.5	22.41	21.38	20.48

LTE Band41PC3(Normal Power)

Band 41					
Bandwidth (MHz)	RB allocation	Frequency (MHz)	Actual output power (dBm)		
	RB offset		QPSK	16QAM	64QAM
5MHz	1RB-High	2687.5	24.02	23.23	22.63
		2640.3	24.04	23.27	22.56
		2593	23.84	23.04	22.33
		2545.8	23.86	23.14	22.35
		2498.5	23.68	22.91	22.24
	1RB-Middle	2687.5	24.22	23.17	22.55
		2640.3	24.19	23.22	22.33
		2593	23.88	23.00	22.30
		2545.8	23.85	23.03	22.13
	1RB-Low	2498.5	23.69	22.85	22.02
		2687.5	24.03	23.25	22.57

		2640.3	24.02	23.17	22.59
		2593	23.79	22.99	22.37
		2545.8	23.81	22.97	22.37
		2498.5	23.68	22.84	22.18
	12RB-High	2687.5	23.14	22.20	21.70
		2640.3	23.15	22.20	21.70
		2593	22.98	22.01	21.53
		2545.8	22.93	22.02	21.52
		2498.5	22.79	21.90	21.38
	12RB-Middle	2687.5	23.18	22.20	21.72
		2640.3	23.09	22.12	21.68
		2593	23.00	22.04	21.54
		2545.8	23.00	22.05	21.59
	12RB-Low	2498.5	22.79	21.93	21.43
		2687.5	23.16	22.16	21.74
		2640.3	23.08	22.16	21.64
		2593	22.95	22.01	21.54
		2545.8	22.96	22.01	21.54
	25RB	2498.5	22.74	21.83	21.40
		2687.5	23.09	22.24	21.69
2640.3		23.05	22.13	21.62	
2593		22.99	22.02	21.54	
2545.8		22.98	22.09	21.52	
10MHz	1RB-High	2498.5	22.80	21.89	21.36
		2687.5	23.09	22.24	21.69
		2640.3	23.05	22.13	21.62
		2593	22.99	22.02	21.54
		2545.8	22.98	22.09	21.52
	1RB-Middle	2685	23.94	23.09	22.51
		2639	23.92	23.14	22.45
		2593	23.77	22.97	22.30
		2547	23.75	22.93	22.26
		2501	23.70	22.85	22.17
	1RB-Low	2685	24.01	23.18	22.52
		2639	23.96	23.17	22.48
		2593	23.79	23.00	22.26
		2547	23.78	22.93	22.27
		2501	23.68	22.81	22.17
	25RB-High	2685	24.08	23.25	22.61
		2639	24.05	23.26	22.61
		2593	23.85	23.03	22.38
		2547	23.86	23.06	22.38
		2501	23.66	22.87	22.14
25RB-Middle	2685	23.15	22.28	21.74	
	2639	23.13	22.22	21.70	
	2593	22.96	22.09	21.54	
	2547	22.95	22.04	21.52	
	2501	22.80	21.89	21.35	
25RB-Low	2685	23.11	22.27	21.66	
	2639	23.11	22.20	21.66	
	2593	23.02	22.15	21.56	
	2547	22.98	22.10	21.52	
	2501	22.82	21.92	21.36	
50RB	2685	23.06	22.20	21.66	
	2639	23.09	22.22	21.65	
	2593	22.93	22.07	21.51	
	2547	22.96	22.09	21.54	
	2501	22.80	21.87	21.32	
		2685	23.13	22.27	21.70

		2639	23.08	22.21	21.64
		2593	22.99	22.13	21.53
		2547	22.99	22.13	21.55
		2501	22.83	21.97	21.37
15MHz	1RB-High	2682.5	23.86	23.03	22.37
		2637.8	23.71	23.06	22.30
		2593	23.72	22.87	22.18
		2548.3	23.68	22.86	22.12
		2503.5	23.62	22.81	22.03
	1RB-Middle	2682.5	23.88	23.08	22.40
		2637.8	23.85	23.00	22.30
		2593	23.63	22.86	22.18
		2548.3	23.65	22.85	22.11
		2503.5	23.52	22.73	22.01
	1RB-Low	2682.5	23.95	23.18	22.48
		2637.8	23.92	23.15	22.42
		2593	23.75	22.97	22.24
		2548.3	23.74	22.95	22.23
		2503.5	23.43	22.66	21.88
	36RB-High	2682.5	23.05	22.09	21.60
		2637.8	22.96	22.10	21.58
		2593	22.86	21.97	21.44
		2548.3	22.84	21.88	21.42
		2503.5	22.72	21.79	21.31
	36RB-Middle	2682.5	23.07	22.09	21.61
		2637.8	23.05	22.08	21.63
		2593	22.87	21.96	21.47
		2548.3	22.85	21.93	21.44
		2503.5	22.67	21.77	21.27
	36RB-Low	2682.5	23.03	22.07	21.60
		2637.8	22.99	22.07	21.58
		2593	22.87	21.95	21.48
		2548.3	22.90	21.95	21.49
		2503.5	22.61	21.71	21.25
	75RB	2682.5	22.94	22.07	21.59
		2637.8	23.05	22.16	21.65
2593		22.88	21.98	21.47	
2548.3		22.88	21.98	21.48	
2503.5		22.68	21.85	21.33	
20MHz	1RB-High	2680	24.20	23.39	22.53
		2636.5	24.35	23.48	22.62
		2593	24.34	23.49	22.67
		2549.5	24.15	23.30	22.49
		2506	24.20	23.37	22.48
	1RB-Middle	2680	24.25	23.39	22.55
		2636.5	24.38	23.54	22.69
		2593	24.31	23.37	22.59
		2549.5	24.23	23.34	22.54
		2506	24.06	23.21	22.39
	1RB-Low	2680	24.38	23.58	22.73
		2636.5	24.54	23.73	22.93
		2593	24.38	23.57	22.74
		2549.5	24.28	23.41	22.64
		2506	23.96	23.09	22.32
	50RB-High	2680	23.35	22.41	21.83

		2636.5	23.47	22.51	21.94
		2593	23.43	22.52	21.95
		2549.5	23.34	22.37	21.79
		2506	23.31	22.34	21.77
	50RB-Middle	2680	23.36	22.38	21.85
		2636.5	23.46	22.51	21.94
		2593	23.45	22.50	21.91
		2549.5	23.36	22.41	21.86
	50RB-Low	2506	23.23	22.22	21.74
		2680	23.38	22.41	21.90
		2636.5	23.54	22.57	21.80
		2593	23.38	22.45	21.87
	100RB	2549.5	23.39	22.42	21.87
		2506	23.16	22.18	21.68
		2680	23.36	22.40	21.99
		2636.5	23.44	22.51	21.91
	2593	23.47	22.47	21.84	
	2549.5	23.40	22.42	21.97	
	2506	23.23	22.25	21.79	
	2680	23.36	22.40	21.99	

LTE Band41PC3(Low Power)

		Band 41			
Bandwidth (MHz)	RB allocation	Frequency (MHz)	Actual output power (dBm)		
	RB offset		QPSK	16QAM	64QAM
5MHz	1RB-High	2687.5	14.44	13.57	12.69
		2640.3	14.56	13.66	12.93
		2593	14.44	13.59	12.79
		2545.8	14.44	13.57	12.88
		2498.5	14.13	13.39	12.50
	1RB-Middle	2687.5	14.49	13.62	12.58
		2640.3	14.56	13.62	12.78
		2593	14.49	13.54	12.72
		2545.8	14.46	13.58	12.67
	1RB-Low	2498.5	14.41	13.26	12.49
		2687.5	14.41	13.53	12.75
		2640.3	14.47	13.62	12.85
		2593	14.39	13.52	12.80
	12RB-High	2545.8	14.40	13.56	12.68
		2498.5	14.14	13.31	12.52
		2687.5	13.45	12.42	11.96
		2640.3	13.55	12.57	12.06
		2593	13.51	12.47	11.95
	12RB-Middle	2545.8	13.48	12.46	11.91
		2498.5	13.25	12.25	11.70
		2687.5	13.50	12.47	11.97
		2640.3	13.53	12.53	12.08
		2593	13.49	12.50	11.92
	12RB-Low	2545.8	13.50	12.48	11.95
2498.5		13.23	12.23	11.73	
2687.5		13.55	12.47	11.96	
2640.3		13.57	12.54	12.01	
2593		13.49	12.43	11.96	
	2545.8	13.51	12.48	12.00	
	2498.5	13.28	12.24	11.74	
	2687.5	13.55	12.47	11.96	

	25RB	2687.5	13.48	12.46	11.87
		2640.3	13.52	12.51	11.94
		2593	13.50	12.49	11.91
		2545.8	13.46	12.48	11.97
		2498.5	13.25	12.19	11.66
10MHz	1RB-High	2685	14.45	13.50	12.65
		2639	14.43	13.61	12.77
		2593	14.38	13.58	12.74
		2547	14.35	13.54	12.72
		2501	14.20	13.37	12.59
	1RB-Middle	2685	14.40	13.56	12.75
		2639	14.47	13.64	12.86
		2593	14.42	13.54	12.80
		2547	14.32	13.53	12.71
		2501	14.03	13.29	12.61
	1RB-Low	2685	14.47	13.65	12.82
		2639	14.62	13.74	12.98
		2593	14.45	13.61	12.83
		2547	14.43	13.66	12.83
		2501	14.14	13.35	12.51
	25RB-High	2685	13.50	12.56	11.96
		2639	13.61	12.67	12.10
		2593	13.52	12.54	11.97
		2547	13.52	12.47	11.99
		2501	13.30	12.28	11.77
	25RB-Middle	2685	13.50	12.48	11.94
		2639	13.60	12.56	12.05
		2593	13.54	12.51	11.97
		2547	13.53	12.54	12.01
		2501	13.29	12.28	11.74
	25RB-Low	2685	13.43	12.49	11.85
		2639	13.57	12.63	12.07
		2593	13.44	12.47	11.90
		2547	13.49	12.54	11.98
		2501	13.22	12.29	11.75
	50RB	2685	13.44	12.44	11.92
		2639	13.50	12.59	12.00
		2593	13.52	12.55	11.96
		2547	13.48	12.54	11.97
		2501	13.32	12.32	11.70
15MHz	1RB-High	2682.5	14.20	13.32	12.38
		2637.8	14.27	13.42	12.58
		2593	14.28	13.43	12.54
		2548.3	14.24	13.38	12.47
		2503.5	14.11	13.19	12.28
	1RB-Middle	2682.5	14.25	13.33	12.44
		2637.8	14.37	13.45	12.61
		2593	14.18	13.30	12.42
		2548.3	14.23	13.31	12.44
		2503.5	13.97	13.10	12.25
	1RB-Low	2682.5	14.42	13.49	12.56
		2637.8	14.51	13.65	12.81
		2593	14.35	13.47	12.59
		2548.3	14.30	13.48	12.58
		2503.5	13.98	13.09	12.19

	36RB-High	2682.5	13.31	12.33	11.83
		2637.8	13.45	12.38	11.90
		2593	13.33	12.32	11.87
		2548.3	13.35	12.30	11.85
		2503.5	13.13	12.09	11.63
	36RB-Middle	2682.5	13.36	12.35	11.85
		2637.8	13.42	12.44	11.97
		2593	13.34	12.32	11.80
		2548.3	13.37	12.30	11.83
		2503.5	13.13	12.09	11.59
	36RB-Low	2682.5	13.37	12.29	11.82
		2637.8	13.45	12.42	11.94
		2593	13.32	12.31	11.78
		2548.3	13.39	12.38	11.87
		2503.5	13.04	12.07	11.59
	75RB	2682.5	13.30	12.36	11.81
		2637.8	13.47	12.49	12.00
		2593	13.37	12.38	11.89
		2548.3	13.39	12.37	11.89
		2503.5	13.14	12.11	11.64
20MHz	1RB-High	2680	14.59	13.63	12.68
		2636.5	14.65	13.72	12.77
		2593	14.47	13.55	12.62
		2549.5	14.34	13.44	12.51
		2506	14.22	13.36	12.35
	1RB-Middle	2680	14.60	13.66	12.74
		2636.5	14.71	13.73	12.85
		2593	14.43	13.47	12.56
		2549.5	14.36	13.49	12.52
		2506	14.13	13.22	12.36
	1RB-Low	2680	14.78	13.84	12.88
		2636.5	14.86	13.94	13.01
		2593	14.54	13.62	12.68
		2549.5	14.46	13.52	12.55
		2506	14.00	13.14	12.14
	50RB-High	2680	13.75	12.66	12.06
		2636.5	13.75	12.73	12.13
		2593	13.54	12.51	11.91
		2549.5	13.52	12.50	11.9
		2506	13.32	12.34	11.77
	50RB-Middle	2680	13.71	12.66	12.08
		2636.5	13.85	12.81	12.2
		2593	13.58	12.51	11.95
		2549.5	13.55	12.53	11.94
		2506	13.28	12.26	11.72
	50RB-Low	2680	13.77	12.71	12.11
		2636.5	13.82	12.75	12.17
		2593	13.53	12.43	11.9
		2549.5	13.56	12.56	11.94
		2506	13.28	12.24	11.65
	100RB	2680	13.65	12.61	12.15
		2636.5	13.83	12.80	12.23
2593		13.59	12.49	12	
2549.5		13.52	12.51	12.02	
2506		13.27	12.29	11.72	

LTE Band41PC2(Normal Power)

Band 41					
Bandwidth (MHz)	RB allocation RB offset	Frequency (MHz)	Actual output power (dBm)		
			QPSK	16QAM	64QAM
5MHz	1RB-High	2687.5	26.28	25.30	24.64
		2640.3	26.63	25.64	24.95
		2593	26.44	25.58	24.86
		2545.8	26.43	25.52	24.91
		2498.5	26.34	25.54	24.91
	1RB-Middle	2687.5	26.26	25.47	24.77
		2640.3	26.50	25.61	24.90
		2593	26.54	25.37	24.90
		2545.8	26.56	25.45	24.90
		2498.5	26.39	25.32	24.73
	1RB-Low	2687.5	26.59	25.58	24.90
		2640.3	26.56	25.67	24.81
		2593	26.36	25.53	24.75
		2545.8	26.39	25.60	24.97
		2498.5	26.29	25.44	24.88
	12RB-High	2687.5	25.35	24.44	23.79
		2640.3	25.65	24.57	24.02
		2593	25.43	24.38	23.77
		2545.8	25.46	24.55	23.83
		2498.5	25.38	24.30	23.64
	12RB-Middle	2687.5	25.51	24.62	23.97
		2640.3	25.59	24.71	23.94
		2593	25.41	24.55	23.83
		2545.8	25.48	24.49	23.84
		2498.5	25.34	24.33	23.65
	12RB-Low	2687.5	25.67	24.73	24.04
		2640.3	25.57	24.66	23.94
		2593	25.47	24.48	23.76
		2545.8	25.46	24.39	23.82
		2498.5	25.35	24.27	23.69
	25RB	2687.5	25.48	24.64	23.92
		2640.3	25.56	24.60	23.83
2593		25.40	24.49	23.75	
2545.8		25.47	24.50	23.76	
2498.5		25.33	24.39	23.62	
10MHz	1RB-High	2685	26.39	25.44	24.70
		2639	26.49	25.81	24.91
		2593	26.27	25.60	24.83
		2547	26.27	25.61	24.84
		2501	26.31	25.57	24.84
	1RB-Middle	2685	26.60	25.84	24.95
		2639	26.48	25.80	24.91
		2593	26.39	25.61	24.89
		2547	26.34	25.62	24.90
		2501	26.27	25.50	24.82
	1RB-Low	2685	26.69	26.00	24.95
		2639	26.65	25.97	24.85
		2593	26.42	25.67	24.96
		2547	26.43	25.79	24.97

	25RB-High	2501	26.18	25.58	24.78
		2685	25.66	24.76	24.01
		2639	25.61	24.68	23.95
		2593	25.47	24.50	23.75
		2547	25.46	24.54	23.81
	25RB-Middle	2501	25.37	24.44	23.69
		2685	25.64	24.72	23.98
		2639	25.59	24.68	23.94
		2593	25.45	24.53	23.79
		2547	25.43	24.57	23.84
	25RB-Low	2501	25.36	24.43	23.67
		2685	25.61	24.70	23.93
		2639	25.56	24.67	23.90
		2593	25.42	24.48	23.75
		2547	25.45	24.55	23.82
	50RB	2501	25.26	24.38	23.63
		2685	25.64	24.71	23.95
		2639	25.58	24.65	23.88
		2593	25.46	24.55	23.78
		2547	25.49	24.56	23.80
15MHz	1RB-High	2501	25.35	24.47	23.65
		2682.5	25.89	25.02	23.24
		2637.8	26.30	25.14	24.39
		2593	26.41	24.78	24.00
		2548.3	26.13	25.54	24.81
	1RB-Middle	2503.5	26.10	25.49	24.78
		2682.5	26.31	25.83	24.85
		2637.8	26.40	25.77	24.81
		2593	26.06	25.54	24.86
		2548.3	26.11	25.55	24.82
	1RB-Low	2503.5	26.01	25.41	24.69
		2682.5	26.46	25.45	24.69
		2637.8	25.67	25.00	24.18
		2593	26.20	24.99	24.21
		2548.3	26.22	25.66	24.93
	36RB-High	2503.5	25.96	25.38	24.67
		2682.5	25.57	24.60	23.88
		2637.8	25.50	24.54	23.86
		2593	25.33	24.38	23.70
		2548.3	25.32	24.38	23.66
36RB-Middle	2503.5	25.28	24.27	23.61	
	2682.5	25.63	24.64	23.92	
	2637.8	25.57	24.56	23.87	
	2593	25.34	24.33	23.68	
	2548.3	25.36	24.38	23.68	
36RB-Low	2503.5	25.23	24.27	23.56	
	2682.5	25.53	24.58	23.87	
	2637.8	25.55	24.56	23.87	
	2593	25.35	24.37	23.72	
	2548.3	25.37	24.39	23.75	
75RB	2503.5	25.17	24.23	23.53	
	2682.5	25.50	24.55	23.87	
	2637.8	25.55	24.63	23.91	
	2593	25.32	24.38	23.70	
		2548.3	25.34	24.40	23.72

20MHz	1RB-High	2503.5	25.25	24.30	23.58
		2680	26.32	25.75	24.48
		2636.5	26.41	25.76	24.52
		2593	26.40	25.80	24.61
		2549.5	26.31	25.66	24.48
	1RB-Middle	2506	26.34	25.73	24.47
		2680	26.35	25.71	24.50
		2636.5	26.42	25.79	24.53
		2593	26.35	25.70	24.52
		2549.5	26.36	25.70	24.47
	1RB-Low	2506	26.24	25.58	24.30
		2680	26.52	25.89	24.60
		2636.5	26.59	26.02	24.70
		2593	26.47	25.84	24.59
		2549.5	26.43	25.80	24.53
	50RB-High	2506	26.14	25.53	24.27
		2680	25.55	24.63	23.61
		2636.5	25.62	24.68	23.68
		2593	25.58	24.65	23.72
		2549.5	25.60	24.66	23.67
	50RB-Middle	2506	25.55	24.60	23.61
		2680	25.52	24.55	23.62
		2636.5	25.61	24.69	23.68
		2593	25.63	24.70	23.71
		2549.5	25.64	24.72	23.67
	50RB-Low	2506	25.53	24.54	23.60
		2680	25.56	24.59	23.61
		2636.5	25.69	24.73	23.75
		2593	25.63	24.67	23.64
		2549.5	25.63	24.69	23.70
	100RB	2506	25.46	24.49	23.48
		2680	25.54	24.63	23.57
2636.5		25.59	24.68	23.68	
2593		25.63	24.71	23.71	
2549.5		25.60	24.64	23.65	
		2506	25.55	24.54	23.58

LTE Band41PC2(Low Power)

		Band 41			
Bandwidth (MHz)	RB allocation RB offset	Frequency (MHz)	Actual output power (dBm)		
			QPSK	16QAM	64QAM
5MHz	1RB-High	2687.5	16.81	15.66	14.87
		2640.3	16.98	15.80	14.96
		2593	16.87	15.68	14.92
		2545.8	16.95	15.74	15.04
		2498.5	16.75	15.49	14.72
	1RB-Middle	2687.5	16.78	15.56	14.78
		2640.3	16.91	15.78	15.00
		2593	16.98	15.64	14.80
		2545.8	16.84	15.66	14.89
		2498.5	16.69	15.42	14.69
	1RB-Low	2687.5	16.81	15.68	14.85
		2640.3	16.96	15.80	15.00
		2593	16.90	15.68	14.94

		2545.8	16.87	15.75	14.98
		2498.5	16.67	15.45	14.71
	12RB-High	2687.5	15.91	14.35	13.87
		2640.3	16.02	14.50	13.91
		2593	16.02	14.53	13.86
		2545.8	16.01	14.46	13.94
		2498.5	15.79	14.33	13.68
	12RB-Middle	2687.5	15.93	14.41	13.79
		2640.3	16.02	14.60	13.93
		2593	16.00	14.51	13.97
		2545.8	16.04	14.54	13.96
	12RB-Low	2498.5	15.78	14.31	13.70
		2687.5	15.98	14.40	13.82
		2640.3	16.03	14.56	13.96
		2593	15.96	14.54	13.95
	25RB	2545.8	16.01	14.56	13.94
		2498.5	15.74	14.31	13.66
		2687.5	15.85	14.47	13.76
		2640.3	15.99	14.53	13.86
		2593	15.97	14.53	13.88
10MHz	1RB-High	2545.8	15.98	14.54	13.86
		2498.5	15.76	14.32	13.64
		2685	16.84	15.56	14.82
		2639	16.87	15.68	14.97
		2593	16.80	15.72	14.93
	1RB-Middle	2547	16.90	15.74	14.92
		2501	16.72	15.61	14.83
		2685	16.90	15.57	14.91
		2639	17.03	15.67	15.04
		2593	16.98	15.60	14.97
	1RB-Low	2547	16.97	15.68	14.97
		2501	16.74	15.44	14.75
		2685	16.97	15.64	15.00
		2639	17.11	15.85	15.13
		2593	17.03	15.75	15.06
	25RB-High	2547	17.03	15.83	15.02
		2501	16.76	15.44	14.76
		2685	15.96	14.48	13.81
		2639	16.06	14.61	13.96
		2593	16.04	14.52	13.89
25RB-Middle	2547	16.05	14.56	13.88	
	2501	15.84	14.37	13.70	
	2685	15.87	14.42	13.76	
	2639	16.06	14.56	13.92	
	2593	16.00	14.53	13.86	
25RB-Low	2547	16.04	14.58	13.94	
	2501	15.81	14.33	13.67	
	2685	15.90	14.39	13.74	
	2639	16.03	14.56	13.89	
	2593	15.99	14.51	13.89	
50RB	2547	16.04	14.57	13.86	
	2501	15.81	14.28	13.65	
	2685	15.91	14.36	13.72	
		2639	16.01	14.63	13.91
		2593	16.03	14.51	13.91

		2547	16.06	14.62	13.88
		2501	15.82	14.28	13.64
15MHz	1RB-High	2682.5	16.66	15.45	14.64
		2637.8	16.82	15.61	14.75
		2593	16.76	15.57	14.78
		2548.3	16.77	15.58	14.81
		2503.5	16.61	15.36	14.59
		2682.5	16.65	15.39	14.60
	1RB-Middle	2637.8	16.78	15.58	14.82
		2593	16.66	15.52	14.69
		2548.3	16.74	15.56	14.74
		2503.5	16.51	15.26	14.54
		2682.5	16.74	15.58	14.80
	1RB-Low	2637.8	16.98	15.82	14.98
		2593	16.82	15.63	14.83
		2548.3	16.81	15.61	14.83
		2503.5	16.47	15.29	14.48
		2682.5	15.77	14.27	13.68
	36RB-High	2637.8	15.92	14.38	13.81
		2593	15.86	14.34	13.75
		2548.3	15.89	14.34	13.78
		2503.5	15.68	14.18	13.58
		2682.5	15.73	14.22	13.60
	36RB-Middle	2637.8	15.97	14.45	13.86
		2593	15.84	14.35	13.75
		2548.3	15.91	14.36	13.76
		2503.5	15.67	14.15	13.55
	36RB-Low	2682.5	15.78	14.27	13.66
		2637.8	15.98	14.44	13.87
		2593	15.94	14.39	13.78
2548.3		15.92	14.42	13.82	
75RB	2503.5	15.63	14.11	13.52	
	2682.5	15.79	14.27	13.65	
	2637.8	15.97	14.48	13.93	
	2593	15.91	14.43	13.81	
	2548.3	15.89	14.42	13.84	
20MHz	1RB-High	2503.5	15.65	14.21	13.59
		2680	16.71	16.03	14.72
		2636.5	16.83	16.14	14.89
		2593	16.76	16.09	14.77
		2549.5	16.70	15.95	14.68
	1RB-Middle	2506	16.54	15.93	14.62
		2680	16.73	16.04	14.73
		2636.5	16.86	16.17	14.89
		2593	16.65	15.97	14.69
		2549.5	16.67	15.98	14.71
	1RB-Low	2506	16.44	15.75	14.46
		2680	16.86	16.24	14.94
		2636.5	17.08	16.36	15.13
		2593	16.85	16.12	14.86
		2549.5	16.72	16.04	14.72
	50RB-High	2506	16.38	15.72	14.45
		2680	15.88	14.90	13.75
		2636.5	16.02	15.00	13.86
		2593	15.84	14.86	13.74

	50RB-Middle	2549.5	15.87	14.89	13.72	
		2506	15.66	14.72	13.6	
		2680	15.95	14.99	13.79	
	50RB-Low	2636.5	16.10	15.09	13.95	
		2593	15.85	14.92	13.72	
		2549.5	15.90	14.91	13.74	
		2506	15.67	14.71	13.55	
		2680	15.85	14.91	13.77	
	100RB	2636.5	16.01	15.06	13.95	
		2593	15.87	14.89	13.74	
		2549.5	15.90	14.93	13.8	
		2506	15.61	14.66	13.5	
		2680	15.85	14.88	13.87	
			2636.5	16.04	15.10	14.01
			2593	15.86	14.91	13.78
		2549.5	15.88	14.91	13.84	
		2506	15.65	14.72	13.62	

LTE Band66(Normal Power) ANT2

		Band 66			
Bandwidth (MHz)	RB allocation	Frequency (MHz)	Actual output power (dBm)		
	RB offset		QPSK	16QAM	64QAM
1.4MHz	1RB-High	1779.3	23.00	22.22	22.21
		1745	23.02	22.37	22.30
		1710.7	23.05	22.36	22.41
	1RB-Middle	1779.3	23.11	22.30	22.38
		1745	23.01	22.45	22.26
		1710.7	23.15	22.58	22.46
	1RB-Low	1779.3	23.04	22.23	22.16
		1745	23.05	22.39	22.33
		1710.7	23.02	22.39	22.34
	3RB-High	1779.3	23.03	22.20	22.34
		1745	23.16	22.20	22.24
		1710.7	23.15	22.21	22.29
	3RB-Middle	1779.3	23.04	22.19	22.19
		1745	23.33	22.01	22.18
		1710.7	23.19	22.07	22.10
	3RB-Low	1779.3	23.09	22.29	22.21
		1745	23.13	22.31	22.21
		1710.7	23.12	22.17	22.29
6RB	1779.3	22.11	21.38	21.24	
	1745	22.20	21.36	21.15	
	1710.7	22.22	21.16	21.24	
3MHz	1RB-High	1778.5	23.13	22.54	22.21
		1745	23.18	22.52	22.35
		1711.5	23.29	22.64	22.35
	1RB-Middle	1778.5	23.05	22.75	22.18
		1745	23.11	22.86	22.13
		1711.5	23.08	22.61	22.40
	1RB-Low	1778.5	23.14	22.45	22.34
		1745	23.20	22.44	22.39
		1711.5	23.16	22.54	22.39
8RB-High	1778.5	22.25	21.36	21.38	
	1745	22.29	21.25	21.44	

	8RB-Middle	1711.5	22.30	21.40	21.43	
		1778.5	22.31	21.33	21.23	
		1745	22.31	21.41	21.36	
	8RB-Low	1711.5	22.39	21.43	21.37	
		1778.5	22.22	21.36	21.36	
		1745	22.21	21.37	21.31	
	15RB	1711.5	22.27	21.37	21.41	
		1778.5	22.28	21.31	21.29	
		1745	22.26	21.18	21.27	
	5MHz	1RB-High	1711.5	22.31	21.38	21.35
			1777.5	23.11	22.51	22.17
			1745	23.12	22.58	21.33
1RB-Middle		1712.5	23.11	22.57	21.41	
		1777.5	23.11	22.54	22.21	
		1745	23.15	22.14	21.37	
1RB-Low		1712.5	23.22	22.54	21.49	
		1777.5	23.14	22.58	22.39	
		1745	23.22	22.61	21.40	
12RB-High		1712.5	23.17	22.59	21.49	
		1777.5	22.28	21.30	21.36	
		1745	22.31	21.31	20.49	
12RB-Middle		1712.5	22.29	21.39	20.46	
		1777.5	22.29	21.39	21.36	
		1745	22.31	21.32	20.29	
12RB-Low		1712.5	22.38	21.44	20.47	
		1777.5	22.22	21.18	21.31	
		1745	22.29	21.39	20.32	
25RB		1712.5	22.31	21.38	20.43	
		1777.5	22.23	21.36	21.33	
		1745	22.21	21.32	20.37	
10MHz		1RB-High	1712.5	22.31	21.36	20.45
			1775	23.07	22.67	22.39
			1745	23.13	22.72	22.27
	1RB-Middle	1715	23.09	22.52	22.36	
		1775	23.13	22.48	22.37	
		1745	23.06	22.44	22.45	
	1RB-Low	1715	23.12	22.39	22.40	
		1775	23.11	22.53	22.40	
		1745	23.10	22.40	22.43	
	25RB-High	1715	23.19	22.68	22.45	
		1775	22.36	21.34	21.38	
		1745	22.29	21.37	21.35	
	25RB-Middle	1715	22.35	21.41	21.28	
		1775	22.23	21.38	21.39	
		1745	22.24	21.32	21.40	
	25RB-Low	1715	22.33	21.47	21.34	
		1775	22.18	21.34	21.33	
		1745	22.29	21.30	21.36	
	50RB	1715	22.30	21.43	21.49	
		1775	22.24	21.39	21.18	
		1745	22.26	21.27	21.23	
	15MHz	1RB-High	1715	22.34	21.45	21.33
			1772.5	23.05	22.41	22.48
			1745	23.04	22.35	22.41
		1717.5	23.02	22.39	22.29	

	1RB-Middle	1772.5	23.07	22.50	22.28	
		1745	23.11	22.41	22.46	
		1717.5	23.04	22.39	22.40	
	1RB-Low	1772.5	23.09	22.50	22.41	
		1745	23.06	22.43	22.33	
		1717.5	23.07	22.56	22.40	
	36RB-High	1772.5	22.10	21.19	21.26	
		1745	22.18	21.26	21.24	
		1717.5	22.19	21.27	21.18	
	36RB-Middle	1772.5	22.09	21.09	21.16	
		1745	22.11	21.23	21.20	
		1717.5	22.21	21.30	21.27	
	36RB-Low	1772.5	22.12	21.13	21.13	
		1745	22.14	21.11	21.17	
		1717.5	22.22	21.28	21.25	
	75RB	1772.5	22.06	21.13	21.25	
		1745	22.21	21.13	21.20	
		1717.5	22.25	21.24	21.22	
	20MHz	1RB-High	1770	23.19	22.31	22.26
			1745	23.09	22.39	22.25
			1720	23.07	22.44	21.12
		1RB-Middle	1770	23.09	22.32	22.16
			1745	23.07	22.40	22.24
			1720	23.00	22.30	21.03
		1RB-Low	1770	23.03	22.36	22.25
			1745	23.09	22.44	22.30
			1720	23.21	22.40	21.11
50RB-High		1770	22.06	21.13	21.06	
		1745	22.20	21.26	21.17	
		1720	22.12	21.17	20.18	
50RB-Middle		1770	22.04	21.12	21.04	
		1745	22.24	21.26	21.17	
		1720	22.15	21.19	20.21	
50RB-Low		1770	22.08	21.12	21.06	
		1745	22.18	21.22	21.15	
		1720	22.15	21.19	20.19	
100RB		1770	22.08	21.08	21.14	
		1745	22.23	21.24	20.27	
		1720	22.16	21.17	20.22	

LTE Band66(Low Power) ANT2

		Band 66			
Bandwidth (MHz)	RB allocation	Frequency (MHz)	Actual output power (dBm)		
	RB offset		QPSK	16QAM	64QAM
1.4MHz	1RB-High	1779.3	15.07	15.32	13.92
		1745	16.07	15.50	13.91
		1710.7	16.10	15.47	13.91
	1RB-Middle	1779.3	15.23	15.33	13.90
		1745	16.38	15.58	13.96
		1710.7	16.39	15.56	14.03
	1RB-Low	1779.3	15.21	15.37	13.91
		1745	16.07	15.36	13.94
		1710.7	16.19	15.42	13.90
	3RB-High	1779.3	16.07	15.14	13.93

		1745	16.09	15.23	13.69	
		1710.7	16.14	15.24	13.78	
		1779.3	16.09	15.22	13.89	
	3RB-Middle		1745	16.14	14.78	13.73
			1710.7	16.18	15.28	13.79
			1779.3	16.06	15.30	13.82
	3RB-Low		1745	16.14	15.28	13.53
			1710.7	16.16	15.31	13.77
			1779.3	15.18	14.26	12.75
	6RB		1745	15.28	14.31	12.70
			1710.7	15.28	14.44	12.80
			1778.5	16.08	15.53	14.94
3MHz	1RB-High	1745	16.22	15.48	14.83	
		1711.5	16.20	15.47	15.03	
		1778.5	16.06	15.35	14.58	
	1RB-Middle		1745	16.08	15.42	14.70
			1711.5	16.12	15.50	14.78
			1778.5	16.19	15.57	15.00
	1RB-Low		1745	16.12	15.58	14.91
			1711.5	16.24	15.65	15.05
			1778.5	15.24	14.37	13.91
	8RB-High		1745	15.33	14.47	13.83
			1711.5	15.34	14.45	14.04
			1778.5	15.39	14.43	13.77
	8RB-Middle		1745	15.40	14.41	13.88
			1711.5	15.48	14.53	13.89
			1778.5	15.33	14.39	13.82
	8RB-Low		1745	15.31	14.38	13.89
			1711.5	15.45	14.42	13.93
			1778.5	15.34	14.27	13.75
	15RB		1745	15.30	14.29	13.78
			1711.5	15.38	14.39	13.96
			1777.5	16.23	15.53	14.85
	5MHz	1RB-High	1745	16.22	15.44	14.95
			1712.5	16.23	15.59	15.15
			1777.5	16.11	15.35	14.83
1RB-Middle			1745	15.97	15.44	14.71
			1712.5	16.14	15.33	14.86
			1777.5	16.25	15.55	14.96
1RB-Low			1745	16.15	15.43	14.80
			1712.5	16.22	15.61	15.08
			1777.5	15.33	14.35	13.83
12RB-High			1745	15.30	14.38	13.72
			1712.5	15.38	14.35	13.84
			1777.5	15.35	14.40	13.88
12RB-Middle			1745	15.43	14.44	13.69
			1712.5	15.47	14.47	13.96
			1777.5	15.34	14.31	13.82
12RB-Low			1745	15.25	14.25	13.81
			1712.5	15.39	14.49	13.85
			1777.5	15.32	14.27	13.97
25RB			1745	15.35	14.35	13.92
			1712.5	15.39	14.38	13.97
			1775	16.00	15.37	14.82
10MHz		1RB-High	1745	16.15	15.33	14.54

	1RB-Middle	1715	16.14	15.45	14.66	
		1775	16.24	15.39	14.93	
		1745	16.13	15.42	14.92	
	1RB-Low	1715	16.10	15.47	14.99	
		1775	16.21	15.36	14.71	
		1745	16.13	15.48	14.82	
	25RB-High	1715	16.29	15.60	14.92	
		1775	15.35	14.35	13.78	
		1745	15.35	14.41	13.81	
	25RB-Middle	1715	15.40	14.36	13.96	
		1775	15.26	14.35	13.84	
		1745	15.41	14.39	13.88	
	25RB-Low	1715	15.43	14.51	14.02	
		1775	15.25	14.33	13.83	
		1745	15.25	14.30	13.83	
	50RB	1715	15.36	14.49	14.05	
		1775	15.26	14.34	13.73	
		1745	15.35	14.42	13.80	
15MHz	1RB-High	1715	15.41	14.41	13.99	
		1772.5	16.01	15.33	13.76	
		1745	16.01	15.31	13.62	
	1RB-Middle	1717.5	16.03	15.25	13.92	
		1772.5	15.93	15.41	13.82	
		1745	16.01	15.38	13.77	
	1RB-Low	1717.5	16.04	15.51	13.79	
		1772.5	15.98	15.34	13.84	
		1745	16.02	15.34	13.72	
	36RB-High	1717.5	16.05	15.36	13.89	
		1772.5	15.22	14.14	12.76	
		1745	15.18	14.24	12.74	
	36RB-Middle	1717.5	15.24	14.16	12.74	
		1772.5	15.23	14.16	12.76	
		1745	15.23	14.19	12.70	
	36RB-Low	1717.5	15.27	14.22	12.80	
		1772.5	15.18	14.10	12.72	
		1745	15.12	14.07	12.67	
75RB	1717.5	15.33	14.27	12.83		
	1772.5	15.25	14.19	12.67		
	1745	15.23	14.19	12.71		
20MHz	1RB-High	1717.5	15.32	14.28	12.69	
		1770	16.06	15.37	14.84	
		1745	15.98	15.40	14.62	
	1RB-Middle	1720	16.05	15.40	14.73	
		1770	16.05	15.45	14.76	
		1745	16.06	15.40	14.72	
	1RB-Low	1720	16.38	15.35	14.66	
		1770	16.05	15.43	14.71	
		1745	16.05	15.36	14.70	
	50RB-High	1720	16.07	15.45	14.86	
		1770	15.29	14.23	13.70	
		1745	15.24	14.19	13.76	
	50RB-Middle	1720	15.30	14.26	13.73	
		1770	15.12	14.15	13.71	
		1745	15.31	14.27	13.71	
			1720	15.28	14.32	13.79

	50RB-Low	1770	15.25	14.19	13.64
		1745	15.15	14.19	13.65
		1720	15.23	14.27	13.75
	100RB	1770	15.22	14.13	13.64
		1745	15.26	14.20	13.76
		1720	15.28	14.30	13.78

LTE Band66 ANT0

Band 66						
Bandwidth (MHz)	RB allocation RB offset	Frequency (MHz)	Actual output power (dBm)			
			QPSK	16QAM	64QAM	
1.4MHz	1RB-High	1779.3	24.48	23.77	23.67	
		1745	24.36	23.59	23.54	
		1710.7	24.42	23.66	23.65	
	1RB-Middle	1779.3	24.52	23.93	23.65	
		1745	24.44	23.64	23.65	
		1710.7	24.46	23.75	23.79	
	1RB-Low	1779.3	24.40	23.66	23.82	
		1745	24.41	23.72	23.72	
		1710.7	24.38	23.75	23.83	
	3RB-High	1779.3	24.44	23.53	23.57	
		1745	24.38	23.52	23.58	
		1710.7	24.47	23.51	23.56	
	3RB-Middle	1779.3	24.45	23.57	23.58	
		1745	24.53	23.52	23.55	
		1710.7	24.48	23.61	23.59	
	3RB-Low	1779.3	24.46	23.46	23.61	
		1745	24.42	23.56	23.62	
		1710.7	24.46	23.48	23.59	
	6RB	1779.3	23.65	22.65	22.37	
		1745	23.47	22.48	22.39	
		1710.7	23.55	22.57	22.50	
	3MHz	1RB-High	1778.5	24.55	23.86	23.77
			1745	24.59	23.93	23.70
			1711.5	24.50	23.96	23.82
1RB-Middle		1778.5	24.52	23.87	23.62	
		1745	24.49	24.16	23.68	
		1711.5	24.49	24.19	23.74	
1RB-Low		1778.5	24.61	23.96	23.68	
		1745	24.52	23.93	23.71	
		1711.5	24.62	23.95	23.77	
8RB-High		1778.5	23.73	22.63	22.65	
		1745	23.62	22.60	22.64	
		1711.5	23.64	22.76	22.73	
8RB-Middle		1778.5	23.63	22.65	22.64	
		1745	23.67	22.70	22.74	
		1711.5	23.65	22.70	22.67	
8RB-Low		1778.5	23.63	22.74	22.79	
		1745	23.62	22.63	22.65	
		1711.5	23.66	22.71	22.77	
15RB		1778.5	23.71	22.70	22.68	
		1745	23.58	22.67	22.55	
		1711.5	23.61	22.66	22.63	
5MHz		1RB-High	1777.5	24.67	24.03	23.83

		1745	24.70	23.89	23.88
		1712.5	24.79	23.84	23.84
		1777.5	24.47	24.16	23.58
	1RB-Middle	1745	24.58	23.50	23.78
		1712.5	24.63	24.19	23.84
		1777.5	24.75	24.07	23.83
	1RB-Low	1745	24.75	24.05	24.06
		1712.5	24.70	23.95	23.76
		1777.5	23.73	22.57	22.61
	12RB-High	1745	23.68	22.72	22.58
		1712.5	23.77	22.80	22.61
		1777.5	23.77	22.75	22.73
	12RB-Middle	1745	23.82	22.80	22.79
		1712.5	23.82	22.77	22.55
		1777.5	23.74	22.86	22.73
	12RB-Low	1745	23.73	22.72	22.71
		1712.5	23.76	22.71	22.74
		1777.5	23.72	22.72	22.74
	25RB	1745	23.74	22.73	22.67
		1712.5	23.77	22.69	22.62
		1775	24.35	23.95	23.78
10MHz	1RB-High	1745	24.43	23.88	23.75
		1715	24.49	23.95	23.83
		1775	24.47	23.81	23.73
	1RB-Middle	1745	24.44	23.81	23.67
		1715	24.43	23.81	23.64
		1775	24.48	23.95	23.63
	1RB-Low	1745	24.50	23.84	23.71
		1715	24.49	23.85	23.74
		1775	23.65	22.60	22.75
	25RB-High	1745	23.68	22.56	22.60
		1715	23.66	22.71	22.66
		1775	23.68	22.73	22.64
	25RB-Middle	1745	23.61	22.71	22.66
		1715	23.61	22.70	22.69
		1775	23.57	22.67	22.75
	25RB-Low	1745	23.59	22.60	22.65
		1715	23.67	22.71	22.67
		1775	23.64	22.73	22.65
	50RB	1745	23.64	22.63	22.57
		1715	23.70	22.65	22.67
		1772.5	24.34	23.76	23.80
15MHz	1RB-High	1745	24.41	23.67	23.51
		1717.5	24.32	23.79	23.70
		1772.5	24.31	23.82	23.67
	1RB-Middle	1745	24.46	23.59	23.74
		1717.5	24.44	23.71	23.74
		1772.5	24.37	23.92	23.86
	1RB-Low	1745	24.44	23.78	23.81
		1717.5	24.38	23.83	23.64
		1772.5	23.50	22.59	22.54
	36RB-High	1745	23.48	22.49	22.49
		1717.5	23.41	22.39	22.41
		1772.5	23.56	22.58	22.63
	36RB-Middle	1745	23.57	22.52	22.56

	36RB-Low	1717.5	23.58	22.46	22.55	
		1772.5	23.46	22.49	22.44	
		1745	23.50	22.46	22.44	
	75RB	1717.5	23.52	22.53	22.50	
		1772.5	23.51	22.55	22.52	
		1745	23.50	22.56	22.44	
	20MHz	1RB-High	1717.5	23.41	22.50	22.42
			1770	24.46	23.93	22.70
			1745	24.39	23.65	22.72
		1RB-Middle	1720	24.31	23.67	22.59
			1770	24.39	23.85	22.75
			1745	24.40	23.82	22.58
1RB-Low		1720	24.40	23.67	22.54	
		1770	24.38	23.83	22.66	
		1745	24.39	23.87	22.70	
50RB-High		1720	24.49	23.74	22.57	
		1770	23.60	22.59	21.59	
		1745	23.45	22.46	21.52	
50RB-Middle		1720	23.46	22.34	21.45	
		1770	23.62	22.62	21.65	
		1745	23.57	22.52	21.59	
50RB-Low		1720	23.43	22.46	21.51	
		1770	23.60	22.62	21.67	
		1745	23.49	22.54	21.56	
100RB		1720	23.56	22.55	21.57	
		1770	23.59	22.59	21.49	
		1745	23.53	22.55	21.46	
			1720	23.53	22.45	21.52

LTE Band71(Normal Power)

Band 71					
Bandwidth (MHz)	RB allocation	Frequency (MHz)	Actual output power (dBm)		
	RB offset		QPSK	16QAM	64QAM
5MHz	1RB-High (24)	695.5 (133447)	23.62	22.23	22.17
		680.5 (133297)	23.61	22.32	21.86
		665.5 (133147)	23.91	22.20	22.04
	1RB-Middle (12)	695.5 (133447)	23.51	22.77	22.63
		680.5 (133297)	23.61	23.11	22.43
		665.5 (133147)	23.34	22.62	22.48
	1RB-Low (0)	695.5 (133447)	23.61	23.65	22.43
		680.5 (133297)	23.55	23.91	24.17
		665.5 (133147)	23.55	22.86	22.64
	12RB-High (13)	695.5 (133447)	23.95	22.90	23.10
		680.5 (133297)	23.91	22.43	22.43
		665.5 (133147)	22.76	21.79	21.82
	12RB-Middle (6)	695.5 (133447)	23.91	22.94	22.43
		680.5 (133297)	23.91	21.67	22.65
		665.5 (133147)	22.41	21.44	21.41
	12RB-Low (0)	695.5 (133447)	23.94	22.88	22.85

	25RB (0)	680.5 (133297)	23.99	22.27	22.65	
		665.5 (133147)	23.04	22.08	22.04	
		695.5 (133447)	23.83	22.96	21.94	
		680.5 (133297)	23.99	22.94	21.94	
		665.5 (133147)	22.39	21.44	21.42	
10MHz	1RB-High (49)	693 (132422)	23.04	22.36	22.19	
		680.5 (133297)	23.04	22.04	21.79	
		668 (133172)	23.54	22.54	23.85	
	1RB-Middle (24)	693 (132422)	23.54	22.43	24.00	
		680.5 (133297)	23.16	22.12	24.17	
		668 (133172)	23.04	22.33	22.23	
	1RB-Low (0)	693 (132422)	23.04	22.33	24.29	
		680.5 (133297)	23.04	22.43	24.31	
		668 (133172)	23.80	23.10	22.92	
	25RB-High (25)	693 (132422)	23.97	22.11	21.86	
		680.5 (133297)	24.00	22.43	21.90	
		668 (133172)	23.03	22.26	21.04	
	25RB-Middle (12)	693 (132422)	23.92	23.00	21.86	
		680.5 (133297)	23.43	22.94	21.91	
		668 (133172)	22.12	21.11	21.01	
	25RB-Low (0)	693 (132422)	23.99	22.84	21.86	
		680.5 (133297)	23.54	22.01	21.79	
		668 (133172)	22.65	21.66	20.42	
	50RB (0)	693 (132422)	23.93	22.94	21.73	
		680.5 (133297)	23.11	22.90	21.80	
		668 (133172)	22.88	21.91	21.26	
	15MHz	1RB-High (74)	690.5 (133397)	23.51	24.56	22.29
			680.5 (133297)	23.62	24.46	23.23
			670.5 (133197)	23.51	24.36	22.25
1RB-Middle (37)		690.5 (133397)	23.55	24.37	22.20	
		680.5 (133297)	23.55	24.29	20.43	
		670.5 (133197)	23.59	24.30	22.71	
1RB-Low (0)		690.5 (133397)	23.51	24.59	21.53	
		680.5 (133297)	23.55	24.52	21.55	
		670.5 (133197)	23.52	23.35	20.96	
36RB-High (38)		690.5 (133397)	23.12	22.10	21.58	
		680.5 (133297)	23.08	22.06	21.58	
		670.5 (133197)	23.09	22.08	21.00	
36RB-Middle (19)		690.5 (133397)	23.16	22.16	21.55	
		680.5 (133297)	23.14	22.16	21.51	
		670.5 (133197)	23.10	22.18	20.03	
36RB-Low (0)		690.5 (133397)	23.15	22.20	20.45	
		680.5 (133297)	23.16	22.10	21.47	
		670.5 (133197)	23.06	22.01	20.00	

	75RB (0)	690.5 (133397)	23.18	22.19	21.03
		680.5 (133297)	23.10	22.16	21.94
		670.5 (133197)	23.14	22.11	20.60
20MHz	1RB-High (99)	688 (133372)	24.02	23.44	22.14
		683 (133322)	23.98	23.63	22.31
		673 (133222)	24.08	23.59	22.36
	1RB-Middle (50)	688 (133372)	24.07	23.46	22.31
		683 (133322)	24.05	23.61	22.4
		673 (133222)	24.01	23.62	21.97
	1RB-Low (0)	688 (133372)	24.21	23.65	22.32
		683 (133322)	24.13	23.63	22.01
		673 (133222)	23.64	22.89	20.94
	50RB-High (50)	688 (133372)	23.06	22.19	21.23
		683 (133322)	23.05	22.12	21.17
		673 (133222)	23.24	22.19	21.06
	50RB-Middle (25)	688 (133372)	23.28	22.26	21.16
		683 (133322)	23.25	22.28	21.37
		673 (133222)	23.27	22.30	20.9
	50RB-Low (0)	688 (133372)	23.20	22.24	21.26
		683 (133322)	23.22	22.25	21.23
		673 (133222)	23.26	22.23	20.69
	100RB (0)	688 (133372)	23.28	22.32	21.09
		683 (133322)	23.20	22.27	21.22
		673 (133222)	23.23	22.25	20.64

LTE Carrier Aggregation Conducted Power (Downlink)

Uplink maximum output power is measured with downlink carrier aggregation active, using the channel with highest measured maximum output power when downlink carrier aggregation is inactive. SAR test is not required since maximum output power when downlink carrier aggregation active is not more than ¼ dB higher than the maximum output power measured when downlink carrier aggregation inactive.

DL LTE CA Class	Normal Power										tune up	conducted power (dBm)
	CC1					CC2						
	PCC Bandwidth	UL channel	DL channel	UL RB	UL RB OFFSET	SCC Bandwidth	DL channel	RB	RB OFFSET			
CA_12A-66A	10M	23130	5130	1	49	20M	66536	1	0	25.00	23.83	
CA_25A-25A	20M	26140	1860	1	0	20M	8590	1	0	25.00	24.12	
CA_25A-26A	20M	26140	1860	1	0	15M	8865	1	0	25.00	24.20	
CA_25A-41APC2	20M	26140	1860	1	0	20M	40620	1	0	25.00	24.19	
CA_25A-41APC3	20M	26140	1860	1	0	20M	40620	1	0	25.00	24.22	
CA_2A-2A	20M	18700	1860	1	0	20M	1100	1	0	25.00	24.07	
CA_2A-4A	20M	18900	1880	1	0	20M	67036	1	0	25.00	24.00	
CA_2A-5A	20M	18700	1860	1	0	15M	8865	1	0	25.00	24.07	
CA_2A-66A	20M	18700	1860	1	0	20M	66536	1	0	25.00	24.07	
CA_2A-71A	20M	18700	1860	1	0	20M	68836	1	0	25.00	24.06	
CA_2C	20M	18700	1860	1	0	20M	898	1	0	25.00	24.07	
CA_4A-12A	20M	132072	1720	1	0	5M	5155	1	12	25.00	23.10	
CA_4A-4A	20M	20050	1720	1	0	20M	2300	1	0	25.00	23.02	
CA_4A-5A	20M	132072	1720	1	0	15M	8865	1	0	25.00	23.04	
CA_4A-71A	20M	132072	1720	1	0	20M	68836	1	0	25.00	23.03	
CA_5A-66A	15M	26865	831.5	1	37	20M	66536	1	0	25.00	24.10	
CA_66A-66A	20M	20050	1720	1	0	20M	2300	1	0	25.00	23.08	
CA_66A-71A	20M	20050	1720	1	0	20M	68836	1	0	25.00	23.10	
CA_66B	10M	132022	1715	1	0	10M	66585	1	0	25.00	22.91	
CA_66C	20M	132572	1770	1	99	20M	67234	1	99	25.00	23.02	
CA_66A-12A	20M	20050	1720	1	0	5M	5155	1	12	25.00	23.04	
CA_26A-25A	15M	26865	831.5	1	37	20M	8590	1	0	25.00	24.17	
CA_41APC2-25A	20M	39750	2506	1	99	20M	8590	1	0	27.50	26.04	
CA_41APC3-25A	20M	39750	2506	1	99	20M	8590	1	0	25.00	24.02	
CA_12A-2A	10M	23130	5130	1	49	20M	1100	1	0	25.00	23.84	
CA_4A-2A	20M	132072	1720	1	0	20M	1100	1	0	25.00	23.09	
CA_5A-2A	15M	26865	831.5	1	37	20M	1100	1	0	25.00	24.13	
CA_66A-2A	20M	20050	1720	1	0	20M	1100	1	0	25.00	23.02	
CA_71A-2A	20M	133322	683	1	0	20M	1100	1	0	25.00	24.02	
CA_12A-4A	10M	23130	5130	1	49	20M	67036	1	0	25.00	23.87	
CA_5A-4A	15M	26865	831.5	1	37	20M	67036	1	0	25.00	24.17	
CA_71A-4A	20M	133322	683	1	0	20M	67036	1	0	25.00	24.01	
CA_66A-5A	20M	20050	1720	1	0	15M	8865	1	0	25.00	23.05	
CA_71A-66A	20M	133322	683	1	0	20M	66536	1	0	25.00	24.00	

DL LTE CA Class	Low Power										
	CC1					CC2				Power	
	PCC Bandwidth	UL channel	DL channel	UL RB	UL RB OFFSET	SCC Bandwidth	DL channel	RB	RB OFFSET	tune up	conducted power (dBm)
CA_12A-66A	10M	23130	5130	1	49	20M	66536	1	0	22	21.36
CA_25A-25A	20M	26140	1860	1	0	20M	8590	1	0	17	15.81
CA_25A-26A	20M	26140	1860	1	0	15M	8865	1	0	17	15.83
CA_25A-41APC2	20M	26140	1860	1	0	20M	40620	1	0	17	15.82
CA_25A-41APC3	20M	26140	1860	1	0	20M	40620	1	0	17	15.9
CA_2A-12A	20M	18900	1880	1	0	5M	5155	1	12	17	16.45
CA_2A-2A	20M	18700	1860	1	0	20M	1100	1	0	17	16.41
CA_2A-4A	20M	18900	1880	1	0	20M	67036	1	0	17	16.4
CA_2A-5A	20M	18700	1860	1	0	15M	8865	1	0	17	16.48
CA_2A-66A	20M	18700	1860	1	0	20M	66536	1	0	17	16.48
CA_2A-71A	20M	18700	1860	1	0	20M	68836	1	0	17	16.49
CA_2C	20M	18700	1860	1	0	20M	898	1	0	17	16.39
CA_4A-12A	20M	132072	1720	1	0	5M	5155	1	12	17	15.93
CA_4A-4A	20M	132072	1720	1	0	20M	2300	1	0	17	15.9
CA_4A-5A	20M	132072	1720	1	0	15M	8865	1	0	17	15.95
CA_4A-71A	20M	132072	1720	1	0	20M	68836	1	0	17	15.97
CA_5A-66A	15M	26865	831.5	1	37	20M	66536	1	0	25	22.98
CA_66A-66A	20M	132072	1720	1	50	20M	2300	1	0	17	16.26
CA_66A-71A	20M	132072	1720	1	50	20M	68836	1	0	17	16.21
CA_66B	10M	132022	1715	1	0	10M	66585	1	0	17	16.19
CA_66C	20M	132572	1770	1	99	20M	67234	1	99	17	15.87
CA_66A-12A	20M	132072	1720	1	50	5M	5155	1	12	17	16.24
CA_26A-25A	15M	26865	831.5	1	37	20M	8590	1	0	25	22.97
CA_41APC2-25A	20M	39750	2506	1	99	20M	8590	1	0	17.5	16.4
CA_41APC3-25A	20M	39750	2506	1	99	20M	8590	1	0	15.00	14.66
CA_12A-2A	10M	23130	5130	1	49	20M	1100	1	0	22	21.28
CA_4A-2A	20M	132072	1720	1	0	20M	1100	1	0	17	15.97
CA_5A-2A	15M	26865	831.5	1	37	20M	1100	1	0	25	23.02
CA_66A-2A	20M	132072	1720	1	0	20M	1100	1	0	17	16.23
CA_71A-2A	20M	133322	683	1	0	20M	1100	1	0	22	21.01
CA_12A-4A	10M	23130	5130	1	49	20M	67036	1	0	22	21.26
CA_5A-4A	15M	26865	831.5	1	37	20M	67036	1	0	25	22.98
CA_71A-4A	20M	133322	683	1	0	20M	67036	1	0	22	21.08
CA_66A-5A	20M	132072	1720	1	0	15M	8865	1	0	17	16.22
CA_71A-66A	20M	133322	683	1	0	20M	66536	1	0	22	21.03



DL LTE CA Class	Normal Power														Power	
	CC1					CC2				CC3				tune up		
	PCC Bandwidth	UL channel	DL channel	UL RB	UL RB OFFSET	SCC Bandwidth	DL channel	RB	RB OFFSET	SCC Bandwidth	DL channel	RB	RB OFFSET			
CA_12A-66A-66A	10M	23130	5130	1	49	20M	66536	1	0	20M	66536	1	0	25.00	23.77	
CA_12A-66C	10M	23130	5130	1	49	20M	66536	1	0	20M	66536	1	0	25.00	23.79	
CA_2A-12A-66A	20M	18700	1860	1	0	20M	1100	1	0	20M	66536	1	0	25.00	24.06	
CA_2A-2A-12A	20M	18700	1860	1	0	20M	1100	1	0	5M	5155	1	12	25.00	24.03	
CA_2A-2A-4A	20M	18700	1860	1	0	20M	1100	1	0	20M	67036	1	0	25.00	24.11	
CA_2A-2A-66A	20M	18700	1860	1	0	20M	1100	1	0	20M	66536	1	0	25.00	24.10	
CA_2A-2A-71A	20M	18700	1860	1	0	20M	1100	1	0	20M	68836	1	0	25.00	24.01	
CA_2A-4A-12A	20M	18700	1860	1	0	20M	67036	1	0	5M	5155	1	12	25.00	24.06	
CA_2A-4A-4A	20M	18700	1860	1	0	20M	67036	1	0	20M	2300	1	0	25.00	24.10	
CA_2A-4A-5A	20M	18700	1860	1	0	20M	67036	1	0	15M	8865	1	0	25.00	24.03	
CA_2A-4A-71A	20M	18700	1860	1	0	20M	67036	1	0	20M	68836	1	0	25.00	24.08	
CA_2A-5A-66A	20M	18700	1860	1	0	15M	8865	1	0	20M	66536	1	0	25.00	24.06	
CA_2A-66A-66A	20M	18700	1860	1	0	20M	2300	1	0	20M	2300	1	0	25.00	24.07	
CA_2A-66A-71A	20M	18700	1860	1	0	20M	2300	1	0	20M	68836	1	0	25.00	24.10	
CA_2A-66C	20M	18700	1860	1	0	20M	2300	1	0	20M	2300	1	0	25.00	24.01	
CA_2C-66A	20M	18700	1860	1	0	20M	2300	1	0	20M	2300	1	0	25.00	24.10	
CA_41APC3-41CPC3	20M	39750	2506	1	99	20M	41490	1	99	20M	39948	1	0	25.00	24.02	
CA_41APC2-41CPC2	20M	39750	2506	1	99	20M	41490	1	99	20M	39948	1	0	27.50	26.12	
CA_41DPC3	20M	39750	2506	1	99	20M	41490	1	99	20M	39948	1	0	25.00	24.10	
CA_41DPC2	20M	39750	2506	1	99	20M	41490	1	99	20M	39948	1	0	27.50	25.66	
CA_4A-4A-12A	20M	20050	1720	1	0	20M	2300	1	0	5M	5155	1	12	25.00	23.08	
CA_4A-4A-71A	20M	20050	1720	1	0	20M	2300	1	0	20M	68836	1	0	25.00	23.04	
CA_66A-66A-71A	20M	20050	1720	1	0	20M	2300	1	0	20M	68836	1	0	25.00	23.03	
CA_66A-66C	20M	20050	1720	1	0	20M	2300	1	0	20M	67234	1	99	25.00	23.06	
CA_66C-71A	20M	132572	1770	1	99	20M	67234	1	99	20M	68836	1	0	25.00	23.07	
CA_66A-12A-66A	20M	20050	1720	1	0	20M	1100	1	0	20M	66536	1	0	25.00	23.11	
CA_66C-12A	20M	132572	1770	1	99	20M	67234	1	99	5M	5155	1	12	25.00	22.99	
CA_66A-2A-12A	20M	20050	1720	1	0	20M	1100	1	0	5M	5155	1	12	25.00	23.04	
CA_12A-2A-2A	10M	23130	5130	1	49	20M	1100	1	0	5M	5155	1	12	25.00	23.83	
CA_4A-2A-2A	20M	132072	1720	1	0	20M	1100	1	0	5M	5155	1	12	25.00	23.11	
CA_66A-2A-2A	20M	20050	1720	1	0	20M	1100	1	0	5M	5155	1	12	25.00	23.11	
CA_71A-2A-2A	20M	133322	683	1	0	20M	1100	1	0	5M	5155	1	12	25.00	23.94	
CA_12A-2A-4A	10M	23130	5130	1	49	20M	1100	1	0	20M	2300	1	0	25.00	23.78	
CA_4A-2A-4A	20M	132072	1720	1	0	20M	1100	1	0	20M	2300	1	0	25.00	23.11	
CA_5A-2A-4A	15M	26865	831.5	1	37	20M	1100	1	0	20M	2300	1	0	25.00	24.09	
CA71A- 2A-4A	20M	133322	683	1	0	20M	1100	1	0	20M	2300	1	0	25.00	23.96	
CA_66A-2A-5A	20M	20050	1720	1	0	20M	1100	1	0	15M	8865	1	0	25.00	23.11	
CA_66A-2A-66A	20M	20050	1720	1	0	20M	1100	1	0	20M	2300	1	0	25.00	23.08	
CA_71A-2A-66A	20M	133322	683	1	0	20M	1100	1	0	20M	2300	1	0	25.00	23.98	
CA_66C-2A	20M	132572	1770	1	99	20M	67234	1	99	5M	5155	1	12	25.00	23.01	
CA_66A-2C	20M	20050	1720	1	0	20M	1100	1	0	5M	5155	1	12	25.00	23.01	
CA_41CPC3-41APC3	20M	39750	2506	1	0	20M	39948	1	0	20M	41490	1	99	25.00	23.86	
CA_41CPC2-41APC2	20M	39750	2506	1	0	20M	39948	1	0	20M	41490	1	99	27.50	27.01	
CA_12A-4A-4A	10M	23130	5130	1	49	20M	1100	1	0	20M	2300	1	0	25.00	23.83	
CA_71A-4A-4A	20M	133322	683	1	0	20M	67036	1	0	20M	2300	1	0	25.00	24.01	
CA_71A-66A-66A	20M	133322	683	1	0	20M	66536	1	0	20M	2300	1	0	25.00	23.97	
CA_66C-66A	20M	132572	1770	1	99	20M	67234	1	99	20M	2300	1	0	25.00	23.09	
CA_71A-66C	20M	133322	683	1	0	20M	66536	1	0	20M	2300	1	0	25.00	23.97	



DL LTE CA Class	Low Power														Power	
	CC1					CC2				CC3				tune up	conducted power (dBm)	
	PCC Bandwidth	UL channel	DL channel	UL RB	UL RB OFFSET	SCC Bandwidth	DL channel	RB	RB OFFSET	SCC Bandwidth	DL channel	RB	RB OFFSET			
CA_12A-66A-66A	10M	23130	5130	1	49	20M	66536	1	0	20M	2300	1	0	22	21.3	
CA_12A-66C	10M	23130	5130	1	49	20M	132572	1	99	20M	67234	1	99	22	21.36	
CA_2A-12A-66A	20M	18900	1880	1	0	5M	5155	1	12	20M	2300	1	0	17	16.35	
CA_2A-2A-12A	20M	18700	1860	1	0	20M	1100	1	0	5M	5155	1	12	17	16.48	
CA_2A-2A-4A	20M	18700	1860	1	0	20M	1100	1	0	20M	67036	1	0	17	16.41	
CA_2A-2A-66A	20M	18700	1860	1	0	20M	1100	1	0	20M	66536	1	0	17	16.41	
CA_2A-2A-71A	20M	18700	1860	1	0	20M	1100	1	0	20M	68836	1	0	17	16.45	
CA_2A-4A-12A	20M	18900	1880	1	0	20M	67036	1	0	5M	5155	1	12	17	16.43	
CA_2A-4A-4A	20M	18900	1880	1	0	20M	67036	1	0	20M	67036	1	0	17	16.4	
CA_2A-4A-5A	20M	18900	1880	1	0	20M	67036	1	0	15M	8865	1	0	17	16.44	
CA_2A-4A-71A	20M	18900	1880	1	0	20M	67036	1	0	20M	68836	1	0	17	16.4	
CA_2A-5A-66A	20M	18700	1860	1	0	15M	8865	1	0	20M	66536	1	0	17	16.42	
CA_2A-66A-66A	20M	18700	1860	1	0	20M	66536	1	0	20M	66536	1	0	17	16.4	
CA_2A-66A-71A	20M	18700	1860	1	0	20M	66536	1	0	20M	68836	1	0	17	16.47	
CA_2A-66C	20M	18700	1860	1	0	20M	66536	1	0	20M	66536	1	0	17	16.43	
CA_2C-66A	20M	18700	1860	1	0	20M	66536	1	0	20M	66536	1	0	17	16.4	
CA_41APC3-41CPC3	20M	39750	2506	1	99	20M	41490	1	99	20M	39948	1	0	15	14.11	
CA_41APC3-41CPC3	20M	39750	2506	1	99	20M	41490	1	99	20M	39948	1	0	15	14.11	
CA_41DPC3	20M	39750	2506	1	99	20M	41490	1	99	20M	39948	1	0	15	14.08	
CA_41DPC2	20M	39750	2506	1	99	20M	41490	1	99	20M	39948	1	0	17.5	15.84	
CA_4A-4A-12A	20M	132072	1720	1	0	20M	2300	1	0	5M	5155	1	12	17	15.93	
CA_4A-4A-71A	20M	132072	1720	1	0	20M	2300	1	0	20M	68836	1	0	17	15.94	
CA_66A-66A-71A	20M	132072	1720	1	50	20M	2300	1	0	20M	68836	1	0	17	16.25	
CA_66A-66C	20M	132072	1720	1	50	20M	2300	1	0	20M	66536	1	0	17	16.22	
CA_66C-71A	20M	132072	1720	1	50	20M	2300	1	0	20M	68836	1	0	17	16.24	
CA_66A-12A-66A	20M	132072	1720	1	50	5M	5155	1	12	20M	66536	1	0	17	16.21	
CA_66C-12A	20M	132572	1770	1	99	20M	67234	1	99	5M	5155	1	12	17	15.9	
CA_66A-2A-12A	20M	132072	1720	1	0	20M	1100	1	0	5M	5155	1	12	17	16.25	
CA_12A-2A-2A	10M	23130	5130	1	49	20M	1100	1	0	20M	1100	1	0	22	21.33	
CA_4A-2A-2A	20M	132072	1720	1	0	20M	1100	1	0	20M	1100	1	0	17	15.93	
CA_66A-2A-2A	20M	132072	1720	1	0	20M	1100	1	0	20M	1100	1	0	17	16.27	
CA_71A-2A-2A	20M	133322	683	1	0	20M	1100	1	0	20M	1100	1	0	22	21.08	
CA_12A-2A-4A	10M	23130	5130	1	49	20M	1100	1	0	20M	2300	1	0	22	21.26	
CA_4A-2A-4A	20M	132072	1720	1	0	20M	1100	1	0	20M	2300	1	0	17	15.93	
CA_5A-2A-4A	15M	26865	831.5	1	37	20M	1100	1	0	20M	2300	1	0	25	23.01	
CA71A- 2A-4A	20M	133322	683	1	0	20M	1100	1	0	20M	2300	1	0	22	21	
CA_66A-2A-5A	20M	132072	1720	1	0	20M	1100	1	0	15M	8865	1	0	17	16.24	
CA_66A-2A-66A	20M	132072	1720	1	0	20M	1100	1	0	20M	66536	1	0	17	16.21	
CA_71A-2A-66A	20M	133322	683	1	0	20M	1100	1	0	20M	66536	1	0	22	21.05	
CA_66C-2A	20M	132072	1720	1	0	20M	1100	1	0	20M	1100	1	0	17	16.25	
CA_66A-2C	20M	132072	1720	1	0	20M	1100	1	0	20M	1100	1	0	17	16.2	
CA_12A-4A-4A	10M	23130	5130	1	49	20M	67036	1	0	20M	2300	1	0	22	21.33	
CA_71A-4A-4A	20M	133322	683	1	0	20M	67036	1	0	20M	2300	1	0	22	21	
CA_71A-66A-66A	20M	133322	683	1	0	20M	66536	1	0	20M	66536	1	0	22	21.07	
CA_66C-66A	20M	132572	1770	1	99	20M	67234	1	99	20M	66536	1	0	17	15.95	
CA_71A-66C	20M	133322	683	1	0	20M	66536	1	0	20M	66536	1	0	22	21	



DL LTE CA Class	Normal Power																Power		
	CC1					CC2				CC3				CC4				tune up	conducted power (dBm)
	PCC Bandwidth	UL channel	DL channel	UL RB	UL RB OFFSET	SCC Bandwidth	DL channel	RB	RB OFFSET	SCC Bandwidth	DL channel	RB	RB OFFSET	SCC Bandwidth	DL channel	RB	RB OFFSET		
CA_25A-41DPC3	20M	26140	1860	1	0	20M	39948	1	0	20M	41490	1	99	20M	41490	1	99	25.00	24.14
CA_25A-41DPC2	20M	26140	1860	1	0	20M	39948	1	0	20M	41490	1	99	20M	41490	1	99	25.00	24.13
CA_2A-12A-66A-66A	20M	18900	1880	1	0	5M	5155	1	12	20M	66536	1	0	20M	66536	1	0	25.00	24.05
CA_2A-12A-66C	20M	18900	1880	1	0	5M	5155	1	12	20M	66536	1	0	20M	66536	1	0	25.00	24.08
CA_2A-2A-12A-66A	20M	18700	1860	1	0	20M	1100	1	0	20M	1100	1	0	20M	66536	1	0	25.00	24.08
CA_2A-2A-4A-12A	20M	18700	1860	1	0	20M	1100	1	0	20M	67036	1	0	5M	5155	1	12	25.00	24.09
CA_2A-2A-4A-71A	20M	18700	1860	1	0	20M	1100	1	0	20M	67036	1	0	20M	68836	1	0	25.00	24.07
CA_2A-2A-66A-66A	20M	18700	1860	1	0	20M	1100	1	0	20M	2300	1	0	20M	2300	1	0	25.00	24.05
CA_2A-2A-66A-71A	20M	18700	1860	1	0	20M	1100	1	0	20M	2300	1	0	20M	2300	1	0	25.00	24.07
CA_2A-2A-66C	20M	18700	1860	1	0	20M	1100	1	0	20M	2300	1	0	20M	2300	1	0	25.00	24.03
CA_2A-4A-4A-12A	20M	18900	1880	1	0	20M	67036	1	0	20M	67036	1	0	5M	5155	1	12	25.00	24.10
CA_2A-66A-66A-71A	20M	18700	1860	1	0	20M	66536	1	0	20M	2300	1	0	20M	68836	1	0	25.00	24.04
CA_2A-66C-71A	20M	18700	1860	1	0	20M	66536	1	0	20M	2300	1	0	20M	68836	1	0	25.00	24.02
CA_2C-66A-66A	20M	18700	1860	1	0	20M	66536	1	0	20M	2300	1	0	20M	2300	1	0	25.00	24.03
CA_41CPC3-41CPC3	20M	39750	2506	1	0	20M	39948	1	0	20M	41490	1	99	20M	39948	1	0	25.00	24.10
CA_41CPC2-41CPC2	20M	39750	2506	1	0	20M	39948	1	0	20M	41490	1	99	20M	39948	1	0	27.50	26.01
CA_41DPC3-25A	20M	39750	2506	1	99	20M	41490	1	99	20M	39948	1	0	20M	8590	1	0	25.00	24.00
CA_41DPC2-25A	20M	39750	2506	1	99	20M	41490	1	99	20M	39948	1	0	20M	8590	1	0	27.50	26.62
CA_66A-2A-12A-66A	20M	20050	1720	1	0	20M	1100	1	0	5M	5155	1	12	20M	2300	1	0	25.00	23.04
CA_66C-2A-12A	20M	132572	1770	1	99	20M	67234	1	99	20M	1100	1	0	5M	5155	1	12	25.00	23.07
CA_12A-2A-2A-66A	10M	23130	5130	1	49	20M	1100	1	0	5M	5155	1	12	20M	2300	1	0	25.00	23.84
CA_4A-2A-2A-12A	20M	132072	1720	1	0	20M	1100	1	0	5M	5155	1	12	5M	5155	1	12	25.00	23.03
CA_71A-2A-2A-4A	20M	133322	683	1	0	20M	1100	1	0	20M	1100	1	0	20M	2300	1	0	25.00	23.94
CA_66A-2A-2A-66A	20M	20050	1720	1	0	20M	1100	1	0	20M	1100	1	0	20M	2300	1	0	25.00	23.08
CA_71A-2A-2A-66A	20M	133322	683	1	0	20M	1100	1	0	20M	1100	1	0	20M	2300	1	0	25.00	23.97
CA_66C-2A-2A	20M	132572	1770	1	99	20M	67234	1	99	20M	1100	1	0	5M	5155	1	12	25.00	23.07
CA_12A-2A-4A-4A	10M	23130	5130	1	49	20M	1100	1	0	20M	2300	1	0	20M	2300	1	0	25.00	23.82
CA_71A-2A-66A-66A	20M	133322	683	1	0	20M	1100	1	0	20M	2300	1	0	20M	2300	1	0	25.00	23.95
CA_71A-2A-66C	20M	133322	683	1	0	20M	1100	1	0	20M	2300	1	0	20M	67234	1	99	25.00	24.00
CA_66A-2C-66A	20M	132572	1770	1	99	20M	67234	1	99	20M	1100	1	0	20M	2300	1	0	25.00	23.05
CA_2A-2A-13A-66A	20M	18700	1860	1	0	20M	1100	1	0	10M	5230	1	24	20M	2300	1	0	25.00	24.11
CA_13A-2A-2A-66A	10M	23130	5130	1	49	20M	1100	1	0	20M	1100	1	0	20M	2300	1	0	25.00	23.33
CA_66A-2A-2A-13A	20M	132572	1770	1	99	20M	1100	1	0	20M	1100	1	0	20M	898	1	0	25.00	24.01

DL LTE CA Class	Low Power																Power		
	CC1					CC2				CC3				CC4				tune up	conducted power (dBm)
	PCC Bandwidth	UL channel	DL channel	UL RB	UL RB OFFSET	SCC Bandwidth	DL channel	RB	RB OFFSET	SCC Bandwidth	DL channel	RB	RB OFFSET	SCC Bandwidth	DL channel	RB	RB OFFSET		
CA_25A-41DPC3	20M	26140	1860	1	0	20M	8590	1	0	20M	41490	1	99	20M	39948	1	0	17	15.83
CA_25A-41DPC2	20M	26140	1860	1	0	20M	8590	1	0	20M	41490	1	99	20M	39948	1	0	17.5	16.01
CA_2A-12A-66A-66A	20M	18900	1880	1	0	5M	5155	1	12	20M	66536	1	0	20M	66536	1	0	17	16.37
CA_2A-12A-66C	20M	18900	1880	1	0	5M	5155	1	12	20M	66536	1	0	20M	66536	1	0	17	16.4
CA_2A-2A-12A-66A	20M	18700	1860	1	0	20M	1100	1	0	5M	5155	1	12	20M	66536	1	0	17	16.49
CA_2A-2A-4A-12A	20M	18700	1860	1	0	20M	1100	1	0	20M	67036	1	0	5M	5155	1	12	17	16.43
CA_2A-2A-4A-71A	20M	18700	1860	1	0	20M	1100	1	0	20M	67036	1	0	20M	68836	1	0	17	16.49
CA_2A-2A-66A-66A	20M	18700	1860	1	0	20M	1100	1	0	20M	66536	1	0	20M	66536	1	0	17	16.49
CA_2A-2A-66A-71A	20M	18700	1860	1	0	20M	1100	1	0	20M	66536	1	0	20M	68836	1	0	17	16.44
CA_2A-2A-66C	20M	18700	1860	1	0	20M	1100	1	0	20M	132572	1	99	20M	67234	1	99	17	16.49
CA_2A-4A-4A-12A	20M	18900	1880	1	0	20M	67036	1	0	20M	67036	1	0	5M	5155	1	12	17	16.44
CA_2A-66A-66A-71A	20M	18700	1860	1	0	20M	66536	1	0	20M	66536	1	0	20M	68836	1	0	17	16.42
CA_2A-66C-71A	20M	18700	1860	1	0	20M	66536	1	0	20M	66536	1	0	20M	68836	1	0	17	16.39
CA_2C-66A-66A	20M	18700	1860	1	0	20M	66536	1	0	20M	66536	1	0	20M	66536	1	0	17	16.39
CA_41CPC3-41CPC3	20M	39750	2506	1	99	20M	41490	1	99	20M	39948	1	0	20M	39948	1	0	15	14.11
CA_41CPC2-41CPC2	20M	39750	2506	1	99	20M	41490	1	99	20M	39948	1	0	20M	39948	1	0	17.5	16.11
CA_41DPC3-25A	20M	39750	2506	1	99	20M	41490	1	99	20M	39948	1	0	20M	8590	1	0	15	14.05
CA_41DPC2-25A	20M	39750	2506	1	99	20M	41490	1	99	20M	39948	1	0	20M	8590	1	0	17.5	16.12
CA_66A-2A-12A-66A	20M	132072	1720	1	0	20M	1100	1	0	5M	5155	1	12	20M	66536	1	0	17	16.2
CA_66C-2A-12A	20M	132572	1770	1	99	20M	67234	1	99	20M	1100	1	0	5M	5155	1	12	17	16.25
CA_12A-2A-2A-66A	10M	23130	5130	1	49	20M	1100	1	0	20M	1100	1	0	20M	66536	1	0	22	21.33
CA_4A-2A-2A-12A	20M	132072	1720	1	0	20M	1100	1	0	20M	2300	1	0	5M	5155	1	12	17	15.98
CA_71A-2A-2A-4A	20M	133322	683	1	0	20M	1100	1	0	20M	1100	1	0	20M	67036	1	0	22	21.01
CA_66A-2A-2A-66A	20M	132072	1720	1	0	20M	1100	1	0	20M	1100	1	0	20M	2300	1	0	17	16.28
CA_71A-2A-2A-66A	20M	133322	683	1	0	20M	1100	1	0	20M	1100	1	0	20M	2300	1	0	22	21.06
CA_66C-2A-2A	20M	132072	1720	1	0	20M	1100	1	0	20M	1100	1	0	20M	1100	1	0	17	16.21
CA_12A-2A-4A-4A	10M	23130	5130	1	49	20M	1100	1	0	20M	2300	1	0	20M	2300	1	0	22	21.32
CA_71A-2A-66A-66A	20M	133322	683	1	0	20M	1100	1	0	20M	67036	1	0	20M	2300	1	0	22	21.04
CA_71A-2A-66C	20M	133322	683	1	0	20M	1100	1	0	20M	66536	1	0	20M	66536	1	0	22	20.99
CA_66A-2C-66A	20M	132072	1720	1	0	20M	1100	1	0	20M	1100	1	0	20M	2300	1	0	17	16.23
CA_2A-2A-13A-66A	20M	18900	1880	1	0	20M	1100	1	0	20M	898	1	0	20M	2300	1	0	17	16.11
CA_13A-2A-2A-66A	10M	23130	5130	1	49	20M	1100	1	0	20M	1100	1	0	20M	2300	1	0	22	21.30
CA_66A-2A-2A-13A	20M	132072	1720	1	0	20M	1100	1	0	20M	1100	1	0	5M	5155	1	12	17	16.22

11.4 NR 5G Measurement result

According to April 2015 TCB workshop, SAR test exclusion can be applied for testing overlapping 5G NR(FR1) bands as follows:

- a) The maximum output power, including tolerance, for the smaller band must be \leq the larger band to qualify for the SAR test exclusion.
- b) The channel bandwidth and other operating parameters for the smaller band must be fully supported by the larger band.

Due to test setup limitations, SAR testing for NR was performed using Factory Test Mode software to establish the connection and perform SAR with 100% transmission.

Uplink RB allocations were used to Table 6.1-1 of the 3GPP TS 138.521-1:

Channel Bandwidth	SCS(kHz)	OFDM	RB allocation							
			Edge_Full_Left	Edge_Full_Right	Edge_1RB_Left	Edge_1RB_Right	Outer_Full	Inner_Full	Inner_1RB_Left	Inner_1RB_Right
5MHz	15	DFT-s	2@0	2@23	1@0	1@24	25@0	12@6	1@1	1@23
		CP	2@0	2@23	1@0	1@24	25@0	13@6	1@1	1@23
	30	DFT-s	2@0	2@9	1@0	1@10	10@0	5@2 ¹	1@1	1@9
		CP	2@0	2@9	1@0	1@10	11@0	5@2 ¹	1@1	1@9
	60	DFT-s	N/A	N/A	N/A	N/A	N/A	N/A	N/A	N/A
		CP	N/A	N/A	N/A	N/A	N/A	N/A	N/A	N/A
10MHz	15	DFT-s	2@0	2@50	1@0	1@51	50@0	25@12	1@1	1@50
		CP	2@0	2@50	1@0	1@51	52@0	26@13	1@1	1@50
	30	DFT-s	2@0	2@22	1@0	1@23	24@0	12@6	1@1	1@22
		CP	2@0	2@22	1@0	1@23	24@0	12@6	1@1	1@22
	60	DFT-s	2@0	2@9	1@0	1@10	10@0	5@2 ¹	1@1	1@9
		CP	2@0	2@9	1@0	1@10	11@0	5@2 ¹	1@1	1@9
15MHz	15	DFT-s	2@0	2@77	1@0	1@78	75@0	36@18	1@1	1@77
		CP	2@0	2@77	1@0	1@78	79@0	39@19 ¹	1@1	1@77
	30	DFT-s	2@0	2@36	1@0	1@37	36@0	18@9	1@1	1@36
		CP	2@0	2@36	1@0	1@37	38@0	19@9	1@1	1@36
	60	DFT-s	2@0	2@16	1@0	1@17	18@0	9@4	1@1	1@16
		CP	2@0	2@16	1@0	1@17	18@0	9@4	1@1	1@16
20MHz	15	DFT-s	2@0	2@104	1@0	1@105	100@0	50@25	1@1	1@104
		CP	2@0	2@104	1@0	1@105	106@0	53@26	1@1	1@104
	30	DFT-s	2@0	2@49	1@0	1@50	50@0	25@12	1@1	1@49
		CP	2@0	2@49	1@0	1@50	51@0	25@12 ¹	1@1	1@49
	60	DFT-s	2@0	2@22	1@0	1@23	24@0	12@6	1@1	1@22
		CP	2@0	2@22	1@0	1@23	24@0	12@6	1@1	1@22
25MHz	15	DFT-s	2@0	2@131	1@0	1@132	128@0	64@32	1@1	1@131
		CP	2@0	2@131	1@0	1@132	133@0	67@33	1@1	1@131
	30	DFT-s	2@0	2@63	1@0	1@64	64@0	32@16	1@1	1@63
		CP	2@0	2@63	1@0	1@64	65@0	33@16	1@1	1@63
	60	DFT-s	2@0	2@29	1@0	1@30	30@0	15@7 ¹	1@1	1@29
		CP	2@0	2@29	1@0	1@30	31@0	15@7 ¹	1@1	1@29
30MHz	15	DFT-s	2@0	2@158	1@0	1@159	160@0	80@40	1@1	1@158
		CP	2@0	2@158	1@0	1@159	160@0	80@40	1@1	1@158
	30	DFT-s	2@0	2@76	1@0	1@77	75@0	36@18	1@1	1@76
		CP	2@0	2@76	1@0	1@77	78@0	39@19	1@1	1@76
	60	DFT-s	2@0	2@36	1@0	1@37	36@0	18@9	1@1	1@36
		CP	2@0	2@36	1@0	1@37	38@0	19@9	1@1	1@36
40MHz	15	DFT-s	2@0	2@214	1@0	1@215	216@0	108@54	1@1	1@214
		CP	2@0	2@214	1@0	1@215	216@0	108@54	1@1	1@214
	30	DFT-s	2@0	2@104	1@0	1@105	100@0	50@25	1@1	1@104
		CP	2@0	2@104	1@0	1@105	106@0	53@26	1@1	1@104
	60	DFT-s	2@0	2@49	1@0	1@50	50@0	25@12	1@1	1@49
		CP	2@0	2@49	1@0	1@50	51@0	25@12 ¹	1@1	1@49
50MHz	15	DFT-s	2@0	2@268	1@0	1@269	270@0	135@67	1@1	1@268
		CP	2@0	2@268	1@0	1@269	270@0	135@67	1@1	1@268
	30	DFT-s	2@0	2@131	1@0	1@132	128@0	64@32	1@1	1@131
		CP	2@0	2@131	1@0	1@132	133@0	67@33	1@1	1@131
	60	DFT-s	2@0	2@63	1@0	1@64	64@0	32@16	1@1	1@63
		CP	2@0	2@63	1@0	1@64	65@0	33@16	1@1	1@63
60MHz	15	DFT-s	N/A	N/A	N/A	N/A	N/A	N/A	N/A	N/A
		CP	N/A	N/A	N/A	N/A	N/A	N/A	N/A	N/A
	30	DFT-s	2@0	2@160	1@0	1@161	162@0	81@40	1@1	1@160
		CP	2@0	2@160	1@0	1@161	162@0	81@40	1@1	1@160
	60	DFT-s	2@0	2@77	1@0	1@78	75@0	36@18	1@1	1@77
		CP	2@0	2@77	1@0	1@78	79@0	39@19 ¹	1@1	1@77
80MHz	15	DFT-s	N/A	N/A	N/A	N/A	N/A	N/A	N/A	N/A
		CP	N/A	N/A	N/A	N/A	N/A	N/A	N/A	N/A

	30	DFT-s	2@0	2@215	1@0	1@216	216@0	108@54	1@1	1@215
		CP	2@0	2@215	1@0	1@216	217@0	109@54	1@1	1@215
	60	DFT-s	2@0	2@105	1@0	1@106	100@0	50@25	1@1	1@105
		CP	2@0	2@105	1@0	1@106	107@0	53@26 ¹	1@1	1@105
90MHz	15	DFT-s	N/A	N/A	N/A	N/A	N/A	N/A	N/A	N/A
		CP	N/A	N/A	N/A	N/A	N/A	N/A	N/A	N/A
	30	DFT-s	2@0	2@243	1@0	1@244	240@0	120@60	1@1	1@243
		CP	2@0	2@243	1@0	1@244	245@0	123@61	1@1	1@243
	60	DFT-s	2@0	2@119	1@0	1@120	120@0	60@30	1@1	1@119
		CP	2@0	2@119	1@0	1@120	121@0	61@30	1@1	1@119
100MHz	15	DFT-s	N/A	N/A	N/A	N/A	N/A	N/A	N/A	N/A
		CP	N/A	N/A	N/A	N/A	N/A	N/A	N/A	N/A
	30	DFT-s	2@0	2@271	1@0	1@272	270@0	135@67	1@1	1@271
		CP	2@0	2@271	1@0	1@272	273@0	137@68	1@1	1@271
	60	DFT-s	2@0	2@133	1@0	1@134	135@0	64@32	1@1	1@133
		CP	2@0	2@133	1@0	1@134	135@0	67@33 ¹	1@1	1@133

Note 1: The allocated RB number L_{CRB} is $\text{ceil}(N_{RB}/2) - 1$ in order to meet Inner RB allocation definition ($RB_{start,Low} \leq RB_{start} \leq RB_{start,High}$) described in subclause 6.2.2 of TS 38.101-1 [2].

3GPP MPR for NR:
Table 6.2.2.3-1: Maximum Power Reduction (MPR) for Power 3

Modulation	MPR (dB)		
	Edge RB allocations	Outer RB allocations	Inner RB allocations
DFT-s-OFDM $\pi/2$ BPSK	$\leq 3.5^1$	$\leq 1.2^1$	$\leq 0.2^1$
	$\leq 0.5^2$		0^2
DFT-s-OFDM QPSK	≤ 1		0
DFT-s-OFDM 16 QAM	≤ 2		≤ 1
DFT-s-OFDM 64 QAM		≤ 2.5	
DFT-s-OFDM 256 QAM		≤ 4.5	
CP-OFDM QPSK	≤ 3		≤ 1.5
CP-OFDM 16 QAM	≤ 3		≤ 2
CP-OFDM 64 QAM		≤ 3.5	
CP-OFDM 256 QAM		≤ 6.5	

NOTE 1: Applicable for UE operating in TDD mode with $\pi/2$ BPSK modulation and UE indicates support for UE capability *powerBoosting-pi2BPSK* and if the IE *powerBoostPi2BPSK* is set to 1 and 40 % or less slots in radio frame are used for UL transmission for bands n40, n41, n77, n78 and n79. The reference power of 0dB MPR is 26dBm.

NOTE 2: Applicable for UE operating in FDD mode, or in TDD mode in bands other than n40, n41, n77, n78 and n79 and if the IE *powerBoostPi2BPSK* is set to 0 and if more than 40% of slots in radio frame are used for UL transmission for bands n40, n41, n77, n78 and n79.

Table 6.2.2-2 Maximum power reduction (MPR) for power class 2

Modulation		MPR (dB)		
		Edge RB allocations	Outer RB allocations	Inner RB allocations
DFT-s-OFDM	$\pi/2$ BPSK	≤ 3.5	≤ 0.5	0
	QPSK	≤ 3.5	≤ 1	0
	16 QAM	≤ 3.5	≤ 2	≤ 1
	64 QAM	≤ 3.5		≤ 2.5
	256 QAM		≤ 4.5	
CP-OFDM	QPSK	≤ 3.5	≤ 3	≤ 1.5
	16 QAM	≤ 3.5	≤ 3	≤ 2
	64 QAM		≤ 3.5	
	256 QAM		≤ 6.5	

No.	Test Freq Description	5G-n25 Normal Power						Tune up	Power Results (dBm)	
		SCS (kHz)	NR BW (MHz)	Modulation	RB allocation		NR Test Freq. (MHz)		NR Test CH.	n25
1	High	15	5	DFT-s-OFDM QPSK	Inner_Full	12_6	1912.5	382500	25.50	24.71
2	Middle	15	5	DFT-s-OFDM QPSK	Inner_Full	12_6	1882.5	376500	25.50	24.79
3	Low	15	5	DFT-s-OFDM QPSK	Inner_Full	12_6	1852.5	370500	25.50	24.77
4	High	15	20	DFT-s-OFDM QPSK	Inner_Full	50_25	1905	381000	25.50	24.66
5	Middle	15	20	DFT-s-OFDM QPSK	Inner_Full	50_25	1882.5	376500	25.50	24.78
6	Low	15	20	DFT-s-OFDM QPSK	Inner_Full	50_25	1860	372000	25.50	24.82
7	Middle	15	20	DFT-s-OFDM P/2 BPSK1	Inner_Full	50_25	1882.5	376500	25.50	25.23
8	Middle	15	20	DFT-s-OFDM 16QAM	Inner_Full	50_25	1882.5	376500	25.50	24.12
9	Middle	15	20	DFT-s-OFDM 64QAM	Inner_Full	50_25	1882.5	376500	25.50	23.60
10	Middle	15	20	DFT-s-OFDM 256QAM	Inner_Full	50_25	1882.5	376500	25.50	23.57
11	Middle	15	20	CP-OFDM QPSK	Inner_Full	50_25	1882.5	376500	25.50	23.55
12	Middle	15	20	CP-OFDM 16QAM	Inner_Full	50_25	1882.5	376500	25.50	23.57
13	Middle	15	20	CP-OFDM 64QAM	Inner_Full	50_25	1882.5	376500	25.50	23.64
14	Middle	15	20	CP-OFDM 256QAM	Inner_Full	50_25	1882.5	376500	25.50	23.62
15	Middle	15	20	DFT-s-OFDM QPSK	Edge_Full_Right	2_23	1882.5	376500	25.50	24.23
16	Middle	15	20	DFT-s-OFDM QPSK	Edge_Full_Left	2_0	1882.5	376500	25.50	24.32
17	Middle	15	20	DFT-s-OFDM QPSK	Edge_1RB_Right	1_24	1882.5	376500	25.50	24.39
18	Middle	15	20	DFT-s-OFDM QPSK	Edge_1RB_Left	1_0	1882.5	376500	25.50	24.33
19	Middle	15	20	DFT-s-OFDM QPSK	Inner_1RB_Right	1_23	1882.5	376500	25.50	25.34
20	Middle	15	20	DFT-s-OFDM QPSK	Inner_1RB_Left	1_1	1882.5	376500	25.50	25.36
21	Middle	15	20	DFT-s-OFDM QPSK	Outer_Full	25_0	1882.5	376500	25.50	24.27
22	High	15	10	DFT-s-OFDM QPSK	Inner_Full	25_12	1910	382000	25.50	25.12
23	Middle	15	10	DFT-s-OFDM QPSK	Inner_Full	25_12	1882.5	376500	25.50	25.31
24	Low	15	10	DFT-s-OFDM QPSK	Inner_Full	25_12	1855	371000	25.50	25.26
25	High	15	15	DFT-s-OFDM QPSK	Inner_Full	36_18	1907.5	381500	25.50	24.99
26	Middle	15	15	DFT-s-OFDM QPSK	Inner_Full	36_18	1882.5	376500	25.50	25.18
27	Low	15	15	DFT-s-OFDM QPSK	Inner_Full	36_18	1857.5	371500	25.50	25.24

No.	Test Freq Description	5G-n25 Low Power						Tune up	Power Results (dBm)	
		SCS (kHz)	NR BW (MHz)	Modulation	RB allocation		NR Test Freq. (MHz)		NR Test CH.	n25
1	High	15	5	DFT-s-OFDM QPSK	Inner_Full	12_6	1912.5	382500	17.50	16.63
2	Middle	15	5	DFT-s-OFDM QPSK	Inner_Full	12_6	1882.5	376500	17.50	16.72
3	Low	15	5	DFT-s-OFDM QPSK	Inner_Full	12_6	1852.5	370500	17.50	16.67
4	High	15	20	DFT-s-OFDM QPSK	Inner_Full	50_25	1905	381000	17.50	16.59
5	Middle	15	20	DFT-s-OFDM QPSK	Inner_Full	50_25	1882.5	376500	17.50	16.70
6	Low	15	20	DFT-s-OFDM QPSK	Inner_Full	50_25	1860	372000	17.50	16.71
7	Middle	15	5	DFT-s-OFDM P/2 BPSK1	Inner_Full	12_6	1882.5	376500	17.50	16.75
8	Middle	15	5	DFT-s-OFDM 16QAM	Inner_Full	12_6	1882.5	376500	17.50	16.77
9	Middle	15	5	DFT-s-OFDM 64QAM	Inner_Full	12_6	1882.5	376500	17.50	16.79
10	Middle	15	5	DFT-s-OFDM 256QAM	Inner_Full	12_6	1882.5	376500	17.50	16.67
11	Middle	15	5	CP-OFDM QPSK	Inner_Full	12_6	1882.5	376500	17.50	16.67
12	Middle	15	5	CP-OFDM 16QAM	Inner_Full	12_6	1882.5	376500	17.50	16.64
13	Middle	15	5	CP-OFDM 64QAM	Inner_Full	12_6	1882.5	376500	17.50	16.61
14	Middle	15	5	CP-OFDM 256QAM	Inner_Full	12_6	1882.5	376500	17.50	16.70
15	Middle	15	5	DFT-s-OFDM QPSK	Edge_Full_Right	2_23	1882.5	376500	17.50	16.74
16	Middle	15	5	DFT-s-OFDM QPSK	Edge_Full_Left	2_0	1882.5	376500	17.50	16.69
17	Middle	15	5	DFT-s-OFDM QPSK	Edge_1RB_Right	1_24	1882.5	376500	17.50	16.84
18	Middle	15	5	DFT-s-OFDM QPSK	Edge_1RB_Left	1_0	1882.5	376500	17.50	16.80
19	Middle	15	5	DFT-s-OFDM QPSK	Inner_1RB_Right	1_23	1882.5	376500	17.50	16.88
20	Middle	15	5	DFT-s-OFDM QPSK	Inner_1RB_Left	1_1	1882.5	376500	17.50	16.79
21	Middle	15	5	DFT-s-OFDM QPSK	Outer_Full	25_0	1882.5	376500	17.50	16.72
22	High	15	10	DFT-s-OFDM QPSK	Inner_Full	25_12	1910	382000	17.50	16.71
23	Middle	15	10	DFT-s-OFDM QPSK	Inner_Full	25_12	1882.5	376500	17.50	16.80
24	Low	15	10	DFT-s-OFDM QPSK	Inner_Full	25_12	1855	371000	17.50	16.65
25	High	15	15	DFT-s-OFDM QPSK	Inner_Full	36_18	1907.5	381500	17.50	16.59
26	Middle	15	15	DFT-s-OFDM QPSK	Inner_Full	36_18	1882.5	376500	17.50	16.69
27	Low	15	15	DFT-s-OFDM QPSK	Inner_Full	36_18	1857.5	371500	17.50	16.64

No.	Test Freq Description	5G-n66 Normal Power							Tune up	Power Results (dBm)
		SCS (kHz)	NR BW (MHz)	Modulation	RB allocation		NR Test Freq. (MHz)	NR Test CH.		n66
1	High	15	5	DFT-s-OFDM QPSK	Inner_Full	12_6	1777.5	355500	25.50	24.77
2	Middle	15	5	DFT-s-OFDM QPSK	Inner_Full	12_6	1745	349000	25.50	24.78
3	Low	15	5	DFT-s-OFDM QPSK	Inner_Full	12_6	1712.5	342500	25.50	24.48
4	High	15	40	DFT-s-OFDM QPSK	Inner_Full	108_54	1760	352000	25.50	25.06
5	Middle	15	40	DFT-s-OFDM QPSK	Inner_Full	108_54	1745	349000	25.50	25.02
6	Low	15	40	DFT-s-OFDM QPSK	Inner_Full	108_54	1730	346000	25.50	25.00
7	Middle	15	40	DFT-s-OFDM PI/2 BPSK1	Inner_Full	12_6	1745	349000	25.50	25.03
8	Middle	15	40	DFT-s-OFDM 16QAM	Inner_Full	12_6	1745	349000	25.50	23.99
9	Middle	15	40	DFT-s-OFDM 64QAM	Inner_Full	12_6	1745	349000	25.50	23.53
10	Middle	15	40	DFT-s-OFDM 256QAM	Inner_Full	12_6	1745	349000	25.50	23.61
11	Middle	15	40	CP-OFDM QPSK	Inner_Full	12_6	1745	349000	25.50	23.63
12	Middle	15	40	CP-OFDM 16QAM	Inner_Full	12_6	1745	349000	25.50	23.58
13	Middle	15	40	CP-OFDM 64QAM	Inner_Full	12_6	1745	349000	25.50	23.52
14	Middle	15	40	CP-OFDM 256QAM	Inner_Full	12_6	1745	349000	25.50	23.57
15	Middle	15	40	DFT-s-OFDM QPSK	Edge_Full_Right	2_23	1745	349000	25.50	24.03
16	Middle	15	40	DFT-s-OFDM QPSK	Edge_Full_Left	2_0	1745	349000	25.50	24.06
17	Middle	15	40	DFT-s-OFDM QPSK	Edge_1RB_Right	1_24	1745	349000	25.50	24.13
18	Middle	15	40	DFT-s-OFDM QPSK	Edge_1RB_Left	1_0	1745	349000	25.50	24.10
19	Middle	15	40	DFT-s-OFDM QPSK	Inner_1RB_Right	1_23	1745	349000	25.50	25.23
20	Middle	15	40	DFT-s-OFDM QPSK	Inner_1RB_Left	1_1	1745	349000	25.50	25.21
21	Middle	15	40	DFT-s-OFDM QPSK	Outer_Full	25_0	1745	349000	25.50	24.07
22	High	15	10	DFT-s-OFDM QPSK	Inner_Full	25_12	1775	355000	25.50	25.11
23	Middle	15	10	DFT-s-OFDM QPSK	Inner_Full	25_12	1745	349000	25.50	25.08
24	Low	15	10	DFT-s-OFDM QPSK	Inner_Full	25_12	1715	343000	25.50	24.21
25	High	15	15	DFT-s-OFDM QPSK	Inner_Full	36_18	1772.5	354500	25.50	24.43
26	Middle	15	15	DFT-s-OFDM QPSK	Inner_Full	36_18	1745	349000	25.50	24.97
27	Low	15	15	DFT-s-OFDM QPSK	Inner_Full	36_18	1717.5	343500	25.50	24.32
28	High	15	20	DFT-s-OFDM QPSK	Inner_Full	50_25	1770	354000	25.50	24.93
29	Middle	15	20	DFT-s-OFDM QPSK	Inner_Full	50_25	1745	349000	25.50	25.09
30	Low	15	20	DFT-s-OFDM QPSK	Inner_Full	50_25	1720	344000	25.50	24.30
31	High	15	25	DFT-s-OFDM QPSK	Inner_Full	64-32	1767.5	353500	25.50	25.01
32	Middle	15	25	DFT-s-OFDM QPSK	Inner_Full	64-32	1745	349000	25.50	24.97
33	Low	15	25	DFT-s-OFDM QPSK	Inner_Full	64-32	1722.5	344500	25.50	25.00
34	High	15	30	DFT-s-OFDM QPSK	Inner_Full	80_40	1765	35300	25.50	25.05
35	Middle	15	30	DFT-s-OFDM QPSK	Inner_Full	80_40	1745	349000	25.50	25.06
36	Low	15	30	DFT-s-OFDM QPSK	Inner_Full	80_40	1725	345000	25.50	25.02

No.	Test Freq Description	5G-n66 Low Power							Tune up	Power Results (dBm)
		SCS (kHz)	NR BW (MHz)	Modulation	RB allocation		NR Test Freq. (MHz)	NR Test CH.		n66
1	High	15	5	DFT-s-OFDM QPSK	Inner_Full	12_6	1777.5	355500	17.50	16.41
2	Middle	15	5	DFT-s-OFDM QPSK	Inner_Full	12_6	1745	349000	17.50	16.38
3	Low	15	5	DFT-s-OFDM QPSK	Inner_Full	12_6	1712.5	342500	17.50	16.48
4	High	15	40	DFT-s-OFDM QPSK	Inner_Full	108_54	1760	352000	17.50	16.33
5	Middle	15	40	DFT-s-OFDM QPSK	Inner_Full	108_54	1745	349000	17.50	16.32
6	Low	15	40	DFT-s-OFDM QPSK	Inner_Full	108_54	1730	346000	17.50	16.27
7	Middle	15	5	DFT-s-OFDM PI/2 BPSK1	Inner_Full	12_6	1745	349000	17.50	16.37
8	Middle	15	5	DFT-s-OFDM 16QAM	Inner_Full	12_6	1745	349000	17.50	16.38
9	Middle	15	5	DFT-s-OFDM 64QAM	Inner_Full	12_6	1745	349000	17.50	16.36
10	Middle	15	5	DFT-s-OFDM 256QAM	Inner_Full	12_6	1745	349000	17.50	16.45
11	Middle	15	5	CP-OFDM QPSK	Inner_Full	12_6	1745	349000	17.50	16.47
12	Middle	15	5	CP-OFDM 16QAM	Inner_Full	12_6	1745	349000	17.50	16.44
13	Middle	15	5	CP-OFDM 64QAM	Inner_Full	12_6	1745	349000	17.50	16.30
14	Middle	15	5	CP-OFDM 256QAM	Inner_Full	12_6	1745	349000	17.50	16.41
15	Middle	15	5	DFT-s-OFDM QPSK	Edge_Full_Right	2_23	1745	349000	17.50	16.47
16	Middle	15	5	DFT-s-OFDM QPSK	Edge_Full_Left	2_0	1745	349000	17.50	16.41
17	Middle	15	5	DFT-s-OFDM QPSK	Edge_1RB_Right	1_24	1745	349000	17.50	16.42
18	Middle	15	5	DFT-s-OFDM QPSK	Edge_1RB_Left	1_0	1745	349000	17.50	16.45
19	Middle	15	5	DFT-s-OFDM QPSK	Inner_1RB_Right	1_23	1745	349000	17.50	16.46
20	Middle	15	5	DFT-s-OFDM QPSK	Inner_1RB_Left	1_1	1745	349000	17.50	16.43
21	Middle	15	5	DFT-s-OFDM QPSK	Outer_Full	25_0	1745	349000	17.50	16.40
22	High	15	10	DFT-s-OFDM QPSK	Inner_Full	25_12	1775	355000	17.50	16.44
23	Middle	15	10	DFT-s-OFDM QPSK	Inner_Full	25_12	1745	349000	17.50	16.40
24	Low	15	10	DFT-s-OFDM QPSK	Inner_Full	25_12	1715	343000	17.50	16.44
25	High	15	15	DFT-s-OFDM QPSK	Inner_Full	36_18	1772.5	354500	17.50	16.31
26	Middle	15	15	DFT-s-OFDM QPSK	Inner_Full	36_18	1745	349000	17.50	16.35
27	Low	15	15	DFT-s-OFDM QPSK	Inner_Full	36_18	1717.5	343500	17.50	16.42
28	High	15	20	DFT-s-OFDM QPSK	Inner_Full	50_25	1770	354000	17.50	16.72
29	Middle	15	20	DFT-s-OFDM QPSK	Inner_Full	50_25	1745	349000	17.50	16.85
30	Low	15	20	DFT-s-OFDM QPSK	Inner_Full	50_25	1720	344000	17.50	17.05
31	High	15	25	DFT-s-OFDM QPSK	Inner_Full	64-32	1767.5	353500	17.50	16.16
32	Middle	15	25	DFT-s-OFDM QPSK	Inner_Full	64-32	1745	349000	17.50	16.39
33	Low	15	25	DFT-s-OFDM QPSK	Inner_Full	64-32	1722.5	344500	17.50	16.50
34	High	15	30	DFT-s-OFDM QPSK	Inner_Full	80_40	1765	35300	17.50	16.47
35	Middle	15	30	DFT-s-OFDM QPSK	Inner_Full	80_40	1745	349000	17.50	16.80
36	Low	15	30	DFT-s-OFDM QPSK	Inner_Full	80_40	1725	345000	17.50	16.91

No.	Test Freq Description	5G-n71 Normal Power						Tune up	Power Results (dBm)	
		SCS (kHz)	NR BW (MHz)	Modulation	RB allocation		NR Test Freq. (MHz)		NR Test CH.	n71
1	High	15	5	DFT-s-OFDM QPSK	Inner_Full	12_6	695.5	139100	25.50	24.96
2	Middle	15	5	DFT-s-OFDM QPSK	Inner_Full	12_6	680.5	136100	25.50	24.89
3	Low	15	5	DFT-s-OFDM QPSK	Inner_Full	12_6	665.5	133100	25.50	25.04
4	High	15	20	DFT-s-OFDM QPSK	Inner_Full	50_25	688	137600	25.50	24.74
5	Middle	15	20	DFT-s-OFDM QPSK	Inner_Full	50_25	680.5	136100	25.50	24.69
6	Low	15	20	DFT-s-OFDM QPSK	Inner_Full	50_25	673	134600	25.50	24.88
1	Middle	15	5	DFT-s-OFDM P1/2 BPSK1	Inner_Full	12_6	680.5	136100	25.50	25.09
2	Middle	15	5	DFT-s-OFDM 16QAM	Inner_Full	12_6	680.5	136100	25.50	23.70
3	Middle	15	5	DFT-s-OFDM 64QAM	Inner_Full	12_6	680.5	136100	25.50	23.56
4	Middle	15	5	DFT-s-OFDM 256QAM	Inner_Full	12_6	680.5	136100	25.50	23.59
5	Middle	15	5	CP-OFDM QPSK	Inner_Full	12_6	680.5	136100	25.50	23.50
6	Middle	15	5	CP-OFDM 16QAM	Inner_Full	12_6	680.5	136100	25.50	23.63
7	Middle	15	5	CP-OFDM 64QAM	Inner_Full	12_6	680.5	136100	25.50	23.61
8	Middle	15	5	CP-OFDM 256QAM	Inner_Full	12_6	680.5	136100	25.50	23.51
9	Middle	15	5	DFT-s-OFDM QPSK	Edge_Full_Right	2_23	680.5	136100	25.50	23.70
10	Middle	15	5	DFT-s-OFDM QPSK	Edge_Full_Left	2_0	680.5	136100	25.50	23.69
11	Middle	15	5	DFT-s-OFDM QPSK	Edge_1RB_Right	1_24	680.5	136100	25.50	23.72
12	Middle	15	5	DFT-s-OFDM QPSK	Edge_1RB_Left	1_0	680.5	136100	25.50	23.67
13	Middle	15	5	DFT-s-OFDM QPSK	Inner_1RB_Right	1_23	680.5	136100	25.50	24.51
14	Middle	15	5	DFT-s-OFDM QPSK	Inner_1RB_Left	1_1	680.5	136100	25.50	24.51
15	Middle	15	5	DFT-s-OFDM QPSK	Outer_Full	25_0	680.5	136100	25.50	23.64
14	High	15	10	DFT-s-OFDM QPSK	Inner_Full	25_12	693	138600	25.50	24.85
15	Middle	15	10	DFT-s-OFDM QPSK	Inner_Full	25_12	680.5	136100	25.50	24.49
16	Low	15	10	DFT-s-OFDM QPSK	Inner_Full	25_12	668	133600	25.50	24.89
17	High	15	15	DFT-s-OFDM QPSK	Inner_Full	36_18	690.5	138100	25.50	24.69
18	Middle	15	15	DFT-s-OFDM QPSK	Inner_Full	36_18	680.5	136100	25.50	24.37
19	Low	15	15	DFT-s-OFDM QPSK	Inner_Full	36_18	670.5	134100	25.50	24.74

No.	Test Freq Description	5G-n71 Low Power						Tune up	Power Results (dBm)	
		SCS (kHz)	NR BW (MHz)	Modulation	RB allocation		NR Test Freq. (MHz)		NR Test CH.	n71
1	High	15	5	DFT-s-OFDM QPSK	Inner_Full	12_6	695.5	139100	22.50	21.82
2	Middle	15	5	DFT-s-OFDM QPSK	Inner_Full	12_6	680.5	136100	22.50	22.02
3	Low	15	5	DFT-s-OFDM QPSK	Inner_Full	12_6	665.5	133100	22.50	22.13
4	High	15	20	DFT-s-OFDM QPSK	Inner_Full	50_25	688	137600	22.50	21.82
5	Middle	15	20	DFT-s-OFDM QPSK	Inner_Full	50_25	680.5	136100	22.50	21.93
6	Low	15	20	DFT-s-OFDM QPSK	Inner_Full	50_25	673	134600	22.50	21.95
7	Middle	15	5	DFT-s-OFDM P1/2 BPSK1	Inner_Full	12_6	680.5	136100	22.50	22.02
8	Middle	15	5	DFT-s-OFDM 16QAM	Inner_Full	12_6	680.5	136100	22.50	21.93
9	Middle	15	5	DFT-s-OFDM 64QAM	Inner_Full	12_6	680.5	136100	22.50	22.01
10	Middle	15	5	DFT-s-OFDM 256QAM	Inner_Full	12_6	680.5	136100	22.50	20.60
11	Middle	15	5	CP-OFDM QPSK	Inner_Full	12_6	680.5	136100	22.50	22.03
12	Middle	15	5	CP-OFDM 16QAM	Inner_Full	12_6	680.5	136100	22.50	22.06
13	Middle	15	5	CP-OFDM 64QAM	Inner_Full	12_6	680.5	136100	22.50	21.48
14	Middle	15	5	CP-OFDM 256QAM	Inner_Full	12_6	680.5	136100	22.50	20.57
15	Middle	15	5	DFT-s-OFDM QPSK	Edge_Full_Right	2_23	680.5	136100	22.50	21.91
16	Middle	15	5	DFT-s-OFDM QPSK	Edge_Full_Left	2_0	680.5	136100	22.50	21.87
17	Middle	15	5	DFT-s-OFDM QPSK	Edge_1RB_Right	1_24	680.5	136100	22.50	22.07
18	Middle	15	5	DFT-s-OFDM QPSK	Edge_1RB_Left	1_0	680.5	136100	22.50	22.03
19	Middle	15	5	DFT-s-OFDM QPSK	Inner_1RB_Right	1_23	680.5	136100	22.50	22.07
20	Middle	15	5	DFT-s-OFDM QPSK	Inner_1RB_Left	1_1	680.5	136100	22.50	22.02
21	Middle	15	5	DFT-s-OFDM QPSK	Outer_Full	25_0	680.5	136100	22.50	21.98
22	High	15	10	DFT-s-OFDM QPSK	Inner_Full	25_12	693	138600	22.50	21.90
23	Middle	15	10	DFT-s-OFDM QPSK	Inner_Full	25_12	680.5	136100	22.50	21.99
24	Low	15	10	DFT-s-OFDM QPSK	Inner_Full	25_12	668	133600	22.50	22.05
25	High	15	15	DFT-s-OFDM QPSK	Inner_Full	36_18	690.5	138100	22.50	21.76
26	Middle	15	15	DFT-s-OFDM QPSK	Inner_Full	36_18	680.5	136100	22.50	21.96
27	Low	15	15	DFT-s-OFDM QPSK	Inner_Full	36_18	670.5	134100	22.50	21.95

No.	Test Freq Description	5G-n41PC2 Normal Power							Power Results (dBm)	
		SCS (kHz)	NR BW (MHz)	Modulation	RB allocation		NR Test Freq. (MHz)	NR Test CH.	Tune up	n41
1	High	30	10	DFT-s-OFDM QPSK	Inner_Full	12_6	2685	537000	27.50	25.85
2	Middle1	30	10	DFT-s-OFDM QPSK	Inner_Full	12_6	2639	527799	27.50	26.27
3	Middle2	30	10	DFT-s-OFDM QPSK	Inner_Full	12_6	2592.99	518598	27.50	26.75
4	Middle3	30	10	DFT-s-OFDM QPSK	Inner_Full	12_6	2455.02	509406	27.50	26.23
5	Low	30	10	DFT-s-OFDM QPSK	Inner_Full	12_6	2501.01	500205	27.50	26.21
6	High	30	100	DFT-s-OFDM QPSK	Inner_Full	135_67	2640	528000	27.50	26.30
7	Middle1	30	100	DFT-s-OFDM QPSK	Inner_Full	135_67	2616.495	523299	27.50	26.36
8	Middle2	30	100	DFT-s-OFDM QPSK	Inner_Full	135_67	2592.99	518598	27.50	26.56
9	Middle3	30	100	DFT-s-OFDM QPSK	Inner_Full	135_67	2569.5	513900	27.50	26.51
10	Low	30	100	DFT-s-OFDM QPSK	Inner_Full	135_67	2546.01	509202	27.50	26.18
11	Middle2	30	10	DFT-s-OFDM PI/2 BPSK1	Inner_Full	12_6	2592.99	518598	27.50	27.15
12	Middle2	30	10	DFT-s-OFDM 16QAM	Inner_Full	12_6	2592.99	518598	27.50	25.98
13	Middle2	30	10	DFT-s-OFDM 64QAM	Inner_Full	12_6	2592.99	518598	27.50	25.53
14	Middle2	30	10	DFT-s-OFDM 256QAM	Inner_Full	12_6	2592.99	518598	27.50	25.52
15	Middle2	30	10	CP-OFDM QPSK	Inner_Full	12_6	2592.99	518598	27.50	25.62
16	Middle2	30	10	CP-OFDM 16QAM	Inner_Full	12_6	2592.99	518598	27.50	25.51
17	Middle2	30	10	CP-OFDM 64QAM	Inner_Full	12_6	2592.99	518598	27.50	25.54
18	Middle2	30	10	CP-OFDM 256QAM	Inner_Full	12_6	2592.99	518598	27.50	25.50
19	Middle	30	10	DFT-s-OFDM QPSK	Edge_Full_Right	2_22	2592.99	518598	27.50	25.51
20	Middle	30	10	DFT-s-OFDM QPSK	Edge_Full_Left	2_0	2592.99	518598	27.50	25.51
21	Middle	30	10	DFT-s-OFDM QPSK	Edge_1RB_Right	1_23	2592.99	518598	27.50	25.55
22	Middle	30	10	DFT-s-OFDM QPSK	Edge_1RB_Left	1_0	2592.99	518598	27.50	25.57
23	Middle	30	10	DFT-s-OFDM QPSK	Inner_1RB_Right	1_22	2592.99	518598	27.50	25.62
24	Middle	30	10	DFT-s-OFDM QPSK	Inner_1RB_Left	1_1	2592.99	518598	27.50	25.61
25	Middle	30	10	DFT-s-OFDM QPSK	Outer_Full	25_0	2592.99	518598	27.50	25.54
26	Middle2	30	15	DFT-s-OFDM QPSK	Inner_Full	18_9	2592.99	518598	27.50	26.93
27	Middle2	30	20	DFT-s-OFDM QPSK	Inner_Full	25_12	2592.99	518598	27.50	26.90
28	Middle2	30	30	DFT-s-OFDM QPSK	Inner_Full	36_18	2592.99	518598	27.50	26.83
29	Middle2	30	40	DFT-s-OFDM QPSK	Inner_Full	50_25	2592.99	518598	27.50	26.80
30	Middle2	30	50	DFT-s-OFDM QPSK	Inner_Full	64_32	2592.99	518598	27.50	26.78
31	Middle2	30	60	DFT-s-OFDM QPSK	Inner_Full	81_40	2592.99	518598	27.50	25.59
32	Middle2	30	70	DFT-s-OFDM QPSK	Inner_Full	90_45	2592.99	518598	27.50	25.60
33	Middle2	30	80	DFT-s-OFDM QPSK	Inner_Full	108_54	2592.99	518598	27.50	26.65
34	Middle2	30	90	DFT-s-OFDM QPSK	Inner_Full	120_60	2592.99	518598	27.50	26.68

No.	Test Freq Description	5G-n41 LowPC2 Power							Power Results (dBm)	
		SCS (kHz)	NR BW (MHz)	Modulation	RB allocation		NR Test Freq. (MHz)	NR Test CH.	Tune up	n41
1	High	30	10	DFT-s-OFDM QPSK	Inner_Full	12_6	2685	537000	17.50	16.91
2	Middle1	30	10	DFT-s-OFDM QPSK	Inner_Full	12_6	2639	527799	17.50	16.83
3	Middle2	30	10	DFT-s-OFDM QPSK	Inner_Full	12_6	2592.99	518598	17.50	16.92
4	Middle3	30	10	DFT-s-OFDM QPSK	Inner_Full	12_6	2455.02	509406	17.50	16.84
5	Low	30	10	DFT-s-OFDM QPSK	Inner_Full	12_6	2501.01	500205	17.50	16.87
6	High	30	100	DFT-s-OFDM QPSK	Inner_Full	135_67	2640	528000	17.50	16.62
7	Middle1	30	100	DFT-s-OFDM QPSK	Inner_Full	135_67	2616.495	523299	17.50	16.63
8	Middle2	30	100	DFT-s-OFDM QPSK	Inner_Full	135_67	2592.99	518598	17.50	16.55
9	Middle3	30	100	DFT-s-OFDM QPSK	Inner_Full	135_67	2569.5	513900	17.50	16.59
10	Low	30	100	DFT-s-OFDM QPSK	Inner_Full	135_67	2546.01	509202	17.50	16.61
11	Middle2	30	10	DFT-s-OFDM PI/2 BPSK1	Inner_Full	12_6	2592.99	518598	17.50	16.83
12	Middle2	30	10	DFT-s-OFDM 16QAM	Inner_Full	12_6	2592.99	518598	17.50	16.76
13	Middle2	30	10	DFT-s-OFDM 64QAM	Inner_Full	12_6	2592.99	518598	17.50	16.83
14	Middle2	30	10	DFT-s-OFDM 256QAM	Inner_Full	12_6	2592.99	518598	17.50	16.91
15	Middle2	30	10	CP-OFDM QPSK	Inner_Full	12_6	2592.99	518598	17.50	16.80
16	Middle2	30	10	CP-OFDM 16QAM	Inner_Full	12_6	2592.99	518598	17.50	16.82
17	Middle2	30	10	CP-OFDM 64QAM	Inner_Full	12_6	2592.99	518598	17.50	16.88
18	Middle2	30	10	CP-OFDM 256QAM	Inner_Full	12_6	2592.99	518598	17.50	16.88
19	Middle	30	10	DFT-s-OFDM QPSK	Edge_Full_Right	2_22	2592.99	518598	17.50	16.81
20	Middle	30	10	DFT-s-OFDM QPSK	Edge_Full_Left	2_0	2592.99	518598	17.50	16.86
21	Middle	30	10	DFT-s-OFDM QPSK	Edge_1RB_Right	1_23	2592.99	518598	17.50	16.92
22	Middle	30	10	DFT-s-OFDM QPSK	Edge_1RB_Left	1_0	2592.99	518598	17.50	16.94
23	Middle	30	10	DFT-s-OFDM QPSK	Inner_1RB_Right	1_22	2592.99	518598	17.50	16.91
24	Middle	30	10	DFT-s-OFDM QPSK	Inner_1RB_Left	1_1	2592.99	518598	17.50	16.93
25	Middle	30	10	DFT-s-OFDM QPSK	Outer_Full	25_0	2592.99	518598	17.50	16.85
26	Middle2	30	15	DFT-s-OFDM QPSK	Inner_Full	18_9	2592.99	518598	17.50	16.72
27	Middle2	30	20	DFT-s-OFDM QPSK	Inner_Full	25_12	2592.99	518598	17.50	16.81
28	Middle2	30	30	DFT-s-OFDM QPSK	Inner_Full	36_18	2592.99	518598	17.50	16.74
29	Middle2	30	40	DFT-s-OFDM QPSK	Inner_Full	50_25	2592.99	518598	17.50	16.82
30	Middle2	30	50	DFT-s-OFDM QPSK	Inner_Full	64_32	2592.99	518598	17.50	16.75
31	Middle2	30	60	DFT-s-OFDM QPSK	Inner_Full	81_40	2592.99	518598	17.50	16.75
32	Middle2	30	70	DFT-s-OFDM QPSK	Inner_Full	90_45	2592.99	518598	17.50	16.20
33	Middle2	30	80	DFT-s-OFDM QPSK	Inner_Full	108_54	2592.99	518598	17.50	16.57
34	Middle2	30	90	DFT-s-OFDM QPSK	Inner_Full	120_60	2592.99	518598	17.50	16.58

No.	Test Freq Description	5G-n77 PC2 L3450_3550 Normal Power							Tune up	Power Results n77
		SCS (kHz)	NR BW (MHz)	Modulation	RB allocation		NR Test Freq. (MHz)	NR Test CH.		
1	High	30	20	DFT-s-OFDM QPSK	Inner_Full	25@12	3540	636000	28.00	27.75
2	Middle	30	20	DFT-s-OFDM QPSK	Inner_Full	25@12	3500.01	633334	28.00	27.78
3	Low	30	20	DFT-s-OFDM QPSK	Inner_Full	25@12	3460.02	630668	28.00	27.71
4	High	30	100	DFT-s-OFDM QPSK	Inner_Full	135@67	3499.98	633332	28.00	27.54
5	Middle	30	100	DFT-s-OFDM QPSK	Inner_Full	135@67	3500.01	633334	28.00	27.50
6	Middle	30	20	DFT-s-OFDM P/2 BPSK1	Inner_Full	135@67	3500.01	633334	28.00	27.49
7	Middle	30	20	DFT-s-OFDM 16QAM	Inner_Full	135@67	3500.01	633334	28.00	26.51
8	Middle	30	20	DFT-s-OFDM 64QAM	Inner_Full	135@67	3500.01	633334	28.00	26.01
9	Middle	30	20	DFT-s-OFDM 256QAM	Inner_Full	135@67	3500.01	633334	28.00	26.03
10	Middle	30	20	CP-OFDM QPSK	Inner_Full	135@67	3500.01	633334	28.00	26.01
11	Middle	30	20	CP-OFDM 16QAM	Inner_Full	135@67	3500.01	633334	28.00	26.05
12	Middle	30	20	CP-OFDM 64QAM	Inner_Full	135@67	3500.01	633334	28.00	26.01
13	Middle	30	20	CP-OFDM 256QAM	Inner_Full	135@67	3500.01	633334	28.00	26.04
14	Middle	30	20	DFT-s-OFDM QPSK	Edge_1RB_Right	2@271	3500.01	633334	28.00	26.03
15	Middle	30	20	DFT-s-OFDM QPSK	Edge_1RB_Left	2@0	3500.01	633334	28.00	26.01
16	Middle	30	20	DFT-s-OFDM QPSK	Edge_Full_Right	1@271	3500.01	633334	28.00	27.60
17	Middle	30	20	DFT-s-OFDM QPSK	Edge_Full_Left	1@1	3500.01	633334	28.00	27.40
18	Middle	30	20	DFT-s-OFDM QPSK	Inner_1RB_Right	270@0	3500.01	633334	28.00	26.40
19	Middle	30	20	DFT-s-OFDM QPSK	Inner_1RB_Left	1@0	3500.01	633334	28.00	26.02
20	Middle	30	100	DFT-s-OFDM QPSK	Outer_Full	1@272	3500.01	633334	28.00	26.05
23	Middle-5	30	40	DFT-s-OFDM QPSK	Inner_Full	50@25	3500.01	633334	28.00	27.60
24	Middle-5	30	50	DFT-s-OFDM QPSK	Inner_Full	64@32	3500.01	633334	28.00	27.61
25	Middle-5	30	60	DFT-s-OFDM QPSK	Inner_Full	81@40	3500.01	633334	28.00	27.66
26	Middle-5	30	80	DFT-s-OFDM QPSK	Inner_Full	108@54	3500.01	633334	28.00	27.51
27	Middle-5	30	90	DFT-s-OFDM QPSK	Inner_Full	120@60	3500.01	633334	28.00	27.48

No.	Test Freq Description	5G-n77 LPC2 L3450_3550 Low Power							Tune up	Power Results (dBm) n77
		SCS (kHz)	NR BW (MHz)	Modulation	RB allocation		NR Test Freq. (MHz)	NR Test CH.		
1	High	30	20	DFT-s-OFDM QPSK	Inner_Full	25@12	3540	636000	18.00	17.70
2	Middle	30	20	DFT-s-OFDM QPSK	Inner_Full	25@12	3500.01	633334	18.00	17.63
3	Low	30	20	DFT-s-OFDM QPSK	Inner_Full	25@12	3460.02	630668	18.00	17.66
4	High	30	100	DFT-s-OFDM QPSK	Inner_Full	135@67	3499.98	633332	18.00	17.33
5	Middle	30	100	DFT-s-OFDM QPSK	Inner_Full	135@67	3500.01	633334	18.00	17.31
6	Middle	30	20	DFT-s-OFDM P/2 BPSK1	Inner_Full	135@67	3500.01	633334	18.00	17.33
7	Middle	30	20	DFT-s-OFDM 16QAM	Inner_Full	135@67	3500.01	633334	18.00	17.34
8	Middle	30	20	DFT-s-OFDM 64QAM	Inner_Full	135@67	3500.01	633334	18.00	17.32
9	Middle	30	20	DFT-s-OFDM 256QAM	Inner_Full	135@67	3500.01	633334	18.00	17.34
10	Middle	30	20	CP-OFDM QPSK	Inner_Full	135@67	3500.01	633334	18.00	17.36
11	Middle	30	20	CP-OFDM 16QAM	Inner_Full	135@67	3500.01	633334	18.00	17.36
12	Middle	30	20	CP-OFDM 64QAM	Inner_Full	135@67	3500.01	633334	18.00	17.37
13	Middle	30	20	CP-OFDM 256QAM	Inner_Full	135@67	3500.01	633334	18.00	17.33
14	Middle	30	20	DFT-s-OFDM QPSK	Edge_1RB_Right	2@271	3500.01	633334	18.00	17.37
15	Middle	30	20	DFT-s-OFDM QPSK	Edge_1RB_Left	2@0	3500.01	633334	18.00	17.15
16	Middle	30	20	DFT-s-OFDM QPSK	Edge_Full_Right	1@271	3500.01	633334	18.00	17.43
17	Middle	30	20	DFT-s-OFDM QPSK	Edge_Full_Left	1@1	3500.01	633334	18.00	17.26
18	Middle	30	20	DFT-s-OFDM QPSK	Inner_1RB_Right	270@0	3500.01	633334	18.00	17.34
19	Middle	30	20	DFT-s-OFDM QPSK	Inner_1RB_Left	1@0	3500.01	633334	18.00	17.27
20	Middle	30	20	DFT-s-OFDM QPSK	Outer_Full	1@272	3500.01	633334	18.00	17.47
21	Middle-5	30	20	DFT-s-OFDM QPSK	Inner_1RB_Left	1@1	3500.01	633334	18.00	17.15
22	Middle-5	30	20	DFT-s-OFDM QPSK	Inner_1RB_Left	1@1	3500.01	633334	18.00	17.14
23	Middle-5	30	40	DFT-s-OFDM QPSK	Inner_Full	50@25	3500.01	633334	18.00	17.63
24	Middle-5	30	50	DFT-s-OFDM QPSK	Inner_Full	64@32	3500.01	633334	18.00	17.46
25	Middle-5	30	60	DFT-s-OFDM QPSK	Inner_Full	81@40	3500.01	633334	18.00	17.51
26	Middle-5	30	80	DFT-s-OFDM QPSK	Inner_Full	108@54	3500.01	633334	18.00	17.32
27	Middle-5	30	90	DFT-s-OFDM QPSK	Inner_Full	120@60	3500.01	633334	18.00	17.29

No.	Test Freq Description	5G-n77 PC2 L3700_3980 Normal Power							Tune up	Power Results (dBm)
		SCS (kHz)	NR BW (MHz)	Modulation	RB allocation	NR Test Freq. (MHz)	NR Test CH.	n77		
1	High	30	20	DFT-s-OFDM QPSK	Inner_Full	25@12	3969.990	664666	28	27.72
2	Middle-1	30	20	DFT-s-OFDM QPSK	Inner_Full	25@12	3918.000	661200	28	27.27
3	Middle-2	30	20	DFT-s-OFDM QPSK	Inner_Full	25@12	3866.000	657733	28	27.64
4	Middle-3	30	20	DFT-s-OFDM QPSK	Inner_Full	25@12	3814.000	654267	28	27.71
5	Middle-5	30	20	DFT-s-OFDM QPSK	Inner_Full	25@12	3762.000	650800	28	27.94
6	Low	30	20	DFT-s-OFDM QPSK	Inner_Full	25@12	3710.010	647334	28	27.83
7	High	30	100	DFT-s-OFDM QPSK	Inner_Full	135@67	3930.000	662000	28	27.09
8	Middle-1	30	100	DFT-s-OFDM QPSK	Inner_Full	135@67	3894.000	659600	28	27.29
9	Middle-2	30	100	DFT-s-OFDM QPSK	Inner_Full	135@67	3858.000	657200	28	27.33
10	Middle-3	30	100	DFT-s-OFDM QPSK	Inner_Full	135@67	3822.000	654800	28	27.44
11	Middle-4	30	100	DFT-s-OFDM QPSK	Inner_Full	135@67	3786.000	652400	28	27.43
12	Low	30	100	DFT-s-OFDM QPSK	Inner_Full	135@67	3750.000	650000	28	27.64
13	Middle-3	30	20	DFT-s-OFDM P1/2 BPSK1	Inner_Full	135@67	3822.000	654800	28	27.78
14	Middle-3	30	20	DFT-s-OFDM 16QAM	Inner_Full	135@67	3822.000	654800	28	26.73
15	Middle-3	30	20	DFT-s-OFDM 64QAM	Inner_Full	135@67	3822.000	654800	28	26.11
16	Middle-3	30	20	DFT-s-OFDM 256QAM	Inner_Full	135@67	3822.000	654800	28	26.16
17	Middle-3	30	20	CP-OFDM QPSK	Inner_Full	135@67	3822.000	654800	28	26.11
18	Middle-3	30	20	CP-OFDM 16QAM	Inner_Full	135@67	3822.000	654800	28	26.07
19	Middle-3	30	20	CP-OFDM 64QAM	Inner_Full	135@67	3822.000	654800	28	26.01
20	Middle-3	30	20	CP-OFDM 256QAM	Inner_Full	135@67	3822.000	654800	28	26.02
21	Middle-3	30	20	CP-OFDM 16QAM	Edge_Full_Right	2@271	3822.000	654800	28	26.04
22	Middle-3	30	20	CP-OFDM 16QAM	Edge_Full_Left	2@0	3822.000	654800	28	26.01
23	Middle-3	30	20	CP-OFDM 16QAM	Inner_1RB_Right	1@271	3822.000	654800	28	26.25
24	Middle-3	30	20	CP-OFDM 16QAM	Inner_1RB_Left	1@1	3822.000	654800	28	26.17
25	Middle-3	30	20	CP-OFDM 16QAM	Outer_Full	270@0	3822.000	654800	28	26.81
26	Middle-3	30	20	CP-OFDM 16QAM	Edge_1RB_Left	1@0	3822.000	654800	28	26.10
27	Middle-3	30	20	CP-OFDM 16QAM	Edge_1RB_Right	1@272	3822.000	654800	28	26.05
28	Middle-1	30	40	CP-OFDM 16QAM	Inner_Full	50@25	3918.000	661200	28	26.95
29	Middle-1	30	50	CP-OFDM 16QAM	Inner_Full	64@32	3918.000	661200	28	26.81
30	Middle-1	30	60	CP-OFDM 16QAM	Inner_Full	81@40	3918.000	661200	28	26.72
31	Middle-1	30	80	CP-OFDM 16QAM	Inner_Full	108@54	3918.000	661200	28	26.63
20	Middle-1	30	90	CP-OFDM 16QAM	Inner_Full	120@60	3918.000	661200	28	26.71

No.	Test Freq Description	5G-n77 PC2 H3700_3980 Lower Power							Tune up	Power Results (dBm)
		SCS (kHz)	NR BW (MHz)	Modulation	RB allocation	NR Test Freq. (MHz)	NR Test CH.	n77		
1	High	30	20	DFT-s-OFDM QPSK	Inner_Full	25@12	3969.990	664666	18	17.66
2	Middle-1	30	20	DFT-s-OFDM QPSK	Inner_Full	25@12	3918.000	661200	18	17.75
3	Middle-2	30	20	DFT-s-OFDM QPSK	Inner_Full	25@12	3866.000	657733	18	17.90
4	Middle-3	30	20	DFT-s-OFDM QPSK	Inner_Full	25@12	3814.000	654267	18	17.93
5	Middle-5	30	20	DFT-s-OFDM QPSK	Inner_Full	25@12	3762.000	650800	18	17.79
6	Low	30	20	DFT-s-OFDM QPSK	Inner_Full	25@12	3710.010	647334	18	17.65
7	High	30	100	DFT-s-OFDM QPSK	Inner_Full	135@67	3930.000	662000	18	17.31
8	Middle-1	30	100	DFT-s-OFDM QPSK	Inner_Full	135@67	3894.000	659600	18	17.51
9	Middle-2	30	100	DFT-s-OFDM QPSK	Inner_Full	135@67	3858.000	657200	18	17.69
10	Middle-3	30	100	DFT-s-OFDM QPSK	Inner_Full	135@67	3822.000	654800	18	17.57
11	Middle-4	30	100	DFT-s-OFDM QPSK	Inner_Full	135@67	3786.000	652400	18	17.59
12	Low	30	100	DFT-s-OFDM QPSK	Inner_Full	135@67	3750.000	650000	18	17.50
13	Middle-3	30	20	DFT-s-OFDM P1/2 BPSK1	Inner_Full	135@67	3822.000	654800	18	17.60
14	Middle-3	30	20	DFT-s-OFDM 16QAM	Inner_Full	135@67	3822.000	654800	18	17.60
15	Middle-3	30	20	DFT-s-OFDM 64QAM	Inner_Full	135@67	3822.000	654800	18	17.59
16	Middle-3	30	20	DFT-s-OFDM 256QAM	Inner_Full	135@67	3822.000	654800	18	17.64
17	Middle-3	30	20	CP-OFDM QPSK	Inner_Full	135@67	3822.000	654800	18	17.65
18	Middle-3	30	20	CP-OFDM 16QAM	Inner_Full	135@67	3822.000	654800	18	17.67
19	Middle-3	30	20	CP-OFDM 64QAM	Inner_Full	135@67	3822.000	654800	18	17.67
20	Middle-3	30	20	CP-OFDM 256QAM	Inner_Full	135@67	3822.000	654800	18	17.63
21	Middle-3	30	20	CP-OFDM 16QAM	Edge_Full_Right	2@271	3822.000	654800	18	17.58
22	Middle-3	30	20	CP-OFDM 16QAM	Edge_Full_Left	2@0	3822.000	654800	18	17.42
23	Middle-3	30	20	CP-OFDM 16QAM	Inner_1RB_Right	1@271	3822.000	654800	18	17.39
24	Middle-3	30	20	CP-OFDM 16QAM	Inner_1RB_Left	1@1	3822.000	654800	18	17.33
25	Middle-3	30	20	CP-OFDM 16QAM	Outer_Full	270@0	3822.000	654800	18	17.58
26	Middle-3	30	20	CP-OFDM 16QAM	Edge_1RB_Left	1@0	3822.000	654800	18	17.30
27	Middle-3	30	20	CP-OFDM 16QAM	Edge_1RB_Right	1@272	3822.000	654800	18	17.52
28	Middle-1	30	40	CP-OFDM 16QAM	Inner_Full	50@25	3918.000	661200	18	17.74
29	Middle-1	30	50	CP-OFDM 16QAM	Inner_Full	64@32	3918.000	661200	18	17.55
30	Middle-1	30	60	CP-OFDM 16QAM	Inner_Full	81@40	3918.000	661200	18	17.51
31	Middle-1	30	80	CP-OFDM 16QAM	Inner_Full	108@54	3918.000	661200	18	17.39
32	Middle-1	30	90	CP-OFDM 16QAM	Inner_Full	120@60	3918.000	661200	18	17.37

11.5 Wi-Fi and BT Measurement result

When the same transmission mode configurations have the same maximum output power on the same channel for the 802.11 a/n/ac/ax modes, the channel in the lower order/sequence 802.11 mode (i.e. a, n, ac then ax) is selected. Therefore the SAR measurements performed for the 802.11n/ac modes, as the lowest order modulation, cover 802.11ax modes.

When the specified maximum output power is the same for both UNII 1 and UNII 2A, begin SAR measurements in UNII 2A with the channel with the highest measured output power. If the reported SAR for UNII 2A is ≤ 1.2 W/kg, SAR is not required for UNII 1; otherwise treat the remaining bands separately and test them independently for SAR.

According to KDB 248227 D01, simultaneous SAR provisions in KDB 447498 D01 apply to determine simultaneous transmission SAR test exclusion for Wi-Fi MIMO. If the sum of 1-g single transmission chain SAR measurements is < 1.6 W/kg and/or the MIMO output power is equal or less than a single chain, then no additional SAR measurements for simultaneously at the specified maximum output power of MIMO operation.

When antennas are spatially separated to the extent that SAR distributions do not overlap and can be treated independently, SAR compliance for simultaneous transmission is determined separately for each individual antenna.

The maximum output power for WiFi 2.4G – Head(receiver on)

802.11b	Channel\data rate	1Mbps
WLAN2450	11(2462MHz)	11.95
	6(2437(MHz)	11.98
	1(2412MHz)	11.75
802.11g	Channel\data rate	6Mbps
WLAN2450	11(2462MHz)	11.52
	6(2437(MHz)	11.81
	1(2412MHz)	11.47
802.11n-20MHz	Channel\data rate	MCS0
WLAN2450	11(2462MHz)	11.41
	6(2437(MHz)	11.63
	1(2412MHz)	11.28
802.11n-40MHz	Channel\data rate	MCS0
WLAN2450	9(2452MHz)	11.96
	6(2437MHz)	11.97
	3(2422MHz)	11.82
tuneup		12.00

The maximum output power for WiFi 2.4G - Body(receiver off)

802.11b	Channel\data rate	1Mbps
WLAN2450	11(2462MHz)	16.34
	6(2437(MHz)	16.48
	1(2412MHz)	16.21
	tuneup	16.50
802.11g	Channel\data rate	6Mbps
WLAN2450	11(2462MHz)	15.01
	6(2437(MHz)	15.20
	1(2412MHz)	14.96
	tuneup	15.50
802.11n-20MHz	Channel\data rate	MCS0
WLAN2450	11(2462MHz)	14.84
	6(2437(MHz)	15.02
	1(2412MHz)	14.78
	tuneup	15.50
802.11n-40MHz	Channel\data rate	MCS0
WLAN2450	9(2452MHz)	12.53
	6(2437MHz)	12.98
	3(2422MHz)	12.95
	tuneup	13.00

**The maximum output power for WiFi 5G- Head(receiver on)**

802.11ac(dBm)-80MHz	
Channel\data rate	MCS0
42(5210 MHz)	9.01
58(5290 MHz)	9.15
106(5530 MHz)	9.34
122(5610 MHz)	9.54
138(5690 MHz)	9.84
155(5775 MHz)	9.98
tuneup	11

The maximum output power for WiFi 5G- Body(receiver off)

802.11a(dBm)	
Channel\data rate	6Mbps
36(5180 MHz)	14.71
40(5200 MHz)	14.61
44(5220 MHz)	14.51
48(5240 MHz)	14.57
52(5260 MHz)	14.59
56(5280 MHz)	14.85
60(5300 MHz)	15.44
64(5320 MHz)	15.84
100(5500 MHz)	15.42
104(5520 MHz)	15.47
108(5540 MHz)	15.34
112(5560 MHz)	15.17
116(5580 MHz)	15.11
120(5600 MHz)	15.10
124(5620 MHz)	15.43
128(5640 MHz)	15.88
132(5660 MHz)	16.08
136(5680 MHz)	16.14
140(5700 MHz)	15.76
144(5720 MHz)	15.41
149(5745 MHz)	15.06
153(5765 MHz)	15.36
157(5785 MHz)	15.70
161(5805 MHz)	16.10
165(5825 MHz)	16.47
tuneup	16.5

12 Antenna Location

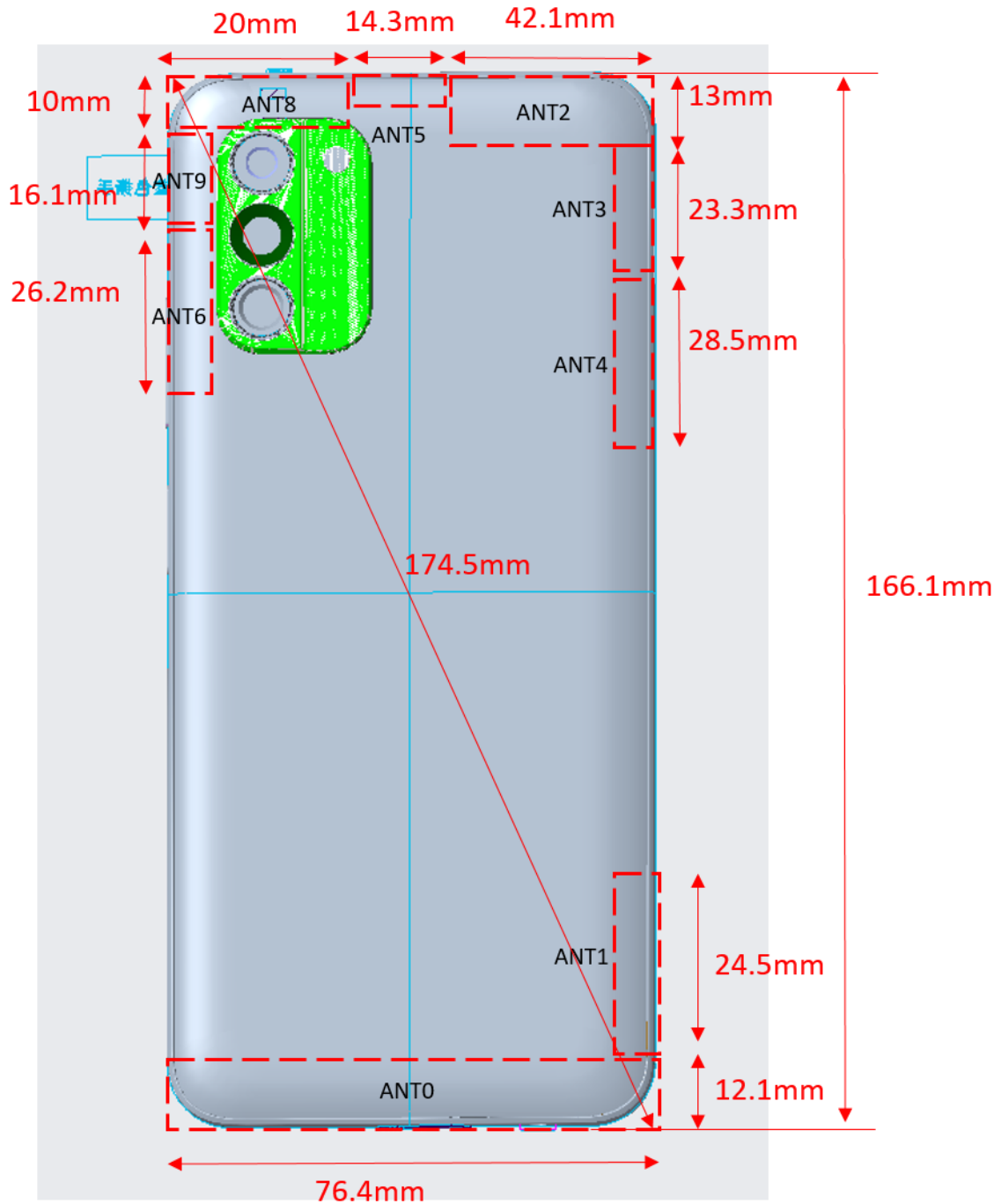

Ref.	Antenna	Band
ANT0	LB TX+M DRX/ENDC	2G:GSM850/900 3G:W5 4G:B5/8/12/13/14/17/20/26/71 TX/PRX + B1/3/39/40 DRX+B2/4/25/66DRX/ENDC_TX+ B7/38/41DRX 5G:N5/26/71 TX/PRX+N29 PRX+N2/25/66/70 DRX+N41 DRX
ANT1	MH DRX	4G:B7/38/41(ATT B30) DRX2+ B2/4/66 DRX2 5G:N41 DRX2+N25/66 DRX2
ANT2	LB DRX+MH TX/PRX	2G:GSM1800/1900 3G:W1/2/4 4G:B1/2/3/4/25/39/40/66TX/PRX+ B5/8/12/13/14/17/20/26/71DRX 5G:N2/25/66/70 TX/PRX+ N5/25/29/71 DRX
ANT3	UHB MIMO+GPS L5	GPS L5 5G:N77 DRX
ANT4	HB TX/PRX+UHB MIMO	4G:B7/38/41(ATT B30) TX/TRX 5G:N41TX/PRX+N77 DRX2
ANT5	UHB TX/PRX	N77 TX/PRX
ANT6	UHB MIMO+HB PRX2	4G:B41(ATT B30) /B2/4/66 PRX2 5G:N77 PRX2+N25/66/41 PRX2
ANT8	GPS L1+2.4G WiFi	GPS L1+WIFI 2.4G 11b/g/n
ANT9	5G WiFi	WIFI 5G11n/a

12.1 SAR Measurement Positions

According to the KDB941225 D06 Hot Spot SAR v01, the edges with less than 2.5 cm distance to the antennas need to be tested for SAR.

SAR measurement positions						
Mode	Front	Rear	Left edge	Right edge	Top edge	Bottom edge
ANT0	Yes	Yes	Yes	Yes	No	Yes
ANT2	Yes	Yes	Yes	No	Yes	No
ANT4	Yes	Yes	Yes	No	No	No
ANT5	Yes	Yes	No	Yes	Yes	No
ANT8	Yes	Yes	No	Yes	Yes	No
ANT9	Yes	Yes	No	Yes	Yes	No

12.2 Standalone SAR Test Exclusion Considerations

Standalone 1-g head or body SAR evaluation by measurement or numerical simulation is not required when the corresponding SAR Exclusion Threshold condition, listed below, is satisfied. The 1-g SAR test exclusion threshold for 100 MHz to 6 GHz at test separation distances ≤ 50 mm are determined by:

$[(\text{max. power of channel, including tune-up tolerance, mW}) / (\text{min. test separation distance, mm})] \cdot [\sqrt{f(\text{GHz})}] \leq 3.0$ for 1-g SAR, where

- $f(\text{GHz})$ is the RF channel transmit frequency in GHz
- Power and distance are rounded to the nearest mW and mm before calculation
- The result is rounded to one decimal place for comparison

Standalone SAR test exclusion considerations

Band/Mode	F(GHz)	Position	SAR test exclusion threshold(mW)	RF output power		SAR test exclusion
				dBm	mW	
Bluetooth	2.441	Head	9.60	10	10	No
		Body	19.20	10	10	No
2.4GHz WLAN	2.45	Head	9.58	12	16	No
		Body	19.17	16.5	45	No
5GHz WLAN	5.2	Head	6.58	11	13	No
		Body	13.16	16.5	45	No
	5.3	Head	6.52	11	13	No
		Body	13.03	16.5	45	No
	5.6	Head	6.34	11	13	No
		Body	12.68	16.5	45	No
	5.8	Head	6.23	11	13	No
		Body	12.46	16.5	45	No

13 SAR Test Result

Note:

KDB 447498 D01 General RF Exposure Guidance:

For WWAN: Reported SAR(W/kg)= Measured SAR(W/kg)*Tune-up Scaling Factor

For BT/WLAN: Reported SAR(W/kg)= Measured SAR(W/kg)* Duty Cycle scaling factor * Tune-up scaling factor

Testing of other required channels within the operating mode of a frequency band is not required when the reported 1-g or 10-g SAR for the mid-band or highest output power channel is:

≤ 0.8 W/kg or 2.0 W/kg, for 1-g or 10-g respectively, when the transmission band is ≤ 100 MHz

≤ 0.6 W/kg or 1.5 W/kg, for 1-g or 10-g respectively, when the transmission band is between 100 MHz and 200 MHz

≤ 0.4 W/kg or 1.0 W/kg, for 1-g or 10-g respectively, when the transmission band is ≥ 200 MHz

KDB 648474 D04 Handset SAR:

With headset attached, when the reported SAR for body-worn accessory, measured without a headset connected to the handset, is > 1.2 W/kg, the highest reported SAR configuration for that wireless mode and frequency band should be repeated for that body-worn accessory with a headset attached to the handset.

KDB 941225 D01 SAR test for 3G devices:

When the maximum output power and tune-up tolerance specified for production units in a secondary mode is ≤ ¼ dB higher than the primary mode or when the highest reported SAR of the primary mode is scaled by the ratio of specified maximum output power and tune-up tolerance of secondary to primary mode and the adjusted SAR is ≤ 1.2 W/kg, SAR measurement is not required for the secondary mode.

KDB 941225 D05 SAR for LTE Devices:

SAR test reduction is applied using the following criteria:

Start with the largest channel bandwidth and measure SAR for QPSK with 1 RB, and 50% RB allocation, using the RB offset and required test channel combination with the highest maximum output power among RB offsets at the upper edge, middle and lower edge of each required test channel.

When the reported SAR is > 0.8 W/kg, testing for other Channels is performed at the highest output power level for 1RB, and 50% RB configuration for that channel.

Testing for 100% RB configuration is performed at the highest output power level for 100% RB configuration across the Low, Mid and High Channel when the highest reported SAR for 1 RB and 50% RB are > 0.8 W/kg. Testing for the remaining required channels is not needed because the reported SAR for 100% RB Allocation < 1.45 W/kg.

Testing for 16-QAM modulation is not required because the reported SAR for QPSK is < 1.45 W/Kg and its output power is not more than 0.5 dB higher than that of QPSK.

Testing for the other channel bandwidths is not required because the reported SAR for the highest channel bandwidth is <1.45 W/Kg and its output power is not more than 0.5 dB higher than that of the highest channel bandwidth.

For LTE bands that do not support at least three non-overlapping channels in certain channel bandwidths, test the available non-overlapping channels instead. When a device supports overlapping channel assignment in a channel bandwidth configuration, the middle channel of the

group of overlapping channels should be selected for testing; therefore, the requirement for H, M and L channels may not fully apply.

KDB 248227 D01 SAR meas for 802.11:

SAR test reduction for 802.11 Wi-Fi transmission mode configurations are considered separately for DSSS and OFDM. An initial test position is determined to reduce the number of tests required for certain exposure configurations with multiple test positions. An initial test configuration is determined for each frequency band and aggregated band according to maximum output power, channel bandwidth, wireless mode configurations and other operating parameters to streamline the measurement requirements. For 2.4 GHz DSSS, either the initial test position or DSSS procedure is applied to reduce the number of SAR tests; these are mutually exclusive. For OFDM, an initial test position is only applicable to next to the ear, UMPC mini-tablet and hotspot mode configurations, which is tested using the initial test configuration to facilitate test reduction. For other exposure conditions with a fixed test position, SAR test reduction is determined using only the initial test configuration.

To determine the initial test position, Area Scans were performed to determine the position with the Maximum Value of SAR (measured). The position that produced the highest Maximum Value of SAR is considered the worst case position; thus used as the initial test position.

The multiple test positions require SAR measurements in head, hotspot mode or UMPC mini-tablet configurations may be reduced according to the highest reported SAR determined using the initial test position(s) by applying the DSSS or OFDM SAR measurement procedures in the required wireless mode test configuration(s). The initial test position(s) is measured using the highest measured maximum output power channel in the required wireless mode test configuration(s).

When the reported SAR for the initial test position is:

≤ 0.4 W/kg, further SAR measurement is not required for the other test positions in that exposure configuration and wireless mode combination within the frequency band or aggregated band. DSSS and OFDM configurations are considered separately according to the required SAR procedures.

> 0.4 W/kg, SAR is repeated using the same wireless mode test configuration tested in the initial test position to measure the subsequent next closet/smallest test separation distance and maximum coupling test position, on the highest maximum output power channel, until the reported SAR is ≤ 0.8 W/kg or all required test positions are tested.

- For subsequent test positions with equivalent test separation distance or when exposure is dominated by coupling conditions, the position for maximum coupling condition should be tested.
- When it is unclear, all equivalent conditions must be tested.

For all positions/configurations tested using the initial test position and subsequent test positions, when the reported SAR is > 0.8 W/kg, measure the SAR for these positions/configurations on the subsequent next highest measured output power channel(s) until the reported SAR is ≤ 1.2 W/kg or all required test channels are considered.

- The additional power measurements required for this step should be limited to those necessary for identifying subsequent highest output power channels to apply the test reduction.

When the specified maximum output power is the same for both UNII 1 and UNII 2A, begin SAR measurements in UNII 2A with the channel with the highest measured output power. If the reported SAR for UNII 2A is ≤ 1.2 W/kg, SAR is not required for UNII 1; otherwise treat the remaining bands separately and test them independently for SAR.

When the specified maximum output power is different between UNII 1 and UNII 2A, begin SAR

with the band that has the higher specified maximum output. If the highest reported SAR for the band with the highest specified power is ≤ 1.2 W/kg, testing for the band with the lower specified output power is not required; otherwise test the remaining bands independently for SAR.

Duty Cycle

Mode	Duty Cycle
Speech for GSM	1:8.3
GPRS&EGPRS 1 Slot	1:8.3
GPRS&EGPRS 2 Slot	1:4
GPRS&EGPRS 3 Slot	1:2.67
GPRS&EGPRS 4 Slot	1:2
WCDMA<E FDD	1:1
TDD PC3	1:1.58

Ambient Temperature: 21.5-23.5 °C Liquid Temperature: 21.5-23.5 °C

Note

EUT2:

Article 1: Difference description:

Only supplier different. Detail as the below table:

	First source	Second source	note
LCD	LCE	TXD	Same spec
Camera	Front camra 16M: Holitech Main camera 48M: TXD Ultrawide camera 5M: KingCome Depth camera 2M: C&T	Front camra 16M: DDHL Main camera 48M: HongShi Ultrawide camera 5M: LCE Depth camera 2M: NewSeasons	Same spec
Charge Circuit	SGM	南芯	Same spec
Memory	Longsys	Samsung	Same spec
MIC	AAC	共达	Same spec

13.1 SAR results

ENDC	Left Cheek	Left Tilt	Right Cheek	Right Tilt	Front 10mm	Rear 10mm	Left Edge 10mm	Right Edge 10mm	Bottom Edge 10mm	Top Edge 10mm
DC_66A_N41A	0.43	0.19	0.98	0.29	0.29	0.28	0.3	0.22	0.06	0
DC_12A_N41A	0.3	0.11	0.82	0.22	0.49	0.52	0.42	0.51	0.06	0
DC_12A-66A_n66A	0.42	0.42	0.57	0.53	0.63	0.57	0.34	0.51	0.06	0.24
DC_2A-(n)71AA	0.33	0.18	0.36	0.19	0.42	0.51	0.32	0.488	0.36	0
DC_2A-12A_n66A	0.44	0.45	0.61	0.54	0.41	0.31	0.21	0.018	0.06	0.24
DC_12A-2A_n66A	0.42	0.42	0.57	0.53	0.63	0.57	0.34	0.51	0.06	0.24
DC_2A-13A_n66A	0.44	0.45	0.61	0.54	0.41	0.31	0.21	0.018	0.06	0.24
DC_2A-2A_n41A	0.32	0.14	0.86	0.23	0.27	0.26	0.29	0.018	0.06	0
DC_2A-2A_n66A	0.44	0.45	0.61	0.54	0.41	0.31	0.21	0.018	0.06	0.24
DC_2A-2A_n71A	0.33	0.18	0.36	0.19	0.42	0.51	0.32	0.488	0.36	0
DC_2A-5A_n66A	0.44	0.45	0.61	0.54	0.41	0.31	0.21	0.018	0.06	0.24
DC_66A-2A_n25A	0.73	0.7	0.89	0.8	0.53	0.44	0.25	0.22	0.06	0.33
DC_2A-66A_n25A	0.62	0.65	0.77	0.74	0.51	0.42	0.24	0.018	0.06	0.33
DC_2A-66A_n66A	0.44	0.45	0.61	0.54	0.41	0.31	0.21	0.018	0.06	0.24
DC_66A-2A_n71A	0.44	0.23	0.48	0.25	0.44	0.53	0.33	0.69	0.36	0
DC_2A-66A_n71A	0.33	0.18	0.36	0.19	0.42	0.51	0.32	0.488	0.36	0
DC_2C_n41A	0.32	0.14	0.86	0.23	0.27	0.28	0.29	0.018	0.06	0
DC_2C_n71A	0.33	0.18	0.36	0.19	0.42	0.51	0.32	0.488	0.36	0
DC_66A-(n)71AA	0.44	0.23	0.48	0.25	0.44	0.53	0.33	0.69	0.36	0
DC_66A-66A_n71A	0.44	0.23	0.48	0.25	0.44	0.53	0.33	0.69	0.36	0
DC_66A-66A_n77A	0.44	0.23	0.48	0.25	0.44	0.53	0.33	0.69	0.36	0
DC_66C_n71A	0.44	0.23	0.48	0.25	0.44	0.53	0.33	0.69	0.36	0
DC_2A-71A_n71A	0.33	0.18	0.36	0.19	0.42	0.51	0.32	0.488	0.36	0
DC_66A-12A_n25A	0.73	0.7	0.89	0.8	0.53	0.44	0.25	0.22	0.06	0.33
DC_12A-66A_n25A	0.6	0.62	0.73	0.73	0.73	0.68	0.37	0.51	0.06	0.33
DC_66A-71A_n71A	0.44	0.23	0.48	0.25	0.44	0.53	0.33	0.69	0.36	0

ENDC+WiFi 2.4G	Left Cheek	Left Tilt	Right Cheek	Right Tilt	Front 10mm	Rear 10mm	Left Edge 10mm	Right Edge 10mm	Bottom Edge 10mm	Top Edge 10mm
DC_66A_N41A	0.63	0.37	1.09	0.36	0.42	0.42	0.30	0.34	0.06	0.25
DC_12A_N41A	0.50	0.29	0.93	0.29	0.62	0.66	0.42	0.63	0.06	0.25
DC_12A-66A_n66A	0.62	0.60	0.68	0.60	0.76	0.71	0.34	0.63	0.06	0.49
DC_2A-(n)71AA	0.53	0.36	0.47	0.26	0.55	0.65	0.32	0.61	0.36	0.25
DC_2A-12A_n66A	0.64	0.63	0.72	0.61	0.54	0.45	0.21	0.14	0.06	0.49
DC_12A-2A_n66A	0.62	0.60	0.68	0.60	0.76	0.71	0.34	0.63	0.06	0.49
DC_2A-13A_n66A	0.64	0.63	0.72	0.61	0.54	0.45	0.21	0.14	0.06	0.49
DC_2A-2A_n41A	0.52	0.32	0.97	0.30	0.40	0.40	0.29	0.14	0.06	0.25
DC_2A-2A_n66A	0.64	0.63	0.72	0.61	0.54	0.45	0.21	0.14	0.06	0.49
DC_2A-2A_n71A	0.53	0.36	0.47	0.26	0.55	0.65	0.32	0.61	0.36	0.25
DC_2A-5A_n66A	0.64	0.63	0.72	0.61	0.54	0.45	0.21	0.14	0.06	0.49
DC_66A-2A_n25A	0.93	0.88	1.00	0.87	0.66	0.58	0.25	0.34	0.06	0.58
DC_2A-66A_n25A	0.82	0.83	0.88	0.81	0.64	0.56	0.24	0.14	0.06	0.58
DC_2A-66A_n66A	0.64	0.63	0.72	0.61	0.54	0.45	0.21	0.14	0.06	0.49
DC_66A-2A_n71A	0.64	0.41	0.59	0.32	0.57	0.67	0.33	0.81	0.36	0.25
DC_2A-66A_n71A	0.53	0.36	0.47	0.26	0.55	0.65	0.32	0.61	0.36	0.25
DC_2C_n41A	0.52	0.32	0.97	0.30	0.40	0.42	0.29	0.14	0.06	0.25
DC_2C_n71A	0.53	0.36	0.47	0.26	0.55	0.65	0.32	0.61	0.36	0.25
DC_66A-(n)71AA	0.64	0.41	0.59	0.32	0.57	0.67	0.33	0.81	0.36	0.25
DC_66A-66A_n71A	0.64	0.41	0.59	0.32	0.57	0.67	0.33	0.81	0.36	0.25
DC_66A-66A_n77A	0.64	0.41	0.59	0.32	0.57	0.67	0.33	0.81	0.36	0.25
DC_66C_n71A	0.64	0.41	0.59	0.32	0.57	0.67	0.33	0.81	0.36	0.25
DC_2A-71A_n71A	0.53	0.36	0.47	0.26	0.55	0.65	0.32	0.61	0.36	0.25
DC_66A-12A_n25A	0.93	0.88	1.00	0.87	0.66	0.58	0.25	0.34	0.06	0.58
DC_12A-66A_n25A	0.80	0.80	0.84	0.80	0.86	0.82	0.37	0.63	0.06	0.58
DC_66A-71A_n71A	0.64	0.41	0.59	0.32	0.57	0.67	0.33	0.81	0.36	0.25

ENDC+WiFi 5G	Left Cheek	Left Tilt	Right Cheek	Right Tilt	Front 10mm	Rear 10mm	Left Edge 10mm	Right Edge 10mm	Bottom Edge 10mm	Top Edge 10mm
DC 66A N41A	0.60	0.32	1.03	0.34	0.41	0.59	0.30	0.66	0.06	0.10
DC 12A N41A	0.47	0.24	0.87	0.27	0.61	0.83	0.42	0.95	0.06	0.10
DC 12A-66A n66A	0.59	0.69	0.62	0.58	0.75	0.88	0.34	0.95	0.06	0.34
DC 2A-(n)71AA	0.50	0.45	0.41	0.24	0.54	0.82	0.32	0.93	0.36	0.10
DC 2A-12A n66A	0.61	0.72	0.66	0.59	0.53	0.62	0.21	0.46	0.06	0.34
DC 12A-2A n66A	0.59	0.69	0.62	0.58	0.75	0.88	0.34	0.95	0.06	0.34
DC 2A-13A n66A	0.61	0.72	0.66	0.59	0.53	0.62	0.21	0.46	0.06	0.34
DC 2A-2A n41A	0.49	0.41	0.91	0.28	0.39	0.57	0.29	0.46	0.06	0.10
DC 2A-2A n66A	0.61	0.72	0.66	0.59	0.53	0.62	0.21	0.46	0.06	0.34
DC 2A-2A n71A	0.50	0.45	0.41	0.24	0.54	0.82	0.32	0.93	0.36	0.10
DC 2A-5A n66A	0.61	0.72	0.66	0.59	0.53	0.62	0.21	0.46	0.06	0.34
DC 66A-2A n25A	0.90	0.97	0.94	0.85	0.65	0.75	0.25	0.66	0.06	0.43
DC 2A-66A n25A	0.79	0.92	0.82	0.79	0.63	0.73	0.24	0.46	0.06	0.43
DC 2A-66A n66A	0.61	0.72	0.66	0.59	0.53	0.62	0.21	0.46	0.06	0.34
DC 66A-2A n71A	0.61	0.50	0.53	0.30	0.56	0.84	0.33	1.13	0.36	0.10
DC 2A-66A n71A	0.50	0.45	0.41	0.24	0.54	0.82	0.32	0.93	0.36	0.10
DC 2C n41A	0.49	0.41	0.91	0.28	0.39	0.59	0.29	0.46	0.06	0.10
DC 2C n71A	0.50	0.45	0.41	0.24	0.54	0.82	0.32	0.93	0.36	0.10
DC 66A-(n)71AA	0.61	0.50	0.53	0.30	0.56	0.84	0.33	1.13	0.36	0.10
DC 66A-66A n71A	0.61	0.50	0.53	0.30	0.56	0.84	0.33	1.13	0.36	0.10
DC 66A-66A n77A	0.61	0.50	0.53	0.30	0.56	0.84	0.33	1.13	0.36	0.10
DC 66C n71A	0.61	0.50	0.53	0.30	0.56	0.84	0.33	1.13	0.36	0.10
DC 2A-71A n71A	0.50	0.45	0.41	0.24	0.54	0.82	0.32	0.93	0.36	0.10
DC 66A-12A n25A	0.90	0.97	0.94	0.85	0.65	0.75	0.25	0.66	0.06	0.43
DC 12A-66A n25A	0.77	0.89	0.78	0.78	0.85	0.99	0.37	0.95	0.06	0.43
DC 66A-71A n71A	0.61	0.50	0.53	0.30	0.56	0.84	0.33	1.13	0.36	0.10

Cellular+WiFi 2.4G	Left Cheek	Left Tilt	Right Cheek	Right Tilt	Front 10mm	Rear 10mm	Left Edge 10mm	Right Edge 10mm	Bottom Edge 10mm	Top Edge 10mm
WCDMA1900	0.80	0.92	1.05	1.03	0.71	/	/	/	/	/
WCDMA 850	/	/	/	/	/	0.76	1.09	/	/	/
LTE Band71	/	/	/	/	/	/	/	0.67	/	/
GSM850	/	/	/	/	/	/	/	/	0.38	/
WCDMA1900	/	/	/	/	/	/	/	/	/	0.80
Cellular+WiFi 5G	Left Cheek	Left Tilt	Right Cheek	Right Tilt	Front 10mm	Rear 10mm	Left Edge 10mm	Right Edge 10mm	Bottom Edge 10mm	Top Edge 10mm
WCDMA1900	0.77	0.87	0.99	1.01	0.70	/	/	/	/	/
WCDMA 850	/	/	/	/	/	0.93	1.09	/	/	/
LTE Band71	/	/	/	/	/	/	/	0.99	/	/
GSM850	/	/	/	/	/	/	/	/	0.38	/
WCDMA1900	/	/	/	/	/	/	/	/	/	0.90

ULCA	Left Cheek	Left Tilt	Right Cheek	Right Tilt	Front 10mm	Rear 10mm	Left Edge 10mm	Right Edge 10mm	Bottom Edge 10mm	Top Edge 10mm
CA 2A-12A	0.68	0.76	0.8	0.85	0.9	0.84	0.48	0.51	0.06	0.49
CA 2A-5A	0.74	0.8	0.87	0.88	0.75	0.65	0.38	0.28	0.07	0.49
CA 4A-12A	0.44	0.46	0.55	0.58	0.75	0.66	0.38	0.51	0.06	0.33
CA 4A-5A	0.5	0.5	0.62	0.61	0.6	0.47	0.28	0.28	0.07	0.33
CA 5A-66A	0.5	0.5	0.62	0.61	0.6	0.47	0.28	0.28	0.07	0.33
CA 12A-66A	0.44	0.46	0.55	0.58	0.75	0.66	0.38	0.51	0.06	0.33
CA 2A-4A	0.92	1.14	1.17	1.31	0.93	0.72	0.48	0	0	0.82
CA 2A-66A	0.92	1.14	1.17	1.31	0.93	0.72	0.48	0	0	0.82
CA 66B	0.68	0.84	0.92	1.04	0.78	0.54	0.38	0	0	0.66
CA 66C	0.68	0.84	0.92	1.04	0.78	0.54	0.38	0	0	0.66
CA 41C PC2	0.22	0.1	0.62	0.1	0.48	0.44	0.9	0	0	0
CA 41C PC3	0.25	0.1	0.69	0.12	0.54	0.52	0.99	0	0	0

RF Exposure Conditions	Frequency Band	Channel Number	Frequency (MHz)	Mode/RB	Test Position	Distance	Figure No./Note	EUT Measured Power (dBm)	Tune up (dBm)	Measured SAR 1g (W/kg)	Calculated SAR 1g (W/kg)	Measured SAR 10g (W/kg)	Calculated SAR 10g (W/kg)	Power Drift
Head	GSM850	190	836.6	/	Left Cheek	0mm	\	32.96	33.50	0.173	0.20	0.126	0.14	-0.20
Head	GSM850	190	836.6	/	Left Tilt	0mm	\	32.96	33.50	0.109	0.12	0.085	0.10	-0.07
Head	GSM850	190	836.6	/	Right Cheek	0mm	\	32.96	33.50	0.202	0.23	0.155	0.18	0.19
Head	GSM850	128	824.2	/	Right Cheek	0mm	\	32.83	33.50	0.182	0.21	0.140	0.16	-0.20
Head	GSM850	251	848.8	/	Right Cheek	0mm	Fig.A1	32.73	33.50	0.266	0.32	0.204	0.24	-0.07
Head	GSM850	190	836.6	/	Right Tilt	0mm	\	32.96	33.50	0.141	0.16	0.107	0.12	0.10
Head	GSM850	251	848.8	/	Right Cheek	0mm	EUT2	32.73	33.50	0.258	0.31	0.184	0.22	0.01
Body	GSM850	190	836.6	GPRS(2TX)	Front	10mm	\	31.14	32.00	0.371	0.45	0.225	0.27	0.03
Body	GSM850	251	848.8	GPRS(2TX)	Rear	10mm	Fig.A2	31.20	32.00	0.586	0.71	0.333	0.40	0.02
Body	GSM850	190	836.6	GPRS(2TX)	Rear	10mm	\	31.14	32.00	0.541	0.66	0.312	0.38	-0.11
Body	GSM850	128	824.2	GPRS(2TX)	Rear	10mm	\	31.04	32.00	0.419	0.52	0.240	0.30	0.09
Body	GSM850	190	836.6	GPRS(2TX)	Left Edge	10mm	\	31.14	32.00	0.104	0.13	0.070	0.08	-0.11
Body	GSM850	190	836.6	GPRS(2TX)	Right Edge	10mm	\	31.14	32.00	0.242	0.29	0.162	0.20	0.09
Body	GSM850	190	836.6	GPRS(2TX)	Bottom Edge	10mm	\	31.14	32.00	0.310	0.38	0.158	0.19	0.02
Body	GSM850	251	848.8	EGPRS(2TX)	Rear	10mm	\	31.13	32.00	0.560	0.68	0.301	0.37	0.11
Body	GSM850	251	848.8	GPRS(2TX)	Rear	10mm	EUT2	31.20	32.00	0.568	0.68	0.301	0.36	-0.07
Head	GSM1900	661	1880	/	Left Cheek	0mm	\	21.89	22.50	0.162	0.19	0.099	0.11	-0.06
Head	GSM1900	661	1880	/	Left Tilt	0mm	\	21.89	22.50	0.196	0.23	0.113	0.13	-0.04
Head	GSM1900	661	1880	/	Right Cheek	0mm	\	21.89	22.50	0.213	0.25	0.127	0.15	-0.10
Head	GSM1900	661	1880	/	Right Tilt	0mm	\	21.89	22.50	0.247	0.28	0.131	0.15	-0.01
Head	GSM1900	810	1909.8	/	Right Tilt	0mm	Fig.A3	21.91	22.50	0.294	0.34	0.150	0.17	0.01
Head	GSM1900	512	1850.2	/	Right Tilt	0mm	\	21.87	22.50	0.268	0.31	0.141	0.16	0.18
Head	GSM1900	810	1909.8	/	Right Tilt	0mm	EUT2	21.91	22.50	0.277	0.32	0.143	0.16	0.19
Body	GSM1900	661	1880	GPRS(1TX)	Front	10mm	\	21.92	22.50	0.066	0.08	0.039	0.04	-0.02
Body	GSM1900	661	1880	GPRS(1TX)	Rear	10mm	\	21.92	22.50	0.075	0.09	0.043	0.05	-0.13
Body	GSM1900	661	1880	GPRS(1TX)	Left Edge	10mm	\	21.92	22.50	0.033	0.04	0.019	0.02	0.14
Body	GSM1900	810	1909.8	GPRS(1TX)	Top Edge	10mm	\	21.92	22.50	0.111	0.13	0.058	0.07	-0.18
Body	GSM1900	661	1880	GPRS(1TX)	Top Edge	10mm	\	21.92	22.50	0.097	0.11	0.051	0.06	-0.02
Body	GSM1900	512	1850.2	GPRS(1TX)	Top Edge	10mm	\	21.91	22.50	0.102	0.12	0.055	0.06	0.02
Body	GSM1900	810	1909.8	EGPRS(1TX)	Top Edge	10mm	\	21.85	22.50	0.106	0.12	0.058	0.07	-0.08
Body	GSM1900	661	1880	GPRS(2TX)	Front	17mm	\	28.00	29.00	0.246	0.31	0.142	0.18	-0.07
Body	GSM1900	810	1909.8	GPRS(2TX)	Front	17mm	Fig.A4	28.05	29.00	0.320	0.40	0.188	0.23	-0.08
Body	GSM1900	512	1850.2	GPRS(2TX)	Front	17mm	\	27.89	29.00	0.238	0.31	0.138	0.18	0.14
Body	GSM1900	661	1880	GPRS(2TX)	Rear	21mm	\	28.00	29.00	0.199	0.25	0.115	0.14	0.20
Body	GSM1900	661	1880	GPRS(2TX)	Left Edge	17mm	\	28.00	29.00	0.137	0.17	0.082	0.10	0.16
Body	GSM1900	661	1880	GPRS(2TX)	Top Edge	21mm	\	28.00	29.00	0.222	0.28	0.128	0.16	0.08
Body	GSM1900	810	1909.8	EGPRS(2TX)	Front	17mm	\	28.05	29.00	0.317	0.39	0.186	0.23	0.20
Body	GSM1900	810	1909.8	GPRS(2TX)	Front	17mm	EUT2	28.05	29.00	0.320	0.40	0.188	0.23	0.09

RF Exposure Conditions	Frequency Band	Channel Number	Frequency (MHz)	Mode/RB	Test Position	Distance	Figure No./Note	EUT Measured Power (dBm)	Tune up (dBm)	Measured SAR 1g (W/kg)	Calculated SAR 1g (W/kg)	Measured SAR 10g (W/kg)	Calculated SAR 10g (W/kg)	Power Drift
Head	WCDMA1900	9400	1880	RMC	Left Cheek	0mm	\	16.26	17.00	0.510	0.60	0.281	0.33	-0.02
Head	WCDMA1900	9400	1880	RMC	Left Tilt	0mm	\	16.26	17.00	0.625	0.74	0.330	0.39	-0.12
Head	WCDMA1900	9400	1880	RMC	Right Cheek	0mm	\	16.26	17.00	0.607	0.72	0.348	0.41	0.02
Head	WCDMA1900	9400	1880	RMC	Right Tilt	0mm	\	16.26	17.00	0.792	0.94	0.381	0.45	-0.02
Head	WCDMA1900	9262	1852.4	RMC	Right Tilt	0mm	\	16.21	17.00	0.729	0.87	0.350	0.42	-0.09
Head	WCDMA1900	9538	1907.6	RMC	Right Tilt	0mm	Fig.A5	16.22	17.00	0.803	0.96	0.381	0.46	-0.02
Head	WCDMA1900	9538	1907.6	RMC	Right Tilt	0mm	EUT2	16.22	17.00	0.800	0.96	0.374	0.45	-0.18
Body	WCDMA1900	9400	1880	RMC	Front	10mm	\	16.26	17.00	0.170	0.20	0.102	0.12	-0.07
Body	WCDMA1900	9400	1880	RMC	Rear	10mm	\	16.26	17.00	0.210	0.25	0.121	0.14	-0.09
Body	WCDMA1900	9400	1880	RMC	Left Edge	10mm	\	16.26	17.00	0.078	0.09	0.048	0.06	0.10
Body	WCDMA1900	9538	1907.6	RMC	Top Edge	10mm	\	16.22	17.00	0.316	0.38	0.166	0.20	0.08
Body	WCDMA1900	9400	1880	RMC	Top Edge	10mm	\	16.26	17.00	0.286	0.34	0.152	0.18	0.13
Body	WCDMA1900	9262	1852.4	RMC	Top Edge	10mm	\	16.21	17.00	0.271	0.32	0.144	0.17	-0.04
Body	WCDMA1900	9400	1880	RMC	Front	17mm	Fig.A6	24.22	25.00	0.487	0.58	0.298	0.36	-0.03
Body	WCDMA1900	9538	1907.6	RMC	Front	17mm	\	24.29	25.00	0.474	0.56	0.291	0.34	0.04
Body	WCDMA1900	9262	1852.4	RMC	Front	17mm	\	24.15	25.00	0.451	0.55	0.272	0.33	0.09
Body	WCDMA1900	9400	1880	RMC	Rear	21mm	\	24.22	25.00	0.389	0.47	0.235	0.28	0.08
Body	WCDMA1900	9400	1880	RMC	Left Edge	17mm	\	24.22	25.00	0.264	0.32	0.166	0.20	0.04
Body	WCDMA1900	9400	1880	RMC	Top Edge	21mm	\	24.22	25.00	0.461	0.55	0.278	0.33	0.14
Body	WCDMA1900	9400	1880	RMC	Front	17mm	EUT2	24.22	25.00	0.475	0.57	0.280	0.34	-0.11
Head	WCDMA1700	1412	1732.4	RMC	Left Cheek	0mm	\	16.15	17.00	0.389	0.47	0.203	0.25	0.12
Head	WCDMA1700	1412	1732.4	RMC	Left Tilt	0mm	\	16.15	17.00	0.457	0.56	0.227	0.28	0.09
Head	WCDMA1700	1412	1732.4	RMC	Right Cheek	0mm	\	16.15	17.00	0.559	0.68	0.299	0.36	-0.10
Head	WCDMA1700	1312	1712.4	RMC	Right Cheek	0mm	\	16.04	17.00	0.505	0.63	0.272	0.34	-0.06
Head	WCDMA1700	1513	1752.6	RMC	Right Cheek	0mm	Fig.A7	16.09	17.00	0.572	0.71	0.308	0.38	-0.18
Head	WCDMA1700	1412	1732.4	RMC	Right Tilt	0mm	\	16.15	17.00	0.518	0.63	0.247	0.30	-0.09
Head	WCDMA1700	1513	1752.6	RMC	Right Cheek	0mm	EUT2	16.09	17.00	0.572	0.71	0.308	0.38	0.06
Body	WCDMA1700	1412	1732.5	RMC	Front	10mm	\	16.15	17.00	0.135	0.16	0.083	0.10	-0.05
Body	WCDMA1700	1412	1732.5	RMC	Rear	10mm	\	16.15	17.00	0.137	0.17	0.082	0.10	0.19
Body	WCDMA1700	1412	1732.5	RMC	Left Edge	10mm	\	16.15	17.00	0.058	0.07	0.035	0.04	0.04
Body	WCDMA1700	1513	1752.6	RMC	Top Edge	10mm	\	16.09	17.00	0.169	0.21	0.092	0.11	-0.14
Body	WCDMA1700	1412	1732.5	RMC	Top Edge	10mm	\	16.15	17.00	0.172	0.21	0.094	0.11	-0.09
Body	WCDMA1700	1312	1712.4	RMC	Top Edge	10mm	\	16.04	17.00	0.151	0.19	0.083	0.10	0.12
Body	WCDMA1700	1412	1732.5	RMC	Front	17mm	Fig.A8	24.02	25.00	0.311	0.39	0.199	0.25	-0.17
Body	WCDMA1700	1513	1752.6	RMC	Rear	21mm	\	24.06	25.00	0.263	0.33	0.151	0.19	0.03
Body	WCDMA1700	1412	1732.5	RMC	Rear	21mm	\	24.02	25.00	0.241	0.30	0.140	0.17	-0.08
Body	WCDMA1700	1312	1712.4	RMC	Rear	21mm	\	24.12	25.00	0.209	0.26	0.122	0.15	0.20
Body	WCDMA1700	1412	1732.5	RMC	Left Edge	17mm	\	24.02	25.00	0.204	0.26	0.117	0.15	0.00
Body	WCDMA1700	1513	1752.6	RMC	Top Edge	21mm	\	24.06	25.00	0.296	0.37	0.175	0.22	-0.14
Body	WCDMA1700	1412	1732.5	RMC	Top Edge	21mm	\	24.02	25.00	0.284	0.36	0.167	0.21	-0.03
Body	WCDMA1700	1312	1712.4	RMC	Top Edge	21mm	\	24.12	25.00	0.249	0.30	0.145	0.18	0.09
Body	WCDMA1700	1412	1732.5	RMC	Front	17mm	EUT2	24.02	25.00	0.278	0.35	0.171	0.21	-0.16
Head	WCDMA 850	4183	836.6	RMC	Left Cheek	0mm	\	24.58	25.00	0.369	0.41	0.257	0.28	-0.09
Head	WCDMA 850	4183	836.6	RMC	Left Tilt	0mm	\	24.58	25.00	0.205	0.23	0.157	0.17	0.20
Head	WCDMA 850	4183	836.6	RMC	Right Cheek	0mm	\	24.58	25.00	0.371	0.41	0.284	0.31	-0.16
Head	WCDMA 850	4132	826.4	RMC	Right Cheek	0mm	\	24.46	25.00	0.288	0.33	0.222	0.25	0.03
Head	WCDMA 850	4233	846.6	RMC	Right Cheek	0mm	Fig.A9	24.57	25.00	0.384	0.42	0.294	0.32	0.08
Head	WCDMA 850	4183	836.6	RMC	Right Tilt	0mm	\	24.58	25.00	0.261	0.29	0.204	0.22	0.14
Head	WCDMA 850	4233	846.6	RMC	Right Cheek	0mm	EUT2	24.57	25.00	0.365	0.40	0.290	0.32	-0.01
Body	WCDMA 850	4183	836.6	RMC	Front	10mm	\	24.58	25.00	0.331	0.37	0.193		

RF Exposure Conditions	Frequency Band	Channel Number	Frequency (MHz)	Mode/RB	Test Position	Distance	Figure No./Note	EUT Measured Power (dBm)	Tune up (dBm)	Measured SAR 1g (W/kg)	Calculated SAR 1g (W/kg)	Measured SAR 10g (W/kg)	Calculated SAR 10g (W/kg)	Power Drift
Head	LTE Band7	21350	2560	1RB-High	Left Cheek	0mm	\	14.28	15.00	0.224	0.26	0.112	0.13	0.14
Head	LTE Band7	21350	2560	1RB-High	Left Tilt	0mm	\	14.28	15.00	0.071	0.08	0.036	0.04	0.12
Head	LTE Band7	21350	2560	1RB-High	Right Cheek	0mm	Fig.A11	14.28	15.00	0.514	0.61	0.220	0.26	0.08
Head	LTE Band7	21350	2560	1RB-High	Right Tilt	0mm	\	14.28	15.00	0.137	0.16	0.066	0.08	0.10
Head	LTE Band7	21350	2560	50RB-Low	Left Cheek	0mm	\	13.39	14.00	0.182	0.21	0.091	0.10	0.16
Head	LTE Band7	21350	2560	50RB-Low	Left Tilt	0mm	\	13.39	14.00	0.057	0.07	0.029	0.03	0.13
Head	LTE Band7	21350	2560	50RB-Low	Right Cheek	0mm	\	13.39	14.00	0.471	0.54	0.198	0.23	0.11
Head	LTE Band7	21350	2560	50RB-Low	Right Tilt	0mm	\	13.39	14.00	0.101	0.12	0.051	0.06	0.13
Head	LTE Band7	21350	2560	1RB-High	Right Cheek	0mm	EUT2	14.28	15.00	0.472	0.56	0.212	0.25	-0.06
Body	LTE Band7	21350	2560	1RB-High	Front	10mm	\	14.28	15.00	0.138	0.16	0.067	0.08	0.20
Body	LTE Band7	21350	2560	1RB-High	Rear	10mm	\	14.28	15.00	0.210	0.25	0.098	0.12	0.00
Body	LTE Band7	21350	2560	1RB-High	Left Edge	10mm	\	14.28	15.00	0.288	0.34	0.128	0.15	-0.03
Body	LTE Band7	21350	2560	50RB-Low	Front	10mm	\	13.39	14.00	0.114	0.13	0.055	0.06	-0.05
Body	LTE Band7	21350	2560	50RB-Low	Rear	10mm	\	13.39	14.00	0.158	0.18	0.076	0.09	-0.16
Body	LTE Band7	21350	2560	50RB-Low	Left Edge	10mm	\	13.39	14.00	0.231	0.27	0.102	0.12	-0.01
Body	LTE Band7	21350	2560	1RB-Middle	Front	17mm	\	23.09	24.00	0.429	0.53	0.241	0.30	-0.15
Body	LTE Band7	21100	2535	1RB-Middle	Rear	21mm	\	23.09	24.00	0.446	0.55	0.250	0.31	0.20
Body	LTE Band7	21350	2560	1RB-Middle	Rear	21mm	\	23.09	24.00	0.411	0.51	0.231	0.28	0.18
Body	LTE Band7	20850	2510	1RB-Middle	Rear	21mm	\	23.09	24.00	0.408	0.50	0.226	0.28	-0.19
Body	LTE Band7	21350	2560	1RB-Middle	Left Edge	17mm	\	23.09	24.00	0.818	1.01	0.424	0.52	0.19
Body	LTE Band7	20850	2510	1RB-Middle	Left Edge	17mm	\	23.09	24.00	0.872	1.08	0.451	0.56	0.02
Body	LTE Band7	21100	2535	1RB-Middle	Left Edge	17mm	Fig.A12	23.09	24.00	0.886	1.09	0.458	0.56	-0.07
Body	LTE Band7	21350	2560	50RB-High	Front	17mm	\	22.24	23.00	0.341	0.41	0.193	0.23	-0.07
Body	LTE Band7	21350	2560	50RB-High	Rear	21mm	\	22.24	23.00	0.335	0.40	0.184	0.22	0.12
Body	LTE Band7	21350	2560	50RB-High	Left Edge	17mm	\	22.24	23.00	0.665	0.79	0.344	0.41	0.12
Body	LTE Band7	21100	2535	1RB-Middle	Left Edge	17mm	EUT2	23.09	24.00	0.865	1.07	0.449	0.55	-0.19
Head	LTE Band12	23130	711	1RB-Low	Left Cheek	0mm	Fig.A13	21.46	22.00	0.087	0.10	0.067	0.08	-0.04
Head	LTE Band12	23130	711	1RB-Low	Left Tilt	0mm	\	21.46	22.00	0.032	0.04	0.019	0.02	-0.20
Head	LTE Band12	23130	711	1RB-Low	Right Cheek	0mm	\	21.46	22.00	0.080	0.09	0.069	0.08	0.12
Head	LTE Band12	23130	711	1RB-Low	Right Tilt	0mm	\	21.46	22.00	0.057	0.06	0.047	0.05	0.09
Head	LTE Band12	23130	711	25RB-Low	Left Cheek	0mm	\	20.40	21.00	0.057	0.07	0.043	0.05	-0.09
Head	LTE Band12	23130	711	25RB-Low	Left Tilt	0mm	\	20.40	21.00	0.028	0.03	0.017	0.02	0.18
Head	LTE Band12	23130	711	25RB-Low	Right Cheek	0mm	\	20.40	21.00	0.057	0.07	0.047	0.05	-0.13
Head	LTE Band12	23130	711	25RB-Low	Right Tilt	0mm	\	20.40	21.00	0.025	0.03	0.016	0.02	-0.03
Head	LTE Band12	23130	711	1RB-Low	Left Cheek	0mm	EUT2	21.46	22.00	0.074	0.08	0.054	0.06	0.00
Body	LTE Band12	23130	711	1RB-Low	Front	10mm	\	21.46	22.00	0.132	0.15	0.101	0.11	0.11
Body	LTE Band12	23130	711	1RB-Low	Rear	10mm	\	21.46	22.00	0.184	0.21	0.142	0.16	0.19
Body	LTE Band12	23130	711	1RB-Low	Left Edge	10mm	\	21.46	22.00	0.115	0.13	0.081	0.09	-0.15
Body	LTE Band12	23130	711	1RB-Low	Right Edge	10mm	\	21.46	22.00	0.188	0.21	0.131	0.15	0.10
Body	LTE Band12	23130	711	1RB-Low	Bottom Edge	10mm	\	21.46	22.00	0.101	0.11	0.050	0.06	-0.02
Body	LTE Band12	23130	711	25RB-Low	Front	10mm	\	20.40	21.00	0.101	0.12	0.075	0.09	0.14
Body	LTE Band12	23130	711	25RB-Low	Rear	10mm	\	20.40	21.00	0.144	0.17	0.110	0.13	0.13
Body	LTE Band12	23130	711	25RB-Low	Left Edge	10mm	\	20.40	21.00	0.090	0.10	0.062	0.07	-0.13
Body	LTE Band12	23130	711	25RB-Low	Right Edge	10mm	\	20.40	21.00	0.155	0.18	0.109	0.12	-0.07
Body	LTE Band12	23130	711	25RB-Low	Bottom Edge	10mm	\	20.40	21.00	0.088	0.10	0.046	0.05	0.20
Body	LTE Band12	23130	711	1RB-Low	Front	17mm	\	24.46	25.00	0.322	0.36	0.246	0.28	0.04
Body	LTE Band12	23130	711	1RB-Low	Rear	21mm	\	24.46	25.00	0.345	0.39	0.263	0.30	-0.02
Body	LTE Band12	23130	711	1RB-Low	Left Edge	17mm	\	24.46	25.00	0.171	0.19	0.120	0.14	0.13
Body	LTE Band12	23130	711	1RB-Low	Right Edge	10mm	Fig.A14	24.46	25.00	0.452	0.51	0.317	0.36	0.10
Body	LTE Band12	23130	711	1RB-Low	Bottom Edge	21mm	\	24.46	25.00	0.055	0.06	0.035	0.04	-0.15
Body	LTE Band12	23130	711	25RB-Low	Front	17mm	\	23.37	24.00	0.265	0.31	0.201	0.23	0.17
Body	LTE Band12	23130	711	25RB-Low	Rear	21mm	\	23.37	24.00	0.279	0.32	0.212	0.25	0.18
Body	LTE Band12	23130	711	25RB-Low	Left Edge	17mm	\	23.37	24.00	0.135	0.16	0.097	0.11	-0.03
Body	LTE Band12	23130	711	25RB-Low	Right Edge	10mm	\	23.37	24.00	0.370	0.43	0.259	0.30	-0.12
Body	LTE Band12	23130	711	25RB-Low	Bottom Edge	21mm	\	23.37	24.00	0.054	0.06	0.034	0.04	-0.12
Body	LTE Band12	23130	711	1RB-Low	Right Edge	10mm	EUT2	24.46	25.00	0.430	0.49	0.301	0.34	-0.19

RF Exposure Conditions	Frequency Band	Channel Number	Frequency (MHz)	Mode/RB	Test Position	Distance	Figure No./Note	EUT Measured Power (dBm)	Tune up (dBm)	Measured SAR 1g (W/kg)	Calculated SAR 1g (W/kg)	Measured SAR 10g (W/kg)	Calculated SAR 10g (W/kg)	Power Drift
Head	LTE Band13	23230	782	1RB-Middle	Left Cheek	0mm	Fig.A15	21.34	22.00	0.109	0.13	0.083	0.10	0.13
Head	LTE Band13	23230	782	1RB-Middle	Left Tilt	0mm	\	21.34	22.00	0.064	0.07	0.051	0.06	0.00
Head	LTE Band13	23230	782	1RB-Middle	Right Cheek	0mm	\	21.34	22.00	0.106	0.12	0.085	0.10	-0.12
Head	LTE Band13	23230	782	1RB-Middle	Right Tilt	0mm	\	21.34	22.00	0.071	0.08	0.058	0.07	0.14
Head	LTE Band13	23230	782	25RB-Middle	Left Cheek	0mm	\	20.42	21.00	0.077	0.09	0.058	0.07	-0.11
Head	LTE Band13	23230	782	25RB-Middle	Left Tilt	0mm	\	20.42	21.00	0.047	0.05	0.037	0.04	0.01
Head	LTE Band13	23230	782	25RB-Middle	Right Cheek	0mm	\	20.42	21.00	0.082	0.09	0.066	0.08	0.17
Head	LTE Band13	23230	782	25RB-Middle	Right Tilt	0mm	\	20.42	21.00	0.054	0.06	0.045	0.05	0.17
Head	LTE Band13	23230	782	1RB-Middle	Left Cheek	0mm	EUT2	21.34	22.00	0.091	0.11	0.074	0.09	0.03
Body	LTE Band13	23230	782	1RB-High	Front	10mm	\	21.34	22.00	0.106	0.12	0.083	0.10	-0.14
Body	LTE Band13	23230	782	1RB-High	Rear	10mm	\	21.34	22.00	0.159	0.19	0.120	0.14	0.16
Body	LTE Band13	23230	782	1RB-High	Left Edge	10mm	\	21.34	22.00	0.089	0.10	0.075	0.09	-0.13
Body	LTE Band13	23230	782	1RB-High	Right Edge	10mm	\	21.34	22.00	0.153	0.18	0.129	0.15	-0.07
Body	LTE Band13	23230	782	1RB-High	Bottom Edge	10mm	\	21.34	22.00	0.126	0.15	0.077	0.09	0.11
Body	LTE Band13	23230	782	25RB-Middle	Front	10mm	\	20.42	21.00	0.080	0.09	0.074	0.08	-0.04
Body	LTE Band13	23230	782	25RB-Middle	Rear	10mm	\	20.42	21.00	0.124	0.14	0.107	0.12	-0.14
Body	LTE Band13	23230	782	25RB-Middle	Left Edge	10mm	\	20.42	21.00	0.068	0.08	0.057	0.07	0.19
Body	LTE Band13	23230	782	25RB-Middle	Right Edge	10mm	\	20.42	21.00	0.116	0.13	0.100	0.11	-0.09
Body	LTE Band13	23230	782	25RB-Middle	Bottom Edge	10mm	\	20.42	21.00	0.090	0.10	0.055	0.06	-0.05
Body	LTE Band13	23230	782	1RB-Middle	Front	17mm	\	24.37	25.00	0.276	0.32	0.214	0.25	-0.09
Body	LTE Band13	23230	782	1RB-Middle	Rear	21mm	\	24.37	25.00	0.280	0.32	0.214	0.25	0.11
Body	LTE Band13	23230	782	1RB-Middle	Left Edge	17mm	\	24.37	25.00	0.127	0.15	0.091	0.11	-0.12
Body	LTE Band13	23230	782	1RB-Middle	Right Edge	10mm	Fig.A16	24.37	25.00	0.391	0.45	0.273	0.32	-0.17
Body	LTE Band13	23230	782	1RB-Middle	Bottom Edge	21mm	\	24.37	25.00	0.075	0.09	0.048	0.06	0.00
Body	LTE Band13	23230	782	25RB-Middle	Front	17mm	\	23.48	24.00	0.236	0.27	0.176	0.20	-0.20
Body	LTE Band13	23230	782	25RB-Middle	Rear	21mm	\	23.48	24.00	0.228	0.26	0.174	0.20	0.02
Body	LTE Band13	23230	782	25RB-Middle	Left Edge	17mm	\	23.48	24.00	0.105	0.12	0.076	0.09	-0.13
Body	LTE Band13	23230	782	25RB-Middle	Right Edge	10mm	\	23.48	24.00	0.312	0.35	0.219	0.25	0.19
Body	LTE Band13	23230	782	25RB-Middle	Bottom Edge	21mm	\	23.48	24.00	0.058	0.07	0.037	0.04	-0.10
Body	LTE Band13	23230	782	1RB-Middle	Right Edge	10mm	EUT2	24.37	25.00	0.380	0.44	0.260	0.30	-0.05
Head	LTE Band25	26590	1905	1RB-Low	Left Cheek	0mm	\	16.48	17.00	0.500	0.56	0.262	0.30	0.13
Head	LTE Band25	26590	1905	1RB-Low	Left Tilt	0mm	\	16.48	17.00	0.623	0.70	0.312	0.35	-0.09
Head	LTE Band25	26590	1905	1RB-Low	Right Cheek	0mm	\	16.48	17.00	0.616	0.69	0.321	0.36	-0.19
Head	LTE Band25	26590	1905	1RB-Low	Right Tilt	0mm	Fig.A17	16.48	17.00	0.685	0.77	0.349	0.39	-0.20
Head	LTE Band25	26365	1882.5	50RB-Middle	Left Cheek	0mm	\	15.35	16.00	0.386	0.45	0.205	0.24	-0.12
Head	LTE Band25	26365	1882.5	50RB-Middle	Left Tilt	0mm	\	15.35	16.00	0.465	0.54	0.234	0.27	-0.13
Head	LTE Band25	26365	1882.5	50RB-Middle	Right Cheek	0mm	\	15.35	16.00	0.461	0.54	0.258	0.30	0.00
Head	LTE Band25	26365	1882.5	50RB-Middle	Right Tilt	0mm	\	15.35	16.00	0.623	0.72	0.286	0.33	0.15
Head	LTE Band25	26590	1905	1RB-Low	Right Tilt	0mm	EUT2	16.48	17.00	0.666	0.75	0.320	0.36	0.03
Body	LTE Band25	26590	1905	1RB-Low	Front	10mm	\	16.48	17.00	0.165	0.19	0.096	0.11	-0.20
Body	LTE Band25	26590	1905	1RB-Low	Rear	10mm	\	16.48	17.00	0.201	0.23	0.112	0.13	-0.17
Body	LTE Band25	26590	1905	1RB-Low	Left Edge	10mm	\	16.48	17.00	0.068	0.08	0.040	0.05	-0.17
Body	LTE Band25	26590	1905	1RB-Low	Top Edge	10mm	\	16.48	17.00	0.278	0.31	0.147	0.17	-0.18
Body	LTE Band25	26365	1882.5	50RB-Middle	Front	10mm	\	15.35	16.00	0.141	0.16	0.083	0.10	0.10
Body	LTE Band25	26365	1882.5	50RB-Middle	Rear	10mm	\	15.35	16.00	0.164	0.19	0.093	0.11	-0.17
Body	LTE Band25	26365	1882.5	50RB-Middle	Left Edge	10mm	\	15.35	16.00	0.059	0.07	0.036	0.04	0.19
Body	LTE Band25	26365	1882.5	50RB-Middle	Top Edge	10mm	\	15.35	16.00	0.216	0.25	0.112	0.13	-0.11
Body	LTE Band25	26590	1905	1RB-Middle	Front	17mm	Fig.A18	24.31	25.00	0.462	0.54	0.282	0.33	-0.19
Body	LTE Band25	26590	1905	1RB-Middle	Rear	21mm	\	24.31	25.00	0.387	0.45	0.237	0.28	-0.18
Body	LTE Band25	26590	1905	1RB-Middle	Left Edge	17mm	\	24.31	25.00	0.246	0.29	0.157	0.18	-0.06
Body	LTE Band25	26590	1905	1RB-Middle	Top Edge	21mm	\	24.31	25.00	0.419	0.49	0.252	0.30	0.00
Body	LTE Band25	26140	1860	50RB-Middle	Front	17mm	\	23.51	24.00	0.387	0.43	0.234	0.26	0.04
Body	LTE Band25	26140	1860	50RB-Middle	Rear	21mm	\	23.51	24.00	0.307	0.34	0.187	0.21	-0.10
Body	LTE Band25	26140	1860	50RB-Middle	Left Edge	17mm	\	23.51	24.00	0.198	0.22	0.124	0.14	-0.06
Body	LTE Band25	26140	1860	50RB-Middle	Top Edge	21mm	\	23.51	24.00	0.329	0.37	0.199	0.22	-0.19
Body	LTE Band25	26590	1905	1RB-Middle	Front	17mm	EUT2	24.31	25.00	0.442	0.52	0.269	0.32	0.05
Head	LTE Band26	26775	822.5	1RB-Low	Left Cheek	0mm	\	23.36	25.00	0.104	0.15	0.078	0.11	-0.16
Head	LTE Band26	26775	822.5	1RB-Low	Left Tilt	0mm	\	23.36	25.00	0.055	0.08	0.043	0.06	0.20
Head	LTE Band26	26775	822.5	1RB-Low	Right Cheek	0mm	Fig.A19	23.36	25.00	0.111	0.16	0.085	0.12	-0.12
Head	LTE Band26	26775	822.5	1RB-Low	Right Tilt	0mm	\	23.36	25.00	0.059	0.09	0.046	0.07	0.19
Head	LTE Band26	26775	822.5	36RB-Low	Left Cheek	0mm	\	22.40	24.00	0.091	0.13	0.064	0.09	-0.07
Head	LTE Band26	26775	822.5	36RB-Low	Left Tilt	0mm	\	22.40	24.00	0.045	0.06	0.034	0.05	0.00
Head	LTE Band26	26775	822.5	36RB-Low	Right Cheek	0mm	\	22.40	24.00	0.076	0.11	0.059	0.09	0.20
Head	LTE Band26	26775	822.5	36RB-Low	Right Tilt	0mm	\	22.40	24.00	0.048	0.07	0.037	0.05	0.01
Head	LTE Band26	26775	822.5	1RB-Low	Right Cheek	0mm	EUT2	23.36	25.00	0.095	0.14	0.075	0.11	0.09
Body	LTE Band26	26775	822.5	1RB-Low	Front	10mm	\	23.36	25.00	0.088	0.13	0.053	0.08	0.03
Body	LTE Band26	26775	822.5	1RB-Low	Rear	10mm	\	23.36	25.00	0.131	0.19	0.077	0.11	0.16
Body	LTE Band26	26775	822.5	1RB-Low	Left Edge	10mm	\	23.36	25.00	0.055	0.08	0.036	0.05	-0.14
Body	LTE Band26	26965	841.5	1RB-Low	Right Edge	10mm	Fig.A20	23.36	25.00	0.240	0.35	0.166	0.24	-0.16
Body	LTE Band26	26775	822.5	1RB-Low	Bottom Edge	10mm	\	23.36	25.00	0.081	0.12	0.039	0.06	-0.16
Body	LTE Band26	26775	822.5	36RB-Low	Front	10mm	\	22.40	24.00	0.075	0.11	0.045	0.07	0.11
Body	LTE Band26	26775	822.5	36RB-Low	Rear	10mm	\	22.40	24.00	0.110	0.16	0.065	0.09	-0.08
Body	LTE Band26	26775	822.5	36RB-Low	Left Edge	10mm	\	22.40	24.00	0.045	0.06	0.029	0.04	-0.06
Body	LTE Band26	26775	822.5	36RB-Low	Right Edge	10mm	\	22.40	24.00	0.071	0.10	0.047	0.07	-0.07
Body	LTE Band26	26775	822.5	36RB-Low	Bottom Edge	10mm	\	22.40	24.00	0.070	0.10	0.034	0.05	0.13
Body	LTE Band26	26965	841.5	1RB-Low	Right Edge	10mm	EUT2	23.36	25.00	0.221	0.32	0.149	0.22	0.01

RF Exposure Conditions	Frequency Band	41099	Frequency (MHz)	Mode/RB	Test Position	Distance	Figure No./Note	EUT Measured Power (dBm)	Tune up (dBm)	Measured SAR 1g (W/kg)	Calculated SAR 1g (W/kg)	Measured SAR 10g (W/kg)	Calculated SAR 10g (W/kg)	Power Drift
Head	LTE Band66	41100	1720	1RB-Middle	Left Cheek	0mm	\	16.38	17.00	0.278	0.32	0.174	0.20	-0.18
Head	LTE Band66	41101	1720	1RB-Middle	Left Tilt	0mm	\	16.38	17.00	0.344	0.40	0.206	0.24	0.08
Head	LTE Band66	41102	1720	1RB-Middle	Right Cheek	0mm	\	16.38	17.00	0.374	0.43	0.233	0.27	-0.12
Head	LTE Band66	41103	1720	1RB-Middle	Right Tilt	0mm	Fig.A25	16.38	17.00	0.419	0.48	0.214	0.25	0.11
Head	LTE Band66	41104	1745	50RB-Middle	Left Cheek	0mm	\	15.31	16.00	0.252	0.30	0.151	0.18	-0.19
Head	LTE Band66	41105	1745	50RB-Middle	Left Tilt	0mm	\	15.31	16.00	0.321	0.38	0.184	0.22	0.00
Head	LTE Band66	41106	1745	50RB-Middle	Right Cheek	0mm	\	15.31	16.00	0.333	0.39	0.206	0.24	-0.15
Head	LTE Band66	41107	1745	50RB-Middle	Right Tilt	0mm	\	15.31	16.00	0.368	0.43	0.183	0.21	0.18
Head	LTE Band66	41108	1720	1RB-Middle	Right Tilt	0mm	EUT2	16.38	17.00	0.402	0.46	0.194	0.22	0.08
Body	LTE Band66	41109	1720	1RB-Middle	Front	10mm	\	16.38	17.00	0.118	0.14	0.074	0.08	-0.09
Body	LTE Band66	41110	1720	1RB-Middle	Rear	10mm	\	16.38	17.00	0.132	0.15	0.077	0.09	-0.06
Body	LTE Band66	41111	1720	1RB-Middle	Left Edge	10mm	\	16.38	17.00	0.052	0.06	0.031	0.04	0.07
Body	LTE Band66	41112	1720	1RB-Middle	Top Edge	10mm	\	16.38	17.00	0.157	0.18	0.086	0.10	-0.11
Body	LTE Band66	41113	1745	50RB-Middle	Front	10mm	\	15.31	16.00	0.110	0.13	0.068	0.08	-0.14
Body	LTE Band66	41114	1745	50RB-Middle	Rear	10mm	\	15.31	16.00	0.122	0.14	0.070	0.08	-0.10
Body	LTE Band66	41115	1745	50RB-Middle	Left Edge	10mm	\	15.31	16.00	0.047	0.05	0.027	0.03	0.01
Body	LTE Band66	41116	1745	50RB-Middle	Top Edge	10mm	\	15.31	16.00	0.144	0.17	0.078	0.09	0.04
Body	LTE Band66	41117	1720	1RB-Low	Front	17mm	Fig.A26	23.21	25.00	0.256	0.39	0.164	0.25	0.04
Body	LTE Band66	41118	1720	1RB-Low	Rear	17mm	\	23.21	25.00	0.177	0.27	0.113	0.17	0.13
Body	LTE Band66	41119	1720	1RB-Low	Left Edge	17mm	\	23.21	25.00	0.092	0.14	0.057	0.09	0.20
Body	LTE Band66	41120	1720	1RB-Low	Top Edge	21mm	\	23.21	25.00	0.216	0.33	0.124	0.19	0.09
Body	LTE Band66	41121	1745	50RB-Middle	Front	17mm	\	22.24	24.00	0.228	0.34	0.134	0.20	-0.14
Body	LTE Band66	41122	1745	50RB-Middle	Rear	21mm	\	22.24	24.00	0.160	0.24	0.092	0.14	-0.01
Body	LTE Band66	41123	1745	50RB-Middle	Left Edge	17mm	\	22.24	24.00	0.126	0.19	0.074	0.11	0.03
Body	LTE Band66	41124	1745	50RB-Middle	Top Edge	21mm	\	22.24	24.00	0.189	0.28	0.109	0.16	0.11
Body	LTE Band66	41125	1720	1RB-Low	Front	17mm	EUT2	23.21	25.00	0.251	0.38	0.157	0.24	0.03
Head	LTE Band71	41126	673	1RB-Low	Left Cheek	0mm	Fig.A27	21.19	22.00	0.089	0.11	0.069	0.08	-0.11
Head	LTE Band71	41127	673	1RB-Low	Left Tilt	0mm	\	21.19	22.00	0.048	0.06	0.039	0.05	0.13
Head	LTE Band71	41128	673	1RB-Low	Right Cheek	0mm	\	21.19	22.00	0.083	0.10	0.068	0.08	0.16
Head	LTE Band71	41129	673	1RB-Low	Right Tilt	0mm	\	21.19	22.00	0.056	0.07	0.045	0.05	0.12
Head	LTE Band71	41130	688	50RB-Middle	Left Cheek	0mm	\	20.30	21.00	0.085	0.10	0.066	0.08	0.20
Head	LTE Band71	41131	688	50RB-Middle	Left Tilt	0mm	\	20.30	21.00	0.000	0.00	0.000	0.00	-0.18
Head	LTE Band71	41132	688	50RB-Middle	Right Cheek	0mm	\	20.30	21.00	0.075	0.09	0.061	0.07	-0.19
Head	LTE Band71	41133	688	50RB-Middle	Right Tilt	0mm	\	20.30	21.00	0.045	0.05	0.037	0.04	-0.19
Head	LTE Band71	41134	673	1RB-Low	Left Cheek	0mm	EUT2	21.19	22.00	0.081	0.10	0.066	0.08	0.11
Body	LTE Band71	41135	673	1RB-Low	Front	10mm	\	21.19	22.00	0.114	0.14	0.087	0.10	0.09
Body	LTE Band71	41136	673	1RB-Low	Rear	10mm	\	21.19	22.00	0.158	0.19	0.122	0.15	0.00
Body	LTE Band71	41137	673	1RB-Low	Left Edge	10mm	\	21.19	22.00	0.119	0.14	0.084	0.10	0.14
Body	LTE Band71	41138	673	1RB-Low	Right Edge	10mm	\	21.19	22.00	0.201	0.24	0.141	0.17	-0.12
Body	LTE Band71	41139	673	1RB-Low	Bottom Edge	10mm	\	21.19	22.00	0.072	0.09	0.039	0.05	0.03
Body	LTE Band71	41140	688	50RB-Middle	Front	10mm	\	20.30	21.00	0.108	0.13	0.083	0.10	0.10
Body	LTE Band71	41141	688	50RB-Middle	Rear	10mm	\	20.30	21.00	0.144	0.17	0.111	0.13	0.16
Body	LTE Band71	41142	688	50RB-Middle	Left Edge	10mm	\	20.30	21.00	0.101	0.12	0.071	0.08	-0.07
Body	LTE Band71	41143	688	50RB-Middle	Right Edge	10mm	\	20.30	21.00	0.180	0.21	0.128	0.15	-0.10
Body	LTE Band71	41144	688	50RB-Middle	Bottom Edge	10mm	\	20.30	21.00	0.094	0.11	0.049	0.06	0.14
Body	LTE Band71	41145	688	1RB-Low	Front	17mm	\	24.21	25.00	0.295	0.35	0.225	0.27	0.20
Body	LTE Band71	41146	688	1RB-Low	Rear	21mm	\	24.21	25.00	0.304	0.36	0.233	0.28	-0.14
Body	LTE Band71	41147	688	1RB-Low	Left Edge	17mm	\	24.21	25.00	0.138	0.17	0.100	0.12	0.17
Body	LTE Band71	41148	688	1RB-Low	Right Edge	10mm	Fig.A28	24.21	25.00	0.462	0.55	0.325	0.39	0.09
Body	LTE Band71	41149	688	1RB-Low	Bottom Edge	21mm	\	24.21	25.00	0.062	0.07	0.038	0.05	0.10
Body	LTE Band71	41150	688	50RB-Middle	Front	17mm	\	23.28	24.00	0.230	0.27	0.176	0.21	0.13
Body	LTE Band71	41151	688	50RB-Middle	Rear	21mm	\	23.28	24.00	0.242	0.29	0.183	0.22	-0.07
Body	LTE Band71	41152	688	50RB-Middle	Left Edge	17mm	\	23.28	24.00	0.138	0.16	0.099	0.12	-0.17
Body	LTE Band71	41153	688	50RB-Middle	Right Edge	10mm	\	23.28	24.00	0.364	0.43	0.257	0.30	0.19
Body	LTE Band71	41154	688	50RB-Middle	Bottom Edge	21mm	\	23.28	24.00	0.056	0.07	0.034	0.04	0.11
Body	LTE Band71	41155	688	1RB-Low	Right Edge	10mm	EUT2	24.21	25.00	0.460	0.55	0.312	0.37	0.10

RF Exposure Conditions	Frequency Band	Channel Number	Frequency (MHz)	Mode/RB	Test Position	Distance	Figure No./Note	EUT Measured Power (dBm)	Tune up (dBm)	Measured SAR 1g (W/kg)	Calculated SAR 1g (W/kg)	Measured SAR 10g (W/kg)	Calculated SAR 10g (W/kg)	Power Drift
Head	LTE Band2 ANTO	18700	1860	1RB-Low	Left Cheek	0mm	\	24.50	25.00	0.110	0.12	0.061	0.07	-0.18
Head	LTE Band2 ANTO	18700	1860	1RB-Low	Left Tilt	0mm	\	24.50	25.00	0.058	0.07	0.033	0.04	0.04
Head	LTE Band2 ANTO	18700	1860	1RB-Low	Right Cheek	0mm	Fig.A45	24.50	25.00	0.117	0.13	0.066	0.07	-0.13
Head	LTE Band2 ANTO	18700	1860	1RB-Low	Right Tilt	0mm	\	24.50	25.00	0.062	0.07	0.036	0.04	-0.06
Head	LTE Band2 ANTO	18700	1860	36RB-Low	Left Cheek	0mm	\	23.48	24.00	0.096	0.11	0.050	0.06	0.09
Head	LTE Band2 ANTO	18700	1860	36RB-Low	Left Tilt	0mm	\	23.48	24.00	0.047	0.05	0.026	0.03	0.19
Head	LTE Band2 ANTO	18700	1860	36RB-Low	Right Cheek	0mm	\	23.48	24.00	0.081	0.09	0.046	0.05	-0.07
Head	LTE Band2 ANTO	18700	1860	36RB-Low	Right Tilt	0mm	\	23.48	24.00	0.050	0.06	0.029	0.03	0.17
Head	LTE Band2 ANTO	18700	1860	1RB-Low	Right Cheek	0mm	EUT2	24.50	25.00	0.100	0.11	0.058	0.07	0.16
Body	LTE Band2 ANTO	18700	1860	1RB-Low	Front	10mm	\	24.50	25.00	0.120	0.14	0.087	0.10	-0.09
Body	LTE Band2 ANTO	18700	1860	1RB-Low	Rear	10mm	\	24.50	25.00	0.113	0.13	0.081	0.09	0.11
Body	LTE Band2 ANTO	18700	1860	1RB-Low	Left Edge	10mm	\	24.50	25.00	0.050	0.06	0.034	0.04	0.19
Body	LTE Band2 ANTO	18700	1860	1RB-Low	Right Edge	10mm	Fig.A46	24.50	25.00	0.159	0.18	0.107	0.12	-0.01
Body	LTE Band2 ANTO	18700	1860	1RB-Low	Bottom Edge	10mm	\	24.50	25.00	0.042	0.05	0.025	0.03	-0.05
Body	LTE Band2 ANTO	18700	1860	50RB-Low	Front	10mm	\	23.48	24.00	0.080	0.09	0.059	0.07	0.08
Body	LTE Band2 ANTO	18700	1860	50RB-Low	Rear	10mm	\	23.48	24.00	0.074	0.08	0.055	0.06	0.04
Body	LTE Band2 ANTO	18700	1860	50RB-Low	Left Edge	10mm	\	23.48	24.00	0.035	0.04	0.025	0.03	-0.10
Body	LTE Band2 ANTO	18700	1860	50RB-Low	Right Edge	10mm	\	23.48	24.00	0.106	0.12	0.071	0.08	0.18
Body	LTE Band2 ANTO	18700	1860	50RB-Low	Bottom Edge	10mm	\	23.48	24.00	0.056	0.06	0.028	0.03	0.03
Body	LTE Band2 ANTO	18700	1860	1RB-Low	Right Edge	10mm	EUT2	24.50	25.00	0.147	0.16	0.096	0.11	0.16
Head	LTE Band66 ANTO	132072	1720	1RB-Low	Left Cheek	0mm	\	24.49	25.00	0.205	0.23	0.101	0.11	-0.06
Head	LTE Band66 ANTO	132072	1720	1RB-Low	Left Tilt	0mm	\	24.49	25.00	0.108	0.12	0.055	0.06	-0.19
Head	LTE Band66 ANTO	132072	1720	1RB-Low	Right Cheek	0mm	Fig.A47	24.49	25.00	0.219	0.25	0.109	0.12	-0.08
Head	LTE Band66 ANTO	132072	1720	1RB-Low	Right Tilt	0mm	\	24.49	25.00	0.117	0.13	0.059	0.07	0.10
Head	LTE Band66 ANTO	26775	1770	50RB-Middle	Left Cheek	0mm	\	23.62	24.00	0.179	0.20	0.082	0.09	0.07
Head	LTE Band66 ANTO	26775	1770	50RB-Middle	Left Tilt	0mm	\	23.62	24.00	0.088	0.10	0.043	0.05	0.14
Head	LTE Band66 ANTO	26775	1770	50RB-Middle	Right Cheek	0mm	\	23.62	24.00	0.151	0.16	0.075	0.08	-0.08
Head	LTE Band66 ANTO	26775	1770	50RB-Middle	Right Tilt	0mm	\	23.62	24.00	0.094	0.10	0.048	0.05	-0.01
Head	LTE Band66 ANTO	132072	1720	1RB-Low	Right Cheek	0mm	EUT2	24.49	25.00	0.187	0.21	0.096	0.11	0.05
Body	LTE Band66 ANTO	132072	1720	1RB-Low	Front	10mm	\	24.49	25.00	0.146	0.16	0.096	0.11	-0.12
Body	LTE Band66 ANTO	132072	1720	1RB-Low	Rear	10mm	\	24.49	25.00	0.137	0.15	0.090	0.10	0.16
Body	LTE Band66 ANTO	132072	1720	1RB-Low	Left Edge	10mm	\	24.49	25.00	0.060	0.07	0.038	0.04	-0.11
Body	LTE Band66 ANTO	132072	1720	1RB-Low	Right Edge	10mm	Fig.A48	24.49	25.00	0.193	0.22	0.118	0.13	-0.20
Body	LTE Band66 ANTO	132072	1720	1RB-Low	Bottom Edge	10mm	\	24.49	25.00	0.051	0.06	0.028	0.03	-0.14
Body	LTE Band66 ANTO	26775	1770	50RB-Middle	Front	10mm	\	23.62	24.00	0.097	0.11	0.065	0.07	0.15
Body	LTE Band66 ANTO	26775	1770	50RB-Middle	Rear	10mm	\	23.62	24.00	0.090	0.10	0.060	0.07	-0.10
Body	LTE Band66 ANTO	26775	1770	50RB-Middle	Left Edge	10mm	\	23.62	24.00	0.043	0.05	0.028	0.03	0.02
Body	LTE Band66 ANTO	26775	1770	50RB-Middle	Right Edge	10mm	\	23.62	24.00	0.128	0.14	0.078	0.09	-0.01
Body	LTE Band66 ANTO	26775	1770	50RB-Middle	Bottom Edge	10mm	\	23.62	24.00	0.068	0.07	0.031	0.03	-0.10
Body	LTE Band66 ANTO	132072	1720	1RB-Low	Right Edge	10mm	EUT2	24.49	25.00	0.178	0.20	0.106	0.12	-0.15

13.2 SAR results for 5G NR

RF Exposure Conditions	Frequency Band	Channel Number	Frequency (MHz)	Mode/RB	Test Position	Distance	Figure No./Note	EUT Measured Power (dBm)	Tune up (dBm)	Measured SAR 1g (W/kg)	Calculated SAR 1g (W/kg)	Measured SAR 10g (W/kg)	Calculated SAR 10g (W/kg)	Power Drift
Head	n25	376500	1882.5	DFT-s-OFDM QPSK	Left Cheek	0mm	\	16.88	17.50	0.430	0.50	0.240	0.28	0.14
Head	n25	376500	1882.5	DFT-s-OFDM QPSK	Left Tilt	0mm	\	16.88	17.50	0.504	0.58	0.263	0.30	-0.11
Head	n25	376500	1882.5	DFT-s-OFDM QPSK	Right Cheek	0mm	\	16.88	17.50	0.558	0.64	0.334	0.39	0.13
Head	n25	376500	1882.5	DFT-s-OFDM QPSK	Right Tilt	0mm	Fig.A33	16.88	17.50	0.584	0.67	0.323	0.37	0.16
Head	n25	376500	1882.5	EUT2	Right Tilt	0mm	\	16.88	17.50	0.566	0.65	0.309	0.36	-0.03
Body	n25	376500	1882.5	DFT-s-OFDM QPSK	Front	10mm	\	16.88	17.50	0.124	0.14	0.071	0.08	0.18
Body	n25	376500	1882.5	DFT-s-OFDM QPSK	Rear	10mm	\	16.88	17.50	0.143	0.16	0.078	0.09	-0.18
Body	n25	376500	1882.5	DFT-s-OFDM QPSK	Left Edge	10mm	\	16.88	17.50	0.060	0.07	0.035	0.04	-0.06
Body	n25	376500	1882.5	DFT-s-OFDM QPSK	Top Edge	10mm	\	16.88	17.50	0.157	0.18	0.083	0.10	0.09
Body	n25	376500	1882.5	DFT-s-OFDM QPSK	Front	17mm	Fig.A34	25.36	25.50	0.355	0.37	0.214	0.22	0.05
Body	n25	376500	1882.5	DFT-s-OFDM QPSK	Rear	21mm	\	25.36	25.50	0.284	0.29	0.171	0.18	-0.01
Body	n25	376500	1882.5	DFT-s-OFDM QPSK	Left Edge	17mm	\	25.36	25.50	0.174	0.18	0.106	0.11	0.05
Body	n25	376500	1882.5	DFT-s-OFDM QPSK	Top Edge	21mm	\	25.36	25.50	0.317	0.33	0.188	0.19	-0.03
Body	n25	376500	1882.5	EUT2	Front	17mm	\	25.36	25.50	0.350	0.36	0.204	0.21	0.02
Head	n66	344000	1720	DFT-s-OFDM QPSK	Left Cheek	0mm	\	17.05	17.50	0.293	0.32	0.167	0.18	-0.19
Head	n66	344000	1720	DFT-s-OFDM QPSK	Left Tilt	0mm	\	17.05	17.50	0.345	0.38	0.183	0.20	0.14
Head	n66	344000	1720	DFT-s-OFDM QPSK	Right Cheek	0mm	Fig.A35	17.05	17.50	0.432	0.48	0.237	0.26	0.13
Head	n66	344000	1720	DFT-s-OFDM QPSK	Right Tilt	0mm	\	17.05	17.50	0.425	0.47	0.199	0.22	-0.15
Head	n66	344000	1720	EUT2	Right Cheek	0mm	\	17.05	17.50	0.421	0.47	0.222	0.25	-0.13
Body	n66	344000	1720	DFT-s-OFDM QPSK	Front	10mm	\	17.05	17.50	0.105	0.12	0.064	0.07	-0.04
Body	n66	344000	1720	DFT-s-OFDM QPSK	Rear	10mm	\	17.05	17.50	0.108	0.12	0.063	0.07	0.16
Body	n66	344000	1720	DFT-s-OFDM QPSK	Left Edge	10mm	\	17.05	17.50	0.046	0.05	0.029	0.03	0.20
Body	n66	344000	1720	DFT-s-OFDM QPSK	Top Edge	10mm	\	17.05	17.50	0.125	0.14	0.068	0.08	-0.04
Body	n66	349000	1745	DFT-s-OFDM QPSK	Front	10mm	Fig.A36	25.23	25.50	0.254	0.27	0.159	0.17	0.16
Body	n66	349000	1745	DFT-s-OFDM QPSK	Rear	21mm	\	25.23	25.50	0.169	0.18	0.113	0.12	0.06
Body	n66	349000	1745	DFT-s-OFDM QPSK	Left Edge	17mm	\	25.23	25.50	0.145	0.15	0.092	0.10	0.02
Body	n66	349000	1745	DFT-s-OFDM QPSK	Top Edge	21mm	\	25.23	25.50	0.229	0.24	0.138	0.15	0.04
Body	n66	349000	1745	EUT2	Front	17mm	\	25.23	25.50	0.245	0.26	0.151	0.16	0.07
Head	n41 pc2	518598	2592.99	DFT-s-OFDM QPSK	Left Cheek	0mm	\	16.94	17.50	0.180	0.20	0.096	0.11	0.08
Head	n41 pc2	518598	2592.99	DFT-s-OFDM QPSK	Left Tilt	0mm	\	16.94	17.50	0.062	0.07	0.033	0.04	0.07
Head	n41 pc2	518598	2592.99	DFT-s-OFDM QPSK	Right Cheek	0mm	Fig.A37	16.94	17.50	0.640	0.73	0.292	0.33	0.08
Head	n41 pc2	518598	2592.99	DFT-s-OFDM QPSK	Right Tilt	0mm	\	16.94	17.50	0.142	0.16	0.073	0.08	0.17
Head	n41 pc2	518598	2592.99	EUT2	Right Cheek	0mm	\	16.94	17.50	0.630	0.72	0.281	0.32	-0.19
Body	n41 pc2	518598	2592.99	DFT-s-OFDM QPSK	Front	10mm	\	16.94	17.50	0.085	0.10	0.043	0.05	0.08
Body	n41 pc2	518598	2592.99	DFT-s-OFDM QPSK	Rear	10mm	\	16.94	17.50	0.132	0.15	0.063	0.07	0.15
Body	n41 pc2	518598	2592.99	DFT-s-OFDM QPSK	Left Edge	10mm	\	16.94	17.50	0.191	0.22	0.082	0.09	0.05
Body	n41 pc2	518598	2592.99	DFT-s-OFDM PI/2 BPSK1	Front	17mm	\	27.15	27.50	0.122	0.13	0.066	0.07	-0.06
Body	n41 pc2	518598	2592.99	DFT-s-OFDM PI/2 BPSK1	Rear	21mm	\	27.15	27.50	0.118	0.13	0.064	0.07	0.00
Body	n41 pc2	518598	2592.99	DFT-s-OFDM PI/2 BPSK1	Left Edge	17mm	Fig.A38	27.15	27.50	0.211	0.23	0.107	0.12	0.18
Body	n41 pc2	518598	2592.99	EUT2	Left Edge	17mm	\	27.15	27.50	0.211	0.23	0.107	0.12	0.16
RF Exposure Conditions	Frequency Band	Channel Number	Frequency (MHz)	Mode/RB	Test Position	Distance	Figure No./Note	EUT Measured Power (dBm)	Tune up (dBm)	Measured SAR 1g (W/kg)	Calculated SAR 1g (W/kg)	Measured SAR 10g (W/kg)	Calculated SAR 10g (W/kg)	Power Drift
Head	n77 pc2	636000	3540	DFT-s-OFDM QPSK	Left Cheek	0mm	\	17.70	18.00	0.397	0.43	0.151	0.16	-0.16
Head	n77 pc2	636000	3540	DFT-s-OFDM QPSK	Left Tilt	0mm	Fig.A39	17.70	18.00	0.565	0.61	0.204	0.22	-0.11
Head	n77 pc2	636000	3540	DFT-s-OFDM QPSK	Right Cheek	0mm	\	17.70	18.00	0.151	0.16	0.065	0.07	-0.13
Head	n77 pc2	636000	3540	DFT-s-OFDM QPSK	Right Tilt	0mm	\	17.70	18.00	0.206	0.22	0.081	0.09	0.10
Head	n77 pc2	636000	3540	EUT2	Left Tilt	0mm	\	17.70	18.00	0.549	0.59	0.183	0.20	-0.18
Body	n77 pc2	636000	3540	DFT-s-OFDM QPSK	Front	10mm	\	17.70	18.00	0.080	0.09	0.036	0.04	-0.06
Body	n77 pc2	636000	3540	DFT-s-OFDM QPSK	Rear	10mm	\	17.70	18.00	0.140	0.15	0.063	0.07	0.10
Body	n77 pc2	636000	3540	DFT-s-OFDM QPSK	Right Edge	10mm	\	17.70	18.00	0.038	0.04	0.019	0.02	-0.03
Body	n77 pc2	636000	3540	DFT-s-OFDM QPSK	Top Edge	10mm	\	17.70	18.00	0.205	0.22	0.091	0.10	0.10
Body	n77 pc2	633334	3500.01	DFT-s-OFDM QPSK	Front	17mm	\	27.78	28.00	0.284	0.30	0.143	0.15	0.00
Body	n77 pc2	633334	3500.01	DFT-s-OFDM QPSK	Rear	21mm	\	27.78	28.00	0.398	0.42	0.204	0.21	-0.14
Body	n77 pc2	633334	3500.01	DFT-s-OFDM QPSK	Right Edge	17mm	\	27.78	28.00	0.159	0.17	0.087	0.09	-0.11
Body	n77 pc2	633334	3500.01	DFT-s-OFDM QPSK	Top Edge	21mm	Fig.A40	27.78	28.00	0.569	0.60	0.285	0.30	-0.01
Body	n77 pc2	633334	3500.01	EUT2	Top Edge	21mm	\	27.78	28.00	0.554	0.58	0.270	0.28	-0.11
Head	n77 pc2	654267	3814.000	DFT-s-OFDM QPSK	Left Cheek	0mm	\	17.93	18	0.831	0.84	0.315	0.32	-0.03
Head	n77 pc2	654267	3814.000	DFT-s-OFDM QPSK	Left Tilt	0mm	Fig.A41	17.93	18	1.030	1.05	0.368	0.37	0.00
Head	n77 pc2	654267	3814.000	DFT-s-OFDM QPSK	Right Cheek	0mm	\	17.93	18	0.382	0.39	0.143	0.14	0.10
Head	n77 pc2	654267	3814.000	DFT-s-OFDM QPSK	Right Tilt	0mm	\	17.93	18	0.508	0.52	0.186	0.19	-0.07
Head	n77 pc2	654267	3814.000	EUT2	Left Tilt	0mm	\	17.93	18	0.983	1.00	0.350	0.36	0.16
Body	n77 pc2	654267	3814.000	DFT-s-OFDM QPSK	Front	10mm	\	17.93	18	0.152	0.15	0.065	0.07	-0.17
Body	n77 pc2	654267	3814.000	DFT-s-OFDM QPSK	Rear	10mm	\	17.93	18	0.187	0.19	0.080	0.08	-0.08
Body	n77 pc2	654267	3814.000	DFT-s-OFDM QPSK	Right Edge	10mm	\	17.93	18	0.045	0.05	0.024	0.02	0.11
Body	n77 pc2	654267	3814.000	DFT-s-OFDM QPSK	Top Edge	10mm	\	17.93	18	0.295	0.30	0.122	0.12	-0.05
Body	n77 pc2	650800	3762.000	DFT-s-OFDM QPSK	Front	17mm	\	27.94	28	0.565	0.57	0.265	0.27	0.15
Body	n77 pc2	650800	3762.000	DFT-s-OFDM QPSK	Rear	21mm	\	27.94	28	0.558	0.57	0.279	0.28	0.15
Body	n77 pc2	650800	3762.000	DFT-s-OFDM QPSK	Right Edge	17mm	\	27.94	28	0.232	0.24	0.125	0.13	0.08
Body	n77 pc2	650800	3762.000	DFT-s-OFDM QPSK	Top Edge	21mm	Fig.A42	27.94	28	0.868	0.88	0.425	0.43	0.04
Body	n77 pc2	650800	3762.000	EUT2	Top Edge	21mm	\	27.94	28	0.850	0.86	0.417	0.42	-0.19
Head	n71	136100	680.5	DFT-s-OFDM PI/2 BPSK1	Left Cheek	0mm	\	25.09	25.50	0.193	0.21	0.143	0.16	0.07
Head	n71	136100	680.5	DFT-s-OFDM PI/2 BPSK1	Left Tilt	0mm	\	25.09	25.50	0.101	0.11	0.079	0.09	-0.03
Head	n71	136100	680.5	DFT-s-OFDM PI/2 BPSK1	Right Cheek	0mm	Fig.A43	25.09	25.50	0.210	0.23	0.161	0.18	-0.09
Head	n71	136100	680.5	DFT-s-OFDM PI/2 BPSK1	Right Tilt	0mm	\	25.09	25.50	0.112	0.12	0.088	0.10	-0.02
Head	n71	136100	680.5	EUT2	Right Cheek	0mm	\	25.09	25.50	0.200	0.22	0.148	0.16	0.02
Body	n71	136100	680.5	DFT-s-OFDM PI/2 BPSK1	Front	10mm	\	25.09	25.50	0.131	0.14	0.074	0.08	0.13
Body	n71	136100	680.5	DFT-s-OFDM PI/2 BPSK1	Rear	10mm	\	25.09	25.50	0.176	0.19	0.084	0.09	0.12
Body	n71	136100	680.5	DFT-s-OFDM PI/2 BPSK1	Left Edge	10mm	\	25.09	25.50	0.122	0.13	0.063	0.07	0.08
Body	n71	136100	680.5	DFT-s-OFDM PI/2 BPSK1	Right Edge	10mm	\	25.09	25.50	0.218	0.24	0.114	0.13	-0.06
Body	n71	136100	680.5	DFT-s-OFDM PI/2 BPSK1	Bottom Edge	10mm	\	25.09	25.50	0.140	0.15	0.051	0.06	0.12
Body	n71	136100	680.5	DFT-s-OFDM PI/2 BPSK1	Front	16mm	\	25.09	25.50	0.257	0.28	0.195	0.21	0.05
Body	n71	136100	680.5	DFT-s-OFDM PI/2 BPSK1	Rear	21mm	\	25.09	25.50	0.345	0.38	0.222	0.24	0.12
Body	n71	136100	680.5	DFT-s-OFDM PI/2 BPSK1	Left Edge	17mm	\	25.09	25.50	0.239	0.26	0.167	0.18	-0.11
Body	n71	136100	680.5	DFT-s-OFDM PI/2 BPSK1	Right Edge	10mm	Fig.A44	25.09	25.50	0.427	0.47	0.300	0.33	-0.06
Body	n71	136100	680.5	DFT-s-OFDM PI/2 BPSK1	Bottom Edge	21mm	\	25.09	25.50	0.274	0.30	0.133	0.15	-0.08
Body	n71	136100	680.5	EUT2	Right Edge	10mm	\	25.09	25.50	0.401	0.44	0.274	0.30	0.15

13.3 SAR results for WLAN

The maximum output power specified for production units are determined for all applicable 802.11 transmission modes in each standalone and aggregated frequency band. Maximum output power is measured for the highest maximum output power configuration(s) in each frequency band according to the default power measurement procedures.

When the same transmission mode configurations have the same maximum output power on the same channel for the 802.11 a/g/n/ac/ax modes, the channel in the lower order/sequence 802.11 mode (i.e. a, g, n ac then ax) is selected.

SAR Test reduction was applied from KDB 248227 guidance, when the same maximum power is specified for multiple transmission modes in a frequency band, the largest channel bandwidth, lowest order modulation, lowest data rate and lowest order 802.11a/g/n/ac mode is used for SAR measurement, on the highest measured output power channel in the initial test configuration, for each frequency band. Additional output power measurements were not deemed necessary.

Duty factor plot

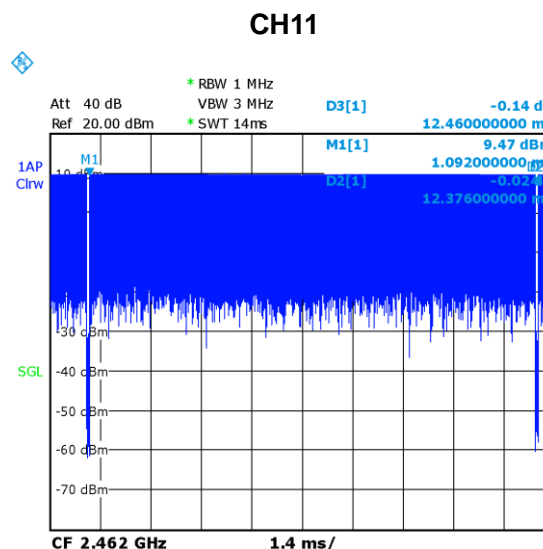
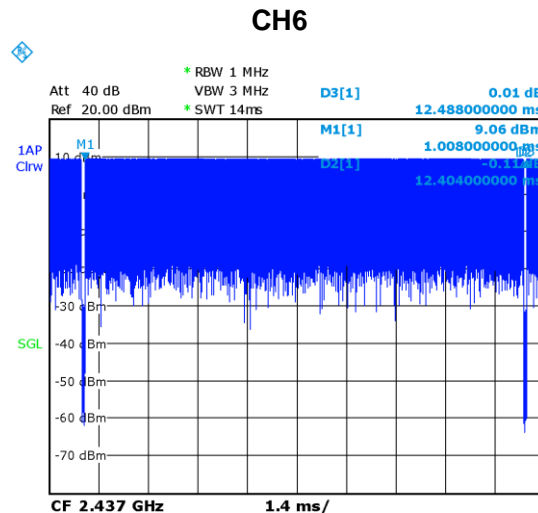

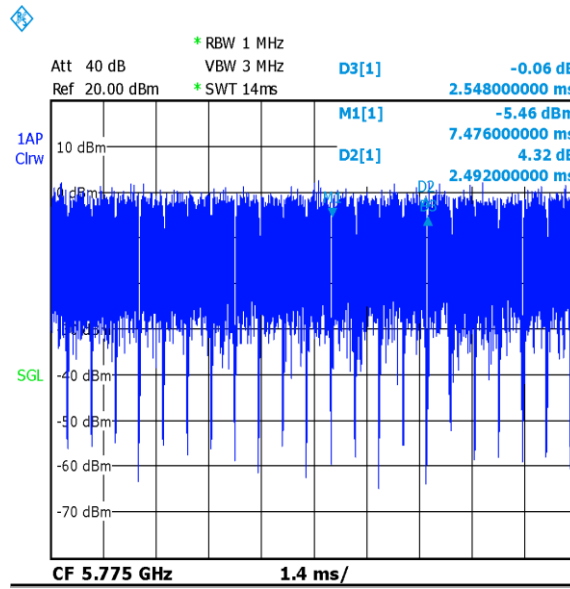
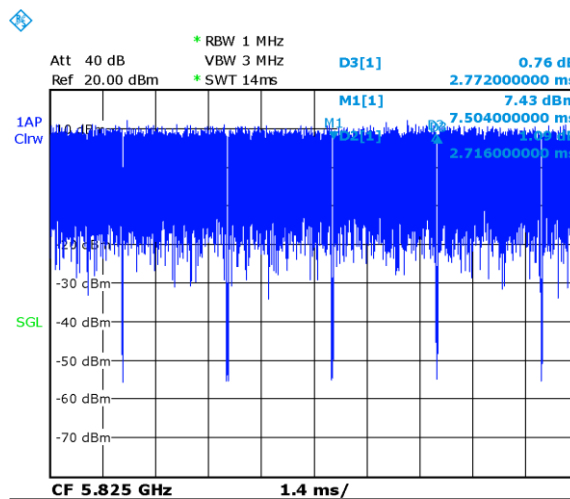
CH155

CH165

WLAN 2.4G

Test Position	Frequency Band	Channel Number	Frequency (MHz)	Mode/RB	Test setup	Figure No./Note	EUT Measured Power (dBm)	Tune up (dBm)	Measured SAR 1g (W/kg)	Calculated SAR 1g (W/kg)	Measured SAR 10g (W/kg)	Calculated SAR 10g (W/kg)	Power Drift
Head	WLAN 2.4G	6	2437	11b	Cheek Left	Fig.29	11.98	12.00	0.197	0.20	0.102	0.10	-0.07
Head	WLAN 2.4G	6	2437	11b	Tilt Left	\	11.98	12.00	0.181	0.18	0.092	0.09	0.03
Head	WLAN 2.4G	6	2437	11b	Cheek Right	\	11.98	12.00	0.110	0.11	0.062	0.06	-0.12
Head	WLAN 2.4G	6	2437	11b	Tilt Right	\	11.98	12.00	0.136	0.14	0.070	0.07	0.14
Head	WLAN 2.4G	6	2437	11b	Cheek Left	EUT2	11.98	12.00	0.181	0.18	0.095	0.10	0.12
Body	WLAN 2.4G	6	2437	11b	Front 10mm	\	16.48	16.50	0.125	0.13	0.073	0.07	0.03
Body	WLAN 2.4G	6	2437	11b	Rear 10mm	\	16.48	16.50	0.141	0.14	0.079	0.08	0.13
Body	WLAN 2.4G	6	2437	11b	Right Edge 10mm	\	16.48	16.50	0.121	0.12	0.067	0.07	0.13
Body	WLAN 2.4G	6	2437	11b	Top Edge 10mm	Fig.30	16.48	16.50	0.244	0.25	0.127	0.13	-0.17
Body	WLAN 2.4G	6	2437	11b	Top Edge 10mm	EUT2	16.48	16.50	0.213	0.21	0.116	0.12	0.18

SAR Values (WLAN - Head) – 802.11b (Scaled Reported SAR)

Frequency		Side	Test Position	Actual duty factor	maximum duty factor	Reported SAR (1g)(W/kg)	Scaled reported SAR (1g)(W/kg)
MHz	Ch.						
2437	6	Left	Cheek	99.3%	100%	0.20	0.20

SAR Values (WLAN - Body) – 802.11b (Scaled Reported SAR)

Frequency		Side	Test Position	Actual duty factor	maximum duty factor	Reported SAR (1g)(W/kg)	Scaled reported SAR (1g)(W/kg)
MHz	Ch.						
2437	6	Left	Tilt	99.3%	100%	0.25	0.25

WLAN 5G

Test Position	Frequency Band	Channel Number	Frequency (MHz)	Mode/RB	Test setup	Figure No./Note	EUT Measured Power (dBm)	Tune up (dBm)	Measured SAR 1g (W/kg)	Calculated SAR 1g (W/kg)	Measured SAR 10g (W/kg)	Calculated SAR 10g (W/kg)	Power Drift
Head	WLAN 5G	58	5290	802.11ac 80M	Right Cheek	\	9.15	11	0.030	0.05	0.006	0.01	0.11
Head	WLAN 5G	58	5290	802.11ac 80M	Right Tilt	\	9.15	11	0.021	0.03	0.005	0.01	0.04
Head	WLAN 5G	58	5290	802.11ac 80M	Left Cheek	\	9.15	11	0.099	0.15	0.030	0.05	0.00
Head	WLAN 5G	58	5290	802.11ac 80M	Left Tilt	\	9.15	11	0.071	0.11	0.024	0.04	0.20
Head	WLAN 5G	138	5690	802.11ac 80M	Right Cheek	\	9.84	11	0.038	0.05	0.011	0.01	0.03
Head	WLAN 5G	138	5690	802.11ac 80M	Right Tilt	\	9.84	11	0.034	0.05	0.008	0.01	-0.16
Head	WLAN 5G	138	5690	802.11ac 80M	Left Cheek	\	9.84	11	0.094	0.12	0.041	0.05	-0.06
Head	WLAN 5G	138	5690	802.11ac 80M	Left Tilt	\	9.84	11	0.095	0.12	0.031	0.04	-0.01
Head	WLAN 5G	155	5775	802.11ac 80M	Right Cheek	\	9.98	11	0.038	0.05	0.012	0.02	-0.09
Head	WLAN 5G	155	5775	802.11ac 80M	Right Tilt	\	9.98	11	0.035	0.04	0.010	0.01	0.13
Head	WLAN 5G	155	5775	802.11ac 80M	Left Cheek	Fig.31	9.98	11	0.133	0.17	0.041	0.05	0.19
Head	WLAN 5G	155	5775	802.11ac 80M	Left Tilt	\	9.98	11	0.100	0.13	0.033	0.04	-0.02
Head	WLAN 5G	155	5775	802.11ac 80M	Left Tilt	EUT2	9.98	11	0.091	0.12	0.028	0.04	0.18
Test Position	Frequency Band	Channel Number	Frequency (MHz)	Mode/RB	Test setup	Figure No./Note	EUT Measured Power (dBm)	Tune up (dBm)	Measured SAR 1g (W/kg)	Calculated SAR 1g (W/kg)	Measured SAR 10g (W/kg)	Calculated SAR 10g (W/kg)	Power Drift
Body	WLAN 5G	64	5320	802.11a 20M	Front 10mm	\	15.84	16.5	0.046	0.05	0.021	0.02	0.04
Body	WLAN 5G	64	5320	802.11a 20M	Rear 10mm	\	15.84	16.5	0.167	0.19	0.072	0.08	0.05
Body	WLAN 5G	64	5320	802.11a 20M	Right Edge 10mm	\	15.84	16.5	0.170	0.20	0.075	0.09	-0.09
Body	WLAN 5G	64	5320	802.11a 20M	Top Edge 10mm	\	15.84	16.5	0.161	0.19	0.071	0.08	-0.20
Body	WLAN 5G	136	5680	802.11a 20M	Front 10mm	\	16.14	16.5	0.108	0.12	0.049	0.05	-0.07
Body	WLAN 5G	136	5680	802.11a 20M	Rear 10mm	\	16.14	16.5	0.195	0.21	0.086	0.09	0.04
Body	WLAN 5G	136	5680	802.11a 20M	Right Edge 10mm	\	16.14	16.5	0.337	0.37	0.133	0.14	-0.16
Body	WLAN 5G	136	5680	802.11a 20M	Top Edge 10mm	\	16.14	16.5	0.091	0.10	0.044	0.05	-0.14
Body	WLAN 5G	165	5825	802.11a 20M	Front 10mm	\	16.47	16.5	0.116	0.12	0.050	0.05	0.11
Body	WLAN 5G	165	5825	802.11a 20M	Rear 10mm	\	16.47	16.5	0.303	0.30	0.119	0.12	0.15
Body	WLAN 5G	165	5825	802.11a 20M	Right Edge 10mm	Fig.32	16.47	16.5	0.425	0.43	0.160	0.16	0.14
Body	WLAN 5G	165	5825	802.11a 20M	Top Edge 10mm	\	16.47	16.5	0.103	0.10	0.041	0.04	0.02
Body	WLAN 5G	165	5825	802.11a 20M	Right Edge 10mm	EUT2	16.47	16.5	0.401	0.40	0.157	0.16	0.19

SAR Values (WLAN - Head) – 802.11b (Scaled Reported SAR)

Frequency		Test Position	Actual duty factor	maximum duty factor	Reported SAR (1g)(W/kg)	Scaled reported SAR (1g)(W/kg)
MHz	Ch.					
5775	155	Left Cheek	98%	100%	0.17	0.17

SAR Values (WLAN - Body) – 802.11b (Scaled Reported SAR)

Frequency		Test Position	Actual duty factor	maximum duty factor	Reported SAR (1g)(W/kg)	Scaled reported SAR (1g)(W/kg)
MHz	Ch.					
5775	155	Left Cheek	98%	100%	0.43	0.44

13.4 SAR results for BT

RF Exposure Conditions	Frequency Band	Channel Number	Frequency (MHz)	Mode/R B	Test Position	Distance	EUT Measured Power (dBm)	Tune up (dBm)	Measured SAR 1g (W/kg)	Calculated SAR 1g (W/kg)	Measured SAR 10g (W/kg)	Calculated SAR 10g (W/kg)	Power Drift
Head	BT	78	2480	EDR	Left Cheek	0mm	9.63	10.00	<0.01	<0.01	<0.01	<0.01	/
Head	BT	78	2480	EDR	Left Tilt	0mm	9.63	10.00	<0.01	<0.01	<0.01	<0.01	/
Head	BT	78	2480	EDR	Right Cheek	0mm	9.63	10.00	<0.01	<0.01	<0.01	<0.01	/
Head	BT	78	2480	EDR	Right Cheek	0mm	9.63	10.00	<0.01	<0.01	<0.01	<0.01	/
Body	BT	78	2480	EDR	Front	10mm	9.63	10.00	<0.01	<0.01	<0.01	<0.01	/
Body	BT	78	2480	EDR	Rear	10mm	9.63	10.00	<0.01	<0.01	<0.01	<0.01	/
Body	BT	78	2480	EDR	Right Edge	10mm	9.63	10.00	<0.01	<0.01	<0.01	<0.01	/
Body	BT	78	2480	EDR	Top Edge	10mm	9.63	10.00	<0.01	<0.01	<0.01	<0.01	/

14 SAR Measurement Variability

SAR measurement variability must be assessed for each frequency band, which is determined by the SAR probe calibration point and tissue-equivalent medium used for the device measurements. When both head and body tissue-equivalent media are required for SAR measurements in a frequency band, the variability measurement procedures should be applied to the tissue medium with the highest measured SAR, using the highest measured SAR configuration for that tissue-equivalent medium.

The following procedures are applied to determine if repeated measurements are required.

- 1) Repeated measurement is not required when the original highest measured SAR is < 0.80 W/kg; steps 2) through 4) do not apply.
- 2) When the original highest measured SAR is ≥ 0.80 W/kg, repeat that measurement once.
- 3) Perform a second repeated measurement only if the ratio of largest to smallest SAR for the original and first repeated measurements is > 1.20 or when the original or repeated measurement is ≥ 1.45 W/kg ($\sim 10\%$ from the 1-g SAR limit).
- 4) Perform a third repeated measurement only if the original, first or second repeated measurement is ≥ 1.5 W/kg and the ratio of largest to smallest SAR for the original, first and second repeated measurements is > 1.20 .

Table 14.1: SAR Measurement Variability

Frequency Band	Channel Number	Frequency (MHz)	Test Position	Distance	Original SAR 1g (W/kg)	First Repeated SAR (W/kg)	The Ratio	Second Repeated SAR (W/kg)
WCDMA1900	9400	1880	Right Tilt	0mm	0.792	0.773	1.02	/
WCDMA1900	9262	1852.4	Right Tilt	0mm	0.729	0.712	1.02	/
WCDMA1900	9538	1907.6	Right Tilt	0mm	0.803	0.791	1.02	/
LTE Band7	21350	2560	Left Edge	17mm	0.818	0.799	1.02	/
LTE Band7	20850	2510	Left Edge	17mm	0.872	0.853	1.02	/
LTE Band7	21100	2535	Left Edge	17mm	0.886	0.876	1.01	/
n77 pc2	654267	3814.000	Left Cheek	0mm	0.831	0.818	1.02	/
n77 pc2	664666	3969.990	Left Cheek	0mm	0.732	0.722	1.01	/
n77 pc2	647334	3710.010	Left Cheek	0mm	0.712	0.697	1.02	/
n77 pc2	654267	3814.000	Left Tilt	0mm	1.030	1.014	1.02	/
n77 pc2	664666	3969.990	Left Tilt	0mm	0.943	0.930	1.01	/
n77 pc2	647334	3710.010	Left Tilt	0mm	0.912	0.899	1.01	/
n77 pc2	650800	3762.000	Top Edge	21mm	0.868	0.857	1.01	/
n77 pc2	664666	3969.990	Top Edge	21mm	0.801	0.784	1.02	/
n77 pc2	647334	3710.010	Top Edge	21mm	0.832	0.813	1.02	/

15 Measurement Uncertainty

Per KDB 865664 D01 SAR Measurement 100 MHz to 6 GHz, when the highest measured 1-g SAR within a frequency band is < 1.5 W/kg and the measured 10-g SAR within a frequency band is < 3.75 W/kg. The expanded SAR measurement uncertainty must be $\leq 30\%$, for a confidence interval of $k = 2$. If these conditions are met, extensive SAR measurement uncertainty analysis described in IEEE Std 1528-2013 is not required in SAR reports submitted for equipment approval.

Therefore, the measurement uncertainty is not required.

16 MAIN TEST INSTRUMENTS

No.	Name	Type	Serial Number	Calibration Date	Valid Period
01	Network analyzer	E5071C	MY46900484	September 1, 2021	One year
02	Power meter	NRP8S	109691	October 20, 2021	One year
03	Power sensor	NRX	102283		
04	Signal Generator	SMC100A	182249	January 15, 2022	One Year
05	Amplifier	60S1G4	0331848	No Calibration Requested	
06	BTS	CMW500	166370	June 25, 2021	One year
07	E-field Probe	SPEAG EX3DV4	7464	January 26,2022	One year
08	DAE	SPEAG DAE4	549	January 07, 2022	One year
09	Dipole Validation Kit	SPEAG D750V3	1017	July 12,,2021	One year
10	Dipole Validation Kit	SPEAG D835V2	4d069	July 12,,2021	One year
11	Dipole Validation Kit	SPEAG D1750V2	1003	July 12, 2021	One year
12	Dipole Validation Kit	SPEAG D1900V2	5d101	July 15,2021	One year
13	Dipole Validation Kit	SPEAG D2450V2	853	July 26,2021	One year
14	Dipole Validation Kit	SPEAG D3500V2	1016	June 21,2021	One year
15	Dipole Validation Kit	SPEAG D3700V2	1004	June 21,2021	One year
16	Dipole Validation Kit	SPEAG D2600V2	1012	July 26,2021	One year
17	Dipole Validation Kit	SPEAG D5GHzV2	1060	June 22,2021	One year

END OF REPORT BODY



Appendixes

Refer to separated files for the following appendixes

ANNEX A Graph Results

ANNEX B System Verification Results

ANNEX C SAR Measurement Setup

ANNEX D Position of the wireless device in relation to the phantom

ANNEX E Equivalent Media Recipes

ANNEX F System Validation

ANNEX G Probe Calibration Certificate

ANNEX H Dipole Calibration Certificate

ANNEX I Sensor Triggering Data Summary

ANNEX J Accreditation Certificate

ANNEX A Graph Results

GSM850_CH251 Right Cheek

Date: 5/7/2022

Electronics: DAE4 Sn549

Medium: head 835 MHz

Medium parameters used: $f = 848.8$ MHz; $\sigma = 0.916$ mho/m; $\epsilon_r = 40.82$; $\rho = 1000$ kg/m³

Ambient Temperature: 22.5°C, Liquid Temperature: 22.3°C

Communication System: GSM850 848.8 MHz Duty Cycle: 1:8.3

Probe: EX3DV4 – SN7464 ConvF(9.96,9.96,9.96)

Area Scan (71x121x1): Interpolated grid: dx=1.500 mm, dy=1.500 mm

Maximum value of SAR (interpolated) = 0.326 W/kg

Zoom Scan (7x7x7)/Cube 0: Measurement grid: dx=8mm, dy=8mm, dz=5mm

Reference Value = 5.077 V/m; Power Drift = -0.07 dB

Peak SAR (extrapolated) = 0.335 W/kg

SAR(1 g) = 0.266 W/kg; SAR(10 g) = 0.204 W/kg

Maximum value of SAR (measured) = 0.276 W/kg

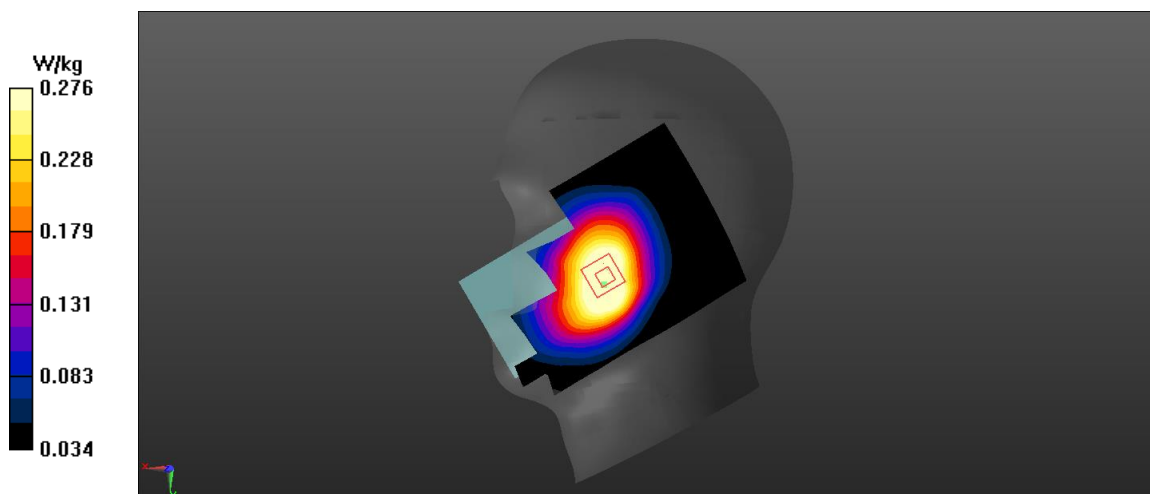

Fig A.1

GSM850_CH251 GPRS(2TX) Rear 10mm

Date: 5/7/2022

Electronics: DAE4 Sn549

Medium: head 835 MHz

Medium parameters used: $f = 848.8$ MHz; $\sigma = 0.899$ mho/m; $\epsilon_r = 41.98$; $\rho = 1000$ kg/m³

Ambient Temperature: 22.5°C, Liquid Temperature: 22.3°C

Communication System: GSM850 848.8 MHz Duty Cycle: 1:4

Probe: EX3DV4 – SN7464 ConvF(9.96,9.96,9.96)

Area Scan (71x121x1): Interpolated grid: dx=1.500 mm, dy=1.500 mm

Maximum value of SAR (interpolated) = 0.842 W/kg

Zoom Scan (7x7x7)/Cube 0: Measurement grid: dx=8mm, dy=8mm, dz=5mm

Reference Value = 18.08 V/m; Power Drift = 0.02 dB

Peak SAR (extrapolated) = 1.08 W/kg

SAR(1 g) = 0.586 W/kg; SAR(10 g) = 0.333 W/kg

Maximum value of SAR (measured) = 0.844 W/kg

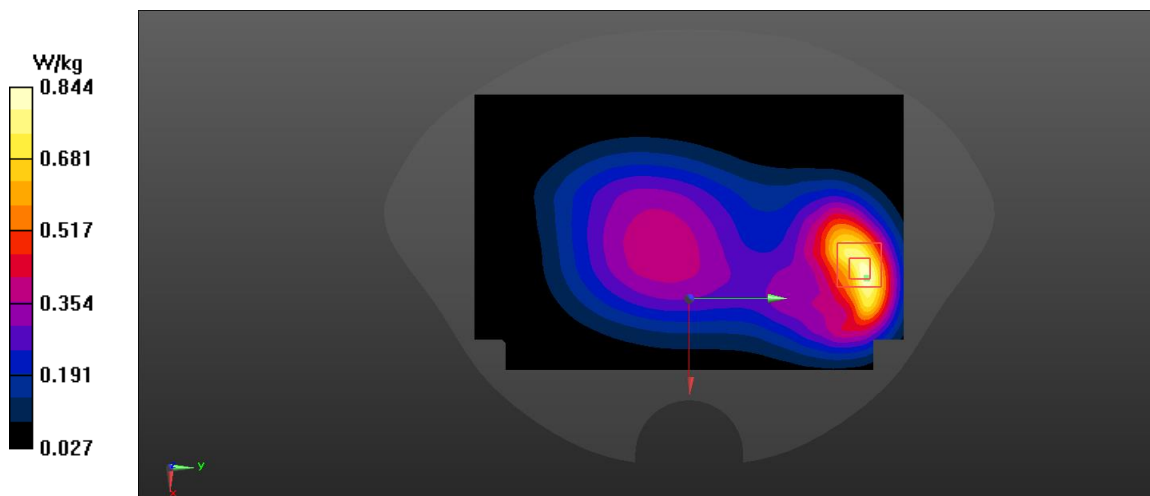
**Fig A.2**

PCS1900_CH810 Right Tilt

Date: 5/11/2022

Electronics: DAE4 Sn549

Medium: head 1900 MHz

Medium parameters used: $f = 1909.8$ MHz; $\sigma = 1.406$ mho/m; $\epsilon_r = 39.43$; $\rho = 1000$ kg/m³

Ambient Temperature: 22.5°C, Liquid Temperature: 22.3°C

Communication System: PCS1900 1909.8 MHz Duty Cycle: 1:8.3

Probe: EX3DV4 – SN7464 ConvF(8.18,8.18,8.18)

Area Scan (71x121x1): Interpolated grid: dx=1.500 mm, dy=1.500 mm

Maximum value of SAR (interpolated) = 0.54 W/kg

Zoom Scan (7x7x7)/Cube 0: Measurement grid: dx=8mm, dy=8mm, dz=5mm

Reference Value = 10.21 V/m; Power Drift = 0.01 dB

Peak SAR (extrapolated) = 0.582 W/kg

SAR(1 g) = 0.294 W/kg; SAR(10 g) = 0.15 W/kg

Maximum value of SAR (measured) = 0.320 W/kg

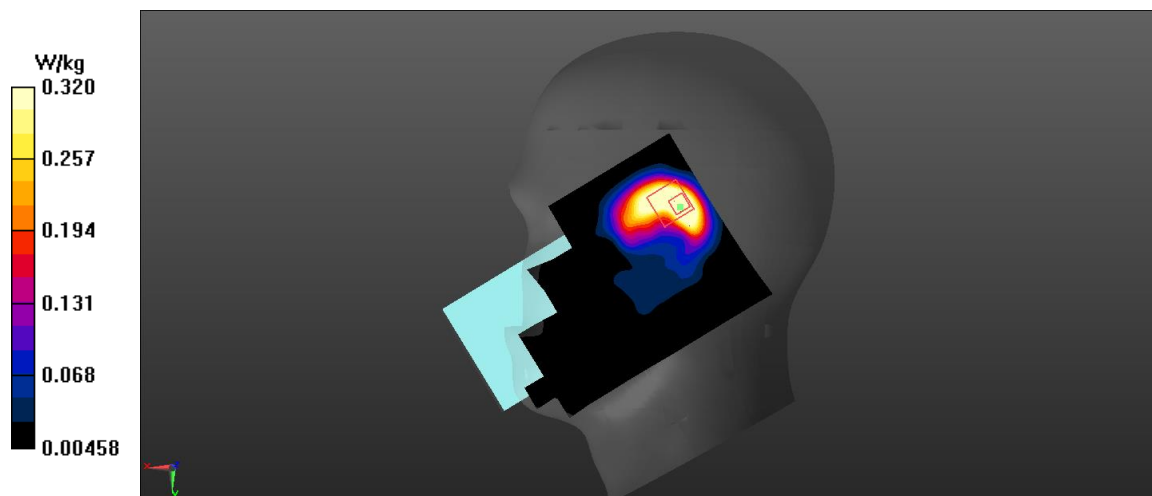

Fig A.3

PCS1900_CH810 GPRS(2TX) Front 17mm

Date: 5/11/2022

Electronics: DAE4 Sn549

Medium: head 1900 MHz

Medium parameters used: $f = 1909.8$ MHz; $\sigma = 1.402$ mho/m; $\epsilon_r = 40.32$; $\rho = 1000$ kg/m³

Ambient Temperature: 22.5°C, Liquid Temperature: 22.3°C

Communication System: PCS1900 1909.8 MHz Duty Cycle: 1:4

Probe: EX3DV4 – SN7464 ConvF(8.18,8.18,8.18)

Area Scan (71x121x1): Interpolated grid: dx=1.500 mm, dy=1.500 mm

Maximum value of SAR (interpolated) = 0.411 W/kg

Zoom Scan (7x7x7)/Cube 0: Measurement grid: dx=8mm, dy=8mm, dz=5mm

Reference Value = 10.61 V/m; Power Drift = -0.08 dB

Peak SAR (extrapolated) = 0.59 W/kg

SAR(1 g) = 0.32 W/kg; SAR(10 g) = 0.188 W/kg

Maximum value of SAR (measured) = 0.515 W/kg

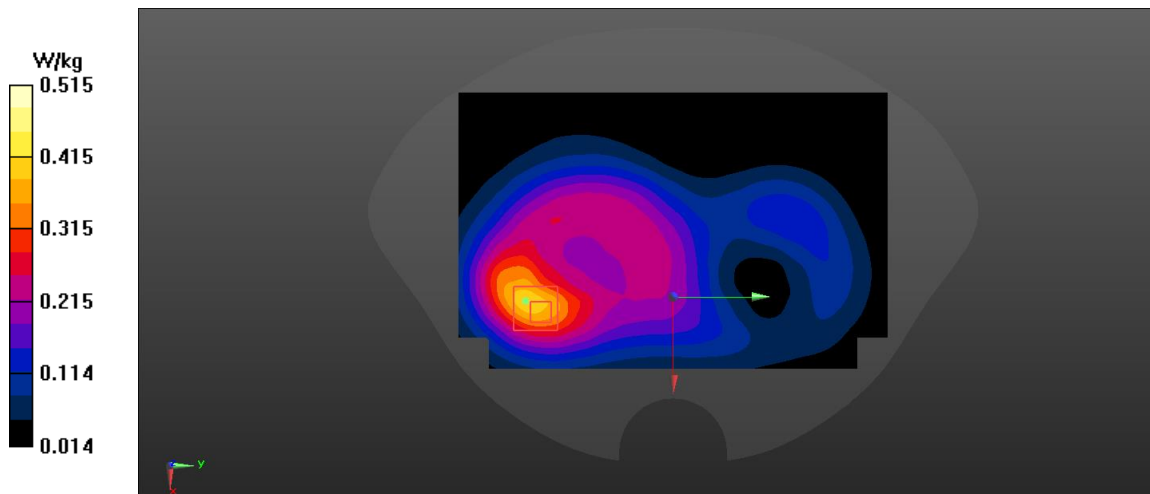

Fig A.4

WCDMA1900-BII_CH9538 RMC Right Tilt

Date: 5/11/2022

Electronics: DAE4 Sn549

Medium: head 1900 MHz

Medium parameters used: $f = 1907.6$ MHz; $\sigma = 1.405$ mho/m; $\epsilon_r = 39.43$; $\rho = 1000$ kg/m³

Ambient Temperature: 22.5°C, Liquid Temperature: 22.3°C

Communication System: WCDMA1900-BII 1907.6 MHz Duty Cycle: 1:1

Probe: EX3DV4 – SN7464 ConvF(8.18,8.18,8.18)

Area Scan (71x121x1): Interpolated grid: dx=1.500 mm, dy=1.500 mm

Maximum value of SAR (interpolated) = 1.46 W/kg

Zoom Scan (7x7x7)/Cube 0: Measurement grid: dx=8mm, dy=8mm, dz=5mm

Reference Value = 17.44 V/m; Power Drift = -0.02 dB

Peak SAR (extrapolated) = 1.62 W/kg

SAR(1 g) = 0.803 W/kg; SAR(10 g) = 0.381 W/kg

Maximum value of SAR (measured) = 0.888 W/kg

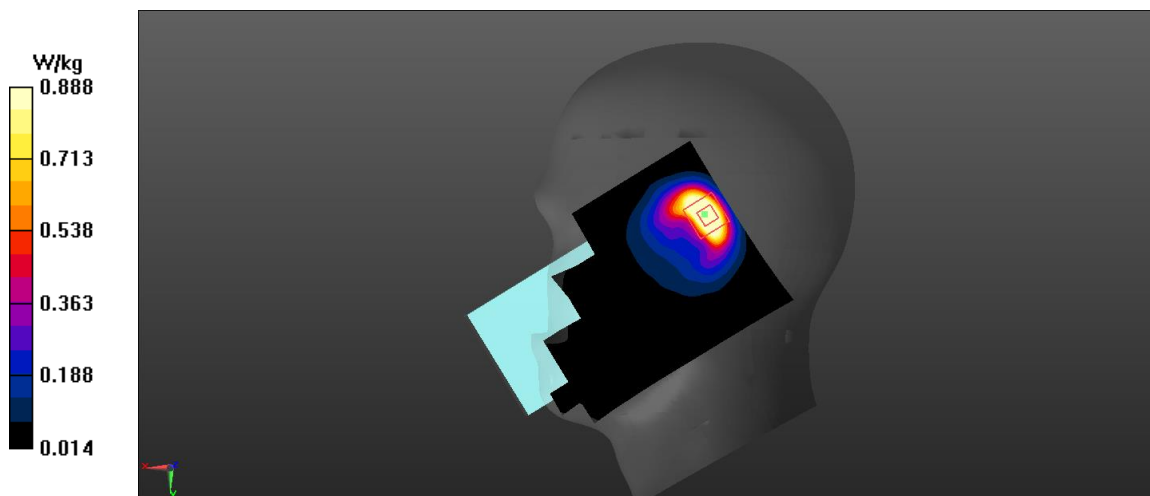
**Fig A.5**

WCDMA1900-BII_CH9400 RMC Front 17mm

Date: 5/11/2022

Electronics: DAE4 Sn549

Medium: head 1900 MHz

Medium parameters used: $f = 1880$ MHz; $\sigma = 1.373$ mho/m; $\epsilon_r = 40.35$; $\rho = 1000$ kg/m³

Ambient Temperature: 22.5°C, Liquid Temperature: 22.3°C

Communication System: WCDMA1900-BII 1880 MHz Duty Cycle: 1:1

Probe: EX3DV4 – SN7464 ConvF(8.18,8.18,8.18)

Area Scan (71x121x1): Interpolated grid: dx=1.500 mm, dy=1.500 mm

Maximum value of SAR (interpolated) = 0.705 W/kg

Zoom Scan (7x7x7)/Cube 0: Measurement grid: dx=8mm, dy=8mm, dz=5mm

Reference Value = 14.98 V/m; Power Drift = -0.03 dB

Peak SAR (extrapolated) = 0.804 W/kg

SAR(1 g) = 0.487 W/kg; SAR(10 g) = 0.298 W/kg

Maximum value of SAR (measured) = 0.687 W/kg

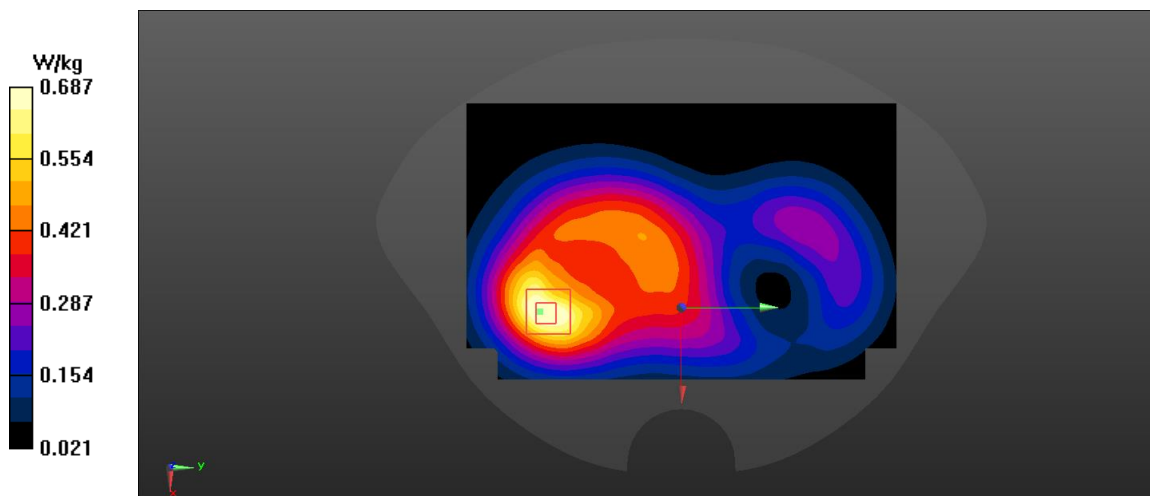

Fig A.6

WCDMA1700-BIV_CH1513 RMC Right Cheek

Date: 5/9/2022

Electronics: DAE4 Sn549

Medium: head 1750 MHz

Medium parameters used: $f = 1752.6$ MHz; $\sigma = 1.383$ mho/m; $\epsilon_r = 40.1$; $\rho = 1000$ kg/m³

Ambient Temperature: 22.5°C, Liquid Temperature: 22.3°C

Communication System: WCDMA1700-BIV 1752.6 MHz Duty Cycle: 1:1

Probe: EX3DV4 – SN7464 ConvF(8.52,8.52,8.52)

Area Scan (71x121x1): Interpolated grid: dx=1.500 mm, dy=1.500 mm

Maximum value of SAR (interpolated) = 0.933 W/kg

Zoom Scan (7x7x7)/Cube 0: Measurement grid: dx=8mm, dy=8mm, dz=5mm

Reference Value = 12.91 V/m; Power Drift = -0.18 dB

Peak SAR (extrapolated) = 1.07 W/kg

SAR(1 g) = 0.572 W/kg; SAR(10 g) = 0.308 W/kg

Maximum value of SAR (measured) = 0.608 W/kg

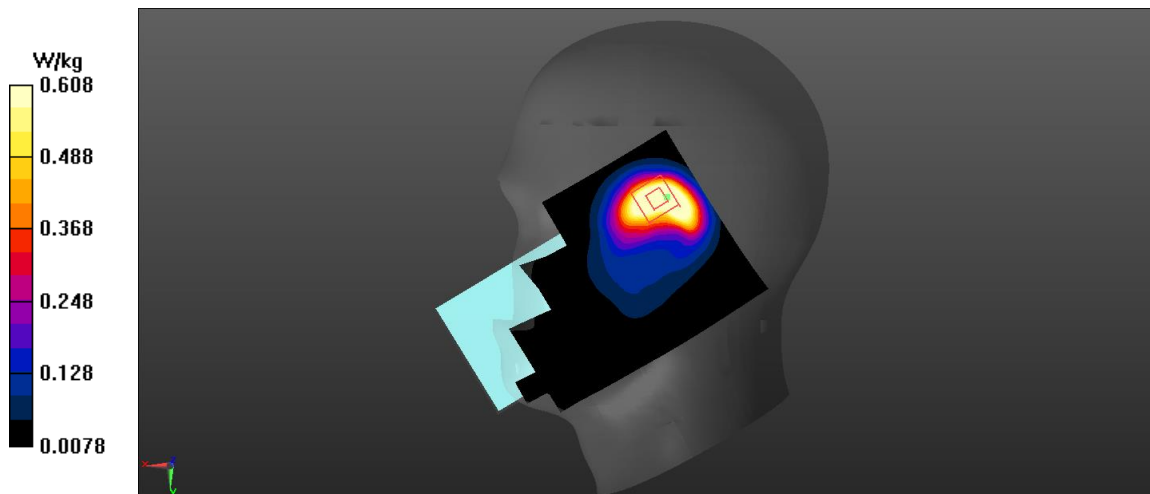
**Fig A.7**

WCDMA1700-BIV_CH1412 RMC Front 17mm

Date: 5/9/2022

Electronics: DAE4 Sn549

Medium: head 1750 MHz

Medium parameters used: $f = 1732.5$ MHz; $\sigma = 1.353$ mho/m; $\epsilon_r = 40.04$; $\rho = 1000$ kg/m³

Ambient Temperature: 22.5°C, Liquid Temperature: 22.3°C

Communication System: WCDMA1700-BIV 1732.5 MHz Duty Cycle: 1:1

Probe: EX3DV4 – SN7464 ConvF(8.52,8.52,8.52)

Area Scan (71x121x1): Interpolated grid: dx=1.500 mm, dy=1.500 mm

Maximum value of SAR (interpolated) = 0.457 W/kg

Zoom Scan (7x7x7)/Cube 0: Measurement grid: dx=8mm, dy=8mm, dz=5mm

Reference Value = 11.6 V/m; Power Drift = -0.17 dB

Peak SAR (extrapolated) = 0.502 W/kg

SAR(1 g) = 0.311 W/kg; SAR(10 g) = 0.199 W/kg

Maximum value of SAR (measured) = 0.433 W/kg

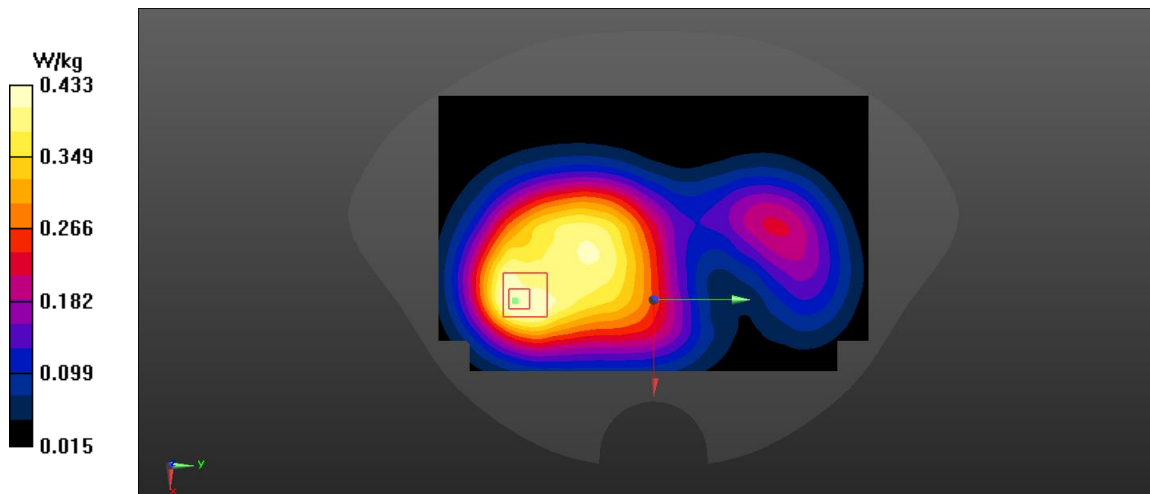

Fig A.8

WCDMA850-BV_CH4233 RMC Right Cheek

Date: 5/7/2022

Electronics: DAE4 Sn549

Medium: head 835 MHz

Medium parameters used: $f = 846.6$ MHz; $\sigma = 0.914$ mho/m; $\epsilon_r = 40.83$; $\rho = 1000$ kg/m³

Ambient Temperature: 22.5°C, Liquid Temperature: 22.3°C

Communication System: WCDMA850-BV 846.6 MHz Duty Cycle: 1:1

Probe: EX3DV4 – SN7464 ConvF(9.96,9.96,9.96)

Area Scan (71x121x1): Interpolated grid: dx=1.500 mm, dy=1.500 mm

Maximum value of SAR (interpolated) = 0.469 W/kg

Zoom Scan (7x7x7)/Cube 0: Measurement grid: dx=8mm, dy=8mm, dz=5mm

Reference Value = 3.17 V/m; Power Drift = 0.08 dB

Peak SAR (extrapolated) = 0.482 W/kg

SAR(1 g) = 0.384 W/kg; SAR(10 g) = 0.294 W/kg

Maximum value of SAR (measured) = 0.400 W/kg

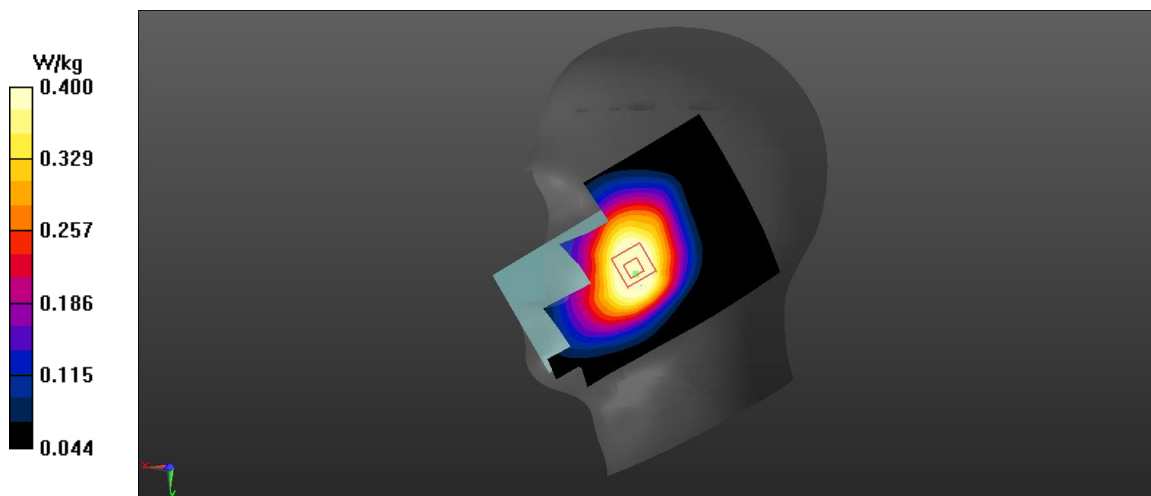
**Fig A.9**

WCDMA850-BV_CH4233 RMC Rear 10mm

Date: 5/7/2022

Electronics: DAE4 Sn549

Medium: head 835 MHz

Medium parameters used: $f = 846.6$ MHz; $\sigma = 0.897$ mho/m; $\epsilon_r = 41.99$; $\rho = 1000$ kg/m³

Ambient Temperature: 22.5°C, Liquid Temperature: 22.3°C

Communication System: WCDMA850-BV 846.6 MHz Duty Cycle: 1:1

Probe: EX3DV4 – SN7464 ConvF(9.96,9.96,9.96)

Area Scan (71x121x1): Interpolated grid: dx=1.500 mm, dy=1.500 mm

Maximum value of SAR (interpolated) = 0.8 W/kg

Zoom Scan (7x7x7)/Cube 0: Measurement grid: dx=8mm, dy=8mm, dz=5mm

Reference Value = 18.75 V/m; Power Drift = -0.03 dB

Peak SAR (extrapolated) = 1.05 W/kg

SAR(1 g) = 0.563 W/kg; SAR(10 g) = 0.317 W/kg

Maximum value of SAR (measured) = 0.829 W/kg

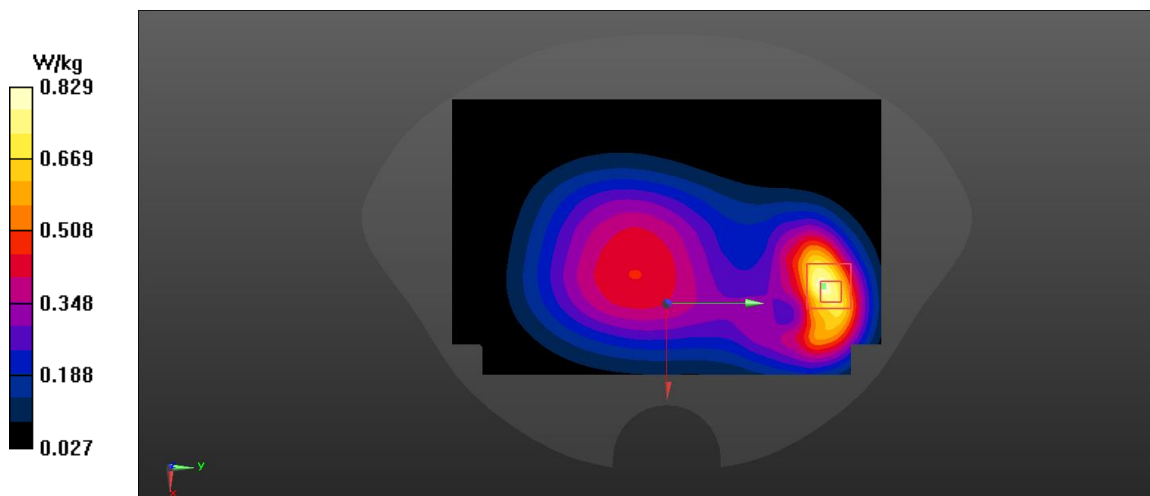

Fig A.10

LTE2500-FDD7_CH21350 1RB-High Right Cheek

Date: 5/13/2022

Electronics: DAE4 Sn549

Medium: head 2600 MHz

Medium parameters used: $f = 2560$ MHz; $\sigma = 1.933$ mho/m; $\epsilon_r = 39.78$; $\rho = 1000$ kg/m³

Ambient Temperature: 22.5°C, Liquid Temperature: 22.3°C

Communication System: LTE2500-FDD7 2560 MHz Duty Cycle: 1:1

Probe: EX3DV4 – SN7464 ConvF(7.64,7.64,7.64)

Area Scan (71x121x1): Interpolated grid: dx=1.200 mm, dy=1.200 mm

Maximum value of SAR (interpolated) = 1.43 W/kg

Zoom Scan (7x7x7)/Cube 0: Measurement grid: dx=5mm, dy=5mm, dz=5mm

Reference Value = 13.55 V/m; Power Drift = 0.08 dB

Peak SAR (extrapolated) = 1.68 W/kg

SAR(1 g) = 0.514 W/kg; SAR(10 g) = 0.22 W/kg

Maximum value of SAR (measured) = 0.576 W/kg

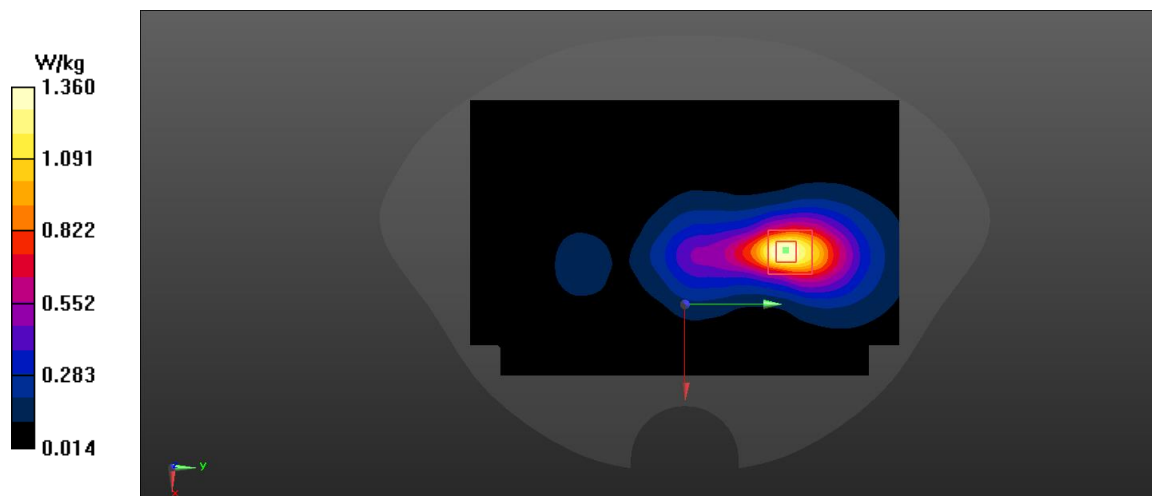

Fig A.11

LTE2500-FDD7_CH21100 1RB-Middle Left Edge 17mm

Date: 5/13/2022

Electronics: DAE4 Sn549

Medium: head 2600 MHz

Medium parameters used: $f = 2535$ MHz; $\sigma = 1.891$ mho/m; $\epsilon_r = 38.49$; $\rho = 1000$ kg/m³

Ambient Temperature: 22.5°C, Liquid Temperature: 22.3°C

Communication System: LTE2500-FDD7 2535 MHz Duty Cycle: 1:1

Probe: EX3DV4 – SN7464 ConvF(7.64,7.64,7.64)

Area Scan (71x121x1): Interpolated grid: dx=1.200 mm, dy=1.200 mm

Maximum value of SAR (interpolated) = 1.43 W/kg

Zoom Scan (7x7x7)/Cube 0: Measurement grid: dx=5mm, dy=5mm, dz=5mm

Reference Value = 13.55 V/m; Power Drift = -0.07 dB

Peak SAR (extrapolated) = 1.68 W/kg

SAR(1 g) = 0.886 W/kg; SAR(10 g) = 0.458 W/kg

Maximum value of SAR (measured) = 1.36 W/kg

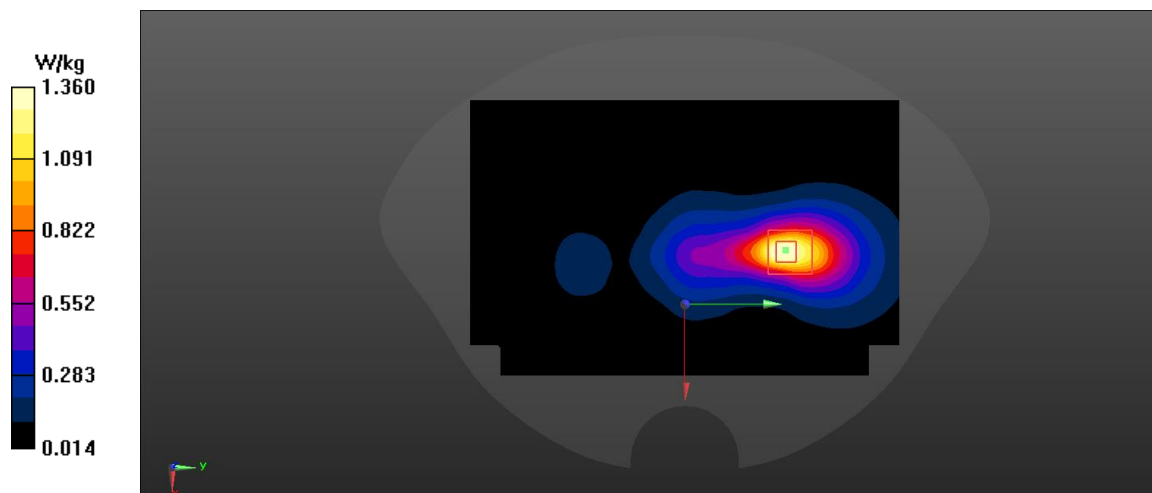

Fig A.12

LTE700-FDD12_CH23130 1RB-Low Left Cheek

Date: 5/5/2022

Electronics: DAE4 Sn549

Medium: head 750 MHz

Medium parameters used: $f = 711$ MHz; $\sigma = 0.86$ mho/m; $\epsilon_r = 42.12$; $\rho = 1000$ kg/m³

Ambient Temperature: 22.5°C, Liquid Temperature: 22.3°C

Communication System: LTE700-FDD12 711 MHz Duty Cycle: 1:1

Probe: EX3DV4 – SN7464 ConvF(10.26,10.26,10.26)

Area Scan (71x121x1): Interpolated grid: dx=1.500 mm, dy=1.500 mm

Maximum value of SAR (interpolated) = 0.104 W/kg

Zoom Scan (7x7x7)/Cube 0: Measurement grid: dx=8mm, dy=8mm, dz=5mm

Reference Value = 2.608 V/m; Power Drift = -0.04 dB

Peak SAR (extrapolated) = 0.115 W/kg

SAR(1 g) = 0.087 W/kg; SAR(10 g) = 0.067 W/kg

Maximum value of SAR (measured) = 0.106 W/kg

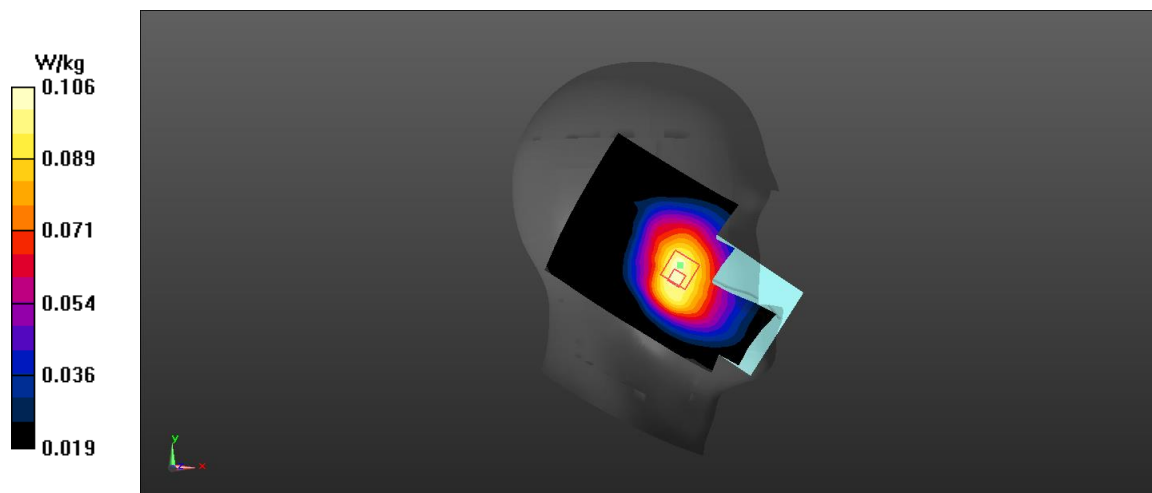

Fig A.13

LTE700-FDD12_CH23130 1RB-Low Right Edge 10mm

Date: 5/5/2022

Electronics: DAE4 Sn549

Medium: head 750 MHz

Medium parameters used: $f = 711$ MHz; $\sigma = 0.854$ mho/m; $\epsilon_r = 41.64$; $\rho = 1000$ kg/m³

Ambient Temperature: 22.5°C, Liquid Temperature: 22.3°C

Communication System: LTE700-FDD12 711 MHz Duty Cycle: 1:1

Probe: EX3DV4 – SN7464 ConvF(10.26,10.26,10.26)

Area Scan (71x121x1): Interpolated grid: dx=1.500 mm, dy=1.500 mm

Maximum value of SAR (interpolated) = 0.243 W/kg

Zoom Scan (7x7x7)/Cube 0: Measurement grid: dx=8mm, dy=8mm, dz=5mm

Reference Value = 14.56 V/m; Power Drift = 0.1 dB

Peak SAR (extrapolated) = 0.276 W/kg

SAR(1 g) = 0.452 W/kg; SAR(10 g) = 0.317 W/kg

Maximum value of SAR (measured) = 0.245 W/kg

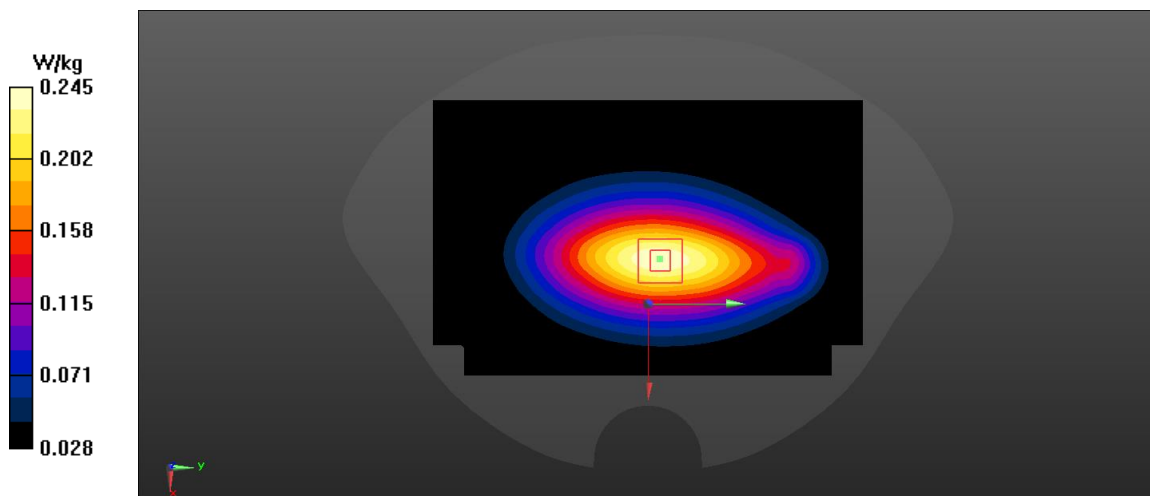
**Fig A.14**

LTE750-FDD13_CH23230 1RB-Middle Left Cheek

Date: 5/5/2022

Electronics: DAE4 Sn549

Medium: head 750 MHz

Medium parameters used: $f = 782$ MHz; $\sigma = 0.927$ mho/m; $\epsilon_r = 42.03$; $\rho = 1000$ kg/m³

Ambient Temperature: 22.5°C, Liquid Temperature: 22.3°C

Communication System: LTE750-FDD13 782 MHz Duty Cycle: 1:1

Probe: EX3DV4 – SN7464 ConvF(10.26,10.26,10.26)

Area Scan (71x121x1): Interpolated grid: dx=1.500 mm, dy=1.500 mm

Maximum value of SAR (interpolated) = 0.129 W/kg

Zoom Scan (7x7x7)/Cube 0: Measurement grid: dx=8mm, dy=8mm, dz=5mm

Reference Value = 2.725 V/m; Power Drift = 0.13 dB

Peak SAR (extrapolated) = 0.142 W/kg

SAR(1 g) = 0.109 W/kg; SAR(10 g) = 0.083 W/kg

Maximum value of SAR (measured) = 0.131 W/kg

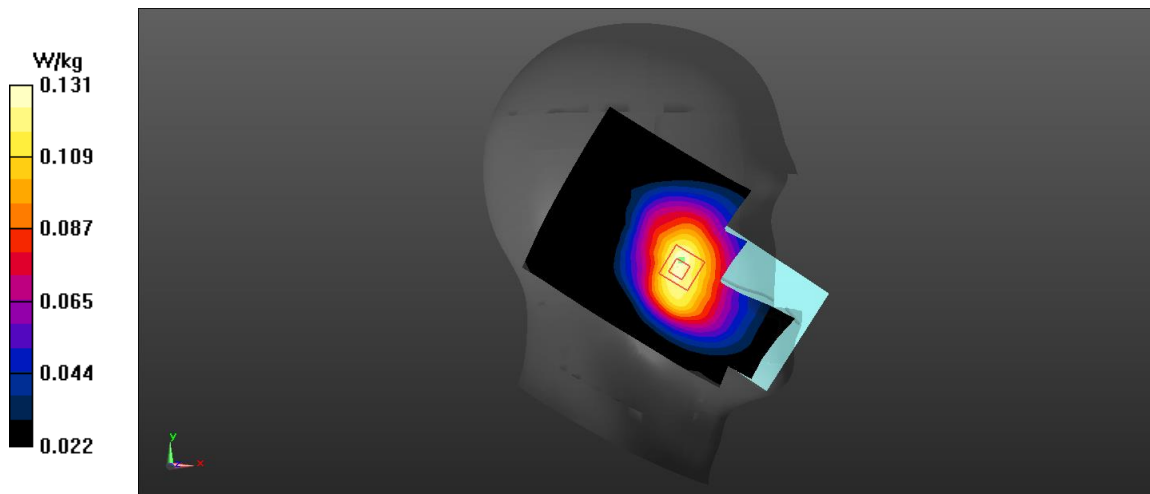

Fig A.15

LTE750-FDD13_CH23230 1RB-Middle Right Edge 10mm

Date: 5/5/2022

Electronics: DAE4 Sn549

Medium: head 750 MHz

Medium parameters used: $f = 782 \text{ MHz}$; $\sigma = 0.921 \text{ mho/m}$; $\epsilon_r = 41.55$; $\rho = 1000 \text{ kg/m}^3$

Ambient Temperature: 22.5°C, Liquid Temperature: 22.3°C

Communication System: LTE750-FDD13 782 MHz Duty Cycle: 1:1

Probe: EX3DV4 – SN7464 ConvF(10.26,10.26,10.26)

Area Scan (71x121x1): Interpolated grid: $dx=1.500 \text{ mm}$, $dy=1.500 \text{ mm}$

Maximum value of SAR (interpolated) = 0.502 W/kg

Zoom Scan (7x7x7)/Cube 0: Measurement grid: $dx=8\text{mm}$, $dy=8\text{mm}$, $dz=5\text{mm}$

Reference Value = 20.7 V/m; Power Drift = -0.17 dB

Peak SAR (extrapolated) = 0.564 W/kg

SAR(1 g) = 0.391 W/kg; SAR(10 g) = 0.273 W/kg

Maximum value of SAR (measured) = 0.502 W/kg

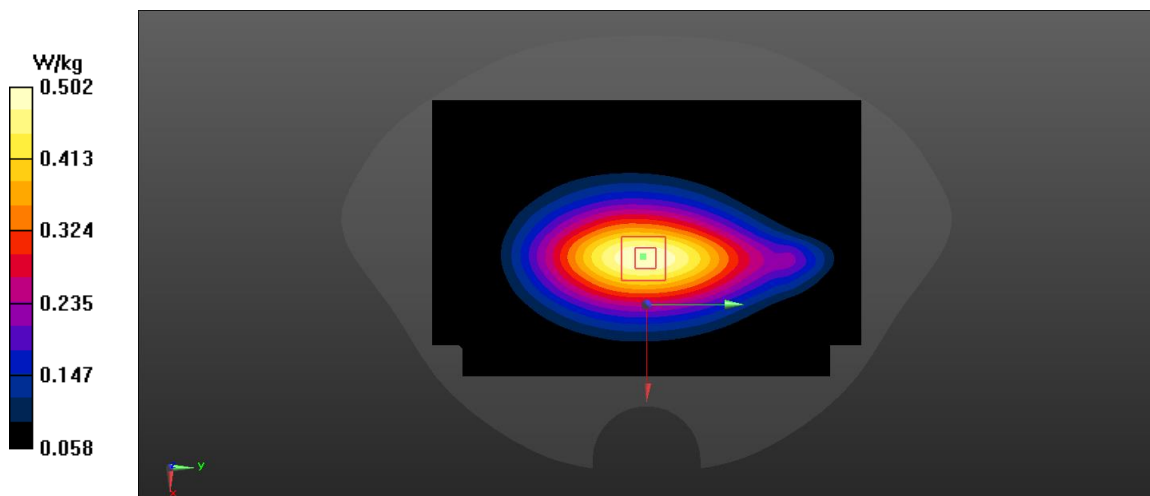

Fig A.16

LTE1900-FDD25_CH26590 1RB-Low Right Tilt

Date: 5/12/2022

Electronics: DAE4 Sn549

Medium: head 1900 MHz

Medium parameters used: $f = 1905$ MHz; $\sigma = 1.402$ mho/m; $\epsilon_r = 39.43$; $\rho = 1000$ kg/m³

Ambient Temperature: 22.5°C, Liquid Temperature: 22.3°C

Communication System: LTE1900-FDD25 1905 MHz Duty Cycle: 1:1

Probe: EX3DV4 – SN7464 ConvF(8.18,8.18,8.18)

Area Scan (71x121x1): Interpolated grid: dx=1.500 mm, dy=1.500 mm

Maximum value of SAR (interpolated) = 1.33 W/kg

Zoom Scan (7x7x7)/Cube 0: Measurement grid: dx=8mm, dy=8mm, dz=5mm

Reference Value = 17.42 V/m; Power Drift = -0.2 dB

Peak SAR (extrapolated) = 1.45 W/kg

SAR(1 g) = 0.685 W/kg; SAR(10 g) = 0.349 W/kg

Maximum value of SAR (measured) = 0.807 W/kg

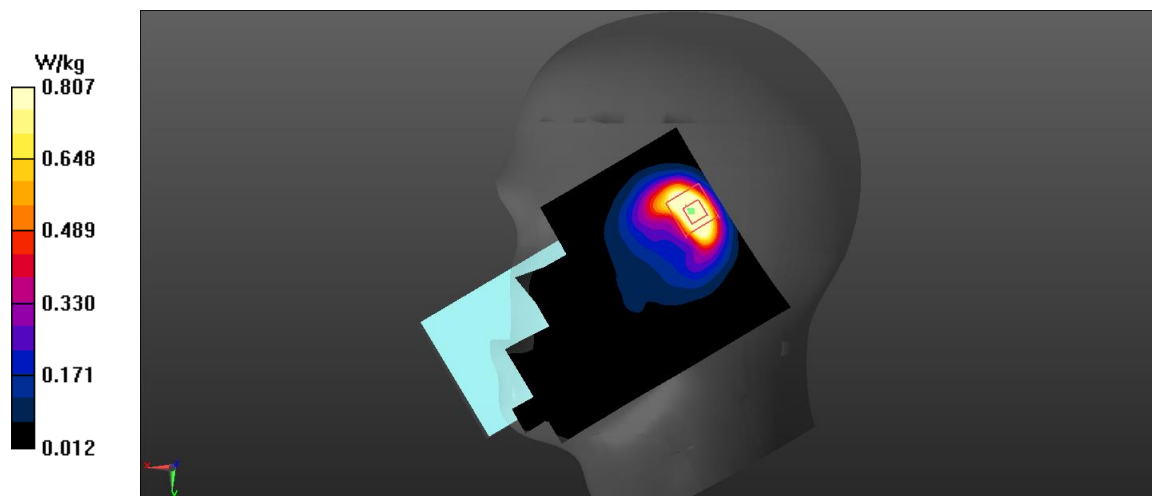

Fig A.17

LTE1900-FDD25_CH26590 1RB-Middle Front 17mm

Date: 5/12/2022

Electronics: DAE4 Sn549

Medium: head 1900 MHz

Medium parameters used: $f = 1905 \text{ MHz}$; $\sigma = 1.397 \text{ mho/m}$; $\epsilon_r = 40.32$; $\rho = 1000 \text{ kg/m}^3$

Ambient Temperature: 22.5°C , Liquid Temperature: 22.3°C

Communication System: LTE1900-FDD25 1905 MHz Duty Cycle: 1:1

Probe: EX3DV4 – SN7464 ConvF(8.18,8.18,8.18)

Area Scan (71x121x1): Interpolated grid: $dx=1.500 \text{ mm}$, $dy=1.500 \text{ mm}$

Maximum value of SAR (interpolated) = 0.669 W/kg

Zoom Scan (7x7x7)/Cube 0: Measurement grid: $dx=8\text{mm}$, $dy=8\text{mm}$, $dz=5\text{mm}$

Reference Value = 13.91 V/m ; Power Drift = -0.19 dB

Peak SAR (extrapolated) = 0.764 W/kg

SAR(1 g) = 0.462 W/kg ; SAR(10 g) = 0.282 W/kg

Maximum value of SAR (measured) = 0.656 W/kg

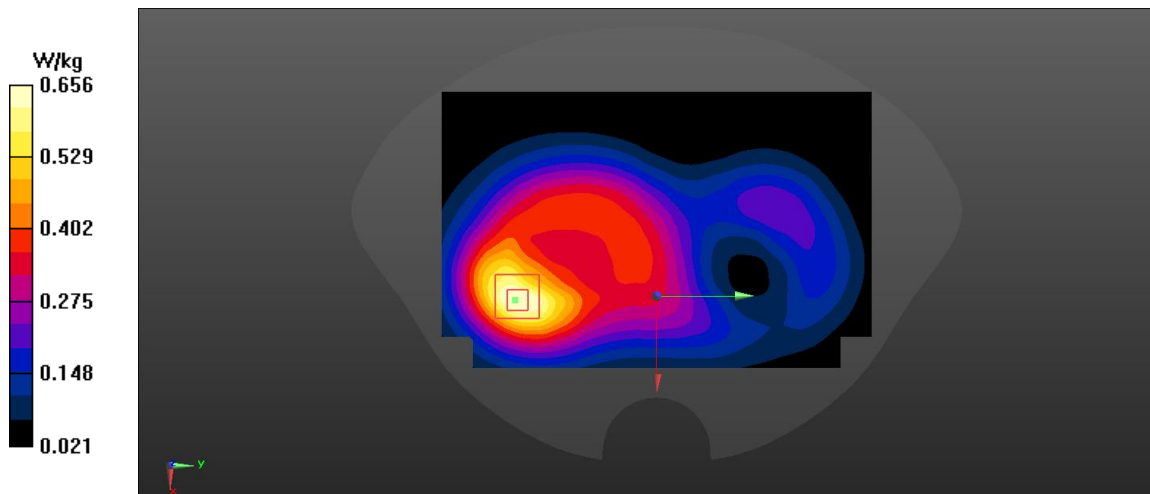

Fig A.18

LTE850-FDD26_CH26775 1RB-Low Right Cheek

Date: 5/8/2022

Electronics: DAE4 Sn549

Medium: head 835 MHz

Medium parameters used: $f = 822.5$ MHz; $\sigma = 0.891$ mho/m; $\epsilon_r = 40.86$; $\rho = 1000$ kg/m³

Ambient Temperature: 22.5°C, Liquid Temperature: 22.3°C

Communication System: LTE850-FDD26 822.5 MHz Duty Cycle: 1:1

Probe: EX3DV4 – SN7464 ConvF(9.96,9.96,9.96)

Area Scan (71x121x1): Interpolated grid: dx=1.500 mm, dy=1.500 mm

Maximum value of SAR (interpolated) = 0.134 W/kg

Zoom Scan (7x7x7)/Cube 0: Measurement grid: dx=8mm, dy=8mm, dz=5mm

Reference Value = 2.393 V/m; Power Drift = -0.12 dB

Peak SAR (extrapolated) = 0.138 W/kg

SAR(1 g) = 0.111 W/kg; SAR(10 g) = 0.085 W/kg

Maximum value of SAR (measured) = 0.115 W/kg

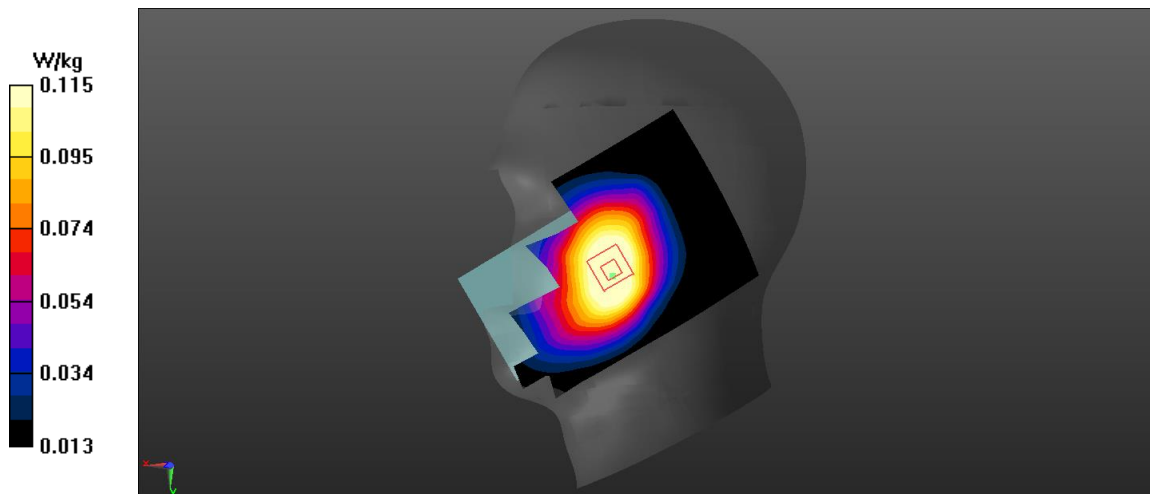
**Fig A.19**

LTE850-FDD26_CH26965 1RB-Low Right Edge 10mm

Date: 5/8/2022

Electronics: DAE4 Sn549

Medium: head 835 MHz

Medium parameters used: $f = 841.5$ MHz; $\sigma = 0.893$ mho/m; $\epsilon_r = 41.99$; $\rho = 1000$ kg/m³

Ambient Temperature: 22.5°C, Liquid Temperature: 22.3°C

Communication System: LTE850-FDD26 841.5 MHz Duty Cycle: 1:1

Probe: EX3DV4 – SN7464 ConvF(9.96,9.96,9.96)

Area Scan (71x121x1): Interpolated grid: dx=1.500 mm, dy=1.500 mm

Maximum value of SAR (interpolated) = 0.312 W/kg

Zoom Scan (7x7x7)/Cube 0: Measurement grid: dx=8mm, dy=8mm, dz=5mm

Reference Value = 15.88 V/m; Power Drift = -0.16 dB

Peak SAR (extrapolated) = 0.352 W/kg

SAR(1 g) = 0.24 W/kg; SAR(10 g) = 0.166 W/kg

Maximum value of SAR (measured) = 0.312 W/kg

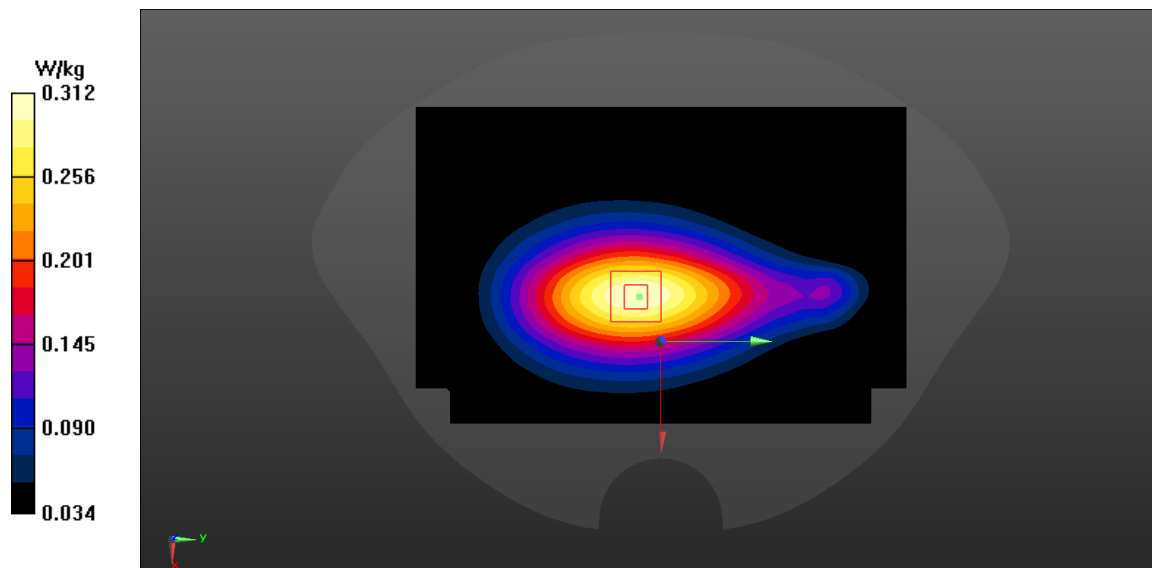

Fig A.20

LTE2600-TDD41 PC3_CH41055 1RB-Low Right Cheek

Date: 5/14/2022

Electronics: DAE4 Sn549

Medium: head 2600 MHz

Medium parameters used: $f = 2636.5$ MHz; $\sigma = 0.301$ mho/m; $\epsilon_r = 41.84$; $\rho = 1000$ kg/m³

Ambient Temperature: 22.5°C, Liquid Temperature: 22.3°C

Communication System: LTE2600-TDD41 2636.5 MHz Duty Cycle: 1:1.58

Probe: EX3DV4 – SN7464 ConvF(7.64,7.64,7.64)

Area Scan (71x121x1): Interpolated grid: dx=1.200 mm, dy=1.200 mm

Maximum value of SAR (interpolated) = 0.736 W/kg

Zoom Scan (7x7x7)/Cube 0: Measurement grid: dx=5mm, dy=5mm, dz=5mm

Reference Value = 1.675 V/m; Power Drift = 0.17 dB

Peak SAR (extrapolated) = 0.921 W/kg

SAR(1 g) = 0.369 W/kg; SAR(10 g) = 0.151 W/kg

Maximum value of SAR (measured) = 0.404 W/kg

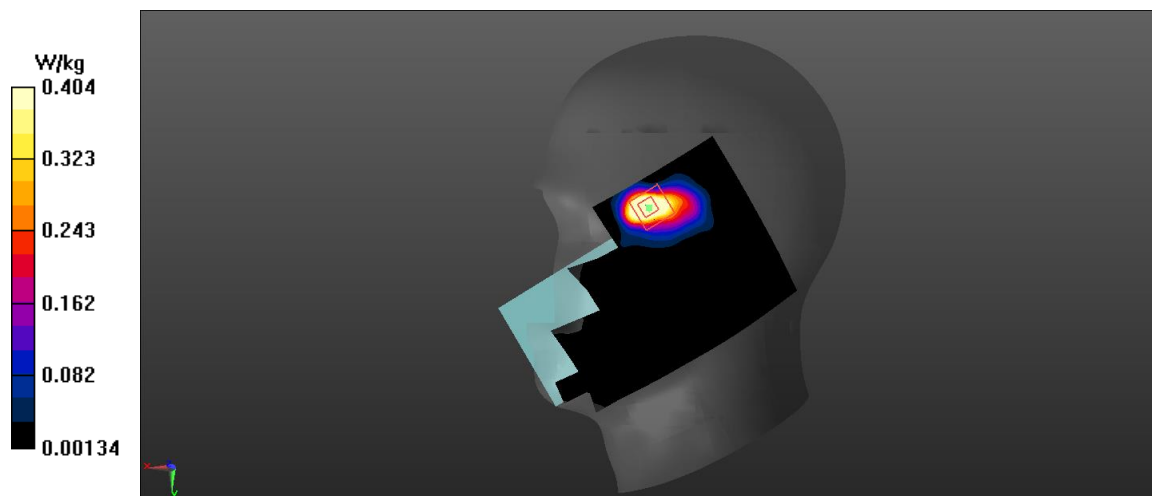

Fig A.21

LTE2600-TDD41 PC3_CH40185 1RB-Middle Left Edge 17mm

Date: 5/14/2022

Electronics: DAE4 Sn549

Medium: head 2600 MHz

Medium parameters used: $f = 2549.5$ MHz; $\sigma = 0.283$ mho/m; $\epsilon_r = 40.52$; $\rho = 1000$ kg/m³

Ambient Temperature: 22.5°C, Liquid Temperature: 22.3°C

Communication System: LTE2600-TDD41 2549.5 MHz Duty Cycle: 1:1.58

Probe: EX3DV4 – SN7464 ConvF(7.64,7.64,7.64)

Area Scan (71x121x1): Interpolated grid: dx=1.200 mm, dy=1.200 mm

Maximum value of SAR (interpolated) = 0.765 W/kg

Zoom Scan (7x7x7)/Cube 0: Measurement grid: dx=5mm, dy=5mm, dz=5mm

Reference Value = 9.299 V/m; Power Drift = -0.03 dB

Peak SAR (extrapolated) = 0.916 W/kg

SAR(1 g) = 0.484 W/kg; SAR(10 g) = 0.253 W/kg

Maximum value of SAR (measured) = 0.734 W/kg

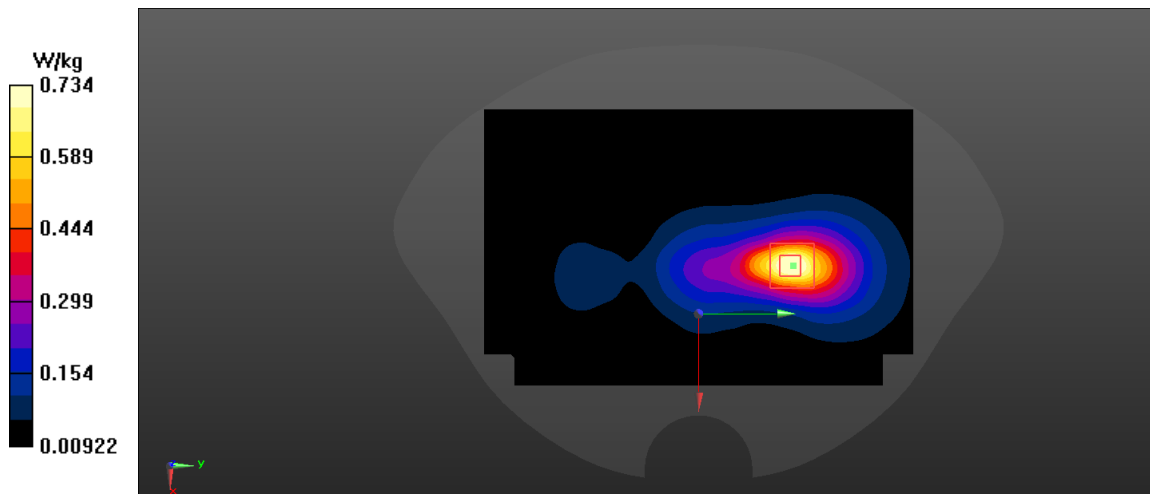

Fig A.22

LTE2600-TDD41 PC2_CH41055 50RB-Middle Right Cheek

Date: 5/14/2022

Electronics: DAE4 Sn549

Medium: head 2600 MHz

Medium parameters used: $f = 2636.5$ MHz; $\sigma = 0.301$ mho/m; $\epsilon_r = 41.84$; $\rho = 1000$ kg/m³

Ambient Temperature: 22.5°C, Liquid Temperature: 22.3°C

Communication System: LTE2600-TDD41 2636.5 MHz Duty Cycle: 1:2.309

Probe: EX3DV4 – SN7464 ConvF(7.64,7.64,7.64)

Area Scan (71x121x1): Interpolated grid: dx=1.200 mm, dy=1.200 mm

Maximum value of SAR (interpolated) = 0.559 W/kg

Zoom Scan (7x7x7)/Cube 0: Measurement grid: dx=5mm, dy=5mm, dz=5mm

Reference Value = 1.566 V/m; Power Drift = -0.01 dB

Peak SAR (extrapolated) = 0.702 W/kg

SAR(1 g) = 0.283 W/kg; SAR(10 g) = 0.116 W/kg

Maximum value of SAR (measured) = 0.310 W/kg

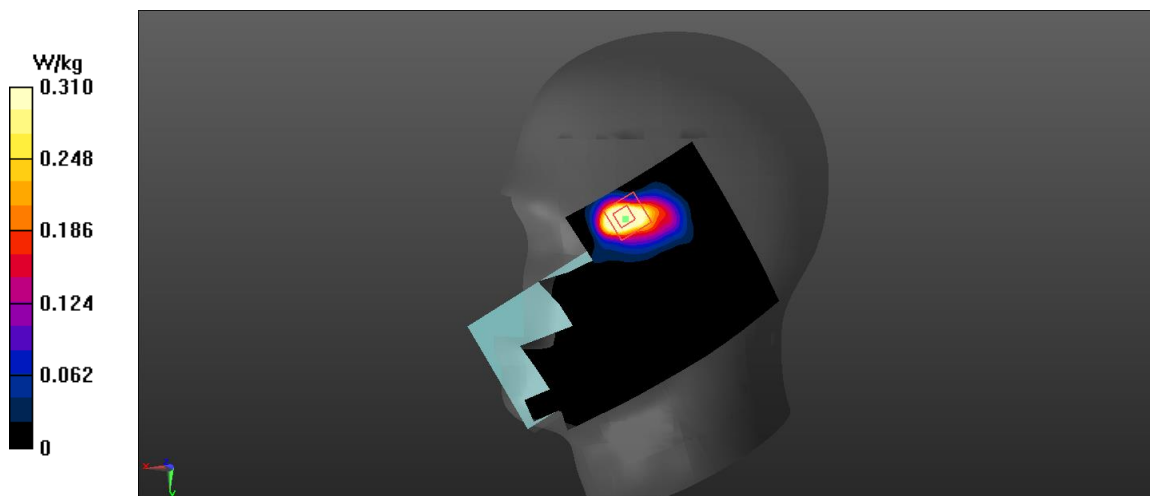

Fig A.23

LTE2600-TDD41 PC2_CH41055 50RB-Low Left Edge 17mm

Date: 5/14/2022

Electronics: DAE4 Sn549

Medium: head 2600 MHz

Medium parameters used: $f = 2636.5$ MHz; $\sigma = 0.283$ mho/m; $\epsilon_r = 40.52$; $\rho = 1000$ kg/m³

Ambient Temperature: 22.5°C, Liquid Temperature: 22.3°C

Communication System: LTE2600-TDD41 2636.5 MHz Duty Cycle: 1:2.309

Probe: EX3DV4 – SN7464 ConvF(7.64,7.64,7.64)

Area Scan (71x121x1): Interpolated grid: dx=1.200 mm, dy=1.200 mm

Maximum value of SAR (interpolated) = 0.611 W/kg

Zoom Scan (7x7x7)/Cube 0: Measurement grid: dx=5mm, dy=5mm, dz=5mm

Reference Value = 8.704 V/m; Power Drift = 0.08 dB

Peak SAR (extrapolated) = 0.724 W/kg

SAR(1 g) = 0.373 W/kg; SAR(10 g) = 0.191 W/kg

Maximum value of SAR (measured) = 0.572 W/kg

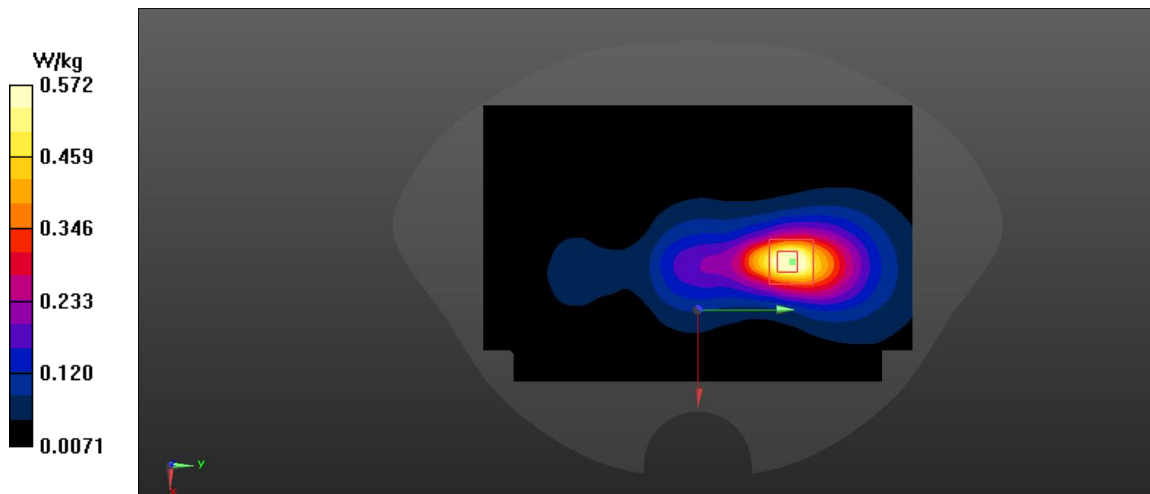

Fig A.24

LTE1700-FDD66_CH132072 1RB-Middle Right Tilt

Date: 5/10/2022

Electronics: DAE4 Sn549

Medium: head 1750 MHz

Medium parameters used: $f = 1720$ MHz; $\sigma = 0.517$ mho/m; $\epsilon_r = 41.19$; $\rho = 1000$ kg/m³

Ambient Temperature: 22.5°C, Liquid Temperature: 22.3°C

Communication System: LTE1700-FDD66 1720 MHz Duty Cycle: 1:1

Probe: EX3DV4 – SN7464 ConvF(8.52,8.52,8.52)

Area Scan (71x121x1): Interpolated grid: dx=1.500 mm, dy=1.500 mm

Maximum value of SAR (interpolated) = 0.77 W/kg

Zoom Scan (7x7x7)/Cube 0: Measurement grid: dx=8mm, dy=8mm, dz=5mm

Reference Value = 13.87 V/m; Power Drift = 0.11 dB

Peak SAR (extrapolated) = 0.822 W/kg

SAR(1 g) = 0.419 W/kg; SAR(10 g) = 0.214 W/kg

Maximum value of SAR (measured) = 0.462 W/kg

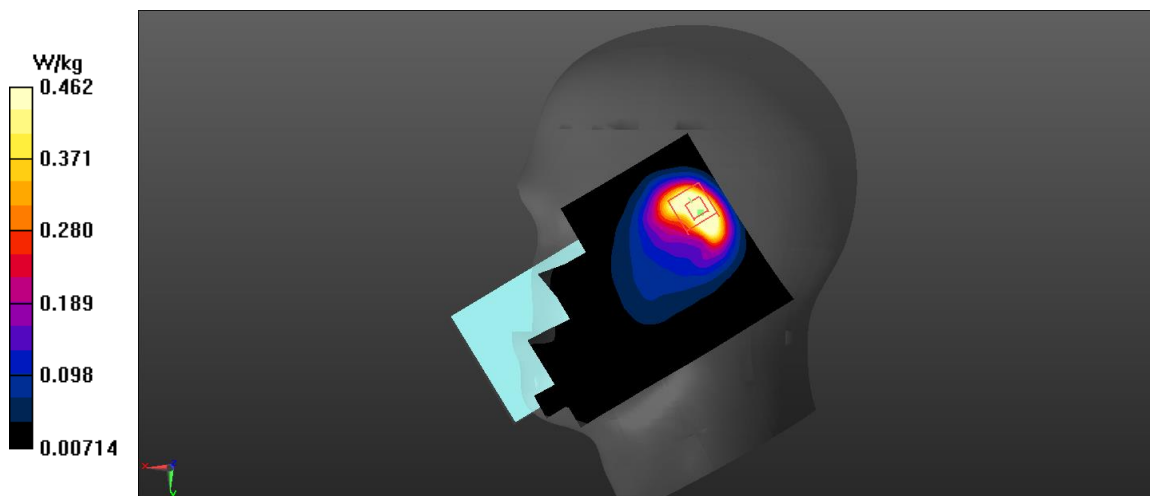

Fig A.25

LTE1700-FDD66_CH132072 1RB-Low Front 17mm

Date: 5/10/2022

Electronics: DAE4 Sn549

Medium: head 1750 MHz

Medium parameters used: $f = 1720$ MHz; $\sigma = 0.507$ mho/m; $\epsilon_r = 41.11$; $\rho = 1000$ kg/m³

Ambient Temperature: 22.5°C, Liquid Temperature: 22.3°C

Communication System: LTE1700-FDD66 1720 MHz Duty Cycle: 1:1

Probe: EX3DV4 – SN7464 ConvF(8.52,8.52,8.52)

Area Scan (71x121x1): Interpolated grid: dx=1.500 mm, dy=1.500 mm

Maximum value of SAR (interpolated) = 0.365 W/kg

Zoom Scan (7x7x7)/Cube 0: Measurement grid: dx=8mm, dy=8mm, dz=5mm

Reference Value = 10.32 V/m; Power Drift = 0.04 dB

Peak SAR (extrapolated) = 0.414 W/kg

SAR(1 g) = 0.256 W/kg; SAR(10 g) = 0.164 W/kg

Maximum value of SAR (measured) = 0.357 W/kg

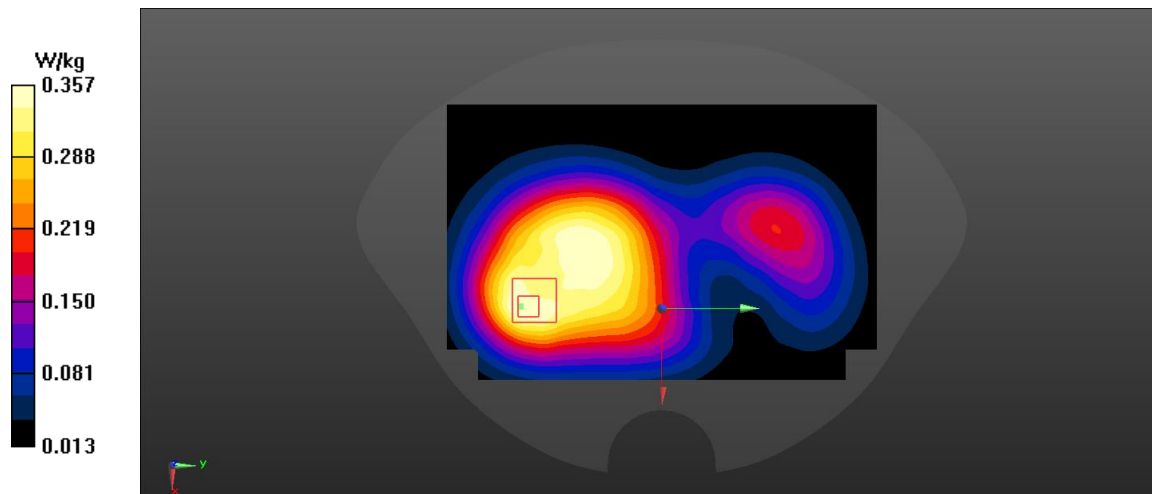

Fig A.26

LTE700-FDD71_CH133222 1RB-Low Left Cheek

Date: 5/6/2022

Electronics: DAE4 Sn549

Medium: head 750 MHz

Medium parameters used: $f = 673$ MHz; $\sigma = 0.984$ mho/m; $\epsilon_r = 41.96$; $\rho = 1000$ kg/m³

Ambient Temperature: 22.5°C, Liquid Temperature: 22.3°C

Communication System: LTE700-FDD71 673 MHz Duty Cycle: 1:1

Probe: EX3DV4 – SN7464 ConvF(10.26,10.26,10.26)

Area Scan (71x121x1): Interpolated grid: dx=1.500 mm, dy=1.500 mm

Maximum value of SAR (interpolated) = 0.106 W/kg

Zoom Scan (7x7x7)/Cube 0: Measurement grid: dx=8mm, dy=8mm, dz=5mm

Reference Value = 2.893 V/m; Power Drift = -0.11 dB

Peak SAR (extrapolated) = 0.117 W/kg

SAR(1 g) = 0.089 W/kg; SAR(10 g) = 0.069 W/kg

Maximum value of SAR (measured) = 0.107 W/kg

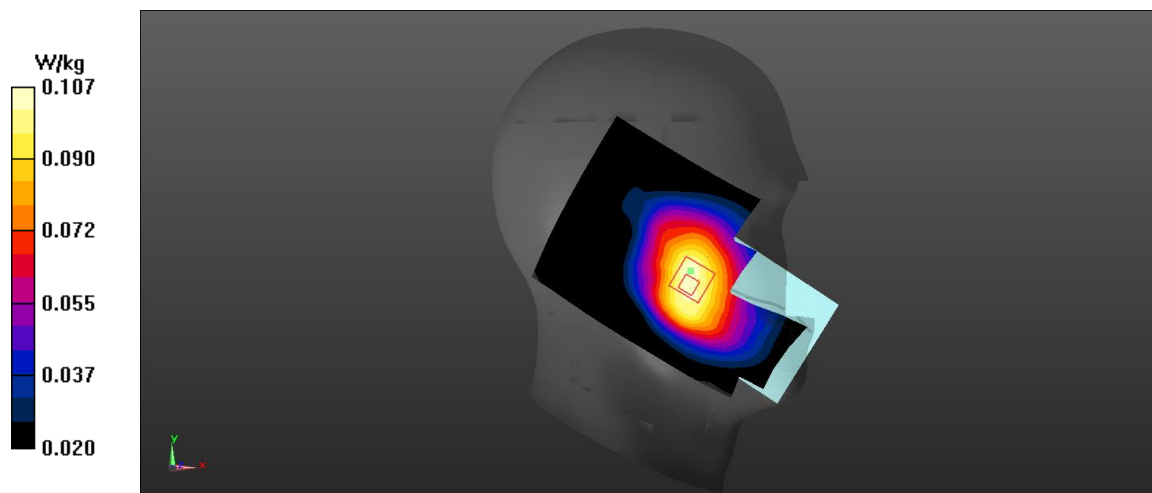

Fig A.27

LTE700-FDD71_CH133372 1RB-Low Right Edge 10mm

Date: 5/6/2022

Electronics: DAE4 Sn549

Medium: head 750 MHz

Medium parameters used: $f = 688 \text{ MHz}$; $\sigma = 0.978 \text{ mho/m}$; $\epsilon_r = 41.48$; $\rho = 1000 \text{ kg/m}^3$

Ambient Temperature: 22.5°C, Liquid Temperature: 22.3°C

Communication System: LTE700-FDD71 688 MHz Duty Cycle: 1:1

Probe: EX3DV4 – SN7464 ConvF(10.26,10.26,10.26)

Area Scan (71x121x1): Interpolated grid: $dx=1.500 \text{ mm}$, $dy=1.500 \text{ mm}$

Maximum value of SAR (interpolated) = 0.591 W/kg

Zoom Scan (7x7x7)/Cube 0: Measurement grid: $dx=8\text{mm}$, $dy=8\text{mm}$, $dz=5\text{mm}$

Reference Value = 22.37 V/m; Power Drift = 0.09 dB

Peak SAR (extrapolated) = 0.665 W/kg

SAR(1 g) = 0.462 W/kg; SAR(10 g) = 0.325 W/kg

Maximum value of SAR (measured) = 0.593 W/kg

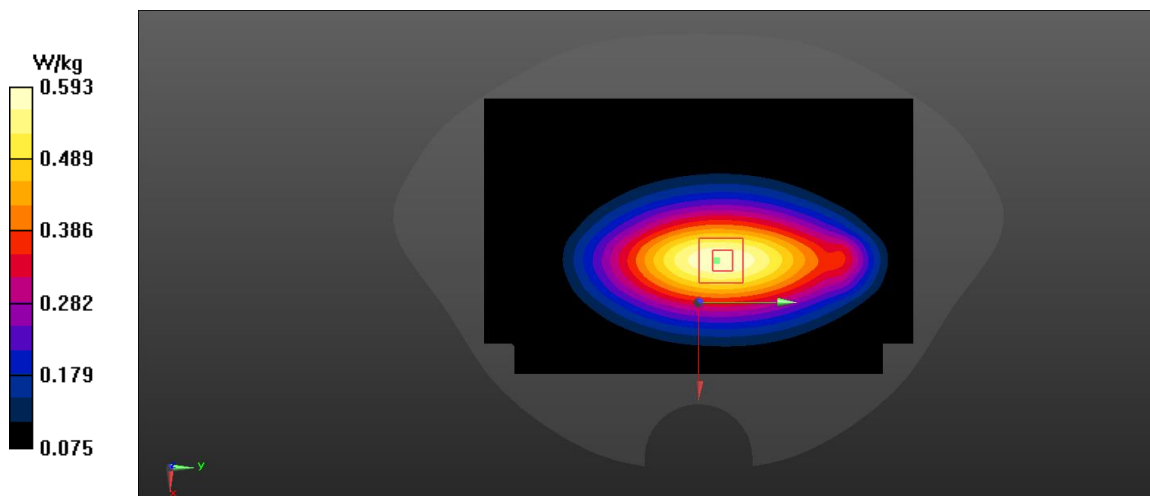

Fig A.28

WLAN2450_CH6 Left Cheek

Date: 5/15/2022

Electronics: DAE4 Sn549

Medium: head 2450 MHz

Medium parameters used: $f = 2437$ MHz; $\sigma = 1.803$ mho/m; $\epsilon_r = 39.34$; $\rho = 1000$ kg/m³

Ambient Temperature: 22.5°C, Liquid Temperature: 22.3°C

Communication System: WLAN2450 2437 Duty Cycle: 1:1

Probe: EX3DV4 – SN7464 ConvF(7.77,7.77,7.77)

Area Scan (71x121x1): Interpolated grid: dx=1.200 mm, dy=1.200 mm

Maximum value of SAR (interpolated) = 0.347 W/kg

Zoom Scan (7x7x7)/Cube 0: Measurement grid: dx=5mm, dy=5mm, dz=5mm

Reference Value = 6.203 V/m; Power Drift = -0.07 dB

Peak SAR (extrapolated) = 0.407 W/kg

SAR(1 g) = 0.197 W/kg; SAR(10 g) = 0.102 W/kg

Maximum value of SAR (measured) = 0.314 W/kg

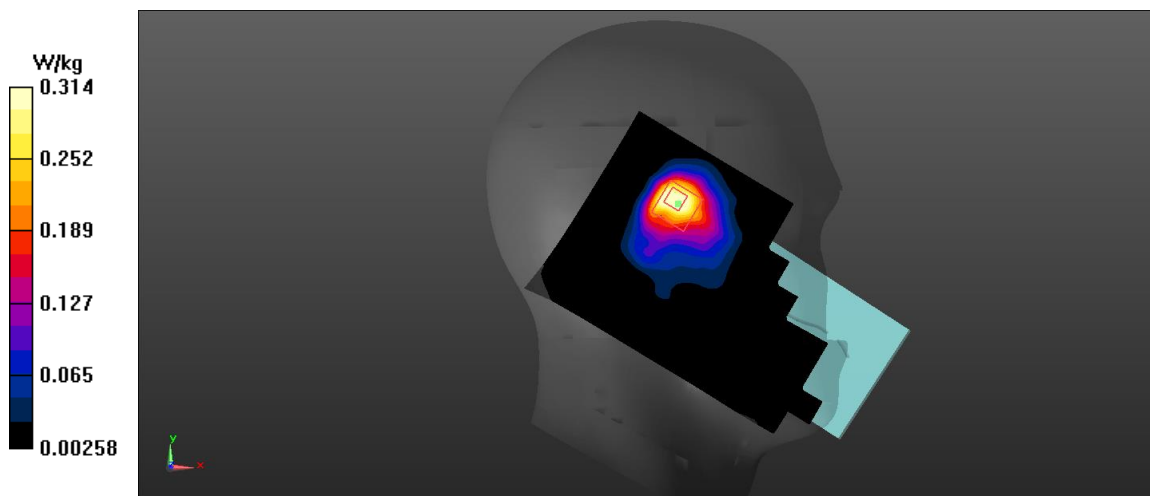

Fig A.29

WLAN2450_CH11 Top Edge 10mm

Date: 5/15/2022

Electronics: DAE4 Sn549

Medium: head 2450 MHz

Medium parameters used: $f = 2462$ MHz; $\sigma = 1.813$ mho/m; $\epsilon_r = 38.86$; $\rho = 1000$ kg/m³

Ambient Temperature: 22.5°C, Liquid Temperature: 22.3°C

Communication System: WLAN2450 2462 Duty Cycle: 1:1

Probe: EX3DV4 – SN7464 ConvF(7.77,7.77,7.77)

Area Scan (71x121x1): Interpolated grid: dx=1.200 mm, dy=1.200 mm

Maximum value of SAR (interpolated) = 0.398 W/kg

Zoom Scan (7x7x7)/Cube 0: Measurement grid: dx=5mm, dy=5mm, dz=5mm

Reference Value = 11.35 V/m; Power Drift = -0.19 dB

Peak SAR (extrapolated) = 0.469 W/kg

SAR(1 g) = 0.244 W/kg; SAR(10 g) = 0.127 W/kg

Maximum value of SAR (measured) = 0.384 W/kg

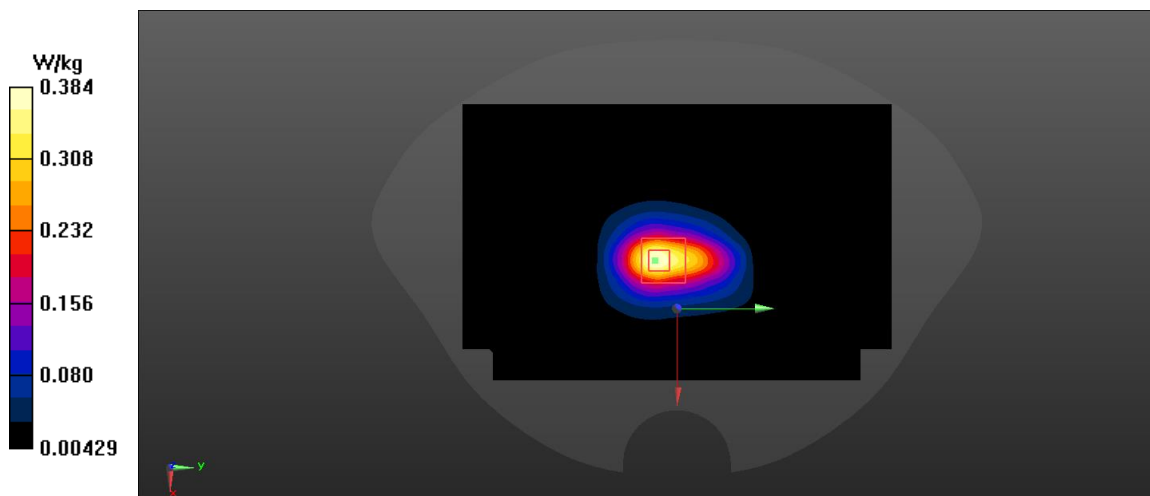

Fig A.30

UNII-3_CH155 Left Cheek

Date: 5/18/2022

Electronics: DAE4 Sn549

Medium: head 5750 MHz

Medium parameters used: $f = 5775$ MHz; $\sigma = 5.178$ mho/m; $\epsilon_r = 34.74$; $\rho = 1000$ kg/m³

Ambient Temperature: 22.5°C, Liquid Temperature: 22.3°C

Communication System: UNII-3 5775 Duty Cycle: 1:1

Probe: EX3DV4 – SN7464 ConvF(4.85,4.85,4.85)

Area Scan (71x121x1): Interpolated grid: dx=1.000 mm, dy=1.000 mm

Maximum value of SAR (interpolated) = 0.555 W/kg

Zoom Scan (7x7x7)/Cube 0: Measurement grid: dx=4mm, dy=4mm, dz=1.4mm

Reference Value = 1.157 V/m; Power Drift = 0.19 dB

Peak SAR (extrapolated) = 0.528 W/kg

SAR(1 g) = 0.133 W/kg; SAR(10 g) = 0.041 W/kg

Maximum value of SAR (measured) = 0.326 W/kg

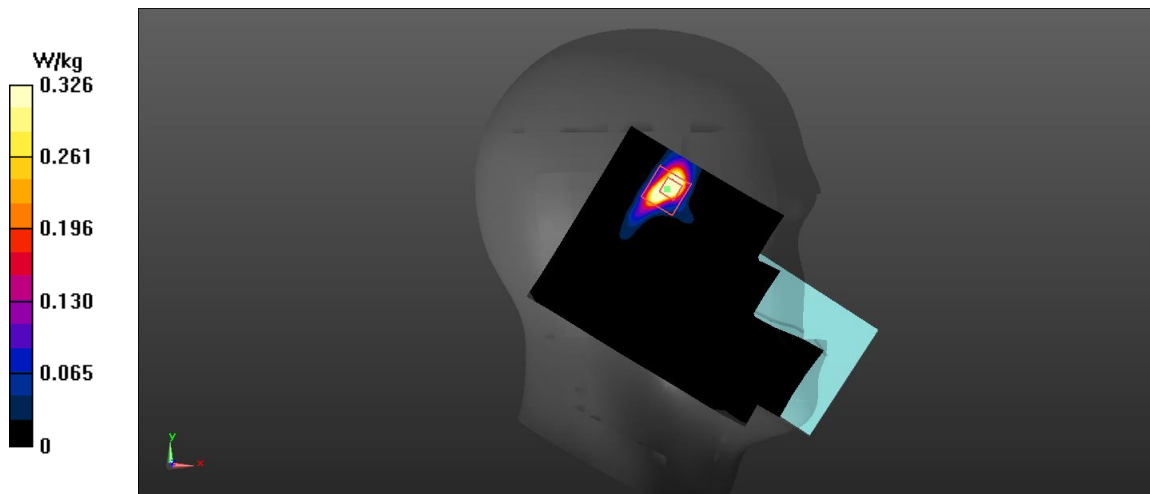

Fig A.31

UNII-3_CH165 Right Edge 10mm

Date: 5/18/2022

Electronics: DAE4 Sn549

Medium: head 5750 MHz

Medium parameters used: $f = 5825$ MHz; $\sigma = 5.308$ mho/m; $\epsilon_r = 35.21$; $\rho = 1000$ kg/m³

Ambient Temperature: 22.5°C, Liquid Temperature: 22.3°C

Communication System: UNII-3 5825 Duty Cycle: 1:1

Probe: EX3DV4 – SN7464 ConvF(4.85,4.85,4.85)

Area Scan (71x121x1): Interpolated grid: dx=1.000 mm, dy=1.000 mm

Maximum value of SAR (interpolated) = 0.743 W/kg

Zoom Scan (7x7x7)/Cube 0: Measurement grid: dx=4mm, dy=4mm, dz=1.4mm

Reference Value = 0 V/m; Power Drift = 0.14 dB

Peak SAR (extrapolated) = 1.22 W/kg

SAR(1 g) = 0.425 W/kg; SAR(10 g) = 0.16 W/kg

Maximum value of SAR (measured) = 0.525 W/kg

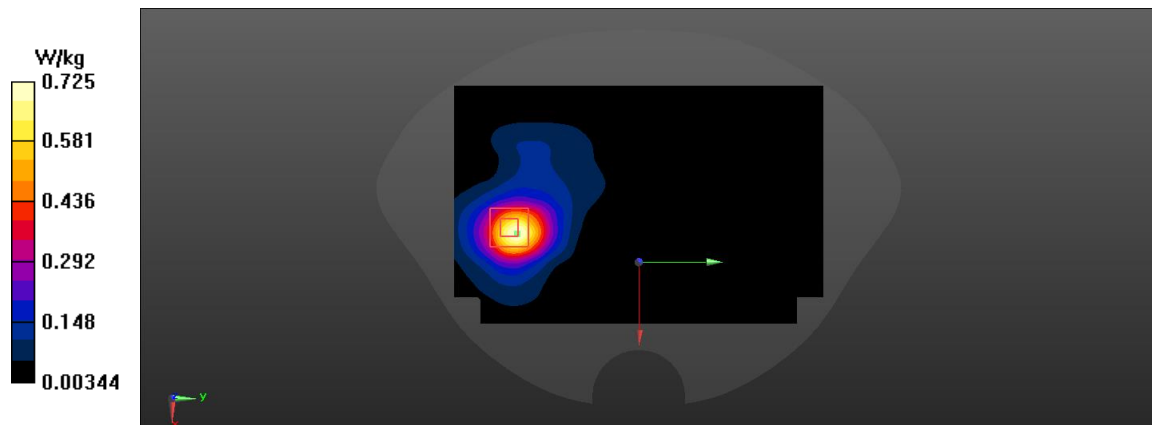
**Fig A.32**

n25_CH376500 Right Tilt

Date: 5/20/2022

Electronics: DAE4 Sn549

Medium: head 1900 MHz

Medium parameters used: $f = 1882.5$; $\sigma = 1.387$ mho/m; $\epsilon_r = 39.383$; $\rho = 1000$ kg/m³

Ambient Temperature: 22.5°C, Liquid Temperature: 22.31°C

Communication System: n25 1882.5 MHz Duty Cycle:1:1

Probe: EX3DV4 – SN7464 ConvF(8.18,8.18,8.18)

Area Scan (81x131x1): Interpolated grid: dx=1.500 mm, dy=1.500 mm

Maximum value of SAR (interpolated) = 1.189 W/kg

Zoom Scan (5x5x7)/Cube 0: Measurement grid: dx=8mm, dy=8mm, dz=5mm

Reference Value = 17.141 V/m; Power Drift = 0.16 dB

Peak SAR (extrapolated) = 1.25 W/kg

SAR(1 g) = 0.584 W/kg; SAR(10 g) = 0.3231 W/kg

Maximum value of SAR (measured) = 0.707 W/kg

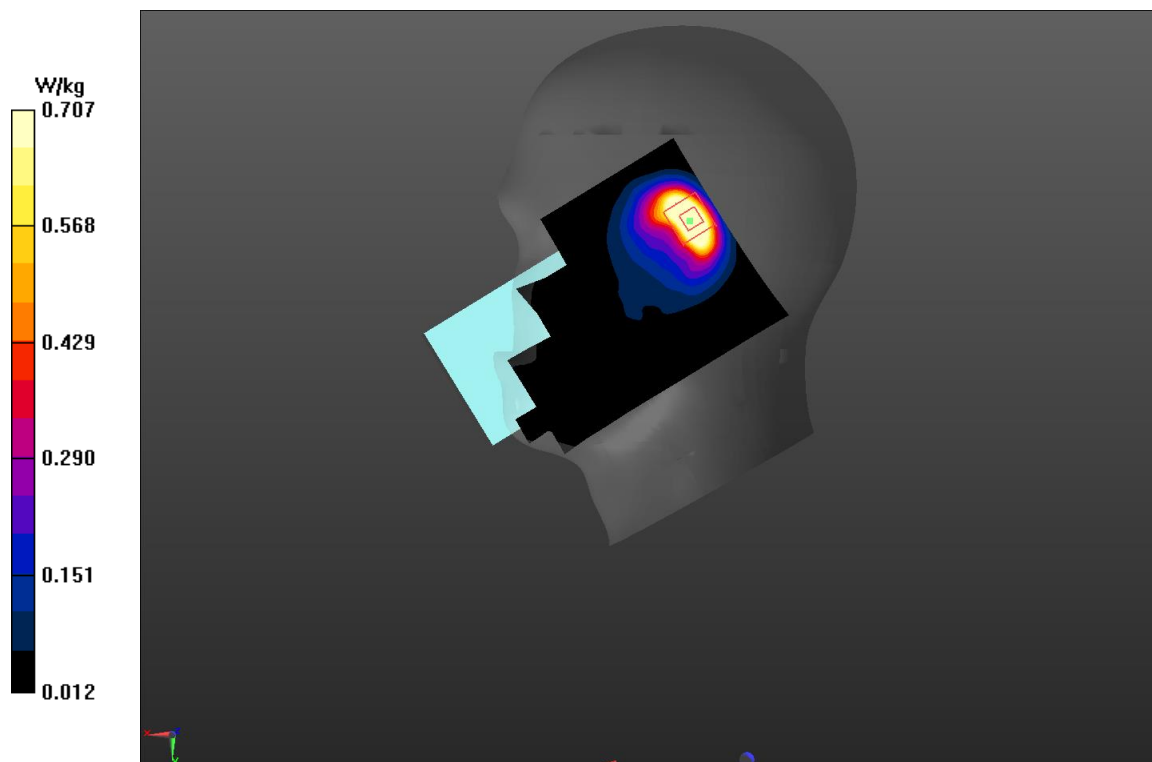

Fig A.33

n25_CH376500 Front 17mm

Date: 5/20/2022

Electronics: DAE4 Sn549

Medium: head 1900 MHz

Medium parameters used: $f = 1882.5$; $\sigma = 1.361$ mho/m; $\epsilon_r = 40.5$; $\rho = 1000$ kg/m³

Ambient Temperature: 22.5°C, Liquid Temperature: 22.31°C

Communication System: n25 1882.5 Duty Cycle:1:1

Probe: EX3DV4 – SN7464 ConvF(8.18,8.18,8.18)

Area Scan (91x141x1): Interpolated grid: dx=1.500 mm, dy=1.500 mm

Maximum value of SAR (interpolated) = 0.515 W/kg

Zoom Scan (5x5x7)/Cube 0: Measurement grid: dx=8mm, dy=8mm, dz=5mm

Reference Value = 11.78 V/m; Power Drift = 0.05 dB

Peak SAR (extrapolated) = 0.599 W/kg

SAR(1 g) = 0.355 W/kg; SAR(10 g) = 0.214 W/kg

Maximum value of SAR (measured) = 0.507 W/kg

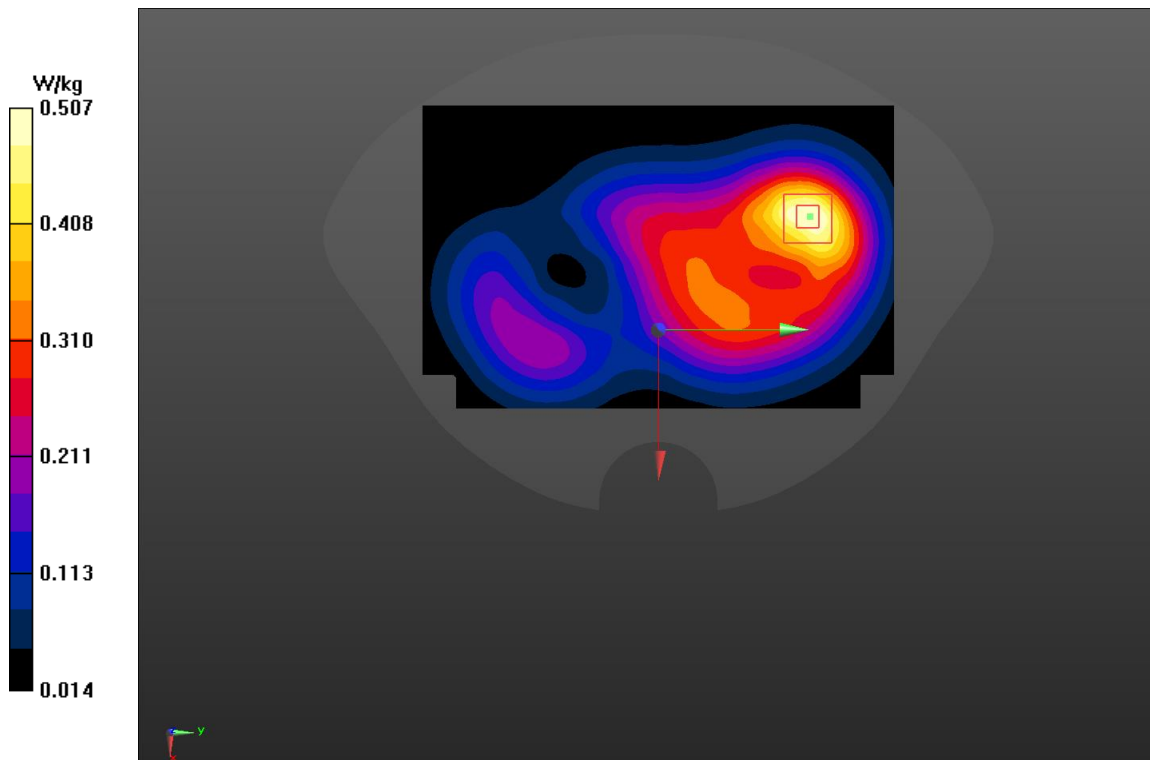

Fig A.34

n66_CH344000 Right Cheek

Date: 5/19/2022

Electronics: DAE4 Sn549

Medium: head 1750 MHz

Medium parameters used: $f = 1720$; $\sigma = 1.318$ mho/m; $\epsilon_r = 40.07$; $\rho = 1000$ kg/m³

Ambient Temperature: 22.5°C, Liquid Temperature: 22.31°C

Communication System: n66 1720 Duty Cycle:1:1

Probe: EX3DV4 – SN7464 ConvF(8.52,8.52,8.52)

Area Scan (71x121x1): Interpolated grid: dx=1.500 mm, dy=1.500 mm

Maximum value of SAR (interpolated) = 0.716 W/kg

Zoom Scan (7x7x7)/Cube 0: Measurement grid: dx=8mm, dy=8mm, dz=5mm

Reference Value = 11.80 V/m; Power Drift = 0.13 dB

Peak SAR (extrapolated) = 0.791 W/kg

SAR(1 g) = 0.432 W/kg; SAR(10 g) = 0.237 W/kg

Maximum value of SAR (measured) = 0.462 W/kg

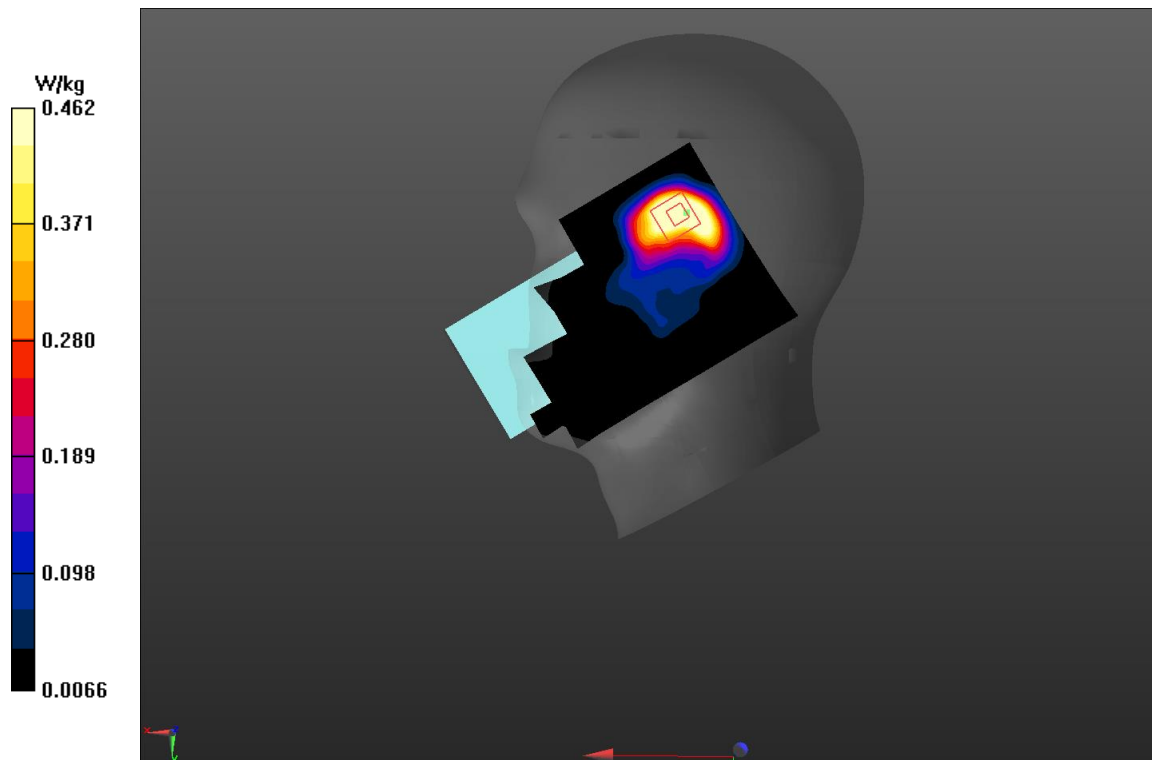

Fig A.35

n66_CH349000 Front 17mm

Date: 5/19/2022

Electronics: DAE4 Sn549

Medium: head 1750 MHz

Medium parameters used: $f = 1745$; $\sigma = 1.371$ mho/m; $\epsilon_r = 39.773$; $\rho = 1000$ kg/m³

Ambient Temperature: 22.5°C, Liquid Temperature: 22.31°C

Communication System: n66 1745 Duty Cycle: 1:1

Probe: EX3DV4 – SN7464 ConvF(8.52,8.52,8.52)

Area Scan (71x121x1): Interpolated grid: dx=1.500 mm, dy=1.500 mm

Maximum value of SAR (interpolated) = 0.3821 W/kg

Zoom Scan (7x7x7)/Cube 0: Measurement grid: dx=8mm, dy=8mm, dz=5mm

Reference Value = 8.314 V/m; Power Drift = 0.16 dB

Peak SAR (extrapolated) = 0.418 W/kg

SAR(1 g) = 0.254 W/kg; SAR(10 g) = 0.159 W/kg

Maximum value of SAR (measured) = 0.358 W/kg

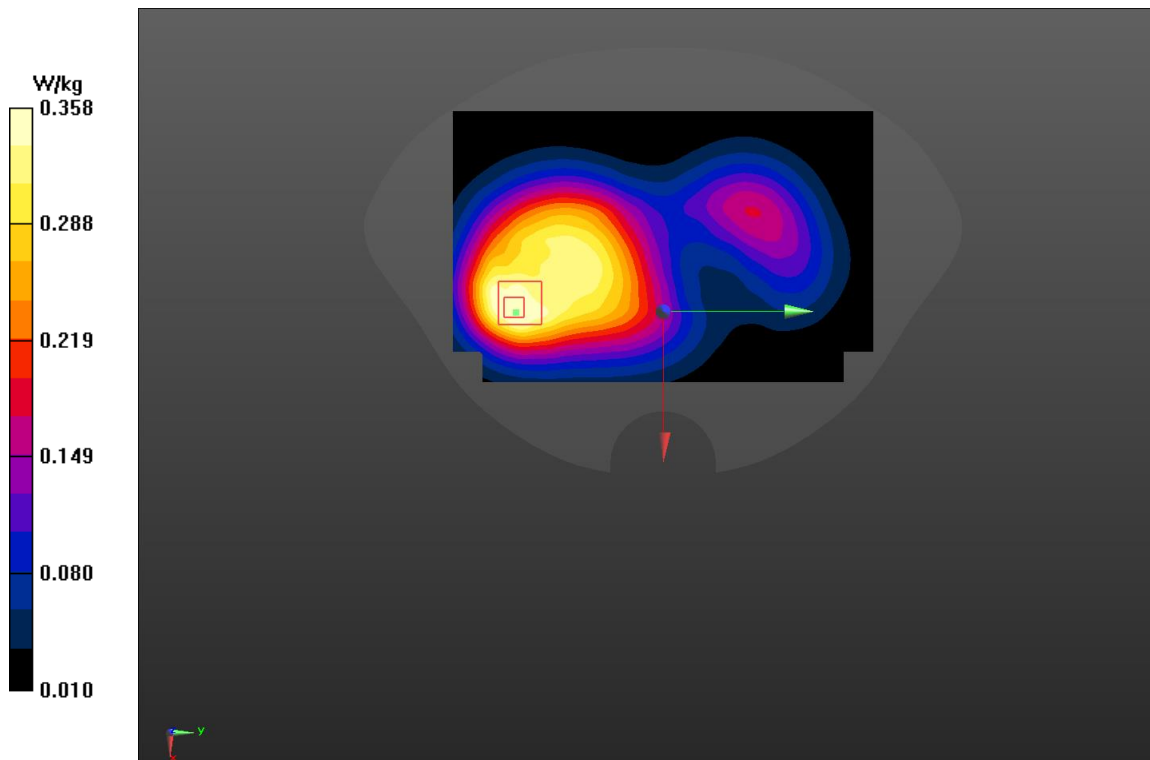

Fig A.36

n71_CH136100 Right Cheek

Date: 5/18/2022

Electronics: DAE4 Sn549

Medium: head 750 MHz

Medium parameters used: $f = 680.5$; $\sigma = 11.65$ mho/m; $\epsilon_r = 28.488$; $\rho = 1000$ kg/m³

Ambient Temperature: 22.5°C, Liquid Temperature: 22.31°C

Communication System: n71 680.5 MHz Duty Cycle: 1:1

Probe: EX3DV4 – SN7464 ConvF(10.26,10.26,10.26)

Area Scan (71x121x1): Interpolated grid: dx=1.500 mm, dy=1.500 mm

Maximum value of SAR (interpolated) = 0.2581 W/kg

Zoom Scan (7x7x7)/Cube 0: Measurement grid: dx=8mm, dy=8mm, dz=5mm

Reference Value = 4.535 V/m; Power Drift = -0.03 dB

Peak SAR (extrapolated) = 0.264 W/kg

SAR(1 g) = 0.210 W/kg; SAR(10 g) = 0.161 W/kg

Maximum value of SAR (measured) = 0.358 W/kg

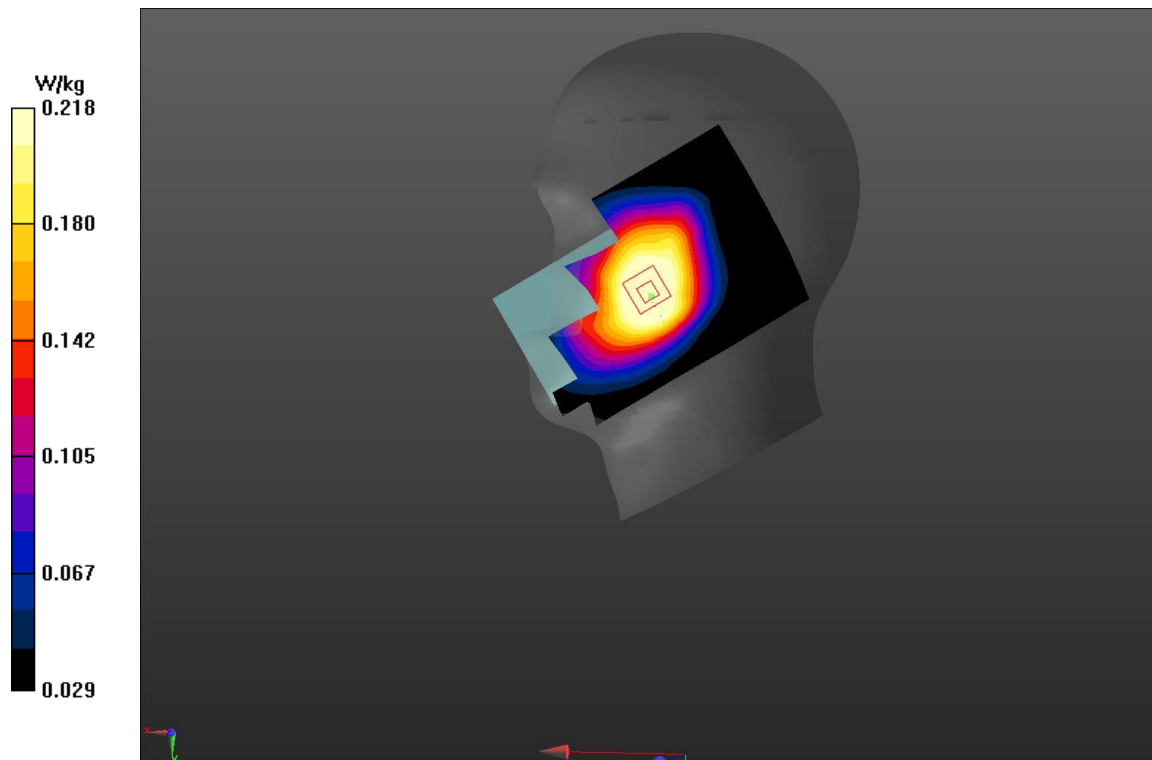

Fig A.37

n71_CH136100 Right Edge 10mm

Date: 5/18/2022

Electronics: DAE4 Sn549

Medium: head 750 MHz

Medium parameters used: $f = 680.5$; $\sigma = 11.644$ mho/m; $\epsilon_r = 28.02$; $\rho = 1000$ kg/m³

Ambient Temperature: 22.5°C, Liquid Temperature: 22.31°C

Communication System: n71 680.5 MHz Duty Cycle: 1:1

Probe: EX3DV4 – SN7464 ConvF(10.26,10.26,10.26)

Area Scan (71x121x1): Interpolated grid: dx=1.500 mm, dy=1.500 mm

Maximum value of SAR (interpolated) = 0.548 W/kg

Zoom Scan (7x7x7)/Cube 0: Measurement grid: dx=8mm, dy=8mm, dz=5mm

Reference Value = 21.531 V/m; Power Drift = -0.11 dB

Peak SAR (extrapolated) = 0.618 W/kg

SAR(1 g) = 0.427 W/kg; SAR(10 g) = 0.300 W/kg

Maximum value of SAR (measured) = 0.554 W/kg

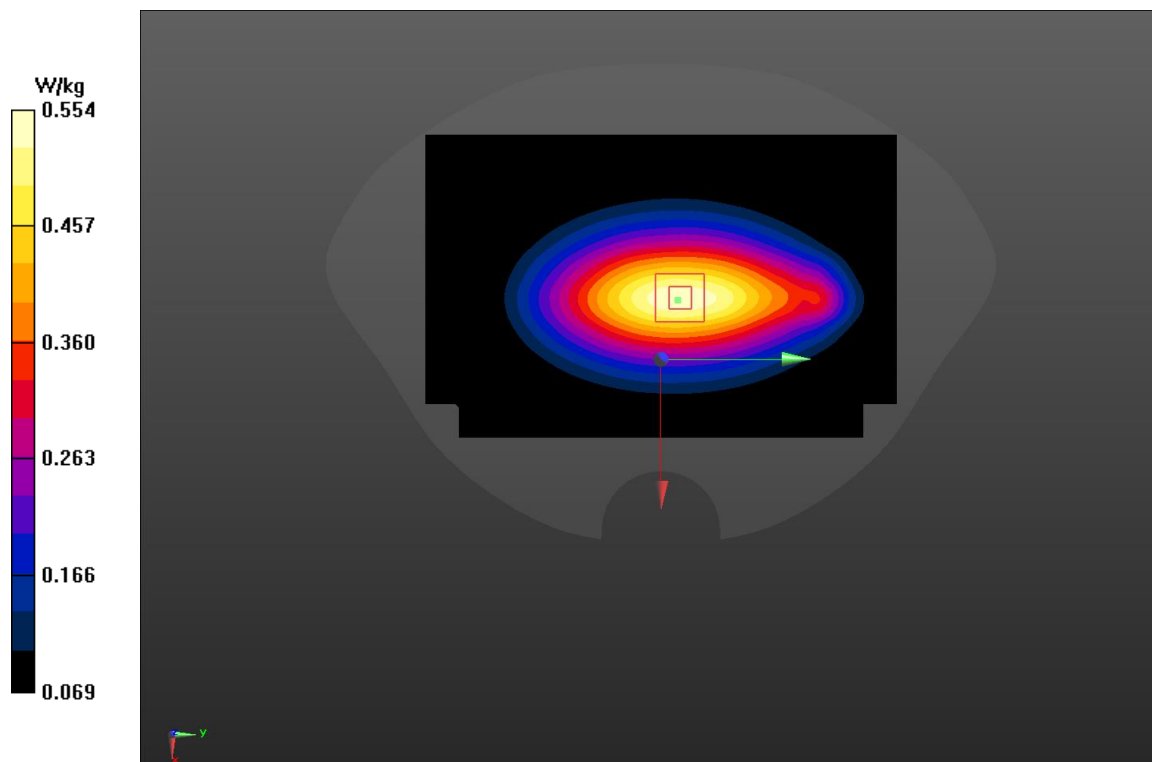

Fig A.38

n41 pc2_CH518598 Right Cheek

Date: 5/21/2022

Electronics: DAE4 Sn549

Medium: head 2600 MHz

Medium parameters used: $f = 2592.98$; $\sigma = 1.958$ mho/m; $\epsilon_r = 37.873$; $\rho = 1000$ kg/m³

Ambient Temperature: 22.5°C, Liquid Temperature: 22.31°C

Communication System: n41 pc2 2592.99 MHz Duty Cycle: 1:2

Probe: EX3DV4 – SN7464 ConvF(8.18,8.18,8.18)

Area Scan (71x121x1): Interpolated grid: dx=1.200 mm, dy=1.200 mm

Maximum value of SAR (interpolated) = 1.27 W/kg

Zoom Scan (7x7x7)/Cube 0: Measurement grid: dx=5mm, dy=5mm, dz=5mm

Reference Value = 3.553 V/m; Power Drift = 0.08 dB

Peak SAR (extrapolated) = 1.611 W/kg

SAR(1 g) = 0.640 W/kg; SAR(10 g) = 0.292 W/kg

Maximum value of SAR (measured) = 0.757 W/kg

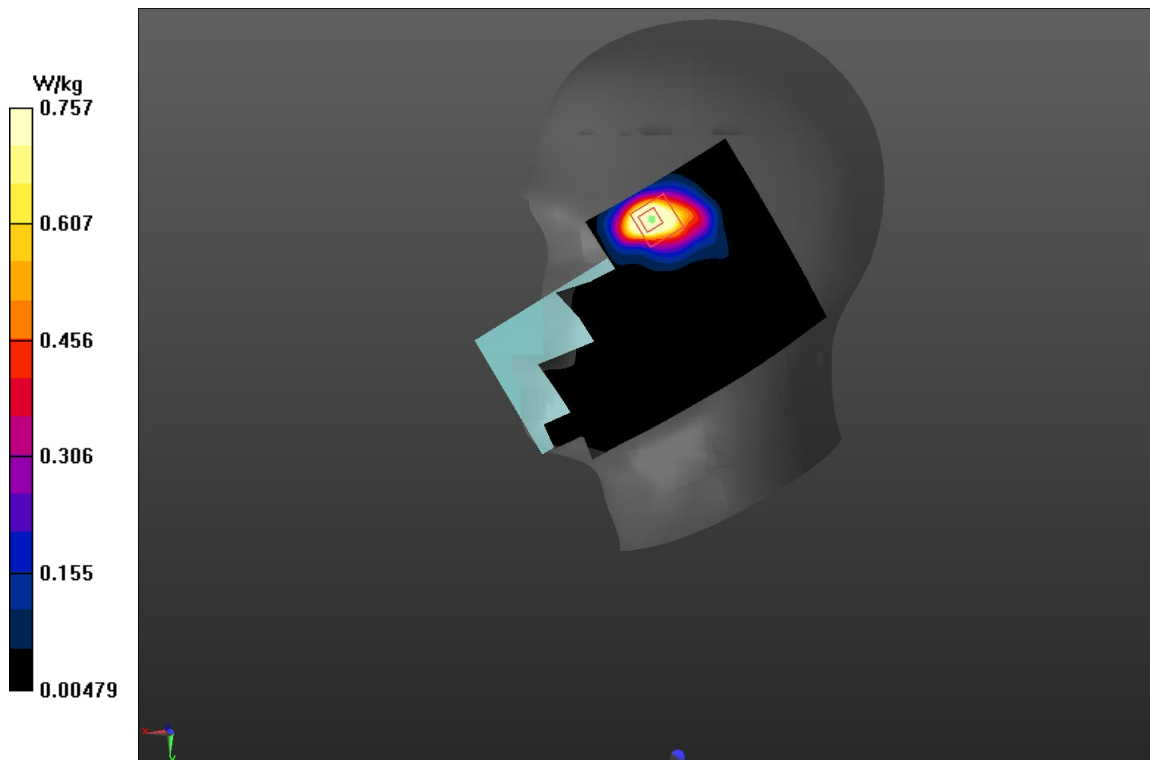

Fig A.39

n41 pc2_CH518598 Left Edge 17mm

Date: 5/21/2022

Electronics: DAE4 Sn549

Medium: head 2600 MHz

Medium parameters used: $f = 2592.99$; $\sigma = 0.947$ mho/m; $\epsilon_r = 41.047$; $\rho = 1000$ kg/m³

Ambient Temperature: 22.5°C, Liquid Temperature: 22.31°C

Communication System: n41 pc2 2592.99 MHz Duty Cycle: 1:2

Probe: EX3DV4 – SN7464 ConvF(8.18,8.18,8.18)

Area Scan (71x121x1): Interpolated grid: dx=1.200 mm, dy=1.200 mm

Maximum value of SAR (interpolated) = 0.3291 W/kg

Zoom Scan (7x7x7)/Cube 0: Measurement grid: dx=5mm, dy=5mm, dz=5mm

Reference Value = 9.549 V/m; Power Drift = 0.18 dB

Peak SAR (extrapolated) = 0.404 W/kg

SAR(1 g) = 0.211 W/kg; SAR(10 g) = 0.107 W/kg

Maximum value of SAR (measured) = 0.329 W/kg

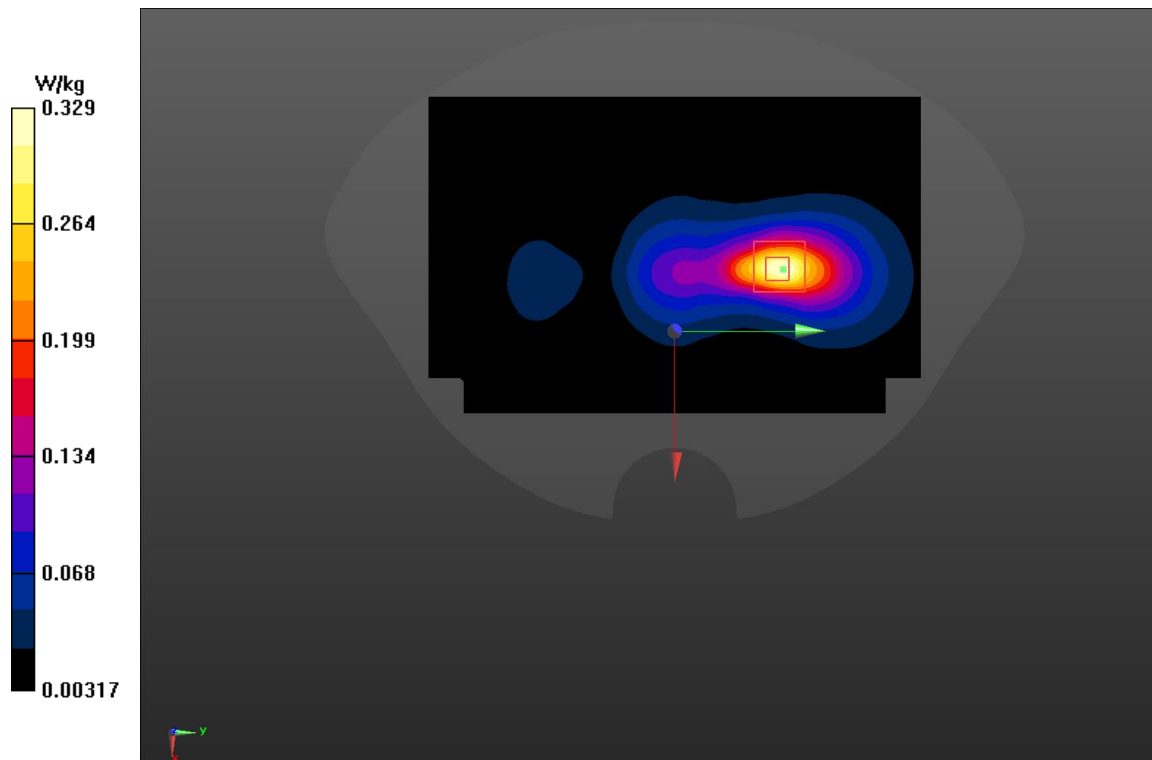

Fig A.40

n77 pc2_CH636000 Left Tilt

Date: 5/22/2022

Electronics: DAE4 Sn549

Medium: head 3500 MHz

Medium parameters used: $f = 3540$; $\sigma = 2.991$ mho/m; $\epsilon_r = 35.809$; $\rho = 1000$ kg/m³

Ambient Temperature: 22.5°C, Liquid Temperature: 22.31°C

Communication System: n77 pc2 3540 MHz Duty Cycle: 1:2

Probe: EX3DV4 – SN7464 ConvF(7.20,7.20,7.20)

Area Scan (71x121x1): Interpolated grid: dx=1.000 mm, dy=1.000 mm

Maximum value of SAR (interpolated) = 0.837 W/kg

Zoom Scan (7x7x7)/Cube 0: Measurement grid: dx=4mm, dy=4mm, dz=1.4mm

Reference Value = 7.924 V/m; Power Drift = -0.16 dB

Peak SAR (extrapolated) = 1.689 W/kg

SAR(1 g) = 0.565 W/kg; SAR(10 g) = 0.204 W/kg

Maximum value of SAR (measured) = 1.92 W/kg

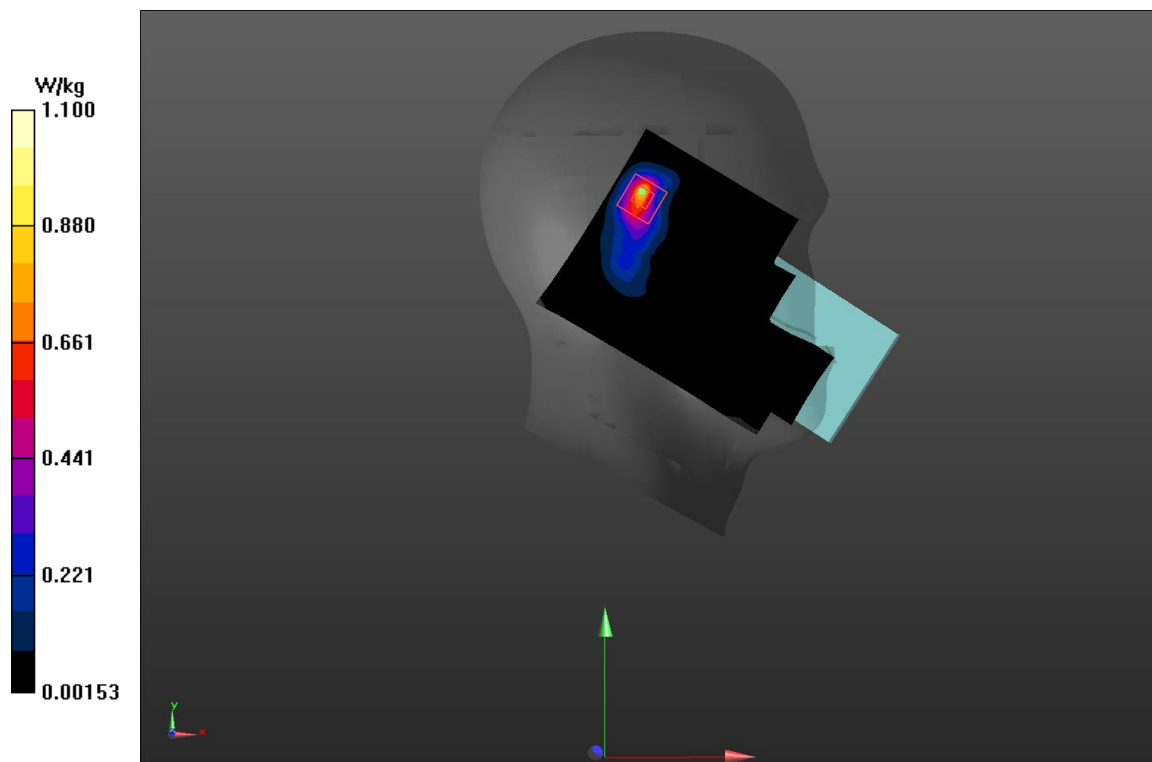

Fig A.41

n77 pc2_CH633334 Top Edge 21mm

Date: 5/22/2022

Electronics: DAE4 Sn549

Medium: head 3500 MHz

Medium parameters used: $f = 3500$; $\sigma = 2.723$ mho/m; $\epsilon_r = 36.121$; $\rho = 1000$ kg/m³

Ambient Temperature: 22.5°C, Liquid Temperature: 22.31°C

Communication System: n77 pc2 3500.01 MHz Duty Cycle:1:2

Probe: EX3DV4 – SN7464 ConvF(7.20,7.20,7.20)

Area Scan (71x121x1): Interpolated grid: dx=1.000 mm, dy=1.000 mm

Maximum value of SAR (interpolated) = 0.967 W/kg

Zoom Scan (7x7x7)/Cube 0: Measurement grid: dx=4mm, dy=4mm, dz=1.4mm

Reference Value = 12.57 V/m; Power Drift = -0.11 dB

Peak SAR (extrapolated) = 1.21 W/kg

SAR(1 g) = 0.569 W/kg; SAR(10 g) = 0.285 W/kg

Maximum value of SAR (measured) = 0.941 W/kg

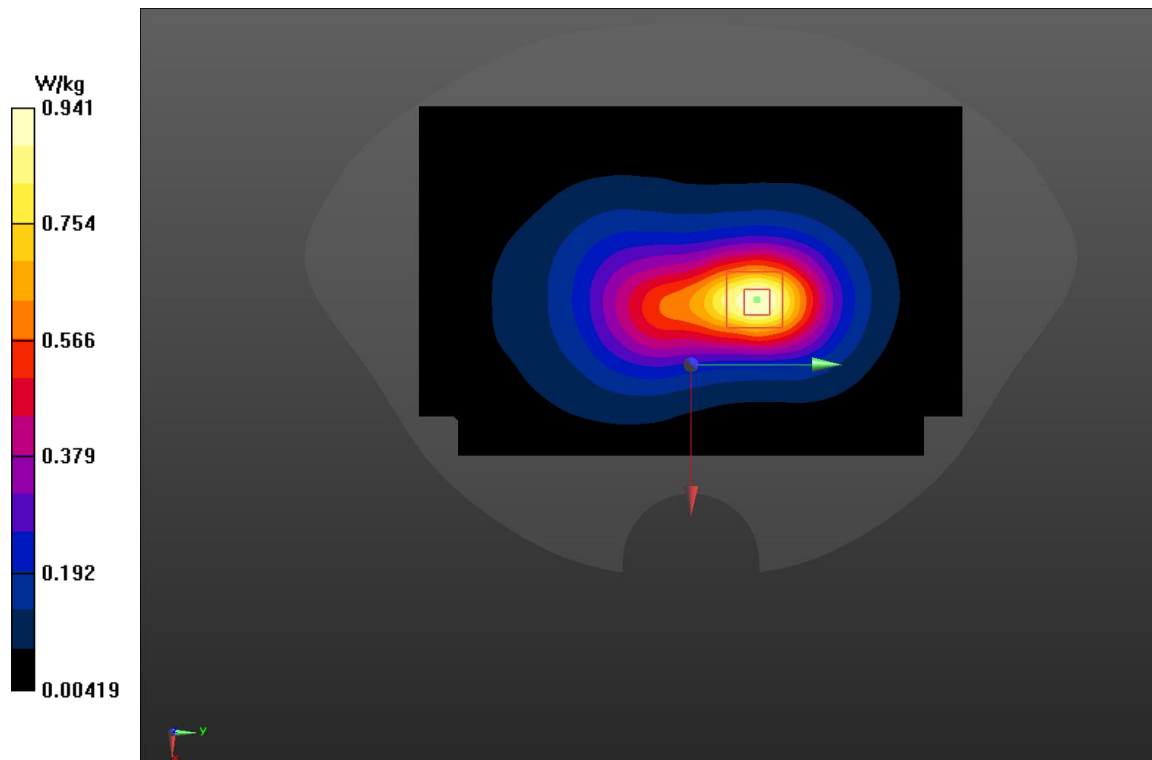

Fig A.42

n77 pc2_CH654267 Left Tilt

Date: 5/23/2022

Electronics: DAE4 Sn549

Medium: head 3900 MHz

Medium parameters used: $f = 3814$; $\sigma = 2.991$ mho/m; $\epsilon_r = 35.809$; $\rho = 1000$ kg/m³

Ambient Temperature: 22.5°C, Liquid Temperature: 22.31°C

Communication System: n77 pc2 3814 MHz Duty Cycle: 1:2

Probe: EX3DV4 – SN7464 ConvF(6.76,6.76,6.76)

Area Scan (71x121x1): Interpolated grid: dx=1.000 mm, dy=1.000 mm

Maximum value of SAR (interpolated) = 1.62 W/kg

Zoom Scan (7x7x7)/Cube 0: Measurement grid: dx=4mm, dy=4mm, dz=1.4mm

Reference Value = 9.176 V/m; Power Drift = -0.03 dB

Peak SAR (extrapolated) = 2.60 W/kg

SAR(1 g) = 1.03 W/kg; SAR(10 g) = 0.368 W/kg

Maximum value of SAR (measured) = 1.92 W/kg

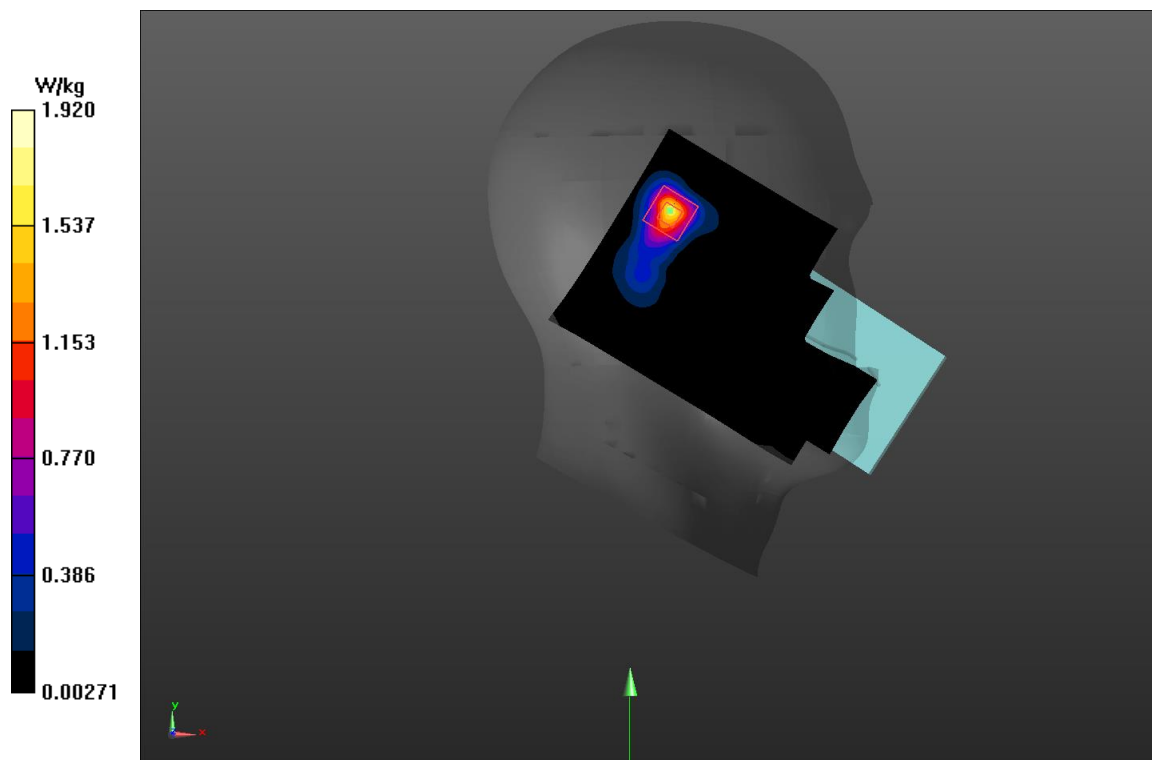
**Fig A.43**

n77 pc2_CH650800 Top Edge 21mm

Date: 5/23/2022

Electronics: DAE4 Sn549

Medium: head 3900 MHz

Medium parameters used: $f = 3762$; $\sigma = 2.943$ mho/m; $\epsilon_r = 35.791$; $\rho = 1000$ kg/m³

Ambient Temperature: 22.5°C, Liquid Temperature: 22.31°C

Communication System: n77 pc2 3762 MHz Duty Cycle: 1:2

Probe: EX3DV4 – SN7464 ConvF(6.76,6.76,6.76)

Area Scan (71x121x1): Interpolated grid: dx=1.000 mm, dy=1.000 mm

Maximum value of SAR (interpolated) = 1.46 W/kg

Zoom Scan (7x7x7)/Cube 0: Measurement grid: dx=4mm, dy=4mm, dz=1.4mm

Reference Value = 13.74 V/m; Power Drift = 0.08 dB

Peak SAR (extrapolated) = 1.95 W/kg

SAR(1 g) = 0.868 W/kg; SAR(10 g) = 0.425 W/kg

Maximum value of SAR (measured) = 1.48 W/kg

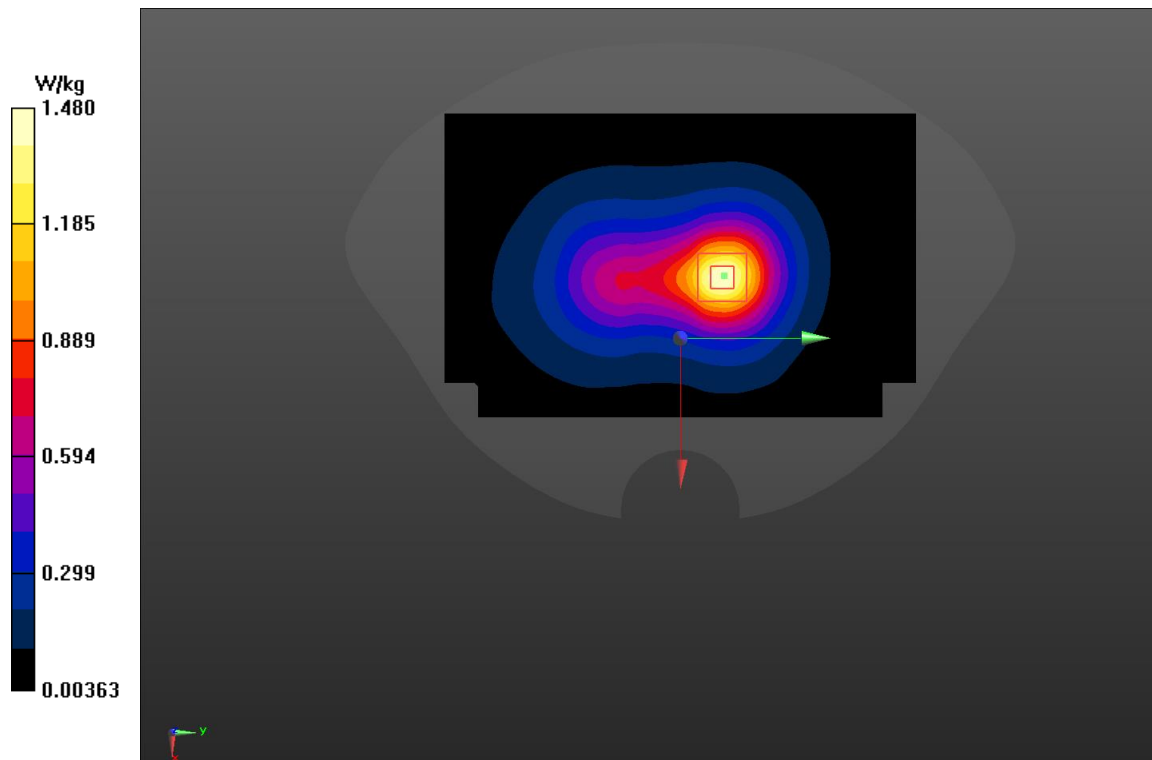

Fig A.44

LTE1900-FDD2_CH18900 Right Cheek 1RB-Low

Date: 5/20/2022

Electronics: DAE4 Sn549

Medium: head 1900 MHz

Medium parameters used: $f = 1880$ MHz; $\sigma = 1.356$ mho/m; $\epsilon_r = 39.97$; $\rho = 1000$ kg/m³

Ambient Temperature: 22.5°C, Liquid Temperature: 22.3°C

Communication System: LTE1900-FDD2 1880 MHz Duty Cycle: 1:1

Probe: EX3DV4 – SN7464 ConvF(8.18,8.18,8.18)

Area Scan (71x121x1): Interpolated grid: dx=1.500 mm, dy=1.500 mm

Maximum value of SAR (interpolated) = 1.16 W/kg

Zoom Scan (7x7x7)/Cube 0: Measurement grid: dx=8mm, dy=8mm, dz=5mm

Reference Value = 6.23 V/m; Power Drift = -0.13 dB

Peak SAR (extrapolated) = 1.34 W/kg

SAR(1 g) = 0.117 W/kg; SAR(10 g) = 0.066 W/kg

Maximum value of SAR (measured) = 0.261 W/kg

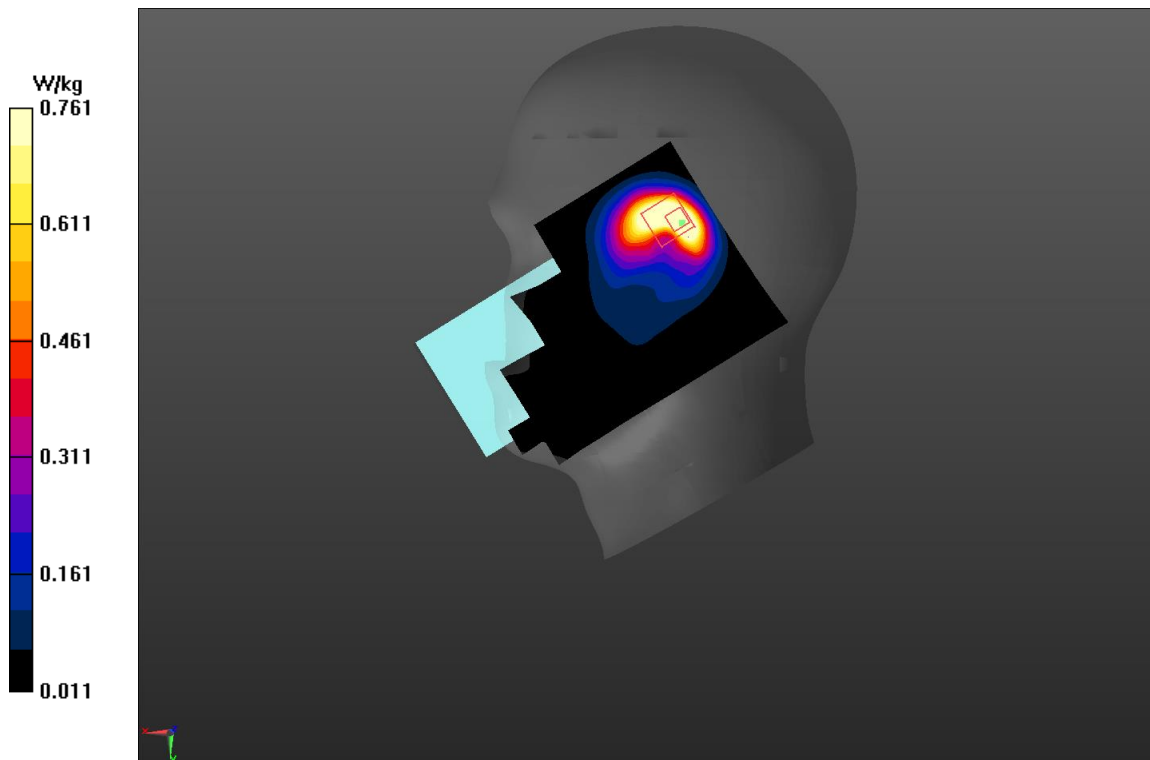

Fig A.45

LTE1900-FDD2_CH18900 Right Edge 10mm 1RB-Low

Date: 5/20/2022

Electronics: DAE4 Sn549

Medium: body 1900 MHz

Medium parameters used: $f = 1880$ MHz; $\sigma = 1.507$ mho/m; $\epsilon_r = 52.89$; $\rho = 1000$ kg/m³

Ambient Temperature: 22.5°C, Liquid Temperature: 22.3°C

Communication System: LTE1900-FDD2 1880 MHz Duty Cycle: 1:1

Probe: EX3DV4 – SN7464 ConvF(8.18,8.18,8.18)

Area Scan (71x121x1): Interpolated grid: dx=1.500 mm, dy=1.500 mm

Maximum value of SAR (interpolated) = 0.121 W/kg

Zoom Scan (7x7x7)/Cube 0: Measurement grid: dx=8mm, dy=8mm, dz=5mm

Reference Value = 4.576 V/m; Power Drift = -0.01 dB

Peak SAR (extrapolated) = 0.139 W/kg

SAR(1 g) = 0.159 W/kg; SAR(10 g) = 0.107 W/kg

Maximum value of SAR (measured) = 0.318 W/kg

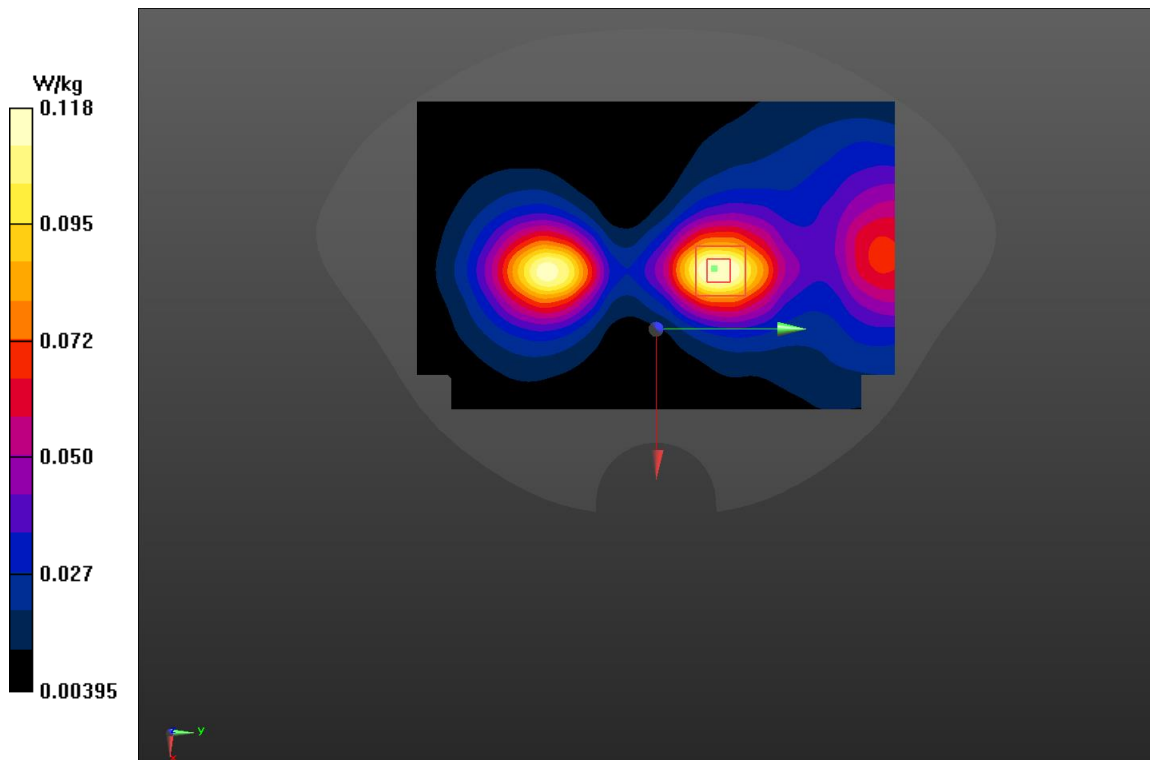

Fig A.46

LTE1700-FDD66_CH132322 Right Cheek 1RB-Low

Date: 5/19/2022

Electronics: DAE4 Sn549

Medium: head 1750 MHz

Medium parameters used: $f = 1745$ MHz; $\sigma = 1.504$ mho/m; $\epsilon_r = 40.05$; $\rho = 1000$ kg/m³

Ambient Temperature: 22.5°C, Liquid Temperature: 22.3°C

Communication System: LTE1700-FDD66 1880 MHz Duty Cycle: 1:1

Probe: EX3DV4 – SN7464 ConvF(8.52,8.52,8.52)

Area Scan (71x121x1): Interpolated grid: dx=1.500 mm, dy=1.500 mm

Maximum value of SAR (interpolated) = 0.754 W/kg

Zoom Scan (7x7x7)/Cube 0: Measurement grid: dx=8mm, dy=8mm, dz=5mm

Reference Value = 13.12 V/m; Power Drift = -0.08 dB

Peak SAR (extrapolated) = 0.933 W/kg

SAR(1 g) = 0.219 W/kg; SAR(10 g) = 0.109 W/kg

Maximum value of SAR (measured) = 0.232 W/kg

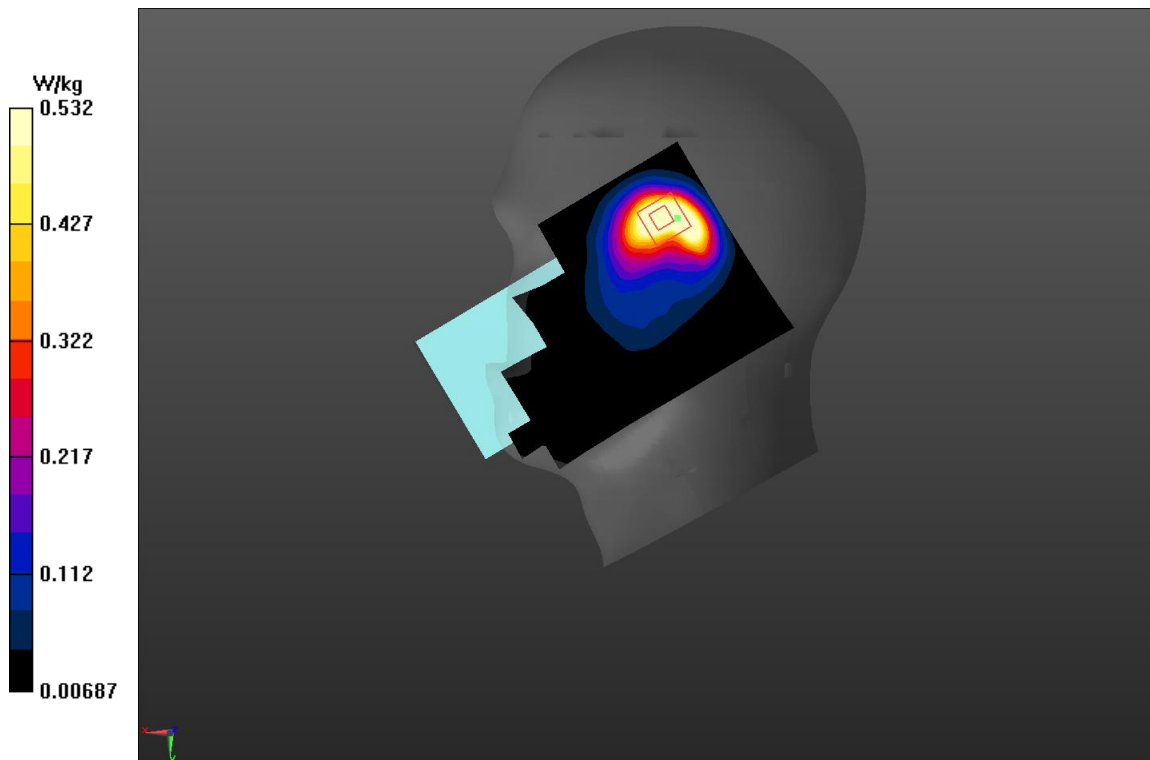

Fig A.47

LTE1700-FDD66_CH132072 Right Edge 10mm 1RB-Low

Date: 5/19/2022

Electronics: DAE4 Sn549

Medium: body 1750 MHz

Medium parameters used: $f = 1745$ MHz; $\sigma = 1.616$ mho/m; $\epsilon_r = 52.79$; $\rho = 1000$ kg/m³

Ambient Temperature: 22.5°C, Liquid Temperature: 22.3°C

Communication System: LTE1700-FDD66 1880 MHz Duty Cycle: 1:1

Probe: EX3DV4 – SN7464 ConvF(8.52,8.52,8.52)

Area Scan (71x121x1): Interpolated grid: dx=1.500 mm, dy=1.500 mm

Maximum value of SAR (interpolated) = 0.277 W/kg

Zoom Scan (7x7x7)/Cube 0: Measurement grid: dx=8mm, dy=8mm, dz=5mm

Reference Value = 6.945 V/m; Power Drift = -0.2 dB

Peak SAR (extrapolated) = 0.316 W/kg

SAR(1 g) = 0.193 W/kg; SAR(10 g) = 0.118 W/kg

Maximum value of SAR (measured) = 0.270 W/kg

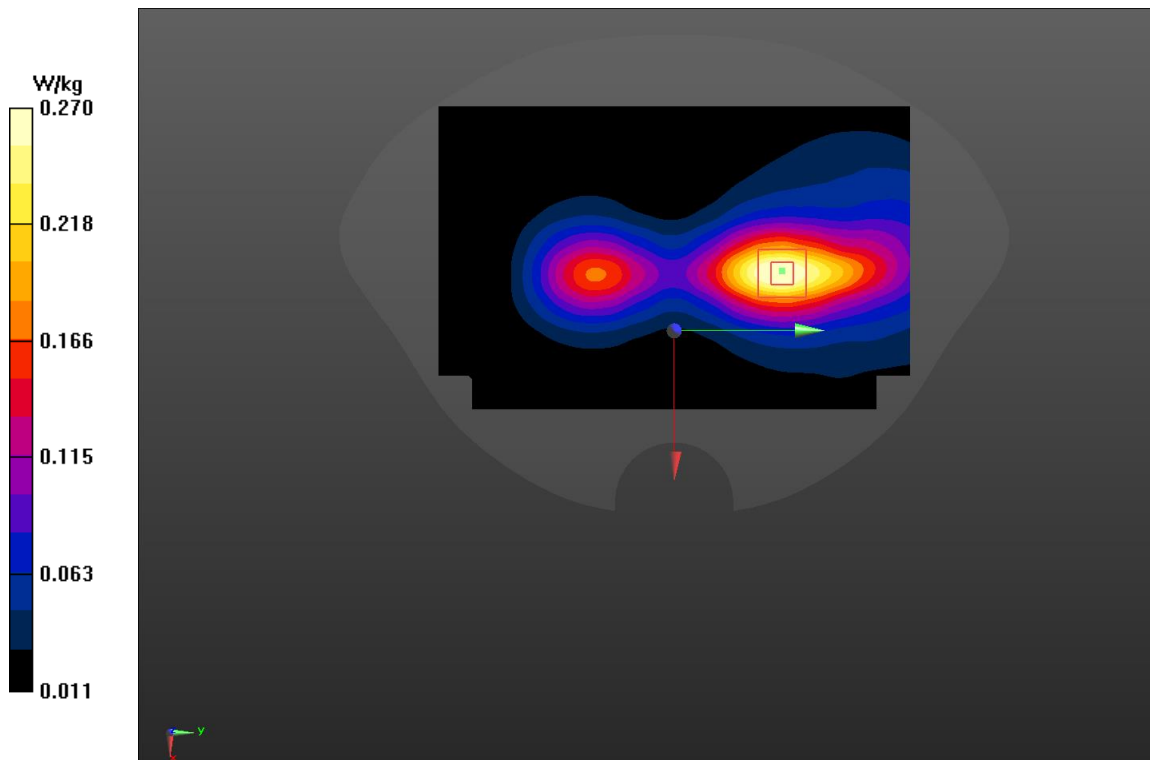

Fig A.48

ANNEX B System Verification Results

750 MHz

Date: 5/5/2022

Electronics: DAE4 Sn549

Medium: Head 750 MHz

Medium parameters used: $f = 750 \text{ MHz}$; $\sigma = 0.897 \text{ mho/m}$; $\epsilon_r = 42.07$; $\rho = 1000 \text{ kg/m}^3$

Ambient Temperature: 22.5°C Liquid Temperature: 22.3°C

Communication System: CW Frequency: 750 MHz Duty Cycle: 1:1

Probe: EX3DV4 – SN7464 ConvF(10.26,10.26,10.26)

System Validation /Area Scan (81x191x1): Interpolated grid: $dx=1.500 \text{ mm}$, $dy=1.500 \text{ mm}$

Reference Value = 58.99 V/m ; Power Drift = -0.1

Fast SAR: SAR(1 g) = 2.08 W/kg ; SAR(10 g) = 1.4 W/kg

Maximum value of SAR (interpolated) = 2.81 W/kg

System Validation /Zoom Scan (7x7x7)/Cube 0: Measurement grid: $dx=8\text{mm}$, $dy=8\text{mm}$, $dz=5\text{mm}$

Reference Value = 58.99 V/m ; Power Drift = -0.1 dB

Peak SAR (extrapolated) = 3.3 W/kg

SAR(1 g) = 2.11 W/kg ; SAR(10 g) = 1.4 W/kg

Maximum value of SAR (measured) = 2.92 W/kg

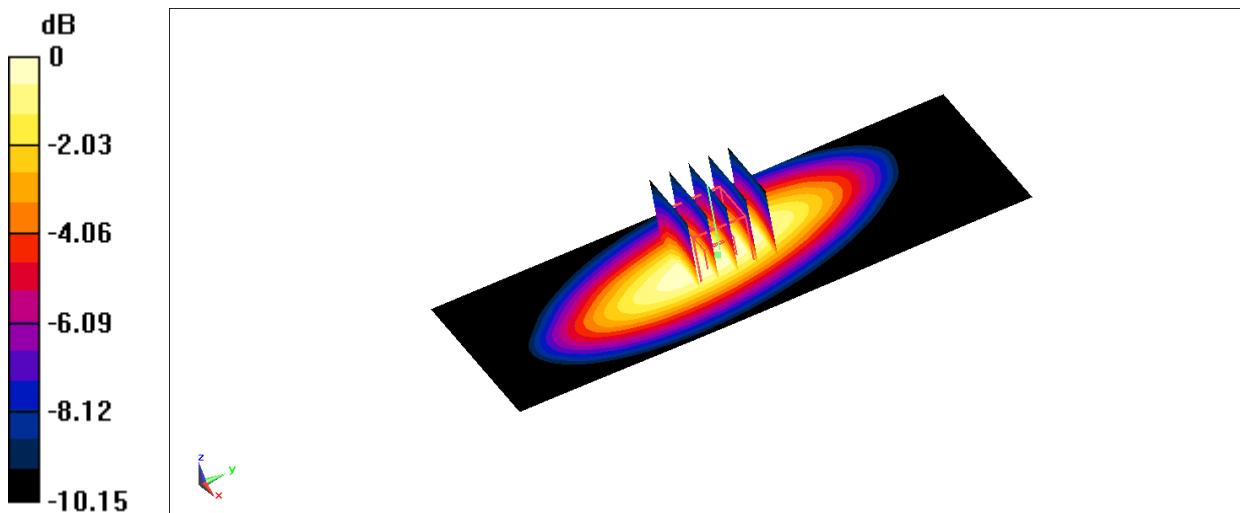

0 dB = 2.90 W/kg = 4.62 dBW/kg

Fig.B.1 validation 750 MHz 250mW

750 MHz

Date: 5/6/2022

Electronics: DAE4 Sn549

Medium: Head 750 MHz

Medium parameters used: $f = 750 \text{ MHz}$; $\sigma = 0.874 \text{ mho/m}$; $\epsilon_r = 41.89$; $\rho = 1000 \text{ kg/m}^3$

Ambient Temperature: 22.5°C Liquid Temperature: 22.3°C

Communication System: CW Frequency: 750 MHz Duty Cycle: 1:1

Probe: EX3DV4 – SN7464 ConvF(10.26,10.26,10.26)

System Validation /Area Scan (81x191x1): Interpolated grid: $dx=1.500 \text{ mm}$, $dy=1.500 \text{ mm}$

Reference Value = 59.75 V/m; Power Drift = -0.05

Fast SAR: SAR(1 g) = 2.13 W/kg; SAR(10 g) = 1.41 W/kg

Maximum value of SAR (interpolated) = 2.83 W/kg

System Validation /Zoom Scan (7x7x7)/Cube 0: Measurement grid: $dx=8\text{mm}$, $dy=8\text{mm}$, $dz=5\text{mm}$

Reference Value = 59.75 V/m; Power Drift = -0.05 dB

Peak SAR (extrapolated) = 3.3 W/kg

SAR(1 g) = 2.16 W/kg; SAR(10 g) = 1.44 W/kg

Maximum value of SAR (measured) = 2.90 W/kg

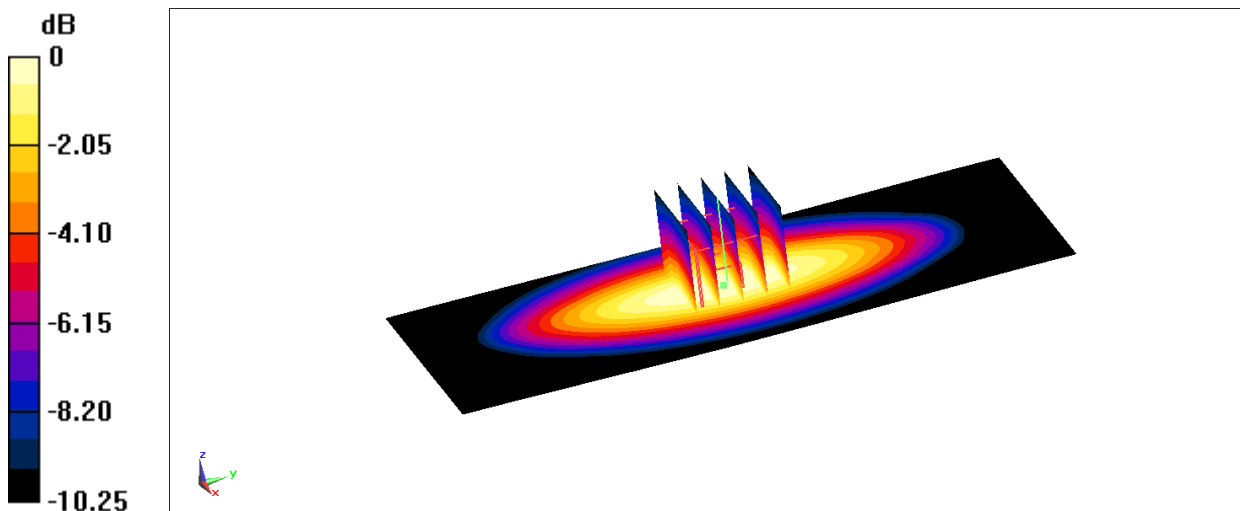

0 dB = 3.07 W/kg = 4.87 dBW/kg

Fig.B.2 validation 750 MHz 250mW

835 MHz

Date: 5/7/2022

Electronics: DAE4 Sn549

Medium: Head 835 MHz

Medium parameters used: $f = 835 \text{ MHz}$; $\sigma = 0.903 \text{ mho/m}$; $\epsilon_r = 40.84$; $\rho = 1000 \text{ kg/m}^3$

Ambient Temperature: 22.5°C Liquid Temperature: 22.3°C

Communication System: CW Frequency: 835 MHz Duty Cycle: 1:1

Probe: EX3DV4 – SN7464 ConvF(9.96,9.96,9.96)

System Validation /Area Scan (81x191x1): Interpolated grid: $dx=1.500 \text{ mm}$, $dy=1.500 \text{ mm}$

Reference Value = 62.6 V/m; Power Drift = -0.04

Fast SAR: SAR(1 g) = 2.45 W/kg; SAR(10 g) = 1.55 W/kg

Maximum value of SAR (interpolated) = 3.2 W/kg

System Validation /Zoom Scan (7x7x7)/Cube 0: Measurement grid: $dx=8\text{mm}$, $dy=8\text{mm}$, $dz=5\text{mm}$

Reference Value = 62.6 V/m; Power Drift = -0.04 dB

Peak SAR (extrapolated) = 3.62 W/kg

SAR(1 g) = 2.45 W/kg; SAR(10 g) = 1.62 W/kg

Maximum value of SAR (measured) = 3.27 W/kg

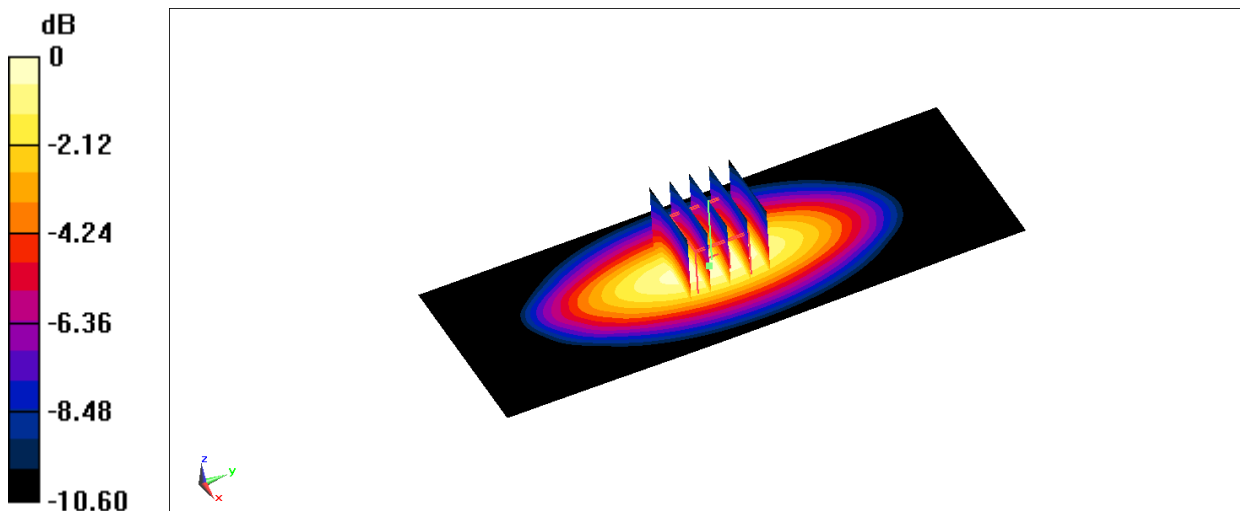

0 dB = 3.27 W/kg = 5.15 dBW/kg

Fig.B.3 validation 835 MHz 250mW

835 MHz

Date: 5/8/2022

Electronics: DAE4 Sn549

Medium: Head 835 MHz

Medium parameters used: $f = 835 \text{ MHz}$; $\sigma = 0.886 \text{ mho/m}$; $\epsilon_r = 42$; $\rho = 1000 \text{ kg/m}^3$

Ambient Temperature: 22.5°C Liquid Temperature: 22.3°C

Communication System: CW Frequency: 835 MHz Duty Cycle: 1:1

Probe: EX3DV4 – SN7464 ConvF(9.96,9.96,9.96)

System Validation /Area Scan (81x191x1): Interpolated grid: $dx=1.500 \text{ mm}$, $dy=1.500 \text{ mm}$

Reference Value = 61.99 V/m; Power Drift = -0.02

Fast SAR: SAR(1 g) = 2.39 W/kg; SAR(10 g) = 1.54 W/kg

Maximum value of SAR (interpolated) = 3.14 W/kg

System Validation /Zoom Scan (7x7x7)/Cube 0: Measurement grid: $dx=8\text{mm}$, $dy=8\text{mm}$, $dz=5\text{mm}$

Reference Value = 61.99 V/m; Power Drift = -0.02 dB

Peak SAR (extrapolated) = 3.72 W/kg

SAR(1 g) = 2.45 W/kg; SAR(10 g) = 1.62 W/kg

Maximum value of SAR (measured) = 3.27 W/kg

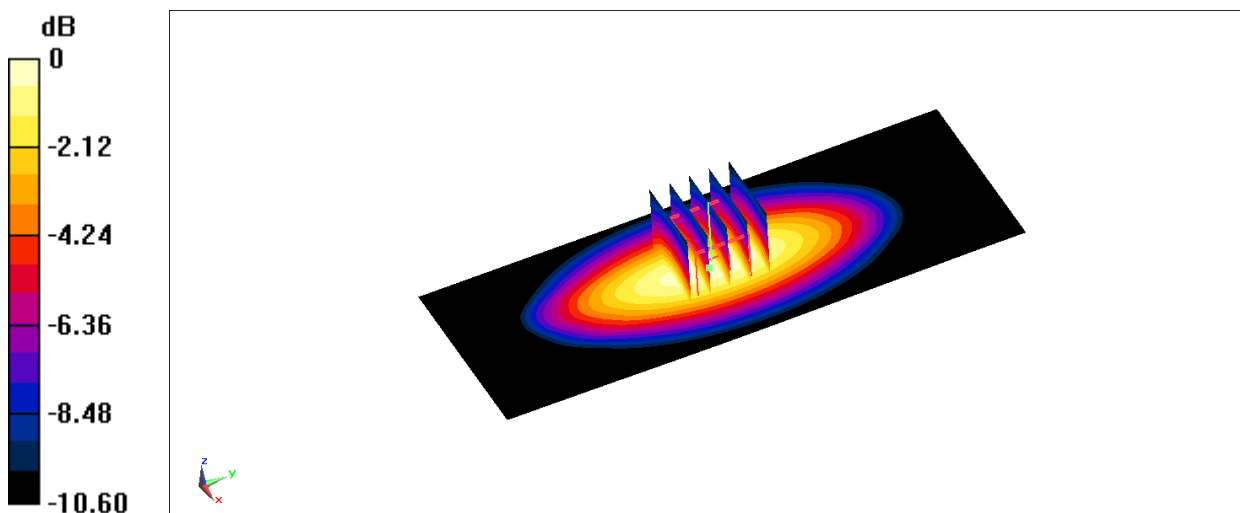

0 dB = 3.27 W/kg = 5.15 dBW/kg

Fig.B.4 validation 835 MHz 250mW

1750 MHz

Date: 5/9/2022

Electronics: DAE4 Sn549

Medium: Head 1750 MHz

Medium parameters used: $f = 1750 \text{ MHz}$; $\sigma = 1.38 \text{ mho/m}$; $\epsilon_r = 40.1$; $\rho = 1000 \text{ kg/m}^3$

Ambient Temperature: 22.5°C Liquid Temperature: 22.3°C

Communication System: CW Frequency: 1750 MHz Duty Cycle: 1:1

Probe: EX3DV4 – SN7464 ConvF(8.52,8.52,8.52)

System Validation /Area Scan (81x191x1): Interpolated grid: $dx=1.500 \text{ mm}$, $dy=1.500 \text{ mm}$

Reference Value = 105.48 V/m ; Power Drift = -0.05

Fast SAR: SAR(1 g) = 8.96 W/kg ; SAR(10 g) = 4.75 W/kg

Maximum value of SAR (interpolated) = 14.3 W/kg

System Validation /Zoom Scan (7x7x7)/Cube 0: Measurement grid: $dx=8\text{mm}$, $dy=8\text{mm}$, $dz=5\text{mm}$

Reference Value = 105.48 V/m ; Power Drift = -0.05 dB

Peak SAR (extrapolated) = 16.63 W/kg

SAR(1 g) = 9.94 W/kg ; SAR(10 g) = 5.24 W/kg

Maximum value of SAR (measured) = 15.0 W/kg

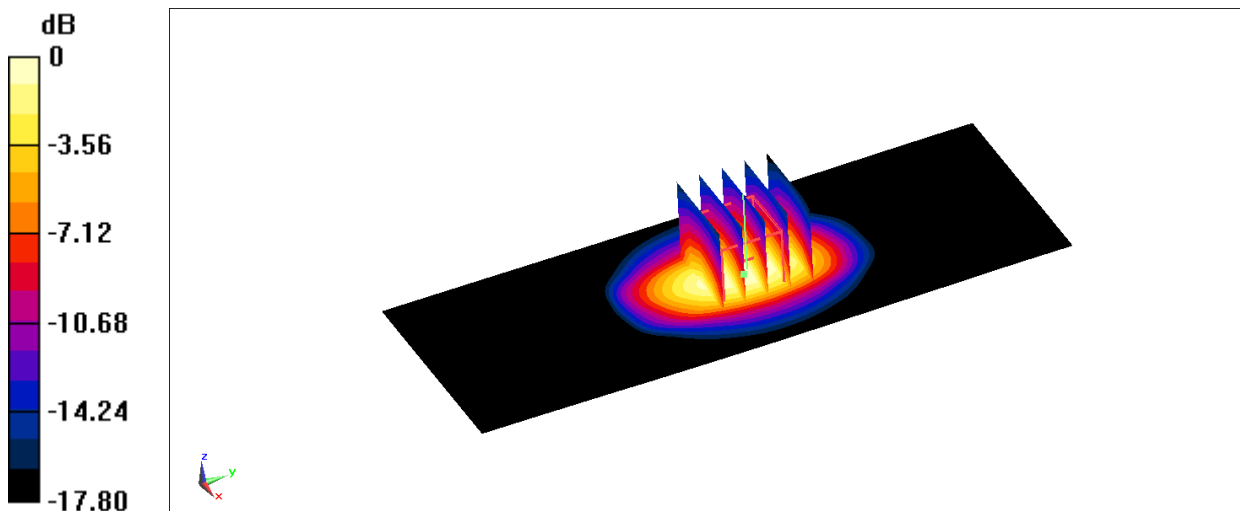

$0 \text{ dB} = 15.0 \text{ W/kg} = 11.76 \text{ dBW/kg}$

Fig.B.5 validation 1750 MHz 250mW

1750 MHz

Date: 5/10/2022

Electronics: DAE4 Sn549

Medium: Head 1750 MHz

Medium parameters used: $f = 1750 \text{ MHz}$; $\sigma = 1.37 \text{ mho/m}$; $\epsilon_r = 40.02$; $\rho = 1000 \text{ kg/m}^3$

Ambient Temperature: 22.5°C Liquid Temperature: 22.3°C

Communication System: CW Frequency: 1750 MHz Duty Cycle: 1:1

Probe: EX3DV4 – SN7464 ConvF(8.52,8.52,8.52)

System Validation /Area Scan (81x191x1): Interpolated grid: $dx=1.500 \text{ mm}$, $dy=1.500 \text{ mm}$

Reference Value = 105.7 V/m; Power Drift = -0.09

Fast SAR: SAR(1 g) = 9.08 W/kg; SAR(10 g) = 4.77 W/kg

Maximum value of SAR (interpolated) = 14.14 W/kg

System Validation /Zoom Scan (7x7x7)/Cube 0: Measurement grid: $dx=8\text{mm}$, $dy=8\text{mm}$, $dz=5\text{mm}$

Reference Value = 105.7 V/m; Power Drift = -0.09 dB

Peak SAR (extrapolated) = 17.12 W/kg

SAR(1 g) = 8.95 W/kg; SAR(10 g) = 4.76 W/kg

Maximum value of SAR (measured) = 13.4 W/kg

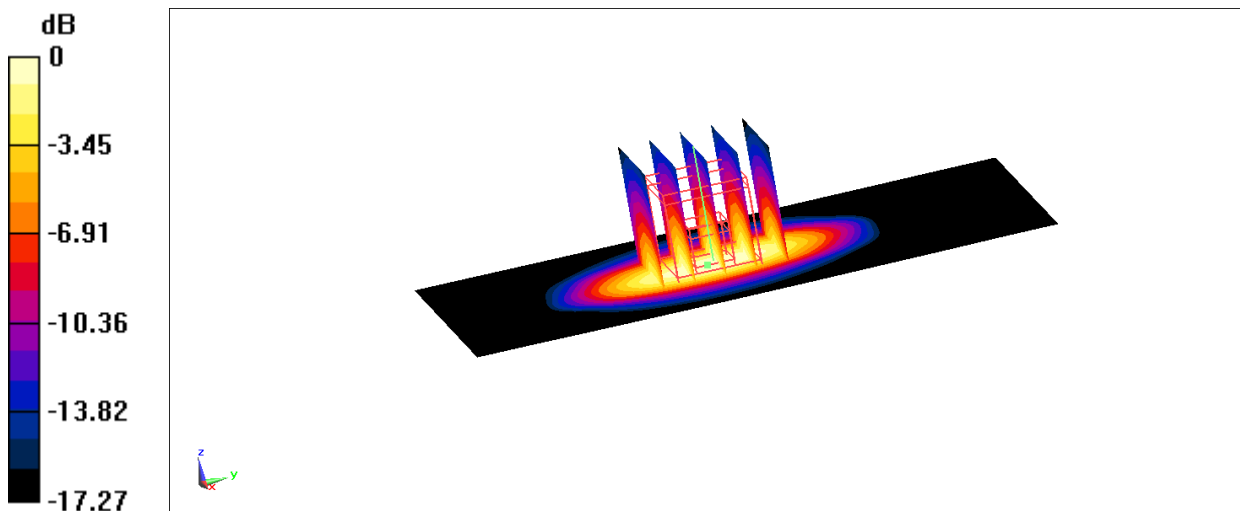

0 dB = 13.4 W/kg = 11.27 dBW/kg

Fig.B.6 validation 1750 MHz 250mW

1900 MHz

Date: 5/11/2022

Electronics: DAE4 Sn549

Medium: Head 1900 MHz

Medium parameters used: $f = 1900$ MHz; $\sigma = 1.397$ mho/m; $\epsilon_r = 39.44$; $\rho = 1000$ kg/m³

Ambient Temperature: 22.5°C Liquid Temperature: 22.3°C

Communication System: CW Frequency: 1900 MHz Duty Cycle: 1:1

Probe: EX3DV4 – SN7464 ConvF(8.18,8.18,8.18)

System Validation /Area Scan (81x191x1): Interpolated grid: dx=1.500 mm, dy=1.500 mm

Reference Value = 110.77 V/m; Power Drift = -0.08

Fast SAR: SAR(1 g) = 9.9 W/kg; SAR(10 g) = 5.11 W/kg

Maximum value of SAR (interpolated) = 15.39 W/kg

System Validation /Zoom Scan (7x7x7)/Cube 0: Measurement grid: dx=8mm, dy=8mm, dz=5mm

Reference Value = 110.77 V/m; Power Drift = -0.08 dB

Peak SAR (extrapolated) = 18.13 W/kg

SAR(1 g) = 10.9 W/kg; SAR(10 g) = 5.62 W/kg

Maximum value of SAR (measured) = 16.5 W/kg

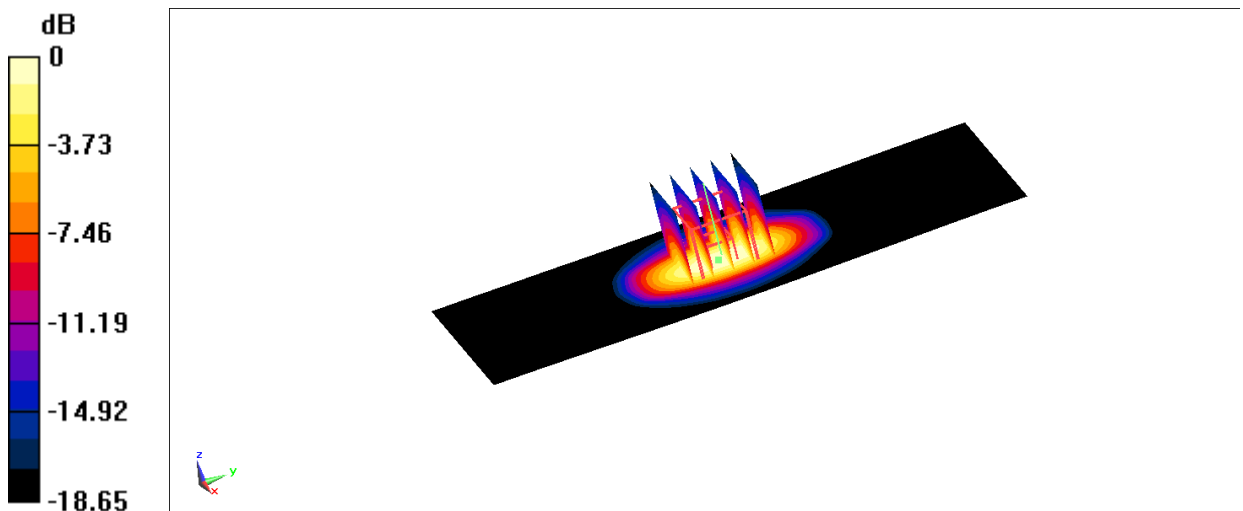

0 dB = 16.5 W/kg = 12.17 dBW/kg

Fig.B.7 validation 1900 MHz 250mW

1900 MHz

Date: 5/12/2022

Electronics: DAE4 Sn549

Medium: Head 1900 MHz

Medium parameters used: $f = 1900 \text{ MHz}$; $\sigma = 1.392 \text{ mho/m}$; $\epsilon_r = 40.33$; $\rho = 1000 \text{ kg/m}^3$

Ambient Temperature: 22.5°C Liquid Temperature: 22.3°C

Communication System: CW Frequency: 1900 MHz Duty Cycle: 1:1

Probe: EX3DV4 – SN7464 ConvF(8.18,8.18,8.18)

System Validation /Area Scan (81x191x1): Interpolated grid: $dx=1.500 \text{ mm}$, $dy=1.500 \text{ mm}$

Reference Value = 109.03 V/m; Power Drift = 0.05

Fast SAR: SAR(1 g) = 9.78 W/kg; SAR(10 g) = 5.07 W/kg

Maximum value of SAR (interpolated) = 15.31 W/kg

System Validation /Zoom Scan (7x7x7)/Cube 0: Measurement grid: $dx=8\text{mm}$, $dy=8\text{mm}$, $dz=5\text{mm}$

Reference Value = 109.03 V/m; Power Drift = 0.05 dB

Peak SAR (extrapolated) = 18.17 W/kg

SAR(1 g) = 9.77 W/kg; SAR(10 g) = 5.07 W/kg

Maximum value of SAR (measured) = 15.06 W/kg

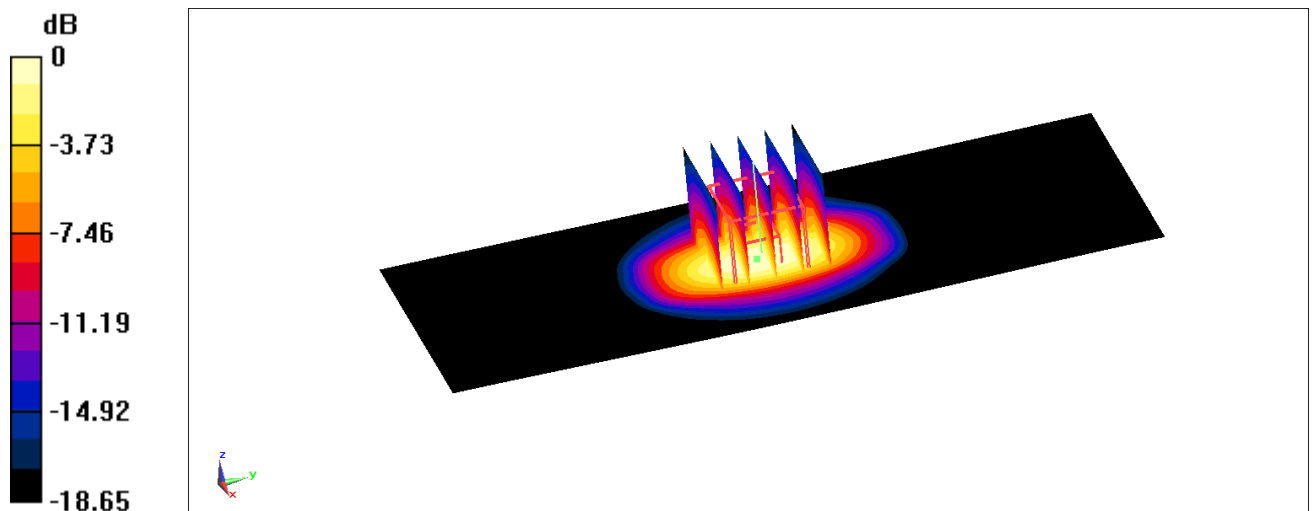

0 dB = 15.06 W/kg = 11.78 dB W/kg

Fig.B.8 validation 1900 MHz 250mW

2600 MHz

Date: 5/13/2022

Electronics: DAE4 Sn549

Medium: Head 2600 MHz

Medium parameters used: $f = 2600$ MHz; $\sigma = 1.971$ mho/m; $\epsilon_r = 39.73$; $\rho = 1000$ kg/m³

Ambient Temperature: 22.5°C Liquid Temperature: 22.3°C

Communication System: CW Frequency: 2600 MHz Duty Cycle: 1:1

Probe: EX3DV4 – SN7464 ConvF(7.64,7.64,7.64)

System Validation /Area Scan (81x191x1): Interpolated grid: dx=1.200 mm, dy=1.200 mm

Reference Value = 123.25 V/m; Power Drift = -0.03

Fast SAR: SAR(1 g) = 14.53 W/kg; SAR(10 g) = 6.21 W/kg

Maximum value of SAR (interpolated) = 24.48 W/kg

System Validation /Zoom Scan (7x7x7)/Cube 0: Measurement grid: dx=5mm, dy=5mm, dz=5mm

Reference Value = 123.25 V/m; Power Drift = -0.03 dB

Peak SAR (extrapolated) = 29.28 W/kg

SAR(1 g) = 14.9 W/kg; SAR(10 g) = 6.59 W/kg

Maximum value of SAR (measured) = 25.8 W/kg

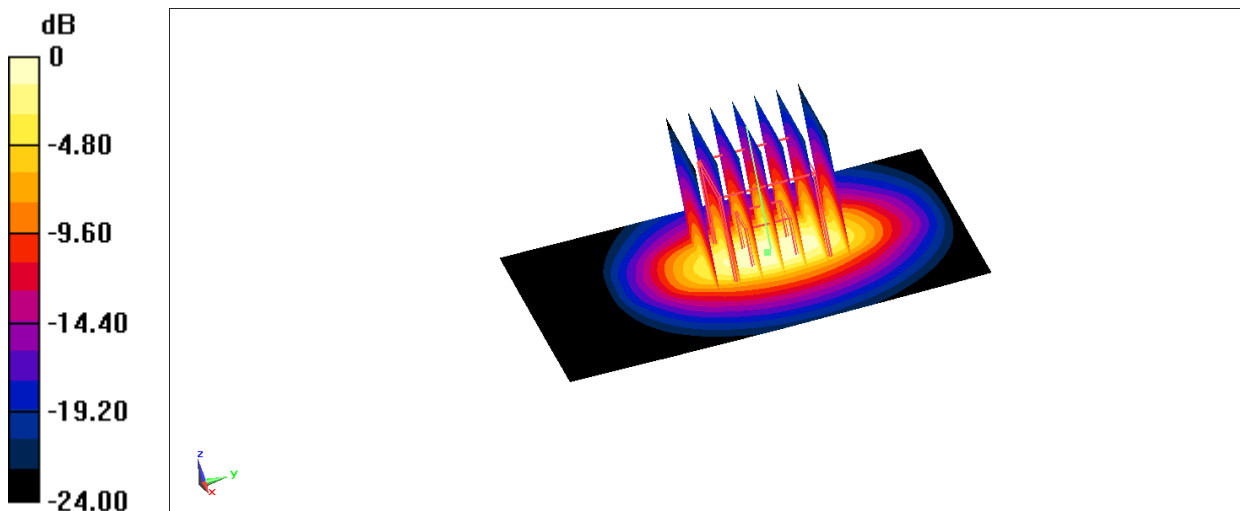

0 dB = 25.8 W/kg = 14.12 dBW/kg

Fig.B.9 validation 2600 MHz 250mW

2600 MHz

Date: 5/14/2022

Electronics: DAE4 Sn549

Medium: Head 2600 MHz

Medium parameters used: $f = 2600$ MHz; $\sigma = 1.953$ mho/m; $\epsilon_r = 38.41$; $\rho = 1000$ kg/m³

Ambient Temperature: 22.5°C Liquid Temperature: 22.3°C

Communication System: CW Frequency: 2600 MHz Duty Cycle: 1:1

Probe: EX3DV4 – SN7464 ConvF(7.64,7.64,7.64)

System Validation /Area Scan (81x191x1): Interpolated grid: dx=1.200 mm, dy=1.200 mm

Reference Value = 121.78 V/m; Power Drift = -0.07

Fast SAR: SAR(1 g) = 14.04 W/kg; SAR(10 g) = 6.29 W/kg

Maximum value of SAR (interpolated) = 24.53 W/kg

System Validation /Zoom Scan (7x7x7)/Cube 0: Measurement grid: dx=5mm, dy=5mm, dz=5mm

Reference Value = 121.78 V/m; Power Drift = -0.07 dB

Peak SAR (extrapolated) = 28.97 W/kg

SAR(1 g) = 13.7 W/kg; SAR(10 g) = 6.07 W/kg

Maximum value of SAR (measured) = 23.3 W/kg

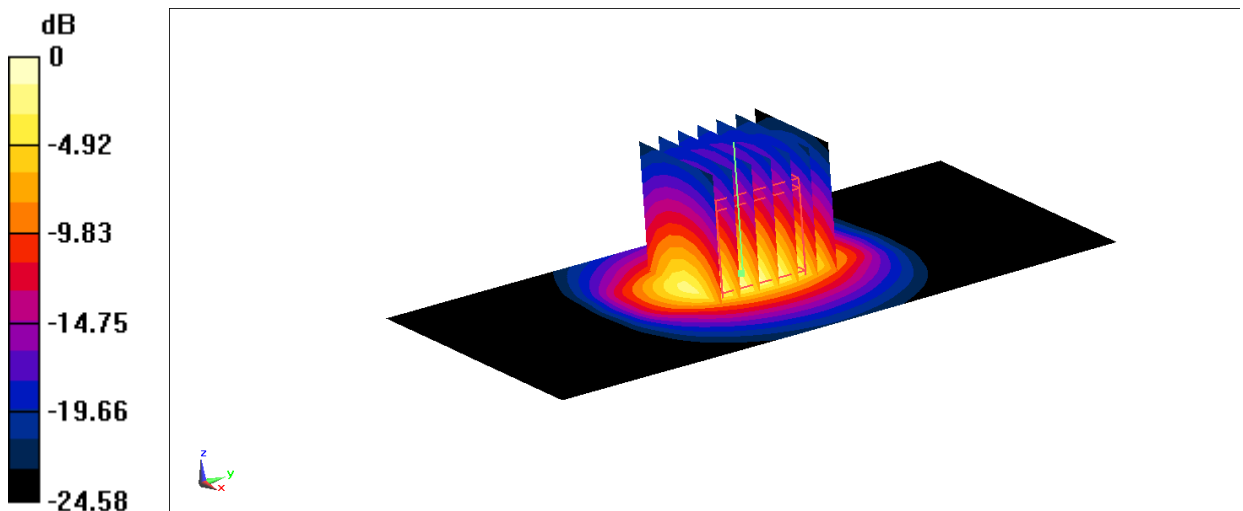

$$0 \text{ dB} = 23.3 \text{ W/kg} = 13.67 \text{ dBW/kg}$$

Fig.B.10 validation 2600 MHz 250mW

2450 MHz

Date: 5/15/2022

Electronics: DAE4 Sn549

Medium: Head 2450 MHz

Medium parameters used: $f = 2450$ MHz; $\sigma = 1.815$ mho/m; $\epsilon_r = 39.32$; $\rho = 1000$ kg/m³

Ambient Temperature: 22.5°C Liquid Temperature: 22.3°C

Communication System: CW Frequency: 2450 MHz Duty Cycle: 1:1

Probe: EX3DV4 – SN7464 ConvF(7.77,7.77,7.77)

System Validation /Area Scan (81x191x1): Interpolated grid: dx=1.200 mm, dy=1.200 mm

Reference Value = 117.26 V/m; Power Drift = -0.1

Fast SAR: SAR(1 g) = 12.89 W/kg; SAR(10 g) = 6.21 W/kg

Maximum value of SAR (interpolated) = 21.73 W/kg

System Validation /Zoom Scan (7x7x7)/Cube 0: Measurement grid: dx=5mm, dy=5mm, dz=5mm

Reference Value = 117.26 V/m; Power Drift = -0.1 dB

Peak SAR (extrapolated) = 26.53 W/kg

SAR(1 g) = 13.06 W/kg; SAR(10 g) = 6.22 W/kg

Maximum value of SAR (measured) = 22.19 W/kg

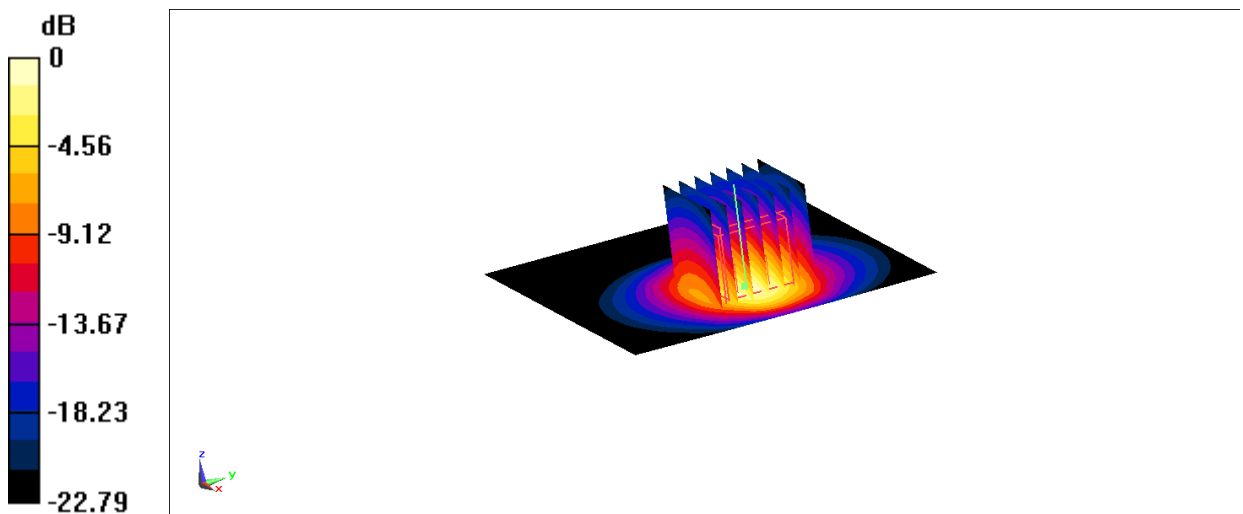

$$0 \text{ dB} = 24.1 \text{ W/kg} = 13.82 \text{ dBW/kg}$$

Fig.B.11 validation 2450 MHz

5250 MHz

Date: 5/16/2022

Electronics: DAE4 Sn549

Medium: Head 5250 MHz

Medium parameters used: $f = 5250 \text{ MHz}$; $\sigma = 4.626 \text{ mho/m}$; $\epsilon_r = 35.89$; $\rho = 1000 \text{ kg/m}^3$

Ambient Temperature: 22.5°C Liquid Temperature: 22.3°C

Communication System: CW Frequency: 5250 MHz Duty Cycle: 1:1

Probe: EX3DV4 – SN7464 ConvF(5.43,5.43,5.43)

System Validation /Area Scan (81x191x1): Interpolated grid: $dx=1.000 \text{ mm}$, $dy=1.000 \text{ mm}$

Maximum value of SAR (interpolated) = 18.4 W/kg

System Validation /Zoom Scan (7x7x7)/Cube 0: Measurement grid: $dx=4\text{mm}$, $dy=4\text{mm}$, $dz=1.4\text{mm}$

Reference Value = 79.46 V/m; Power Drift = -0.05 dB

Peak SAR (extrapolated) = 28.57 W/kg

SAR(1 g) = 20.28 W/kg; SAR(10 g) = 5.67 W/kg

Maximum value of SAR (measured) = 18.11 W/kg

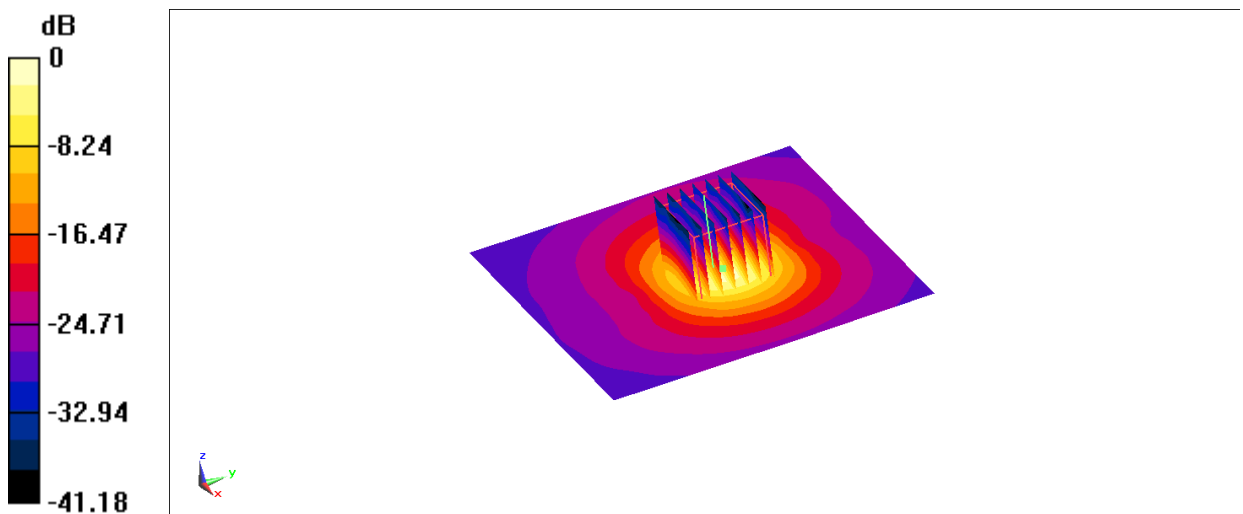

0 dB = 17.7 W/kg = 12.48 dBW/kg

Fig.B.12 validation 5250 MHz 100mW

5600 MHz

Date: 5/17/2022

Electronics: DAE4 Sn549

Medium: Head 5600 MHz

Medium parameters used: $f = 5600$ MHz; $\sigma = 5.085$ mho/m; $\epsilon_r = 34.97$; $\rho = 1000$ kg/m³

Ambient Temperature: 22.5°C Liquid Temperature: 22.3°C

Communication System: CW Frequency: 5600 MHz Duty Cycle: 1:1

Probe: EX3DV4 – SN7464 ConvF(5.11,5.11,5.11)

System Validation /Area Scan (81x191x1): Interpolated grid: dx=1.000 mm, dy=1.000 mm

Maximum value of SAR (interpolated) = 20.09 W/kg

System Validation /Zoom Scan (7x7x7)/Cube 0: Measurement grid: dx=4mm, dy=4mm, dz=1.4mm

Reference Value =78.21 V/m; Power Drift = -0.04 dB

Peak SAR (extrapolated) = 31.35 W/kg

SAR(1 g) = 20.54 W/kg; SAR(10 g) = 5.88 W/kg

Maximum value of SAR (measured) = 20.37 W/kg

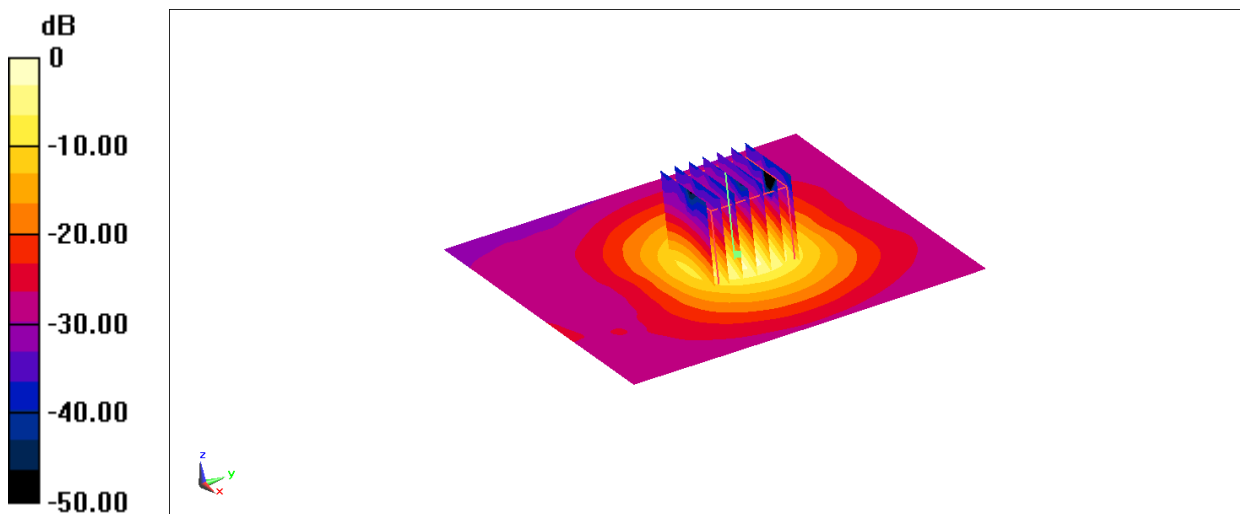

0 dB = 18.9 W/kg = 12.76 dBW/kg

Fig.B.13 validation 5600 MHz 100mW

5750 MHz

Date: 5/18/2022

Electronics: DAE4 Sn549

Medium: Head 5750 MHz

Medium parameters used: $f = 5750 \text{ MHz}$; $\sigma = 5.154 \text{ mho/m}$; $\epsilon_r = 34.77$; $\rho = 1000 \text{ kg/m}^3$

Ambient Temperature: 22.5°C Liquid Temperature: 22.3°C

Communication System: CW Frequency: 5750 MHz Duty Cycle: 1:1

Probe: EX3DV4 – SN7464 ConvF(4.85,4.85,4.85)

System Validation /Area Scan (81x191x1): Interpolated grid: $dx=1.000 \text{ mm}$, $dy=1.000 \text{ mm}$

Maximum value of SAR (interpolated) = 20.15 W/kg

System Validation /Zoom Scan (7x7x7)/Cube 0: Measurement grid: $dx=4\text{mm}$, $dy=4\text{mm}$, $dz=1.4\text{mm}$

Reference Value = 76.92 V/m; Power Drift = 0.06 dB

Peak SAR (extrapolated) = 31.83 W/kg

SAR(1 g) = 20.15 W/kg; SAR(10 g) = 5.77 W/kg

Maximum value of SAR (measured) = 19.52 W/kg

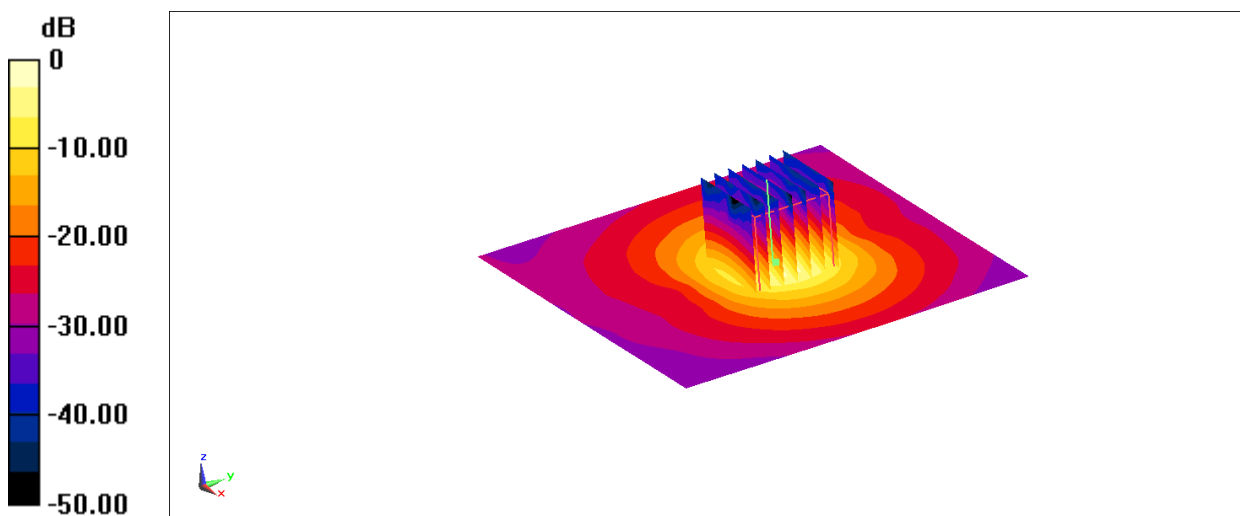

0 dB = 18.4 W/kg = 12.65 dBW/kg

Fig.B.14 validation 5750 MHz 100mW

750 MHz

Date: 2022/5/18

Electronics: DAE4 Sn549

Medium: Head 750 MHz

Medium parameters used: $f = 750 \text{ MHz}$; $\sigma = 0.875 \text{ S/m}$; $\epsilon_r = 45.729$; $\rho = 1000 \text{ kg/m}^3$

Ambient Temperature: 22.5°C Liquid Temperature: 22.3°C

Communication System: CW Frequency: 750 MHz Duty Cycle: 1:1

Probe: EX3DV4 – SN7464 ConvF(10.26,10.26,10.26)

System Validation /Area Scan (81x191x1): Interpolated grid: $dx=1.500 \text{ mm}$, $dy=1.500 \text{ mm}$

Reference Value = 58.99 V/m ; Power Drift = -0.1

Fast SAR: SAR(1 g) = 2.08 W/kg ; SAR(10 g) = 1.4 W/kg

Maximum value of SAR (interpolated) = 2.81 W/kg

System Validation /Zoom Scan (7x7x7)/Cube 0: Measurement grid: $dx=5\text{mm}$, $dy=5\text{mm}$, $dz=5\text{mm}$

Reference Value = 58.99 V/m ; Power Drift = -0.1 dB

Peak SAR (extrapolated) = 3.3 W/kg

SAR(1 g) = 2.11 W/kg ; SAR(10 g) = 1.4 W/kg

Maximum value of SAR (measured) = 2.92 W/kg

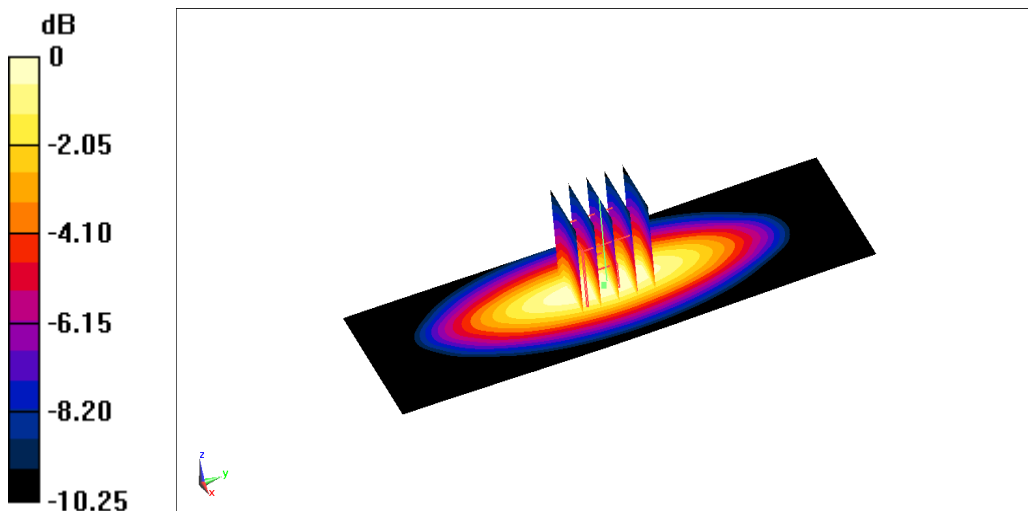

$0 \text{ dB} = 2.92 \text{ W/kg} = 4.65 \text{ dB W/kg}$

Fig.B.15 validation 750 MHz 250mW

3500 MHz

Date: 2022/5/22

Electronics: DAE4 Sn549

Medium: Body 3500 MHz

Medium parameters used: $f = 3500 \text{ MHz}$; $\sigma = 2.963 \text{ S/m}$; $\epsilon_r = 38.84$; $\rho = 1000 \text{ kg/m}^3$

Ambient Temperature: 22.5°C Liquid Temperature: 22.3°C

Communication System: CW Frequency: 3500 MHz Duty Cycle: 1:1

Probe: EX3DV4 – SN7464 ConvF(7.20,7.20,7.20)

System Validation /Area Scan (81x191x1): Interpolated grid: $dx=1.000 \text{ mm}$, $dy=1.000 \text{ mm}$

Maximum value of SAR (interpolated) = 38 W/kg

System Validation /Zoom Scan (7x7x7)/Cube 0: Measurement grid: $dx=4\text{mm}$, $dy=4\text{mm}$, $dz=1.4\text{mm}$

Reference Value = 106.36 V/m; Power Drift = 0.05 dB

Peak SAR (extrapolated) = 50.01 W/kg

SAR(1 g) = 17.14 W/kg; SAR(10 g) = 6.19 W/kg

Maximum value of SAR (measured) = 34.41 W/kg

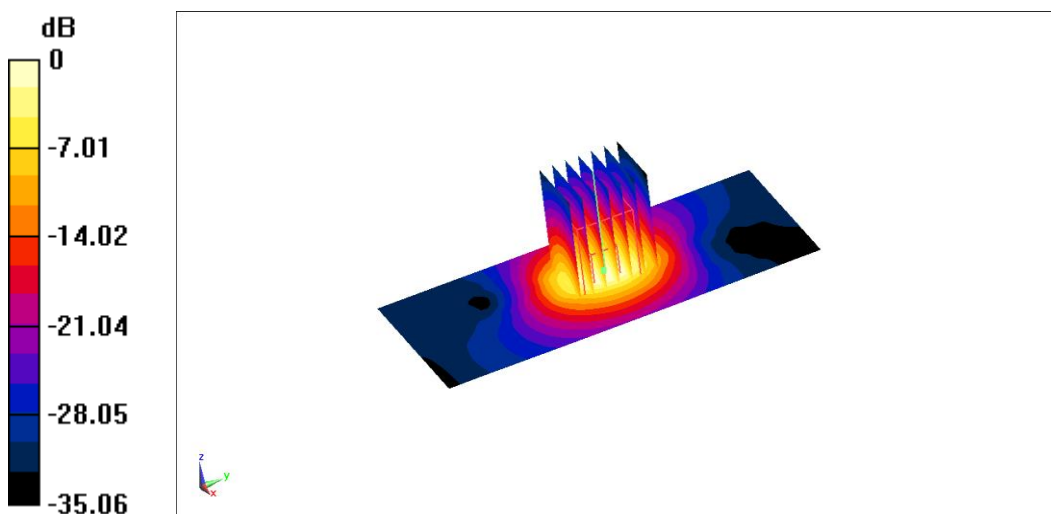

0 dB = 34.41 W/kg = 15.37 dB W/kg

Fig.B.16 validation 3500 MHz 250mW

1750 MHz

Date: 2022/5/19

Electronics: DAE4 Sn549

Medium: Head 1750 MHz

Medium parameters used: $f = 1750 \text{ MHz}$; $\sigma = 1.388 \text{ S/m}$; $\epsilon_r = 43.348$; $\rho = 1000 \text{ kg/m}^3$

Ambient Temperature: 22.5°C Liquid Temperature: 22.3°C

Communication System: CW Frequency: 1750 MHz Duty Cycle: 1:1

Probe: EX3DV4 – SN7464 ConvF(8.52,8.52,8.52)

System Validation /Area Scan (81x191x1): Interpolated grid: $dx=1.500 \text{ mm}$, $dy=1.500 \text{ mm}$

Reference Value = 106.62 V/m ; Power Drift = -0.05

Fast SAR: SAR(1 g) = 9.16 W/kg ; SAR(10 g) = 4.85 W/kg

Maximum value of SAR (interpolated) = 14.15 W/kg

System Validation /Zoom Scan (7x7x7)/Cube 0: Measurement grid: $dx=8\text{mm}$, $dy=8\text{mm}$, $dz=5\text{mm}$

Reference Value = 106.62 V/m ; Power Drift = -0.05 dB

Peak SAR (extrapolated) = 17.02 W/kg

SAR(1 g) = 9.2 W/kg ; SAR(10 g) = 4.73 W/kg

Maximum value of SAR (measured) = 13.88 W/kg

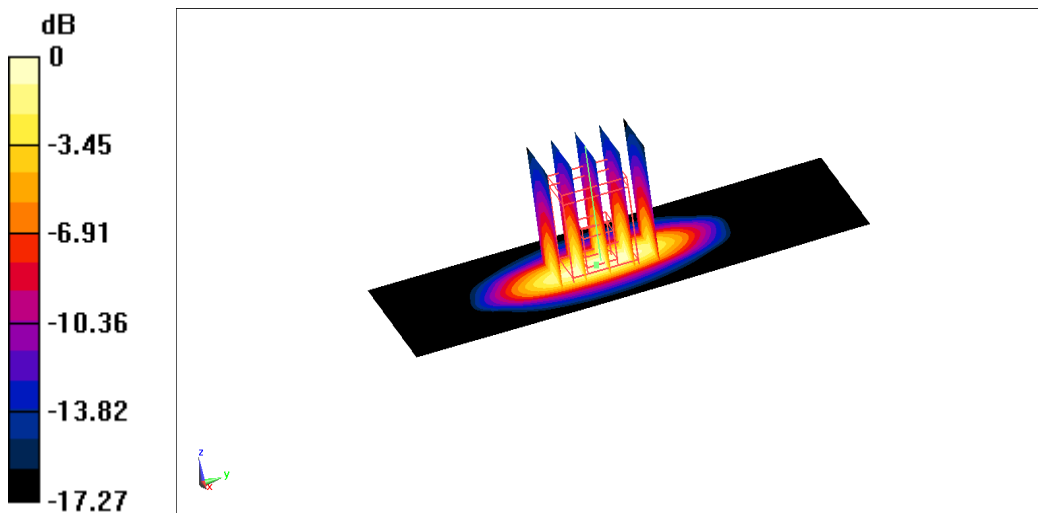

0 dB = 13.88 W/kg = 11.42 dB W/kg

Fig.B.17 validation 1750 MHz 250mW

3900 MHz

Date: 2022/5/23

Electronics: DAE4 Sn549

Medium: Body 3900 MHz

Medium parameters used: $f = 3900 \text{ MHz}$; $\sigma = 3.358 \text{ S/m}$; $\epsilon_r = 38.018$; $\rho = 1000 \text{ kg/m}^3$

Ambient Temperature: 22.5°C Liquid Temperature: 22.3°C

Communication System: CW Frequency: 3900 MHz Duty Cycle: 1:1

Probe: EX3DV4 – SN7464 ConvF(6.76,6.76,6.76)

System Validation /Area Scan (81x191x1): Interpolated grid: dx=1.000 mm, dy=1.000 mm

Maximum value of SAR (interpolated) = 35.11 W/kg

System Validation /Zoom Scan (7x7x7)/Cube 0: Measurement grid: dx=4mm, dy=4mm, dz=1.4mm

Reference Value =65.22 V/m; Power Drift = -0.04 dB

Peak SAR (extrapolated) = 46.39 W/kg

SAR(1 g) = 17.66 W/kg; SAR(10 g) = 6.03 W/kg

Maximum value of SAR (measured) = 32.44 W/kg

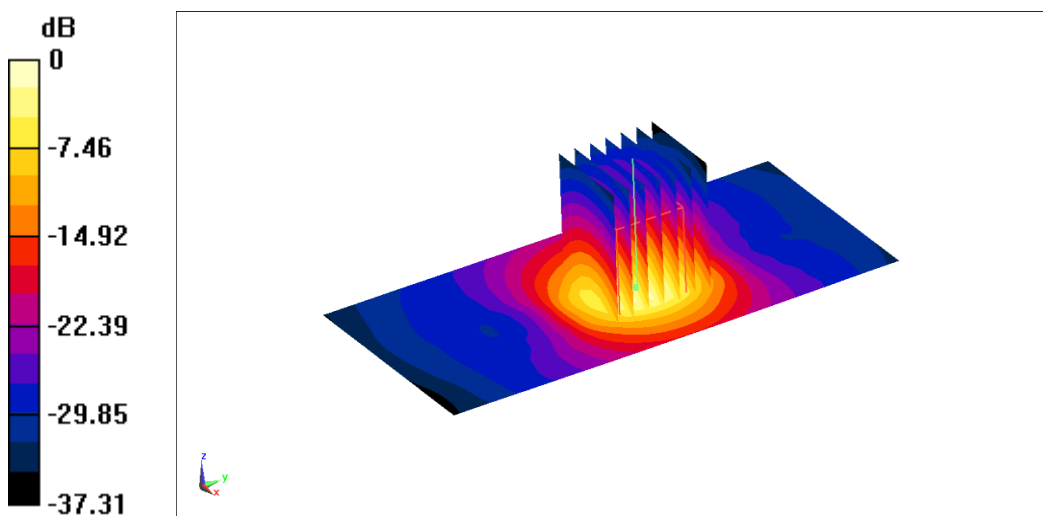

0 dB = 32.44 W/kg = 15.11 dB W/kg

Fig.B.18 validation 3900 MHz 250mW

1900 MHz

Date: 2022/5/20

Electronics: DAE4 Sn549

Medium: Head 1900 MHz

Medium parameters used: $f = 1900 \text{ MHz}$; $\sigma = 1.404 \text{ mho/m}$; $\epsilon_r = 39.36$; $\rho = 1000 \text{ kg/m}^3$

Ambient Temperature: 22.5°C Liquid Temperature: 22.3°C

Communication System: CW Frequency: 1900 MHz Duty Cycle: 1:1

Probe: EX3DV4 – SN7464 ConvF(8.33,8.33,8.33)

System Validation /Area Scan (81x191x1): Interpolated grid: $dx=1.500 \text{ mm}$, $dy=1.500 \text{ mm}$

Reference Value = 107.96 V/m; Power Drift = -0.04

Fast SAR: SAR(1 g) = 10.09 W/kg; SAR(10 g) = 5.1 W/kg

Maximum value of SAR (interpolated) = 15.24 W/kg

System Validation /Zoom Scan (7x7x7)/Cube 0: Measurement grid: $dx=8\text{mm}$, $dy=8\text{mm}$, $dz=5\text{mm}$

Reference Value = 107.96 V/m; Power Drift = -0.04 dB

Peak SAR (extrapolated) = 18.06 W/kg

SAR(1 g) = 9.77 W/kg; SAR(10 g) = 5.13 W/kg

Maximum value of SAR (measured) = 15.33 W/kg

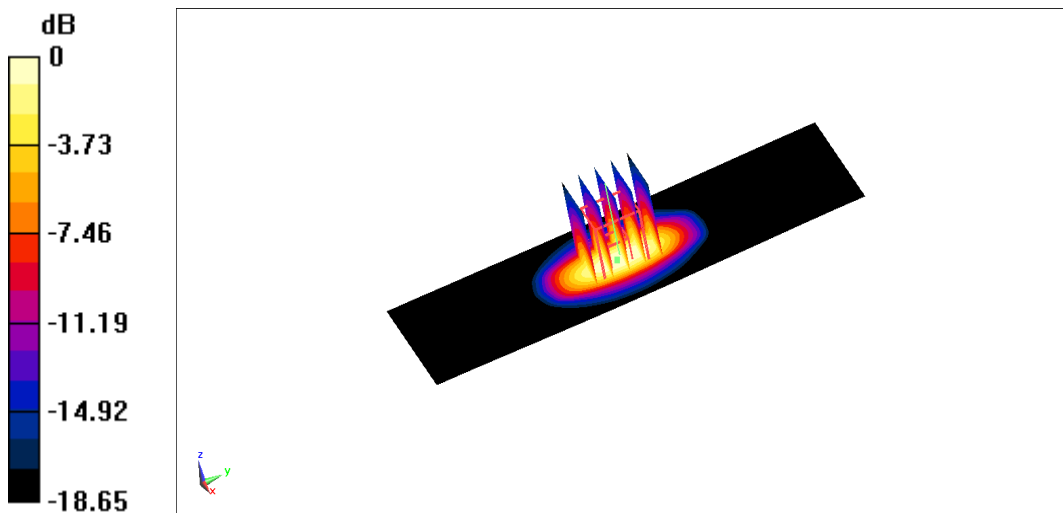

0 dB = 15.33 W/kg = 11.86 dB W/kg

Fig.B.19 validation 1900 MHz 250mW

2600 MHz

Date: 2022/5/21

Electronics: DAE4 Sn549

Medium: Head 2600 MHz

Medium parameters used: $f = 2600$ MHz; $\sigma = 2.041$ S/m; $\epsilon_r = 39.938$; $\rho = 1000$ kg/m³

Ambient Temperature: 22.5°C Liquid Temperature: 22.3°C

Communication System: CW Frequency: 2600 MHz Duty Cycle: 1:1

Probe: EX3DV4 – SN7464 ConvF(8.18,8.18,8.18)

System Validation /Area Scan (81x191x1): Interpolated grid: dx=1.200 mm, dy=1.200 mm

Reference Value = 123.17 V/m; Power Drift = 0.06

Fast SAR: SAR(1 g) = 14.33 W/kg; SAR(10 g) = 6.31 W/kg

Maximum value of SAR (interpolated) = 24.71 W/kg

System Validation /Zoom Scan (7x7x7)/Cube 0: Measurement grid: dx=5mm, dy=5mm, dz=5mm

Reference Value = 123.17 V/m; Power Drift = 0.06 dB

Peak SAR (extrapolated) = 29.05 W/kg

SAR(1 g) = 14.28 W/kg; SAR(10 g) = 6.43 W/kg

Maximum value of SAR (measured) = 23.93 W/kg

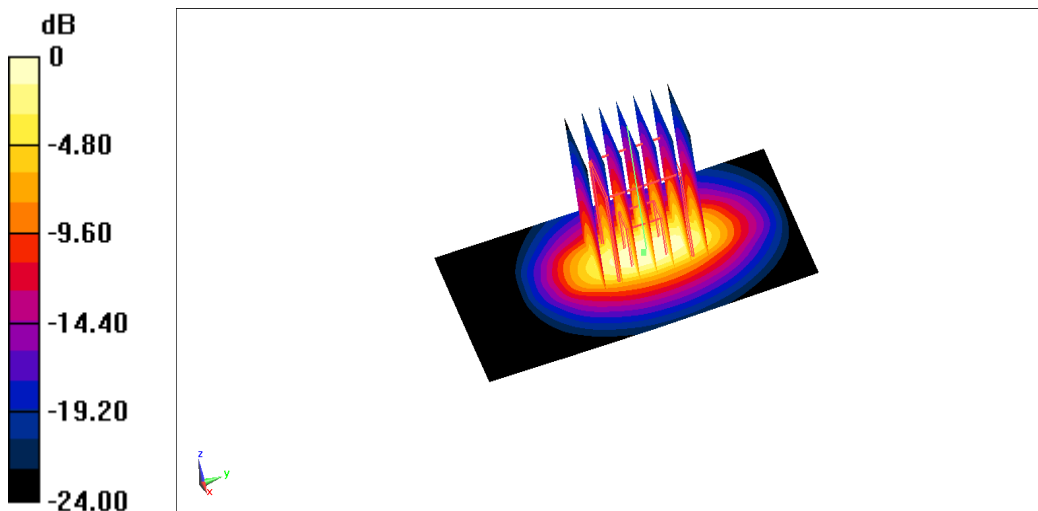

0 dB = 23.93 W/kg = 13.79 dB W/kg

Fig.B.20 validation 2600 MHz 250mW

1750 MHz

Date: 5/19/2022

Electronics: DAE4 Sn549

Medium: Head 1750 MHz

Medium parameters used: $f = 1750 \text{ MHz}$; $\sigma = 1.381 \text{ mho/m}$; $\epsilon_r = 40.21$; $\rho = 1000 \text{ kg/m}^3$

Ambient Temperature: 22.5°C Liquid Temperature: 22.3°C

Communication System: CW Frequency: 1750 MHz Duty Cycle: 1:1

Probe: EX3DV4 – SN7464 ConvF(8.52,8.52,8.52)

System Validation /Area Scan (81x191x1): Interpolated grid: $dx=1.500 \text{ mm}$, $dy=1.500 \text{ mm}$

Reference Value = 105.26 V/m; Power Drift = -0.1

Fast SAR: SAR(1 g) = 8.96 W/kg; SAR(10 g) = 4.84 W/kg

Maximum value of SAR (interpolated) = 14.06 W/kg

System Validation /Zoom Scan (7x7x7)/Cube 0: Measurement grid: $dx=8\text{mm}$, $dy=8\text{mm}$, $dz=5\text{mm}$

Reference Value = 105.26 V/m; Power Drift = -0.1 dB

Peak SAR (extrapolated) = 17.01 W/kg

SAR(1 g) = 9.08 W/kg; SAR(10 g) = 4.85 W/kg

Maximum value of SAR (measured) = 14.35 W/kg

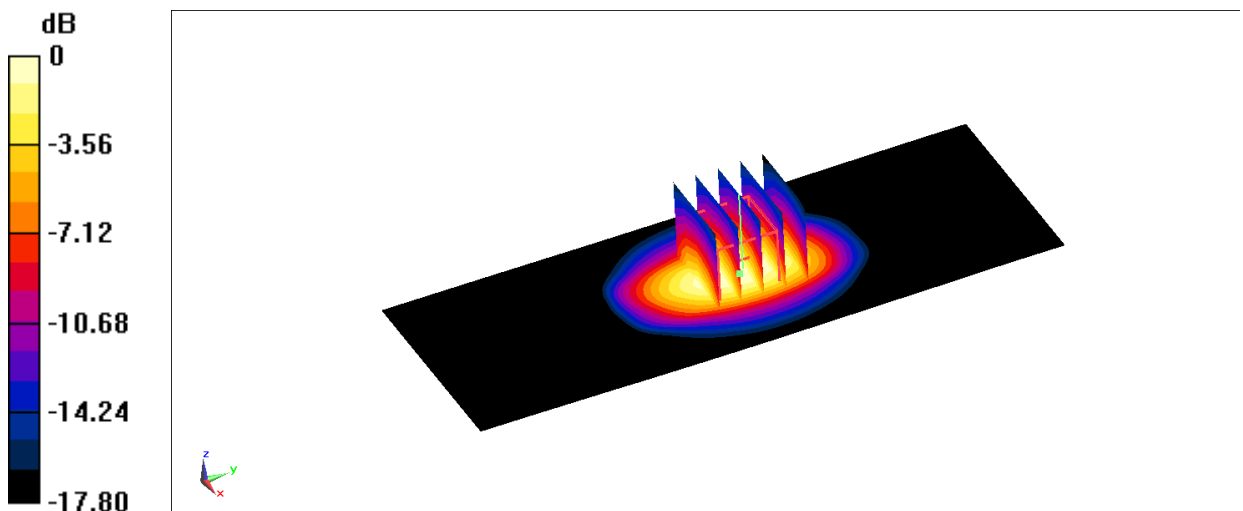

0 dB = 14.35 W/kg = 11.57 dB W/kg

Fig.B.21 validation 1750 MHz 250mW

1900 MHz

Date: 5/20/2022

Electronics: DAE4 Sn549

Medium: Head 1900 MHz

Medium parameters used: $f = 1900$ MHz; $\sigma = 1.375$ mho/m; $\epsilon_r = 39.95$; $\rho = 1000$ kg/m³

Ambient Temperature: 22.5°C Liquid Temperature: 22.3°C

Communication System: CW Frequency: 1900 MHz Duty Cycle: 1:1

Probe: EX3DV4 – SN7464 ConvF(8.18,8.18,8.18)

System Validation /Area Scan (81x191x1): Interpolated grid: dx=1.500 mm, dy=1.500 mm

Reference Value = 109.43 V/m; Power Drift = -0.05

Fast SAR: SAR(1 g) = 9.94 W/kg; SAR(10 g) = 5.23 W/kg

Maximum value of SAR (interpolated) = 15.27 W/kg

System Validation /Zoom Scan (7x7x7)/Cube 0: Measurement grid: dx=8mm, dy=8mm, dz=5mm

Reference Value = 109.43 V/m; Power Drift = -0.05 dB

Peak SAR (extrapolated) = 18.44 W/kg

SAR(1 g) = 9.98 W/kg; SAR(10 g) = 5.1 W/kg

Maximum value of SAR (measured) = 14.96 W/kg

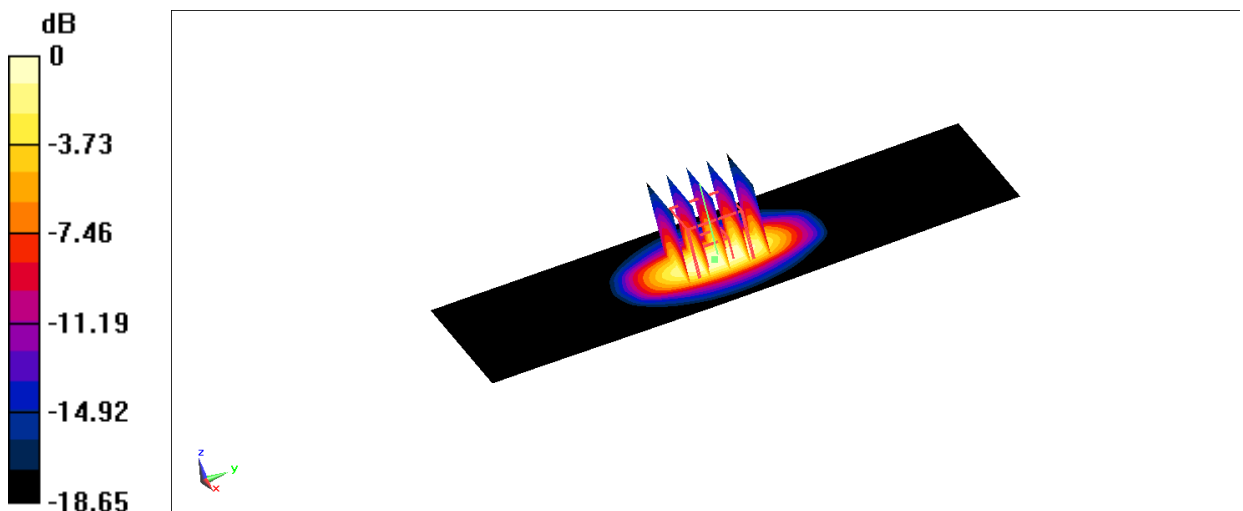

0 dB = 14.96 W/kg = 11.75 dB W/kg

Fig.B.22 validation 1900 MHz 250mW

ANNEX C SAR Measurement Setup

C.1 Measurement Set-up

The Dasy5 or DASY6 system for performing compliance tests is illustrated above graphically. This

system consists of the following items:

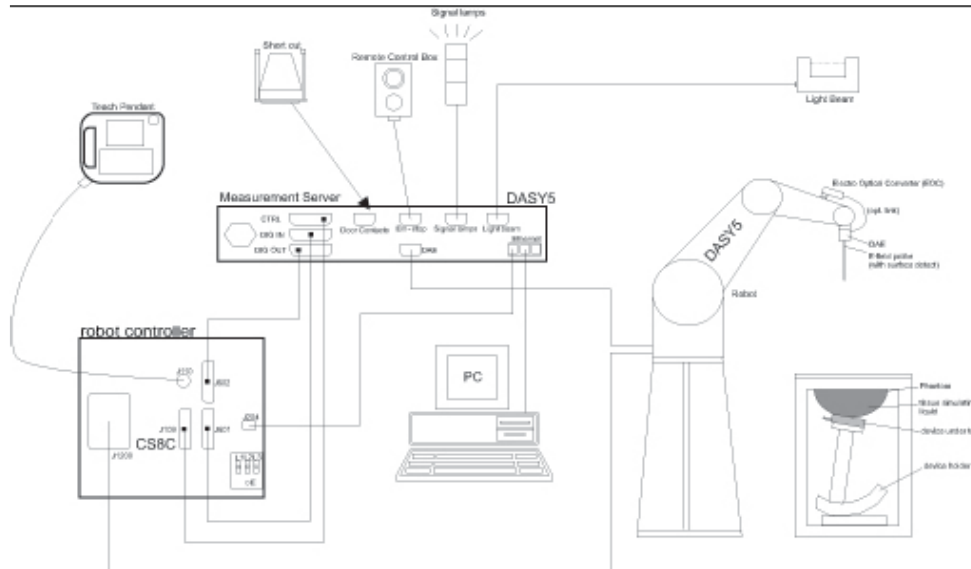

Picture C.1 SAR Lab Test Measurement Set-up

- A standard high precision 6-axis robot (StäubliTX=RX family) with controller, teach pendant and software. An arm extension for accommodating the data acquisition electronics (DAE).
- An isotropic field probe optimized and calibrated for the targeted measurement.
- A data acquisition electronics (DAE) which performs the signal amplification, signal multiplexing, AD-conversion, offset measurements, mechanical surface detection, collision detection, etc. The unit is battery powered with standard or rechargeable batteries. The signal is optically transmitted to the EOC.
- The Electro-optical converter (EOC) performs the conversion from optical to electrical signals for the digital communication to the DAE. To use optical surface detection, a special version of the EOC is required. The EOC signal is transmitted to the measurement server.
- The function of the measurement server is to perform the time critical tasks such as signal filtering, control of the robot operation and fast movement interrupts.
- The Light Beam used is for probe alignment. This improves the (absolute) accuracy of the probe positioning.
- A computer running WinXP and the DASY5 or DASY6 software.
- Remote control and teach pendant as well as additional circuitry for robot safety such as
- warning lamps, etc.
- The phantom, the device holder and other accessories according to the targeted measurement.

C.2 Dasy5 E-field Probe System

The SAR measurements were conducted with the dosimetric probe designed in the classical triangular configuration and optimized for dosimetric evaluation. The probe is constructed using the thick film technique; with printed resistive lines on ceramic substrates. The probe is equipped with an optical multifiber line ending at the front of the probe tip. It is connected to the EOC box on the

robot arm and provides an automatic detection of the phantom surface. Half of the fibers are connected to a pulsed infrared transmitter, the other half to a synchronized receiver. As the probe approaches the surface, the reflection from the surface produces a coupling from the transmitting to the receiving fibers. This reflection increases first during the approach, reaches maximum and then decreases. If the probe is flatly touching the surface, the coupling is zero. The distance of the coupling maximum to the surface is independent of the surface reflectivity and largely independent of the surface to probe angle. The DASY5 or DASY6 software reads the reflection during a software approach and looks for the maximum using 2nd order curve fitting. The approach is stopped at reaching the maximum.

Probe Specifications:

Model: ES3DV3, EX3DV4
Frequency 10MHz — 6.0GHz(EX3DV4)
Range: 10MHz — 4GHz(ES3DV3)
Calibration: In head and body simulating tissue at
 Frequencies from 835 up to 5800MHz
Linearity: ± 0.2 dB(30 MHz to 6 GHz) for EX3DV4
 ± 0.2 dB(30 MHz to 4 GHz) for ES3DV3
DynamicRange: 10 mW/kg — 100W/kg
Probe Length: 330 mm
Probe Tip
Length: 20 mm
Body Diameter: 12 mm
Tip Diameter: 2.5 mm (3.9 mm for ES3DV3)
Tip-Center: 1 mm (2.0mm for ES3DV3)
Application:SAR Dosimetry Testing
 Compliance tests of mobile phones
 Dosimetry in strong gradient fields



Picture C.2Near-field Probe



Picture C.3E-field Probe

C.3 E-field Probe Calibration

Each E-Probe/Probe Amplifier combination has unique calibration parameters. A TEM cell calibration procedure is conducted to determine the proper amplifier settings to enter in the probe parameters. The amplifier settings are determined for a given frequency by subjecting the probe to a known E-field density (1 mW/cm²) using an RF Signal generator, TEM cell, and RF Power Meter.

The free space E-field from amplified probe outputs is determined in a test chamber. This calibration can be performed in a TEM cell if the frequency is below 1 GHz and in a waveguide or other methodologies above 1 GHz for free space. For the free space calibration, the probe is placed in the volumetric center of the cavity and at the proper orientation with the field. The probe is then rotated 360 degrees until the three channels show the maximum reading. The power density readings equate to 1 mW/cm².

E-field temperature correlation calibration is performed in a flat phantom filled with the appropriate simulated brain tissue. The E-field in the medium correlates with the temperature rise in the

dielectric medium. For temperature correlation calibration a RF transparent thermistor-based temperature probe is used in conjunction with the E-field probe.

$$SAR = C \frac{\Delta T}{\Delta t}$$

Where:

Δt = Exposure time (30 seconds),

C = Heat capacity of tissue (brain or muscle),

ΔT = Temperature increase due to RF exposure.

$$SAR = \frac{|E|^2 \cdot \sigma}{\rho}$$

Where:

σ = Simulated tissue conductivity,

ρ = Tissue density (kg/m³).

C.4 Other Test Equipment

C.4.1 Data Acquisition Electronics(DAE)

The data acquisition electronics consist of a highly sensitive electrometer-grade preamplifier with auto-zeroing, a channel and gain-switching multiplexer, a fast 16 bit AD-converter and a command decoder with a control logic unit. Transmission to the measurement server is accomplished through an optical downlink for data and status information, as well as an optical uplink for commands and the clock.

The mechanical probe mounting device includes two different sensor systems for frontal and sideways probe contacts. They are used for mechanical surface detection and probe collision detection.

The input impedance of the DAE is 200 MOhm; the inputs are symmetrical and floating. Common mode rejection is above 80 dB.

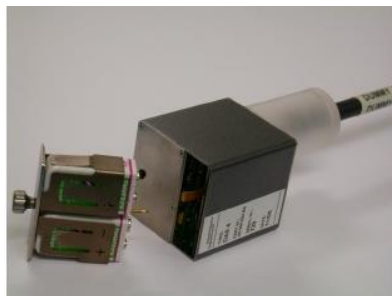

PictureC.4: DAE

C.4.2 Robot

The SPEAG DASY system uses the high precision robots (DASY5: RX160L) type from Stäubli SA (France). For the 6-axis controller system, the robot controller version from Stäubli is used. The Stäubli robot series have many features that are important for our application:

- High precision (repeatability 0.02mm)

- High reliability (industrial design)
- Low maintenance costs (virtually maintenance free due to direct drive gears; no belt drives)
- Jerk-free straight movements (brushless synchron motors; no stepper motors)
- Low ELF interference (motor control fields shielded via the closed metallic construction shields)



Picture C.5 DASY 5

C.4.3 Measurement Server

The Measurement server is based on a PC/104 CPU board with CPU (DASY5: 400 MHz, Intel Celeron), chipdisk (DASY5: 128MB), RAM DASY5: 128MB). The necessary circuits for communication with the DAE electronic box, as well as the 16 bit AD converter system for optical detection and digital I/O interface are contained on the DASY I/O board, which is directly connected to the PC/104 bus of the CPU board.

The measurement server performs all real-time data evaluation of field measurements and surface detection, controls robot movements and handles safety operation. The PC operating system cannot interfere with these time critical processes. All connections are supervised by a watchdog, and disconnection of any of the cables to the measurement server will automatically disarm the robot and disable all program-controlled robot movements. Furthermore, the measurement server is equipped with an expansion port which is reserved for future applications. Please note that this expansion port does not have a standardized pinout, and therefore only devices provided by SPEAG can be connected. Devices from any other supplier could seriously damage the measurement server.



Picture C.6 Server for DASY 5

C.4.4 Device Holder for Phantom

The SAR in the phantom is approximately inversely proportional to the square of the distance between the source and the liquid surface. For a source at 5mm distance, a positioning uncertainty of $\pm 0.5\text{mm}$ would produce a SAR uncertainty of $\pm 20\%$. Accurate device positioning is therefore crucial for accurate and repeatable measurements. The positions in which the devices must be

measured are defined by the standards.

The DASY device holder is designed to cope with the different positions given in the standard. It has two scales for device rotation (with respect to the body axis) and device inclination (with respect to the line between the ear reference points). The rotation centers for both scales are the ear reference point (ERP). Thus the device needs no repositioning when changing the angles.

The DASY device holder is constructed of low-loss POM material having the following dielectric parameters: relative permittivity $\epsilon = 3$ and loss tangent $\delta = 0.02$. The amount of dielectric material has been reduced in the closest vicinity of the device, since measurements have suggested that the influence of the clamp on the test results could thus be lowered.

<Laptop Extension Kit>

The extension is lightweight and made of POM, acrylic glass and foam. It fits easily on the upper part of the Mounting Device in place of the phone positioner. The extension is fully compatible with the Twin-SAM and ELI phantoms.



Picture C7-1: Device Holder

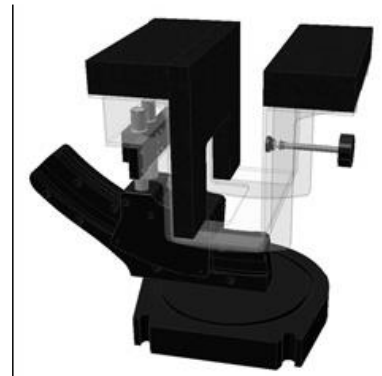

Picture C.7-2: Laptop Extension Kit

C.4.5 Phantom

The SAM Twin Phantom V4.0 is constructed of a fiberglass shell integrated in a table. The shape of the shell is based on data from an anatomical study designed to

Represent the 90th percentile of the population. The phantom enables the dissymmetric evaluation of SAR for both left and right handed handset usage, as well as body-worn usage using the flat phantom region. Reference markings on the Phantom allow the complete setup of all predefined phantom positions and measurement grids by manually teaching three points in the robot. The shell phantom has a 2mm shell thickness (except the ear region where shell thickness increases to 6 mm).

Shell Thickness: 2 ± 0.2 mm

Filling Volume: Approx. 25 liters

Dimensions: 810 x 1000 x 500 mm (H x L x W)

Available: Special



Picture C.8: SAM Twin Phantom

ANNEX D Position of the wireless device in relation to the phantom

D.1 General considerations

This standard specifies two handset test positions against the head phantom – the “cheek” position and the “tilt” position.

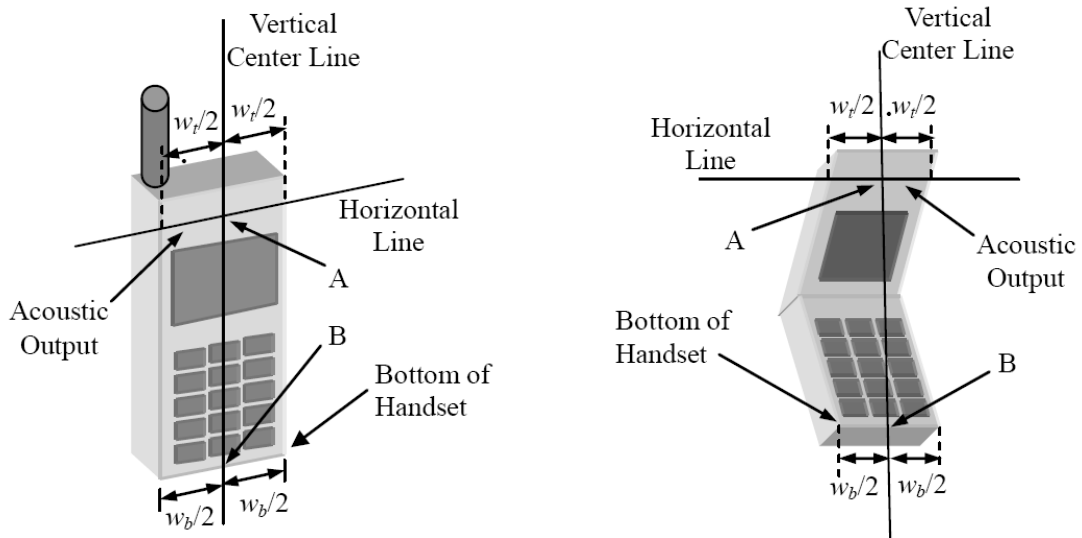

- w_t Width of the handset at the level of the acoustic
- w_b Width of the bottom of the handset
- A Midpoint of the width w_t of the handset at the level of the acoustic output
- B Midpoint of the width w_b of the bottom of the handset

Picture D.1-a Typical “fixed” case handset Picture D.1-b Typical “clam-shell” case handset

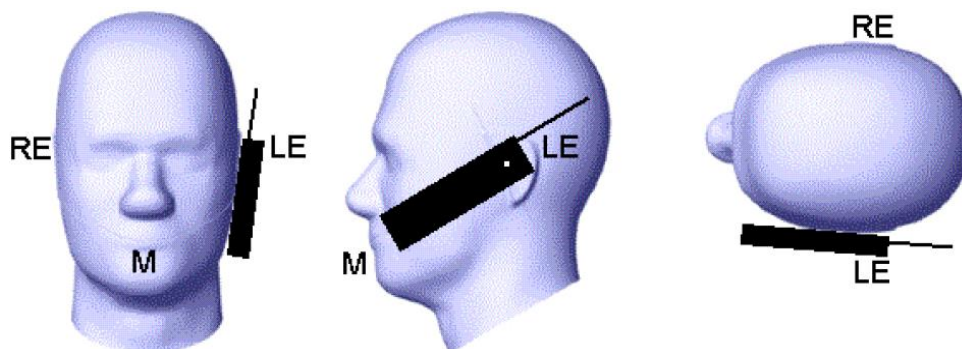

Picture D.2 Cheek position of the wireless device on the left side of SAM

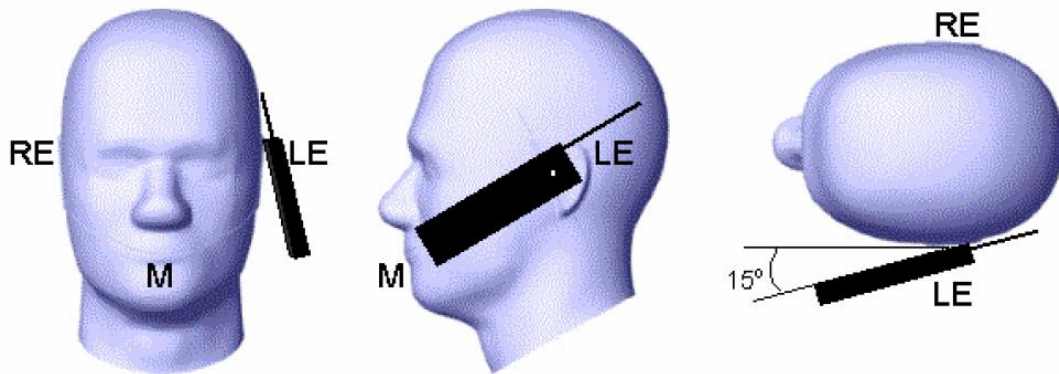

Picture D.3 Tilt position of the wireless device on the left side of SAM

D.2 Body-worn device

A typical example of a body-worn device is a mobile phone, wireless enabled PDA or other battery operated wireless device with the ability to transmit while mounted on a person's body using a carry accessory approved by the wireless device manufacturer.

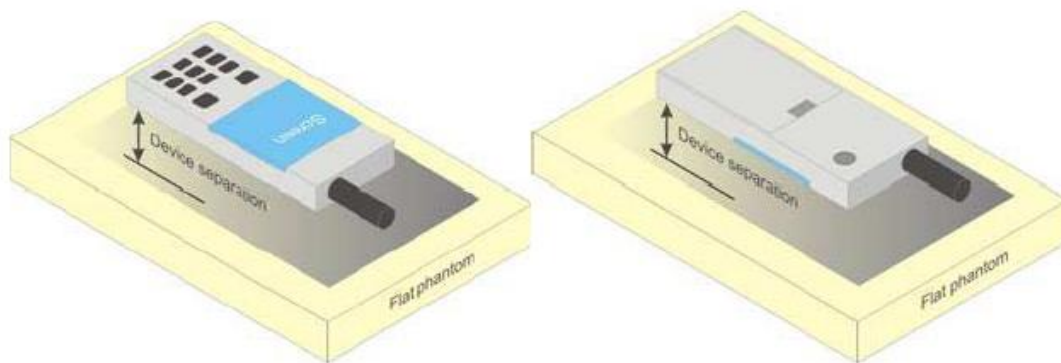

Picture D.4 Test positions for body-worn devices

D.3 Desktop device

A typical example of a desktop device is a wireless enabled desktop computer placed on a table or desk when used.

The DUT shall be positioned at the distance and in the orientation to the phantom that corresponds to the intended use as specified by the manufacturer in the user instructions. For devices that employ an external antenna with variable positions, tests shall be performed for all antenna positions specified. Picture 8.5 show positions for desktop device SAR tests. If the intended use is not specified, the device shall be tested directly against the flat phantom.