

# FCC HAC (RF Emission) Test Report

**Report No.** : PSU-NQN2204190209HA01  
**Applicant** : HMD Global Oy  
**Address** : Bertel Jungin aukio 9,02600 Espoo,Finland  
**Product** : GSM/WCDMA/LTE Mobile Phone  
**FCC ID** : 2AJOTTA-1469  
**Brand** : NOKIA  
**Model No.** : TA-1469  
**Standards** : FCC 47 CFR Part 20.19, ANSI C63.19-2011  
                   KDB 285076 D01 v05, KDB 285076 D02 v03  
**Sample Received Date** : Apr.14, 2022  
  
**Date of Testing** : Apr.14, 2022 ~ Apr.17, 2022  
**Summary M-Rating** : M4

**CERTIFICATION:** The above equipment have been tested by **Huarui Saiwei (Suzhou) Technology Co., LTD.**, and found compliance with the requirement of the above standards. The test record, data evaluation & Equipment Under Test (EUT) configurations represented herein are true and accurate accounts of the measurements of the sample's HAC characteristics under the conditions specified in this report. It should not be reproduced except in full, without the written approval of our laboratory. The client should not use it to claim product certification, approval, or endorsement by A2LA or any government agencies.

**Prepared By :**

*Shunxin Hou*

---

Shun Xin Hou / Engineer



Certificate #6613.01

**Approved By :**

*Chao Wu*

---

Chao Wu/ Manager

This report is for your exclusive use. Any copying or replication of this report to or for any other person or entity, or use of our name or trademark, is permitted only with our prior written permission. This report sets forth our findings solely with respect to the test samples identified herein. The results set forth in this report are not indicative or representative of the quality or characteristics of the lot from which a test sample was taken or any similar or identical product unless specifically and expressly noted. Our report includes all of the tests requested by you and the results thereof based upon the information that you provided to us. You have 60 days from date of issuance of this report to notify us of any material error or omission caused by our negligence, provided, however, that such notice shall be in writing and shall specifically address the issue you wish to raise. A failure to raise such issue within the prescribed time shall constitute your unqualified acceptance of the completeness of this report, the tests conducted and the correctness of the report contents. Unless specific mention, the uncertainty of measurement has been explicitly taken into account to declare the compliance or non-compliance to the specification.

## Table of Contents

<b>Release Control Record .....</b>	<b>3</b>
<b>1. Summary of Maximum M-Rating .....</b>	<b>4</b>
<b>2. Description of Equipment Under Test .....</b>	<b>5</b>
<b>3. HAC RF Emission Measurement System .....</b>	<b>7</b>
3.1 SPEAG DASYS System .....	7
3.1.1 Robot .....	8
3.1.2 Probes.....	8
3.1.3 Data Acquisition Electronics (DAE) .....	9
3.1.4 Phantoms .....	9
3.1.5 Device Holder.....	9
3.1.6 RF Emission Calibration Dipoles.....	9
3.2 DASYS System Verification.....	10
3.3 EUT Measurements Reference and Plane.....	11
3.4 HAC RF Emission Measurement Procedure .....	12
3.5 Modulation Interference Factor .....	14
<b>4. HAC Measurement Evaluation.....</b>	<b>16</b>
4.1 M-Rating Category .....	16
4.2 EUT Configuration and Setting.....	16
4.3 System Verification .....	16
4.4 Maximum Target Conducted Power .....	17
4.5 Low Power Exemption Evaluation.....	19
4.6 Measured Conducted Power Results.....	20
4.7 HAC RF Emission Testing Results .....	21
<b>5. Calibration of Test Equipment.....</b>	<b>22</b>
<b>6. Measurement Uncertainty .....</b>	<b>23</b>
<b>7. Information of the Testing Laboratories.....</b>	<b>24</b>
<b>Appendix A. Plots of System Verification</b>	
<b>Appendix B. Plots of HAC RF Emission Measurement</b>	
<b>Appendix C. Calibration Certificate for Probe and Dipole</b>	
<b>Appendix D. Photographs of EUT and Setup</b>	



## FCC HAC (RF Emission) Test Report

---

### 1. Summary of Maximum M-Rating

Mode	Band	Maximum Audio Interference Level (dBV/m)	M-Rating
GSM	GSM850	32.86	M4
WCDMA	Band V	N/A	M4
FDD-LTE	Band 5	N/A	M4
	Band 7	N/A	M4
Summary		M4	

**Note:**

1. The HAC RF emission limit (**M-rating Category M3**) is specified in FCC 47 CFR part 20.19 and ANSI C63.19.
2. The device RF emission rating is determined by the minimum rating.

## FCC HAC (RF Emission) Test Report

### 2. Description of Equipment Under Test

<b>EUT Type</b>	<b>GSM/WCDMA/LTE Mobile Phone</b>
<b>FCC ID</b>	<b>2AJOTTA-1469</b>
<b>Brand Name</b>	<b>NOKIA</b>
<b>Model Name</b>	<b>TA-1469</b>
<b>HW Version</b>	<b>FF618-MB-V0.2</b>
<b>SW Version</b>	<b>0.2216.11.08</b>
<b>Tx Frequency Bands (Unit: MHz)</b>	<b>GSM</b> GSM850 : 824.2 ~ 848.8 <b>WCDMA</b> Band V : 826.4 ~ 846.6 <b>FDD-LTE</b> Band 5 : 824.7 ~ 848.3 (BW: 1.4M, 3M, 5M, 10M) Band 7 : 2502.5~2567.5 (BW: 5M, 10M, 15M, 20M)
<b>Modulations Supported in Uplink</b>	GSM & GPRS : GMSK WCDMA : QPSK LTE : QPSK, 16QAM
<b>Antenna Type</b>	Fixed Internal Antenna
<b>EUT Stage</b>	Production Unit

**Note:**

1. The above EUT information is declared by manufacturer and for more detailed features description please refers to the manufacturer's specifications or User's Manual.

**List of Accessory:**

<b>Battery</b>	<b>Brand Name</b>	<b>NOKIA</b>
	<b>Model Name</b>	<b>BL-L4E</b>
	<b>Power Rating</b>	-
	<b>Type</b>	<b>Rechargeable Li-ion battery</b>

## FCC HAC (RF Emission) Test Report

### Air Interface and Operational Mode:

Air Interface	Bands	Transport Type	HAC Tested	Simultaneous But Not Tested	Name of Voice Service	Power Reduction
GSM	850	VO	YES	WLAN or BT	CMRS Voice	No
	EGPRS	DT	No	WLAN or BT	N/A	No
WCDMA	V	VO	No <sup>(1)</sup>	WLAN or BT	CMRS Voice	No
	HSPA	DT	No	WLAN or BT	N/A	No
FDD-LTE	5	VD	No	WLAN or BT	VoLTE	No
	7					No
<b>Transport Type</b> VO = Legacy Cellular Voice Service DT = Digital Transport Only (No Voice) VD = IP Voice Service over Digital Transport			<b>Note</b> 1. It applies the low power exemption per ANSI C63.19-2011..			

### **3. HAC RF Emission Measurement System**

#### **3.1 SPEAG DASY System**

DASY system consists of high precision robot, probe alignment sensor, phantom, robot controller, controlled measurement server and near-field probe. The robot includes six axes that can move to the precision position of the DASY5 software defined. The DASY software can define the area that is detected by the probe. The robot is connected to controlled box. Controlled measurement server is connected to the controlled robot box. The DAE includes amplifier, signal multiplexing, AD converter, offset measurement and surface detection. It is connected to the Electro-optical coupler (ECO). The ECO performs the conversion from the optical into digital electric signal of the DAE and transfers data to the PC.

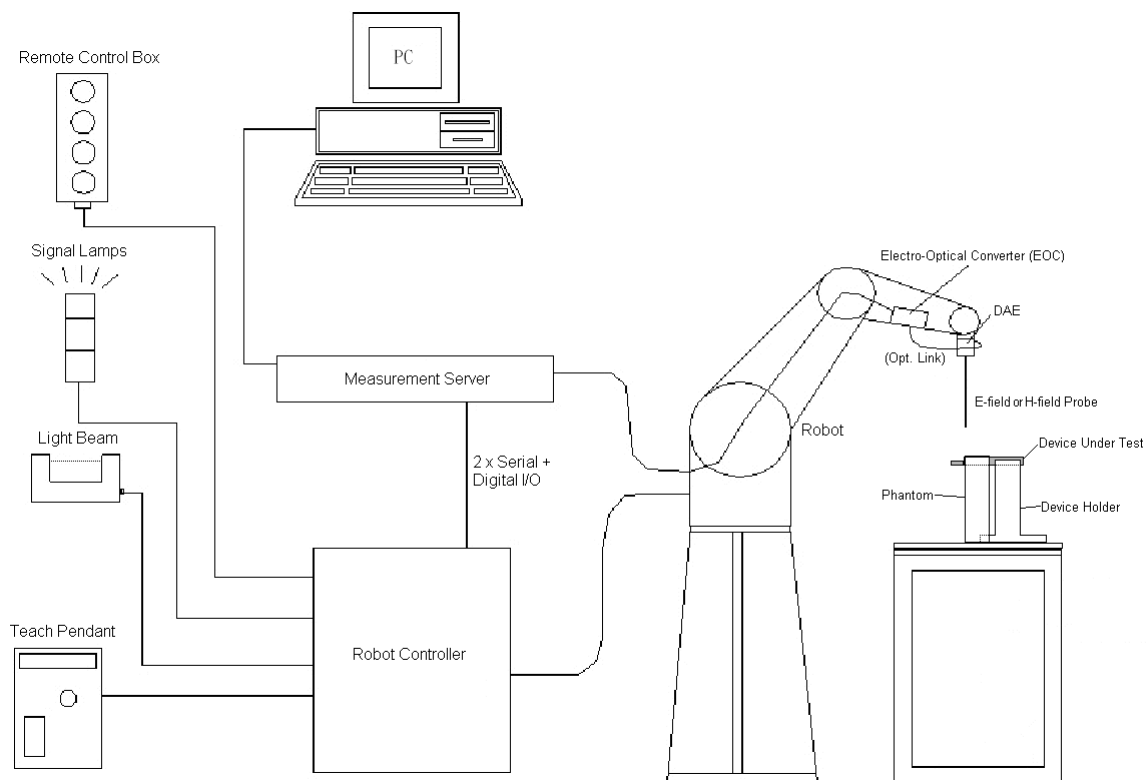

**Fig-3.1 DASY System Setup**

## FCC HAC (RF Emission) Test Report

### 3.1.1 Robot

The DASY6 system uses the high precision robots from Stäubli SA (France). For the 6-axis controller system, the robot controller version (DASY6: CS8c) from Stäubli is used. The Stäubli robot series have many features that are important for our application:

- High precision (repeatability  $\pm 0.035$  mm)
- High reliability (industrial design)
- Jerk-free straight movements
- Low ELF interference (the closed metallic construction shields against motor control fields)

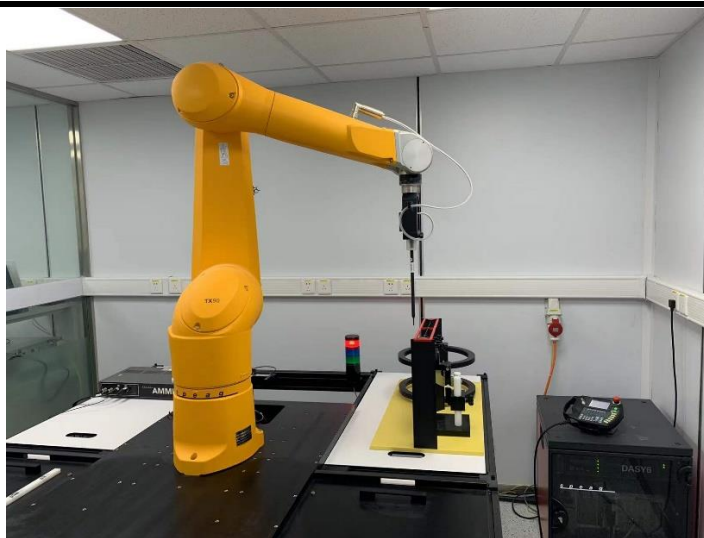

**Fig-3.2 DASY6 Measurement System**

### 3.1.2 Probes

<b>Model</b>	ER3DV6	
<b>Construction</b>	One dipole parallel, two dipoles normal to probe axis Built-in shielding against static charges	
<b>Frequency</b>	40 MHz to 3 GHz Linearity: $\pm 0.2$ dB	
<b>Directivity</b>	$\pm 0.2$ dB in air (rotation around probe axis) $\pm 0.4$ dB in air (rotation normal to probe axis)	
<b>Dynamic Range</b>	2 V/m to 1000 V/m Linearity: $\pm 0.2$ dB	
<b>Dimensions</b>	Overall length: 337 mm (Tip: 16 mm) Tip diameter: 8 mm (Body: 12 mm) Distance from probe tip to dipole centers: 2.5 mm	

<b>Model</b>	EF3DV3	
<b>Construction</b>	One dipole parallel, two dipoles normal to probe axis Built-in shielding against static charges	
<b>Frequency</b>	40 MHz to 6 GHz Linearity: $\pm 0.2$ dB	
<b>Directivity</b>	$\pm 0.2$ dB in air (rotation around probe axis) $\pm 0.4$ dB in air (rotation normal to probe axis)	
<b>Dynamic Range</b>	2 V/m to 1000 V/m Linearity: $\pm 0.2$ dB	
<b>Dimensions</b>	Overall length: 337 mm (Tip: 20 mm) Tip diameter: 3.9 mm (Body: 12 mm) Distance from probe tip to dipole centers: 1.5 mm	



## FCC HAC (RF Emission) Test Report

### 3.1.3 Data Acquisition Electronics (DAE)

<b>Model</b>	DAE3, DAE4	
<b>Construction</b>	Signal amplifier, multiplexer, A/D converter and control logic. Serial optical link for communication with DASY embedded system (fully remote controlled). Two step probe touch detector for mechanical surface detection and emergency robot stop.	
<b>Measurement Range</b>	-100 to +300 mV (16 bit resolution and two range settings: 4mV, 400mV)	
<b>Input Offset Voltage</b>	< 5 $\mu$ V (with auto zero)	
<b>Input Bias Current</b>	< 50 fA	
<b>Dimensions</b>	60 x 60 x 68 mm	

### 3.1.4 Phantoms

<b>Model</b>	Test Arch	
<b>Construction</b>	Enables easy and well defined positioning of the phone and validation dipoles as well as simple teaching of the robot.	
<b>Dimensions</b>	Length : 370 mm Width : 370 mm Height : 370 mm	

### 3.1.5 Device Holder

<b>Model</b>	Mounting Device	
<b>Construction</b>	The Mounting Device enables the rotation of the mounted transmitter device in spherical coordinates. Rotation point is the ear opening point. Transmitter devices can be easily and accurately positioned according to ANSI C63.19.	
<b>Material</b>	POM	

### 3.1.6 RF Emission Calibration Dipoles

<b>Model</b>	CD-Serial	
<b>Construction</b>	Free space antenna Hearing Aid susceptibility measurements according to ANSI C63.19. Validation of Hearing Aid RF setup for wireless device emission measurements according to ANSI C63.19	
<b>Frequency</b>	CD700V3 : 698 ~ 806 MHz CD835V3 : 800 ~ 960 MHz CD1880V3 : 1710 ~ 2000 MHz CD2450V3 : 2250 ~ 2650 MHz CD2600V3 : 2450 ~ 2750 MHz CD3500V3 : 3300 ~ 3950 MHz CD5500V3 : 5000 ~ 5900 MHz	
<b>Return Loss</b>	CD700V3 : > 15 dB (750 MHz > 20 dB) CD835V3 : > 15 dB (835 MHz > 25 dB) CD1880V3 : > 18 dB (1880 MHz > 20 dB) CD2450V3 : > 18 dB (2450 MHz > 25 dB) CD2600V3 : > 18 dB (2600 MHz > 20 dB) CD3500V3 : > 16 dB (3500 MHz > 20 dB) CD5500V3 : > 18 dB (5500 MHz > 20 dB)	
<b>Power Capability</b>	> 40 W continuous	

**3.2 DASY System Verification**

The system check verifies that the system operates within its specifications. It is performed before every E-field measurement. The system check uses normal measurements in the center section of the arch phantom with a matched dipole at a specified distance. The system verification setup is shown as below.

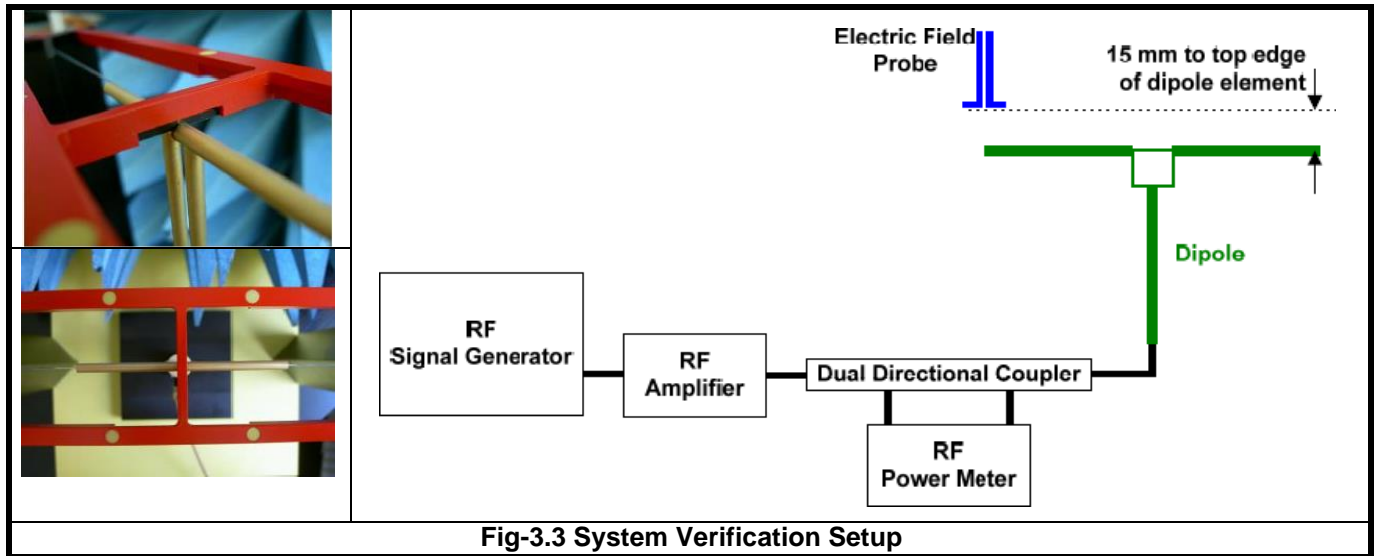

The validation dipole is placed beneath the center of arch phantom. The power meter measures the forward power at the location of the system check dipole connector. The signal generator is adjusted for the desired forward power, 100 mW (20 dBm) at the dipole connector and the RF power meter is read at that level. After connecting the cable to the dipole, the signal generator is readjusted for the same reading at RF power meter.

After system check testing, the E-field result will be compared with the reference value derived from validation dipole certificate report. The deviation of system check should be within 25 %.

The result of system verification is shown in section 4.3 of this report.

## FCC HAC (RF Emission) Test Report

### 3.3 EUT Measurements Reference and Plane

The EUT is mounted in the device holder. The acoustic output of the EUT will coincide with the center point of the area formed by the dielectric wire and the middle bar of the arch's top frame. Then EUT will be moved vertically upwards until it touches the frame.

Fig-3.4 and Fig-3.5 illustrate the references and reference plane that is used in the RF emissions measurement.

- The grid is 50 mm by 50 mm area that is divided into nine evenly sized blocks or sub-grids.
- The grid is centered on the audio frequency output transducer of the EUT.
- The grid is in a reference plane, which is defined as the planar area that contains the highest point in the area of the phone that normally rests against the user's ear. It is parallel to the centerline of the receiver area of the phone and is defined by the points of the receiver-end of the EUT handset, which in normal handset use rest against the ear.
- The measurement plane is parallel to and 15 mm in front of the reference plane.



Fig-3.4 EUT Reference and Plane

## FCC HAC (RF Emission) Test Report

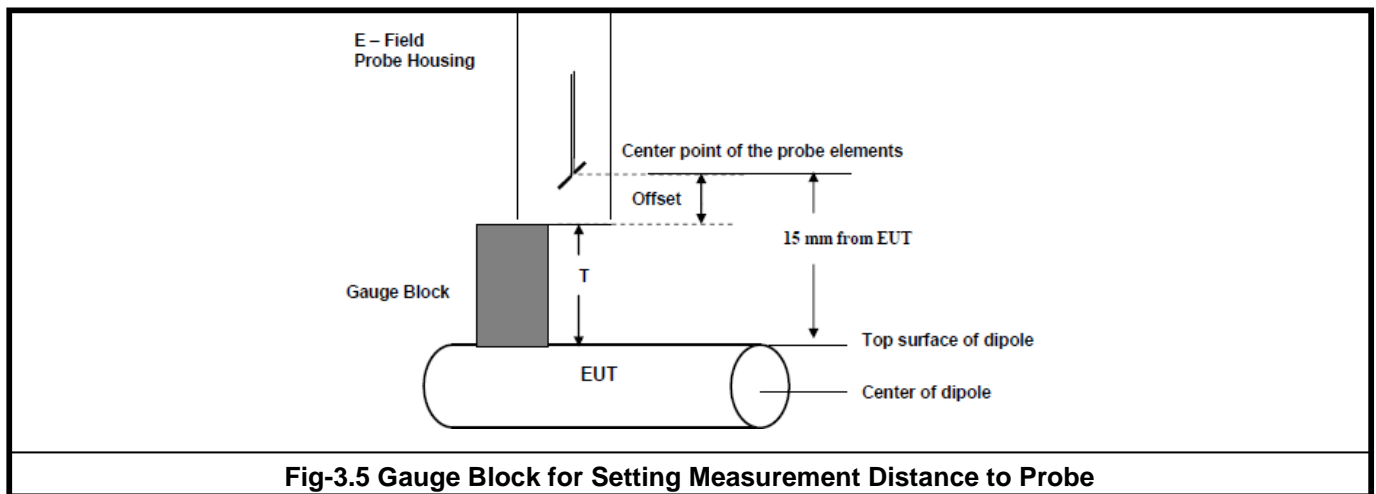

### 3.4 HAC RF Emission Measurement Procedure

The RF emissions test procedure for wireless communications device is as below.

1. Confirm the proper operation of the field probe, probe measurement system, and other instrumentation and the positioning system.
2. Position the WD in its intended test position.
3. Set the WD to transmit a fixed and repeatable combination of signal power and modulation characteristic that is representative of the worst case (highest interference potential) encountered in normal use. Transiently occurring start-up, changeover, or termination conditions, or other operations likely to occur less than 1% of the time during normal operation, may be excluded from consideration.
4. The center sub-grid shall be centered on the T-Coil mode perpendicular measurement point or the acoustic output, as appropriate. Locate the field probe at the initial test position in the 50 mm by 50 mm grid, which is contained in the measurement plane, illustrated in Fig-3.4. If the field alignment method is used, align the probe for maximum field reception.
5. Record the reading at the output of the measurement system.
6. Scan the entire 50 mm by 50 mm region in equally spaced increments and record the reading at each measurement point. The distance between measurement points shall be sufficient to assure the identification of the maximum reading.
7. Identify the five contiguous sub-grids around the center sub-grid whose maximum reading is the lowest of all available choices. This eliminates the three sub-grids with the maximum readings. Thus, the six areas to be used to determine the WD's highest emissions are identified.
8. Identify the maximum reading within the non-excluded sub-grids identified in step 7.
9. Indirect Measurement Method: The RF audio interference level in dB(V/m) is obtained by adding the MIF (in dB) to the maximum steady-state rms field-strength reading, in dB(V/m), from step 8. Use this result to determine the category rating.

## FCC HAC (RF Emission) Test Report

10. Compare this RF audio interference level with the categories in section 4.1 and record the resulting WD category rating.
- 11 For the T-Coil mode M-rating assessment, determine whether the chosen perpendicular measurement point is contained in an included sub-grid of the first can. If so, then a second scan is not necessary. The first scan and resultant category rating may be used for the T-Coil mode M-rating. Otherwise, repeat step 1 through step 9, with the grid shifted so that it is centered on the perpendicular measurement point. Record the WD category rating.

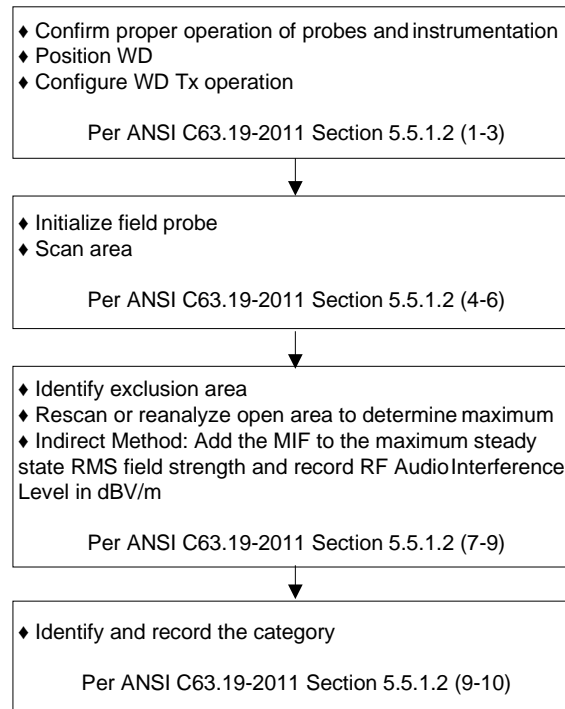

**Fig-3.6 WD Near-Field Emission Test Flowchart**

## FCC HAC (RF Emission) Test Report

### 3.5 Modulation Interference Factor

The HAC Standard ANSI C63.19-2011 defines a new scaling using the Modulation Interference Factor (MIF) which replaces the need for the Articulation Weighting Factor (AWF) during the evaluation and is applicable to any modulation scheme.

The Modulation Interference Factor (MIF, in dB) is added to the measured average E-field (in dBV/m) and converts it to the RF audio interference potential (in dBV/m). This level considers the audible amplitude modulation components in the RF E-field. CW fields without amplitude modulation are assumed to not interfere with the hearing aid electronics. Modulations without time slots and low fluctuations at low frequencies have low MIF values, TDMA modulations with narrow transmission slots and repetition rates of few 100 Hz have high MIF values and give similar classification as ANSI C63.19-2007.

ER3D E-field probe have a bandwidth <10 kHz and can therefore not evaluate the RF envelope in the full audio band. DASY52 is therefore using the "indirect" measurement method according to ANSI C63.19-2011 which is the primary method. This near field probe read the averaged E-field. Especially for the new high peak-to-average (PAR) signal types, the probes shall be linearized by PMR calibration in order to not overestimate the field reading.

The evaluation method for the MIF is defined in ANSI C63.19-2011 section D.7. An RMS demodulated RF signal is fed to a spectral filter (similar to an A weighting filter) and forwarded to a temporal filter acting as a quasi-peak detector. The averaged output of these filtering is scaled to a 1 kHz 80% AM signal as reference. It may alternatively be determined through analysis and simulation, because it is constant and characteristic for a communication signal. DASY52 uses well-defined signals for PMR calibration. The MIF of these signals has been determined numerically. It allows a precise scaling and is therefore automatically applied.

The following table lists the MIF values evaluated by DASY manufacturer (SPEAG), and the test result will be calculated with the MIF parameter automatically. The detailed parameters for E-field probe can be found in the probe calibration report in appendix C.

UID	Reversion	Communication System Name	MIF (dB)
10021	DAC	GSM-FDD (TDMA, GMSK)	3.63
10025	DAC	EDGE-FDD (TDMA, 8PSK, TN 0)	3.75
10460	AAA	UMTS-FDD (WCDMA, AMR)	-25.43
10225	CAB	UMTS-FDD (HSPA+)	-20.39
10081	CAB	CDMA2000 (1xRTT, RC3)	-19.71
10295	AAB	CDMA2000, RC1, SO3, 1/8th Rate 25 fr.	3.26
10403	AAB	CDMA2000 (1xEV-DO, Rev. 0)	-17.67
10170	CAE	LTE-FDD (SC-FDMA, 1 RB, 20 MHz, 16-QAM)	-9.76
10172	CAG	LTE-TDD (SC-FDMA, 1 RB, 20 MHz, QPSK)	-1.62
10173	CAG	LTE-TDD (SC-FDMA, 1 RB, 20 MHz, 16-QAM)	-1.44
10174	CAG	LTE-TDD (SC-FDMA, 1 RB, 20 MHz, 64-QAM)	-1.54
10061	CAB	IEEE 802.11b WiFi 2.4 GHz (DSSS, 11 Mbps)	-2.02
10077	CAB	IEEE 802.11g WiFi 2.4 GHz (DSSS/OFDM, 54 Mbps)	0.12
10427	AAB	IEEE 802.11n (HT Greenfield, 150 Mbps, 64-QAM)	-13.44
10069	CAC	IEEE 802.11a/h WiFi 5 GHz (OFDM, 54 Mbps)	-3.15
10616	AAB	IEEE 802.11ac WiFi (40MHz, MCS0, 90pc duty cycle)	-5.57

## FCC HAC (RF Emission) Test Report

---

The MIF measurement uncertainty listed in following table is estimated by SPEAG.

MIF (dB)	MIF Measurement Uncertainty (dB)
-7 to +5	0.2
-13 to +11	0.5
> -20	1.0

## FCC HAC (RF Emission) Test Report

### 4. HAC Measurement Evaluation

#### 4.1 M-Rating Category

The HAC Standard ANSI C63.19-2011 represents performance requirements for acceptable interoperability of hearing aids with wireless communications devices. When these parameters are met, a hearing aid operates acceptably in close proximity to a wireless communications device.

Emission Categories	E-Field Emissions < 960 MHz (dB V/m)	E-Field Emissions > 960 MHz (dB V/m)
Category M1	50 - 55	40 - 45
Category M2	45 - 50	35 - 40
Category M3	40 - 45	30 - 35
Category M4	< 40	< 30

#### 4.2 EUT Configuration and Setting

For HAC RF emission testing, the EUT was linked and controlled by base station emulator. Communication between the EUT and the emulator was established by air link. The distance between the EUT and the communicating antenna of the emulator is larger than 50 cm and the output power radiated from the emulator antenna is at least 30 dB smaller than the output power of EUT. The EUT was set from the emulator to radiate maximum output power during HAC testing.

#### 4.3 System Verification

The measuring results for system check are shown as below.

Frequency (MHz)	Input Power (dBm)	Target Value (V/m)	E-Field 1 (V/m)	E-Field 2 (V/m)	Average E-Field (V/m)	Deviation (%)	Test Date
835	20.0	105	106.3	120.2	113.25	7.86	Apr.17,2021

#### Note:

- Comparing to the reference target value provided by SPEAG, the validation data should be within its specification of 25 %. The result indicates the system check can meet the variation criterion and the plots can be referred to Appendix A of this report.
- For E-Field, the deviation is  $[(E\text{-Field } 1 + E\text{-Field } 2) / 2 - \text{Target Value}] / \text{Target Value} \times 100\%$



## FCC HAC (RF Emission) Test Report

---

### 4.4 Maximum Target Conducted Power

The maximum conducted average power (Unit: dBm) including tune-up tolerance is shown as below.

Air Interface		Max. Tune-up Power
GSM	GSM850	33.5
	EDGE850	27.0
WCDMA	Band V	23.5
FDD-LTE	Band 5	24.0
	Band 7	24.0

## FCC HAC (RF Emission) Test Report

### 4.5 Low Power Exemption Evaluation

According to ANSI C63.19-2011 section 4, RF air interface technologies that have low power have been found to produce sufficiently low RF interference potential, so it is possible to exempt them from the product testing. An RF air interface technology of a device is exempt from testing when its average antenna input power plus its worst-case MIF is  $\leq 17$  dBm for any of its operating modes. If a device supports multiple RF air interfaces, each RF air interface shall be evaluated individually. An RF air interface technology that is exempted from testing by above method could be rated as M4.

The low power exemption for this device is analyzed in below.

Air Interface		Max. Tune-up Power (dBm)	Worst Case MIF (dB)	Power + MIF (dB)	C63.19 Testing Required
GSM	GSM850	33.5	3.63	37.13	<b>YES</b>
	EDGE850	27.0	3.75	23.25	No
WCDMA	AMR	23.5	-25.43	-1.93	No
	HSPA	22.5	-20.39	2.11	No
FDD-LTE		24.0	-9.76	14.24	No

**Note:**

1. The EDGE data modes were considered but not tested because GSM voice mode was worst case for the GSM air interface.
2. The TDD-LTE 16QAM data modes were considered but not tested because QPSK mode was worst case for the TDD-LTE air interface.

## FCC HAC (RF Emission) Test Report

---

### 4.6 Measured Conducted Power Results

The measuring conducted average power (Unit: dBm) are shown as below.

Band	GSM850		
Channel	128	189	251
Frequency (MHz)	824.2	836.4	848.8
GSM (GMSK, 1 Tx Slot)	32.81	32.84	32.86

## FCC HAC (RF Emission) Test Report

---

### 4.7 HAC RF Emission Testing Results

Plot No.	Band	Mode	Channel	Audio Interference Level (dB V/m)	FCC Limit (dB V/m)	FCC Margin (dB)	M-Rating
P01	GSM850	Voice	128	30.97	45	14.03	M4
P02	GSM850	Voice	189	31.79	45	13.21	M4
P03	GSM850	Voice	251	32.16	45	12.84	M4

Test Engineer:

## FCC HAC (RF Emission) Test Report

### 5. Calibration of Test Equipment

Equipment	Manufacturer	Model	SN	Cal. Date	Cal. Interval
835MHz Calibration Dipole	SPEAG	CD835V3	1213	Sep.17,2020	3 Years
Isotropic E-Field Probe	SPEAG	EF3DV3	4075	Mar.03,2022	1 Year
Data Acquisition Electronics	SPEAG	DAE4	1633	Oct.26,2021	1 Year
Universal Radio Communication Tester	R&S	CMW500	169210	Oct.18,2021	1 Year
Wireless Communication Analyzer	Agilent	E5515C	MY50260600	Jun.02,2021	1 Year
ENA Series Network Analyzer	Agilent	E5071C	MY46214638	Jun.03,2021	1 Year
Spectrum Analyzer	KEYSIGHT	N9010A	MY54510355	Jun.03,2021	1 Year
MXG Analog Signal Generator	KEYSIGHT	N5183A	MY50143024	Jun.09,2021	1 Year
Power Meter	Agilent	N1914A	MY52180044	May,02,2021	1 Year
Power Sensor	Agilent	E9304AH18	MY52050011	May.25,2021	1 Year
Power Meter	ANRITSU	ML2495A	1506002	Jun.07,2021	1 Year
Power Sensor	ANRITSU	MA4211B	1339353	May.07,2021	1 Year
Temp.& Humi.Recorder	CLOCK	HTC-1	157248	Jun.02,2021	1 Year
Electronic Thermometer	YONGFA	YF-160A	120100323	Jun.02,2021	1 Year
Coupler	Woken	0110A056020-10	COM27RW1A	Jun.02,2021	1 Year
Test Arch Phantom	SPEAG	Arch	N/A	N/A	N/A

## FCC HAC (RF Emission) Test Report

### 6. Measurement Uncertainty

HAC Uncertainty Budget for RF 2011 version According to ANSI C63.19						
Error Description	Uncertainty Value (±%)	Probability	Divisor	(Ci) E	(Ci) H	Standard Uncertainty (E) (±%)
<b>Measurement System</b>						
Probe Calibration	5.1	N	1	1	1	5.1
Axial Isotropy	4.7	R	1.732	1	1	2.7
Sensor Displacement	16.5	R	1.732	1	0.145	9.5
Boundary Effects	2.4	R	1.732	1	1	1.4
Phantom Boundary Effect	7.2	R	1.732	1	0	4.2
Linearity	4.7	R	1.732	1	1	2.7
Scaling with PMR calibration	10.0	R	1.732	1	1	5.8
System Detection Limit	1.0	R	1.732	1	1	0.6
Readout Electronics	0.3	N	1	1	1	0.3
Response Time	2.6	R	1.732	1	1	1.5
Integration Time	2.6	R	1.732	1	1	1.5
RF Ambient Conditions	3.0	R	1.732	1	1	1.7
RF Reflections	12.0	R	1.732	1	1	6.9
Probe Positioner	1.2	R	1.732	1	0.67	0.7
Probe Positioning	4.7	R	1.732	1	0.67	2.7
Extrap. and Interpolation	1.0	R	1.732	1	1	0.6
<b>Test Sample Related</b>						
Device Positioning Vertical	4.7	R	1.732	1	0.67	2.7
Device Positioning Lateral	1.0	R	1.732	1	1	0.6
Device Holder and Phantom	2.4	R	1.732	1	1	1.4
Power Drift	5.0	R	1.732	1	1	2.9
<b>Phantom and Setup Related</b>						
Phantom Thickness	2.4	R	1.732	1	0.67	1.4
<b>Combined Std. Uncertainty</b>						16.4%
<b>Coverage Factor for 95 %</b>						K=2
<b>Expanded STD Uncertainty</b>						32.7%

**Uncertainty budget for HAC RF Emission**

## **FCC HAC (RF Emission) Test Report**

---

### **7. Information of the Testing Laboratories**

We, Huarui Saiwei (Suzhou) Technology Co., LTD., were founded in 2020 to provide our best service in EMC, Radio, Telecom and Safety consultation.

If you have any comments, please feel free to contact us at the following:

Add: Tower N, Innovation Center, 88 Zuyi Road, High-tech District, Suzhou City, Anhui Province

The road map of all our labs can be found in our web site also.

---END---

## **Appendix A. Plots of System Verification**



## **Appendix B. Plots of HAC RF Emission Measurement**

## **Appendix C. Calibration Certificate for Probe and Dipole**

## **Appendix D. Photographs of EUT and Setup**