

# FCC SAR Test Report

**Report No.** : W7L-P22030026-5SA01  
**Applicant** : HMD Global Oy  
**Address** : Bertel Jungin aukio 9, 02600 Espoo, Finland  
**Manufacturer** : HMD Global Oy  
**Address** : Bertel Jungin aukio 9, 02600 Espoo, Finland  
**Product** : Multi-band GSM/WCDMA/LTE phone with Bluetooth&WLAN  
**FCC ID** : 2AJOTTA-1444  
**Brand** : NOKIA  
**Model No.** : TA-1444  
**Standards** : FCC 47 CFR Part 2 (2.1093) / IEEE C95.1:1992 / IEEE 1528:2013  
 KDB 865664 D01 v01r04 / KDB 865664 D02 v01r02 / KDB 248227 D01 v02r02  
 KDB 447498 D01 v06 / KDB 648474 D04 v01r03 / KDB 941225 D01 v03r01  
 KDB 941225 D05 v02r05 / KDB 941225 D06 v02r01  
**Sample Received Date** : Mar. 30, 2022  
**Date of Testing** : Apr. 12, 2022 ~ Apr. 15, 2022  
**FCC Designation No.** : CN1171

**CERTIFICATION:** The above equipment have been tested by **BV 7LAYERS COMMUNICATIONS TECHNOLOGY (SHENZHEN) CO. LTD.**, and found compliance with the requirement of the above standards. The test record, data evaluation & Equipment Under Test (EUT) configurations represented herein are true and accurate accounts of the measurements of the sample's SAR characteristics under the conditions specified in this report. It should not be reproduced except in full, without the written approval of our laboratory. The client should not use it to claim product certification, approval, or endorsement by A2LA or any government agencies.

**Prepared By :** Jerry Chen  
 Jerry Chen / Engineer  
**Approved By :** Luke Lu  
 Luke Lu / Manager



This report is governed by, and incorporates by reference, CPS Conditions of Service as posted at the date of issuance of this report at <http://www.bureauveritas.com/home/about-us/our-business/cps/about-us/terms-conditions> and is intended for your exclusive use. Any copying or replication of this report to or for any other person or entity, or use of our name or trademark, is permitted only with our prior written permission. This report sets forth our findings solely with respect to the test samples identified herein. The results set forth in this report are not indicative or representative of the quality or characteristics of the lot from which a test sample was taken or any similar or identical product unless specifically and expressly noted. Our report includes all of the tests requested by you and the results thereof based upon the information that you provided to us. Measurement uncertainty is only provided upon request for accredited tests. You have 60 days from date of issuance of this report to notify us of any material error or omission caused by our negligence or if you require measurement uncertainty; provided, however, that such notice shall be in writing and shall specifically address the issue you wish to raise. A failure to raise such issue within the prescribed time shall constitute your unqualified acceptance of the completeness of this report, the tests conducted and the correctness of the report contents.

## Table of Contents

Release Control Record .....	3
1. Summary of Maximum SAR Value .....	4
2. Description of Equipment Under Test .....	5
3. SAR Measurement System .....	6
3.1 Definition of Specific Absorption Rate (SAR) .....	6
3.2 SPEAG DASY System .....	6
3.2.1 Robot .....	7
3.2.2 Probes .....	8
3.2.3 Data Acquisition Electronics (DAE) .....	8
3.2.4 Phantoms .....	9
3.2.5 Device Holder .....	10
3.2.6 System Validation Dipoles .....	10
3.2.7 Tissue Simulating Liquids .....	11
3.3 SAR System Verification .....	13
3.4 SAR Measurement Procedure .....	14
3.4.1 Area & Zoom Scan Procedure .....	14
3.4.2 Volume Scan Procedure .....	14
3.4.3 Power Drift Monitoring .....	15
3.4.4 Spatial Peak SAR Evaluation .....	15
3.4.5 SAR Averaged Methods .....	15
4. SAR Measurement Evaluation .....	16
4.1 EUT Configuration and Setting .....	16
4.2 EUT Testing Position .....	28
4.2.1 Head Exposure Conditions .....	28
4.2.2 Body-worn Accessory Exposure Conditions .....	30
4.2.3 Hotspot Mode Exposure Conditions .....	31
4.2.4 Extremity Exposure Conditions .....	32
4.2.5 Simultaneous Transmission Possibilities .....	32
4.3 Tissue Verification .....	33
4.4 System Verification .....	33
4.5 Maximum Output Power .....	34
4.5.1 Maximum Conducted Power .....	34
4.5.2 Measured Conducted Power Result .....	36
4.6 SAR Testing Results .....	50
4.6.1 SAR Test Reduction Considerations .....	50
4.6.2 SAR Results for Head Exposure Condition .....	52
4.6.3 SAR Results for Body-worn Exposure Condition (Separation Distance is 1.0 cm Gap) .....	52
4.6.4 SAR Results for Hotspot Exposure Condition (Separation Distance is 1.0 cm Gap) .....	53
4.6.5 SAR Results for Extremity Exposure Condition (Separation Distance is 0 cm Gap) .....	53
4.6.6 SAR Measurement Variability .....	54
4.6.7 Simultaneous Multi-band Transmission Evaluation .....	55
5. Calibration of Test Equipment .....	60
6. Measurement Uncertainty .....	61
7. Information on the Testing Laboratories .....	63
Appendix A. SAR Plots of System Verification	
Appendix B. SAR Plots of SAR Measurement	
Appendix C. Calibration Certificate for Probe and Dipole	
Appendix D. Photographs of EUT and Setup	



### 1. Summary of Maximum SAR Value

Equipment Class	Mode	Highest Reported Head SAR <sub>1g</sub> (W/kg)	Highest Reported Body-worn SAR <sub>1g</sub> (1.0 cm Gap) (W/kg)	Highest Reported Hotspot SAR <sub>1g</sub> (1.0 cm Gap) (W/kg)	Highest Reported Extremity SAR <sub>10g</sub> (0 cm Gap) (W/kg)
PCE	GSM850	0.41	0.59	0.59	N/A
	GSM1900	0.16	0.47	0.65	N/A
	WCDMA II	0.44	0.57	0.69	N/A
	WCDMA IV	0.28	0.55	0.66	2.24
	WCDMA V	0.29	0.50	0.50	N/A
	LTE 2	0.24	0.43	0.62	N/A
	LTE 5	0.46	0.46	0.46	N/A
	LTE 7	0.29	0.46	0.98	2.04
	LTE 12 / 17	0.22	0.45	0.39	N/A
	LTE 13	0.32	0.41	0.41	N/A
LTE 66 / 4	0.25	0.54	0.70	2.07	
DTS	2.4G WLAN	0.53	0.15	0.15	N/A
DSS	Bluetooth	0.10	0.03	0.03	N/A
Highest Simultaneous Transmission SAR		Head (W/kg)	Body-worn (W/kg)	Hotspot (W/kg)	Extremity (W/kg)
		0.99	0.75	0.98	2.24

**Note:**

- The SAR limit (Head & Body: SAR<sub>1g</sub> 1.6 W/kg, Extremity: SAR<sub>10g</sub> 4.0 W/kg) for general population / uncontrolled exposure is specified in FCC 47 CFR part 2 (2.1093) and ANSI/IEEE C95.1-1992.

## 2. Description of Equipment Under Test

<b>EUT Type</b>	Multi-band GSM/WCDMA/LTE phone with Bluetooth&WLAN
<b>FCC ID</b>	2AJOTTA-1444
<b>Brand Name</b>	NOKIA
<b>Model Name</b>	TA-1444
<b>HW Version</b>	19661_1_12
<b>SW Version</b>	000T_0_050
<b>Tx Frequency Bands (Unit: MHz)</b>	GSM850 : 824.2 ~ 848.8 GSM1900 : 1850.2 ~ 1909.8 WCDMA Band II : 1852.4 ~ 1907.6 WCDMA Band IV : 1712.4 ~ 1752.6 WCDMA Band V : 826.4 ~ 846.6 LTE Band 2 : 1850.7 ~ 1909.3 LTE Band 4 : 1710.7 ~ 1754.3 LTE Band 5 : 824.7 ~ 848.3 LTE Band 7 : 2502.5 ~ 2567.5 LTE Band 12 : 699.7 ~ 715.3 LTE Band 13 : 779.5 ~ 784.5 LTE Band 17 : 706.5 ~ 713.5 LTE Band 66 : 1710.7 ~ 1799.3 WLAN : 2412 ~ 2462 Bluetooth : 2402 ~ 2480
<b>Uplink Modulations</b>	GSM & GPRS & EDGE : GMSK, 8PSK WCDMA : BPSK, QPSK LTE : QPSK, 16QAM, 64QAM 802.11b : DSSS 802.11g/n : OFDM Bluetooth : GFSK, $\pi/4$ -DQPSK, 8-DPSK
<b>Maximum Tune-up Conducted Power (Unit: dBm)</b>	Please refer to section 4.5.1 of this report.
<b>Antenna Type</b>	WWAN: Fixed Internal Antenna WLAN/BT: Fixed Internal Antenna
<b>EUT Stage</b>	Identical Prototype

**Note:**

1. The above EUT information is declared by manufacturer and for more detailed features description please refers to the manufacturer's specifications or User's Manual.
2. This device supports both LTE B4/B17 and B66/B12. Since the supported frequency span for LTE B4/B17 falls completely within the LTE B66/B12, they have the same target power, and share the same transmission path, therefore SAR was only assessed for LTE B66/B12 ;
3. For WWAN Ant, when the p-sensor is detect close to the body sate, power reduction will be activated to limit the maximum power.

Exposure Condition	WWAN Ant		Power reduce
	Audio Receiver	P-sensor	
Head	On	N/A	No
Body	Off	On	Yes

### 3. SAR Measurement System

#### 3.1 Definition of Specific Absorption Rate (SAR)

SAR is related to the rate at which energy is absorbed per unit mass in an object exposed to a radio field. The SAR distribution in a biological body is complicated and is usually carried out by experimental techniques or numerical modeling. The standard recommends limits for two tiers of groups, occupational/controlled and general population/uncontrolled, based on a person’s awareness and ability to exercise control over his or her exposure. In general, occupational/controlled exposure limits are higher than the limits for general population/uncontrolled.

The SAR definition is the time derivative (rate) of the incremental energy (dW) absorbed by (dissipated in) an incremental mass (dm) contained in a volume element (dv) of a given density (ρ). The equation description is as below:

$$SAR = \frac{d}{dt} \left( \frac{dW}{dm} \right) = \frac{d}{dt} \left( \frac{dW}{\rho dv} \right)$$

SAR is expressed in units of Watts per kilogram (W/kg)

SAR measurement can be related to the electrical field in the tissue by

$$SAR = \frac{\sigma |E|^2}{\rho}$$

Where: σ is the conductivity of the tissue, ρ is the mass density of the tissue and E is the RMS electrical field strength.

#### 3.2 SPEAG DASY System

DASY system consists of high precision robot, probe alignment sensor, phantom, robot controller, controlled measurement server and near-field probe. The robot includes six axes that can move to the precision position of the DASY5 software defined. The DASY software can define the area that is detected by the probe. The robot is connected to controlled box. Controlled measurement server is connected to the controlled robot box. The DAE includes amplifier, signal multiplexing, AD converter, offset measurement and surface detection. It is connected to the Electro-optical coupler (ECO). The ECO performs the conversion form the optical into digital electric signal of the DAE and transfers data to the PC.

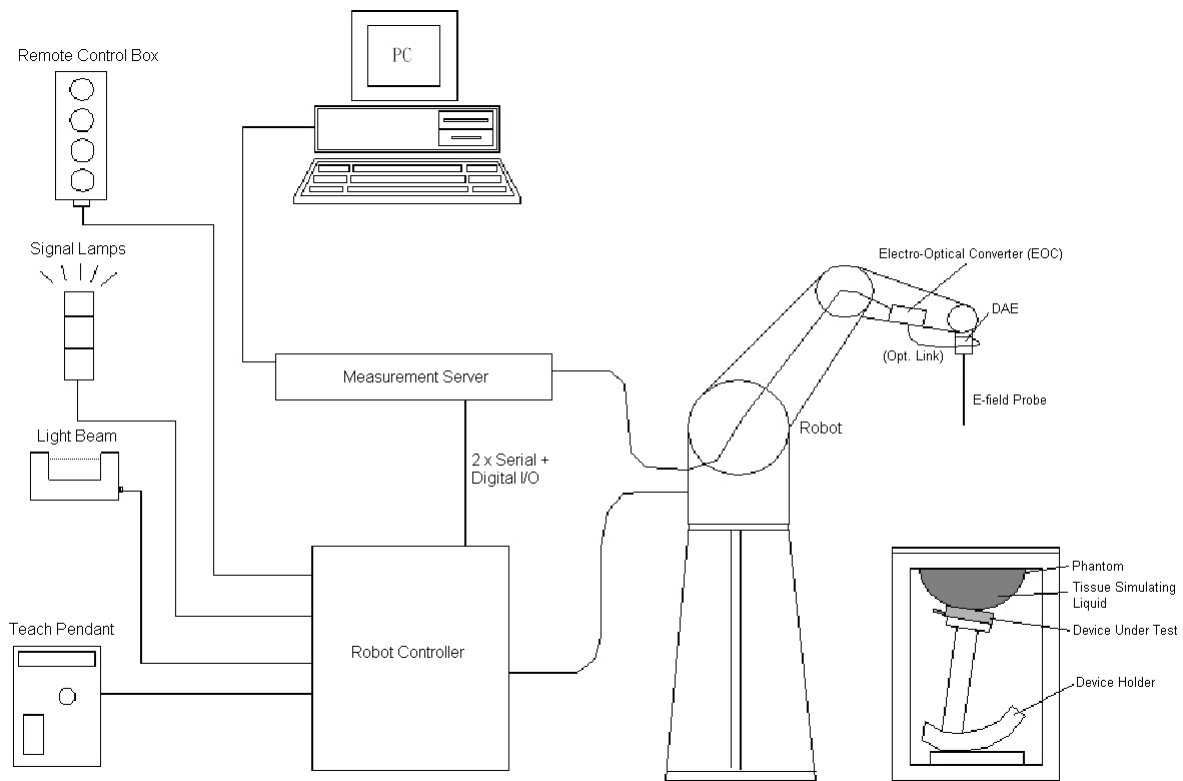

**Fig-3.1 DASY System Setup**

**3.2.1 Robot**

The DASY system uses the high precision robots from Stäubli SA (France). For the 6-axis controller system, the robot controller version (DASY5: CS8c) from Stäubli is used. The Stäubli robot series have many features that are important for our application:

- High precision (repeatability  $\pm 0.035$  mm)
- High reliability (industrial design)
- Jerk-free straight movements
- Low ELF interference (the closed metallic construction shields against motor control fields)





**Fig-3.2 DASY5**

## FCC SAR Test Report

### 3.2.2 Probes

The SAR measurement is conducted with the dosimetric probe. The probe is specially designed and calibrated for use in liquid with high permittivity. The dosimetric probe has special calibration in liquid at different frequency.

<b>Model</b>	EX3DV4	
<b>Construction</b>	Symmetrical design with triangular core. Built-in shielding against static charges. PEEK enclosure material (resistant to organic solvents, e.g., DGBE).	
<b>Frequency</b>	10 MHz to 6 GHz Linearity: $\pm 0.2$ dB	
<b>Directivity</b>	$\pm 0.3$ dB in HSL (rotation around probe axis) $\pm 0.5$ dB in tissue material (rotation normal to probe axis)	
<b>Dynamic Range</b>	10 $\mu$ W/g to 100 mW/g Linearity: $\pm 0.2$ dB (noise: typically $< 1$ $\mu$ W/g)	
<b>Dimensions</b>	Overall length: 337 mm (Tip: 20 mm) Tip diameter: 2.5 mm (Body: 12 mm) Typical distance from probe tip to dipole centers: 1 mm	

<b>Model</b>	ES3DV3	
<b>Construction</b>	Symmetrical design with triangular core. Interleaved sensors. Built-in shielding against static charges. PEEK enclosure material (resistant to organic solvents, e.g., DGBE).	
<b>Frequency</b>	10 MHz to 4 GHz Linearity: $\pm 0.2$ dB	
<b>Directivity</b>	$\pm 0.2$ dB in HSL (rotation around probe axis) $\pm 0.3$ dB in tissue material (rotation normal to probe axis)	
<b>Dynamic Range</b>	5 $\mu$ W/g to 100 mW/g Linearity: $\pm 0.2$ dB	
<b>Dimensions</b>	Overall length: 337 mm (Tip: 20 mm) Tip diameter: 3.9 mm (Body: 12 mm) Distance from probe tip to dipole centers: 2.0 mm	

### 3.2.3 Data Acquisition Electronics (DAE)

<b>Model</b>	DAE3, DAE4	
<b>Construction</b>	Signal amplifier, multiplexer, A/D converter and control logic. Serial optical link for communication with DASY embedded system (fully remote controlled). Two step probe touch detector for mechanical surface detection and emergency robot stop.	
<b>Measurement Range</b>	-100 to +300 mV (16 bit resolution and two range settings: 4mV, 400mV)	
<b>Input Offset Voltage</b>	$< 5$ $\mu$ V (with auto zero)	
<b>Input Bias Current</b>	$< 50$ fA	
<b>Dimensions</b>	60 x 60 x 68 mm	



# FCC SAR Test Report

## 3.2.4 Phantoms

<b>Model</b>	Twin SAM	
<b>Construction</b>	The shell corresponds to the specifications of the Specific Anthropomorphic Mannequin (SAM) phantom defined in IEEE 1528 and IEC 62209-1. It enables the dosimetric evaluation of left and right hand phone usage as well as body mounted usage at the flat phantom region. A cover prevents evaporation of the liquid. Reference markings on the phantom allow the complete setup of all predefined phantom positions and measurement grids by teaching three points with the robot.	
<b>Material</b>	Vinylester, glass fiber reinforced (VE-GF)	
<b>Shell Thickness</b>	2 ± 0.2 mm (6 ± 0.2 mm at ear point)	
<b>Dimensions</b>	Length: 1000 mm Width: 500 mm Height: adjustable feet	
<b>Filling Volume</b>	approx. 25 liters	

<b>Model</b>	ELI	
<b>Construction</b>	Phantom for compliance testing of handheld and body-mounted wireless devices in the frequency range of 30 MHz to 6 GHz. ELI is fully compatible with the IEC 62209-2 standard and all known tissue simulating liquids. ELI has been optimized regarding its performance and can be integrated into our standard phantom tables. A cover prevents evaporation of the liquid. Reference markings on the phantom allow installation of the complete setup, including all predefined phantom positions and measurement grids, by teaching three points. The phantom is compatible with all SPEAG dosimetric probes and dipoles.	
<b>Material</b>	Vinylester, glass fiber reinforced (VE-GF)	
<b>Shell Thickness</b>	2.0 ± 0.2 mm (bottom plate)	
<b>Dimensions</b>	Major axis: 600 mm Minor axis: 400 mm	
<b>Filling Volume</b>	approx. 30 liters	

# FCC SAR Test Report

## 3.2.5 Device Holder

<b>Model</b>	Mounting Device	
<b>Construction</b>	In combination with the Twin SAM Phantom or ELI4, the Mounting Device enables the rotation of the mounted transmitter device in spherical coordinates. Rotation point is the ear opening point. Transmitter devices can be easily and accurately positioned according to IEC, IEEE, FCC or other specifications. The device holder can be locked for positioning at different phantom sections (left head, right head, flat).	
<b>Material</b>	POM	

<b>Model</b>	Laptop Extensions Kit	
<b>Construction</b>	Simple but effective and easy-to-use extension for Mounting Device that facilitates the testing of larger devices according to IEC 62209-2 (e.g., laptops, cameras, etc.). It is lightweight and fits easily on the upper part of the Mounting Device in place of the phone positioner.	
<b>Material</b>	POM, Acrylic glass, Foam	

## 3.2.6 System Validation Dipoles

<b>Model</b>	D-Serial	
<b>Construction</b>	Symmetrical dipole with 1/4 balun. Enables measurement of feed point impedance with NWA. Matched for use near flat phantoms filled with tissue simulating solutions.	
<b>Frequency</b>	750 MHz to 5800 MHz	
<b>Return Loss</b>	> 20 dB	
<b>Power Capability</b>	> 100 W (f < 1GHz), > 40 W (f > 1GHz)	

### 3.2.7 Tissue Simulating Liquids

For SAR measurement of the field distribution inside the phantom, the phantom must be filled with homogeneous tissue simulating liquid to a depth of at least 15 cm. For head SAR testing, the liquid height from the ear reference point (ERP) of the phantom to the liquid top surface is larger than 15 cm. For body SAR testing, the liquid height from the center of the flat phantom to the liquid top surface is larger than 15 cm. The nominal dielectric values of the tissue simulating liquids in the phantom and the tolerance of 5% are listed in Table-3.1.

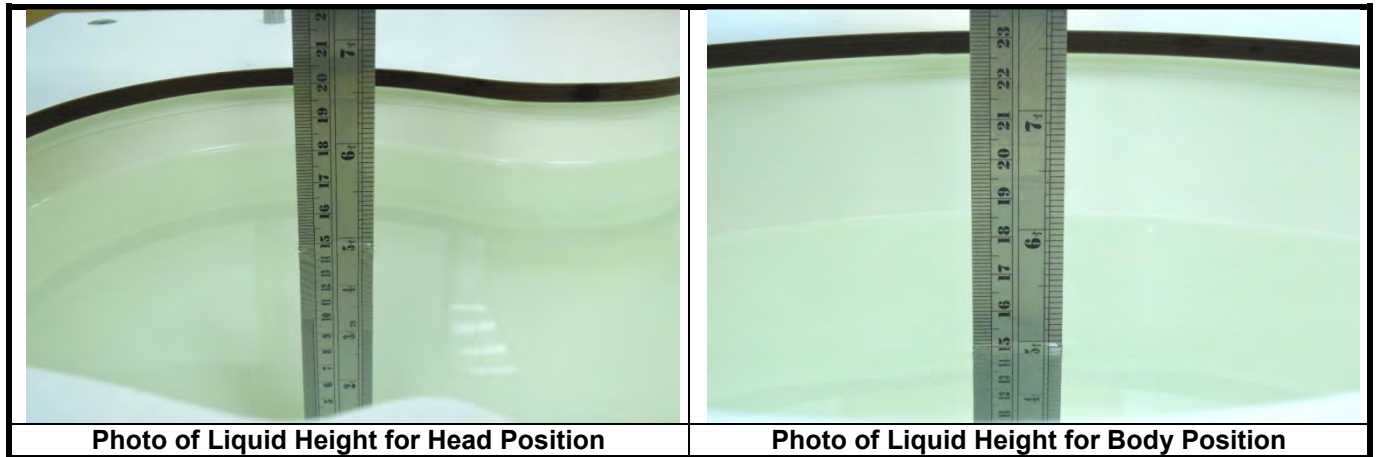

The dielectric properties of the head tissue simulating liquids are defined in IEEE 1528, and KDB 865664 D01 Appendix A. For the body tissue simulating liquids, the dielectric properties are defined in KDB 865664 D01 Appendix A. The dielectric properties of the tissue simulating liquids were verified prior to the SAR evaluation using a dielectric assessment kit and a network analyzer.

**Table-3.1 Targets of Tissue Simulating Liquid**

Frequency (MHz)	Target Permittivity	Range of $\pm 5\%$	Target Conductivity	Range of $\pm 5\%$
<b>For Head</b>				
750	41.9	39.8 ~ 44.0	0.89	0.85 ~ 0.93
835	41.5	39.4 ~ 43.6	0.90	0.86 ~ 0.95
900	41.5	39.4 ~ 43.6	0.97	0.92 ~ 1.02
1450	40.5	38.5 ~ 42.5	1.20	1.14 ~ 1.26
1640	40.3	38.3 ~ 42.3	1.29	1.23 ~ 1.35
1750	40.1	38.1 ~ 42.1	1.37	1.30 ~ 1.44
1800	40.0	38.0 ~ 42.0	1.40	1.33 ~ 1.47
1900	40.0	38.0 ~ 42.0	1.40	1.33 ~ 1.47
2000	40.0	38.0 ~ 42.0	1.40	1.33 ~ 1.47
2300	39.5	37.5 ~ 41.5	1.67	1.59 ~ 1.75
2450	39.2	37.2 ~ 41.2	1.80	1.71 ~ 1.89
2600	39.0	37.1 ~ 41.0	1.96	1.86 ~ 2.06
3500	37.9	36.0 ~ 39.8	2.91	2.76 ~ 3.06
5200	36.0	34.2 ~ 37.8	4.66	4.43 ~ 4.89
5300	35.9	34.1 ~ 37.7	4.76	4.52 ~ 5.00
5500	35.6	33.8 ~ 37.4	4.96	4.71 ~ 5.21
5600	35.5	33.7 ~ 37.3	5.07	4.82 ~ 5.32
5800	35.3	33.5 ~ 37.1	5.27	5.01 ~ 5.53

The following table gives the recipes for tissue simulating liquids.

**Table-3.2 Recipes of Tissue Simulating Liquid**

Tissue Type	Bactericide	DGBE	HEC	NaCl	Sucrose	Triton X-100	Water	Diethylene Glycol Mono-hexylether
H750	0.2	-	0.2	1.5	56.0	-	42.1	-
H835	0.2	-	0.2	1.5	57.0	-	41.1	-
H900	0.2	-	0.2	1.4	58.0	-	40.2	-
H1450	-	43.3	-	0.6	-	-	56.1	-
H1640	-	45.8	-	0.5	-	-	53.7	-
H1750	-	47.0	-	0.4	-	-	52.6	-
H1800	-	44.5	-	0.3	-	-	55.2	-
H1900	-	44.5	-	0.2	-	-	55.3	-
H2000	-	44.5	-	0.1	-	-	55.4	-
H2300	-	44.9	-	0.1	-	-	55.0	-
H2450	-	45.0	-	0.1	-	-	54.9	-
H2600	-	45.1	-	0.1	-	-	54.8	-
H3500	-	28.0	-	0.2	-	20.0	71.8	-
H5G	-	-	-	-	-	17.2	65.5	17.3

**3.3 SAR System Verification**

The system check verifies that the system operates within its specifications. It is performed daily or before every SAR measurement. The system check uses normal SAR measurements in the flat section of the phantom with a matched dipole at a specified distance. The system verification setup is shown as below.

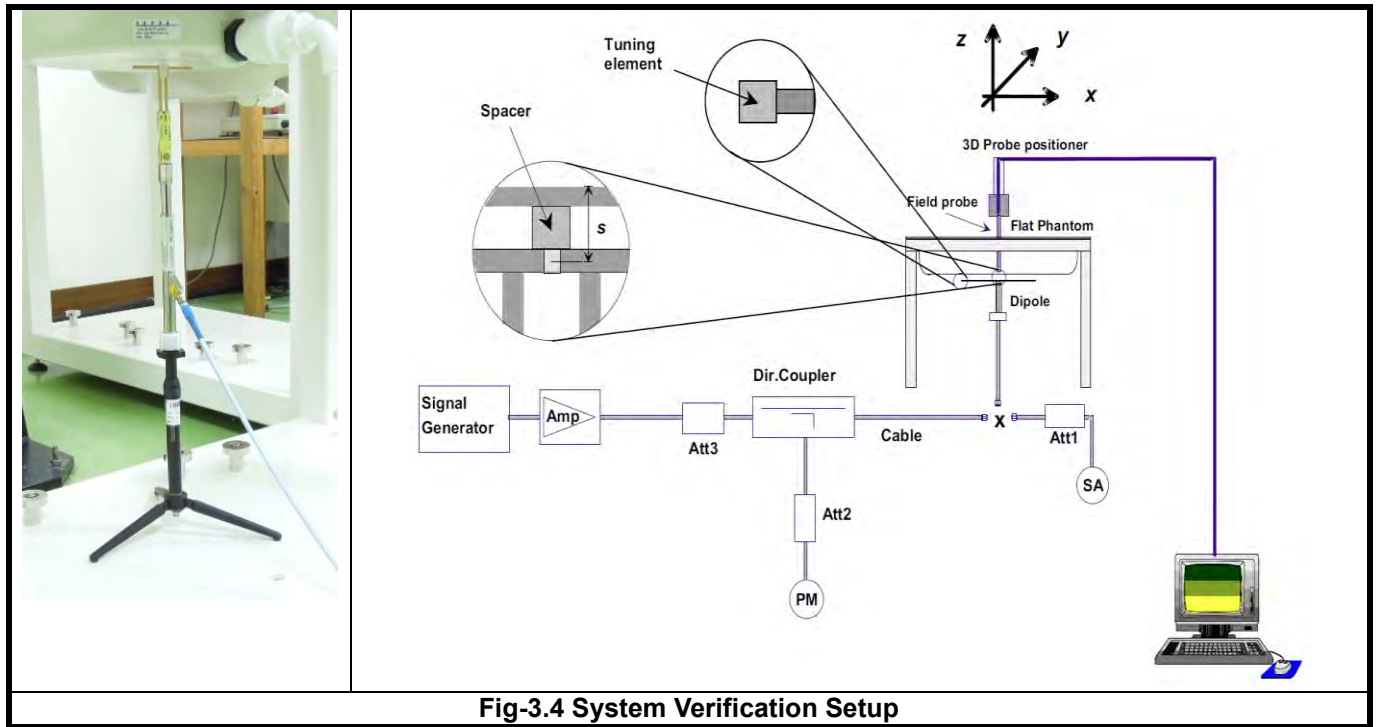

**Fig-3.4 System Verification Setup**

The validation dipole is placed beneath the flat phantom with the specific spacer in place. The distance spacer is touch the phantom surface with a light pressure at the reference marking and be oriented parallel to the long side of the phantom. The spectrum analyzer measures the forward power at the location of the system check dipole connector. The signal generator is adjusted for the desired forward power (250 mW is used for 700 MHz to 3 GHz, 100 mW is used for 3.5 GHz to 6 GHz) at the dipole connector and the power meter is read at that level. After connecting the cable to the dipole, the signal generator is readjusted for the same reading at power meter.

After system check testing, the SAR result will be normalized to 1W forward input power and compared with the reference SAR value derived from validation dipole certificate report. The deviation of system check should be within 10 %.

**3.4 SAR Measurement Procedure**

According to the SAR test standard, the recommended procedure for assessing the peak spatial-average SAR value consists of the following steps:

- (a) Power reference measurement
- (b) Area scan
- (c) Zoom scan
- (d) Power drift measurement

The SAR measurement procedures for each of test conditions are as follows:

- (a) Make EUT to transmit maximum output power
- (b) Measure conducted output power through RF cable
- (c) Place the EUT in the specific position of phantom
- (d) Perform SAR testing steps on the DASY system
- (e) Record the SAR value

**3.4.1 Area & Zoom Scan Procedure**

First Area Scan is used to locate the approximate location(s) of the local peak SAR value(s). The measurement grid within an Area Scan is defined by the grid extent, grid step size and grid offset. Next, in order to determine the EM field distribution in a three-dimensional spatial extension, Zoom Scan is required. The Zoom Scan is performed around the highest E-field value to determine the averaged SAR-distribution over 10 g. According to KDB 865664 D01, the resolution for Area and Zoom scan is specified in the table below.

Items	<= 2 GHz	2-3 GHz	3-4 GHz	4-5 GHz	5-6 GHz
Area Scan ( $\Delta x, \Delta y$ )	<= 15 mm	<= 12 mm	<= 12 mm	<= 10 mm	<= 10 mm
Zoom Scan ( $\Delta x, \Delta y$ )	<= 8 mm	<= 5 mm	<= 5 mm	<= 4 mm	<= 4 mm
Zoom Scan ( $\Delta z$ )	<= 5 mm	<= 5 mm	<= 4 mm	<= 3 mm	<= 2 mm
Zoom Scan Volume	>= 30 mm	>= 30 mm	>= 28 mm	>= 25 mm	>= 22 mm

**Note:**

When zoom scan is required and report SAR is <= 1.4 W/kg, the zoom scan resolution of  $\Delta x / \Delta y$  (2-3GHz: <= 8 mm, 3-4GHz: <= 7 mm, 4-6GHz: <= 5 mm) may be applied.

**3.4.2 Volume Scan Procedure**

The volume scan is used for assess overlapping SAR distributions for antennas transmitting in different frequency bands. It is equivalent to an oversized zoom scan used in standalone measurements. The measurement volume will be used to enclose all the simultaneous transmitting antennas. For antennas transmitting simultaneously in different frequency bands, the volume scan is measured separately in each frequency band. In order to sum correctly to compute the 1g aggregate SAR, the EUT remain in the same test position for all measurements and all volume scan use the same spatial resolution and grid spacing. When all volume scan were completed, the software, SEMCAD postprocessor can combine and subsequently superpose these measurement data to calculating the multiband SAR.

### 3.4.3 Power Drift Monitoring

All SAR testing is under the EUT install full charged battery and transmit maximum output power. In DASY measurement software, the power reference measurement and power drift measurement procedures are used for monitoring the power drift of EUT during SAR test. Both these procedures measure the field at a specified reference position before and after the SAR testing. The software will calculate the field difference in dB. If the power drift more than 5%, the SAR will be retested.

### 3.4.4 Spatial Peak SAR Evaluation

The procedure for spatial peak SAR evaluation has been implemented according to the test standard. It can be conducted for 1g and 10g, as well as for user-specific masses. The DASY software includes all numerical procedures necessary to evaluate the spatial peak SAR value.

The base for the evaluation is a "cube" measurement. The measured volume must include the 1g and 10g cubes with the highest averaged SAR values. For that purpose, the center of the measured volume is aligned to the interpolated peak SAR value of a previously performed area scan.

The entire evaluation of the spatial peak values is performed within the post-processing engine (SEMCAD). The system always gives the maximum values for the 1g and 10g cubes. The algorithm to find the cube with highest averaged SAR is divided into the following stages:

- (a) Extraction of the measured data (grid and values) from the Zoom Scan
- (b) Calculation of the SAR value at every measurement point based on all stored data (A/D values and measurement parameters)
- (c) Generation of a high-resolution mesh within the measured volume
- (d) Interpolation of all measured values from the measurement grid to the high-resolution grid
- (e) Extrapolation of the entire 3-D field distribution to the phantom surface over the distance from sensor to surface
- (f) Calculation of the averaged SAR within masses of 1g and 10g

### 3.4.5 SAR Averaged Methods

In DASY, the interpolation and extrapolation are both based on the modified Quadratic Shepard's method. The interpolation scheme combines a least-square fitted function method and a weighted average method which are the two basic types of computational interpolation and approximation.

Extrapolation routines are used to obtain SAR values between the lowest measurement points and the inner phantom surface. The extrapolation distance is determined by the surface detection distance and the probe sensor offset. The uncertainty increases with the extrapolation distance. To keep the uncertainty within 1% for the 1 g and 10 g cubes, the extrapolation distance should not be larger than 5 mm.

## 4. SAR Measurement Evaluation

### 4.1 EUT Configuration and Setting

#### <Connections between EUT and System Simulator>

For WWAN SAR testing, the EUT was linked and controlled by base station emulator (Agilent E5515C is used for GSM/WCDMA/CDMA, and Anritsu MT8820C is used for LTE). Communication between the EUT and the emulator was established by air link. The distance between the EUT and the communicating antenna of the emulator is larger than 50 cm and the output power radiated from the emulator antenna is at least 30 dB smaller than the output power of EUT. The EUT was set from the emulator to radiate maximum output power during SAR testing.

#### < Proximity Sensor Triggering Distances >

The proximity sensor triggering distance was determined per KDB 616217 section 6.2, and EUT moving further away from the flat phantom and EUT moving toward the flat phantom were both assessed.

In the preliminary triggering distance testing, the tissue-equivalent medium for different frequency bands were used for verification; no other frequency bands tissue-equivalent medium was found to result in shortest triggering than that for 5700MHz, and the tissue-equivalent medium for 5700MHz was used for formal proximity sensor triggering testing.

Summary for power verification per distance was tabulated in the below table.

#### WWAN Ant

Output Power Verification in dBm for EUT Front Face (moving toward phantom)											
Distance (mm)	10	11	12	13	14	15	16	17	18	19	20
WCDMA II	23.0	23.0	23.0	23.0	23.0	25.0	25.0	25.0	25.0	25.0	25.0
WCDMA IV	22.0	22.0	22.0	22.0	22.0	25.0	25.0	25.0	25.0	25.0	25.0
LTE 2	22.5	22.5	22.5	22.5	22.5	24.5	24.5	24.5	24.5	24.5	24.5
LTE 4	21.5	21.5	21.5	21.5	21.5	24.5	24.5	24.5	24.5	24.5	24.5
LTE 7	22.0	22.0	22.0	22.0	22.0	24.0	24.0	24.0	24.0	24.0	24.0
LTE 66	21.5	21.5	21.5	21.5	21.5	24.5	24.5	24.5	24.5	24.5	24.5



# FCC SAR Test Report

## Front Face (moving toward phantom)

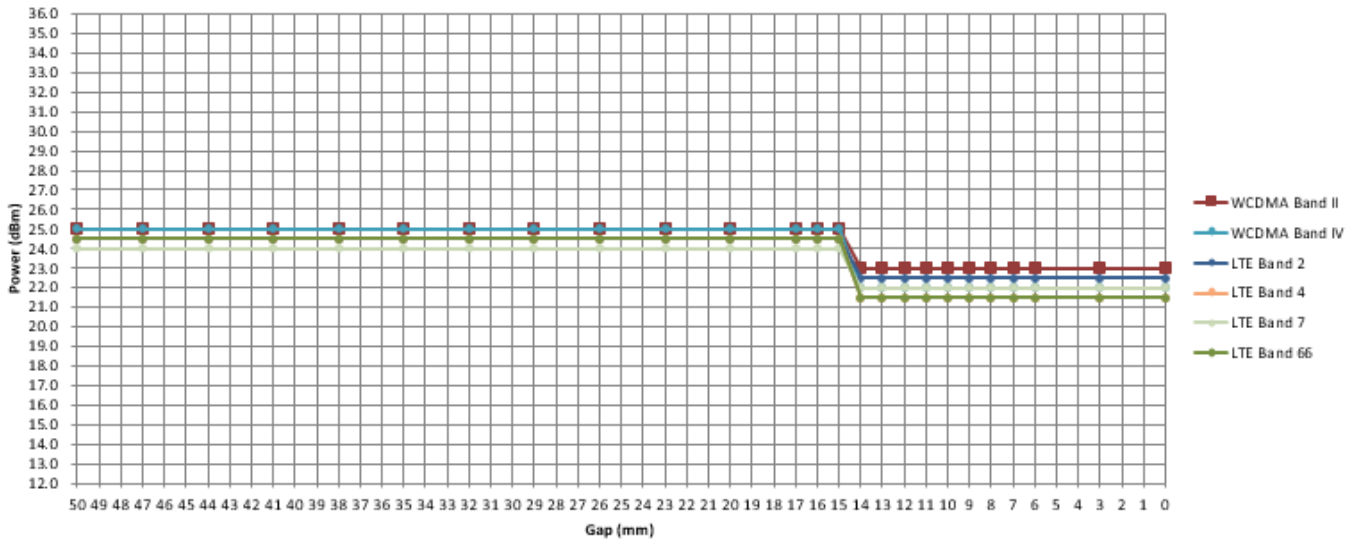

## Output Power Verification in dBm for EUT Front Face (moving away phantom)

Distance (mm)	12	13	14	15	16	17	18	19	20	21	22
WCDMA II	23.0	23.0	23.0	23.0	23.0	25.0	25.0	25.0	25.0	25.0	25.0
WCDMA IV	22.0	22.0	22.0	22.0	22.0	25.0	25.0	25.0	25.0	25.0	25.0
LTE 2	22.5	22.5	22.5	22.5	22.5	24.5	24.5	24.5	24.5	24.5	24.5
LTE 4	21.5	21.5	21.5	21.5	21.5	24.5	24.5	24.5	24.5	24.5	24.5
LTE 7	22.0	22.0	22.0	22.0	22.0	24.0	24.0	24.0	24.0	24.0	24.0
LTE 66	21.5	21.5	21.5	21.5	21.5	24.5	24.5	24.5	24.5	24.5	24.5

## Front Face (moving away phantom)

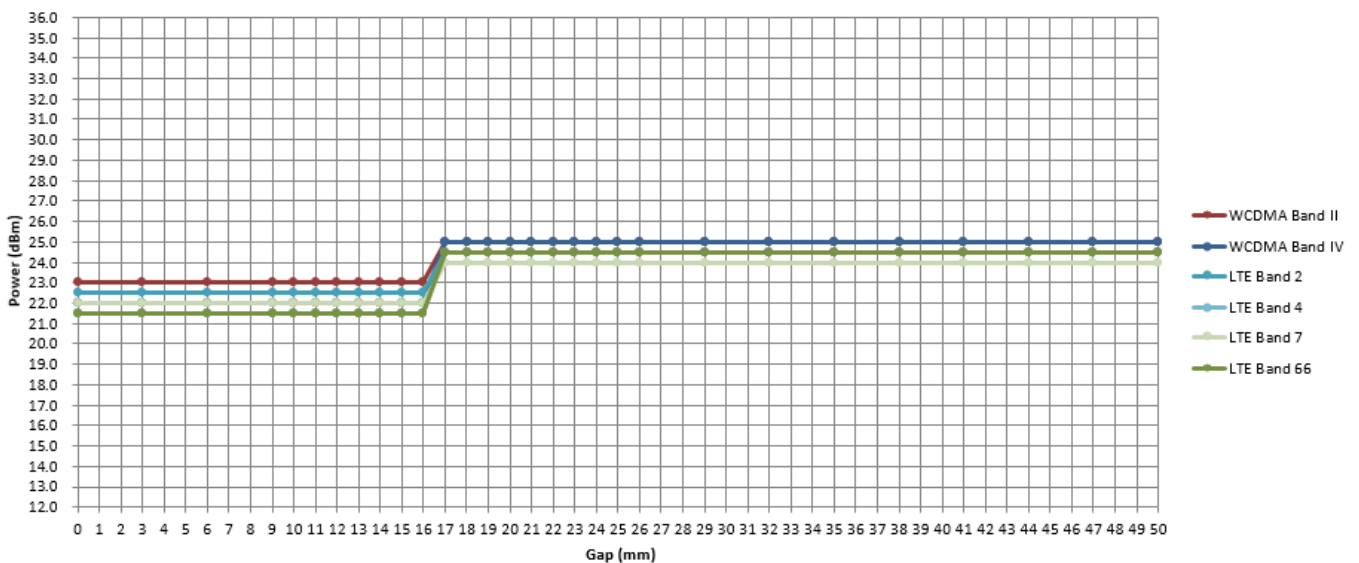

# FCC SAR Test Report

Output Power Verification in dBm for EUT Rear Face (moving toward phantom)											
Distance (mm)	15	16	17	18	19	20	21	22	23	24	25
WCDMA II	23.0	23.0	23.0	23.0	23.0	25.0	25.0	25.0	25.0	25.0	25.0
WCDMA IV	22.0	22.0	22.0	22.0	22.0	25.0	25.0	25.0	25.0	25.0	25.0
LTE 2	22.5	22.5	22.5	22.5	22.5	24.5	24.5	24.5	24.5	24.5	24.5
LTE 4	21.5	21.5	21.5	21.5	21.5	24.5	24.5	24.5	24.5	24.5	24.5
LTE 7	22.0	22.0	22.0	22.0	22.0	24.0	24.0	24.0	24.0	24.0	24.0
LTE 66	21.5	21.5	21.5	21.5	21.5	24.5	24.5	24.5	24.5	24.5	24.5

Rear Face  
(moving toward phantom)

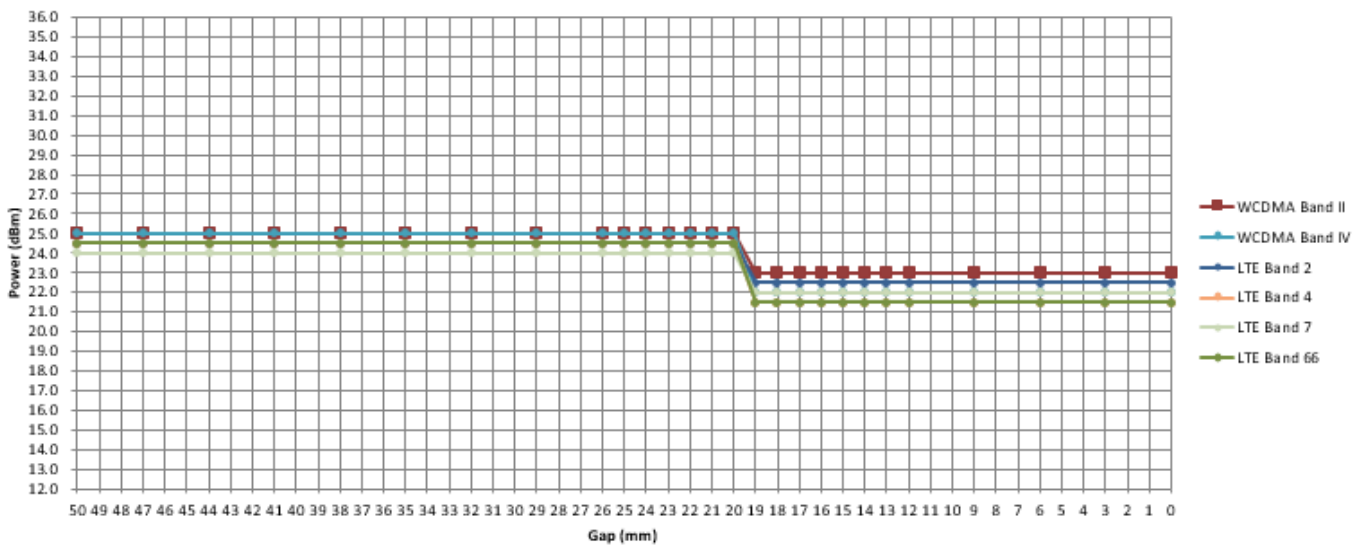

Output Power Verification in dBm for EUT Rear Face (moving away phantom)											
Distance (mm)	17	18	19	20	21	22	23	24	25	26	27
WCDMA II	23.0	23.0	23.0	23.0	23.0	25.0	25.0	25.0	25.0	25.0	25.0
WCDMA IV	22.0	22.0	22.0	22.0	22.0	25.0	25.0	25.0	25.0	25.0	25.0
LTE 2	22.5	22.5	22.5	22.5	22.5	24.5	24.5	24.5	24.5	24.5	24.5
LTE 4	21.5	21.5	21.5	21.5	21.5	24.5	24.5	24.5	24.5	24.5	24.5
LTE 7	22.0	22.0	22.0	22.0	22.0	24.0	24.0	24.0	24.0	24.0	24.0
LTE 66	21.5	21.5	21.5	21.5	21.5	24.5	24.5	24.5	24.5	24.5	24.5

# FCC SAR Test Report

## Rear Face (moving away phantom)

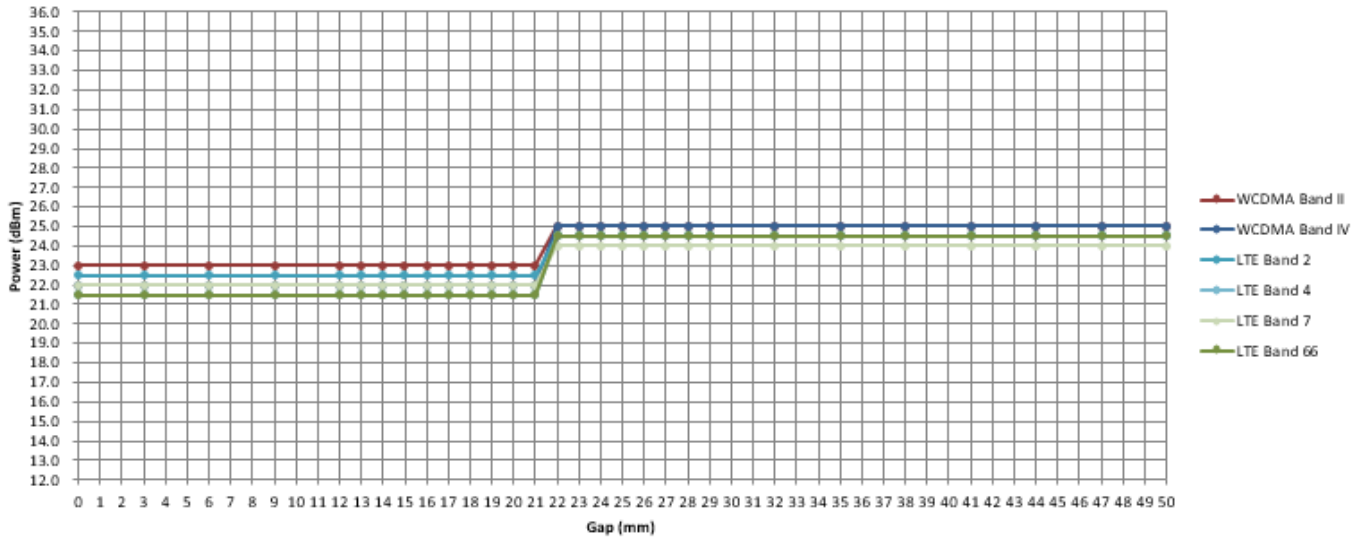

**Output Power Verification in dBm for EUT Bottom Side  
(moving toward phantom)**

Distance (mm)	18	19	20	21	22	23	24	25	26	27	28
WCDMA II	23.0	23.0	23.0	23.0	23.0	25.0	25.0	25.0	25.0	25.0	25.0
WCDMA IV	22.0	22.0	22.0	22.0	22.0	25.0	25.0	25.0	25.0	25.0	25.0
LTE 2	22.5	22.5	22.5	22.5	22.5	24.5	24.5	24.5	24.5	24.5	24.5
LTE 4	21.5	21.5	21.5	21.5	21.5	24.5	24.5	24.5	24.5	24.5	24.5
LTE 7	22.0	22.0	22.0	22.0	22.0	24.0	24.0	24.0	24.0	24.0	24.0
LTE 66	21.5	21.5	21.5	21.5	21.5	24.5	24.5	24.5	24.5	24.5	24.5

## Bottom Side (moving toward phantom)

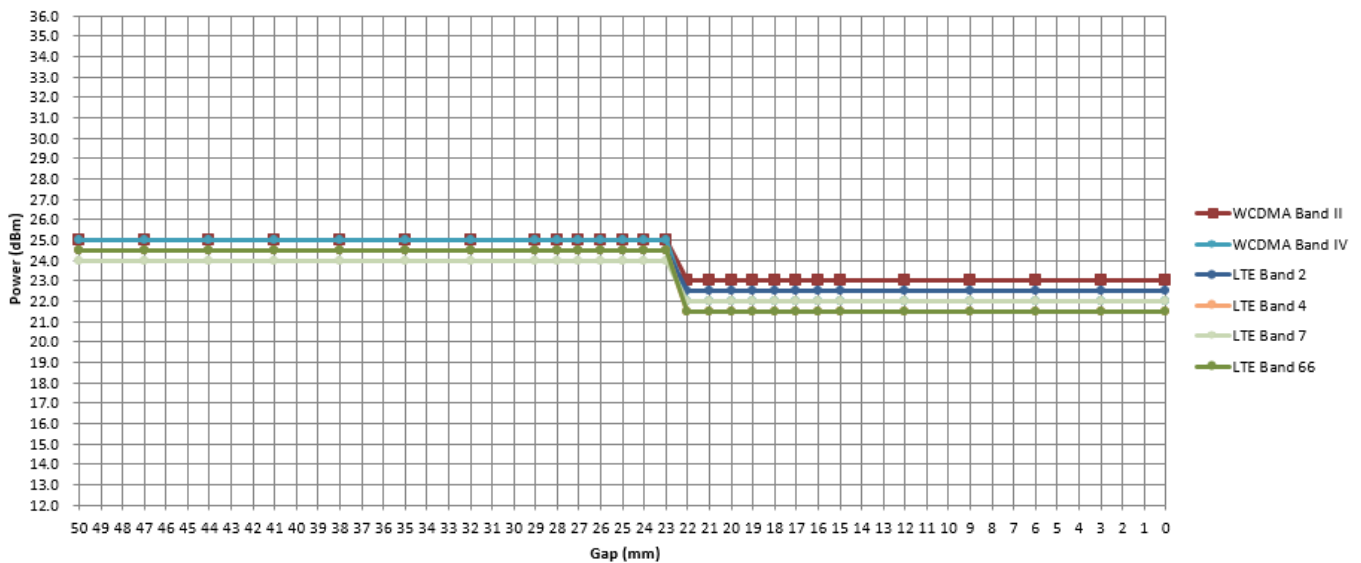

# FCC SAR Test Report

Output Power Verification in dBm for EUT Bottom Side (moving away phantom)											
Distance (mm)	20	21	22	23	24	25	26	27	28	29	30
WCDMA II	23.0	23.0	23.0	23.0	23.0	25.0	25.0	25.0	25.0	25.0	25.0
WCDMA IV	22.0	22.0	22.0	22.0	22.0	25.0	25.0	25.0	25.0	25.0	25.0
LTE 2	22.5	22.5	22.5	22.5	22.5	24.5	24.5	24.5	24.5	24.5	24.5
LTE 4	21.5	21.5	21.5	21.5	21.5	24.5	24.5	24.5	24.5	24.5	24.5
LTE 7	22.0	22.0	22.0	22.0	22.0	24.0	24.0	24.0	24.0	24.0	24.0
LTE 66	21.5	21.5	21.5	21.5	21.5	24.5	24.5	24.5	24.5	24.5	24.5

**Bottom Side  
(moving away phantom)**

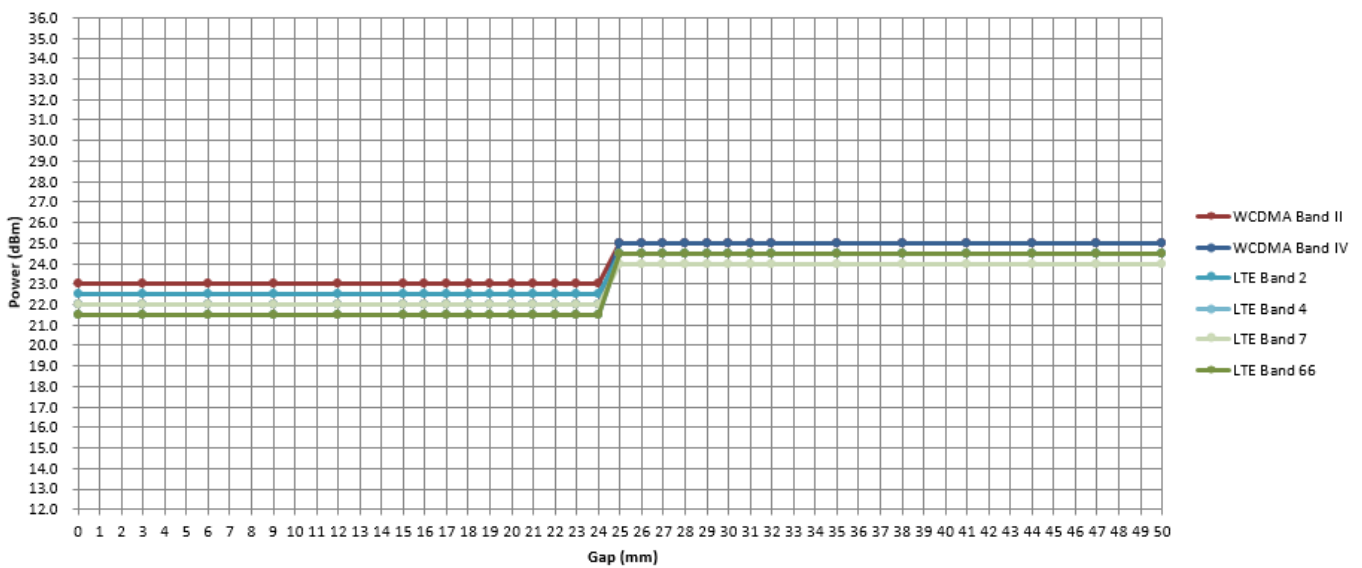

## < Proximity Sensor Coverage >

In KDB 616217 section 6.3, if a sensor is spatially offset from the antenna(s), it is necessary to verify sensor triggering for conditions where the antenna is next to the user but the sensor is laterally further away to ensure sensor coverage is sufficient for reducing the power to maintain compliance. For p-sensor coverage testing, the device is moved and “along the direction of maximum antenna and sensor offset”.

However, this device uses a capacitive proximity sensor that is same metallic component as the transmitting antenna to facilitate triggering in any condition the user may use the device in proximity of the antenna in the device. Therefore, no further sensor coverage assessments were required.

# FCC SAR Test Report

## <Proximity Sensor Tilt Angle Influences>

The proximity sensor tilt angle influence was determined per KDB 616217 for applicable edge. Summary for proximity sensor tilt angle influence is shown in below.

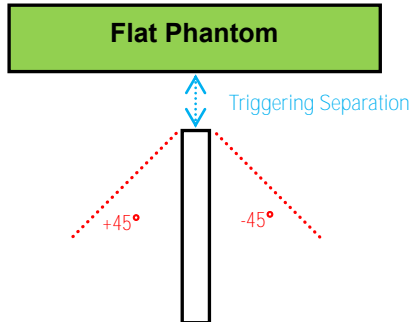

Orientation	Separation Distance (mm)	Tilt Angle										
		-45°	-40°	-30°	-20°	-10°	0°	10°	20°	30°	40°	45°
Bottom Side	21	On	On	On	On	On	On	On	On	On	On	On

## <Summary for Proximity Sensor Triggering Test>

According to the procedures noticed in KDB 616217 D04,

The WWAN for proximity sensor triggering distance is 14 mm for EUT Front Face, 18 mm for EUT Rear Face, 22 mm for EUT Bottom Side. The separation distance of 21 mm determined by the smallest triggering distance on Bottom Side is used to access the tilt angle influence and the sensor does not release during  $\pm 45$  degree. Therefore, the smallest separation distance for tilt angle influence is 21 mm for the Bottom Side. The conservation triggering distances based on the separation distance for the sensor trigger / not triggered as EUT with power reduction at 0 mm, and EUT without power reduction at 13 mm for EUT Front Face, 18 mm for EUT Rear Face, and 20mm for Bottom Side were used to test SAR.

The power reduction is depends on the proximity sensor input. For a steady SAR test, the power reduction was enabled or disabled manually by engineering software during SAR testing.

WWAN Proximity Sensor Trigger Distance (mm)			
Position	Front Face	Rear Face	Bottom Side
Minimum	14	19	21

## FCC SAR Test Report

---

### <Considerations Related to GSM / GPRS / EDGE for Setup and Testing>

The maximum multi-slot capability supported by this device is as below.

1. This EUT is class B device
2. This EUT supports GPRS multi-slot class 12 (max. uplink: 4, max. downlink: 4, total timeslots: 5)
3. This EUT supports EDGE multi-slot class 12 (max. uplink: 4, max. downlink: 4, total timeslots: 5)

For GSM850 frequency band, the power control level is set to 5 for GSM mode and GPRS (GMSK: CS1), and set to 8 for EDGE (GMSK: MCS1, 8PSK: MCS9). For GSM1900 frequency band, the power control level is set to 0 for GSM mode and GPRS (GMSK: CS1), and set to 2 for EDGE (GMSK: MCS1, 8PSK: MCS9).

SAR test reduction for GPRS and EDGE modes is determined by the source-based time-averaged output power specified for production units, including tune-up tolerance. The data mode with highest specified time-averaged output power should be tested for SAR compliance in the applicable exposure conditions. For modes with the same specified maximum output power and tolerance, the higher number time-slot configuration should be tested.

The frame-averaged power is linearly proportion to the slot number configured and it is linearly scaled the maximum burst-averaged power based on time slots. The calculated method is shown as below:

Frame-averaged power = 10 x log (Burst-averaged power mW x Slot used / 8)

### <Considerations Related to WCDMA for Setup and Testing>

#### WCDMA Handsets Head SAR

SAR for next to the ear head exposure is measured using a 12.2 kbps RMC with TPC bits configured to all "1's". The 3G SAR test reduction procedure is applied to AMR configurations with 12.2 kbps RMC as the primary mode.

#### WCDMA Handsets Body-worn SAR

SAR for body-worn configurations is measured using a 12.2 kbps RMC with TPC bits configured to all "1's". The 3G SAR test reduction procedure is applied to other spreading codes and multiple DPDCH<sub>n</sub> configurations supported by the handset with 12.2 kbps RMC as the primary mode.

#### Handsets with Release 5 HSDPA

The 3G SAR test reduction procedure is applied to HSDPA body-worn configurations with 12.2 kbps RMC as the primary mode. Otherwise, SAR is measured for HSDPA using the HSDPA body SAR procedures in the "Release 5 HSDPA Data Devices", for the highest reported SAR body-worn exposure configuration in 12.2 kbps RMC. Handsets with both HSDPA and HSUPA are tested according to Release 6 HSPA test procedures.

#### Handsets with Release 6 HSUPA

The 3G SAR test reduction procedure is applied to HSPA (HSUPA/HSDPA with RMC) body-worn configurations with 12.2 kbps RMC as the primary mode. Otherwise, SAR is measured for HSPA using the HSPA body SAR procedures in the "Release 6 HSPA Data Devices", for the highest reported body-worn exposure SAR configuration in 12.2 kbps RMC. When VOIP is applicable for next to the ear head exposure in HSPA, the 3G SAR test reduction procedure is applied to HSPA with 12.2 kbps RMC as the primary mode; otherwise, the same HSPA configuration used for body-worn measurements is tested for next to the ear head exposure.

## FCC SAR Test Report

### Release 5 HSDPA Data Devices

The 3G SAR test reduction procedure is applied to body SAR with 12.2 kbps RMC as the primary mode. Otherwise, body SAR for HSDPA is measured using an FRC with H-Set 1 in Sub-test 1 and a 12.2 kbps RMC configured in Test Loop Mode 1, for the highest reported SAR configuration in 12.2 kbps RMC without HSDPA. HSDPA is configured according to the applicable UE category of a test device. The number of HS-DSCH / HS-PDSCHs, HARQ processes, minimum inter-TTI interval, transport block sizes and RV coding sequence are defined by the H-set. To maintain a consistent test configuration and stable transmission conditions, QPSK is used in the H-set for SAR testing. HS-DPCCH should be configured with a CQI feedback cycle of 4 ms and a CQI repetition factor of 2 to maintain a constant rate of active CQI slots. DPCCH and DPDCH gain factors ( $\beta_c$ ,  $\beta_d$ ), and HS-DPCCH power offset parameters ( $\Delta_{ACK}$ ,  $\Delta_{NACK}$ ,  $\Delta_{CQI}$ ) are set according to values indicated in below. The CQI value is determined by the UE category, transport block size, number of HS-PDSCHs and modulation used in the H-set.

Sub-test	$\beta_c$	$\beta_d$	$\beta_d$ (SF)	$\beta_c / \beta_d$	$\beta_{hs}^{(1)}$	CM (dB) <sup>(2)</sup>	MPR
1	2 / 15	15 / 15	64	2 / 15	4 / 15	0.0	0
2	12 / 15 <sup>(3)</sup>	15 / 15 <sup>(3)</sup>	64	12 / 15 <sup>(3)</sup>	24 / 15	1.0	0
3	15 / 15	8 / 15	64	15 / 8	30 / 15	1.5	0.5
4	15 / 15	4 / 15	64	15 / 4	30 / 15	1.5	0.5

Note 1:  $\Delta_{ACK}$ ,  $\Delta_{NACK}$  and  $\Delta_{CQI} = 8 \Leftrightarrow A_{hs} = \beta_{hs} / \beta_c = 30 / 15 \Leftrightarrow \beta_{hs} = 30 / 15 * \beta_c$ .  
 Note 2: CM = 1 for  $\beta_c / \beta_d = 12 / 15$ ,  $\beta_{hs} / \beta_c = 24 / 15$ .  
 Note 3: For subtest 2 the  $\beta_c / \beta_d$  ratio of 12 / 15 for the TFC during the measurement period (TF1, TF0) is achieved by setting the signaled gain factors for the reference TFC (TF1, TF1) to  $\beta_c = 11 / 15$  and  $\beta_d = 15 / 15$ .

### Release 6 HSUPA Data Devices

The 3G SAR test reduction procedure is applied to body SAR with 12.2 kbps RMC as the primary mode. Otherwise, body SAR for HSPA is measured with E-DCH Sub-test 5, using H-Set 1 and QPSK for FRC and a 12.2 kbps RMC configured in Test Loop Mode 1 and power control algorithm 2, according to the highest reported body SAR configuration in 12.2 kbps RMC without HSPA. When VOIP applies to head exposure, the 3G SAR test reduction procedure is applied with 12.2 kbps RMC as the primary mode. Otherwise, the same HSPA configuration used for body SAR measurements are applied to head exposure testing. Due to inner loop power control requirements in HSPA, a communication test set is required for output power and SAR tests. The 12.2 kbps RMC, FRC H-set 1 and E-DCH configurations for HSPA are configured according to the  $\beta$  values indicated in below.

# FCC SAR Test Report

Sub-test	$\beta_c$	$\beta_d$	$\beta_d$ (SF)	$\beta_c / \beta_d$	$\beta_{HS}^{(1)}$	$\beta_{ec}$	$\beta_{ed}$	$\beta_{ed}$ (SF)	$\beta_{ed}$ (codes)	CM <sup>(2)</sup> (dB)	MPR (dB)	AG <sup>(4)</sup> Index	E-TFCI
1	11 / 15 <sup>(3)</sup>	15 / 15 <sup>(3)</sup>	64	11 / 15 <sup>(3)</sup>	22 / 15	209 / 225	1039 / 225	4	1	1.0	0.0	20	75
2	6 / 15	15 / 15	64	6 / 15	12 / 15	12 / 15	94 / 75	4	1	3.0	2.0	12	67
3	15 / 15	9 / 15	64	15 / 9	30 / 15	30 / 15	$\beta_{ed1}: 47/15$ $\beta_{ed2}: 47/15$	4	2	2.0	1.0	15	92
4	2 / 15	15 / 15	64	2 / 15	4 / 15	2 / 15	56 / 75	4	1	3.0	2.0	17	71
5	15 / 15 <sup>(4)</sup>	15 / 15 <sup>(4)</sup>	64	15 / 15 <sup>(4)</sup>	30 / 15	24 / 15	134 / 15	4	1	1.0	0.0	21	81

Note 1:  $\Delta_{ACK}, \Delta_{NACK}$  and  $\Delta_{COI} = 8 \Leftrightarrow A_{HS} = \beta_{HS} / \beta_c = 30 / 15 \Leftrightarrow \beta_{HS} = 30 / 15 * \beta_c$   
 Note 2: CM = 1 for  $\beta_c / \beta_d = 12 / 15, \beta_{HS} / \beta_c = 24 / 15$ . For all other combinations of DPDCH, DPCCH, HS-DPCCH, E-DPDCH and E-DPCCH the MPR is based on the relative CM difference.  
 Note 3: For subtest 1 the  $\beta_c / \beta_d$  ratio of 11 / 15 for the TFC during the measurement period (TF1, TF0) is achieved by setting the signaled gain factors for the reference TFC (TF1, TF1) to  $\beta_c = 10 / 15$  and  $\beta_d = 15 / 15$ .  
 Note 4: For subtest 5 the  $\beta_c / \beta_d$  ratio of 15 / 15 for the TFC during the measurement period (TF1, TF0) is achieved by setting the signaled gain factors for the reference TFC (TF1, TF1) to  $\beta_c = 14 / 15$  and  $\beta_d = 15 / 15$ .  
 Note 5: Testing UE using E-DPDCH Physical Layer category 1 Sub-test 3 is not required according to TS 25.306 Table 5.1g.  
 Note 6:  $\beta_{ed}$  cannot be set directly: it is set by Absolute Grant Value.

## HSPA+ SAR Guidance

The 3G SAR test reduction procedure is applied to HSPA+ (uplink) with 12.2 kbps RMC as the primary mode. Otherwise, when SAR is required for Rel. 6 HSPA, SAR is required for Rel. 7 HSPA+. Power is measured for HSPA+ that supports uplink 16QAM according to configurations in Table C.11.1.4 of 3GPP TS 34.121-1 to determine SAR test reduction.

## DC-HSDPA SAR Guidance

The 3G SAR test reduction procedure is applied to DC-HSDPA with 12.2 kbps RMC as the primary mode. Otherwise, when SAR is required for Rel. 5 HSDPA, SAR is required for Rel. 8 DC-HSDPA. Power is measured for DC-HSDPA according to the H-Set 12, FRC configuration in Table C.8.1.12 of 3GPP TS 34.121-1 to determine SAR test reduction. A primary and a secondary serving HS-DSCH Cell are required to perform the power measurement and for the results to be acceptable.

## <Considerations Related to LTE for Setup and Testing>

This device contains LTE transmitter which follows 3GPP standards, supports both QPSK 16QAM and 64QAM modulations, and supported LTE band and channel bandwidth is listed in below. The output power was tested per 3GPP TS 36.521-1 maximum transmit procedures for both QPSK 16QAM and 64QAM modulation. The results please refer to section 4.6 of this report.

EUT Supported LTE Band and Channel Bandwidth						
LTE Band	BW 1.4 MHz	BW 3 MHz	BW 5 MHz	BW 10 MHz	BW 15 MHz	BW 20 MHz
2	V	V	V	V	V	V
4	V	V	V	V	V	V
5	V	V	V	V		
7			V	V	V	V
12	V	V	V	V		
13			V	V		
17			V	V		
66	V	V	V	V	V	V



# FCC SAR Test Report

The LTE maximum power reduction (MPR) in accordance with 3GPP TS 36.101 is active all times during LTE operation. The allowed MPR for the maximum output power is specified in below.

Modulation	Channel Bandwidth / RB Configurations						LTE MPR Setting (dB)
	BW 1.4 MHz	BW 3 MHz	BW 5 MHz	BW 10 MHz	BW 15 MHz	BW 20 MHz	
QPSK	> 5	> 4	> 8	> 12	> 16	> 18	1
16QAM	<= 5	<= 4	<= 8	<= 12	<= 16	<= 18	1
16QAM	> 5	> 4	> 8	> 12	> 16	> 18	2
64QAM	<= 5	<= 4	<= 8	<= 12	<= 16	<= 18	2
64QAM	> 5	> 4	> 8	> 12	> 16	> 18	3

**Note:** MPR is according to the standard and implemented in the circuit (mandatory).

In addition, the device is compliant with additional maximum power reduction (A-MPR) requirements defined in 3GPP TS 36.101 section 6.2.4 that was disabled for all FCC compliance testing.

During LTE SAR testing, the related parameters of operating band, channel bandwidth, uplink channel number, modulation type, and RB was set in base station simulator. When the EUT has registered and communicated to base station simulator, the simulator set to make EUT transmitting the maximum radiated power.

### <Considerations Related to WLAN for Setup and Testing>

In general, various vendor specific external test software and chipset based internal test modes are typically used for SAR measurement. These chipset based test mode utilities are generally hardware and manufacturer dependent, and often include substantial flexibility to reconfigure or reprogram a device. A Wi-Fi device must be configured to transmit continuously at the required data rate, channel bandwidth and signal modulation, using the highest transmission duty factor supported by the test mode tools for SAR measurement. The test frequencies established using test mode must correspond to the actual channel frequencies. When 802.11 frame gaps are accounted for in the transmission, a maximum transmission duty factor of 92 - 96% is typically achievable in most test mode configurations. A minimum transmission duty factor of 85% is required to avoid certain hardware and device implementation issues related to wide range SAR scaling. In addition, a periodic transmission duty factor is required for current generation SAR systems to measure SAR correctly. The reported SAR must be scaled to 100% transmission duty factor to determine compliance at the maximum tune-up tolerance limit.

According to KDB 248227 D01, this device has installed WLAN engineering testing software which can provide continuous transmitting RF signal. During WLAN SAR testing, this device was operated to transmit continuously at the maximum transmission duty with specified transmission mode, operating frequency, lowest data rate, and maximum output power.

### Initial Test Configuration

An initial test configuration is determined for OFDM transmission modes in 2.4 GHz and 5 GHz bands according to the channel bandwidth, modulation and data rate combination(s) with the highest maximum output power specified for production units in each standalone and aggregated frequency band. When the same maximum power is specified for multiple transmission modes in a frequency band, the largest channel bandwidth, lowest order modulation, lowest data rate and lowest order 802.11a/g/n/ac mode is used for SAR measurement, on the highest measured output power channel in the initial test configuration, for each frequency band.

### Subsequent Test Configuration

SAR measurement requirements for the remaining 802.11 transmission mode configurations that have not been tested in the initial test configuration are determined separately for each standalone and aggregated frequency band, in each exposure condition, according to the maximum output power specified for production units. Additional power measurements may be required to determine if SAR measurements are required for subsequent highest output power channels in a subsequent test configuration. When the highest reported SAR for the initial test configuration according to the initial test position or fixed exposure position requirements, is adjusted by the ratio of the subsequent test configuration to initial test configuration specified maximum output power and the adjusted SAR is  $\leq 1.2$  W/kg, SAR is not required for that subsequent test configuration.

### SAR Test Configuration and Channel Selection

When multiple channel bandwidth configurations in a frequency band have the same specified maximum output power, the initial test configuration is using largest channel bandwidth, lowest order modulation, lowest data rate, and lowest order 802.11 mode (i.e., 802.11a is chosen over 802.11n then 802.11ac or 802.11g is chosen over 802.11n). After an initial test configuration is determined, if multiple test channels have the same measured maximum output power, the channel chosen for SAR measurement is determined according to the following.

1) The channel closest to mid-band frequency is selected for SAR measurement.

# FCC SAR Test Report

2) For channels with equal separation from mid-band frequency; for example, high and low channels or two mid-band channels, the higher frequency (number) channel is selected for SAR measurement.

## <Considerations Related to Bluetooth for Setup and Testing>

This device has installed Bluetooth engineering testing software which can provide continuous transmitting RF signal. During Bluetooth SAR testing, this device was operated to transmit continuously at the maximum transmission duty with specified transmission mode, operating frequency, lowest data rate, and maximum output power.

## <BT Duty Cycle of Test Signal>

**BT\_GFSK:** Duty cycle = 2.900 / 3.750 = 0.7733

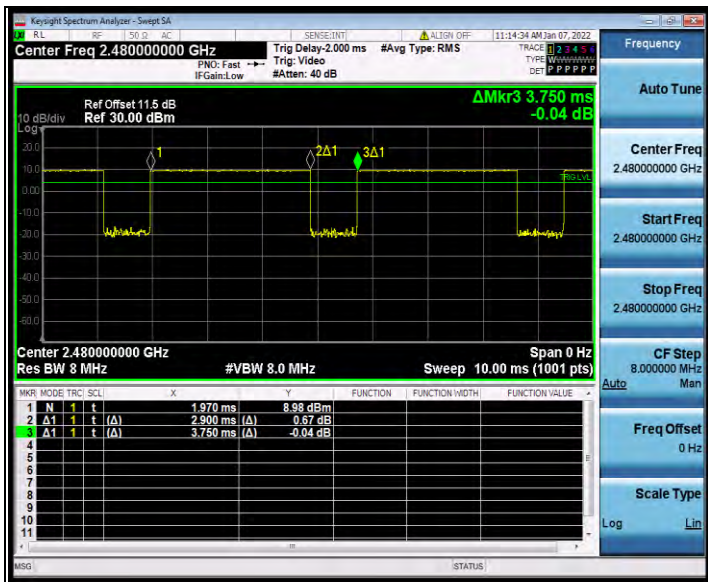

**4.2 EUT Testing Position**

According to KDB 648474 D04, handsets are tested for SAR compliance in head, body-worn accessory and other use configurations described in the following subsections.

**4.2.1 Head Exposure Conditions**

Head exposure is limited to next to the ear voice mode operations. Head SAR compliance is tested according to the test positions defined in IEEE Std 1528-2013 using the SAM phantom illustrated as below.

1. Define two imaginary lines on the handset
  - (a) The vertical centerline passes through two points on the front side of the handset - the midpoint of the width  $w_t$  of the handset at the level of the acoustic output, and the midpoint of the width  $w_b$  of the bottom of the handset.
  - (b) The horizontal line is perpendicular to the vertical centerline and passes through the center of the acoustic output. The horizontal line is also tangential to the face of the handset at point A.
  - (c) The two lines intersect at point A. Note that for many handsets, point A coincides with the center of the acoustic output; however, the acoustic output may be located elsewhere on the horizontal line. Also note that the vertical centerline is not necessarily parallel to the front face of the handset, especially for clamshell handsets, handsets with flip covers, and other irregularly shaped handsets.

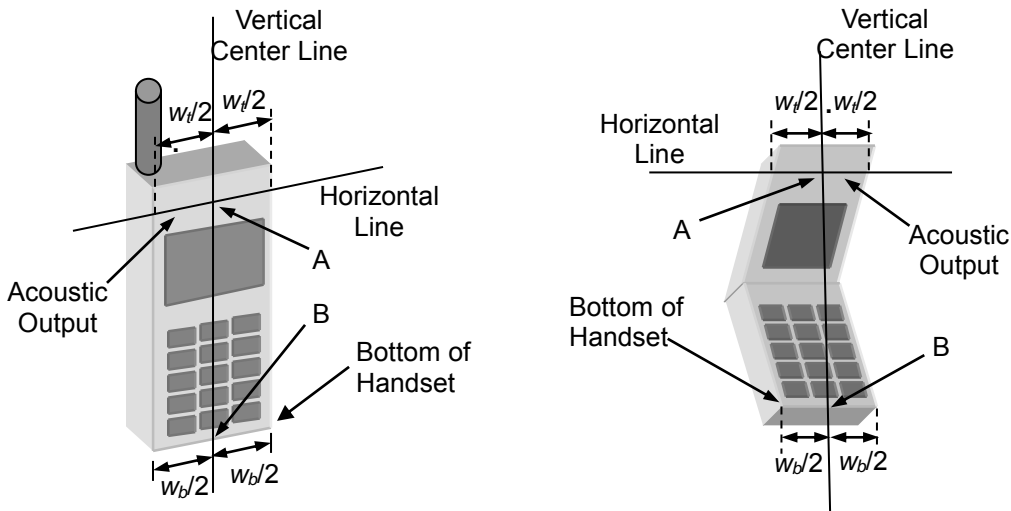
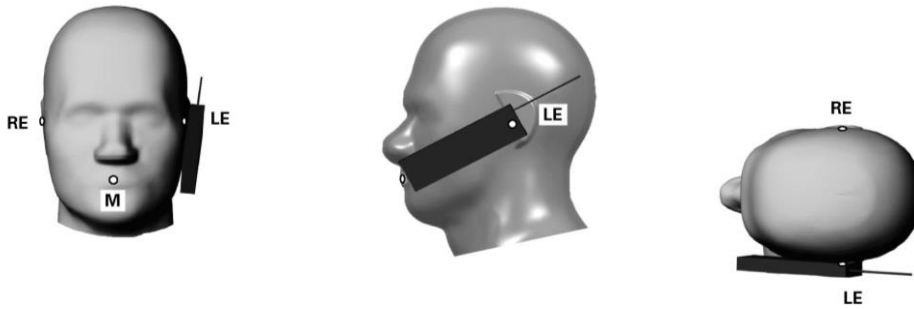

**Fig-4.1 Illustration for Handset Vertical and Horizontal Reference Lines**

**2. Cheek Position**

- (a) To position the device with the vertical center line of the body of the device and the horizontal line crossing the center piece in a plane parallel to the sagittal plane of the phantom. While maintaining the device in this plane, align the vertical center line with the reference plane containing the three ear and mouth reference point (M: Mouth, RE: Right Ear, and LE: Left Ear) and align the center of the ear piece with the line RE-LE.
- (b) To move the device towards the phantom with the ear piece aligned with the line LE-RE until the phone touched the ear. While maintaining the device in the reference plane and maintaining the phone contact with the ear, move the bottom of the phone until any point on the front side is in contact with the cheek of the phantom or until

contact with the ear is lost (see Fig-4.2).

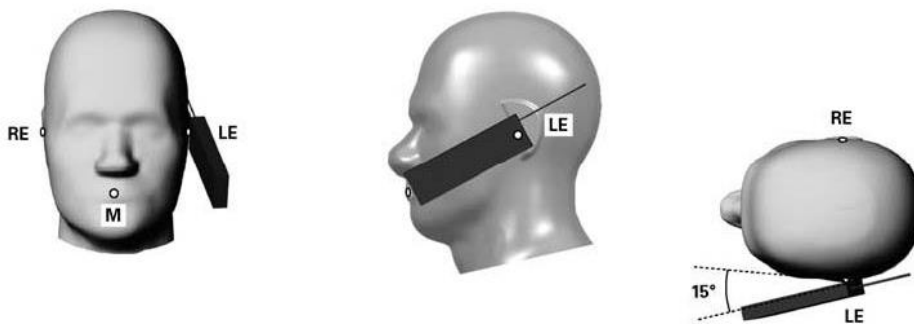

**Fig-4.2 Illustration for Cheek Position**

3. Tilted Position

(a) To position the device in the “cheek” position described above.

(b) While maintaining the device the reference plane described above and pivoting against the ear, moves it outward away from the mouth by an angle of 15 degrees or until contact with the ear is lost (see Fig-4.3).



**Fig-4.3 Illustration for Tilted Position**

**4.2.2 Body-worn Accessory Exposure Conditions**

Body-worn accessory exposure is typically related to voice mode operations when handsets are carried in body-worn accessories. The body-worn accessory procedures in KDB 447498 D01 are used to test for body-worn accessory SAR compliance, without a headset connected to it. This enables the test results for such configuration to be compatible with that required for hotspot mode when the body-worn accessory test separation distance is greater than or equal to that required for hotspot mode. When the reported SAR for a body-worn accessory, measured without a headset connected to the handset, is > 1.2 W/kg, the highest reported SAR configuration for that wireless mode and frequency band should be repeated for that body-worn accessory with a headset attached to the handset.

Body-worn accessories that do not contain metallic or conductive components may be tested according to worst-case exposure configurations, typically according to the smallest test separation distance required for the group of body-worn accessories with similar operating and exposure characteristics. All body-worn accessories containing metallic components are tested in conjunction with the host device.

Body-worn accessory SAR compliance is based on a single minimum test separation distance for all wireless and operating modes applicable to each body-worn accessory used by the host, and according to the relevant voice and/or data mode transmissions and operations. If a body-worn accessory supports voice only operations in its normal and expected use conditions, testing of data mode for body-worn compliance is not required.

A conservative minimum test separation distance for supporting off-the-shelf body-worn accessories that may be acquired by users of consumer handsets is used to test for body-worn accessory SAR compliance. This distance is determined by the handset manufacturer, according to the requirements of Supplement C 01-01. Devices that are designed to operate on the body of users using lanyards and straps, or without requiring additional body-worn accessories, will be tested using a conservative minimum test separation distance  $\leq 5$  mm to support compliance.

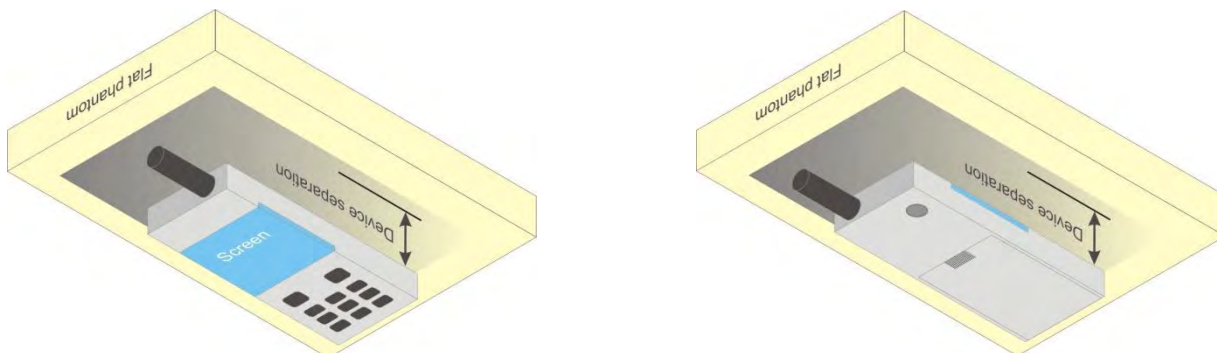

**Fig-4.4 Illustration for Body Worn Position**

**4.2.3 Hotspot Mode Exposure Conditions**

For handsets that support hotspot mode operations, with wireless router capabilities and various web browsing functions, the relevant hand and body exposure conditions are tested according to the hotspot SAR procedures in KDB 941225 D06. A test separation distance of 10 mm is required between the phantom and all surfaces and edges with a transmitting antenna located within 25 mm from that surface or edge. When the form factor of a handset is smaller than 9 cm x 5 cm, a test separation distance of 5 mm (instead of 10 mm) is required for testing hotspot mode. When the separation distance required for body-worn accessory testing is larger than or equal to that tested for hotspot mode, in the same wireless mode and for the same surface of the phone, the hotspot mode SAR data may be used to support body-worn accessory SAR compliance for that particular configuration (surface).

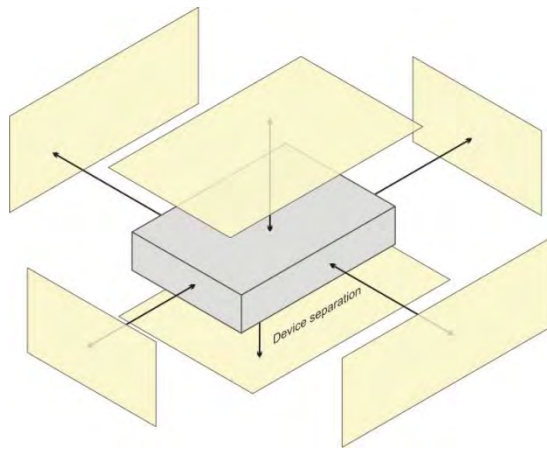

Based on the antenna location shown on appendix D of this report, the SAR testing required for hotspot mode is listed as below.

Antenna	Front Face	Rear Face	Left Side	Right Side	Top Side	Bottom Side
WWAN	V	V	V	V		V
WLAN / BT	V	V		V	V	

**4.2.4 Extremity Exposure Conditions**

For smart phones with a display diagonal dimension > 15 cm or an overall diagonal dimension > 16 cm that provide similar mobile web access and multimedia support found in mini-tablets or UMPC mini-tablets that support voice calls next to the ear, the following phablet procedures should be applied to evaluate SAR compliance for each applicable wireless modes and frequency band. Devices marketed as phablets, regardless of form factors and operating characteristics must be tested as a phablet to determine SAR compliance.

1. The normally required head and body-worn accessory SAR test procedures for handsets, including hotspot mode, must be applied.
2. The UMPC mini-tablet procedures must also be applied to test the SAR of all surfaces and edges with an antenna located at <= 25 mm from that surface or edge, in direct contact with a flat phantom, for 10-g extremity SAR according to the body-equivalent tissue dielectric parameters in KDB 865664 to address interactive hand use exposure conditions. The UMPC mini-tablet 1-g SAR at 5 mm is not required. When hotspot mode applies, 10-g extremity SAR is required only for the surfaces and edges with hotspot mode 1-g SAR > 1.2 W/kg. The normal tablet procedures in KDB 616217 are required when the over diagonal dimension of the device is > 20 cm. Hotspot mode SAR is not required when normal tablet procedures are applied. Extremity 10-g SAR is also not required for the front (top) surface of large form factor full size tablets. The more conservative tablet SAR results can be used to support the 10-g extremity SAR for phablet mode.
3. The simultaneous transmission operating configurations applicable to voice and data transmissions for both phone and mini-tablet modes must be taken into consideration separately for 1-g and 10-g SAR to determine the simultaneous transmission SAR test exclusion and measurement requirements for the relevant wireless modes and exposure conditions.

**4.2.5 Simultaneous Transmission Possibilities**

The simultaneous transmission possibilities for this device are listed as below.

Simultaneous TX Combination	Capable Transmit Configurations	Head	Body-worn	Hotspot	Extremity
1	WWAN + WLAN2.4G			Yes	
2	WWAN + BT			Yes	



**4.3 Tissue Verification**

The measuring results for tissue simulating liquid are shown as below.

Test Date	Tissue Type	Frequency (MHz)	Liquid Temp. (°C)	Measured Conductivity (σ)	Measured Permittivity (ε <sub>r</sub> )	Target Conductivity (σ)	Target Permittivity (ε <sub>r</sub> )	Conductivity Deviation (%)	Permittivity Deviation (%)
Apr. 12, 2022	Head	750	22.6	0.892	41.078	0.89	41.90	0.22	-1.96
Apr. 13, 2022	Head	835	22.2	0.904	41.721	0.90	41.50	0.44	0.53
Apr. 13, 2022	Head	1750	22.4	1.380	41.180	1.37	40.10	0.73	2.69
Apr. 14, 2022	Head	1900	22.8	1.433	39.805	1.40	40.00	2.36	-0.49
Apr. 14, 2022	Head	2450	22.3	1.844	39.407	1.80	39.20	2.44	0.53
Apr. 15, 2022	Head	2600	22.6	2.056	37.587	1.96	39.00	4.90	-3.62

**Note:**

The dielectric properties of the tissue simulating liquid must be measured within 24 hours before the SAR testing and within ±5% of the target values. Liquid temperature during the SAR testing must be within ±2 °C.

**4.4 System Verification**

The measuring result for system verification is tabulated as below.

Test Date	Mode	Frequency (MHz)	1W Target SAR-1g (W/kg)	Measured SAR-1g (W/kg)	Normalized to 1W SAR-1g (W/kg)	Deviation (%)	Dipole S/N	Probe S/N	DAE S/N
Apr. 12, 2022	Head	750	8.34	2.13	8.52	2.16	1067	3873	1389
Apr. 13, 2022	Head	835	9.47	2.49	9.96	5.17	4d139	3873	1389
Apr. 13, 2022	Head	1750	36.60	8.78	35.12	-4.04	1071	3873	1389
Apr. 14, 2022	Head	1900	39.70	10.40	41.60	4.79	5d159	3873	1389
Apr. 14, 2022	Head	2450	53.60	14.30	57.20	6.72	893	3873	1389
Apr. 15, 2022	Head	2600	55.80	14.90	59.60	6.81	1110	3873	1389

**Note:**

Comparing to the reference SAR value provided by SPEAG, the validation data should be within its specification of 10 %. The result indicates the system check can meet the variation criterion and the plots can be referred to Appendix A of this report.

# FCC SAR Test Report

## 4.5 Maximum Output Power

### 4.5.1 Maximum Conducted Power

The maximum conducted average power (Unit: dBm) including tune-up tolerance is shown as below.

Mode	GSM850		GSM1900	
	Full Power	Reduced Power(Body)	Full Power	Reduced Power(Body)
GSM (GMSK, 1Tx-slot)	34.0	N/A	31.0	N/A
GPRS (GMSK, 1Tx-slot)	34.0	N/A	31.0	N/A
GPRS (GMSK, 2Tx-slot)	32.0	N/A	29.0	N/A
GPRS (GMSK, 3Tx-slot)	30.0	N/A	27.0	N/A
GPRS (GMSK, 4Tx-slot)	28.0	N/A	25.0	N/A
EDGE (8PSK, 1Tx-slot)	27.0	N/A	27.5	N/A
EDGE (8PSK, 2Tx-slot)	26.0	N/A	26.5	N/A
EDGE (8PSK, 3Tx-slot)	23.5	N/A	23.5	N/A
EDGE (8PSK, 4Tx-slot)	21.0	N/A	21.5	N/A

Mode	WCDMA Band II		WCDMA Band IV		WCDMA Band V	
	Full Power	Reduced Power(Body)	Full Power	Reduced Power(Body)	Full Power	Reduced Power(Body)
RMC 12.2K	25.0	23.0	25.0	22.0	25.0	N/A
HSDPA	24.0	22.0	24.0	21.0	24.0	N/A
DC-HSDPA	24.0	22.0	24.0	21.0	24.0	N/A
HSPA+	24.0	22.0	24.0	21.0	24.0	N/A

Mode	LTE 2		LTE 4		LTE 5	
	Full Power	Reduced Power(Body)	Full Power	Reduced Power(Body)	Full Power	Reduced Power(Body)
QPSK	24.5	22.5	24.5	21.5	25.0	N/A
16QAM	23.5	21.5	23.5	20.5	24.0	N/A
64QAM	22.5	20.5	22.5	19.5	23.0	N/A

Mode	LTE 7		LTE 12		LTE 13	
	Full Power	Reduced Power(Body)	Full Power	Reduced Power(Body)	Full Power	Reduced Power(Body)
QPSK	24.0	22.0	25.0	N/A	24.0	N/A
16QAM	23.0	21.0	24.0	N/A	23.0	N/A
64QAM	22.0	20.0	23.0	N/A	22.0	N/A

Mode	LTE 17		LTE 66	
	Full Power	Reduced Power(Body)	Full Power	Reduced Power(Body)
QPSK	25.0	N/A	24.5	21.5
16QAM	24.0	N/A	23.5	20.5
64QAM	23.0	N/A	22.5	19.5

## FCC SAR Test Report

---

### WLAN / BT

Mode	WLAN2.4G
802.11b	18.0
802.11g	17.0
802.11n-HT20	15.0

Mode	Bluetooth
BR/EDR	8.0
LE	3.0

# FCC SAR Test Report

## 4.5.2 Measured Conducted Power Result

The measuring conducted average power (Unit: dBm) is shown as below.

Band	GSM850			GSM1900		
Channel	128	189	251	512	661	810
Frequency (MHz)	824.2	836.4	848.8	1850.2	1880.0	1909.8
<b>Maximum Burst-Averaged Output Power</b>						
GSM (GMSK, 1Tx-slot)	32.50	32.60	<b>32.61</b>	29.91	30.05	<b>30.07</b>
GPRS (GMSK, 1Tx-slot)	32.48	32.58	32.60	29.89	30.04	30.05
GPRS (GMSK, 2Tx-slot)	30.46	30.40	30.46	27.93	27.83	27.66
GPRS (GMSK, 3Tx-slot)	28.55	28.48	28.54	26.37	26.27	26.08
GPRS (GMSK, 4Tx-slot)	26.43	26.40	26.42	24.35	24.28	24.07
EDGE (8PSK, 1Tx-slot)	25.48	25.76	25.79	26.11	26.59	25.35
EDGE (8PSK, 2Tx-slot)	25.36	25.63	25.59	25.88	25.41	25.28
EDGE (8PSK, 3Tx-slot)	22.97	23.05	23.10	23.04	22.59	22.90
EDGE (8PSK, 4Tx-slot)	20.50	20.65	20.73	20.97	20.85	20.76
<b>Maximum Frame-Averaged Output Power</b>						
GSM (GMSK, 1Tx-slot)	23.50	23.60	23.61	20.91	21.05	21.07
GPRS (GMSK, 1Tx-slot)	23.48	23.58	23.60	20.89	21.04	21.05
GPRS (GMSK, 2Tx-slot)	24.46	24.40	<b>24.46</b>	21.93	21.83	21.66
GPRS (GMSK, 3Tx-slot)	24.29	24.22	24.28	<b>22.11</b>	22.01	21.82
GPRS (GMSK, 4Tx-slot)	23.43	23.40	23.42	21.35	21.28	21.07
EDGE (8PSK, 1Tx-slot)	16.48	16.76	16.79	17.11	17.59	16.35
EDGE (8PSK, 2Tx-slot)	19.36	19.63	19.59	19.88	19.41	19.28
EDGE (8PSK, 3Tx-slot)	18.71	18.79	18.84	18.78	18.33	18.64
EDGE (8PSK, 4Tx-slot)	17.50	17.65	17.73	17.97	17.85	17.76

Band	WCDMA Band II			WCDMA Band IV			WCDMA Band V			3GPP MPR (dB)
Channel	9262	9400	9538	1312	1413	1513	4132	4182	4233	
Frequency (MHz)	1852.4	1880.0	1907.6	1712.4	1732.6	1752.6	826.4	836.4	846.6	
RMC 12.2K	23.41	<b>23.47</b>	23.36	<b>23.41</b>	23.34	23.39	24.15	24.14	<b>24.18</b>	-
HSDPA Subtest-1	22.41	22.50	22.38	22.43	22.39	22.43	23.12	23.14	23.17	0
HSDPA Subtest-2	22.41	22.43	22.31	22.41	22.30	22.34	23.13	23.08	23.11	0
HSDPA Subtest-3	21.87	21.96	21.86	21.87	21.83	21.89	22.57	22.59	22.64	0.5
HSDPA Subtest-4	21.89	21.90	21.78	21.97	21.85	21.89	22.58	22.52	22.55	0.5
DC-HSDPA Subtest-1	22.39	22.44	22.36	22.40	22.32	22.40	23.11	23.09	23.16	0
DC-HSDPA Subtest-2	22.34	22.45	22.32	22.34	22.32	22.35	23.05	23.09	23.11	0
DC-HSDPA Subtest-3	21.87	21.90	21.80	21.88	21.78	21.84	22.54	22.50	22.55	0.5
DC-HSDPA Subtest-4	21.84	21.91	21.76	21.85	21.79	21.80	22.52	22.52	22.52	0.5
HSUPA Subtest-1	22.44	22.43	22.38	22.44	22.30	22.41	23.17	23.09	23.19	0
HSUPA Subtest-2	20.38	20.45	20.30	20.38	20.32	20.33	21.10	21.10	21.10	2
HSUPA Subtest-3	21.45	21.47	21.39	21.38	21.27	21.35	22.18	22.13	22.20	1
HSUPA Subtest-4	20.39	20.48	20.41	20.31	20.27	20.36	21.10	21.12	21.20	2
HSUPA Subtest-5	22.40	22.47	22.33	20.40	20.34	20.36	23.13	23.13	23.14	0
HSPA+ Subtest-1	20.12	20.16	20.10	19.88	19.79	19.89	20.80	20.77	20.86	2.5

# FCC SAR Test Report

LTE Band 2																	
BW	MCS Index	RB Size	RB Offset	Low	Mid	High	3GPP MPR (dB)	BW	MCS Index	RB Size	RB Offset	Low	Mid	High	3GPP MPR (dB)		
		Channel		18700	18900	19100				Channel		18675	18900	19125			
		Frequency(MHz)		1860	1880	1900				Frequency(MHz)		1857.5	1880	1902.5			
20M	QPSK	1	0	24.00	24.25	24.11	0	15M	QPSK	1	0	23.92	24.21	24.06	0		
		1	50	24.00	24.15	24.09	0			1	37	23.98	24.07	24.08	0		
		1	99	23.89	24.14	24.00	0			1	74	23.81	24.10	23.95	0		
		50	0	22.97	23.15	23.06	1			36	0	22.94	23.09	23.04	1		
		50	25	22.97	23.13	23.02	1			36	19	22.95	23.06	22.97	1		
		50	50	22.86	23.05	22.98	1			36	39	22.80	22.97	22.96	1		
	100	0	22.96	23.16	22.97	1	75		0	22.95	23.14	22.89	1				
	16QAM	1	0	23.19	23.39	23.28	1		1	0	23.12	23.31	23.22	1			
		1	50	22.89	23.07	22.98	1		1	37	22.86	23.01	22.96	1			
		1	99	22.88	23.04	22.93	1		1	74	22.86	22.97	22.88	1			
		50	0	22.08	22.27	22.20	2		36	0	22.02	22.19	22.18	2			
		50	25	22.07	22.22	22.16	2		36	19	22.05	22.14	22.15	2			
		50	50	22.03	22.28	22.14	2		36	39	21.95	22.24	22.09	2			
	100	0	22.20	22.35	22.29	2	75		0	22.18	22.27	22.28	2				
	64QAM	1	0	22.11	22.36	22.22	2		1	0	22.03	22.32	22.17	2			
		1	50	22.13	22.31	22.22	2		1	37	22.10	22.25	22.20	2			
		1	99	21.96	22.12	22.01	2		1	74	21.94	22.05	21.96	2			
		50	0	20.63	20.82	20.75	3		36	0	20.57	20.74	20.73	3			
		50	25	20.35	20.55	20.36	3		36	19	20.34	20.53	20.28	3			
		50	50	20.43	20.61	20.50	3		36	39	20.38	20.53	20.44	3			
	100	0	20.53	20.69	20.60	3	75		0	20.52	20.63	20.58	3				
	10M	QPSK	Channel		18650	18900	19150		3GPP MPR (dB)	5M	QPSK	Channel		18625	18900	19175	3GPP MPR (dB)
			Frequency(MHz)		1855	1880	1905					Frequency(MHz)		1852.5	1880	1907.5	
			1	0	23.99	24.21	24.03					0	1	0	23.94	24.23	
1			24	23.96	24.12	24.03	0	1	12			23.93	24.10	24.07	0		
1			49	23.87	24.13	23.96	0	1	24			23.83	24.07	23.95	0		
25			0	22.91	23.10	23.05	1	12	0			22.90	23.10	23.04	1		
25		12	22.96	23.11	22.97	1	12	6	22.89		23.11	22.96	1				
25		25	22.78	22.98	22.96	1	12	13	22.78		23.04	22.96	1				
50		0	22.95	23.12	22.94	1	25	0	22.92		23.11	22.89	1				
16QAM		1	0	23.16	23.38	23.22	1	1	0		23.11	23.38	23.26	1			
		1	24	22.85	23.02	22.96	1	1	12		22.84	23.02	22.94	1			
		1	49	22.82	23.02	22.90	1	1	24		22.86	22.96	22.92	1			
		25	0	22.06	22.19	22.19	2	12	0		22.00	22.23	22.15	2			
		25	12	21.99	22.18	22.11	2	12	6		22.04	22.16	22.14	2			
		25	25	22.00	22.22	22.12	2	12	13		22.01	22.21	22.09	2			
50		0	22.19	22.30	22.21	2	25	0	22.14		22.27	22.27	2				
64QAM		1	0	22.05	22.33	22.18	2	1	0		22.10	22.34	22.14	2			
		1	24	22.11	22.24	22.17	2	1	12		22.08	22.23	22.16	2			
		1	49	21.90	22.04	21.99	2	1	24		21.95	22.06	21.99	2			
		25	0	20.62	20.80	20.67	3	12	0		20.58	20.80	20.68	3			
		25	12	20.28	20.47	20.30	3	12	6		20.33	20.47	20.35	3			
		25	25	20.41	20.60	20.46	3	12	13		20.35	20.57	20.45	3			
50		0	20.51	20.61	20.59	3	25	0	20.51		20.61	20.59	3				
3M		QPSK	Channel		18615	18900	19185	3GPP MPR (dB)	1.4M		QPSK	Channel		18607	18900	19193	3GPP MPR (dB)
	Frequency(MHz)		1851.5	1880	1908.5	Frequency(MHz)				1850.7		1880	1909.3				
	1		0	23.95	24.18	24.06	0			1		0	23.92	24.21	24.06	0	
	1		7	23.98	24.07	24.07	0	1		2		23.97	24.09	24.07	0		
	1		14	23.84	24.06	23.99	0	1		5		23.87	24.07	23.95	0		
	8		0	22.93	23.10	23.01	1	3		0		23.91	24.07	24.04	1		
	8	3	22.89	23.12	22.97	1	3	1		23.96	24.11	23.94	1				
	8	7	22.82	23.00	22.97	1	3	3		23.81	23.97	23.92	1				
	15	0	22.90	23.14	22.92	1	6	0		22.95	23.10	22.95	1				
	16QAM	1	0	23.12	23.34	23.26	1	1		0	23.14	23.32	23.23	1			
		1	7	22.81	23.05	22.93	1	1		2	22.87	22.99	22.96	1			
		1	14	22.86	22.96	22.91	1	1		5	22.83	22.96	22.92	1			
		8	0	22.00	22.21	22.12	2	3		0	23.04	23.22	23.15	2			
		8	3	22.01	22.20	22.10	2	3		1	22.99	23.21	23.11	2			
		8	7	21.96	22.23	22.12	2	3		3	22.99	23.23	23.13	2			
	15	0	22.14	22.28	22.24	2	6	0		22.14	22.33	22.24	2				
	64QAM	1	0	22.04	22.31	22.20	2	1		0	22.04	22.31	22.20	2			
		1	7	22.05	22.29	22.16	2	1		2	22.05	22.29	22.17	2			
		1	14	21.88	22.11	21.99	2	1		5	21.94	22.04	21.99	2			
		8	0	20.59	20.77	20.67	3	3		0	21.55	21.76	21.67	3			
		8	3	20.27	20.54	20.34	3	3		1	21.29	21.53	21.30	3			
		8	7	20.39	20.56	20.42	3	3		3	21.38	21.53	21.49	3			
	15	0	20.47	20.67	20.57	3	6	0		20.49	20.64	20.55	3				

# FCC SAR Test Report

LTE Band 4															
BW	MCS Index	RB Size	RB Offset	Low	Mid	High	3GPP MPR (dB)	BW	MCS Index	RB Size	RB Offset	Low	Mid	High	3GPP MPR (dB)
		Channel		20050	20175	20300				Channel		20025	20175	20325	
		Frequency(MHz)		1720	1732.5	1745				Frequency(MHz)		1717.5	1732.5	1747.5	
20M	QPSK	1	0	23.87	23.80	23.73	0	15M	QPSK	1	0	23.86	23.76	23.65	0
		1	50	23.76	23.73	23.67	0			1	37	23.72	23.70	23.61	0
		1	99	23.71	23.68	23.62	0			1	74	23.69	23.67	23.58	0
		50	0	22.82	22.77	22.71	1			36	0	22.76	22.72	22.70	1
		50	25	22.78	22.75	22.76	1			36	19	22.77	22.73	22.71	1
		50	50	22.78	22.75	22.77	1			36	39	22.70	22.68	22.75	1
		100	0	22.80	22.73	22.71	1			75	0	22.79	22.69	22.68	1
	16QAM	1	0	23.38	23.36	23.28	1		1	0	23.35	23.35	23.22	1	
		1	50	23.20	23.15	23.15	1		1	37	23.16	23.10	23.13	1	
		1	99	23.25	23.25	23.21	1		1	74	23.19	23.23	23.18	1	
		50	0	21.88	21.78	21.82	2		36	0	21.86	21.70	21.81	2	
		50	25	21.88	21.88	21.84	2		36	19	21.80	21.84	21.79	2	
		50	50	21.94	21.87	21.88	2		36	39	21.91	21.81	21.86	2	
		100	0	22.07	21.99	21.93	2		75	0	22.06	21.94	21.85	2	
	64QAM	1	0	22.37	22.36	22.32	2		1	0	22.31	22.33	22.28	2	
		1	50	22.31	22.22	22.21	2		1	37	22.29	22.15	22.16	2	
		1	99	22.34	22.28	22.31	2		1	74	22.28	22.20	22.29	2	
		50	0	19.59	19.54	19.45	3		36	0	19.58	19.52	19.37	3	
		50	25	19.66	19.61	19.60	3		36	19	19.59	19.53	19.54	3	
		50	50	19.97	19.94	19.88	3		36	39	19.95	19.93	19.84	3	
		100	0	19.76	19.66	19.70	3		75	0	19.74	19.58	19.69	3	
10M	QPSK	Channel		20000	20175	20350	3GPP MPR (dB)	5M	QPSK	Channel		19975	20175	20375	3GPP MPR (dB)
		Frequency(MHz)		1715	1732.5	1750				Frequency(MHz)		1712.5	1732.5	1752.5	
		1	0	23.79	23.76	23.68				0	1	0	23.82	23.73	
		1	24	23.74	23.65	23.66	0			1	12	23.74	23.65	23.65	0
		1	49	23.63	23.64	23.57	0			1	24	23.66	23.60	23.61	0
		25	0	22.79	22.71	22.69	1			12	0	22.78	22.72	22.66	1
		25	12	22.76	22.68	22.71	1			12	6	22.70	22.74	22.71	1
	25	25	22.72	22.67	22.75	1	12		13	22.74	22.70	22.76	1		
	50	0	22.79	22.71	22.63	1	25		0	22.74	22.71	22.66	1		
	16QAM	1	0	23.31	23.28	23.22	1		1	0	23.31	23.31	23.26	1	
		1	24	23.17	23.09	23.13	1		1	12	23.12	23.13	23.10	1	
		1	49	23.23	23.18	23.16	1		1	24	23.23	23.17	23.19	1	
		25	0	21.82	21.70	21.80	2		12	0	21.80	21.72	21.74	2	
		25	12	21.86	21.80	21.83	2		12	6	21.82	21.86	21.78	2	
		25	25	21.86	21.83	21.83	2		12	13	21.87	21.82	21.86	2	
		50	0	22.05	21.91	21.92	2		25	0	22.01	21.92	21.88	2	
	64QAM	1	0	22.29	22.32	22.27	2		1	0	22.30	22.31	22.30	2	
		1	24	22.28	22.16	22.19	2		1	12	22.23	22.20	22.15	2	
		1	49	22.32	22.21	22.26	2		1	24	22.26	22.27	22.29	2	
		25	0	19.53	19.46	19.43	3		12	0	19.55	19.49	19.37	3	
		25	12	19.65	19.59	19.52	3		12	6	19.58	19.60	19.58	3	
25		25	19.92	19.86	19.82	3	12	13	19.93	19.89	19.80	3			
50		0	19.75	19.60	19.68	3	25	0	19.70	19.64	19.67	3			
3M	QPSK	Channel		19965	20175	20385	3GPP MPR (dB)	1.4M	QPSK	Channel		19957	20175	20393	3GPP MPR (dB)
		Frequency(MHz)		1711.5	1732.5	1753.5				Frequency(MHz)		1710.7	1732.5	1754.3	
		1	0	23.81	23.78	23.67				0	1	0	23.79	23.76	
		1	7	23.69	23.68	23.65	0			1	2	23.73	23.67	23.65	0
		1	14	23.65	23.61	23.57	0			1	5	23.69	23.61	23.57	0
		8	0	22.75	22.72	22.69	1			3	0	23.76	23.69	23.69	1
		8	3	22.70	22.73	22.70	1			3	1	23.77	23.73	23.68	1
	8	7	22.70	22.74	22.75	1	3		3	23.73	23.67	23.71	1		
	15	0	22.76	22.68	22.63	1	6		0	22.79	22.67	22.69	1		
	16QAM	1	0	23.30	23.35	23.26	1		1	0	23.33	23.29	23.23	1	
		1	7	23.15	23.10	23.11	1		1	2	23.18	23.07	23.13	1	
		1	14	23.23	23.17	23.20	1		1	5	23.20	23.17	23.20	1	
		8	0	21.80	21.74	21.77	2		3	0	22.84	22.73	22.77	2	
		8	3	21.85	21.82	21.82	2		3	1	22.80	22.87	22.79	2	
		8	7	21.92	21.80	21.83	2		3	3	22.90	22.82	22.87	2	
		15	0	22.01	21.91	21.91	2		6	0	22.01	21.97	21.88	2	
	64QAM	1	0	22.36	22.34	22.24	2		1	0	22.30	22.31	22.30	2	
		1	7	22.26	22.14	22.15	2		1	2	22.23	22.20	22.16	2	
		1	14	22.33	22.22	22.29	2		1	5	22.32	22.20	22.29	2	
		8	0	19.54	19.52	19.38	3		3	0	20.51	19.48	19.37	3	
		8	3	19.64	19.53	19.59	3		3	1	20.60	19.59	19.54	3	
8		7	19.89	19.90	19.83	3	3	3	20.92	19.86	19.87	3			
15		0	19.74	19.58	19.69	3	6	0	19.72	19.61	19.65	3			

# FCC SAR Test Report

LTE Band 5																				
BW	MCS Index	RB Size	RB Offset	Low	Mid	High	3GPP MPR (dB)	BW	MCS Index	RB Size	RB Offset	Low	Mid	High	3GPP MPR (dB)					
		Channel		20450	20525	20600				Channel		20425	20525	20625						
		Frequency(MHz)		829	836.5	844				Frequency(MHz)		826.5	836.5	846.5						
10M	QPSK	1	0	23.74	23.37	23.45	0	5M	QPSK	1	0	23.69	23.30	23.40	0					
		1	24	23.82	23.42	23.49	0			1	12	23.80	23.34	23.47	0					
		1	49	<b>23.98</b>	23.62	23.65	0			1	24	23.93	23.54	23.64	0					
		25	0	23.17	22.82	22.83	1			12	0	23.13	22.77	22.78	1					
		25	12	23.07	22.80	22.77	1			12	6	22.99	22.79	22.72	1					
		25	25	22.77	22.42	22.47	1			12	13	22.73	22.37	22.46	1					
	16QAM	50	0	23.10	22.80	22.78	1		25	0	23.04	22.78	22.73	1						
		1	0	23.22	22.90	22.94	1		1	0	23.15	22.85	22.92	1						
		1	24	23.42	23.14	23.12	1		1	12	23.34	23.12	23.07	1						
		1	49	23.23	22.83	22.90	1		1	24	23.21	22.75	22.88	1						
		25	0	22.09	21.77	21.76	2		12	0	22.01	21.71	21.68	2						
		25	12	22.07	21.77	21.74	2		12	6	22.01	21.75	21.68	2						
	64QAM	25	25	22.02	21.70	21.74	2		12	13	21.95	21.65	21.72	2						
		50	0	22.10	21.75	21.78	2		25	0	22.04	21.68	21.73	2						
		1	0	21.98	21.66	21.70	2		1	0	21.91	21.61	21.68	2						
		1	24	22.24	21.96	21.93	2		1	12	22.16	21.94	21.87	2						
		1	49	21.99	21.72	21.72	2		1	24	21.91	21.71	21.70	2						
		25	0	21.20	20.85	20.83	3		12	0	21.16	20.80	20.75	3						
	3M	QPSK	25	12	19.99	19.72	19.72		3	1.4M	QPSK	12	6	19.91	19.71	19.70	3			
			25	25	20.01	19.66	19.64		3			12	13	19.97	19.61	19.56	3			
			50	0	19.96	19.66	19.66		3			25	0	19.90	19.64	19.63	3			
			16QAM	1	0	20415	20525		20635			3GPP MPR (dB)	BW	16QAM	1	0	20407	20525	20643	3GPP MPR (dB)
				1	7	825.5	836.5		847.5						1	2	824.7	836.5	848.3	
				1	14	23.68	23.35		23.39						0	1	5	23.96	23.55	
64QAM		8		0	23.10	22.77	22.81	1	QPSK		3	0			24.11	23.74	23.81	1		
		8		3	22.99	22.78	22.71	1			3	1			24.06	23.78	23.69	1		
		8		7	22.69	22.41	22.45	1			3	3			23.72	23.34	23.41	1		
		15	0	23.06	22.75	22.70	1	6			0	23.09		22.74	22.76	1				
		1	0	23.14	22.89	22.92	1	1			0	23.17		22.83	22.89	1				
		1	7	23.37	23.09	23.08	1	1			2	23.40		23.06	23.10	1				
16QAM		1	14	23.21	22.75	22.89	1	16QAM	1		5	23.18		22.75	22.89	1				
		8	0	22.01	21.73	21.71	2		3		0	23.05		22.72	22.71	2				
		8	3	22.04	21.71	21.72	2		3		1	22.99		22.76	22.69	2				
		8	7	22.00	21.63	21.69	2		3		3	22.98		22.65	22.73	2				
		15	0	22.04	21.67	21.76	2		6		0	22.04		21.73	21.73	2				
		1	0	21.97	21.64	21.62	2		1		0	22.91		21.61	21.68	2				
64QAM		1	7	22.19	21.88	21.87	2	64QAM	1		2	22.16		21.94	21.88	2				
		1	14	21.98	21.66	21.70	2		1		5	21.97		21.64	21.70	2				
		8	0	21.15	20.83	20.76	3		3		0	22.12		21.79	21.75	3				
		8	3	19.97	19.64	19.71	3		3		1	20.93		20.70	20.66	3				
		8	7	19.93	19.62	19.59	3		3		3	20.96		20.58	20.63	3				
		15	0	19.94	19.58	19.65	3		6		0	19.92		19.61	19.61	3				

# FCC SAR Test Report

LTE Band 7																	
BW	MCS Index	RB Size	RB Offset	Low	Mid	High	3GPP MPR (dB)	BW	MCS Index	RB Size	RB Offset	Low	Mid	High	3GPP MPR (dB)		
		Channel		20850	21100	21350				Channel		20825	21100	21375			
		Frequency(MHz)		2510	2535	2560				Frequency(MHz)		2507.5	2535	2562.5			
20M	QPSK	1	0	23.40	23.39	23.21	0	15M	QPSK	1	0	23.39	23.35	23.13	0		
		1	50	23.42	23.45	23.28	0			1	37	23.38	23.42	23.22	0		
		1	99	23.43	23.46	23.29	0			1	74	23.41	23.45	23.25	0		
		50	0	22.39	22.42	22.32	1			36	0	22.33	22.37	22.31	1		
		50	25	22.46	22.47	22.30	1			36	19	22.45	22.45	22.25	1		
		50	50	22.40	22.43	22.34	1			36	39	22.32	22.36	22.32	1		
		100	0	22.46	22.47	22.33	1			75	0	22.45	22.43	22.30	1		
	16QAM	1	0	22.81	22.85	22.66	1		16QAM	1	0	22.78	22.84	22.60	1		
		1	50	22.70	22.71	22.60	1			1	37	22.66	22.66	22.58	1		
		1	99	22.66	22.72	22.57	1			1	74	22.60	22.70	22.54	1		
		50	0	21.83	21.79	21.72	2			36	0	21.81	21.71	21.71	2		
		50	25	21.82	21.88	21.73	2			36	19	21.74	21.84	21.68	2		
		50	50	21.83	21.82	21.72	2			36	39	21.80	21.76	21.70	2		
		100	0	21.87	21.85	21.68	2			75	0	21.86	21.80	21.60	2		
	64QAM	1	0	20.90	20.95	20.80	2		64QAM	1	0	20.84	20.92	20.76	2		
		1	50	21.00	20.97	20.85	2			1	37	20.98	20.90	20.80	2		
		1	99	21.10	21.10	21.02	2			1	74	21.04	21.02	21.00	2		
		50	0	20.08	20.09	19.89	3			36	0	20.07	20.07	19.81	3		
		50	25	20.03	20.04	19.92	3			36	19	19.96	19.96	19.86	3		
		50	50	20.18	20.21	20.04	3			36	39	20.16	20.20	20.00	3		
		100	0	20.16	20.12	20.05	3			75	0	20.14	20.04	20.04	3		
	10M	QPSK	Channel		20800	21100	21400		3GPP MPR (dB)	5M	QPSK	Channel		20775	21100	21425	3GPP MPR (dB)
			Frequency(MHz)		2505	2535	2565					Frequency(MHz)		2502.5	2535	2567.5	
			1	0	23.32	23.35	23.16					0	16QAM	1	0	23.35	
1			24	23.40	23.37	23.27	0	1	12			23.40		23.37	23.26	0	
1			49	23.35	23.42	23.24	0	1	24			23.38		23.38	23.28	0	
25			0	22.36	22.36	22.30	1	12	0			22.35		22.37	22.27	1	
25			12	22.44	22.40	22.25	1	12	6			22.38		22.46	22.25	1	
25		25	22.34	22.35	22.32	1	12	13	22.36		22.38	22.33		1			
50		0	22.45	22.45	22.25	1	25	0	22.40		22.45	22.28		1			
16QAM		1	0	22.74	22.77	22.60	1	16QAM	1		0	22.74	22.80	22.64	1		
		1	24	22.67	22.65	22.58	1		1		12	22.62	22.69	22.55	1		
		1	49	22.64	22.65	22.52	1		1		24	22.64	22.64	22.55	1		
		25	0	21.77	21.71	21.70	2		12		0	21.75	21.73	21.64	2		
		25	12	21.80	21.80	21.72	2		12		6	21.76	21.86	21.67	2		
		25	25	21.75	21.78	21.67	2		12		13	21.76	21.77	21.70	2		
		50	0	21.85	21.77	21.67	2		25		0	21.81	21.78	21.63	2		
64QAM		1	0	20.82	20.91	20.75	2	64QAM	1		0	20.83	20.90	20.78	2		
		1	24	20.97	20.91	20.83	2		1		12	20.92	20.95	20.79	2		
		1	49	21.08	21.03	20.97	2		1		24	21.02	21.09	21.00	2		
		25	0	20.02	20.01	19.87	3		12		0	20.04	20.04	19.81	3		
		25	12	20.02	20.02	19.84	3		12		6	19.95	20.03	19.90	3		
		25	25	20.13	20.13	19.98	3		12		13	20.14	20.16	19.96	3		
		50	0	20.15	20.06	20.03	3		25		0	20.10	20.10	20.02	3		



# FCC SAR Test Report

LTE Band 12																	
BW	MCS Index	RB Size	RB Offset	Low	Mid	High	3GPP MPR (dB)	BW	MCS Index	RB Size	RB Offset	Low	Mid	High	3GPP MPR (dB)		
		Channel		20360	23095	23130				Channel		23035	23095	23155			
		Frequency(MHz)		704	707.5	711				Frequency(MHz)		701.5	707.5	713.5			
10M	QPSK	1	0	24.08	24.14	24.05	0	5M	QPSK	1	0	24.03	24.07	24.00	0		
		1	24	24.19	24.21	24.16	0			1	12	24.17	24.13	24.14	0		
		1	49	24.17	24.22	24.18	0			1	24	24.12	24.14	24.17	0		
		25	0	23.26	23.33	23.26	1			12	0	23.22	23.28	23.21	1		
		25	12	23.04	23.19	23.04	1			12	6	22.96	23.18	22.99	1		
		25	25	23.10	23.17	23.06	1			12	13	23.06	23.12	23.05	1		
	16QAM	50	0	23.01	23.13	22.99	1		25	0	22.95	23.11	22.94	1			
		1	0	23.59	23.69	23.61	1		1	0	23.52	23.64	23.59	1			
		1	24	23.45	23.59	23.45	1		1	12	23.37	23.57	23.40	1			
		1	49	23.66	23.68	23.63	1		1	24	23.64	23.60	23.61	1			
		25	0	22.53	22.63	22.50	2		12	0	22.45	22.57	22.42	2			
		25	12	22.57	22.69	22.54	2		12	6	22.51	22.67	22.48	2			
	64QAM	25	25	22.67	22.77	22.69	2		12	13	22.60	22.72	22.67	2			
		50	0	22.66	22.73	22.64	2		25	0	22.60	22.66	22.59	2			
		1	0	22.54	22.64	22.56	2		1	0	22.47	22.59	22.54	2			
		1	24	22.41	22.55	22.40	2		1	12	22.33	22.53	22.34	2			
		1	49	22.76	22.91	22.79	2		1	24	22.68	22.90	22.77	2			
		25	0	18.74	18.81	18.67	3		12	0	18.70	18.76	18.59	3			
	3M	QPSK	25	12	18.81	18.96	18.84		3	1.4M	QPSK	12	6	18.73	18.95	18.82	3
			25	25	19.04	19.11	18.97		3			12	13	19.00	19.06	18.89	3
			50	0	18.92	19.04	18.92		3			25	0	18.86	19.02	18.89	3
1			0	24.02	24.12	23.99	0	1	0			24.00	24.10	24.00	0		
1			7	24.12	24.16	24.14	0	1	2			24.16	24.15	24.14	0		
1			14	24.11	24.15	24.13	0	1	5			24.15	24.15	24.13	0		
16QAM		8	0	23.19	23.28	23.24	1	3	0		24.20	24.25	24.24	1			
		8	3	22.96	23.17	22.98	1	3	1		24.03	24.17	23.96	1			
		8	7	23.02	23.16	23.04	1	3	3		24.05	24.09	24.00	1			
		15	0	22.97	23.08	22.91	1	6	0		23.00	23.07	22.97	1			
		1	0	23.51	23.68	23.59	1	1	0		23.54	23.62	23.56	1			
		1	7	23.40	23.54	23.41	1	1	2		23.43	23.51	23.43	1			
64QAM		1	14	23.64	23.60	23.62	1	1	5		23.61	23.60	23.62	1			
		8	0	22.45	22.59	22.45	2	3	0		23.49	23.58	23.45	2			
		8	3	22.54	22.63	22.52	2	3	1		23.49	23.68	23.49	2			
		8	7	22.65	22.70	22.64	2	3	3		23.63	23.72	23.68	2			
		15	0	22.60	22.65	22.62	2	6	0		22.60	22.71	22.59	2			
		1	0	22.53	22.62	22.48	2	1	0		22.47	22.59	22.54	2			
16QAM		1	7	22.36	22.47	22.34	2	1	2		22.33	22.53	22.35	2			
		1	14	22.75	22.85	22.77	2	1	5		22.74	22.83	22.77	2			
		8	0	18.69	18.79	18.60	3	3	0		19.66	19.75	19.59	3			
	8	3	18.79	18.88	18.83	3	3	1	19.75	19.94	19.78	3					
	8	7	18.96	19.07	18.92	3	3	3	19.99	20.03	19.96	3					
	15	0	18.90	18.96	18.91	3	6	0	18.88	18.99	18.87	3					