



Test Report No.: W7L-P22030026-5RF05



VARIANT FCC TEST REPORT (PART 27)



Applicant:	HMD Global Oy
Address:	Bertel Jungin aukio 9, 02600 Espoo, Finland

Manufacturer or Supplier:	HMD Global Oy
Address:	Bertel Jungin aukio 9, 02600 Espoo, Finland
Product:	Multi-band GSM/WCDMA/LTE phone with Bluetooth&WLAN
Brand Name:	Nokia
Model Name:	TA-1444
FCC ID:	2AJOTTA-1444
Date of tests:	Jan. 02, 2022 ~ Apr. 19, 2022

The tests have been carried out according to the requirements of the following standard:

- FCC Part 27 ANSI/TIA/EIA-603-D
- FCC Part 2 ANSI/TIA/EIA-603-E ANSI C63.26-2015

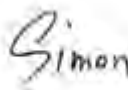
CONCLUSION: The submitted sample was found to COMPLY with the test requirement

Prepared by Simon Wang Engineer / Mobile Department	Approved by Luke Lu Manager / Mobile Department
 Date: Apr. 19, 2022	 Date: Apr. 19, 2022

This report is governed by, and incorporates by reference, CPS Conditions of Service as posted at the date of issuance of this report at <http://www.bureauveritas.com/home/about-us/our-business/cps/about-us/terms-conditions> and is intended for your exclusive use. Any copying or replication of this report to or for any other person or entity, or use of our name or trademark, is permitted only with our prior written permission. This report sets forth our findings solely with respect to the test samples identified herein. The results set forth in this report are not indicative or representative of the quality or characteristics of the lot from which a test sample was taken or any similar or identical product unless specifically and expressly noted. Our report includes all of the tests requested by you and the results thereof based upon the information that you provided to us. Measurement uncertainty is only provided upon request for accredited tests. You have 60 days from date of issuance of this report to notify us of any material error or omission caused by our negligence or if you require measurement uncertainty; provided, however, that such notice shall be in writing and shall specifically address the issue you wish to raise. A failure to raise such issue within the prescribed time shall constitute your unqualified acceptance of the completeness of this report, the tests conducted and the correctness of the report contents.



TABLE OF CONTENTS

RELEASE CONTROL RECORD	4
1 SUMMARY OF TEST RESULTS	5
1.1 MEASUREMENT UNCERTAINTY	6
1.2 TEST SITE AND INSTRUMENTS	7
2 GENERAL INFORMATION	8
2.1 GENERAL DESCRIPTION OF EUT	8
2.2 CONFIGURATION OF SYSTEM UNDER TEST	14
2.3 DESCRIPTION OF SUPPORT UNITS	15
2.4 TEST ITEM AND TEST CONFIGURATION	15
2.5 GENERAL DESCRIPTION OF APPLIED STANDARDS	25
3 TEST TYPES AND RESULTS	26
3.1 OUTPUT POWER MEASUREMENT	26
3.1.1 LIMITS OF OUTPUT POWER MEASUREMENT	26
3.1.2 TEST PROCEDURES	26
3.1.3 TEST SETUP	27
3.1.4 TEST RESULTS	28
3.2 FREQUENCY STABILITY MEASUREMENT	71
3.2.1 LIMITS OF FREQUENCY STABILITY MEASUREMENT	71
3.2.2 TEST PROCEDURE	71
3.2.3 TEST SETUP	71
3.2.4 TEST RESULTS	72
3.3 OCCUPIED BANDWIDTH MEASUREMENT	73
3.3.1 LIMITS OF OCCUPIED BANDWIDTH MEASUREMENT	73
3.3.2 TEST SETUP	73
3.3.3 TEST PROCEDURES	73
3.3.4 TEST RESULTS	74
3.4 BAND EDGE MEASUREMENT	75
3.4.1 LIMITS OF BAND EDGE MEASUREMENT	75
3.4.2 TEST SETUP	76
3.4.3 TEST PROCEDURES	76
3.4.4 TEST RESULTS	77
3.5 CONDUCTED SPURIOUS EMISSIONS	78
3.5.1 LIMITS OF CONDUCTED SPURIOUS EMISSIONS MEASUREMENT	78
3.5.2 TEST PROCEDURE	78
3.5.3 TEST SETUP	78
3.5.4 TEST RESULTS	79
3.6 RADIATED EMISSION MEASUREMENT	80
3.6.1 LIMITS OF RADIATED EMISSION MEASUREMENT	80
3.6.2 TEST PROCEDURES	80
3.6.3 DEVIATION FROM TEST STANDARD	80
3.6.4 TEST SETUP	81
3.6.5 TEST RESULTS	83
3.7 PEAK TO AVERAGE RATIO	163
3.7.1 LIMITS OF PEAK TO AVERAGE RATIO MEASUREMENT	163
3.7.2 TEST SETUP	163
3.7.3 TEST PROCEDURES	163
3.7.4 TEST RESULTS	164
4 INFORMATION ON THE TESTING LABORATORIES	165



**BUREAU
VERITAS**

Test Report No.: W7L-P22030026-5RF05

5 MODIFICATIONS RECORDERS FOR ENGINEERING CHANGES TO THE EUT BY THE LAB. 166

6 APPENDIX 167

WCDMA B4	167
LTE BAND4	180
LTE BAND7	318
LTE BAND12	414
LTE BAND13	509
LTE BAND17	556
LTE BAND66	606



Test Report No.: W7L-P22030026-5RF05

RELEASE CONTROL RECORD

ISSUE NO.	REASON FOR CHANGE	DATE ISSUED
W7L-P21120037RF05	Original release	Jan. 24, 2022
W7L-P21120038RF05	The model name is revised based on the W7L-P21120037RF05 report. The two models are only the difference between single SIM and double SIM, and the data reflects the original report data.	Feb. 23, 2022
W7L-P22030026-5RF05	Based on the original report W7L-P21120038RF05 change the chip, add to 2 nd battery, Verify the RSE worst case.	Apr. 19, 2022

1 SUMMARY OF TEST RESULTS

The EUT has been tested according to the following specifications:

APPLIED STANDARD: FCC PART 27 & PART 2		
STANDARD SECTION	TEST TYPE AND LIMIT	RESULT
§2.1046	Conducted Output Power	Compliance
§27.50(b)(10) §27.50(c)(10)	Effective Radiated Power (Band 12) (Band 13) (Band 17)	Compliance
§27.50(d)(4) §27.50(h)(2)	Equivalent Isotropically Radiated Power (Band 4) (Band 7) (Band 66)	Compliance
§2.1055 §27.54	Frequency Stability	Compliance
§2.1049	Occupied Bandwidth	Compliance
§2.1051 §27.53(c)(2)(4) §27.53(g) §27.53(h) §27.53(m)(4)(6)	Conducted Band Edge Measurements (Band 12) (Band 13) (Band 17) (Band 4) (Band 7) (Band 66)	Compliance
§2.1051 §27.53(c)(2)(4) §27.53(g) §27.53(h) §27.53(m)(4)(6)	Conducted Spurious Emissions (Band 12) (Band 13) (Band 17) (Band 4) (Band 7) (Band 66)	Compliance
§2.1053 §27.53(c)(2) §27.53(f) §27.53(g) §27.53(h) §27.53(m)(4)(6)	Radiated Spurious Emissions (Band 12) (Band 13) (Band 17) (Band 4) (Band 7) (Band 66)	Compliance

1.1 MEASUREMENT UNCERTAINTY

Where relevant, the following measurement uncertainty levels have been estimated for tests performed on the EUT as specified in CISPR 16-4-2:

MEASUREMENT	UNCERTAINTY
Frequency Stability	±76.97Hz
Radiated emissions & Radiated Power (30MHz~1GMHz)	±4.98dB
Radiated emissions & Radiated Power (1GMHz ~6GMHz)	±4.70dB
Radiated emissions (6GMHz ~18GMHz)	±4.60dB
Radiated emissions (18GMHz ~40GMHz)	±4.12dB
Conducted emissions	±4.01dB
Occupied Channel Bandwidth	±43.58KHz
Conducted Output power	±2.06dB
Band Edge Measurements	±4.70dB

This uncertainty represents an expanded uncertainty expressed at approximately the 95% confidence level using a coverage factor of k=2.



1.2 TEST SITE AND INSTRUMENTS

Equipment	Manufacturer	Model No.	Serial No.	Last Cal.	Next Cal.
MXE EMI Receiver	KEYSIGHT	N9038A-544	MY54450026	Apr. 22,21	Apr. 21,22
EXA Signal Analyzer	KEYSIGHT	N9010A-544	MY54510355	Jun. 03,21	Jun. 02,22
Bilog Antenna 2	ETS-LINDGREN	3143B	00161965	Mar. 05,21	Mar. 04,22
Bilog Antenna 2	ETS-LINDGREN	3143B	00161965	Mar. 04,22	Mar. 03,23
Loop Antenna	Schwarzbeck	FMZB 1519B	1519B-051	Feb. 14,20	Feb. 13,23
Horn Antenna 1	ETS-LINDGREN	3117	00168728	Aug. 19,21	Aug. 18,22
Horn Antenna (18GHz-40GHz)	N/A	QWH-SL-18-40-K-SG/QMS-00361	15433	Aug. 25, 21	Aug. 24, 22
Radio Communication Analyzer	ANRITSU	MT8820C	6201465426	Feb. 25,21	Feb. 24,22
Radio Communication Analyzer	ANRITSU	MT8820C	6201465426	Feb. 24,22	Feb. 23,23
Signal Pre-Amplifier	EMSI	EMC 9135	980249	Jun. 02,21	Jun. 01,22
Signal Pre-Amplifier	EMSI	EMC 012645B	980257	Jun. 03,21	Jun. 02,22
Signal Pre-Amplifier	EMSI	EMC 184045B	980259	Apr. 22,21	Apr. 21,22
3m Semi-anechoic Chamber	ETS-LINDGREN	9m*6m*6m	Euroshieldpn-CT0001143-1216	May. 19,20	May. 18,23
Test Software	E3	V 9.160323	N/A	N/A	N/A
Test Software	ADT	ADT_Radiated_V 7.6.15.9.2	N/A	N/A	N/A
10dB Attenuator	JFW/USA	50HF-010-SMA	1505	Jun. 03,21	Jun. 02,22
Power Meter	Anritsu	ML2495A	1506002	Apr. 07,21	Apr. 06,22
Power Meter	Anritsu	ML2495A	1506002	Apr. 06,22	Apr. 05,23
Power Sensor	Anritsu	MA2411B	1339352	May. 07,21	May. 06,22
Temperature Chamber	ESPEC	SH-242	93000855	Jun. 02,21	Jun. 01,22
MXG Analog Microwave Signal Generator	KEYSIGHT	N5183A	MY50143024	Mar. 05,21	Mar. 04,22
MXG Analog Microwave Signal Generator	KEYSIGHT	N5183A	MY50143024	Mar. 04,22	Mar. 03,23

- NOTE:**
1. The calibration interval of the above test instruments is 12 months or 36 months and the calibrations are traceable to CEPREI/CHINA, GRGT/CHINA and NIM/CHINA.
 2. The test was performed in 3m Semi-anechoic Chamber and RF Oven Room.
 3. The horn antenna is used only for the measurement of emission frequency above 1GHz if tested.
 4. The FCC Site Registration No. is 525120; The Designation No. is CN1171.

2 GENERAL INFORMATION

2.1 GENERAL DESCRIPTION OF EUT

PRODUCT	Multi-band GSM/WCDMA/LTE phone with Bluetooth&WLAN	
BRAND NAME	Nokia	
MODEL NAME	TA-1444	
NOMINAL VOLTAGE	5.0Vdc(adapter or host equipment) 3.85Vdc (Li-ion, battery)	
MODULATION TECHNOLOGY	WCDMA IV	BPSK, QPSK
	LTE	QPSK, 16QAM, 64QAM
FREQUENCY RANGE	WCDMA IV	1712.4MHz ~ 1752.6MHz
	LTE Band 4 Channel Bandwidth: 1.4MHz	1710.7MHz ~ 1754.3MHz
	LTE Band 4 Channel Bandwidth: 3MHz	1711.5MHz ~ 1753.5MHz
	LTE Band 4 Channel Bandwidth: 5MHz	1712.5MHz ~ 1752.5MHz
	LTE Band 4 Channel Bandwidth: 10MHz	1715MHz ~ 1750MHz
	LTE Band 4 Channel Bandwidth: 15MHz	1717.5MHz ~ 1747.5 MHz
	LTE Band 4 Channel Bandwidth: 20MHz	1720MHz ~ 1745MHz
	LTE Band 7 Channel Bandwidth: 5MHz	2502.5MHz ~ 2567.5MHz
	LTE Band 7 Channel Bandwidth: 10MHz	2505MHz ~ 2565MHz
	LTE Band 7 Channel Bandwidth: 15MHz	2507.5MHz ~ 2562.5MHz
	LTE Band 7 Channel Bandwidth: 20MHz	2510MHz ~ 2560MHz
	LTE Band 12 Channel Bandwidth: 1.4MHz	699.7MHz ~ 715.3MHz
	LTE Band 12 Channel Bandwidth: 3MHz	700.5MHz ~ 714.5MHz
	LTE Band 12 Channel Bandwidth: 5MHz	701.5MHz ~ 713.5MHz
	LTE Band 12 Channel Bandwidth: 10MHz	704MHz ~ 711MHz
	LTE Band 13 Channel Bandwidth: 5MHz	779.5MHz ~ 784.5MHz
	LTE Band 13 Channel Bandwidth: 10MHz	782MHz



**BUREAU
VERITAS**

Test Report No.: W7L-P22030026-5RF05

FREQUENCY RAN	LTE Band 17 Channel Bandwidth: 5MHz	706.5MHz ~ 713.5MHz
	LTE Band 17 Channel Bandwidth: 10MHz	709MHz ~ 711 MHz
	LTE Band 66 Channel Bandwidth: 1.4MHz	1710.7MHz ~ 1779.3MHz
	LTE Band 66 Channel Bandwidth: 3MHz	1711.5MHz ~ 1778.5MHz
	LTE Band 66 Channel Bandwidth: 5MHz	1712.5MHz ~ 1777.5MHz
	LTE Band 66 Channel Bandwidth: 10MHz	1715MHz ~ 1775MHz
	LTE Band 66 Channel Bandwidth: 15MHz	1717.5MHz ~ 1772.5MHz
	LTE Band 66 Channel Bandwidth: 20MHz	1720MHz ~ 1770MHz
MAX. EIRP POWER	WCDMA IV	210.38mW
	LTE Band 4 Channel Bandwidth: 1.4MHz	242.1mW
	LTE Band 4 Channel Bandwidth: 3MHz	240.99mW
	LTE Band 4 Channel Bandwidth: 5MHz	241.55mW
	LTE Band 4 Channel Bandwidth: 10MHz	241.55mW
	LTE Band 4 Channel Bandwidth: 15MHz	241.55mW
	LTE Band 4 Channel Bandwidth: 20MHz	244.34mW
	LTE Band 7 Channel Bandwidth: 5MHz	273.53mW
	LTE Band 7 Channel Bandwidth: 10MHz	276.06mW
	LTE Band 7 Channel Bandwidth: 15MHz	277.97mW
	LTE Band 7 Channel Bandwidth: 20MHz	278.61mW
	LTE Band 12 Channel Bandwidth: 1.4MHz	79.98mW
	LTE Band 12 Channel Bandwidth: 3MHz	80.35mW
	LTE Band 12 Channel Bandwidth: 5MHz	80.17mW
	LTE Band 12 Channel Bandwidth: 10MHz	80.91mW



**BUREAU
VERITAS**

Test Report No.: W7L-P22030026-5RF05

MAX. EIRP POWER	LTE Band 13 Channel Bandwidth: 5MHz	52.72mW
	LTE Band 13 Channel Bandwidth: 10MHz	53.33mW
	LTE Band 17 Channel Bandwidth: 5MHz	81.66mW
	LTE Band 17 Channel Bandwidth: 10MHz	82.60mW
	LTE Band 66 Channel Bandwidth: 1.4MHz	253.51mW
	LTE Band 66 Channel Bandwidth: 3MHz	252.93mW
	LTE Band 66 Channel Bandwidth: 5MHz	253.51mW
	LTE Band 66 Channel Bandwidth: 10MHz	253.51mW
	LTE Band 66 Channel Bandwidth: 15MHz	251.77mW
	LTE Band 66 Channel Bandwidth: 20MHz	256.45mW
	EMISSION DESIGNATOR	WCDMA IV
LTE Band 4 Channel Bandwidth: 1.4MHz		QPSK: 1M09G7D
		16QAM: 1M09W7D
		64QAM: 1M09W7D
LTE Band 4 Channel Bandwidth: 3MHz		QPSK: 2M70G7D
		16QAM: 2M70W7D
		64QAM: 2M70W7D
LTE Band 4 Channel Bandwidth: 5MHz		QPSK: 4M50G7D
		16QAM: 4M50W7D
		64QAM: 4M50W7D
LTE Band 4 Channel Bandwidth: 10MHz		QPSK: 9M10G7D
		16QAM: 9M10W7D
		64QAM: 9M10W7D
LTE Band 4 Channel Bandwidth: 15MHz		QPSK: 13M5G7D
		16QAM: 13M5W7D
		64QAM: 13M5W7D
LTE Band 4		QPSK: 18M1G7D



BUREAU
VERITAS

Test Report No.: W7L-P22030026-5RF05

EMISSION DESIGNATOR	Channel Bandwidth: 20MHz	16QAM: 18M1W7D
		64QAM: 18M1W7D
	LTE Band 7 Channel Bandwidth: 5MHz	QPSK: 4M50G7D
		16QAM: 4M51W7D
		64QAM: 4M50W7D
	LTE Band 7 Channel Bandwidth: 10MHz	QPSK:9M10G7D
		16QAM: 9M10W7D
		64QAM: 9M10W7D
	LTE Band 7 Channel Bandwidth: 15MHz	QPSK: 13M5G7D
		16QAM: 13M5W7D
		64QAM: 13M5W7D
	LTE Band 7 Channel Bandwidth: 20MHz	QPSK: 18M1G7D
		16QAM: 18M1W7D
		64QAM: 18M1W7D
	LTE Band 12 Channel Bandwidth: 1.4MHz	QPSK: 1M10G7D
		16QAM: 1M10W7D
		64QAM: 1M10W7D
	LTE Band 12 Channel Bandwidth: 3MHz	QPSK: 2M70G7D
		16QAM: 2M70W7D
		64QAM: 2M70W7D
LTE Band 12 Channel Bandwidth: 5MHz	QPSK: 4M50G7D	
	16QAM: 4M50W7D	
	64QAM: 4M50W7D	
LTE Band 12 Channel Bandwidth: 10MHz	QPSK: 9M10G7D	
	16QAM: 9M10W7D	
	64QAM: 9M10W7D	
LTE Band 13 Channel Bandwidth: 5MHz	QPSK: 4M49G7D	
	16QAM: 4M50W7D	



**BUREAU
VERITAS**

Test Report No.: W7L-P22030026-5RF05

EMISSION DESIGNATOR		64QAM: 4M50W7D
	LTE Band 13 Channel Bandwidth: 10MHz	QPSK: 9M10G7D
		16QAM: 9M10W7D
		64QAM: 9M10W7D
	LTE Band 17 Channel Bandwidth: 5MHz	QPSK: 4M50G7D
		16QAM: 4M50W7D
		64QAM: 4M50W7D
	LTE Band 17 Channel Bandwidth: 10MHz	QPSK: 9M10G7D
		16QAM: 9M10W7D
		64QAM: 9M10W7D
	LTE Band 66 Channel Bandwidth: 1.4MHz	QPSK: 1M10G7D
		16QAM: 1M10W7D
		64QAM: 1M10W7D
	LTE Band 66 Channel Bandwidth: 3MHz	QPSK: 2M70G7D
		16QAM: 2M70W7D
		64QAM: 2M70W7D
	LTE Band 66 Channel Bandwidth: 5MHz	QPSK: 4M50G7D
		16QAM: 4M50W7D
		64QAM: 4M50W7D
	LTE Band 66 Channel Bandwidth: 10MHz	QPSK: 9M10G7D
		16QAM: 9M10W7D
64QAM: 9M10W7D		
LTE Band 66 Channel Bandwidth: 15MHz	QPSK: 13M5G7D	
	16QAM: 13M5W7D	
	64QAM: 13M5W7D	
LTE Band 66 Channel Bandwidth: 20MHz	QPSK: 18M1G7D	
	16QAM: 18M1W7D	
	64QAM: 18M1W7D	



BUREAU
VERITAS

Test Report No.: W7L-P22030026-5RF05

ANTENNA TYPE	Fixed Internal Antenna with 0.09 dBi gain for WCDMA IV Fixed Internal Antenna with 0.09dBi gain for LTE4 Fixed Internal Antenna with 0.63 dBi gain for LTE7 Fixed Internal Antenna with -2.31 dBi gain for LTE12 Fixed Internal Antenna with -3.07 dBi gain for LTE13 Fixed Internal Antenna with -2.31 dBi gain for LTE17 Fixed Internal Antenna with 0.05 dBi gain for LTE66
HW VERSION	19661_1_12
SW VERSION	000T_0_050
I/O PORTS	Refer to user's manual
CABLE SUPPLIED	USB cable: unshielded without ferrite, 1.0meter Earphone1: non-shielded cable, with w/o ferrite core, 1.2 meter Earphone2: non-shielded cable, with w/o ferrite core, 1.2 meter
EXTREME TEMPERATURE	0-40 °C
EXTREME VOLTAGE	3.5V - 4.4V

NOTE:

1. For a more detailed features description, please refer to the manufacturer's specifications or the user's manual.
2. For the test results, the EUT had been tested with all conditions. But only the worst case was shown in test report.

List of Accessory:

ACCESSORIES	BRAND	MANUFACTURER	MODEL	SPECIFICATION
Battery 1	Nokia	GUANGDONG FENGHUA NEW ENERGY CO.,LTD.	WT410	Capacity: 3.85 Vdc, 3920mAh
Battery 2	Nokia	HuNan ADF Alternative Energy Technology Co.,Ltd	WT410	Capacity: 3.85 Vdc, 3920mAh
AC Adapter	Nokia	ShenZhenBaiJunDa Electronic CO., LTD.	AD-010U	I/P: 100-240Vac, 0.35A, O/P: 5.0Vdc, 2.0A
Earphone 1	Nokia	NEW LEADER INDUSTRY CO.,LTD	HS-34	Signal Line, 1.2meter
Earphone 2	Nokia	Guangdong Wivtak Technology Co., Ltd.	HS-34	Signal Line, 1.2meter
USB Cable	Nokia	Saibao(Jiangxi) Communication Industrial Co.,Ltd	CB-12A	Signal Line, 1.0meter

2.2 CONFIGURATION OF SYSTEM UNDER TEST FOR RADIATION EMISSION TEST

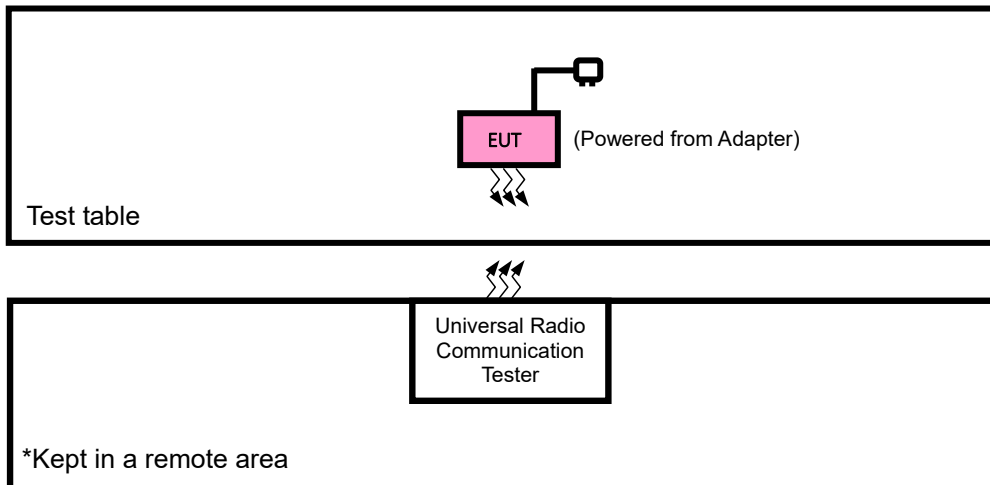



2.3 DESCRIPTION OF SUPPORT UNITS

The EUT has been tested as an independent unit together with other necessary accessories or support units. The following support units or accessories were used to form a representative test configuration during the tests.

NO.	PRODUCT	BRAND	MODEL NO.	SERIAL NO.	FCC ID
1	DC source	LONG WEI	PS-6403D	010934269	N/A

NO.	SIGNAL CABLE DESCRIPTION OF THE ABOVE SUPPORT UNITS
1	DC Line: Unshielded, Detachable 1.8m

2.4 TEST ITEM AND TEST CONFIGURATION

Pre-Scan has been conducted to determine the worst-case mode from all possible combinations between available modulations, data rates, XYZ axis and antenna ports. The worst case was found when positioned on Y-plane for EIRP and X-axis for radiated emission. Following channel(s) was (were) selected for the final test as listed below:

EUT CONFIGURE MODE	1.1.1.1.1DESCRIPTION
A	EUT + Adapter + USB Cable with WCDMA or LTE link
B	EUT + Battery with WCDMA or LTE link

WCDMA MODE

EUT CONFIGURE MODE	TEST ITEM	AVAILABLE CHANNEL	TESTED CHANNEL	MODE
A	EIRP	1312 to 1513	1312, 1413, 1513	WCDMA
B	FREQUENCY STABILITY	1312 to 1513	1312, 1413, 1513	WCDMA
A	OCCUPIED BANDWIDTH	1312 to 1513	1312, 1413, 1513	WCDMA
A	BAND EDGE	1312 to 1513, 1312, 1413, 1513	1312, 1513	WCDMA
A	PEAK TO AVERAGE RATIO	1312 to 1513	1312, 1413, 1513	WCDMA
A	CONDCUDED EMISSION	1312 to 1513	1312, 1413, 1513	WCDMA
A	RADIATED EMISSION	1312 to 1513	1312, 1413, 1513	WCDMA

LTE BAND 4 MODE

EUT CONFIGURE MODE	TEST ITEM	AVAILABLE CHANNEL	TESTED CHANNEL	CHANNEL BANDWIDTH	MODULATION	MODE
A	EIRP	19957 to 20393	19957, 20175, 20393	1.4MHz	QPSK, 16QAM, 64QAM	1 RB / 0 RB Offset
		19965 to 20385	19965, 20175, 20385	3MHz	QPSK, 16QAM, 64QAM	1 RB / 0 RB Offset
		19975 to 20375	19975, 20175, 20375	5MHz	QPSK, 16QAM, 64QAM	1 RB / 0 RB Offset
		20000 to 20350	20000, 20175, 20350	10MHz	QPSK, 16QAM, 64QAM	1 RB / 0 RB Offset
		20025 to 20325	20025, 20175, 20325	15MHz	QPSK, 16QAM, 64QAM	1 RB / 0 RB Offset
		20050 to 20300	20050, 20175, 20300	20MHz	QPSK, 16QAM, 64QAM	1 RB / 0 RB Offset
B	FREQUENCY STABILITY	19957 to 20393	19957, 20175, 20393	1.4MHz	QPSK, 16QAM, 64QAM	6 RB / 0 RB Offset
		19965 to 20385	19965, 20175, 20385	3MHz	QPSK, 16QAM, 64QAM	15 RB / 0 RB Offset
		19975 to 20375	19975, 20175, 20375	5MHz	QPSK, 16QAM, 64QAM	25 RB / 0 RB Offset
		20000 to 20350	20000, 20175, 20350	10MHz	QPSK, 16QAM, 64QAM	50 RB / 0 RB Offset
		20025 to 20325	20025, 20175, 20325	15MHz	QPSK, 16QAM, 64QAM	75 RB / 0 RB Offset
		20050 to 20300	20050, 20175, 20300	20MHz	QPSK, 16QAM, 64QAM	100 RB / 0 RB Offset
A	OCCUPIED BANDWIDTH	19957 to 20393	19957, 20175, 20393	1.4MHz	QPSK, 16QAM, 64QAM	6 RB / 0 RB Offset
		19965 to 20385	19965, 20175, 20385	3MHz	QPSK, 16QAM, 64QAM	15 RB / 0 RB Offset
		19975 to 20375	19975, 20175, 20375	5MHz	QPSK, 16QAM, 64QAM	25 RB / 0 RB Offset
		20000 to 20350	20000, 20175, 20350	10MHz	QPSK, 16QAM, 64QAM	50 RB / 0 RB Offset
		20025 to 20325	20025, 20175, 20325	15MHz	QPSK, 16QAM, 64QAM	75 RB / 0 RB Offset
		20050 to 20300	20050, 20175, 20300	20MHz	QPSK, 16QAM, 64QAM	100 RB / 0 RB Offset
A	PEAK TO AVERAGE RATIO	19957 to 20393	19957, 20175, 20393	1.4MHz	QPSK, 16QAM, 64QAM	1 RB / 0 RB Offse 6 RB / 0 RB Offset
		19965 to 20385	19965, 20175, 20385	3MHz	QPSK, 16QAM, 64QAM	1 RB / 0 RB Offse 15 RB / 0 RB Offset
		19975 to 20375	19975, 20175, 20375	5MHz	QPSK, 16QAM, 64QAM	1 RB / 0 RB Offse 25 RB / 0 RB Offset
		20000 to 20350	20000, 20175, 20350	10MHz	QPSK, 16QAM, 64QAM	1 RB / 0 RB Offse 50 RB / 0 RB Offset
		20025 to 20325	20025, 20175, 20325	15MHz	QPSK, 16QAM, 64QAM	1 RB / 0 RB Offse 75 RB / 0 RB Offset
		20050 to 20300	20050, 20175, 20300	20MHz	QPSK, 16QAM, 64QAM	1 RB / 0 RB Offse 100 RB / 0 RB Offset
A	BAND EDGE	19957 to 20393	19957	1.4MHz	QPSK, 16QAM, 64QAM	1 RB / 0 RB Offset 6 RB / 0 RB Offset
			20393	1.4MHz	QPSK, 16QAM, 64QAM	1 RB / 5 RB Offset 6 RB / 0 RB Offset
		19965 to 20385	19965	3MHz	QPSK, 16QAM, 64QAM	1 RB / 0 RB Offset 15 RB / 0 RB Offset
			20385	3MHz	QPSK, 16QAM, 64QAM	1 RB / 14 RB Offset 15 RB / 0 RB Offset
		19975 to 20375	19975	5MHz	QPSK, 16QAM, 64QAM	1 RB / 0 RB Offset 25 RB / 0 RB Offset
			20375	5MHz	QPSK, 16QAM, 64QAM	1 RB / 24 RB Offset 25 RB / 0 RB Offset
		20000 to 20350	20000	10MHz	QPSK, 16QAM, 64QAM	1 RB / 0 RB Offset 50 RB / 0 RB Offset
			20350	10MHz	QPSK, 16QAM, 64QAM	1 RB / 49 RB Offset



**BUREAU
VERITAS**

Test Report No.: W7L-P22030026-5RF05

						50 RB / 0 RB Offset
A	BAND EDGE	20025 to 20325	20025	15MHz	QPSK, 16QAM, 64QAM	1 RB / 0 RB Offset
						75 RB / 0 RB Offset
		20050 to 20300	20325	15MHz	QPSK, 16QAM, 64QAM	1 RB / 74 RB Offset
						75 RB / 0 RB Offset
		20050 to 20300	20050	20MHz	QPSK, 16QAM, 64QAM	1 RB / 0 RB Offset
						100 RB / 0 RB Offset
		20300	20MHz	QPSK, 16QAM, 64QAM	1 RB / 99 RB Offset	
					100 RB / 0 RB Offset	
A	CONDCUDEDED EMISSION	19957 to 20393	19957, 20175, 20393	1.4MHz	QPSK	1 RB / 0 RB Offset
		19965 to 20385	19965, 20175, 20385	3MHz	QPSK	1 RB / 0 RB Offset
		19975 to 20375	19975, 20175, 20375	5MHz	QPSK	1 RB / 0 RB Offset
		20000 to 20350	20000, 20175, 20350	10MHz	QPSK	1 RB / 0 RB Offset
		20025 to 20325	20025, 20175, 20325	15MHz	QPSK	1 RB / 0 RB Offset
		20050 to 20300	20050, 20175, 20300	20MHz	QPSK	1 RB / 0 RB Offset
A	RADIATED EMISSION	19957 to 20393	20175	1.4MHz	QPSK	1 RB / 0 RB Offset
		19965 to 20385	19965, 20175, 20385	3MHz	QPSK	1 RB / 0 RB Offset
		19975 to 20375	20175	5MHz	QPSK	1 RB / 0 RB Offset
		20000 to 20350	20175	10MHz	QPSK	1 RB / 0 RB Offset
		20025 to 20325	20175	15MHz	QPSK	1 RB / 0 RB Offset
		20050 to 20300	20175	20MHz	QPSK	1 RB / 0 RB Offset

Note: This device was tested under all bandwidths, RB configurations and modulations. The worst case was found in QPSK modulation.

LTE BAND 7 MODE

EUT CONFIGURE MODE	TEST ITEM	AVAILABLE CHANNEL	TESTED CHANNEL	CHANNEL BANDWIDT H	MODULATION	MODE		
A	EIRP	20775 to 21425	20775, 21100, 21425	5MHz	QPSK, 16QAM, 64QAM	1 RB / 0 RB Offset		
		20800 to 21400	20800, 21100, 21400	10MHz	QPSK, 16QAM, 64QAM	1 RB / 0RB Offset		
		20825 to 21375	20825, 21100, 21375	15MHz	QPSK, 16QAM, 64QAM	1 RB / 0 RB Offset		
		20850 to 21350	20850, 21100, 21350	20MHz	QPSK, 16QAM, 64QAM	1 RB / 0 RB Offset		
B	FREQUENCY STABILITY	20775 to 21425	20775, 21100, 21425	5MHz	QPSK, 16QAM, 64QAM	25 RB / 0 RB Offset		
		20800 to 21400	20800, 21100, 21400	10MHz	QPSK, 16QAM, 64QAM	50 RB / 0 RB Offset		
		20825 to 21375	20825, 21100, 21375	15MHz	QPSK, 16QAM, 64QAM	75 RB / 0 RB Offset		
		20850 to 21350	20850, 21100, 21350	20MHz	QPSK, 16QAM, 64QAM	100 RB / 0 RB Offset		
A	OCCUPIED BANDWIDTH	20775 to 21425	20775, 21100, 21425	5MHz	QPSK, 16QAM, 64QAM	25 RB / 0 RB Offset		
		20800 to 21400	20800, 21100, 21400	10MHz	QPSK, 16QAM, 64QAM	50 RB / 0 RB Offset		
		20825 to 21375	20825, 21100, 21375	15MHz	QPSK, 16QAM, 64QAM	75 RB / 0 RB Offset		
		20850 to 21350	20850, 21100, 21350	20MHz	QPSK, 16QAM, 64QAM	100 RB / 0 RB Offset		
A	BAND EDGE	20775 to 21425	20775	5MHz	QPSK, 16QAM, 64QAM	1 RB / 0 RB Offset		
			21425	5MHz	QPSK, 16QAM, 64QAM	25 RB / 0 RB Offset		
		20800 to 21400	20800	10MHz	QPSK, 16QAM, 64QAM	1 RB / 24 RB Offset		
			21400	10MHz	QPSK, 16QAM, 64QAM	25 RB / 0 RB Offset		
		20825 to 21375	20825	15MHz	QPSK, 16QAM, 64QAM	1 RB / 0 RB Offset		
			21375	15MHz	QPSK, 16QAM, 64QAM	75 RB / 0 RB Offset		
		20850 to 21350	20850	20MHz	QPSK, 16QAM, 64QAM	1 RB / 49 RB Offset		
			21350	20MHz	QPSK, 16QAM, 64QAM	50 RB / 0 RB Offset		
		A	CONDCUDE TED EMISSION	20775 to 21425	20775, 21100, 21425	5MHz	QPSK, 16QAM, 64QAM	1 RB / 0 RB Offset
				20800 to 21400	20800, 21100, 21400	10MHz	QPSK, 16QAM, 64QAM	1 RB / 0RB Offset
				20825 to 21375	20825, 21100, 21375	15MHz	QPSK, 16QAM, 64QAM	1 RB / 0 RB Offset
				20850 to 21350	20850, 21100, 21350	20MHz	QPSK, 16QAM, 64QAM	1 RB / 0 RB Offset
A	RADIATED EMISSION	20775 to 21425	21100	5MHz	QPSK	1 RB / 0 RB Offset		
		20800 to 21400	20800, 21100, 21400	10MHz	QPSK	1 RB / 0 RB Offset		
		20825 to 21375	21100	15MHz	QPSK	1 RB / 0 RB Offset		
		20850 to 21350	21100	20MHz	QPSK	1 RB / 0 RB Offset		

Note: This device was tested under all bandwidths, RB configurations and modulations. The worst case was found in QPSK modulation.

LTE BAND 12 MODE

EUT CONFIGURE MODE	TEST ITEM	AVAILABLE CHANNEL	TESTED CHANNEL	CHANNEL BANDWIDTH	MODULATION	MODE		
A	ERP	23017 to 23173	23017, 23095 , 23173	1.4MHz	QPSK, 16QAM, 64QAM	1 RB / 0 RB Offset		
		23025 to 23165	23025, 23095 ,23165	3MHz	QPSK, 16QAM, 64QAM	1 RB / 0 RB Offset		
		23035 to 23155	23035, 23095 ,23155	5MHz	QPSK, 16QAM, 64QAM	1 RB / 0 RB Offset		
		23060 to 23130	23060, 23095 ,23130	10MHz	QPSK, 16QAM, 64QAM	1 RB / 0 RB Offset		
B	FREQUENCY STABILITY	23017 to 23173	23017, 23095 , 23173	1.4MHz	QPSK, 16QAM, 64QAM	6 RB / 0 RB Offset		
		23025 to 23165	23025, 23095 ,23165	3MHz	QPSK, 16QAM, 64QAM	15 RB / 0 RB Offset		
		23035 to 23155	23035, 23095 ,23155	5MHz	QPSK, 16QAM, 64QAM	25 RB / 0 RB Offset		
		23060 to 23130	23060, 23095 ,23130	10MHz	QPSK, 16QAM, 64QAM	50 RB / 0 RB Offset		
A	OCCUPIED BANDWIDTH	23017 to 23173	23017, 23095 , 23173	1.4MHz	QPSK, 16QAM, 64QAM	6 RB / 0 RB Offset		
		23025 to 23165	23025, 23095 ,23165	3MHz	QPSK, 16QAM, 64QAM	15 RB / 0 RB Offset		
		23035 to 23155	23035, 23095 ,23155	5MHz	QPSK, 16QAM, 64QAM	25 RB / 0 RB Offset		
		23060 to 23130	23060, 23095 ,23130	10MHz	QPSK, 16QAM, 64QAM	50 RB / 0 RB Offset		
A	PEAK TO AVERAGE RATIO	23017 to 23173	23017, 23095 , 23173	1.4MHz	QPSK, 16QAM, 64QAM	1 RB / 0 RB Offset 6 RB / 0 RB Offset		
		23025 to 23165	23025, 23095 ,23165	3MHz	QPSK, 16QAM, 64QAM	1 RB / 0 RB Offset 15 RB / 0 RB Offset		
		23035 to 23155	23035, 23095 ,23155	5MHz	QPSK, 16QAM, 64QAM	1 RB / 0 RB Offset 25 RB / 0 RB Offset		
		23060 to 23130	23060, 23095 ,23130	10MHz	QPSK, 16QAM, 64QAM	1 RB / 0 RB Offset 50 RB / 0 RB Offset		
A	BAND EDGE	23017 to 23173	23017	1.4MHz	QPSK	1 RB / 0 RB Offset 6 RB / 0 RB Offset		
			23173	1.4MHz	QPSK	1 RB / 5 RB Offset 6 RB / 0 RB Offset		
		23025 to 23165	23025	3MHz	QPSK	1 RB / 0 RB Offset 15 RB / 0 RB Offset		
			23165	3MHz	QPSK	1 RB / 14 RB Offset 15 RB / 0 RB Offset		
		23035 to 23155	23035	5MHz	QPSK	1 RB / 0 RB Offset 25 RB / 0 RB Offset		
			23155	5MHz	QPSK	1 RB / 24 RB Offset 25 RB / 0 RB Offset		
		23060 to 23130	23060	10MHz	QPSK	1 RB / 0 RB Offset 50 RB / 0 RB Offset		
			23130	10MHz	QPSK	1 RB / 49 RB Offset 50 RB / 0 RB Offset		
		A	CONDCUDED EMISSION	23017 to 23173	23017, 23095 , 23173	1.4MHz	QPSK, 16QAM, 64QAM	1 RB / 0 RB Offset
				23025 to 23165	23025, 23095 ,23165	3MHz	QPSK, 16QAM, 64QAM	1 RB / 0 RB Offset
				23035 to 23155	23035, 23095 ,23155	5MHz	QPSK, 16QAM, 64QAM	1 RB / 0 RB Offset
				23060 to 23130	23060, 23095 ,23130	10MHz	QPSK, 16QAM, 64QAM	1 RB / 0 RB Offset
A	RADIATED EMISSION	23017 to 23173	23095	1.4MHz	QPSK	1 RB / 0 RB Offset		
		23025 to 23165	23095	3MHz	QPSK	1 RB / 0 RB Offset		
		23035 to 23155	23035, 23095 ,23155	5MHz	QPSK	1 RB / 0 RB Offset		
		23060 to 23130	23095	10MHz	QPSK	1 RB / 0 RB Offset		



**BUREAU
VERITAS**

Test Report No.: W7L-P22030026-5RF05

Note: This device was tested under all bandwidths, RB configurations and modulations. The worst case was found in QPSK modulation.

LTE BAND 13 MODE

EUT CONFIGURE MODE	TEST ITEM	AVAILABLE CHANNEL	TESTED CHANNEL	CHANNEL BANDWIDTH	MODULATION	MODE
A	ERP	23205 to 23255	20025, 20175, 20325	5MHz	QPSK, 16QAM, 64QAM	1 RB / 0 RB Offset
		23230	23230	10MHz	QPSK, 16QAM, 64QAM	1 RB / 0 RB Offset
B	FREQUENCY STABILITY	23205 to 23255	20025, 20325	1.4MHz	QPSK, 16QAM, 64QAM	25 RB / 0 RB Offset
		23230	23230	10MHz	QPSK, 16QAM, 64QAM	50 RB / 0 RB Offset
A	OCCUPIED BANDWIDTH	23205 to 23255	20025, 20175, 20325	5MHz	QPSK, 16QAM, 64QAM	25 RB / 0 RB Offset
		23230	23230	10MHz	QPSK, 16QAM, 64QAM	50 RB / 0 RB Offset
A	BAND EDGE	23205 to 23255	23250	5MHz	QPSK, 16QAM, 64QAM	1 RB / 0 RB Offset
			23255	5MHz	QPSK, 16QAM, 64QAM	25 RB / 0 RB Offset
		23230	23230	10MHz	QPSK, 16QAM, 64QAM	1 RB / 0 RB Offset
			/	10MHz	QPSK, 16QAM, 64QAM	50 RB / 0 RB Offset
			23230	10MHz	QPSK, 16QAM, 64QAM	1 RB / 24 RB Offset
			23230	10MHz	QPSK, 16QAM, 64QAM	25 RB / 0 RB Offset
A	CONDCUDED EMISSION	23205 to 23255	20025, 20175, 20325	5MHz	QPSK, 16QAM, 64QAM	1 RB / 0 RB Offset
		23230	23230	10MHz	QPSK, 16QAM, 64QAM	1 RB / 0 RB Offset
A	RADIATED EMISSION	23205 to 23255	20025, 20175, 20325	5MHz	QPSK	1 RB / 0 RB Offset
		23230	23230	10MHz	QPSK	1 RB / 0 RB Offset

Note: This device was tested under all bandwidths, RB configurations and modulations. The worst case was found in QPSK modulation.



Test Report No.: W7L-P22030026-5RF05

LTE BAND 17 MODE

EUT CONFIGURE MODE	TEST ITEM	AVAILABLE CHANNEL	TESTED CHANNEL	CHANNEL BANDWIDTH	MODULATION	MODE
A	ERP	23755 to 23825	23755, 23790, 23825	5MHz	QPSK, 16QAM, 64QAM	1 RB / 0 RB Offset
		23780 to 23800	23780, 23790, 23800	10MHz	QPSK, 16QAM, 64QAM	1 RB / 0 RB Offset
B	FREQUENCY STABILITY	23755 to 23825	23755, 23790, 23825	5MHz	QPSK, 16QAM, 64QAM	25 RB / 0 RB Offset
		23780 to 23800	23780, 23790, 23800	10MHz	QPSK, 16QAM, 64QAM	50 RB / 0 RB Offset
A	OCCUPIED BANDWIDTH	23755 to 23825	23755, 23790, 23825	5MHz	QPSK, 16QAM, 64QAM	25 RB / 0 RB Offset
		23780 to 23800	23780, 23790, 23800	10MHz	QPSK, 16QAM, 64QAM	50 RB / 0 RB Offset
A	BAND EDGE	23755 to 23825	23755	5MHz	QPSK, 16QAM, 64QAM	1 RB / 0 RB Offset
			23825	5MHz	QPSK, 16QAM, 64QAM	25 RB / 0 RB Offset
		23780 to 23800	23780	10MHz	QPSK, 16QAM, 64QAM	1 RB / 24 RB Offset
			23800	10MHz	QPSK, 16QAM, 64QAM	25 RB / 0 RB Offset
						1 RB / 0 RB Offset
						50 RB / 0 RB Offset
A	CONDCUDED EMISSION	23755 to 23825	23755, 23790, 23825	5MHz	QPSK, 16QAM, 64QAM	1 RB / 49 RB Offset
		23780 to 23800	23780, 23790, 23800	10MHz	QPSK, 16QAM, 64QAM	50 RB / 0 RB Offset
A	RADIATED EMISSION	23755 to 23825	23755, 23790, 23825	5MHz	QPSK	1 RB / 0 RB Offset
		23780 to 23800	23790	10MHz	QPSK	1 RB / 0 RB Offset

Note: This device was tested under all bandwidths, RB configurations and modulations. The worst case was found in QPSK modulation.



Test Report No.: W7L-P22030026-5RF05

LTE BAND 66 MODE

EUT CONFIGURE MODE	TEST ITEM	AVAILABLE CHANNEL	TESTED CHANNEL	CHANNEL BANDWIDTH	MODULATION	MODE
A	EIRP	131979 to 132665	131979,132322,132665	1.4MHz	QPSK,16QAM,64QAM	1 RB / 0 RB Offset
		131987 to 132657	131987,132322,132657	3MHz	QPSK,16QAM,64QAM	1 RB / 0 RB Offset
		131997 to 132647	131997,132322,132647	5MHz	QPSK,16QAM,64QAM	1 RB / 0 RB Offset
		132022 to 132622	132022,132322,132622	10MHz	QPSK,16QAM,64QAM	1 RB / 0 RB Offset
		132047 to 132597	132047,132322,132597	15MHz	QPSK,16QAM,64QAM	1 RB / 0 RB Offset
		132072 to 132572	132072,132322,132572	20MHz	QPSK,16QAM,64QAM	1 RB / 0 RB Offset
B	FREQUENCY STABILITY	131979 to 132665	131979,132322,132665	1.4MHz	25 RB / 0 RB Offset	6 RB / 0 RB Offset
		131987 to 132657	131987,132322,132657	3MHz	50 RB / 0 RB Offset	15 RB / 0 RB Offset
		131997 to 132647	131997,132322,132647	5MHz	25 RB / 0 RB Offset	25 RB / 0 RB Offset
		132022 to 132622	132022,132322,132622	10MHz	50 RB / 0 RB Offset	50 RB / 0 RB Offset
		132047 to 132597	132047,132322,132597	15MHz	25 RB / 0 RB Offset	75 RB / 0 RB Offset
		132072 to 132572	132072,132322,132572	20MHz	50 RB / 0 RB Offset	6 RB / 0 RB Offset
A	OCCUPIED BANDWIDTH	131979 to 132665	131979,132322,132665	1.4MHz	QPSK,16QAM,64QAM	6 RB / 0 RB Offset
		131987 to 132657	131987,132322,132657	3MHz	QPSK,16QAM,64QAM	15 RB / 0 RB Offset
		131997 to 132647	131997,132322,132647	5MHz	QPSK,16QAM,64QAM	25 RB / 0 RB Offset
		132022 to 132622	132022,132322,132622	10MHz	QPSK,16QAM,64QAM	50 RB / 0 RB Offset
		132047 to 132597	132047,132322,132597	15MHz	QPSK,16QAM,64QAM	75 RB / 0 RB Offset
		132072 to 132572	132072,132322,132572	20MHz	QPSK,16QAM,64QAM	100 RB / 0 RB Offset
A	BAND EDGE	131979 to 132322	131979	1.4MHz	QPSK,16QAM, 64QAM	1 RB / 0 RB Offset 6 RB / 0 RB Offset
			132322	1.4MHz	QPSK,16QAM, 64QAM	1 RB / 5 RB Offset 6 RB / 0 RB Offset
		131987 to 132657	131987	3MHz	QPSK,16QAM, 64QAM	1 RB / 0 RB Offset 15 RB / 0 RB Offset
			132657	3MHz	QPSK,16QAM, 64QAM	1 RB / 14 RB Offset 15 RB / 0 RB Offset
		131987 to 132657	131987	5MHz	QPSK,16QAM, 64QAM	1 RB / 0 RB Offset 25 RB / 0 RB Offset
			132657	5MHz	QPSK,16QAM, 64QAM	1 RB / 24 RB Offset 25 RB / 0 RB Offset
		131997 to 132647	131997	10MHz	QPSK,16QAM, 64QAM	1 RB / 0 RB Offset 50 RB / 0 RB Offset
			132647	10MHz	QPSK,16QAM, 64QAM	1 RB / 49 RB Offset 50 RB / 0 RB Offset
		132047 to 132597	132047	15MHz	QPSK,16QAM, 64QAM	1 RB / 0 RB Offset 75 RB / 0 RB Offset
			132597	15MHz	QPSK,16QAM, 64QAM	1 RB / 74 RB Offset 75 RB / 0 RB Offset
		132072 to 132572	132072	20MHz	QPSK,16QAM, 64QAM	1 RB / 0 RB Offset 100 RB / 0 RB Offset
			132572	20MHz	QPSK,16QAM, 64QAM	1 RB / 99 RB Offset



**BUREAU
VERITAS**

Test Report No.: W7L-P22030026-5RF05

						100 RB / 0 RB Offset
A	CONDCUDED EMISSION	131979 to 132665	131979,132322,132665	1.4MHz	QPSK	1 RB / 0 RB Offset
		131987 to 132657	131987,132322,132657	3MHz	QPSK	1 RB / 0 RB Offset
		131997 to 132647	131997,132322,132647	5MHz	QPSK	1 RB / 0 RB Offset
		132022 to 132622	132022,132322,132622	10MHz	QPSK	1 RB / 0 RB Offset
		132047 to 132597	132047,132322,132597	15MHz	QPSK	1 RB / 0 RB Offset
		132072 to 132572	132072,132322,132572	20MHz	QPSK	1 RB / 0 RB Offset
A	RADIATED EMISSION	131979 to 132665	132322	1.4MHz	QPSK	1 RB / 0 RB Offset
		131987 to 132657	132322	3MHz	QPSK	1 RB / 0 RB Offset
		131997 to 132647	131997,132322,132647	5MHz	QPSK	1 RB / 0 RB Offset
		132022 to 132622	132322	10MHz	QPSK	1 RB / 0 RB Offset
		132047 to 132597	132322	15MHz	QPSK	1 RB / 0 RB Offset
		132072 to 132572	132322	20MHz	QPSK	1 RB / 0 RB Offset

Note: This device was tested under all bandwidths, RB configurations and modulations. The worst case was found in QPSK modulation.



Test Report No.: W7L-P22030026-5RF05

TEST CONDITION:

TEST ITEM	ENVIRONMENTAL CONDITIONS	INPUT POWER	TESTED BY
ERP&EIRP	23deg. C, 70%RH	DC 5V By Adapter	Jace Hu
FREQUENCY STABILITY	23deg. C, 70%RH	DC 3.85V/3.5V/4.4V By Battery	James Fu
OCCUPIED BANDWIDTH	23deg. C, 70%RH	DC5V By Adapter	James Fu
BAND EDGE	23deg. C, 70%RH	DC 5V By Adapter	James Fu
CONDCUDETED EMISSION	23deg. C, 70%RH	DC5V By Adapter	James Fu
RADIATED EMISSION	23deg. C, 70%RH	DC5V By Adapter	Jace Hu
PEAK TO AVERAGE RATIO	23deg. C, 70%RH	DC5V By Adapter	James Fu



Test Report No.: W7L-P22030026-5RF05

2.5 GENERAL DESCRIPTION OF APPLIED STANDARDS

The EUT is a RF product. According to the specifications of the manufacturer, it must comply with the requirements of the following standards:

FCC 47 CFR Part 2

FCC 47 CFR Part 27

KDB 971168 D01 Power Meas License Digital Systems v03r01

ANSI/TIA/EIA-603-D

ANSI/TIA/EIA-603-E

ANSI C63.26-2015

NOTE: All test items have been performed and recorded as per the above standards.

3 TEST TYPES AND RESULTS

3.1 OUTPUT POWER MEASUREMENT

3.1.1 LIMITS OF OUTPUT POWER MEASUREMENT

The radiated peak output power shall be according to the specific rule Part 27.50(h)(2) that “User stations are limited to 2 watts” and 27.50(i) specific that “Peak transmit power must be measure over any interval of continuous transmission using instrumentation calibration in terms of rms-equivalent voltage.”

Fixed, mobile, and portable (hand-held) stations operating in the 1710-1755 MHz band and mobile and portable stations operating in the 1695-1710 MHz and 1755-1780 MHz bands are limited to 1 watt EIRP

According to the specific rule Part 27.50(b)(10) and 27.50(c)(10) Fixed, mobile, and Portable stations (hand-held devices) transmitting in the 698-746 MHz, 746-757 MHz, 776-788 MHz, and 805-806 MHz bands are limited to 3 watts ERP.

3.1.2 TEST PROCEDURES

EIRP MEASUREMENT:

Per KDB 971168 D01 Power Meas License Digital Systems v03r01 or subclause 5.2.5.5 of ANSI C63.26-2015, the relevant equation for determining the ERP or EIRP from the conducted RF output power measured using the guidance provided above is:

$$\text{ERP or EIRP} = P_{\text{Meas}} + G_{\text{T}} - L_{\text{C}}$$

Where:

ERP or EIRP = effective radiated power or equivalent isotropically radiated power, respectively
(expressed in the same units as P_{Meas} , typically dBW or dBm);

P_{Meas} = measured transmitter output power or PSD, in dBm or dBW;

G_{T} = gain of the transmitting antenna, in dBd (ERP) or dBi (EIRP);

L_{C} = signal attenuation in the connecting cable between the transmitter and antenna, in dB.

CONDUCTED POWER MEASUREMENT:

- a. The EUT was set up for the maximum power with LTE link data modulation and link up with simulator.
- b. Set the EUT to transmit under low, middle and high channel and record the power level shown on simulator.



Test Report No.: W7L-P22030026-5RF05

3.1.3 TEST SETUP

CONDUCTED POWER MEASUREMENT:

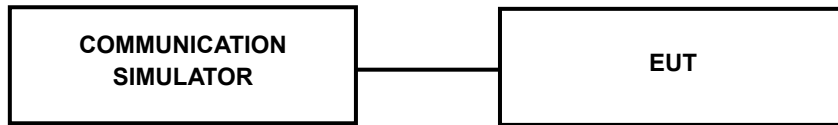

For the actual test configuration, please refer to the attached file (Test Setup Photo).

3.1.4 TEST RESULTS

AVERAGE CONDUCTED OUTPUT POWER (dBm)

Band	WCDMA IV		
	1312	1413	1513
Channel	1712.4	1732.6	1752.6
Frequency (MHz)	1712.4	1732.6	1752.6
RMC 12.2K	23.14	23.13	23.06
HSDPA Subtest-1	22.20	22.12	22.21
HSDPA Subtest-2	22.22	22.11	22.19
HSDPA Subtest-3	21.64	21.56	21.65
HSDPA Subtest-4	21.65	21.61	21.63
DC-HSDPA Subtest-1	22.25	22.12	22.22
DC-HSDPA Subtest-2	22.21	22.06	22.14
DC-HSDPA Subtest-3	21.68	21.56	21.68
DC-HSDPA Subtest-4	21.71	21.60	21.60
HSUPA Subtest-1	22.14	22.01	22.09
HSUPA Subtest-2	20.23	20.12	20.22
HSUPA Subtest-3	21.17	21.11	21.14
HSUPA Subtest-4	20.18	20.10	20.19
HSUPA Subtest-5	22.16	22.08	22.17
HSPA+ Subtest-1	20.09	20.04	20.13



**BUREAU
VERITAS**

Test Report No.: W7L-P22030026-5RF05

LTE Band 4

Band/BW	Modulation	RB Size	RB Offset	Low CH 19957	Mid CH 20175	High CH 20393	MPR
				Frequency 1710.7 MHz	Frequency 1732.5 MHz	Frequency 1754.3 MHz	
4/ 1.4	QPSK	1	0	23.67	23.68	23.74	0
		1	2	23.66	23.60	23.71	0
		1	5	23.62	23.54	23.63	0
		3	0	23.67	23.62	23.75	0
		3	1	23.59	23.55	23.56	0
		3	3	23.52	23.46	23.55	0
		6	0	22.61	22.53	22.64	1
	16QAM	1	0	23.08	23.03	23.12	1
		1	2	23.05	22.96	23.09	1
		1	5	23.00	22.94	23.08	1
		3	0	22.68	22.64	22.71	1
		3	1	22.51	22.55	22.58	1
		3	3	22.58	22.54	22.65	1
		6	0	21.57	21.58	21.62	2
	64QAM	1	0	21.79	21.78	21.88	2
		1	2	21.71	21.74	21.78	2
		1	5	21.79	21.70	21.83	2
		3	0	20.55	19.54	19.59	2
		3	1	20.66	19.67	19.70	2
		3	3	21.03	19.97	20.11	2
		6	0	19.52	19.48	19.55	3



Test Report No.: W7L-P22030026-5RF05

Band/BW	Modulation	RB Size	RB Offset	Low CH 19965	Mid CH 20175	High CH 20385	MPR
				Frequency 1711.5 MHz	Frequency 1732.5 MHz	Frequency 1753.5 MHz	
4/3	QPSK	1	0	23.69	23.70	23.73	0
		1	7	23.62	23.61	23.71	0
		1	14	23.58	23.54	23.63	0
		8	0	22.66	22.65	22.75	1
		8	3	22.52	22.55	22.58	1
		8	7	22.49	22.53	22.59	1
		15	0	22.58	22.54	22.58	1
	16QAM	1	0	23.05	23.09	23.15	1
		1	7	23.02	22.99	23.07	1
		1	14	23.03	22.94	23.08	1
		8	0	21.64	21.65	21.71	2
		8	3	21.56	21.50	21.61	2
		8	7	21.60	21.52	21.61	2
		15	0	21.57	21.52	21.65	2
	64QAM	1	0	21.85	21.81	21.82	2
		1	7	21.74	21.68	21.77	2
		1	14	21.80	21.72	21.83	2
		8	0	19.58	19.58	19.60	3
		8	3	19.70	19.61	19.75	3
		8	7	20.00	20.01	20.07	3
		15	0	19.54	19.45	19.59	3

Band/BW	Modulation	RB Size	RB Offset	Low CH 19975	Mid CH 20175	High CH 20375	MPR
				Frequency 1712.5 MHz	Frequency 1732.5 MHz	Frequency 1752.5 MHz	
4/5	QPSK	1	0	23.70	23.65	23.74	0
		1	12	23.67	23.58	23.71	0
		1	24	23.59	23.53	23.67	0
		12	0	22.69	22.65	22.72	1
		12	6	22.52	22.56	22.59	1
		12	13	22.53	22.49	22.60	1
		25	0	22.56	22.57	22.61	1
	16QAM	1	0	23.06	23.05	23.15	1
		1	12	22.99	23.02	23.06	1
		1	24	23.03	22.94	23.07	1
		12	0	21.64	21.63	21.68	2
		12	6	21.53	21.54	21.57	2
		12	13	21.55	21.54	21.64	2
		25	0	21.57	21.53	21.62	2
	64QAM	1	0	21.79	21.78	21.88	2
		1	12	21.71	21.74	21.77	2
		1	24	21.73	21.77	21.83	2
		12	0	19.59	19.55	19.59	3
		12	6	19.64	19.68	19.74	3
		12	13	20.04	20.00	20.04	3
		25	0	19.50	19.51	19.57	3

Band/BW	Modulation	RB Size	RB Offset	Low CH 20000	Mid CH 20175	High CH 20350	MPR
				Frequency 1715 MHz	Frequency 1732.5 MHz	Frequency 1750 MHz	
4/ 10	QPSK	1	0	23.67	23.68	23.74	0
		1	24	23.67	23.58	23.72	0
		1	49	23.56	23.57	23.63	0
		25	0	22.70	22.64	22.75	1
		25	12	22.58	22.50	22.59	1
		25	25	22.51	22.46	22.59	1
		50	0	22.61	22.57	22.58	1
	16QAM	1	0	23.06	23.02	23.11	1
		1	24	23.04	22.98	23.09	1
		1	49	23.03	22.95	23.04	1
		25	0	21.66	21.61	21.74	2
		25	12	21.57	21.48	21.62	2
		25	25	21.54	21.55	21.61	2
		50	0	21.61	21.52	21.66	2
	64QAM	1	0	21.78	21.79	21.85	2
		1	24	21.76	21.70	21.81	2
		1	49	21.79	21.71	21.80	2
		25	0	19.57	19.52	19.65	3
		25	12	19.71	19.67	19.68	3
		25	25	20.03	19.97	20.06	3
		50	0	19.55	19.47	19.58	3

Band/BW	Modulation	RB Size	RB Offset	Low CH 20025	Mid CH 20175	High CH 20325	MPR
				Frequency 1717.5 MHz	Frequency 1732.5 MHz	Frequency 1747.5 MHz	
4/ 15	QPSK	1	0	23.74	23.68	23.71	0
		1	37	23.65	23.63	23.67	0
		1	74	23.62	23.60	23.64	0
		36	0	22.67	22.65	22.76	1
		36	19	22.59	22.55	22.59	1
		36	39	22.49	22.47	22.59	1
		75	0	22.61	22.55	22.63	1
	16QAM	1	0	23.10	23.09	23.11	1
		1	37	23.03	22.99	23.09	1
		1	74	22.99	23.00	23.06	1
		36	0	21.70	21.61	21.75	2
		36	19	21.51	21.52	21.58	2
		36	39	21.59	21.53	21.64	2
		75	0	21.62	21.55	21.59	2
	64QAM	1	0	21.80	21.80	21.86	2
		1	37	21.77	21.69	21.78	2
		1	74	21.75	21.70	21.83	2
		36	0	19.62	19.58	19.59	3
		36	19	19.65	19.61	19.70	3
		36	39	20.06	20.04	20.08	3
		75	0	19.54	19.45	19.59	3

Band/BW	Modulation	RB Size	RB Offset	Low CH 20050	Mid CH 20175	High CH 20300	MPR
				Frequency 1720 MHz	Frequency 1732.5 MHz	Frequency 1745 MHz	
4/ 20	QPSK	1	0	23.75	23.72	23.79	0
		1	50	23.69	23.66	23.73	0
		1	99	23.64	23.61	23.68	0
		50	0	22.73	22.70	22.77	1
		50	25	22.60	22.57	22.64	1
		50	50	22.57	22.54	22.61	1
		100	0	22.62	22.59	22.66	1
	16QAM	1	0	23.13	23.10	23.17	1
		1	50	23.07	23.04	23.11	1
		1	99	23.05	23.02	23.09	1
		50	0	21.72	21.69	21.76	2
		50	25	21.59	21.56	21.63	2
		50	50	21.62	21.59	21.66	2
		100	0	21.63	21.60	21.67	2
	64QAM	1	0	21.86	21.83	21.90	2
		1	50	21.79	21.76	21.83	2
		1	99	21.81	21.78	21.85	2
		50	0	19.63	19.60	19.67	3
		50	25	19.72	19.69	19.76	3
		50	50	20.08	20.05	20.12	3
		100	0	19.56	19.53	19.60	3

LTE Band 7

Band/BW	Modulation	RB Size	RB Offset	Low CH 20775	Mid CH 21100	High CH 21425	MPR
				Frequency 2502.5 MHz	Frequency 2535 MHz	Frequency 2567.5 MHz	
7/5	QPSK	1	0	23.49	23.58	23.46	0
		1	12	23.50	23.55	23.47	0
		1	24	23.66	23.74	23.67	0
		12	0	22.41	22.51	22.37	1
		12	6	22.44	22.62	22.44	1
		12	13	22.40	22.50	22.40	1
		25	0	22.45	22.60	22.43	1
	16QAM	1	0	22.15	22.28	22.17	1
		1	12	22.27	22.44	22.27	1
		1	24	22.41	22.46	22.38	1
		12	0	21.47	21.60	21.44	2
		12	6	21.46	21.61	21.43	2
		12	13	21.51	21.64	21.53	2
		25	0	21.43	21.53	21.41	2
	64QAM	1	0	20.93	21.06	20.95	2
		1	12	21.09	21.26	21.08	2
		1	24	21.85	22.03	21.88	2
		12	0	19.95	20.05	19.88	3
		12	6	19.99	20.17	20.02	3
		12	13	20.32	20.42	20.25	3
		25	0	20.12	20.27	20.12	3

Band/BW	Modulation	RB Size	RB Offset	Low CH 20800	Mid CH 21100	High CH 21400	MPR
				Frequency 2505 MHz	Frequency 2535 MHz	Frequency 2565 MHz	
7/ 10	QPSK	1	0	23.46	23.61	23.46	0
		1	24	23.50	23.55	23.48	0
		1	49	23.63	23.78	23.63	0
		25	0	22.42	22.50	22.40	1
		25	12	22.50	22.56	22.44	1
		25	25	22.38	22.47	22.39	1
		50	0	22.50	22.60	22.40	1
	16QAM	1	0	22.15	22.25	22.13	1
		1	24	22.32	22.40	22.30	1
		1	49	22.41	22.47	22.35	1
		25	0	21.49	21.58	21.50	2
		25	12	21.50	21.55	21.48	2
		25	25	21.50	21.65	21.50	2
		50	0	21.47	21.52	21.45	2
	64QAM	1	0	20.92	21.07	20.92	2
		1	24	21.14	21.22	21.12	2
		1	49	21.91	21.97	21.85	2
		25	0	19.93	20.02	19.94	3
		25	12	20.06	20.16	19.96	3
		25	25	20.31	20.39	20.27	3
		50	0	20.17	20.23	20.13	3

Band/BW	Modulation	RB Size	RB Offset	Low CH 20825	Mid CH 21100	High CH 21375	MPR
				Frequency 2507.5 MHz	Frequency 2535 MHz	Frequency 2562.5 MHz	
7/ 15	QPSK	1	0	23.53	23.61	23.43	0
		1	37	23.48	23.60	23.43	0
		1	74	23.69	23.81	23.64	0
		36	0	22.39	22.51	22.41	1
		36	19	22.51	22.61	22.44	1
		36	39	22.36	22.48	22.39	1
		75	0	22.50	22.58	22.45	1
	16QAM	1	0	22.19	22.32	22.13	1
		1	37	22.31	22.41	22.30	1
		1	74	22.37	22.52	22.37	1
		36	0	21.53	21.58	21.51	2
		36	19	21.44	21.59	21.44	2
		36	39	21.55	21.63	21.53	2
		75	0	21.48	21.55	21.38	2
	64QAM	1	0	20.94	21.08	20.93	2
		1	37	21.15	21.21	21.09	2
		1	74	21.87	21.96	21.88	2
		36	0	19.98	20.08	19.88	3
		36	19	20.00	20.10	19.98	3
		36	39	20.34	20.46	20.29	3
		75	0	20.16	20.21	20.14	3

Band/BW	Modulation	RB Size	RB Offset	Low CH 20850	Mid CH 21100	High CH 21350	MPR
				Frequency 2510 MHz	Frequency 2535 MHz	Frequency 2560 MHz	
7/ 20	QPSK	1	0	23.54	23.65	23.51	0
		1	50	23.52	23.63	23.49	0
		1	99	23.71	23.82	23.68	0
		50	0	22.45	22.56	22.42	1
		50	25	22.52	22.63	22.49	1
		50	50	22.44	22.55	22.41	1
		100	0	22.51	22.62	22.48	1
	16QAM	1	0	22.22	22.33	22.19	1
		1	50	22.35	22.46	22.32	1
		1	99	22.43	22.54	22.40	1
		50	0	21.55	21.66	21.52	2
		50	25	21.52	21.63	21.49	2
		50	50	21.58	21.69	21.55	2
		100	0	21.49	21.60	21.46	2
	64QAM	1	0	21.00	21.11	20.97	2
		1	50	21.17	21.28	21.14	2
		1	99	21.93	22.04	21.90	2
		50	0	19.99	20.10	19.96	3
		50	25	20.07	20.18	20.04	3
		50	50	20.36	20.47	20.33	3
		100	0	20.18	20.29	20.15	3



**BUREAU
VERITAS**

Test Report No.: W7L-P22030026-5RF05

LTE Band 12

Band/BW	Modulation	RB Size	RB Offset	Low CH 23017	Mid CH 23095	High CH 23173	MPR
				Frequency 699.7 MHz	Frequency 707.5 MHz	Frequency 715.3 MHz	
12/ 1.4	QPSK	1	0	23.39	23.49	23.45	0
		1	2	23.37	23.40	23.41	0
		1	5	23.46	23.47	23.46	0
		3	0	23.36	23.40	23.43	0
		3	1	23.18	23.23	23.14	0
		3	3	23.26	23.29	23.28	0
		6	0	22.17	22.18	22.19	1
	16QAM	1	0	22.47	22.51	22.50	1
		1	2	22.71	22.71	22.74	1
		1	5	22.54	22.57	22.61	1
		3	0	22.34	22.39	22.36	1
		3	1	22.64	22.77	22.70	1
		3	3	22.43	22.48	22.49	1
		6	0	21.59	21.69	21.63	2
	64QAM	1	0	21.37	21.45	21.45	2
		1	2	21.33	21.45	21.39	2
		1	5	21.47	21.47	21.50	2
		3	0	18.91	18.99	18.94	2
		3	1	18.98	19.08	19.01	2
		3	3	19.31	19.34	19.38	2
		6	0	18.16	18.21	18.18	3



Test Report No.: W7L-P22030026-5RF05

Band/BW	Modulation	RB Size	RB Offset	Low CH 23025	Mid CH 23095	High CH 23165	MPR
				Frequency 700.5 MHz	Frequency 707.5 MHz	Frequency 714.5 MHz	
12/ 3	QPSK	1	0	23.41	23.51	23.44	0
		1	7	23.33	23.41	23.41	0
		1	14	23.42	23.47	23.46	0
		8	0	22.35	22.43	22.43	1
		8	3	22.11	22.23	22.16	1
		8	7	22.23	22.36	22.32	1
		15	0	22.14	22.19	22.13	1
	16QAM	1	0	22.44	22.57	22.53	1
		1	7	22.68	22.74	22.72	1
		1	14	22.57	22.57	22.61	1
		8	0	21.30	21.40	21.36	2
		8	3	21.69	21.72	21.73	2
		8	7	21.45	21.46	21.45	2
		15	0	21.59	21.63	21.66	2
	64QAM	1	0	21.43	21.48	21.39	2
		1	7	21.36	21.39	21.38	2
		1	14	21.48	21.49	21.50	2
		8	0	17.94	18.03	17.95	3
		8	3	18.02	18.02	18.06	3
		8	7	18.28	18.38	18.34	3
		15	0	18.18	18.18	18.22	3

Band/BW	Modulation	RB Size	RB Offset	Low CH 23035	Mid CH 23095	High CH 23155	MPR
				Frequency 701.5 MHz	Frequency 707.5 MHz	Frequency 713.5 MHz	
12/ 5	QPSK	1	0	23.42	23.46	23.45	0
		1	12	23.38	23.38	23.41	0
		1	24	23.43	23.46	23.50	0
		12	0	22.38	22.43	22.40	1
		12	6	22.11	22.24	22.17	1
		12	13	22.27	22.32	22.33	1
		25	0	22.12	22.22	22.16	1
	16QAM	1	0	22.45	22.53	22.53	1
		1	12	22.65	22.77	22.71	1
		1	24	22.57	22.57	22.60	1
		12	0	21.30	21.38	21.33	2
		12	6	21.66	21.76	21.69	2
		12	13	21.40	21.48	21.48	2
		25	0	21.59	21.64	21.63	2
	64QAM	1	0	21.37	21.45	21.45	2
		1	12	21.33	21.45	21.38	2
		1	24	21.41	21.54	21.50	2
		12	0	17.95	18.00	17.94	3
		12	6	17.96	18.09	18.05	3
		12	13	18.32	18.37	18.31	3
		25	0	18.14	18.24	18.20	3

Band/BW	Modulation	RB Size	RB Offset	Low CH 23060	Mid CH 23095	High CH 23130	MPR
				Frequency 704 MHz	Frequency 707.5 MHz	Frequency 711 MHz	
12/ 10	QPSK	1	0	23.47	23.53	23.50	0
		1	24	23.40	23.46	23.43	0
		1	49	23.48	23.54	23.51	0
		25	0	22.42	22.48	22.45	1
		25	12	22.19	22.25	22.22	1
		25	25	22.31	22.37	22.34	1
		50	0	22.18	22.24	22.21	1
	16QAM	1	0	22.52	22.58	22.55	1
		1	24	22.73	22.79	22.76	1
		1	49	22.59	22.65	22.62	1
		25	0	21.38	21.44	21.41	2
		25	12	21.72	21.78	21.75	2
		25	25	21.47	21.53	21.50	2
		50	0	21.65	21.71	21.68	2
	64QAM	1	0	21.44	21.50	21.47	2
		1	24	21.41	21.47	21.44	2
		1	49	21.49	21.55	21.52	2
		25	0	17.99	18.05	18.02	3
		25	12	18.04	18.10	18.07	3
		25	25	18.36	18.42	18.39	3
		50	0	18.20	18.26	18.23	3



**BUREAU
VERITAS**

Test Report No.: W7L-P22030026-5RF05

LTE Band 13

Band/BW	Modulation	RB Size	RB Offset	Low CH 23205	Mid CH 23230	High CH 23255	MPR
				Frequency 779.5 MHz	Frequency 782.0 MHz	Frequency 784.5 MHz	
13/ 5	QPSK	1	0	22.44	22.42	22.44	0
		1	12	22.42	22.36	22.42	0
		1	24	22.20	22.17	22.24	0
		12	0	21.33	21.32	21.32	1
		12	6	21.40	21.47	21.43	1
		12	13	21.41	21.40	21.44	1
		25	0	21.36	21.40	21.37	1
	16QAM	1	0	21.44	21.46	21.49	1
		1	12	21.37	21.43	21.40	1
		1	24	21.56	21.50	21.56	1
		12	0	20.20	20.22	20.20	2
		12	6	20.56	20.60	20.56	2
		12	13	20.59	20.61	20.64	2
		25	0	20.61	20.60	20.62	2
	64QAM	1	0	20.51	20.53	20.56	2
		1	12	20.62	20.68	20.64	2
		1	24	20.68	20.75	20.74	2
		12	0	18.27	18.26	18.23	3
		12	6	18.21	18.28	18.27	3
		12	13	18.27	18.26	18.23	3
		25	0	18.16	18.20	18.19	3



Test Report No.: W7L-P22030026-5RF05

Band/BW	Modulation	RB Size	RB Offset	/	Mid CH 23230	/	MPR
				/	Frequency 782.0 MHz	/	
13/ 10	QPSK	1	0	/	22.49	/	0
		1	24	/	22.44	/	0
		1	49	/	22.25	/	0
		25	0	/	21.37	/	1
		25	12	/	21.48	/	1
		25	25	/	21.45	/	1
		50	0	/	21.42	/	1
	16QAM	1	0	/	21.51	/	1
		1	24	/	21.45	/	1
		1	49	/	21.58	/	1
		25	0	/	20.28	/	2
		25	12	/	20.62	/	2
		25	25	/	20.66	/	2
		50	0	/	20.67	/	2
	64QAM	1	0	/	20.58	/	2
		1	24	/	20.70	/	2
		1	49	/	20.76	/	2
		25	0	/	18.31	/	3
		25	12	/	18.29	/	3
		25	25	/	18.31	/	3
		50	0	/	18.22	/	3



**BUREAU
VERITAS**

Test Report No.: W7L-P22030026-5RF05

LTE Band 17

Band/BW	Modulation	RB Size	RB Offset	Low CH 23755	Mid CH 23790	High CH 23825	MPR
				Frequency 706.5 MHz	Frequency 710 MHz	Frequency 713.5 MHz	
17/ 5	QPSK	1	0	23.44	23.29	23.28	0
		1	12	23.38	23.19	23.22	0
		1	24	23.58	23.42	23.46	0
		12	0	22.34	22.20	22.17	1
		12	6	22.16	22.10	22.03	1
		12	13	22.18	22.04	22.05	1
		25	0	22.14	22.05	21.99	1
	16QAM	1	0	22.76	22.65	22.65	1
		1	12	22.63	22.56	22.50	1
		1	24	22.76	22.57	22.60	1
		12	0	21.46	21.35	21.30	2
		12	6	21.75	21.66	21.59	2
		12	13	21.46	21.35	21.35	2
		25	0	21.56	21.42	21.41	2
	64QAM	1	0	21.68	21.57	21.57	2
		1	12	21.54	21.47	21.40	2
		1	24	21.51	21.45	21.41	2
		12	0	18.08	17.94	17.88	3
		12	6	18.12	18.06	18.02	3
		12	13	18.51	18.37	18.31	3
		25	0	18.36	18.27	18.23	3

Band/BW	Modulation	RB Size	RB Offset	Low CH 23780	Mid CH 23790	High CH 23800	MPR
				Frequency 709 MHz	Frequency 710 MHz	Frequency 711 MHz	
17/ 10	QPSK	1	0	23.49	23.36	23.33	0
		1	24	23.40	23.27	23.24	0
		1	49	23.63	23.50	23.47	0
		25	0	22.38	22.25	22.22	1
		25	12	22.24	22.11	22.08	1
		25	25	22.22	22.09	22.06	1
		50	0	22.20	22.07	22.04	1
	16QAM	1	0	22.83	22.70	22.67	1
		1	24	22.71	22.58	22.55	1
		1	49	22.78	22.65	22.62	1
		25	0	21.54	21.41	21.38	2
		25	12	21.81	21.68	21.65	2
		25	25	21.53	21.40	21.37	2
		50	0	21.62	21.49	21.46	2
	64QAM	1	0	21.75	21.62	21.59	2
		1	24	21.62	21.49	21.46	2
		1	49	21.59	21.46	21.43	2
		25	0	18.12	17.99	17.96	3
		25	12	18.20	18.07	18.04	3
		25	25	18.55	18.42	18.39	3
		50	0	18.42	18.29	18.26	3

LTE Band 66

Band/BW	Modulation	RB Size	RB Offset	Low CH 131979	Mid CH 132322	High CH 132665	MPR
				Frequency 1710.7MHz	Frequency 1745MHz	Frequency 1779.3MHz	
66/ 1.4	QPSK	1	0	23.79	23.68	23.99	0
		1	2	23.76	23.58	23.94	0
		1	5	22.75	22.55	22.89	0
		3	0	23.48	23.31	23.69	0
		3	1	23.45	23.29	23.55	0
		3	3	23.47	23.29	23.63	0
		6	0	22.46	22.26	22.62	1
	16QAM	1	0	22.53	22.36	22.70	1
		1	2	22.53	22.32	22.70	1
		1	5	22.36	22.18	22.57	1
		3	0	22.50	22.34	22.66	1
		3	1	22.42	22.34	22.62	1
		3	3	22.44	22.28	22.64	1
		6	0	21.56	21.45	21.74	2
	64QAM	1	0	21.68	21.55	21.90	2
		1	2	21.49	21.40	21.69	2
		1	5	21.60	21.39	21.77	2
		3	0	21.02	20.89	21.19	2
		3	1	20.81	20.70	20.98	2
		3	3	20.76	20.58	20.97	2
		6	0	19.88	19.72	20.04	3



Test Report No.: W7L-P22030026-5RF05

Band/BW	Modulation	RB Size	RB Offset	Low CH 131987	Mid CH 132322	High CH 132657	MPR
				Frequency 1711.5MHz	Frequency 1745MHz	Frequency 1778.5MHz	
66/ 3	QPSK	1	0	23.81	23.70	23.98	0
		1	7	23.72	23.59	23.94	0
		1	14	22.71	22.55	22.89	0
		8	0	22.47	22.34	22.69	1
		8	3	22.38	22.29	22.57	1
		8	7	22.44	22.36	22.67	1
		15	0	22.43	22.27	22.56	1
	16QAM	1	0	22.50	22.42	22.73	1
		1	7	22.50	22.35	22.68	1
		1	14	22.39	22.18	22.57	1
		8	0	21.46	21.35	21.66	2
		8	3	21.47	21.29	21.65	2
		8	7	21.46	21.26	21.60	2
		15	0	21.56	21.39	21.77	2
	64QAM	1	0	21.74	21.58	21.84	2
		1	7	21.52	21.34	21.68	2
		1	14	21.61	21.41	21.77	2
		8	0	20.05	19.93	20.20	3
		8	3	19.85	19.64	20.03	3
		8	7	19.73	19.62	19.93	3
		15	0	19.90	19.69	20.08	3



Test Report No.: W7L-P22030026-5RF05

Band/BW	Modulation	RB Size	RB Offset	Low CH 131997	Mid CH 132322	High CH 132647	MPR
				Frequency 1712.5MHz	Frequency 1745MHz	Frequency 1777.5MHz	
66/ 5	QPSK	1	0	23.82	23.65	23.99	0
		1	12	23.77	23.56	23.94	0
		1	24	22.72	22.54	22.93	0
		12	0	22.50	22.34	22.66	1
		12	6	22.38	22.30	22.58	1
		12	13	22.48	22.32	22.68	1
		25	0	22.41	22.30	22.59	1
	16QAM	1	0	22.51	22.38	22.73	1
		1	12	22.47	22.38	22.67	1
		1	24	22.39	22.18	22.56	1
		12	0	21.46	21.33	21.63	2
		12	6	21.44	21.33	21.61	2
		12	13	21.41	21.28	21.63	2
		25	0	21.56	21.40	21.74	2
	64QAM	1	0	21.68	21.55	21.90	2
		1	12	21.49	21.40	21.68	2
		1	24	21.54	21.46	21.77	2
		12	0	20.06	19.90	20.19	3
		12	6	19.79	19.71	20.02	3
		12	13	19.77	19.61	19.90	3
		25	0	19.86	19.75	20.06	3



Test Report No.: W7L-P22030026-5RF05

Band/BW	Modulation	RB Size	RB Offset	Low CH 132022	Mid CH 132322	High CH 132622	MPR
				Frequency 1715MHz	Frequency 1745MHz	Frequency 1775MHz	
66/ 10	QPSK	1	0	23.79	23.68	23.99	0
		1	24	23.77	23.56	23.95	0
		1	49	22.69	22.58	22.89	0
		25	0	22.51	22.33	22.69	1
		25	12	22.44	22.24	22.58	1
		25	25	22.46	22.29	22.67	1
		50	0	22.46	22.30	22.56	1
	16QAM	1	0	22.51	22.35	22.69	1
		1	24	22.52	22.34	22.70	1
		1	49	22.39	22.19	22.53	1
		25	0	21.48	21.31	21.69	2
		25	12	21.48	21.27	21.66	2
		25	25	21.40	21.29	21.60	2
		50	0	21.60	21.39	21.78	2
	64QAM	1	0	21.67	21.56	21.87	2
		1	24	21.54	21.36	21.72	2
		1	49	21.60	21.40	21.74	2
		25	0	20.04	19.87	20.25	3
		25	12	19.86	19.70	19.96	3
		25	25	19.76	19.58	19.92	3
		50	0	19.91	19.71	20.07	3

Band/BW	Modulation	RB Size	RB Offset	Low CH 132072	Mid CH 132322	High CH 132572	MPR
				Frequency 1720MHz	Frequency 1745MHz	Frequency 1770MHz	
66/ 15	QPSK	1	0	23.86	23.68	23.96	0
		1	37	23.75	23.61	23.90	0
		1	74	22.75	22.61	22.90	0
		36	0	22.48	22.34	22.70	1
		36	19	22.45	22.29	22.58	1
		36	39	22.44	22.30	22.67	1
		75	0	22.46	22.28	22.61	1
	16QAM	1	0	22.55	22.42	22.69	1
		1	37	22.51	22.35	22.70	1
		1	74	22.35	22.24	22.55	1
		36	0	21.52	21.31	21.70	2
		36	19	21.42	21.31	21.62	2
		36	39	21.45	21.27	21.63	2
		75	0	21.61	21.42	21.71	2
	64QAM	1	0	21.69	21.57	21.88	2
		1	37	21.55	21.35	21.69	2
		1	74	21.56	21.39	21.77	2
		36	0	20.09	19.93	20.19	3
		36	19	19.80	19.64	19.98	3
		36	39	19.79	19.65	19.94	3
		75	0	19.90	19.69	20.08	3

Band/BW	Modulation	RB Size	RB Offset	Low CH 132072	Mid CH 132322	High CH 132572	MPR
				Frequency 1720MHz	Frequency 1745MHz	Frequency 1770MHz	
66/ 20	QPSK	1	0	23.87	23.72	24.04	0
		1	50	23.79	23.64	23.96	0
		1	99	22.77	22.62	22.94	0
		50	0	22.54	22.39	22.71	1
		50	25	22.46	22.31	22.63	1
		50	50	22.52	22.37	22.69	1
		100	0	22.47	22.32	22.64	1
	16QAM	1	0	22.58	22.43	22.75	1
		1	50	22.55	22.40	22.72	1
		1	99	22.41	22.26	22.58	1
		50	0	21.54	21.39	21.71	2
		50	25	21.50	21.35	21.67	2
		50	50	21.48	21.33	21.65	2
		100	0	21.62	21.47	21.79	2
	64QAM	1	0	21.75	21.60	21.92	2
		1	50	21.57	21.42	21.74	2
		1	99	21.62	21.47	21.79	2
		50	0	20.10	19.95	20.27	3
		50	25	19.87	19.72	20.04	3
		50	50	19.81	19.66	19.98	3
		100	0	19.92	19.77	20.09	3



**BUREAU
VERITAS**

Test Report No.: W7L-P22030026-5RF05

EIRP

WCDMA IV

Channel	Frequency (MHz)	Conducted Power (dBm)	G _T -L _c (dB)	EIRP (dBm)	EIRP (mW)	Limit (W)
1312	1712.4	23.14	0.09	23.23	210.38	1
1413	1732.6	23.13	0.09	23.22	209.89	1
1513	1752.6	23.06	0.09	23.15	206.54	1

LTE BAND 4

CHANNEL BANDWIDTH: 1.4MHz QPSK

Channel	Frequency (MHz)	Conducted Power (dBm)	G _T -L _c (dB)	EIRP (dBm)	EIRP (mW)	Limit (W)
19957	1710.7	23.67	0.09	23.76	237.68	1
20175	1732.5	23.68	0.09	23.77	238.23	1
20393	1754.3	23.75	0.09	23.84	242.1	1

CHANNEL BANDWIDTH: 1.4MHz 16QAM

Channel	Frequency (MHz)	Conducted Power (dBm)	G _T -L _c (dB)	EIRP (dBm)	EIRP (mW)	Limit (W)
19957	1710.7	23.08	0.09	23.17	207.49	1
20175	1732.5	23.03	0.09	23.12	205.12	1
20393	1754.3	23.12	0.09	23.21	209.41	1

CHANNEL BANDWIDTH: 1.4MHz 64QAM

Channel	Frequency (MHz)	Conducted Power (dBm)	G _T -L _c (dB)	EIRP (dBm)	EIRP (mW)	Limit (W)
19957	1710.7	21.79	0.09	21.88	154.17	1
20175	1732.5	21.78	0.09	21.87	153.82	1
20393	1754.3	21.88	0.09	21.97	157.4	1

CHANNEL BANDWIDTH: 3MHz QPSK

Channel	Frequency (MHz)	Conducted Power (dBm)	G _T -L _c (dB)	EIRP (dBm)	EIRP (mW)	Limit (W)
19965	1711.5	23.69	0.09	23.78	238.78	1
20175	1732.5	23.7	0.09	23.79	239.33	1
20385	1753.5	23.73	0.09	23.82	240.99	1

CHANNEL BANDWIDTH: 3MHz 16QAM

Channel	Frequency (MHz)	Conducted Power (dBm)	G _T -L _c (dB)	EIRP (dBm)	EIRP (mW)	Limit (W)
19965	1711.5	23.05	0.09	23.14	206.06	1
20175	1732.5	23.09	0.09	23.18	207.97	1
20385	1753.5	21.61	0.09	21.7	147.91	1

CHANNEL BANDWIDTH: 3MHz 64QAM

Channel	Frequency (MHz)	Conducted Power (dBm)	G _T -L _c (dB)	EIRP (dBm)	EIRP (mW)	Limit (W)
19965	1711.5	21.85	0.09	21.94	156.31	1
20175	1732.5	21.81	0.09	21.9	154.88	1
20385	1753.5	21.83	0.09	21.92	155.6	1

CHANNEL BANDWIDTH: 5MHz QPSK

Channel	Frequency (MHz)	Conducted Power (dBm)	G _T -L _c (dB)	EIRP (dBm)	EIRP (mW)	Limit (W)
19975	1712.5	23.7	0.09	23.79	239.33	1
20175	1732.5	23.65	0.09	23.74	236.59	1
20375	1752.5	23.74	0.09	23.83	241.55	1

CHANNEL BANDWIDTH: 5MHz 16QAM

Channel	Frequency (MHz)	Conducted Power (dBm)	G _T -L _c (dB)	EIRP (dBm)	EIRP (mW)	Limit (W)
19975	1712.5	23.06	0.09	23.15	206.54	1
20175	1732.5	23.05	0.09	23.14	206.06	1
20375	1752.5	23.15	0.09	23.24	210.86	1

CHANNEL BANDWIDTH: 5MHz 64QAM

Channel	Frequency (MHz)	Conducted Power (dBm)	G _T -L _c (dB)	EIRP (dBm)	EIRP (mW)	Limit (W)
19975	1712.5	21.79	0.09	21.88	154.17	1
20175	1732.5	21.78	0.09	21.87	153.82	1
20375	1752.5	21.88	0.09	21.97	157.4	1

CHANNEL BANDWIDTH: 10MHz QPSK

Channel	Frequency (MHz)	Conducted Power (dBm)	G _T -L _c (dB)	EIRP (dBm)	EIRP (mW)	Limit (W)
20000	1715	23.67	0.09	23.76	237.68	1
20175	1732.5	23.68	0.09	23.77	238.23	1
20350	1750	23.74	0.09	23.83	241.55	1

CHANNEL BANDWIDTH: 10MHz 16QAM

Channel	Frequency (MHz)	Conducted Power (dBm)	G _T -L _c (dB)	EIRP (dBm)	EIRP (mW)	Limit (W)
20000	1715	23.06	0.09	23.15	206.54	1
20175	1732.5	23.02	0.09	23.11	204.64	1
20350	1750	23.11	0.09	23.2	208.93	1

CHANNEL BANDWIDTH: 10MHz 64QAM

Channel	Frequency (MHz)	Conducted Power (dBm)	G _T -L _c (dB)	EIRP (dBm)	EIRP (mW)	Limit (W)
20000	1715	21.79	0.09	21.88	154.17	1
20175	1732.5	21.79	0.09	21.88	154.17	1
20350	1750	21.85	0.09	21.94	156.31	1

CHANNEL BANDWIDTH: 15MHz QPSK

Channel	Frequency (MHz)	Conducted Power (dBm)	G _T -L _c (dB)	EIRP (dBm)	EIRP (mW)	Limit (W)
20025	1717.5	23.74	0.09	23.83	241.55	1
20175	1732.5	23.68	0.09	23.77	238.23	1
20325	1747.5	23.71	0.09	23.8	239.88	1

CHANNEL BANDWIDTH: 15MHz 16QAM

Channel	Frequency (MHz)	Conducted Power (dBm)	G _T -L _c (dB)	EIRP (dBm)	EIRP (mW)	Limit (W)
20025	1717.5	23.1	0.09	23.19	208.45	1
20175	1732.5	23.09	0.09	23.18	207.97	1
20325	1747.5	23.11	0.09	23.2	208.93	1

CHANNEL BANDWIDTH: 15MHz 64QAM

Channel	Frequency (MHz)	Conducted Power (dBm)	G _T -L _c (dB)	EIRP (dBm)	EIRP (mW)	Limit (W)
20025	1717.5	21.8	0.09	21.89	154.53	1
20175	1732.5	21.8	0.09	21.89	154.53	1
20325	1747.5	21.86	0.09	21.95	156.68	1

CHANNEL BANDWIDTH: 20MHz QPSK

Channel	Frequency (MHz)	Conducted Power (dBm)	G _T -L _c (dB)	EIRP (dBm)	EIRP (mW)	Limit (W)
20050	1720	23.75	0.09	23.84	242.1	1
20175	1732.5	23.72	0.09	23.81	240.44	1
20300	1745	23.79	0.09	23.88	244.34	1

CHANNEL BANDWIDTH: 20MHz 16QAM

Channel	Frequency (MHz)	Conducted Power (dBm)	G _T -L _c (dB)	EIRP (dBm)	EIRP (mW)	Limit (W)
20050	1720	23.13	0.09	23.22	209.89	1
20175	1732.5	23.1	0.09	23.19	208.45	1
20300	1745	23.17	0.09	23.26	211.84	1

CHANNEL BANDWIDTH: 20MHz 64QAM

Channel	Frequency (MHz)	Conducted Power (dBm)	G _T -L _c (dB)	EIRP (dBm)	EIRP (mW)	Limit (W)
20050	1720	21.86	0.09	21.95	156.68	1
20175	1732.5	21.83	0.09	21.92	155.6	1
20300	1745	21.9	0.09	21.99	158.12	1

LTE BAND 7

CHANNEL BANDWIDTH: 5MHz QPSK

Channel	Frequency (MHz)	Conducted Power (dBm)	G _T -L _c (dB)	EIRP (dBm)	EIRP (mW)	Limit (W)
20775	2502.5	23.66	0.63	24.29	268.53	2
21100	2535.0	23.74	0.63	24.37	273.53	2
21425	2567.5	23.67	0.63	24.3	269.15	2

CHANNEL BANDWIDTH: 5MHz 16QAM

Channel	Frequency (MHz)	Conducted Power (dBm)	G _T -L _c (dB)	EIRP (dBm)	EIRP (mW)	Limit (W)
20775	2502.5	22.41	0.63	23.04	201.37	2
21100	2535.0	22.46	0.63	23.09	203.7	2
21425	2567.5	22.38	0.63	23.01	199.99	2

CHANNEL BANDWIDTH: 5MHz 64QAM

Channel	Frequency (MHz)	Conducted Power (dBm)	G _T -L _c (dB)	EIRP (dBm)	EIRP (mW)	Limit (W)
20775	2502.5	21.85	0.63	22.48	177.01	2
21100	2535	22.03	0.63	22.66	184.5	2
21425	2567.5	21.88	0.63	22.51	178.24	2

CHANNEL BANDWIDTH: 10MHz QPSK

Channel	Frequency (MHz)	Conducted Power (dBm)	G _T -L _c (dB)	EIRP (dBm)	EIRP (mW)	Limit (W)
20800	2505.0	23.63	0.63	24.26	266.69	2
21100	2535.0	23.78	0.63	24.41	276.06	2
21400	2565.0	23.63	0.63	24.26	266.69	2

CHANNEL BANDWIDTH: 10MHz 16QAM

Channel	Frequency (MHz)	Conducted Power (dBm)	G _T -L _c (dB)	EIRP (dBm)	EIRP (mW)	Limit (W)
20800	2505.0	22.41	0.63	23.04	201.37	2
21100	2535.0	22.47	0.63	23.1	204.17	2
21400	2565.0	22.35	0.63	22.98	198.61	2

CHANNEL BANDWIDTH: 10MHz 64QAM

Channel	Frequency (MHz)	Conducted Power (dBm)	G _T -L _c (dB)	EIRP (dBm)	EIRP (mW)	Limit (W)
20800	2505	21.91	0.63	22.54	179.47	2
21100	2535	21.97	0.63	22.6	181.97	2
21400	2565	21.85	0.63	22.48	177.01	2

CHANNEL BANDWIDTH: 15MHz QPSK

Channel	Frequency (MHz)	Conducted Power (dBm)	G _T -L _c (dB)	EIRP (dBm)	EIRP (mW)	Limit (W)
20825	2507.5	23.69	0.63	24.32	270.4	2
21100	2535.0	23.81	0.63	24.44	277.97	2
21375	2562.5	23.64	0.63	24.27	267.3	2

CHANNEL BANDWIDTH: 15MHz 16QAM

Channel	Frequency (MHz)	Conducted Power (dBm)	G _T -L _c (dB)	EIRP (dBm)	EIRP (mW)	Limit (W)
20825	2507.5	22.37	0.63	23	199.53	2
21100	2535.0	22.52	0.63	23.15	206.54	2
21375	2562.5	22.37	0.63	23	199.53	2

CHANNEL BANDWIDTH: 15MHz 64QAM

Channel	Frequency (MHz)	Conducted Power (dBm)	G _T -L _c (dB)	EIRP (dBm)	EIRP (mW)	Limit (W)
20825	2507.5	21.87	0.63	22.5	177.83	2
21100	2535	21.96	0.63	22.59	181.55	2
21375	2562.5	21.88	0.63	22.51	178.24	2



**BUREAU
VERITAS**

Test Report No.: W7L-P22030026-5RF05

CHANNEL BANDWIDTH: 20MHz QPSK

Channel	Frequency (MHz)	Conducted Power (dBm)	G _T -L _c (dB)	EIRP (dBm)	EIRP (mW)	Limit (W)
20850	2510.0	23.71	0.63	24.34	271.64	2
21100	2535.0	23.82	0.63	24.45	278.61	2
21350	2560.0	23.68	0.63	24.31	269.77	2

CHANNEL BANDWIDTH: 20MHz 16QAM

Channel	Frequency (MHz)	Conducted Power (dBm)	G _T -L _c (dB)	EIRP (dBm)	EIRP (mW)	Limit (W)
20850	2510.0	22.43	0.63	23.06	202.3	2
21100	2535.0	22.54	0.63	23.17	207.49	2
21350	2560.0	22.4	0.63	23.03	200.91	2

CHANNEL BANDWIDTH: 20MHz 64QAM

Channel	Frequency (MHz)	Conducted Power (dBm)	G _T -L _c (dB)	EIRP (dBm)	EIRP (mW)	Limit (W)
20850	2510	21.93	0.63	22.56	180.3	2
21100	2535	22.04	0.63	22.67	184.93	2
21350	2560	21.9	0.63	22.53	179.06	2



BUREAU
VERITAS

Test Report No.: W7L-P22030026-5RF05

LTE BAND 12

CHANNEL BANDWIDTH: 1.4MHz QPSK

Channel	Frequency (MHz)	Conducted Power (dBm)	G _T -L _c (dB)	ERP (dBm)	ERP (mW)	Limit (W)
23017	699.7	23.46	-2.31	19	79.43	3
23095	707.5	23.49	-2.31	19.03	79.98	3
23173	715.3	23.46	-2.31	19	79.43	3

CHANNEL BANDWIDTH: 1.4MHz 16QAM

Channel	Frequency (MHz)	Conducted Power (dBm)	G _T -L _c (dB)	ERP (dBm)	ERP (mW)	Limit (W)
23017	699.7	22.71	-2.31	18.25	66.83	3
23095	707.5	22.77	-2.31	18.31	67.76	3
23173	715.3	22.74	-2.31	18.28	67.3	3

CHANNEL BANDWIDTH: 1.4MHz 64QAM

Channel	Frequency (MHz)	Conducted Power (dBm)	G _T -L _c (dB)	ERP (dBm)	ERP (mW)	Limit (W)
23017	699.7	21.47	-2.31	17.01	50.23	3
23095	707.5	21.47	-2.31	17.01	50.23	3
23173	715.3	21.5	-2.31	17.04	50.58	3

CHANNEL BANDWIDTH: 3MHz QPSK

Channel	Frequency (MHz)	Conducted Power (dBm)	G _T -L _c (dB)	ERP (dBm)	ERP (mW)	Limit (W)
23025	700.5	23.42	-2.31	18.96	78.7	3
23095	707.5	23.51	-2.31	19.05	80.35	3
23165	714.5	23.46	-2.31	19	79.43	3

CHANNEL BANDWIDTH: 3MHz 16QAM

Channel	Frequency (MHz)	Conducted Power (dBm)	G _T -L _c (dB)	ERP (dBm)	ERP (mW)	Limit (W)
23025	700.5	22.68	-2.31	18.22	66.37	3
23095	707.5	22.74	-2.31	18.28	67.3	3
23165	714.5	22.72	-2.31	18.26	66.99	3

CHANNEL BANDWIDTH: 3MHz 64QAM

Channel	Frequency (MHz)	Conducted Power (dBm)	G _T -L _c (dB)	ERP (dBm)	ERP (mW)	Limit (W)
23025	700.5	21.48	-2.31	17.02	50.35	3
23095	707.5	21.49	-2.31	17.03	50.47	3
23165	714.5	21.5	-2.31	17.04	50.58	3

CHANNEL BANDWIDTH: 5MHz QPSK

Channel	Frequency (MHz)	Conducted Power (dBm)	G _T -L _c (dB)	ERP (dBm)	ERP (mW)	Limit (W)
23035	701.5	23.43	-2.31	18.97	78.89	3
23095	707.5	23.46	-2.31	19	79.43	3
23155	713.5	23.5	-2.31	19.04	80.17	3

CHANNEL BANDWIDTH: 5MHz 16QAM

Channel	Frequency (MHz)	Conducted Power (dBm)	G _T -L _c (dB)	ERP (dBm)	ERP (mW)	Limit (W)
23035	701.5	22.65	-2.31	18.19	65.92	3
23095	707.5	22.77	-2.31	18.31	67.76	3
23155	713.5	22.71	-2.31	18.25	66.83	3

CHANNEL BANDWIDTH: 5MHz 64QAM

Channel	Frequency (MHz)	Conducted Power (dBm)	G _T -L _c (dB)	ERP (dBm)	ERP (mW)	Limit (W)
23035	701.5	21.41	-2.31	16.95	49.55	3
23095	707.5	21.54	-2.31	17.08	51.05	3
23155	713.5	21.5	-2.31	17.04	50.58	3



**BUREAU
VERITAS**

Test Report No.: W7L-P22030026-5RF05

CHANNEL BANDWIDTH: 10MHz QPSK

Channel	Frequency (MHz)	Conducted Power (dBm)	G _T -L _c (dB)	ERP (dBm)	ERP (mW)	Limit (W)
23060	704	23.48	-2.31	19.02	79.8	3
23095	707.5	23.54	-2.31	19.08	80.91	3
23130	711	23.51	-2.31	19.05	80.35	3

CHANNEL BANDWIDTH: 10MHz 16QAM

Channel	Frequency (MHz)	Conducted Power (dBm)	G _T -L _c (dB)	ERP (dBm)	ERP (mW)	Limit (W)
23060	704	22.73	-2.31	18.27	67.14	3
23095	707.5	22.79	-2.31	18.33	68.08	3
23130	711	22.76	-2.31	18.3	67.61	3

CHANNEL BANDWIDTH: 10MHz 64QAM

Channel	Frequency (MHz)	Conducted Power (dBm)	G _T -L _c (dB)	ERP (dBm)	ERP (mW)	Limit (W)
23060	704	21.49	-2.31	17.03	50.47	3
23095	707.5	21.55	-2.31	17.09	51.17	3
23130	711	21.52	-2.31	17.06	50.82	3

REMARKS: ERP Output Power (dBm) = ERP (dBm) -2.15(dB).



**BUREAU
VERITAS**

Test Report No.: W7L-P22030026-5RF05

LTE BAND 13

CHANNEL BANDWIDTH: 5MHz QPSK

Channel	Frequency (MHz)	Conducted Power (dBm)	G _T -L _c (dB)	ERP (dBm)	ERP (mW)	Limit (W)
23205	779.5	22.44	-3.07	17.22	52.72	3
23230	782	22.42	-3.07	17.2	52.48	3
23255	784.5	22.44	-3.07	17.22	52.72	3

CHANNEL BANDWIDTH: 5MHz 16QAM

Channel	Frequency (MHz)	Conducted Power (dBm)	G _T -L _c (dB)	ERP (dBm)	ERP (mW)	Limit (W)
23205	779.5	21.56	-3.07	16.34	43.05	3
23230	782	21.5	-3.07	16.28	42.46	3
23255	784.5	21.56	-3.07	16.34	43.05	3

CHANNEL BANDWIDTH: 5MHz 64QAM

Channel	Frequency (MHz)	Conducted Power (dBm)	G _T -L _c (dB)	ERP (dBm)	ERP (mW)	Limit (W)
23205	779.5	20.68	-3.07	15.46	35.16	3
23230	782	20.75	-3.07	15.53	35.73	3
23255	784.5	20.74	-3.07	15.52	35.65	3



Test Report No.: W7L-P22030026-5RF05

CHANNEL BANDWIDTH: 10MHz QPSK

Channel	Frequency (MHz)	Conducted Power (dBm)	G _T -L _c (dB)	ERP (dBm)	ERP (mW)	Limit (W)
-	-	-	-	-	-	-
23230	782	22.49	-3.07	17.27	53.33	3
-	-	-	-	-	-	-

CHANNEL BANDWIDTH: 10MHz 16QAM

Channel	Frequency (MHz)	Conducted Power (dBm)	G _T -L _c (dB)	ERP (dBm)	ERP (mW)	Limit (W)
-	-	-	-	-	-	-
23230	782	21.58	-3.07	16.36	43.25	3
-	-	-	-	-	-	-

CHANNEL BANDWIDTH: 10MHz 64QAM

Channel	Frequency (MHz)	Conducted Power (dBm)	G _T -L _c (dB)	ERP (dBm)	ERP (mW)	Limit (W)
-	-	-	-	-	-	-
23230	782	20.76	-3.07	15.54	35.81	3
-	-	-	-	-	-	-

REMARKS: ERP Output Power (dBm) = ERP (dBm) -2.15(dB).

LTE BAND 17

CHANNEL BANDWIDTH: 5MHz QPSK

Channel	Frequency (MHz)	Conducted Power (dBm)	G _T -L _c (dB)	ERP (dBm)	ERP (mW)	Limit (W)
23755	706.5	23.58	-2.31	19.12	81.66	3
23790	710	23.42	-2.31	18.96	78.7	3
23825	713.5	23.46	-2.31	19	79.43	3

CHANNEL BANDWIDTH: 5MHz 16QAM

Channel	Frequency (MHz)	Conducted Power (dBm)	G _T -L _c (dB)	ERP (dBm)	ERP (mW)	Limit (W)
23755	706.5	22.76	-2.31	18.3	67.61	3
23790	710	22.65	-2.31	18.19	65.92	3
23825	713.5	22.65	-2.31	18.19	65.92	3

CHANNEL BANDWIDTH: 5MHz 64QAM

Channel	Frequency (MHz)	Conducted Power (dBm)	G _T -L _c (dB)	ERP (dBm)	ERP (mW)	Limit (W)
23755	706.5	21.68	-2.31	17.22	52.72	3
23790	710	21.57	-2.31	17.11	51.4	3
23825	713.5	21.57	-2.31	17.11	51.4	3

CHANNEL BANDWIDTH: 10MHz QPSK

Channel	Frequency (MHz)	Conducted Power (dBm)	G _T -L _c (dB)	ERP (dBm)	ERP (mW)	Limit (W)
23780	709	23.63	-2.31	19.17	82.6	3
23790	710	23.5	-2.31	19.04	80.17	3
23800	711	23.47	-2.31	19.01	79.62	3

CHANNEL BANDWIDTH: 10MHz 16QAM

Channel	Frequency (MHz)	Conducted Power (dBm)	G _T -L _c (dB)	ERP (dBm)	ERP (mW)	Limit (W)
23780	709	22.83	-2.31	18.37	68.71	3
23790	710	22.7	-2.31	18.24	66.68	3
23800	711	22.67	-2.31	18.21	66.22	3



Test Report No.: W7L-P22030026-5RF05

CHANNEL BANDWIDTH: 10MHz 64QAM

Channel	Frequency (MHz)	Conducted Power (dBm)	G _T -L _c (dB)	ERP (dBm)	ERP (mW)	Limit (W)
23780	709	21.75	-2.31	17.29	53.58	3
23790	710	21.62	-2.31	17.16	52	3
23800	711	21.59	-2.31	17.13	51.64	3

REMARKS: ERP Output Power (dBm) = ERP (dBm) -2.15(dB).



BUREAU
VERITAS

Test Report No.: W7L-P22030026-5RF05

LTE BAND 66

CHANNEL BANDWIDTH: 1.4MHz QPSK

Channel	Frequency (MHz)	Conducted Power (dBm)	G _T -L _c (dB)	EIRP (dBm)	EIRP (mW)	Limit (W)
131979	1710.7	23.79	0.05	23.84	242.10	1
132322	1745	23.68	0.05	23.73	236.05	1
132665	1779.3	23.99	0.05	24.04	253.51	1

CHANNEL BANDWIDTH: 1.4MHz 16QAM

Channel	Frequency (MHz)	Conducted Power (dBm)	G _T -L _c (dB)	EIRP (dBm)	EIRP (mW)	Limit (W)
131979	1710.7	22.53	0.05	22.58	181.13	1
132322	1745	22.36	0.05	22.41	174.18	1
132665	1779.3	22.7	0.05	22.75	188.36	1

CHANNEL BANDWIDTH: 1.4MHz 64QAM

Channel	Frequency (MHz)	Conducted Power (dBm)	G _T -L _c (dB)	EIRP (dBm)	EIRP (mW)	Limit (W)
131979	1710.7	21.68	0.05	21.73	148.94	1
132322	1745	21.55	0.05	21.6	144.54	1
132665	1779.3	21.9	0.05	21.95	156.68	1

CHANNEL BANDWIDTH: 3MHz QPSK

Channel	Frequency (MHz)	Conducted Power (dBm)	G _T -L _c (dB)	EIRP (dBm)	EIRP (mW)	Limit (W)
131987	1711.5	23.81	0.05	23.86	243.22	1
132322	1745	23.7	0.05	23.75	237.14	1
132657	1778.5	23.98	0.05	24.03	252.93	1

CHANNEL BANDWIDTH: 3MHz 16QAM

Channel	Frequency (MHz)	Conducted Power (dBm)	G _T -L _c (dB)	EIRP (dBm)	EIRP (mW)	Limit (W)
131987	1711.5	22.5	0.05	22.55	179.89	1
132322	1745	22.42	0.05	22.47	176.6	1
132657	1778.5	22.73	0.05	22.78	189.67	1

CHANNEL BANDWIDTH: 3MHz 64QAM

Channel	Frequency (MHz)	Conducted Power (dBm)	G _T -L _c (dB)	EIRP (dBm)	EIRP (mW)	Limit (W)
131987	1711.5	21.74	0.05	21.79	151.01	1
132322	1745	21.58	0.05	21.63	145.55	1
132657	1778.5	21.84	0.05	21.89	154.53	1

CHANNEL BANDWIDTH: 5MHz QPSK

Channel	Frequency (MHz)	Conducted Power (dBm)	G _T -L _c (dB)	EIRP (dBm)	EIRP (mW)	Limit (W)
131997	1712.5	23.82	0.05	23.87	243.78	1
132322	1745	23.65	0.05	23.7	234.42	1
132647	1777.5	23.99	0.05	24.04	253.51	1

CHANNEL BANDWIDTH: 5MHz 16QAM

Channel	Frequency (MHz)	Conducted Power (dBm)	G _T -L _c (dB)	EIRP (dBm)	EIRP (mW)	Limit (W)
131997	1712.5	22.51	0.05	22.56	180.3	1
132322	1745	22.38	0.05	22.43	174.98	1
132647	1777.5	22.73	0.05	22.78	189.67	1

CHANNEL BANDWIDTH: 5MHz 64QAM

Channel	Frequency (MHz)	Conducted Power (dBm)	G _T -L _c (dB)	EIRP (dBm)	EIRP (mW)	Limit (W)
131997	1712.5	21.68	0.05	21.73	148.94	1
132322	1745	21.55	0.05	21.6	144.54	1
132647	1777.5	21.9	0.05	21.95	156.68	1

CHANNEL BANDWIDTH: 10MHz QPSK

Channel	Frequency (MHz)	Conducted Power (dBm)	G _T -L _c (dB)	EIRP (dBm)	EIRP (mW)	Limit (W)
132022	1715	23.79	0.05	23.84	242.10	1
132322	1745	23.68	0.05	23.73	236.05	1
132622	1775	23.99	0.05	24.04	253.51	1

CHANNEL BANDWIDTH: 10MHz 16QAM

Channel	Frequency (MHz)	Conducted Power (dBm)	G _T -L _c (dB)	EIRP (dBm)	EIRP (mW)	Limit (W)
132022	1715	22.52	0.05	22.57	180.72	1
132322	1745	22.35	0.05	22.4	173.78	1
132622	1775	22.7	0.05	22.75	188.36	1

CHANNEL BANDWIDTH: 10MHz 64QAM

Channel	Frequency (MHz)	Conducted Power (dBm)	G _T -L _c (dB)	EIRP (dBm)	EIRP (mW)	Limit (W)
132022	1715	21.67	0.05	21.72	148.59	1
132322	1745	21.56	0.05	21.61	144.88	1
132622	1775	21.87	0.05	21.92	155.6	1

CHANNEL BANDWIDTH: 15MHz QPSK

Channel	Frequency (MHz)	Conducted Power (dBm)	G _T -L _c (dB)	EIRP (dBm)	EIRP (mW)	Limit (W)
132047	1717.5	23.86	0.05	23.91	246.04	1
132322	1745	23.68	0.05	23.73	236.05	1
132597	1772.5	23.96	0.05	24.01	251.77	1

CHANNEL BANDWIDTH: 15MHz 16QAM

Channel	Frequency (MHz)	Conducted Power (dBm)	G _T -L _c (dB)	EIRP (dBm)	EIRP (mW)	Limit (W)
132047	1715	22.55	0.05	22.6	181.97	1
132322	1745	22.42	0.05	22.47	176.6	1
132622	1775	22.7	0.05	22.75	188.36	1

CHANNEL BANDWIDTH: 15MHz 64QAM

Channel	Frequency (MHz)	Conducted Power (dBm)	G _T -L _c (dB)	EIRP (dBm)	EIRP (mW)	Limit (W)
132047	1715	21.69	0.05	21.74	149.28	1
132322	1745	21.57	0.05	21.62	145.21	1
132622	1775	21.88	0.05	21.93	155.96	1

CHANNEL BANDWIDTH: 20MHz QPSK

Channel	Frequency (MHz)	Conducted Power (dBm)	G _T -L _c (dB)	EIRP (dBm)	EIRP (mW)	Limit (W)
132072	1720	23.87	0.05	23.92	246.6	1
132322	1745	23.72	0.05	23.77	238.23	1
132572	1770	24.04	0.05	24.09	256.45	1

CHANNEL BANDWIDTH: 20MHz 16QAM

Channel	Frequency (MHz)	Conducted Power (dBm)	G _T -L _c (dB)	EIRP (dBm)	EIRP (mW)	Limit (W)
132072	1720	22.58	0.05	22.63	183.23	1
132322	1745	22.43	0.05	22.48	177.01	1
132572	1770	22.75	0.05	22.8	190.55	1

CHANNEL BANDWIDTH: 20MHz 64QAM

Channel	Frequency (MHz)	Conducted Power (dBm)	G _T -L _c (dB)	EIRP (dBm)	EIRP (mW)	Limit (W)
132072	1720	21.75	0.05	21.8	151.36	1
132322	1745	21.6	0.05	21.65	146.22	1
132572	1770	21.92	0.05	21.97	157.4	1

3.2 FREQUENCY STABILITY MEASUREMENT

3.2.1 LIMITS OF FREQUENCY STABILITY MEASUREMENT

The frequency stability shall be sufficient to ensure that the fundamental emissions stay within the authorized bands of operation.

3.2.2 TEST PROCEDURE

- Device is placed at the oven room. The oven room could control the temperatures and humidity. Power warm up is at least 15 min and power applied should perform before recording frequency error.
- EUT is connected the external power supply to control the DC input power. The test voltage range is from minimum to maximum working voltage. Each step shall be record the frequency error rate.
- The temperature range step is 10 degrees in this test items. All temperature levels shall be hold the $\pm 0.5^{\circ}\text{C}$ during the measurement testing. The each temperature step shall be at least 0.5 hours, consider the EUT could be test under the stability condition.

NOTE: The frequency error was recorded frequency error from the communication simulator.

3.2.3 TEST SETUP

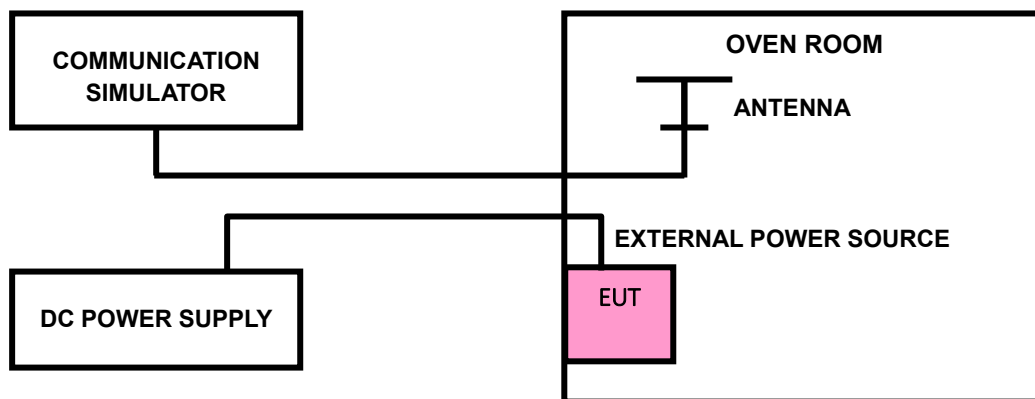



Test Report No.: W7L-P22030026-5RF05

3.2.4 TEST RESULTS

Please Refer to Appendix Of this test report.

3.3 OCCUPIED BANDWIDTH MEASUREMENT

3.3.1 LIMITS OF OCCUPIED BANDWIDTH MEASUREMENT

The width of a frequency band such that, below the lower and above the upper frequency limits, the mean powers emitted are each equal to a specified percentage 0.5 % of the total mean power of a given emission.

3.3.2 TEST SETUP

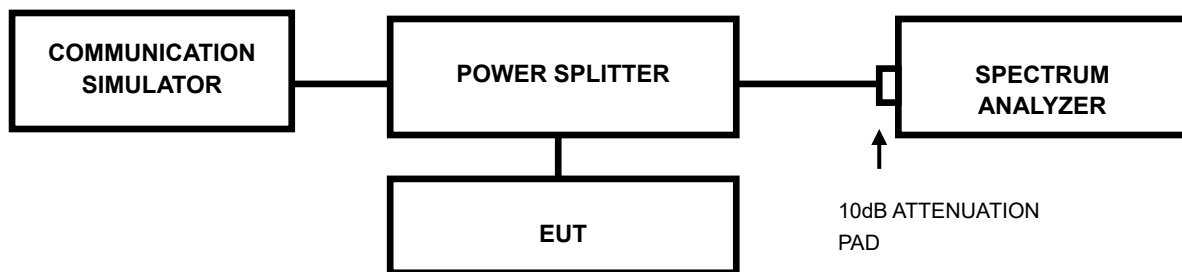

3.3.3 TEST PROCEDURES

- The conducted occupied bandwidth used the power splitter via EUT RF power connector between simulation base station and spectrum analyzer.
- Use OBW measurement function of Spectrum analyzer to measure 99 % occupied bandwidth.



Test Report No.: W7L-P22030026-5RF05

3.3.4 TEST RESULTS

Please Refer to Appendix Of this test report.

3.4 BAND EDGE MEASUREMENT

3.4.1 LIMITS OF BAND EDGE MEASUREMENT

According to FCC 27.53(c) specified that For operations in the 746-758 MHz band and the 776-788 MHz band , the power of any emission shall be attenuated outside the band below the transmitter power (P) by at least $43 + 10 \log (P)$ dB. However, in the 100 kilohertz bands immediately outside and adjacent to a licensee's frequency block, a resolution bandwidth of at least 30 kHz may be employed. In addition, the power of any unwanted emission in a 6.25kHz bandwidth for all frequencies between 763-775 MHz and 793-806 MHz shall be attenuated below the transmitter power, $P(\text{dBW})$, by at least $65 + 10 \log 10p(P)$, dB, for mobile and portable equipment.

According to FCC 27.53(g) specified that For operations in the 600 MHz band and the 698-746 MHz band, the power of any emission outside a licensee's frequency band(s) of operation shall be attenuated below the transmitter power (P) within the licensed band(s) of operation, measured in watts, by at least $43 + 10 \log (P)$ dB. However, in the 100 kilohertz bands immediately outside and adjacent to a licensee's frequency block, a resolution bandwidth of at least 30 kHz may be employed.

According to FCC 27.53(h) specified that For operations in the 1710-1755 MHz band, the power of any emission outside a licensee's frequency band(s) of operation shall be attenuated below the transmitter power (P) within the licensed band(s) of operation, measured in watts, by at least $43 + 10 \log (P)$ dB. However, in the 1 megahertz bands immediately outside and adjacent to the licensee's frequency block, a resolution bandwidth of at least one percent of the emission bandwidth of the fundamental emission of the transmitter may be employed.

According to FCC 27.53(m)(4) specified that For mobile digital stations, the attenuation factor shall be not less than $40 + 10 \log (P)$ dB on all frequencies between the channel edge and 5 megahertz from the channel edge, $43 + 10 \log (P)$ dB on all frequencies between 5 megahertz and X megahertz from the channel edge, and $55 + 10 \log (P)$ dB on all frequencies more than X megahertz from the channel edge, where X is the greater of 6 megahertz or the actual emission bandwidth as defined in paragraph (m)(6) of this section. In addition, the attenuation factor shall not be less that $43 + 10 \log (P)$ dB on all frequencies between 2490.5 MHz and 2496 MHz and $55 + 10 \log (P)$ dB at or below 2490.5 MHz. Mobile Satellite Service licensees operating on frequencies below 2495 MHz may also submit a documented interference complaint against BRS licensees operating on channel BRS Channel 1 on the same terms and conditions as adjacent channel BRS or EBS licensees. For mobile digital stations, in the 1 megahertz bands immediately outside and adjacent to the frequency block a resolution bandwidth of at least two percent may be employed.

3.4.2 TEST SETUP

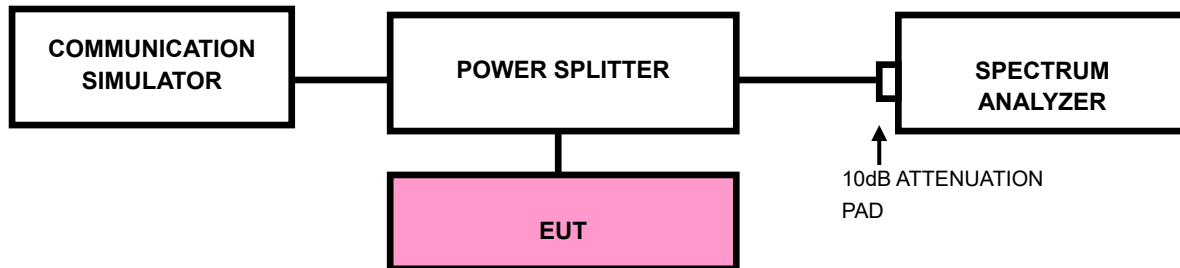

3.4.3 TEST PROCEDURES

- a. All measurements were done at low and high operational frequency range.
- b. The center frequency of spectrum is the band edge frequency and span is 1~5 MHz.
RBW of the spectrum is 10kHz and VBW of the spectrum is 30kHz (LTE bandwidth for (1.4M/3M/5M/10M/15M/20M)1RB/0RB&1RB/MAXRB).
- c. The center frequency of spectrum is the band edge frequency and span is 10MHz.
RBW of the spectrum is 100kHz and VBW of the spectrum is 300kHz (WCDMA).
- d. The center frequency of spectrum is the band edge frequency and span is 1~5 MHz.
RBW of the spectrum is $\geq 1\% \cdot \text{EBW}$ kHz and VBW of the spectrum is $3 \cdot \text{RBW}$ kHz.
(LTE bandwidth 1.4M/3M/5M/10M/15M/20MHz).
- e. Record the max trace plot into the test report.



Test Report No.: W7L-P22030026-5RF05

3.4.4 TEST RESULTS

Please Refer to Appendix Of this test report.

3.5 CONDUCTED SPURIOUS EMISSIONS

3.5.1 LIMITS OF CONDUCTED SPURIOUS EMISSIONS MEASUREMENT

The power of any emission outside of the authorized operating frequency ranges must be attenuated below the transmitting power (P) by a factor of at least $43 + 10 \log(P)$ dB. The emission limit equal to -13dBm .

For: LTE Band7

The power of any emission outside a licensee's frequency block shall be attenuated below the transmitter power (P) by at least $55 + 10 \log_{10}(P)$ dB. The limit of emission is equal to -25dBm .

3.5.2 TEST PROCEDURE

- a. The EUT makes a phone call to the communication simulator. All measurements were done at low, middle and high operational frequency range.
- b. Measuring frequency range is from 9kHz up to a frequency including its 10th harmonic. 10dB attenuation pad is connected with spectrum. RBW=1MHz and VBW=3MHz is used for conducted emission measurement.

3.5.3 TEST SETUP

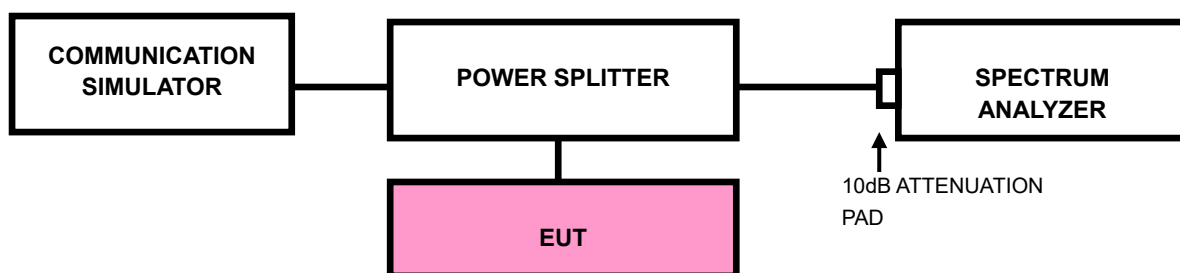



**BUREAU
VERITAS**

Test Report No.: W7L-P22030026-5RF05

3.5.4 TEST RESULTS

NOTE : The 9K~30MHz amplitude of spurious emissions attenuated more than 20 dB below the permissible value is not required in the report.

Please Refer to Appendix Of this test report.



3.6 RADIATED EMISSION MEASUREMENT

3.6.1 LIMITS OF RADIATED EMISSION MEASUREMENT

The power of any emission outside of the authorized operating frequency ranges must be attenuated below the transmitting power (P) by a factor of at least $43 + 10 \log(P)$ dB. The emission limit equal to -13dBm .

For: LTE Band7

The power of any emission outside a licensee's frequency block shall be attenuated below the transmitter power (P) by at least $55 + 10 \log_{10}(P)$ dB. The limit of emission is equal to -25dBm .

3.6.2 TEST PROCEDURES

- a. Substitution method is used for E.I.R.P measurement. In the semi-anechoic chamber, EUT placed on the 0.8m height of Turn Table, rotated the table around 360 degrees to search the maximum radiation power and receiver antenna shall be rotated vertical and horizontal polarization and moved height from 1m to 4m to find the maximum polar radiated power. The "Read Value" is the spectrum reading the maximum power value.
- b. The substitution horn antenna is substituted for EUT at the same position and signals generator export the CW signal to the substitution antenna via a TX cable. Rotated the Turn Table and moved receiving antenna to find the maximum radiation power. Adjust output power level of S.G to get a Value of spectrum reading equal to "Read Value " of step a. Record the power level of S.G.
- c. $\text{EIRP} = \text{Output power level of S.G} - \text{TX cable loss} + \text{Antenna gain of substitution horn}$.
- d. E.R.P power can be calculated form E.I.R.P power by subtracting the gain of dipole, $\text{E.R.P power} = \text{E.I.P.R power} - 2.15\text{dBi}$.

NOTE: The resolution bandwidth of spectrum analyzer is 1 MHz and the video bandwidth is 3 MHz.

3.6.3 DEVIATION FROM TEST STANDARD

No deviation