

VARIANT FCC TEST REPORT (PART 24)



Applicant:	HMD Global Oy
Address:	Bertel Jungin aukio 9, 02600 Espoo, Finland

Manufacturer or Supplier:	HMD Global Oy
Address:	Bertel Jungin aukio 9, 02600 Espoo, Finland
Product:	Multi-band GSM/WCDMA/LTE phone with Bluetooth&WLAN
Brand Name:	Nokia
Model Name:	TA-1425
FCC ID:	2AJOTTA-1425
Date of tests:	Jan. 02, 2022 ~ Apr. 19, 2022

The tests have been carried out according to the requirements of the following standard:

- FCC PART 24, Subpart E** **FCC PART 2**
 ANSI/TIA/EIA-603-D **ANSI/TIA/EIA-603-E** **ANSI C63.26-2015**

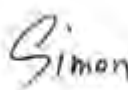
CONCLUSION: The submitted sample was found to COMPLY with the test requirement

Prepared by Simon Wang Engineer / Mobile Department	Approved by Luke Lu Manager / Mobile Department
	
Date: Apr. 19, 2022	Date: Apr. 19, 2022

This report is governed by, and incorporates by reference, CPS Conditions of Service as posted at the date of issuance of this report at <http://www.bureauveritas.com/home/about-us/our-business/cps/about-us/terms-conditions> and is intended for your exclusive use. Any copying or replication of this report to or for any other person or entity, or use of our name or trademark, is permitted only with our prior written permission. This report sets forth our findings solely with respect to the test samples identified herein. The results set forth in this report are not indicative or representative of the quality or characteristics of the lot from which a test sample was taken or any similar or identical product unless specifically and expressly noted. Our report includes all of the tests requested by you and the results thereof based upon the information that you provided to us. Measurement uncertainty is only provided upon request for accredited tests. You have 60 days from date of issuance of this report to notify us of any material error or omission caused by our negligence or if you require measurement uncertainty; provided, however, that such notice shall be in writing and shall specifically address the issue you wish to raise. A failure to raise such issue within the prescribed time shall constitute your unqualified acceptance of the completeness of this report, the tests conducted and the correctness of the report contents.



TABLE OF CONTENTS

RELEASE CONTROL RECORD	4
1 SUMMARY OF TEST RESULTS	5
1.1 MEASUREMENT UNCERTAINTY	5
1.2 TEST SITE AND INSTRUMENTS	6
2 GENERAL INFORMATION	7
2.1 GENERAL DESCRIPTION OF EUT	7
2.2 CONFIGURATION OF SYSTEM UNDER TEST	10
2.3 DESCRIPTION OF SUPPORT UNITS	11
2.4 TEST ITEM AND TEST CONFIGURATION.....	11
2.5 EUT OPERATING CONDITIONS	14
2.6 GENERAL DESCRIPTION OF APPLIED STANDARDS	14
3 TEST TYPES AND RESULTS	15
3.1 OUTPUT POWER MEASUREMENT	15
3.1.1 LIMITS OF OUTPUT POWER MEASUREMENT	15
3.1.2 TEST PROCEDURES	15
3.1.3 TEST SETUP	16
3.1.4 TEST RESULTS	16
3.2 FREQUENCY STABILITY MEASUREMENT	30
3.2.1 LIMITS OF FREQUENCY STABILITY MEASUREMENT	30
3.2.2 TEST PROCEDURE	30
3.2.3 TEST SETUP	30
3.2.4 TEST RESULTS	31
3.3 OCCUPIED BANDWIDTH MEASUREMENT	32
3.3.1 TEST PROCEDURES	32
3.3.2 TEST SETUP	32
3.3.3 TEST RESULTS	33
3.4 BAND EDGE MEASUREMENTC	34
3.4.1 LIMITS OF BAND EDGE MEASUREMENT	34
3.4.2 TEST SETUP	34
3.4.3 TEST PROCEDURES	35
3.4.4. TEST RESULTS	36
3.5 CONDUCTED SPURIOUS EMISSIONS.....	37
3.5.1 LIMITS OF CONDUCTED SPURIOUS EMISSIONS MEASUREMENT	37
3.5.2 TEST PROCEDURE	37
3.5.3 TEST SETUP	37
3.5.4 TEST RESULTS	38
3.6 RADIATED EMISSION MEASUREMENT	39
3.6.1 LIMITS OF RADIATED EMISSION MEASUREMENT	39
3.6.2 TEST PROCEDURES.....	39
3.6.3 DEVIATION FROM TEST STANDARD.....	39



BUREAU
VERITAS

Test Report No.: W7L-P22030026-2RF04

3.6.4 TEST SETUP	40
3.6.5 TEST RESULTS	42
3.7 PEAK TO AVERAGE RATIO	78
3.7.1 LIMITS OF PEAK TO AVERAGE RATIO MEASUREMENT	78
3.7.2 TEST SETUP	78
3.7.3 TEST PROCEDURES	78
3.7.4 TEST RESULTS	79
4 INFORMATION ON THE TESTING LABORATORIES	80
5 MODIFICATIONS RECORDERS FOR ENGINEERING CHANGES TO THE EUT BY THE LAB.....	81
6 APPENDIX	82



Test Report No.: W7L-P22030026-2RF04

RELEASE CONTROL RECORD

ISSUE NO.	REASON FOR CHANGE	DATE ISSUED
W7L-P21120037RF04	Original release	Jan. 24, 2022
W7L-P22030026-2RF04	Based on the original report W7L-P21120037RF04 change the chip, add to 2 nd battery, Verify the RSE worst case.	Apr. 19, 2022

1 SUMMARY OF TEST RESULTS

The EUT has been tested according to the following specifications:

APPLIED STANDARD: FCC Part 24 & Part 2		
STANDARD SECTION	TEST TYPE	RESULT
§2.1046	Coducted Output Power	Compliance
§24.232(c)	Equivalent Isotropic Radiated Power	Compliance
§2.1055 §24.235	Frequency Stability	Compliance
§2.1049	Occupied Bandwidth	Compliance
§24.232(d)	Peak to average ratio	Compliance
§24.238(a)(b)	Band Edge Measurements	Compliance
§2.1051 §24.238(a)(b)	Conducted Spurious Emissions	Compliance
§2.1053 §24.238(a)(b)	Radiated Spurious Emissions	Compliance

1.1 MEASUREMENT UNCERTAINTY

Where relevant, the following measurement uncertainty levels have been estimated for tests performed on the EUT as specified in CISPR 16-4-2:

MEASUREMENT	UNCERTAINTY
Frequency Stability	$\pm 76.97\text{Hz}$
Radiated emissions & Radiated Power (30MHz~1GMHz)	$\pm 4.98\text{dB}$
Radiated emissions & Radiated Power (1GMHz ~6GMHz)	$\pm 4.70\text{dB}$
Radiated emissions (6GMHz ~18GMHz)	$\pm 4.60\text{dB}$
Radiated emissions (18GMHz ~40GMHz)	$\pm 4.12\text{dB}$
Conducted emissions	$\pm 4.01\text{dB}$
Occupied Channel Bandwidth	$\pm 43.58\text{KHz}$
Conducted Output power	$\pm 2.06\text{dB}$
Band Edge Measurements	$\pm 4.70\text{dB}$
Peak to average ratio	$\pm 0.76\text{dB}$

This uncertainty represents an expanded uncertainty expressed at approximately the 95% confidence level using a coverage factor of $k=2$.



1.2 TEST SITE AND INSTRUMENTS

Equipment	Manufacturer	Model No.	Serial No.	Last Cal.	Next Cal.
MXE EMI Receiver	KEYSIGHT	N9038A-544	MY54450026	Apr. 22,21	Apr. 21,22
EXA Signal Analyzer	KEYSIGHT	N9010A-544	MY54510355	Jun. 03,21	Jun. 02,22
Bilog Antenna 2	ETS-LINDGREN	3143B	00161965	Mar. 05,21	Mar. 04,22
Bilog Antenna 2	ETS-LINDGREN	3143B	00161965	Mar. 04,22	Mar. 03,23
Loop Antenna	Schwarzbeck	FMZB 1519B	1519B-051	Feb. 14,20	Feb. 13,23
Horn Antenna 1	ETS-LINDGREN	3117	00168728	Aug. 19,21	Aug. 18,22
Horn Antenna (18GHz-40GHz)	N/A	QWH-SL-18-40-K-SG/QMS-00361	15433	Aug. 25, 21	Aug. 24, 22
Radio Communication Analyzer	ANRITSU	MT8820C	6201465426	Feb. 25,21	Feb. 24,22
Radio Communication Analyzer	ANRITSU	MT8820C	6201465426	Feb. 24,22	Feb. 23,23
Signal Pre-Amplifier	EMSI	EMC 9135	980249	Jun. 02,21	Jun. 01,22
Signal Pre-Amplifier	EMSI	EMC 012645B	980257	Jun. 03,21	Jun. 02,22
Signal Pre-Amplifier	EMSI	EMC 184045B	980259	Apr. 22,21	Apr. 21,22
3m Semi-anechoic Chamber	ETS-LINDGREN	9m*6m*6m	Euroshieldpn-CT0001143-1216	May. 19,20	May. 18,23
Test Software	E3	V 9.160323	N/A	N/A	N/A
Test Software	ADT	ADT_Radiated_V 7.6.15.9.2	N/A	N/A	N/A
10dB Attenuator	JFW/USA	50HF-010-SMA	1505	Jun. 03,21	Jun. 02,22
Power Meter	Anritsu	ML2495A	1506002	Apr. 07,21	Apr. 06,22
Power Meter	Anritsu	ML2495A	1506002	Apr. 06,22	Apr. 05,23
Power Sensor	Anritsu	MA2411B	1339352	May. 07,21	May. 06,22
Temperature Chamber	ESPEC	SH-242	93000855	Jun. 02,21	Jun. 01,22
MXG Analog Microwave Signal Generator	KEYSIGHT	N5183A	MY50143024	Mar. 05,21	Mar. 04,22
MXG Analog Microwave Signal Generator	KEYSIGHT	N5183A	MY50143024	Mar. 04,22	Mar. 03,23

- NOTE:**
1. The calibration interval of the above test instruments is 12 months or 36 months and the calibrations are traceable to CEPREI/CHINA, GRGT/CHINA and NIM/CHINA.
 2. The test was performed in 3m Semi-anechoic Chamber and RF Oven Room.
 3. The horn antenna is used only for the measurement of emission frequency above 1GHz if tested.
 4. The FCC Site Registration No. is 525120; The Designation No. is CN1171.



2 GENERAL INFORMATION

2.1 GENERAL DESCRIPTION OF EUT

PRODUCT	Multi-band GSM/WCDMA/LTE phone with Bluetooth&WLAN	
BRAND NAME	Nokia	
MODEL NAME	TA-1425	
NOMINAL VOLTAGE	5.0Vdc(adapter or host equipment) 3.85Vdc (Li-ion, battery)	
MODULATION TYPE	GSM/GPRS: GMSK EDGE: 8PSK WCDMA: BPSK, QPSK LTE Band 2: QPSK, 16QAM, 64QAM	
FREQUENCY RANGE	GSM/GPRS, EDGE	1850.2MHz ~ 1909.8MHz
	WCDMA	1852.4MHz ~ 1907.6MHz
	LTE Band 2 Channel Bandwidth: 1.4MHz	1850.7MHz ~ 1909.3MHz
	LTE Band 2 Channel Bandwidth: 3MHz	1851.5MHz ~ 1908.5MHz
	LTE Band 2 Channel Bandwidth: 5MHz	1852.5MHz ~ 1907.5MHz
	LTE Band 2 Channel Bandwidth: 10MHz	1855.0MHz ~ 1905.0MHz
	LTE Band 2 Channel Bandwidth: 15MHz	1857.5MHz ~ 1902.5MHz
	LTE Band 2 Channel Bandwidth: 20MHz	1860.0MHz ~ 1900.0MHz
	MAX. EIRP POWER	GSM/GPRS
EDGE		413.05mW
WCDMA		234.42mW
LTE Band 2 Channel Bandwidth: 1.4MHz		298.54mW
LTE Band 2 Channel Bandwidth: 3MHz		299.92mW
LTE Band 2 Channel Bandwidth: 5MHz		300.61mW
LTE Band 2 Channel Bandwidth: 10MHz		298.54mW
LTE Band 2 Channel Bandwidth: 15MHz		303.39mW



	LTE Band 2 Channel Bandwidth: 20MHz	304.09mW	
EMISSION DESIGNATOR	GSM/GPRS	245KGXW	
	EDGE	246KG7W	
	WCDMA	4M17F9W	
	LTE Band 2 Channel Bandwidth: 1.4MHz	QPSK: 1M09G7D	
		16QAM: 1M09W7D	
		64QAM: 1M09W7D	
	LTE Band 2 Channel Bandwidth: 3MHz	QPSK: 2M70G7D	
		16QAM: 2M70W7D	
		64QAM: 2M70W7D	
	LTE Band 2 Channel Bandwidth: 5MHz	QPSK: 4M50G7D	
		16QAM: 4M50W7D	
		64QAM: 4M50W7D	
	LTE Band 2 Channel Bandwidth: 10MHz	QPSK: 9M10G7D	
16QAM: 9M10W7D			
64QAM: 9M10W7D			
LTE Band 2 Channel Bandwidth: 15MHz	QPSK: 13M5G7D		
	16QAM: 13M5W7D		
	64QAM: 13M5W7D		
LTE Band 2 Channel Bandwidth: 20MHz	QPSK: 18M1G7D		
	16QAM: 18M1W7D		
	64QAM: 18M0W7D		
ANTENNA TYPE	Fixed Internal Antenna with 0.54dBi gain for GSM1900/ WCDMA II/LTE B2		
HW VERSION	19661_1_12		
SW VERSION	000T_0_050		
I/O PORTS	Refer to user's manual		
CABLE SUPPLIED	USB cable: unshielded without ferrite, 1.0meter Earphone1: non-shielded cable, with w/o ferrite core, 1.2 meter Earphone2: non-shielded cable, with w/o ferrite core, 1.2 meter		
EXTREME TEMPERATURE	0-40 °C		
EXTREME VOLTAGE	3.5V - 4.4V		

NOTE:

1. For a more detailed features description, please refer to the manufacturer's specifications or the user's manual.



- 2. The EUT incorporates a SISO function. Physically, the EUT provides one completed transmitter and one receiver.

MODULATION MODE	TX FUNCTION
GSM/GPRS/EDGE	1TX/1RX
WCDMA	1TX/1RX
LTE	1TX/1RX

- 3. For the test results, the EUT had been tested with all conditions. But only the worst case was shown in test report.

List of Accessory:

ACCESSORIES	BRAND	MANUFACTURER	MODEL	SPECIFICATION
Battery 1	Nokia	GUANGDONG FENGHUA NEW ENERGY CO.,LTD.	WT410	Capacity : 3.85 Vdc, 3920mAh
Battery 2	Nokia	HuNan ADF Alternative Energy Technology Co.,Ltd	WT410	Capacity : 3.85 Vdc, 3920mAh
AC Adapter	Nokia	ShenZhenBaiJunDa Electronic CO., LTD.	AD-010U	I/P: 100-240Vac, 0.35A, O/P: 5.0Vdc, 2.0A
Earphone 1	Nokia	NEW LEADER INDUSTRY CO.,LTD	HS-34	Signal Line, 1.2meter
Earphone 2	Nokia	Guangdong Wivtak Technology Co., Ltd.	HS-34	Signal Line, 1.2meter
USB Cable	Nokia	Saibao(Jiangxi) Communication Industrial Co.,Ltd	CB-12A	Signal Line, 1.0meter



2.2 CONFIGURATION OF SYSTEM UNDER TEST

FOR RADIATION EMISSION TEST

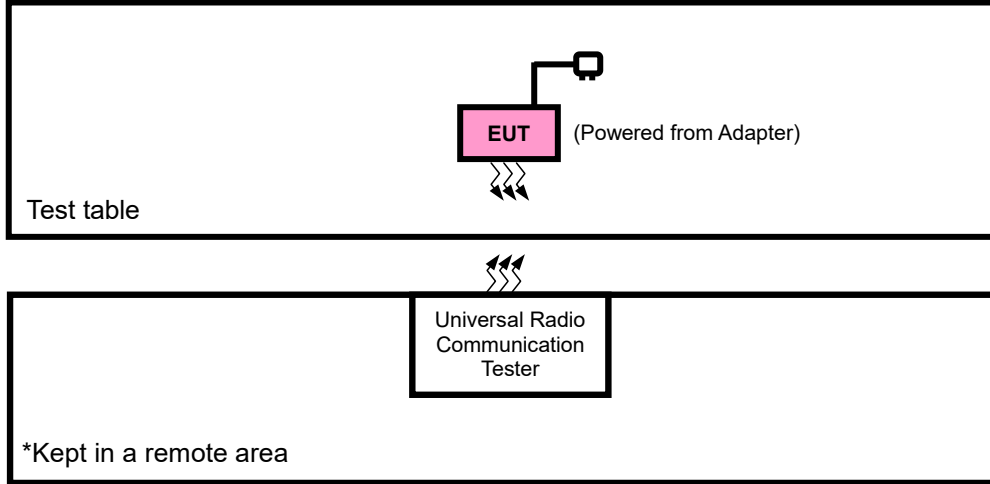



2.3 DESCRIPTION OF SUPPORT UNITS

The EUT has been tested as an independent unit together with other necessary accessories or support units. The following support units or accessories were used to form a representative test configuration during the tests.

NO.	PRODUCT	BRAND	MODEL NO.	SERIAL NO.	FCC ID
1	DC source	Kikusui/JP	PMX18-5A	0000001	N/A

NO.	SIGNAL CABLE DESCRIPTION OF THE ABOVE SUPPORT UNITS
1	DC Line: Unshielded, Detachable 1.0m

2.4 TEST ITEM AND TEST CONFIGURATION

Pre-Scan has been conducted to determine the worst-case mode from all possible combinations between available modulations, data rates, XYZ axis and antenna ports. The worst case in EIRP and radiated emission was found when positioned on X-plane for GSM/EDGE/ LTE. Following channel(s) was (were) selected for the final test as listed below:

EUT CONFIGURE MODE	1.1.1.1.1 DESCRIPTION
A	EUT + Adapter with GSM or WCDMA or LTE link
B	EUT + Battery with GSM or WCDMA or LTE link

GSM MODE

EUT CONFIGURE MODE	TEST ITEM	AVAILABLE CHANNEL	TESTED CHANNEL	MODE
A	EIRP	512 to 810	512, 661, 810	GSM, EDGE
B	FREQUENCY STABILITY	512 to 810	512, 661, 810	GSM, EDGE
A	OCCUPIED BANDWIDTH	512 to 810	512, 661, 810	GSM, EDGE
A	PEAK TO AVERAGE RATIO	512 to 810	512, 661, 810	GSM, EDGE
A	BAND EDGE	512 to 810	512, 810	GSM, EDGE
A	CONDUCTED EMISSION	512 to 810	512, 661, 810	GSM, EDGE
A	RADIATED EMISSION	512 to 810	512, 661, 810	GSM, EDGE



**BUREAU
VERITAS**

Test Report No.: W7L-P22030026-2RF04

WCDMA

EUT CONFIGURE MODE	TEST ITEM	AVAILABLE CHANNEL	TESTED CHANNEL	MODE
A	EIRP	9262 to 9538	9262, 9400, 9538	WCDMA
B	FREQUENCY STABILITY	9262 to 9538	9262, 9400, 9538	WCDMA
A	OCCUPIED BANDWIDTH	9262 to 9538	9262, 9400, 9538	WCDMA
A	PEAK TO AVERAGE RATIO	9262 to 9538	9262, 9400, 9538	WCDMA
A	BAND EDGE	9262 to 9538	9262, 9538	WCDMA
A	CONDCUDED EMISSION	9262 to 9538	9262, 9400, 9538	WCDMA
A	RADIATED EMISSION	9262 to 9538	9262, 9400, 9538	WCDMA

LTE BAND 2 MODE

EUT CONFIGURE MODE	TEST ITEM	AVAILABLE CHANNEL	TESTED CHANNEL	CHANNEL BANDWIDTH	MODULATION	MODE
A	EIRP	18607 to 19193	18607, 18900, 19193	1.4MHz	QPSK,16QAM, 64QAM	1 RB / 0 RB Offset
		18615 to 19185	18615, 18900, 19185	3MHz	QPSK,16QAM, 64QAM	1 RB / 0 RB Offset
		18625 to 19175	18625, 18900, 19175	5MHz	QPSK,16QAM, 64QAM	1 RB / 0 RB Offset
		18650 to 19150	18650, 18900, 19150	10MHz	QPSK,16QAM, 64QAM	1 RB / 0 RB Offset
		18675 to 19125	18675, 18900, 19125	15MHz	QPSK,16QAM, 64QAM	1 RB / 0 RB Offset
		18700 to 19100	18700, 18900, 19100	20MHz	QPSK,16QAM, 64QAM	1 RB / 0 RB Offset
B	FREQUENCY STABILITY	18607 to 19193	18607, 18900, 19193	1.4MHz	QPSK,16QAM, 64QAM	6 RB / 0 RB Offset
		18615 to 19185	18615, 18900, 19185	3MHz	QPSK,16QAM, 64QAM	15 RB / 0 RB Offset
		18625 to 19175	18625, 18900, 19175	5MHz	QPSK,16QAM, 64QAM	25 RB / 0 RB Offset
		18650 to 19150	18650, 18900, 19150	10MHz	QPSK,16QAM, 64QAM	50 RB / 0 RB Offset
		18675 to 19125	18675, 18900, 19125	15MHz	QPSK,16QAM, 64QAM	75 RB / 0 RB Offset
		18700 to 19100	18700, 18900, 19100	20MHz	QPSK,16QAM, 64QAM	100 RB / 0 RB Offset
A	OCCUPIED BANDWIDTH	18607 to 19193	18607, 18900, 19193	1.4MHz	QPSK,16QAM, 64QAM	6 RB / 0 RB Offset
		18615 to 19185	18615, 18900, 19185	3MHz	QPSK,16QAM, 64QAM	15 RB / 0 RB Offset
		18625 to 19175	18625, 18900, 19175	5MHz	QPSK,16QAM, 64QAM	25 RB / 0 RB Offset
		18650 to 19150	18650, 18900, 19150	10MHz	QPSK,16QAM, 64QAM	50 RB / 0 RB Offset
		18675 to 19125	18675, 18900, 19125	15MHz	QPSK,16QAM, 64QAM	75 RB / 0 RB Offset
		18700 to 19100	18700, 18900, 19100	20MHz	QPSK,16QAM, 64QAM	100 RB / 0 RB Offset
A	PEAK TO AVERAGE RATIO	18607 to 19193	18607, 18900, 19193	1.4MHz	QPSK,16QAM, 64QAM	1 RB / 0 RB Offset 6 RB / 0 RB Offset
		18615 to 19185	18615, 18900, 19185	3MHz	QPSK,16QAM, 64QAM	1 RB / 0 RB Offset 15 RB / 0 RB Offset
		18625 to 19175	18625, 18900, 19175	5MHz	QPSK,16QAM, 64QAM	1 RB / 0 RB Offset 25 RB / 0 RB Offset
		18650 to 19150	18650, 18900, 19150	10MHz	QPSK,16QAM, 64QAM	1 RB / 0 RB Offset 50 RB / 0 RB Offset



		18675 to 19125	18675, 18900, 19125	15MHz	QPSK,16QAM, 64QAM	1 RB / 0 RB Offset 75 RB / 0 RB Offset		
		18700 to 19100	18700, 18900, 19100	20MHz	QPSK,16QAM, 64QAM	1 RB / 0 RB Offset 100 RB / 0 RB Offset		
A	BAND EDGE	18607 to 19193	18607	1.4MHz	QPSK,16QAM, 64QAM	1 RB / 0 RB Offset 6 RB / 0 RB Offset		
			19193	1.4MHz	QPSK,16QAM, 64QAM	1 RB / 5 RB Offset 6 RB / 0 RB Offset		
		18615 to 19185	18615	3MHz	QPSK,16QAM, 64QAM	1 RB / 0 RB Offset 15 RB / 0 RB Offset		
			19185	3MHz	QPSK,16QAM, 64QAM	1 RB / 14 RB Offset 15 RB / 0 RB Offset		
		18625 to 19175	18625	5MHz	QPSK,16QAM, 64QAM	1 RB / 0 RB Offset 25 RB / 0 RB Offset		
			19175	5MHz	QPSK,16QAM, 64QAM	1 RB / 24 RB Offset 25 RB / 0 RB Offset		
		18650 to 19150	18650	10MHz	QPSK,16QAM, 64QAM	1 RB / 0 RB Offset 50 RB / 0 RB Offset		
			19150	10MHz	QPSK,16QAM, 64QAM	1 RB / 49 RB Offset 50 RB / 0 RB Offset		
		18675 to 19125	18675	15MHz	QPSK,16QAM, 64QAM	1 RB / 0 RB Offset 75 RB / 0 RB Offset		
			19125	15MHz	QPSK,16QAM, 64QAM	1 RB / 74 RB Offset 75 RB / 0 RB Offset		
		18700 to 19100	18700	20MHz	QPSK,16QAM, 64QAM	1 RB / 0 RB Offset 100 RB / 0 RB Offset		
			19100	20MHz	QPSK,16QAM, 64QAM	1 RB / 99 RB Offset 100 RB / 0 RB Offset		
		A	CONDCUDET ED EMISSION	18607 to 19193	18607, 18900, 19193	1.4MHz	QPSK,16QAM, 64QAM	1 RB / 0 RB Offset
				18615 to 19185	18615, 18900, 19185	3MHz	QPSK,16QAM, 64QAM	1 RB / 0 RB Offset
				18625 to 19175	18625, 18900, 19175	5MHz	QPSK,16QAM, 64QAM	1 RB / 0 RB Offset
				18650 to 19150	18650, 18900, 19150	10MHz	QPSK,16QAM, 64QAM	1 RB / 0 RB Offset
18675 to 19125	18675, 18900, 19125			15MHz	QPSK,16QAM, 64QAM	1 RB / 0 RB Offset		
18700 to 19100	18700, 18900, 19100			20MHz	QPSK,16QAM, 64QAM	1 RB / 0 RB Offset		
A	RADIATED EMISSION	18607 to 19193	18900	1.4MHz	QPSK	1 RB / 0 RB Offset		
		18615 to 19185	18900	3MHz	QPSK	1 RB / 0 RB Offset		
		18625 to 19175	18900	5MHz	QPSK	1 RB / 0 RB Offset		
		18650 to 19150	18607, 18900, 19193	10MHz	QPSK	1 RB / 0 RB Offset		
		18675 to 19125	18900	15MHz	QPSK	1 RB / 0 RB Offset		
		18700 to 19100	18900	20MHz	QPSK	1 RB / 0 RB Offset		



TEST CONDITION:

TEST ITEM	ENVIRONMENTAL CONDITIONS	INPUT POWER	TESTED BY
EIRP	25deg. C, 57%RH	DC 5V By Adapter	Jace Hu
FREQUENCY STABILITY	23deg. C, 61%RH	DC 3.85V/3.5V/4.4V By Battery	James Fu
OCCUPIED BANDWIDTH	23deg. C, 61%RH	DC5V By Adapter	James Fu
PEAK TO AVERAGE RATIO	23deg. C, 61%RH	DC 5V By Adapter	James Fu
BAND EDGE	23deg. C, 61%RH	DC5V By Adapter	James Fu
CONDCUDED EMISSION	23deg. C, 61%RH	DC5V By Adapter	James Fu
RADIATED EMISSION	23deg. C, 70%RH	DC5V By Adapter	Jace Hu

2.5 EUT OPERATING CONDITIONS

The EUT makes a call to the communication simulator. The communication simulator station system controlled a EUT to export maximum output power under transmission mode and specific channel frequency

2.6 GENERAL DESCRIPTION OF APPLIED STANDARDS

The EUT is a RF product. According to the specifications of the manufacturer, it must comply with the requirements of the following standards:

FCC 47 CFR Part 2

FCC 47 CFR Part 24

KDB 971168 D01 Power Meas License Digital Systems v03r01

ANSI/TIA/EIA-603-D

ANSI/TIA/EIA-603-E

ANSI C63.26-2015

NOTE: All test items have been performed and recorded as per the above standards.



3 TEST TYPES AND RESULTS

3.1 OUTPUT POWER MEASUREMENT

3.1.1 LIMITS OF OUTPUT POWER MEASUREMENT

Mobile and portable stations are limited to 2 watts EIRP.

3.1.2 TEST PROCEDURES

EIRP MEASUREMENT:

Per KDB 971168 D01 Power Meas License Digital Systems v03r01 or subclause 5.2.5.5 of ANSI C63.26-2015, the relevant equation for determining the ERP or EIRP from the conducted RF output power measured using the guidance provided above is:

$$\text{ERP or EIRP} = P_{\text{Meas}} + G_{\text{T}} - L_{\text{C}}$$

Where:

ERP or EIRP = effective radiated power or equivalent isotropically radiated power, respectively

(expressed in the same units as P_{Meas} , typically dBW or dBm);

P_{Meas} = measured transmitter output power or PSD, in dBm or dBW;

G_{T} = gain of the transmitting antenna, in dBd (ERP) or dBi (EIRP);

L_{C} = signal attenuation in the connecting cable between the transmitter and antenna, in dB.

CONDUCTED POWER MEASUREMENT:

The EUT was set up for the maximum power with WCDMA link data modulation and link up with simulator. Set the EUT to transmit under low, middle and high channel and record the power level shown on simulator.



3.1.3 TEST SETUP

EIRP / ERP Measurement:

CONDUCTED POWER MEASUREMENT:

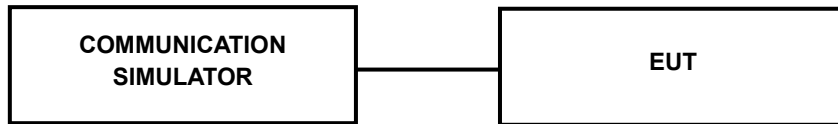

3.1.4 TEST RESULTS

CONDUCTED OUTPUT POWER (dBm)

Ant0:

Band	GSM1900			Max. Tune-up Power
	512	661	810	
Channel	512	661	810	
Frequency	1850.2	1880	1909.8	
GSM (GMSK, 1Tx-slot)	29.17	29.28	29.04	31.0
GPRS (GMSK, 1Tx-slot)	29.15	29.26	29.02	31.0
GPRS (GMSK, 2Tx-slot)	27.19	27.11	27.08	29.0
GPRS (GMSK, 3Tx-slot)	25.62	25.50	25.19	27.0
GPRS (GMSK, 4Tx-slot)	23.62	23.51	23.25	25.0
EDGE (8PSK, 1Tx-slot)	25.52	25.62	25.57	27.5
EDGE (8PSK, 2Tx-slot)	24.59	24.93	24.54	26.5
EDGE (8PSK, 3Tx-slot)	22.00	23.12	21.82	23.5
EDGE (8PSK, 4Tx-slot)	19.53	20.44	19.64	21.5

Band	WCDMA II			Max. Tune-up Power
	9262	9400	9538	
Channel	9262	9400	9538	
Frequency	1852.4	1880	1907.6	
RMC 12.2K	23.05	23.09	23.16	25.0
HSDPA Subtest-1	22.21	22.12	22.23	24.0
HSDPA Subtest-2	22.19	22.08	22.21	24.0
HSDPA Subtest-3	21.57	21.63	21.67	23.5
HSDPA Subtest-4	21.53	21.63	21.65	23.5
DC-HSDPA Subtest-1	22.16	22.09	22.24	24.0
DC-HSDPA Subtest-2	22.12	22.11	22.16	24.0
DC-HSDPA Subtest-3	21.59	21.61	21.70	23.5
DC-HSDPA Subtest-4	21.62	21.65	21.62	23.5
HSUPA Subtest-1	22.05	22.06	22.11	24.0
HSUPA Subtest-2	20.14	20.11	20.24	22.0
HSUPA Subtest-3	21.08	21.16	21.16	23.0
HSUPA Subtest-4	20.09	20.15	20.21	22.0
HSUPA Subtest-5	22.07	22.12	22.19	24.0
HSPA+ Subtest-1	20.03	20.09	20.12	24.0



**BUREAU
VERITAS**

Test Report No.: W7L-P22030026-2RF04

LTE BAND 2

Band/BW	Modulation	RB Size	RB Offset	Low CH 18607	Mid CH 18900	High CH 19193	MPR
				Frequency 1850.7 MHz	Frequency 1880 MHz	Frequency 1909.3 MHz	
2/ 1.4	QPSK	1	0	24.21	24.16	23.80	0
		1	2	24.03	23.91	23.60	0
		1	5	23.96	23.82	23.49	0
		3	0	24.17	24.06	23.77	0
		3	1	24.16	24.06	23.65	0
		3	3	24.07	23.95	23.62	0
		6	0	23.09	22.95	22.64	1
	16QAM	1	0	23.21	23.10	22.77	1
		1	2	23.11	22.96	22.67	1
		1	5	23.04	22.92	22.64	1
		3	0	23.20	23.10	22.75	1
		3	1	23.14	23.12	22.73	1
		3	3	23.04	22.94	22.63	1
		6	0	22.19	22.14	21.76	2
	64QAM	1	0	22.39	22.32	22.00	2
		1	2	22.33	22.30	21.92	2
		1	5	22.41	22.26	21.97	2
		3	0	21.69	21.62	21.25	2
		3	1	21.43	21.38	20.99	2
		3	3	21.29	21.17	20.89	2
		6	0	20.52	20.42	20.07	3



**BUREAU
VERITAS**

Test Report No.: W7L-P22030026-2RF04

Band/BW	Modulation	RB Size	RB Offset	Low CH 18615	Mid CH 18900	High CH 19185	MPR
				Frequency 1851.5 MHz	Frequency 1880 MHz	Frequency 1908.5 MHz	
2/3	QPSK	1	0	24.23	24.18	23.79	0
		1	7	23.99	23.92	23.60	0
		1	14	23.92	23.82	23.49	0
		8	0	23.16	23.09	22.77	1
		8	3	23.09	23.06	22.67	1
		8	7	23.04	23.02	22.66	1
		15	0	23.06	22.96	22.58	1
	16QAM	1	0	23.18	23.16	22.80	1
		1	7	23.08	22.99	22.65	1
		1	14	23.07	22.92	22.64	1
		8	0	22.16	22.11	21.75	2
		8	3	22.19	22.07	21.76	2
		8	7	22.06	21.92	21.59	2
		15	0	22.19	22.08	21.79	2
	64QAM	1	0	22.45	22.35	21.94	2
		1	7	22.36	22.24	21.91	2
		1	14	22.42	22.28	21.97	2
		8	0	20.72	20.66	20.26	3
		8	3	20.47	20.32	20.04	3
		8	7	20.26	20.21	19.85	3
		15	0	20.54	20.39	20.11	3



**BUREAU
VERITAS**

Test Report No.: W7L-P22030026-2RF04

Band/BW	Modulation	RB Size	RB Offset	Low CH 18625	Mid CH 18900	High CH 19175	MPR
				Frequency 1852.5 MHz	Frequency 1880 MHz	Frequency 1907.5 MHz	
2 / 5	QPSK	1	0	24.24	24.13	23.80	0
		1	12	24.04	23.89	23.60	0
		1	24	23.93	23.81	23.53	0
		12	0	23.19	23.09	22.74	1
		12	6	23.09	23.07	22.68	1
		12	13	23.08	22.98	22.67	1
		25	0	23.04	22.99	22.61	1
	16QAM	1	0	23.19	23.12	22.80	1
		1	12	23.05	23.02	22.64	1
		1	24	23.07	22.92	22.63	1
		12	0	22.16	22.09	21.72	2
		12	6	22.16	22.11	21.72	2
		12	13	22.01	21.94	21.62	2
		25	0	22.19	22.09	21.76	2
	64QAM	1	0	22.39	22.32	22.00	2
		1	12	22.33	22.30	21.91	2
		1	24	22.35	22.33	21.97	2
		12	0	20.73	20.63	20.25	3
		12	6	20.41	20.39	20.03	3
		12	13	20.30	20.20	19.82	3
		25	0	20.50	20.45	20.09	3



**BUREAU
VERITAS**

Test Report No.: W7L-P22030026-2RF04

Band/BW	Modulation	RB Size	RB Offset	Low CH 18650	Mid CH 18900	High CH 19150	MPR
				Frequency 1855 MHz	Frequency 1880 MHz	Frequency 1905 MHz	
2/ 10	QPSK	1	0	24.21	24.16	23.80	0
		1	24	24.04	23.89	23.61	0
		1	49	23.90	23.85	23.49	0
		25	0	23.20	23.08	22.77	1
		25	12	23.15	23.01	22.68	1
		25	25	23.06	22.95	22.66	1
		50	0	23.09	22.99	22.58	1
	16QAM	1	0	23.19	23.09	22.76	1
		1	24	23.10	22.98	22.67	1
		1	49	23.07	22.93	22.60	1
		25	0	22.18	22.07	21.78	2
		25	12	22.20	22.05	21.77	2
		25	25	22.00	21.95	21.59	2
		50	0	22.23	22.08	21.80	2
	64QAM	1	0	22.38	22.33	21.97	2
		1	24	22.38	22.26	21.95	2
		1	49	22.41	22.27	21.94	2
		25	0	20.71	20.60	20.31	3
		25	12	20.48	20.38	19.97	3
		25	25	20.29	20.17	19.84	3
		50	0	20.55	20.41	20.10	3



**BUREAU
VERITAS**

Test Report No.: W7L-P22030026-2RF04

Band/BW	Modulation	RB Size	RB Offset	Low CH 18675	Mid CH 18900	High CH 19125	MPR
				Frequency 1857.5 MHz	Frequency 1880 MHz	Frequency 1902.5 MHz	
2/ 15	QPSK	1	0	24.28	24.16	23.77	0
		1	37	24.02	23.94	23.56	0
		1	74	23.96	23.88	23.50	0
		36	0	23.17	23.09	22.78	1
		36	19	23.16	23.06	22.68	1
		36	39	23.04	22.96	22.66	1
		75	0	23.09	22.97	22.63	1
	16QAM	1	0	23.23	23.16	22.76	1
		1	37	23.09	22.99	22.67	1
		1	74	23.03	22.98	22.62	1
		36	0	22.22	22.07	21.79	2
		36	19	22.14	22.09	21.73	2
		36	39	22.05	21.93	21.62	2
		75	0	22.24	22.11	21.73	2
	64QAM	1	0	22.40	22.34	21.98	2
		1	37	22.39	22.25	21.92	2
		1	74	22.37	22.26	21.97	2
		36	0	20.76	20.66	20.25	3
		36	19	20.42	20.32	19.99	3
		36	39	20.32	20.24	19.86	3
		75	0	20.54	20.39	20.11	3



**BUREAU
VERITAS**

Test Report No.: W7L-P22030026-2RF04

Band/BW	Modulation	RB Size	RB Offset	Low CH 18700	Mid CH 18900	High CH 19100	MPR
				Frequency 1860 MHz	Frequency 1880 MHz	Frequency 1900 MHz	
2/ 20	QPSK	1	0	24.29	24.20	23.85	0
		1	50	24.06	23.97	23.62	0
		1	99	23.98	23.89	23.54	0
		50	0	23.23	23.14	22.79	1
		50	25	23.17	23.08	22.73	1
		50	50	23.12	23.03	22.68	1
		100	0	23.10	23.01	22.66	1
	16QAM	1	0	23.26	23.17	22.82	1
		1	50	23.13	23.04	22.69	1
		1	99	23.09	23.00	22.65	1
		50	0	22.24	22.15	21.80	2
		50	25	22.22	22.13	21.78	2
		50	50	22.08	21.99	21.64	2
		100	0	22.25	22.16	21.81	2
	64QAM	1	0	22.46	22.37	22.02	2
		1	50	22.41	22.32	21.97	2
		1	99	22.43	22.34	21.99	2
		50	0	20.77	20.68	20.33	3
		50	25	20.49	20.40	20.05	3
		50	50	20.34	20.25	19.90	3
		100	0	20.56	20.47	20.12	3



EIRP POWER (dBm)

GSM

Channel	Frequency (MHz)	Conducted Power (dBm)	G _{T-Lc} (dB)	EIRP (dBm)	EIRP (mW)	Limit (W)
512	1850.2	29.17	0.54	29.71	935.41	2
661	1880.0	29.28	0.54	29.82	959.40	2
810	1909.8	29.04	0.54	29.58	907.82	2

EDGE

Channel	Frequency (MHz)	Conducted Power (dBm)	G _{T-Lc} (dB)	EIRP (dBm)	EIRP (mW)	Limit (W)
512	1850.2	25.52	0.54	26.06	403.65	2
661	1880.0	25.62	0.54	26.16	413.05	2
810	1909.8	25.57	0.54	26.11	408.32	2

WCDMA

Channel	Frequency (MHz)	Conducted Power (dBm)	G _{T-Lc} (dB)	EIRP (dBm)	EIRP (mW)	Limit (W)
9262	1852.4	23.05	0.54	23.59	228.56	2
9400	1880	23.09	0.54	23.63	230.67	2
9538	1907.6	23.16	0.54	23.7	234.42	2



LTE BAND 2

CHANNEL BANDWIDTH: 1.4MHz QPSK

Channel	Frequency (MHz)	Conducted Power (dBm)	G _{T-Lc} (dB)	EIRP (dBm)	EIRP (mW)	Limit (W)
18607	1850.7	24.21	0.54	24.75	298.54	2
18900	1880.0	24.16	0.54	24.7	295.12	2
19193	1909.3	23.8	0.54	24.34	271.64	2

CHANNEL BANDWIDTH: 1.4MHz 16QAM

Channel	Frequency (MHz)	Conducted Power (dBm)	G _{T-Lc} (dB)	EIRP (dBm)	EIRP (mW)	Limit (W)
18607	1850.7	23.21	0.54	23.75	237.14	2
18900	1880.0	23.12	0.54	23.66	232.27	2
19193	1909.3	22.77	0.54	23.31	214.29	2

CHANNEL BANDWIDTH: 1.4MHz 64QAM

Channel	Frequency (MHz)	Conducted Power (dBm)	G _{T-Lc} (dB)	EIRP (dBm)	EIRP (mW)	Limit (W)
18607	1850.7	22.41	0.54	22.95	197.24	2
18900	1880.0	22.32	0.54	22.86	193.2	2
19193	1909.3	22	0.54	22.54	179.47	2



CHANNEL BANDWIDTH: 3MHz QPSK

Channel	Frequency (MHz)	Conducted Power (dBm)	G _{T-Lc} (dB)	EIRP (dBm)	EIRP (mW)	Limit (W)
18615	1851.5	24.23	0.54	24.77	299.92	2
18900	1880.0	24.18	0.54	24.72	296.48	2
19185	1908.5	23.79	0.54	24.33	271.02	2

CHANNEL BANDWIDTH: 3MHz 16QAM

Channel	Frequency (MHz)	Conducted Power (dBm)	G _{T-Lc} (dB)	EIRP (dBm)	EIRP (mW)	Limit (W)
18615	1851.5	23.18	0.54	23.72	235.5	2
18900	1880.0	23.16	0.54	23.7	234.42	2
19185	1908.5	22.8	0.54	23.34	215.77	2

CHANNEL BANDWIDTH: 3MHz 64QAM

Channel	Frequency (MHz)	Conducted Power (dBm)	G _{T-Lc} (dB)	EIRP (dBm)	EIRP (mW)	Limit (W)
18615	1851.5	22.45	0.54	22.99	199.07	2
18900	1880.0	22.35	0.54	22.89	194.54	2
19185	1908.5	21.97	0.54	22.51	178.24	2



**BUREAU
VERITAS**

Test Report No.: W7L-P22030026-2RF04

CHANNEL BANDWIDTH: 5MHz QPSK

Channel	Frequency (MHz)	Conducted Power (dBm)	G _T -L _C (dB)	EIRP (dBm)	EIRP (mW)	Limit (W)
18625	1852.5	24.24	0.54	24.78	300.61	2
18900	1880.0	24.13	0.54	24.67	293.09	2
19175	1907.5	23.8	0.54	24.34	271.64	2

CHANNEL BANDWIDTH: 5MHz 16QAM

Channel	Frequency (MHz)	Conducted Power (dBm)	G _T -L _C (dB)	EIRP (dBm)	EIRP (mW)	Limit (W)
18625	1852.5	23.19	0.54	23.73	236.05	2
18900	1880.0	23.12	0.54	23.66	232.27	2
19175	1907.5	22.8	0.54	23.34	215.77	2

CHANNEL BANDWIDTH: 5MHz 64QAM

Channel	Frequency (MHz)	Conducted Power (dBm)	G _T -L _C (dB)	EIRP (dBm)	EIRP (mW)	Limit (W)
18625	1852.5	22.39	0.54	22.93	196.34	2
18900	1880.0	22.33	0.54	22.87	193.64	2
19175	1907.5	22	0.54	22.54	179.47	2



CHANNEL BANDWIDTH: 10MHz QPSK

Channel	Frequency (MHz)	Conducted Power (dBm)	G _{T-Lc} (dB)	EIRP (dBm)	EIRP (mW)	Limit (W)
18650	1855.0	24.21	0.54	24.75	298.54	2
18900	1880.0	24.16	0.54	24.7	295.12	2
19150	1905.0	23.8	0.54	24.34	271.64	2

CHANNEL BANDWIDTH: 10MHz 16QAM

Channel	Frequency (MHz)	Conducted Power (dBm)	G _{T-Lc} (dB)	EIRP (dBm)	EIRP (mW)	Limit (W)
18650	1855.0	23.19	0.54	23.73	236.05	2
18900	1880.0	23.09	0.54	23.63	230.67	2
19150	1905.0	22.76	0.54	23.3	213.8	2

CHANNEL BANDWIDTH: 10MHz 64QAM

Channel	Frequency (MHz)	Conducted Power (dBm)	G _{T-Lc} (dB)	EIRP (dBm)	EIRP (mW)	Limit (W)
18650	1855.0	22.41	0.54	22.95	197.24	2
18900	1880.0	22.33	0.54	22.87	193.64	2
19150	1905.0	21.97	0.54	22.51	178.24	2



CHANNEL BANDWIDTH: 15MHz QPSK

Channel	Frequency (MHz)	Conducted Power (dBm)	G _{T-Lc} (dB)	EIRP (dBm)	EIRP (mW)	Limit (W)
18675	1857.5	24.28	0.54	24.82	303.39	2
18900	1880.0	24.16	0.54	24.7	295.12	2
19125	1902.5	23.77	0.54	24.31	269.77	2

CHANNEL BANDWIDTH: 15MHz 16QAM

Channel	Frequency (MHz)	Conducted Power (dBm)	G _{T-Lc} (dB)	EIRP (dBm)	EIRP (mW)	Limit (W)
18675	1857.5	23.23	0.54	23.77	238.23	2
18900	1880.0	23.16	0.54	23.7	234.42	2
19125	1902.5	22.76	0.54	23.3	213.8	2

CHANNEL BANDWIDTH: 15MHz 64QAM

Channel	Frequency (MHz)	Conducted Power (dBm)	G _{T-Lc} (dB)	EIRP (dBm)	EIRP (mW)	Limit (W)
18675	1857.5	22.4	0.54	22.94	196.79	2
18900	1880.0	22.34	0.54	22.88	194.09	2
19125	1902.5	21.98	0.54	22.52	178.65	2



CHANNEL BANDWIDTH: 20MHz QPSK

Channel	Frequency (MHz)	Conducted Power (dBm)	G _{T-Lc} (dB)	EIRP (dBm)	EIRP (mW)	Limit (W)
18700	1860	24.29	0.54	24.83	304.09	2
18900	1880	24.2	0.54	24.74	297.85	2
19100	1900	23.85	0.54	24.39	274.79	2

CHANNEL BANDWIDTH: 20MHz 16QAM

Channel	Frequency (MHz)	Conducted Power (dBm)	G _{T-Lc} (dB)	EIRP (dBm)	EIRP (mW)	Limit (W)
18700	1860	23.26	0.54	23.8	239.88	2
18900	1880	23.17	0.54	23.71	234.96	2
19100	1900	22.82	0.54	23.36	216.77	2

CHANNEL BANDWIDTH: 20MHz 64QAM

Channel	Frequency (MHz)	Conducted Power (dBm)	G _{T-Lc} (dB)	EIRP (dBm)	EIRP (mW)	Limit (W)
18700	1860	22.46	0.54	23	199.53	2
18900	1880	22.37	0.54	22.91	195.43	2
19100	1900	22.02	0.54	22.56	180.3	2



3.2 FREQUENCY STABILITY MEASUREMENT

3.2.1 LIMITS OF FREQUENCY STABILITY MEASUREMENT

The frequency stability shall be sufficient to ensure that the fundamental emission stays within the authorized frequency block.

3.2.2 TEST PROCEDURE

- a. Device is placed at the oven room. The oven room could control the temperatures and humidity. Power warm up is at least 15 min and power applied should perform before recording frequency error.
- b. EUT is connected the external power supply to control the DC input power. The test voltage range is from minimum to maximum working voltage. Each step shall be record the frequency error rate.
- c. The temperature range step is 10 degrees in this test items. All temperature levels shall be hold the $\pm 0.5^{\circ}\text{C}$ during the measurement testing. The each temperature step shall be at least 0.5 hours, consider the EUT could be test under the stability condition.

NOTE: The frequency error was recorded frequency error from the communication simulator.

3.2.3 TEST SETUP

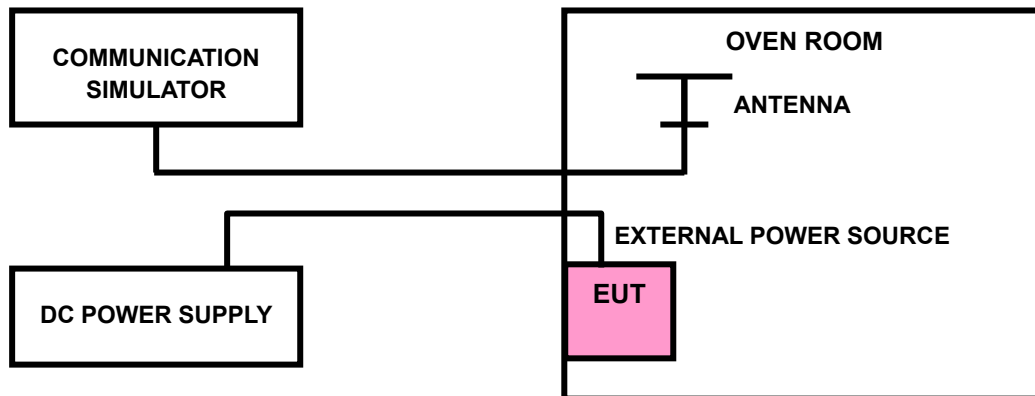



**BUREAU
VERITAS**

Test Report No.: W7L-P22030026-2RF04

3.2.4 TEST RESULTS

Please Refer to Appendix Of this test report.



3.3 OCCUPIED BANDWIDTH MEASUREMENT

3.3.1 TEST PROCEDURES

The EUT makes a call to the communication simulator. All measurements were done at low, middle and high operational frequency range. The communication simulator station system controlled a EUT to export maximum output power under transmission mode and specific channel frequency. Use OBW measurement function of Spectrum analyzer to measure 99 % occupied bandwidth.

3.3.2 TEST SETUP

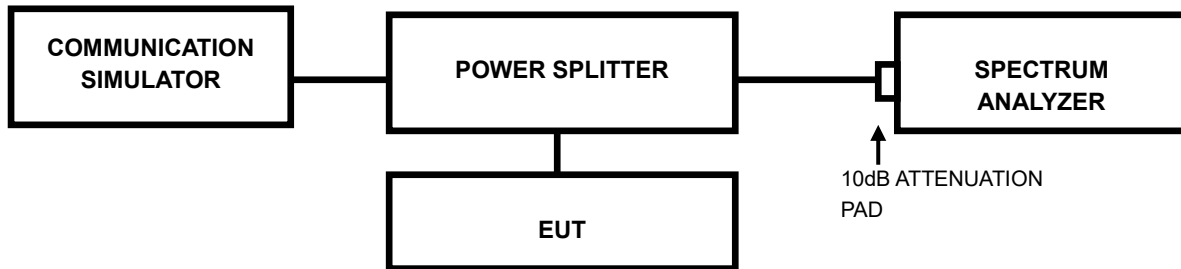



BUREAU
VERITAS

Test Report No.: W7L-P22030026-2RF04

3.3.3 TEST RESULTS

Please Refer to Appendix Of this test report.



3.4 BAND EDGE MEASUREMENTC

3.4.1 LIMITS OF BAND EDGE MEASUREMENT

Power of any emission outside of the authorized operating frequency ranges must be attenuated below the transmitting power (P) by a factor of at least $43 + 10 \log(P)$ dB. In the 1 MHz bands immediately outside and adjacent to the frequency block a resolution bandwidth of at least one percent of the emission bandwidth of the fundamental emission of the transmitter may be employed.

3.4.2 TEST SETUP

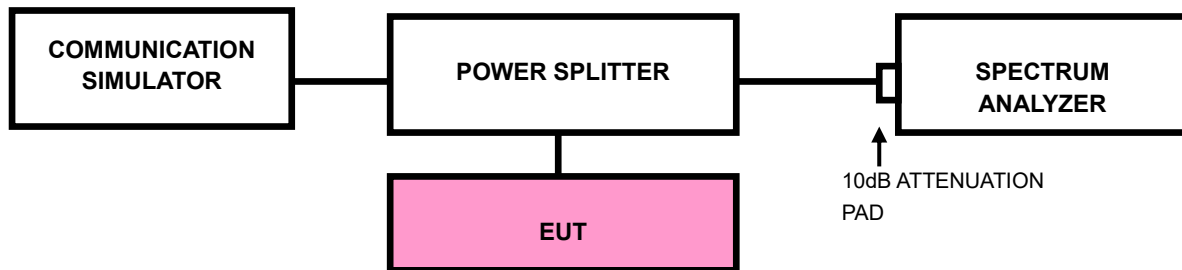



3.4.3 TEST PROCEDURES

- a. All measurements were done at low and high operational frequency range.
- b. The center frequency of spectrum is the band edge frequency and span is 1~5 MHz. RBW of the spectrum is 10kHz and VBW of the spectrum is 30kHz (LTE bandwidth for (1.4M/3M/5M/10M/15M/20M)1RB/0RB&1RB/MAXRB).
- c. The center frequency of spectrum is the band edge frequency and span is 10MHz. RBW of the spectrum is 100kHz and VBW of the spectrum is 300kHz (WCDMA).
- d. The center frequency of spectrum is the band edge frequency and span is 1~5 MHz. RBW of the spectrum is $\geq 1\% \cdot \text{EBW}$ kHz and VBW of the spectrum is $3 \cdot \text{RBW}$ kHz. (LTE bandwidth 1.4M/3M/5M/10M/15M/20MHz).
- e. Record the max trace plot into the test report.



**BUREAU
VERITAS**

Test Report No.: W7L-P22030026-2RF04

3.4.4. TEST RESULTS

Please Refer to Appendix Of this test report.



3.5 CONDUCTED SPURIOUS EMISSIONS

3.5.1 LIMITS OF CONDUCTED SPURIOUS EMISSIONS MEASUREMENT

The power of any emission outside of the authorized operating frequency ranges must be attenuated below the transmitting power (P) by a factor of at least $43 + 10 \log(P)$ dB. The emission limit equal to -13dBm .

3.5.2 TEST PROCEDURE

- a. The EUT makes a phone call to the communication simulator. All measurements were done at low, middle and high operational frequency range.
- b. Measuring frequency range is from 30MHz up to a frequency including its 10th harmonic. 10dB attenuation pad is connected with spectrum. RBW=1MHz and VBW=3MHz is used for conducted emission measurement.

3.5.3 TEST SETUP

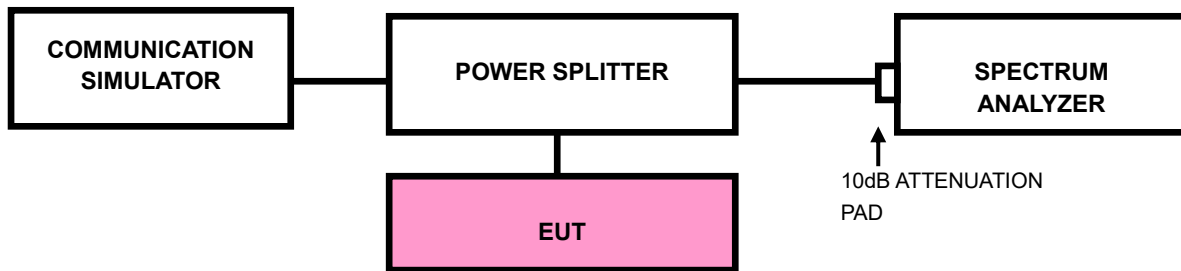



**BUREAU
VERITAS**

Test Report No.: W7L-P22030026-2RF04

3.5.4 TEST RESULTS

NOTE : The 9K~30MHz amplitude of spurious emissions attenuated more than 20 dB below the permissible value is not required in the report.

Please Refer to Appendix Of this test report.



3.6 RADIATED EMISSION MEASUREMENT

3.6.1 LIMITS OF RADIATED EMISSION MEASUREMENT

The power of any emission outside of the authorized operating frequency ranges must be attenuated below the transmitting power (P) by a factor of at least $43 + 10 \log(P)$ dB. The emission limit equal to -13dBm .

3.6.2 TEST PROCEDURES

- a. Substitution method is used for E.I.R.P measurement. In the semi-anechoic chamber, EUT placed on the 0.8m height of Turn Table, rotated the table around 360 degrees to search the maximum radiation power and receiver antenna shall be rotated vertical and horizontal polarization and moved height from 1m to 4m to find the maximum polar radiated power. The "Read Value" is the spectrum reading the maximum power value.
- b. The substitution horn antenna is substituted for EUT at the same position and signals generator export the CW signal to the substitution antenna via a TX cable. Rotated the Turn Table and moved receiving antenna to find the maximum radiation power. Adjust output power level of S.G to get a Value of spectrum reading equal to "Read Value " of step a. Record the power level of S.G
- c. $\text{EIRP} = \text{Output power level of S.G} - \text{TX cable loss} + \text{Antenna gain of substitution horn}$.

NOTE: The resolution bandwidth and video bandwidth of test receiver/spectrum analyzer is 1MHz/3MHz.

3.6.3 DEVIATION FROM TEST STANDARD

No deviation



3.6.4 TEST SETUP

< Frequency Range below 30MHz >

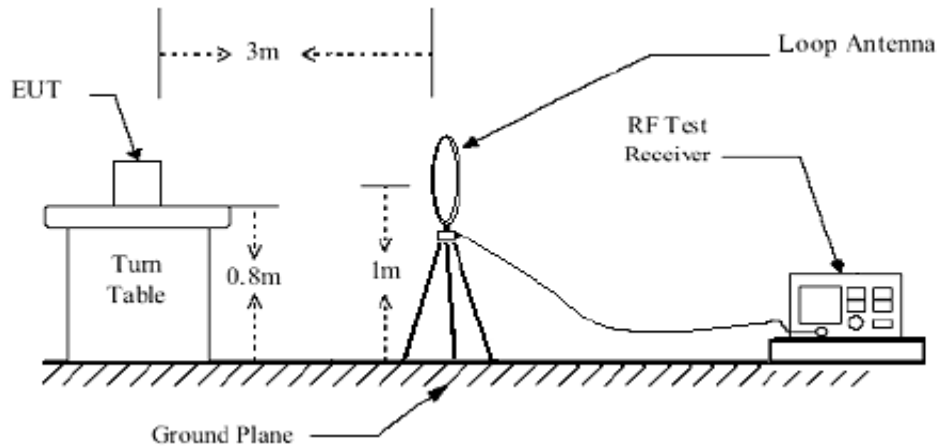

< Frequency Range 30MHz~1GHz >

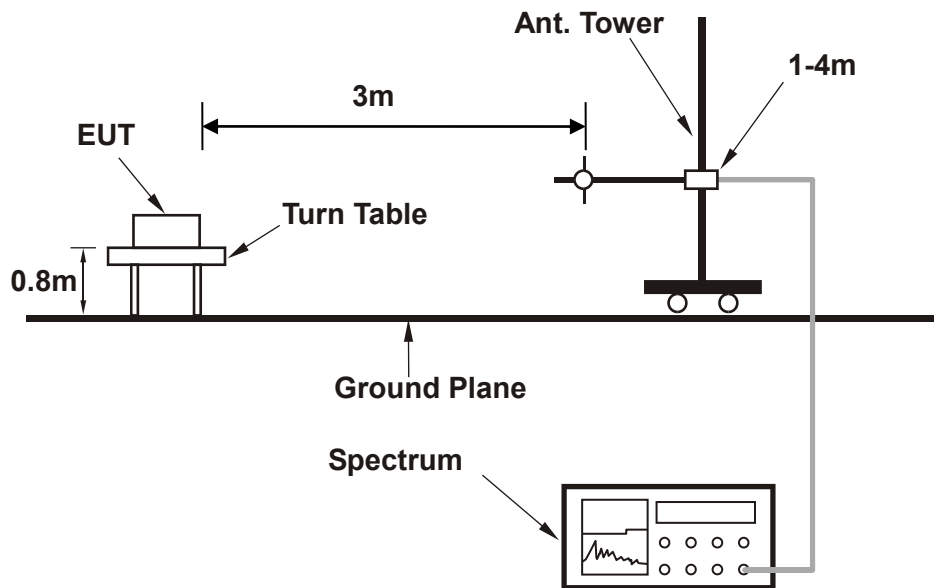



<Frequency Range above 1GHz>

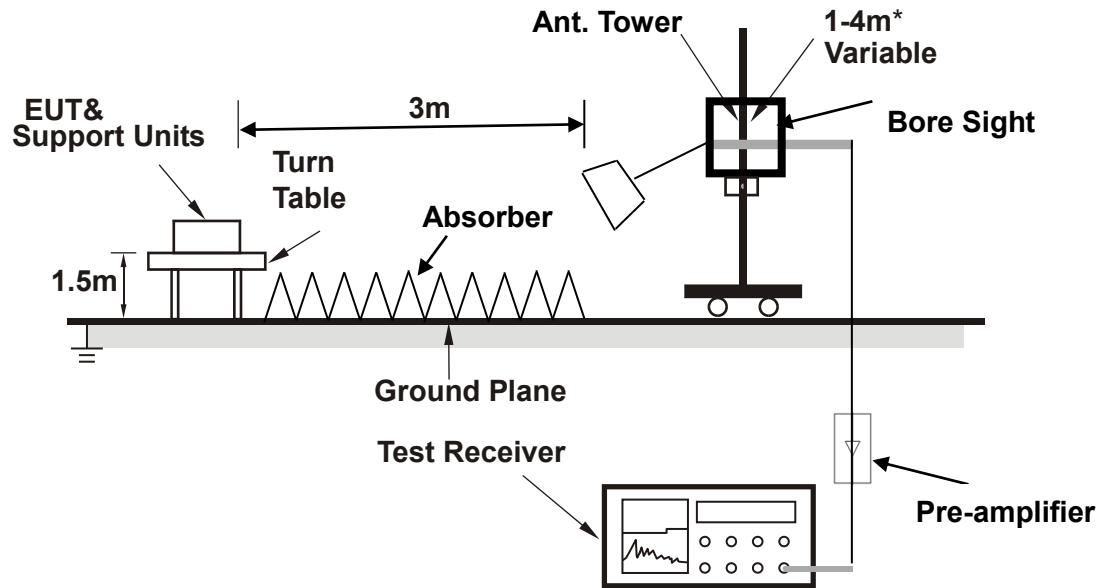

Note: Above 1G is a directional antenna

Depends on the EUT height and the antenna 3dB beamwidth both, refer to section 7.3 of CISPR 16-2-3.

For the actual test configuration, please refer to the attached file (Test Setup Photo).



3.6.5 TEST RESULTS

NOTE : The 9K~30MHz amplitude of spurious emissions attenuated more than 20 dB below the permissible value is not required in the report.

BELOW 1GHz WORST-CASE DATA

30 MHz – 1GHz data:

LTE Band2:

CHANNEL BANDWIDTH: 1.4MHz / QPSK

MODE	TX channel 19193	FREQUENCY RANGE	Below 1000MHz
ENVIRONMENTAL CONDITIONS	23deg. C, 70%RH	INPUT POWER	AC 120V/60HZ
TESTED BY	Jace Hu		
ANTENNA POLARITY & TEST DISTANCE: HORIZONTAL AT 3 M			

	Freq	Level	Read Level	Limit Line	Over Limit	Factor	Remark	Pol/Phase
	MHz	dBm/m	dBm	dBm/m	dB	dB/m		
1	34.850	-34.63	-53.47	-13.00	-21.63	18.84	Peak	Horizontal
2	81.410	-30.80	-38.69	-13.00	-17.80	7.89	Peak	Horizontal
3	202.660	-31.67	-42.79	-13.00	-18.67	11.12	Peak	Horizontal
4 PP	312.270	-28.91	-43.27	-13.00	-15.91	14.36	Peak	Horizontal
5	438.370	-39.29	-56.88	-13.00	-26.29	17.59	Peak	Horizontal
6	653.710	-38.15	-59.92	-13.00	-25.15	21.77	Peak	Horizontal

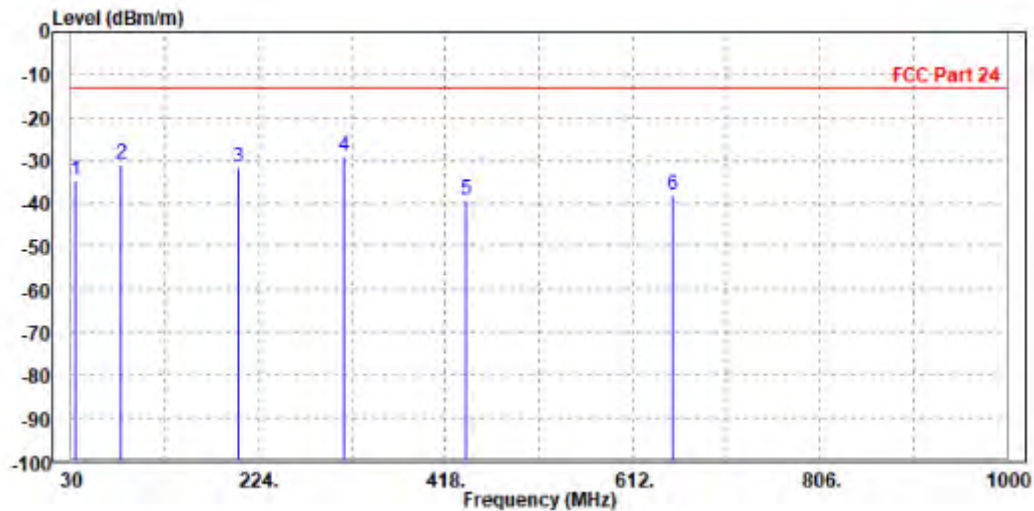



**BUREAU
VERITAS**

Test Report No.: W7L-P22030026-2RF04

MODE	TX channel 19193	FREQUENCY RANGE	Below 1000MHz
ENVIRONMENTAL CONDITIONS	23deg. C, 70%RH	INPUT POWER	AC 120V/60HZ
TESTED BY	Jace Hu		
ANTENNA POLARITY & TEST DISTANCE: VERTICAL AT 3 M			

	Freq	Level	Read Level	Limit Line	Over Limit	Factor	Remark	Pol/Phase
	MHz	dBm/m	dBm	dBm/m	dB	dB/m		
1	PP	33.880	-22.15	-40.64	-13.00	-9.15	18.49 Peak	Vertical
2		62.010	-30.36	-38.26	-13.00	-17.36	7.90 Peak	Vertical
3		209.450	-39.70	-51.63	-13.00	-26.70	11.93 Peak	Vertical
4		313.240	-34.24	-49.53	-13.00	-21.24	15.29 Peak	Vertical
5		436.430	-38.51	-56.40	-13.00	-25.51	17.89 Peak	Vertical
6		575.140	-40.19	-60.64	-13.00	-27.19	20.45 Peak	Vertical

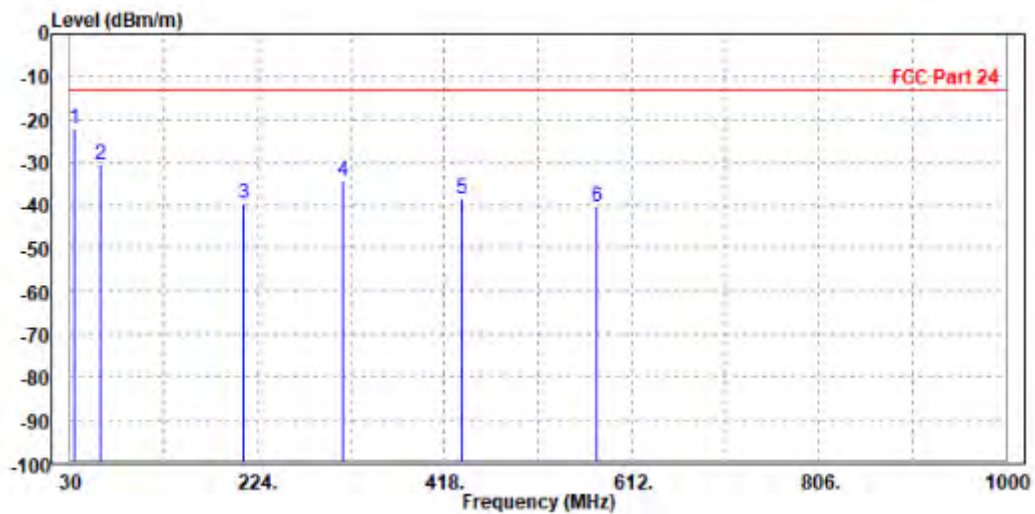



**BUREAU
VERITAS**

Test Report No.: W7L-P22030026-2RF04

ABOVE 1GHz DATA

Note: For higher frequency, the emission is too low to be detected.

WORST-CASE DATA

GSM 1900:

CH 512

MODE	TX channel 512	FREQUENCY RANGE	Above 1000MHz
ENVIRONMENTAL CONDITIONS	23deg. C, 70%RH	INPUT POWER	AC 120V/60HZ
TESTED BY	Jace Hu		
ANTENNA POLARITY & TEST DISTANCE: HORIZONTAL AT 3 M			

	Freq	Level	Read Level	Limit Line	Over Limit	Factor	Remark	Pol/Phase
	MHz	dBm/m	dBm	dBm/m	dB	dB/m		
1	PP 3698.000	-49.44	-58.22	-13.00	-36.44	8.78	Peak	Horizontal
2	5550.600	-49.60	-59.79	-13.00	-36.60	10.19	Peak	Horizontal

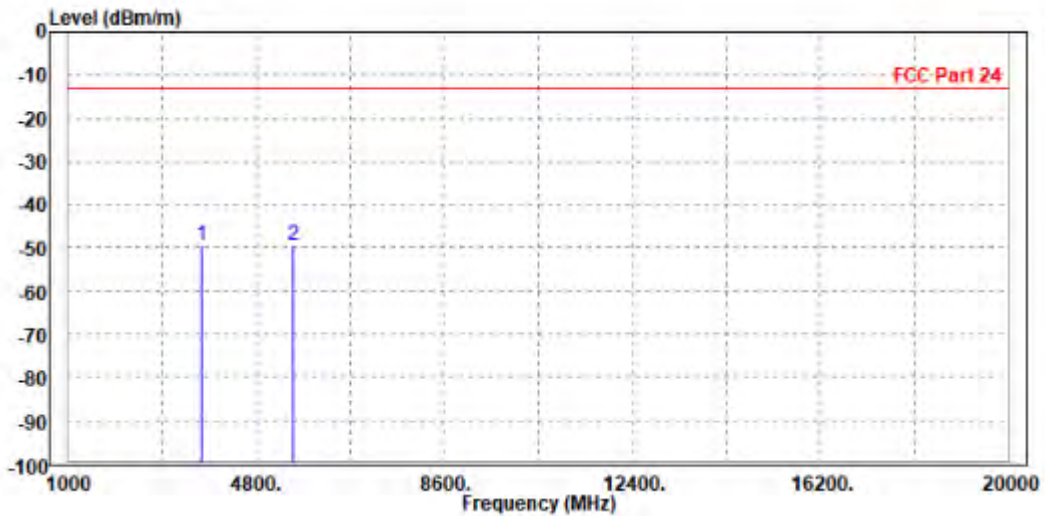



**BUREAU
VERITAS**

Test Report No.: W7L-P22030026-2RF04

MODE	TX channel 512	FREQUENCY RANGE	Above 1000MHz
ENVIRONMENTAL CONDITIONS	23deg. C, 70%RH	INPUT POWER	AC 120V/60HZ
TESTED BY	Jace Hu		
ANTENNA POLARITY & TEST DISTANCE: VERTICAL AT 3 M			

	Freq	Level	Read Level	Limit Line	Over Limit	Factor	Remark	Pol/Phase
	MHz	dBm/m	dBm	dBm/m	dB	dB/m		
1	3698.000	-46.58	-55.83	-13.00	-33.58	9.25	Peak	Vertical
2 PP	5550.600	-46.24	-56.14	-13.00	-33.24	9.90	Peak	Vertical

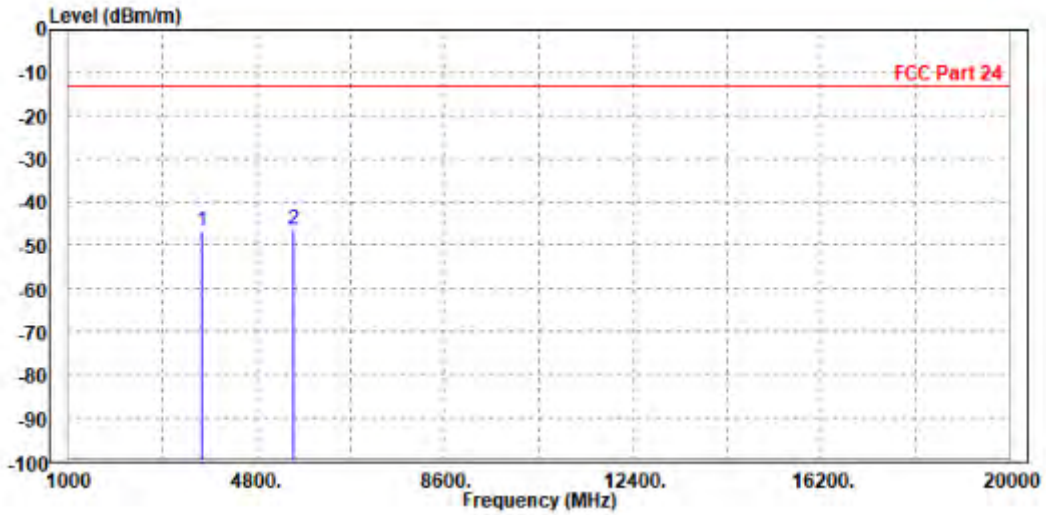



**BUREAU
VERITAS**

Test Report No.: W7L-P22030026-2RF04

CH 661

MODE	TX channel 661	FREQUENCY RANGE	Above 1000MHz
ENVIRONMENTAL CONDITIONS	23deg. C, 70%RH	INPUT POWER	AC 120V/60HZ
TESTED BY	Jace Hu		
ANTENNA POLARITY & TEST DISTANCE: HORIZONTAL AT 3 M			

	Freq	Level	Read Level	Limit Line	Over Limit	Factor	Remark	Pol/Phase
	MHz	dBm/m	dBm	dBm/m	dB	dB/m		
1	PP 3755.000	-42.10	-50.95	-13.00	-29.10	8.85	Peak	Horizontal
2	5640.000	-42.56	-53.04	-13.00	-29.56	10.48	Peak	Horizontal

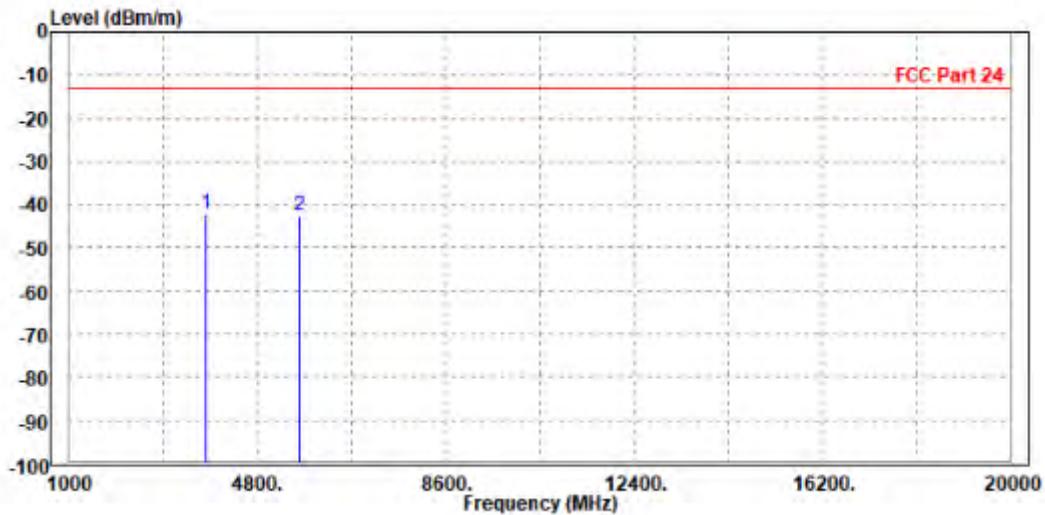



**BUREAU
VERITAS**

Test Report No.: W7L-P22030026-2RF04

MODE	TX channel 661	FREQUENCY RANGE	Above 1000MHz
ENVIRONMENTAL CONDITIONS	23deg. C, 70%RH	INPUT POWER	AC 120V/60HZ
TESTED BY	Jace Hu		
ANTENNA POLARITY & TEST DISTANCE: VERTICAL AT 3 M			

	Freq	Level	Read Level	Limit Line	Over Limit	Factor	Remark	Pol/Phase
	MHz	dBm/m	dBm	dBm/m	dB	dB/m		
1	3755.000	-44.87	-54.14	-13.00	-31.87	9.27	Peak	Vertical
2 PP	5640.000	-43.76	-54.01	-13.00	-30.76	10.25	Peak	Vertical

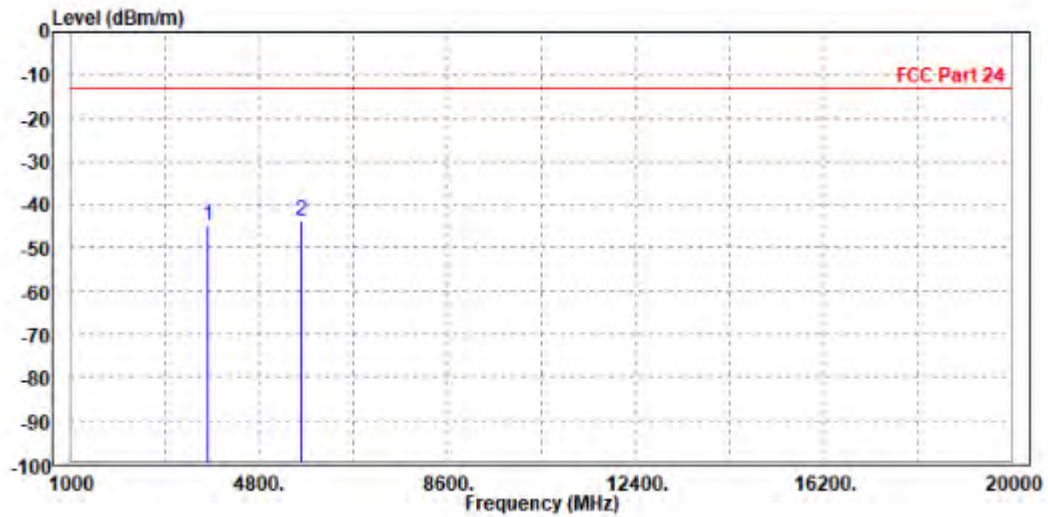



**BUREAU
VERITAS**

Test Report No.: W7L-P22030026-2RF04

CH 810

MODE	TX channel 810	FREQUENCY RANGE	Above 1000MHz
ENVIRONMENTAL CONDITIONS	23deg. C, 70%RH	INPUT POWER	AC 120V/60HZ
TESTED BY	Jace Hu		
ANTENNA POLARITY & TEST DISTANCE: HORIZONTAL AT 3 M			

	Freq	Level	Read Level	Limit Line	Over Limit	Factor	Remark	Pol/Phase
	MHz	dBm/m	dBm	dBm/m	dB	dB/m		
1	PP 3819.600	-42.18	-51.09	-13.00	-29.18	8.91	Peak	Horizontal
2	5729.400	-44.78	-55.56	-13.00	-31.78	10.78	Peak	Horizontal

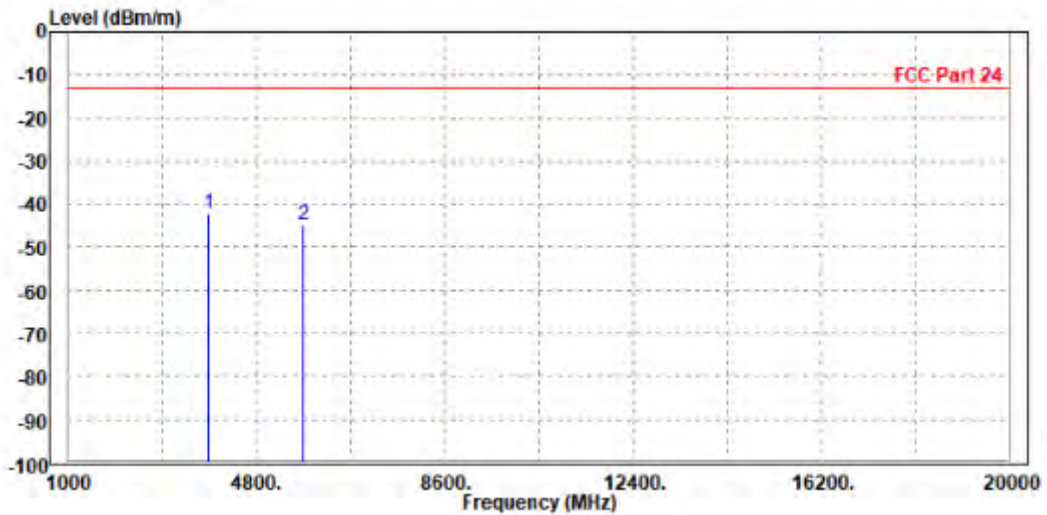



BUREAU
VERITAS

Test Report No.: W7L-P22030026-2RF04

MODE	TX channel 810	FREQUENCY RANGE	Above 1000MHz
ENVIRONMENTAL CONDITIONS	23deg. C, 70%RH	INPUT POWER	AC 120V/60HZ
TESTED BY	Jace Hu		
ANTENNA POLARITY & TEST DISTANCE: VERTICAL AT 3 M			

	Freq	Level	Read Level	Limit Line	Over Limit	Factor	Remark	Pol/Phase
	MHz	dBm/m	dBm	dBm/m	dB	dB/m		
1	3812.000	-43.59	-52.88	-13.00	-30.59	9.29	Peak	Vertical
2 PP	5731.000	-43.09	-53.69	-13.00	-30.09	10.60	Peak	Vertical

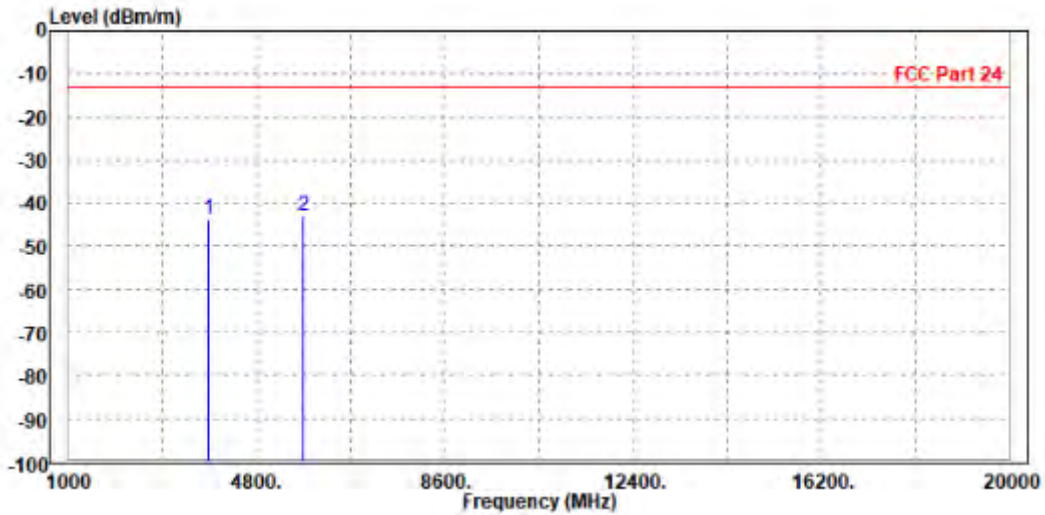



BUREAU VERITAS

Test Report No.: W7L-P22030026-2RF04

EDGE 1900:

CH 512

MODE	TX channel 512	FREQUENCY RANGE	Above 1000MHz
ENVIRONMENTAL CONDITIONS	23deg. C, 70%RH	INPUT POWER	AC 120V/60HZ
TESTED BY	Jace Hu		
ANTENNA POLARITY & TEST DISTANCE: HORIZONTAL AT 3 M			

	Freq	Level	Read Level	Limit Line	Over Limit	Factor	Remark	Pol/Phase
	MHz	dBm/m	dBm	dBm/m	dB	dB/m		
1 PP	3698.000	-41.46	-50.24	-13.00	-28.46	8.78	Peak	Horizontal
2	5550.600	-47.83	-58.02	-13.00	-34.83	10.19	Peak	Horizontal

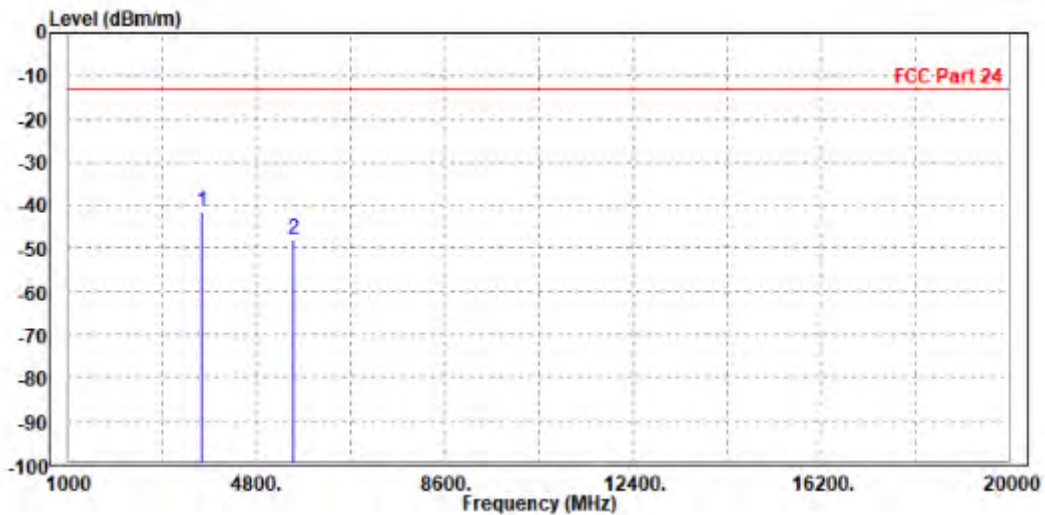



**BUREAU
VERITAS**

Test Report No.: W7L-P22030026-2RF04

MODE	TX channel 512	FREQUENCY RANGE	Above 1000MHz
ENVIRONMENTAL CONDITIONS	23deg. C, 70%RH	INPUT POWER	AC 120V/60HZ
TESTED BY	Jace Hu		
ANTENNA POLARITY & TEST DISTANCE: VERTICAL AT 3 M			

	Freq	Level	Read Level	Limit Line	Over Limit	Factor	Remark	Pol/Phase
	MHz	dBm/m	dBm	dBm/m	dB	dB/m		
1	PP 3698.000	-40.22	-49.47	-13.00	-27.22	9.25	Peak	Vertical
2	5550.600	-47.16	-57.06	-13.00	-34.16	9.90	Peak	Vertical

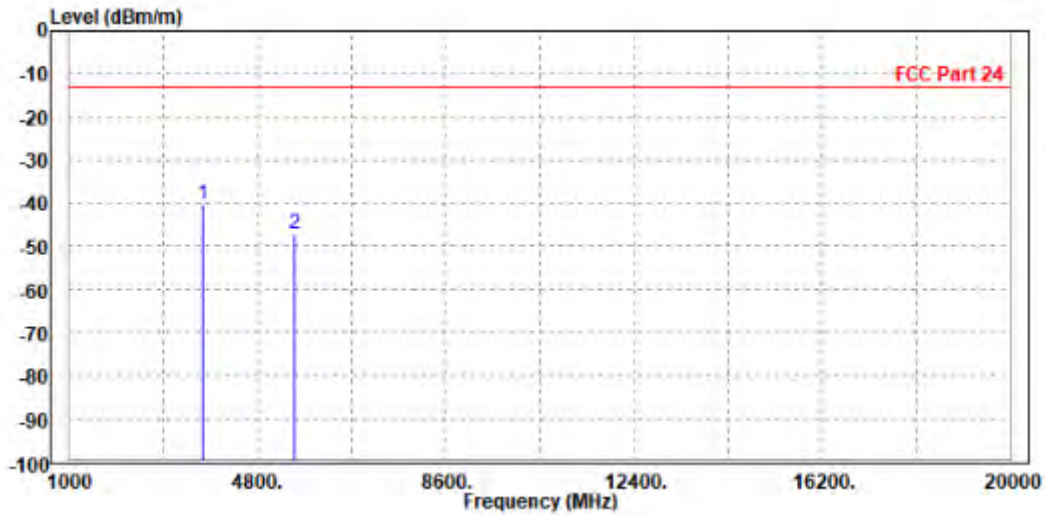



**BUREAU
VERITAS**

Test Report No.: W7L-P22030026-2RF04

CH 661

MODE	TX channel 661	FREQUENCY RANGE	Above 1000MHz
ENVIRONMENTAL CONDITIONS	23deg. C, 70%RH	INPUT POWER	AC 120V/60HZ
TESTED BY	Jace Hu		
ANTENNA POLARITY & TEST DISTANCE: HORIZONTAL AT 3 M			

	Freq	Level	Read Level	Limit Line	Over Limit	Factor	Remark	Pol/Phase
	MHz	dBm/m	dBm	dBm/m	dB	dB/m		
1	3755.000	-44.94	-54.21	-13.00	-31.94	9.27	Peak	Vertical
2 PP	5640.000	-41.44	-51.69	-13.00	-28.44	10.25	Peak	Vertical

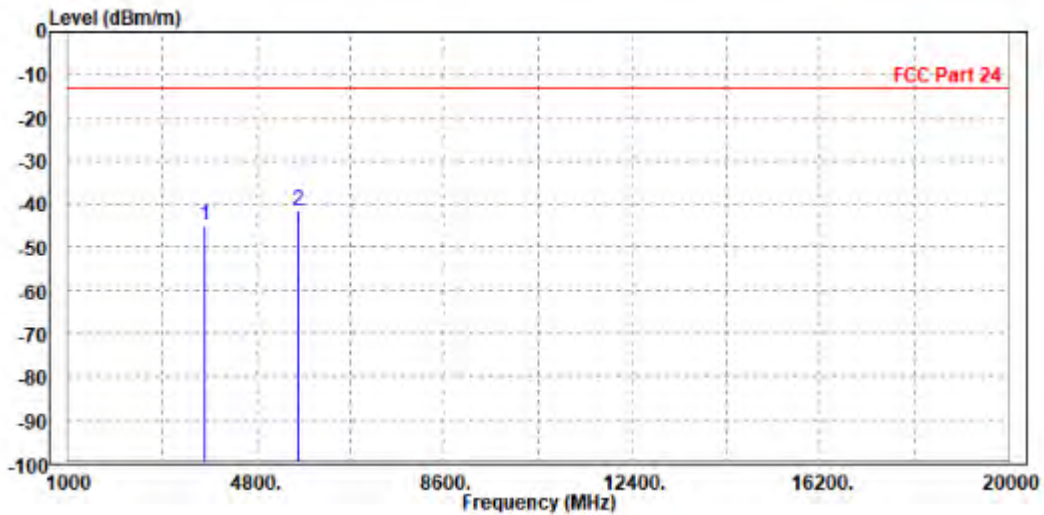



**BUREAU
VERITAS**

Test Report No.: W7L-P22030026-2RF04

MODE	TX channel 661	FREQUENCY RANGE	Above 1000MHz
ENVIRONMENTAL CONDITIONS	23deg. C, 70%RH	INPUT POWER	AC 120V/60HZ
TESTED BY	Jace Hu		
ANTENNA POLARITY & TEST DISTANCE: VERTICAL AT 3 M			

	Freq	Level	Read Level	Limit Line	Over Limit	Factor	Remark	Pol/Phase
	MHz	dBm/m	dBm	dBm/m	dB	dB/m		
1	PP 3819.600	-42.75	-51.66	-13.00	-29.75	8.91	Peak	Horizontal
2	5729.400	-43.59	-54.37	-13.00	-30.59	10.78	Peak	Horizontal

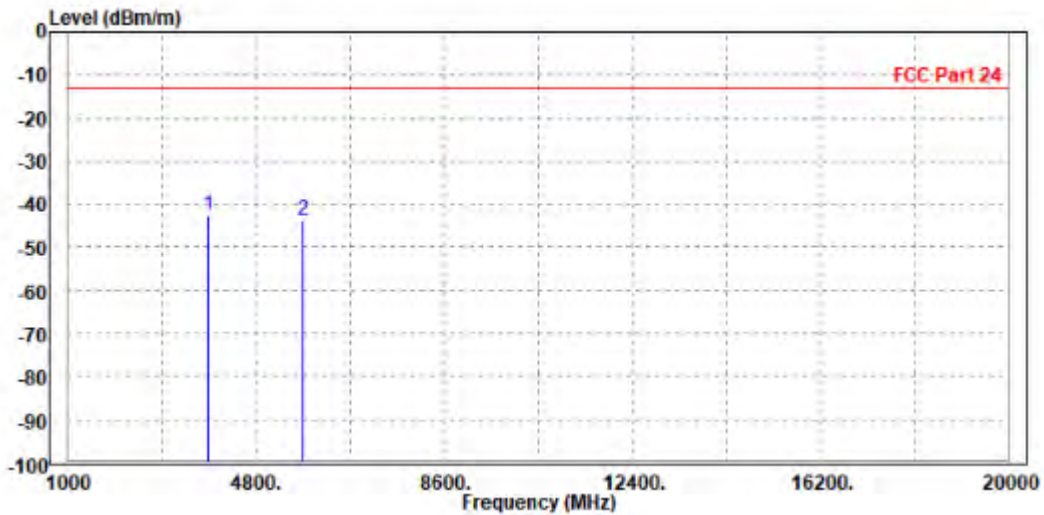



**BUREAU
VERITAS**

Test Report No.: W7L-P22030026-2RF04

CH 810

MODE	TX channel 810	FREQUENCY RANGE	Above 1000MHz
ENVIRONMENTAL CONDITIONS	23deg. C, 70%RH	INPUT POWER	AC 120V/60HZ
TESTED BY	Jace Hu		
ANTENNA POLARITY & TEST DISTANCE: HORIZONTAL AT 3 M			

	Freq	Level	Read Level	Limit Line	Over Limit	Factor	Remark	Pol/Phase
	MHz	dBm/m	dBm	dBm/m	dB	dB/m		
1	3812.000	-49.02	-57.93	-13.00	-36.02	8.91	Peak	Horizontal
2 PP	5729.400	-47.14	-57.92	-13.00	-34.14	10.78	Peak	Horizontal

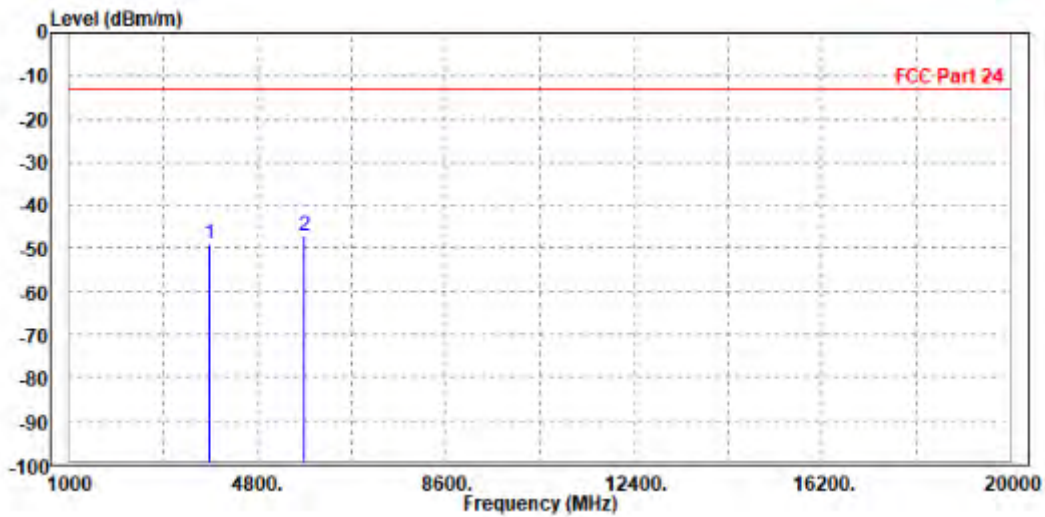



**BUREAU
VERITAS**

Test Report No.: W7L-P22030026-2RF04

MODE	TX channel 810	FREQUENCY RANGE	Above 1000MHz
ENVIRONMENTAL CONDITIONS	23deg. C, 70%RH	INPUT POWER	AC 120V/60HZ
TESTED BY	Jace Hu		
ANTENNA POLARITY & TEST DISTANCE: VERTICAL AT 3 M			

		Read	Limit	Over				
	Freq	Level	Level	Line	Limit	Factor	Remark	Pol/Phase
	MHz	dBm/m	dBm	dBm/m	dB	dB/m		
1	PP 3819.600	-43.86	-53.15	-13.00	-30.86	9.29	Peak	Vertical
2	5729.400	-44.23	-54.82	-13.00	-31.23	10.59	Peak	Vertical

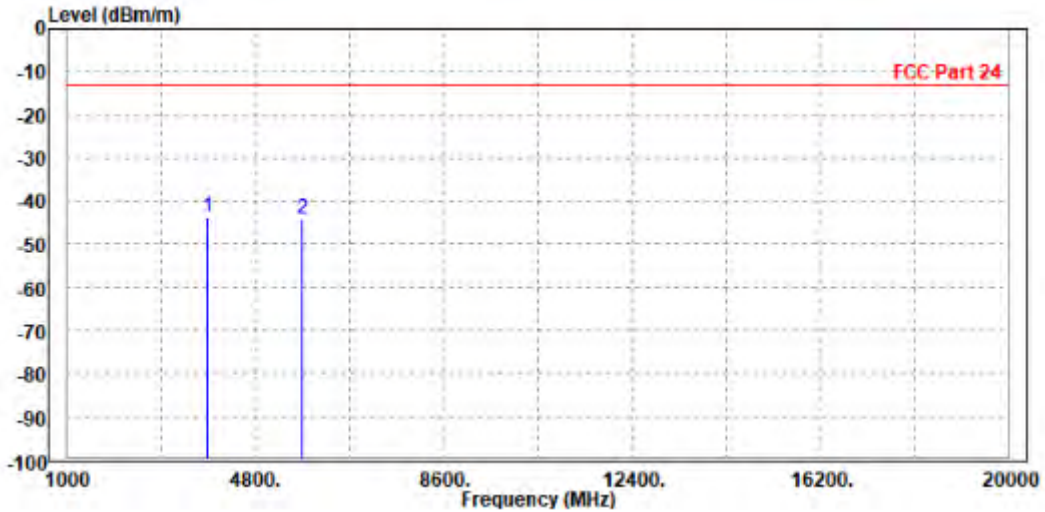



**BUREAU
VERITAS**

Test Report No.: W7L-P22030026-2RF04

WCDMA Band II

CH 9262

MODE	TX channel 9262	FREQUENCY RANGE	Above 1000MHz
ENVIRONMENTAL CONDITIONS	23deg. C, 70%RH	INPUT POWER	AC 120V/60HZ
TESTED BY	Jace Hu		
ANTENNA POLARITY & TEST DISTANCE: HORIZONTAL AT 3 M			

	Freq	Level	Read Level	Limit Line	Over Limit	Factor	Remark	Pol/Phase
	MHz	dBm/m	dBm	dBm/m	dB	dB/m		
1	PP 3698.000	-35.27	-44.05	-13.00	-22.27	8.78	Peak	Horizontal
2	5557.200	-50.24	-60.45	-13.00	-37.24	10.21	Peak	Horizontal

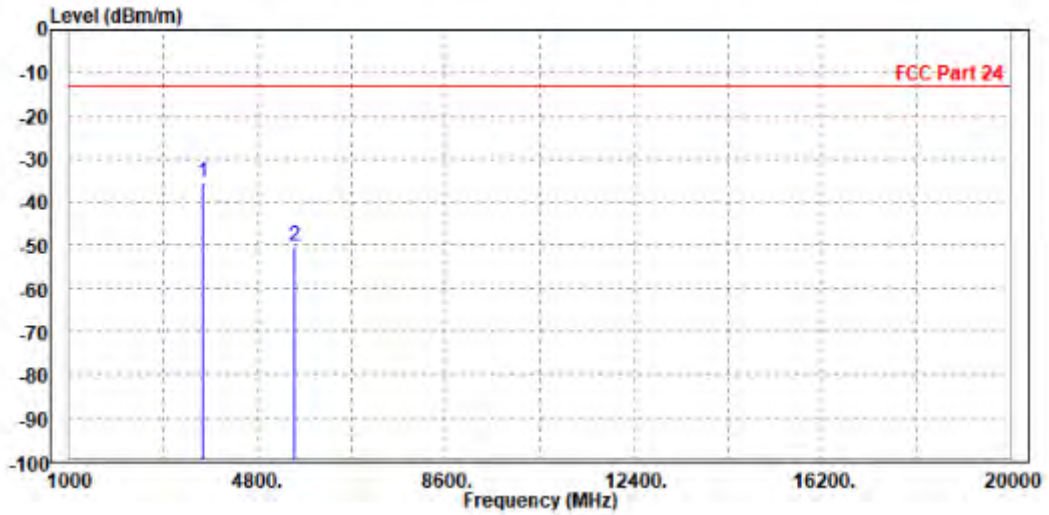



**BUREAU
VERITAS**

Test Report No.: W7L-P22030026-2RF04

MODE	TX channel 9262	FREQUENCY RANGE	Above 1000MHz
ENVIRONMENTAL CONDITIONS	23deg. C, 70%RH	INPUT POWER	AC 120V/60HZ
TESTED BY	Jace Hu		
ANTENNA POLARITY & TEST DISTANCE: VERTICAL AT 3 M			

	Freq	Level	Read Level	Limit Line	Over Limit	Factor	Remark	Pol/Phase
	MHz	dBm/m	dBm	dBm/m	dB	dB/m		
1	PP 3698.000	-41.70	-50.95	-13.00	-28.70	9.25	Peak	Vertical
2	5557.200	-49.35	-59.28	-13.00	-36.35	9.93	Peak	Vertical

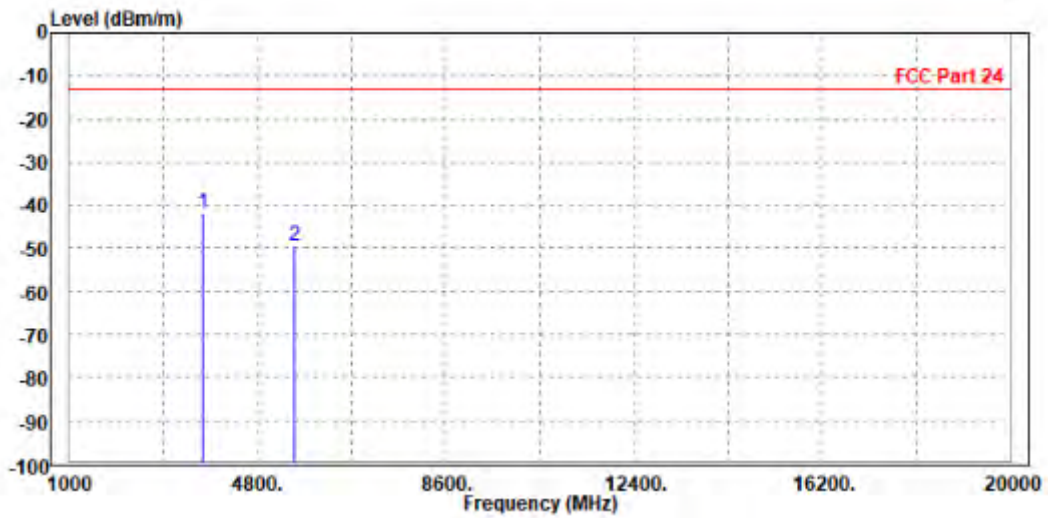



BUREAU
VERITAS

Test Report No.: W7L-P22030026-2RF04

CH 9400

MODE	TX channel 9400	FREQUENCY RANGE	Above 1000MHz
ENVIRONMENTAL CONDITIONS	23deg. C, 70%RH	INPUT POWER	AC 120V/60HZ
TESTED BY	Jace Hu		
ANTENNA POLARITY & TEST DISTANCE: HORIZONTAL AT 3 M			

	Freq	Level	Read Level	Limit Line	Over Limit	Factor	Remark	Pol/Phase
	MHz	dBm/m	dBm	dBm/m	dB	dB/m		
1	PP 3755.000	-37.47	-46.32	-13.00	-24.47	8.85	Peak	Horizontal
2	5640.000	-48.91	-59.39	-13.00	-35.91	10.48	Peak	Horizontal

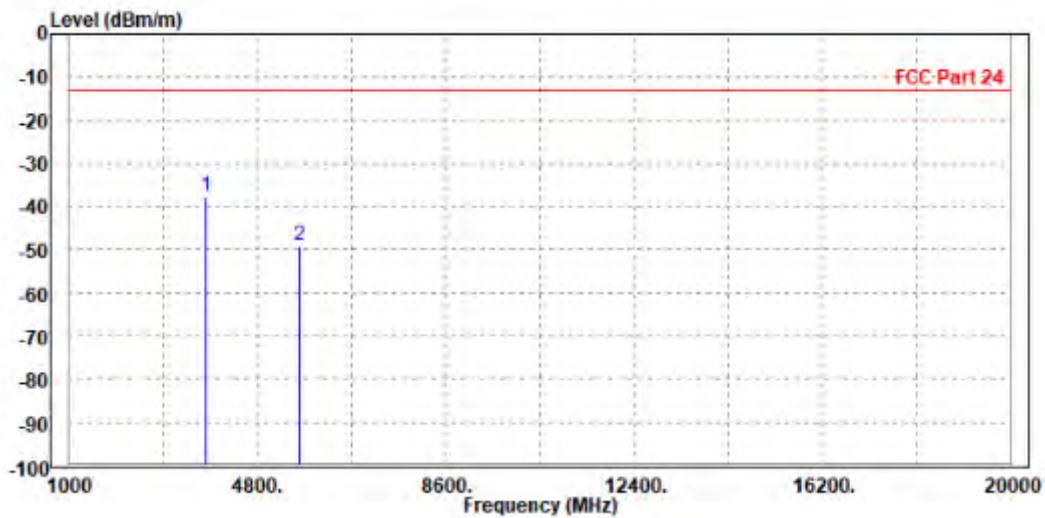



**BUREAU
VERITAS**

Test Report No.: W7L-P22030026-2RF04

MODE	TX channel 9400	FREQUENCY RANGE	Above 1000MHz
ENVIRONMENTAL CONDITIONS	23deg. C, 70%RH	INPUT POWER	AC 120V/60HZ
TESTED BY	Jace Hu		
ANTENNA POLARITY & TEST DISTANCE: VERTICAL AT 3 M			

	Freq	Level	Read Level	Limit Line	Over Limit	Factor	Remark	Pol/Phase
	MHz	dBm/m	dBm	dBm/m	dB	dB/m		
1	PP 3755.000	-40.38	-49.65	-13.00	-27.38	9.27	Peak	Vertical
2	5640.000	-48.74	-58.99	-13.00	-35.74	10.25	Peak	Vertical

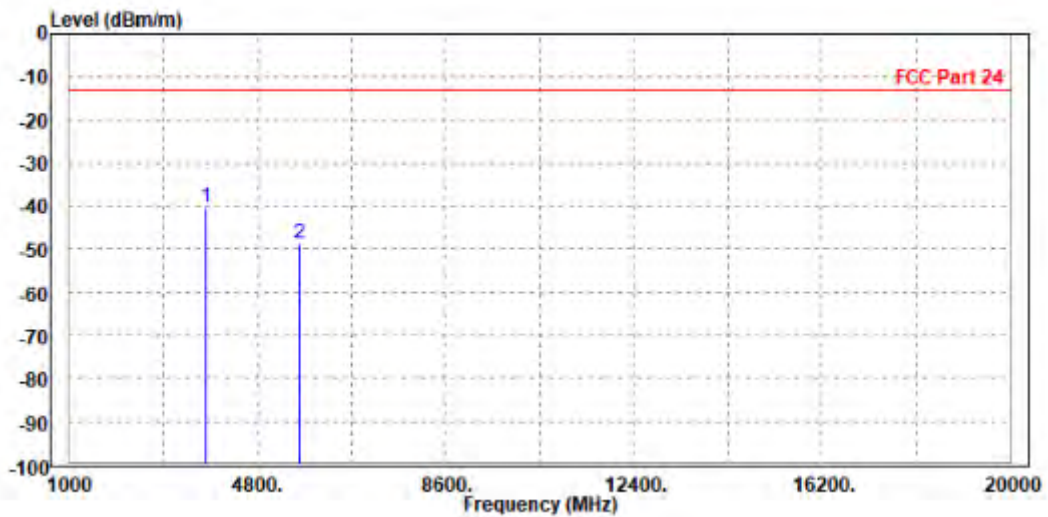



BUREAU VERITAS

Test Report No.: W7L-P22030026-2RF04

CH 9538

MODE	TX channel 9538	FREQUENCY RANGE	Above 1000MHz
ENVIRONMENTAL CONDITIONS	23deg. C, 70%RH	INPUT POWER	AC 120V/60HZ
TESTED BY	Jace Hu		
ANTENNA POLARITY & TEST DISTANCE: HORIZONTAL AT 3 M			

	Freq	Level	Read Level	Limit Line	Over Limit	Factor	Remark	Pol/Phase
	MHz	dBm/m	dBm	dBm/m	dB	dB/m		
1	PP 3812.000	-40.07	-48.98	-13.00	-27.07	8.91	Peak	Horizontal
2	5722.800	-45.32	-56.08	-13.00	-32.32	10.76	Peak	Horizontal

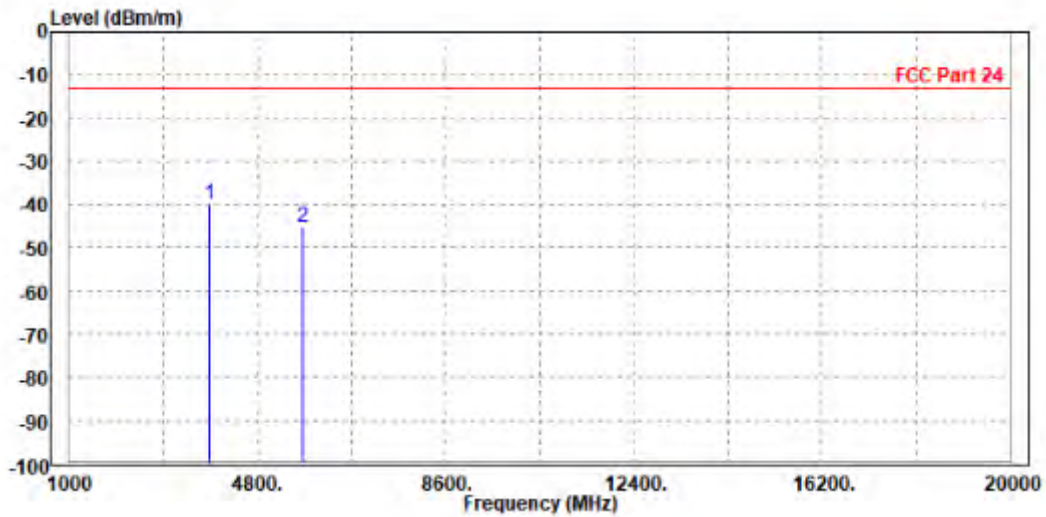



**BUREAU
VERITAS**

Test Report No.: W7L-P22030026-2RF04

MODE	TX channel 9538	FREQUENCY RANGE	Above 1000MHz
ENVIRONMENTAL CONDITIONS	23deg. C, 70%RH	INPUT POWER	AC 120V/60HZ
TESTED BY	Jace Hu		
ANTENNA POLARITY & TEST DISTANCE: VERTICAL AT 3 M			

	Freq	Level	Read Level	Limit Line	Over Limit	Factor	Remark	Pol/Phase
	MHz	dBm/m	dBm	dBm/m	dB	dB/m		
1	PP 3815.200	-42.12	-51.41	-13.00	-29.12	9.29	Peak	Vertical
2	5722.800	-45.68	-56.25	-13.00	-32.68	10.57	Peak	Vertical

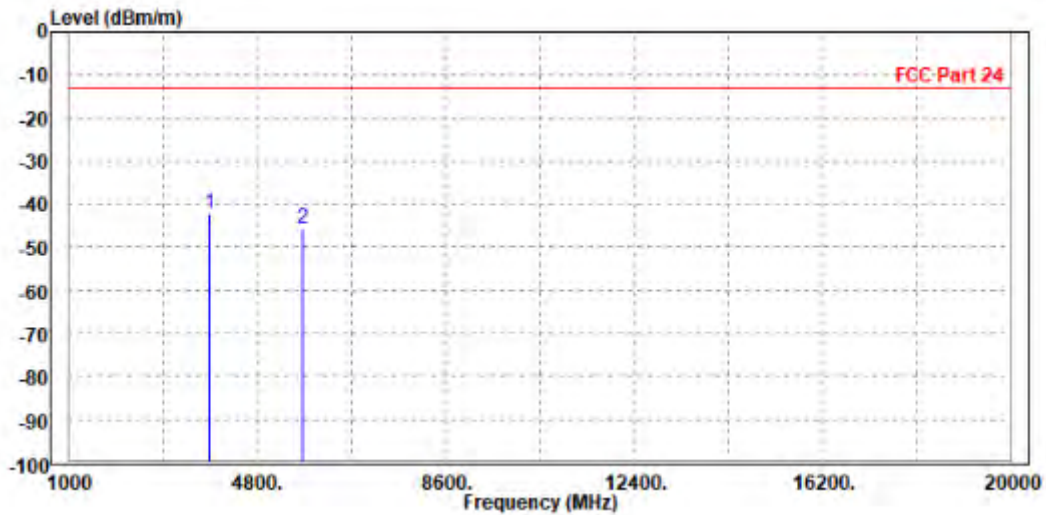



LTE Band 2

CHANNEL BANDWIDTH: 1.4MHz / QPSK

CH18607

MODE	TX channel 18607	FREQUENCY RANGE	Above 1000MHz
ENVIRONMENTAL CONDITIONS	23deg. C, 70%RH	INPUT POWER	AC 120V/60HZ
TESTED BY	Jace Hu		
ANTENNA POLARITY & TEST DISTANCE: HORIZONTAL AT 3 M			

	Freq	Level	Read Level	Limit Line	Over Limit	Factor	Remark	Pol/Phase
	MHz	dBm/m	dBm	dBm/m	dB	dB/m		
1	PP 3755.000	-39.52	-48.37	-13.00	-26.52	8.85	Peak	Horizontal
2	5640.000	-49.06	-59.54	-13.00	-36.06	10.48	Peak	Horizontal

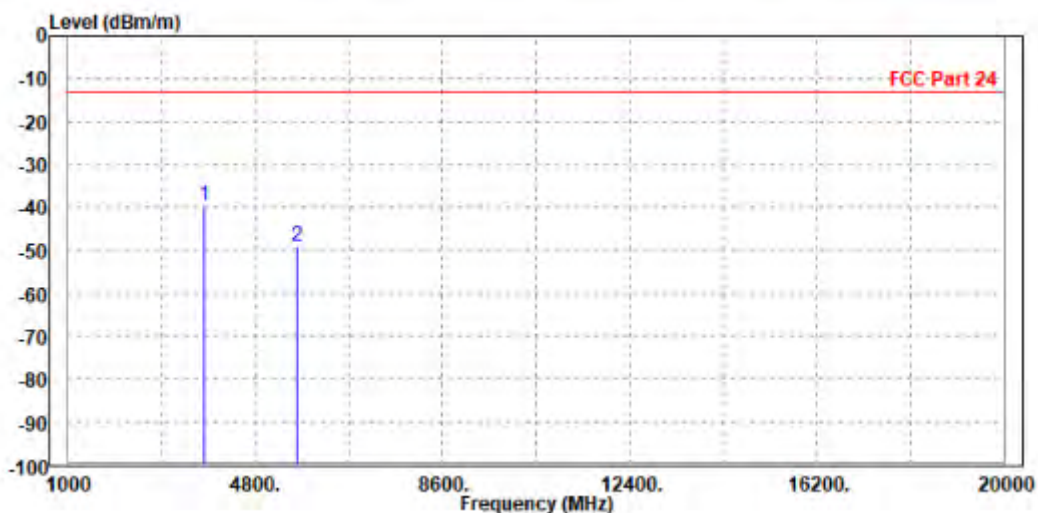



**BUREAU
VERITAS**

Test Report No.: W7L-P22030026-2RF04

MODE	TX channel 18607	FREQUENCY RANGE	Above 1000MHz
ENVIRONMENTAL CONDITIONS	23deg. C, 70%RH	INPUT POWER	AC 120V/60HZ
TESTED BY	Jace Hu		
ANTENNA POLARITY & TEST DISTANCE: VERTICAL AT 3 M			

	Freq	Level	Read Level	Limit Line	Over Limit	Factor	Remark	Pol/Phase
	MHz	dBm/m	dBm	dBm/m	dB	dB/m		
1	PP 3698.000	-37.76	-47.01	-13.00	-24.76	9.25	Peak	Vertical
2	5552.100	-49.92	-59.83	-13.00	-36.92	9.91	Peak	Vertical

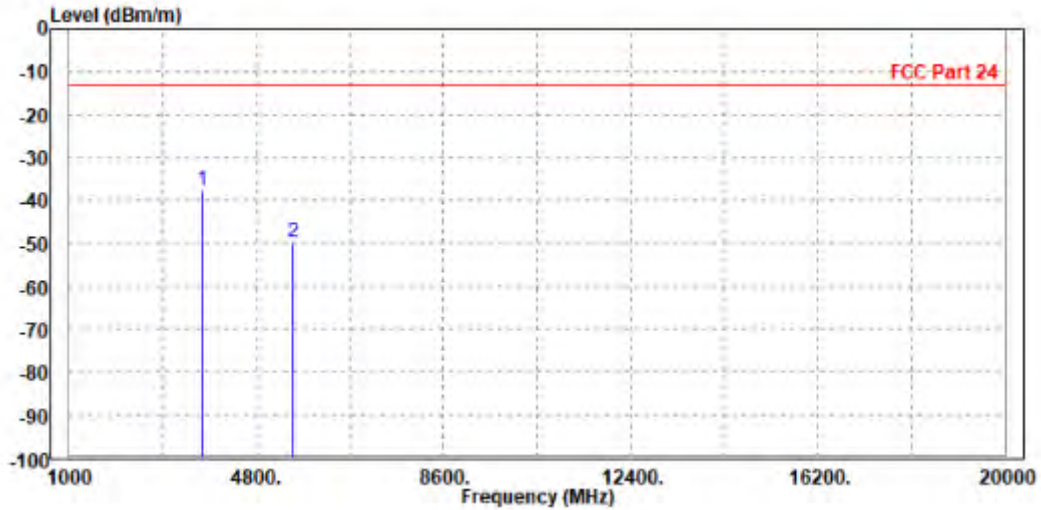



**BUREAU
VERITAS**

Test Report No.: W7L-P22030026-2RF04

CH18900

MODE	TX channel 18900	FREQUENCY RANGE	Above 1000MHz
ENVIRONMENTAL CONDITIONS	23deg. C, 70%RH	INPUT POWER	AC 120V/60HZ
TESTED BY	Jace Hu		
ANTENNA POLARITY & TEST DISTANCE: HORIZONTAL AT 3 M			

	Freq	Level	Read Level	Limit Line	Over Limit	Factor	Remark	Pol/Phase
	MHz	dBm/m	dBm	dBm/m	dB	dB/m		
1	PP 3755.000	-36.69	-45.54	-13.00	-23.69	8.85	Peak	Horizontal
2	5640.000	-48.39	-58.87	-13.00	-35.39	10.48	Peak	Horizontal

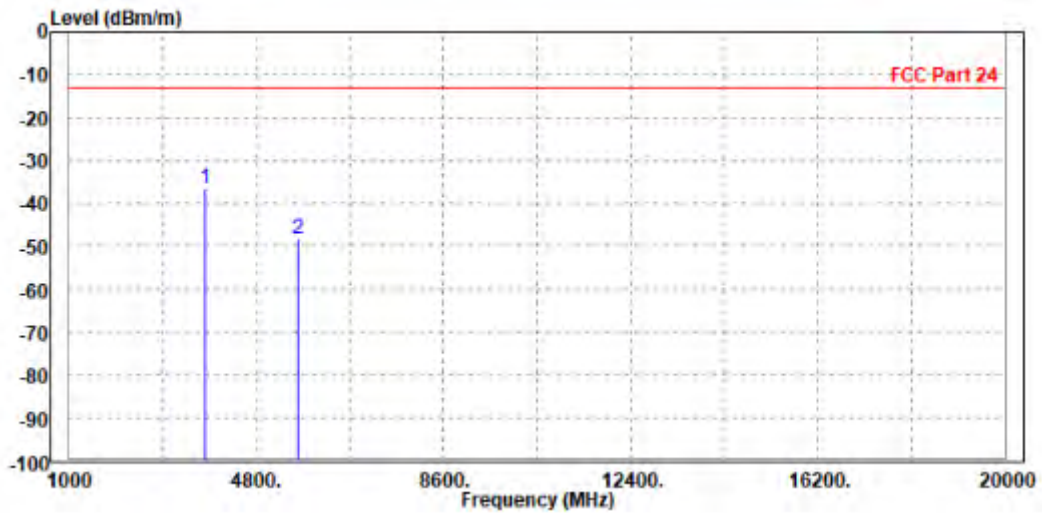



**BUREAU
VERITAS**

Test Report No.: W7L-P22030026-2RF04

MODE	TX channel 18900	FREQUENCY RANGE	Above 1000MHz
ENVIRONMENTAL CONDITIONS	23deg. C, 70%RH	INPUT POWER	AC 120V/60HZ
TESTED BY	Jace Hu		
ANTENNA POLARITY & TEST DISTANCE: VERTICAL AT 3 M			

	Freq	Level	Read Level	Limit Line	Over Limit	Factor	Remark	Pol/Phase
	MHz	dBm/m	dBm	dBm/m	dB	dB/m		
1	PP 3755.000	-38.61	-47.88	-13.00	-25.61	9.27	Peak	Vertical
2	5640.000	-48.00	-58.25	-13.00	-35.00	10.25	Peak	Vertical

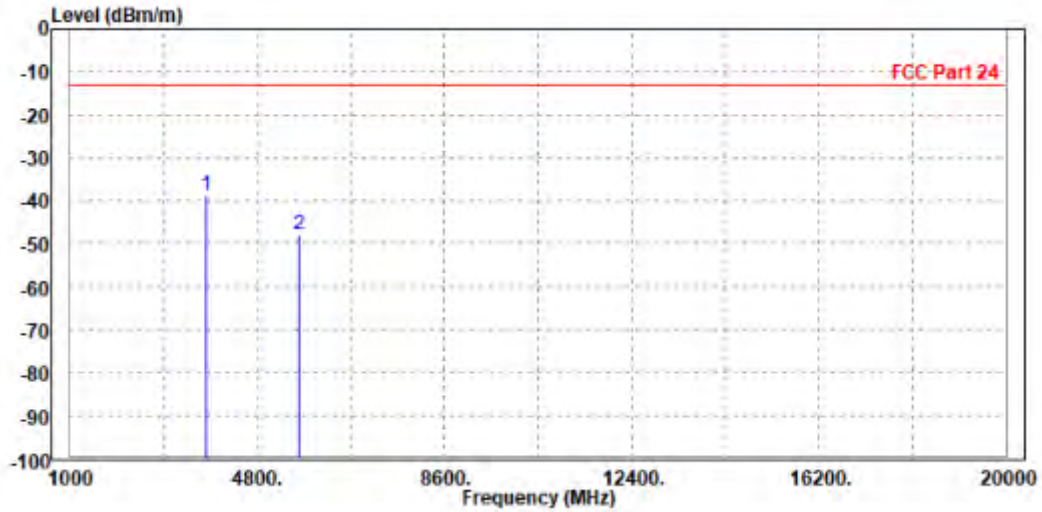



**BUREAU
VERITAS**

Test Report No.: W7L-P22030026-2RF04

CH19193

MODE	TX channel 19193	FREQUENCY RANGE	Above 1000MHz
ENVIRONMENTAL CONDITIONS	23deg. C, 70%RH	INPUT POWER	AC 120V/60HZ
TESTED BY	Jace Hu		
ANTENNA POLARITY & TEST DISTANCE: HORIZONTAL AT 3 M			

	Freq	Level	Read Level	Limit Line	Over Limit	Factor	Remark	Pol/Phase
	MHz	dBm/m	dBm	dBm/m	dB	dB/m		
1	3812.000	-48.63	-57.54	-13.00	-35.63	8.91	Peak	Horizontal
2 PP	5731.000	-44.92	-55.70	-13.00	-31.92	10.78	Peak	Horizontal

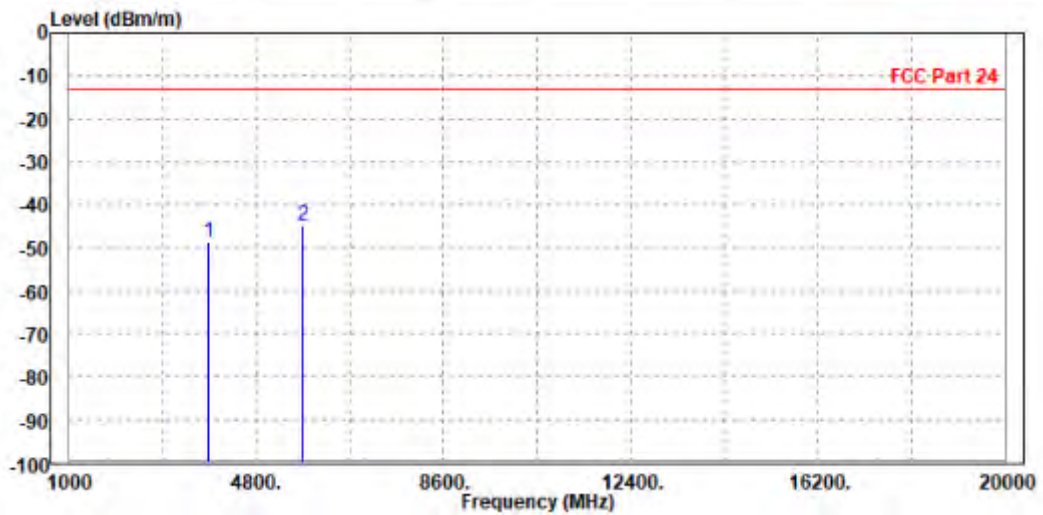



**BUREAU
VERITAS**

Test Report No.: W7L-P22030026-2RF04

MODE	TX channel 19193	FREQUENCY RANGE	Above 1000MHz
ENVIRONMENTAL CONDITIONS	23deg. C, 70%RH	INPUT POWER	AC 120V/60HZ
TESTED BY	Jace Hu		
ANTENNA POLARITY & TEST DISTANCE: VERTICAL AT 3 M			

	Freq	Level	Read Level	Limit Line	Over Limit	Factor	Remark	Pol/Phase
	MHz	dBm/m	dBm	dBm/m	dB	dB/m		
1	3818.600	-47.22	-56.51	-13.00	-34.22	9.29	Peak	Vertical
2 PP	5727.900	-45.40	-55.99	-13.00	-32.40	10.59	Peak	Vertical

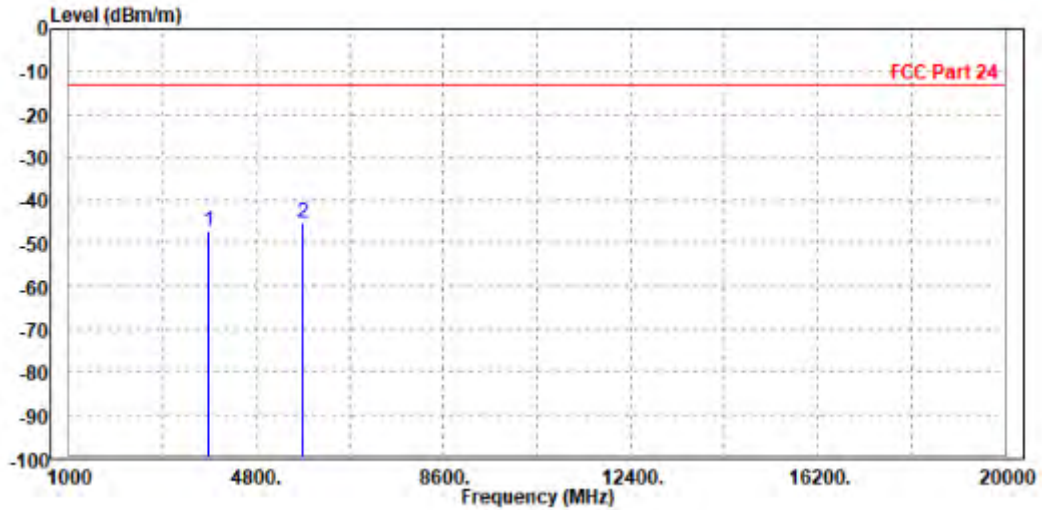



**BUREAU
VERITAS**

Test Report No.: W7L-P22030026-2RF04

CHANNEL BANDWIDTH: 3MHz / QPSK

MODE	TX channel 18900	FREQUENCY RANGE	Above 1000MHz
ENVIRONMENTAL CONDITIONS	23deg. C, 70%RH	INPUT POWER	AC 120V/60HZ
TESTED BY	Jace Hu		
ANTENNA POLARITY & TEST DISTANCE: HORIZONTAL AT 3 M			

	Freq	Level	Read Level	Limit Line	Over Limit	Factor	Remark	Pol/Phase
	MHz	dBm/m	dBm	dBm/m	dB	dB/m		
1	PP 3755.000	-39.52	-48.37	-13.00	-26.52	8.85	Peak	Horizontal
2	5640.000	-49.06	-59.54	-13.00	-36.06	10.48	Peak	Horizontal

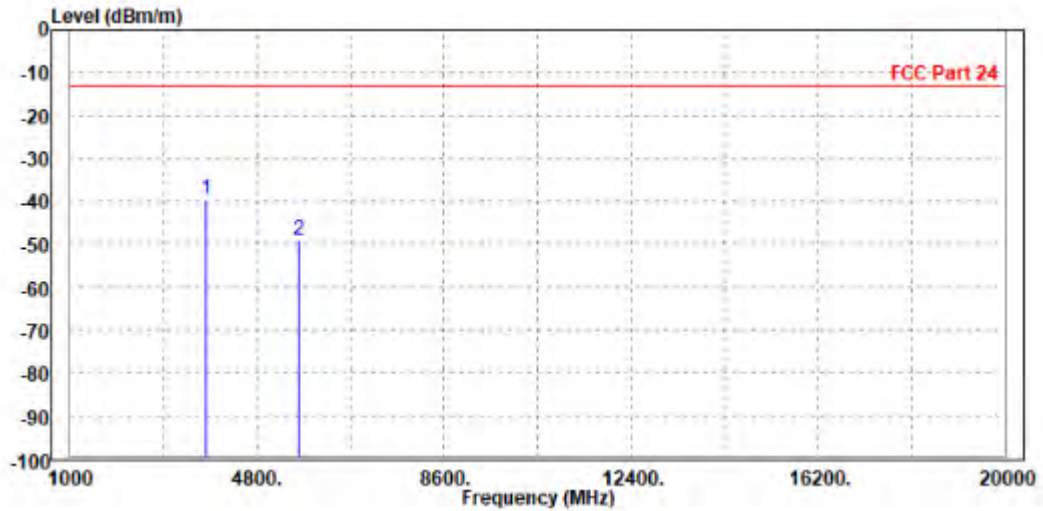



**BUREAU
VERITAS**

Test Report No.: W7L-P22030026-2RF04

MODE	TX channel 18900	FREQUENCY RANGE	Above 1000MHz
ENVIRONMENTAL CONDITIONS	23deg. C, 70%RH	INPUT POWER	AC 120V/60HZ
TESTED BY	Jace Hu		
ANTENNA POLARITY & TEST DISTANCE: VERTICAL AT 3 M			

	Freq	Level	Read Level	Limit Line	Over Limit	Factor	Remark	Pol/Phase
	MHz	dBm/m	dBm	dBm/m	dB	dB/m		
1	PP 3755.000	-41.29	-50.56	-13.00	-28.29	9.27	Peak	Vertical
2	5640.000	-48.90	-59.15	-13.00	-35.90	10.25	Peak	Vertical

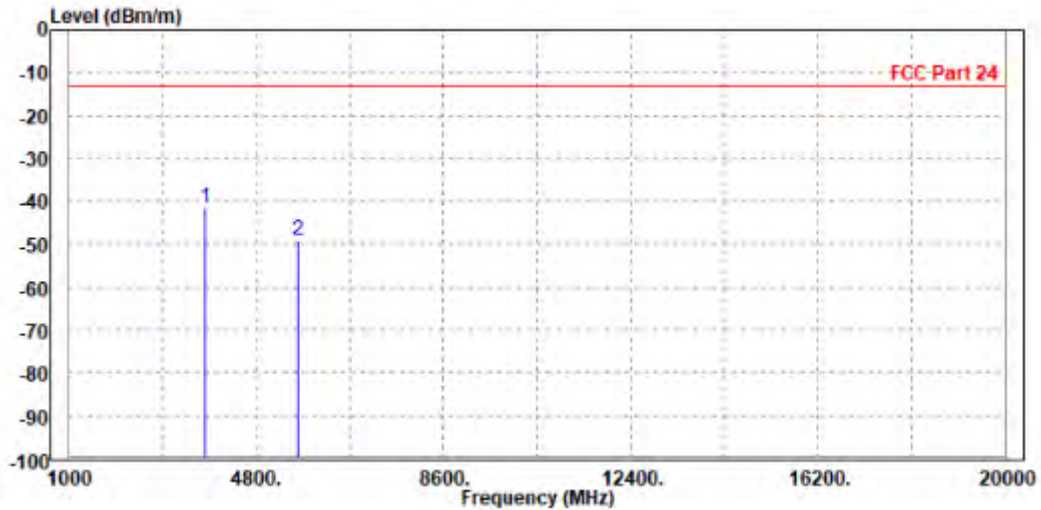



**BUREAU
VERITAS**

Test Report No.: W7L-P22030026-2RF04

CHANNEL BANDWIDTH: 5MHz / QPSK

MODE	TX channel 18900	FREQUENCY RANGE	Above 1000MHz
ENVIRONMENTAL CONDITIONS	23deg. C, 70%RH	INPUT POWER	AC 120V/60HZ
TESTED BY	Jace Hu		
ANTENNA POLARITY & TEST DISTANCE: HORIZONTAL AT 3 M			

	Freq	Level	Read Level	Limit Line	Over Limit	Factor	Remark	Pol/Phase
	MHz	dBm/m	dBm	dBm/m	dB	dB/m		
1 PP	3755.000	-38.89	-47.74	-13.00	-25.89	8.85	Peak	Horizontal
2	5640.000	-48.87	-59.35	-13.00	-35.87	10.48	Peak	Horizontal

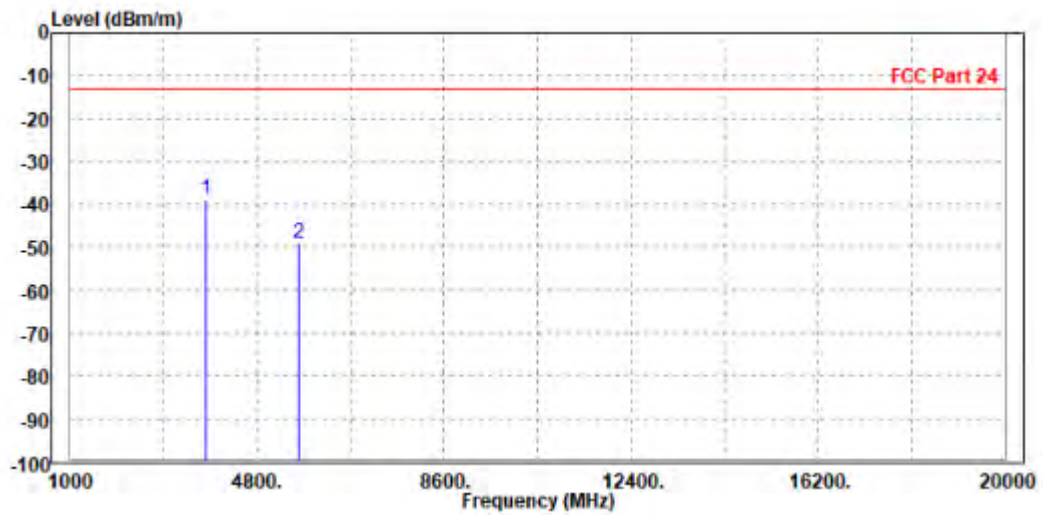



**BUREAU
VERITAS**

Test Report No.: W7L-P22030026-2RF04

MODE	TX channel 18900	FREQUENCY RANGE	Above 1000MHz
ENVIRONMENTAL CONDITIONS	23deg. C, 70%RH	INPUT POWER	AC 120V/60HZ
TESTED BY	Jace Hu		
ANTENNA POLARITY & TEST DISTANCE: VERTICAL AT 3 M			

	Freq	Level	Read Level	Limit Line	Over Limit	Factor	Remark	Pol/Phase
	MHz	dBm/m	dBm	dBm/m	dB	dB/m		
1	PP 3755.000	-42.94	-52.21	-13.00	-29.94	9.27	Peak	Vertical
2	5640.000	-49.19	-59.44	-13.00	-36.19	10.25	Peak	Vertical

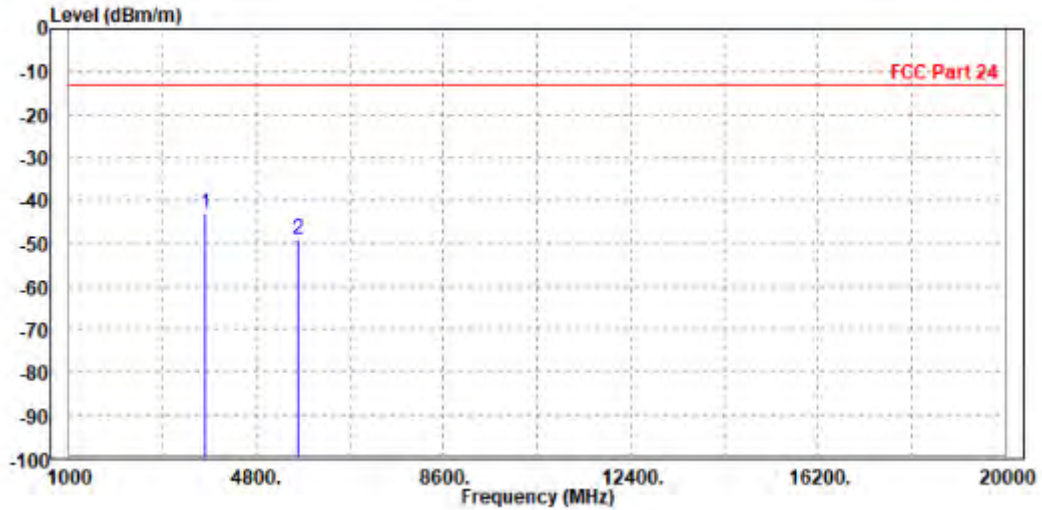



**BUREAU
VERITAS**

Test Report No.: W7L-P22030026-2RF04

CHANNEL BANDWIDTH: 10MHz / QPSK

MODE	TX channel 18900	FREQUENCY RANGE	Above 1000MHz
ENVIRONMENTAL CONDITIONS	23deg. C, 70%RH	INPUT POWER	AC 120V/60HZ
TESTED BY	Jace Hu		
ANTENNA POLARITY & TEST DISTANCE: HORIZONTAL AT 3 M			

	Freq	Level	Read Level	Limit Line	Over Limit	Factor	Remark	Pol/Phase
	MHz	dBm/m	dBm	dBm/m	dB	dB/m		
1 PP	3755.000	-41.65	-50.50	-13.00	-28.65	8.85	Peak	Horizontal
2	5640.000	-48.29	-58.77	-13.00	-35.29	10.48	Peak	Horizontal

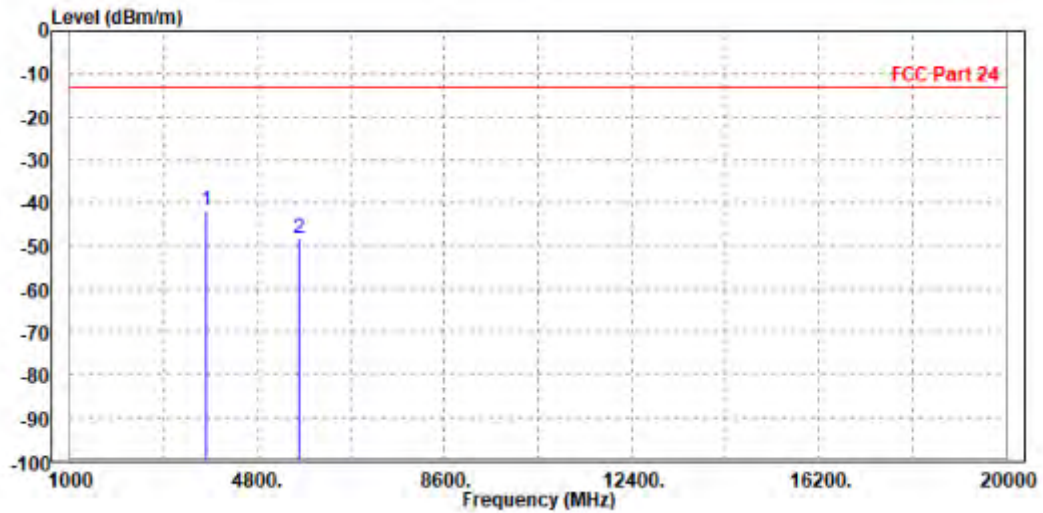



**BUREAU
VERITAS**

Test Report No.: W7L-P22030026-2RF04

MODE	TX channel 18900	FREQUENCY RANGE	Above 1000MHz
ENVIRONMENTAL CONDITIONS	23deg. C, 70%RH	INPUT POWER	AC 120V/60HZ
TESTED BY	Jace Hu		
ANTENNA POLARITY & TEST DISTANCE: VERTICAL AT 3 M			

	Freq	Level	Read Level	Limit Line	Over Limit	Factor	Remark	Pol/Phase
	MHz	dBm/m	dBm	dBm/m	dB	dB/m		
1 PP	3755.000	-44.15	-53.42	-13.00	-31.15	9.27	Peak	Vertical
2	5640.000	-48.85	-59.10	-13.00	-35.85	10.25	Peak	Vertical

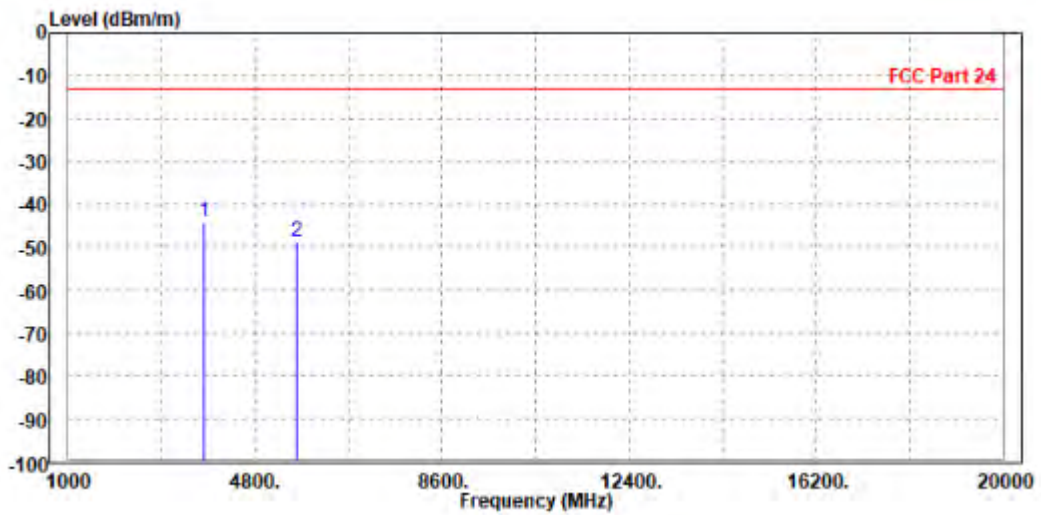



**BUREAU
VERITAS**

Test Report No.: W7L-P22030026-2RF04

CHANNEL BANDWIDTH: 15MHz / QPSK

MODE	TX channel 18900	FREQUENCY RANGE	Above 1000MHz
ENVIRONMENTAL CONDITIONS	23deg. C, 70%RH	INPUT POWER	AC 120V/60HZ
TESTED BY	Jace Hu		
ANTENNA POLARITY & TEST DISTANCE: HORIZONTAL AT 3 M			

	Freq	Level	Read Level	Limit Line	Over Limit	Factor	Remark	Pol/Phase
	MHz	dBm/m	dBm	dBm/m	dB	dB/m		
1 PP	3755.000	-41.34	-50.19	-13.00	-28.34	8.85	Peak	Horizontal
2	5640.000	-48.79	-59.27	-13.00	-35.79	10.48	Peak	Horizontal

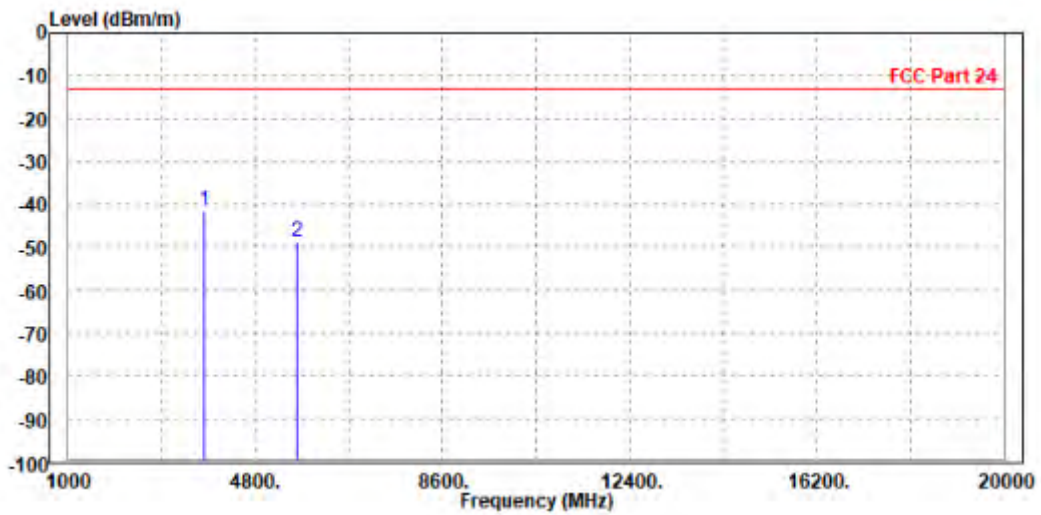



**BUREAU
VERITAS**

Test Report No.: W7L-P22030026-2RF04

MODE	TX channel 18900	FREQUENCY RANGE	Above 1000MHz
ENVIRONMENTAL CONDITIONS	23deg. C, 70%RH	INPUT POWER	AC 120V/60HZ
TESTED BY	Jace Hu		
ANTENNA POLARITY & TEST DISTANCE: VERTICAL AT 3 M			

		Read	Limit	Over			
	Freq	Level	Level	Line	Limit	Factor	Remark
	MHz	dBm/m	dBm	dBm/m	dB	dB/m	
1	PP 3755.000	-45.62	-54.89	-13.00	-32.62	9.27	Peak Vertical
2	5640.000	-48.72	-58.97	-13.00	-35.72	10.25	Peak Vertical

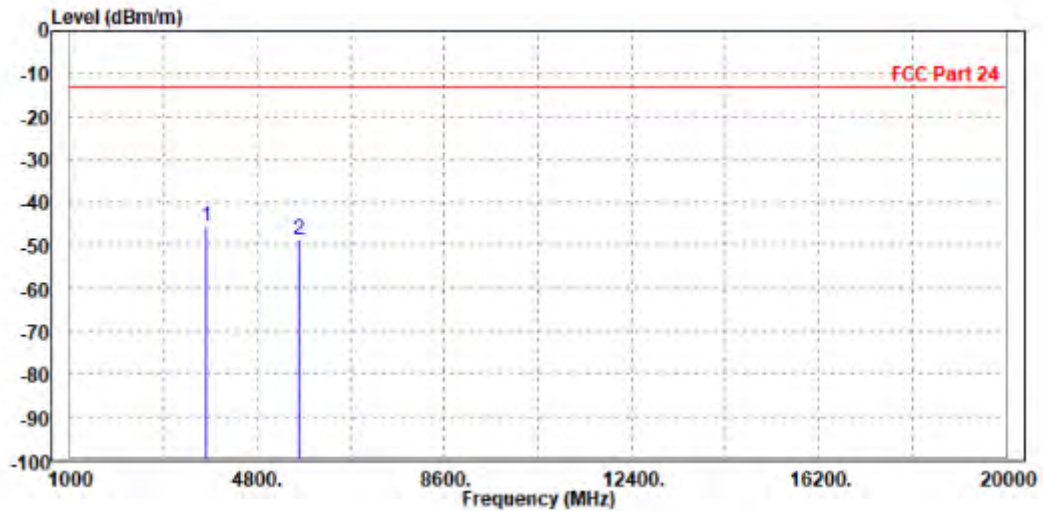



**BUREAU
VERITAS**

Test Report No.: W7L-P22030026-2RF04

CHANNEL BANDWIDTH: 20MHz / QPSK

MODE	TX channel 18900	FREQUENCY RANGE	Above 1000MHz
ENVIRONMENTAL CONDITIONS	23deg. C, 70%RH	INPUT POWER	AC 120V/60HZ
TESTED BY	Jace Hu		
ANTENNA POLARITY & TEST DISTANCE: HORIZONTAL AT 3 M			

	Freq	Level	Read Level	Limit Line	Over Limit	Factor	Remark	Pol/Phase
	MHz	dBm/m	dBm	dBm/m	dB	dB/m		
1	PP 3755.000	-43.62	-52.47	-13.00	-30.62	8.85	Peak	Horizontal
2	5640.000	-49.30	-59.78	-13.00	-36.30	10.48	Peak	Horizontal

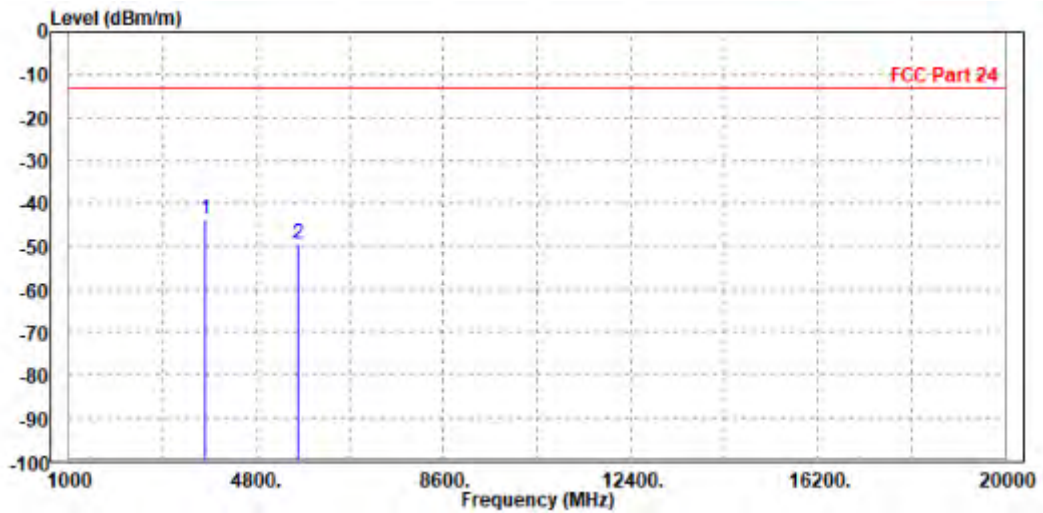



**BUREAU
VERITAS**

Test Report No.: W7L-P22030026-2RF04

MODE	TX channel 18900	FREQUENCY RANGE	Above 1000MHz
ENVIRONMENTAL CONDITIONS	23deg. C, 70%RH	INPUT POWER	AC 120V/60HZ
TESTED BY	Jace Hu		
ANTENNA POLARITY & TEST DISTANCE: VERTICAL AT 3 M			

	Freq	Level	Read Level	Limit Line	Over Limit	Factor	Remark	Pol/Phase
	MHz	dBm/m	dBm	dBm/m	dB	dB/m		
1	PP 3755.000	-46.28	-55.55	-13.00	-33.28	9.27	Peak	Vertical
2	5640.000	-48.85	-59.10	-13.00	-35.85	10.25	Peak	Vertical

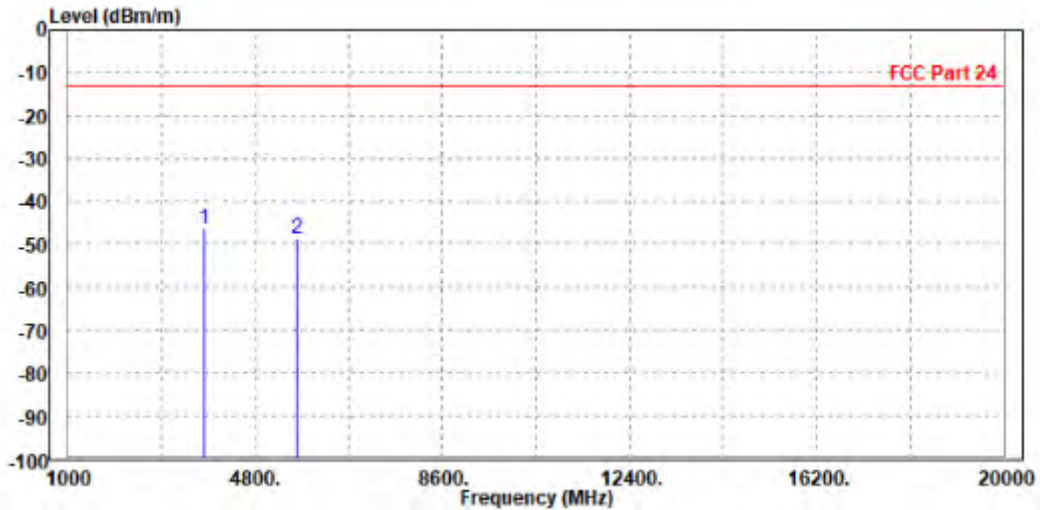



3.7 PEAK TO AVERAGE RATIO

3.7.1 LIMITS OF PEAK TO AVERAGE RATIO MEASUREMENT

In measuring transmissions in this band using an average power technique, the peak to-average ratio (PAR) of the transmission may not exceed 13 dB

3.7.2 TEST SETUP

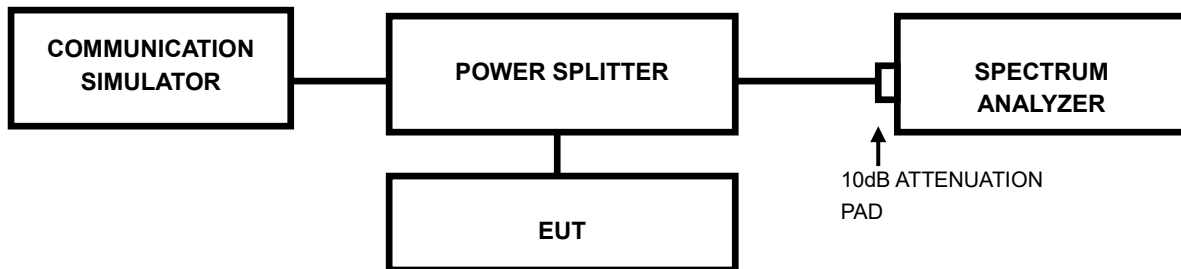

3.7.3 TEST PROCEDURES

1. Set resolution/measurement bandwidth \geq signal's occupied bandwidth;
2. Set the number of counts to a value that stabilizes the measured CCDF curve;
3. Record the maximum PAPR level associated with a probability of 0.1%.



BUREAU
VERITAS

Test Report No.: W7L-P22030026-2RF04

3.7.4 TEST RESULTS

Please Refer to Appendix Of this test report.



**BUREAU
VERITAS**

Test Report No.: W7L-P22030026-2RF04

4 INFORMATION ON THE TESTING LABORATORIES

We, BV 7LAYERS COMMUNICATIONS TECHNOLOGY (SHENZHEN) CO. LTD., were founded in 2015 to provide our best service in EMC, Radio, Telecom and Safety consultation. Our laboratories are accredited and approved according to ISO/IEC 17025.

If you have any comments, please feel free to contact us at the following:

Shenzhen EMC/RF Lab:

Tel: +86-755-88696566

Fax: +86-755-88696577

Email: customerservice.sw@bureauveritas.com

Web Site: www.adt.com.tw

The address and road map of all our labs can be found in our web site also.



Test Report No.: W7L-P22030026-2RF04

5 MODIFICATIONS RECORDERS FOR ENGINEERING CHANGES TO THE EUT BY THE LAB

No any modifications are made to the EUT by the lab during the test.



6 Appendix

GSM1900

PEAK-TO-AVERAGE RATIO (CCDF)

Test Result

Band	Channel	Result(dB)	Limit(dB)	Verdict
GSM1900	512	2.62	13	PASS
GSM1900	661	2.62	13	PASS
GSM1900	810	2.63	13	PASS
EGPRS1900	512	5.47	13	PASS
EGPRS1900	661	5.4	13	PASS
EGPRS1900	810	5.37	13	PASS



BUREAU VERITAS

Test Report No.: W7L-P22030026-2RF04

Test Graphs

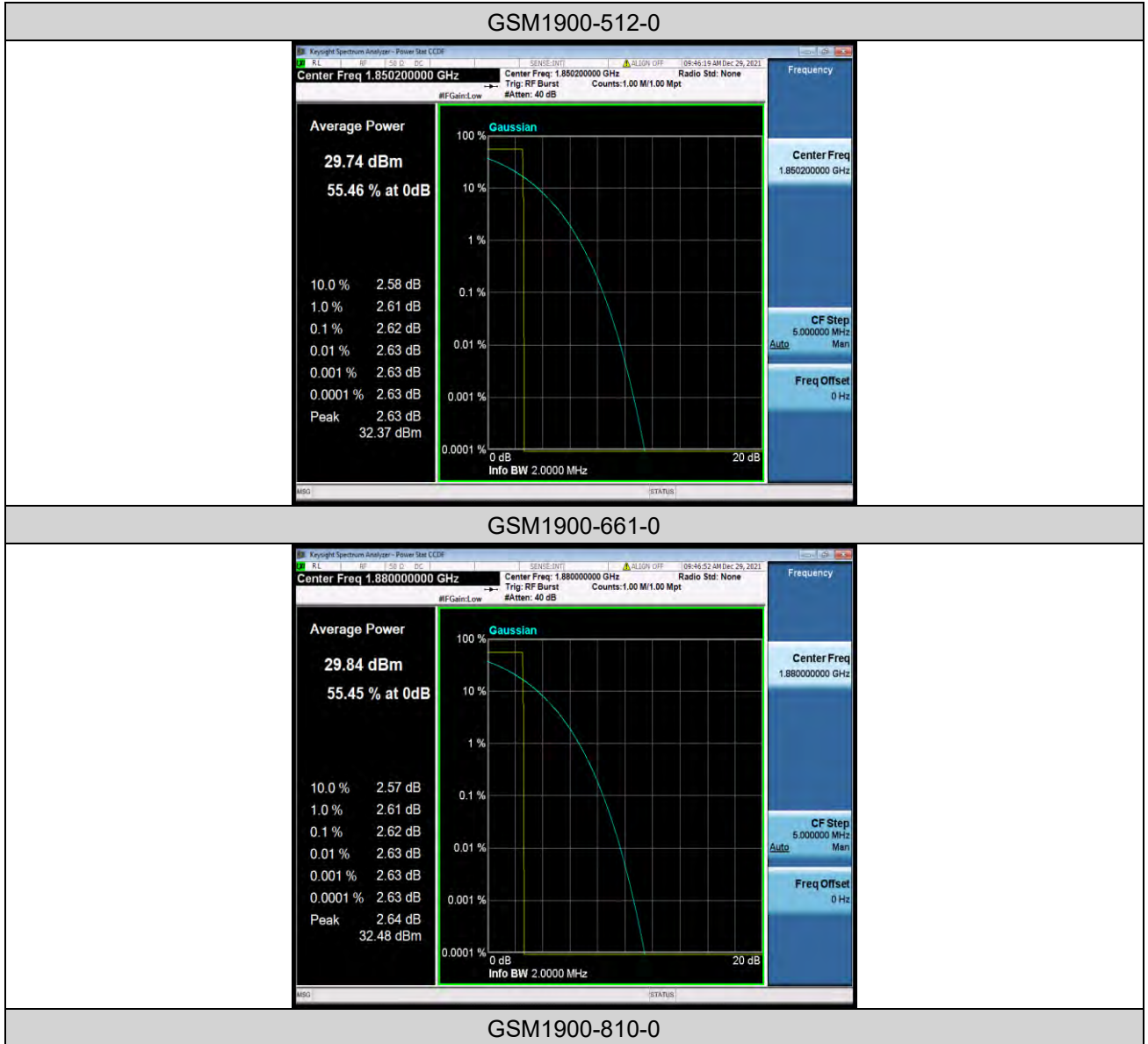



BUREAU VERITAS

Test Report No.: W7L-P22030026-2RF04



EGPRS1900-512-2



EGPRS1900-661-2

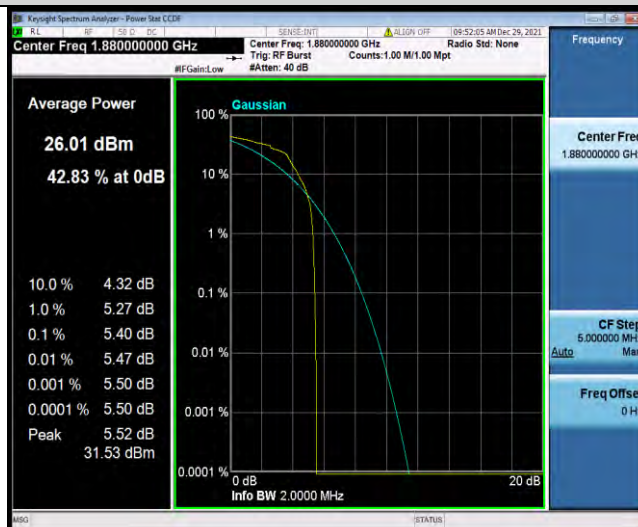

EGPRS1900-810-2



BUREAU
VERITAS

Test Report No.: W7L-P22030026-2RF04

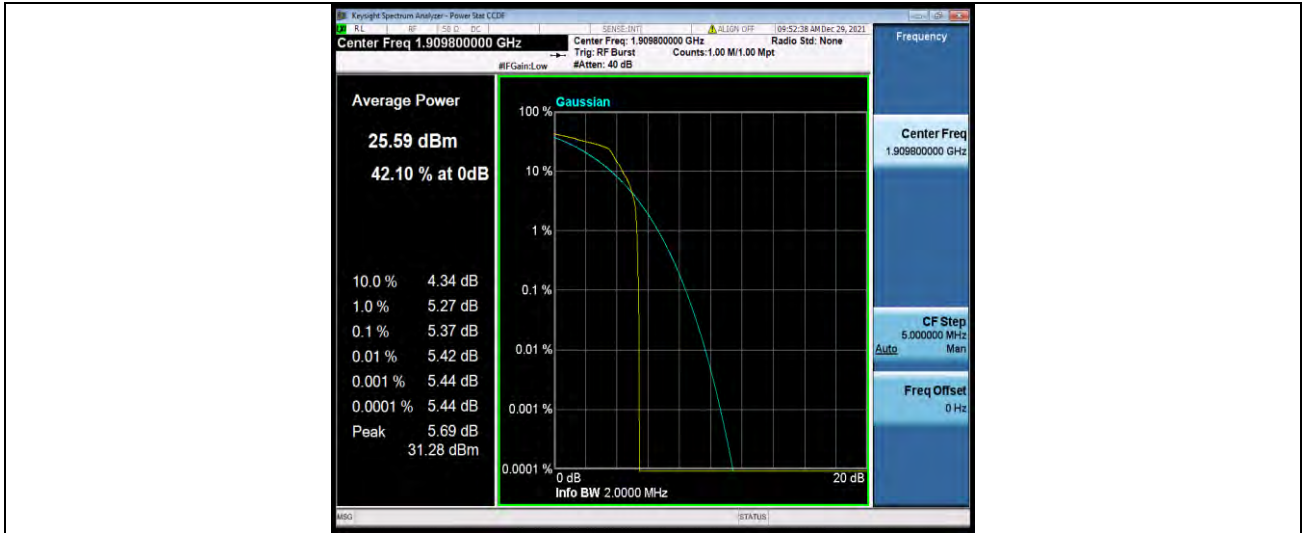



**BUREAU
VERITAS**

Test Report No.: W7L-P22030026-2RF04

26DB BANDWIDTH AND OCCUPIED BANDWIDTH

Test Result

Band	Channel	Occupied Bandwidth (MHz)	26dB Bandwidth (MHz)	Limit (MHz)	Verdict
GSM1900	512	0.24514	0.3129	---	PASS
GSM1900	661	0.24200	0.3081	---	PASS
GSM1900	810	0.24478	0.3108	---	PASS
EGPRS1900	512	0.24561	0.3097	---	PASS
EGPRS1900	661	0.24227	0.3050	---	PASS
EGPRS1900	810	0.24567	0.3086	---	PASS



BUREAU VERITAS

Test Report No.: W7L-P22030026-2RF04

Test Graphs

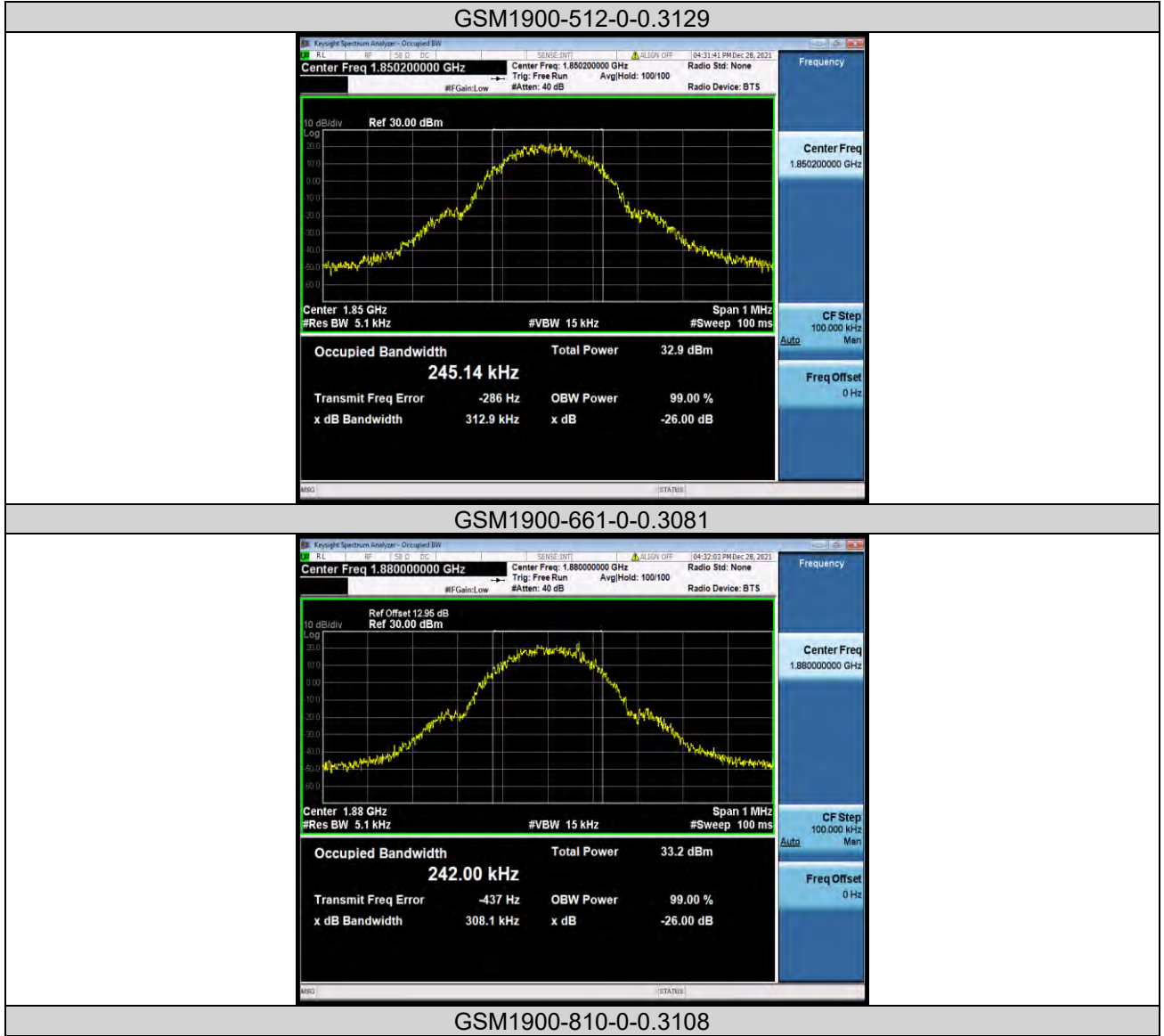



BUREAU VERITAS

Test Report No.: W7L-P22030026-2RF04

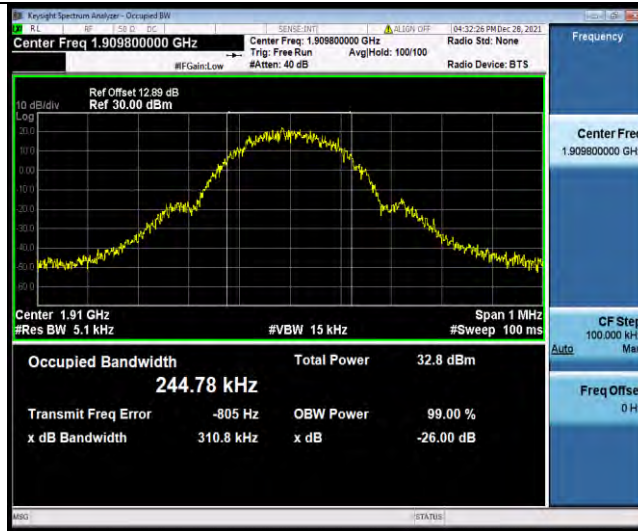

EGPRS1900-512-2-0.3097

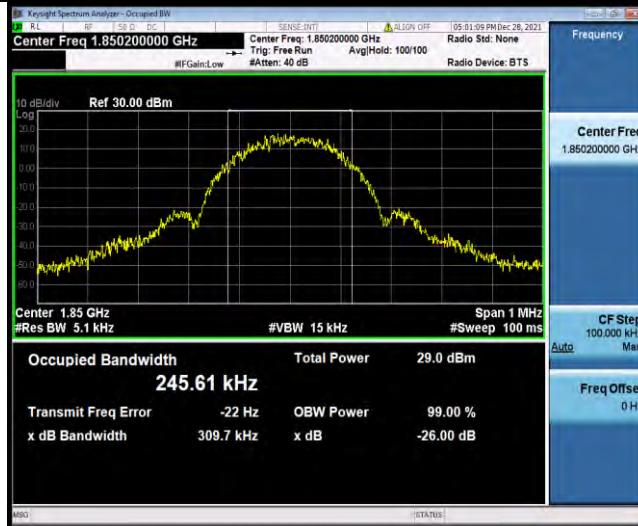

EGPRS1900-661-2-0.3050



EGPRS1900-810-2-0.3086



BUREAU VERITAS

Test Report No.: W7L-P22030026-2RF04

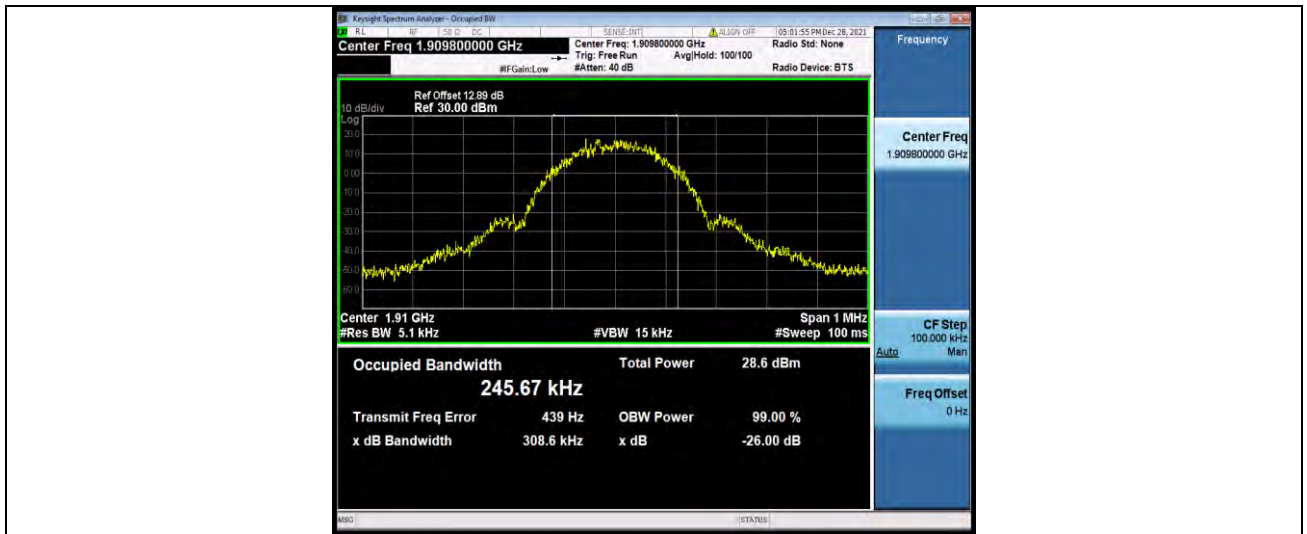



BUREAU
VERITAS

Test Report No.: W7L-P22030026-2RF04

BAND EDGE

Test Result

Band	Channel	Freq (MHz)	Result (dBm)	Limit(dBm)	Verdict
GSM1900	512	1849.98	-27.36	-13	PASS
GSM1900	810	1910.02	-26.37	-13	PASS
EGPRS1900	512	1849.99	-32.56	-13	PASS
EGPRS1900	810	1910.03	-33.03	-13	PASS



BUREAU
VERITAS

Test Report No.: W7L-P22030026-2RF04

Test Graphs

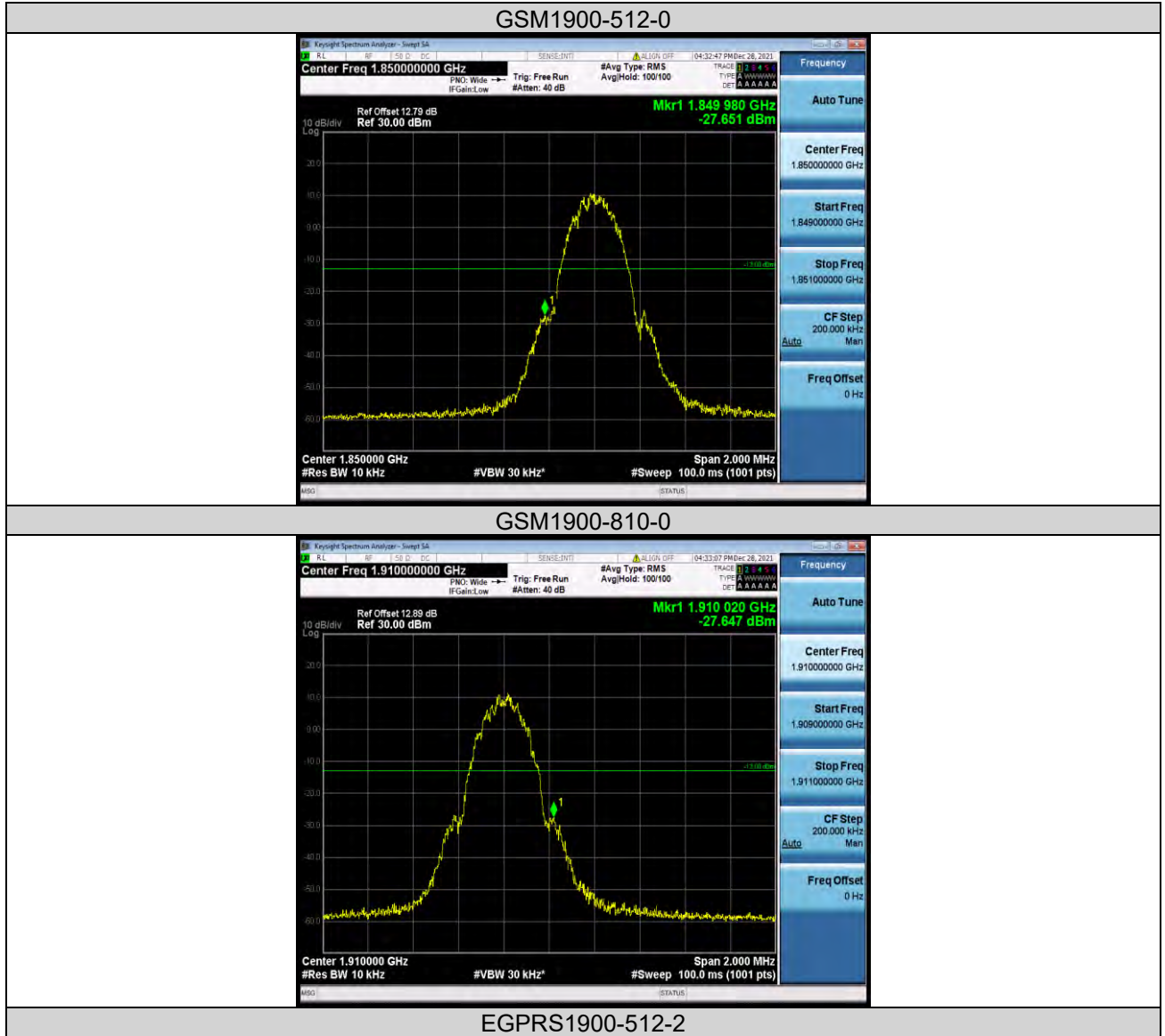



BUREAU VERITAS

Test Report No.: W7L-P22030026-2RF04

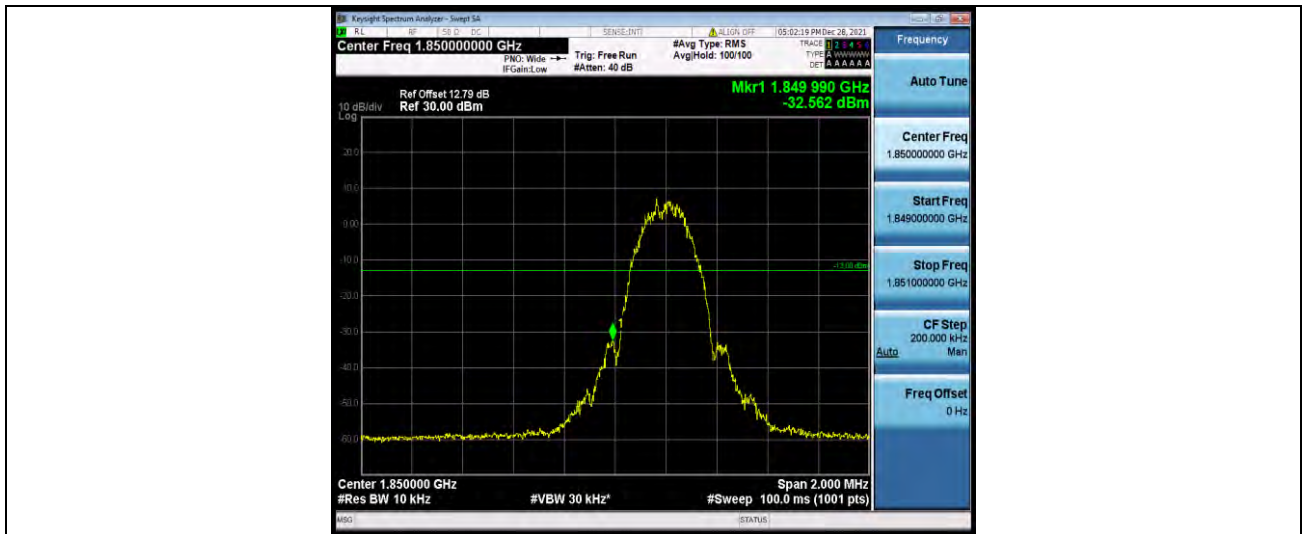

EGPRS1900-810-2

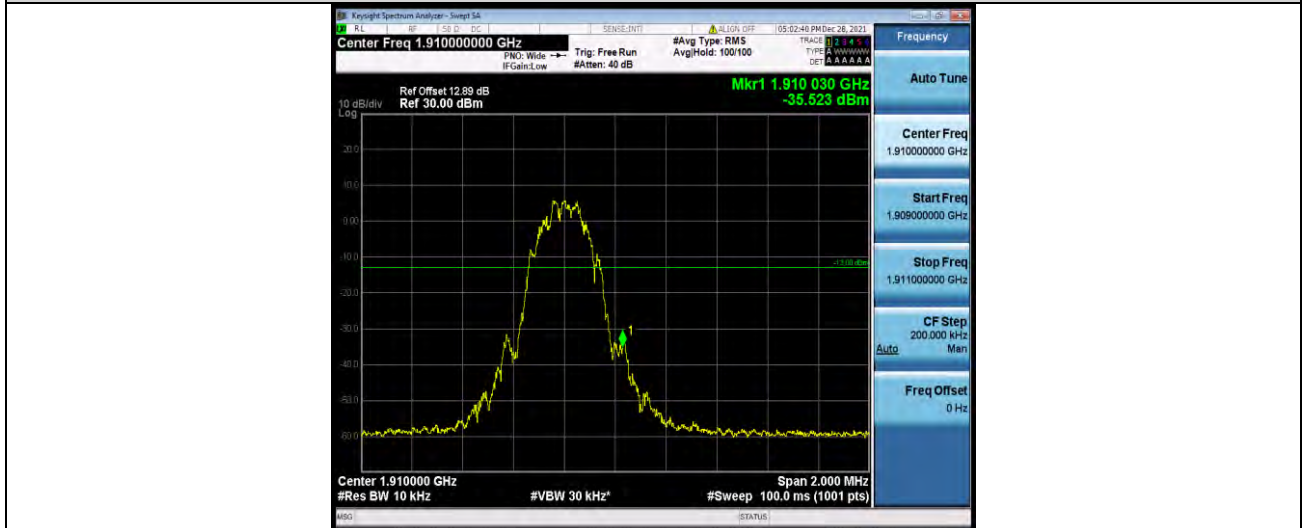



CONDUCTED SPURIOUS EMISSION

Test Result

Band	Channel	Frequency Range(MHz)	Max.Freq. (MHz)	Result (dBm)	Limit (dBm)	Verdict
GSM1900	512	30~1000MHz	813.89	-49.14	-13	PASS
GSM1900	512	1000~3000MHz	2634.07	-46.89	-13	PASS
GSM1900	512	3000~20000MHz	7639.3	-42.56	-13	PASS
GSM1900	661	30~1000MHz	895.3	-49.3	-13	PASS
GSM1900	661	1000~3000MHz	2645.27	-46.9	-13	PASS
GSM1900	661	3000~20000MHz	7639.3	-42.16	-13	PASS
GSM1900	810	30~1000MHz	838.69	-48.84	-13	PASS
GSM1900	810	1000~3000MHz	2640	-46.85	-13	PASS
GSM1900	810	3000~20000MHz	7639.3	-43.09	-13	PASS
EGPRS1900	512	30~1000MHz	803.35	-49.06	-13	PASS
EGPRS1900	512	1000~3000MHz	2636.67	-46.84	-13	PASS
EGPRS1900	512	3000~20000MHz	19125.07	-43.61	-13	PASS
EGPRS1900	661	30~1000MHz	913.83	-49.08	-13	PASS
EGPRS1900	661	1000~3000MHz	2638.27	-46.83	-13	PASS
EGPRS1900	661	3000~20000MHz	19138.1	-43.64	-13	PASS
EGPRS1900	810	30~1000MHz	948.49	-48.68	-13	PASS
EGPRS1900	810	1000~3000MHz	2648.27	-46.81	-13	PASS
EGPRS1900	810	3000~20000MHz	19172.67	-43.68	-13	PASS



BUREAU
VERITAS

Test Report No.: W7L-P22030026-2RF04

Test Graphs

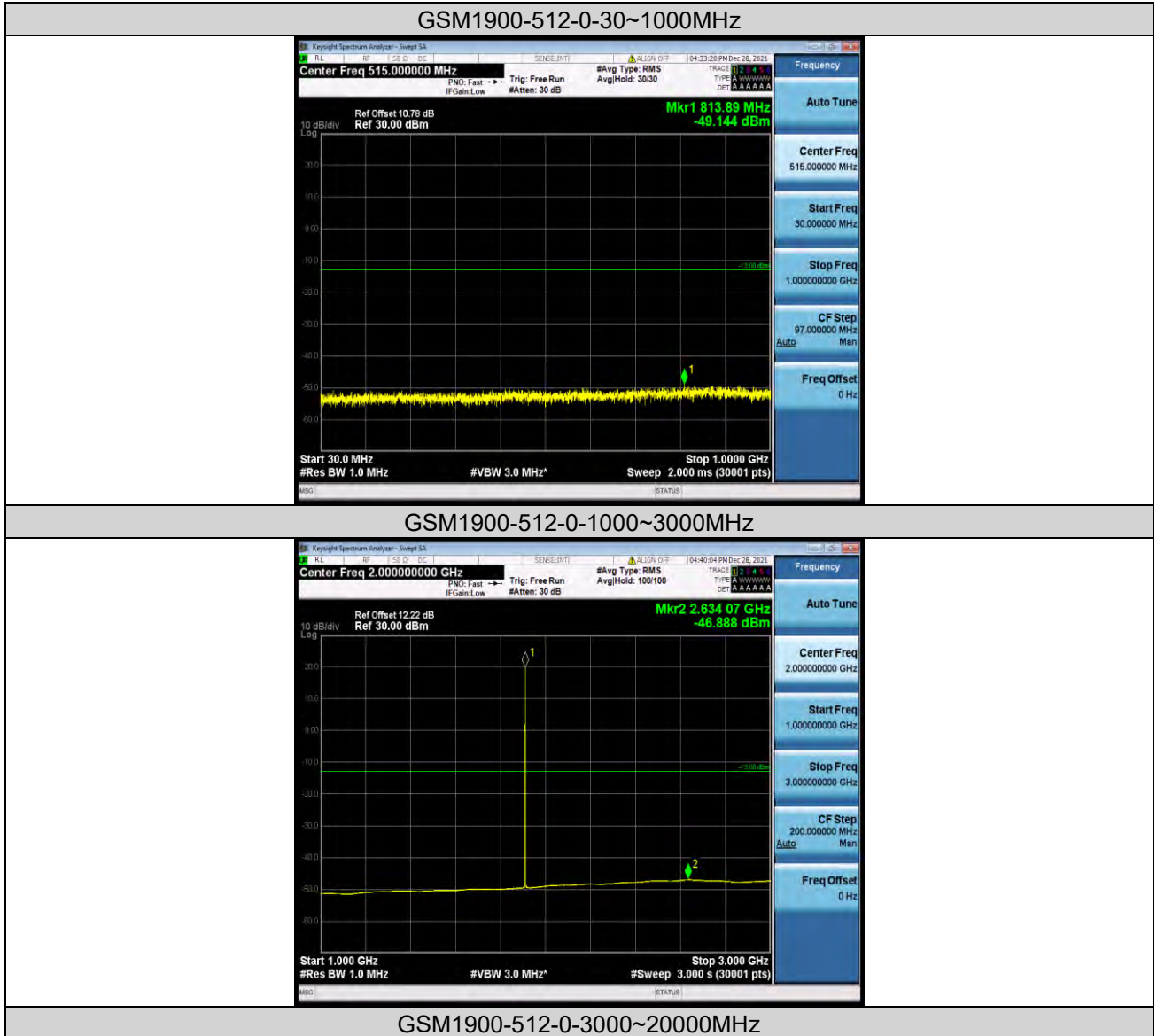



BUREAU VERITAS

Test Report No.: W7L-P22030026-2RF04

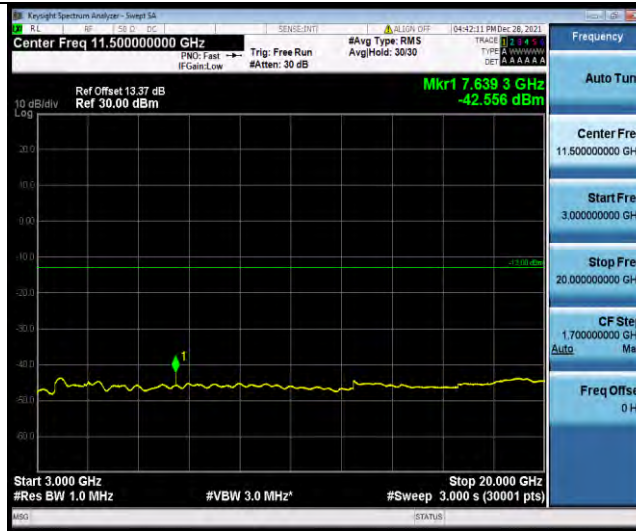

GSM1900-661-0-30~1000MHz



GSM1900-661-0-1000~3000MHz



GSM1900-661-0-3000~20000MHz



BUREAU VERITAS

Test Report No.: W7L-P22030026-2RF04



GSM1900-810-0-30~1000MHz

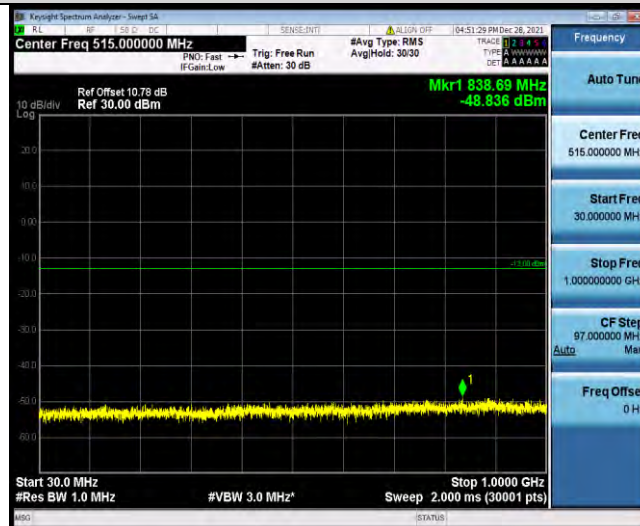

GSM1900-810-0-1000~3000MHz



GSM1900-810-0-3000~20000MHz



BUREAU VERITAS

Test Report No.: W7L-P22030026-2RF04



EGPRS1900-512-2-30~1000MHz



EGPRS1900-512-2-1000~3000MHz



EGPRS1900-512-2-3000~20000MHz

BV 7Layers Communications Technology (Shenzhen) Co., Ltd

No.B102, Dazu Chuangxin Mansion, North of Beihuan Avenue, North Area, Hi-Tech Industrial Park, Nanshan District, Shenzhen, Guangdong, China

Tel: +86 755 8869 6566
Fax: +86 755 8869 6577
Email: customerservice.sw@bureauveritas.com



BUREAU VERITAS

Test Report No.: W7L-P22030026-2RF04



EGPRS1900-661-2-30~1000MHz

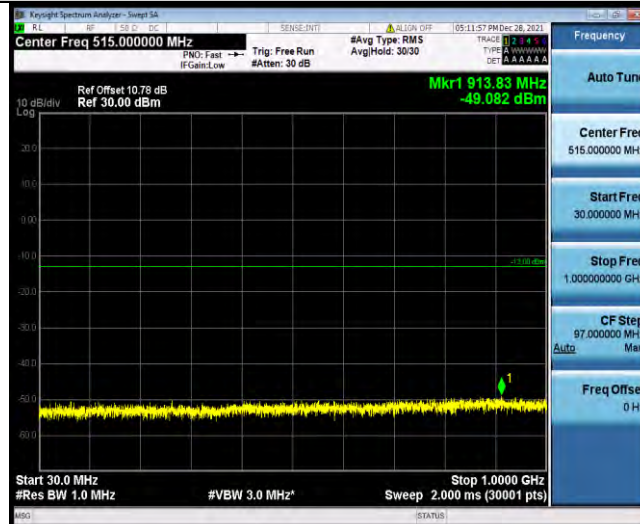

EGPRS1900-661-2-1000~3000MHz



EGPRS1900-661-2-3000~20000MHz



BUREAU VERITAS

Test Report No.: W7L-P22030026-2RF04



EGPRS1900-810-2-30~1000MHz



EGPRS1900-810-2-1000~3000MHz

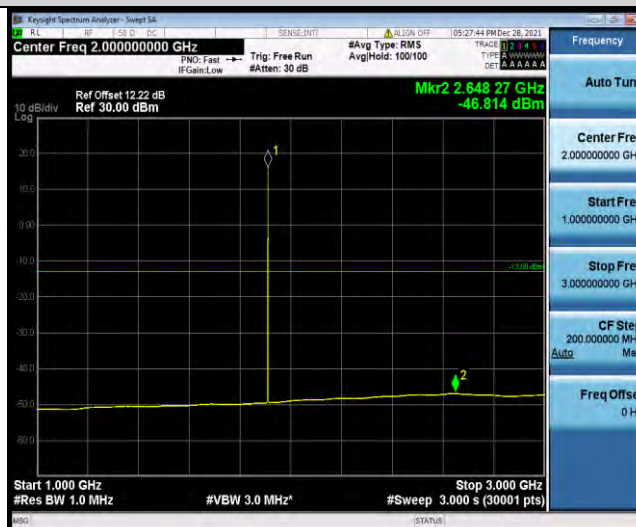

EGPRS1900-810-2-3000~20000MHz



BUREAU
VERITAS

Test Report No.: W7L-P22030026-2RF04



BV 7Layers Communications Technology
(Shenzhen) Co., Ltd

No.B102, Dazu Chuangxin Mansion, North of Beihuan
Avenue, North Area, Hi-Tech Industrial Park, Nanshan
District, Shenzhen, Guangdong, China

Tel: +86 755 8869 6566
Fax: +86 755 8869 6577
Email: customerservice.sw@bureauveritas.com



FREQUENCY STABILITY

Test Result

Voltage							
Band	Channel	Voltage [Vdc]	Temperature (°C)	Deviation (Hz)	Deviation (ppm)	Limit (ppm)	Verdict
GSM1900	512	VL	NT	3.87	0.002092	±2.5	PASS
GSM1900	512	VN	NT	-5.33	-0.002881	±2.5	PASS
GSM1900	512	VH	NT	-8.43	-0.004556	±2.5	PASS
GSM1900	661	VL	NT	16.01	0.008516	±2.5	PASS
GSM1900	661	VN	NT	1.49	0.000793	±2.5	PASS
GSM1900	661	VH	NT	11.95	0.006356	±2.5	PASS
GSM1900	810	VL	NT	12.43	0.006509	±2.5	PASS
GSM1900	810	VN	NT	-13.59	-0.007116	±2.5	PASS
GSM1900	810	VH	NT	9.30	0.004870	±2.5	PASS
EGPRS1900	512	VL	NT	-13.24	-0.007156	±2.5	PASS
EGPRS1900	512	VN	NT	-7.78	-0.004205	±2.5	PASS
EGPRS1900	512	VH	NT	-3.97	-0.002146	±2.5	PASS
EGPRS1900	661	VL	NT	-1.52	-0.000809	±2.5	PASS
EGPRS1900	661	VN	NT	0.23	0.000122	±2.5	PASS
EGPRS1900	661	VH	NT	-0.94	-0.000500	±2.5	PASS
EGPRS1900	810	VL	NT	-1.45	-0.000759	±2.5	PASS
EGPRS1900	810	VN	NT	-9.36	-0.004901	±2.5	PASS
EGPRS1900	810	VH	NT	0.03	0.000016	±2.5	PASS

Temperature							
Band	Channel	Voltage [Vdc]	Temperature (°C)	Deviation (Hz)	Deviation (ppm)	Limit (ppm)	Verdict
GSM1900	512	NV	-30	-8.43	-0.004556	±2.5	PASS
GSM1900	512	NV	-20	-10.14	-0.005480	±2.5	PASS
GSM1900	512	NV	-10	0.42	0.000227	±2.5	PASS
GSM1900	512	NV	0	-2.91	-0.001573	±2.5	PASS
GSM1900	512	NV	10	7.10	0.003837	±2.5	PASS
GSM1900	512	NV	20	4.13	0.002232	±2.5	PASS
GSM1900	512	NV	30	9.81	0.005302	±2.5	PASS
GSM1900	512	NV	40	2.55	0.001378	±2.5	PASS
GSM1900	512	NV	50	-5.00	-0.002702	±2.5	PASS



BUREAU
VERITAS

Test Report No.: W7L-P22030026-2RF04

GSM1900	661	NV	-30	13.53	0.007197	±2.5	PASS
GSM1900	661	NV	-20	18.27	0.009718	±2.5	PASS
GSM1900	661	NV	-10	19.31	0.010271	±2.5	PASS
GSM1900	661	NV	0	13.20	0.007021	±2.5	PASS
GSM1900	661	NV	10	9.23	0.004910	±2.5	PASS
GSM1900	661	NV	20	-0.29	-0.000154	±2.5	PASS
GSM1900	661	NV	30	17.05	0.009069	±2.5	PASS
GSM1900	661	NV	40	11.07	0.005888	±2.5	PASS
GSM1900	661	NV	50	16.18	0.008606	±2.5	PASS
GSM1900	810	NV	-30	7.43	0.003890	±2.5	PASS
GSM1900	810	NV	-20	9.59	0.005021	±2.5	PASS
GSM1900	810	NV	-10	10.43	0.005461	±2.5	PASS
GSM1900	810	NV	0	2.20	0.001152	±2.5	PASS
GSM1900	810	NV	10	12.56	0.006577	±2.5	PASS
GSM1900	810	NV	20	10.14	0.005309	±2.5	PASS
GSM1900	810	NV	30	1.97	0.001032	±2.5	PASS
GSM1900	810	NV	40	4.97	0.002602	±2.5	PASS
GSM1900	810	NV	50	11.46	0.006001	±2.5	PASS
EGPRS1900	512	NV	-30	-4.36	-0.002357	±2.5	PASS
EGPRS1900	512	NV	-20	-10.49	-0.005670	±2.5	PASS
EGPRS1900	512	NV	-10	-3.65	-0.001973	±2.5	PASS
EGPRS1900	512	NV	0	-10.98	-0.005934	±2.5	PASS
EGPRS1900	512	NV	10	-4.65	-0.002513	±2.5	PASS
EGPRS1900	512	NV	20	-5.29	-0.002859	±2.5	PASS
EGPRS1900	512	NV	30	3.00	0.001621	±2.5	PASS
EGPRS1900	512	NV	40	1.52	0.000822	±2.5	PASS
EGPRS1900	512	NV	50	-15.21	-0.008221	±2.5	PASS
EGPRS1900	661	NV	-30	-0.90	-0.000479	±2.5	PASS
EGPRS1900	661	NV	-20	6.72	0.003574	±2.5	PASS
EGPRS1900	661	NV	-10	5.91	0.003144	±2.5	PASS
EGPRS1900	661	NV	0	2.49	0.001324	±2.5	PASS
EGPRS1900	661	NV	10	-13.17	-0.007005	±2.5	PASS
EGPRS1900	661	NV	20	-19.50	-0.010372	±2.5	PASS
EGPRS1900	661	NV	30	-11.98	-0.006372	±2.5	PASS
EGPRS1900	661	NV	40	-11.56	-0.006149	±2.5	PASS



BUREAU
VERITAS

Test Report No.: W7L-P22030026-2RF04

00							
EGPRS19 00	661	NV	50	-8.75	-0.004654	±2.5	PASS
EGPRS19 00	810	NV	-30	-4.58	-0.002398	±2.5	PASS
EGPRS19 00	810	NV	-20	-3.94	-0.002063	±2.5	PASS
EGPRS19 00	810	NV	-10	-11.82	-0.006189	±2.5	PASS
EGPRS19 00	810	NV	0	-14.04	-0.007352	±2.5	PASS
EGPRS19 00	810	NV	10	-14.37	-0.007524	±2.5	PASS
EGPRS19 00	810	NV	20	-4.97	-0.002602	±2.5	PASS
EGPRS19 00	810	NV	30	-14.11	-0.007388	±2.5	PASS
EGPRS19 00	810	NV	40	-0.94	-0.000492	±2.5	PASS
EGPRS19 00	810	NV	50	1.65	0.000864	±2.5	PASS



**BUREAU
VERITAS**

Test Report No.: W7L-P22030026-2RF04

WCDMA BAND2

PEAK-TO-AVERAGE RATIO

Test Result

Band	Channel	Peak-to-Average Ratio(dB)	Limit(dBm)	Verdict
Band2	9262	3.05	13	PASS
Band2	9400	3.06	13	PASS
Band2	9538	3.05	13	PASS



BUREAU
VERITAS

Test Report No.: W7L-P22030026-2RF04

Test Graphs

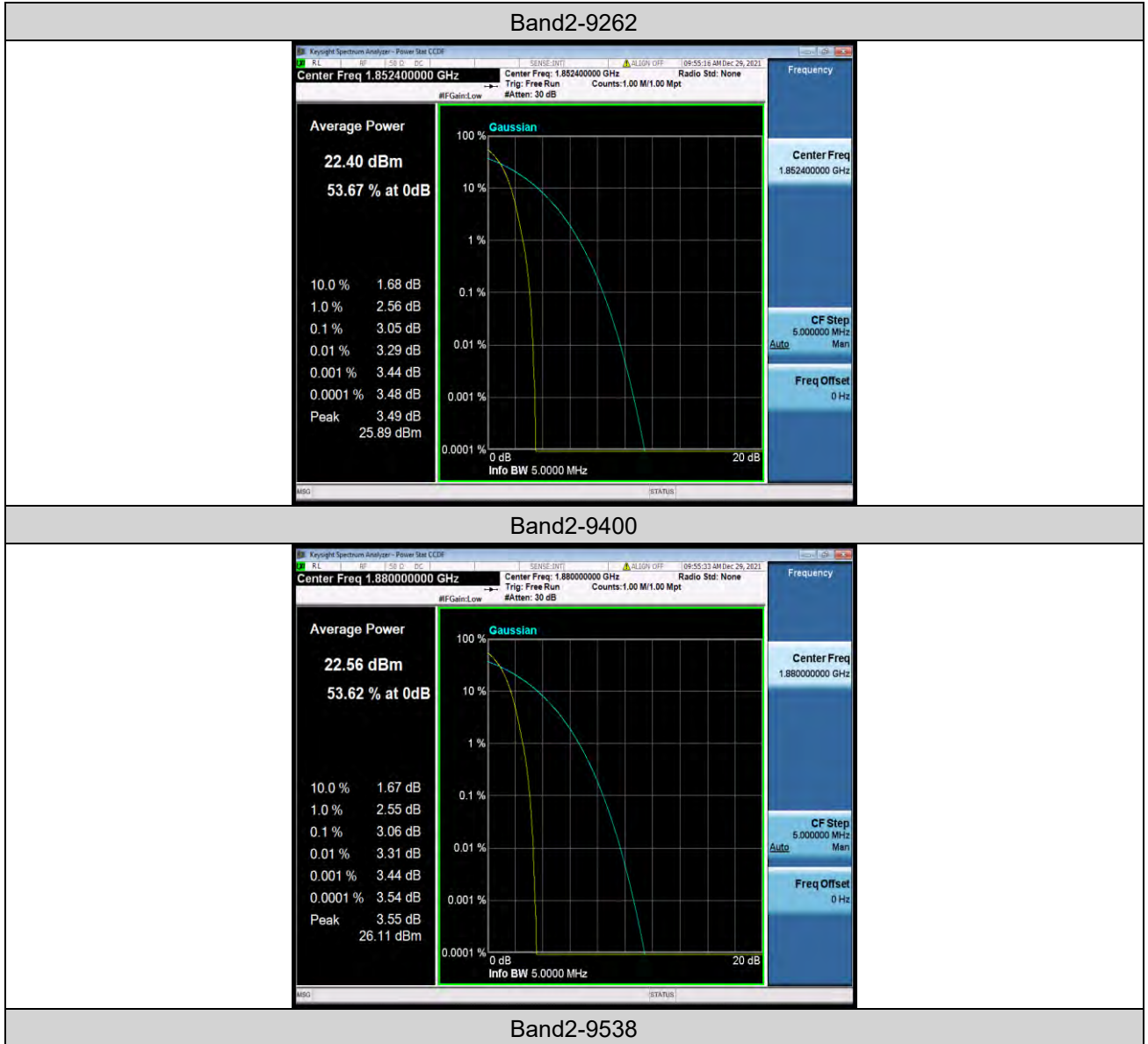



**BUREAU
VERITAS**

Test Report No.: W7L-P22030026-2RF04

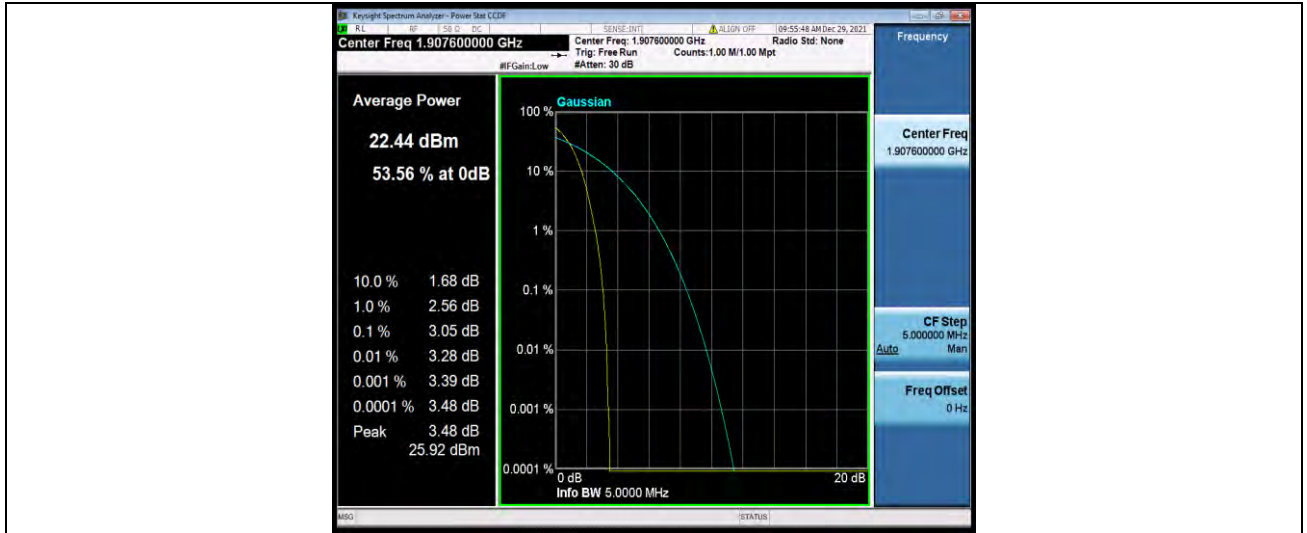

26DB BANDWIDTH AND OCCUPIED BANDWIDTH

Test Result

Band	Channel	Occupied Bandwidth (MHz)	26dB Bandwidth (MHz)	Limit(kHz)	Verdict
Band2	9262	4.1697	4.685	---	PASS
Band2	9400	4.1684	4.682	---	PASS
Band2	9538	4.1599	4.696	---	PASS



BUREAU
VERITAS

Test Report No.: W7L-P22030026-2RF04

Test Graphs





BUREAU VERITAS

Test Report No.: W7L-P22030026-2RF04

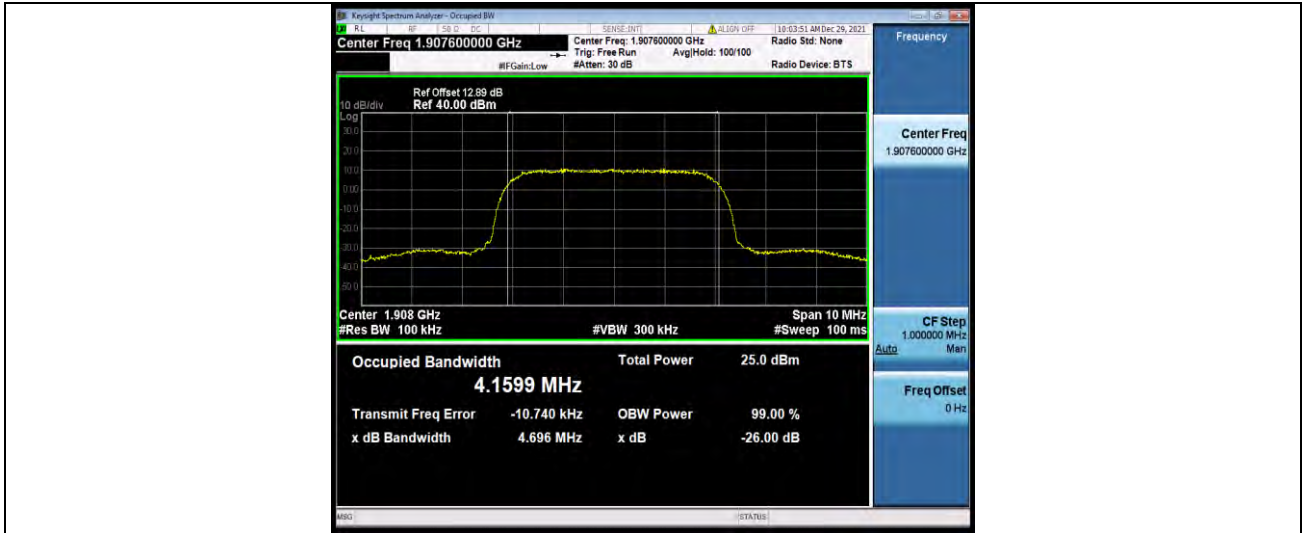

BAND EDGE

Test Result

Band	Channel	Frequency (MHz)	Result (dBm)	Limit(dBm)	Verdict
Band2	9262	1849.92	-28.76	-13	PASS
Band2	9538	1910.08	-29.36	-13	PASS



BUREAU
VERITAS

Test Report No.: W7L-P22030026-2RF04

Test Graphs

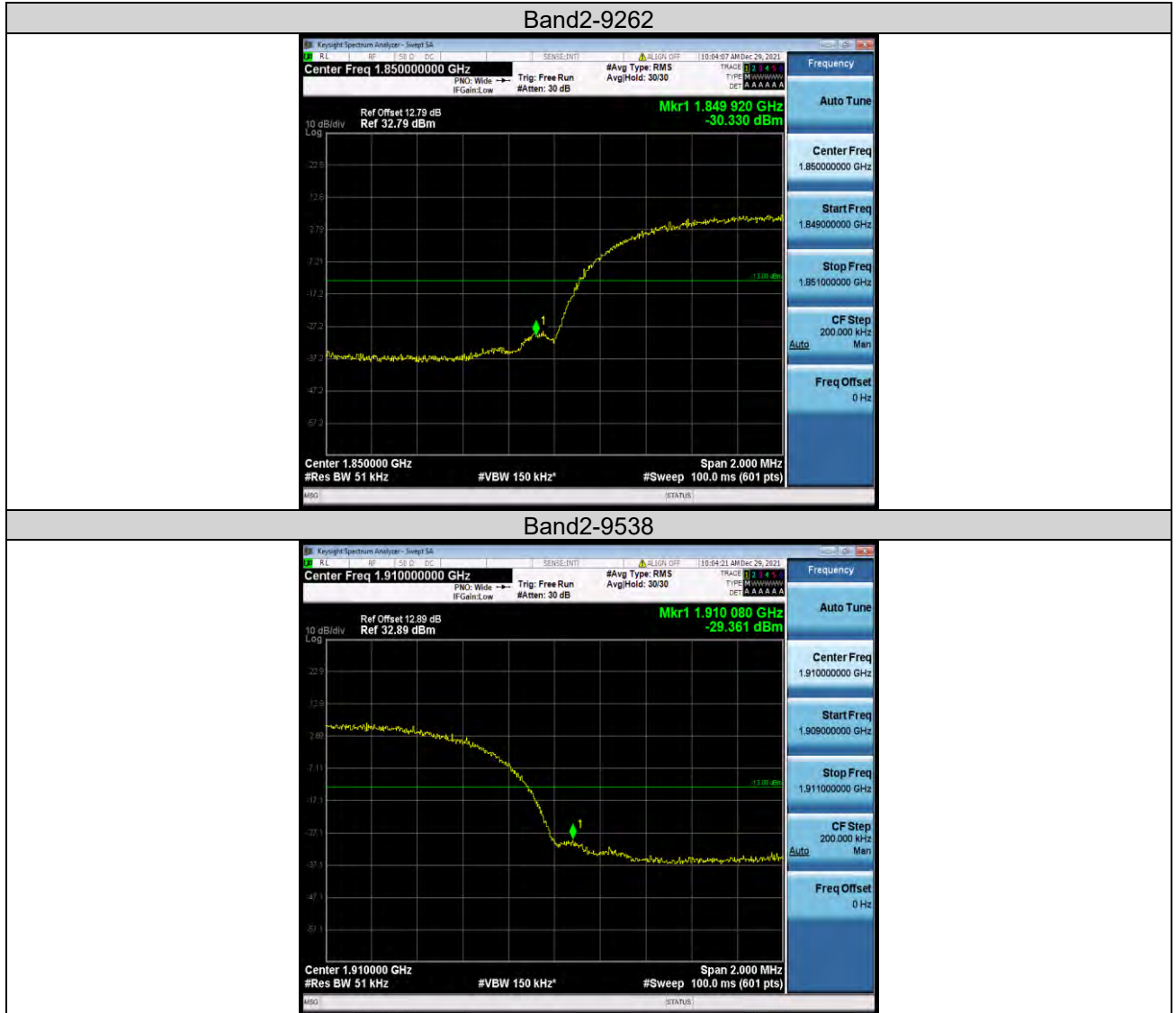



CONDUCTED SPURIOUS EMISSION

Test Result

Band	Channel	Frequency Range (Mhz)	Frequency (dBm)	Result (dBm)	Limit (dBm)	Verdict
Band2	9262	0.15~30MHz	0.17	-40.26	-23	PASS
Band2	9262	30~1000MHz	872.54	-37.15	-13	PASS
Band2	9262	1000~3000MHz	2638.73	-36.53	-13	PASS
Band2	9262	3000~20000MHz	19080.87	-33.36	-13	PASS
Band2	9400	0.15~30MHz	0.16	-37.32	-23	PASS
Band2	9400	30~1000MHz	804.71	-37.68	-13	PASS
Band2	9400	1000~3000MHz	2643.4	-36.48	-13	PASS
Band2	9400	3000~20000MHz	3761.6	-33.16	-13	PASS
Band2	9538	0.15~30MHz	0.16	-38.64	-23	PASS
Band2	9538	30~1000MHz	989.59	-37.42	-13	PASS
Band2	9538	1000~3000MHz	2624.6	-36.52	-13	PASS
Band2	9538	3000~20000MHz	3816.57	-33.31	-13	PASS



BUREAU
VERITAS

Test Report No.: W7L-P22030026-2RF04

Test Graphs

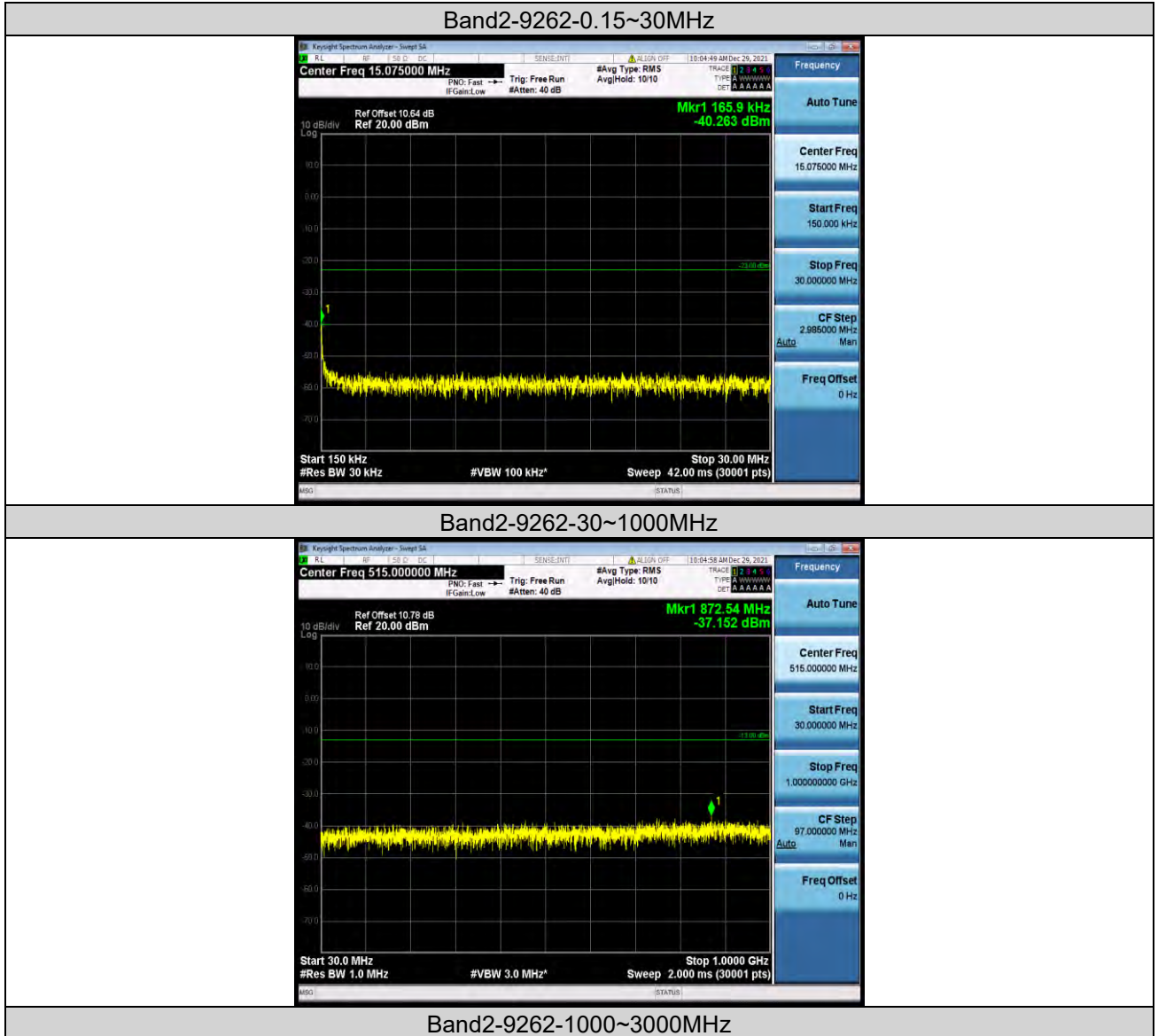



BUREAU VERITAS

Test Report No.: W7L-P22030026-2RF04



Band2-9262-3000~20000MHz



Band2-9400-0.15~30MHz



Band2-9400-30~1000MHz



BUREAU VERITAS

Test Report No.: W7L-P22030026-2RF04

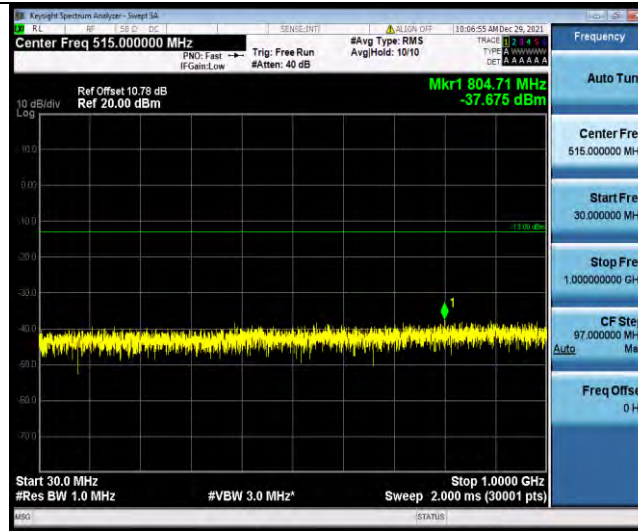

Band2-9400-1000~3000MHz



Band2-9400-3000~20000MHz



Band2-9538-0.15~30MHz

BV 7Layers Communications Technology (Shenzhen) Co., Ltd

No.B102, Dazu Chuangxin Mansion, North of Beihuan Avenue, North Area, Hi-Tech Industrial Park, Nanshan District, Shenzhen, Guangdong, China

Tel: +86 755 8869 6566
Fax: +86 755 8869 6577

Email: customerservice.sw@bureauveritas.com