



Test Report No.: W7L-P22030026-2RF03



VARIANT FCC TEST REPORT

(PART 22)



Applicant:	HMD Global Oy
Address:	Bertel Jungin aukio 9, 02600 Espoo, Finland

Manufacturer or Supplier:	HMD Global Oy
Address:	Bertel Jungin aukio 9, 02600 Espoo, Finland
Product:	Multi-band GSM/WCDMA/LTE phone with Bluetooth&WLAN
Brand Name:	Nokia
Model Name:	TA-1425
FCC ID:	2AJOTTA-1425
Date of tests:	Jan. 02, 2022 ~ Apr. 19, 2022

The tests have been carried out according to the requirements of the following standard:

- FCC PART 22, Subpart H
- ANSI/TIA/EIA-603-D
- ANSI/TIA/EIA-603-E
- FCC Part 2
- ANSI C63.26-2015

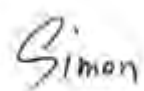
CONCLUSION: The submitted sample was found to COMPLY with the test requirement

Prepared by Simon Wang Engineer / Mobile Department	Approved by Luke Lu Manager / Mobile Department
	
Date: Apr. 19, 2022	Date: Apr. 19, 2022

This report is governed by, and incorporates by reference, CPS Conditions of Service as posted at the date of issuance of this report at <http://www.bureauveritas.com/home/about-us/our-business/cps/about-us/terms-conditions> and is intended for your exclusive use. Any copying or replication of this report to or for any other person or entity, or use of our name or trademark, is permitted only with our prior written permission. This report sets forth our findings solely with respect to the test samples identified herein. The results set forth in this report are not indicative or representative of the quality or characteristics of the lot from which a test sample was taken or any similar or identical product unless specifically and expressly noted. Our report includes all of the tests requested by you and the results thereof based upon the information that you provided to us. Measurement uncertainty is only provided upon request for accredited tests. You have 60 days from date of issuance of this report to notify us of any material error or omission caused by our negligence or if you require measurement uncertainty; provided, however, that such notice shall be in writing and shall specifically address the issue you wish to raise. A failure to raise such issue within the prescribed time shall constitute your unqualified acceptance of the completeness of this report, the tests conducted and the correctness of the report contents.



TABLE OF CONTENTS

RELEASE CONTROL RECORD4

1 SUMMARY OF TEST RESULTS.....5

1.1 MEASUREMENT UNCERTAINTY5

1.2 TEST SITE AND INSTRUMENTS6

2 GENERAL INFORMATION7

2.1 GENERAL DESCRIPTION OF EUT7

2.2 CONFIGURATION OF SYSTEM UNDER TEST 10

2.3 DESCRIPTION OF SUPPORT UNITS 11

2.4 TEST ITEM AND TEST CONFIGURATION..... 11

2.5 EUT OPERATING CONDITIONS 15

2.6 GENERAL DESCRIPTION OF APPLIED STANDARDS 16

3 TEST TYPES AND RESULTS.....17

3.1 OUTPUT POWER MEASUREMENT 17

3.1.1 LIMITS OF OUTPUT POWER MEASUREMENT 17

3.1.2 TEST PROCEDURES 17

3.1.3 TEST SETUP 18

3.1.4 TEST RESULTS 18

3.2 FREQUENCY STABILITY MEASUREMENT 27

3.2.1 LIMITS OF FREQUENCY STABILITY MEASUREMENT 27

3.2.2 TEST PROCEDURE 27

3.2.3 TEST SETUP 27

3.2.4 TEST RESULTS 28

3.3 OCCUPIED BANDWIDTH MEASUREMENT 29

3.3.1 TEST PROCEDURES 29

3.3.2 TEST SETUP 29

3.3.3 TEST RESULTS 30

3.4 BAND EDGE MEASUREMENT 31

3.4.1 LIMITS OF BAND EDGE MEASUREMENT 31

3.4.2 TEST SETUP 31

3.4.3 TEST PROCEDURES 32

3.4.4 TEST RESULTS 33

3.5 CONDUCTED SPURIOUS EMISSIONS..... 34

3.5.1 LIMITS OF CONDUCTED SPURIOUS EMISSIONS MEASUREMENT 34

3.5.2 TEST PROCEDURE 34

3.5.3 TEST SETUP 34

3.5.4 TEST RESULTS 35

3.6 RADIATED EMISSION MEASUREMENT 36

3.6.1 LIMITS OF RADIATED EMISSION MEASUREMENT 36

3.6.2 TEST PROCEDURES 36

3.6.3 DEVIATION FROM TEST STANDARD 36

3.6.4 TEST SETUP 37



**BUREAU
VERITAS**

Test Report No.: W7L-P22030026-2RF03

3.6.5	TEST RESULTS	39
3.7	PEAK TO AVERAGE RATIO	71
3.7.1	LIMITS OF PEAK TO AVERAGE RATIO MEASUREMENT	71
3.7.2	TEST SETUP	71
3.7.3	TEST PROCEDURES	71
3.7.4	TEST RESULTS	72
4	PHOTOGRAPHS OF THE TEST CONFIGURATION	73
5	INFORMATION ON THE TESTING LABORATORIES	74
6	MODIFICATIONS RECORDERS FOR ENGINEERING CHANGES TO THE EUT BY THE LAB	75
7	APPENDIX.....	76
	GSM850	76
	WCMDA BAND5	94
	LTE BAND5	108



BUREAU
VERITAS

Test Report No.: W7L-P22030026-2RF03

RELEASE CONTROL RECORD

ISSUE NO.	REASON FOR CHANGE	DATE ISSUED
W7L-P21120037RF03	Original release	Jan. 24, 2022
W7L-P22030026-2RF03	Based on the original report W7L-P21120037RF03 change the chip, add to 2 nd battery, Verify the RSE worst case.	Apr. 19, 2022



1 SUMMARY OF TEST RESULTS

The EUT has been tested according to the following specifications:

APPLIED STANDARD: FCC Part 22 & Part 2		
STANDARD SECTION	TEST TYPE	RESULT
§2.1046	Conducted Output Power	Compliance
§22.913 (a)(5)	Effective Radiated Power	Compliance
§2.1055 §22.355	Frequency Stability	Compliance
§2.1049	Occupied Bandwidth	Compliance
§22.913 (d)	Peak to average ratio*	Compliance
§22.917(a)	Band Edge Measurements	Compliance
§2.1051 §22.917(a)	Conducted Spurious Emissions	Compliance
§2.1053 §22.917(a)	Radiated Spurious Emissions	Compliance

* Refer to KDB 971168 D01 Power Meas License Digital Systems v03r01.

1.1 MEASUREMENT UNCERTAINTY

Where relevant, the following measurement uncertainty levels have been estimated for tests performed on the EUT as specified in CISPR 16-4-2:

MEASUREMENT	UNCERTAINTY
Maximum Peak Output Power	±2.06dB
Frequency Stability	±76.97Hz
Radiated emissions (30MHz~1GMHz)	±4.98dB
Radiated emissions (1GMHz ~6GMHz)	±4.70dB
Radiated emissions (6GMHz ~18GMHz)	±4.60dB
Radiated emissions (18GMHz ~40GMHz)	±4.12dB
Conducted emissions	±4.01dB
Occupied Channel Bandwidth	±43.58KHz
Band Edge Measurements	±4.70dB
Peak to average ratio	±0.76dB

This uncertainty represents an expanded uncertainty expressed at approximately the 95% confidence level using a coverage factor of k=2.



1.2 TEST SITE AND INSTRUMENTS

Equipment	Manufacturer	Model No.	Serial No.	Last Cal.	Next Cal.
MXE EMI Receiver	KEYSIGHT	N9038A-544	MY54450026	Apr. 22,21	Apr. 21,22
EXA Signal Analyzer	KEYSIGHT	N9010A-544	MY54510355	Jun. 03,21	Jun. 02,22
Bilog Antenna 2	ETS-LINDGREN	3143B	00161965	Mar. 05,21	Mar. 04,22
Bilog Antenna 2	ETS-LINDGREN	3143B	00161965	Mar. 04,22	Mar. 03,23
Loop Antenna	Schwarzbeck	FMZB 1519B	1519B-051	Feb. 14,20	Feb. 13,23
Horn Antenna 1	ETS-LINDGREN	3117	00168728	Aug. 19,21	Aug. 18,22
Horn Antenna (18GHz-40GHz)	N/A	QWH-SL-18-40-K-SG/QMS-00361	15433	Aug. 25, 21	Aug. 24, 22
Radio Communication Analyzer	ANRITSU	MT8820C	6201465426	Feb. 25,21	Feb. 24,22
Radio Communication Analyzer	ANRITSU	MT8820C	6201465426	Feb. 24,22	Feb. 23,23
Signal Pre-Amplifier	EMSI	EMC 9135	980249	Jun. 02,21	Jun. 01,22
Signal Pre-Amplifier	EMSI	EMC 012645B	980257	Jun. 03,21	Jun. 02,22
Signal Pre-Amplifier	EMSI	EMC 184045B	980259	Apr. 22,21	Apr. 21,22
3m Semi-anechoic Chamber	ETS-LINDGREN	9m*6m*6m	Euroshieldpn-CT0001143-1216	May. 19,20	May. 18,23
Test Software	E3	V 9.160323	N/A	N/A	N/A
Test Software	ADT	ADT_Radiated_V 7.6.15.9.2	N/A	N/A	N/A
10dB Attenuator	JFW/USA	50HF-010-SMA	1505	Jun. 03,21	Jun. 02,22
Power Meter	Anritsu	ML2495A	1506002	Apr. 07,21	Apr. 06,22
Power Meter	Anritsu	ML2495A	1506002	Apr. 06,22	Apr. 05,23
Power Sensor	Anritsu	MA2411B	1339352	May. 07,21	May. 06,22
Temperature Chamber	ESPEC	SH-242	93000855	Jun. 02,21	Jun. 01,22
MXG Analog Microwave Signal Generator	KEYSIGHT	N5183A	MY50143024	Mar. 05,21	Mar. 04,22
MXG Analog Microwave Signal Generator	KEYSIGHT	N5183A	MY50143024	Mar. 04,22	Mar. 03,23

- NOTE:**
1. The calibration interval of the above test instruments is 12 months or 36 months and the calibrations are traceable to CEPREI/CHINA, GRGT/CHINA and NIM/CHINA.
 2. The test was performed in 3m Semi-anechoic Chamber and RF Oven Room.
 3. The horn antenna is used only for the measurement of emission frequency above 1GHz if tested.
 4. The FCC Site Registration No. is 525120; The Designation No. is CN1171.



2 GENERAL INFORMATION

2.1 GENERAL DESCRIPTION OF EUT

PRODUCT	Multi-band GSM/WCDMA/LTE phone with Bluetooth&WLAN	
BRAND NAME	Nokia	
MODEL NAME	TA-1425	
NOMINAL VOLTAGE	5.0Vdc(adapter or host equipment) 3.85Vdc (Li-ion, battery)	
MODULATION TYPE	GSM/GPRS/EDGE	GMSK, 8PSK
	WCDMA	BPSK, QPSK
	LTE	QPSK, 16QAM, 64QAM
FREQUENCY RANGE	GSM/GPRS/EDGE	824.2MHz ~ 848.8MHz
	WCDMA	826.4MHz ~ 846.6MHz
	LTE Band 5 (Channel Bandwidth: 1.4MHz)	824.7MHz ~ 848.3MHz
	LTE Band 5 (Channel Bandwidth: 3MHz)	825.5MHz ~ 847.5MHz
	LTE Band 5 (Channel Bandwidth: 5MHz)	826.5MHz ~ 846.5MHz
	LTE Band 5 (Channel Bandwidth: 10MHz)	829MHz ~ 844MHz
MAX. ERP POWER	GSM/GPRS	582.1mW
	EDGE	119.67mW
	WCDMA	85.9mW
	LTE Band 5 (Channel Bandwidth: 1.4MHz)	77.45mW
	LTE Band 5 (Channel Bandwidth: 3MHz)	77.45mW
	LTE Band 5 (Channel Bandwidth: 5MHz)	68.39mW
	LTE Band 5 (Channel Bandwidth: 10MHz)	77.98mW
EMISSION DESIGNATORGOGN	GSM/GPRS	245KGXW
	EDGE	248KG7W
	WCDMA	4M17F9W
	LTE Band 5 (Channel Bandwidth: 1.4MHz)	QPSK: 1M09G7D
		16QAM: 1M09W7D
		64QAM: 1M09W7D
	LTE Band 5 (Channel Bandwidth: 3MHz)	QPSK: 2M70G7D
16QAM: 2M70W7D		



		64QAM: 2M70W7D
	LTE Band 5 (Channel Bandwidth: 5MHz)	QPSK: 4M50G7D
		16QAM: 4M50W7D
	LTE Band 5 (Channel Bandwidth: 10MHz)	64QAM: 4M51W7D
		QPSK: 9M10G7D
		16QAM: 9M10W7D
ANTENNA TYPE	Fixed Internal Antenna with -2.55dBi gain for GSM850/ WCDMA V/LTE B5	
HW VERSION	19661_1_12	
SW VERSION	000T_0_050	
I/O PORTS	Refer to user's manual	
CABLE SUPPLIED	USB cable: unshielded without ferrite, 1.0meter Earphone1: non-shielded cable, with w/o ferrite core, 1.2 meter Earphone2: non-shielded cable, with w/o ferrite core, 1.2 meter	
EXTREME TEMPERATURE	0- 40 °C	
EXTREME VOLTAGE	3.5V - 4.4V	

NOTE:

1. For a more detailed features description, please refer to the manufacturer's specifications or the user's manual.
2. The EUT incorporates a SISO function. Physically, the EUT provides one completed transmitter and one receiver.

MODULATION MODE	TX FUNCTION
GSM/GPRS/EDGE	1TX/1RX
WCDMA	1TX/1RX
LTE	1TX/1RX

3. For the test results, the EUT had been tested with all conditions. But only the worst case was shown in test report.



List of Accessory:

ACCESSORIES	BRAND	MANUFACTURER	MODEL	SPECIFICATION
Battery 1	Nokia	GUANGDONG FENGHUA NEW ENERGY CO.,LTD.	WT410	Capacity: 3.85 Vdc, 3920mAh
Battery 2	Nokia	HuNan ADF Alternative Energy Technology Co.,Ltd	WT410	Capacity: 3.85 Vdc, 3920mAh
AC Adapter	Nokia	ShenZhenBaiJunDa Electronic CO., LTD.	AD-010U	I/P: 100-240Vac, 0.35A, O/P: 5.0Vdc, 2.0A
Earphone 1	Nokia	NEW LEADER INDUSTRY CO.,LTD	HS-34	Signal Line, 1.2meter
Earphone 2	Nokia	Guangdong Wivtak Technology Co., Ltd.	HS-34	Signal Line, 1.2meter
USB Cable	Nokia	Saibao(Jiangxi) Communication Industrial Co.,Ltd	CB-12A	Signal Line, 1.0meter



2.2 CONFIGURATION OF SYSTEM UNDER TEST FOR RADIATION EMISSION

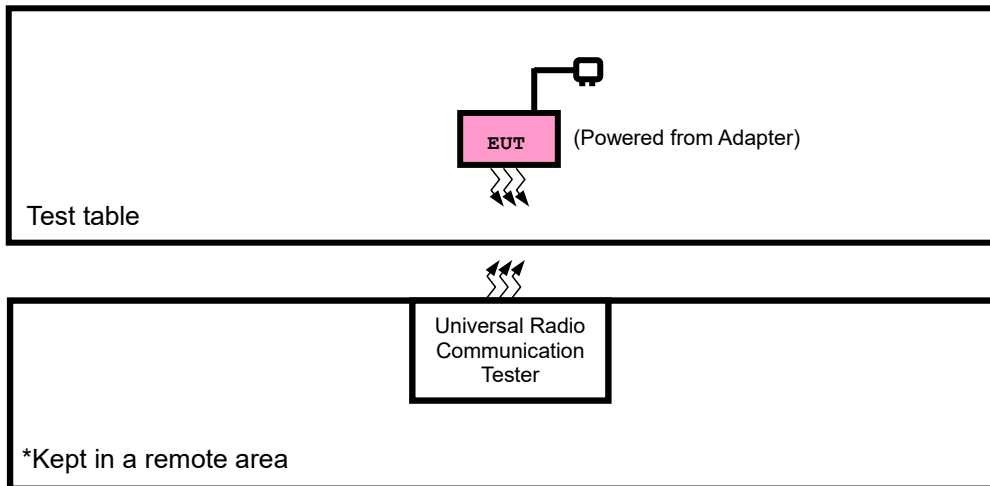



2.3 DESCRIPTION OF SUPPORT UNITS

The EUT has been tested as an independent unit together with other necessary accessories or support units. The following support units or accessories were used to form a representative test configuration during the tests.

NO.	PRODUCT	BRAND	MODEL NO.	SERIAL NO.	FCC ID
1	DC source	Kikusui/JP	PMX18-5A	0000001	N/A

NO.	SIGNAL CABLE DESCRIPTION OF THE ABOVE SUPPORT UNITS
1	DC Line: Unshielded, Detachable 1.0m

2.4 TEST ITEM AND TEST CONFIGURATION

Pre-Scan has been conducted to determine the worst-case mode from all possible combinations between available modulations, data rates, XYZ axis and antenna ports. The worst case in ERP and radiated emission was found when positioned on X-plane for GSM /EDGE /LTE. Following channel(s) was (were) selected for the final test as listed below:

EUT CONFIGURE MODE	DESCRIPTION
A	EUT + Adapter with GSM or WCDMA or LTE link
B	EUT + Battery with GSM or WCDMA or LTE link



GSM MODE

EUT CONFIGURE MODE	TEST ITEM	AVAILABLE CHANNEL	TESTED CHANNEL	MODE
A	ERP	128 to 251	128, 189, 251	GSM,EDGE
B	FREQUENCY STABILITY	128 to 251	128, 189, 251	GSM,EDGE
A	OCCUPIED BANDWIDTH	128 to 251	128, 189, 251	GSM,EDGE
A	BAND EDGE	128 to 251	128, 251	GSM,EDGE
A	CONDCUDETED EMISSION	128 to 251	128, 189, 251	GSM,EDGE
A	RADIATED EMISSION	128 to 251	128, 189, 251	GSM,EDGE
A	PEAK TO AVERAGE RATIO	128 to 251	128, 189, 251	GSM,EDGE

WCDMA MODE

EUT CONFIGURE MODE	TEST ITEM	AVAILABLE CHANNEL	TESTED CHANNEL	MODE
A	ERP	4132 to 4233	4132, 4182, 4233	WCDMA
B	FREQUENCY STABILITY	4132 to 4233	4132, 4182, 4233	WCDMA
A	OCCUPIED BANDWIDTH	4132 to 4233	4132, 4182, 4233	WCDMA
A	BAND EDGE	4132 to 4233	4132, 4233	WCDMA
A	CONDCUDETED EMISSION	4132 to 4233	4132, 4182, 4233	WCDMA
A	RADIATED EMISSION	4132 to 4233	4132, 4182, 4233	WCDMA
A	PEAK TO AVERAGE RATIO	4132 to 4233	4132, 4182, 4233	WCDMA



LTE BAND 5 MODE

EUT CONFIGURE MODE	TEST ITEM	Available Channel	Tested Channel	Channel bandwidth	modulation	mode
A	ERP	20407 to 20643	20407, 20525, 20643	1.4MHz	QPSK,16QAM,64QAM	1 RB / 0 RB Offset
		20415 to 20635	20415, 20525, 20635	3MHz	QPSK,16QAM,64QAM	1 RB / 0 RB Offset
		20425 to 20625	20425, 20525, 20625	5MHz	QPSK,16QAM,64QAM	1 RB / 0 RB Offset
		20450 to 20600	20450, 20525, 20600	10MHz	QPSK,16QAM,64QAM	1 RB / 0 RB Offset
B	FREQUENCY STABILITY	20407 to 20643	20407, 20525, 20643	1.4MHz	QPSK,16QAM,64QAM	6 RB / 0 RB Offset
		20415 to 20635	20415, 20525, 20635	3MHz	QPSK,16QAM,64QAM	15 RB / 0 RB Offset
		20425 to 20625	20425, 20525, 20625	5MHz	QPSK,16QAM,64QAM	25 RB / 0 RB Offset
		20450 to 20600	20450, 20525, 20600	10MHz	QPSK,16QAM,64QAM	50 RB / 0 RB Offset
A	OCCUPIED BANDWIDTH	20407 to 20643	20407, 20525, 20643	1.4MHz	QPSK,16QAM,64QAM	6 RB / 0 RB Offset
		20415 to 20635	20415, 20525, 20635	3MHz	QPSK,16QAM,64QAM	15 RB / 0 RB Offset
		20425 to 20625	20425, 20525, 20625	5MHz	QPSK,16QAM,64QAM	25 RB / 0 RB Offset
		20450 to 20600	20450, 20525, 20600	10MHz	QPSK,16QAM,64QAM	50 RB / 0 RB Offset
A	BAND EDGE	20407 to 20643	20407	1.4 MHz	QPSK,16QAM,64QAM	1 RB / 0 RB Offset
						6 RB / 0 RB Offset
		20407 to 20643	20643	1.4 MHz	QPSK,16QAM,64QAM	1 RB / 5 RB Offset
						6 RB / 0 RB Offset
		20415 to 20635	20415	3 MHz	QPSK,16QAM,64QAM	1 RB / 0 RB Offset
						15 RB / 0 RB Offset
		20415 to 20635	20635	3 MHz	QPSK,16QAM,64QAM	1 RB / 14 RB Offset
						15 RB / 0 RB Offset
		20425 to 20625	20425	5MHz	QPSK,16QAM,64QAM	1 RB / 0 RB Offset
						25 RB / 0 RB Offset
		20425 to 20625	20625	5MHz	QPSK,16QAM,64QAM	1 RB / 24 RB Offset
						25 RB / 0 RB Offset
		20450 to 20600	20450	10MHz	QPSK,16QAM,64QAM	1 RB / 0 RB Offset
						50 RB / 0 RB Offset
		20450 to 20600	20600	10MHz	QPSK,16QAM,64QAM	1 RB / 49 RB Offset
						50 RB / 0 RB Offset



A	CONDCUDED EMISSION	20407 to 20643	20407, 20525, 20643	1.4MHz	QPSK, 16QAM, 64QAM	1 RB / 0 RB Offset
		20415 to 20635	20415, 20525, 20635	3MHz	QPSK, 16QAM, 64QAM	1 RB / 0 RB Offset
		20425 to 20625	20425, 20525, 20625	5MHz	QPSK, 16QAM, 64QAM	1 RB / 0 RB Offset
		20450 to 20600	20450, 20525, 20600	10MHz	QPSK, 16QAM, 64QAM	1 RB / 0 RB Offset
A	RADIATED EMISSION	20407 to 20643	20525	1.4MHz	QPSK	1 RB / 0 RB Offset
		20415 to 20635	20415, 20525, 20635	3MHz	QPSK	1 RB / 0 RB Offset
		20425 to 20625	20525	5MHz	QPSK	1 RB / 0 RB Offset
		20450 to 20600	20525	10MHz	QPSK	1 RB / 0 RB Offset
A	PEAK TO AVERAGE RATIO	20407 to 20643	20407, 20525, 20643	1.4MHz	QPSK, 16QAM, 64QAM	1 RB / 0 RB Offset 6 RB / 0 RB Offset
		20415 to 20635	20415, 20525, 20635	3MHz	QPSK, 16QAM, 64QAM	1 RB / 0 RB Offset 15 RB / 0 RB Offset
		20425 to 20625	20425, 20525, 20625	5MHz	QPSK, 16QAM, 64QAM	1 RB / 0 RB Offset 25 RB / 0 RB Offset
		20450 to 20600	20450, 20525, 20600	10MHz	QPSK, 16QAM, 64QAM	1 RB / 0 RB Offset 50 RB / 0 RB Offset

Note: This device was tested under all bandwidths, RB configurations and modulations. The worst case was found in QPSK modulation.



TEST CONDITION:

TEST ITEM	ENVIRONMENTAL CONDITIONS	INPUT POWER	TESTED BY
ERP	23deg. C, 70%RH	DC 5V By Adapter	Jace Hu
FREQUENCY STABILITY	23deg. C, 70%RH	DC 3.85V/3.5V/4.4V By Battery	James Fu
OCCUPIED BANDWIDTH	23deg. C, 70%RH	DC5V By Adapter	James Fu
BAND EDGE	23deg. C, 70%RH	DC 5V By Adapter	James Fu
CONDCUDED EMISSION	23deg. C, 70%RH	DC5V By Adapter	James Fu
RADIATED EMISSION	23deg. C, 70%RH	DC5V By Adapter	Jace Hu
PEAK TO AVERAGE RATIO	23deg. C, 70%RH	DC5V By Adapter	James Fu

2.5 EUT OPERATING CONDITIONS

The EUT makes a call to the communication simulator. The communication simulator station system controlled a EUT to export maximum output power under transmission mode and specific channel frequency



**BUREAU
VERITAS**

Test Report No.: W7L-P22030026-2RF03

2.6 GENERAL DESCRIPTION OF APPLIED STANDARDS

The EUT is a RF product. According to the specifications of the manufacturer, it must comply with the requirements of the following standards:

FCC 47 CFR Part 2

FCC 47 CFR Part 22

KDB 971168 D01 Power Meas License Digital Systems v03r01

ANSI/TIA/EIA-603-D

ANSI/TIA/EIA-603-E

ANSI C63.26-2015

NOTE: All test items have been performed and recorded as per the above standards.

3 TEST TYPES AND RESULTS

3.1 OUTPUT POWER MEASUREMENT

3.1.1 LIMITS OF OUTPUT POWER MEASUREMENT

Mobile / Portable station are limited to 7 watts e.r.p.

3.1.2 TEST PROCEDURES

EIRP / ERP MEASUREMENT:

Per KDB 971168 D01 Power Meas License Digital Systems v03r01 or subclause 5.2.5.5 of ANSI C63.26-2015, the relevant equation for determining the ERP or EIRP from the conducted RF output power measured using the guidance provided above is:

$$\text{ERP or EIRP} = P_{\text{Meas}} + G_{\text{T}} - L_{\text{C}}$$

Where:

ERP or EIRP = effective radiated power or equivalent isotropically radiated power, respectively

(expressed in the same units as P_{Meas} , typically dBW or dBm);

P_{Meas} = measured transmitter output power or PSD, in dBm or dBW;

G_{T} = gain of the transmitting antenna, in dBd (ERP) or dBi (EIRP);

L_{C} = signal attenuation in the connecting cable between the transmitter and antenna, in dB.

CONDUCTED POWER MEASUREMENT:

The EUT was set up for the maximum power with WCDMA link data modulation and link up with simulator. Set the EUT to transmit under low, middle and high channel and record the power level shown on simulator.



3.1.3 TEST SETUP

EIRP / ERP Measurement:

CONDUCTED POWER MEASUREMENT:

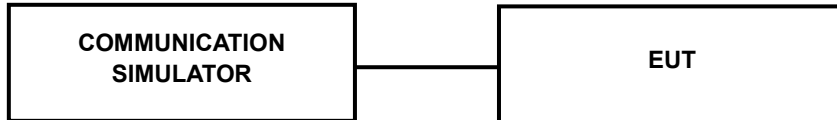

3.1.4 TEST RESULTS

CONDUCTED OUTPUT POWER (dBm)

Band	GSM850			Max. Tune-up Power
	128	189	251	
Channel	128	189	251	Max. Tune-up Power
Frequency	824.2	836.4	848.8	
GSM (GMSK, 1Tx-slot)	32.29	32.33	32.35	34.0
GPRS (GMSK, 1Tx-slot)	32.27	32.30	32.31	34.0
GPRS (GMSK, 2Tx-slot)	30.19	30.22	30.24	32.0
GPRS (GMSK, 3Tx-slot)	28.21	28.24	28.27	30.0
GPRS (GMSK, 4Tx-slot)	26.19	26.23	26.29	28.0
EDGE (8PSK, 1Tx-slot)	25.12	25.48	25.38	27.0
EDGE (8PSK, 2Tx-slot)	24.51	24.87	24.62	26.0
EDGE (8PSK, 3Tx-slot)	23.24	23.32	22.87	23.5
EDGE (8PSK, 4Tx-slot)	20.67	20.71	20.60	21.0

Band	WCDMA V			Max. Tune-up Power
	4132	4182	4233	
Channel	4132	4182	4233	Max. Tune-up Power
Frequency	826.4	836.4	846.6	
RMC 12.2K	23.93	23.98	24.04	25.0
HSDPA Subtest-1	22.68	22.91	23.04	24.0
HSDPA Subtest-2	22.68	22.88	23.00	24.0
HSDPA Subtest-3	22.18	22.41	22.54	23.5
HSDPA Subtest-4	22.19	22.46	22.52	23.5
DC-HSDPA Subtest-1	22.70	22.88	23.02	24.0
DC-HSDPA Subtest-2	22.74	22.90	23.02	24.0
DC-HSDPA Subtest-3	22.14	22.33	22.49	23.5
DC-HSDPA Subtest-4	22.23	22.43	22.47	23.5
HSUPA Subtest-1	22.67	22.85	22.97	24.0
HSUPA Subtest-2	20.73	20.93	21.07	22.0
HSUPA Subtest-3	21.68	21.93	22.00	23.0
HSUPA Subtest-4	20.68	20.91	21.04	22.0
HSUPA Subtest-5	22.69	22.92	23.05	24.0
HSPA+ Subtest-1	20.55	20.81	20.98	24.0



LTE Band 5

Band/BW	Modulation	RB Size	RB Offset	Low CH 20407	Mid CH 20525	High CH 20643	MPR
				Frequency 824.7 MHz	Frequency 836.5 MHz	Frequency 848.3 MHz	
5/ 1.4	QPSK	1	0	23.42	23.39	23.52	0
		1	2	23.51	23.41	23.59	0
		1	5	23.53	23.41	23.57	0
		3	0	23.47	23.38	23.58	0
		3	1	23.48	23.40	23.48	0
		3	3	23.46	23.36	23.52	0
		6	0	22.43	22.31	22.49	1
	16QAM	1	0	22.86	22.77	22.93	1
		1	2	22.93	22.80	23.00	1
		1	5	22.95	22.85	23.06	1
		3	0	22.70	22.62	22.76	1
		3	1	22.64	22.64	22.74	1
		3	3	22.47	22.39	22.57	1
		6	0	21.80	21.77	21.88	2
	64QAM	1	0	21.23	21.18	21.35	2
		1	2	21.61	21.60	21.71	2
		1	5	21.45	21.32	21.52	2
		3	0	19.93	19.88	20.00	2
		3	1	19.76	19.73	19.83	2
		3	3	19.73	19.63	19.84	2
		6	0	18.89	18.81	18.95	3



Band/BW	Modulation	RB Size	RB Offset	Low CH 20415	Mid CH 20525	High CH 20635	MPR
				Frequency 825.5 MHz	Frequency 836.5 MHz	Frequency 847.5 MHz	
5/3	QPSK	1	0	23.44	23.41	23.51	0
		1	7	23.47	23.42	23.59	0
		1	14	23.49	23.41	23.57	0
		8	0	22.46	22.41	22.58	1
		8	3	22.41	22.40	22.50	1
		8	7	22.43	22.43	22.56	1
		15	0	22.40	22.32	22.43	1
	16QAM	1	0	22.83	22.83	22.96	1
		1	7	22.90	22.83	22.98	1
		1	14	22.98	22.85	23.06	1
		8	0	21.66	21.63	21.76	2
		8	3	21.69	21.59	21.77	2
		8	7	21.49	21.37	21.53	2
		15	0	21.80	21.71	21.91	2
	64QAM	1	0	21.29	21.21	21.29	2
		1	7	21.64	21.54	21.70	2
		1	14	21.46	21.34	21.52	2
		8	0	18.96	18.92	19.01	3
		8	3	18.80	18.67	18.88	3
		8	7	18.70	18.67	18.80	3
		15	0	18.91	18.78	18.99	3



Band/BW	Modulation	RB Size	RB Offset	Low CH 20425	Mid CH 20525	High CH 20625	MPR
				Frequency 826.5 MHz	Frequency 836.5 MHz	Frequency 846.5 MHz	
5 / 5	QPSK	1	0	23.45	23.36	23.52	0
		1	12	23.52	23.39	23.59	0
		1	24	23.50	23.40	23.61	0
		12	0	22.49	22.41	22.55	1
		12	6	22.41	22.41	22.51	1
		12	13	22.47	22.39	22.57	1
		25	0	22.38	22.35	22.46	1
	16QAM	1	0	22.84	22.79	22.96	1
		1	12	22.87	22.86	22.97	1
		1	24	22.98	22.85	23.05	1
		12	0	21.66	21.61	21.73	2
		12	6	21.66	21.63	21.73	2
		12	13	21.44	21.39	21.56	2
		25	0	21.80	21.72	21.88	2
	64QAM	1	0	21.23	21.18	21.35	2
		1	12	21.61	21.60	21.70	2
		1	24	21.39	21.39	21.52	2
		12	0	18.97	18.89	19.00	3
		12	6	18.74	18.74	18.87	3
		12	13	18.74	18.66	18.77	3
		25	0	18.87	18.84	18.97	3



Band/BW	Modulation	RB Size	RB Offset	Low CH 20450	Mid CH 20525	High CH 20600	MPR
				Frequency 829 MHz	Frequency 836.5 MHz	Frequency 844 MHz	
5/ 10	QPSK	1	0	23.50	23.43	23.57	0
		1	24	23.54	23.47	23.61	0
		1	49	23.55	23.48	23.62	0
		25	0	22.53	22.46	22.60	1
		25	12	22.49	22.42	22.56	1
		25	25	22.51	22.44	22.58	1
		50	0	22.44	22.37	22.51	1
	16QAM	1	0	22.91	22.84	22.98	1
		1	24	22.95	22.88	23.02	1
		1	49	23.00	22.93	23.07	1
		25	0	21.74	21.67	21.81	2
		25	12	21.72	21.65	21.79	2
		25	25	21.51	21.44	21.58	2
		50	0	21.86	21.79	21.93	2
	64QAM	1	0	21.30	21.23	21.37	2
		1	24	21.69	21.62	21.76	2
		1	49	21.47	21.40	21.54	2
		25	0	19.01	18.94	19.08	3
		25	12	18.82	18.75	18.89	3
		25	25	18.78	18.71	18.85	3
		50	0	18.93	18.86	19.00	3



ERP POWER (dBm)

GSM

Channel	Frequency (MHz)	Conducted Power (dBm)	G _T -L _c (dB)	ERP (dBm)	ERP (mW)	Limit (W)
128	824.2	32.29	-2.55	27.59	574.12	7
189	836.4	32.33	-2.55	27.63	579.43	7
251	848.8	32.35	-2.55	27.65	582.10	7

REMARKS: ERP Output Power (dBm) = EIRP (dBm) -2.15(dB).

EDGE

Channel	Frequency (MHz)	Conducted Power (dBm)	G _T -L _c (dB)	ERP (dBm)	ERP (mW)	Limit (W)
128	824.2	25.12	-2.55	20.42	110.15	7
189	836.4	25.48	-2.55	20.78	119.67	7
251	848.8	25.38	-2.55	20.68	116.95	7

REMARKS: ERP Output Power (dBm) = EIRP (dBm) -2.15(dB).

WCDMA

Channel	Frequency (MHz)	Conducted Power (dBm)	G _T -L _c (dB)	ERP (dBm)	ERP (mW)	Limit (W)
4132	826.4	23.93	-2.55	19.23	83.75	7
4182	836.4	23.98	-2.55	19.28	84.72	7
4233	846.6	24.04	-2.55	19.34	85.9	7

REMARKS: ERP Output Power (dBm) = EIRP (dBm) -2.15(dB).



LTE BAND 5

CHANNEL BANDWIDTH: 1.4MHz QPSK

Channel	Frequency (MHz)	Conducted Power (dBm)	G _T -L _c (dB)	ERP (dBm)	ERP (mW)	Limit (W)
20407	824.7	23.53	-2.55	18.83	76.38	7
20525	836.5	23.41	-2.55	18.71	74.30	7
20643	848.3	23.59	-2.55	18.89	77.45	7

CHANNEL BANDWIDTH: 1.4MHz 16QAM

Channel	Frequency (MHz)	Conducted Power (dBm)	G _T -L _c (dB)	ERP (dBm)	ERP (mW)	Limit (W)
20407	824.7	22.95	-2.55	18.25	66.83	7
20525	836.5	22.85	-2.55	18.15	65.31	7
20643	848.3	23.06	-2.55	18.36	68.55	7

CHANNEL BANDWIDTH: 1.4MHz 64QAM

Channel	Frequency (MHz)	Conducted Power (dBm)	G _T -L _c (dB)	ERP (dBm)	ERP (mW)	Limit (W)
20407	824.7	21.61	-2.55	16.91	49.09	7
20525	836.5	21.6	-2.55	16.9	48.98	7
20643	848.3	21.71	-2.55	17.01	50.23	7

CHANNEL BANDWIDTH: 3MHz QPSK

Channel	Frequency (MHz)	Conducted Power (dBm)	G _T -L _c (dB)	ERP (dBm)	ERP (mW)	Limit (W)
20415	825.5	23.49	-2.55	18.79	75.68	7
20525	836.5	23.42	-2.55	18.72	74.47	7
20635	847.5	23.59	-2.55	18.89	77.45	7

CHANNEL BANDWIDTH: 3MHz 16QAM

Channel	Frequency (MHz)	Conducted Power (dBm)	G _T -L _c (dB)	ERP (dBm)	ERP (mW)	Limit (W)
20415	825.5	22.98	-2.55	18.28	67.30	7
20525	836.5	22.85	-2.55	18.15	65.31	7
20635	847.5	23.06	-2.55	18.36	68.55	7



CHANNEL BANDWIDTH: 3MHz 64QAM

Channel	Frequency (MHz)	Conducted Power (dBm)	G _{T-Lc} (dB)	ERP (dBm)	ERP (mW)	Limit (W)
20415	825.5	21.64	-2.55	16.94	49.43	7
20525	836.5	21.54	-2.55	16.84	48.31	7
20635	847.5	21.7	-2.55	17	50.12	7

CHANNEL BANDWIDTH: 5MHz QPSK

Channel	Frequency (MHz)	Conducted Power (dBm)	G _{T-Lc} (dB)	ERP (dBm)	ERP (mW)	Limit (W)
20425	826.5	22.98	-2.55	18.28	67.30	7
20525	836.5	22.86	-2.55	18.16	65.46	7
20625	846.5	23.05	-2.55	18.35	68.39	7

CHANNEL BANDWIDTH: 5MHz 16QAM

Channel	Frequency (MHz)	Conducted Power (dBm)	G _{T-Lc} (dB)	ERP (dBm)	ERP (mW)	Limit (W)
20425	826.5	22.98	-2.55	18.28	67.3	7
20525	836.5	22.86	-2.55	18.16	65.46	7
20625	846.5	23.05	-2.55	18.35	68.39	7

CHANNEL BANDWIDTH: 5MHz 64QAM

Channel	Frequency (MHz)	Conducted Power (dBm)	G _{T-Lc} (dB)	ERP (dBm)	ERP (mW)	Limit (W)
20425	826.5	21.61	-2.55	16.91	49.09	7
20525	836.5	21.6	-2.55	16.9	48.98	7
20625	846.5	21.7	-2.55	17	50.12	7

CHANNEL BANDWIDTH: 10MHz QPSK

Channel	Frequency (MHz)	Conducted Power (dBm)	G _{T-Lc} (dB)	ERP (dBm)	ERP (mW)	Limit (W)
20450	829.0	23.55	-2.55	18.85	76.74	7
20525	836.5	23.48	-2.55	18.78	75.51	7
20600	844.0	23.62	-2.55	18.92	77.98	7



CHANNEL BANDWIDTH: 10MHz 16QAM

Channel	Frequency (MHz)	Conducted Power (dBm)	G _{T-Lc} (dB)	ERP (dBm)	ERP (mW)	Limit (W)
20450	829.0	23	-2.55	18.3	67.61	7
20525	836.5	22.93	-2.55	18.23	66.53	7
20600	844.0	23.07	-2.55	18.37	68.71	7

CHANNEL BANDWIDTH: 10MHz 64QAM

Channel	Frequency (MHz)	Conducted Power (dBm)	G _{T-Lc} (dB)	ERP (dBm)	ERP (mW)	Limit (W)
20450	829.0	21.69	-2.55	16.99	50	7
20525	836.5	21.62	-2.55	16.92	49.2	7
20600	844.0	21.76	-2.55	17.06	50.82	7

REMARKS: ERP Output Power (dBm) = EIRP (dBm) -2.15(dB).



3.2 FREQUENCY STABILITY MEASUREMENT

3.2.1 LIMITS OF FREQUENCY STABILITY MEASUREMENT

1.5 ppm is for base and fixed station. 2.5 ppm is for mobile station.

3.2.2 TEST PROCEDURE

- Device is placed at the oven room. The oven room could control the temperatures and humidity. Power warm up is at least 15 min and power applied should perform before recording frequency error.
- EUT is connected the external power supply to control the DC input power. The test voltage range is from minimum to maximum working voltage. Each step shall be record the frequency error rate.
- The temperature range step is 10 degrees in this test items. All temperature levels shall be hold the $\pm 0.5^{\circ}\text{C}$ during the measurement testing. The each temperature step shall be at least 0.5 hours, consider the EUT could be test under the stability condition.

NOTE: The frequency error was recorded frequency error from the communication simulator.

3.2.3 TEST SETUP

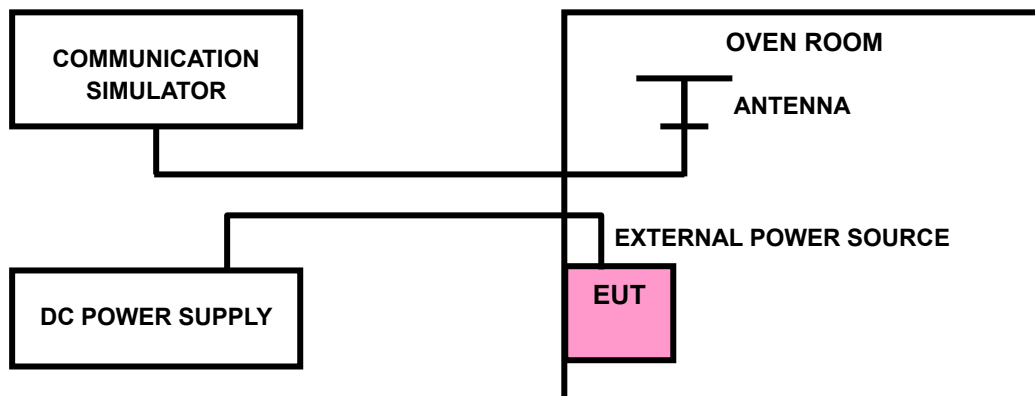



**BUREAU
VERITAS**

Test Report No.: W7L-P22030026-2RF03

3.2.4 TEST RESULTS

Please Refer to Appendix Of this test report.



3.3 OCCUPIED BANDWIDTH MEASUREMENT

3.3.1 TEST PROCEDURES

The EUT makes a call to the communication simulator. All measurements were done at low, middle and high operational frequency range. The communication simulator station system controlled a EUT to export maximum output power under transmission mode and specific channel frequency. Use OBW measurement function of Spectrum analyzer to measure 99 % occupied bandwidth.

3.3.2 TEST SETUP

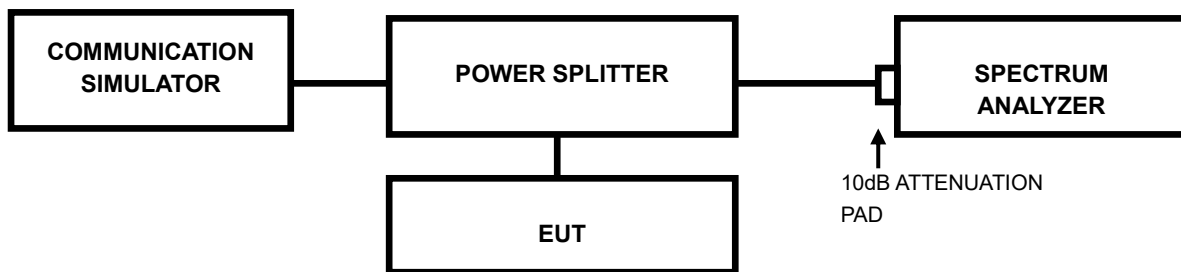



**BUREAU
VERITAS**

Test Report No.: W7L-P22030026-2RF03

3.3.3 TEST RESULTS

Please Refer to Appendix Of this test report.

3.4 BAND EDGE MEASUREMENT

3.4.1 LIMITS OF BAND EDGE MEASUREMENT

Power of any emission outside of the authorized operating frequency ranges must be attenuated below the transmitting power (P) by a factor of at least $43 + 10 \log(P)$ dB. In the 1 MHz bands immediately outside and adjacent to the frequency block a resolution bandwidth of at least one percent of the emission bandwidth of the fundamental emission of the transmitter may be employed.

3.4.2 TEST SETUP

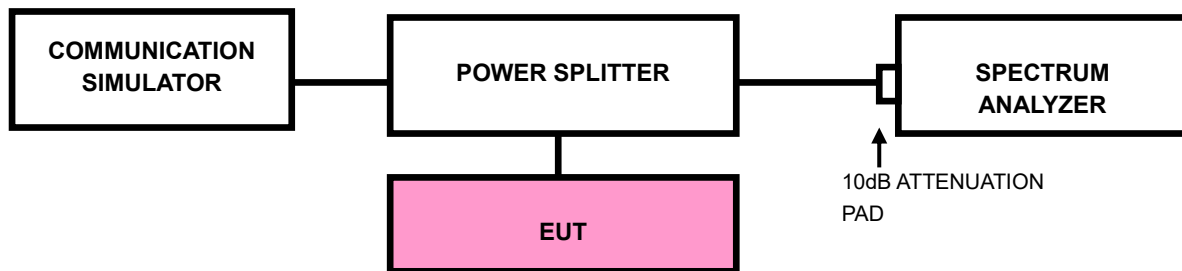



3.4.3 TEST PROCEDURES

- a. All measurements were done at low and high operational frequency range.
- b. The center frequency of spectrum is the band edge frequency and span is 1~5 MHz. RBW of the spectrum is 10kHz and VBW of the spectrum is 30kHz (GSM/GPRS/EDGE/LTE bandwidth for (1.4M/3M/5M/10M/15M/20M)1RB/0RB&1RB/MAXRB).
- c. The center frequency of spectrum is the band edge frequency and span is 10MHz. RBW of the spectrum is 100kHz and VBW of the spectrum is 300kHz (WCDMA).
- d. The center frequency of spectrum is the band edge frequency and span is 1~5 MHz. RBW of the spectrum is $\geq 1\% \cdot \text{EBW}$ kHz and VBW of the spectrum is $3 \cdot \text{RBW}$ kHz. (LTE bandwidth 1.4M/3M/5M/10M/15M/20MHz).
- e. Record the max trace plot into the test report.



**BUREAU
VERITAS**

Test Report No.: W7L-P22030026-2RF03

3.4.4 TEST RESULTS

Please Refer to Appendix Of this test report.



3.5 CONDUCTED SPURIOUS EMISSIONS

3.5.1 LIMITS OF CONDUCTED SPURIOUS EMISSIONS MEASUREMENT

The power of any emission outside of the authorized operating frequency ranges must be attenuated below the transmitting power (P) by a factor of at least $43 + 10 \log(P)$ dB. The emission limit equal to -13dBm .

3.5.2 TEST PROCEDURE

- a. The EUT makes a phone call to the communication simulator. All measurements were done at low, middle and high operational frequency range.
- b. Measuring frequency range is from 9kHz up to a frequency including its 10th harmonic. 10dB attenuation pad is connected with spectrum. RBW=1MHz and VBW=3MHz is used for conducted emission measurement.

3.5.3 TEST SETUP

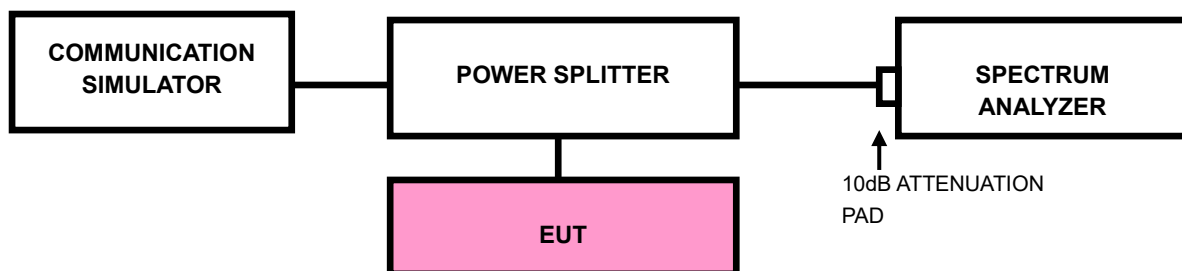



**BUREAU
VERITAS**

Test Report No.: W7L-P22030026-2RF03

3.5.4 TEST RESULTS

NOTE : The 9K~30MHz amplitude of spurious emissions attenuated more than 20 dB below the permissible value is not required in the report.

Please Refer to Appendix Of this test report.



3.6 RADIATED EMISSION MEASUREMENT

3.6.1 LIMITS OF RADIATED EMISSION MEASUREMENT

The power of any emission outside of the authorized operating frequency ranges must be attenuated below the transmitting power (P) by a factor of at least $43 + 10 \log(P)$ dB. The emission limit equal to -13dBm .

3.6.2 TEST PROCEDURES

- a. Substitution method is used for E.I.R.P measurement. In the semi-anechoic chamber, EUT placed on the 0.8m height of Turn Table, rotated the table around 360 degrees to search the maximum radiation power and receiver antenna shall be rotated vertical and horizontal polarization and moved height from 1m to 4m to find the maximum polar radiated power. The "Read Value" is the spectrum reading the maximum power value.
- b. The substitution horn antenna is substituted for EUT at the same position and signals generator export the CW signal to the substitution antenna via a TX cable. Rotated the Turn Table and moved receiving antenna to find the maximum radiation power. Adjust output power level of S.G to get a Value of spectrum reading equal to "Read Value " of step a. Record the power level of S.G
- c. $\text{EIRP} = \text{Output power level of S.G} - \text{TX cable loss} + \text{Antenna gain of substitution horn.}$
- d. E.R.P power can be calculated form E.I.R.P power by subtracting the gain of dipole,
 $\text{E.R.P power} = \text{E.I.P.R power} - 2.15\text{dBi.}$

NOTE: The resolution bandwidth and video bandwidth of test receiver/spectrum analyzer is 1MHz/3MHz.

3.6.3 DEVIATION FROM TEST STANDARD

No deviation



3.6.4 TEST SETUP

< Frequency Range below 30MHz >

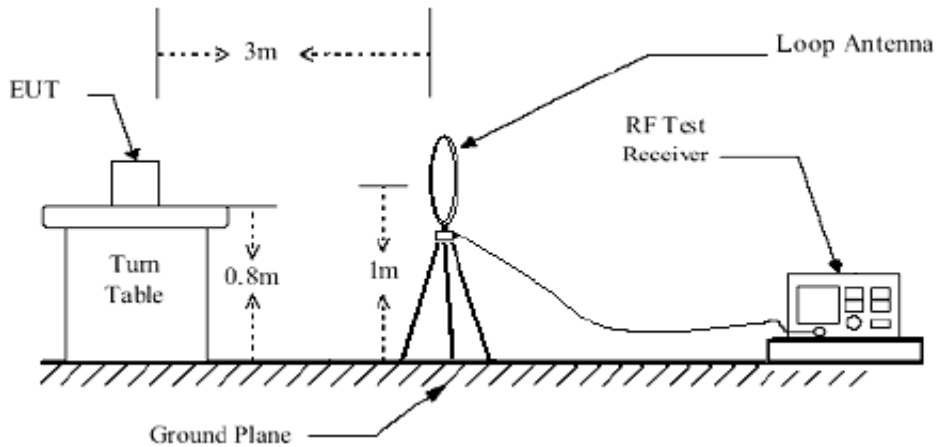

< Frequency Range 30MHz~1GHz >

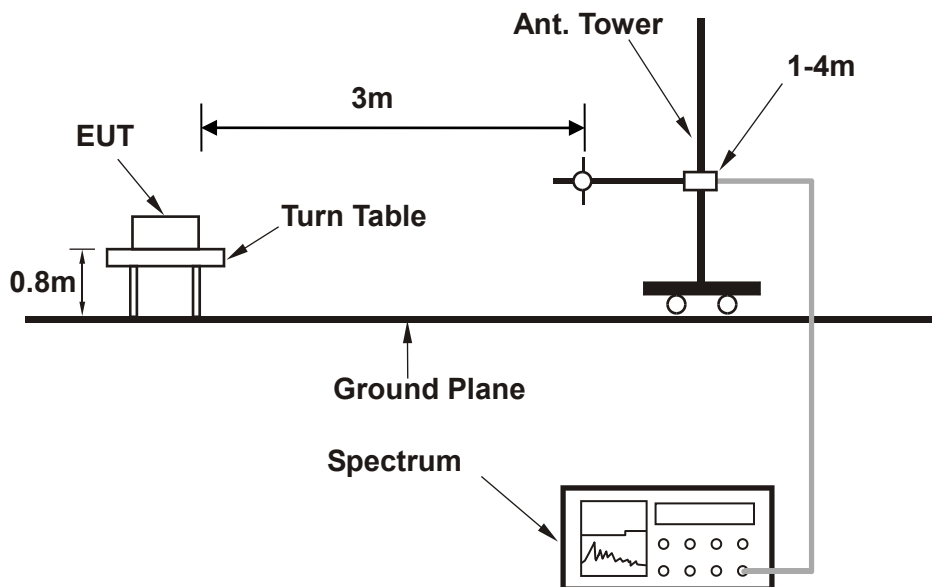



<Frequency Range above 1GHz>

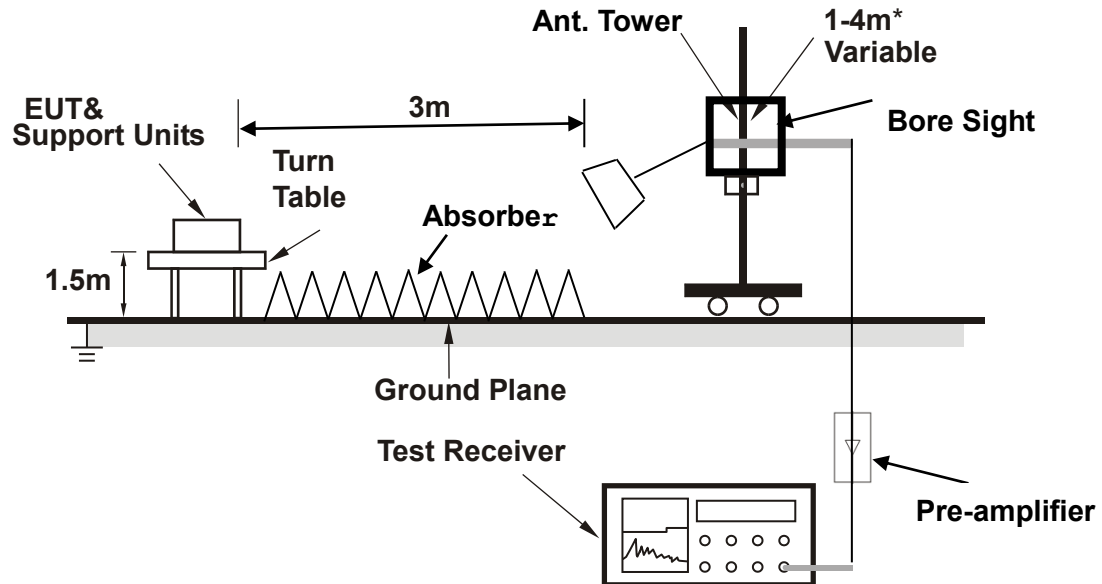

Note: Above 1G is a directional antenna

Depends on the EUT height and the antenna 3dB beamwidth both, refer to section 7.3 of CISPR 16-2-3.

For the actual test configuration, please refer to the attached file (Test Setup Photo).



3.6.5 TEST RESULTS

NOTE : The 9K~30MHz amplitude of spurious emissions attenuated more than 20 dB below the permissible value is not required in the report.

BELOW 1GHz WORST-CASE DATA

30 MHz – 1GHz data:

GSM850

CHANNEL BANDWIDTH: 128 ~ 251

MODE	TX channel 251	FREQUENCY RANGE	Below 1000MHz
ENVIRONMENTAL CONDITIONS	23deg. C, 70%RH	INPUT POWER	AC 120V/60HZ
TESTED BY	Jace Hu		
ANTENNA POLARITY & TEST DISTANCE: HORIZONTAL AT 3 M			

	Freq	Level	Read Level	Limit Line	Over Limit	Factor	Remark	Pol/Phase
	MHz	dBm/m	dBm	dBm/m	dB	dB/m		
1	33.880	-33.12	-52.26	-13.00	-20.12	19.14	Peak	Horizontal
2 PP	80.440	-30.23	-38.13	-13.00	-17.23	7.90	Peak	Horizontal
3	202.660	-31.76	-42.88	-13.00	-18.76	11.12	Peak	Horizontal
4	308.390	-30.39	-44.63	-13.00	-17.39	14.24	Peak	Horizontal
5	438.370	-39.66	-57.25	-13.00	-26.66	17.59	Peak	Horizontal
6	650.800	-37.87	-59.59	-13.00	-24.87	21.72	Peak	Horizontal

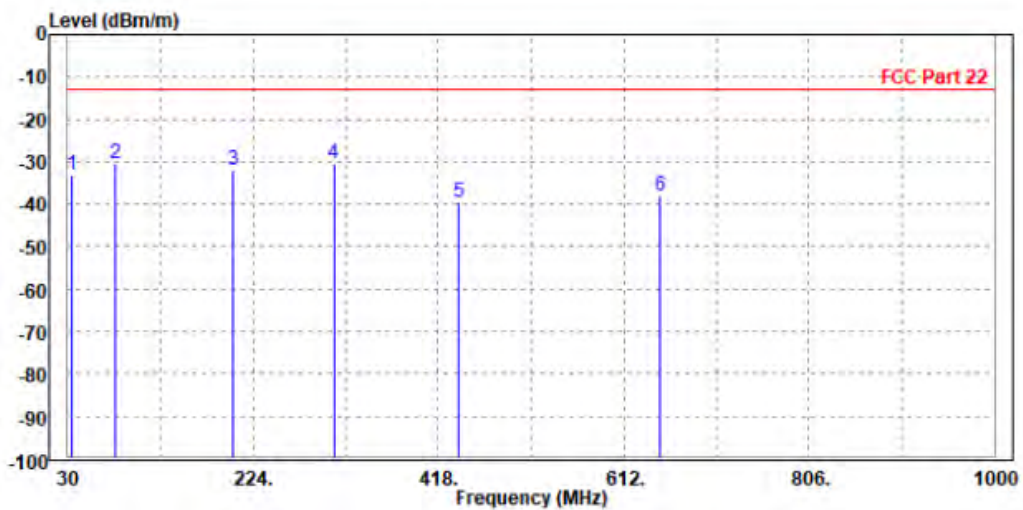



**BUREAU
VERITAS**

Test Report No.: W7L-P22030026-2RF03

MODE	TX channel 251	FREQUENCY RANGE	Below 1000MHz
ENVIRONMENTAL CONDITIONS	23deg. C, 70%RH	INPUT POWER	AC 120V/60HZ
TESTED BY	Jace Hu		
ANTENNA POLARITY & TEST DISTANCE: VERTICAL AT 3 M			

	Freq	Level	Read Level	Limit Line	Over Limit	Factor	Remark	Pol/Phase
	MHz	dBm/m	dBm	dBm/m	dB	dB/m		
1	PP	33.880	-22.16	-40.65	-13.00	-9.16	18.49 Peak	Vertical
2		80.440	-29.72	-38.03	-13.00	-16.72	8.31 Peak	Vertical
3		201.690	-37.09	-48.67	-13.00	-24.09	11.58 Peak	Vertical
4		310.330	-32.81	-48.04	-13.00	-19.81	15.23 Peak	Vertical
5		436.430	-38.60	-56.49	-13.00	-25.60	17.89 Peak	Vertical
6		600.360	-39.29	-60.20	-13.00	-26.29	20.91 Peak	Vertical

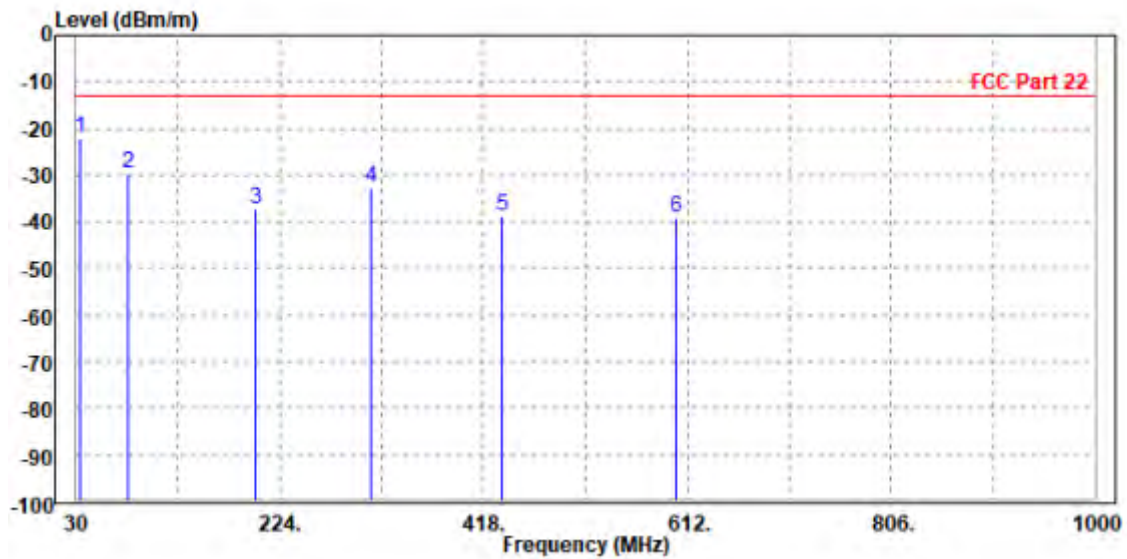



**BUREAU
VERITAS**

Test Report No.: W7L-P22030026-2RF03

ABOVE 1GHz DATA

Note: For higher frequency, the emission is too low to be detected.

GSM 850

CH 128:

MODE	TX channel 128	FREQUENCY RANGE	Above 1000MHz
ENVIRONMENTAL CONDITIONS	23deg. C, 70%RH	INPUT POWER	AC 120V/60HZ
TESTED BY	Jace Hu		
ANTENNA POLARITY & TEST DISTANCE: HORIZONTAL AT 3 M			

	Freq	Level	Read Level	Limit Line	Over Limit	Factor	Remark	Pol/Phase
	MHz	dBm/m	dBm	dBm/m	dB	dB/m		
1	1648.400	-53.05	-56.31	-13.00	-40.05	3.26	Peak	Horizontal
2	PP 2472.600	-27.49	-35.51	-13.00	-14.49	8.02	Peak	Horizontal

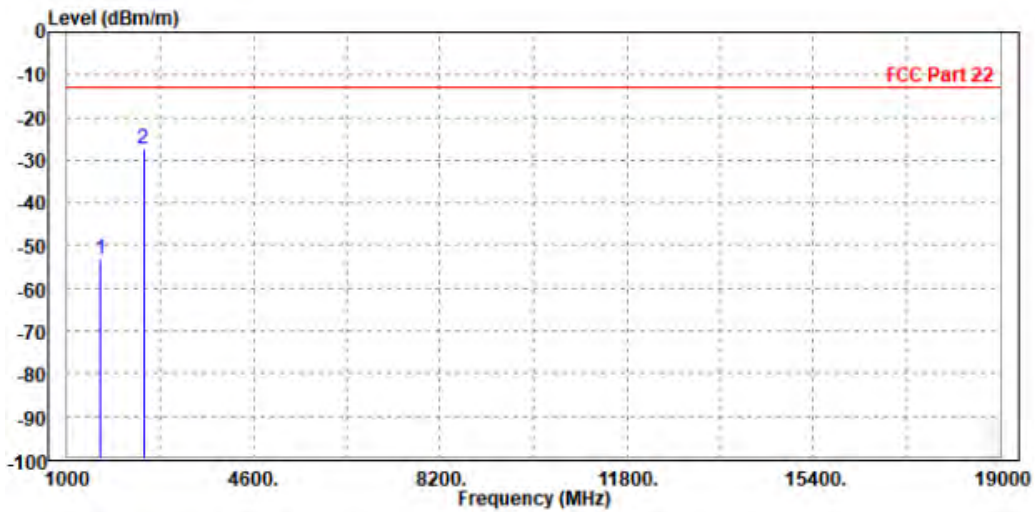



BUREAU VERITAS

Test Report No.: W7L-P22030026-2RF03

MODE	TX channel 128	FREQUENCY RANGE	Above 1000MHz
ENVIRONMENTAL CONDITIONS	23deg. C, 70%RH	INPUT POWER	AC 120V/60HZ
TESTED BY	Jace Hu		
ANTENNA POLARITY & TEST DISTANCE: VERTICAL AT 3 M			

	Freq	Level	Read Level	Limit	Over Limit	Factor	Remark	Pol/Phase
	MHz	dBm/m	dBm	dBm/m	dB	dB/m		
1	1648.000	-52.50	-55.88	-13.00	-39.50	3.38	Peak	Vertical
2 PP	2476.000	-30.89	-37.93	-13.00	-17.89	7.04	Peak	Vertical

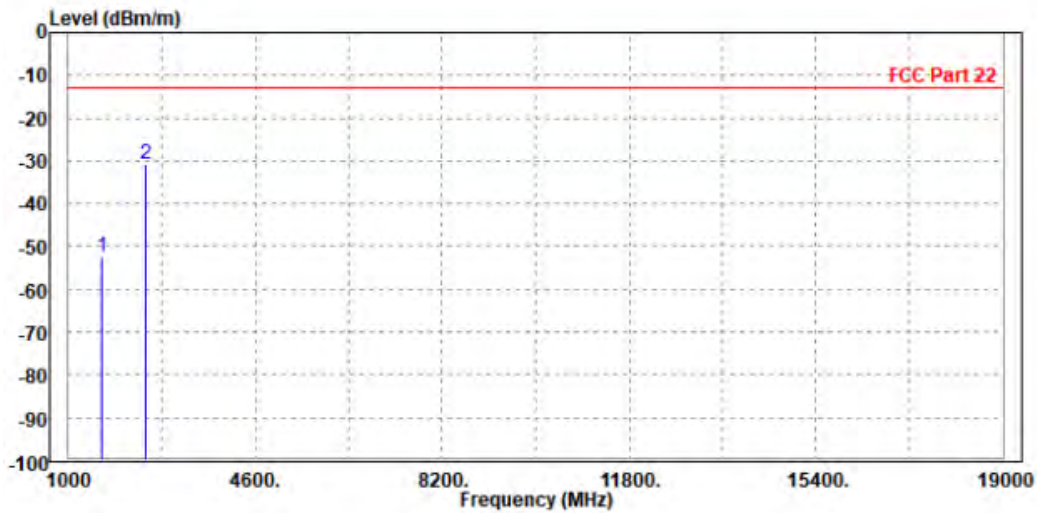



**BUREAU
VERITAS**

Test Report No.: W7L-P22030026-2RF03

CH 189:

MODE	TX channel 189	FREQUENCY RANGE	Above 1000MHz
ENVIRONMENTAL CONDITIONS	23deg. C, 70%RH	INPUT POWER	AC 120V/60HZ
TESTED BY	Jace Hu		
ANTENNA POLARITY & TEST DISTANCE: HORIZONTAL AT 3 M			

	Freq	Level	Read Level	Limit Line	Over Limit	Factor	Remark	Pol/Phase
	MHz	dBm/m	dBm	dBm/m	dB	dB/m		
1	1666.000	-39.52	-42.99	-13.00	-26.52	3.47	Peak	Horizontal
2 PP	2509.200	-33.47	-41.53	-13.00	-20.47	8.06	Peak	Horizontal

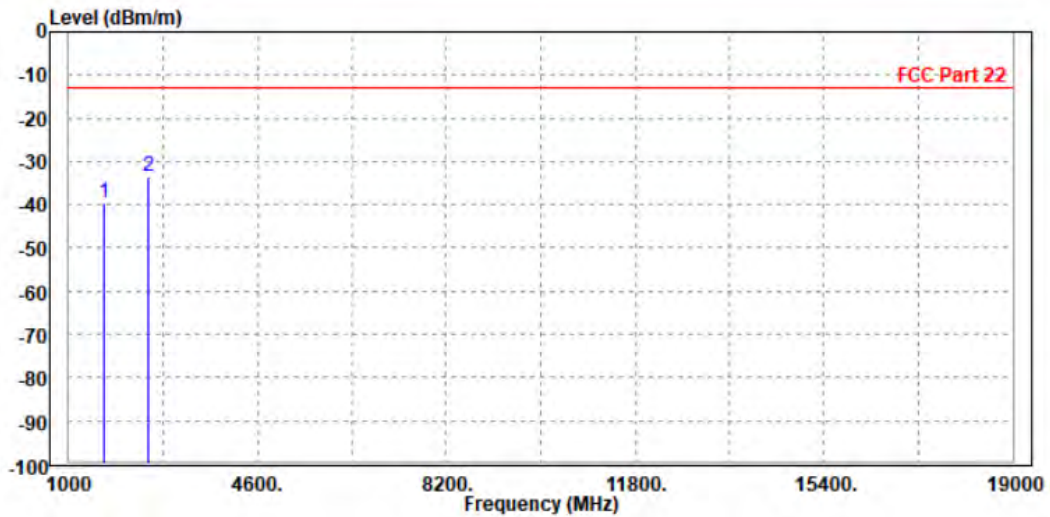



BUREAU VERITAS

Test Report No.: W7L-P22030026-2RF03

MODE	TX channel 189	FREQUENCY RANGE	Above 1000MHz
ENVIRONMENTAL CONDITIONS	23deg. C, 70%RH	INPUT POWER	AC 120V/60HZ
TESTED BY	Jace Hu		
ANTENNA POLARITY & TEST DISTANCE: VERTICAL AT 3 M			

	Freq	Level	Read Level	Limit Line	Over Limit	Factor	Remark	Pol/Phase
	MHz	dBm/m	dBm	dBm/m	dB	dB/m		
1	1666.000	-40.80	-44.34	-13.00	-27.80	3.54	Peak	Vertical
2 PP	2509.200	-34.34	-41.44	-13.00	-21.34	7.10	Peak	Vertical

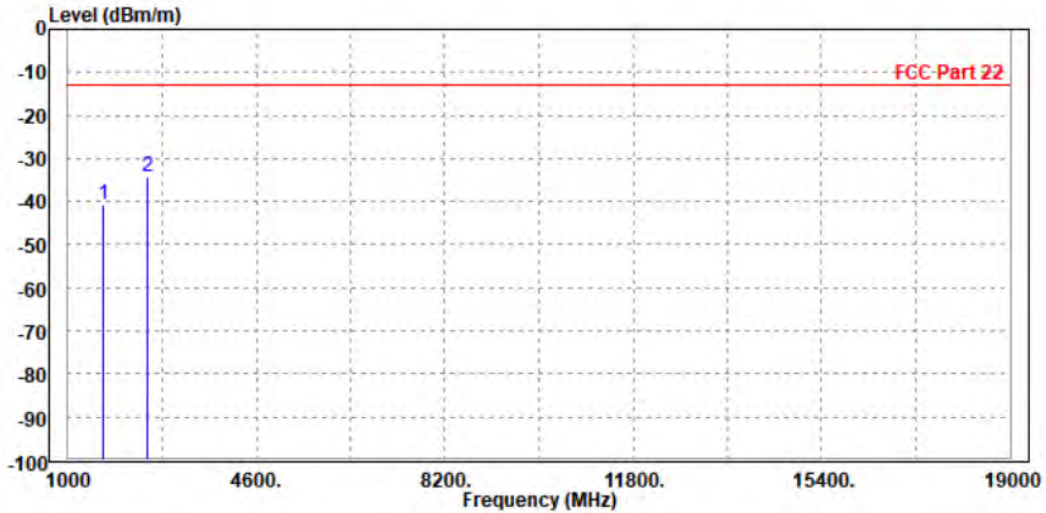



**BUREAU
VERITAS**

Test Report No.: W7L-P22030026-2RF03

CH 251:

MODE	TX channel 251	FREQUENCY RANGE	Above 1000MHz
ENVIRONMENTAL CONDITIONS	23deg. C, 70%RH	INPUT POWER	AC 120V/60HZ
TESTED BY	Jace Hu		
ANTENNA POLARITY & TEST DISTANCE: HORIZONTAL AT 3 M			

	Freq	Level	Read Level	Limit Line	Over Limit	Factor	Remark	Pol/Phase
	MHz	dBm/m	dBm	dBm/m	dB	dB/m		
1	1702.000	-52.37	-56.28	-13.00	-39.37	3.91	Peak	Horizontal
2 PP	2546.400	-39.52	-47.63	-13.00	-26.52	8.11	Peak	Horizontal

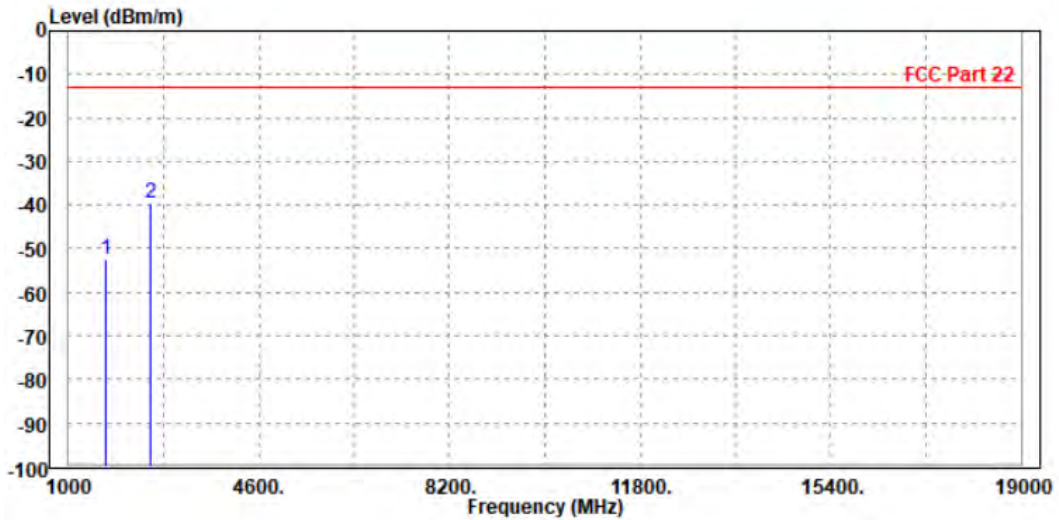



**BUREAU
VERITAS**

Test Report No.: W7L-P22030026-2RF03

MODE	TX channel 251	FREQUENCY RANGE	Above 1000MHz
ENVIRONMENTAL CONDITIONS	23deg. C, 70%RH	INPUT POWER	AC 120V/60HZ
TESTED BY	Jace Hu		
ANTENNA POLARITY & TEST DISTANCE: VERTICAL AT 3 M			

	Freq	Level	Read Level	Limit Line	Over Limit	Factor	Remark	Pol/Phase
	MHz	dBm/m	dBm	dBm/m	dB	dB/m		
1	1702.000	-50.92	-54.79	-13.00	-37.92	3.87	Peak	Vertical
2 PP	2546.400	-40.17	-47.39	-13.00	-27.17	7.22	Peak	Vertical

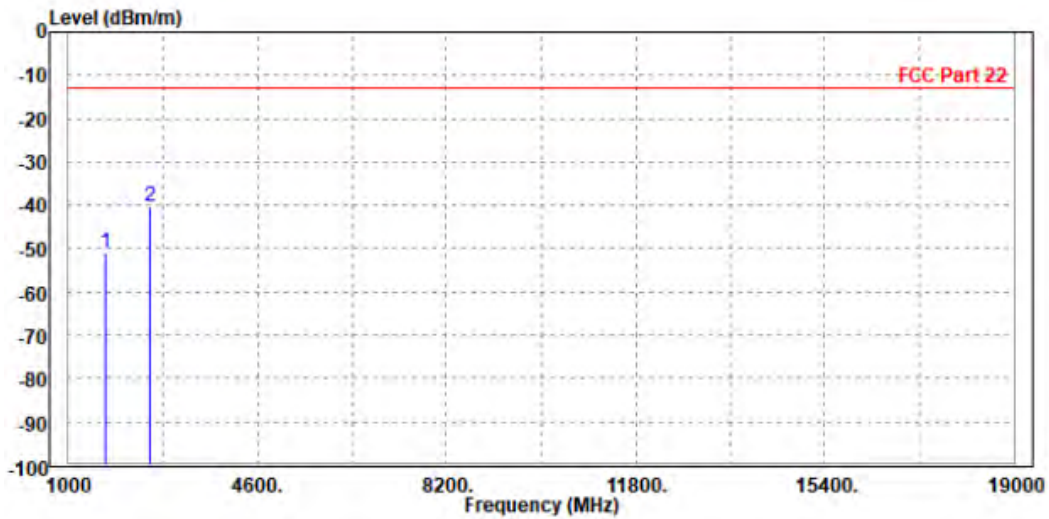



**BUREAU
VERITAS**

Test Report No.: W7L-P22030026-2RF03

EDGE 850:

CH 128:

MODE	TX channel 128	FREQUENCY RANGE	Above 1000MHz
ENVIRONMENTAL CONDITIONS	23deg. C, 70%RH	INPUT POWER	AC 120V/60HZ
TESTED BY	Jace Hu		
ANTENNA POLARITY & TEST DISTANCE: HORIZONTAL AT 3 M			

	Freq	Level	Read Level	Limit Line	Over Limit	Factor	Remark	Pol/Phase
	MHz	dBm/m	dBm	dBm/m	dB	dB/m		
1	1648.000	-52.32	-55.57	-13.00	-39.32	3.25	Peak	Horizontal
2 PP	2472.600	-18.44	-26.46	-13.00	-5.44	8.02	Peak	Horizontal

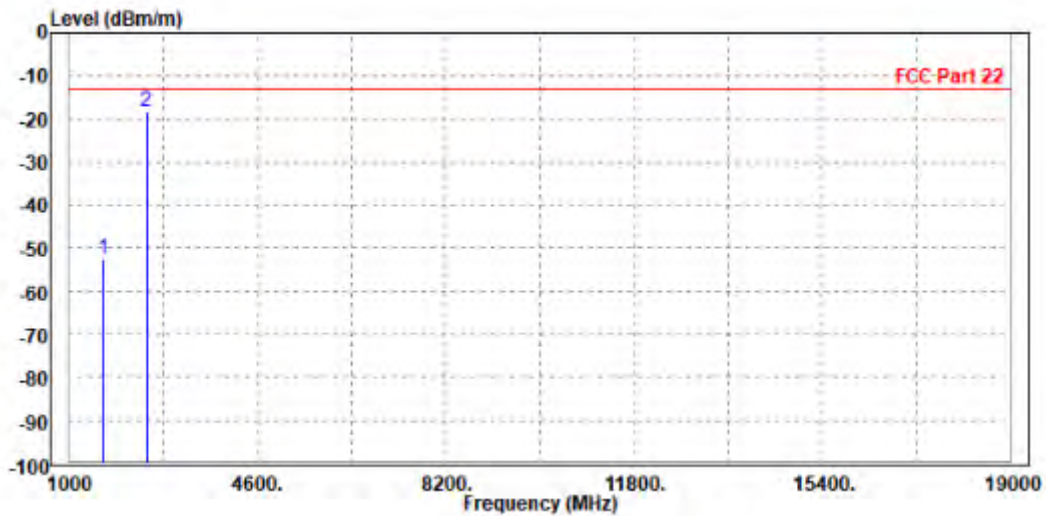



**BUREAU
VERITAS**

Test Report No.: W7L-P22030026-2RF03

MODE	TX channel 128	FREQUENCY RANGE	Above 1000MHz
ENVIRONMENTAL CONDITIONS	23deg. C, 70%RH	INPUT POWER	AC 120V/60HZ
TESTED BY	Jace Hu		
ANTENNA POLARITY & TEST DISTANCE: VERTICAL AT 3 M			

	Freq	Level	Read Level	Limit Line	Over Limit	Factor	Remark	Pol/Phase
	MHz	dBm/m	dBm	dBm/m	dB	dB/m		
1	1648.000	-34.27	-37.65	-13.00	-21.27	3.38	Peak	Vertical
2 PP	2476.000	-18.52	-25.56	-13.00	-5.52	7.04	Peak	Vertical

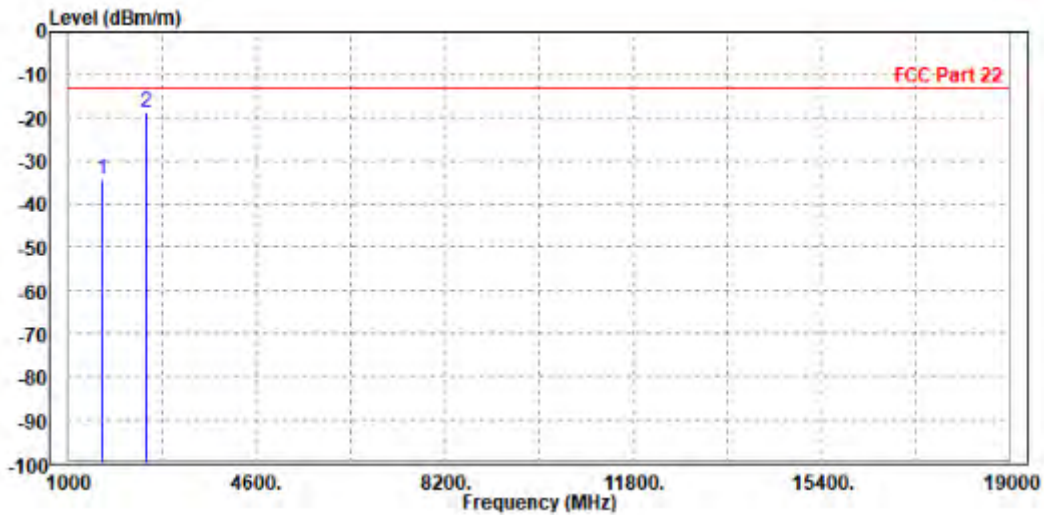



**BUREAU
VERITAS**

Test Report No.: W7L-P22030026-2RF03

CH 189:

MODE	TX channel 189	FREQUENCY RANGE	Above 1000MHz
ENVIRONMENTAL CONDITIONS	23deg. C, 70%RH	INPUT POWER	AC 120V/60HZ
TESTED BY	Jace Hu		
ANTENNA POLARITY & TEST DISTANCE: HORIZONTAL AT 3 M			

	Freq	Level	Read Level	Limit Line	Over Limit	Factor	Remark	Pol/Phase
	MHz	dBm/m	dBm	dBm/m	dB	dB/m		
1	PP 1666.000	-30.17	-33.64	-13.00	-17.17	3.47	Peak	Horizontal
2	2509.200	-36.47	-44.53	-13.00	-23.47	8.06	Peak	Horizontal

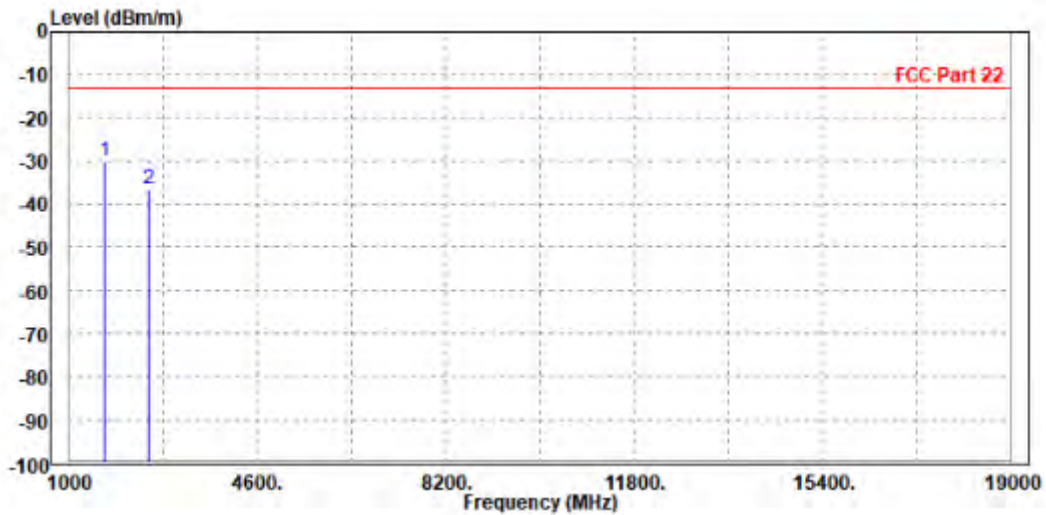



**BUREAU
VERITAS**

Test Report No.: W7L-P22030026-2RF03

MODE	TX channel 189	FREQUENCY RANGE	Above 1000MHz
ENVIRONMENTAL CONDITIONS	23deg. C, 70%RH	INPUT POWER	AC 120V/60HZ
TESTED BY	Jace Hu		
ANTENNA POLARITY & TEST DISTANCE: VERTICAL AT 3 M			

	Freq	Level	Read Level	Limit Line	Over Limit	Factor	Remark	Pol/Phase
	MHz	dBm/m	dBm	dBm/m	dB	dB/m		
1	1666.000	-51.42	-54.96	-13.00	-38.42	3.54	Peak	Vertical
2 PP	2509.200	-44.67	-51.77	-13.00	-31.67	7.10	Peak	Vertical

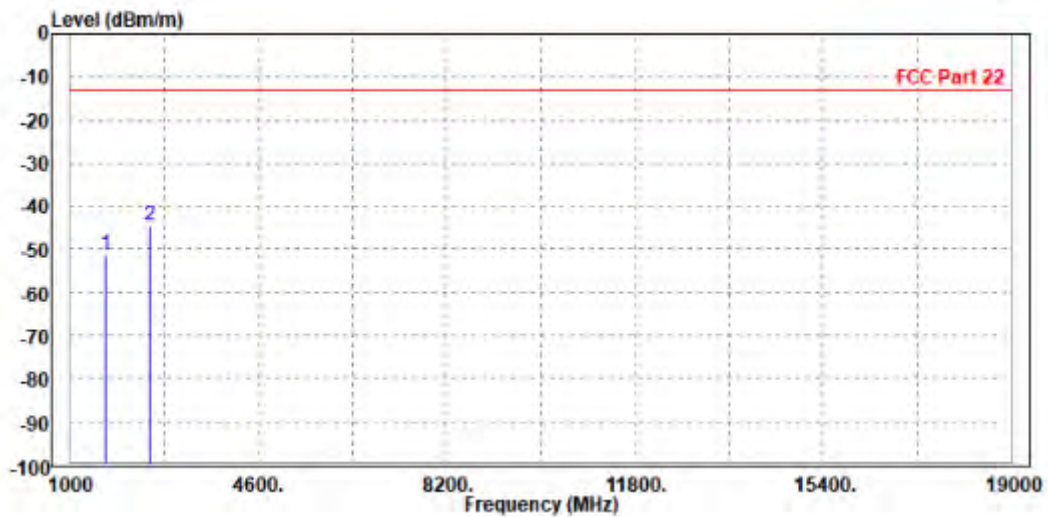



CH 251:

MODE	TX channel 251	FREQUENCY RANGE	Above 1000MHz
ENVIRONMENTAL CONDITIONS	23deg. C, 70%RH	INPUT POWER	AC 120V/60HZ
TESTED BY	Jace Hu		
ANTENNA POLARITY & TEST DISTANCE: HORIZONTAL AT 3 M			

	Freq	Level	Read Level	Limit Line	Over Limit	Factor	Remark	Pol/Phase
	MHz	dBm/m	dBm	dBm/m	dB	dB/m		
1	PP 1702.000	-29.37	-33.28	-13.00	-16.37	3.91	Peak	Horizontal
2	2546.400	-39.11	-47.22	-13.00	-26.11	8.11	Peak	Horizontal

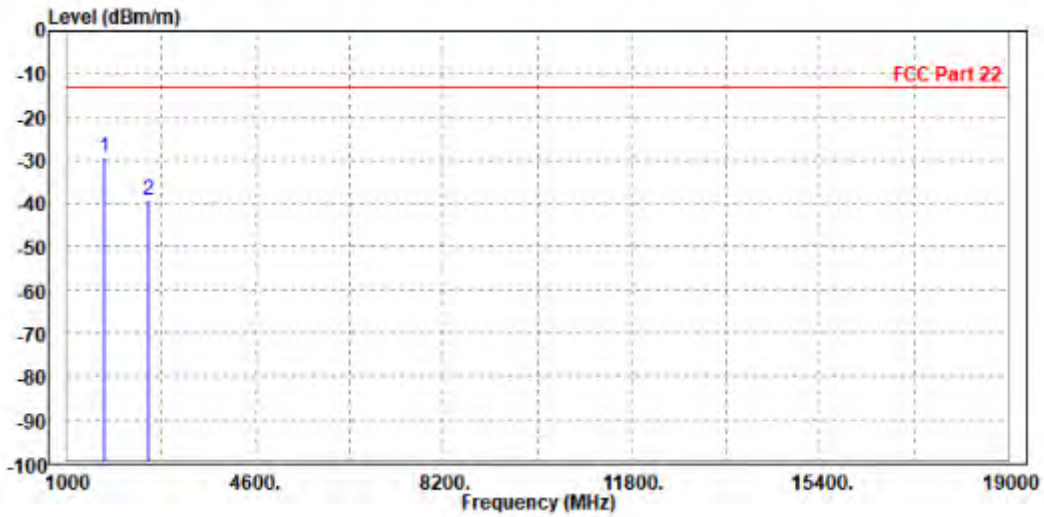



**BUREAU
VERITAS**

Test Report No.: W7L-P22030026-2RF03

MODE	TX channel 251	FREQUENCY RANGE	Above 1000MHz
ENVIRONMENTAL CONDITIONS	23deg. C, 70%RH	INPUT POWER	AC 120V/60HZ
TESTED BY	Jace Hu		
ANTENNA POLARITY & TEST DISTANCE: VERTICAL AT 3 M			

	Freq	Level	Read Level	Limit Line	Over Limit	Factor	Remark	Pol/Phase
	MHz	dBm/m	dBm	dBm/m	dB	dB/m		
1	PP 1702.000	-31.82	-35.69	-13.00	-18.82	3.87	Peak	Vertical
2	2546.400	-42.34	-49.56	-13.00	-29.34	7.22	Peak	Vertical

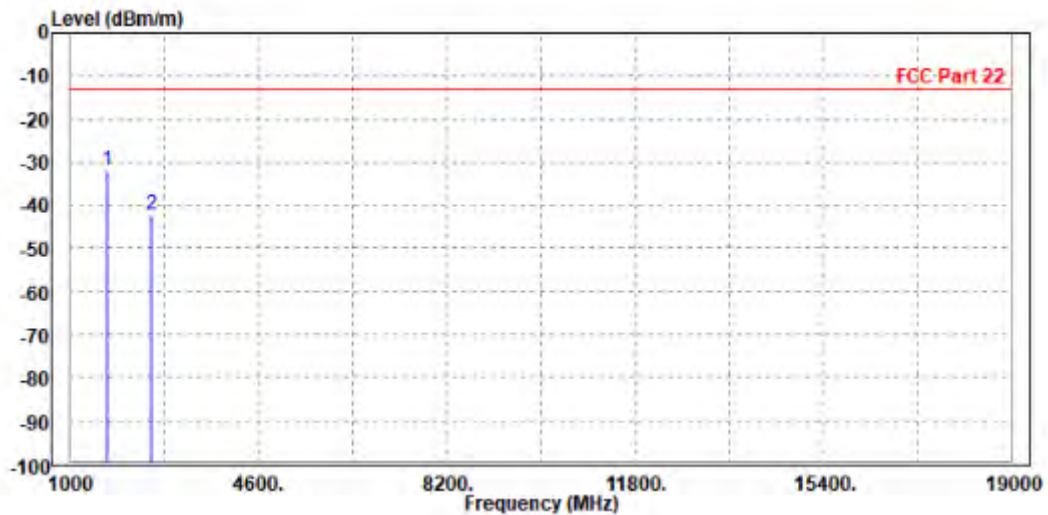



WCDMA Band V:

CH 4132:

MODE	TX channel 4132	FREQUENCY RANGE	Above 1000MHz
ENVIRONMENTAL CONDITIONS	23deg. C, 70%RH	INPUT POWER	AC 120V/60HZ
TESTED BY	Jace Hu		
ANTENNA POLARITY & TEST DISTANCE: HORIZONTAL AT 3 M			

	Freq	Level	Read Level	Limit Line	Over Limit	Factor	Remark	Pol/Phase
	MHz	dBm/m	dBm	dBm/m	dB	dB/m		
1	1648.000	-42.35	-45.60	-13.00	-29.35	3.25	Peak	Horizontal
2 PP	2476.000	-23.68	-31.71	-13.00	-10.68	8.03	Peak	Horizontal

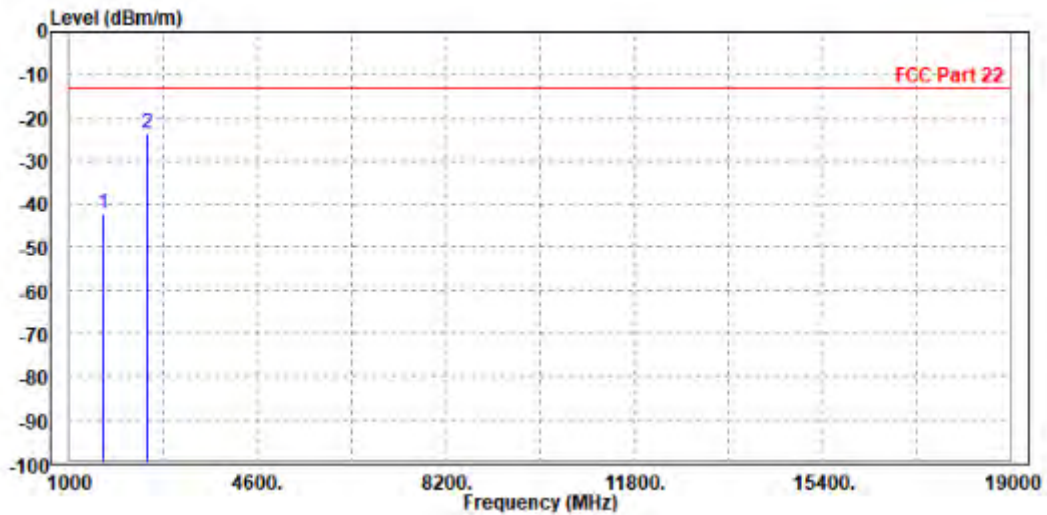



**BUREAU
VERITAS**

Test Report No.: W7L-P22030026-2RF03

MODE	TX channel 4132	FREQUENCY RANGE	Above 1000MHz
ENVIRONMENTAL CONDITIONS	23deg. C, 70%RH	INPUT POWER	AC 120V/60HZ
TESTED BY	Jace Hu		
ANTENNA POLARITY & TEST DISTANCE: VERTICAL AT 3 M			

	Freq	Level	Read Level	Limit Line	Over Limit	Factor	Remark	Pol/Phase
	MHz	dBm/m	dBm	dBm/m	dB	dB/m		
1	1652.800	-43.28	-46.71	-13.00	-30.28	3.43	Peak	Vertical
2 PP	2479.200	-20.61	-27.66	-13.00	-7.61	7.05	Peak	Vertical

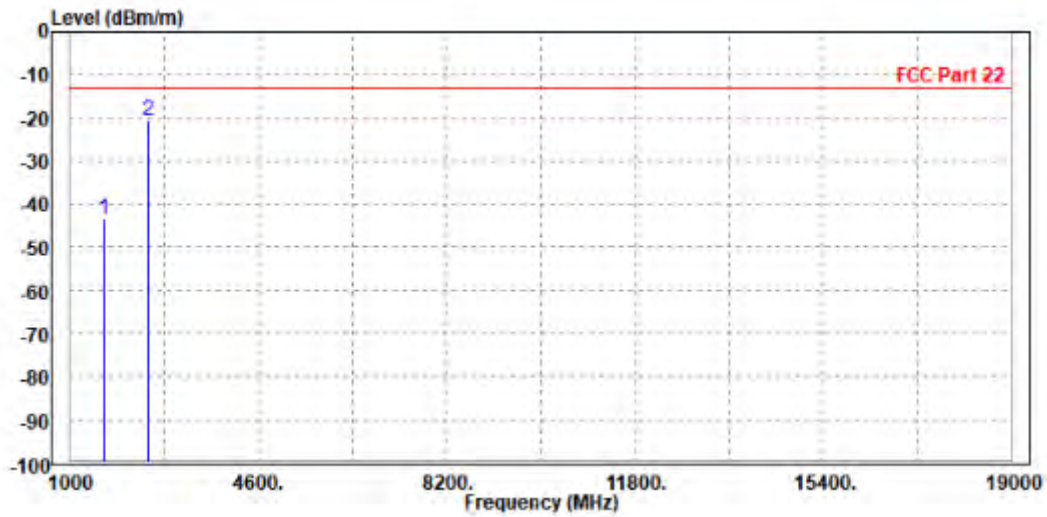



CH 4182:

MODE	TX channel 4182	FREQUENCY RANGE	Above 1000MHz
ENVIRONMENTAL CONDITIONS	23deg. C, 70%RH	INPUT POWER	AC 120V/60HZ
TESTED BY	Jace Hu		
ANTENNA POLARITY & TEST DISTANCE: HORIZONTAL AT 3 M			

	Freq	Level	Read Level	Limit Line	Over Limit	Factor	Remark	Pol/Phase
	MHz	dBm/m	dBm	dBm/m	dB	dB/m		
1	PP 1666.000	-40.23	-43.70	-13.00	-27.23	3.47	Peak	Horizontal
2	2509.200	-40.93	-48.99	-13.00	-27.93	8.06	Peak	Horizontal

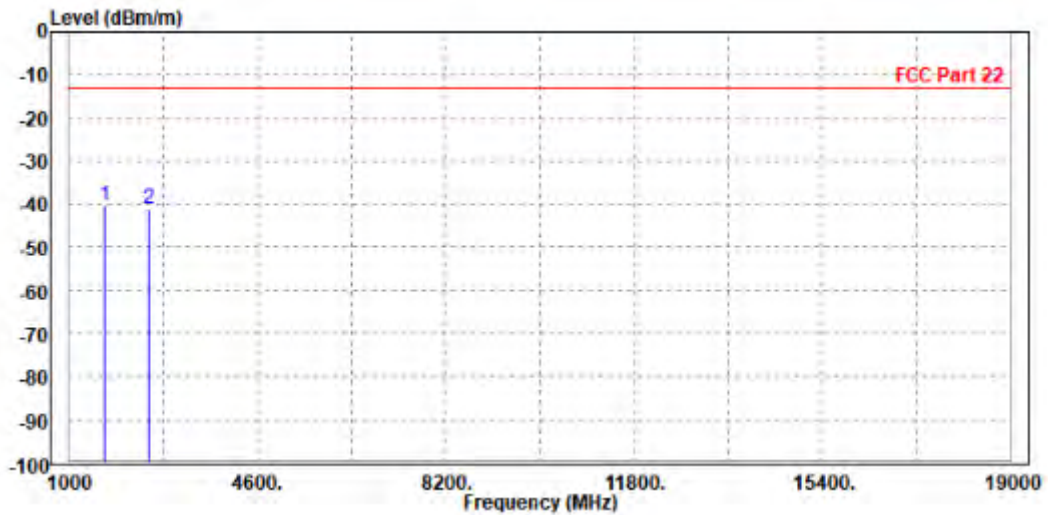



BUREAU VERITAS

Test Report No.: W7L-P22030026-2RF03

MODE	TX channel 4182	FREQUENCY RANGE	Above 1000MHz
ENVIRONMENTAL CONDITIONS	23deg. C, 70%RH	INPUT POWER	AC 120V/60HZ
TESTED BY	Jace Hu		
ANTENNA POLARITY & TEST DISTANCE: VERTICAL AT 3 M			

	Freq	Level	Read Level	Limit Line	Over Limit	Factor	Remark	Pol/Phase
	MHz	dBm/m	dBm	dBm/m	dB	dB/m		
1	1666.000	-42.38	-45.92	-13.00	-29.38	3.54	Peak	Vertical
2 PP	2509.200	-41.50	-48.60	-13.00	-28.50	7.10	Peak	Vertical

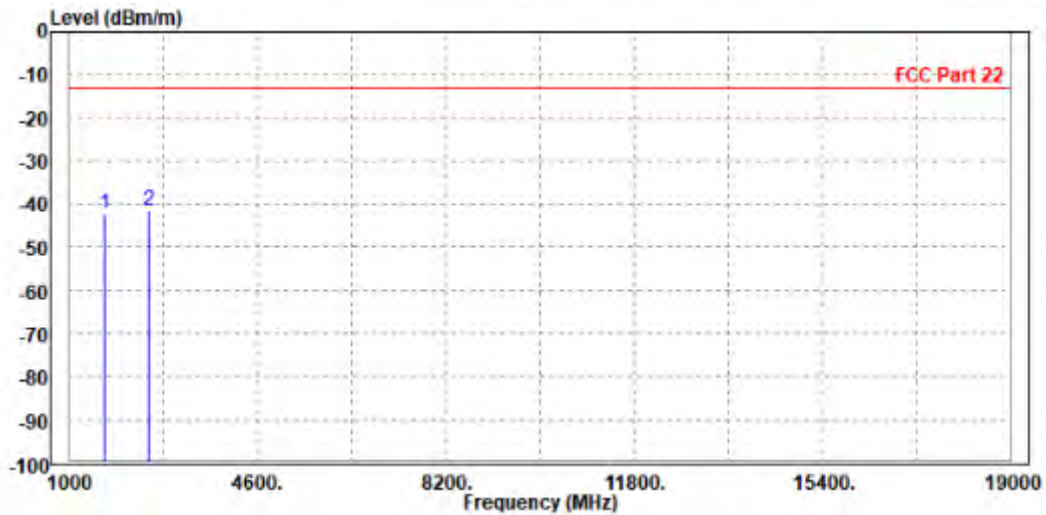



CH 4233:

MODE	TX channel 4233	FREQUENCY RANGE	Above 1000MHz
ENVIRONMENTAL CONDITIONS	23deg. C, 70%RH	INPUT POWER	AC 120V/60HZ
TESTED BY	Jace Hu		
ANTENNA POLARITY & TEST DISTANCE: HORIZONTAL AT 3 M			

	Freq	Level	Read Level	Limit Line	Over Limit	Factor	Remark	Pol/Phase
	MHz	dBm/m	dBm	dBm/m	dB	dB/m		
1	PP 1702.000	-43.07	-46.98	-13.00	-30.07	3.91	Peak	Horizontal
2	2539.800	-45.58	-53.68	-13.00	-32.58	8.10	Peak	Horizontal

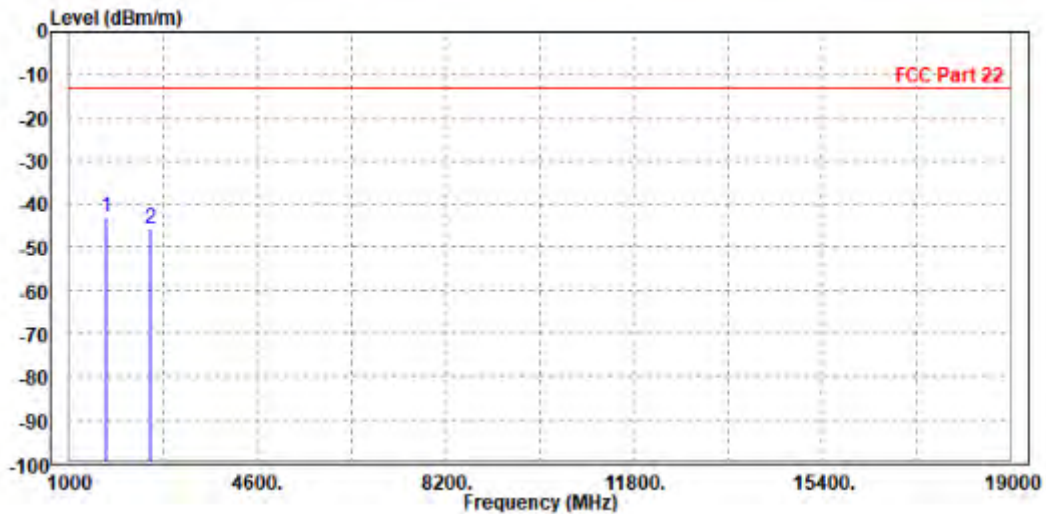



MODE	TX channel 4233	FREQUENCY RANGE	Above 1000MHz
ENVIRONMENTAL CONDITIONS	23deg. C, 70%RH	INPUT POWER	AC 120V/60HZ
TESTED BY	Jace Hu		
ANTENNA POLARITY & TEST DISTANCE: VERTICAL AT 3 M			

	Freq	Level	Read Level	Limit Line	Over Limit	Factor	Remark	Pol/Phase
	MHz	dBm/m	dBm	dBm/m	dB	dB/m		
1	PP 1702.000	-42.77	-46.64	-13.00	-29.77	3.87	Peak	Vertical
2	2539.800	-43.65	-50.85	-13.00	-30.65	7.20	Peak	Vertical

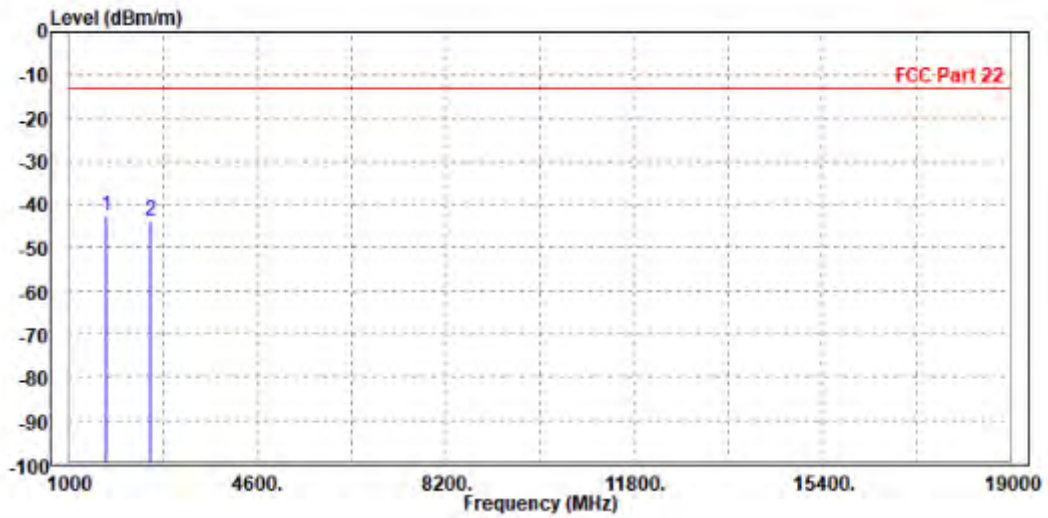



LTE Band 5

CHANNEL BANDWIDTH: 1.4MHz / QPSK

MODE	TX channel 20525	FREQUENCY RANGE	Above 1000MHz
ENVIRONMENTAL CONDITIONS	23deg. C, 70%RH	INPUT POWER	AC 120V/60HZ
TESTED BY	Jace Hu		
ANTENNA POLARITY & TEST DISTANCE: HORIZONTAL AT 3 M			

	Freq	Level	Read Level	Limit Line	Over Limit	Factor	Remark	Pol/Phase
	MHz	dBm/m	dBm	dBm/m	dB	dB/m		
1	1673.000	-51.92	-55.48	-13.00	-38.92	3.56	Peak	Horizontal
2 PP	2512.000	-42.04	-50.10	-13.00	-29.04	8.06	Peak	Horizontal

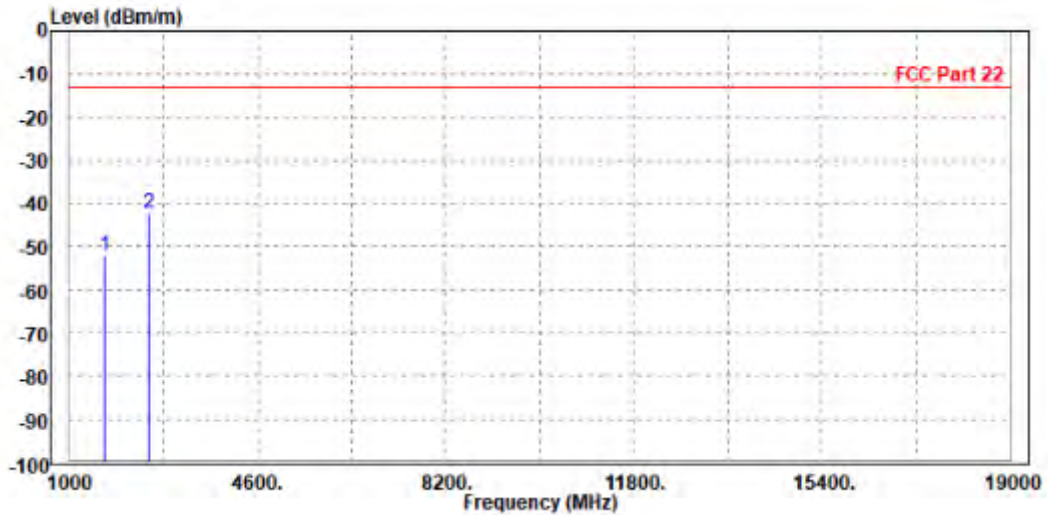



BUREAU VERITAS

Test Report No.: W7L-P22030026-2RF03

MODE	TX channel 20525	FREQUENCY RANGE	Above 1000MHz
ENVIRONMENTAL CONDITIONS	23deg. C, 70%RH	INPUT POWER	AC 120V/60HZ
TESTED BY	Jace Hu		
ANTENNA POLARITY & TEST DISTANCE: VERTICAL AT 3 M			

	Freq	Level	Read Level	Limit Line	Over Limit	Factor	Remark	Pol/Phase
	MHz	dBm/m	dBm	dBm/m	dB	dB/m		
1	1666.000	-52.35	-55.89	-13.00	-39.35	3.54	Peak	Vertical
2	PP 2509.500	-42.87	-49.97	-13.00	-29.87	7.10	Peak	Vertical

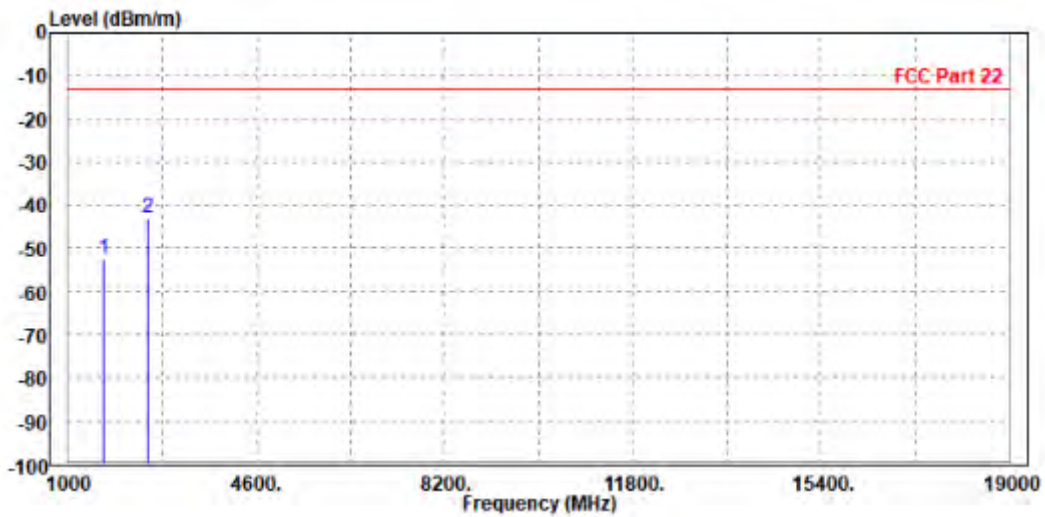



CHANNEL BANDWIDTH: 3MHz / QPSK

MODE	TX channel 20525	FREQUENCY RANGE	Above 1000MHz
ENVIRONMENTAL CONDITIONS	23deg. C, 70%RH	INPUT POWER	AC 120V/60HZ
TESTED BY	Jace Hu		
ANTENNA POLARITY & TEST DISTANCE: HORIZONTAL AT 3 M			

	Freq	Level	Read Level	Limit Line	Over Limit	Factor	Remark	Pol/Phase
	MHz	dBm/m	dBm	dBm/m	dB	dB/m		
1	1666.000	-44.41	-47.88	-13.00	-31.41	3.47	Peak	Horizontal
2 PP	2509.500	-41.46	-49.52	-13.00	-28.46	8.06	Peak	Horizontal

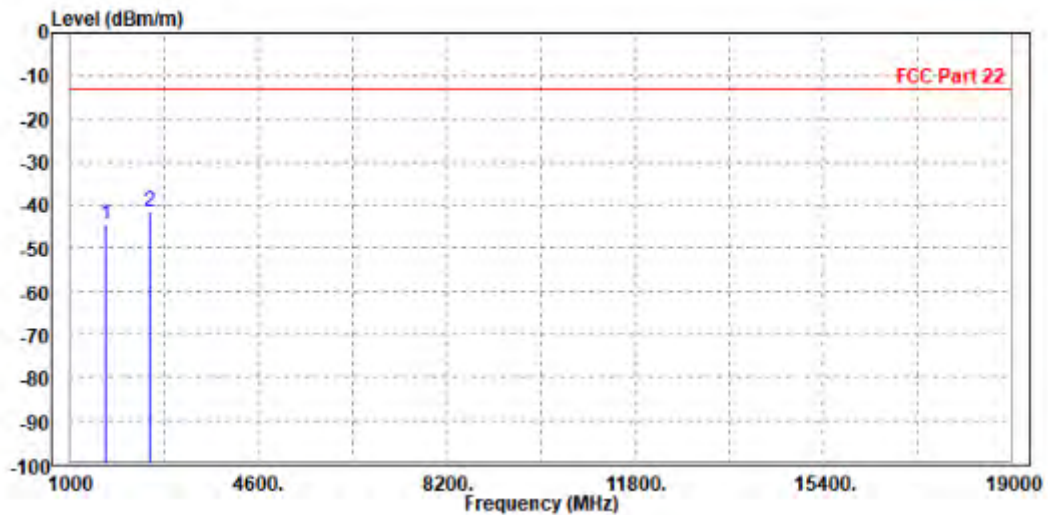



**BUREAU
VERITAS**

Test Report No.: W7L-P22030026-2RF03

MODE	TX channel 20525	FREQUENCY RANGE	Above 1000MHz
ENVIRONMENTAL CONDITIONS	23deg. C, 70%RH	INPUT POWER	AC 120V/60HZ
TESTED BY	Jace Hu		
ANTENNA POLARITY & TEST DISTANCE: VERTICAL AT 3 M			

	Freq	Level	Read Level	Limit Line	Over Limit	Factor	Remark	Pol/Phase
	MHz	dBm/m	dBm	dBm/m	dB	dB/m		
1	1673.000	-43.63	-47.24	-13.00	-30.63	3.61	Peak	Vertical
2 PP	2512.000	-43.23	-50.34	-13.00	-30.23	7.11	Peak	Vertical

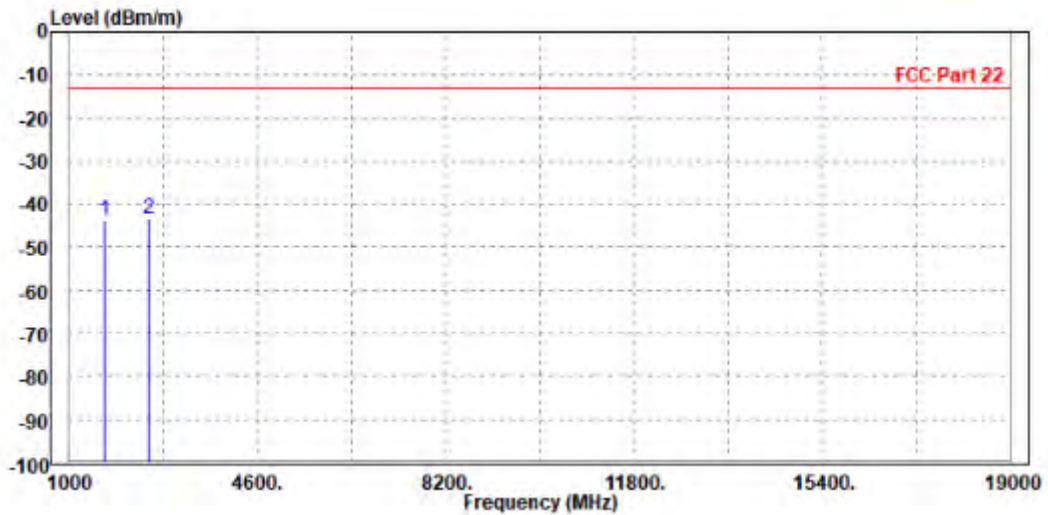



CHANNEL BANDWIDTH: 5MHz / QPSK

CH20425:

MODE	TX channel 20425	FREQUENCY RANGE	Above 1000MHz
ENVIRONMENTAL CONDITIONS	23deg. C, 70%RH	INPUT POWER	AC 120V/60HZ
TESTED BY	Jace Hu		
ANTENNA POLARITY & TEST DISTANCE: HORIZONTAL AT 3 M			

	Freq	Level	Read Level	Limit Line	Over Limit	Factor	Remark	Pol/Phase
	MHz	dBm/m	dBm	dBm/m	dB	dB/m		
1	1648.000	-43.97	-47.22	-13.00	-30.97	3.25	Peak	Horizontal
2 PP	2476.000	-35.52	-43.55	-13.00	-22.52	8.03	Peak	Horizontal

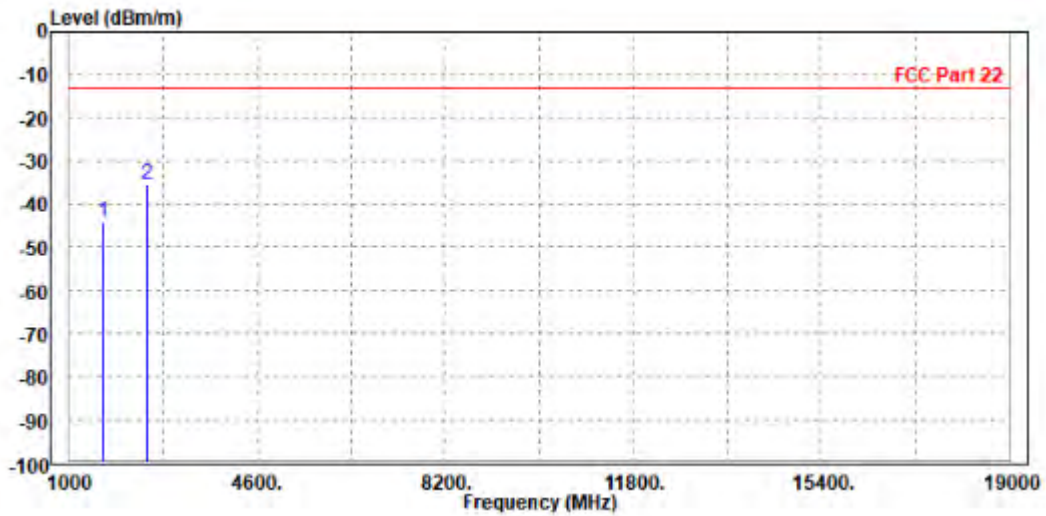



**BUREAU
VERITAS**

Test Report No.: W7L-P22030026-2RF03

MODE	TX channel 20425	FREQUENCY RANGE	Above 1000MHz
ENVIRONMENTAL CONDITIONS	23deg. C, 70%RH	INPUT POWER	AC 120V/60HZ
TESTED BY	Jace Hu		
ANTENNA POLARITY & TEST DISTANCE: VERTICAL AT 3 M			

	Freq	Level	Read Level	Limit Line	Over Limit	Factor	Remark	Pol/Phase
	MHz	dBm/m	dBm	dBm/m	dB	dB/m		
1	1648.000	-43.32	-46.70	-13.00	-30.32	3.38	Peak	Vertical
2 PP	2476.000	-37.53	-44.57	-13.00	-24.53	7.04	Peak	Vertical

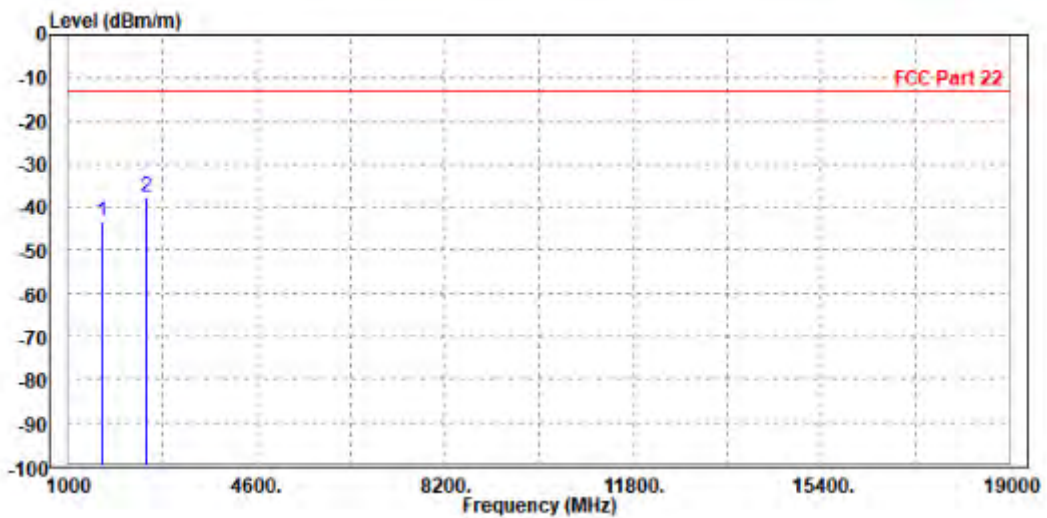



**BUREAU
VERITAS**

Test Report No.: W7L-P22030026-2RF03

CH20525:

MODE	TX channel 20525	FREQUENCY RANGE	Above 1000MHz
ENVIRONMENTAL CONDITIONS	23deg. C, 70%RH	INPUT POWER	AC 120V/60HZ
TESTED BY	Jace Hu		
ANTENNA POLARITY & TEST DISTANCE: HORIZONTAL AT 3 M			

	Freq	Level	Read Level	Limit Line	Over Limit	Factor	Remark	Pol/Phase
	MHz	dBm/m	dBm	dBm/m	dB	dB/m		
1	PP 1666.000	-39.52	-42.99	-13.00	-26.52	3.47	Peak	Horizontal
2	2509.500	-43.26	-51.32	-13.00	-30.26	8.06	Peak	Horizontal

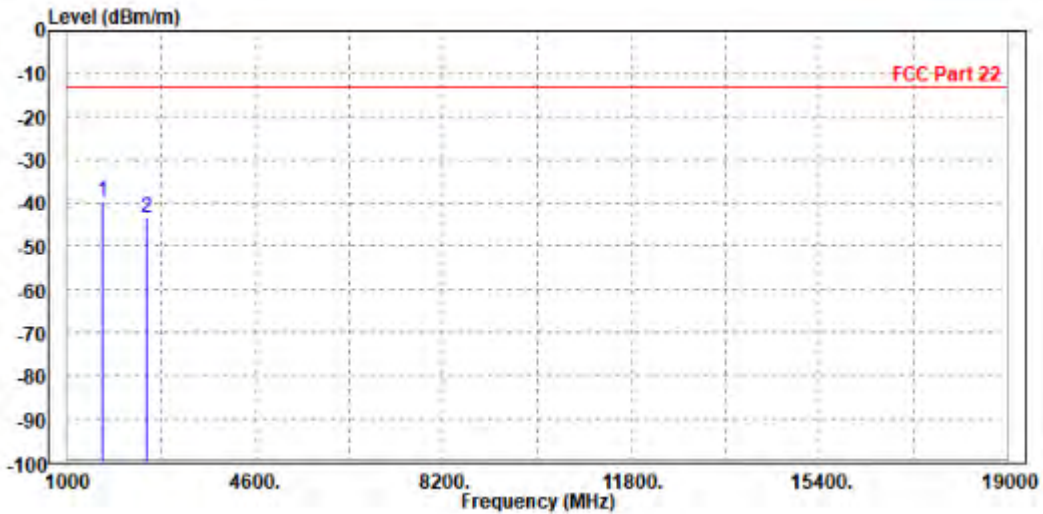



**BUREAU
VERITAS**

Test Report No.: W7L-P22030026-2RF03

MODE	TX channel 20525	FREQUENCY RANGE	Above 1000MHz
ENVIRONMENTAL CONDITIONS	23deg. C, 70%RH	INPUT POWER	AC 120V/60HZ
TESTED BY	Jace Hu		
ANTENNA POLARITY & TEST DISTANCE: VERTICAL AT 3 M			

	Freq	Level	Read Level	Limit Line	Over Limit	Factor	Remark	PoI/Phase
	MHz	dBm/m	dBm	dBm/m	dB	dB/m		
1 PP	1666.000	-37.96	-41.50	-13.00	-24.96	3.54	Peak	Vertical
2	2509.500	-43.56	-50.66	-13.00	-30.56	7.10	Peak	Vertical

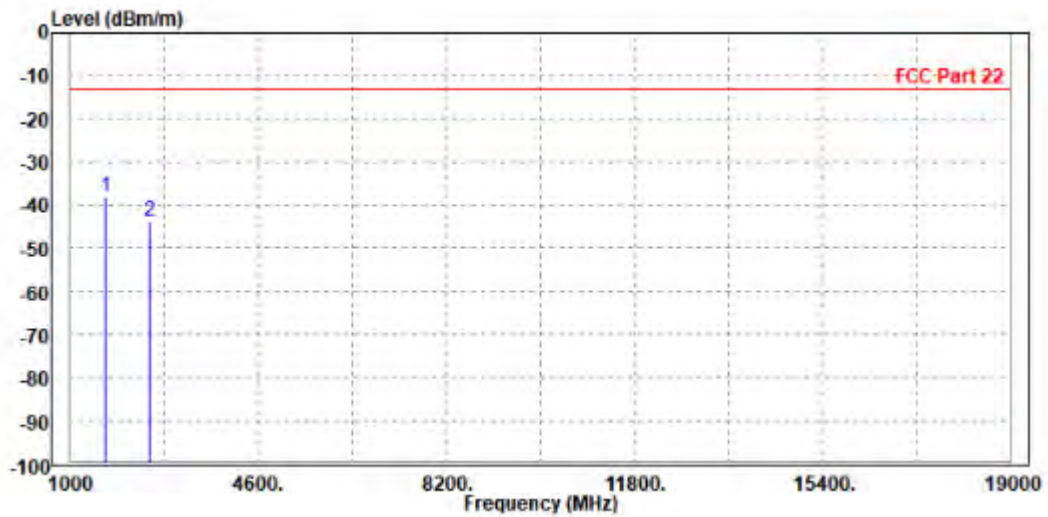



CH20625:

MODE	TX channel 20625	FREQUENCY RANGE	Above 1000MHz
ENVIRONMENTAL CONDITIONS	23deg. C, 70%RH	INPUT POWER	AC 120V/60Hz
TESTED BY	Jace Hu		
ANTENNA POLARITY & TEST DISTANCE: HORIZONTAL AT 3 M			

	Freq	Level	Read Level	Limit Line	Over Limit	Factor	Remark	Pol/Phase
	MHz	dBm/m	dBm	dBm/m	dB	dB/m		
1	1693.000	-52.21	-56.01	-13.00	-39.21	3.80	Peak	Horizontal
2 PP	2548.000	-36.83	-44.94	-13.00	-23.83	8.11	Peak	Horizontal

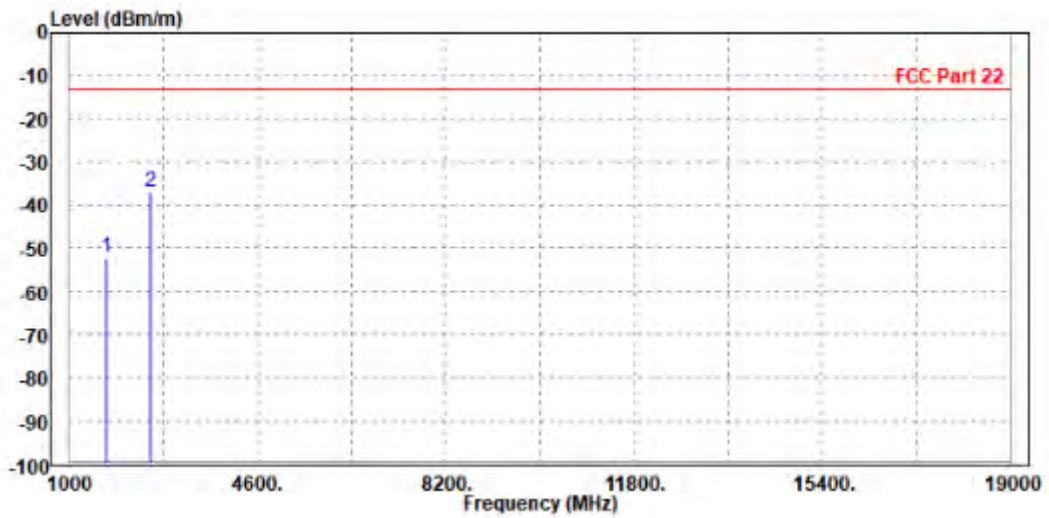



**BUREAU
VERITAS**

Test Report No.: W7L-P22030026-2RF03

MODE	TX channel 20625	FREQUENCY RANGE	Above 1000MHz
ENVIRONMENTAL CONDITIONS	23deg. C, 70%RH	INPUT POWER	AC 120V/60Hz
TESTED BY	Jace Hu		
ANTENNA POLARITY & TEST DISTANCE: VERTICAL AT 3 M			

	Freq	Level	Read Level	Limit Line	Over Limit	Factor	Remark	Pol/Phase
	MHz	dBm/m	dBm	dBm/m	dB	dB/m		
1	1684.000	-52.57	-56.28	-13.00	-39.57	3.71	Peak	Vertical
2 PP	2539.500	-49.95	-57.15	-13.00	-36.95	7.20	Peak	Vertical

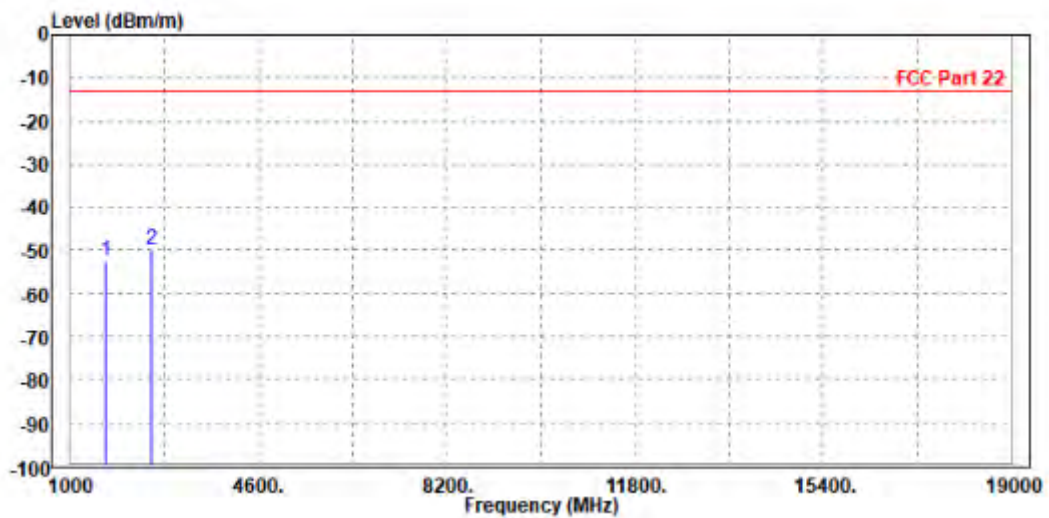



**BUREAU
VERITAS**

Test Report No.: W7L-P22030026-2RF03

CHANNEL BANDWIDTH: 10MHz / QPSK

MODE	TX channel 20525	FREQUENCY RANGE	Above 1000MHz
ENVIRONMENTAL CONDITIONS	23deg. C, 70%RH	INPUT POWER	AC 120V/60Hz
TESTED BY	Jace Hu		
ANTENNA POLARITY & TEST DISTANCE: HORIZONTAL AT 3 M			

	Freq	Level	Read Level	Limit Line	Over Limit	Factor	Remark	Pol/Phase
	MHz	dBm/m	dBm	dBm/m	dB	dB/m		
1	PP 1673.000	-42.49	-46.05	-13.00	-29.49	3.56	Peak	Horizontal
2	2512.000	-42.67	-50.73	-13.00	-29.67	8.06	Peak	Horizontal

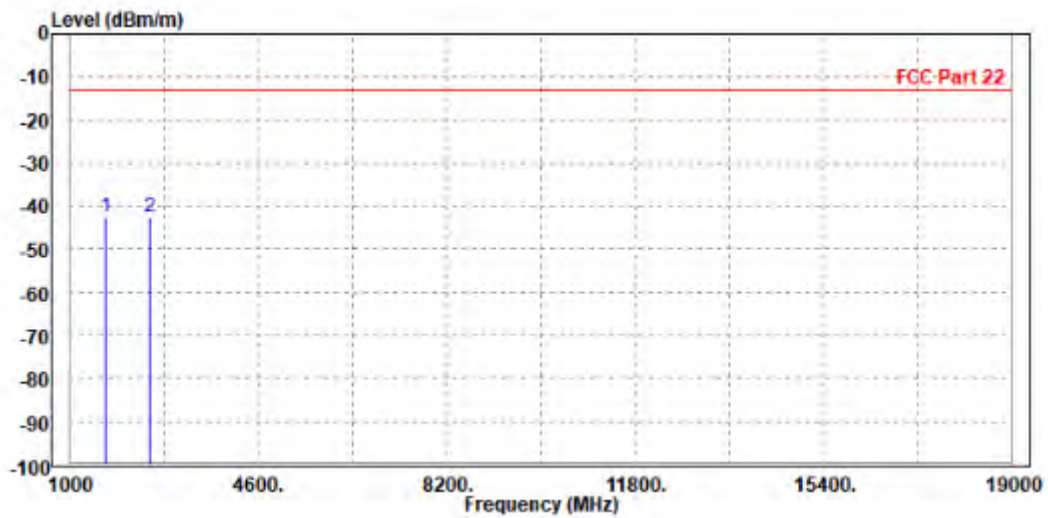



**BUREAU
VERITAS**

Test Report No.: W7L-P22030026-2RF03

MODE	TX channel 20525	FREQUENCY RANGE	Above 1000MHz
ENVIRONMENTAL CONDITIONS	23deg. C, 70%RH	INPUT POWER	AC 120V/60Hz
TESTED BY	Jace Hu		
ANTENNA POLARITY & TEST DISTANCE: VERTICAL AT 3 M			

	Freq	Level	Read Level	Limit Line	Over Limit	Factor	Remark	Pol/Phase
	MHz	dBm/m	dBm	dBm/m	dB	dB/m		
1 PP	1666.000	-39.03	-42.57	-13.00	-26.03	3.54	Peak	Vertical
2	2509.500	-44.59	-51.69	-13.00	-31.59	7.10	Peak	Vertical

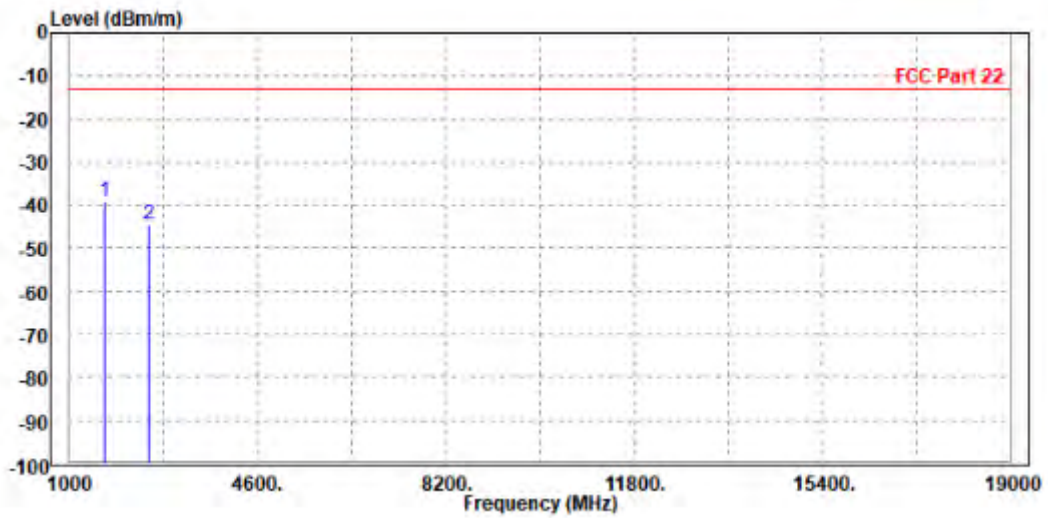



3.7 PEAK TO AVERAGE RATIO

3.7.1 LIMITS OF PEAK TO AVERAGE RATIO MEASUREMENT

In measuring transmissions in this band using an average power technique, the peak to-average ratio (PAR) of the transmission may not exceed 13 dB

3.7.2 TEST SETUP

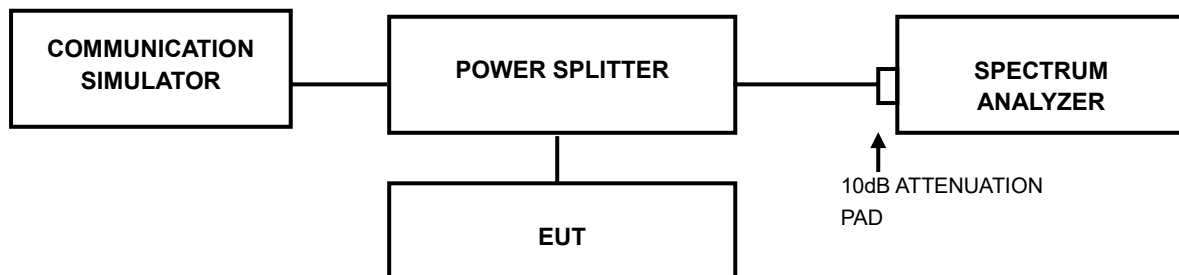

3.7.3 TEST PROCEDURES

1. Set resolution/measurement bandwidth \geq signal's occupied bandwidth;
2. Set the number of counts to a value that stabilizes the measured CCDF curve;
3. Record the maximum PAPR level associated with a probability of 0.1%.



**BUREAU
VERITAS**

Test Report No.: W7L-P22030026-2RF03

3.7.4 TEST RESULTS

Please Refer to Appendix Of this test report.



**BUREAU
VERITAS**

Test Report No.: W7L-P22030026-2RF03

4 PHOTOGRAPHS OF THE TEST CONFIGURATION

Please refer to the attached file (Test Setup Photo).



**BUREAU
VERITAS**

Test Report No.: W7L-P22030026-2RF03

5 INFORMATION ON THE TESTING LABORATORIES

We, BV 7LAYERS COMMUNICATIONS TECHNOLOGY (SHENZHEN) CO. LTD., were founded in 2015 to provide our best service in EMC, Radio, Telecom and Safety consultation. Our laboratories are accredited and approved according to ISO/IEC 17025.

If you have any comments, please feel free to contact us at the following:

Shenzhen EMC/RF Lab:

Tel: +86-755-88696566

Fax: +86-755-88696577

Email: customerservice.sw@bureauveritas.com

Web Site: www.adt.com.tw

The address and road map of all our labs can be found in our web site also.



**BUREAU
VERITAS**

Test Report No.: W7L-P22030026-2RF03

6 MODIFICATIONS RECORDERS FOR ENGINEERING CHANGES TO THE EUT BY THE LAB

No any modifications are made to the EUT by the lab during the test.



7 APPENDIX

GSM850

PEAK-TO-AVERAGE RATIO(CCDF)

Test Result

Band	Channel	Result(dB)	Limit(dB)	Verdict
GSM850	128	2.59	13	PASS
GSM850	190	2.59	13	PASS
GSM850	251	2.60	13	PASS
EGPRS850	128	5.38	13	PASS
EGPRS850	190	5.42	13	PASS
EGPRS850	251	5.44	13	PASS



Test Graphs

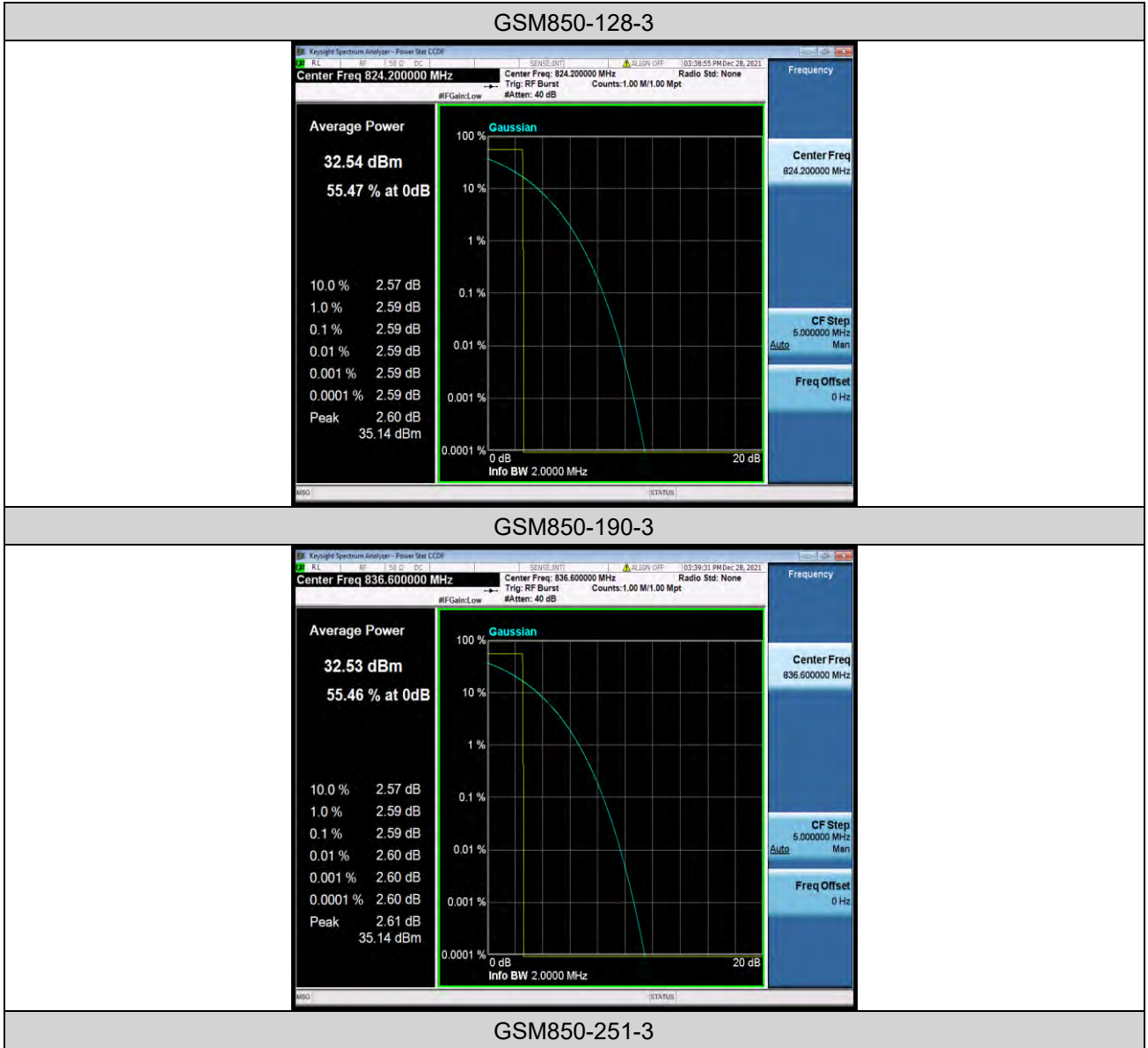

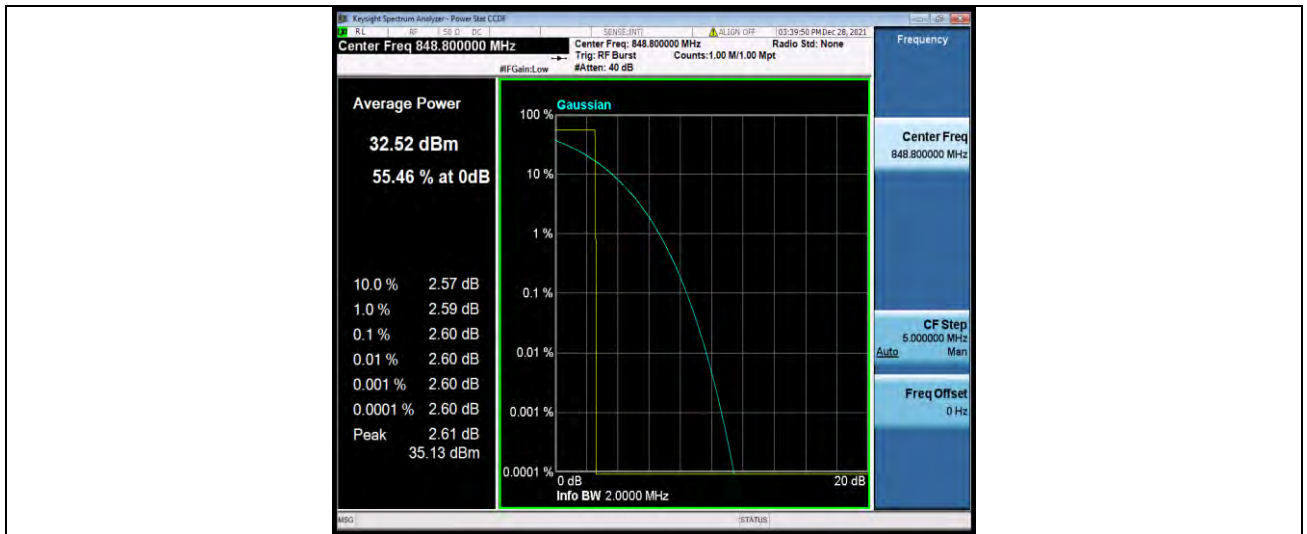

EGPRS850-128-8

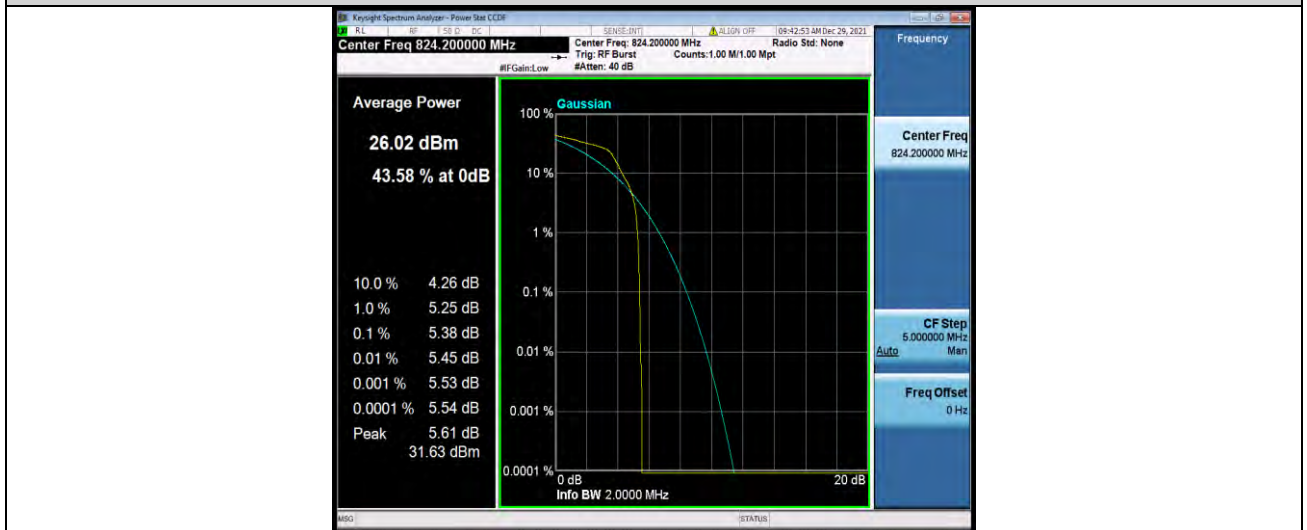

EGPRS850-190-8

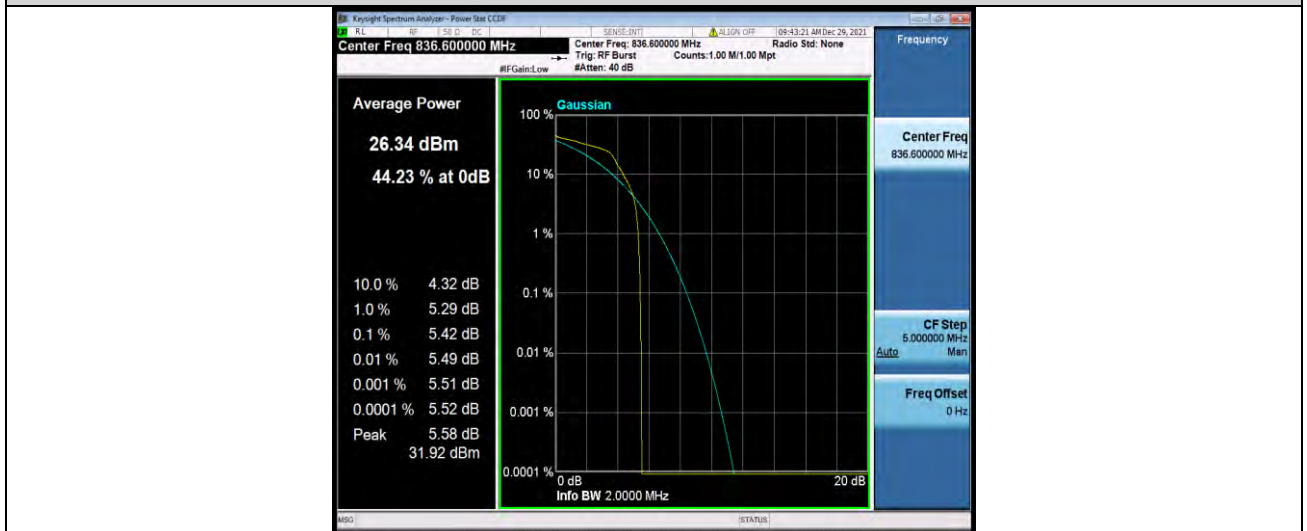

EGPRS850-251-8



**BUREAU
VERITAS**

Test Report No.: W7L-P22030026-2RF03

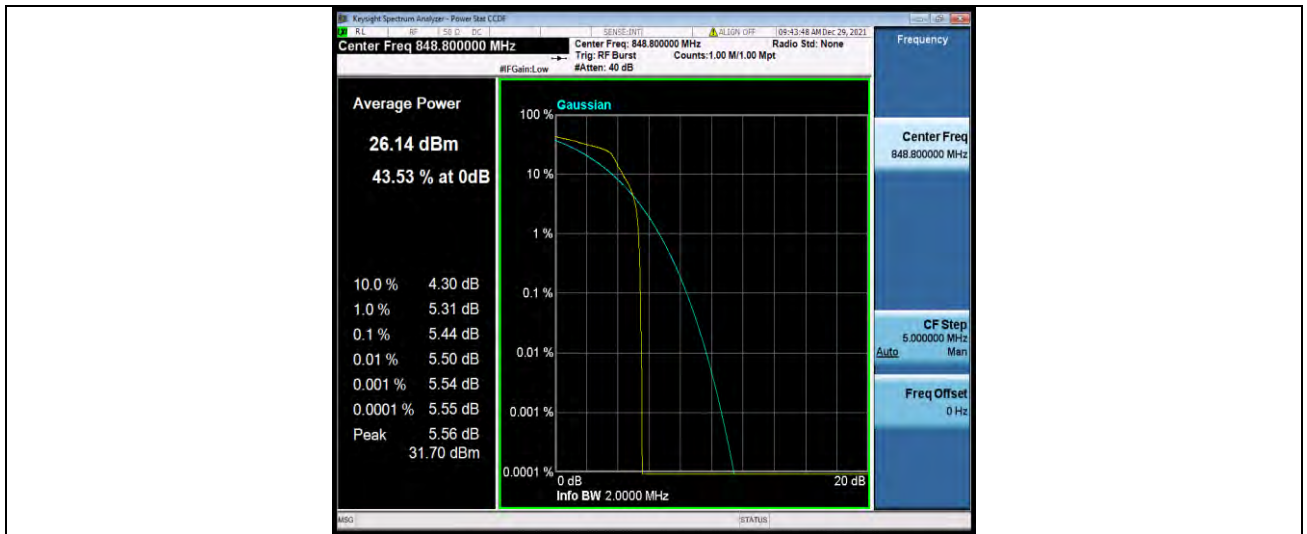



26DB BANDWIDTH AND OCCUPIED BANDWIDTH

Test Result

Band	Channel	Occupied Bandwidth (MHz)	26dB Bandwidth (MHz)	Limit (MHz)	Verdict
GSM850	128	0.24497	0.3066	---	PASS
GSM850	190	0.24233	0.3036	---	PASS
GSM850	251	0.24502	0.3087	---	PASS
EGPRS850	128	0.24261	0.3003	---	PASS
EGPRS850	190	0.24828	0.3019	---	PASS
EGPRS850	251	0.24521	0.3080	---	PASS



BUREAU VERITAS

Test Report No.: W7L-P22030026-2RF03

Test Graphs

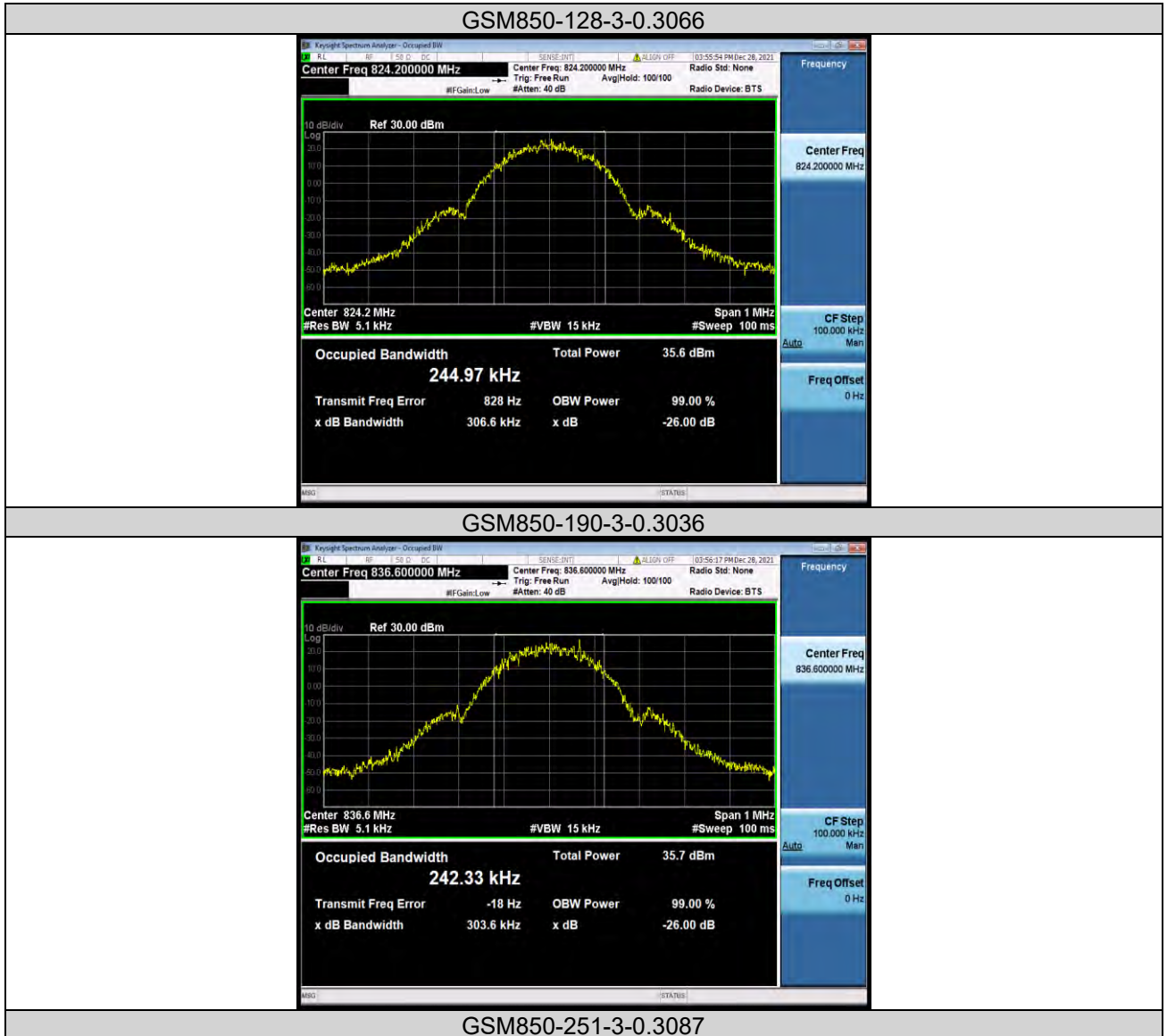



BUREAU VERITAS

Test Report No.: W7L-P22030026-2RF03

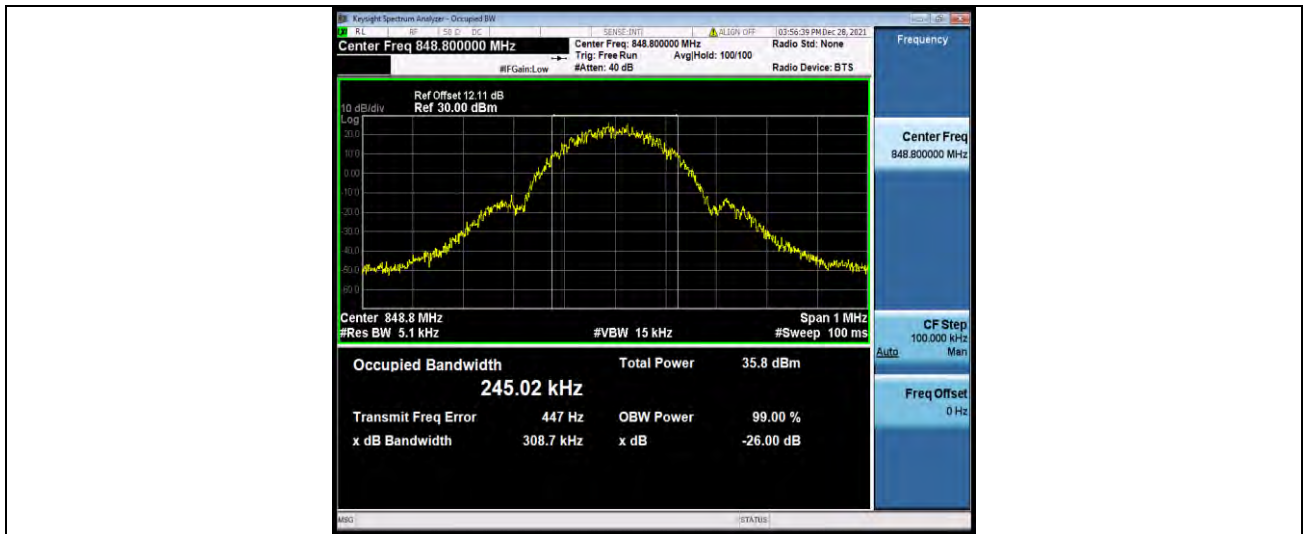

EGPRS850-128-8-0.3003

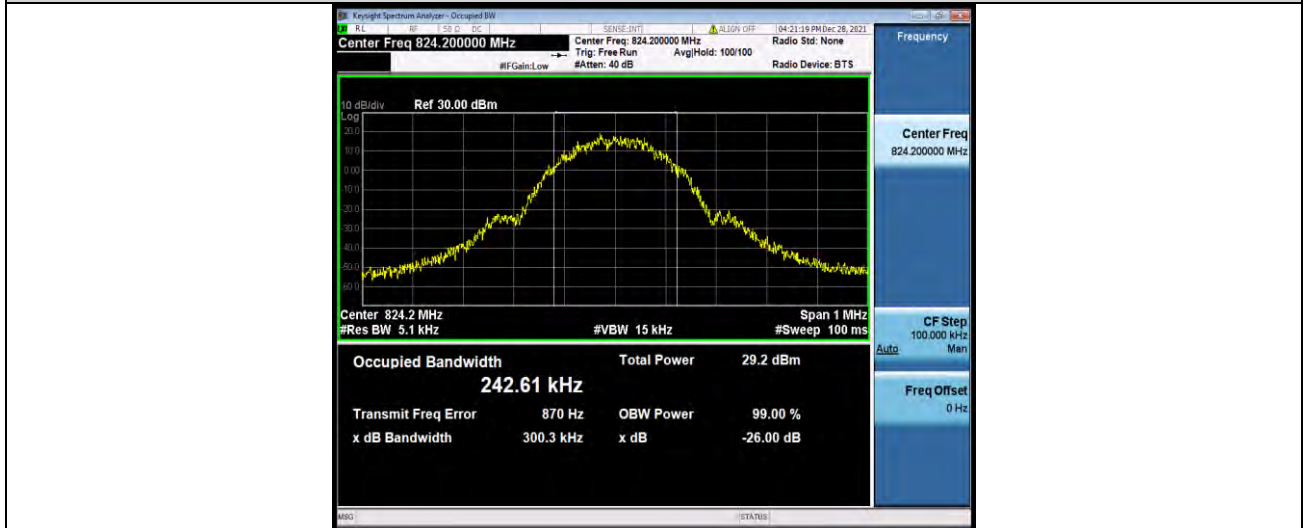

EGPRS850-190-8-0.3019

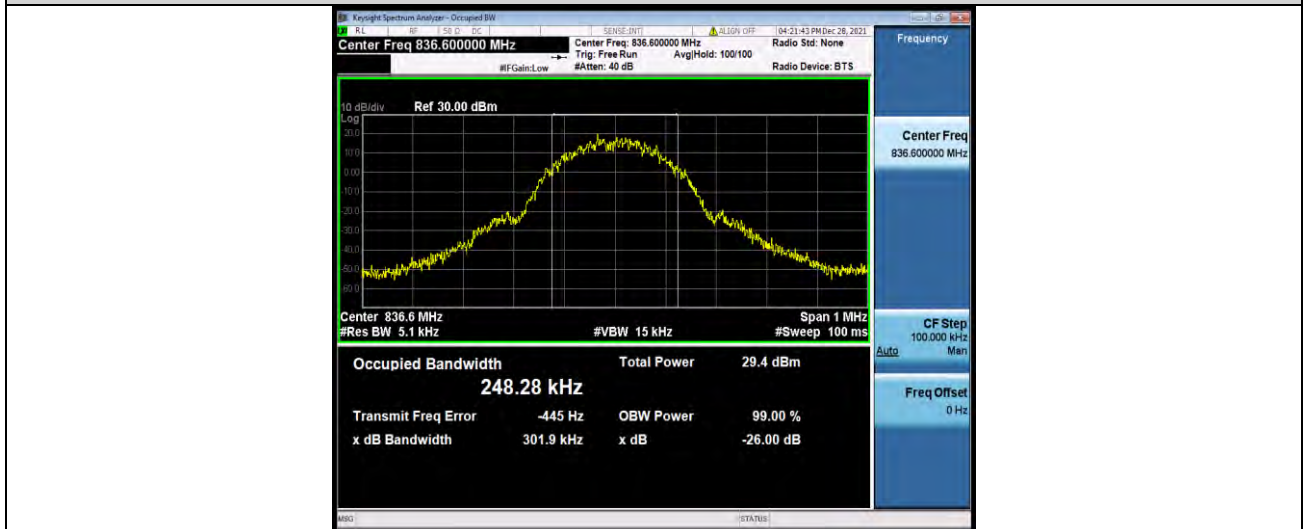

EGPRS850-251-8-0.3080



**BUREAU
VERITAS**

Test Report No.: W7L-P22030026-2RF03

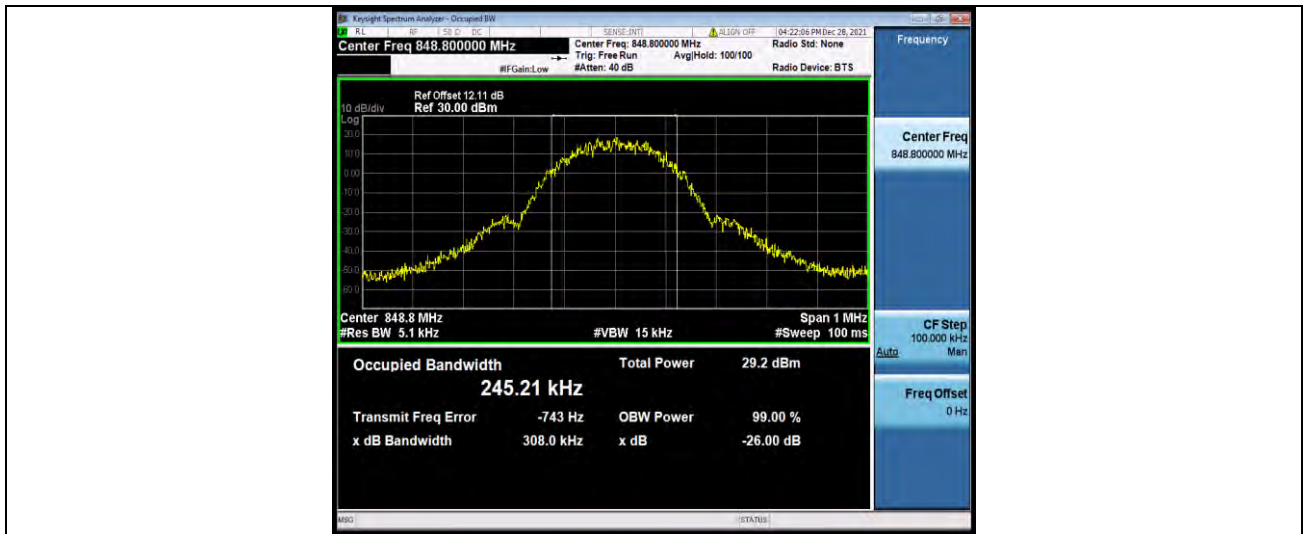



BUREAU
VERITAS

Test Report No.: W7L-P22030026-2RF03

BAND EDGE

Test Result

Band	Channel	Freq (MHz)	Result (dBm)	Limit(dBm)	Verdict
GSM850	128	823.98	-23.86	-13	PASS
GSM850	251	849.02	-22.47	-13	PASS
EGPRS850	128	823.99	-31.61	-13	PASS
EGPRS850	251	849.01	-32.99	-13	PASS



BUREAU
VERITAS

Test Report No.: W7L-P22030026-2RF03

Test Graphs

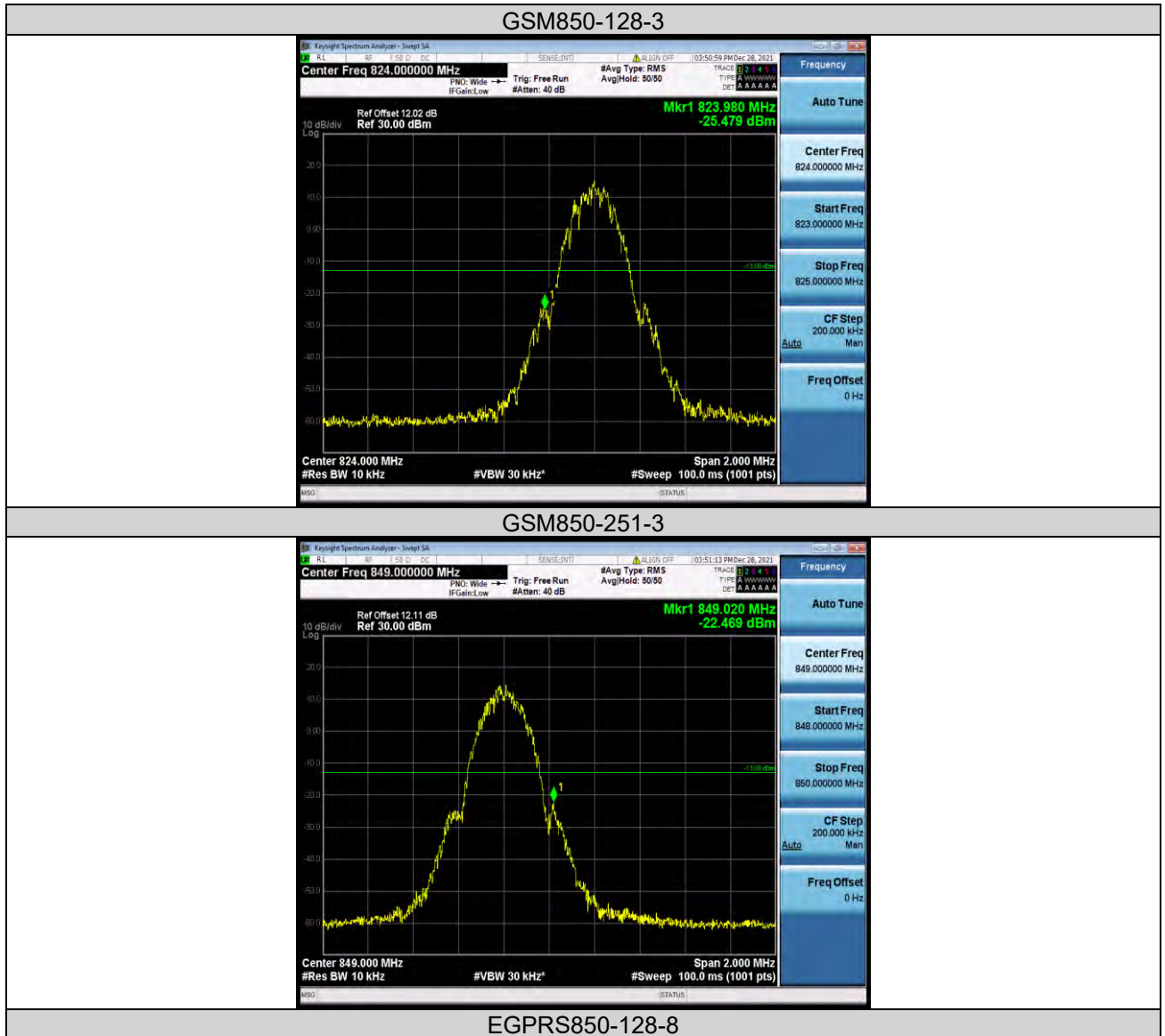



BUREAU
VERITAS

Test Report No.: W7L-P22030026-2RF03

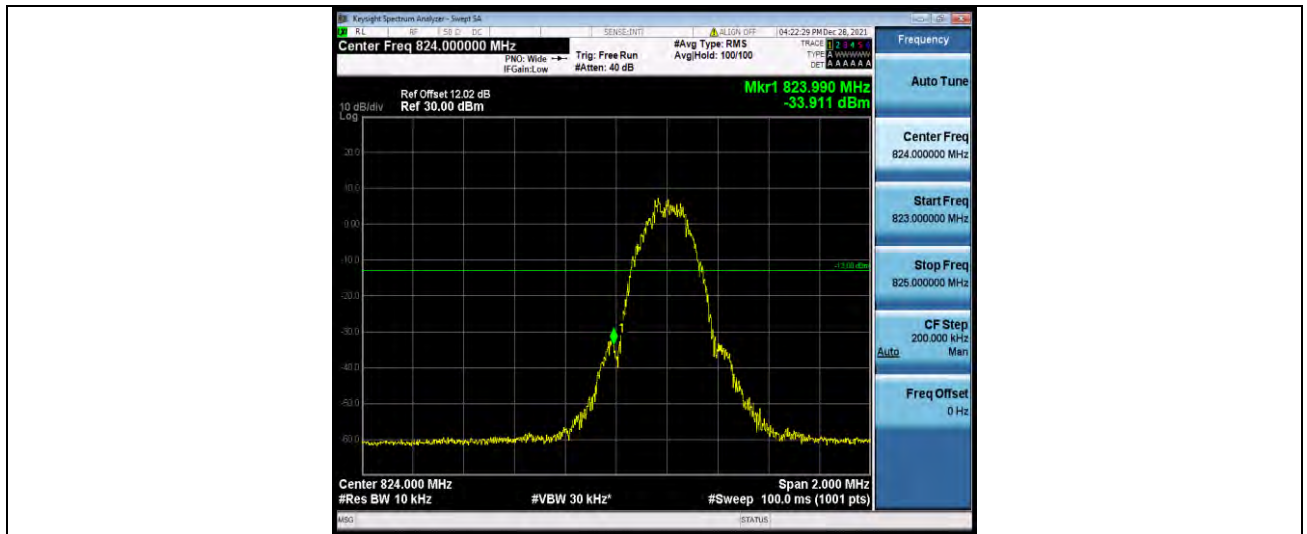

EGPRS850-251-8

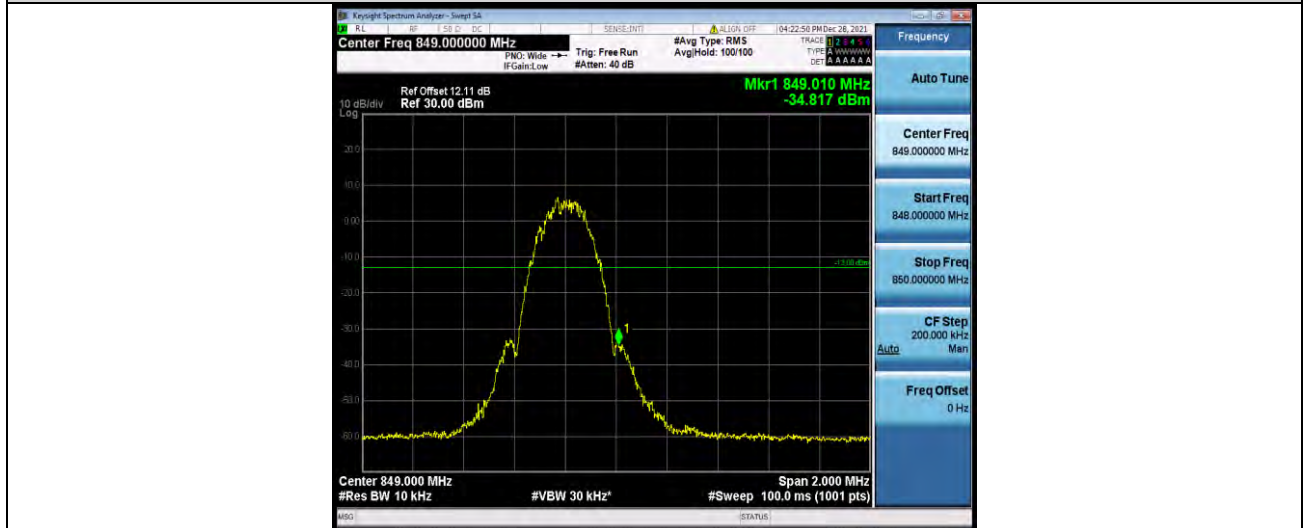



CONDUCTED SPURIOUS EMISSION

Test Result

Band	Channel	Frequency Range(MHz)	Max.Freq. (MHz)	Result (dBm)	Limit (dBm)	Verdict
GSM850	128	30~1000MHz	956.67	-50.25	-13	PASS
GSM850	128	1000~10000MHz	2510.8	-41.72	-13	PASS
GSM850	190	30~1000MHz	937.56	-50.03	-13	PASS
GSM850	190	1000~10000MHz	2511.1	-39.03	-13	PASS
GSM850	251	30~1000MHz	951.95	-50.36	-13	PASS
GSM850	251	1000~10000MHz	2511.1	-40.01	-13	PASS
EGPRS850	128	30~1000MHz	416.03	-42.22	-13	PASS
EGPRS850	128	1000~10000MHz	3780.4	-44.69	-13	PASS
EGPRS850	190	30~1000MHz	416.03	-41.24	-13	PASS
EGPRS850	190	1000~10000MHz	3802.3	-44.67	-13	PASS
EGPRS850	251	30~1000MHz	416.03	-41.77	-13	PASS
EGPRS850	251	1000~10000MHz	3786.7	-44.73	-13	PASS

Test Graphs

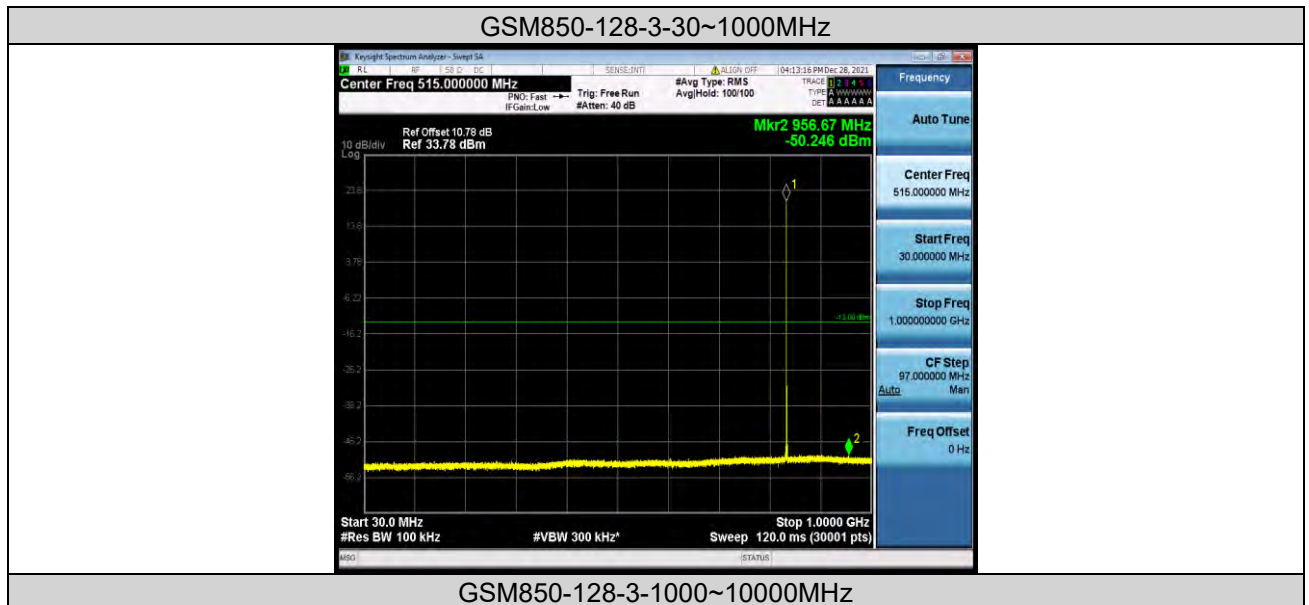



BUREAU VERITAS

Test Report No.: W7L-P22030026-2RF03

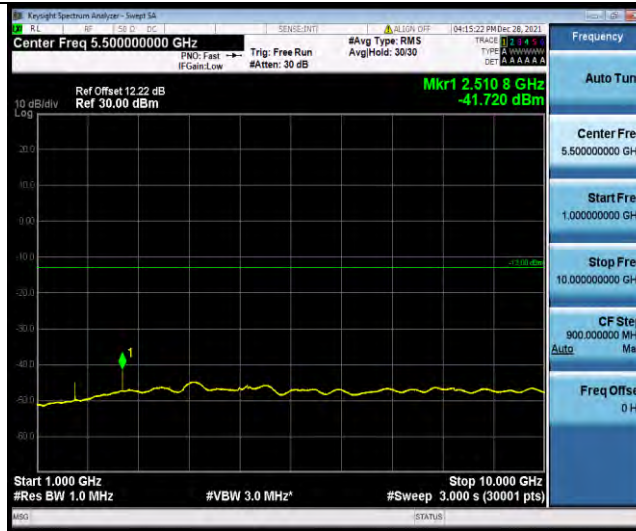

GSM850-190-3-30~1000MHz



GSM850-190-3-1000~10000MHz



GSM850-251-3-30~1000MHz



BUREAU VERITAS

Test Report No.: W7L-P22030026-2RF03

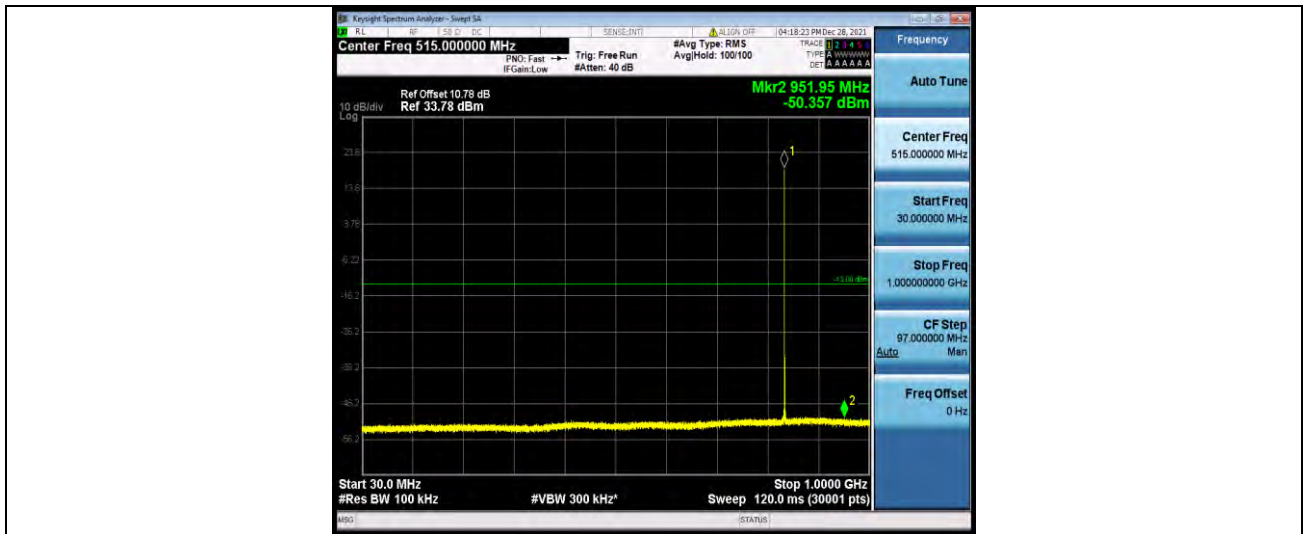

GSM850-251-3-1000~10000MHz



EGPRS850-128-8-30~1000MHz



EGPRS850-128-8-1000~10000MHz



BUREAU VERITAS

Test Report No.: W7L-P22030026-2RF03



EGPRS850-190-8-30~1000MHz



EGPRS850-190-8-1000~10000MHz

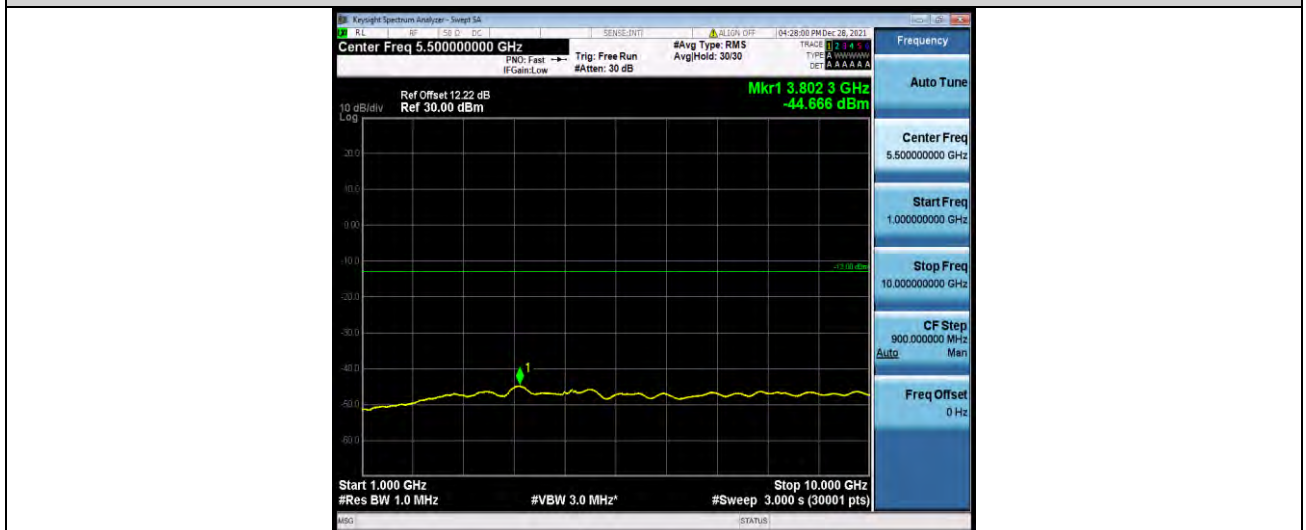

EGPRS850-251-8-30~1000MHz



BUREAU VERITAS

Test Report No.: W7L-P22030026-2RF03



EGPRS850-251-8-1000~10000MHz





FREQUENCY STABILITY

Test Result

Voltage							
Band	Channel	Voltage [Vdc]	Temperature (°C)	Deviation (Hz)	Deviation (ppm)	Limit (ppm)	Verdict
GSM850	128	VL	NT	3.75	0.004550	±2.5	PASS
GSM850	128	VN	NT	2.36	0.002863	±2.5	PASS
GSM850	128	VH	NT	6.62	0.008032	±2.5	PASS
GSM850	190	VL	NT	6.49	0.007758	±2.5	PASS
GSM850	190	VN	NT	-6.59	-0.007877	±2.5	PASS
GSM850	190	VH	NT	6.33	0.007566	±2.5	PASS
GSM850	251	VL	NT	-9.07	-0.010686	±2.5	PASS
GSM850	251	VN	NT	-7.10	-0.008365	±2.5	PASS
GSM850	251	VH	NT	-8.27	-0.009743	±2.5	PASS
EGPRS850	128	VL	NT	-6.49	-0.007874	±2.5	PASS
EGPRS850	128	VN	NT	-4.97	-0.006030	±2.5	PASS
EGPRS850	128	VH	NT	-4.62	-0.005605	±2.5	PASS
EGPRS850	190	VL	NT	-0.06	-0.000072	±2.5	PASS
EGPRS850	190	VN	NT	-0.77	-0.000920	±2.5	PASS
EGPRS850	190	VH	NT	-2.42	-0.002893	±2.5	PASS
EGPRS850	251	VL	NT	-2.26	-0.002663	±2.5	PASS
EGPRS850	251	VN	NT	-5.10	-0.006008	±2.5	PASS
EGPRS850	251	VH	NT	-2.20	-0.002592	±2.5	PASS

Temperature							
Band	Channel	Voltage [Vdc]	Temperature (°C)	Deviation (Hz)	Deviation (ppm)	Limit (ppm)	Verdict
GSM850	128	NV	-30	3.84	0.004659	±2.5	PASS
GSM850	128	NV	-20	0.65	0.000789	±2.5	PASS
GSM850	128	NV	-10	1.42	0.001723	±2.5	PASS
GSM850	128	NV	0	13.69	0.016610	±2.5	PASS
GSM850	128	NV	10	2.91	0.003531	±2.5	PASS
GSM850	128	NV	20	9.23	0.011199	±2.5	PASS
GSM850	128	NV	30	2.16	0.002621	±2.5	PASS
GSM850	128	NV	40	4.71	0.005715	±2.5	PASS
GSM850	128	NV	50	5.78	0.007013	±2.5	PASS
GSM850	190	NV	-30	13.04	0.015587	±2.5	PASS
GSM850	190	NV	-20	10.36	0.012383	±2.5	PASS
GSM850	190	NV	-10	7.23	0.008642	±2.5	PASS
GSM850	190	NV	0	3.87	0.004626	±2.5	PASS
GSM850	190	NV	10	7.75	0.009264	±2.5	PASS
GSM850	190	NV	20	1.03	0.001231	±2.5	PASS
GSM850	190	NV	30	11.72	0.014009	±2.5	PASS
GSM850	190	NV	40	9.17	0.010961	±2.5	PASS
GSM850	190	NV	50	9.62	0.011499	±2.5	PASS



GSM850	251	NV	-30	-8.52	-0.010038	±2.5	PASS
GSM850	251	NV	-20	-11.01	-0.012971	±2.5	PASS
GSM850	251	NV	-10	-3.23	-0.003805	±2.5	PASS
GSM850	251	NV	0	-3.10	-0.003652	±2.5	PASS
GSM850	251	NV	10	-1.42	-0.001673	±2.5	PASS
GSM850	251	NV	20	-10.91	-0.012853	±2.5	PASS
GSM850	251	NV	30	-4.94	-0.005820	±2.5	PASS
GSM850	251	NV	40	-11.88	-0.013996	±2.5	PASS
GSM850	251	NV	50	-15.05	-0.017731	±2.5	PASS
EGPRS850	128	NV	-30	-7.23	-0.008772	±2.5	PASS
EGPRS850	128	NV	-20	-2.36	-0.002863	±2.5	PASS
EGPRS850	128	NV	-10	-6.78	-0.008226	±2.5	PASS
EGPRS850	128	NV	0	-7.68	-0.009318	±2.5	PASS
EGPRS850	128	NV	10	-3.07	-0.003725	±2.5	PASS
EGPRS850	128	NV	20	-1.55	-0.001881	±2.5	PASS
EGPRS850	128	NV	30	-0.61	-0.000740	±2.5	PASS
EGPRS850	128	NV	40	-2.13	-0.002584	±2.5	PASS
EGPRS850	128	NV	50	-1.74	-0.002111	±2.5	PASS
EGPRS850	190	NV	-30	1.71	0.002044	±2.5	PASS
EGPRS850	190	NV	-20	-3.45	-0.004124	±2.5	PASS
EGPRS850	190	NV	-10	-0.94	-0.001124	±2.5	PASS
EGPRS850	190	NV	0	-0.23	-0.000275	±2.5	PASS
EGPRS850	190	NV	10	-4.04	-0.004829	±2.5	PASS
EGPRS850	190	NV	20	2.13	0.002546	±2.5	PASS
EGPRS850	190	NV	30	-1.36	-0.001626	±2.5	PASS
EGPRS850	190	NV	40	1.03	0.001231	±2.5	PASS
EGPRS850	190	NV	50	-4.62	-0.005522	±2.5	PASS
EGPRS850	251	NV	-30	-2.68	-0.003157	±2.5	PASS
EGPRS850	251	NV	-20	0.00	0.000000	±2.5	PASS
EGPRS850	251	NV	-10	2.97	0.003499	±2.5	PASS
EGPRS850	251	NV	0	1.97	0.002321	±2.5	PASS
EGPRS850	251	NV	10	0.06	0.000071	±2.5	PASS
EGPRS850	251	NV	20	-1.00	-0.001178	±2.5	PASS
EGPRS850	251	NV	30	2.49	0.002934	±2.5	PASS
EGPRS850	251	NV	40	-2.87	-0.003381	±2.5	PASS
EGPRS850	251	NV	50	-3.39	-0.003994	±2.5	PASS



WCMDA BAND5

PEAK-TO-AVERAGE RATIO

Test Result

Band	Channel	Peak-to-Average Ratio(dB)	Limit(dBm)	Verdict
Band5	4132	2.98	13	PASS
Band5	4182	2.87	13	PASS
Band5	4233	2.76	13	PASS



Test Graphs

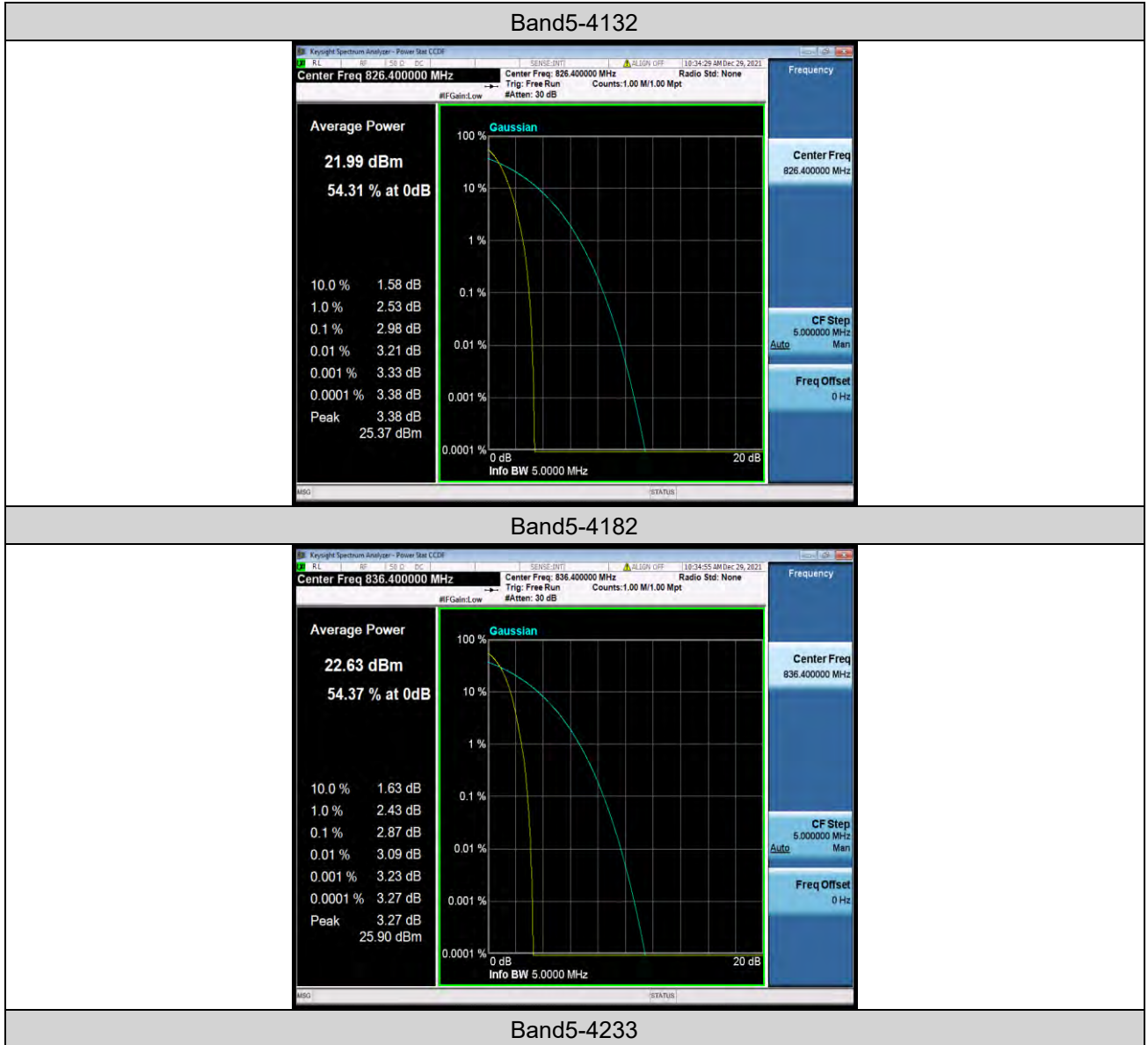



**BUREAU
VERITAS**

Test Report No.: W7L-P22030026-2RF03

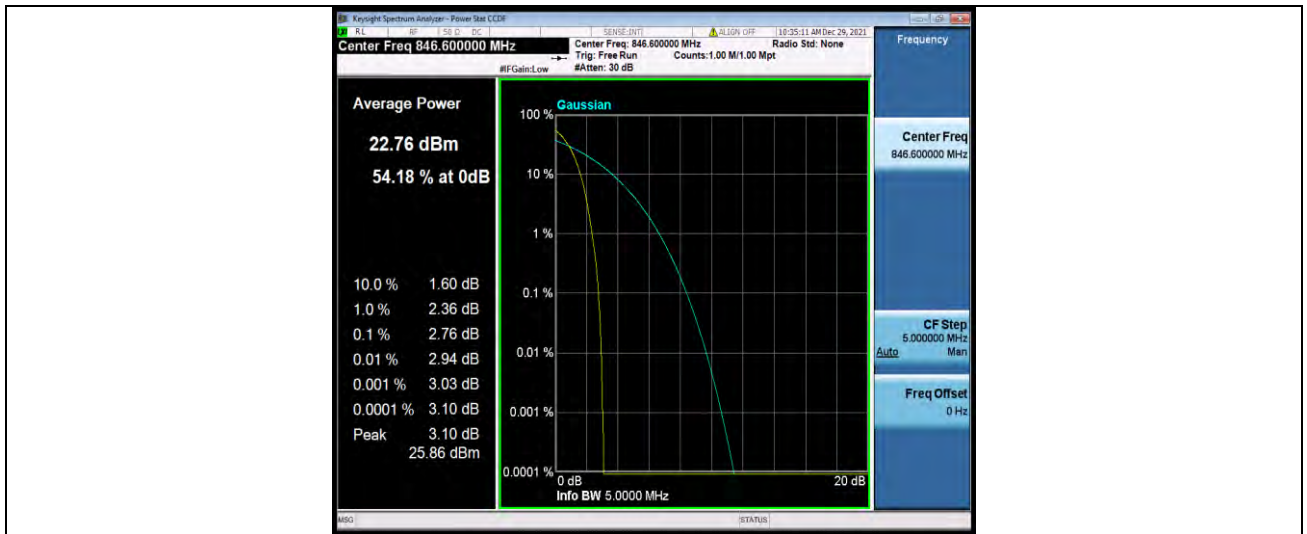



BUREAU
VERITAS

Test Report No.: W7L-P22030026-2RF03

26DB BANDWIDTH AND OCCUPIED BANDWIDTH

Test Result

Band	Channel	Occupied Bandwidth (MHz)	26dB Bandwidth (MHz)	Limit(kHz)	Verdict
Band5	4132	4.1613	4.693	---	PASS
Band5	4182	4.1659	4.689	---	PASS
Band5	4233	4.1667	4.698	---	PASS



BUREAU VERITAS

Test Report No.: W7L-P22030026-2RF03

Test Graphs

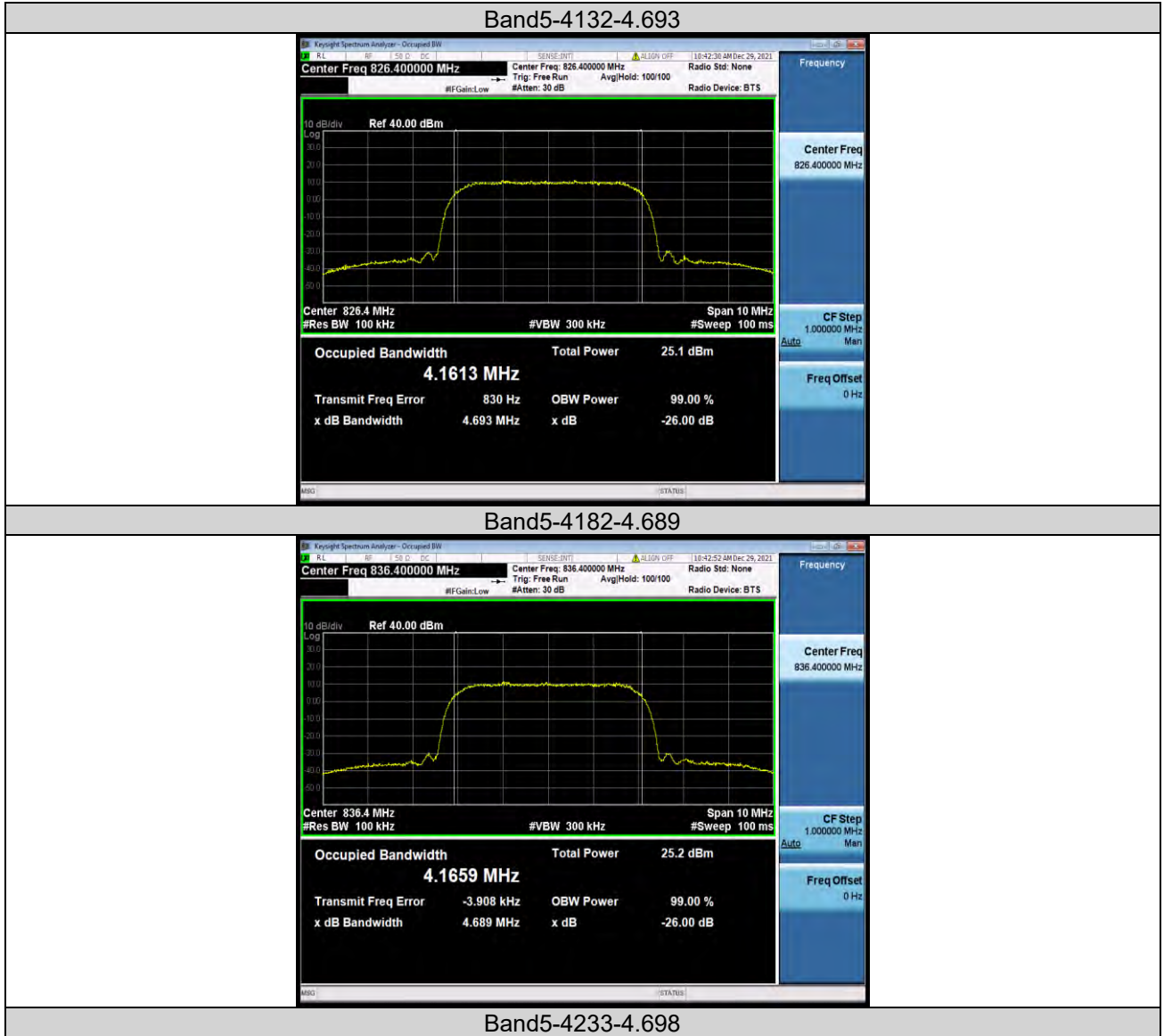



**BUREAU
VERITAS**

Test Report No.: W7L-P22030026-2RF03

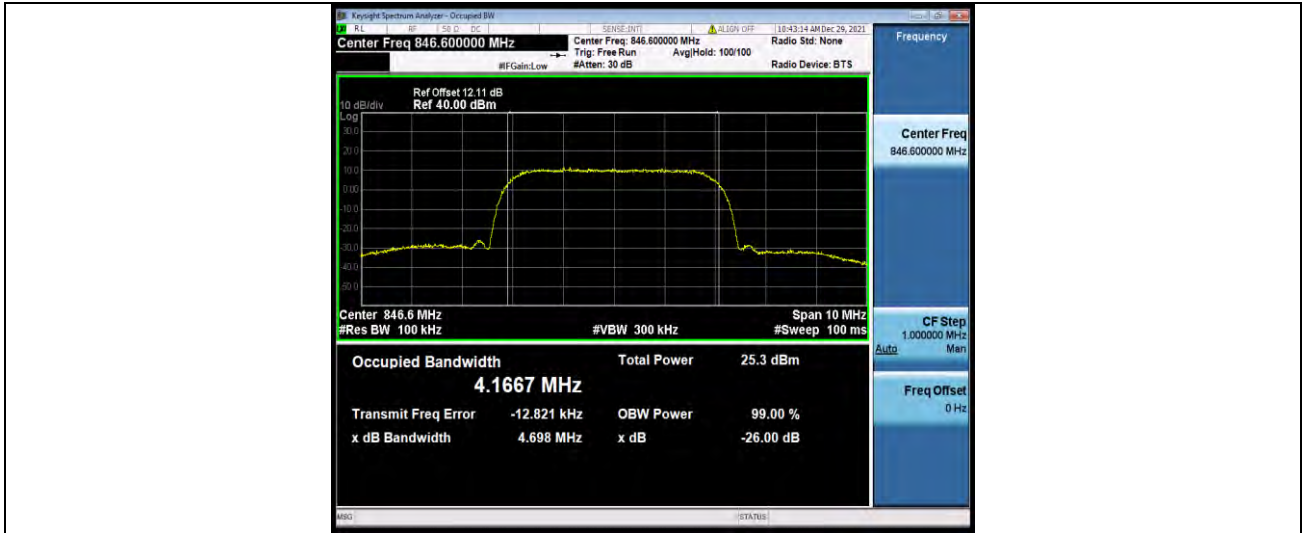



**BUREAU
VERITAS**

Test Report No.: W7L-P22030026-2RF03

BAND EDGE

Test Result

Band	Channel	Frequency (MHz)	Result (dBm)	Limit(dBm)	Verdict
Band5	4132	824.00	-30.29	-13	PASS
Band5	4233	849.00	-29.99	-13	PASS



BUREAU VERITAS

Test Report No.: W7L-P22030026-2RF03

Test Graphs





CONDUCTED SPURIOUS EMISSION

Test Result

Band	Channel	Frequency Range (Mhz)	Frequency (dBm)	Result (dBm)	Limit (dBm)	Verdict
Band5	4132	0.15~30MHz	0.15	-37.38	-13	PASS
Band5	4132	30~1000MHz	929.22	-48.05	-13	PASS
Band5	4132	1000~10000MHz	3815.8	-34.72	-13	PASS
Band5	4182	0.15~30MHz	0.16	-38.75	-13	PASS
Band5	4182	30~1000MHz	954.86	-47.85	-13	PASS
Band5	4182	1000~10000MHz	3770.2	-34.7	-13	PASS
Band5	4233	0.15~30MHz	0.15	-38.73	-13	PASS
Band5	4233	30~1000MHz	995.7	-47.95	-13	PASS
Band5	4233	1000~10000MHz	3797.5	-34.62	-13	PASS



BUREAU VERITAS

Test Report No.: W7L-P22030026-2RF03

Test Graphs

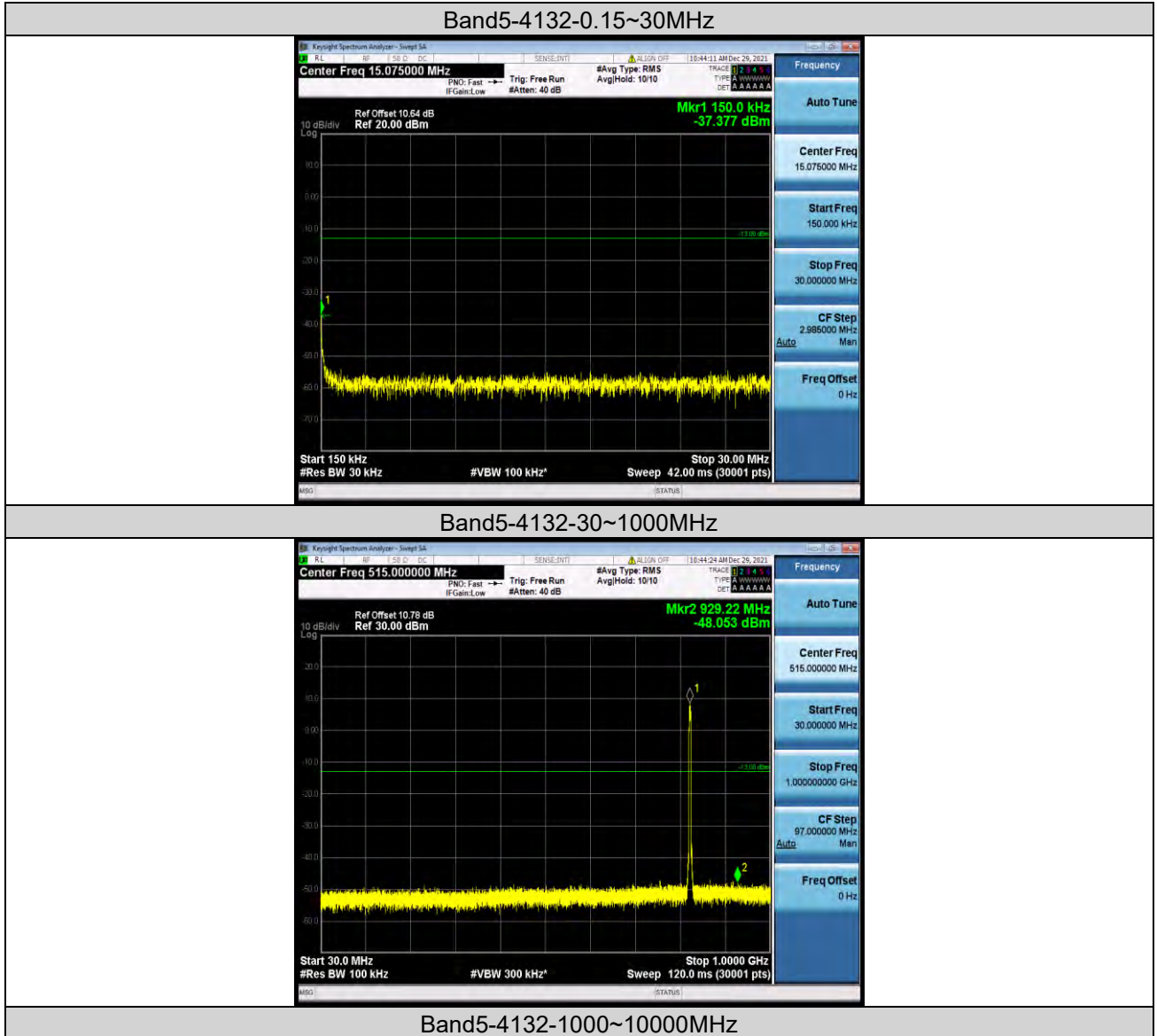



BUREAU VERITAS

Test Report No.: W7L-P22030026-2RF03

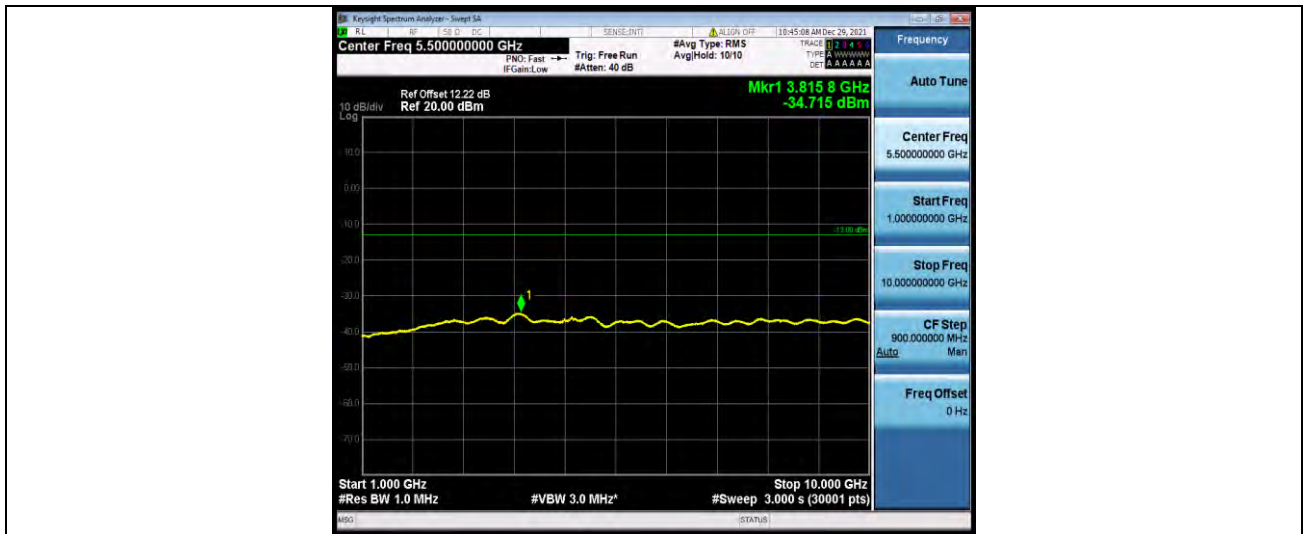

Band5-4182-0.15~30MHz

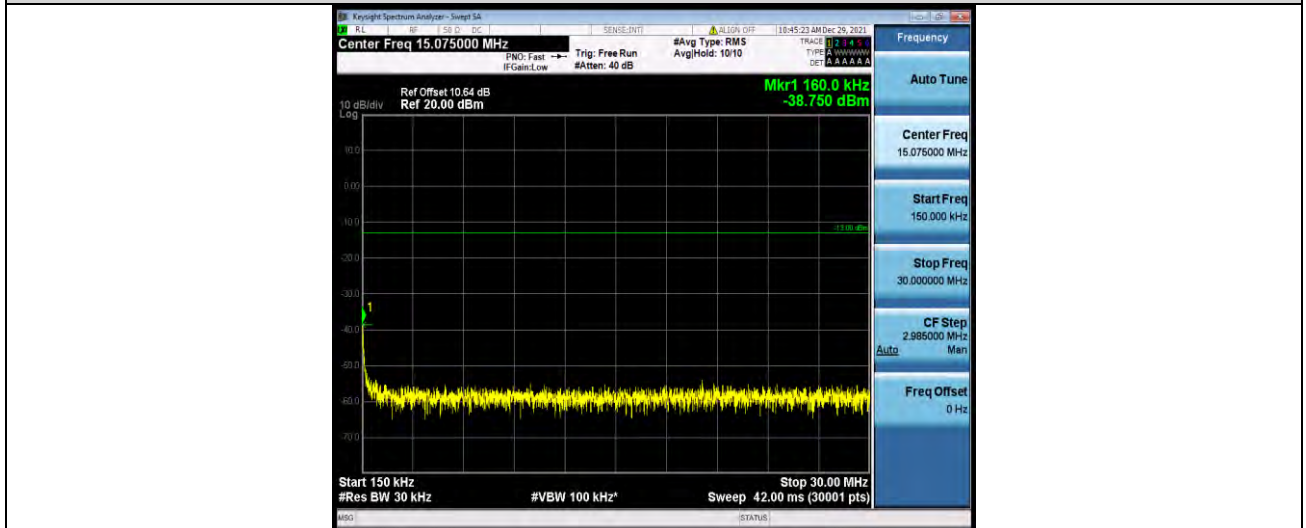

Band5-4182-30~1000MHz

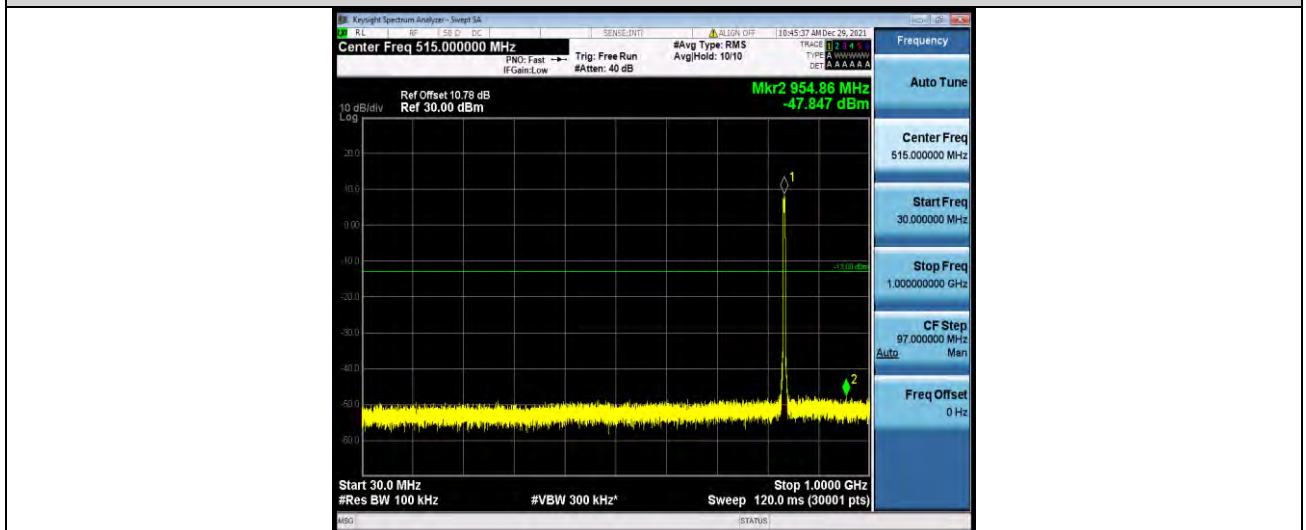

Band5-4182-1000~10000MHz



BUREAU VERITAS

Test Report No.: W7L-P22030026-2RF03



Band5-4233-0.15~30MHz

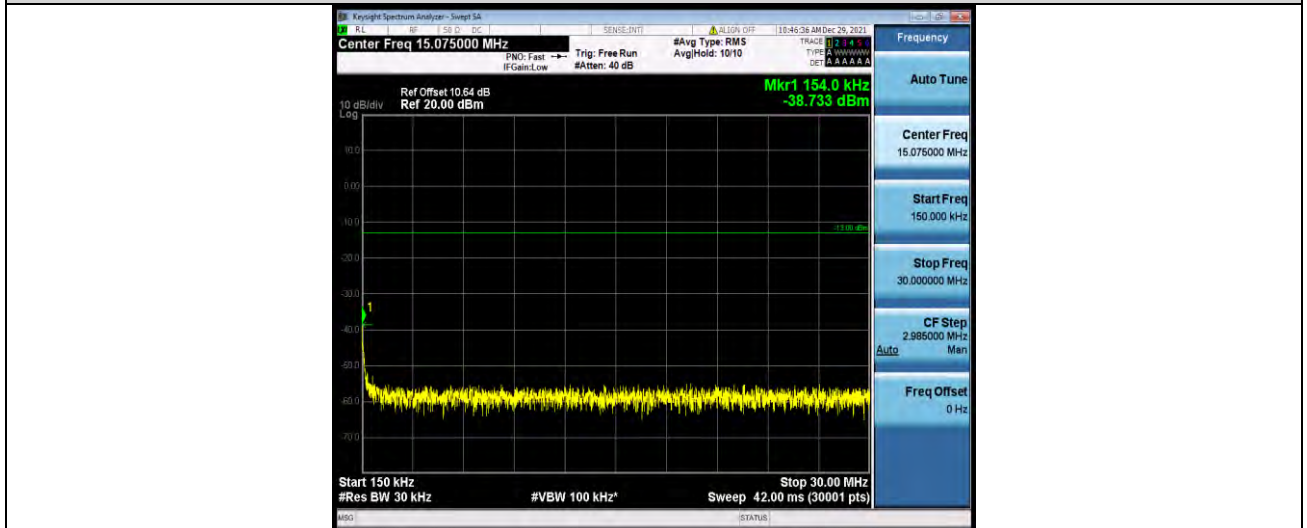

Band5-4233-30~1000MHz

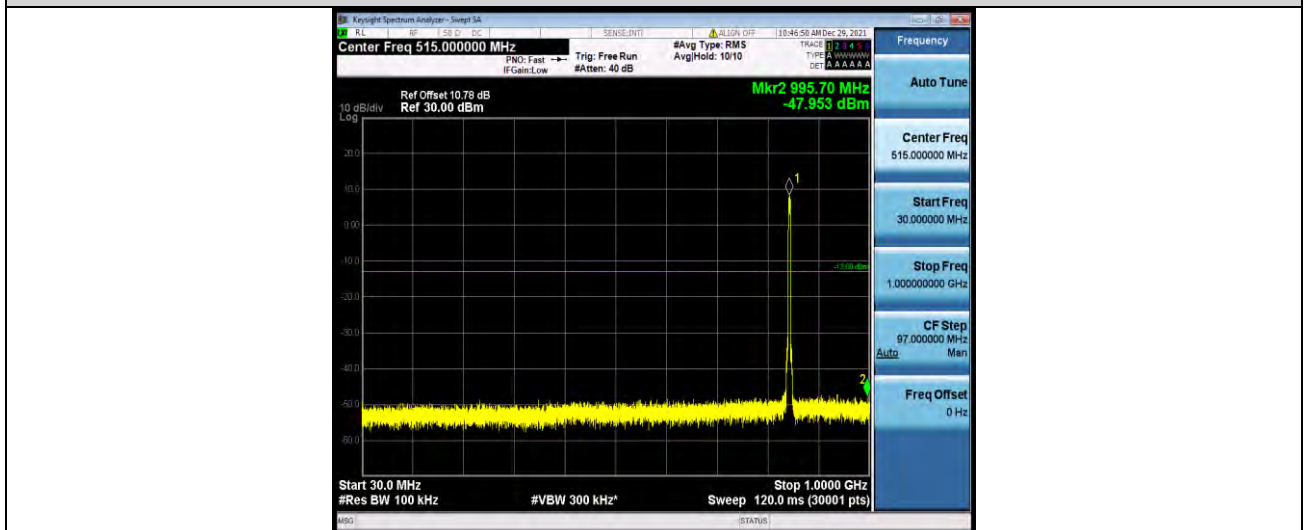

Band5-4233-1000~10000MHz



**BUREAU
VERITAS**

Test Report No.: W7L-P22030026-2RF03

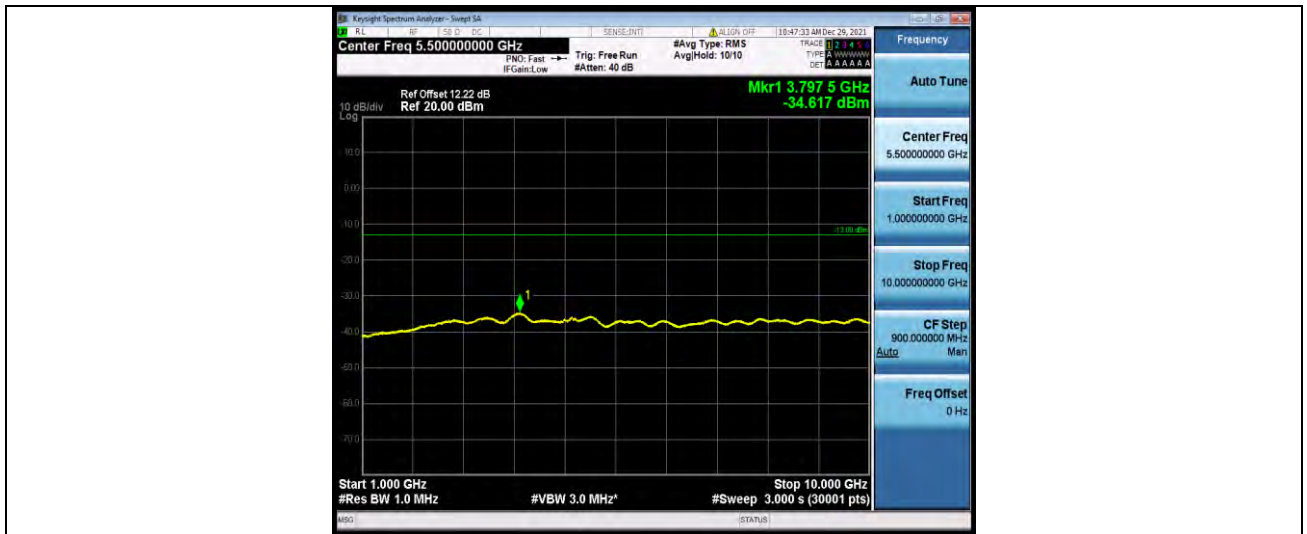



FREQUENCY STABILITY

Test Result

Voltage							
Band	Channel	Voltage (Vdc)	Temperature (°C)	Deviation (Hz)	Deviation (ppm)	Limit (ppm)	Verdict
Band5	4132	VL	NT	0.15	0.000182	±2.5	PASS
Band5	4132	VN	NT	-0.58	-0.000702	±2.5	PASS
Band5	4132	VH	NT	0.12	0.000145	±2.5	PASS
Band5	4182	VL	NT	-0.54	-0.000646	±2.5	PASS
Band5	4182	VN	NT	0.24	0.000287	±2.5	PASS
Band5	4182	VH	NT	-0.59	-0.000705	±2.5	PASS
Band5	4233	VL	NT	-0.65	-0.000768	±2.5	PASS
Band5	4233	VN	NT	-0.69	-0.000815	±2.5	PASS
Band5	4233	VH	NT	-0.18	-0.000213	±2.5	PASS

Temperature							
Band	Channel	Voltage (Vdc)	Temperature (°C)	Deviation (Hz)	Deviation (ppm)	Limit (ppm)	Verdict
Band5	4132	NV	-30	-0.43	-0.000520	±2.5	PASS
Band5	4132	NV	-20	0.38	0.000460	±2.5	PASS
Band5	4132	NV	0	1.99	0.002408	±2.5	PASS
Band5	4132	NV	10	1.59	0.001924	±2.5	PASS
Band5	4132	NV	20	0.17	0.000206	±2.5	PASS
Band5	4132	NV	30	-10.18	-0.0060	±2.5	PASS
Band5	4132	NV	40	-9.32	-0.0054	±2.5	PASS
Band5	4132	NV	50	-8.14	-0.0048	±2.5	PASS
Band5	4182	NV	-30	-0.23	-0.000275	±2.5	PASS
Band5	4182	NV	-20	0.36	0.000430	±2.5	PASS
Band5	4182	NV	0	-0.82	-0.000980	±2.5	PASS
Band5	4182	NV	10	0.18	0.000215	±2.5	PASS
Band5	4182	NV	20	0.74	0.000885	±2.5	PASS
Band5	4182	NV	30	-6.62	-0.0039	±2.5	PASS
Band5	4182	NV	40	-5.92	-0.0035	±2.5	PASS
Band5	4182	NV	50	-4.51	-0.0026	±2.5	PASS
Band5	4233	NV	-30	-1.50	-0.001772	±2.5	PASS
Band5	4233	NV	-20	-0.31	-0.000366	±2.5	PASS
Band5	4233	NV	0	1.60	0.001890	±2.5	PASS
Band5	4233	NV	10	0.89	0.001051	±2.5	PASS
Band5	4233	NV	20	0.97	0.001146	±2.5	PASS
Band5	4233	NV	30	-2.74	-0.0016	±2.5	PASS
Band5	4233	NV	40	-1.56	-0.0009	±2.5	PASS
Band5	4233	NV	50	-0.39	-0.0002	±2.5	PASS



LTE BAND5

PEAK-TO-AVERAGE RATIO(CCDF)

Test Result

Band	Bandwidth	Modulation	Channel	RB Configuration	Result(dB)	Limit(dB)	Verdict
Band5	1.4MHz	QPSK	20407	1RB#0	4.23	13	PASS
Band5	1.4MHz	QPSK	20407	6RB#0	5.13	13	PASS
Band5	1.4MHz	QPSK	20525	1RB#0	4.54	13	PASS
Band5	1.4MHz	QPSK	20525	6RB#0	5.06	13	PASS
Band5	1.4MHz	QPSK	20643	1RB#0	4.03	13	PASS
Band5	1.4MHz	QPSK	20643	6RB#0	4.78	13	PASS
Band5	1.4MHz	16QAM	20407	1RB#0	5.30	13	PASS
Band5	1.4MHz	16QAM	20407	6RB#0	5.67	13	PASS
Band5	1.4MHz	16QAM	20525	1RB#0	5.43	13	PASS
Band5	1.4MHz	16QAM	20525	6RB#0	5.76	13	PASS
Band5	1.4MHz	16QAM	20643	1RB#0	4.79	13	PASS
Band5	1.4MHz	16QAM	20643	6RB#0	5.36	13	PASS
Band5	3MHz	QPSK	20415	1RB#0	4.51	13	PASS
Band5	3MHz	QPSK	20415	15RB#0	4.98	13	PASS
Band5	3MHz	QPSK	20525	1RB#0	4.72	13	PASS
Band5	3MHz	QPSK	20525	15RB#0	5.08	13	PASS
Band5	3MHz	QPSK	20635	1RB#0	3.37	13	PASS
Band5	3MHz	QPSK	20635	15RB#0	4.66	13	PASS
Band5	3MHz	16QAM	20415	1RB#0	5.14	13	PASS
Band5	3MHz	16QAM	20415	15RB#0	5.77	13	PASS
Band5	3MHz	16QAM	20525	1RB#0	5.79	13	PASS
Band5	3MHz	16QAM	20525	15RB#0	5.89	13	PASS
Band5	3MHz	16QAM	20635	1RB#0	4.64	13	PASS
Band5	3MHz	16QAM	20635	15RB#0	5.53	13	PASS
Band5	5MHz	QPSK	20425	1RB#0	4.42	13	PASS
Band5	5MHz	QPSK	20425	25RB#0	5.09	13	PASS
Band5	5MHz	QPSK	20525	1RB#0	5.02	13	PASS
Band5	5MHz	QPSK	20525	25RB#0	5.04	13	PASS
Band5	5MHz	QPSK	20625	1RB#0	3.52	13	PASS
Band5	5MHz	QPSK	20625	25RB#0	4.48	13	PASS
Band5	5MHz	16QAM	20425	1RB#0	5.19	13	PASS
Band5	5MHz	16QAM	20425	25RB#0	5.80	13	PASS
Band5	5MHz	16QAM	20525	1RB#0	5.84	13	PASS
Band5	5MHz	16QAM	20525	25RB#0	5.77	13	PASS
Band5	5MHz	16QAM	20625	1RB#0	4.21	13	PASS
Band5	5MHz	16QAM	20625	25RB#0	5.28	13	PASS
Band5	10MHz	QPSK	20450	1RB#0	4.49	13	PASS
Band5	10MHz	QPSK	20450	50RB#0	5.24	13	PASS
Band5	10MHz	QPSK	20525	1RB#0	4.84	13	PASS
Band5	10MHz	QPSK	20525	50RB#0	5.00	13	PASS
Band5	10MHz	QPSK	20600	1RB#0	3.84	13	PASS



BUREAU
VERITAS

Test Report No.: W7L-P22030026-2RF03

Band5	10MHz	QPSK	20600	50RB#0	4.48	13	PASS
Band5	10MHz	16QAM	20450	1RB#0	5.09	13	PASS
Band5	10MHz	16QAM	20450	50RB#0	6.03	13	PASS
Band5	10MHz	16QAM	20525	1RB#0	5.77	13	PASS
Band5	10MHz	16QAM	20525	50RB#0	5.79	13	PASS
Band5	10MHz	16QAM	20600	1RB#0	4.66	13	PASS
Band5	10MHz	16QAM	20600	50RB#0	5.14	13	PASS
Band5	1.4MHz	64QAM	20407	1RB#0	6.07	13	PASS
Band5	1.4MHz	64QAM	20407	6RB#0	6.22	13	PASS
Band5	1.4MHz	64QAM	20525	1RB#0	5.74	13	PASS
Band5	1.4MHz	64QAM	20525	6RB#0	6.24	13	PASS
Band5	1.4MHz	64QAM	20643	1RB#0	5.56	13	PASS
Band5	1.4MHz	64QAM	20643	6RB#0	6.23	13	PASS
Band5	3MHz	64QAM	20415	1RB#0	6.12	13	PASS
Band5	3MHz	64QAM	20415	15RB#0	6.33	13	PASS
Band5	3MHz	64QAM	20525	1RB#0	5.79	13	PASS
Band5	3MHz	64QAM	20525	15RB#0	6.32	13	PASS
Band5	3MHz	64QAM	20635	1RB#0	5.49	13	PASS
Band5	3MHz	64QAM	20635	15RB#0	6.27	13	PASS
Band5	5MHz	64QAM	20425	1RB#0	6.03	13	PASS
Band5	5MHz	64QAM	20425	25RB#0	6.14	13	PASS
Band5	5MHz	64QAM	20525	1RB#0	5.53	13	PASS
Band5	5MHz	64QAM	20525	25RB#0	6.31	13	PASS
Band5	5MHz	64QAM	20625	1RB#0	5.76	13	PASS
Band5	5MHz	64QAM	20625	25RB#0	6.31	13	PASS
Band5	10MHz	64QAM	20450	1RB#0	5.94	13	PASS
Band5	10MHz	64QAM	20450	50RB#0	6.16	13	PASS
Band5	10MHz	64QAM	20525	1RB#0	5.55	13	PASS
Band5	10MHz	64QAM	20525	50RB#0	6.29	13	PASS
Band5	10MHz	64QAM	20600	1RB#0	5.38	13	PASS
Band5	10MHz	64QAM	20600	50RB#0	6.24	13	PASS



BUREAU VERITAS

Test Report No.: W7L-P22030026-2RF03

Test Graphs

Band5-1.4MHz-QPSK-20407-1RB#0

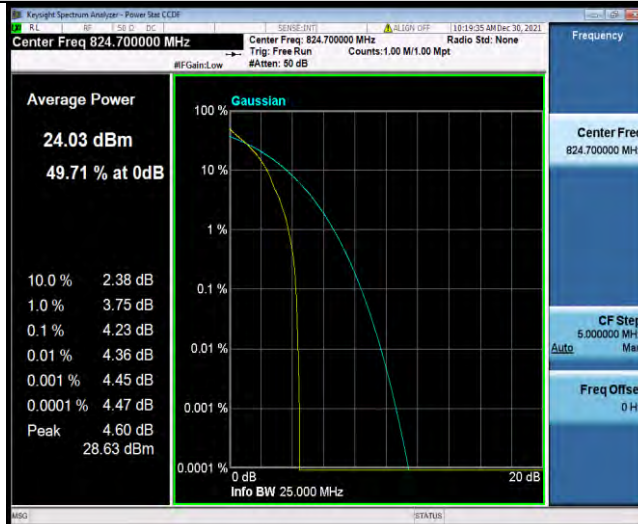

Band5-1.4MHz-QPSK-20407-6RB#0

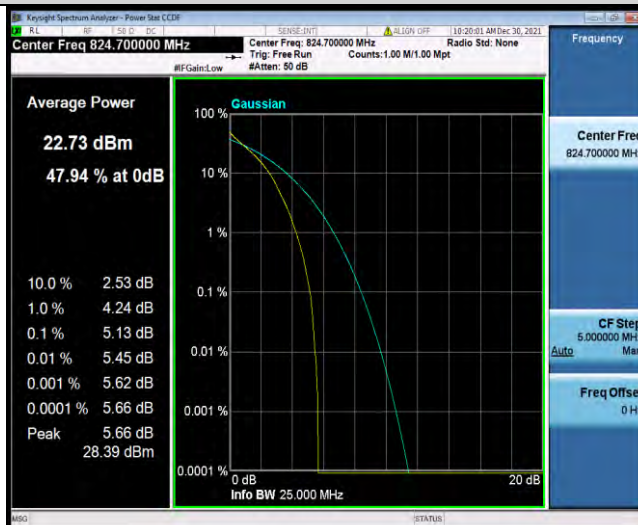

Band5-1.4MHz-QPSK-20525-1RB#0



BUREAU VERITAS

Test Report No.: W7L-P22030026-2RF03

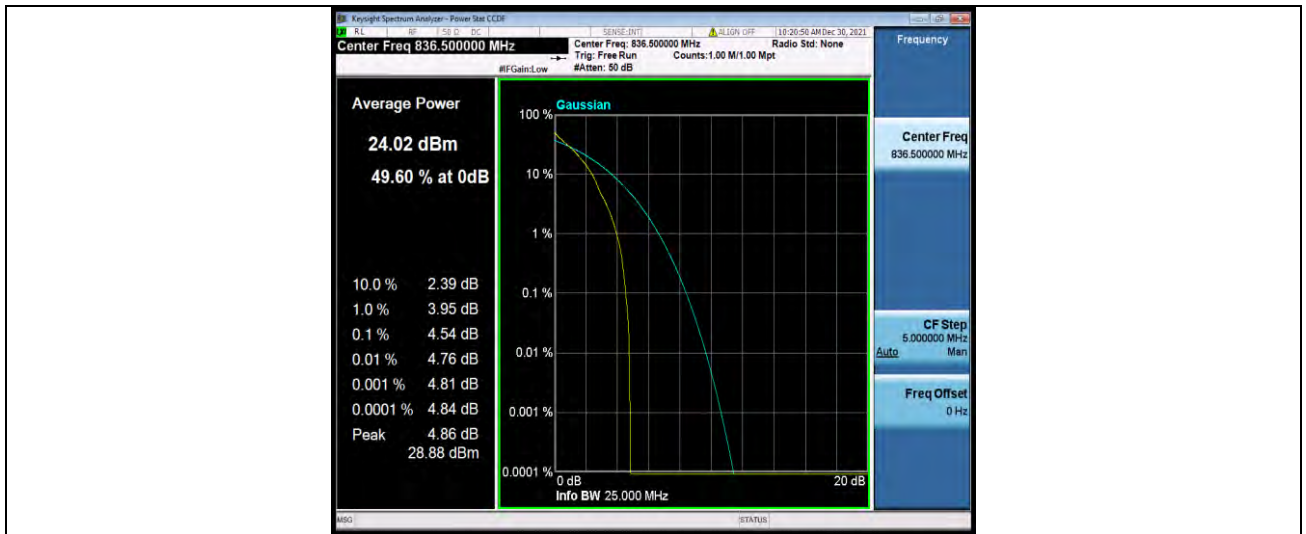

Band5-1.4MHz-QPSK-20525-6RB#0

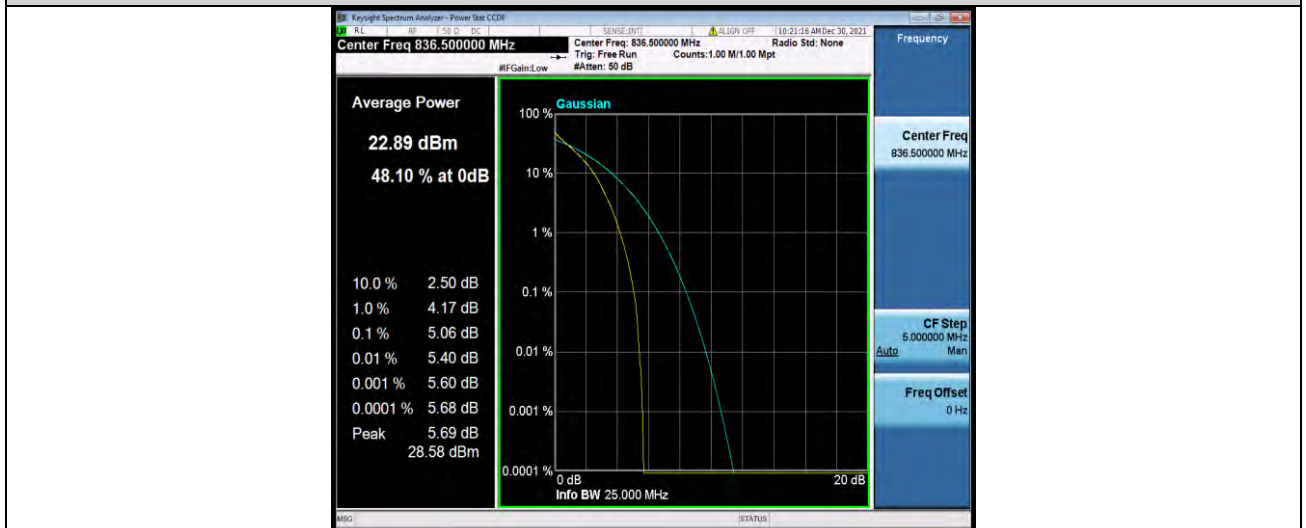

Band5-1.4MHz-QPSK-20643-1RB#0

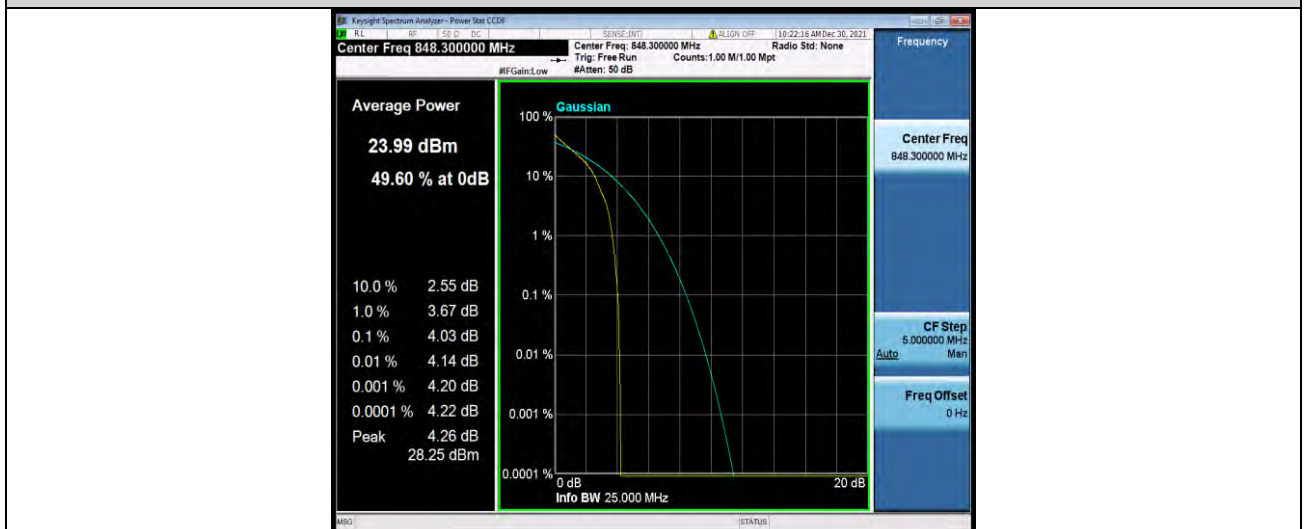

Band5-1.4MHz-QPSK-20643-6RB#0