

Band/BW	Modulation	RB Size	RB Offset	Low CH 132072	Mid CH 132322	High CH 132572	MPR
				Frequency 1720MHz	Frequency 1745MHz	Frequency 1770MHz	
66/ 20	QPSK	1	0	23.87	23.72	24.04	0
		1	50	23.79	23.64	23.96	0
		1	99	22.77	22.62	22.94	0
		50	0	22.54	22.39	22.71	1
		50	25	22.46	22.31	22.63	1
		50	50	22.52	22.37	22.69	1
		100	0	22.47	22.32	22.64	1
	16QAM	1	0	22.58	22.43	22.75	1
		1	50	22.55	22.40	22.72	1
		1	99	22.41	22.26	22.58	1
		50	0	21.54	21.39	21.71	2
		50	25	21.50	21.35	21.67	2
		50	50	21.48	21.33	21.65	2
		100	0	21.62	21.47	21.79	2
	64QAM	1	0	21.75	21.60	21.92	2
		1	50	21.57	21.42	21.74	2
		1	99	21.62	21.47	21.79	2
		50	0	20.10	19.95	20.27	3
		50	25	19.87	19.72	20.04	3
		50	50	19.81	19.66	19.98	3
		100	0	19.92	19.77	20.09	3



BUREAU
VERITAS

Test Report No.: W7L-P21120037RF05

EIRP

WCDMA IV

Channel	Frequency (MHz)	Conducted Power (dBm)	G _T -L _c (dB)	EIRP (dBm)	EIRP (mW)	Limit (W)
1312	1712.4	23.14	0.09	23.23	210.38	1
1413	1732.6	23.13	0.09	23.22	209.89	1
1513	1752.6	23.06	0.09	23.15	206.54	1

LTE BAND 4

CHANNEL BANDWIDTH: 1.4MHz QPSK

Channel	Frequency (MHz)	Conducted Power (dBm)	G _T -L _c (dB)	EIRP (dBm)	EIRP (mW)	Limit (W)
19957	1710.7	23.67	0.09	23.76	237.68	1
20175	1732.5	23.68	0.09	23.77	238.23	1
20393	1754.3	23.75	0.09	23.84	242.1	1

CHANNEL BANDWIDTH: 1.4MHz 16QAM

Channel	Frequency (MHz)	Conducted Power (dBm)	G _T -L _c (dB)	EIRP (dBm)	EIRP (mW)	Limit (W)
19957	1710.7	23.08	0.09	23.17	207.49	1
20175	1732.5	23.03	0.09	23.12	205.12	1
20393	1754.3	23.12	0.09	23.21	209.41	1

CHANNEL BANDWIDTH: 1.4MHz 64QAM

Channel	Frequency (MHz)	Conducted Power (dBm)	G _T -L _c (dB)	EIRP (dBm)	EIRP (mW)	Limit (W)
19957	1710.7	21.79	0.09	21.88	154.17	1
20175	1732.5	21.78	0.09	21.87	153.82	1
20393	1754.3	21.88	0.09	21.97	157.4	1

CHANNEL BANDWIDTH: 3MHz QPSK

Channel	Frequency (MHz)	Conducted Power (dBm)	G _T -L _c (dB)	EIRP (dBm)	EIRP (mW)	Limit (W)
19965	1711.5	23.69	0.09	23.78	238.78	1
20175	1732.5	23.7	0.09	23.79	239.33	1
20385	1753.5	23.73	0.09	23.82	240.99	1

CHANNEL BANDWIDTH: 3MHz 16QAM

Channel	Frequency (MHz)	Conducted Power (dBm)	G _T -L _c (dB)	EIRP (dBm)	EIRP (mW)	Limit (W)
19965	1711.5	23.05	0.09	23.14	206.06	1
20175	1732.5	23.09	0.09	23.18	207.97	1
20385	1753.5	21.61	0.09	21.7	147.91	1

CHANNEL BANDWIDTH: 3MHz 64QAM

Channel	Frequency (MHz)	Conducted Power (dBm)	G _T -L _c (dB)	EIRP (dBm)	EIRP (mW)	Limit (W)
19965	1711.5	21.85	0.09	21.94	156.31	1
20175	1732.5	21.81	0.09	21.9	154.88	1
20385	1753.5	21.83	0.09	21.92	155.6	1

CHANNEL BANDWIDTH: 5MHz QPSK

Channel	Frequency (MHz)	Conducted Power (dBm)	G _T -L _c (dB)	EIRP (dBm)	EIRP (mW)	Limit (W)
19975	1712.5	23.7	0.09	23.79	239.33	1
20175	1732.5	23.65	0.09	23.74	236.59	1
20375	1752.5	23.74	0.09	23.83	241.55	1

CHANNEL BANDWIDTH: 5MHz 16QAM

Channel	Frequency (MHz)	Conducted Power (dBm)	G _T -L _c (dB)	EIRP (dBm)	EIRP (mW)	Limit (W)
19975	1712.5	23.06	0.09	23.15	206.54	1
20175	1732.5	23.05	0.09	23.14	206.06	1
20375	1752.5	23.15	0.09	23.24	210.86	1

CHANNEL BANDWIDTH: 5MHz 64QAM

Channel	Frequency (MHz)	Conducted Power (dBm)	G _T -L _c (dB)	EIRP (dBm)	EIRP (mW)	Limit (W)
19975	1712.5	21.79	0.09	21.88	154.17	1
20175	1732.5	21.78	0.09	21.87	153.82	1
20375	1752.5	21.88	0.09	21.97	157.4	1

CHANNEL BANDWIDTH: 10MHz QPSK

Channel	Frequency (MHz)	Conducted Power (dBm)	G _T -L _c (dB)	EIRP (dBm)	EIRP (mW)	Limit (W)
20000	1715	23.67	0.09	23.76	237.68	1
20175	1732.5	23.68	0.09	23.77	238.23	1
20350	1750	23.74	0.09	23.83	241.55	1

CHANNEL BANDWIDTH: 10MHz 16QAM

Channel	Frequency (MHz)	Conducted Power (dBm)	G _T -L _c (dB)	EIRP (dBm)	EIRP (mW)	Limit (W)
20000	1715	23.06	0.09	23.15	206.54	1
20175	1732.5	23.02	0.09	23.11	204.64	1
20350	1750	23.11	0.09	23.2	208.93	1

CHANNEL BANDWIDTH: 10MHz 64QAM

Channel	Frequency (MHz)	Conducted Power (dBm)	G _T -L _c (dB)	EIRP (dBm)	EIRP (mW)	Limit (W)
20000	1715	21.79	0.09	21.88	154.17	1
20175	1732.5	21.79	0.09	21.88	154.17	1
20350	1750	21.85	0.09	21.94	156.31	1

CHANNEL BANDWIDTH: 15MHz QPSK

Channel	Frequency (MHz)	Conducted Power (dBm)	G _T -L _c (dB)	EIRP (dBm)	EIRP (mW)	Limit (W)
20025	1717.5	23.74	0.09	23.83	241.55	1
20175	1732.5	23.68	0.09	23.77	238.23	1
20325	1747.5	23.71	0.09	23.8	239.88	1

CHANNEL BANDWIDTH: 15MHz 16QAM

Channel	Frequency (MHz)	Conducted Power (dBm)	G _T -L _c (dB)	EIRP (dBm)	EIRP (mW)	Limit (W)
20025	1717.5	23.1	0.09	23.19	208.45	1
20175	1732.5	23.09	0.09	23.18	207.97	1
20325	1747.5	23.11	0.09	23.2	208.93	1

CHANNEL BANDWIDTH: 15MHz 64QAM

Channel	Frequency (MHz)	Conducted Power (dBm)	G _T -L _c (dB)	EIRP (dBm)	EIRP (mW)	Limit (W)
20025	1717.5	21.8	0.09	21.89	154.53	1
20175	1732.5	21.8	0.09	21.89	154.53	1
20325	1747.5	21.86	0.09	21.95	156.68	1

CHANNEL BANDWIDTH: 20MHz QPSK

Channel	Frequency (MHz)	Conducted Power (dBm)	G _T -L _c (dB)	EIRP (dBm)	EIRP (mW)	Limit (W)
20050	1720	23.75	0.09	23.84	242.1	1
20175	1732.5	23.72	0.09	23.81	240.44	1
20300	1745	23.79	0.09	23.88	244.34	1

CHANNEL BANDWIDTH: 20MHz 16QAM

Channel	Frequency (MHz)	Conducted Power (dBm)	G _T -L _c (dB)	EIRP (dBm)	EIRP (mW)	Limit (W)
20050	1720	23.13	0.09	23.22	209.89	1
20175	1732.5	23.1	0.09	23.19	208.45	1
20300	1745	23.17	0.09	23.26	211.84	1

CHANNEL BANDWIDTH: 20MHz 64QAM

Channel	Frequency (MHz)	Conducted Power (dBm)	G _T -L _c (dB)	EIRP (dBm)	EIRP (mW)	Limit (W)
20050	1720	21.86	0.09	21.95	156.68	1
20175	1732.5	21.83	0.09	21.92	155.6	1
20300	1745	21.9	0.09	21.99	158.12	1

LTE BAND 7

CHANNEL BANDWIDTH: 5MHz QPSK

Channel	Frequency (MHz)	Conducted Power (dBm)	G _T -L _c (dB)	EIRP (dBm)	EIRP (mW)	Limit (W)
20775	2502.5	23.66	0.63	24.29	268.53	2
21100	2535.0	23.74	0.63	24.37	273.53	2
21425	2567.5	23.67	0.63	24.3	269.15	2

CHANNEL BANDWIDTH: 5MHz 16QAM

Channel	Frequency (MHz)	Conducted Power (dBm)	G _T -L _c (dB)	EIRP (dBm)	EIRP (mW)	Limit (W)
20775	2502.5	22.41	0.63	23.04	201.37	2
21100	2535.0	22.46	0.63	23.09	203.7	2
21425	2567.5	22.38	0.63	23.01	199.99	2

CHANNEL BANDWIDTH: 5MHz 64QAM

Channel	Frequency (MHz)	Conducted Power (dBm)	G _T -L _c (dB)	EIRP (dBm)	EIRP (mW)	Limit (W)
20775	2502.5	21.85	0.63	22.48	177.01	2
21100	2535	22.03	0.63	22.66	184.5	2
21425	2567.5	21.88	0.63	22.51	178.24	2

CHANNEL BANDWIDTH: 10MHz QPSK

Channel	Frequency (MHz)	Conducted Power (dBm)	G _T -L _c (dB)	EIRP (dBm)	EIRP (mW)	Limit (W)
20800	2505.0	23.63	0.63	24.26	266.69	2
21100	2535.0	23.78	0.63	24.41	276.06	2
21400	2565.0	23.63	0.63	24.26	266.69	2

CHANNEL BANDWIDTH: 10MHz 16QAM

Channel	Frequency (MHz)	Conducted Power (dBm)	G _T -L _c (dB)	EIRP (dBm)	EIRP (mW)	Limit (W)
20800	2505.0	22.41	0.63	23.04	201.37	2
21100	2535.0	22.47	0.63	23.1	204.17	2
21400	2565.0	22.35	0.63	22.98	198.61	2

CHANNEL BANDWIDTH: 10MHz 64QAM

Channel	Frequency (MHz)	Conducted Power (dBm)	G _T -L _c (dB)	EIRP (dBm)	EIRP (mW)	Limit (W)
20800	2505	21.91	0.63	22.54	179.47	2
21100	2535	21.97	0.63	22.6	181.97	2
21400	2565	21.85	0.63	22.48	177.01	2

CHANNEL BANDWIDTH: 15MHz QPSK

Channel	Frequency (MHz)	Conducted Power (dBm)	G _T -L _c (dB)	EIRP (dBm)	EIRP (mW)	Limit (W)
20825	2507.5	23.69	0.63	24.32	270.4	2
21100	2535.0	23.81	0.63	24.44	277.97	2
21375	2562.5	23.64	0.63	24.27	267.3	2

CHANNEL BANDWIDTH: 15MHz 16QAM

Channel	Frequency (MHz)	Conducted Power (dBm)	G _T -L _c (dB)	EIRP (dBm)	EIRP (mW)	Limit (W)
20825	2507.5	22.37	0.63	23	199.53	2
21100	2535.0	22.52	0.63	23.15	206.54	2
21375	2562.5	22.37	0.63	23	199.53	2

CHANNEL BANDWIDTH: 15MHz 64QAM

Channel	Frequency (MHz)	Conducted Power (dBm)	G _T -L _c (dB)	EIRP (dBm)	EIRP (mW)	Limit (W)
20825	2507.5	21.87	0.63	22.5	177.83	2
21100	2535	21.96	0.63	22.59	181.55	2
21375	2562.5	21.88	0.63	22.51	178.24	2



**BUREAU
VERITAS**

Test Report No.: W7L-P21120037RF05

CHANNEL BANDWIDTH: 20MHz QPSK

Channel	Frequency (MHz)	Conducted Power (dBm)	G _T -L _c (dB)	EIRP (dBm)	EIRP (mW)	Limit (W)
20850	2510.0	23.71	0.63	24.34	271.64	2
21100	2535.0	23.82	0.63	24.45	278.61	2
21350	2560.0	23.68	0.63	24.31	269.77	2

CHANNEL BANDWIDTH: 20MHz 16QAM

Channel	Frequency (MHz)	Conducted Power (dBm)	G _T -L _c (dB)	EIRP (dBm)	EIRP (mW)	Limit (W)
20850	2510.0	22.43	0.63	23.06	202.3	2
21100	2535.0	22.54	0.63	23.17	207.49	2
21350	2560.0	22.4	0.63	23.03	200.91	2

CHANNEL BANDWIDTH: 20MHz 64QAM

Channel	Frequency (MHz)	Conducted Power (dBm)	G _T -L _c (dB)	EIRP (dBm)	EIRP (mW)	Limit (W)
20850	2510	21.93	0.63	22.56	180.3	2
21100	2535	22.04	0.63	22.67	184.93	2
21350	2560	21.9	0.63	22.53	179.06	2



**BUREAU
VERITAS**

Test Report No.: W7L-P21120037RF05

LTE BAND 12

CHANNEL BANDWIDTH: 1.4MHz QPSK

Channel	Frequency (MHz)	Conducted Power (dBm)	G _T -L _c (dB)	ERP (dBm)	ERP (mW)	Limit (W)
23017	699.7	23.46	-2.31	19	79.43	3
23095	707.5	23.49	-2.31	19.03	79.98	3
23173	715.3	23.46	-2.31	19	79.43	3

CHANNEL BANDWIDTH: 1.4MHz 16QAM

Channel	Frequency (MHz)	Conducted Power (dBm)	G _T -L _c (dB)	ERP (dBm)	ERP (mW)	Limit (W)
23017	699.7	22.71	-2.31	18.25	66.83	3
23095	707.5	22.77	-2.31	18.31	67.76	3
23173	715.3	22.74	-2.31	18.28	67.3	3

CHANNEL BANDWIDTH: 1.4MHz 64QAM

Channel	Frequency (MHz)	Conducted Power (dBm)	G _T -L _c (dB)	ERP (dBm)	ERP (mW)	Limit (W)
23017	699.7	21.47	-2.31	17.01	50.23	3
23095	707.5	21.47	-2.31	17.01	50.23	3
23173	715.3	21.5	-2.31	17.04	50.58	3

CHANNEL BANDWIDTH: 3MHz QPSK

Channel	Frequency (MHz)	Conducted Power (dBm)	G _T -L _c (dB)	ERP (dBm)	ERP (mW)	Limit (W)
23025	700.5	23.42	-2.31	18.96	78.7	3
23095	707.5	23.51	-2.31	19.05	80.35	3
23165	714.5	23.46	-2.31	19	79.43	3

CHANNEL BANDWIDTH: 3MHz 16QAM

Channel	Frequency (MHz)	Conducted Power (dBm)	G _T -L _c (dB)	ERP (dBm)	ERP (mW)	Limit (W)
23025	700.5	22.68	-2.31	18.22	66.37	3
23095	707.5	22.74	-2.31	18.28	67.3	3
23165	714.5	22.72	-2.31	18.26	66.99	3

CHANNEL BANDWIDTH: 3MHz 64QAM

Channel	Frequency (MHz)	Conducted Power (dBm)	G _T -L _c (dB)	ERP (dBm)	ERP (mW)	Limit (W)
23025	700.5	21.48	-2.31	17.02	50.35	3
23095	707.5	21.49	-2.31	17.03	50.47	3
23165	714.5	21.5	-2.31	17.04	50.58	3

CHANNEL BANDWIDTH: 5MHz QPSK

Channel	Frequency (MHz)	Conducted Power (dBm)	G _T -L _c (dB)	ERP (dBm)	ERP (mW)	Limit (W)
23035	701.5	23.43	-2.31	18.97	78.89	3
23095	707.5	23.46	-2.31	19	79.43	3
23155	713.5	23.5	-2.31	19.04	80.17	3

CHANNEL BANDWIDTH: 5MHz 16QAM

Channel	Frequency (MHz)	Conducted Power (dBm)	G _T -L _c (dB)	ERP (dBm)	ERP (mW)	Limit (W)
23035	701.5	22.65	-2.31	18.19	65.92	3
23095	707.5	22.77	-2.31	18.31	67.76	3
23155	713.5	22.71	-2.31	18.25	66.83	3

CHANNEL BANDWIDTH: 5MHz 64QAM

Channel	Frequency (MHz)	Conducted Power (dBm)	G _T -L _c (dB)	ERP (dBm)	ERP (mW)	Limit (W)
23035	701.5	21.41	-2.31	16.95	49.55	3
23095	707.5	21.54	-2.31	17.08	51.05	3
23155	713.5	21.5	-2.31	17.04	50.58	3



**BUREAU
VERITAS**

Test Report No.: W7L-P21120037RF05

CHANNEL BANDWIDTH: 10MHz QPSK

Channel	Frequency (MHz)	Conducted Power (dBm)	G _T -L _c (dB)	ERP (dBm)	ERP (mW)	Limit (W)
23060	704	23.48	-2.31	19.02	79.8	3
23095	707.5	23.54	-2.31	19.08	80.91	3
23130	711	23.51	-2.31	19.05	80.35	3

CHANNEL BANDWIDTH: 10MHz 16QAM

Channel	Frequency (MHz)	Conducted Power (dBm)	G _T -L _c (dB)	ERP (dBm)	ERP (mW)	Limit (W)
23060	704	22.73	-2.31	18.27	67.14	3
23095	707.5	22.79	-2.31	18.33	68.08	3
23130	711	22.76	-2.31	18.3	67.61	3

CHANNEL BANDWIDTH: 10MHz 64QAM

Channel	Frequency (MHz)	Conducted Power (dBm)	G _T -L _c (dB)	ERP (dBm)	ERP (mW)	Limit (W)
23060	704	21.49	-2.31	17.03	50.47	3
23095	707.5	21.55	-2.31	17.09	51.17	3
23130	711	21.52	-2.31	17.06	50.82	3

REMARKS: ERP Output Power (dBm) = ERP (dBm) -2.15(dB).



**BUREAU
VERITAS**

Test Report No.: W7L-P21120037RF05

LTE BAND 13

CHANNEL BANDWIDTH: 5MHz QPSK

Channel	Frequency (MHz)	Conducted Power (dBm)	G _T -L _c (dB)	ERP (dBm)	ERP (mW)	Limit (W)
23205	779.5	22.44	-3.07	17.22	52.72	3
23230	782	22.42	-3.07	17.2	52.48	3
23255	784.5	22.44	-3.07	17.22	52.72	3

CHANNEL BANDWIDTH: 5MHz 16QAM

Channel	Frequency (MHz)	Conducted Power (dBm)	G _T -L _c (dB)	ERP (dBm)	ERP (mW)	Limit (W)
23205	779.5	21.56	-3.07	16.34	43.05	3
23230	782	21.5	-3.07	16.28	42.46	3
23255	784.5	21.56	-3.07	16.34	43.05	3

CHANNEL BANDWIDTH: 5MHz 64QAM

Channel	Frequency (MHz)	Conducted Power (dBm)	G _T -L _c (dB)	ERP (dBm)	ERP (mW)	Limit (W)
23205	779.5	20.68	-3.07	15.46	35.16	3
23230	782	20.75	-3.07	15.53	35.73	3
23255	784.5	20.74	-3.07	15.52	35.65	3



Test Report No.: W7L-P21120037RF05

CHANNEL BANDWIDTH: 10MHz QPSK

Channel	Frequency (MHz)	Conducted Power (dBm)	G _T -L _c (dB)	ERP (dBm)	ERP (mW)	Limit (W)
-	-	-	-	-	-	-
23230	782	22.49	-3.07	17.27	53.33	3
-	-	-	-	-	-	-

CHANNEL BANDWIDTH: 10MHz 16QAM

Channel	Frequency (MHz)	Conducted Power (dBm)	G _T -L _c (dB)	ERP (dBm)	ERP (mW)	Limit (W)
-	-	-	-	-	-	-
23230	782	21.58	-3.07	16.36	43.25	3
-	-	-	-	-	-	-

CHANNEL BANDWIDTH: 10MHz 64QAM

Channel	Frequency (MHz)	Conducted Power (dBm)	G _T -L _c (dB)	ERP (dBm)	ERP (mW)	Limit (W)
-	-	-	-	-	-	-
23230	782	20.76	-3.07	15.54	35.81	3
-	-	-	-	-	-	-

REMARKS: ERP Output Power (dBm) = ERP (dBm) -2.15(dB).

LTE BAND 17

CHANNEL BANDWIDTH: 5MHz QPSK

Channel	Frequency (MHz)	Conducted Power (dBm)	G _T -L _c (dB)	ERP (dBm)	ERP (mW)	Limit (W)
23755	706.5	23.58	-2.31	19.12	81.66	3
23790	710	23.42	-2.31	18.96	78.7	3
23825	713.5	23.46	-2.31	19	79.43	3

CHANNEL BANDWIDTH: 5MHz 16QAM

Channel	Frequency (MHz)	Conducted Power (dBm)	G _T -L _c (dB)	ERP (dBm)	ERP (mW)	Limit (W)
23755	706.5	22.76	-2.31	18.3	67.61	3
23790	710	22.65	-2.31	18.19	65.92	3
23825	713.5	22.65	-2.31	18.19	65.92	3

CHANNEL BANDWIDTH: 5MHz 64QAM

Channel	Frequency (MHz)	Conducted Power (dBm)	G _T -L _c (dB)	ERP (dBm)	ERP (mW)	Limit (W)
23755	706.5	21.68	-2.31	17.22	52.72	3
23790	710	21.57	-2.31	17.11	51.4	3
23825	713.5	21.57	-2.31	17.11	51.4	3

CHANNEL BANDWIDTH: 10MHz QPSK

Channel	Frequency (MHz)	Conducted Power (dBm)	G _T -L _c (dB)	ERP (dBm)	ERP (mW)	Limit (W)
23780	709	23.63	-2.31	19.17	82.6	3
23790	710	23.5	-2.31	19.04	80.17	3
23800	711	23.47	-2.31	19.01	79.62	3

CHANNEL BANDWIDTH: 10MHz 16QAM

Channel	Frequency (MHz)	Conducted Power (dBm)	G _T -L _c (dB)	ERP (dBm)	ERP (mW)	Limit (W)
23780	709	22.83	-2.31	18.37	68.71	3
23790	710	22.7	-2.31	18.24	66.68	3
23800	711	22.67	-2.31	18.21	66.22	3



Test Report No.: W7L-P21120037RF05

CHANNEL BANDWIDTH: 10MHz 64QAM

Channel	Frequency (MHz)	Conducted Power (dBm)	G _T -L _c (dB)	ERP (dBm)	ERP (mW)	Limit (W)
23780	709	21.75	-2.31	17.29	53.58	3
23790	710	21.62	-2.31	17.16	52	3
23800	711	21.59	-2.31	17.13	51.64	3

REMARKS: ERP Output Power (dBm) = ERP (dBm) -2.15(dB).



BUREAU
VERITAS

Test Report No.: W7L-P21120037RF05

LTE BAND 66

CHANNEL BANDWIDTH: 1.4MHz QPSK

Channel	Frequency (MHz)	Conducted Power (dBm)	G _T -L _c (dB)	EIRP (dBm)	EIRP (mW)	Limit (W)
131979	1710.7	23.79	0.05	23.84	242.10	1
132322	1745	23.68	0.05	23.73	236.05	1
132665	1779.3	23.99	0.05	24.04	253.51	1

CHANNEL BANDWIDTH: 1.4MHz 16QAM

Channel	Frequency (MHz)	Conducted Power (dBm)	G _T -L _c (dB)	EIRP (dBm)	EIRP (mW)	Limit (W)
131979	1710.7	22.53	0.05	22.58	181.13	1
132322	1745	22.36	0.05	22.41	174.18	1
132665	1779.3	22.7	0.05	22.75	188.36	1

CHANNEL BANDWIDTH: 1.4MHz 64QAM

Channel	Frequency (MHz)	Conducted Power (dBm)	G _T -L _c (dB)	EIRP (dBm)	EIRP (mW)	Limit (W)
131979	1710.7	21.68	0.05	21.73	148.94	1
132322	1745	21.55	0.05	21.6	144.54	1
132665	1779.3	21.9	0.05	21.95	156.68	1

CHANNEL BANDWIDTH: 3MHz QPSK

Channel	Frequency (MHz)	Conducted Power (dBm)	G _T -L _c (dB)	EIRP (dBm)	EIRP (mW)	Limit (W)
131987	1711.5	23.81	0.05	23.86	243.22	1
132322	1745	23.7	0.05	23.75	237.14	1
132657	1778.5	23.98	0.05	24.03	252.93	1

CHANNEL BANDWIDTH: 3MHz 16QAM

Channel	Frequency (MHz)	Conducted Power (dBm)	G _T -L _c (dB)	EIRP (dBm)	EIRP (mW)	Limit (W)
131987	1711.5	22.5	0.05	22.55	179.89	1
132322	1745	22.42	0.05	22.47	176.6	1
132657	1778.5	22.73	0.05	22.78	189.67	1

CHANNEL BANDWIDTH: 3MHz 64QAM

Channel	Frequency (MHz)	Conducted Power (dBm)	G _T -L _c (dB)	EIRP (dBm)	EIRP (mW)	Limit (W)
131987	1711.5	21.74	0.05	21.79	151.01	1
132322	1745	21.58	0.05	21.63	145.55	1
132657	1778.5	21.84	0.05	21.89	154.53	1

CHANNEL BANDWIDTH: 5MHz QPSK

Channel	Frequency (MHz)	Conducted Power (dBm)	G _T -L _c (dB)	EIRP (dBm)	EIRP (mW)	Limit (W)
131997	1712.5	23.82	0.05	23.87	243.78	1
132322	1745	23.65	0.05	23.7	234.42	1
132647	1777.5	23.99	0.05	24.04	253.51	1

CHANNEL BANDWIDTH: 5MHz 16QAM

Channel	Frequency (MHz)	Conducted Power (dBm)	G _T -L _c (dB)	EIRP (dBm)	EIRP (mW)	Limit (W)
131997	1712.5	22.51	0.05	22.56	180.3	1
132322	1745	22.38	0.05	22.43	174.98	1
132647	1777.5	22.73	0.05	22.78	189.67	1

CHANNEL BANDWIDTH: 5MHz 64QAM

Channel	Frequency (MHz)	Conducted Power (dBm)	G _T -L _c (dB)	EIRP (dBm)	EIRP (mW)	Limit (W)
131997	1712.5	21.68	0.05	21.73	148.94	1
132322	1745	21.55	0.05	21.6	144.54	1
132647	1777.5	21.9	0.05	21.95	156.68	1

CHANNEL BANDWIDTH: 10MHz QPSK

Channel	Frequency (MHz)	Conducted Power (dBm)	G _T -L _c (dB)	EIRP (dBm)	EIRP (mW)	Limit (W)
132022	1715	23.79	0.05	23.84	242.10	1
132322	1745	23.68	0.05	23.73	236.05	1
132622	1775	23.99	0.05	24.04	253.51	1

CHANNEL BANDWIDTH: 10MHz 16QAM

Channel	Frequency (MHz)	Conducted Power (dBm)	G _T -L _c (dB)	EIRP (dBm)	EIRP (mW)	Limit (W)
132022	1715	22.52	0.05	22.57	180.72	1
132322	1745	22.35	0.05	22.4	173.78	1
132622	1775	22.7	0.05	22.75	188.36	1

CHANNEL BANDWIDTH: 10MHz 64QAM

Channel	Frequency (MHz)	Conducted Power (dBm)	G _T -L _c (dB)	EIRP (dBm)	EIRP (mW)	Limit (W)
132022	1715	21.67	0.05	21.72	148.59	1
132322	1745	21.56	0.05	21.61	144.88	1
132622	1775	21.87	0.05	21.92	155.6	1

CHANNEL BANDWIDTH: 15MHz QPSK

Channel	Frequency (MHz)	Conducted Power (dBm)	G _T -L _c (dB)	EIRP (dBm)	EIRP (mW)	Limit (W)
132047	1717.5	23.86	0.05	23.91	246.04	1
132322	1745	23.68	0.05	23.73	236.05	1
132597	1772.5	23.96	0.05	24.01	251.77	1

CHANNEL BANDWIDTH: 15MHz 16QAM

Channel	Frequency (MHz)	Conducted Power (dBm)	G _T -L _c (dB)	EIRP (dBm)	EIRP (mW)	Limit (W)
132047	1715	22.55	0.05	22.6	181.97	1
132322	1745	22.42	0.05	22.47	176.6	1
132622	1775	22.7	0.05	22.75	188.36	1

CHANNEL BANDWIDTH: 15MHz 64QAM

Channel	Frequency (MHz)	Conducted Power (dBm)	G _T -L _c (dB)	EIRP (dBm)	EIRP (mW)	Limit (W)
132047	1715	21.69	0.05	21.74	149.28	1
132322	1745	21.57	0.05	21.62	145.21	1
132622	1775	21.88	0.05	21.93	155.96	1

CHANNEL BANDWIDTH: 20MHz QPSK

Channel	Frequency (MHz)	Conducted Power (dBm)	G _T -L _c (dB)	EIRP (dBm)	EIRP (mW)	Limit (W)
132072	1720	23.87	0.05	23.92	246.6	1
132322	1745	23.72	0.05	23.77	238.23	1
132572	1770	24.04	0.05	24.09	256.45	1

CHANNEL BANDWIDTH: 20MHz 16QAM

Channel	Frequency (MHz)	Conducted Power (dBm)	G _T -L _c (dB)	EIRP (dBm)	EIRP (mW)	Limit (W)
132072	1720	22.58	0.05	22.63	183.23	1
132322	1745	22.43	0.05	22.48	177.01	1
132572	1770	22.75	0.05	22.8	190.55	1

CHANNEL BANDWIDTH: 20MHz 64QAM

Channel	Frequency (MHz)	Conducted Power (dBm)	G _T -L _c (dB)	EIRP (dBm)	EIRP (mW)	Limit (W)
132072	1720	21.75	0.05	21.8	151.36	1
132322	1745	21.6	0.05	21.65	146.22	1
132572	1770	21.92	0.05	21.97	157.4	1

3.2 FREQUENCY STABILITY MEASUREMENT

3.2.1 LIMITS OF FREQUENCY STABILITY MEASUREMENT

The frequency stability shall be sufficient to ensure that the fundamental emissions stay within the authorized bands of operation.

3.2.2 TEST PROCEDURE

- a. Device is placed at the oven room. The oven room could control the temperatures and humidity. Power warm up is at least 15 min and power applied should perform before recording frequency error.
- b. EUT is connected the external power supply to control the DC input power. The test voltage range is from minimum to maximum working voltage. Each step shall be record the frequency error rate.
- c. The temperature range step is 10 degrees in this test items. All temperature levels shall be hold the $\pm 0.5^{\circ}\text{C}$ during the measurement testing. The each temperature step shall be at least 0.5 hours, consider the EUT could be test under the stability condition.

NOTE: The frequency error was recorded frequency error from the communication simulator.

3.2.3 TEST SETUP

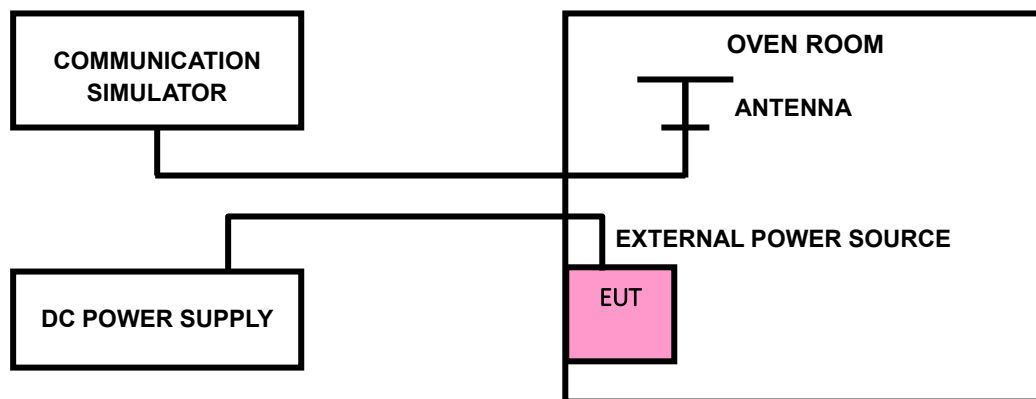



Test Report No.: W7L-P21120037RF05

3.2.4 TEST RESULTS

Please Refer to Appendix Of this test report.

3.3 OCCUPIED BANDWIDTH MEASUREMENT

3.3.1 LIMITS OF OCCUPIED BANDWIDTH MEASUREMENT

The width of a frequency band such that, below the lower and above the upper frequency limits, the mean powers emitted are each equal to a specified percentage 0.5 % of the total mean power of a given emission.

3.3.2 TEST SETUP

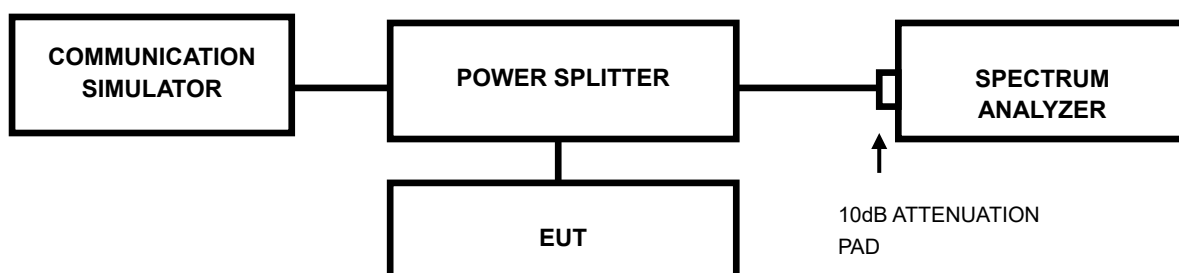

3.3.3 TEST PROCEDURES

- The conducted occupied bandwidth used the power splitter via EUT RF power connector between simulation base station and spectrum analyzer.
- Use OBW measurement function of Spectrum analyzer to measure 99 % occupied bandwidth.



Test Report No.: W7L-P21120037RF05

3.3.4 TEST RESULTS

Please Refer to Appendix Of this test report.

3.4 BAND EDGE MEASUREMENT

3.4.1 LIMITS OF BAND EDGE MEASUREMENT

According to FCC 27.53(c) specified that For operations in the 746-758 MHz band and the 776-788 MHz band , the power of any emission shall be attenuated outside the band below the transmitter power (P) by at least $43 + 10 \log (P)$ dB. However, in the 100 kilohertz bands immediately outside and adjacent to a licensee's frequency block, a resolution bandwidth of at least 30 kHz may be employed. In addition, the power of any unwanted emission in an 6.25kHz bandwidth for all frequencies between 763-775 MHz and 793-806 MHz shall be attenuated below the transmitter power, P(dBW), by at least $65 + 10 \log 10p(P)$, dB, for mobile and portable equipment.

According to FCC 27.53(g) specified that For operations in the 600 MHz band and the 698-746 MHz band, the power of any emission outside a licensee's frequency band(s) of operation shall be attenuated below the transmitter power (P) within the licensed band(s) of operation, measured in watts, by at least $43 + 10 \log (P)$ dB. However, in the 100 kilohertz bands immediately outside and adjacent to a licensee's frequency block, a resolution bandwidth of at least 30 kHz may be employed.

According to FCC 27.53(h) specified that For operations in the 1710-1755 MHz band, the power of any emission outside a licensee's frequency band(s) of operation shall be attenuated below the transmitter power (P) within the licensed band(s) of operation, measured in watts, by at least $43 + 10 \log (P)$ dB. However, in the 1 megahertz bands immediately outside and adjacent to the licensee's frequency block, a resolution bandwidth of at least one percent of the emission bandwidth of the fundamental emission of the transmitter may be employed.

According to FCC 27.53(m)(4) specified that For mobile digital stations, the attenuation factor shall be not less than $40 + 10 \log (P)$ dB on all frequencies between the channel edge and 5 megahertz from the channel edge, $43 + 10 \log (P)$ dB on all frequencies between 5 megahertz and X megahertz from the channel edge, and $55 + 10 \log (P)$ dB on all frequencies more than X megahertz from the channel edge, where X is the greater of 6 megahertz or the actual emission bandwidth as defined in paragraph (m)(6) of this section. In addition, the attenuation factor shall not be less that $43 + 10 \log (P)$ dB on all frequencies between 2490.5 MHz and 2496 MHz and $55 + 10 \log (P)$ dB at or below 2490.5 MHz. Mobile Satellite Service licensees operating on frequencies below 2495 MHz may also submit a documented interference complaint against BRS licensees operating on channel BRS Channel 1 on the same terms and conditions as adjacent channel BRS or EBS licensees. For mobile digital stations, in the 1 megahertz bands immediately outside and adjacent to the frequency block a resolution bandwidth of at least two percent may be employed.

3.4.2 TEST SETUP

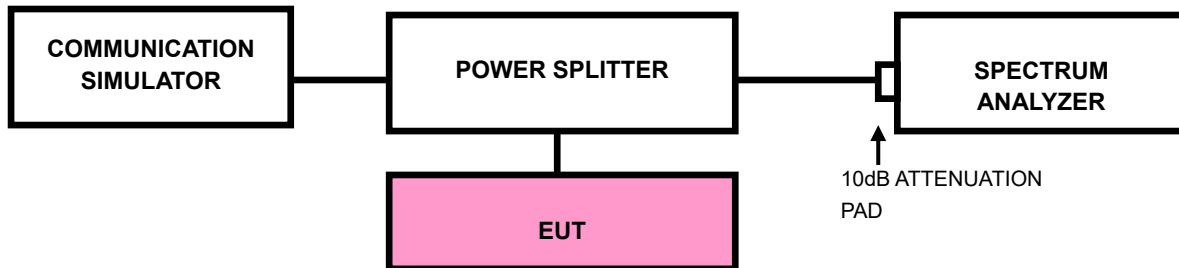

3.4.3 TEST PROCEDURES

- a. All measurements were done at low and high operational frequency range.
- b. The center frequency of spectrum is the band edge frequency and span is 1~5 MHz.
RBW of the spectrum is 10kHz and VBW of the spectrum is 30kHz (LTE bandwidth for (1.4M/3M/5M/10M/15M/20M)1RB/0RB&1RB/MAXRB).
- c. The center frequency of spectrum is the band edge frequency and span is 10MHz.
RBW of the spectrum is 100kHz and VBW of the spectrum is 300kHz (WCDMA).
- d. The center frequency of spectrum is the band edge frequency and span is 1~5 MHz.
RBW of the spectrum is $\geq 1\% \cdot \text{EBW}$ kHz and VBW of the spectrum is $3 \cdot \text{RBW}$ kHz.
(LTE bandwidth 1.4M/3M/5M/10M/15M/20MHz).
- e. Record the max trace plot into the test report.



Test Report No.: W7L-P21120037RF05

3.4.4 TEST RESULTS

Please Refer to Appendix Of this test report.

3.5 CONDUCTED SPURIOUS EMISSIONS

3.5.1 LIMITS OF CONDUCTED SPURIOUS EMISSIONS MEASUREMENT

The power of any emission outside of the authorized operating frequency ranges must be attenuated below the transmitting power (P) by a factor of at least $43 + 10 \log(P)$ dB. The emission limit equal to -13dBm .

For: LTE Band7

The power of any emission outside a licensee's frequency block shall be attenuated below the transmitter power (P) by at least $55 + 10 \log_{10}(P)$ dB. The limit of emission is equal to -25dBm .

3.5.2 TEST PROCEDURE

- a. The EUT makes a phone call to the communication simulator. All measurements were done at low, middle and high operational frequency range.
- b. Measuring frequency range is from 9kHz up to a frequency including its 10th harmonic. 10dB attenuation pad is connected with spectrum. RBW=1MHz and VBW=3MHz is used for conducted emission measurement.

3.5.3 TEST SETUP

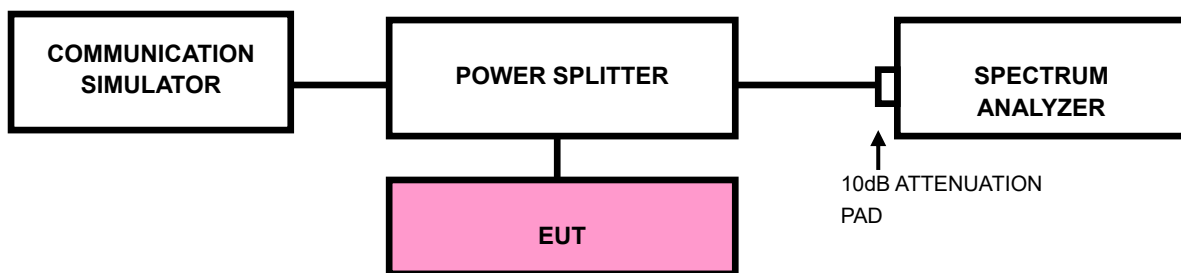



BUREAU
VERITAS

Test Report No.: W7L-P21120037RF05

3.5.4 TEST RESULTS

NOTE : The 9K~30MHz amplitude of spurious emissions attenuated more than 20 dB below the permissible value is not required in the report.

Please Refer to Appendix Of this test report.



3.6 RADIATED EMISSION MEASUREMENT

3.6.1 LIMITS OF RADIATED EMISSION MEASUREMENT

The power of any emission outside of the authorized operating frequency ranges must be attenuated below the transmitting power (P) by a factor of at least $43 + 10 \log(P)$ dB. The emission limit equal to -13dBm .

For: LTE Band7

The power of any emission outside a licensee's frequency block shall be attenuated below the transmitter power (P) by at least $55 + 10 \log_{10}(P)$ dB. The limit of emission is equal to -25dBm .

3.6.2 TEST PROCEDURES

- a. Substitution method is used for E.I.R.P measurement. In the semi-anechoic chamber, EUT placed on the 0.8m height of Turn Table, rotated the table around 360 degrees to search the maximum radiation power and receiver antenna shall be rotated vertical and horizontal polarization and moved height from 1m to 4m to find the maximum polar radiated power. The "Read Value" is the spectrum reading the maximum power value.
- b. The substitution horn antenna is substituted for EUT at the same position and signals generator export the CW signal to the substitution antenna via a TX cable. Rotated the Turn Table and moved receiving antenna to find the maximum radiation power. Adjust output power level of S.G to get a Value of spectrum reading equal to "Read Value " of step a. Record the power level of S.G.
- c. $\text{EIRP} = \text{Output power level of S.G} - \text{TX cable loss} + \text{Antenna gain of substitution horn}$.
- d. E.R.P power can be calculated form E.I.R.P power by subtracting the gain of dipole, $\text{E.R.P power} = \text{E.I.P.R power} - 2.15\text{dBi}$.

NOTE: The resolution bandwidth of spectrum analyzer is 1 MHz and the video bandwidth is 3 MHz.

3.6.3 DEVIATION FROM TEST STANDARD

No deviation

3.6.4 TEST SETUP

< Frequency Range below 30MHz >

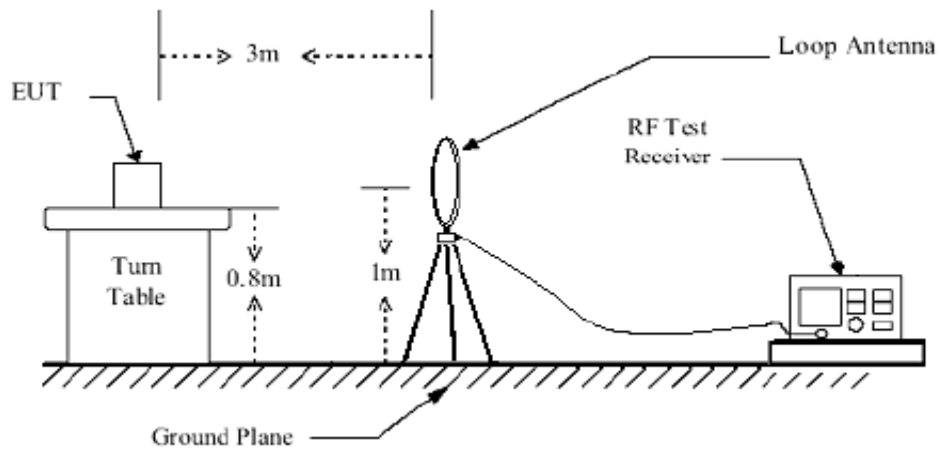

< Frequency Range 30MHz~1GHz >

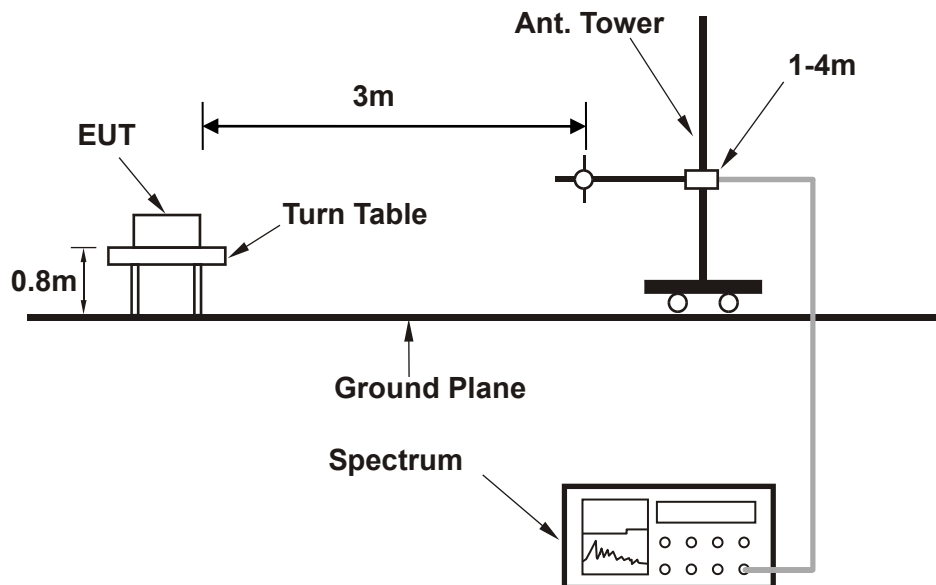

<Frequency Range above 1GHz>

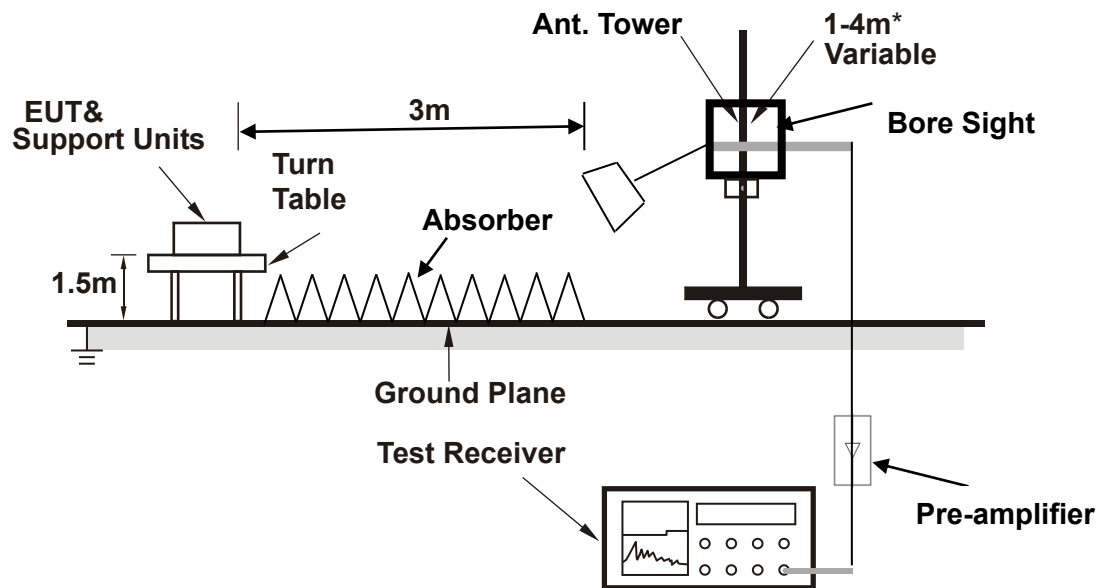

Note: Above 1G is a directional antenna depends on the EUT height and the antenna 3dB beamwidth both, refer to section 7.3 of CISPR 16-2-3.

For the actual test configuration, please refer to the attached file (Test Setup Photo).



3.6.5 TEST RESULTS

NOTE : The 9K~30MHz amplitude of spurious emissions attenuated more than 20 dB below the permissible value is not required in the report.

BELOW 1GHz WORST-CASE DATA

30 MHz – 1GHz data:

LTE Band 7

CHANNEL BANDWIDTH: 5MHz / QPSK

MODE	TX channel 21425	FREQUENCY RANGE	Below 1000MHz
ENVIRONMENTAL CONDITIONS	23deg. C, 70%RH	INPUT POWER	AC 120V/60HZ
TESTED BY	Jace Hu		
ANTENNA POLARITY & TEST DISTANCE: HORIZONTAL AT 3 M			

	Freq	Level	Read Level	Limit Line	Over Limit	Factor	Remark	Pol/Phase
	MHz	dBm/m	dBm	dBm/m	dB	dB/m		
1	33.880	-39.60	-58.74	-25.00	-14.60	19.14	Peak	Horizontal
2	91.110	-44.85	-52.69	-25.00	-19.85	7.84	Peak	Horizontal
3	182.290	-41.16	-51.45	-25.00	-16.16	10.29	Peak	Horizontal
4 PP	309.360	-33.25	-47.52	-25.00	-8.25	14.27	Peak	Horizontal
5	422.850	-42.11	-59.42	-25.00	-17.11	17.31	Peak	Horizontal
6	614.910	-41.99	-62.99	-25.00	-16.99	21.00	Peak	Horizontal

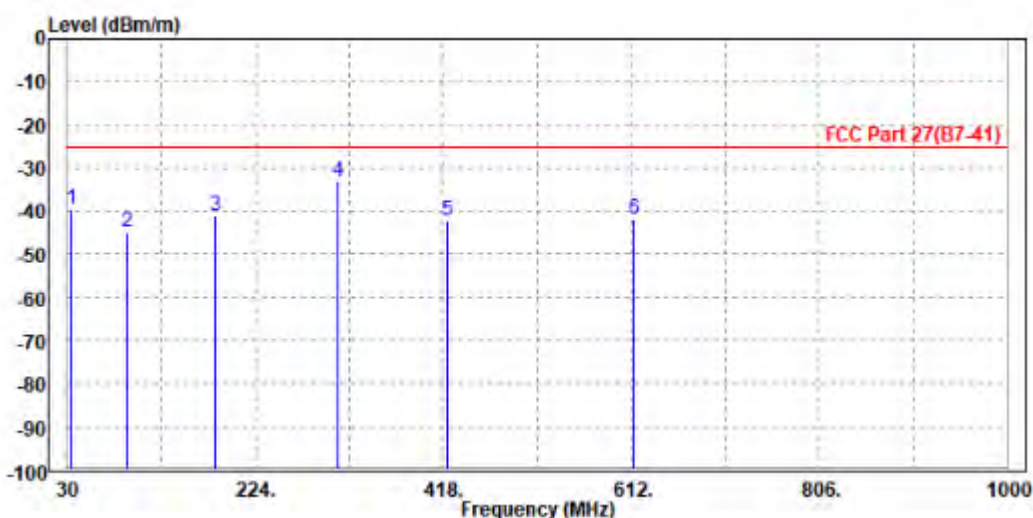



Test Report No.: W7L-P21120037RF05

MODE	TX channel 21425	FREQUENCY RANGE	Below 1000MHz
ENVIRONMENTAL CONDITIONS	23deg. C, 70%RH	INPUT POWER	AC 120V/60HZ
TESTED BY	Jace Hu		
ANTENNA POLARITY & TEST DISTANCE: VERTICAL AT 3 M			

	Freq	Level	Read Level	Limit Line	Over Limit	Factor	Remark	Pol/Phase
	MHz	dBm/m	dBm	dBm/m	dB	dB/m		
1	PP	33.880	-30.90	-49.39	-25.00	-5.90	18.49 Peak	Vertical
2		92.080	-44.58	-53.06	-25.00	-19.58	8.48 Peak	Vertical
3		202.660	-39.34	-50.96	-25.00	-14.34	11.62 Peak	Vertical
4		336.520	-43.75	-59.55	-25.00	-18.75	15.80 Peak	Vertical
5		413.150	-39.80	-57.25	-25.00	-14.80	17.45 Peak	Vertical
6		519.850	-42.19	-61.65	-25.00	-17.19	19.46 Peak	Vertical

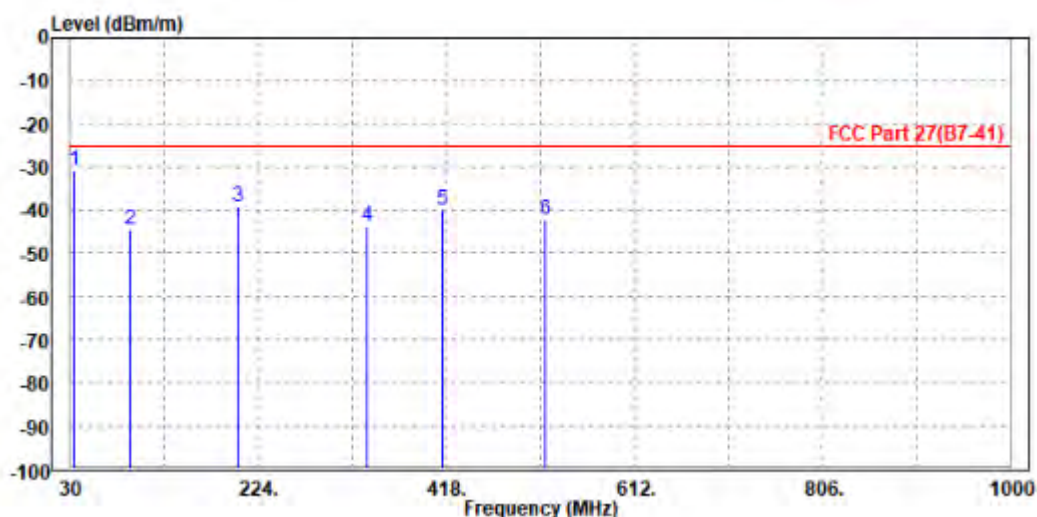



BUREAU VERITAS

Test Report No.: W7L-P21120037RF05

ABOVE 1GHz

Note: For higher frequency, the emission is too low to be detected.

WCDMA Band IV:

CH 1312

MODE	TX channel 1312	FREQUENCY RANGE	Above 1000MHz
ENVIRONMENTAL CONDITIONS	23deg. C, 70%RH	INPUT POWER	AC 120V/60HZ
TESTED BY	Jace Hu		
ANTENNA POLARITY & TEST DISTANCE: HORIZONTAL AT 3 M			

	Freq	Level	Read Level	Limit Line	Over Limit	Factor	Remark	Pol/Phase
	MHz	dBm/m	dBm	dBm/m	dB	dB/m		
1	PP 3418.000	-47.30	-55.89	-13.00	-34.30	8.59	Peak	Horizontal
2	5137.200	-47.98	-56.92	-13.00	-34.98	8.94	Peak	Horizontal

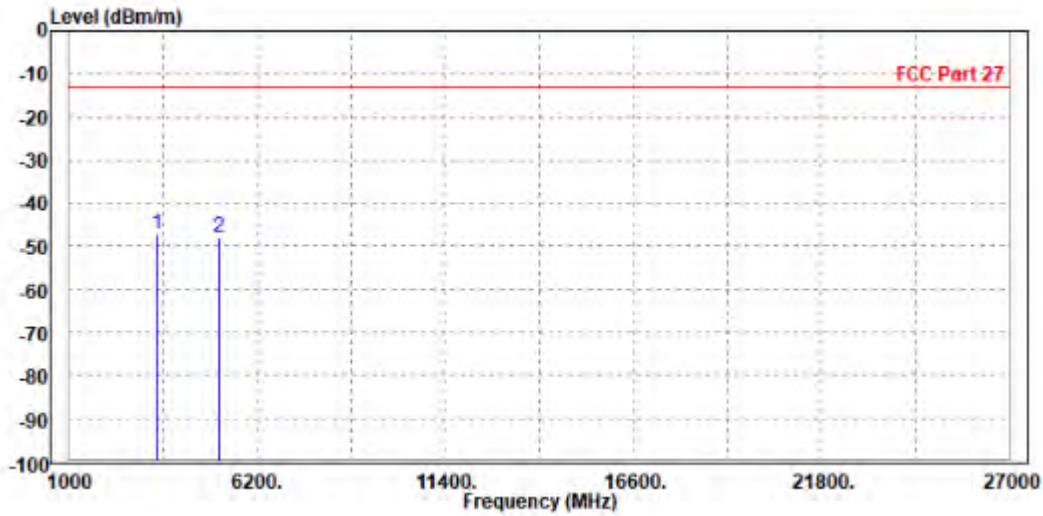



Test Report No.: W7L-P21120037RF05

MODE	TX channel 1312	FREQUENCY RANGE	Above 1000MHz
ENVIRONMENTAL CONDITIONS	23deg. C, 70%RH	INPUT POWER	AC 120V/60HZ
TESTED BY	Jace Hu		
ANTENNA POLARITY & TEST DISTANCE: VERTICAL AT 3 M			

	Freq	Level	Read Level	Limit Line	Over Limit	Factor	Remark	Pol/Phase
	MHz	dBm/m	dBm	dBm/m	dB	dB/m		
1	PP 3418.000	-47.37	-56.48	-13.00	-34.37	9.11	Peak	Vertical
2	5137.200	-47.81	-57.66	-13.00	-34.81	9.85	Peak	Vertical

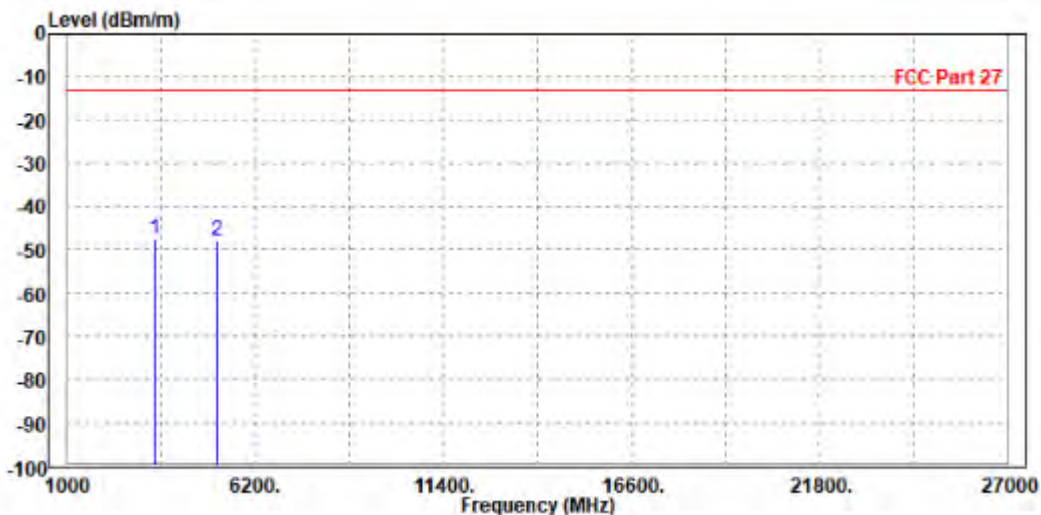



Test Report No.: W7L-P21120037RF05

CH 1413

MODE	TX channel 1413	FREQUENCY RANGE	Above 1000MHz
ENVIRONMENTAL CONDITIONS	23deg. C, 70%RH	INPUT POWER	AC 120V/60HZ
TESTED BY	Jace Hu		
ANTENNA POLARITY & TEST DISTANCE: HORIZONTAL AT 3 M			

	Freq	Level	Read Level	Limit Line	Over Limit	Factor	Remark	Pol/Phase
	MHz	dBm/m	dBm	dBm/m	dB	dB/m		
1	3470.000	-48.35	-56.93	-13.00	-35.35	8.58	Peak	Horizontal
2 PP	5197.800	-31.57	-40.69	-13.00	-18.57	9.12	Peak	Horizontal

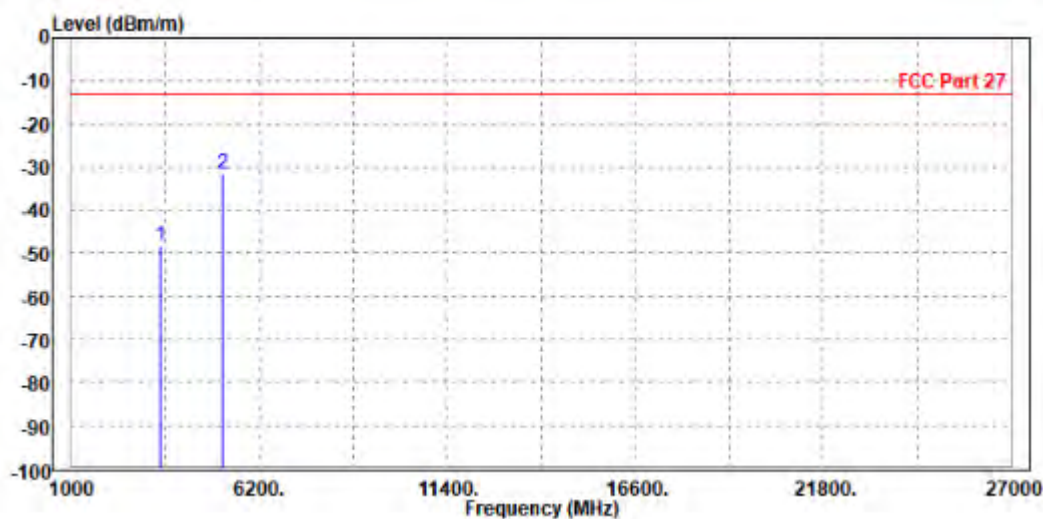



Test Report No.: W7L-P21120037RF05

MODE	TX channel 1413	FREQUENCY RANGE	Above 1000MHz
ENVIRONMENTAL CONDITIONS	23deg. C, 70%RH	INPUT POWER	AC 120V/60HZ
TESTED BY	Jace Hu		
ANTENNA POLARITY & TEST DISTANCE: VERTICAL AT 3 M			

	Freq	Level	Read Level	Limit Line	Over Limit	Factor	Remark	Pol/Phase
	MHz	dBm/m	dBm	dBm/m	dB	dB/m		
1	3470.000	-46.24	-55.40	-13.00	-33.24	9.16	Peak	Vertical
2 PP	5197.800	-28.89	-38.71	-13.00	-15.89	9.82	Peak	Vertical

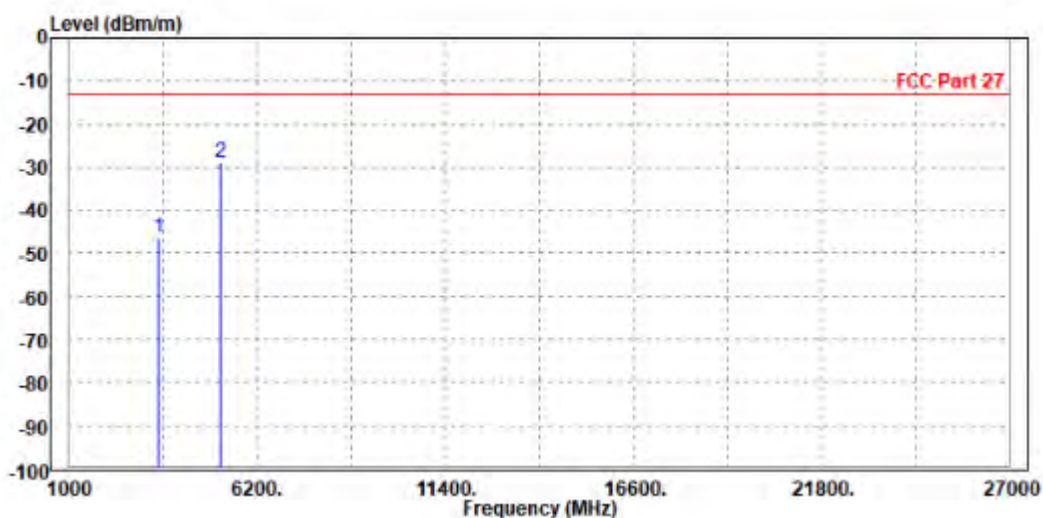



Test Report No.: W7L-P21120037RF05

CH 1513

MODE	TX channel 1513	FREQUENCY RANGE	Above 1000MHz
ENVIRONMENTAL CONDITIONS	23deg. C, 70%RH	INPUT POWER	AC 120V/60HZ
TESTED BY	Jace Hu		
ANTENNA POLARITY & TEST DISTANCE: HORIZONTAL AT 3 M			

	Freq	Level	Read Level	Limit Line	Over Limit	Factor	Remark	Pol/Phase
	MHz	dBm/m	dBm	dBm/m	dB	dB/m		
1	PP 3496.000	-42.33	-50.90	-13.00	-29.33	8.57	Peak	Horizontal
2	5257.800	-47.57	-56.87	-13.00	-34.57	9.30	Peak	Horizontal

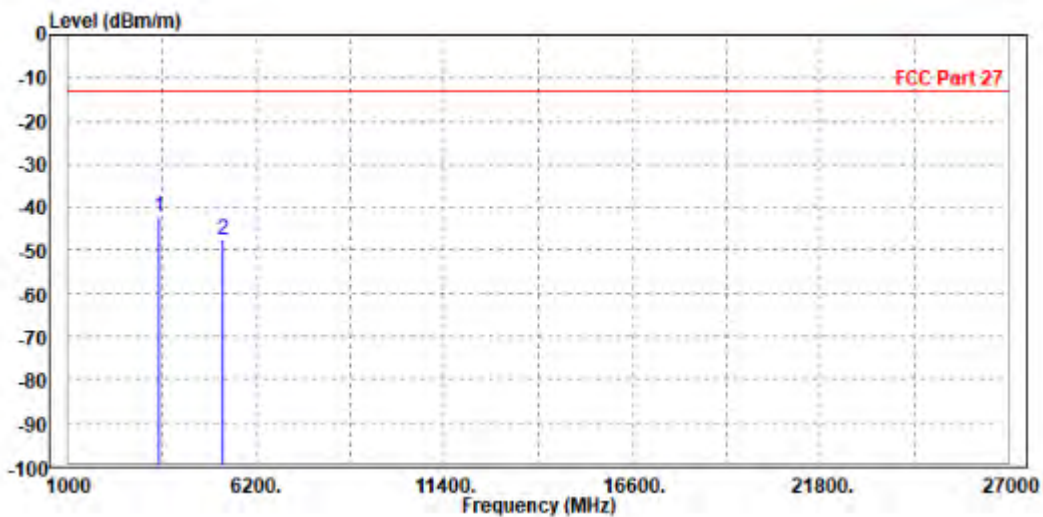



**BUREAU
VERITAS**

Test Report No.: W7L-P21120037RF05

MODE	TX channel 1513	FREQUENCY RANGE	Above 1000MHz
ENVIRONMENTAL CONDITIONS	23deg. C, 70%RH	INPUT POWER	AC 120V/60HZ
TESTED BY	Jace Hu		
ANTENNA POLARITY & TEST DISTANCE: VERTICAL AT 3 M			

		Freq	Level	Read Level	Limit Line	Over Limit	Factor	Remark	Pol/Phase
		MHz	dBm/m	dBm	dBm/m	dB	dB/m		
1	PP	3496.000	-41.42	-50.61	-13.00	-28.42	9.19	Peak	Vertical
2		5257.800	-47.19	-56.99	-13.00	-34.19	9.80	Peak	Vertical

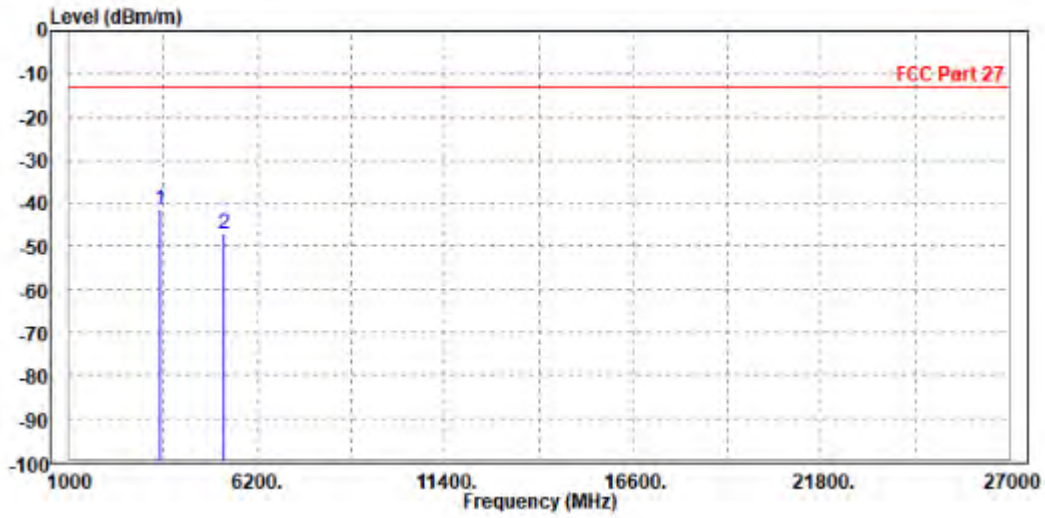



BUREAU
VERITAS

Test Report No.: W7L-P21120037RF05

LTE Band 4
CHANNEL BANDWIDTH: 1.4MHz / QPSK
CH 20175

MODE	TX channel 20175	FREQUENCY RANGE	Above 1000MHz
ENVIRONMENTAL CONDITIONS	23deg. C, 70%RH	INPUT POWER	AC 120V/60HZ
TESTED BY	Jace Hu		
ANTENNA POLARITY & TEST DISTANCE: HORIZONTAL AT 3 M			

	Freq	Level	Read Level	Limit Line	Over Limit	Factor	Remark	Pol/Phase
	MHz	dBm/m	dBm	dBm/m	dB	dB/m		
1	3470.000	-45.60	-54.18	-13.00	-32.60	8.58	Peak	Horizontal
2 PP	5197.500	-32.95	-42.07	-13.00	-19.95	9.12	Peak	Horizontal

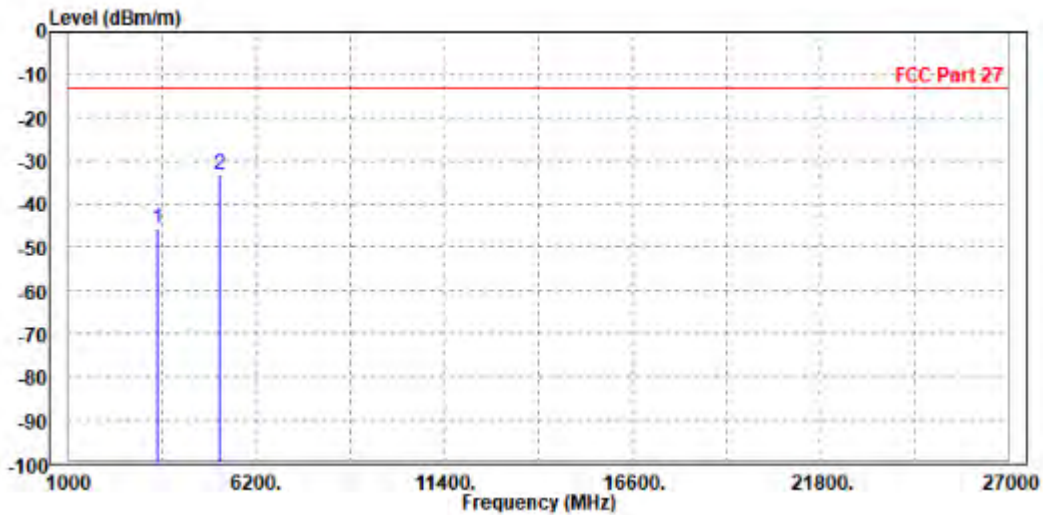



Test Report No.: W7L-P21120037RF05

MODE	TX channel 20175	FREQUENCY RANGE	Above 1000MHz
ENVIRONMENTAL CONDITIONS	23deg. C, 70%RH	INPUT POWER	AC 120V/60HZ
TESTED BY	Jace Hu		
ANTENNA POLARITY & TEST DISTANCE: VERTICAL AT 3 M			

	Freq	Level	Read Level	Limit Line	Over Limit	Factor	Remark	Pol/Phase
	MHz	dBm/m	dBm	dBm/m	dB	dB/m		
1	3465.000	-47.44	-56.60	-13.00	-34.44	9.16	Peak	Vertical
2 PP	5186.000	-31.97	-41.80	-13.00	-18.97	9.83	Peak	Vertical

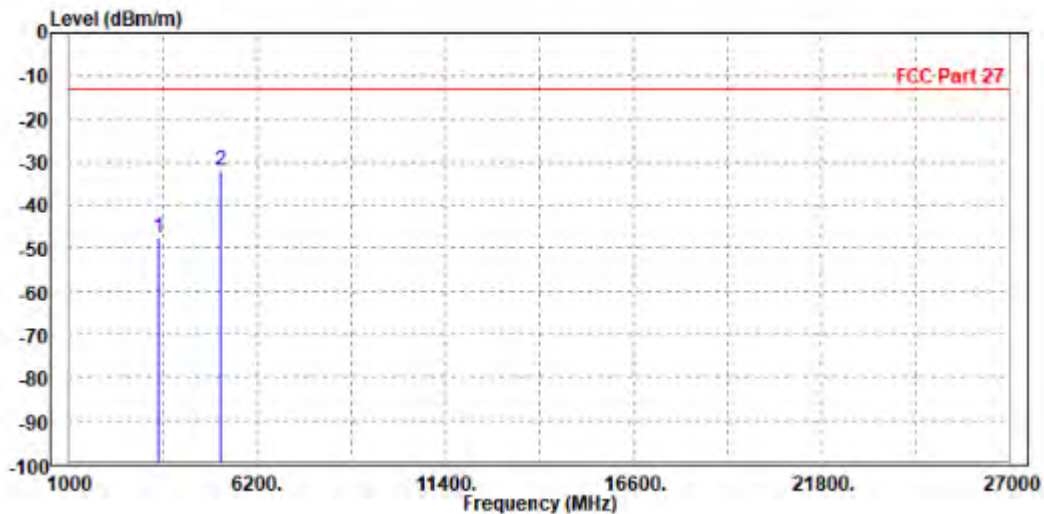



BUREAU VERITAS

Test Report No.: W7L-P21120037RF05

CHANNEL BANDWIDTH: 3MHz / QPSK

CH 20175

MODE	TX channel 20175	FREQUENCY RANGE	Above 1000MHz
ENVIRONMENTAL CONDITIONS	23deg. C, 70%RH	INPUT POWER	AC 120V/60HZ
TESTED BY	Jace Hu		
ANTENNA POLARITY & TEST DISTANCE: HORIZONTAL AT 3 M			

	Freq	Level	Read Level	Limit Line	Over Limit	Factor	Remark	Pol/Phase
	MHz	dBm/m	dBm	dBm/m	dB	dB/m		
1	3465.000	-47.36	-55.94	-13.00	-34.36	8.58	Peak	Horizontal
2 PP	5186.000	-32.40	-41.48	-13.00	-19.40	9.08	Peak	Horizontal

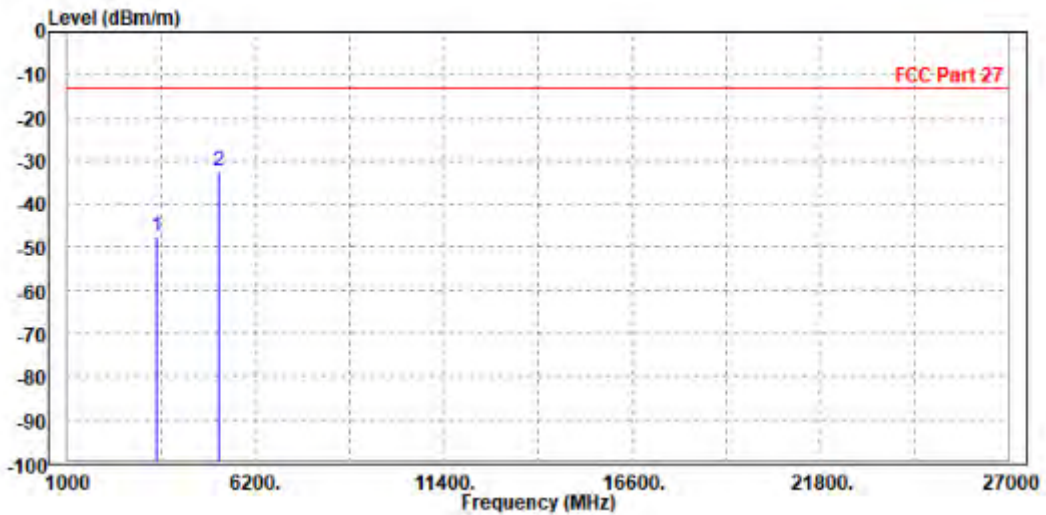



Test Report No.: W7L-P21120037RF05

MODE	TX channel 20175	FREQUENCY RANGE	Above 1000MHz
ENVIRONMENTAL CONDITIONS	23deg. C, 70%RH	INPUT POWER	AC 120V/60HZ
TESTED BY	Jace Hu		
ANTENNA POLARITY & TEST DISTANCE: VERTICAL AT 3 M			

	Freq	Level	Read Level	Limit Line	Over Limit	Factor	Remark	Pol/Phase
	MHz	dBm/m	dBm	dBm/m	dB	dB/m		
1	3470.000	-47.65	-56.81	-13.00	-34.65	9.16	Peak	Vertical
2 PP	5197.500	-47.00	-56.82	-13.00	-34.00	9.82	Peak	Vertical

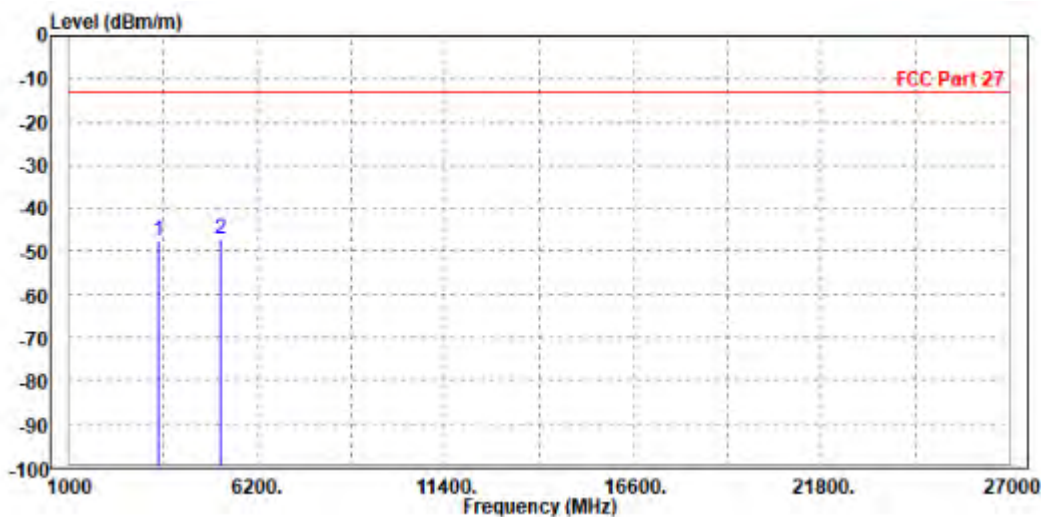



**BUREAU
VERITAS**

Test Report No.: W7L-P21120037RF05

CHANNEL BANDWIDTH: 5MHz / QPSK

CH 20175

MODE	TX channel 20175	FREQUENCY RANGE	Above 1000MHz
ENVIRONMENTAL CONDITIONS	23deg. C, 70%RH	INPUT POWER	AC 120V/60HZ
TESTED BY	Jace Hu		
ANTENNA POLARITY & TEST DISTANCE: HORIZONTAL AT 3 M			

	Freq	Level	Read Level	Limit Line	Over Limit	Factor	Remark	Pol/Phase
	MHz	dBm/m	dBm	dBm/m	dB	dB/m		
1	3470.000	-47.25	-55.83	-13.00	-34.25	8.58	Peak	Horizontal
2	PP 5197.500	-30.98	-40.10	-13.00	-17.98	9.12	Peak	Horizontal

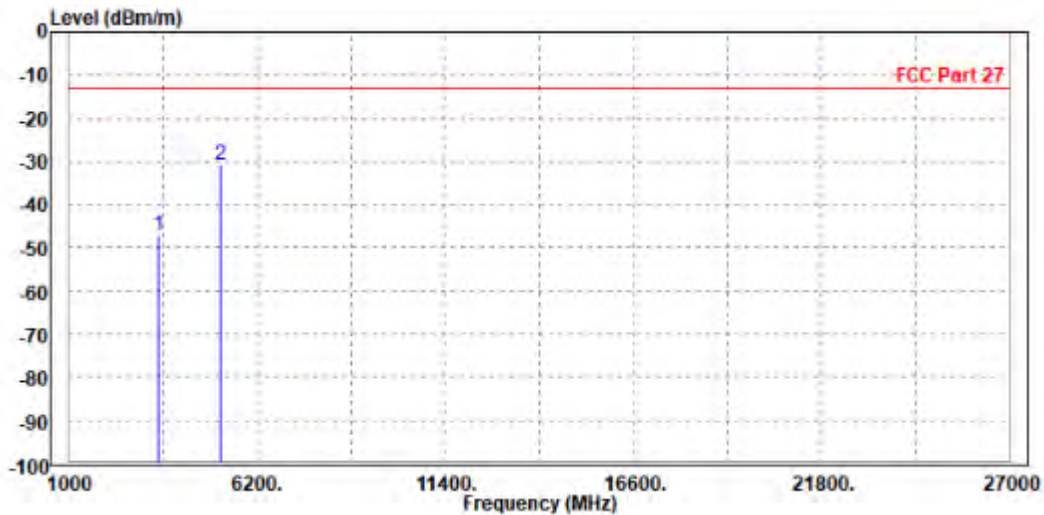



Test Report No.: W7L-P21120037RF05

MODE	TX channel 20175	FREQUENCY RANGE	Above 1000MHz
ENVIRONMENTAL CONDITIONS	23deg. C, 70%RH	INPUT POWER	AC 120V/60HZ
TESTED BY	Jace Hu		
ANTENNA POLARITY & TEST DISTANCE: VERTICAL AT 3 M			

	Freq	Level	Read Level	Limit Line	Over Limit	Factor	Remark	Pol/Phase
	MHz	dBm/m	dBm	dBm/m	dB	dB/m		
1	3465.000	-47.84	-57.00	-13.00	-34.84	9.16	Peak	Vertical
2 PP	5186.000	-33.93	-43.76	-13.00	-20.93	9.83	Peak	Vertical

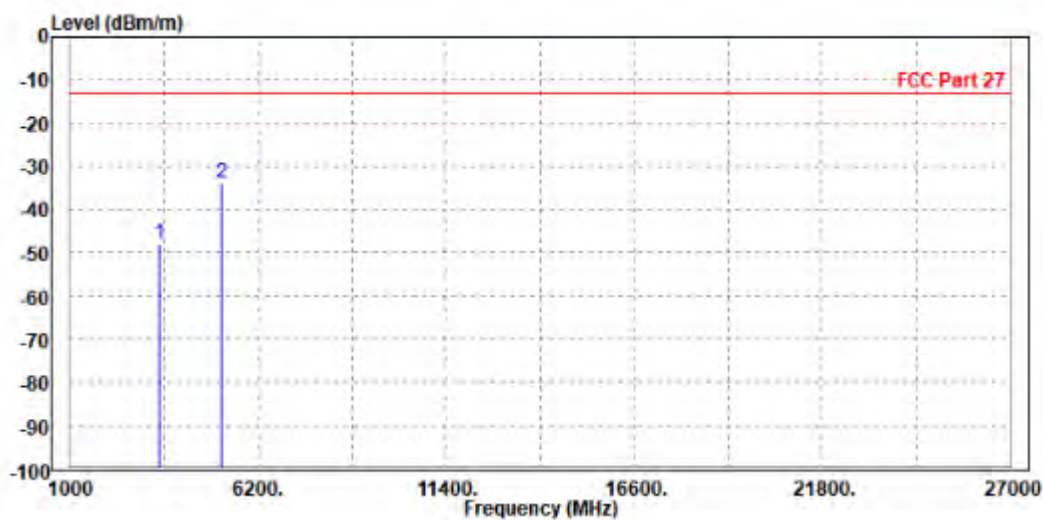



**BUREAU
VERITAS**

Test Report No.: W7L-P21120037RF05

CHANNEL BANDWIDTH: 10MHz / QPSK

MODE	TX channel 20175	FREQUENCY RANGE	Above 1000MHz
ENVIRONMENTAL CONDITIONS	23deg. C, 70%RH	INPUT POWER	AC 120V/60HZ
TESTED BY	Jace Hu		
ANTENNA POLARITY & TEST DISTANCE: HORIZONTAL AT 3 M			

	Freq	Level	Read Level	Limit Line	Over Limit	Factor	Remark	Pol/Phase
	MHz	dBm/m	dBm	dBm/m	dB	dB/m		
1	3465.000	-46.52	-55.10	-13.00	-33.52	8.58	Peak	Horizontal
2 PP	5186.000	-37.78	-46.86	-13.00	-24.78	9.08	Peak	Horizontal

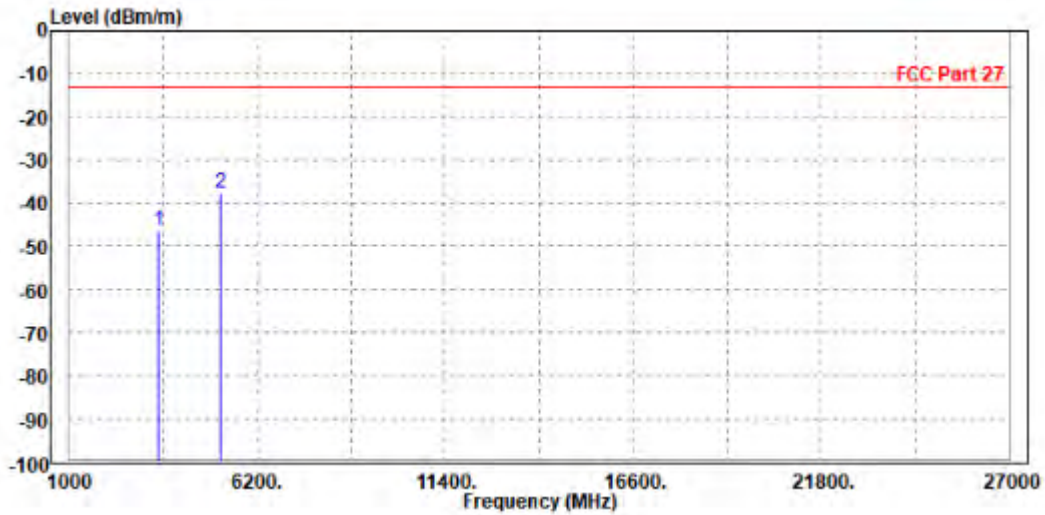



Test Report No.: W7L-P21120037RF05

MODE	TX channel 20175	FREQUENCY RANGE	Above 1000MHz
ENVIRONMENTAL CONDITIONS	23deg. C, 70%RH	INPUT POWER	AC 120V/60HZ
TESTED BY	Jace Hu		
ANTENNA POLARITY & TEST DISTANCE: VERTICAL AT 3 M			

	Freq	Level	Read Level	Limit Line	Over Limit	Factor	Remark	Pol/Phase
	MHz	dBm/m	dBm	dBm/m	dB	dB/m		
1	3470.000	-46.16	-55.32	-13.00	-33.16	9.16	Peak	Vertical
2 PP	5197.500	-30.73	-40.55	-13.00	-17.73	9.82	Peak	Vertical

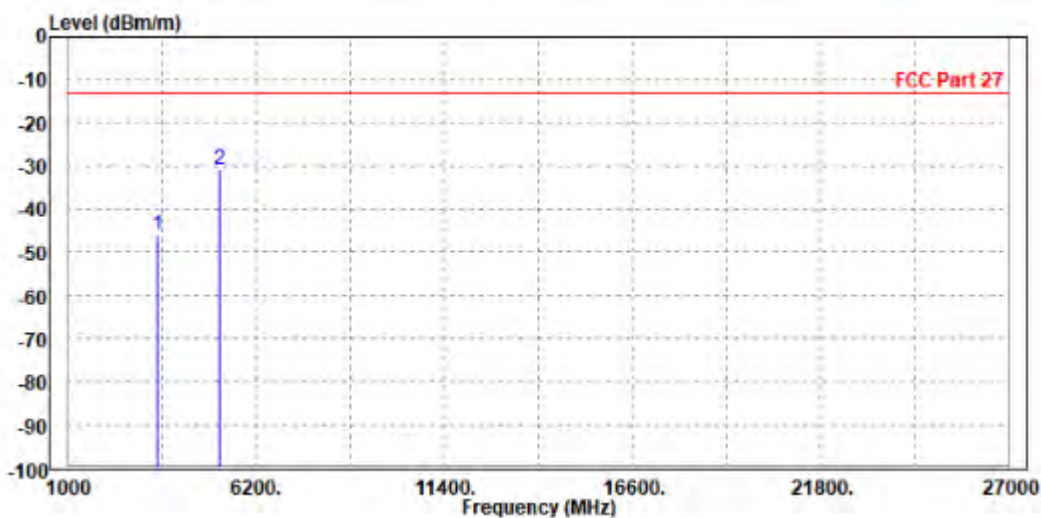



**BUREAU
VERITAS**

Test Report No.: W7L-P21120037RF05

CHANNEL BANDWIDTH: 15MHz / QPSK

MODE	TX channel 20175	FREQUENCY RANGE	Above 1000MHz
ENVIRONMENTAL CONDITIONS	23deg. C, 70%RH	INPUT POWER	AC 120V/60HZ
TESTED BY	Jace Hu		
ANTENNA POLARITY & TEST DISTANCE: HORIZONTAL AT 3 M			

	Freq	Level	Read Level	Limit Line	Over Limit	Factor	Remark	Pol/Phase
	MHz	dBm/m	dBm	dBm/m	dB	dB/m		
1	3465.000	-47.52	-56.10	-13.00	-34.52	8.58	Peak	Horizontal
2 PP	5186.000	-32.68	-41.76	-13.00	-19.68	9.08	Peak	Horizontal

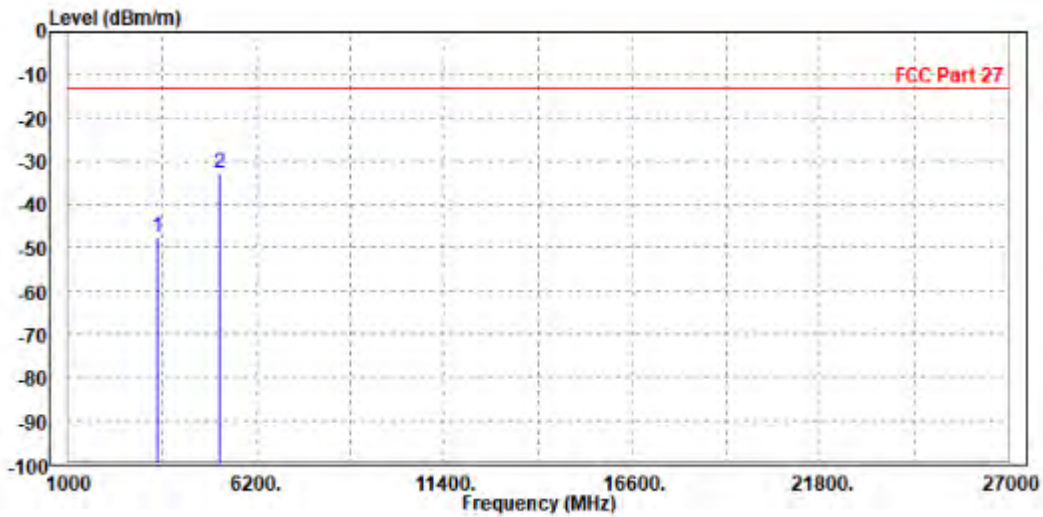



Test Report No.: W7L-P21120037RF05

MODE	TX channel 20175	FREQUENCY RANGE	Above 1000MHz
ENVIRONMENTAL CONDITIONS	23deg. C, 70%RH	INPUT POWER	AC 120V/60HZ
TESTED BY	Jace Hu		
ANTENNA POLARITY & TEST DISTANCE: VERTICAL AT 3 M			

	Freq	Level	Read Level	Limit Line	Over Limit	Factor	Remark	Pol/Phase
	MHz	dBm/m	dBm	dBm/m	dB	dB/m		
1	3470.000	-47.87	-57.03	-13.00	-34.87	9.16	Peak	Vertical
2 PP	5197.500	-32.21	-42.03	-13.00	-19.21	9.82	Peak	Vertical

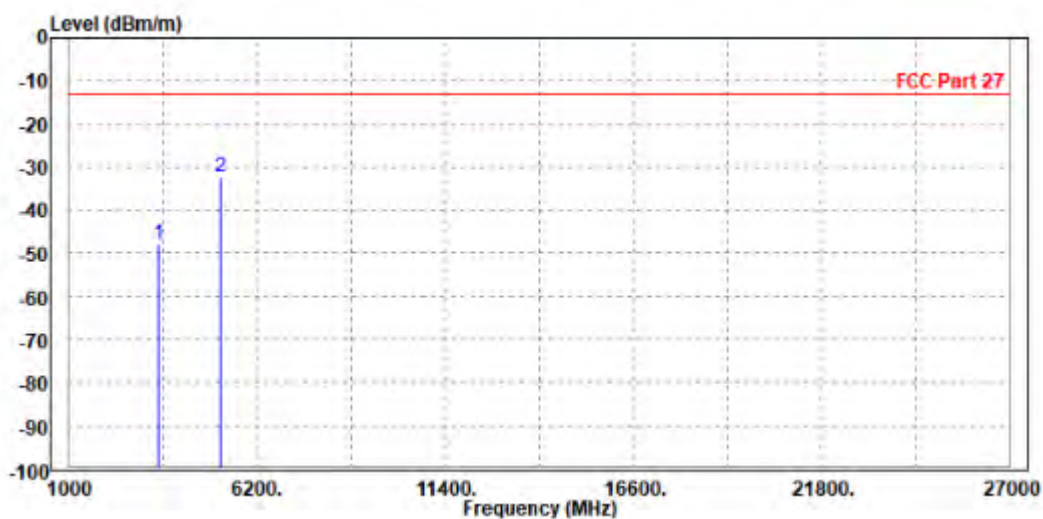



**BUREAU
VERITAS**

Test Report No.: W7L-P21120037RF05

CHANNEL BANDWIDTH: 20MHz / QPSK

CH 20050

MODE	TX channel 20050	FREQUENCY RANGE	Above 1000MHz
ENVIRONMENTAL CONDITIONS	23deg. C, 70%RH	INPUT POWER	AC 120V/60HZ
TESTED BY	Jace Hu		
ANTENNA POLARITY & TEST DISTANCE: HORIZONTAL AT 3 M			

	Freq	Level	Read Level	Limit Line	Over Limit	Factor	Remark	Pol/Phase
	MHz	dBm/m	dBm	dBm/m	dB	dB/m		
1	3440.000	-48.19	-56.77	-13.00	-35.19	8.58	Peak	Horizontal
2 PP	5160.000	-34.77	-43.77	-13.00	-21.77	9.00	Peak	Horizontal

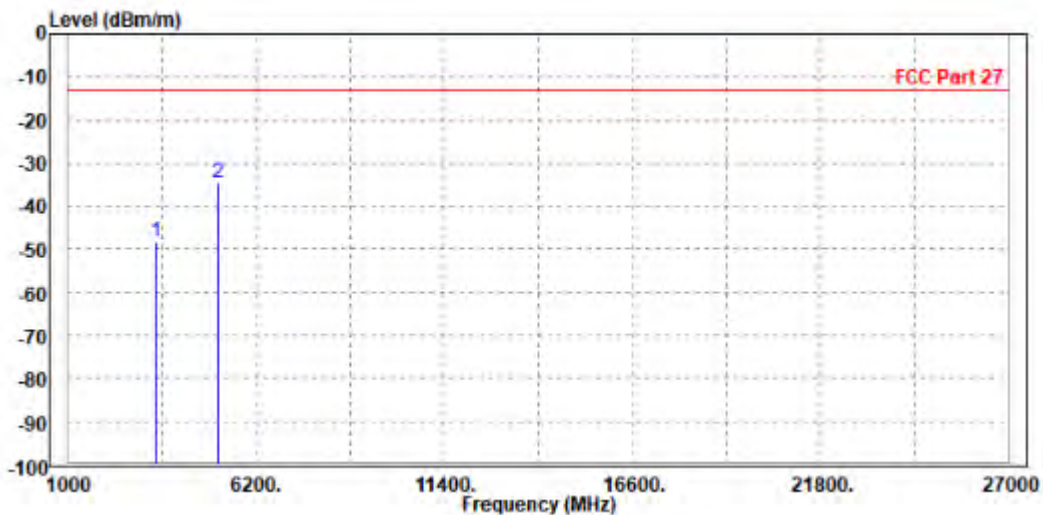



Test Report No.: W7L-P21120037RF05

MODE	TX channel 20050	FREQUENCY RANGE	Above 1000MHz
ENVIRONMENTAL CONDITIONS	23deg. C, 70%RH	INPUT POWER	AC 120V/60HZ
TESTED BY	Jace Hu		
ANTENNA POLARITY & TEST DISTANCE: VERTICAL AT 3 M			

	Freq	Level	Read Level	Limit Line	Over Limit	Factor	Remark	Pol/Phase
	MHz	dBm/m	dBm	dBm/m	dB	dB/m		
1 PP	3444.000	-47.78	-56.92	-13.00	-34.78	9.14	Peak	Vertical
2	5160.000	-49.11	-58.95	-13.00	-36.11	9.84	Peak	Vertical

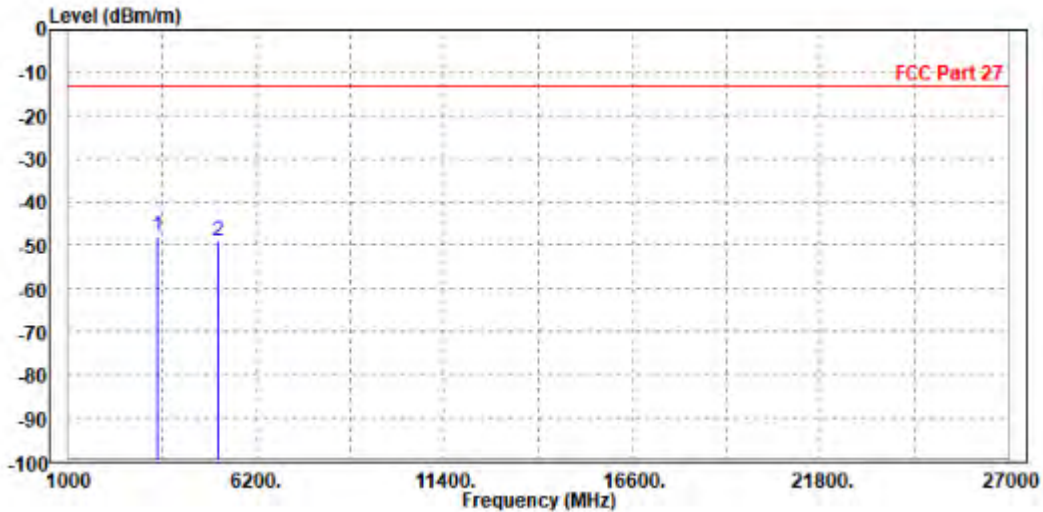



BUREAU VERITAS

Test Report No.: W7L-P21120037RF05

CH 20175

MODE	TX channel 20175	FREQUENCY RANGE	Above 1000MHz
ENVIRONMENTAL CONDITIONS	23deg. C, 70%RH	INPUT POWER	AC 120V/60HZ
TESTED BY	Jace Hu		
ANTENNA POLARITY & TEST DISTANCE: HORIZONTAL AT 3 M			

	Freq	Level	Read Level	Limit Line	Over Limit	Factor	Remark	Pol/Phase
	MHz	dBm/m	dBm	dBm/m	dB	dB/m		
1	3470.000	-47.30	-55.88	-13.00	-34.30	8.58	Peak	Horizontal
2	PP 5197.500	-33.79	-42.91	-13.00	-20.79	9.12	Peak	Horizontal

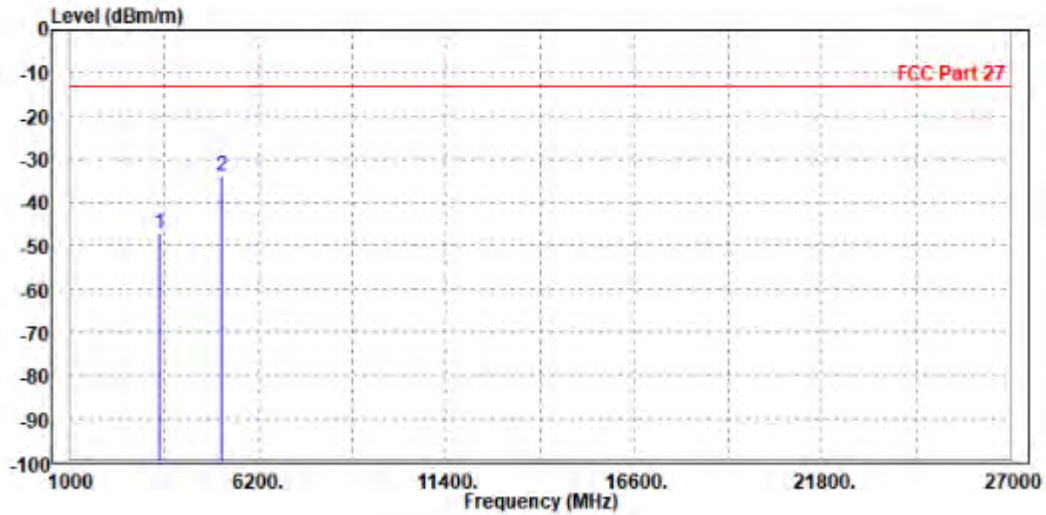



Test Report No.: W7L-P21120037RF05

MODE	TX channel 20175	FREQUENCY RANGE	Above 1000MHz
ENVIRONMENTAL CONDITIONS	23deg. C, 70%RH	INPUT POWER	AC 120V/60HZ
TESTED BY	Jace Hu		
ANTENNA POLARITY & TEST DISTANCE: VERTICAL AT 3 M			

	Freq	Level	Read Level	Limit Line	Over Limit	Factor	Remark	Pol/Phase
	MHz	dBm/m	dBm	dBm/m	dB	dB/m		
1	3470.000	-46.18	-55.34	-13.00	-33.18	9.16	Peak	Vertical
2 PP	5197.500	-29.23	-39.05	-13.00	-16.23	9.82	Peak	Vertical

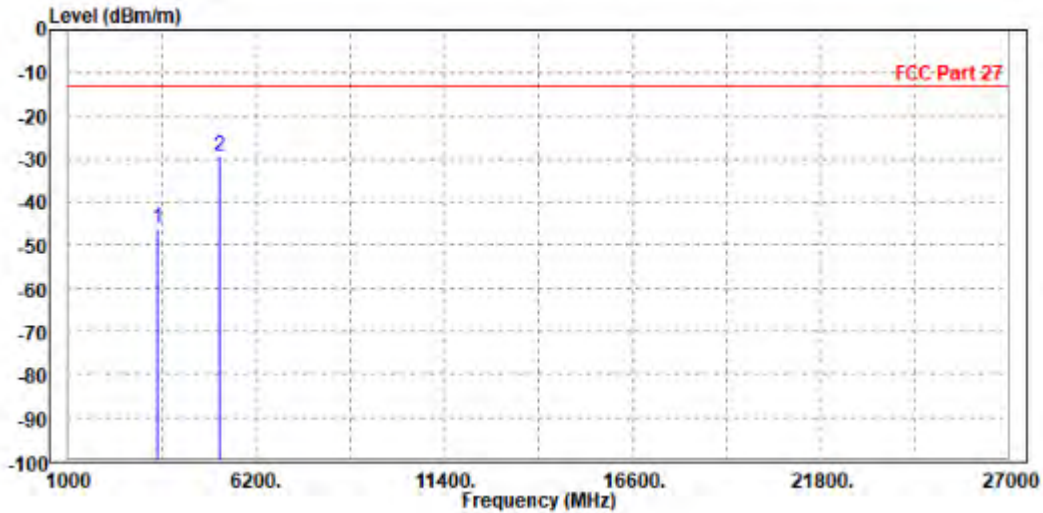



**BUREAU
VERITAS**

Test Report No.: W7L-P21120037RF05

CH 20300

MODE	TX channel 20300	FREQUENCY RANGE	Above 1000MHz
ENVIRONMENTAL CONDITIONS	23deg. C, 70%RH	INPUT POWER	AC 120V/60HZ
TESTED BY	Jace Hu		
ANTENNA POLARITY & TEST DISTANCE: HORIZONTAL AT 3 M			

	Freq	Level	Read Level	Limit Line	Over Limit	Factor	Remark	Pol/Phase
	MHz	dBm/m	dBm	dBm/m	dB	dB/m		
1	PP 3490.000	-42.34	-50.91	-13.00	-29.34	8.57	Peak	Horizontal
2	5238.000	-50.40	-59.64	-13.00	-37.40	9.24	Peak	Horizontal

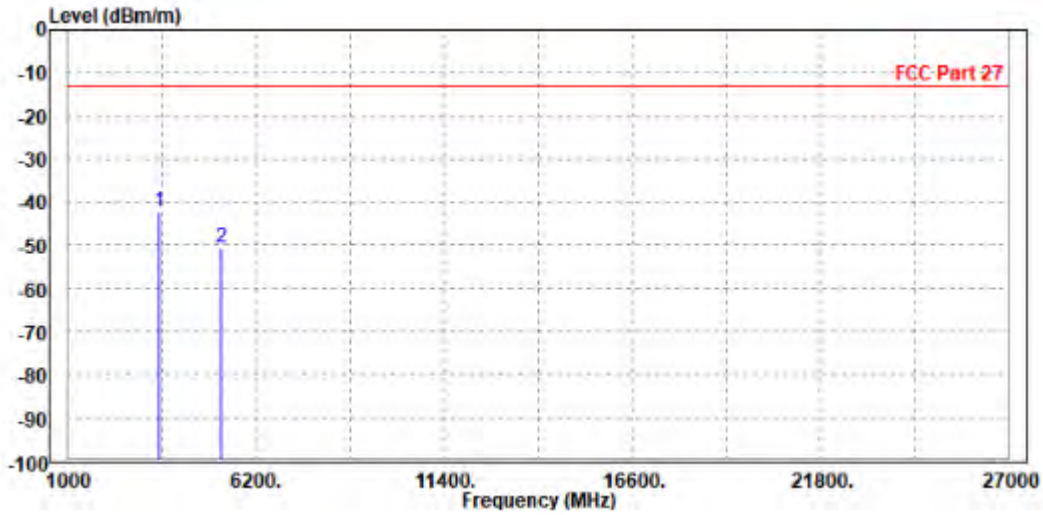



Test Report No.: W7L-P21120037RF05

MODE	TX channel 20300	FREQUENCY RANGE	Above 1000MHz
ENVIRONMENTAL CONDITIONS	23deg. C, 70%RH	INPUT POWER	AC 120V/60HZ
TESTED BY	Jace Hu		
ANTENNA POLARITY & TEST DISTANCE: VERTICAL AT 3 M			

		Read	Limit	Over			
	Freq	Level	Level	Line	Limit	Factor	Remark
	MHz	dBm/m	dBm	dBm/m	dB	dB/m	
1	PP 3496.000	-42.18	-51.37	-13.00	-29.18	9.19	Peak Vertical
2	5235.000	-48.90	-58.71	-13.00	-35.90	9.81	Peak Vertical

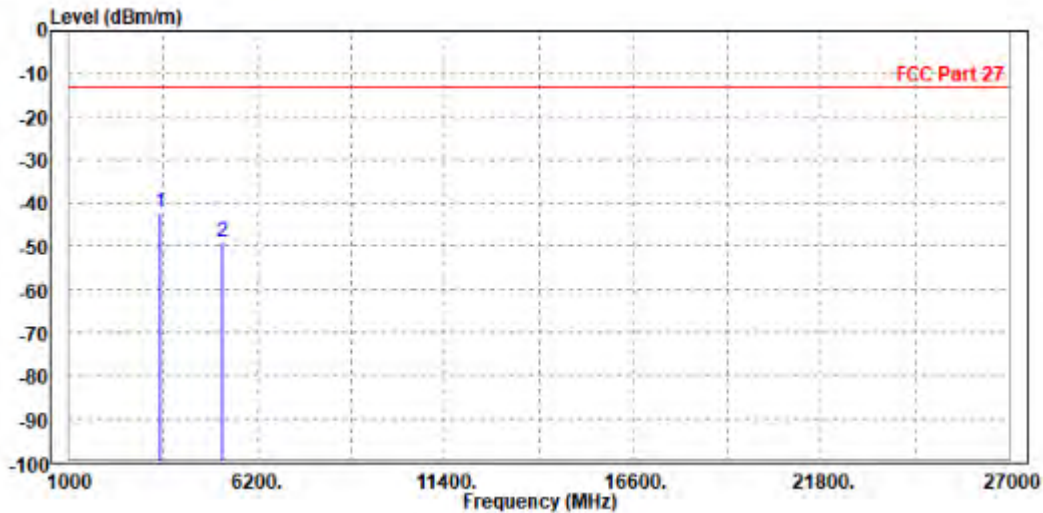



Test Report No.: W7L-P21120037RF05

LTE Band 7
 CHANNEL BANDWIDTH: 5MHz / QPSK
 CH 20775

MODE	TX channel 20775	FREQUENCY RANGE	Above 1000MHz
ENVIRONMENTAL CONDITIONS	23deg. C, 70%RH	INPUT POWER	AC 120V/60HZ
TESTED BY	Jace Hu		
ANTENNA POLARITY & TEST DISTANCE: HORIZONTAL AT 3 M			

	Freq	Level	Read Level	Limit Line	Over Limit	Factor	Remark	Pol/Phase
	MHz	dBm/m	dBm	dBm/m	dB	dB/m		
1	5004.000	-49.48	-58.02	-25.00	-24.48	8.54	Peak	Horizontal
2 PP	7507.500	-44.74	-56.10	-25.00	-19.74	11.36	Peak	Horizontal

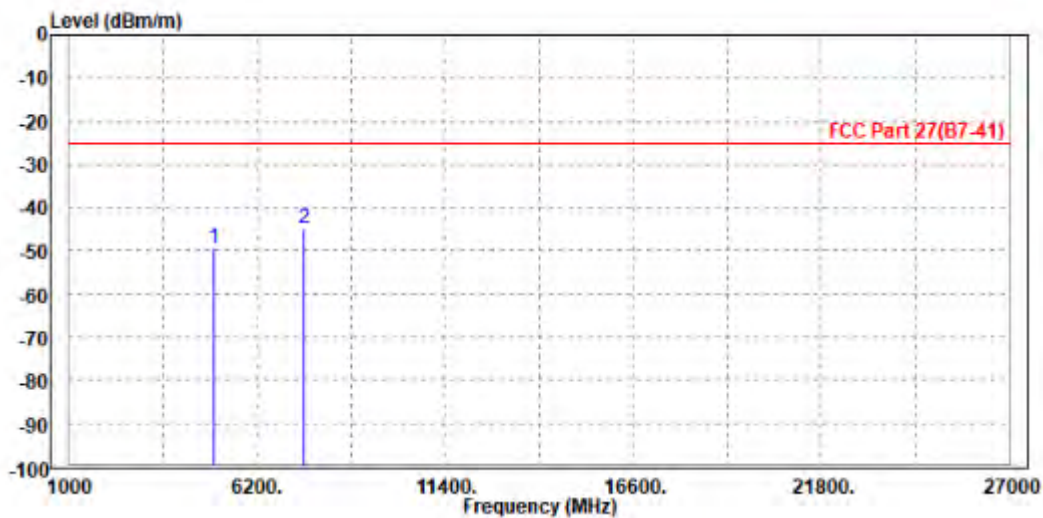



Test Report No.: W7L-P21120037RF05

MODE	TX channel 20775	FREQUENCY RANGE	Above 1000MHz
ENVIRONMENTAL CONDITIONS	23deg. C, 70%RH	INPUT POWER	AC 120V/60HZ
TESTED BY	Jace Hu		
ANTENNA POLARITY & TEST DISTANCE: VERTICAL AT 3 M			

	Freq	Level	Read Level	Limit Line	Over Limit	Factor	Remark	Pol/Phase
	MHz	dBm/m	dBm	dBm/m	dB	dB/m		
1	5004.000	-47.72	-57.62	-25.00	-22.72	9.90	Peak	Vertical
2	PP 7507.500	-45.37	-58.11	-25.00	-20.37	12.74	Peak	Vertical

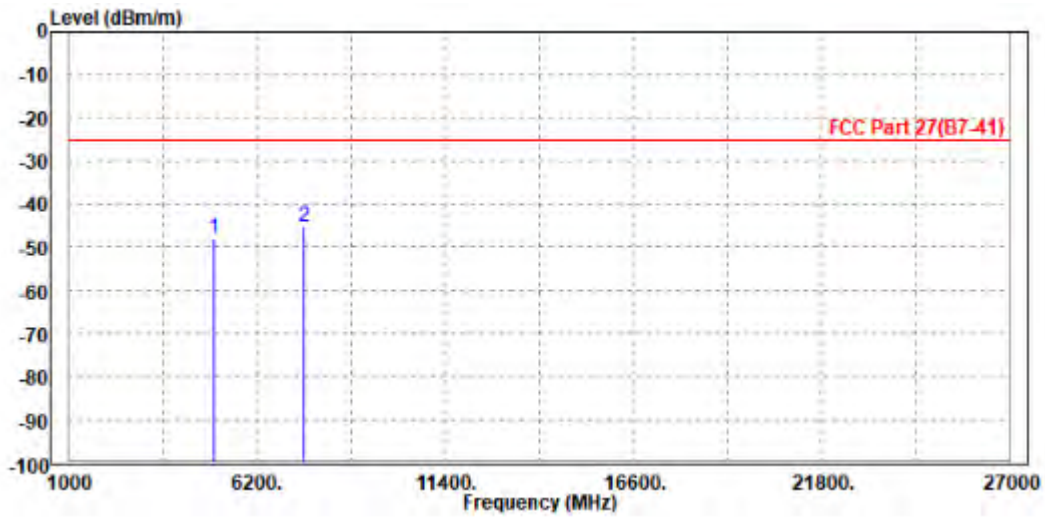



BUREAU VERITAS

Test Report No.: W7L-P21120037RF05

CH 21100

MODE	TX channel 21100	FREQUENCY RANGE	Above 1000MHz
ENVIRONMENTAL CONDITIONS	23deg. C, 70%RH	INPUT POWER	AC 120V/60HZ
TESTED BY	Jace Hu		
ANTENNA POLARITY & TEST DISTANCE: HORIZONTAL AT 3 M			

	Freq	Level	Read Level	Limit Line	Over Limit	Factor	Remark	Pol/Phase
	MHz	dBm/m	dBm	dBm/m	dB	dB/m		
1	5082.000	-47.95	-56.72	-25.00	-22.95	8.77	Peak	Horizontal
2 PP	7605.000	-43.28	-54.68	-25.00	-18.28	11.40	Peak	Horizontal

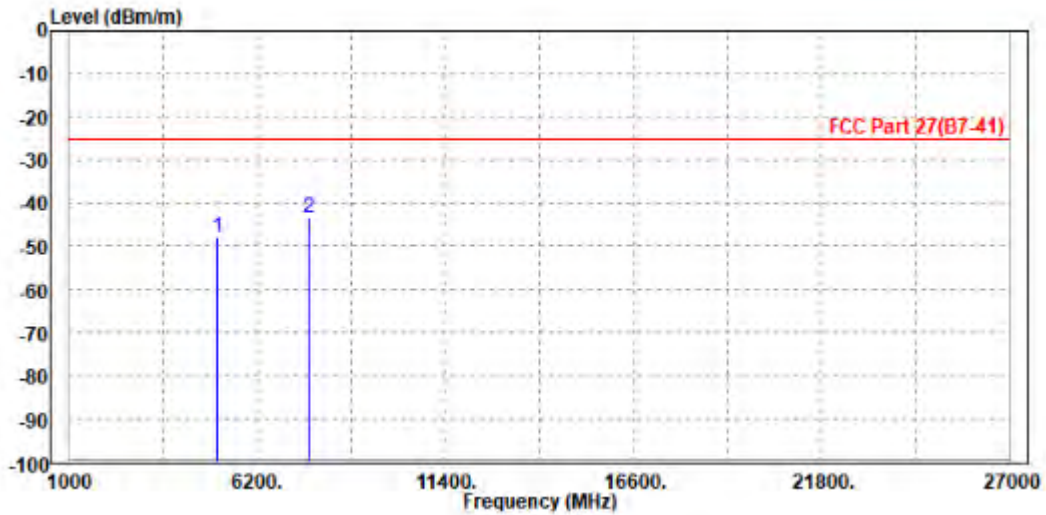



Test Report No.: W7L-P21120037RF05

MODE	TX channel 21100	FREQUENCY RANGE	Above 1000MHz
ENVIRONMENTAL CONDITIONS	23deg. C, 70%RH	INPUT POWER	AC 120V/60HZ
TESTED BY	Jace Hu		
ANTENNA POLARITY & TEST DISTANCE: VERTICAL AT 3 M			

	Freq	Level	Read Level	Limit Line	Over Limit	Factor	Remark	Pol/Phase
	MHz	dBm/m	dBm	dBm/m	dB	dB/m		
1	5082.000	-47.73	-57.60	-25.00	-22.73	9.87	Peak	Vertical
2	PP 7605.000	-43.34	-56.12	-25.00	-18.34	12.78	Peak	Vertical

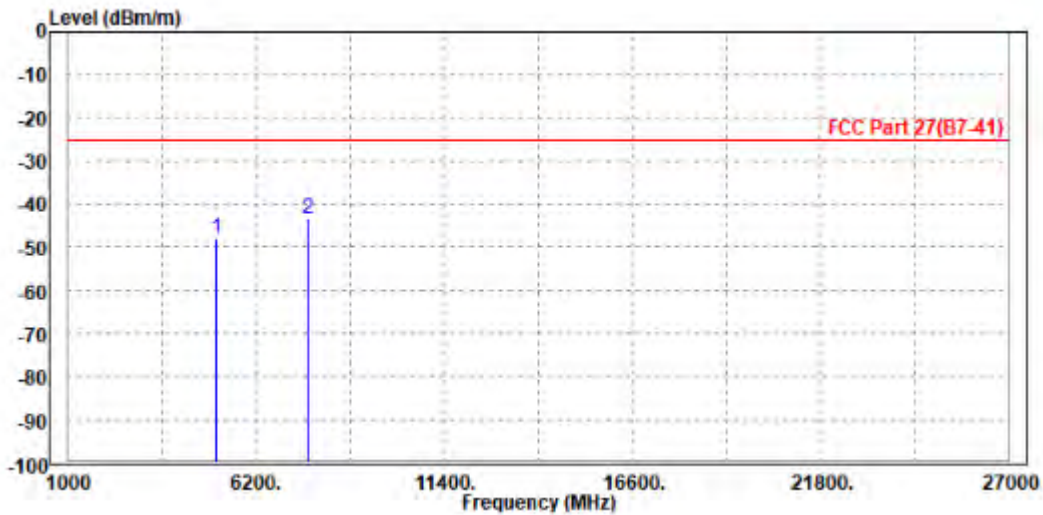



**BUREAU
VERITAS**

Test Report No.: W7L-P21120037RF05

CH 21425

MODE	TX channel 21425	FREQUENCY RANGE	Above 1000MHz
ENVIRONMENTAL CONDITIONS	23deg. C, 70%RH	INPUT POWER	AC 120V/60HZ
TESTED BY	Jace Hu		
ANTENNA POLARITY & TEST DISTANCE: HORIZONTAL AT 3 M			

	Freq	Level	Read Level	Limit Line	Over Limit	Factor	Remark	Pol/Phase
	MHz	dBm/m	dBm	dBm/m	dB	dB/m		
1	5134.000	-48.28	-57.21	-25.00	-23.28	8.93	Peak	Horizontal
2 PP	7702.500	-47.65	-59.09	-25.00	-22.65	11.44	Peak	Horizontal

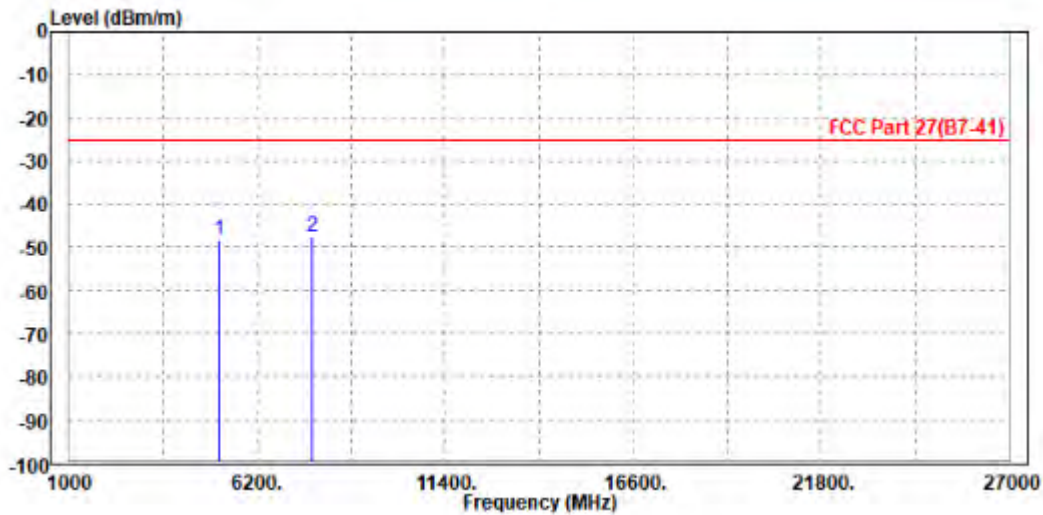



Test Report No.: W7L-P21120037RF05

MODE	TX channel 21425	FREQUENCY RANGE	Above 1000MHz
ENVIRONMENTAL CONDITIONS	23deg. C, 70%RH	INPUT POWER	AC 120V/60HZ
TESTED BY	Jace Hu		
ANTENNA POLARITY & TEST DISTANCE: VERTICAL AT 3 M			

	Freq	Level	Read Level	Limit Line	Over Limit	Factor	Remark	Pol/Phase
	MHz	dBm/m	dBm	dBm/m	dB	dB/m		
1	5134.000	-47.28	-57.13	-25.00	-22.28	9.85	Peak	Vertical
2 PP	7702.500	-47.27	-60.09	-25.00	-22.27	12.82	Peak	Vertical

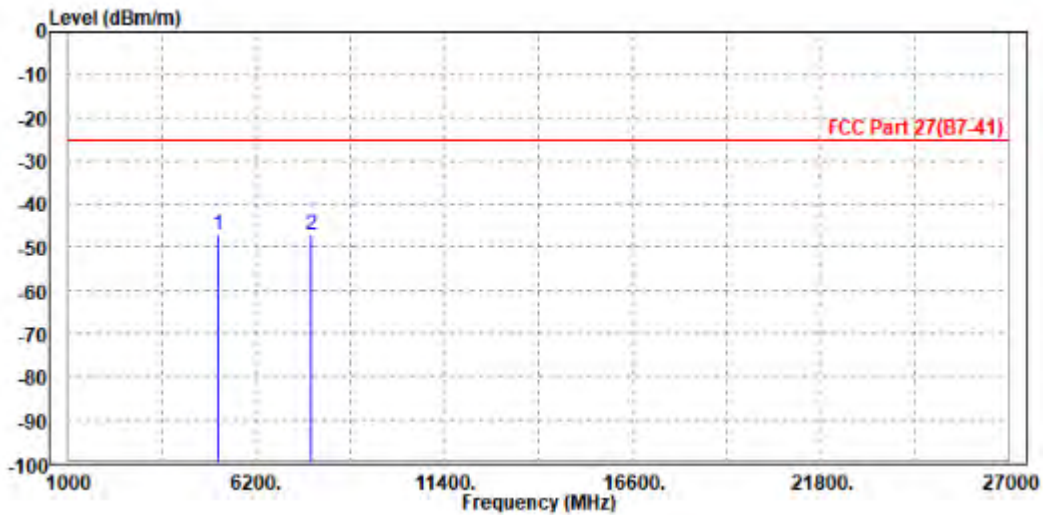



Test Report No.: W7L-P21120037RF05

CHANNEL BANDWIDTH: 10MHz / QPSK

MODE	TX channel 21100	FREQUENCY RANGE	Above 1000MHz
ENVIRONMENTAL CONDITIONS	23deg. C, 70%RH	INPUT POWER	AC 120V/60HZ
TESTED BY	Jace Hu		
ANTENNA POLARITY & TEST DISTANCE: HORIZONTAL AT 3 M			

	Freq	Level	Read Level	Limit Line	Over Limit	Factor	Remark	Pol/Phase
	MHz	dBm/m	dBm	dBm/m	dB	dB/m		
1	5082.000	-48.74	-57.51	-25.00	-23.74	8.77	Peak	Horizontal
2 PP	7605.000	-45.14	-56.54	-25.00	-20.14	11.40	Peak	Horizontal

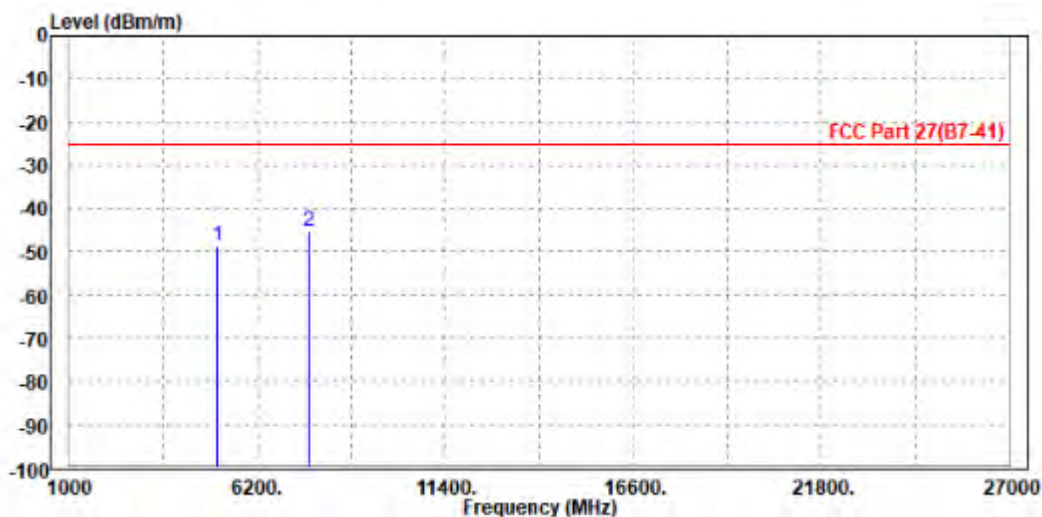



Test Report No.: W7L-P21120037RF05

MODE	TX channel 21100	FREQUENCY RANGE	Above 1000MHz
ENVIRONMENTAL CONDITIONS	23deg. C, 70%RH	INPUT POWER	AC 120V/60HZ
TESTED BY	Jace Hu		
ANTENNA POLARITY & TEST DISTANCE: VERTICAL AT 3 M			

	Freq	Level	Read Level	Limit Line	Over Limit	Factor	Remark	Pol/Phase
	MHz	dBm/m	dBm	dBm/m	dB	dB/m		
1	PP 5082.000	-46.86	-56.73	-25.00	-21.86	9.87	Peak	Vertical
2	7605.000	-47.47	-60.25	-25.00	-22.47	12.78	Peak	Vertical

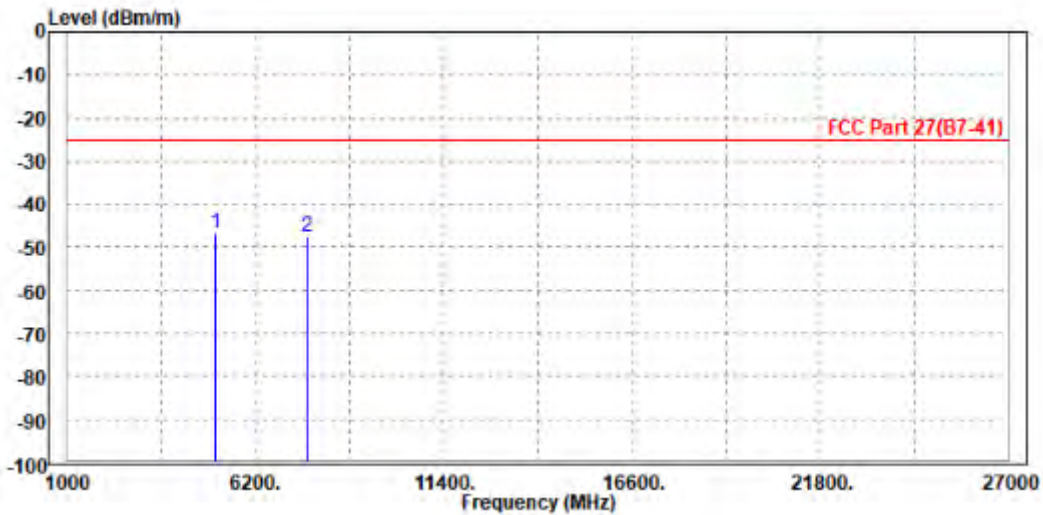



**BUREAU
VERITAS**

Test Report No.: W7L-P21120037RF05

CHANNEL BANDWIDTH: 15MHz / QPSK

MODE	TX channel 21100	FREQUENCY RANGE	Above 1000MHz
ENVIRONMENTAL CONDITIONS	23deg. C, 70%RH	INPUT POWER	AC 120V/60HZ
TESTED BY	Jace Hu		
ANTENNA POLARITY & TEST DISTANCE: HORIZONTAL AT 3 M			

	Freq	Level	Read Level	Limit Line	Over Limit	Factor	Remark	Pol/Phase
	MHz	dBm/m	dBm	dBm/m	dB	dB/m		
1	5082.000	-48.73	-57.50	-25.00	-23.73	8.77	Peak	Horizontal
2	PP 7605.000	-47.66	-59.06	-25.00	-22.66	11.40	Peak	Horizontal

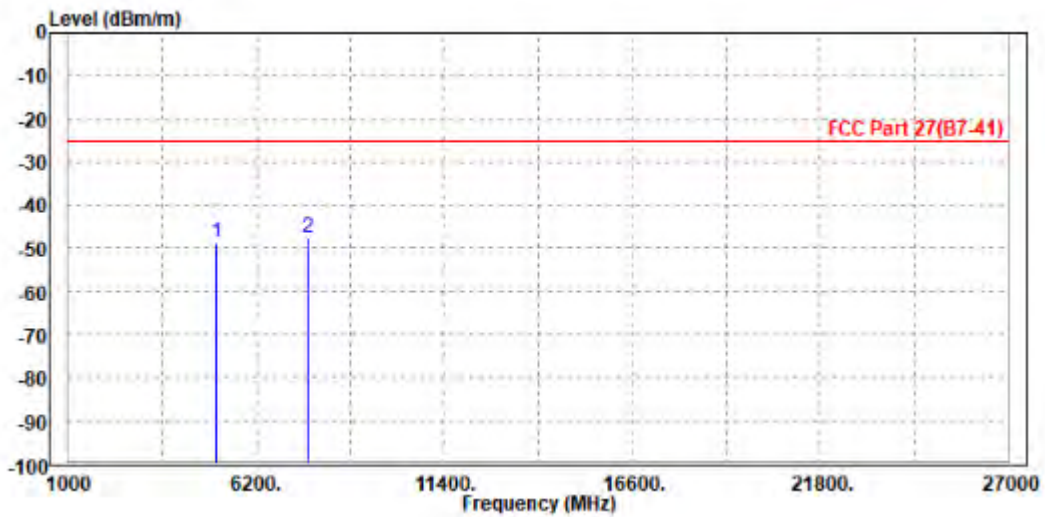



Test Report No.: W7L-P21120037RF05

MODE	TX channel 21100	FREQUENCY RANGE	Above 1000MHz
ENVIRONMENTAL CONDITIONS	23deg. C, 70%RH	INPUT POWER	AC 120V/60HZ
TESTED BY	Jace Hu		
ANTENNA POLARITY & TEST DISTANCE: VERTICAL AT 3 M			

	Freq	Level	Read Level	Limit Line	Over Limit	Factor	Remark	Pol/Phase
	MHz	dBm/m	dBm	dBm/m	dB	dB/m		
1	5082.000	-47.43	-57.30	-25.00	-22.43	9.87	Peak	Vertical
2	PP 7605.000	-46.17	-58.95	-25.00	-21.17	12.78	Peak	Vertical

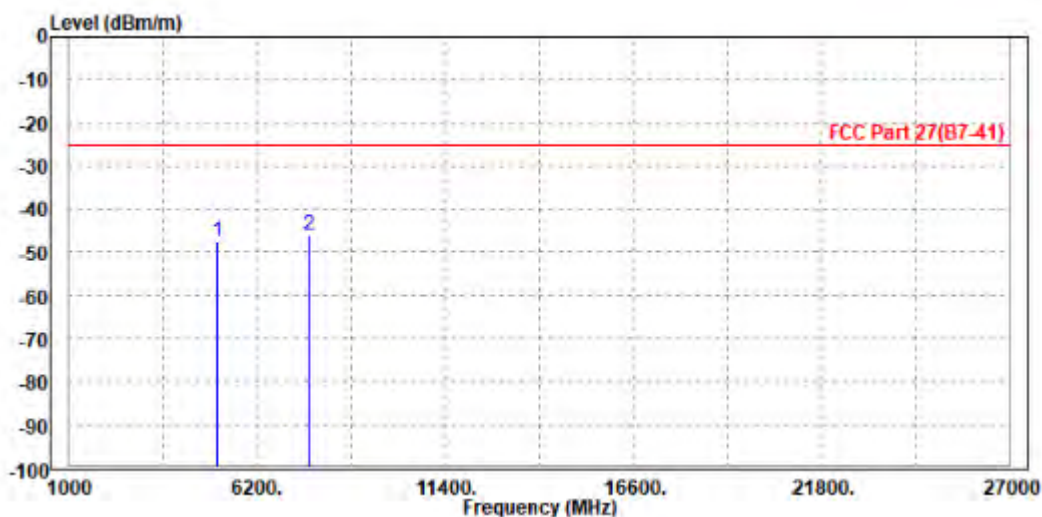



**BUREAU
VERITAS**

Test Report No.: W7L-P21120037RF05

CHANNEL BANDWIDTH: 20MHz / QPSK

MODE	TX channel 21100	FREQUENCY RANGE	Above 1000MHz
ENVIRONMENTAL CONDITIONS	23deg. C, 70%RH	INPUT POWER	AC 120V/60HZ
TESTED BY	Jace Hu		
ANTENNA POLARITY & TEST DISTANCE: HORIZONTAL AT 3 M			

	Freq	Level	Read Level	Limit Line	Over Limit	Factor	Remark	Pol/Phase
	MHz	dBm/m	dBm	dBm/m	dB	dB/m		
1	PP 5082.000	-48.41	-57.18	-25.00	-23.41	8.77	Peak	Horizontal
2	7605.000	-49.11	-60.51	-25.00	-24.11	11.40	Peak	Horizontal

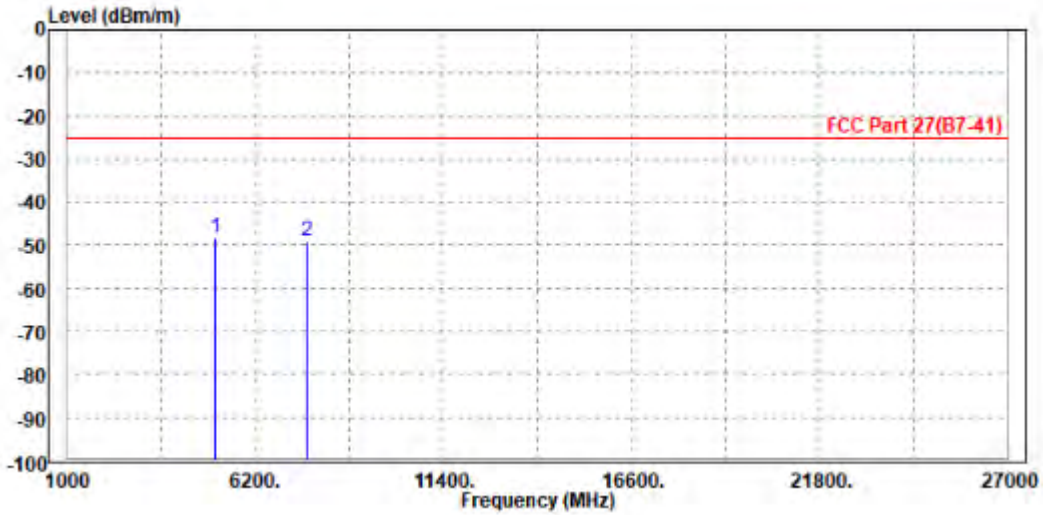



Test Report No.: W7L-P21120037RF05

MODE	TX channel 21100	FREQUENCY RANGE	Above 1000MHz
ENVIRONMENTAL CONDITIONS	23deg. C, 70%RH	INPUT POWER	AC 120V/60HZ
TESTED BY	Jace Hu		
ANTENNA POLARITY & TEST DISTANCE: VERTICAL AT 3 M			

		Read	Limit	Over			
	Freq	Level	Level	Line	Limit	Factor	Remark
	MHz	dBm/m	dBm	dBm/m	dB	dB/m	
1	PP 5082.000	-47.36	-57.23	-25.00	-22.36	9.87	Peak Vertical
2	7605.000	-47.45	-60.23	-25.00	-22.45	12.78	Peak Vertical

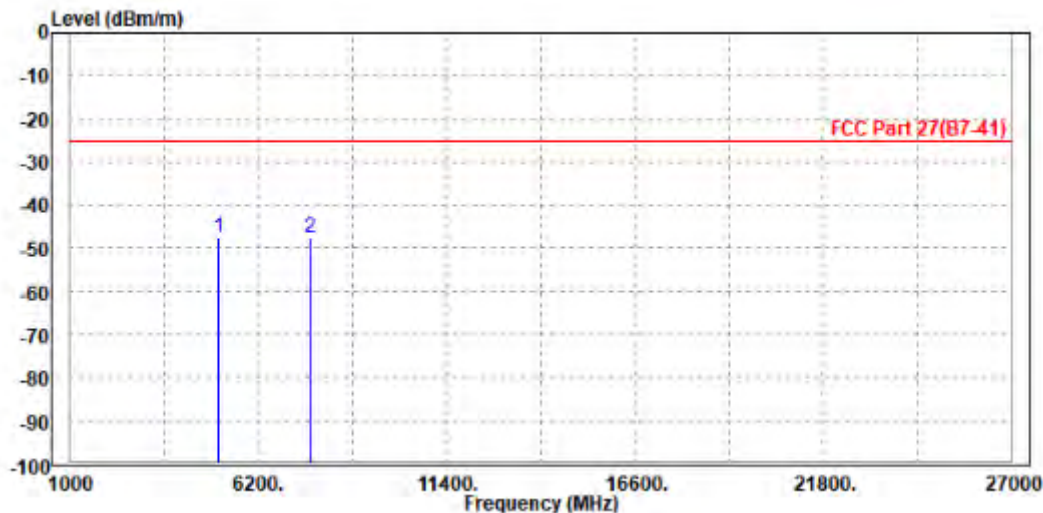



**BUREAU
VERITAS**

Test Report No.: W7L-P21120037RF05

LTE BAND 12

CHANNEL BANDWIDTH: 1.4MHz / QPSK

CH23017

MODE	TX channel 23017	FREQUENCY RANGE	Above 1000MHz
ENVIRONMENTAL CONDITIONS	23deg. C, 70%RH	INPUT POWER	AC 120V/60HZ
TESTED BY	Jace Hu		
ANTENNA POLARITY & TEST DISTANCE: HORIZONTAL AT 3 M			

	Freq	Level	Read Level	Limit Line	Over Limit	Factor	Remark	Pol/Phase
	MHz	dBm/m	dBm	dBm/m	dB	dB/m		
1 PP	1390.000	-33.59	-34.56	-13.00	-20.59	0.97	Peak	Horizontal
2	2099.100	-47.23	-54.88	-13.00	-34.23	7.65	Peak	Horizontal

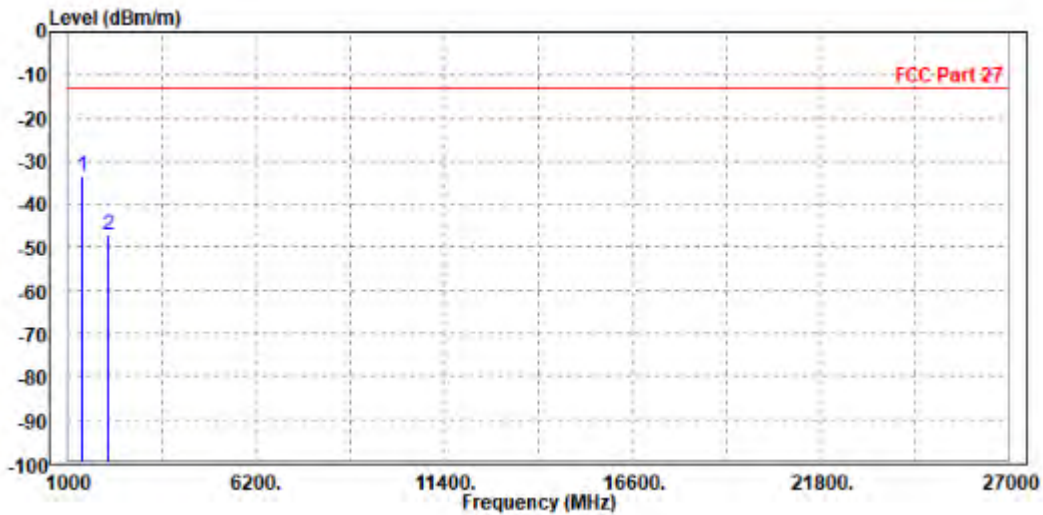



Test Report No.: W7L-P21120037RF05

MODE	TX channel 23017	FREQUENCY RANGE	Above 1000MHz
ENVIRONMENTAL CONDITIONS	23deg. C, 70%RH	INPUT POWER	AC 120V/60HZ
TESTED BY	Jace Hu		
ANTENNA POLARITY & TEST DISTANCE: VERTICAL AT 3 M			

	Freq	Level	Read Level	Limit Line	Over Limit	Factor	Remark	Pol/Phase
	MHz	dBm/m	dBm	dBm/m	dB	dB/m		
1	PP 1390.000	-32.22	-33.80	-13.00	-19.22	1.58	Peak	Vertical
2	2099.100	-49.88	-56.54	-13.00	-36.88	6.66	Peak	Vertical

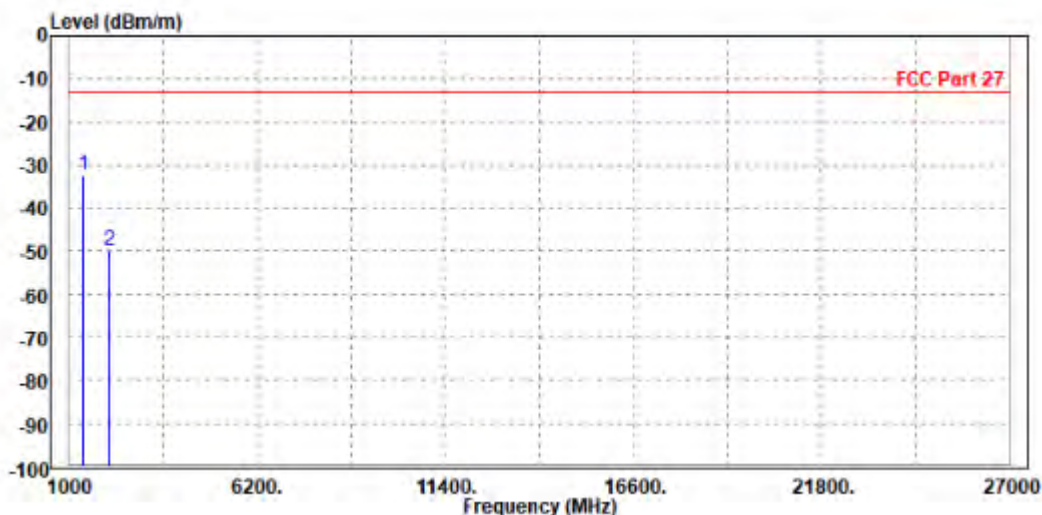



**BUREAU
VERITAS**

Test Report No.: W7L-P21120037RF05

CH23095

MODE	TX channel 23095	FREQUENCY RANGE	Above 1000MHz
ENVIRONMENTAL CONDITIONS	23deg. C, 70%RH	INPUT POWER	AC 120V/60HZ
TESTED BY	Jace Hu		
ANTENNA POLARITY & TEST DISTANCE: HORIZONTAL AT 3 M			

	Freq	Level	Read Level	Limit Line	Over Limit	Factor	Remark	Pol/Phase
	MHz	dBm/m	dBm	dBm/m	dB	dB/m		
1	PP 1415.000	-24.80	-25.87	-13.00	-11.80	1.07	Peak	Horizontal
2	2118.000	-47.76	-55.43	-13.00	-34.76	7.67	Peak	Horizontal

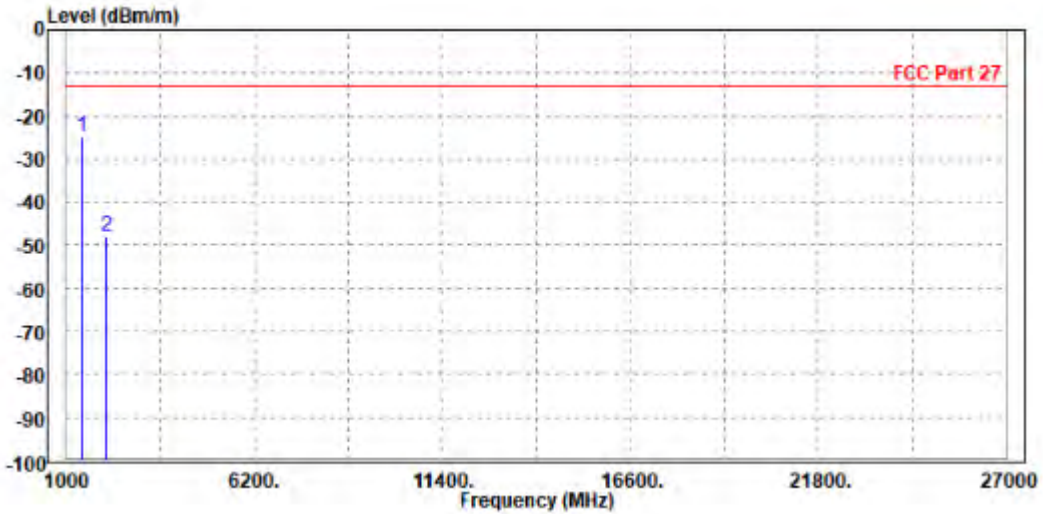



Test Report No.: W7L-P21120037RF05

MODE	TX channel 23095	FREQUENCY RANGE	Above 1000MHz
ENVIRONMENTAL CONDITIONS	23deg. C, 70%RH	INPUT POWER	AC 120V/60HZ
TESTED BY	Jace Hu		
ANTENNA POLARITY & TEST DISTANCE: VERTICAL AT 3 M			

	Freq	Level	Read Level	Limit Line	Over Limit	Factor	Remark	Pol/Phase
	MHz	dBm/m	dBm	dBm/m	dB	dB/m		
1	PP 1416.000	-25.80	-27.49	-13.00	-12.80	1.69	Peak	Vertical
2	2122.500	-46.85	-53.54	-13.00	-33.85	6.69	Peak	Vertical

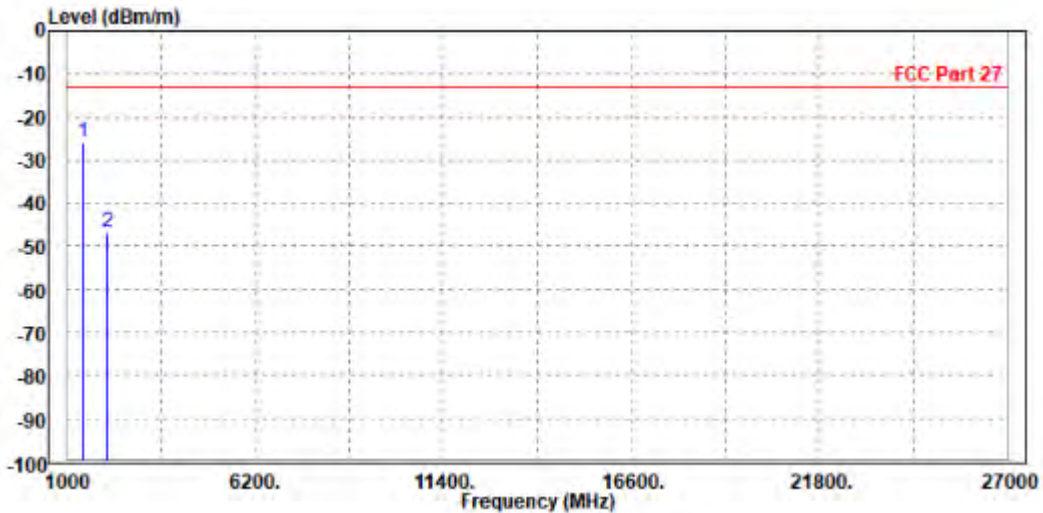



BUREAU VERITAS

Test Report No.: W7L-P21120037RF05

CH23173

MODE	TX channel 23173	FREQUENCY RANGE	Above 1000MHz
ENVIRONMENTAL CONDITIONS	23deg. C, 70%RH	INPUT POWER	AC 120V/60HZ
TESTED BY	Jace Hu		
ANTENNA POLARITY & TEST DISTANCE: HORIZONTAL AT 3 M			

	Freq	Level	Read Level	Limit Line	Over Limit	Factor	Remark	Pol/Phase
	MHz	dBm/m	dBm	dBm/m	dB	dB/m		
1	PP 1442.000	-32.16	-33.35	-13.00	-19.16	1.19	Peak	Horizontal
2	2145.900	-47.37	-55.06	-13.00	-34.37	7.69	Peak	Horizontal

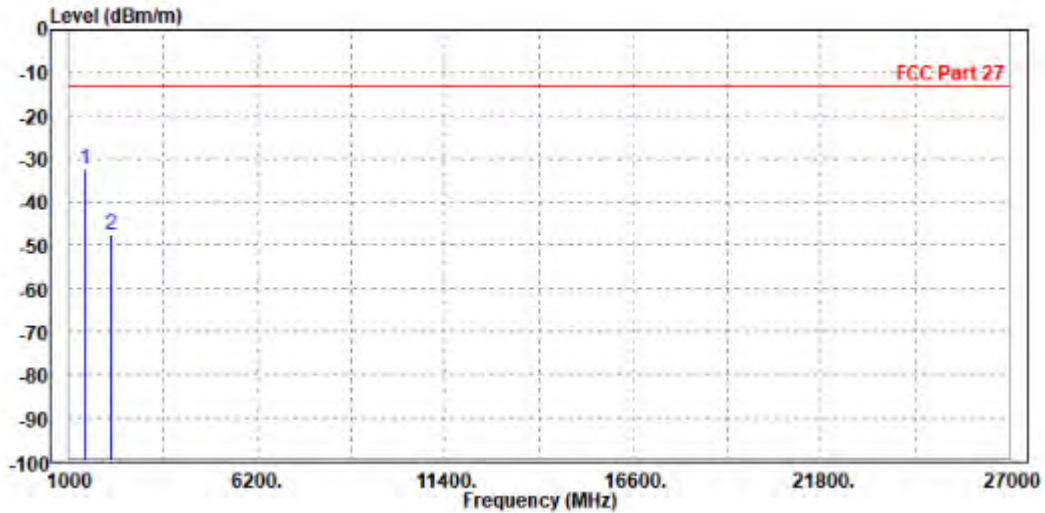



Test Report No.: W7L-P21120037RF05

MODE	TX channel 23173	FREQUENCY RANGE	Above 1000MHz
ENVIRONMENTAL CONDITIONS	23deg. C, 70%RH	INPUT POWER	AC 120V/60HZ
TESTED BY	Jace Hu		
ANTENNA POLARITY & TEST DISTANCE: VERTICAL AT 3 M			

	Freq	Level	Read Level	Limit Line	Over Limit	Factor	Remark	Pol/Phase
	MHz	dBm/m	dBm	dBm/m	dB	dB/m		
1	PP 1442.000	-31.38	-33.18	-13.00	-18.38	1.80	Peak	Vertical
2	2145.900	-48.96	-55.67	-13.00	-35.96	6.71	Peak	Vertical

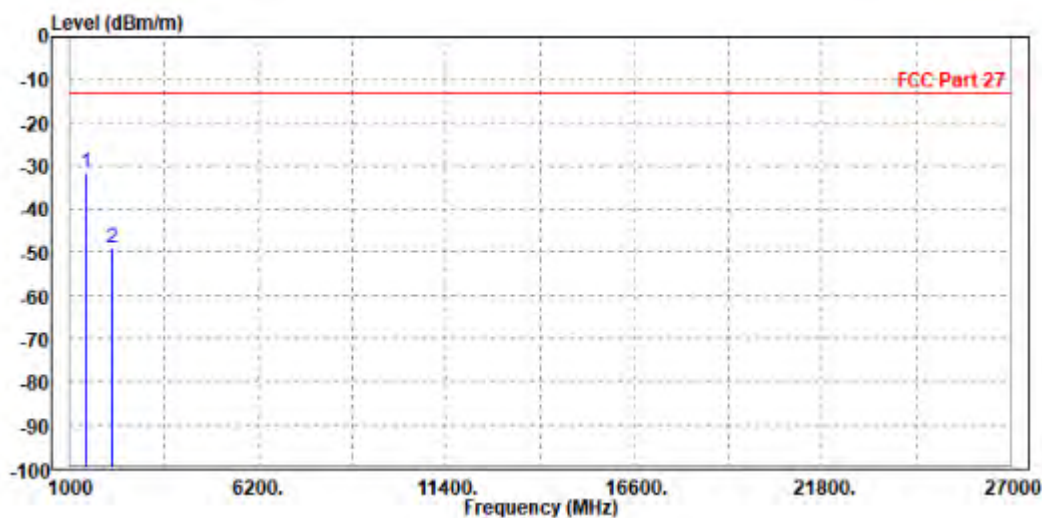



**BUREAU
VERITAS**

Test Report No.: W7L-P21120037RF05

CHANNEL BANDWIDTH: 3MHz / QPSK

CH23095

MODE	TX channel 23095	FREQUENCY RANGE	Above 1000MHz
ENVIRONMENTAL CONDITIONS	23deg. C, 70%RH	INPUT POWER	AC 120V/60HZ
TESTED BY	Jace Hu		
ANTENNA POLARITY & TEST DISTANCE: HORIZONTAL AT 3 M			

	Freq	Level	Read Level	Limit Line	Over Limit	Factor	Remark	Pol/Phase
	MHz	dBm/m	dBm	dBm/m	dB	dB/m		
1	PP 1416.000	-26.70	-27.78	-13.00	-13.70	1.08	Peak	Horizontal
2	2122.500	-45.46	-53.13	-13.00	-32.46	7.67	Peak	Horizontal

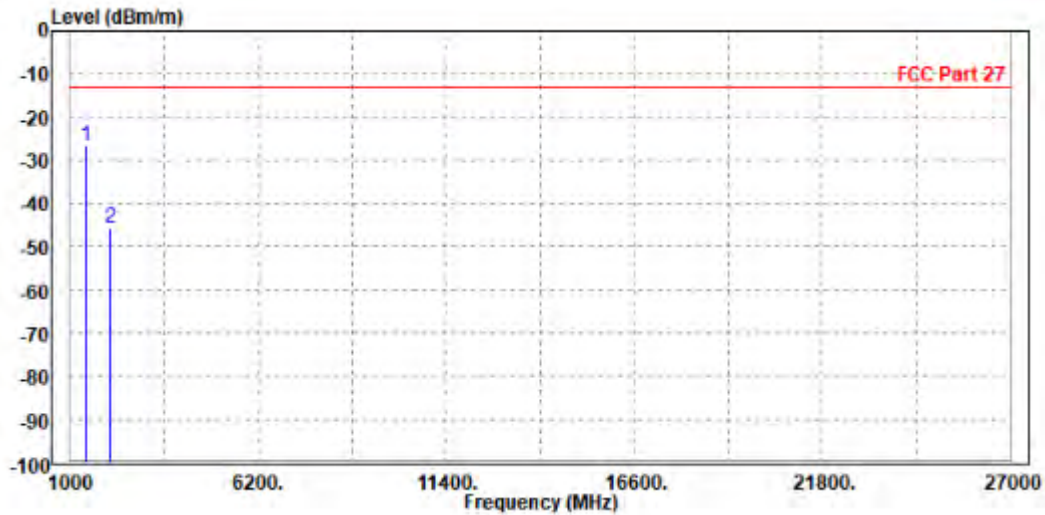



Test Report No.: W7L-P21120037RF05

MODE	TX channel 23095	FREQUENCY RANGE	Above 1000MHz
ENVIRONMENTAL CONDITIONS	23deg. C, 70%RH	INPUT POWER	AC 120V/60HZ
TESTED BY	Jace Hu		
ANTENNA POLARITY & TEST DISTANCE: VERTICAL AT 3 M			

	Freq	Level	Read Level	Limit Line	Over Limit	Factor	Remark	Pol/Phase
	MHz	dBm/m	dBm	dBm/m	dB	dB/m		
1	PP 1415.000	-26.41	-28.10	-13.00	-13.41	1.69	Peak	Vertical
2	2118.000	-47.64	-54.32	-13.00	-34.64	6.68	Peak	Vertical

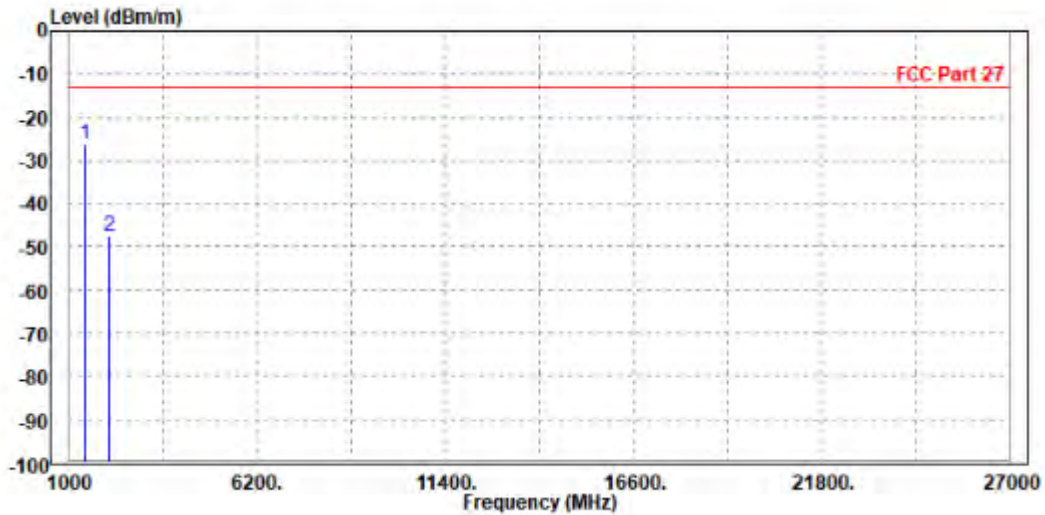



Test Report No.: W7L-P21120037RF05

CHANNEL BANDWIDTH: 5MHz / QPSK

MODE	TX channel 23095	FREQUENCY RANGE	Above 1000MHz
ENVIRONMENTAL CONDITIONS	23deg. C, 70%RH	INPUT POWER	AC 120V/60HZ
TESTED BY	Jace Hu		
ANTENNA POLARITY & TEST DISTANCE: HORIZONTAL AT 3 M			

	Freq	Level	Read Level	Limit Line	Over Limit	Factor	Remark	Pol/Phase
	MHz	dBm/m	dBm	dBm/m	dB	dB/m		
1	PP 1415.000	-25.38	-26.45	-13.00	-12.38	1.07	Peak	Horizontal
2	2118.000	-46.40	-54.07	-13.00	-33.40	7.67	Peak	Horizontal

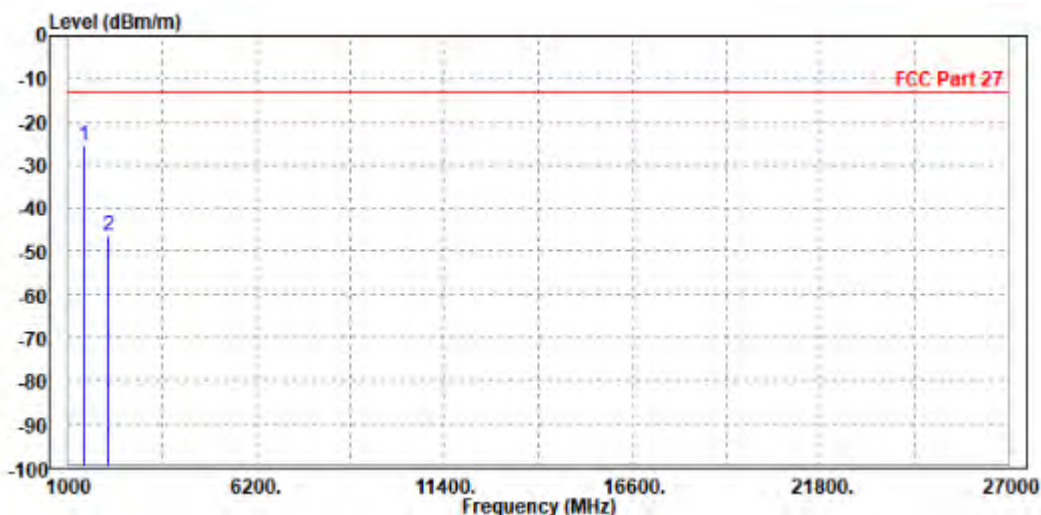



Test Report No.: W7L-P21120037RF05

MODE	TX channel 23095	FREQUENCY RANGE	Above 1000MHz
ENVIRONMENTAL CONDITIONS	23deg. C, 70%RH	INPUT POWER	AC 120V/60HZ
TESTED BY	Jace Hu		
ANTENNA POLARITY & TEST DISTANCE: VERTICAL AT 3 M			

	Freq	Level	Read Level	Limit Line	Over Limit	Factor	Remark	Pol/Phase
	MHz	dBm/m	dBm	dBm/m	dB	dB/m		
1	PP 1416.000	-26.20	-27.89	-13.00	-13.20	1.69	Peak	Vertical
2	2122.500	-46.43	-53.12	-13.00	-33.43	6.69	Peak	Vertical

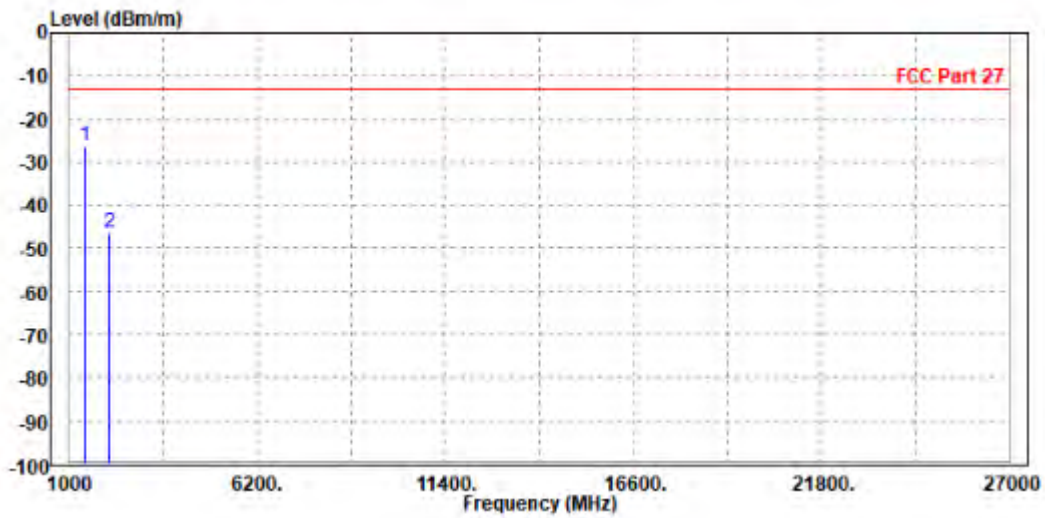



Test Report No.: W7L-P21120037RF05

CHANNEL BANDWIDTH: 10MHz / QPSK

MODE	TX channel 23095	FREQUENCY RANGE	Above 1000MHz
ENVIRONMENTAL CONDITIONS	23deg. C, 70%RH	INPUT POWER	AC 120V/60HZ
TESTED BY	Jace Hu		
ANTENNA POLARITY & TEST DISTANCE: HORIZONTAL AT 3 M			

	Freq	Level	Read Level	Limit Line	Over Limit	Factor	Remark	Pol/Phase
	MHz	dBm/m	dBm	dBm/m	dB	dB/m		
1	PP 1416.000	-30.13	-31.21	-13.00	-17.13	1.08	Peak	Horizontal
2	2122.500	-47.15	-54.82	-13.00	-34.15	7.67	Peak	Horizontal

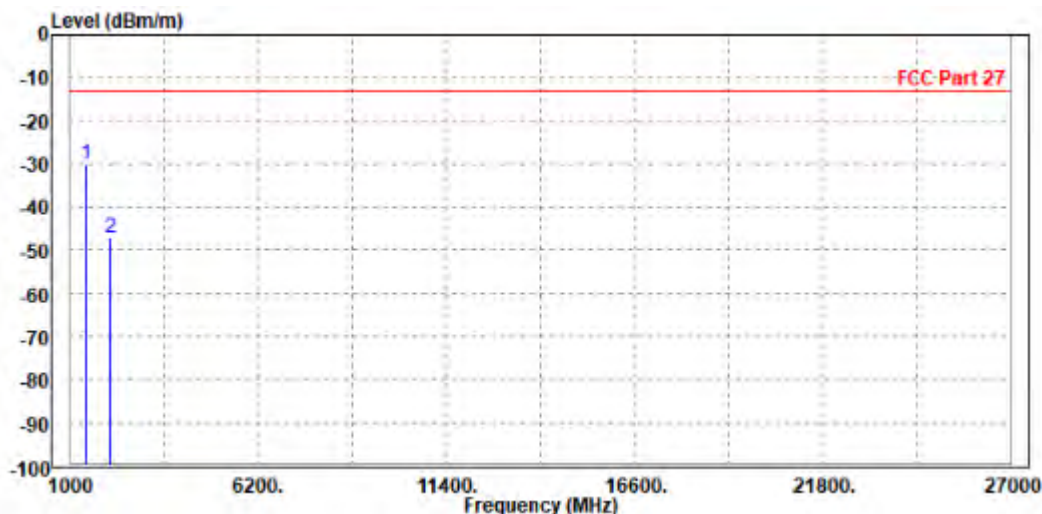



Test Report No.: W7L-P21120037RF05

MODE	TX channel 23095	FREQUENCY RANGE	Above 1000MHz
ENVIRONMENTAL CONDITIONS	23deg. C, 70%RH	INPUT POWER	AC 120V/60HZ
TESTED BY	Jace Hu		
ANTENNA POLARITY & TEST DISTANCE: VERTICAL AT 3 M			

	Freq	Level	Read Level	Limit Line	Over Limit	Factor	Remark	Pol/Phase
	MHz	dBm/m	dBm	dBm/m	dB	dB/m		
1 PP	1415.000	-25.20	-26.89	-13.00	-12.20	1.69	Peak	Vertical
2	2118.000	-46.26	-52.94	-13.00	-33.26	6.68	Peak	Vertical

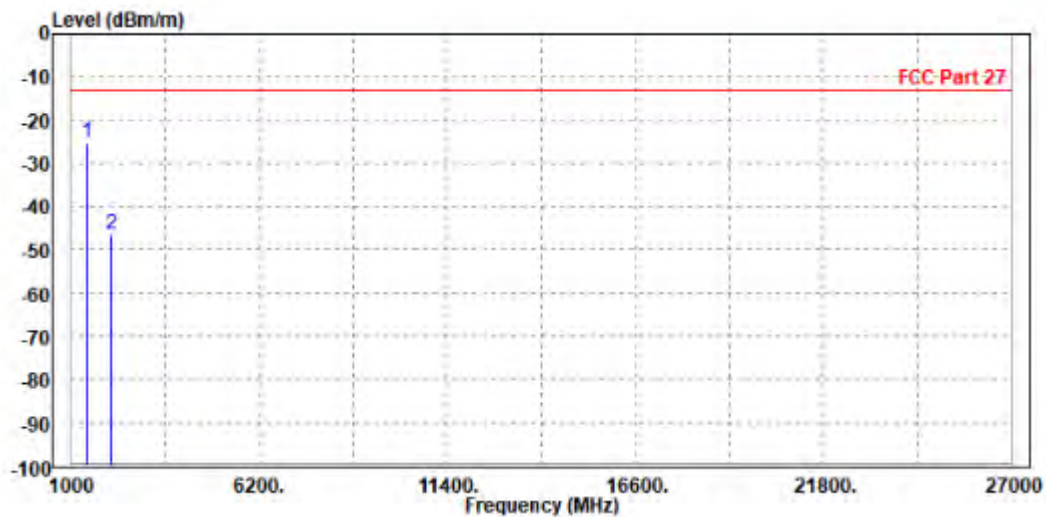



Test Report No.: W7L-P21120037RF05

LTE B13

CHANNEL BANDWIDTH: 5MHz / QPSK

CH23205

MODE	TX channel 23205	FREQUENCY RANGE	Above 1000MHz
ENVIRONMENTAL CONDITIONS	23deg. C, 70%RH	INPUT POWER	AC 120V/60HZ
TESTED BY	Jace Hu		
ANTENNA POLARITY & TEST DISTANCE: HORIZONTAL AT 3 M			

	Freq	Level	Read Level	Limit Line	Over Limit	Factor	Remark	Pol/Phase
	MHz	dBm/m	dBm	dBm/m	dB	dB/m		
1	PP 1572.000	-53.29	-55.61	-40.00	-13.29	2.32	Peak	Horizontal
2	2338.500	-39.21	-47.10	-13.00	-26.21	7.89	Peak	Horizontal

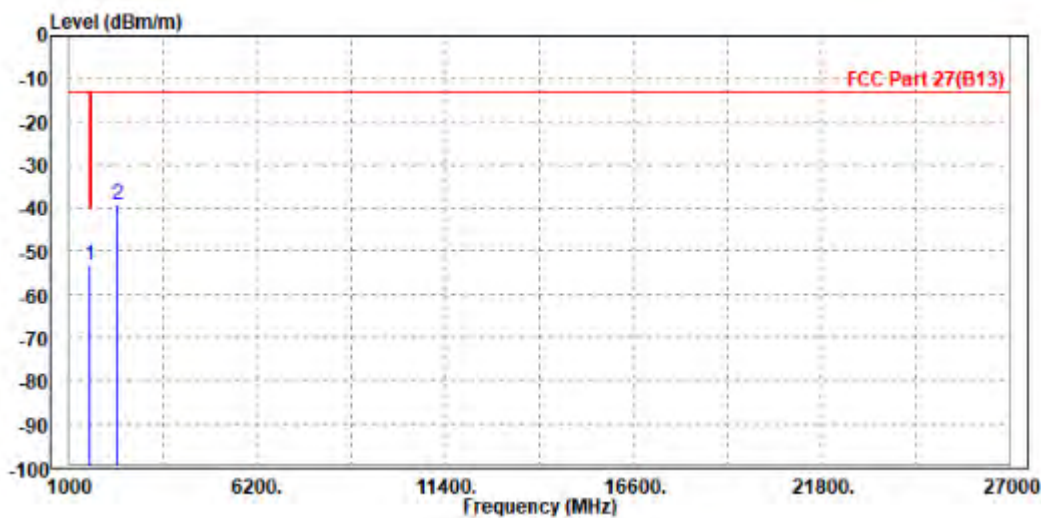



Test Report No.: W7L-P21120037RF05

MODE	TX channel 23205	FREQUENCY RANGE	Above 1000MHz
ENVIRONMENTAL CONDITIONS	23deg. C, 70%RH	INPUT POWER	AC 120V/60HZ
TESTED BY	Jace Hu		
ANTENNA POLARITY & TEST DISTANCE: VERTICAL AT 3 M			

	Freq	Level	Read Level	Limit Line	Over Limit	Factor	Remark	Pol/Phase
	MHz	dBm/m	dBm	dBm/m	dB	dB/m		
1	PP 1559.000	-52.90	-55.48	-40.00	-12.90	2.58	Peak	Vertical
2	2326.000	-38.79	-45.68	-13.00	-25.79	6.89	Peak	Vertical

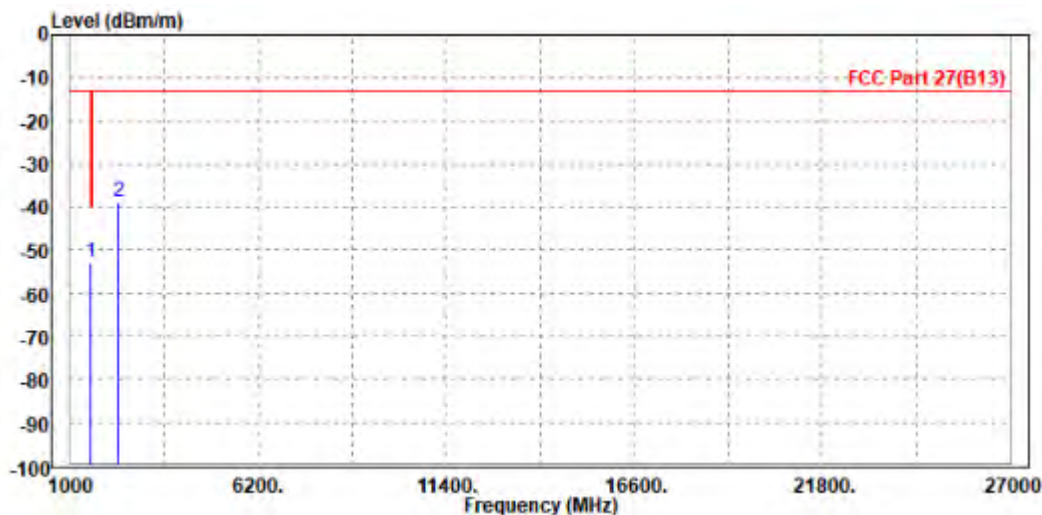



Test Report No.: W7L-P21120037RF05

CH23230

MODE	TX channel 23230	FREQUENCY RANGE	Above 1000MHz
ENVIRONMENTAL CONDITIONS	23deg. C, 70%RH	INPUT POWER	AC 120V/60HZ
TESTED BY	Jace Hu		
ANTENNA POLARITY & TEST DISTANCE: HORIZONTAL AT 3 M			

	Freq	Level	Read Level	Limit Line	Over Limit	Factor	Remark	Pol/Phase
	MHz	dBm/m	dBm	dBm/m	dB	dB/m		
1 PP	1572.000	-44.60	-46.92	-40.00	-4.60	2.32	Peak	Horizontal
2	2352.000	-46.57	-54.47	-13.00	-33.57	7.90	Peak	Horizontal

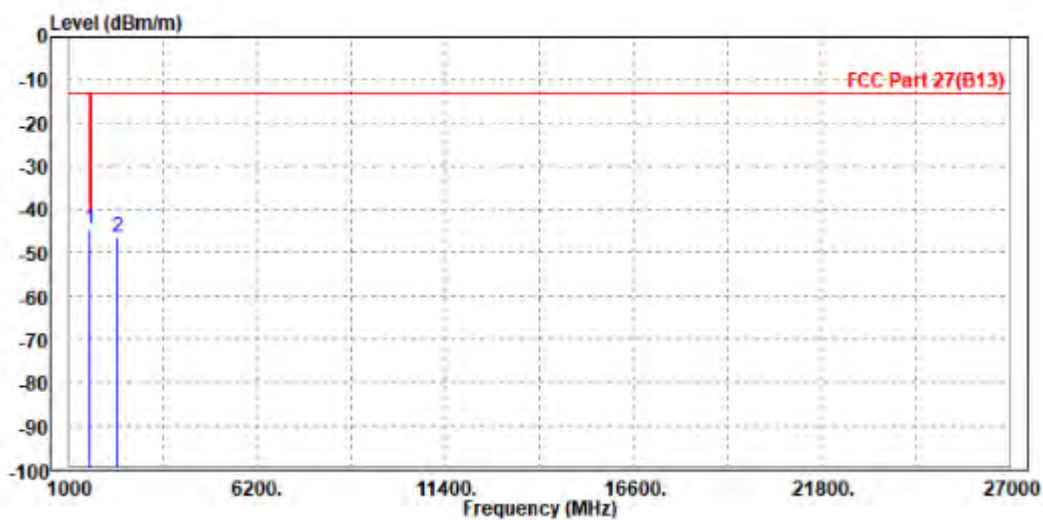



Test Report No.: W7L-P21120037RF05

MODE	TX channel 23230	FREQUENCY RANGE	Above 1000MHz
ENVIRONMENTAL CONDITIONS	23deg. C, 70%RH	INPUT POWER	AC 120V/60HZ
TESTED BY	Jace Hu		
ANTENNA POLARITY & TEST DISTANCE: VERTICAL AT 3 M			

	Freq	Level	Read Level	Limit Line	Over Limit	Factor	Remark	Pol/Phase
	MHz	dBm/m	dBm	dBm/m	dB	dB/m		
1	PP 1572.000	-44.94	-47.64	-40.00	-4.94	2.70	Peak	Vertical
2	2346.000	-45.22	-52.13	-13.00	-32.22	6.91	Peak	Vertical

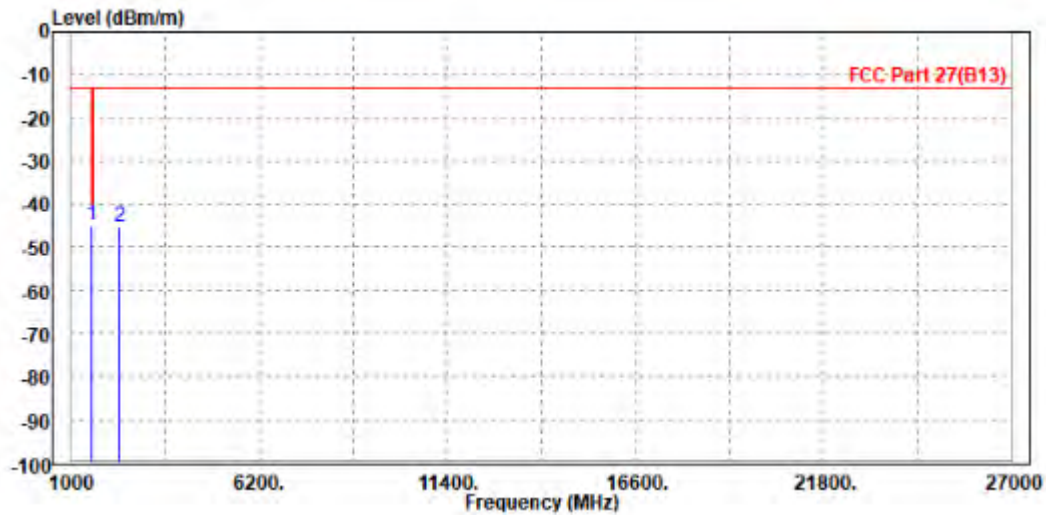



Test Report No.: W7L-P21120037RF05

CH23255

MODE	TX channel 23255	FREQUENCY RANGE	Above 1000MHz
ENVIRONMENTAL CONDITIONS	23deg. C, 70%RH	INPUT POWER	AC 120V/60HZ
TESTED BY	Jace Hu		
ANTENNA POLARITY & TEST DISTANCE: HORIZONTAL AT 3 M			

	Freq	Level	Read Level	Limit Line	Over Limit	Factor	Remark	Pol/Phase
	MHz	dBm/m	dBm	dBm/m	dB	dB/m		
1	PP 1559.000	-52.96	-55.13	-40.00	-12.96	2.17	Peak	Horizontal
2	2326.000	-39.48	-47.35	-13.00	-26.48	7.87	Peak	Horizontal

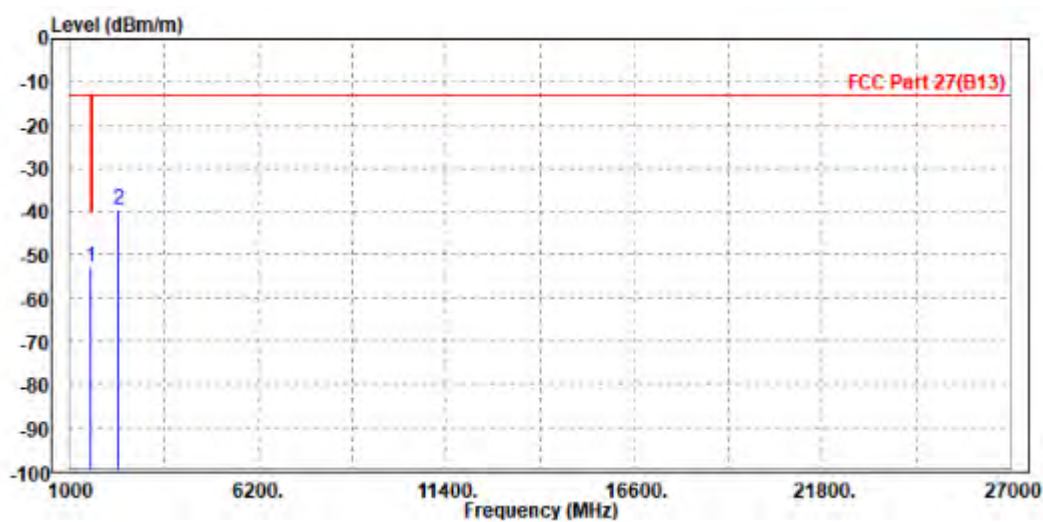



Test Report No.: W7L-P21120037RF05

MODE	TX channel 23255	FREQUENCY RANGE	Above 1000MHz
ENVIRONMENTAL CONDITIONS	23deg. C, 70%RH	INPUT POWER	AC 120V/60HZ
TESTED BY	Jace Hu		
ANTENNA POLARITY & TEST DISTANCE: VERTICAL AT 3 M			

	Freq	Level	Read Level	Limit Line	Over Limit	Factor	Remark	Pol/Phase
	MHz	dBm/m	dBm	dBm/m	dB	dB/m		
1	PP 1572.000	-53.21	-55.91	-40.00	-13.21	2.70	Peak	Vertical
2	2338.500	-37.53	-44.43	-13.00	-24.53	6.90	Peak	Vertical

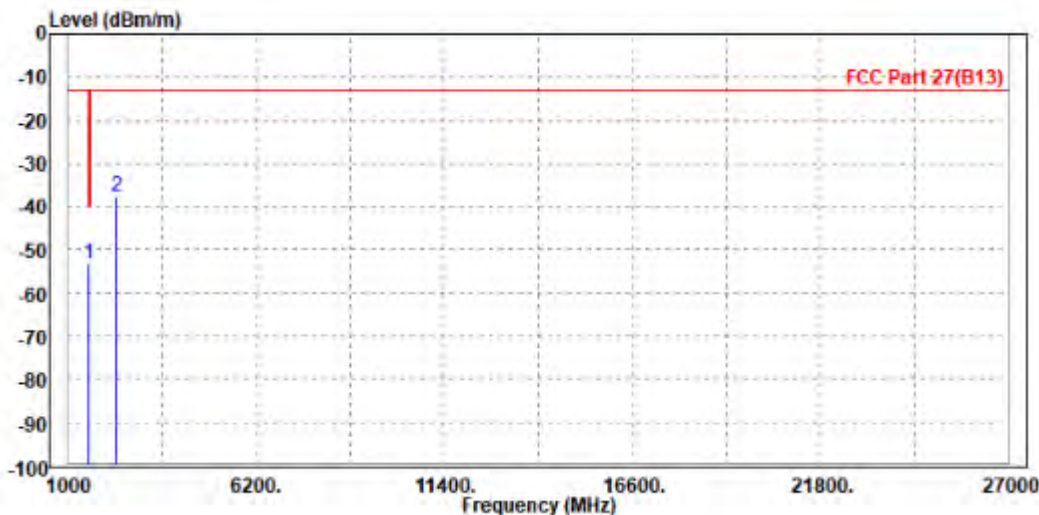



Test Report No.: W7L-P21120037RF05

CHANNEL BANDWIDTH: 10MHz /QPSK

MODE	TX channel 23230	FREQUENCY RANGE	Above 1000MHz
ENVIRONMENTAL CONDITIONS	23deg. C, 70%RH	INPUT POWER	AC 120V/60HZ
TESTED BY	Jace Hu		
ANTENNA POLARITY & TEST DISTANCE: HORIZONTAL AT 3 M			

	Freq	Level	Read Level	Limit Line	Over Limit	Factor	Remark	Pol/Phase
	MHz	dBm/m	dBm	dBm/m	dB	dB/m		
1	PP 1572.000	-54.09	-56.41	-40.00	-14.09	2.32	Peak	Horizontal
2	2346.000	-48.15	-56.05	-13.00	-35.15	7.90	Peak	Horizontal

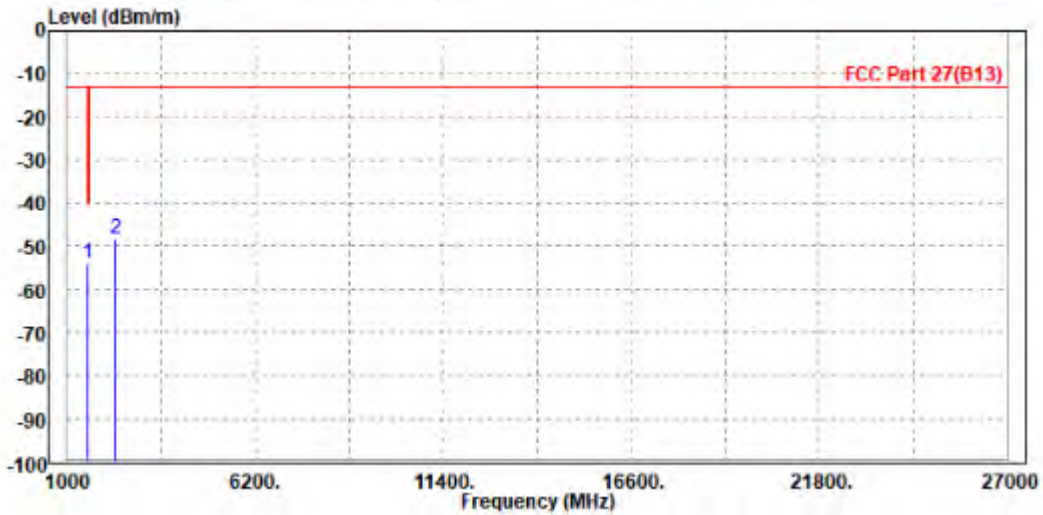



Test Report No.: W7L-P21120037RF05

MODE	TX channel 23230	FREQUENCY RANGE	Above 1000MHz
ENVIRONMENTAL CONDITIONS	23deg. C, 70%RH	INPUT POWER	AC 120V/60HZ
TESTED BY	Jace Hu		
ANTENNA POLARITY & TEST DISTANCE: VERTICAL AT 3 M			

	Freq	Level	Read Level	Limit Line	Over Limit	Factor	Remark	Pol/Phase
	MHz	dBm/m	dBm	dBm/m	dB	dB/m		
1	PP 1564.000	-51.56	-54.18	-40.00	-11.56	2.62	Peak	Vertical
2	2352.000	-49.18	-56.10	-13.00	-36.18	6.92	Peak	Vertical

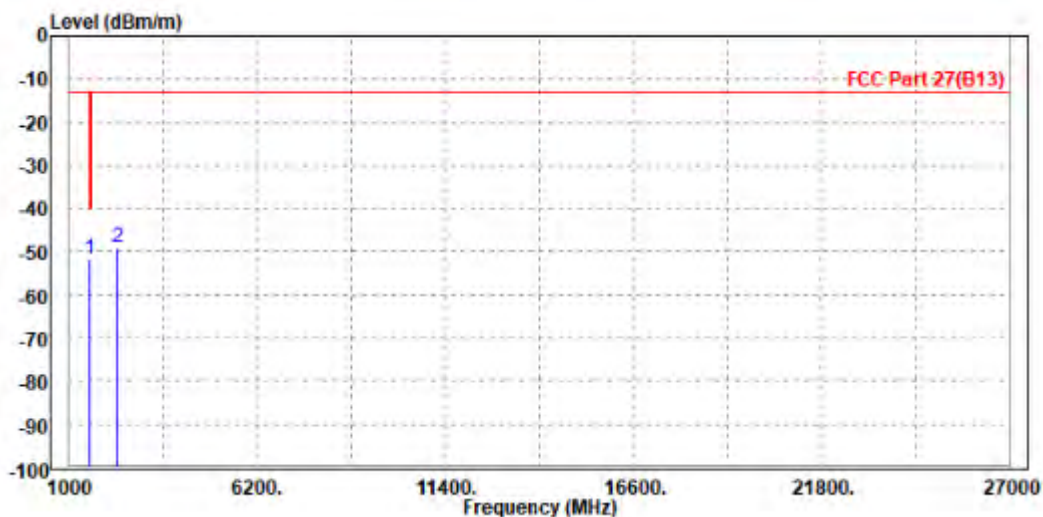



Test Report No.: W7L-P21120037RF05

LTE B17

CHANNEL BANDWIDTH: 5MHz / QPSK

MODE	TX channel 23790	FREQUENCY RANGE	Above 1000MHz
ENVIRONMENTAL CONDITIONS	23deg. C, 70%RH	INPUT POWER	AC 120V/60HZ
TESTED BY	Jace Hu		
ANTENNA POLARITY & TEST DISTANCE: HORIZONTAL AT 3 M			

	Freq	Level	Read Level	Limit Line	Over Limit	Factor	Remark	Pol/Phase
	MHz	dBm/m	dBm	dBm/m	dB	dB/m		
1 PP	1416.000	-25.67	-26.75	-13.00	-12.67	1.08	Peak	Horizontal
2	2130.000	-46.84	-54.52	-13.00	-33.84	7.68	Peak	Horizontal

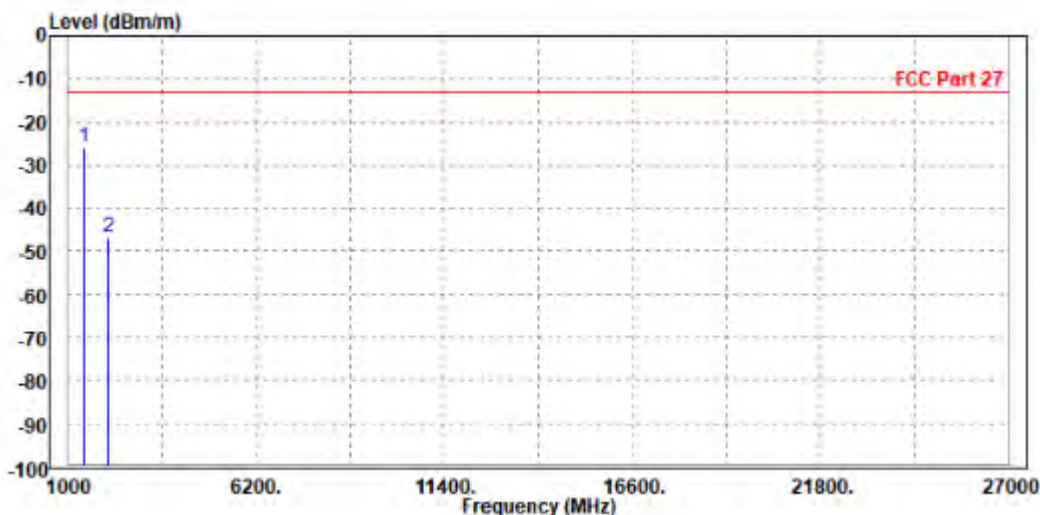



Test Report No.: W7L-P21120037RF05

MODE	TX channel 23790	FREQUENCY RANGE	Above 1000MHz
ENVIRONMENTAL CONDITIONS	23deg. C, 70%RH	INPUT POWER	AC 120V/60HZ
TESTED BY	Jace Hu		
ANTENNA POLARITY & TEST DISTANCE: VERTICAL AT 3 M			

	Freq	Level	Read Level	Limit Line	Over Limit	Factor	Remark	Pol/Phase
	MHz	dBm/m	dBm	dBm/m	dB	dB/m		
1	PP 1416.000	-27.06	-28.75	-13.00	-14.06	1.69	Peak	Vertical
2	2130.000	-45.48	-52.18	-13.00	-32.48	6.70	Peak	Vertical

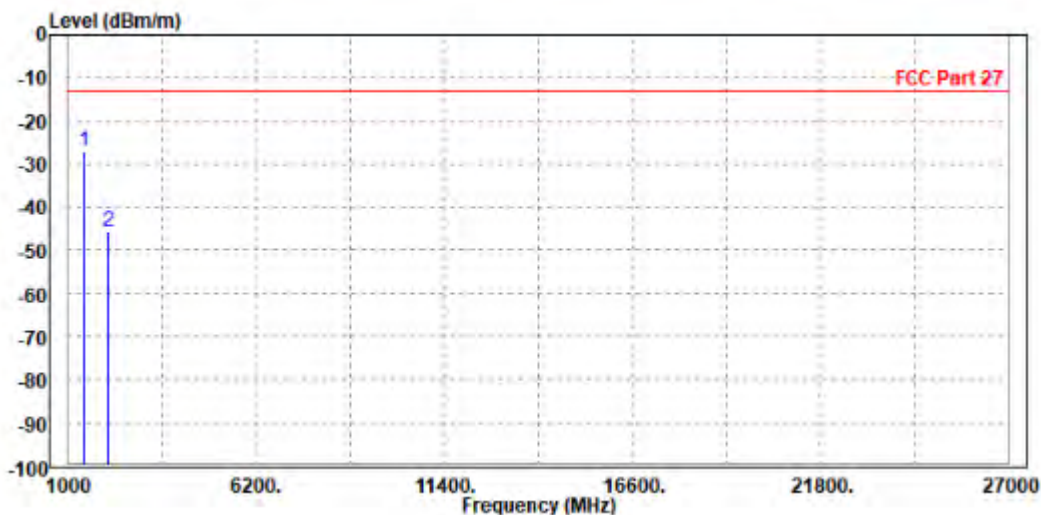



Test Report No.: W7L-P21120037RF05

CHANNEL BANDWIDTH: 10MHz / QPSK

CH23780

MODE	TX channel 23780	FREQUENCY RANGE	Above 1000MHz
ENVIRONMENTAL CONDITIONS	23deg. C, 70%RH	INPUT POWER	AC 120V/60HZ
TESTED BY	Jace Hu		
ANTENNA POLARITY & TEST DISTANCE: HORIZONTAL AT 3 M			

	Freq	Level	Read Level	Limit Line	Over Limit	Factor	Remark	Pol/Phase
	MHz	dBm/m	dBm	dBm/m	dB	dB/m		
1	PP 1416.000	-29.21	-30.29	-13.00	-16.21	1.08	Peak	Horizontal
2	2127.000	-46.78	-54.45	-13.00	-33.78	7.67	Peak	Horizontal

