



TEST REPORT

No.I22N00716-SAR

For

HMD Global Oy

Smart Phone

Model Name: TA-1413

With

Hardware Version: V01

Software Version: 00WW_0_017

FCC ID: 2AJOTTA-1413

Issued Date: 2022-04-25

Designation Number: CN1210

Note:

The test results in this test report relate only to the devices specified in this report. This report shall not be reproduced except in full without the written approval of SAICT.

Test Laboratory:

SAICT, Shenzhen Academy of Information and Communications Technology

Building G, Shenzhen International Innovation Center, No.1006 Shennan Road, Futian District, Shenzhen, Guangdong, P. R. China 518000.

Tel:+86(0)755-33322000, Fax:+86(0)755-33322001

Email: yewu@caict.ac.cn. www.saict.ac.cn



REPORT HISTORY

Report Number	Revision	Description	Issue Date
I22N00716-SAR	Rev.0	1st edition	2022-04-25



TCONTENTS

1. SUMMARY OF TEST REPORT	5
1.1. TEST ITEMS	5
1.2. TEST STANDARDS	5
1.3. TEST RESULT.....	5
1.4. TESTING LOCATION	5
1.5. PROJECT DATA	5
1.6. SIGNATURE	5
2. STATEMENT OF COMPLIANCE	6
3. CLIENT INFORMATION	9
3.1. APPLICANT INFORMATION.....	9
3.2. MANUFACTURER INFORMATION	9
4. EQUIPMENT UNDER TEST (EUT) AND ANCILLARY EQUIPMENT (AE)	10
4.1. ABOUT EUT	10
4.2. INTERNAL IDENTIFICATION OF EUT USED DURING THE TEST	11
4.3. INTERNAL IDENTIFICATION OF AE USED DURING THE TEST	11
5. TEST METHODOLOGY	12
5.1. APPLICABLE LIMIT REGULATIONS.....	12
5.2. APPLICABLE MEASUREMENT STANDARDS	12
6. SPECIFIC ABSORPTION RATE (SAR).....	13
6.1. INTRODUCTION.....	13
6.2. SAR DEFINITION.....	13
7. TISSUE SIMULATING LIQUIDS	14
7.1. TARGETS FOR TISSUE SIMULATING LIQUID	14
7.2. DIELECTRIC PERFORMANCE	14
8. SYSTEM VERIFICATION	19
8.1. SYSTEM SETUP.....	19
8.2. SYSTEM VERIFICATION	20
9. MEASUREMENT PROCEDURES	21
9.1. TESTS TO BE PERFORMED.....	21
9.2. GENERAL MEASUREMENT PROCEDURE	23
9.3. WCDMA MEASUREMENT PROCEDURES FOR SAR	24
9.4. SAR MEASUREMENT FOR LTE.....	25
9.5. BLUETOOTH & WLAN MEASUREMENT PROCEDURES FOR SAR.....	25
9.6. POWER DRIFT.....	26
10. CONDUCTED OUTPUT POWER	27



10.1. GSM MEASUREMENT RESULT 27

10.2. WCDMA MEASUREMENT RESULT 29

10.3. LTE MEASUREMENT RESULT 32

10.4. BLUETOOTH AND WLAN MEASUREMENT RESULT 72

11. SIMULTANEOUS TX SAR CONSIDERATIONS 74

11.1. INTRODUCTION 74

11.2. TRANSMIT ANTENNA SEPARATION DISTANCES 74

11.3. SAR MEASUREMENT POSITIONS 75

12. EVALUATION OF SIMULTANEOUS 76

13. SUMMARY OF TEST RESULTS 77

13.1. TESTING ENVIRONMENT 77

13.2. SAR RESULTS 78

13.3. WLAN EVALUATION FOR 2.4G 91

13.4. WLAN EVALUATION FOR 5G 93

13.5. PRODUCT SPECIFIC 10G SAR 95

14. SAR MEASUREMENT VARIABILITY 96

15. MEASUREMENT UNCERTAINTY 97

15.1. MEASUREMENT UNCERTAINTY FOR NORMAL SAR TESTS (300MHz~3GHz) 97

15.2. MEASUREMENT UNCERTAINTY FOR NORMAL SAR TESTS (3GHz~6GHz) 98

16. MAIN TEST INSTRUMENTS 99

ANNEX A: GRAPH RESULTS 100

ANNEX B: SYSTEM VERIFICATION RESULTS 131

ANNEX C: SAR MEASUREMENT SETUP 140

ANNEX D: POSITION OF THE WIRELESS DEVICE IN RELATION TO THE PHANTOM 146

ANNEX E: EQUIVALENT MEDIA RECIPES 149

ANNEX F: SYSTEM VALIDATION 150

ANNEX G: DAE CALIBRATION CERTIFICATE 151

ANNEX H: PROBE CALIBRATION CERTIFICATE 154

ANNEX I: DIPOLE CALIBRATION CERTIFICATE 172

ANNEX J: EXTENDED CALIBRATION SAR DIPOLE 228



1. Summary of Test Report

1.1. Test Items

Description: Smart Phone
Model Name: TA-1413
Applicant's Name: HMD Global Oy
Manufacturer's Name: HMD Global Oy

1.2. Test Standards

ANSI C95.1:1992, IEEE 1528:2013

1.3. Test Result

Pass. Please refer to "13. Summary of Test Results"

1.4. Testing Location

Address: Building G, Shenzhen International Innovation Center, No.1006 Shennan Road,
Futian District, Shenzhen, Guangdong, P. R. China

1.5. Project Data

Testing Start Date: 2022-03-25

Testing End Date: 2022-04-20

1.6. Signature

Li Yongfu

(Prepared this test report)

Zhang Yunzhan

(Reviewed this test report)

Cao Junfei

(Approved this test report)



2. Statement of Compliance

The maximum results of Specific Absorption Rate (SAR) found during testing for HMD Global Oy Smart Phone TA-1413 are as follows:

Table 2.1: Highest Reported SAR for Head (1g)

Exposure Configuration	Technology Band	Highest Reported SAR 1g(W/Kg)	Equipment Class
Head (Separation Distance 0mm)	GSM850	0.27	PCE
	PCS1900	0.08	
	WCDMA Band 2	0.14	
	WCDMA Band 4	0.22	
	WCDMA Band 5	0.26	
	LTE Band 2	0.13	
	LTE Band 5	0.26	
	LTE Band 7	0.10	
	LTE Band 12	0.18	
	LTE Band 13	0.17	
	LTE Band 28	0.18	
	LTE Band 66	0.13	
	Bluetooth	0.05	
	WLAN 2.4GHz	0.27	DTS
	WLAN 5GHz	0.17	NII

Table 2.2: Highest Reported SAR for Hotspot (1g)

Exposure Configuration	Technology Band	Highest Reported SAR 1g(W/Kg)	Equipment Class
Hotspot (Separation Distance 10mm)	GSM850	0.43	PCE
	PCS1900	1.06	
	WCDMA Band 2	1.08	
	WCDMA Band 4	1.02	
	WCDMA Band 5	0.35	
	LTE Band 2	1.17	
	LTE Band 5	0.31	
	LTE Band 7	0.69	
	LTE Band 12	0.30	
	LTE Band 13	0.28	
	LTE Band 28	0.38	
	LTE Band 66	1.03	
	Bluetooth	0.01	
	WLAN 2.4GHz	0.07	DTS
	WLAN 5GHz	0.22	NII

Table 2.3: Highest Reported SAR for Body-worn (1g)

Exposure Configuration	Technology Band	Highest Reported SAR 1g(W/Kg)	Equipment Class
Body-worn (Separation Distance 10/15mm)	GSM850	0.43	PCE
	PCS1900	0.65	
	WCDMA Band 2	0.66	
	WCDMA Band 4	0.94	
	WCDMA Band 5	0.35	
	LTE Band 2	0.73	
	LTE Band 5	0.31	
	LTE Band 7	0.69	
	LTE Band 12	0.27	
	LTE Band 13	0.28	
	LTE Band 28	0.38	
	LTE Band 66	0.67	
	Bluetooth	0.01	
	WLAN 2.4GHz	0.06	DTS
	WLAN 5GHz	0.17	NII

Table 2.4: Highest Reported Extremity SAR (10g)

Exposure Configuration	Technology Band	Highest Reported SAR 10g(W/Kg)	Equipment Class
Extremity (Separation Distance 0mm)	WLAN 5GHz	0.59	NII

The SAR values found for the Mobile Phone are below the maximum recommended levels of 1.6 W/Kg as averaged over any 1g tissue according to the ANSI C95.1-1992.

The measurement together with the test system set-up is described in annex C of this test report. A detailed description of the equipment under test can be found in chapter 4 of this test report.

The highest reported SAR value is obtained at the case of **(Table 2.1 & 2.2 & 2.3 & 2.4)**, Head value is **0.27 kg (1g)**, Hotspot value is **1.17 kg (1g)**, Body-worn value is **0.94 kg (1g)** and Extremity SAR value is **0.59g (10g)**.

Table 2.5: The sum of reported SAR values for WWAN antenna and WLAN antenna

/	Position	WWAN (W/kg)	WLAN (W/kg)	Sum (W/kg)
Highest reported SAR value for Head	Left Cheek	0.26 (WCDMA Band 5)	0.27 (WLAN 2.4G)	0.53
Highest reported SAR value for Hotspot	Bottom Side	1.17 (LTE Band 2)	/	1.17
Highest reported SAR value for Body-worn	Rear Side	0.94 (WCDMA Band 4)	0.17 (WLAN 5G)	1.13

Note: the test positions of above tables are for the worse case that has been evaluated.

Table 2.6: The sum of reported SAR values for WWAN antenna and Bluetooth antenna

/	Position	WWAN (W/kg)	Bluetooth (W/kg)	Sum (W/kg)
Highest reported SAR value for Head	Left Cheek	0.26 (WCDMA Band 5)	0.05	0.31
Highest reported SAR value for Hotspot	Bottom Side	1.17 (LTE Band 2)	/	1.17
Highest reported SAR value for Body-worn	Rear Side	0.94 (WCDMA Band 4)	0.01	0.95

Note: the test positions of above tables are for the worse case that has been evaluated.

According to the above tables, the highest sum of reported SAR values is **1.17 W/kg (1g)**.

The detail for simultaneous transmission consideration is described in chapter 12.



3. Client Information

3.1. Applicant Information

Company Name:	HMD Global Oy
Address:	Bertel Jungin aukio 9, 02600,
City:	Espoo
Country:	Finland
Telephone:	+393 31 6272922

3.2. Manufacturer Information

Company Name:	HMD Global Oy
Address:	Bertel Jungin aukio 9, 02600,
City:	Espoo
Country:	Finland
Telephone:	+393 31 6272922

4. Equipment under Test (EUT) and Ancillary Equipment (AE)

4.1. About EUT

Description:	Smart Phone
Model Name:	TA-1413
Condition of EUT as received:	No obvious damage in appearance
Frequency Bands:	GSM850, PCS1900, WCDMA Band 2/4/5, LTE Band 2/4/5/7/12/13/17/28/66, Bluetooth, WLAN 2.4GHz, WLAN 5GHz
Tested Tx Frequency:	824 – 849MHz (GSM850)
	1850 – 1910MHz (PCS1900)
	1850 – 1910MHz (WCDMA Band 2)
	1710 – 1755MHz (WCDMA Band 4)
	824 – 849MHz (WCDMA Band 5)
	1850 – 1910MHz (LTE Band 2)
	1710 – 1755MHz (LTE Band 4)
	824 – 849MHz (LTE Band 5)
	2500 – 2570MHz (LTE Band 7)
	699 – 716MHz (LTE Band 12)
	777 – 787MHz (LTE Band 13)
	704 – 716MHz (LTE Band 17)
	703 – 748MHz (LTE Band 28)
	1710 – 1780MHz (LTE Band 66)
	2402 – 2480MHz (Bluetooth)
2412 – 2462MHz (WLAN 2.4GHz)	
5150 – 5850MHz (WLAN 5GHz)	
Test device Production information:	Production unit
Device type:	Portable device
Antenna type:	Integrated antenna
Hotspot mode:	Support
Product Dimensions:	Long 164.8mm; Wide 75.89mm; Overall Diagonal 174.5mm
<p>Remark:</p> <ol style="list-style-type: none"> This device does not support DTM operation. This device WLAN 5GHz U-NII-2A and U-NII-2C don't support hotspot operation. There is one power reduction level of WWAN antenna. Detail descriptions of the power reduction mechanism are included in the operational description. For WWAN transmitter. <ol style="list-style-type: none"> Hotspot/Body-Worn exposure conditions: Reduced power level 1 – WCDMA Band 2/4, LTE Band 4/7/66 While the device is transmitting at the WWAN antenna and receiver is not working, power reduction enabled for those bands. 	

4.2. Internal Identification of EUT used during the test

EUT ID*	IMEI	HW Version	SW Version	Receipt Date
UT04aa	355400570002884	V01	00WW_0_017	2022-03-24
UT05aa	355400570002868	V01	00WW_0_017	2022-03-24
UT06aa	355400570002686	V01	00WW_0_017	2022-03-24
UT07aa	355400570003163	V01	00WW_0_017	2022-03-24
UT11aa	355400570002363	V01	00WW_0_017	2022-03-24

*EUT ID: is used to identify the test sample in the lab internally.

Note: It is performed to test SAR with the UT06aa & UT07aa & UT11aa, and conducted power with the UT04aa & UT05aa.

4.3. Internal Identification of AE used during the test

AE ID*	Description	Model	Manufacturer
AE1	Battery	GH6581	Shenzhen Aerospace Electronic CO., Ltd.
AE2	Headset	JWEP1199-M01H	JUWEI ELECTRONICS CO.,LTD

*AE ID: is used to identify the test sample in the lab internally.



5. Test Methodology

5.1. Applicable Limit Regulations

ANSI C95.1:1992 IEEE Standard for Safety Levels with Respect to Human Exposure to Radio Frequency Electromagnetic Fields, 3 kHz to 300 GHz.

It specifies the maximum exposure limit of **1.6 W/kg** as averaged over any 1 gram of tissue for portable devices being used within 20 cm of the user in the uncontrolled environment.

5.2. Applicable Measurement Standards

IEEE 1528:2013 Recommended Practice for Determining the Peak Spatial-Average Specific Absorption Rate (SAR) in the Human Head from Wireless Communications Devices: Experimental Techniques.

KDB 447498 D01 General RF Exposure Guidance v06 RF Exposure Procedures and Equipment Authorization Policies for Mobile and Portable Devices

KDB 648474 D04 Handset SAR v01r03 SAR Evaluation Considerations for Wireless Handsets.

KDB 941225 D01 SAR test for 3G devices v03r01 SAR Measurement Procedures for 3G Devices

KDB 941225 D05 SAR for LTE Devices v02r05 SAR Evaluation Considerations for LTE Devices

KDB 941225 D06 Hot Spot SAR v02r01 SAR Evaluation Procedures for Portable Devices with Wireless Router Capabilities

KDB 248227 D01 802.11 Wi-Fi SAR v02r02 SAR Guidance for IEEE 802.11 (Wi-Fi) Transmitters.

KDB 865664 D01 SAR measurement 100 MHz to 6 GHz v01r04 SAR Measurement Requirements for 100 MHz to 6 GHz

KDB 865664 D02 RF Exposure Reporting v01r02 RF Exposure Compliance Reporting and Documentation Considerations

KDB 941225 D07 UMPC Mini Tablet v01r02 SAR Evaluation Procedures for UMPC Mini-Tablet Devices

TCB workshop April 2019; RF Exposure Procedures (Tissue Simulating Liquids)

6. Specific Absorption Rate (SAR)

6.1. Introduction

SAR is related to the rate at which energy is absorbed per unit mass in an object exposed to a radio field. The SAR distribution in a biological body is complicated and is usually carried out by experimental techniques or numerical modeling. The standard recommends limits for two tiers of groups, occupational/controlled and general population/uncontrolled, based on a person's awareness and ability to exercise control over his or her exposure. In general, occupational/controlled exposure limits are higher than the limits for general population/uncontrolled.

6.2. SAR Definition

The SAR definition is the time derivative (rate) of the incremental energy (dW) absorbed by (dissipated in) an incremental mass (dm) contained in a volume element (dv) of a given density (ρ). The equation description is as below:

$$SAR = \frac{d}{dt} \left(\frac{dW}{dm} \right) = \frac{d}{dt} \left(\frac{dW}{\rho dv} \right)$$

SAR is expressed in units of Watts per kilogram (W/kg)

SAR measurement can be either related to the temperature elevation in tissue by

$$SAR = c \left(\frac{\delta T}{\delta t} \right)$$

Where: C is the specific heat capacity, δT is the temperature rise and δt is the exposure duration, or related to the electrical field in the tissue by

$$SAR = \frac{\sigma |E|^2}{\rho}$$

Where: σ is the conductivity of the tissue, ρ is the mass density of tissue and E is the RMS electrical field strength.

However for evaluating SAR of low power transmitter, electrical field measurement is typically applied.

7. Tissue Simulating Liquids

7.1. Targets for tissue simulating liquid

Table 7.1: Targets for tissue simulating liquid

Frequency (MHz)	Liquid Type	Conductivity (σ)	$\pm 5\%$ Range	Permittivity (ϵ)	$\pm 5\%$ Range
750	Head	0.89	0.85~0.93	41.9	39.8~44.0
835	Head	0.90	0.86~0.95	41.5	39.4~43.6
1750	Head	1.37	1.30~1.44	40.1	38.1~42.1
1900	Head	1.40	1.33~1.47	40.0	38.0~42.0
2450	Head	1.80	1.71~1.89	39.2	37.2~41.2
2550	Head	1.91	1.81~2.01	39.1	37.1~41.0
5250	Head	4.71	4.47~4.95	35.9	34.1~37.7
5600	Head	5.07	4.82~5.32	35.5	33.8~37.3
5750	Head	5.22	4.96~5.48	35.4	33.6~37.1

7.2. Dielectric Performance

Table 7.2: Dielectric Performance of Tissue Simulating Liquid

Measurement Date (yyyy-mm-dd)	Type	Frequency (MHz)	Conductivity σ (S/m)	Drift (%)	Permittivity ϵ	Drift (%)
2022-03-25	Head	750	0.903	1.46	40.51	-3.32
2022-03-26	Head	835	0.916	1.78	40.24	-3.04
2022-04-17	Head	1750	1.358	-0.88	39.60	-1.25
2022-04-15	Head	1900	1.425	1.79	39.27	-1.82
2022-04-09	Head	2450	1.843	2.39	38.25	-2.42
2022-04-20	Head	2550	1.932	1.15	37.94	-2.97
2022-04-10	Head	5250	4.658	-1.10	36.74	2.34
2022-04-10	Head	5600	4.975	-1.87	36.37	2.45
2022-04-10	Head	5750	5.316	1.84	34.88	-1.47

Note: The liquid temperature is 22.0°C.

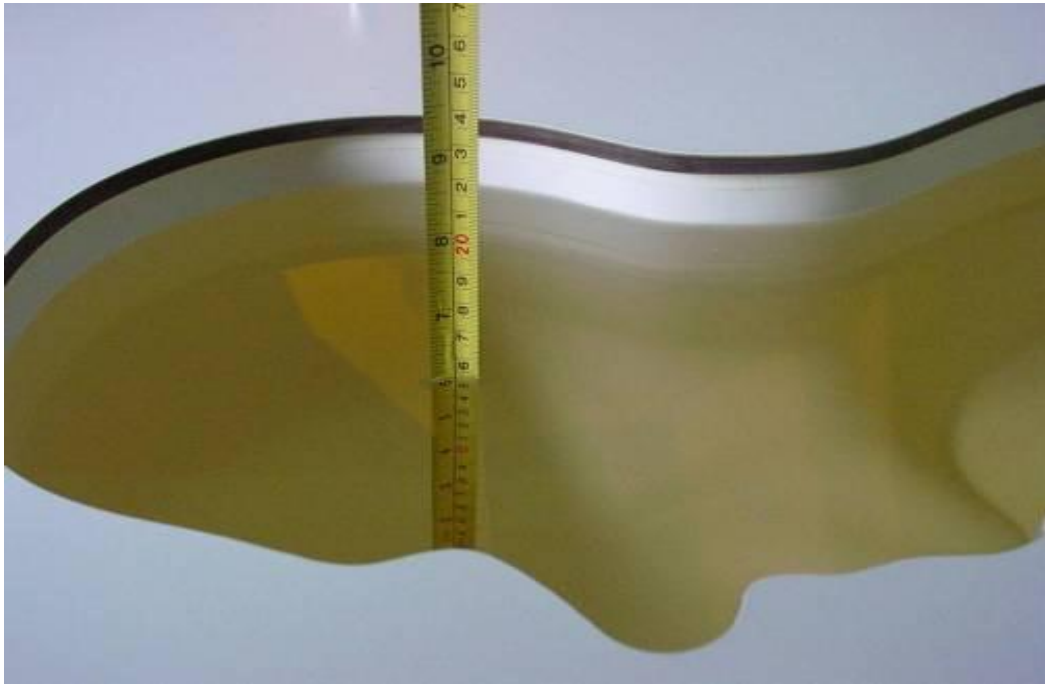

Picture 7-1: Liquid depth in the Head Phantom (750MHz)



Picture 7-2: Liquid depth in the Head Phantom (835MHz)

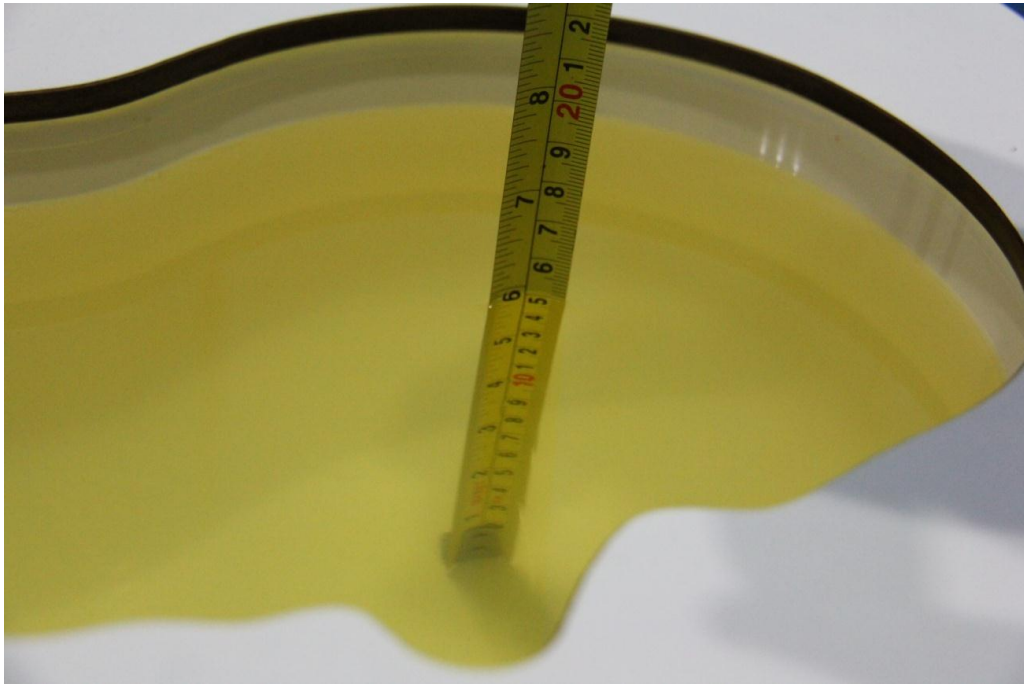

Picture 7-3: Liquid depth in the Head Phantom (1750MHz)



Picture 7-4: Liquid depth in the Head Phantom (1900MHz)

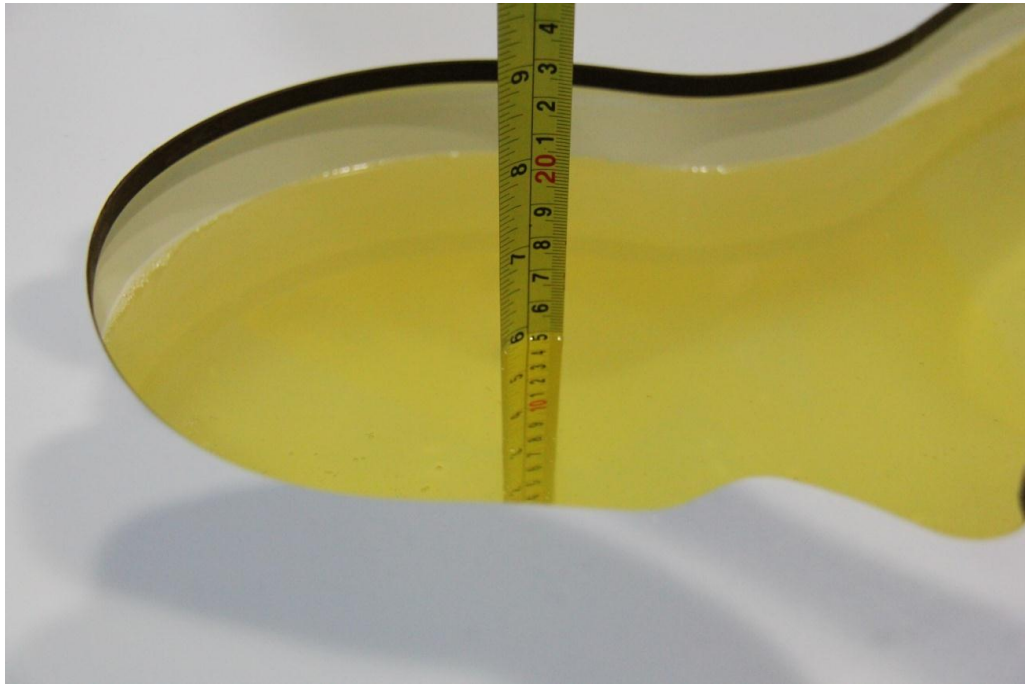

Picture 7-5: Liquid depth in the Head Phantom(2450MHz)

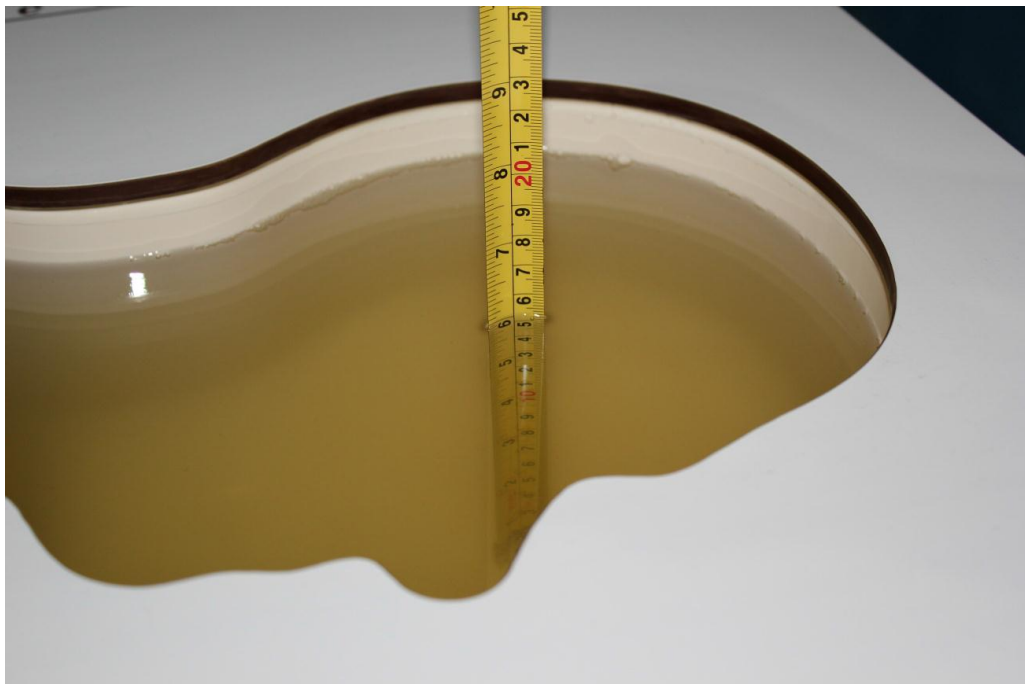

Picture 7-6: Liquid depth in the Head Phantom(2550MHz)



Picture 7-7: Liquid depth in the Head Phantom(5GHz)

8. System verification

8.1. System Setup

In the simplified setup for system evaluation, the DUT is replaced by a calibrated dipole and the power source is replaced by a continuous wave that comes from a signal generator. The calibrated dipole must be placed beneath the flat phantom section of the SAM twin phantom with the correct distance holder. The distance holder should touch the phantom surface with a light pressure at the reference marking and be oriented parallel to the long side of the phantom. The equipment setup is shown below:

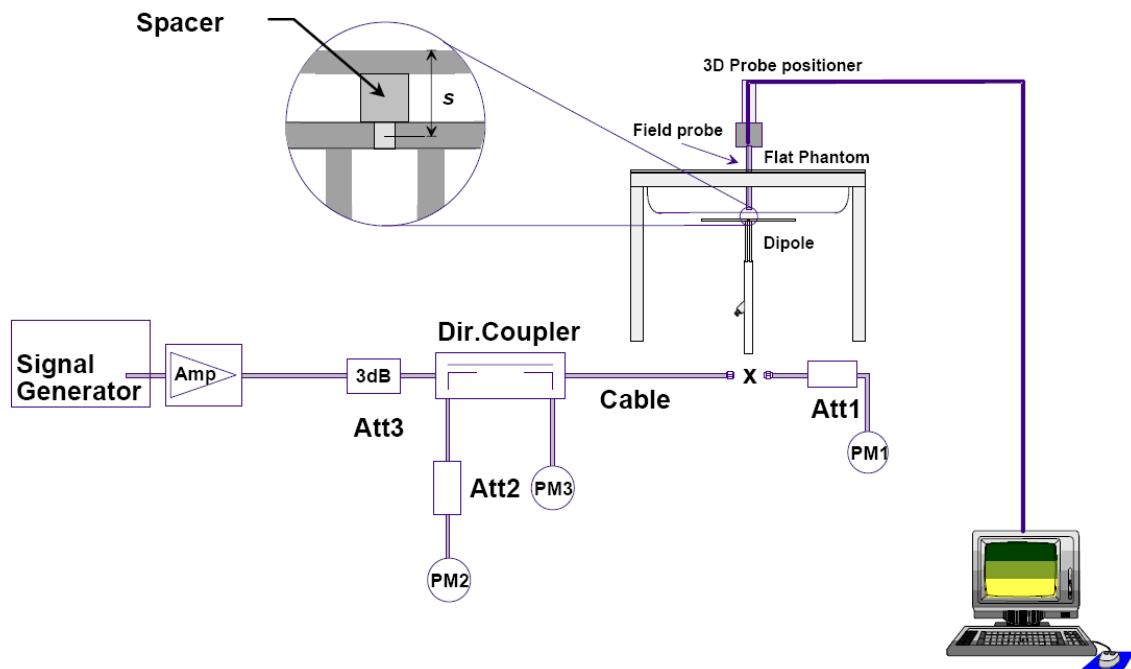

Picture 8.1 System Setup for System Evaluation

For the dipole below 3GHz, the output power on dipole port must be calibrated to 24 dBm (250mW) before dipole is connected.

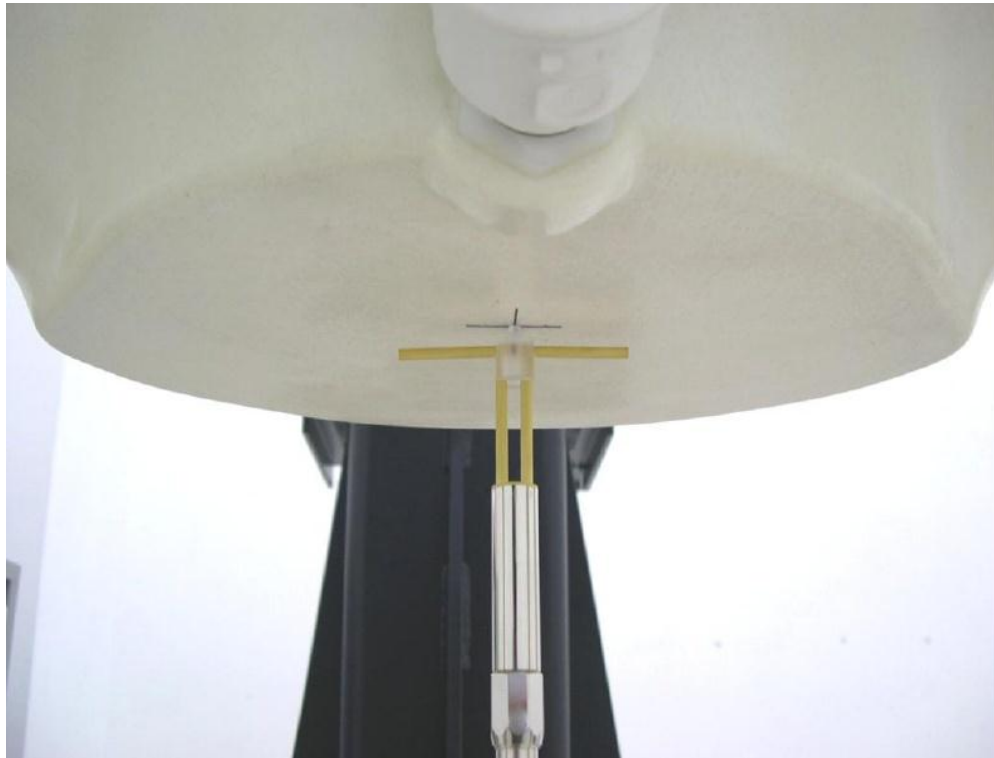

Picture 8.2 Photo of Dipole Setup

8.2. System Verification

SAR system verification is required to confirm measurement accuracy, according to the tissue dielectric media, probe calibration points and other system operating parameters required for measuring the SAR of a test device. The system verification must be performed for each frequency band and within the valid range of each probe calibration point required for testing the device.

Table 8.1: System Verification of Head

Measurement Date	Frequency (MHz)	Target value (W/kg)		Measured value (W/kg)				Deviation (%)	
		10 g	1 g	/		Normalize to 1W		10 g	1 g
				10 g	1 g	10 g	1 g		
2022-03-25	750	5.70	8.53	1.44	2.20	5.76	8.80	1.05	3.17
2022-03-26	835	6.29	9.64	1.61	2.49	6.44	9.96	2.38	3.32
2022-04-17	1750	19.30	36.40	4.74	8.82	18.96	35.28	-1.76	-3.08
2022-04-15	1900	20.50	40.20	5.22	10.4	20.88	41.60	1.85	3.48
2022-04-09	2450	24.20	53.20	6.25	13.9	25.00	55.60	3.31	4.51
2022-04-20	2550	25.20	55.90	6.37	14.3	25.48	57.20	1.11	2.33
2022-04-10	5250	22.30	78.00	2.20	7.62	22.00	76.20	-1.35	-2.31
2022-04-10	5600	22.70	79.50	2.21	7.59	22.10	75.90	-2.64	-4.53
2022-04-10	5750	22.20	78.40	2.26	8.14	22.60	81.40	1.80	3.83

9. Measurement Procedures

9.1. Tests to be performed

In order to determine the highest value of the peak spatial-average SAR of a handset, all device positions, configurations and operational modes shall be tested for each frequency band according to steps 1 to 3 below. A flowchart of the test process is shown in picture 9.1.

Step 1: The tests described in 9.2 shall be performed at the channel that is closest to the center of the transmit frequency band (f_c) for:

- a) all device positions (cheek and tilt, for both left and right sides of the SAM phantom, as described in annex D),
- b) all configurations for each device position in a), e.g., antenna extended and retracted, and
- c) all operational modes, e.g., analogue and digital, for each device position in a) and configuration in b) in each frequency band.

If more than three frequencies need to be tested according to 11.1 (i.e., $N_c > 3$), then all frequencies, configurations and modes shall be tested for all of the above test conditions.

Step 2: For the condition providing highest peak spatial-average SAR determined in Step 1, perform all tests described in 9.2 at all other test frequencies, i.e., lowest and highest frequencies. In addition, for all other conditions (device position, configuration and operational mode) where the peak spatial-average SAR value determined in Step 1 is within 3 dB of the applicable SAR limit, it is recommended that all other test frequencies shall be tested as well.

Step 3: Examine all data to determine the highest value of the peak spatial-average SAR found in Steps 1 to 2.

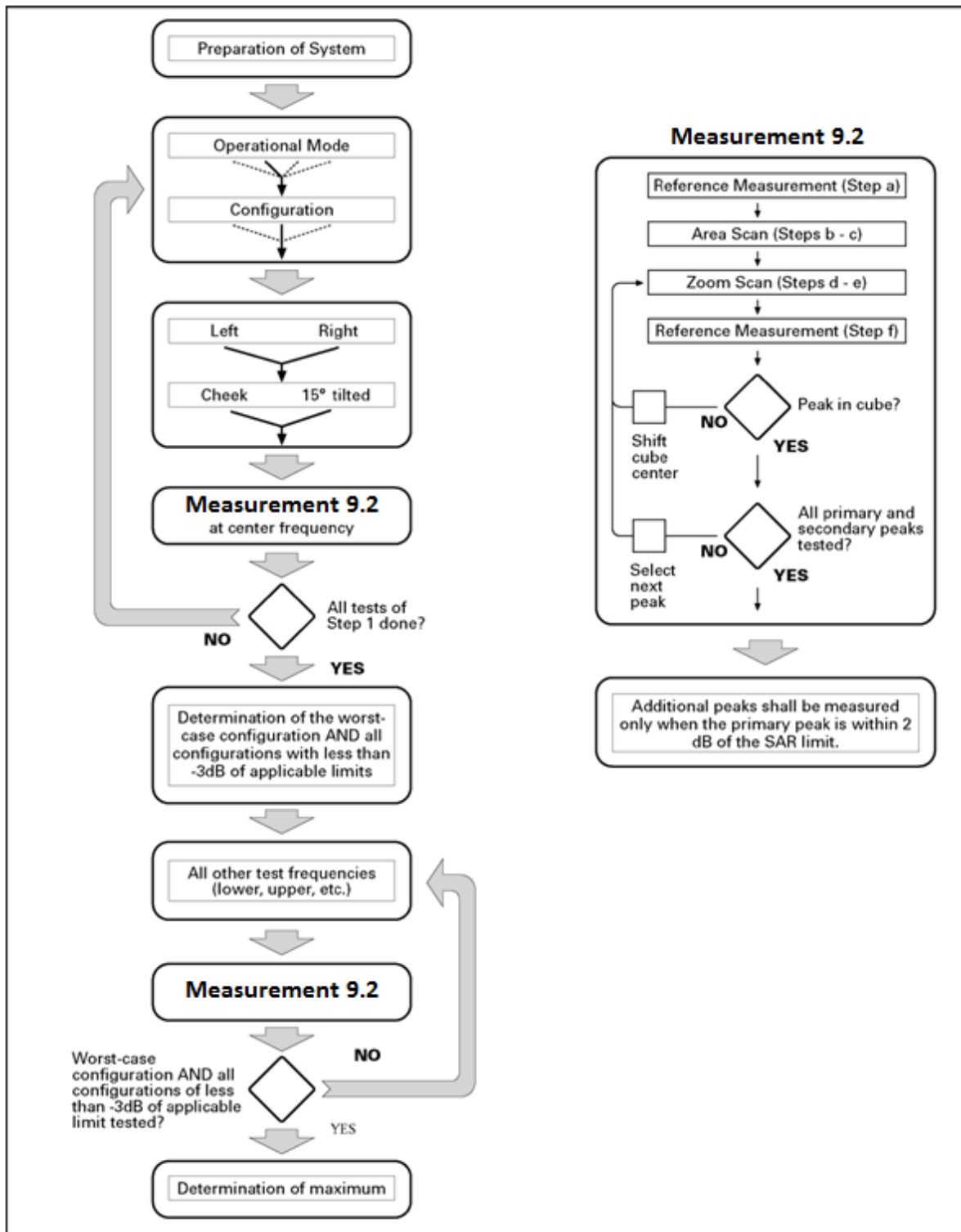

Picture 9.1 Block diagram of the tests to be performed

9.2. General Measurement Procedure

The area and zoom scan resolutions specified in the table below must be applied to the SAR measurements and fully documented in SAR reports to qualify for TCB approval. Probe boundary effect error compensation is required for measurements with the probe tip closer than half a probe tip diameter to the phantom surface. Both the probe tip diameter and sensor offset distance must satisfy measurement protocols; to ensure probe boundary effect errors are minimized and the higher fields closest to the phantom surface can be correctly measured and extrapolated to the phantom surface for computing 1-g SAR. Tolerances of the post-processing algorithms must be verified by the test laboratory for the scan resolutions used in the SAR measurements, according to the reference distribution functions specified in IEEE Std 1528-2013. The results should be documented as part of the system validation records and may be requested to support test results when all the measurement parameters in the following table are not satisfied.

		≤ 3 GHz	> 3 GHz	
Maximum distance from closest measurement point (geometric center of probe sensors) to phantom surface		5 ± 1 mm	$\frac{1}{2} \cdot \delta \cdot \ln(2) \pm 0.5$ mm	
Maximum probe angle from probe axis to phantom surface normal at the measurement location		$30^\circ \pm 1^\circ$	$20^\circ \pm 1^\circ$	
Maximum area scan spatial resolution: Δx_{Area} , Δy_{Area}		≤ 2 GHz: ≤ 15 mm 2 – 3 GHz: ≤ 12 mm	3 – 4 GHz: ≤ 12 mm 4 – 6 GHz: ≤ 10 mm	
		When the x or y dimension of the test device, in the measurement plane orientation, is smaller than the above, the measurement resolution must be \leq the corresponding x or y dimension of the test device with at least one measurement point on the test device.		
Maximum zoom scan spatial resolution: Δx_{Zoom} , Δy_{Zoom}		≤ 2 GHz: ≤ 8 mm 2 – 3 GHz: ≤ 5 mm*	3 – 4 GHz: ≤ 5 mm* 4 – 6 GHz: ≤ 4 mm*	
Maximum zoom scan spatial resolution, normal to phantom surface	uniform grid: $\Delta z_{Zoom}(n)$	≤ 5 mm	3 – 4 GHz: ≤ 4 mm 4 – 5 GHz: ≤ 3 mm 5 – 6 GHz: ≤ 2 mm	
	graded grid	$\Delta z_{Zoom}(1)$: between 1 st two points closest to phantom surface	≤ 4 mm	3 – 4 GHz: ≤ 3 mm 4 – 5 GHz: ≤ 2.5 mm 5 – 6 GHz: ≤ 2 mm
		$\Delta z_{Zoom}(n>1)$: between subsequent points	$\leq 1.5 \cdot \Delta z_{Zoom}(n-1)$	
Minimum zoom scan volume	x, y, z	≥ 30 mm	3 – 4 GHz: ≥ 28 mm 4 – 5 GHz: ≥ 25 mm 5 – 6 GHz: ≥ 22 mm	
Note: δ is the penetration depth of a plane-wave at normal incidence to the tissue medium; see draft standard IEEE P1528-2011 for details. * When zoom scan is required and the <i>reported</i> SAR from the area scan based 1-g SAR estimation procedures of KDB 447498 is ≤ 1.4 W/kg, ≤ 8 mm, ≤ 7 mm and ≤ 5 mm zoom scan resolution may be applied, respectively, for 2 GHz to 3 GHz, 3 GHz to 4 GHz and 4 GHz to 6 GHz.				

9.3. WCDMA Measurement Procedures for SAR

The following procedures are applicable to WCDMA handsets operating under 3GPP Release99, Release 5 and Release 6. The default test configuration is to measure SAR with an established radio link between the DUT and a communication test set using a 12.2kbps RMC (reference measurement channel) configured in Test Loop Mode 1. SAR is selectively confirmed for other physical channel configurations (DPCCH & DPDCH_n), HSDPA and HSPA (HSUPA/HSDPA) modes according to output power, exposure conditions and device operating capabilities. Both uplink and downlink should be configured with the same RMC or AMR, when required. SAR for Release 5 HSDPA and Release 6 HSPA are measured using the applicable FRC (fixed reference channel) and E-DCH reference channel configurations. Maximum output power is verified according to applicable versions of 3GPP TS 34.121 and SAR must be measured according to these maximum output conditions. When Maximum Power Reduction (MPR) is not implemented according to Cubic Metric (CM) requirements for Release 6 HSPA, the following procedures do not apply.

For Release 5 HSDPA Data Devices:

Sub-test	β_c	β_d	β_d (SF)	β_c / β_d	β_{hs}	CM/dB
1	2/15	15/15	64	2/15	4/15	0.0
2	12/15	15/15	64	12/15	24/25	1.0
3	15/15	8/15	64	15/8	30/15	1.5
4	15/15	4/15	64	15/4	30/15	1.5

For Release 6 HSPA Data Devices

Sub-test	β_c	β_d	β_d (SF)	β_c / β_d	β_{hs}	β_{ec}	β_{ed}	β_{ed} (SF)	β_{ed} (codes)	CM (dB)	MPR (dB)	AG Index	E-TFCI
1	11/15	15/15	64	11/15	22/15	209/225	1039/225	4	1	1.0	0.0	20	75
2	6/15	15/15	64	6/15	12/15	12/15	12/15	4	1	3.0	2.0	12	67
3	15/15	9/15	64	15/9	30/15	30/15	$\beta_{ed1}:47/1$ 5 $\beta_{ed2}:47/15$	4	2	2.0	1.0	15	92
4	2/15	15/15	64	2/15	4/15	4/15	56/75	4	1	3.0	2.0	17	71
5	15/15	15/15	64	15/15	24/15	30/15	134/15	4	1	1.0	0.0	21	81

9.4. SAR Measurement for LTE

SAR tests for LTE are performed with a base station simulator, Anristu MT8820C. Closed loop power control was used so the UE transmits with maximum output power during SAR testing. All powers were measured with the Anristu MT8820C. It is performed for conducted power and SAR based on the KDB941225 D05.

SAR is evaluated separately according to the following procedures for the different test positions in each exposure condition – head, body, body-worn accessories and other use conditions. The procedures in the following subsections are applied separately to test each LTE frequency band.

1) QPSK with 1 RB allocation

Start with the largest channel bandwidth and measure SAR for QPSK with 1 RB allocation, using the RB offset and required test channel combination with the highest maximum output power among RB offsets at the upper edge, middle and lower edge of each required test channel. When the reported SAR is ≤ 0.8 W/kg, testing of the remaining RB offset configurations and required test channels is not required for 1 RB allocation; otherwise, SAR is required for the remaining required test channels and only for the RB offset configuration with the highest output power for that channel. When the reported SAR of a required test channel is > 1.45 W/kg, SAR is required for all three RB offset configurations for that required test channel.

2) QPSK with 50% RB allocation

The procedures required for 1 RB allocation in 1) are applied to measure the SAR for QPSK with 50% RB allocation.

3) QPSK with 100% RB allocation

For QPSK with 100% RB allocation, SAR is not required when the highest maximum output power for 100 % RB allocation is less than the highest maximum output power in 50% and 1 RB allocations and the highest reported SAR for 1 RB and 50% RB allocation in 1) and 2) are ≤ 0.8 W/kg. Otherwise, SAR is measured for the highest output power channel; and if the reported SAR is > 1.45 W/kg, the remaining required test channels must also be tested.

9.5. Bluetooth & WLAN Measurement Procedures for SAR

Normal network operating configurations are not suitable for measuring the SAR of 802.11 transmitters in general. Unpredictable fluctuations in network traffic and antenna diversity conditions can introduce undesirable variations in SAR results. The SAR for these devices should be measured using chipset based test mode software to ensure that the results are consistent and reliable.

Chipset based test mode software is hardware dependent and generally varies among manufacturers. The device operating parameters established in a test mode for SAR measurements must be identical to those programmed in production units, including output power levels, amplifier gain settings and other RF performance tuning parameters. The test frequencies should correspond to actual channel frequencies defined for domestic use. SAR for devices with switched diversity should be measured with only one antenna transmitting at a time during each SAR measurement, according to a fixed modulation and data rate. The same data pattern should be used for all measurements.



9.6. Power Drift

To control the output power stability during the SAR test, DASY5 system calculates the power drift by measuring the E-field at the same location at the beginning and at the end of the measurement for each test position. These drift values can be found in Section 14 labeled as: (Power Drift [dB]). This ensures that the power drift during one measurement is within 5%.

10. Conducted Output Power

10.1. GSM Measurement result

During the process of testing, the EUT was controlled via Agilent Digital Radio Communication tester (E5515C) to ensure the maximum power transmission and proper modulation. This result contains conducted output power for the EUT. In all cases, the measured peak output power should be greater and within 5% than EMI measurement.

Table 10.1: The conducted power measurement results for GSM / GPRS/ EGPRS

GSM 850 Speech	Tune up	Measured Power (dBm)			calculation	Averaged Power (dBm)		
		Ch.251	Ch.190	Ch.128		Ch.251	Ch.190	Ch.128
1Tx slot	33.0	31.92	31.99	31.96	/	/	/	/
GPRS850/ EGPRS850	/	Measured Power (dBm)			calculation	Averaged Power (dBm)		
		Ch.251	Ch.190	Ch.128		Ch.251	Ch.190	Ch.128
1Tx-slots	33.0	31.90	31.99	31.92	-9.03dB	22.87	22.96	22.89
2Tx-slots	31.5	30.81	30.93	31.01	-6.02dB	24.79	24.91	24.99
3Tx-slots	29.5	28.96	29.04	29.12	-4.26dB	24.70	24.78	24.86
4Tx-slots	28.5	27.83	27.86	28.04	-3.01dB	24.82	24.85	25.03
EGPRS 850 (8PSK)	/	Measured Power (dBm)			calculation	Averaged Power (dBm)		
		Ch.251	Ch.190	Ch.128		Ch.251	Ch.190	Ch.128
1Tx-slots	26.5	25.93	25.87	25.63	-9.03dB	16.90	16.84	16.60
2Tx-slots	25.5	24.04	24.49	24.44	-6.02dB	18.02	18.47	18.42
3Tx-slots	22.5	21.45	21.96	21.86	-4.26dB	17.19	17.70	17.60
4Tx-slots	20.5	19.01	19.61	19.35	-3.01dB	16.00	16.60	16.34

GSM 1900 Speech	Tune up	Measured Power (dBm)			calculation	Averaged Power (dBm)		
		Ch.810	Ch.661	Ch.512		Ch.810	Ch.661	Ch.512
1Tx slot	30.5	29.17	29.28	29.35	/	/	/	/
GPRS1900/ EGPRS1900	/	Measured Power (dBm)			calculation	Averaged Power (dBm)		
		Ch.810	Ch.661	Ch.512		Ch.810	Ch.661	Ch.512
1Tx-slots	30.5	29.15	29.22	29.30	-9.03dB	20.12	20.19	20.27
2Tx-slots	29.5	27.72	27.96	28.23	-6.02dB	21.70	21.94	22.21
3Tx-slots	27.5	26.12	26.38	26.65	-4.26dB	21.86	22.12	22.39
4Tx-slots	26.5	25.05	25.26	25.54	-3.01dB	22.04	22.25	22.53
EGPRS1900 (8PSK)	/	Measured Power (dBm)			calculation	Averaged Power (dBm)		
		Ch.810	Ch.661	Ch.512		Ch.810	Ch.661	Ch.512
1Tx-slots	26.5	25.78	23.38	25.65	-9.03dB	16.75	14.35	16.62
2Tx-slots	24.5	23.73	23.45	23.69	-6.02dB	17.71	17.43	17.67
3Tx-slots	22.5	21.82	21.54	22.03	-4.26dB	17.56	17.28	17.77
4Tx-slots	21.0	20.10	19.78	20.27	-3.01dB	17.09	16.77	17.26

Notes:

1) Division Factors

To average the power, the division factor is as follows:

1TX-slot = 1 transmit time slot out of 8 time slots=> conducted power divided by (8/1) => -9.03dB

2TX-slots = 2 transmit time slots out of 8 time slots=> conducted power divided by (8/2) => -6.02dB

3TX-slots = 3 transmit time slots out of 8 time slots=> conducted power divided by (8/3) => -4.26dB

4TX-slots = 4 transmit time slots out of 8 time slots=> conducted power divided by (8/4) => -3.01dB

According to the conducted power as above, the body measurements are performed with 4Tx slots for GSM850 and GSM1900.

10.2. WCDMA Measurement result

Table 10.2: The conducted power measurement results WCDMA

Normal Power					
Item	band	WCDMA Band 2			
	ARFCN	Tune up	Ch.9538 (1907.6MHz)	Ch.9400 (1880MHz)	Ch.9262 (1852.4MHz)
WCDMA	\	24.0	22.90	22.90	23.10
HSUPA	1	21.0	19.70	19.80	19.90
	2	21.5	20.20	20.30	20.50
	3	21.0	19.90	20.00	20.20
	4	21.5	20.50	20.50	20.80
	5	23.5	22.30	22.50	22.60
HSDPA	1	23.5	22.40	22.60	22.70
	2	23.5	22.00	22.20	22.40
	3	23.0	21.90	22.00	22.10
	4	23.0	21.90	22.00	22.10
DC-HSDPA	1	23.5	22.60	22.60	22.60
	2	23.5	22.10	22.20	22.30
	3	23.0	21.90	22.00	22.10
	4	23.0	21.80	21.80	21.90
Reduced power level 1					
Item	band	WCDMA Band 2			
	ARFCN	Tune up	Ch.9538 (1907.6MHz)	Ch.9400 (1880MHz)	Ch.9262 (1852.4MHz)
WCDMA	\	22.5	21.50	21.50	21.60
HSUPA	1	19.5	18.30	18.50	18.70
	2	20.0	18.90	19.00	19.20
	3	19.5	18.60	18.70	18.90
	4	20.0	19.10	19.40	19.40
	5	22.0	21.10	21.20	21.20
HSDPA	1	22.0	21.10	21.20	21.20
	2	22.0	20.80	20.90	21.00
	3	21.5	20.60	20.70	20.80
	4	21.5	20.60	20.70	20.80
DC-HSDPA	1	22.0	21.10	21.10	21.10
	2	22.0	20.90	20.90	21.00
	3	21.5	20.60	20.70	20.80
	4	21.5	20.70	20.70	20.70

Normal Power					
Item	band	WCDMA Band 4			
	ARFCN	Tune up	Ch.1513 (1752.6MHz)	Ch.1413 (1732.6MHz)	Ch.1312 (1712.4MHz)
WCDMA	\	24.0	22.80	22.80	22.80
HSUPA	1	22.5	21.80	21.70	21.70
	2	23.0	22.10	21.90	21.90
	3	22.5	21.80	21.70	21.60
	4	23.0	22.30	22.10	22.30
	5	23.5	22.60	22.40	22.60
HSDPA	1	23.5	22.60	22.40	22.50
	2	23.5	22.60	22.30	22.60
	3	23.0	22.60	22.30	22.50
	4	23.0	22.40	22.30	22.50
DC-HSDPA	1	23.5	22.50	22.50	22.50
	2	23.5	22.60	22.40	22.50
	3	23.0	22.50	22.30	22.40
	4	23.0	22.50	22.30	22.30
Reduced power level 1					
Item	band	WCDMA Band 4			
	ARFCN	Tune up	Ch.1513 (1752.6MHz)	Ch.1413 (1732.6MHz)	Ch.1312 (1712.4MHz)
WCDMA	\	21.0	19.80	19.90	19.90
HSUPA	1	19.5	18.80	18.70	18.80
	2	20.0	19.20	19.00	19.00
	3	19.5	18.90	18.70	17.90
	4	20.0	19.30	19.20	19.40
	5	20.5	19.60	19.50	19.60
HSDPA	1	20.5	19.70	19.50	19.60
	2	20.5	19.70	19.60	19.70
	3	20.0	19.60	19.50	19.70
	4	20.0	19.70	19.50	19.70
DC-HSDPA	1	20.5	19.50	19.50	19.60
	2	20.5	19.50	19.60	19.70
	3	20.0	19.50	19.50	19.50
	4	20.0	19.40	19.50	19.60



Item	band	WCDMA Band 5			
	ARFCN	Tune up	Ch.4233 (846.6MHz)	Ch.4183 (836.6MHz)	Ch.4132 (826.4MHz)
WCDMA	\	24.0	22.80	22.80	22.80
HSUPA	1	21.0	19.70	19.90	20.10
	2	21.5	20.00	20.10	20.40
	3	21.0	19.70	19.80	20.10
	4	21.5	19.80	19.90	20.20
	5	23.0	21.90	22.10	22.30
HSDPA	1	23.0	21.70	21.90	22.10
	2	23.0	21.30	21.60	21.80
	3	22.5	20.90	21.20	21.50
	4	22.5	20.90	21.20	21.40
DC-HSDPA	1	23.0	21.80	21.90	22.00
	2	23.0	21.40	21.60	21.80
	3	22.5	21.00	21.20	21.50
	4	22.5	20.90	21.10	21.20

10.3. LTE Measurement result

According to April 2015 TCB workshop, SAR Test exclusion can be applied for testing overlapping LTE Bands as follows:

- a) The maximum out power, including tolerance, for the smaller band must be \leq the larger band to qualify for SAR test exclusion.
- b) The channel bandwidth and other operating parameters for the smaller band must be fully supported by the larger band.

LTE Band 4 (1710-1755MHz) is covered by LTE Band 66 (1710-1780MHz)

LTE Band 17 (704-716MHz) is covered by LTE Band 12 (699-716MHz)

Table 10.3: The conducted Power for LTE

LTE Band 2			Actual output Power (dBm)			Tune up		
Band -width	RB No. / RB offset	Frequency (MHz)	Modulation			Modulation		
			QPSK	16QAM	64QAM	QPSK	16QAM	64QAM
1.4 MHz	1RB_5	1909.3	23.27	22.33	/	24.0	23.0	/
		1880.0	23.18	22.05	/			
		1850.7	23.03	22.74	/			
	1RB_3	1909.3	23.26	22.24	/			
		1880.0	23.04	22.11	/			
		1850.7	22.99	22.76	/			
	1RB_0	1909.3	23.20	22.31	/			
		1880.0	23.16	22.15	/			
		1850.7	22.98	22.66	/			
	3RB_3	1909.3	23.33	22.49	/			
		1880.0	23.01	22.21	/			
		1850.7	23.16	22.38	/			
	3RB_1	1909.3	23.33	22.50	/			
		1880.0	23.08	21.98	/			
		1850.7	23.13	22.44	/			
	3RB_0	1909.3	23.32	22.54	/			
		1880.0	23.17	21.97	/			
		1850.7	23.07	22.39	/			
6RB_0	1909.3	22.30	21.23	/	23.0	22.0	/	
	1880.0	22.06	21.02	/				
	1850.7	22.11	20.86	/				



LTE Band 2			Actual output Power (dBm)			Tune up		
Band -width	RB No. / RB offset	Frequency (MHz)	Modulation			Modulation		
			QPSK	16QAM	64QAM	QPSK	16QAM	64QAM
3 MHz	1RB_14	1908.5	23.25	22.40	/	24.0	23.0	/
		1880.0	23.00	22.06	/			
		1851.5	22.98	22.63	/			
	1RB_7	1908.5	23.28	22.39	/			
		1880.0	22.99	22.14	/			
		1851.5	22.89	22.68	/			
	1RB_0	1908.5	23.09	22.23	/	23.0	22.0	/
		1880.0	23.05	21.67	/			
		1851.5	23.00	22.66	/			
	8RB_7	1908.5	22.34	21.44	/			
		1880.0	22.12	21.40	/			
		1851.5	22.09	21.21	/			
	8RB_4	1908.5	22.38	21.43	/			
		1880.0	22.05	21.44	/			
		1851.5	22.14	21.29	/			
	8RB_0	1908.5	22.26	21.69	/			
		1880.0	22.00	21.12	/			
		1851.5	22.13	21.28	/			
15RB_0	1908.5	22.33	21.47	/				
	1880.0	22.03	21.10	/				
	1851.5	22.17	21.24	/				



LTE Band 2			Actual output Power (dBm)			Tune up			
Band -width	RB No. / RB offset	Frequency (MHz)	Modulation			Modulation			
			QPSK	16QAM	64QAM	QPSK	16QAM	64QAM	
5 MHz	1RB_24	1907.5	23.24	22.29	/	24.0	23.0	/	
		1880.0	22.97	22.12	/				
		1852.5	23.06	22.15	/				
	1RB_12	1907.5	23.19	22.23	/				
		1880.0	22.96	22.15	/				
		1852.5	23.00	22.15	/				
	1RB_0	1907.5	23.22	22.20	/				
		1880.0	22.97	22.16	/				
		1852.5	23.05	22.21	/				
	12RB_13	1907.5	22.38	21.43	/	23.0	22.0	/	
		1880.0	22.01	21.44	/				
		1852.5	22.13	21.15	/				
		12RB_6	1907.5	22.28	21.63				/
			1880.0	22.09	21.15				/
			1852.5	22.05	21.10				/
	12RB_0	1907.5	22.21	21.65	/				
		1880.0	22.13	21.16	/				
		1852.5	22.10	21.19	/				
25RB_0	1907.5	22.21	21.51	/					
	1880.0	21.99	21.35	/					
	1852.5	22.12	21.06	/					



LTE Band 2			Actual output Power (dBm)			Tune up			
Band -width	RB No. / RB offset	Frequency (MHz)	Modulation			Modulation			
			QPSK	16QAM	64QAM	QPSK	16QAM	64QAM	
10 MHz	1RB_49	1905.0	23.34	22.90	/	24.0	23.0	/	
		1880.0	23.12	22.65	/				
		1855.0	23.06	22.48	/				
	1RB_24	1905.0	23.14	22.64	/				
		1880.0	23.05	22.59	/				
		1855.0	23.10	22.56	/				
	1RB_0	1905.0	23.11	22.54	/				
		1880.0	23.09	22.63	/				
		1855.0	23.11	22.61	/				
	25RB_25	1905.0	22.31	21.55	/	23.0	22.0	/	
		1880.0	22.17	21.13	/				
		1855.0	22.11	21.34	/				
		25RB_12	1905.0	22.23	21.59				/
			1880.0	22.02	21.13				/
			1855.0	22.06	21.40				/
	25RB_0	1905.0	22.25	21.17	/				
		1880.0	22.02	21.09	/				
		1855.0	22.16	21.06	/				
50RB_0	1905.0	22.14	21.58	/					
	1880.0	22.03	21.18	/					
	1855.0	22.03	21.51	/					



LTE Band 2			Actual output Power (dBm)			Tune up		
Band -width	RB No. / RB offset	Frequency (MHz)	Modulation			Modulation		
			QPSK	16QAM	64QAM	QPSK	16QAM	64QAM
15 MHz	1RB_74	1902.5	23.25	22.79	/	24.0	23.0	/
		1880.0	23.08	22.78	/			
		1857.5	22.98	22.58	/			
	1RB_37	1902.5	22.95	22.69	/			
		1880.0	22.97	22.69	/			
		1857.5	22.99	22.62	/			
	1RB_0	1902.5	23.01	22.68	/	23.0	22.0	/
		1880.0	23.07	22.65	/			
		1857.5	22.98	22.70	/			
	36RB_38	1902.5	22.21	21.54	/			
		1880.0	22.14	21.04	/			
		1857.5	22.05	21.06	/			
	36RB_19	1902.5	22.21	21.24	/			
		1880.0	22.09	21.09	/			
		1857.5	22.15	21.47	/			
	36RB_0	1902.5	22.12	21.15	/			
		1880.0	22.07	21.12	/			
		1857.5	22.13	21.46	/			
75RB_0	1902.5	22.18	21.31	/				
	1880.0	22.11	21.17	/				
	1857.5	22.06	21.55	/				



LTE Band 2			Actual output Power (dBm)			Tune up			
Band -width	RB No. / RB offset	Frequency (MHz)	Modulation			Modulation			
			QPSK	16QAM	64QAM	QPSK	16QAM	64QAM	
20 MHz	1RB_99	1900.0	23.26	22.42	/	24.0	23.0	/	
		1880.0	23.30	22.28	/				
		1860.0	23.07	22.13	/				
	1RB_50	1900.0	22.92	22.12	/				
		1880.0	23.01	21.97	/				
		1860.0	22.98	22.05	/				
	1RB_0	1900.0	22.98	22.17	/				
		1880.0	23.12	22.15	/				
		1860.0	23.06	22.10	/				
	50RB_50	1900.0	22.26	21.61	/	23.0	22.0	/	
		1880.0	22.20	21.22	/				
		1860.0	22.14	21.46	/				
		50RB_25	1900.0	22.08	21.20				/
			1880.0	22.08	21.22				/
			1860.0	22.08	21.16				/
	50RB_0	1900.0	22.14	21.18	/				
		1880.0	22.19	21.19	/				
		1860.0	22.08	21.48	/				
100RB_0	1900.0	22.17	21.22	/					
	1880.0	22.08	21.17	/					
	1860.0	22.11	21.10	/					



LTE Band 5			Actual output Power (dBm)			Tune up		
Band -width	RB No. / RB offset	Frequency (MHz)	Modulation			Modulation		
			QPSK	16QAM	64QAM	QPSK	16QAM	64QAM
1.4 MHz	1RB_5	848.3	23.29	22.78	/	24.0	23.0	/
		836.5	23.25	22.70	/			
		824.7	23.27	22.77	/			
	1RB_3	848.3	23.28	22.87	/			
		836.5	23.28	22.74	/			
		824.7	23.25	22.89	/			
	1RB_0	848.3	23.23	22.62	/			
		836.5	23.26	22.86	/			
		824.7	23.28	22.81	/			
	3RB_3	848.3	23.40	22.83	/			
		836.5	23.36	22.57	/			
		824.7	23.33	22.69	/			
	3RB_1	848.3	23.45	22.85	/			
		836.5	23.45	22.55	/			
		824.7	23.47	22.61	/			
	3RB_0	848.3	23.39	22.43	/			
		836.5	23.41	22.54	/			
		824.7	23.34	22.62	/			
6RB_0	848.3	22.71	21.40	/	23.0	22.0	/	
	836.5	22.29	21.48	/				
	824.7	22.39	21.55	/				



LTE Band 5			Actual output Power (dBm)			Tune up			
Band -width	RB No. / RB offset	Frequency (MHz)	Modulation			Modulation			
			QPSK	16QAM	64QAM	QPSK	16QAM	64QAM	
3 MHz	1RB_14	847.5	23.26	22.88	/	24.0	23.0	/	
		836.5	23.29	22.72	/				
		825.5	23.40	22.76	/				
	1RB_7	847.5	23.28	22.85	/				
		836.5	23.29	22.68	/				
		825.5	23.23	22.66	/				
	1RB_0	847.5	23.21	22.83	/				
		836.5	23.20	22.75	/				
		825.5	23.31	22.24	/				
	8RB_7	8RB_7	847.5	22.60	21.76	/	23.0	22.0	/
			836.5	22.28	21.86	/			
			825.5	22.71	21.93	/			
		8RB_4	847.5	22.34	21.81	/			
			836.5	22.28	21.84	/			
			825.5	22.38	21.89	/			
	8RB_0	847.5	22.36	21.82	/				
		836.5	22.69	21.81	/				
		825.5	22.40	21.91	/				
15RB_0	15RB_0	847.5	22.36	21.85	/				
		836.5	22.39	21.77	/				
		825.5	22.33	21.83	/				



LTE Band 5			Actual output Power (dBm)			Tune up			
Band -width	RB No. / RB offset	Frequency (MHz)	Modulation			Modulation			
			QPSK	16QAM	64QAM	QPSK	16QAM	64QAM	
5 MHz	1RB_24	846.5	23.32	22.81	/	24.0	23.0	/	
		836.5	23.25	22.82	/				
		826.5	23.35	22.44	/				
	1RB_12	846.5	23.31	22.88	/				
		836.5	23.27	22.80	/				
		826.5	23.29	22.69	/				
	1RB_0	846.5	23.35	22.85	/				
		836.5	23.22	22.21	/				
		826.5	23.21	22.34	/				
	12RB_13	846.5	22.42	21.72	/	23.0	22.0	/	
		836.5	22.31	21.82	/				
		826.5	22.70	21.88	/				
		12RB_6	846.5	22.37	21.78				/
			836.5	22.36	21.76				/
			826.5	22.82	21.87				/
	12RB_0	846.5	22.37	21.78	/				
		836.5	22.75	21.78	/				
		826.5	22.40	21.80	/				
25RB_0	846.5	22.29	21.70	/					
	836.5	22.38	21.91	/					
	826.5	22.86	21.94	/					



LTE Band 5			Actual output Power (dBm)			Tune up		
Band -width	RB No. / RB offset	Frequency (MHz)	Modulation			Modulation		
			QPSK	16QAM	64QAM	QPSK	16QAM	64QAM
10 MHz	1RB_49	844.0	23.36	22.68	/	24.0	23.0	/
		836.5	23.46	22.79	/			
		829.0	23.53	22.91	/			
	1RB_24	844.0	23.20	22.68	/			
		836.5	23.37	22.72	/			
		829.0	23.46	22.86	/			
	1RB_0	844.0	23.25	22.87	/			
		836.5	23.43	22.87	/			
		829.0	23.40	22.75	/			
	25RB_25	844.0	22.47	21.78	/	23.0	22.0	/
		836.5	22.42	21.92	/			
		829.0	22.55	21.79	/			
	25RB_12	844.0	22.77	21.70	/			
		836.5	22.42	21.95	/			
		829.0	22.45	21.45	/			
	25RB_0	844.0	22.38	21.25	/			
		836.5	22.78	21.95	/			
		829.0	22.87	21.77	/			
50RB_0	844.0	22.77	21.79	/				
	836.5	22.38	21.75	/				
	829.0	22.46	21.45	/				



Normal Power								
LTE Band 7			Actual output Power (dBm)			Tune up		
Band -width	RB No. / RB offset	Frequency (MHz)	Modulation			Modulation		
			QPSK	16QAM	64QAM	QPSK	16QAM	64QAM
5 MHz	1RB_24	2567.5	22.14	21.69	/	23.5	22.5	/
		2535.0	22.16	21.72	/			
		2502.5	22.41	22.00	/			
	1RB_12	2567.5	22.08	21.70	/			
		2535.0	22.21	21.89	/			
		2502.5	22.35	21.94	/			
	1RB_0	2567.5	22.01	21.76	/			
		2535.0	22.13	21.96	/			
		2502.5	22.40	21.93	/			
	12RB_13	2567.5	21.22	20.40	/	22.5	21.5	/
		2535.0	21.31	20.43	/			
		2502.5	21.52	20.67	/			
	12RB_6	2567.5	21.31	20.41	/			
		2535.0	21.35	20.48	/			
		2502.5	21.58	20.72	/			
	12RB_0	2567.5	21.19	20.47	/			
		2535.0	21.30	20.48	/			
		2502.5	21.42	20.56	/			
25RB_0	2567.5	21.22	20.57	/				
	2535.0	21.34	20.41	/				
	2502.5	21.53	20.81	/				



Normal Power								
LTE Band 7			Actual output Power (dBm)			Tune up		
Band -width	RB No. / RB offset	Frequency (MHz)	Modulation			Modulation		
			QPSK	16QAM	64QAM	QPSK	16QAM	64QAM
10 MHz	1RB_49	2565.0	22.11	21.70	/	23.5	22.5	/
		2535.0	22.20	22.11	/			
		2505.0	22.38	22.21	/			
	1RB_24	2565.0	22.09	21.70	/			
		2535.0	22.22	21.92	/			
		2505.0	22.39	22.12	/			
	1RB_0	2565.0	22.11	21.68	/			
		2535.0	22.19	21.88	/			
		2505.0	22.32	22.10	/			
	25RB_25	2565.0	21.25	20.34	/	22.5	21.5	/
		2535.0	21.26	20.40	/			
		2505.0	21.61	20.63	/			
	25RB_12	2565.0	21.24	20.39	/			
		2535.0	21.38	20.43	/			
		2505.0	21.58	20.63	/			
	25RB_0	2565.0	21.19	20.32	/			
		2535.0	21.38	20.41	/			
		2505.0	21.50	20.58	/			
50RB_0	2565.0	21.23	20.35	/				
	2535.0	21.23	20.45	/				
	2505.0	21.53	20.71	/				



Normal Power								
LTE Band 7			Actual output Power (dBm)			Tune up		
Band -width	RB No. / RB offset	Frequency (MHz)	Modulation			Modulation		
			QPSK	16QAM	64QAM	QPSK	16QAM	64QAM
15 MHz	1RB_74	2562.5	22.12	22.04	/	23.5	22.5	/
		2535.0	22.15	21.74	/			
		2507.5	22.39	21.93	/			
	1RB_37	2562.5	22.05	22.10	/			
		2535.0	22.13	21.74	/			
		2507.5	22.32	21.85	/			
	1RB_0	2562.5	22.02	22.07	/			
		2535.0	22.16	21.73	/			
		2507.5	22.29	22.21	/			
	36RB_38	2562.5	21.30	20.46	/	22.5	21.5	/
		2535.0	21.27	20.61	/			
		2507.5	21.65	20.62	/			
	36RB_19	2562.5	21.28	20.35	/			
		2535.0	21.29	20.64	/			
		2507.5	21.50	20.69	/			
	36RB_0	2562.5	21.10	20.30	/			
		2535.0	21.27	20.53	/			
		2507.5	21.57	20.64	/			
75RB_0	2562.5	21.18	20.52	/				
	2535.0	21.32	20.50	/				
	2507.5	21.50	20.75	/				



Normal Power								
LTE Band 7			Actual output Power (dBm)			Tune up		
Band -width	RB No. / RB offset	Frequency (MHz)	Modulation			Modulation		
			QPSK	16QAM	64QAM	QPSK	16QAM	64QAM
20 MHz	1RB_99	2560.0	22.21	21.63	/	23.5	22.5	/
		2535.0	22.37	21.72	/			
		2510.0	22.35	21.68	/			
	1RB_50	2560.0	22.03	21.46	/			
		2535.0	22.22	21.51	/			
		2510.0	22.32	21.62	/			
	1RB_0	2560.0	21.94	21.47	/			
		2535.0	22.20	21.56	/			
		2510.0	22.34	21.84	/			
	50RB_50	2560.0	21.19	20.43	/	22.5	21.5	/
		2535.0	21.28	20.43	/			
		2510.0	21.55	20.65	/			
	50RB_25	2560.0	21.17	20.25	/			
		2535.0	21.23	20.43	/			
		2510.0	21.43	20.70	/			
	50RB_0	2560.0	21.16	20.34	/			
		2535.0	21.15	20.36	/			
		2510.0	21.50	20.61	/			
100RB_0	2560.0	21.20	20.40	/				
	2535.0	21.38	20.40	/				
	2510.0	21.52	20.61	/				



Reduced power level 1								
LTE Band 7			Actual output Power (dBm)			Tune up		
Band -width	RB No. / RB offset	Frequency (MHz)	Modulation			Modulation		
			QPSK	16QAM	64QAM	QPSK	16QAM	64QAM
5 MHz	1RB_24	2567.5	20.41	20.05	/	21.0	21.0	/
		2535.0	20.36	20.09	/			
		2502.5	20.50	20.29	/			
	1RB_12	2567.5	20.26	20.05	/			
		2535.0	20.33	20.16	/			
		2502.5	20.55	20.29	/			
	1RB_0	2567.5	20.29	20.06	/			
		2535.0	20.38	20.14	/			
		2502.5	20.56	20.38	/			
	12RB_13	2567.5	19.46	17.53	/	20.0	19.0	/
		2535.0	19.48	17.22	/			
		2502.5	19.65	17.40	/			
	12RB_6	2567.5	19.34	17.68	/			
		2535.0	19.53	17.43	/			
		2502.5	19.76	17.54	/			
	12RB_0	2567.5	19.43	17.54	/			
		2535.0	19.45	17.35	/			
		2502.5	19.78	17.42	/			
	25RB_0	2567.5	19.48	17.56	/			
		2535.0	19.53	17.29	/			
		2502.5	19.65	17.43	/			



Reduced power level 1								
LTE Band 7			Actual output Power (dBm)			Tune up		
Band -width	RB No. / RB offset	Frequency (MHz)	Modulation			Modulation		
			QPSK	16QAM	64QAM	QPSK	16QAM	64QAM
10 MHz	1RB_49	2565.0	20.34	20.13	/	21.0	21.0	/
		2535.0	20.41	20.14	/			
		2505.0	20.65	20.33	/			
	1RB_24	2565.0	20.33	20.03	/			
		2535.0	20.39	20.15	/			
		2505.0	20.53	20.27	/			
	1RB_0	2565.0	20.20	20.03	/			
		2535.0	20.35	20.16	/			
		2505.0	20.63	20.27	/			
	25RB_25	2565.0	19.39	17.93	/	20.0	19.0	/
		2535.0	19.51	17.58	/			
		2505.0	19.61	17.73	/			
	25RB_12	2565.0	19.39	17.77	/			
		2535.0	19.50	17.37	/			
		2505.0	19.64	17.27	/			
	25RB_0	2565.0	19.39	17.78	/			
		2535.0	19.54	17.40	/			
		2505.0	19.60	17.11	/			
	50RB_0	2565.0	19.46	17.87	/			
		2535.0	19.46	17.46	/			
		2505.0	19.60	17.39	/			



Reduced power level 1								
LTE Band 7			Actual output Power (dBm)			Tune up		
Band -width	RB No. / RB offset	Frequency (MHz)	Modulation			Modulation		
			QPSK	16QAM	64QAM	QPSK	16QAM	64QAM
15 MHz	1RB_74	2562.5	20.28	20.24	/	21.0	21.0	/
		2535.0	20.36	19.90	/			
		2507.5	20.46	20.37	/			
	1RB_37	2562.5	20.17	20.17	/			
		2535.0	20.34	19.81	/			
		2507.5	20.45	20.37	/			
	1RB_0	2562.5	20.22	20.16	/			
		2535.0	20.28	19.92	/			
		2507.5	20.55	20.43	/			
	36RB_38	2562.5	19.49	17.88	/	20.0	19.0	/
		2535.0	19.44	17.42	/			
		2507.5	19.65	17.97	/			
	36RB_19	2562.5	19.47	17.90	/			
		2535.0	19.55	17.40	/			
		2507.5	19.59	17.49	/			
	36RB_0	2562.5	19.47	18.25	/			
		2535.0	19.49	17.68	/			
		2507.5	19.67	17.33	/			
75RB_0	2562.5	19.44	18.08	/				
	2535.0	19.56	17.57	/				
	2507.5	19.63	17.67	/				



Reduced power level 1								
LTE Band 7			Actual output Power (dBm)			Tune up		
Band -width	RB No. / RB offset	Frequency (MHz)	Modulation			Modulation		
			QPSK	16QAM	64QAM	QPSK	16QAM	64QAM
20 MHz	1RB_99	2560.0	20.40	20.29	/	21.0	21.0	/
		2535.0	20.54	20.00	/			
		2510.0	20.55	20.03	/			
	1RB_50	2560.0	20.32	20.13	/			
		2535.0	20.45	19.85	/			
		2510.0	20.53	20.01	/			
	1RB_0	2560.0	20.33	20.12	/			
		2535.0	20.48	19.98	/			
		2510.0	20.57	20.03	/			
	50RB_50	2560.0	19.43	18.26	/	20.0	19.0	/
		2535.0	19.51	17.74	/			
		2510.0	19.76	18.02	/			
	50RB_25	2560.0	19.35	18.31	/			
		2535.0	19.44	17.62	/			
		2510.0	19.67	17.38	/			
	50RB_0	2560.0	19.31	18.82	/			
		2535.0	19.48	18.11	/			
		2510.0	19.58	17.14	/			
100RB_0	2560.0	19.47	18.54	/				
	2535.0	19.49	17.92	/				
	2510.0	19.64	17.60	/				



LTE Band 12			Actual output Power (dBm)			Tune up		
Band -width	RB No. / RB offset	Frequency (MHz)	Modulation			Modulation		
			QPSK	16QAM	64QAM	QPSK	16QAM	64QAM
1.4 MHz	1RB_5	715.3	23.62	22.84	/	24.0	23.0	/
		707.5	23.33	22.63	/			
		699.7	23.59	22.70	/			
	1RB_3	715.3	23.64	22.81	/			
		707.5	23.33	22.66	/			
		699.7	23.59	22.68	/			
	1RB_0	715.3	23.64	22.73	/			
		707.5	23.34	22.63	/			
		699.7	23.59	22.72	/			
	3RB_3	715.3	23.83	22.97	/			
		707.5	23.40	22.58	/			
		699.7	23.81	22.99	/			
	3RB_1	715.3	23.77	22.98	/			
		707.5	23.38	22.74	/			
		699.7	23.73	22.83	/			
	3RB_0	715.3	23.76	22.83	/			
		707.5	23.41	22.58	/			
		699.7	23.72	22.88	/			
6RB_0	715.3	22.78	21.52	/	23.0	22.0	/	
	707.5	22.37	21.19	/				
	699.7	22.77	21.55	/				



LTE Band 12			Actual output Power (dBm)			Tune up			
Band -width	RB No. / RB offset	Frequency (MHz)	Modulation			Modulation			
			QPSK	16QAM	64QAM	QPSK	16QAM	64QAM	
3 MHz	1RB_14	714.5	23.66	22.71	/	24.0	23.0	/	
		707.5	23.19	22.67	/				
		700.5	23.63	22.79	/				
	1RB_7	714.5	23.67	22.66	/				
		707.5	23.23	22.72	/				
		700.5	23.59	22.64	/				
	1RB_0	714.5	23.61	22.65	/				
		707.5	23.27	22.62	/				
		700.5	23.55	22.75	/				
	8RB_7	714.5	22.69	21.93	/	23.0	22.0	/	
		707.5	22.43	21.52	/				
		700.5	22.83	21.90	/				
		8RB_4	714.5	22.71	21.79				/
			707.5	22.30	21.43				/
			700.5	22.73	21.85				/
	8RB_0	714.5	22.78	21.69	/				
		707.5	22.41	21.83	/				
		700.5	22.71	21.76	/				
15RB_0	714.5	22.84	21.80	/					
	707.5	22.24	21.55	/					
	700.5	22.71	21.82	/					



LTE Band 12			Actual output Power (dBm)			Tune up		
Band -width	RB No. / RB offset	Frequency (MHz)	Modulation			Modulation		
			QPSK	16QAM	64QAM	QPSK	16QAM	64QAM
5 MHz	1RB_24	713.5	23.78	22.79	/	24.0	23.0	/
		707.5	23.30	22.62	/			
		701.5	23.26	22.49	/			
	1RB_12	713.5	23.72	22.81	/			
		707.5	23.22	22.74	/			
		701.5	23.58	22.69	/			
	1RB_0	713.5	23.72	22.89	/	23.0	22.0	/
		707.5	23.24	22.76	/			
		701.5	23.58	22.69	/			
	12RB_13	713.5	22.77	21.76	/			
		707.5	22.40	21.38	/			
		701.5	22.73	21.76	/			
	12RB_6	713.5	22.79	21.79	/			
		707.5	22.32	21.32	/			
		701.5	22.81	21.80	/			
	12RB_0	713.5	22.68	21.77	/			
		707.5	22.32	21.74	/			
		701.5	22.72	21.70	/			
25RB_0	713.5	22.83	21.67	/				
	707.5	22.61	21.72	/				
	701.5	22.73	21.79	/				



LTE Band 12			Actual output Power (dBm)			Tune up		
Band -width	RB No. / RB offset	Frequency (MHz)	Modulation			Modulation		
			QPSK	16QAM	64QAM	QPSK	16QAM	64QAM
10 MHz	1RB_49	711.0	23.80	22.81	/	24.0	23.0	/
		707.5	23.77	22.74	/			
		704.0	23.35	22.39	/			
	1RB_24	711.0	23.21	22.79	/			
		707.5	23.28	22.41	/			
		704.0	23.28	22.41	/			
	1RB_0	711.0	23.27	22.30	/			
		707.5	23.58	22.73	/			
		704.0	23.66	22.64	/			
	25RB_25	711.0	22.85	21.89	/	23.0	22.0	/
		707.5	22.88	21.97	/			
		704.0	22.30	21.97	/			
	25RB_12	711.0	22.76	21.95	/			
		707.5	22.34	21.41	/			
		704.0	22.47	21.61	/			
	25RB_0	711.0	22.51	21.55	/			
		707.5	22.35	21.98	/			
		704.0	22.84	21.93	/			
50RB_0	711.0	22.76	21.78	/				
	707.5	22.37	21.49	/				
	704.0	22.49	21.38	/				

LTE Band 13			Actual output Power (dBm)			Tune up					
Band -width	RB No. / RB offset	Frequency (MHz)	Modulation			Modulation					
			QPSK	16QAM	64QAM	QPSK	16QAM	64QAM			
5 MHz	1RB_24	784.5	23.41	22.74	/	24.0	23.0	/			
		782.0	23.34	22.33	/						
		779.5	23.32	22.47	/						
	1RB_12	784.5	23.41	22.78	/						
		782.0	23.31	22.56	/						
		779.5	23.37	22.15	/						
	1RB_0	784.5	23.35	22.93	/	23.0	22.0	/			
		782.0	23.23	22.21	/						
		779.5	23.39	22.39	/						
	12RB_13	784.5	22.45	21.38	/						
		782.0	22.40	21.52	/						
		779.5	22.31	21.48	/						
	12RB_6	784.5	22.25	21.57	/	23.0	22.0	/			
		782.0	22.57	21.55	/						
		779.5	22.39	21.54	/						
	12RB_0	784.5	22.46	21.51	/						
		782.0	22.33	21.56	/						
		779.5	22.48	21.40	/						
25RB_0	784.5	22.22	21.47	/	23.0	22.0	/				
	782.0	22.47	21.67	/							
	779.5	22.30	21.71	/							
LTE Band 13			Actual output Power (dBm)					Tune up			
Band -width	RB No. / RB offset	Frequency (MHz)	Modulation					Modulation			
			QPSK	16QAM				64QAM	QPSK	16QAM	64QAM
10 MHz	1RB_49	782.0	23.32	22.38	/	24.0	23.0	/			
	1RB_24	782.0	23.34	22.51	/						
	1RB_0	782.0	23.39	22.39	/						
	25RB_25	782.0	22.31	21.76	/	23.0	22.0	/			
	25RB_12	782.0	22.50	21.73	/						
	25RB_0	782.0	22.37	21.71	/						
	50RB_0	782.0	22.52	21.55	/						



LTE Band 28			Actual output Power (dBm)			Tune up			
Band -width	RB No. / RB offset	Frequency (MHz)	Modulation			Modulation			
			QPSK	16QAM	64QAM	QPSK	16QAM	64QAM	
3 MHz	1RB_14	746.5	23.01	22.73	/	24.0	23.0	/	
		719.5	23.13	22.68	/				
		704.5	23.59	22.74	/				
	1RB_7	746.5	23.09	22.77	/				
		719.5	23.14	22.84	/				
		704.5	23.31	22.75	/				
	1RB_0	746.5	23.19	22.60	/				
		719.5	23.49	22.83	/				
		704.5	23.26	22.75	/				
	8RB_7	746.5	22.63	21.77	/	23.0	22.0	/	
		719.5	22.73	21.80	/				
		704.5	22.74	21.91	/				
		8RB_4	746.5	22.63	21.76				/
			719.5	22.78	21.82				/
			704.5	22.45	21.82				/
	8RB_0	746.5	22.24	21.77	/				
		719.5	22.78	21.82	/				
		704.5	22.43	21.79	/				
15RB_0	746.5	22.64	21.73	/					
	719.5	22.77	21.78	/					
	704.5	22.48	21.74	/					



LTE Band 28			Actual output Power (dBm)			Tune up			
Band -width	RB No. / RB offset	Frequency (MHz)	Modulation			Modulation			
			QPSK	16QAM	64QAM	QPSK	16QAM	64QAM	
5 MHz	1RB_24	745.5	23.07	22.86	/	24.0	23.0	/	
		720.5	23.46	22.72	/				
		705.5	23.58	22.67	/				
	1RB_12	745.5	23.18	22.81	/				
		720.5	23.05	22.68	/				
		705.5	23.56	22.68	/				
	1RB_0	745.5	23.02	22.79	/				
		720.5	23.45	22.65	/				
		705.5	23.07	22.31	/				
	12RB_13	745.5	22.67	21.71	/	23.0	22.0	/	
		720.5	22.74	21.71	/				
		705.5	22.74	21.77	/				
		12RB_6	745.5	22.22	21.67				/
			720.5	22.62	21.70				/
			705.5	22.83	21.78				/
	12RB_0	745.5	22.31	21.68	/				
		720.5	22.68	21.71	/				
		705.5	22.31	21.82	/				
25RB_0	745.5	22.27	21.55	/					
	720.5	22.65	21.61	/					
	705.5	22.80	21.95	/					



LTE Band 28			Actual output Power (dBm)			Tune up		
Band -width	RB No. / RB offset	Frequency (MHz)	Modulation			Modulation		
			QPSK	16QAM	64QAM	QPSK	16QAM	64QAM
10 MHz	1RB_49	743.0	23.12	22.80	/	24.0	23.0	/
		723.0	23.37	22.67	/			
		708.0	23.42	22.46	/			
	1RB_24	743.0	23.10	22.74	/			
		723.0	23.69	22.68	/			
		708.0	23.70	22.75	/			
	1RB_0	743.0	23.05	22.59	/			
		723.0	23.62	22.66	/			
		708.0	23.36	22.33	/			
	25RB_25	743.0	22.33	21.81	/	23.0	22.0	/
		723.0	22.75	21.97	/			
		708.0	22.84	21.98	/			
	25RB_12	743.0	22.70	21.80	/			
		723.0	22.72	21.86	/			
		708.0	22.71	21.93	/			
	25RB_0	743.0	22.59	21.80	/			
		723.0	22.70	21.79	/			
		708.0	22.76	21.89	/			
50RB_0	743.0	22.64	21.70	/				
	723.0	22.77	21.72	/				
	708.0	22.75	21.74	/				



LTE Band 28			Actual output Power (dBm)			Tune up		
Band -width	RB No. / RB offset	Frequency (MHz)	Modulation			Modulation		
			QPSK	16QAM	64QAM	QPSK	16QAM	64QAM
15 MHz	1RB_74	740.5	23.15	22.76	/	24.0	23.0	/
		725.5	23.19	22.87	/			
		710.5	23.64	22.82	/			
	1RB_37	740.5	23.09	22.75	/			
		725.5	23.45	22.81	/			
		710.5	23.27	22.76	/			
	1RB_0	740.5	23.44	22.34	/			
		725.5	23.42	22.79	/			
		710.5	23.27	22.66	/			
	36RB_38	740.5	22.72	21.75	/	23.0	22.0	/
		725.5	22.77	21.63	/			
		710.5	22.76	21.76	/			
	36RB_19	740.5	22.72	21.68	/			
		725.5	22.75	21.67	/			
		710.5	22.68	21.70	/			
	36RB_0	740.5	22.63	21.70	/			
		725.5	22.70	21.72	/			
		710.5	22.66	21.67	/			
75RB_0	740.5	22.67	21.66	/				
	725.5	22.69	21.76	/				
	710.5	22.81	21.87	/				



LTE Band 28			Actual output Power (dBm)			Tune up			
Band -width	RB No. / RB offset	Frequency (MHz)	Modulation			Modulation			
			QPSK	16QAM	64QAM	QPSK	16QAM	64QAM	
20 MHz	1RB_99	738.0	23.14	22.41	/	24.0	23.0	/	
		728.0	23.24	22.82	/				
		713.0	23.64	22.88	/				
	1RB_50	738.0	23.13	22.57	/				
		728.0	23.53	22.82	/				
		713.0	23.32	22.52	/				
	1RB_0	738.0	23.08	21.83	/				
		728.0	23.13	22.75	/				
		713.0	23.27	22.86	/				
	50RB_50	50RB_50	738.0	22.76	21.79	/	23.0	22.0	/
			728.0	22.80	21.82	/			
			713.0	22.89	21.91	/			
		50RB_25	738.0	22.71	21.68	/			
			728.0	22.58	21.71	/			
			713.0	22.41	21.40	/			
	50RB_0	738.0	22.63	21.66	/				
		728.0	22.58	21.69	/				
		713.0	22.64	21.69	/				
100RB_0	738.0	22.72	21.65	/					
	728.0	22.73	21.73	/					
	713.0	22.42	21.44	/					



Normal Power								
LTE Band 66			Actual output Power (dBm)			Tune up		
Band -width	RB No. / RB offset	Frequency (MHz)	Modulation			Modulation		
			QPSK	16QAM	64QAM	QPSK	16QAM	64QAM
1.4 MHz	1RB_5	1779.3	23.14	22.66	/	24.0	23.0	/
		1745.0	23.01	22.64	/			
		1710.7	23.01	22.67	/			
	1RB_3	1779.3	23.02	22.75	/			
		1745.0	23.04	22.64	/			
		1710.7	22.95	22.74	/			
	1RB_0	1779.3	23.08	22.72	/			
		1745.0	23.05	22.19	/			
		1710.7	22.99	22.77	/			
	3RB_3	1779.3	23.20	22.47	/			
		1745.0	23.13	22.36	/			
		1710.7	23.12	22.29	/			
	3RB_1	1779.3	23.21	22.48	/			
		1745.0	23.21	22.39	/			
		1710.7	23.17	22.38	/			
	3RB_0	1779.3	23.24	22.39	/			
		1745.0	23.16	22.32	/			
		1710.7	23.21	22.37	/			
	6RB_0	1779.3	22.23	21.19	/	23.0	22.0	/
		1745.0	22.03	20.89	/			
		1710.7	22.11	20.80	/			



Normal Power								
LTE Band 66			Actual output Power (dBm)			Tune up		
Band -width	RB No. / RB offset	Frequency (MHz)	Modulation			Modulation		
			QPSK	16QAM	64QAM	QPSK	16QAM	64QAM
3 MHz	1RB_14	1778.5	23.18	22.18	/	24.0	23.0	/
		1745.0	23.05	22.20	/			
		1711.5	22.89	22.54	/			
	1RB_7	1778.5	23.13	22.26	/			
		1745.0	23.11	22.17	/			
		1711.5	23.00	22.73	/			
	1RB_0	1778.5	23.18	22.17	/			
		1745.0	23.01	22.18	/			
		1711.5	22.92	22.71	/			
	8RB_7	1778.5	22.21	21.47	/	23.0	22.0	/
		1745.0	22.05	21.28	/			
		1711.5	22.15	21.16	/			
	8RB_4	1778.5	22.23	21.48	/			
		1745.0	22.12	21.26	/			
		1711.5	22.15	21.25	/			
	8RB_0	1778.5	22.20	21.34	/			
		1745.0	22.12	21.19	/			
		1711.5	22.09	21.30	/			
15RB_0	1778.5	22.21	21.38	/				
	1745.0	22.09	21.27	/				
	1711.5	22.16	21.22	/				



Normal Power								
LTE Band 66			Actual output Power (dBm)			Tune up		
Band -width	RB No. / RB offset	Frequency (MHz)	Modulation			Modulation		
			QPSK	16QAM	64QAM	QPSK	16QAM	64QAM
5 MHz	1RB_24	1777.5	23.16	22.70	/	24.0	23.0	/
		1745.0	22.88	22.65	/			
		1712.5	22.92	22.03	/			
	1RB_12	1777.5	23.19	22.78	/			
		1745.0	22.96	22.61	/			
		1712.5	22.86	22.01	/			
	1RB_0	1777.5	23.17	22.79	/			
		1745.0	22.98	22.58	/			
		1712.5	22.90	22.04	/			
	12RB_13	1777.5	22.24	21.29	/	23.0	22.0	/
		1745.0	22.02	21.57	/			
		1712.5	22.12	21.19	/			
	12RB_6	1777.5	22.09	21.28	/			
		1745.0	22.11	21.15	/			
		1712.5	22.11	21.09	/			
	12RB_0	1777.5	22.19	21.22	/			
		1745.0	22.04	21.05	/			
		1712.5	22.15	21.16	/			
25RB_0	1777.5	22.17	21.02	/				
	1745.0	22.11	21.05	/				
	1712.5	22.11	21.04	/				



Normal Power								
LTE Band 66			Actual output Power (dBm)			Tune up		
Band -width	RB No. / RB offset	Frequency (MHz)	Modulation			Modulation		
			QPSK	16QAM	64QAM	QPSK	16QAM	64QAM
10 MHz	1RB_49	1775.0	23.13	22.19	/	24.0	23.0	/
		1745.0	23.03	22.09	/			
		1715.0	23.10	22.63	/			
	1RB_24	1775.0	23.10	22.22	/			
		1745.0	23.09	22.14	/			
		1715.0	23.03	22.66	/			
	1RB_0	1775.0	23.14	22.11	/			
		1745.0	23.04	22.85	/			
		1715.0	23.07	22.73	/			
	25RB_25	1775.0	22.12	21.38	/	23.0	22.0	/
		1745.0	22.10	21.43	/			
		1715.0	22.13	21.45	/			
	25RB_12	1775.0	22.16	21.45	/			
		1745.0	22.01	21.09	/			
		1715.0	22.04	21.43	/			
	25RB_0	1775.0	22.13	21.33	/			
		1745.0	22.08	21.05	/			
		1715.0	22.12	21.02	/			
50RB_0	1775.0	22.17	21.29	/				
	1745.0	22.07	21.17	/				
	1715.0	22.02	21.42	/				



Normal Power								
LTE Band 66			Actual output Power (dBm)			Tune up		
Band -width	RB No. / RB offset	Frequency (MHz)	Modulation			Modulation		
			QPSK	16QAM	64QAM	QPSK	16QAM	64QAM
15 MHz	1RB_74	1772.5	22.96	22.76	/	24.0	23.0	/
		1745.0	23.04	22.66	/			
		1717.5	22.87	22.72	/			
	1RB_37	1772.5	23.00	22.75	/			
		1745.0	23.00	22.68	/			
		1717.5	22.83	22.55	/			
	1RB_0	1772.5	22.98	22.69	/			
		1745.0	23.16	22.88	/			
		1717.5	23.00	22.64	/			
	36RB_38	1772.5	22.19	21.26	/	23.0	22.0	/
		1745.0	21.96	20.99	/			
		1717.5	21.93	21.04	/			
	36RB_19	1772.5	22.14	21.08	/			
		1745.0	22.10	21.05	/			
		1717.5	21.96	21.38	/			
	36RB_0	1772.5	22.16	21.15	/			
		1745.0	22.12	21.08	/			
		1717.5	22.00	21.48	/			
75RB_0	1772.5	22.22	21.17	/				
	1745.0	22.06	21.08	/				
	1717.5	22.02	21.40	/				



Normal Power								
LTE Band 66			Actual output Power (dBm)			Tune up		
Band -width	RB No. / RB offset	Frequency (MHz)	Modulation			Modulation		
			QPSK	16QAM	64QAM	QPSK	16QAM	64QAM
20 MHz	1RB_99	1770.0	23.08	22.29	/	24.0	23.0	/
		1745.0	22.92	22.67	/			
		1720.0	22.95	22.54	/			
	1RB_50	1770.0	23.15	21.94	/			
		1745.0	23.01	22.54	/			
		1720.0	22.87	22.57	/			
	1RB_0	1770.0	23.12	22.17	/			
		1745.0	23.03	22.64	/			
		1720.0	22.95	22.61	/			
	50RB_50	1770.0	22.19	21.19	/	23.0	22.0	/
		1745.0	22.09	21.07	/			
		1720.0	22.19	21.19	/			
	50RB_25	1770.0	22.12	21.12	/			
		1745.0	22.10	21.15	/			
		1720.0	22.06	21.00	/			
	50RB_0	1770.0	22.11	21.19	/			
		1745.0	22.07	21.15	/			
		1720.0	22.02	21.41	/			
100RB_0	1770.0	22.20	21.23	/				
	1745.0	22.15	21.15	/				
	1720.0	21.96	21.02	/				



Reduced power level 1								
LTE Band 66			Actual output Power (dBm)			Tune up		
Band -width	RB No. / RB offset	Frequency (MHz)	Modulation			Modulation		
			QPSK	16QAM	64QAM	QPSK	16QAM	64QAM
1.4 MHz	1RB_5	1779.3	21.11	20.73	/	21.5	21.0	/
		1745.0	20.69	20.30	/			
		1710.7	20.62	20.33	/			
	1RB_3	1779.3	21.15	20.72	/			
		1745.0	20.70	20.30	/			
		1710.7	20.60	20.34	/			
	1RB_0	1779.3	21.13	20.74	/			
		1745.0	20.74	20.34	/			
		1710.7	20.65	20.31	/			
	3RB_3	1779.3	21.21	20.42	/			
		1745.0	20.97	20.00	/			
		1710.7	20.76	19.95	/			
	3RB_1	1779.3	21.20	20.47	/			
		1745.0	20.94	20.01	/			
		1710.7	20.84	20.02	/			
	3RB_0	1779.3	21.25	20.40	/			
		1745.0	20.89	19.97	/			
		1710.7	20.79	19.97	/			
	6RB_0	1779.3	20.18	18.00	/	20.5	19.5	/
		1745.0	19.77	18.36	/			
		1710.7	19.79	18.09	/			



Reduced power level 1								
LTE Band 66			Actual output Power (dBm)			Tune up		
Band -width	RB No. / RB offset	Frequency (MHz)	Modulation			Modulation		
			QPSK	16QAM	64QAM	QPSK	16QAM	64QAM
3 MHz	1RB_14	1778.5	21.01	20.70	/	21.5	21.0	/
		1745.0	21.01	20.66	/			
		1711.5	20.96	20.65	/			
	1RB_7	1778.5	21.01	20.73	/			
		1745.0	20.69	20.41	/			
		1711.5	20.64	20.35	/			
	1RB_0	1778.5	20.97	20.69	/			
		1745.0	21.01	20.75	/			
		1711.5	20.58	20.39	/			
	8RB_7	1778.5	20.24	18.93	/	20.5	19.5	/
		1745.0	19.83	18.26	/			
		1711.5	20.03	18.03	/			
	8RB_4	1778.5	20.19	18.17	/			
		1745.0	19.81	18.37	/			
		1711.5	19.81	18.10	/			
	8RB_0	1778.5	20.13	18.26	/			
		1745.0	19.84	18.42	/			
		1711.5	19.79	18.08	/			
15RB_0	1778.5	20.22	18.22	/				
	1745.0	19.91	18.37	/				
	1711.5	19.77	18.04	/				



Reduced power level 1								
LTE Band 66			Actual output Power (dBm)			Tune up		
Band -width	RB No. / RB offset	Frequency (MHz)	Modulation			Modulation		
			QPSK	16QAM	64QAM	QPSK	16QAM	64QAM
5 MHz	1RB_24	1777.5	21.16	20.65	/	21.5	21.0	/
		1745.0	20.91	20.63	/			
		1712.5	21.12	20.63	/			
	1RB_12	1777.5	21.10	20.68	/			
		1745.0	20.61	20.32	/			
		1712.5	21.08	20.59	/			
	1RB_0	1777.5	20.84	20.38	/			
		1745.0	20.98	20.63	/			
		1712.5	20.78	20.36	/			
	12RB_13	1777.5	20.23	18.15	/	20.5	19.5	/
		1745.0	20.11	18.12	/			
		1712.5	20.07	18.13	/			
	12RB_6	1777.5	20.13	18.04	/			
		1745.0	19.87	18.31	/			
		1712.5	20.12	18.09	/			
	12RB_0	1777.5	20.12	18.02	/			
		1745.0	20.11	18.31	/			
		1712.5	19.84	18.18	/			
	25RB_0	1777.5	20.06	18.25	/			
		1745.0	19.75	18.18	/			
		1712.5	19.99	18.16	/			



Reduced power level 1								
LTE Band 66			Actual output Power (dBm)			Tune up		
Band -width	RB No. / RB offset	Frequency (MHz)	Modulation			Modulation		
			QPSK	16QAM	64QAM	QPSK	16QAM	64QAM
10 MHz	1RB_49	1775.0	21.14	20.25	/	21.5	21.0	/
		1745.0	20.82	20.46	/			
		1715.0	21.04	20.06	/			
	1RB_24	1775.0	20.83	19.85	/			
		1745.0	20.82	20.48	/			
		1715.0	21.05	20.09	/			
	1RB_0	1775.0	21.12	20.03	/			
		1745.0	20.75	20.71	/			
		1715.0	20.82	19.74	/			
	25RB_25	1775.0	20.20	18.31	/	20.5	19.5	/
		1745.0	20.10	18.41	/			
		1715.0	20.14	18.48	/			
	25RB_12	1775.0	19.84	18.44	/			
		1745.0	19.84	18.40	/			
		1715.0	20.20	18.13	/			
	25RB_0	1775.0	20.08	18.85	/			
		1745.0	20.14	18.61	/			
		1715.0	20.11	18.03	/			
50RB_0	1775.0	19.83	18.61	/				
	1745.0	19.85	18.52	/				
	1715.0	20.18	18.28	/				



Reduced power level 1								
LTE Band 66			Actual output Power (dBm)			Tune up		
Band -width	RB No. / RB offset	Frequency (MHz)	Modulation			Modulation		
			QPSK	16QAM	64QAM	QPSK	16QAM	64QAM
15 MHz	1RB_74	1772.5	21.11	20.69	/	21.5	21.0	/
		1745.0	20.96	20.71	/			
		1717.5	20.62	20.67	/			
	1RB_37	1772.5	20.83	20.66	/			
		1745.0	20.84	20.47	/			
		1717.5	20.86	20.64	/			
	1RB_0	1772.5	20.80	20.66	/			
		1745.0	20.97	20.76	/			
		1717.5	20.67	20.39	/			
	36RB_38	1772.5	19.92	18.19	/	20.5	19.5	/
		1745.0	19.81	18.14	/			
		1717.5	19.79	18.56	/			
	36RB_19	1772.5	20.16	18.25	/			
		1745.0	19.81	18.30	/			
		1717.5	20.07	18.12	/			
	36RB_0	1772.5	20.16	18.50	/			
		1745.0	20.23	18.80	/			
		1717.5	20.14	18.00	/			
75RB_0	1772.5	20.19	18.29	/				
	1745.0	19.93	18.48	/				
	1717.5	20.13	18.31	/				



Reduced power level 1								
LTE Band 66			Actual output Power (dBm)			Tune up		
Band -width	RB No. / RB offset	Frequency (MHz)	Modulation			Modulation		
			QPSK	16QAM	64QAM	QPSK	16QAM	64QAM
20 MHz	1RB_99	1770.0	20.79	20.76	/	21.5	21.0	/
		1745.0	20.64	20.36	/			
		1720.0	20.92	20.60	/			
	1RB_50	1770.0	20.83	20.62	/			
		1745.0	20.78	20.37	/			
		1720.0	20.96	20.61	/			
	1RB_0	1770.0	21.13	20.76	/			
		1745.0	20.74	20.39	/			
		1720.0	20.72	20.38	/			
	50RB_50	1770.0	19.90	18.23	/	20.5	19.5	/
		1745.0	19.81	18.45	/			
		1720.0	20.10	18.82	/			
	50RB_25	1770.0	20.09	18.25	/			
		1745.0	19.81	18.46	/			
		1720.0	20.13	18.28	/			
	50RB_0	1770.0	20.18	18.82	/			
		1745.0	20.15	19.25	/			
		1720.0	20.16	18.15	/			
100RB_0	1770.0	20.19	18.26	/				
	1745.0	19.82	18.84	/				
	1720.0	20.17	18.34	/				

10.4. Bluetooth and WLAN Measurement result

Table 10.5: The conducted Power measurement results for Bluetooth

Averaged Power (dBm)				
Mode	Tune up	Ch.0 (2402MHz)	Ch.39 (2441MHz)	Ch.78 (2480MHz)
GFSK	9.0	7.37	8.44	7.54
EDR2M-4_DQPSK	10.5	8.99	9.91	8.96
EDR3M-8DPSK	11.0	9.23	10.23	9.24
/	/	Ch.0 (2402MHz)	Ch.19 (2440MHz)	Ch.39 (2480MHz)
BLE(1M)	8.0	6.86	7.66	7.08
BLE(2M)	8.0	6.59	7.48	6.83

Table 10.6: The conducted Power measurement results for WLAN 2.4GHz

Averaged Power (dBm) Duty Cycle: 100%				
Mode	Tune up	Ch.1 (2412MHz)	Ch.6 (2437MHz)	Ch.11 (2462MHz)
802.11b	16.0	15.67	14.25	14.27
802.11g	14.5	14.12	12.81	12.78
802.11n(20MHz)	13.5	13.42	12.05	11.99
/	/	Ch.3 (2422MHz)	Ch.6 (2437MHz)	Ch.9 (2452MHz)
802.11n(40MHz)	13.5	13.28	12.67	12.23

Table 10.7: The conducted Power measurement results for WLAN 5GHz

Averaged Power (dBm) Duty Cycle: 100%								
Mode	802.11a	802.11n -20MHz	802.11ac -20MHz	Mode	802.11n -40MHz	802.11ac -40MHz	Mode	802.11ac -80MHz
Channel	6Mbps	MCS0	MCS0	Channel	MCS0	MCS0	Channel	MCS0
<U-NII-1>								
Tune up	14.5	14.5	14.5	/	14.0	14.0	/	13.0
36(5180MHz)	13.63	13.49	13.52	38(5190MHz)	13.24	13.52	42(5210MHz)	12.11
40(5200MHz)	13.56	13.45	13.44	46(5230MHz)	13.07	13.44	/	/
44(5220MHz)	13.51	13.44	13.42	/	/	/	/	/
48(5240MHz)	13.48	13.33	13.31	/	/	/	/	/
<U-NII-2A>								
Tune up	15.5	15.5	15.5	/	15.0	15.0	/	14.0
52(5260MHz)	13.95	13.87	13.87	54(5270MHz)	13.51	13.41	58(5290MHz)	12.90
56(5280MHz)	13.91	13.82	13.81	62(5310MHz)	14.19	14.05	/	/
60(5300MHz)	14.75	14.69	14.66	/	/	/	/	/
64(5320MHz)	14.65	14.52	14.54	/	/	/	/	/
<U-NII-2C>								
Tune up	15.0	15.0	15.0	/	14.5	14.5	/	14.0
100(5500MHz)	14.61	14.56	14.51	102(5510MHz)	14.05	13.98	106(5530MHz)	13.21
116(5580MHz)	14.56	14.52	14.53	110(5550MHz)	13.77	13.68	122(5610MHz)	13.17
124(5620MHz)	14.38	14.22	14.19	126(5630MHz)	13.70	13.61	138(5690MHz)	13.36
132(5660MHz)	14.25	14.21	14.12	134(5670MHz)	13.61	13.48	/	/
140(5700MHz)	14.13	14.02	13.97	/	/	/	/	/
<U-NII-3>								
Tune up	14.0	14.0	14.0	/	13.5	13.5	/	13.5
149(5745MHz)	13.69	13.51	13.47	151(5755MHz)	12.98	12.87	155(5775MHz)	13.14
157(5785MHz)	13.38	13.18	13.07	159(5795MHz)	12.64	12.53	/	/
165(5825MHz)	12.92	12.82	12.73	/	/	/	/	/

11. Simultaneous TX SAR Considerations

11.1. Introduction

The following procedures adopted from “FCC SAR Considerations for Cell Phones with Multiple Transmitters” are applicable to handsets with built-in unlicensed transmitters such as 802.11 a/b/g and Bluetooth devices which may simultaneously transmit with the licensed transmitter.

For this device, the Bluetooth and WLAN can transmit simultaneous with other transmitters.

11.2. Transmit Antenna Separation Distances

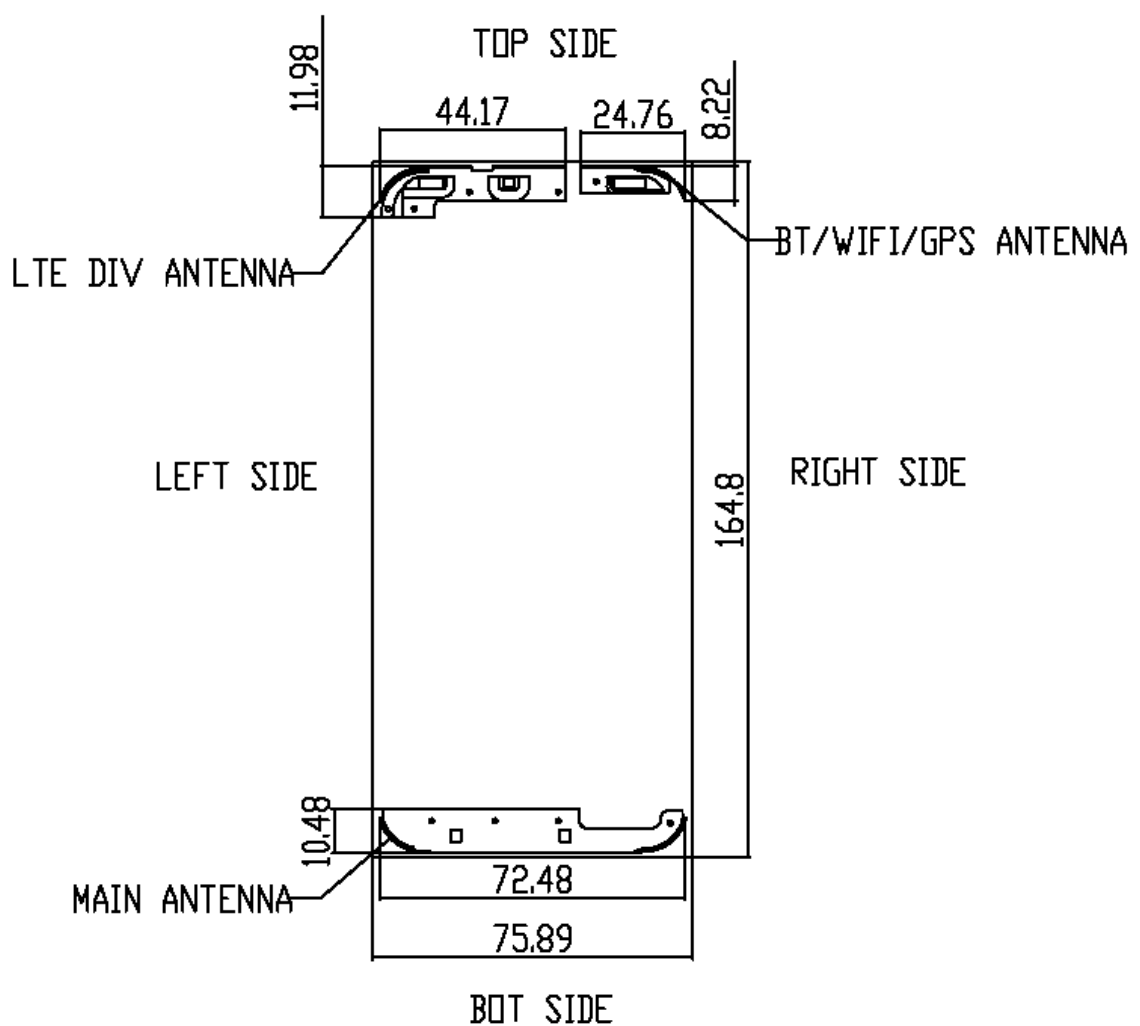

Picture 11.1 Antenna Locations (Front View)



11.3. SAR Measurement Positions

According to the KDB941225 D06 Hot Spot SAR, the edges with less than 25mm distance to the antennas need to be tested for SAR.

SAR measurement positions						
Mode	Front	Rear	Left edge	Right edge	Top edge	Bottom edge
Main antenna	Yes	Yes	Yes	Yes	No	Yes
WLAN/Bluetooth antenna	Yes	Yes	Yes	Yes	Yes	No

12. Evaluation of Simultaneous

Table 12.1: The sum of reported SAR values for WWAN antenna and WLAN antenna

/	Position	WWAN (W/kg)	WLAN (W/kg)	Sum (W/kg)
Highest reported SAR value for Head	Left Cheek	0.26 (WCDMA Band 5)	0.27 (WLAN 2.4G)	0.53
Highest reported SAR value for Hotspot	Bottom Side	1.17 (LTE Band 2)	/	1.17
Highest reported SAR value for Body-worn	Rear Side	0.94 (WCDMA Band 4)	0.17 (WLAN 5G)	1.13

Note: the test positions of above tables are for the worse case that has been evaluated.

Table 12.2: The sum of reported SAR values for WWAN antenna and Bluetooth antenna

/	Position	WWAN (W/kg)	Bluetooth (W/kg)	Sum (W/kg)
Highest reported SAR value for Head	Left Cheek	0.26 (WCDMA Band 5)	0.05	0.31
Highest reported SAR value for Hotspot	Bottom Side	1.17 (LTE Band 2)	/	1.17
Highest reported SAR value for Body-worn	Rear Side	0.94 (WCDMA Band 4)	0.01	0.95

Note: the test positions of above tables are for the worse case that has been evaluated.

Conclusion:

According to the above tables, the sum of reported SAR values is less than limit. So the simultaneous transmission SAR with volume scans is not required.

13. Summary of Test Results

According to the client's decision rule in the test registration form, which is "based on the measurement results as the basis of the conformity statement", the test conclusion of this report meets the limit requirements.

The calculated SAR is obtained by the following formula:

$$\text{Reported SAR} = \text{Measured SAR} \times 10^{(P_{\text{Target}} - P_{\text{Measured}})/10}$$

Where P_{Target} is the power of manufacturing upper limit;

P_{Measured} is the measured power in chapter 10.

General Note:

1. Per KDB648474 D04v01r03, for smart phones with a display diagonal dimension > 15.0 cm or an overall diagonal dimension > 16.0 cm, when hotspot mode applies, 10-g extremity SAR is required only for the surfaces and edges with hotspot mode 1-g reported SAR > 1.2 W/kg, however, when power reduction applies to hotspot mode the measured SAR must be scaled to the maximum output power, including tolerance, allowed for phablet modes to compare with the 1.2 W/kg SAR test reduction threshold.

a. WLAN 5GHz U-NII-2A and U-NII-2C tested the product specific 10g SAR since it has no hotspot mode.

b. When 10-g product specific 10g SAR is considered, SAR thresholds is specified in the procedures for SAR test reduction and exclusion should be multiplied by 2.5.

Duty Cycle

Mode	Duty Cycle
Speech for GSM	1:8.3
GPRS	1:2
WCDMA	1:1
FDD_LTE	1:1
Bluetooth	1:1

13.1. Testing Environment

Temperature:	18°C~25°C
Relative humidity:	30%~70%
Ground system resistance:	<4Ω
Ambient noise & Reflection:	< 0.012 W/kg

13.2. SAR results

Table 13.1: SAR Values (GSM850 - Head)

Frequency		Test Mode	Test Position	Figure No./ Note	Conducted Power (dBm)	Max. tune-up Power (dBm)	Measured SAR(1g) (W/kg)	Reported SAR(1g) (W/kg)	Power Drift(dB)
Ch.	MHz								
190	836.6	Speech	Left Cheek	/	31.99	33.0	0.189	0.24	0.03
190	836.6	Speech	Left Tilt	/	31.99	33.0	0.112	0.14	-0.02
190	836.6	Speech	Right Cheek	1	31.99	33.0	0.212	0.27	0.00
190	836.6	Speech	Right Tilt	/	31.99	33.0	0.115	0.15	0.06

Table 13.2: SAR Values (GSM850 - Body)

Frequency		Test Mode	Test Position	Figure No./ Note	Conducted Power (dBm)	Max. tune-up Power (dBm)	Measured SAR(1g) (W/kg)	Reported SAR(1g) (W/kg)	Power Drift(dB)
Ch.	MHz								
Hotspot/Body-Worn Test Data (10mm)									
190	836.6	GPRS-4	Front	/	27.86	28.5	0.264	0.31	-0.09
190	836.6	GPRS-4	Rear	2	27.86	28.5	0.368	0.43	-0.02
Hotspot Test Data (10mm)									
190	836.6	GPRS-4	Left	/	27.86	28.5	0.329	0.38	0.05
190	836.6	GPRS-4	Right	/	27.86	28.5	0.339	0.39	0.13
190	836.6	GPRS-4	Bottom	/	27.86	28.5	0.079	0.09	0.17

Table 13.3: SAR Values (PCS1900 - Head)

Frequency		Test Mode	Test Position	Figure No./ Note	Conducted Power (dBm)	Max. tune-up Power (dBm)	Measured SAR(1g) (W/kg)	Reported SAR(1g) (W/kg)	Power Drift(dB)
Ch.	MHz								
661	1880.0	Speech	Left Cheek	/	29.28	30.5	0.042	0.05	0.16
661	1880.0	Speech	Left Tilt	3	29.28	30.5	0.060	0.08	0.05
661	1880.0	Speech	Right Cheek	/	29.28	30.5	0.056	0.07	0.09
661	1880.0	Speech	Right Tilt	/	29.28	30.5	0.032	0.04	0.03

Table 13.4: SAR Values (PCS1900 - Body)

Frequency		Test Mode	Test Position	Figure No./ Note	Conducted Power (dBm)	Max. tune-up Power (dBm)	Measured SAR(1g) (W/kg)	Reported SAR(1g) (W/kg)	Power Drift(dB)
Ch.	MHz								
Hotspot/Body-Worn Test Data (10mm)									
661	1880.0	GPRS-4	Front	/	25.26	26.5	0.242	0.32	0.13
661	1880.0	GPRS-4	Rear	/	25.26	26.5	0.488	0.65	0.02
Hotspot Test Data (10mm)									
661	1880.0	GPRS-4	Left	/	25.26	26.5	0.105	0.14	0.05
661	1880.0	GPRS-4	Right	/	25.26	26.5	0.059	0.08	0.04
661	1880.0	GPRS-4	Bottom	/	25.26	26.5	0.719	0.96	0.08
810	1909.8	GPRS-4	Bottom	/	25.05	26.5	0.635	0.89	0.09
512	1850.2	GPRS-4	Bottom	4	25.54	26.5	0.848	1.06	0.12

Table 13.5: SAR Values (WCDMA Band 2 - Head)

Frequency		Test Mode	Test Position	Figure No./ Note	Conducted Power (dBm)	Max. tune-up Power (dBm)	Measured SAR(1g) (W/kg)	Reported SAR(1g) (W/kg)	Power Drift(dB)
Ch.	MHz								
9400	1880.0	RMC	Left Cheek	/	22.90	24.0	0.082	0.11	0.16
9400	1880.0	RMC	Left Tilt	/	22.90	24.0	0.098	0.13	0.07
9400	1880.0	RMC	Right Cheek	5	22.90	24.0	0.111	0.14	0.04
9400	1880.0	RMC	Right Tilt	/	22.90	24.0	0.065	0.08	0.15

Table 13.6: SAR Values (WCDMA Band 2 - Body)

Frequency		Test Mode	Test Position	Figure No./ Note	Conducted Power (dBm)	Max. tune-up Power (dBm)	Measured SAR(1g) (W/kg)	Reported SAR(1g) (W/kg)	Power Drift(dB)
Ch.	MHz								
Hotspot/Body-Worn Test Data (10mm) - Reduced power level 1									
9400	1880.0	RMC	Front	/	21.50	22.5	0.275	0.35	-0.02
9400	1880.0	RMC	Rear	/	21.50	22.5	0.523	0.66	-0.17
Hotspot Test Data (10mm) - Reduced power level 1									
9400	1880.0	RMC	Left	/	21.50	22.5	0.113	0.14	0.17
9400	1880.0	RMC	Right	/	21.50	22.5	0.064	0.08	-0.06
9400	1880.0	RMC	Bottom	/	21.50	22.5	0.784	0.99	0.00
9538	1908.0	RMC	Bottom	/	21.50	22.5	0.771	0.97	0.20
9262	1852.4	RMC	Bottom	6	21.60	22.5	0.875	1.08	0.01

Table 13.7: SAR Values (WCDMA Band 4 - Head)

Frequency		Test Mode	Test Position	Figure No./ Note	Conducted Power (dBm)	Max. tune-up Power (dBm)	Measured SAR(1g) (W/kg)	Reported SAR(1g) (W/kg)	Power Drift(dB)
Ch.	MHz								
1413	1732.6	RMC	Left Cheek	/	22.80	24.0	0.111	0.15	0.07
1413	1732.6	RMC	Left Tilt	/	22.80	24.0	0.109	0.14	-0.02
1413	1732.6	RMC	Right Cheek	7	22.80	24.0	0.167	0.22	0.04
1413	1732.6	RMC	Right Tilt	/	22.80	24.0	0.086	0.11	0.03

Table 13.8: SAR Values (WCDMA Band 4 - Body)

Frequency		Test Mode	Test Position	Figure No./ Note	Conducted Power (dBm)	Max. tune-up Power (dBm)	Measured SAR(1g) (W/kg)	Reported SAR(1g) (W/kg)	Power Drift(dB)
Ch.	MHz								
Hotspot/Body-Worn Test Data (10mm) - Reduced power level 1									
1413	1732.6	RMC	Front	/	19.90	21.0	0.261	0.34	0.17
1413	1732.6	RMC	Rear	/	19.90	21.0	0.672	0.87	0.12
1513	1752.6	RMC	Rear	/	19.80	21.0	0.589	0.78	-0.11
1312	1712.4	RMC	Rear	/	19.90	21.0	0.727	0.94	0.01
Hotspot Test Data (10mm) - Reduced power level 1									
1413	1732.6	RMC	Left	/	19.90	21.0	0.047	0.06	-0.07
1413	1732.6	RMC	Right	/	19.90	21.0	0.061	0.08	-0.17
1413	1732.6	RMC	Bottom	8	19.90	21.0	0.794	1.02	-0.04
1513	1752.6	RMC	Bottom	/	19.80	21.0	0.718	0.95	-0.09
1312	1712.4	RMC	Bottom	/	19.90	21.0	0.787	1.01	-0.09

Table 13.9: SAR Values (WCDMA Band 5 - Head)

Frequency		Test Mode	Test Position	Figure No./ Note	Conducted Power (dBm)	Max. tune-up Power (dBm)	Measured SAR(1g) (W/kg)	Reported SAR(1g) (W/kg)	Power Drift(dB)
Ch.	MHz								
4183	836.6	RMC	Left Cheek	/	22.80	24.0	0.194	0.26	0.04
4183	836.6	RMC	Left Tilt	/	22.80	24.0	0.071	0.09	0.16
4183	836.6	RMC	Right Cheek	9	22.80	24.0	0.196	0.26	0.05
4183	836.6	RMC	Right Tilt	/	22.80	24.0	0.086	0.11	0.06

Table 13.10: SAR Values (WCDMA Band 5 - Body)

Frequency		Test Mode	Test Position	Figure No./ Note	Conducted Power (dBm)	Max. tune-up Power (dBm)	Measured SAR(1g) (W/kg)	Reported SAR(1g) (W/kg)	Power Drift(dB)
Ch.	MHz								
Hotspot/Body-Worn Test Data (10mm)									
4183	836.6	RMC	Front	/	22.80	24.0	0.173	0.23	0.06
4183	836.6	RMC	Rear	10	22.80	24.0	0.268	0.35	0.03
Hotspot Test Data (10mm)									
4183	836.6	RMC	Left	/	22.80	24.0	0.175	0.23	0.18
4183	836.6	RMC	Right	/	22.80	24.0	0.230	0.30	0.17
4183	836.6	RMC	Bottom	/	22.80	24.0	0.062	0.08	0.08

Table 13.11: SAR Values (LTE Band 2 - Head)

Frequency		Test Mode	Test Position	Figure No./ Note	Conducted Power (dBm)	Max. tune-up Power (dBm)	Measured SAR(1g) (W/kg)	Reported SAR(1g) (W/kg)	Power Drift(dB)
Ch.	MHz								
18900	1880.0	1RB99	Left Cheek	/	23.30	24.0	0.087	0.10	0.02
19100	1900.0	50RB50	Left Cheek	/	22.26	23.0	0.072	0.09	0.05
18900	1880.0	1RB99	Left Tilt	/	23.30	24.0	0.094	0.11	0.12
19100	1900.0	50RB50	Left Tilt	/	22.26	23.0	0.076	0.09	0.04
18900	1880.0	1RB99	Right Cheek	11	23.30	24.0	0.112	0.13	0.17
19100	1900.0	50RB50	Right Cheek	/	22.26	23.0	0.088	0.10	0.03
18900	1880.0	1RB99	Right Tilt	/	23.30	24.0	0.064	0.08	0.11
19100	1900.0	50RB50	Right Tilt	/	22.26	23.0	0.052	0.06	0.03

Table 13.12: SAR Values (LTE Band 2 - Body)

Frequency		Test Mode	Test Position	Figure No./ Note	Conducted Power (dBm)	Max. tune-up Power (dBm)	Measured SAR(1g) (W/kg)	Reported SAR(1g) (W/kg)	Power Drift(dB)
Ch.	MHz								
Hotspot/Body-Worn Test Data (10mm)									
18900	1880.0	1RB99	Front	/	23.30	24.0	0.374	0.44	0.04
19100	1900.0	50RB50	Front	/	22.26	23.0	0.304	0.36	0.02
18900	1880.0	1RB99	Rear	/	23.30	24.0	0.618	0.73	-0.07
19100	1900.0	50RB50	Rear	/	22.26	23.0	0.447	0.53	0.14
Hotspot Test Data (10mm)									
18900	1880.0	1RB99	Left	/	23.30	24.0	0.111	0.13	0.11
19100	1900.0	50RB50	Left	/	22.26	23.0	0.100	0.12	0.10
18900	1880.0	1RB99	Right	/	23.30	24.0	0.069	0.08	0.03
19100	1900.0	50RB50	Right	/	22.26	23.0	0.057	0.07	0.09
18900	1880.0	1RB99	Bottom	12	23.30	24.0	0.995	1.17	0.05
19100	1900.0	50RB50	Bottom	/	22.26	23.0	0.793	0.94	0.04
19100	1900.0	1RB99	Bottom	/	23.26	24.0	0.932	1.11	0.01
18700	1860.0	1RB99	Bottom	/	23.07	24.0	0.917	1.14	0.04
18900	1880.0	50RB50	Bottom	/	22.20	23.0	0.735	0.88	0.03
18700	1860.0	50RB50	Bottom	/	22.14	23.0	0.783	0.95	0.09
19100	1900.0	100RB	Bottom	/	22.17	23.0	0.725	0.88	0.01

Table 13.13: SAR Values (LTE Band 5 - Head)

Frequency		Test Mode	Test Position	Figure No./ Note	Conducted Power (dBm)	Max. tune-up Power (dBm)	Measured SAR(1g) (W/kg)	Reported SAR(1g) (W/kg)	Power Drift(dB)
Ch.	MHz								
20450	829.0	1RB49	Left Cheek	/	23.53	24.0	0.227	0.25	0.05
20450	829.0	25RB0	Left Cheek	/	22.87	23.0	0.177	0.18	0.04
20450	829.0	1RB49	Left Tilt	/	23.53	24.0	0.119	0.13	0.08
20450	829.0	25RB0	Left Tilt	/	22.87	23.0	0.089	0.09	0.10
20450	829.0	1RB49	Right Cheek	13	23.53	24.0	0.231	0.26	0.07
20450	829.0	25RB0	Right Cheek	/	22.87	23.0	0.168	0.17	0.06
20450	829.0	1RB49	Right Tilt	/	23.53	24.0	0.112	0.12	0.09
20450	829.0	25RB0	Right Tilt	/	22.87	23.0	0.087	0.09	0.13

Table 13.14: SAR Values (LTE Band 5 - Body)

Frequency		Test Mode	Test Position	Figure No./ Note	Conducted Power (dBm)	Max. tune-up Power (dBm)	Measured SAR(1g) (W/kg)	Reported SAR(1g) (W/kg)	Power Drift(dB)
Ch.	MHz								
Hotspot/Body-Worn Test Data (10mm)									
20450	829.0	1RB49	Front	/	23.53	24.0	0.211	0.24	0.11
20450	829.0	25RB0	Front	/	22.87	23.0	0.176	0.18	0.05
20450	829.0	1RB49	Rear	14	23.53	24.0	0.276	0.31	0.01
20450	829.0	25RB0	Rear	/	22.87	23.0	0.219	0.23	0.02
Hotspot Test Data (10mm)									
20450	829.0	1RB49	Left	/	23.53	24.0	0.163	0.18	0.12
20450	829.0	25RB0	Left	/	22.87	23.0	0.155	0.16	0.13
20450	829.0	1RB49	Right	/	23.53	24.0	0.212	0.24	0.09
20450	829.0	25RB0	Right	/	22.87	23.0	0.175	0.18	0.02
20450	829.0	1RB49	Bottom	/	23.53	24.0	0.094	0.11	0.15
20450	829.0	25RB0	Bottom	/	22.87	23.0	0.065	0.07	0.17

Table 13.15: SAR Values (LTE Band 7 - Head)

Frequency		Test Mode	Test Position	Figure No./ Note	Conducted Power (dBm)	Max. tune-up Power (dBm)	Measured SAR(1g) (W/kg)	Reported SAR(1g) (W/kg)	Power Drift(dB)
Ch.	MHz								
21100	2535.0	1RB99	Left Cheek	/	22.37	23.5	0.037	0.05	0.09
20850	2510.0	50RB50	Left Cheek	/	21.55	22.5	0.025	0.03	0.03
21100	2535.0	1RB99	Left Tilt	/	22.37	23.5	0.022	0.03	0.06
20850	2510.0	50RB50	Left Tilt	/	21.55	22.5	0.024	0.03	0.04
21100	2535.0	1RB99	Right Cheek	15	22.37	23.5	0.078	0.10	0.08
20850	2510.0	50RB50	Right Cheek	/	21.55	22.5	0.053	0.07	0.03
21100	2535.0	1RB99	Right Tilt	/	22.37	23.5	0.028	0.04	0.06
20850	2510.0	50RB50	Right Tilt	/	21.55	22.5	0.017	0.02	0.16

Table 13.16: SAR Values (LTE Band 7 - Body)

Frequency		Test Mode	Test Position	Figure No./ Note	Conducted Power (dBm)	Max. tune-up Power (dBm)	Measured SAR(1g) (W/kg)	Reported SAR(1g) (W/kg)	Power Drift(dB)
Ch.	MHz								
Hotspot/Body-Worn Test Data (10mm) - Reduced power level 1									
20850	2510.0	1RB99	Front	/	20.55	21.0	0.240	0.27	-0.01
20850	2510.0	50RB50	Front	/	19.76	20.0	0.222	0.23	-0.17
20850	2510.0	1RB99	Rear	16	20.55	21.0	0.626	0.69	-0.07
20850	2510.0	50RB50	Rear	/	19.76	20.0	0.566	0.60	0.08
Hotspot Test Data (10mm) - Reduced power level 1									
20850	2510.0	1RB99	Left	/	20.55	21.0	0.059	0.07	-0.09
20850	2510.0	50RB50	Left	/	19.76	20.0	0.056	0.06	0.01
20850	2510.0	1RB99	Right	/	20.55	21.0	0.129	0.14	0.01
20850	2510.0	50RB50	Right	/	19.76	20.0	0.129	0.14	-0.17
20850	2510.0	1RB99	Bottom	/	20.55	21.0	0.423	0.47	-0.13
20850	2510.0	50RB50	Bottom	/	19.76	20.0	0.402	0.42	-0.12

Table 13.17: SAR Values (LTE Band 12 - Head)

Frequency		Test Mode	Test Position	Figure No./ Note	Conducted Power (dBm)	Max. tune-up Power (dBm)	Measured SAR(1g) (W/kg)	Reported SAR(1g) (W/kg)	Power Drift(dB)
Ch.	MHz								
23130	711.0	1RB49	Left Cheek	/	23.80	24.0	0.145	0.15	0.03
23095	707.5	25RB25	Left Cheek	/	22.88	23.0	0.111	0.11	0.02
23130	711.0	1RB49	Left Tilt	/	23.80	24.0	0.082	0.09	0.06
23095	707.5	25RB25	Left Tilt	/	22.88	23.0	0.063	0.06	0.13
23130	711.0	1RB49	Right Cheek	17	23.80	24.0	0.171	0.18	0.16
23095	707.5	25RB25	Right Cheek	/	22.88	23.0	0.127	0.13	0.04
23130	711.0	1RB49	Right Tilt	/	23.80	24.0	0.076	0.08	0.07
23095	707.5	25RB25	Right Tilt	/	22.88	23.0	0.057	0.06	0.11

Table 13.18: SAR Values (LTE Band 12 - Body)

Frequency		Test Mode	Test Position	Figure No./ Note	Conducted Power (dBm)	Max. tune-up Power (dBm)	Measured SAR(1g) (W/kg)	Reported SAR(1g) (W/kg)	Power Drift(dB)
Ch.	MHz								
Hotspot/Body-Worn Test Data (10mm)									
23130	711.0	1RB49	Front	/	23.80	24.0	0.249	0.26	0.09
23095	707.5	25RB25	Front	/	22.88	23.0	0.204	0.21	0.07
23130	711.0	1RB49	Rear	/	23.80	24.0	0.258	0.27	0.03
23095	707.5	25RB25	Rear	/	22.88	23.0	0.241	0.25	0.04
Hotspot Test Data (10mm)									
23130	711.0	1RB49	Left	/	23.80	24.0	0.270	0.28	0.14
23095	707.5	25RB25	Left	/	22.88	23.0	0.252	0.26	0.17
23130	711.0	1RB49	Right	18	23.80	24.0	0.284	0.30	0.01
23095	707.5	25RB25	Right	/	22.88	23.0	0.268	0.28	0.03
23130	711.0	1RB49	Bottom	/	23.80	24.0	0.051	0.05	-0.03
23095	707.5	25RB25	Bottom	/	22.88	23.0	0.038	0.04	-0.01

Note: SAR for LTE Band 17 is covered by LTE Band 12 due to similar frequency range, same maximum tune-up limit and same channel bandwidth.

Table 13.19: SAR Values (LTE Band 13 - Head)

Frequency		Test Mode	Test Position	Figure No./ Note	Conducted Power (dBm)	Max. tune-up Power (dBm)	Measured SAR(1g) (W/kg)	Reported SAR(1g) (W/kg)	Power Drift(dB)
Ch.	MHz								
23230	782.0	1RB0	Left Cheek	19	23.39	24.0	0.151	0.17	0.06
23230	782.0	25RB12	Left Cheek	/	22.50	23.0	0.094	0.11	0.03
23230	782.0	1RB0	Left Tilt	/	23.39	24.0	0.067	0.08	0.13
23230	782.0	25RB12	Left Tilt	/	22.50	23.0	0.050	0.06	0.11
23230	782.0	1RB0	Right Cheek	/	23.39	24.0	0.137	0.16	0.03
23230	782.0	25RB12	Right Cheek	/	22.50	23.0	0.116	0.13	0.08
23230	782.0	1RB0	Right Tilt	/	23.39	24.0	0.069	0.08	0.17
23230	782.0	25RB12	Right Tilt	/	22.50	23.0	0.051	0.06	0.10

Table 13.20: SAR Values (LTE Band 13 - Body)

Frequency		Test Mode	Test Position	Figure No./ Note	Conducted Power (dBm)	Max. tune-up Power (dBm)	Measured SAR(1g) (W/kg)	Reported SAR(1g) (W/kg)	Power Drift(dB)
Ch.	MHz								
Hotspot/Body-Worn Test Data (10mm)									
23230	782.0	1RB0	Front	/	23.39	24.0	0.176	0.20	0.06
23230	782.0	25RB12	Front	/	22.50	23.0	0.126	0.14	0.14
23230	782.0	1RB0	Rear	20	23.39	24.0	0.243	0.28	-0.08
23230	782.0	25RB12	Rear	/	22.50	23.0	0.150	0.17	0.09
Hotspot Test Data (10mm)									
23230	782.0	1RB0	Left	/	23.39	24.0	0.193	0.22	0.13
23230	782.0	25RB12	Left	/	22.50	23.0	0.137	0.15	0.07
23230	782.0	1RB0	Right	/	23.39	24.0	0.242	0.28	0.12
23230	782.0	25RB12	Right	/	22.50	23.0	0.172	0.19	0.02
23230	782.0	1RB0	Bottom	/	23.39	24.0	0.090	0.10	-0.04
23230	782.0	25RB12	Bottom	/	22.50	23.0	0.064	0.07	-0.05

Table 13.21: SAR Values (LTE Band 28 - Head)

Frequency		Test Mode	Test Position	Figure No./ Note	Conducted Power (dBm)	Max. tune-up Power (dBm)	Measured SAR(1g) (W/kg)	Reported SAR(1g) (W/kg)	Power Drift(dB)
Ch.	MHz								
27310	713.0	1RB99	Left Cheek	/	23.64	24.0	0.149	0.16	0.05
27310	713.0	50RB50	Left Cheek	/	22.89	23.0	0.113	0.12	0.10
27310	713.0	1RB99	Left Tilt	/	23.64	24.0	0.108	0.12	0.16
27310	713.0	50RB50	Left Tilt	/	22.89	23.0	0.088	0.09	-0.01
27310	713.0	1RB99	Right Cheek	21	23.64	24.0	0.170	0.18	0.04
27310	713.0	50RB50	Right Cheek	/	22.89	23.0	0.141	0.14	0.07
27310	713.0	1RB99	Right Tilt	/	23.64	24.0	0.079	0.09	0.16
27310	713.0	50RB50	Right Tilt	/	22.89	23.0	0.060	0.06	0.12

Table 13.22: SAR Values (LTE Band 28 - Body)

Frequency		Test Mode	Test Position	Figure No./ Note	Conducted Power (dBm)	Max. tune-up Power (dBm)	Measured SAR(1g) (W/kg)	Reported SAR(1g) (W/kg)	Power Drift(dB)
Ch.	MHz								
Hotspot/Body-Worn Test Data (10mm)									
27310	713.0	1RB99	Front	/	23.64	24.0	0.237	0.26	0.07
27310	713.0	50RB50	Front	/	22.89	23.0	0.202	0.21	0.05
27310	713.0	1RB99	Rear	22	23.64	24.0	0.351	0.38	0.08
27310	713.0	50RB50	Rear	/	22.89	23.0	0.283	0.29	0.03
Hotspot Test Data (10mm)									
27310	713.0	1RB99	Left	/	23.64	24.0	0.302	0.33	0.11
27310	713.0	50RB50	Left	/	22.89	23.0	0.264	0.27	0.13
27310	713.0	1RB99	Right	/	23.64	24.0	0.308	0.33	0.08
27310	713.0	50RB50	Right	/	22.89	23.0	0.279	0.29	0.06
27310	713.0	1RB99	Bottom	/	23.64	24.0	0.054	0.06	0.04
27310	713.0	50RB50	Bottom	/	22.89	23.0	0.041	0.04	0.02

Table 13.23: SAR Values (LTE Band 66 - Head)

Frequency		Test Mode	Test Position	Figure No./ Note	Conducted Power (dBm)	Max. tune-up Power (dBm)	Measured SAR(1g) (W/kg)	Reported SAR(1g) (W/kg)	Power Drift(dB)
Ch.	MHz								
132572	1770.0	1RB50	Left Cheek	/	23.15	24.0	0.071	0.09	0.05
132572	1770.0	50RB50	Left Cheek	/	22.19	23.0	0.058	0.07	0.02
132572	1770.0	1RB50	Left Tilt	/	23.15	24.0	0.086	0.11	0.06
132572	1770.0	50RB50	Left Tilt	/	22.19	23.0	0.069	0.08	0.04
132572	1770.0	1RB50	Right Cheek	23	23.15	24.0	0.110	0.13	0.04
132572	1770.0	50RB50	Right Cheek	/	22.19	23.0	0.090	0.11	0.02
132572	1770.0	1RB50	Right Tilt	/	23.15	24.0	0.067	0.08	0.14
132572	1770.0	50RB50	Right Tilt	/	22.19	23.0	0.056	0.07	0.19

Table 13.24: SAR Values (LTE Band 66 - Body)

Frequency		Test Mode	Test Position	Figure No./ Note	Conducted Power (dBm)	Max. tune-up Power (dBm)	Measured SAR(1g) (W/kg)	Reported SAR(1g) (W/kg)	Power Drift(dB)
Ch.	MHz								
Hotspot/Body-Worn Test Data (10mm) - Reduced power level 1									
132572	1770.0	1RB50	Front	/	20.96	21.5	0.262	0.30	0.09
132572	1770.0	50RB0	Front	/	20.18	20.5	0.219	0.24	0.11
132572	1770.0	1RB50	Rear	/	20.96	21.5	0.592	0.67	-0.14
132572	1770.0	50RB0	Rear	/	20.18	20.5	0.483	0.52	0.15
Hotspot Test Data (10mm) - Reduced power level 1									
132572	1770.0	1RB50	Left	/	20.96	21.5	0.048	0.05	-0.16
132572	1770.0	50RB0	Left	/	20.18	20.5	0.041	0.04	0.15
132572	1770.0	1RB50	Right	/	20.96	21.5	0.050	0.06	-0.15
132572	1770.0	50RB0	Right	/	20.18	20.5	0.037	0.04	0.02
132572	1770.0	1RB50	Bottom	24	20.96	21.5	0.908	1.03	0.03
132572	1770.0	50RB0	Bottom	/	20.18	20.5	0.811	0.87	0.15
132322	1745.0	1RB50	Bottom	/	20.83	21.5	0.833	0.97	-0.10
132072	1720.0	1RB50	Bottom	/	20.78	21.5	0.833	0.98	0.06
132322	1745.0	50RB0	Bottom	/	20.15	20.5	0.784	0.85	0.10
132072	1720.0	50RB0	Bottom	/	20.16	20.5	0.793	0.86	-0.12
132072	1720.0	100RB	Bottom	/	20.17	20.5	0.678	0.73	0.08

Note: SAR for LTE Band 4 is covered by LTE Band 66 due to similar frequency range, same maximum tune-up limit and same channel bandwidth.

Table 13.25: SAR Values (Bluetooth - Head)

Frequency		Test Mode	Test Position	Figure No./ Note	Conducted Power (dBm)	Max. tune-up Power (dBm)	Measured SAR(1g) (W/kg)	Reported SAR(1g) (W/kg)	Power Drift(dB)
Ch.	MHz								
39	2441.0	8DPSK	Left Cheek	25	10.23	11.0	0.040	0.05	-0.02
39	2441.0	8DPSK	Left Tilt	/	10.23	11.0	0.032	0.04	-0.16
39	2441.0	8DPSK	Right Cheek	/	10.23	11.0	0.022	0.03	0.07
39	2441.0	8DPSK	Right Tilt	/	10.23	11.0	0.020	0.02	-0.03

Table 13.26: SAR Values (Bluetooth - Body)

Frequency		Test Mode	Test Position	Figure No./ Note	Conducted Power (dBm)	Max. tune-up Power (dBm)	Measured SAR(1g) (W/kg)	Reported SAR(1g) (W/kg)	Power Drift(dB)
Ch.	MHz								
Test Data (10mm)									
39	2441.0	8DPSK	Front	/	10.23	11.0	0.010	0.01	0.03
39	2441.0	8DPSK	Rear	26	10.23	11.0	0.012	0.01	0.07
39	2441.0	8DPSK	Left	/	10.23	11.0	0.002	<0.01	0.03
39	2441.0	8DPSK	Right	/	10.23	11.0	0.009	0.01	0.04
39	2441.0	8DPSK	Top	/	10.23	11.0	0.011	0.01	0.07

13.3. WLAN Evaluation for 2.4G

According to the KDB248227 D01, SAR is measured for 2.4GHz 802.11b DSSS using the initial test position procedure.

Table 13.27: SAR Values (WLAN 2.4GHz - Head)

Frequency		Test Mode	Test Position	Figure No./ Note	Conducted Power (dBm)	Max. tune-up Power (dBm)	Measured SAR(1g) (W/kg)	Reported SAR(1g) (W/kg)	Power Drift(dB)
Ch.	MHz								
1	2412.0	802.11b	Left Cheek	27	15.67	16.0	0.248	0.27	0.07
1	2412.0	802.11b	Left Tilt	/	15.67	16.0	0.218	0.24	0.03
1	2412.0	802.11b	Right Cheek	/	15.67	16.0	0.119	0.13	0.02
1	2412.0	802.11b	Right Tilt	/	15.67	16.0	0.107	0.12	0.02

Note: For all positions/configurations tested using the initial test position and subsequent test positions, when the reported SAR is > 0.8 W/kg, SAR is measured for these test positions/configurations on the subsequent next highest measured output power channel until the reported SAR is ≤ 1.2 W/kg or all required channels are tested.

According to the KDB248227 D01, The reported SAR must be scaled to 100% transmission duty factor to determine compliance at the maximum tune-up tolerance limit.

Table 13.28: SAR Values (WLAN - Head) – 802.11b (Scaled Reported SAR)

Frequency		Test Position	Actual duty factor	maximum duty factor	Reported SAR (1g)(W/kg)	Scaled reported SAR (1g)(W/kg)
Ch.	MHz					
1	2412.0	Left Cheek	100%	100%	0.27	0.27

SAR is not required for OFDM because the 802.11b adjusted SAR ≤ 1.2 W/kg.

Table 13.29: SAR Values (WLAN 2.4GHz - Body)

Frequency		Test Mode	Test Position	Figure No./ Note	Conducted Power (dBm)	Max. tune-up Power (dBm)	Measured SAR(1g) (W/kg)	Reported SAR(1g) (W/kg)	Power Drift(dB)
Ch.	MHz								
Hotspot/Body-Worn Test Data (10mm)									
1	2412.0	802.11b	Front	/	15.67	16.0	0.045	0.05	0.12
1	2412.0	802.11b	Rear	/	15.67	16.0	0.060	0.06	0.03
Hotspot Test Data (10mm)									
1	2412.0	802.11b	Left	/	15.67	16.0	0.003	<0.01	-0.04
1	2412.0	802.11b	Right	/	15.67	16.0	0.045	0.05	-0.17
1	2412.0	802.11b	Top	28	15.67	16.0	0.062	0.07	0.04

Note: For all positions/configurations tested using the initial test position and subsequent test positions, when the reported SAR is > 0.8 W/kg, SAR is measured for these test positions/configurations on the subsequent next highest measured output power channel until the reported SAR is ≤ 1.2 W/kg or all required channels are tested.

According to the KDB248227 D01, The reported SAR must be scaled to 100% transmission duty factor to determine compliance at the maximum tune-up tolerance limit.

Table 13.30: SAR Values (WLAN - Body) – 802.11b (Scaled Reported SAR)

Frequency		Test Position	Actual duty factor	maximum duty factor	Reported SAR (1g)(W/kg)	Scaled reported SAR (1g)(W/kg)
Ch.	MHz					
1	2412.0	Top	100%	100%	0.07	0.07

SAR is not required for OFDM because the 802.11b adjusted SAR ≤ 1.2 W/kg.

13.4. WLAN Evaluation for 5G

Table 13.31: SAR Values (WLAN 5GHz - Head)

Frequency		Test Mode	Test Position	Figure No./ Note	Conducted Power (dBm)	Max. tune-up Power (dBm)	Measured SAR(1g) (W/kg)	Reported SAR(1g) (W/kg)	Power Drift(dB)
Ch.	MHz								
U-NII-2A									
60	5300.0	802.11a	Left Cheek	/	14.75	15.5	0.106	0.13	0.07
60	5300.0	802.11a	Left Tilt	29	14.75	15.5	0.143	0.17	0.05
60	5300.0	802.11a	Right Cheek	/	14.75	15.5	0.101	0.12	0.06
60	5300.0	802.11a	Right Tilt	/	14.75	15.5	0.123	0.15	0.08
U-NII-2C									
100	5500.0	802.11a	Left Cheek	/	14.61	15.0	0.081	0.09	0.07
100	5500.0	802.11a	Left Tilt	/	14.61	15.0	0.100	0.11	0.03
100	5500.0	802.11a	Right Cheek	/	14.61	15.0	0.060	0.07	0.16
100	5500.0	802.11a	Right Tilt	/	14.61	15.0	0.055	0.06	0.05
U-NII-3									
149	5745.0	802.11a	Left Cheek	/	13.69	14.0	0.048	0.05	0.09
149	5745.0	802.11a	Left Tilt	/	13.69	14.0	0.045	0.05	0.03
149	5745.0	802.11a	Right Cheek	/	13.69	14.0	0.029	0.03	-0.12
149	5745.0	802.11a	Right Tilt	/	13.69	14.0	0.033	0.04	0.07

Note:

1. The maximum output of U-NII-2A is greater than that of U-NII-1; SAR is measured for U-NII-2A band first. Adjusted SAR of U-NII-2A band is $\leq 1.2\text{W/kg}$, SAR is not required for U-NII-1 band.
2. For all positions/configurations tested using the initial test position and subsequent test positions, when the reported SAR is $> 0.8\text{ W/kg}$, SAR is measured for these test positions/configurations on the subsequent next highest measured output power channel until the reported SAR is $\leq 1.2\text{ W/kg}$ or all required channels are tested.

According to the KDB248227 D01, The reported SAR must be scaled to 100% transmission duty factor to determine compliance at the maximum tune-up tolerance limit.

Table 13.32: SAR Values (WLAN - Head) – 802.11a (Scaled Reported SAR)

Frequency		Test Position	Actual duty factor	maximum duty factor	Reported SAR (1g)(W/kg)	Scaled reported SAR (1g)(W/kg)
Ch.	MHz					
60	5300.0	Left Tilt	100%	100%	0.17	0.17

Table 13.33: SAR Values (WLAN 5GHz - Body)

Frequency		Test Mode	Test Position	Figure No./ Note	Conducted Power (dBm)	Max. tune-up Power (dBm)	Measured SAR(1g) (W/kg)	Reported SAR(1g) (W/kg)	Power Drift(dB)
Ch.	MHz								
<U-NII-1> - Hotspot Test Data (10mm)									
36	5180.0	802.11a	Front	/	13.63	14.5	0.053	0.06	0.04
36	5180.0	802.11a	Rear	30	13.63	14.5	0.184	0.22	0.03
36	5180.0	802.11a	Left	/	13.63	14.5	0.038	0.05	0.03
36	5180.0	802.11a	Right	/	13.63	14.5	0.092	0.11	0.12
36	5180.0	802.11a	Top	/	13.63	14.5	0.145	0.18	0.07
<U-NII-3> - Hotspot Test Data (10mm)									
149	5745.0	802.11a	Front	/	13.69	14.0	0.036	0.04	0.03
149	5745.0	802.11a	Rear	/	13.69	14.0	0.096	0.10	0.01
149	5745.0	802.11a	Left	/	13.69	14.0	0.032	0.03	0.07
149	5745.0	802.11a	Right	/	13.69	14.0	0.056	0.06	-0.12
149	5745.0	802.11a	Top	/	13.69	14.0	0.056	0.06	-0.03
<U-NII-2A> - Body-Worn Test Data (15mm)									
60	5300.0	802.11a	Front	/	14.75	15.5	0.021	0.02	0.03
60	5300.0	802.11a	Rear	/	14.75	15.5	0.139	0.17	0.09
<U-NII-2C> - Body-Worn Test Data (15mm)									
100	5500.0	802.11a	Front	/	14.61	15.0	0.032	0.04	0.04
100	5500.0	802.11a	Rear	/	14.61	15.0	0.088	0.10	0.09
<U-NII-3> - Body-Worn Test Data (10mm)									
149	5745.0	802.11a	Front	/	13.69	14.0	0.036	0.04	0.03
149	5745.0	802.11a	Rear	/	13.69	14.0	0.096	0.10	0.01

Note:

1. The maximum output of U-NII-2A is greater than that of U-NII-1; SAR is measured for U-NII-2A band first. Adjusted SAR of U-NII-2A band is ≤ 1.2 W/kg, SAR is not required for U-NII-1 band.
2. For all positions/configurations tested using the initial test position and subsequent test positions, when the reported SAR is > 0.8 W/kg, SAR is measured for these test positions/configurations on the subsequent next highest measured output power channel until the reported SAR is ≤ 1.2 W/kg or all required channels are tested.

According to the KDB248227 D01, The reported SAR must be scaled to 100% transmission duty factor to determine compliance at the maximum tune-up tolerance limit.

Table 13.34: SAR Values (WLAN - Body) – 802.11a (Scaled Reported SAR)

Frequency		Test Position	Actual duty factor	maximum duty factor	Reported SAR (1g)(W/kg)	Scaled reported SAR (1g)(W/kg)
Ch.	MHz					
36	5180.0	Rear	100%	100%	0.22	0.22



13.5. Product specific 10g SAR

Table 13.35: SAR Values (WLAN 5GHz - Extremity)

Frequency		Test Mode	Test Position	Figure No./ Note	Conducted Power (dBm)	Max. tune-up Power (dBm)	Measured SAR(10g) (W/kg)	Reported SAR(10g) (W/kg)	Power Drift(dB)
Ch.	MHz								
<U-NII-2A> -Test Data (0mm)									
60	5300.0	802.11a	Front	/	14.75	15.5	0.066	0.08	0.07
60	5300.0	802.11a	Rear	31	14.75	15.5	0.500	0.59	0.00
60	5300.0	802.11a	Left	/	14.75	15.5	0.041	0.05	-0.13
60	5300.0	802.11a	Right	/	14.75	15.5	0.127	0.15	-0.05
60	5300.0	802.11a	Top	/	14.75	15.5	0.286	0.34	-0.03
<U-NII-2C> -Test Data (0mm)									
100	5500.0	802.11a	Front	/	14.61	15.0	0.051	0.06	0.06
100	5500.0	802.11a	Rear	/	14.61	15.0	0.371	0.41	0.00
100	5500.0	802.11a	Left	/	14.61	15.0	0.014	0.02	-0.17
100	5500.0	802.11a	Right	/	14.61	15.0	0.101	0.11	-0.13
100	5500.0	802.11a	Top	/	14.61	15.0	0.243	0.27	-0.05

14. SAR Measurement Variability

SAR measurement variability must be assessed for each frequency band, which is determined by the SAR probe calibration point and tissue-equivalent medium used for the device measurements. When both head and body tissue-equivalent media are required for SAR measurements in a frequency band, the variability measurement procedures should be applied to the tissue medium with the highest measured SAR, using the highest measured SAR configuration for that tissue-equivalent medium.

The following procedures are applied to determine if repeated measurements are required.

- 1) Repeated measurement is not required when the original highest measured SAR is < 0.80 W/kg; steps 2) through 4) do not apply.
- 2) When the original highest measured SAR is ≥ 0.80 W/kg, repeat that measurement once.
- 3) Perform a second repeated measurement only if the ratio of largest to smallest SAR for the original and first repeated measurements is > 1.20 or when the original or repeated measurement is ≥ 1.45 W/kg (~ 10% from the 1-g SAR limit).
- 4) Perform a third repeated measurement only if the original, first or second repeated measurement is ≥ 1.5 W/kg and the ratio of largest to smallest SAR for the original, first and second repeated measurements is > 1.20 .

Table 14.1: SAR Measurement Variability for Body – PCS1900

Frequency		Test Position	Original	1 st Repeated	Ratio	2 nd Repeated
Ch.	MHz		SAR (W/kg)	SAR (W/kg)		SAR (W/kg)
512	1850.2	Bottom	0.848	0.825	1.03	/

Table 14.2: SAR Measurement Variability for Body – WCDMA Band 2

Frequency		Test Position	Original	1 st Repeated	Ratio	2 nd Repeated
Ch.	MHz		SAR (W/kg)	SAR (W/kg)		SAR (W/kg)
9262	1852.4	Bottom	0.875	0.860	1.02	/

Table 14.3: SAR Measurement Variability for Body – LTE Band 2

Frequency		Test Position	Original	1 st Repeated	Ratio	2 nd Repeated
Ch.	MHz		SAR (W/kg)	SAR (W/kg)		SAR (W/kg)
18900	1880.0	Bottom	0.995	0.974	1.02	/

Table 14.4: SAR Measurement Variability for Body – LTE Band 66

Frequency		Test Position	Original	1 st Repeated	Ratio	2 nd Repeated
Ch.	MHz		SAR (W/kg)	SAR (W/kg)		SAR (W/kg)
132572	1770.0	Bottom	0.908	0.882	1.03	/

15. Measurement Uncertainty

15.1. Measurement Uncertainty for Normal SAR Tests (300MHz~3GHz)

No.	Error Description	Type	Uncertainty value	Probably Distribution	Div.	(Ci) 1g	(Ci) 10g	Std. Unc. (1g)	Std. Unc. (10g)	Degree of freedom
Measurement system										
1	Probe calibration	B	12	N	2	1	1	6.0	6.0	∞
2	Axial isotropy	B	4.7	R	$\sqrt{3}$	$\sqrt{0.5}$	$\sqrt{0.5}$	4.3	4.3	∞
3	Hemispherical isotropy	B	9.6	R	$\sqrt{3}$	1	1	4.8	4.8	∞
4	Boundary effect	B	1.1	R	$\sqrt{3}$	1	1	0.6	0.6	∞
5	Linearity	B	4.7	R	$\sqrt{3}$	1	1	2.7	2.7	∞
6	Detection limit	B	1.0	R	$\sqrt{3}$	1	1	0.6	0.6	∞
7	Modulation response	B	4.0	R	$\sqrt{3}$	1	1	2.3	2.3	∞
8	Readout electronics	B	1.0	N	1	1	1	1.0	1.0	∞
9	Response time	B	0.8	R	$\sqrt{3}$	1	1	0.5	0.5	∞
10	Integration time	B	1.7	R	$\sqrt{3}$	1	1	1.0	1.0	∞
11	RF ambient conditions-noise	B	3.0	R	$\sqrt{3}$	1	1	1.7	1.7	∞
12	RF ambient conditions-reflection	B	3.0	R	$\sqrt{3}$	1	1	1.7	1.7	∞
13	Probe positioned mech. restrictions	B	0.35	R	$\sqrt{3}$	1	1	0.2	0.2	∞
14	Probe positioning with respect to phantom shell	B	2.9	R	$\sqrt{3}$	1	1	1.7	1.7	∞
15	Post-processing	B	1.0	R	$\sqrt{3}$	1	1	0.6	0.6	∞
Test sample related										
16	Test sample positioning	A	3.3	N	1	1	1	3.3	3.3	5
17	Device holder uncertainty	A	3.4	N	1	1	1	3.4	3.4	5
18	Drift of output power	B	5.0	R	$\sqrt{3}$	1	1	2.9	2.9	∞
Phantom and set-up										
19	Phantom uncertainty	B	1.0	R	$\sqrt{3}$	1	1	0.6	0.6	∞
20	Liquid conductivity (target)	B	5.0	R	$\sqrt{3}$	0.64	0.43	1.8	1.2	∞
21	Liquid conductivity (meas.)	A	1.3	N	1	0.64	0.43	0.83	0.56	9
22	Liquid permittivity (target)	B	5.0	R	$\sqrt{3}$	0.6	0.49	1.7	1.4	∞
23	Liquid permittivity (meas.)	A	1.6	N	1	0.6	0.49	0.96	0.78	9
Combined standard uncertainty		$u_c = \sqrt{\sum_{i=1}^{23} c_i^2 u_i^2}$						11.3	11.2	95.5
Expanded uncertainty (Confidence interval of 95 %)		$u_e = 2u_c$						22.6	22.4	

15.2. Measurement Uncertainty for Normal SAR Tests (3GHz~6GHz)

No.	Error Description	Type	Uncertainty value	Probably Distribution	Div.	(Ci) 1g	(Ci) 10g	Std. Unc. (1g)	Std. Unc. (10g)	Degree of freedom
Measurement system										
1	Probe calibration	B	13.1	N	2	1	1	6.65	6.65	∞
2	Axial isotropy	B	4.7	R	$\sqrt{3}$	$\sqrt{0.5}$	$\sqrt{0.5}$	4.3	4.3	∞
3	Hemispherical isotropy	B	9.6	R	$\sqrt{3}$	1	1	4.8	4.8	∞
4	Boundary effect	B	1.1	R	$\sqrt{3}$	1	1	0.6	0.6	∞
5	Linearity	B	4.7	R	$\sqrt{3}$	1	1	2.7	2.7	∞
6	Detection limit	B	1.0	R	$\sqrt{3}$	1	1	0.6	0.6	∞
7	modulation response	B	4.0	R	$\sqrt{3}$	1	1	2.3	2.3	∞
8	Readout electronics	B	1.0	N	1	1	1	1.0	1.0	∞
9	Response time	B	0.0	R	$\sqrt{3}$	1	1	0.0	0.0	∞
10	Integration time	B	1.7	R	$\sqrt{3}$	1	1	1.0	1.0	∞
11	RF ambient conditions-noise	B	3.0	R	$\sqrt{3}$	1	1	1.7	1.7	∞
12	RF ambient conditions-reflection	B	3.0	R	$\sqrt{3}$	1	1	1.7	1.7	∞
13	Probe positioned mech. Restrictions	B	0.35	R	$\sqrt{3}$	1	1	0.2	0.2	∞
14	Probe positioning with respect to phantom shell	B	2.9	R	$\sqrt{3}$	1	1	1.7	1.7	∞
15	Post-processing	B	1.0	R	$\sqrt{3}$	1	1	0.6	0.6	∞
Test sample related										
16	Test sample positioning	A	3.3	N	1	1	1	3.3	3.3	5
17	Device holder uncertainty	A	3.4	N	1	1	1	3.4	3.4	5
18	Drift of output power	B	5.0	R	$\sqrt{3}$	1	1	2.9	2.9	∞
Phantom and set-up										
19	Phantom uncertainty	B	1.0	R	$\sqrt{3}$	1	1	0.6	0.6	∞
20	Liquid conductivity (target)	B	5.0	R	$\sqrt{3}$	0.64	0.43	1.8	1.2	∞
21	Liquid conductivity (meas.)	A	1.3	N	1	0.64	0.43	0.83	0.56	43
22	Liquid permittivity (target)	B	5.0	R	$\sqrt{3}$	0.6	0.49	1.7	1.4	∞
23	Liquid permittivity (meas.)	A	1.6	N	1	0.6	0.49	0.96	0.78	521
Combined standard uncertainty		$u_c = \sqrt{\sum_{i=1}^{22} c_i^2 u_i^2}$						11.6	11.5	257
Expanded uncertainty (Confidence interval of 95 %)		$u_e = 2u_c$						23.2	23.0	

16. Main Test Instruments

Table 16.1: List of Main Instruments

No.	Name	Type	Serial Number	Calibration Date	Valid Period
01	Network analyzer	E5071C	MY46103759	2021-11-15	One year
02	Dielectric probe	85070E	MY44300317	/	/
03	Power meter	E4418B	MY50000366	2021-12-13	One year
04	Power sensor	E9304A	MY50000188		
05	Power meter	NRP	101460	2022-01-15	One year
06	Power sensor	NRP-Z91	100553		
07	Signal Generator	E8257D	MY47461211	2022-01-15	One year
08	Amplifier	VTL5400	0404	/	/
09	E-field Probe	EX3DV4	7683	2021-12-29 & 2021-09-22	One year
10	DAE	DAE4	1527	2022-01-12	One year
11	Dipole Validation Kit	D750V3	1163	2019-09-03	Three years
12	Dipole Validation Kit	D835V2	4d057	2021-10-18	Three years
13	Dipole Validation Kit	D1750V2	1152	2019-08-30	Three years
14	Dipole Validation Kit	D1900V2	5d088	2021-10-18	Three years
15	Dipole Validation Kit	D2450V2	873	2021-10-21	Three years
16	Dipole Validation Kit	D2550V2	1010	2021-05-21	Three years
17	Dipole Validation Kit	D5GHzV2	1238	2019-08-29	Three years
18	BTS	MT8820C	6201341853	2022-01-15	One year
19	BTS	E5515C	GB46110722	2022-01-15	One year
20	BTS	CMW500	152499	2021-07-16	One year
21	Software	DASY5	/	/	/

ANNEX A: Graph Results

GSM850 Head

Date: 2022-3-26

Electronics: DAE4 Sn1527

Medium: Head 835MHz

Medium parameters used (interpolated): $f = 836.6$ MHz; $\sigma = 0.917$ S/m; $\epsilon_r = 40.219$; $\rho = 1000$ kg/m³

Communication System: UID 0, GSM (0) Frequency: 836.6 MHz Duty Cycle: 1:8.3

Probe: EX3DV4 - SN7683 ConvF (10.34, 10.34, 10.34)

Right Cheek Middle/Area Scan (61x61x1): Interpolated grid: $dx=1.500$ mm, $dy=1.500$ mm

Maximum value of SAR (interpolated) = 0.231 W/kg

Right Cheek Middle/Zoom Scan (5x5x7)/Cube 0: Measurement grid: $dx=8$ mm, $dy=8$ mm, $dz=5$ mm

Reference Value = 2.896 V/m; Power Drift = 0.00 dB

Peak SAR (extrapolated) = 0.260 W/kg

SAR(1 g) = 0.212 W/kg; SAR(10 g) = 0.164 W/kg

Maximum value of SAR (measured) = 0.240 W/kg

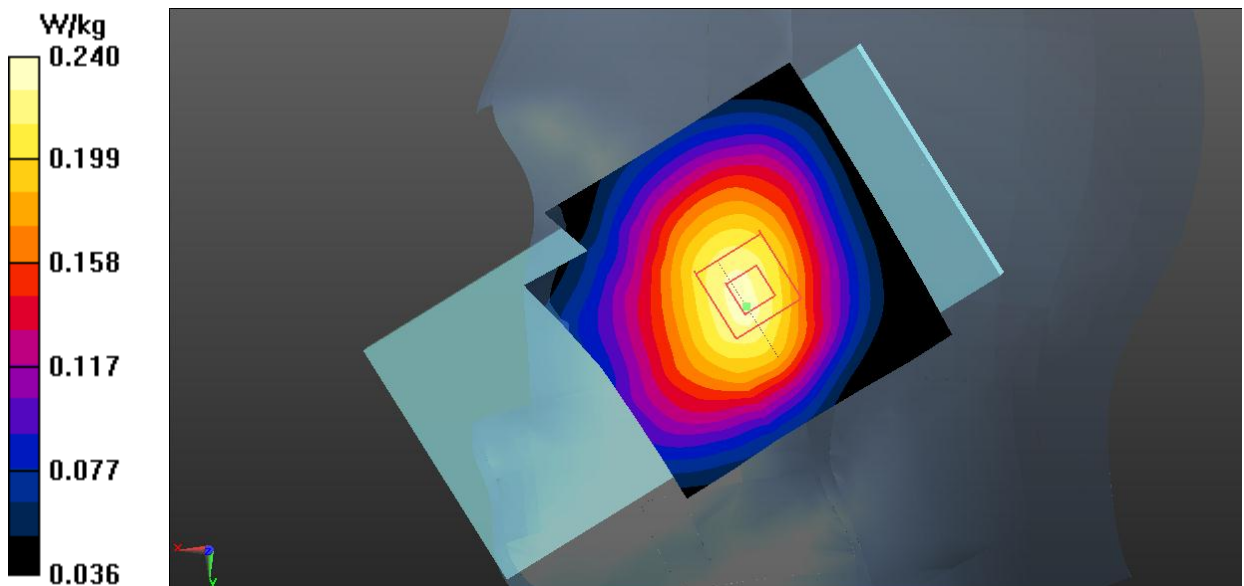

Fig.1 GSM850 Head

GSM850 Body

Date: 2022-3-26

Electronics: DAE4 Sn1527

Medium: Head 835MHz

Medium parameters used (interpolated): $f = 836.6$ MHz; $\sigma = 0.917$ S/m; $\epsilon_r = 40.219$; $\rho = 1000$ kg/m³

Communication System: UID 0, 4 slot GPRS (0) Frequency: 836.6 MHz Duty Cycle: 1:2

Probe: EX3DV4 - SN7683 ConvF (10.34, 10.34, 10.34)

Rear Side Middle/Area Scan (61x101x1): Interpolated grid: dx=1.500 mm, dy=1.500 mm

Maximum value of SAR (interpolated) = 0.428 W/kg

Rear Side Middle/Zoom Scan (5x5x7)/Cube 0: Measurement grid: dx=8mm, dy=8mm, dz=5mm

Reference Value = 19.64 V/m; Power Drift = -0.02 dB

Peak SAR (extrapolated) = 0.470 W/kg

SAR(1 g) = 0.368 W/kg; SAR(10 g) = 0.278 W/kg

Maximum value of SAR (measured) = 0.422 W/kg

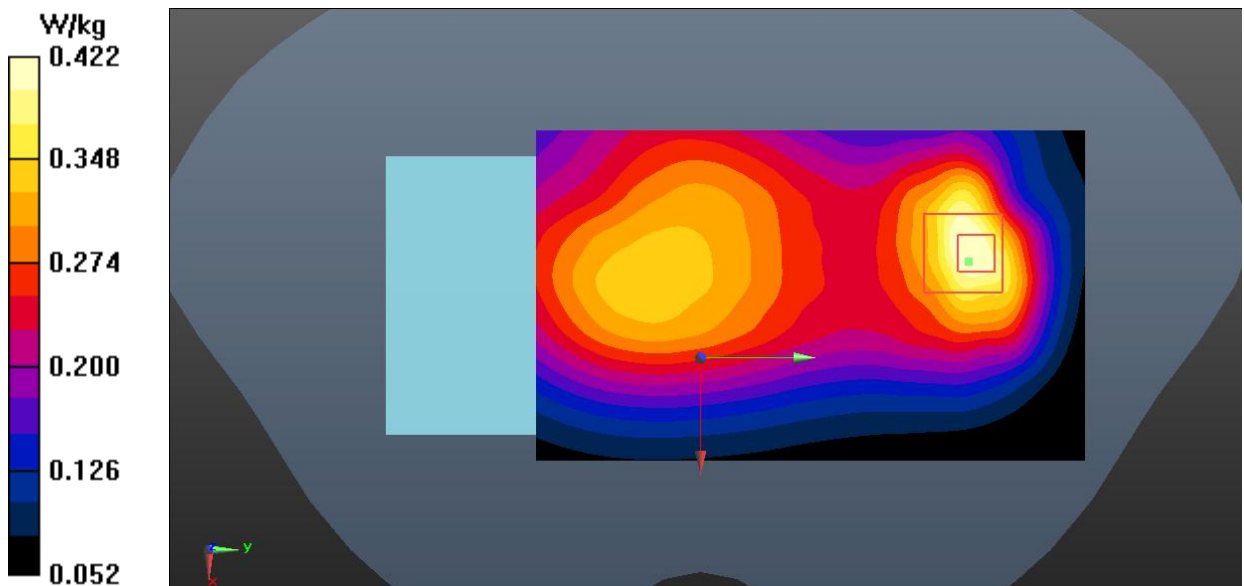
**Fig.2 GSM850 Body**

PCS1900 Head

Date: 2022-4-15

Electronics: DAE4 Sn1527

Medium: Head 1900MHz

Medium parameters used: $f = 1880$ MHz; $\sigma = 1.407$ S/m; $\epsilon_r = 39.351$; $\rho = 1000$ kg/m³

Communication System: UID 0, GSM (0) Frequency: 1880 MHz Duty Cycle: 1:1.83

Probe: EX3DV4 - SN7683 ConvF (8.33, 8.33, 8.33)

Left Tilt Middle/Area Scan (61x61x1): Interpolated grid: $dx=1.500$ mm, $dy=1.500$ mm
Maximum value of SAR (interpolated) = 0.0796 W/kg

Left Tilt Middle/Zoom Scan (5x5x7)/Cube 0: Measurement grid: $dx=8$ mm, $dy=8$ mm, $dz=5$ mm

Reference Value = 3.632 V/m; Power Drift = 0.05 dB

Peak SAR (extrapolated) = 0.0910 W/kg

SAR(1 g) = 0.060 W/kg; SAR(10 g) = 0.037 W/kg

Maximum value of SAR (measured) = 0.0762 W/kg

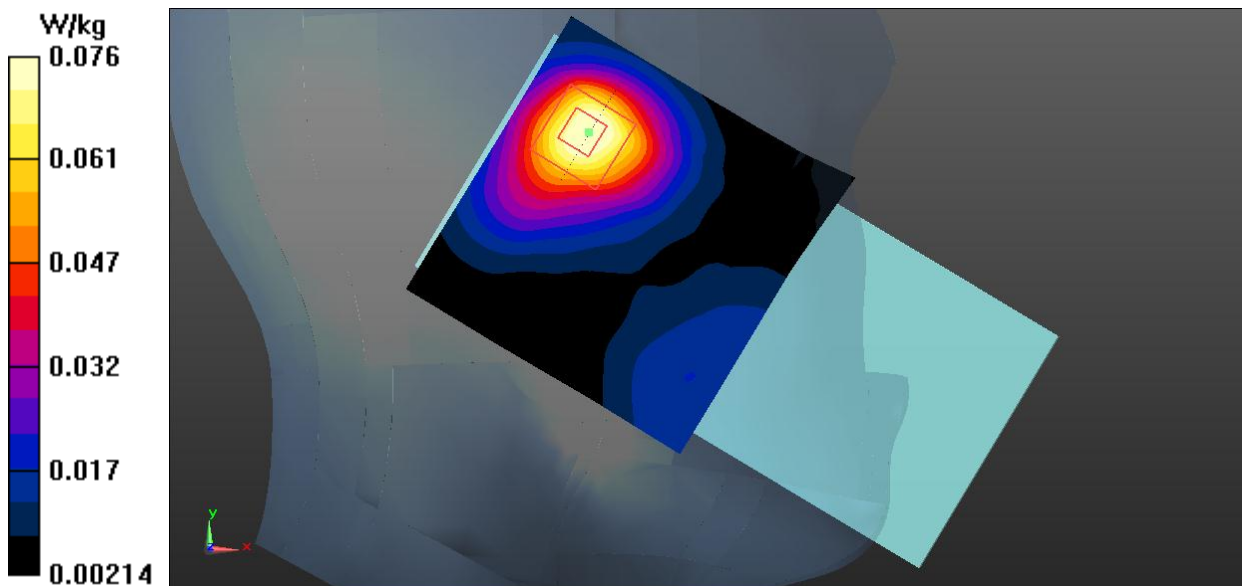
**Fig.3 PCS1900 Head**

PCS1900 Body

Date: 2022-4-15

Electronics: DAE4 Sn1527

Medium: Head 1900MHz

Medium parameters used (interpolated): $f = 1850.2$ MHz; $\sigma = 1.381$ S/m; $\epsilon_r = 39.467$; $\rho = 1000$ kg/m³

Communication System: UID 0, 4 slot GPRS (0) Frequency: 1850.2 MHz Duty Cycle: 1:2

Probe: EX3DV4 - SN7683 ConvF (8.33, 8.33, 8.33)

Bottom Side Low/Area Scan (41x71x1): Interpolated grid: dx=1.500 mm, dy=1.500 mm

Maximum value of SAR (interpolated) = 1.17 W/kg

Bottom Side Low/Zoom Scan (5x5x7)/Cube 0: Measurement grid: dx=8mm, dy=8mm, dz=5mm

Reference Value = 20.03 V/m; Power Drift = 0.12 dB

Peak SAR (extrapolated) = 1.42 W/kg

SAR(1 g) = 0.848 W/kg; SAR(10 g) = 0.462 W/kg

Maximum value of SAR (measured) = 1.16 W/kg

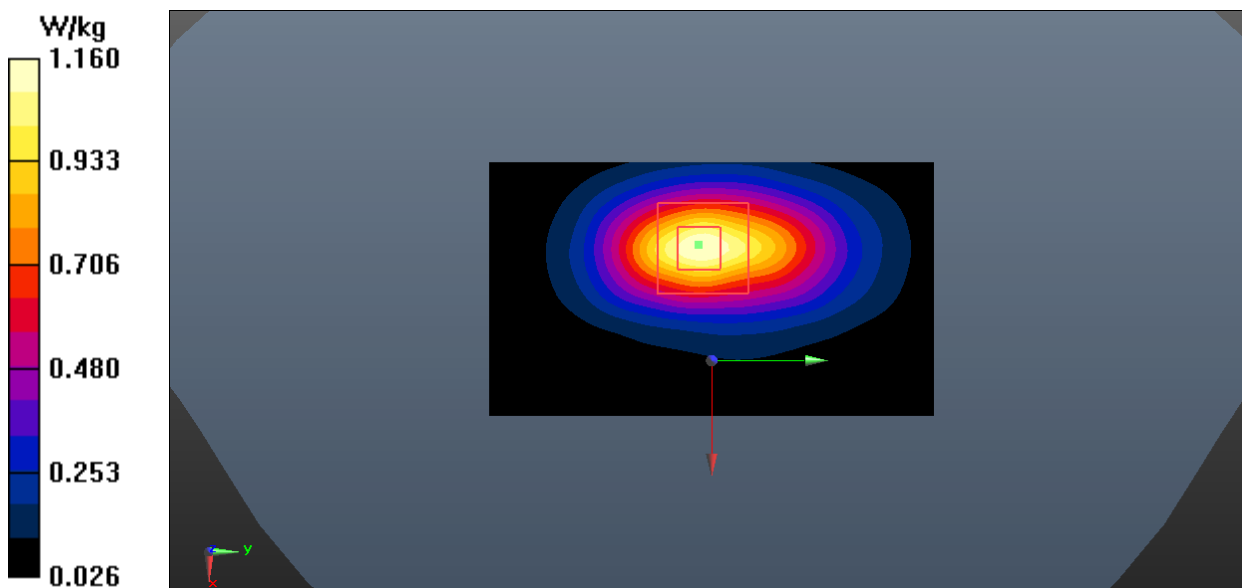

Fig.4 PCS1900 Body

WCDMA Band 2 Head

Date: 2022-4-15

Electronics: DAE4 Sn1527

Medium: Head 1900MHz

Medium parameters used: $f = 1880$ MHz; $\sigma = 1.407$ S/m; $\epsilon_r = 39.351$; $\rho = 1000$ kg/m³

Communication System: UID 0, WCDMA (0) Frequency: 1880 MHz Duty Cycle: 1:1

Probe: EX3DV4 - SN7683 ConvF (8.33, 8.33, 8.33)

Right Cheek Middle/Area Scan (61x61x1): Interpolated grid: $dx=1.500$ mm, $dy=1.500$ mm
Maximum value of SAR (interpolated) = 0.146 W/kg**Right Cheek Middle/Zoom Scan (5x5x7)/Cube 0:** Measurement grid: $dx=8$ mm, $dy=8$ mm, $dz=5$ mm

Reference Value = 3.108 V/m; Power Drift = 0.04 dB

Peak SAR (extrapolated) = 0.157 W/kg

SAR(1 g) = 0.111 W/kg; SAR(10 g) = 0.074 W/kg

Maximum value of SAR (measured) = 0.134 W/kg

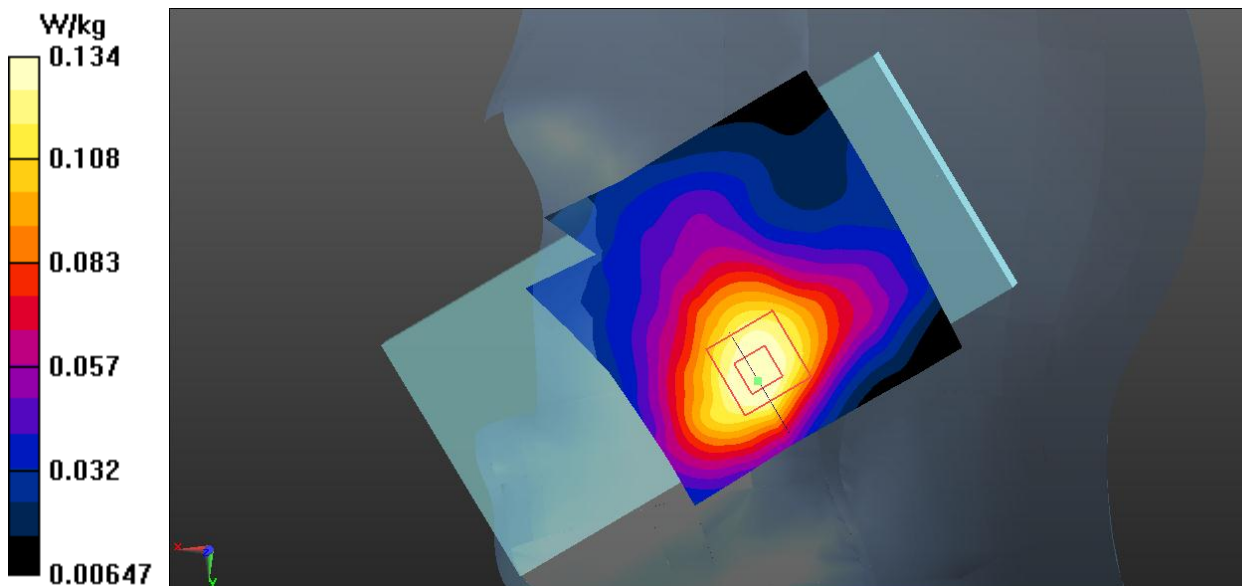

Fig.5 WCDMA Band 2 Head

WCDMA Band 2 Body

Date: 2022-4-15

Electronics: DAE4 Sn1527

Medium: Head 1900MHz

Medium parameters used (interpolated): $f = 1852.4$ MHz; $\sigma = 1.383$ S/m; $\epsilon_r = 39.459$; $\rho = 1000$ kg/m³

Communication System: UID 0, WCDMA (0) Frequency: 1852.4 MHz Duty Cycle: 1:1

Probe: EX3DV4 - SN7683 ConvF (8.33, 8.33, 8.33)

Bottom Side Low/Area Scan (41x71x1): Interpolated grid: dx=1.500 mm, dy=1.500 mm

Maximum value of SAR (interpolated) = 1.13 W/kg

Bottom Side Low/Zoom Scan (5x5x7)/Cube 0: Measurement grid: dx=8mm, dy=8mm, dz=5mm

Reference Value = 13.90 V/m; Power Drift = 0.01 dB

Peak SAR (extrapolated) = 1.50 W/kg

SAR(1 g) = 0.875 W/kg; SAR(10 g) = 0.476 W/kg

Maximum value of SAR (measured) = 1.08 W/kg

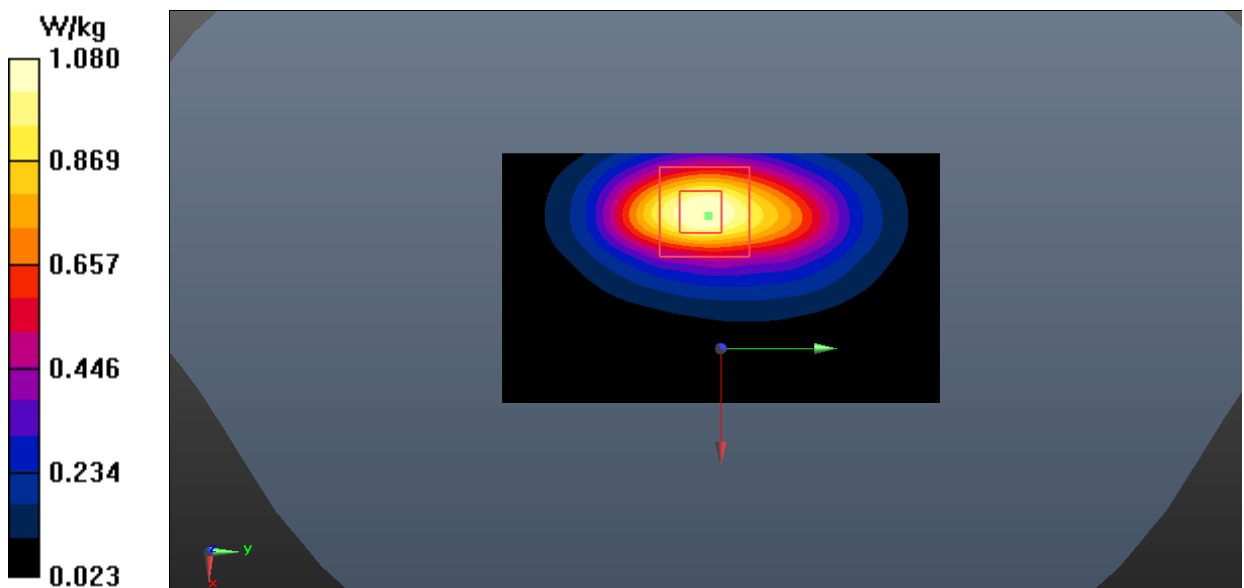

Fig.6 WCDMA Band 2 Body

WCDMA Band 4 Head

Date: 2022-4-17

Electronics: DAE4 Sn1527

Medium: Head 1750MHz

Medium parameters used: $f = 1733$ MHz; $\sigma = 1.343$ S/m; $\epsilon_r = 39.67$; $\rho = 1000$ kg/m³

Communication System: UID 0, WCDMA (0) Frequency: 1732.6 MHz Duty Cycle: 1:1

Probe: EX3DV4 - SN7683 ConvF (8.58, 8.58, 8.58)

Right Cheek Middle/Area Scan (61x61x1): Interpolated grid: dx=1.500 mm, dy=1.500 mm
Maximum value of SAR (interpolated) = 0.215 W/kg

Right Cheek Middle/Zoom Scan (5x5x7)/Cube 0: Measurement grid: dx=8mm, dy=8mm, dz=5mm

Reference Value = 3.813 V/m; Power Drift = 0.04 dB

Peak SAR (extrapolated) = 0.238 W/kg

SAR(1 g) = 0.167 W/kg; SAR(10 g) = 0.111 W/kg

Maximum value of SAR (measured) = 0.202 W/kg

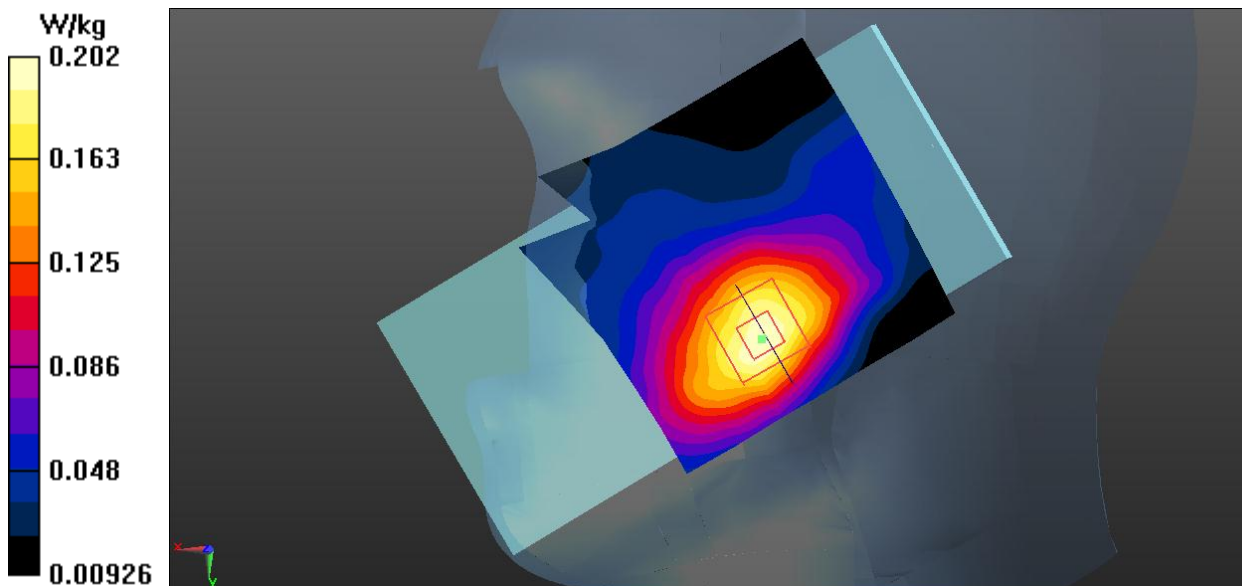
**Fig.7 WCDMA Band 4 Head**

WCDMA Band 4 Body

Date: 2022-4-17

Electronics: DAE4 Sn1527

Medium: Head 1750MHz

Medium parameters used: $f = 1733$ MHz; $\sigma = 1.343$ S/m; $\epsilon_r = 39.67$; $\rho = 1000$ kg/m³

Communication System: UID 0, WCDMA (0) Frequency: 1732.6 MHz Duty Cycle: 1:1

Probe: EX3DV4 - SN7683 ConvF (8.58, 8.58, 8.58)

Bottom Side Middle/Area Scan (41x71x1): Interpolated grid: dx=1.500 mm, dy=1.500 mm
Maximum value of SAR (interpolated) = 1.13 W/kg**Bottom Side Middle/Zoom Scan (5x5x7)/Cube 0:** Measurement grid: dx=8mm, dy=8mm, dz=5mm

Reference Value = 25.40 V/m; Power Drift = -0.04 dB

Peak SAR (extrapolated) = 1.37 W/kg

SAR(1 g) = 0.794 W/kg; SAR(10 g) = 0.430 W/kg

Maximum value of SAR (measured) = 1.08 W/kg

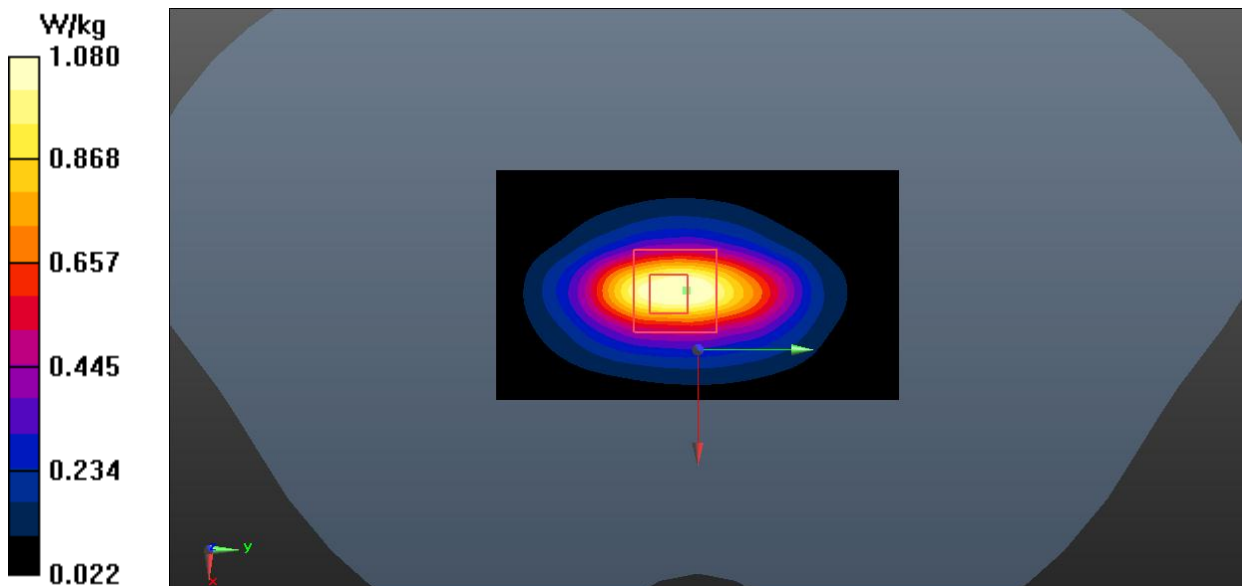

Fig.8 WCDMA Band 4 Body

WCDMA Band 5 Head

Date: 2022-3-26

Electronics: DAE4 Sn1527

Medium: Head 835MHz

Medium parameters used (interpolated): $f = 836.6$ MHz; $\sigma = 0.917$ S/m; $\epsilon_r = 40.219$; $\rho = 1000$ kg/m³

Communication System: UID 0, WCDMA (0) Frequency: 836.6 MHz Duty Cycle: 1:1

Probe: EX3DV4 - SN7683 ConvF (10.34, 10.34, 10.34)

Right Cheek Middle/Area Scan (61x61x1): Interpolated grid: $dx=1.500$ mm, $dy=1.500$ mm
Maximum value of SAR (interpolated) = 0.228 W/kg**Right Cheek Middle/Zoom Scan (5x5x7)/Cube 0:** Measurement grid: $dx=8$ mm, $dy=8$ mm,
 $dz=5$ mm

Reference Value = 5.604 V/m; Power Drift = 0.05 dB

Peak SAR (extrapolated) = 0.239 W/kg

SAR(1 g) = 0.196 W/kg; SAR(10 g) = 0.152 W/kg

Maximum value of SAR (measured) = 0.219 W/kg

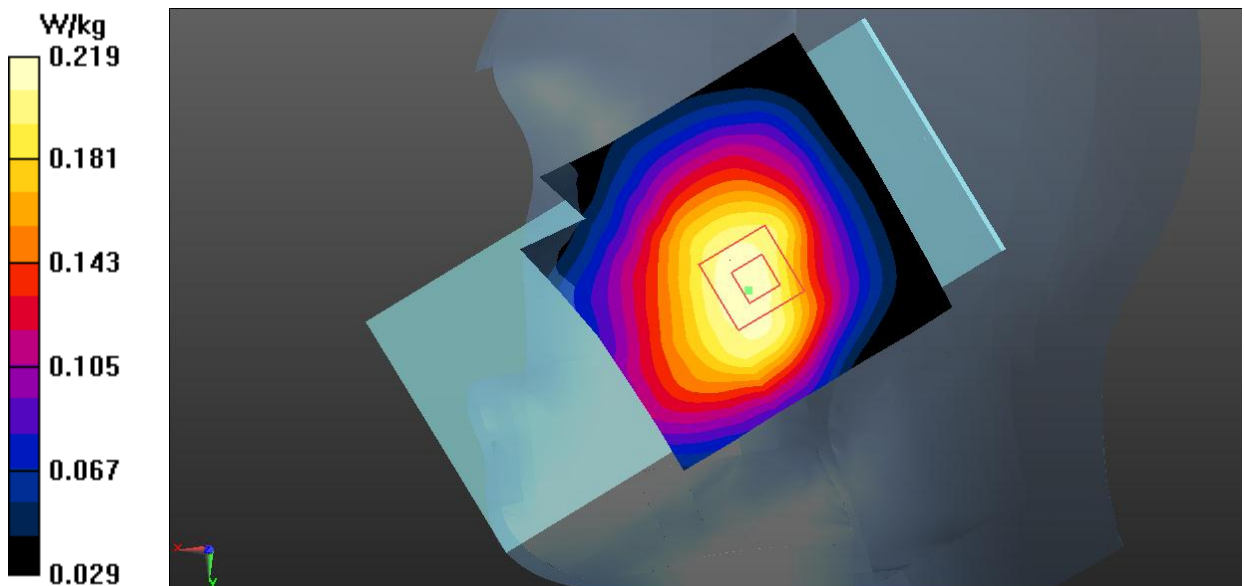

Fig.9 WCDMA Band 5 Head

WCDMA Band 5 Body

Date: 2022-3-26

Electronics: DAE4 Sn1527

Medium: Head 835MHz

Medium parameters used (interpolated): $f = 836.6$ MHz; $\sigma = 0.917$ S/m; $\epsilon_r = 40.219$; $\rho = 1000$ kg/m³

Communication System: UID 0, WCDMA (0) Frequency: 836.6 MHz Duty Cycle: 1:1

Probe: EX3DV4 - SN7683 ConvF (10.34, 10.34, 10.34)

Rear Side Middle/Area Scan (61x101x1): Interpolated grid: dx=1.500 mm, dy=1.500 mm

Maximum value of SAR (interpolated) = 0.356 W/kg

Rear Side Middle/Zoom Scan (5x5x7)/Cube 0: Measurement grid: dx=8mm, dy=8mm, dz=5mm

Reference Value = 15.55 V/m; Power Drift = 0.03 dB

Peak SAR (extrapolated) = 0.425 W/kg

SAR(1 g) = 0.268 W/kg; SAR(10 g) = 0.167 W/kg

Maximum value of SAR (measured) = 0.343 W/kg

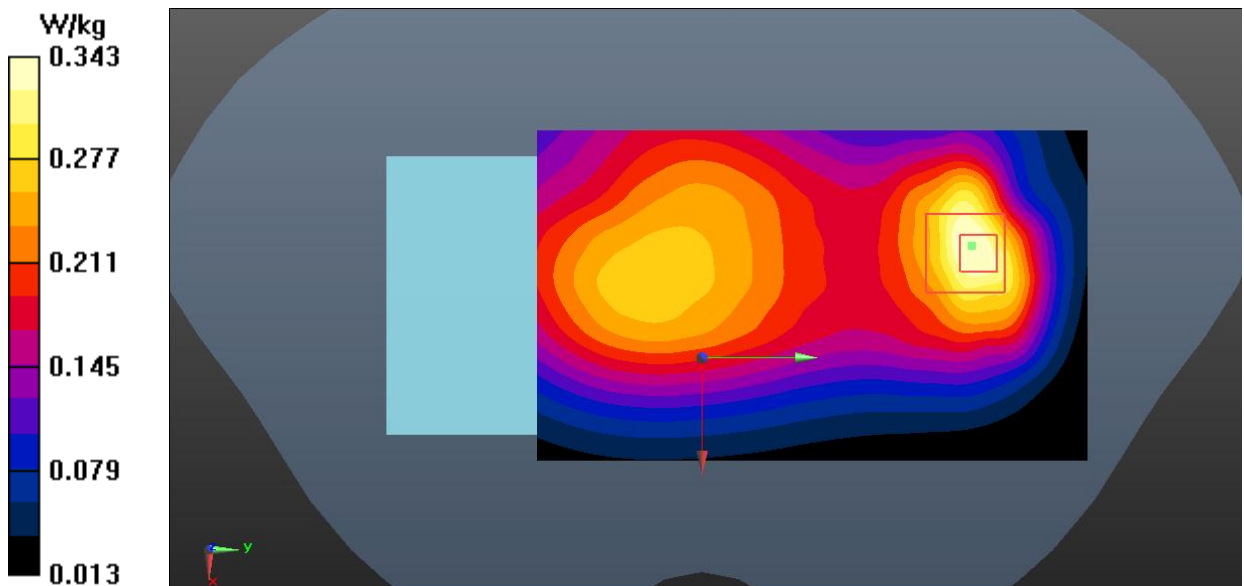

Fig.10 WCDMA Band 5 Body

LTE Band 2 Head

Date: 2022-4-15

Electronics: DAE4 Sn1527

Medium: Head 1900MHz

Medium parameters used: $f = 1880$ MHz; $\sigma = 1.407$ S/m; $\epsilon_r = 39.351$; $\rho = 1000$ kg/m³

Communication System: UID 0, LTE_FDD (0) Frequency: 1880 MHz Duty Cycle: 1:1

Probe: EX3DV4 - SN7683 ConvF (8.33, 8.33, 8.33)

Right Cheek Middle 1RB99/Area Scan (61x61x1): Interpolated grid: dx=1.500 mm, dy=1.500 mm
Maximum value of SAR (interpolated) = 0.145 W/kg**Right Cheek Middle 1RB99/Zoom Scan (5x5x7)/Cube 0:** Measurement grid: dx=8mm, dy=8mm, dz=5mm

Reference Value = 2.502 V/m; Power Drift = 0.17 dB

Peak SAR (extrapolated) = 0.157 W/kg

SAR(1 g) = 0.112 W/kg; SAR(10 g) = 0.076 W/kg

Maximum value of SAR (measured) = 0.133 W/kg

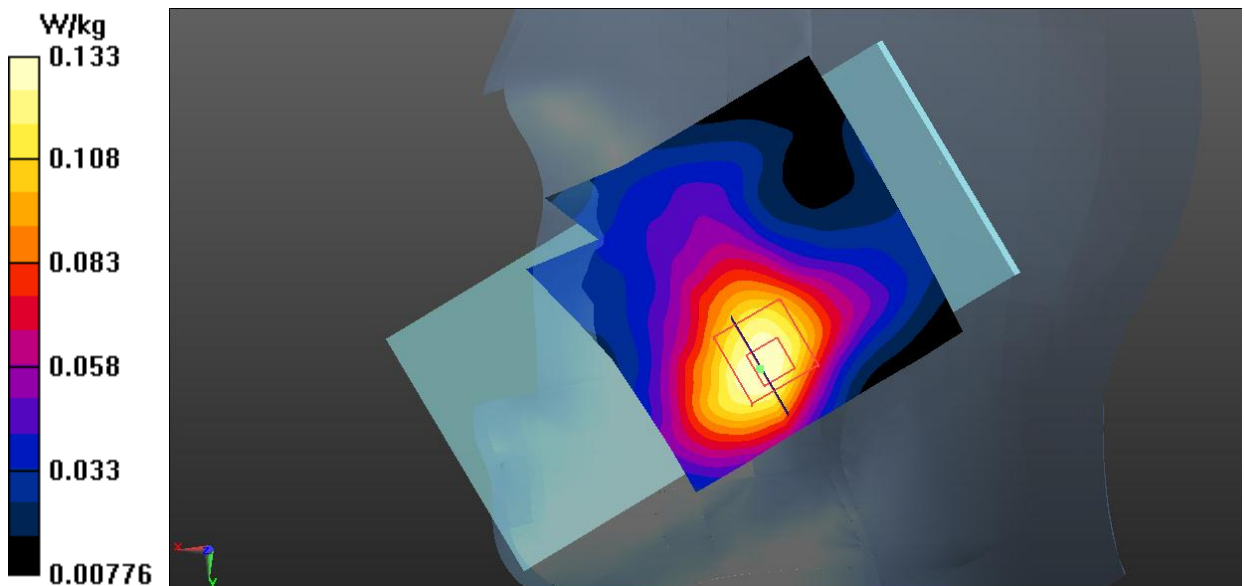

Fig.11 LTE Band 2 Head

LTE Band 2 Body

Date: 2022-4-15

Electronics: DAE4 Sn1527

Medium: Head 1900MHz

Medium parameters used: $f = 1880$ MHz; $\sigma = 1.407$ S/m; $\epsilon_r = 39.351$; $\rho = 1000$ kg/m³

Communication System: UID 0, LTE_FDD (0) Frequency: 1880 MHz Duty Cycle: 1:1

Probe: EX3DV4 - SN7683 ConvF (8.33, 8.33, 8.33)

Bottom Side Middle 1RB99/Area Scan (41x71x1): Interpolated grid: $dx=1.500$ mm, $dy=1.500$ mm
 Maximum value of SAR (interpolated) = 1.35 W/kg

Bottom Side Middle 1RB99/Zoom Scan (5x5x7)/Cube 0: Measurement grid: $dx=8$ mm, $dy=8$ mm, $dz=5$ mm

Reference Value = 23.95 V/m; Power Drift = 0.05 dB

Peak SAR (extrapolated) = 1.72 W/kg

SAR(1 g) = 0.995 W/kg; SAR(10 g) = 0.534 W/kg

Maximum value of SAR (measured) = 1.39 W/kg

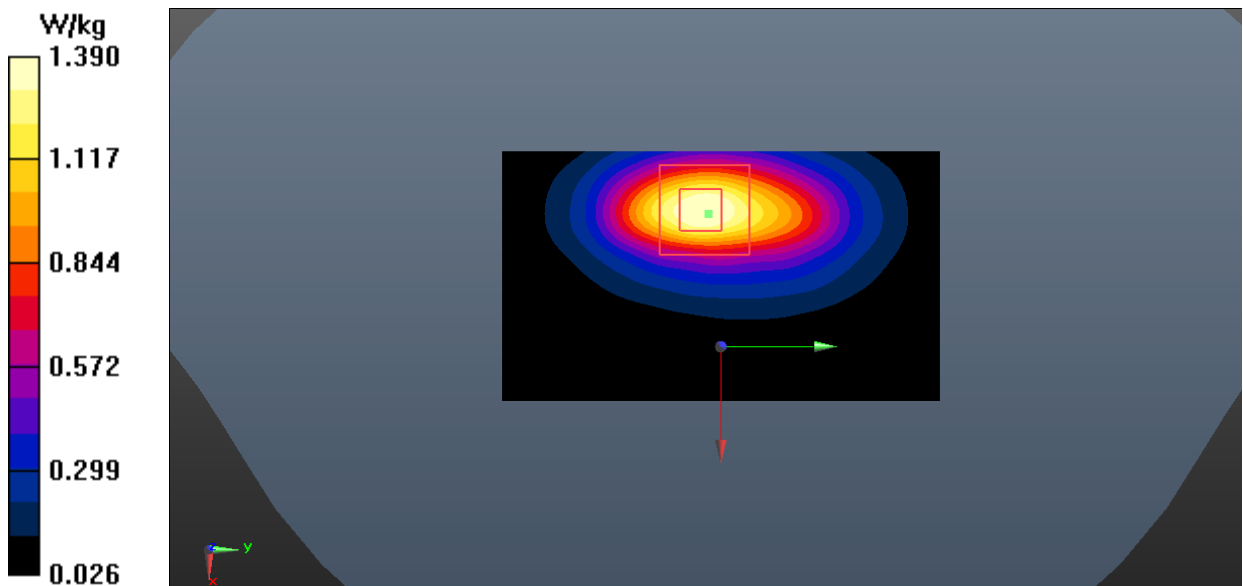

Fig.12 LTE Band 2 Body

LTE Band 5 Head

Date: 2022-3-26

Electronics: DAE4 Sn1527

Medium: Head 835MHz

Medium parameters used (interpolated): $f = 829$ MHz; $\sigma = 0.911$ S/m; $\epsilon_r = 40.31$; $\rho = 1000$ kg/m³

Communication System: UID 0, LTE_FDD (0) Frequency: 829 MHz Duty Cycle: 1:1

Probe: EX3DV4 - SN7683 ConvF (10.34, 10.34, 10.34)

Right Cheek Low 1RB49/Area Scan (61x61x1): Interpolated grid: dx=1.500 mm, dy=1.500 mm
Maximum value of SAR (interpolated) = 0.261 W/kg**Right Cheek Low 1RB49/Zoom Scan (5x5x7)/Cube 0:** Measurement grid: dx=8mm, dy=8mm, dz=5mm

Reference Value = 3.278 V/m; Power Drift = 0.07 dB

Peak SAR (extrapolated) = 0.285 W/kg

SAR(1 g) = 0.231 W/kg; SAR(10 g) = 0.181 W/kg

Maximum value of SAR (measured) = 0.260 W/kg

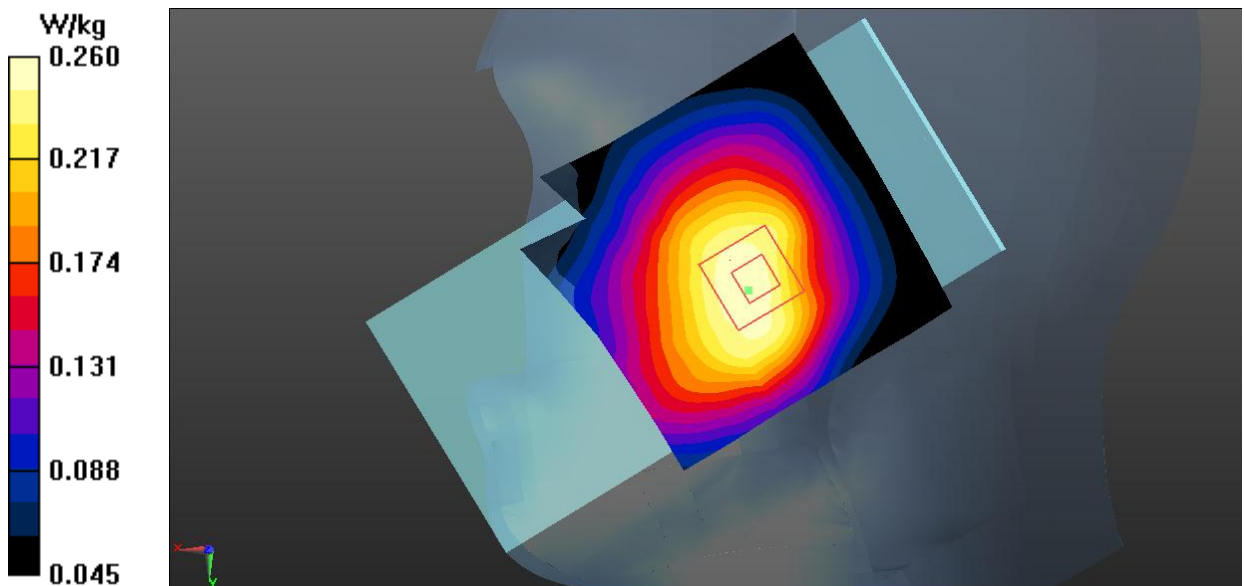

Fig.13 LTE Band 5 Head

LTE Band 5 Body

Date: 2022-3-26

Electronics: DAE4 Sn1527

Medium: Head 835MHz

Medium parameters used (interpolated): $f = 829$ MHz; $\sigma = 0.911$ S/m; $\epsilon_r = 40.31$; $\rho = 1000$ kg/m³

Communication System: UID 0, LTE_FDD (0) Frequency: 829 MHz Duty Cycle: 1:1

Probe: EX3DV4 - SN7683 ConvF (10.34, 10.34, 10.34)

Rear Side Low 1RB49/Area Scan (61x101x1): Interpolated grid: $dx=1.500$ mm, $dy=1.500$ mm
 Maximum value of SAR (interpolated) = 0.317 W/kg

Rear Side Low 1RB49/Zoom Scan (5x5x7)/Cube 0: Measurement grid: $dx=8$ mm, $dy=8$ mm, $dz=5$ mm

Reference Value = 16.98 V/m; Power Drift = 0.01 dB

Peak SAR (extrapolated) = 0.349 W/kg

SAR(1 g) = 0.276 W/kg; SAR(10 g) = 0.211 W/kg

Maximum value of SAR (measured) = 0.318 W/kg

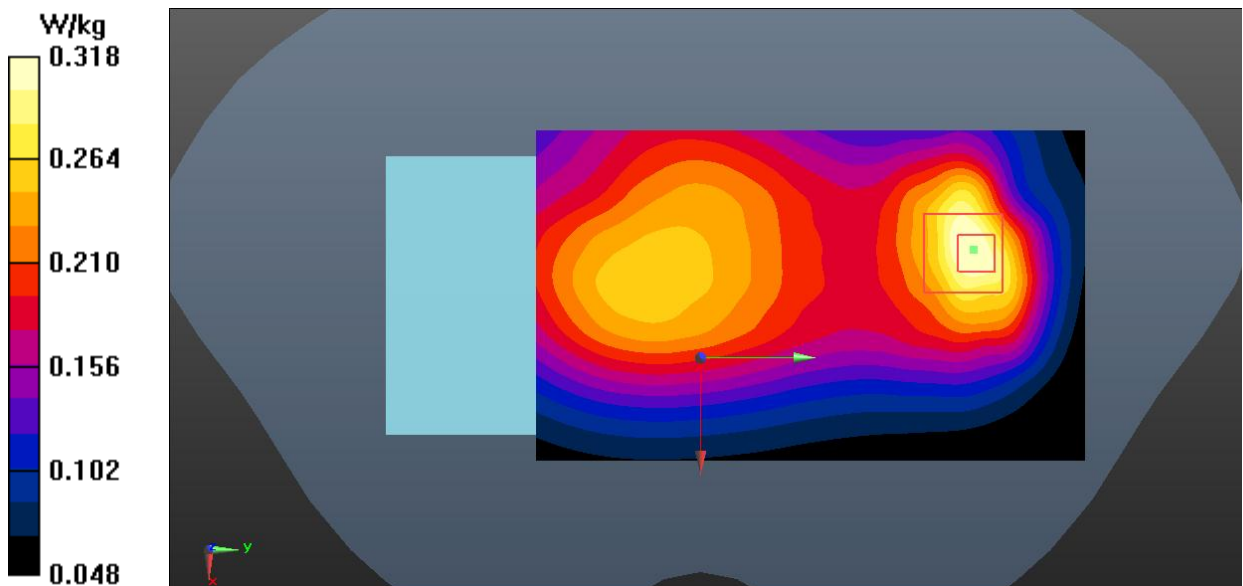

Fig.14 LTE Band 5 Body

LTE Band 7 Head

Date: 2022-4-20

Electronics: DAE4 Sn1527

Medium: Head 2550MHz

Medium parameters used (interpolated): $f = 2535$ MHz; $\sigma = 1.914$ S/m; $\epsilon_r = 37.994$; $\rho = 1000$ kg/m³

Communication System: UID 0, LTE_FDD (0) Frequency: 2535 MHz Duty Cycle: 1:1

Probe: EX3DV4 - SN7683 ConvF (7.85, 7.85, 7.85)

Right Cheek Middle 1RB99/Area Scan (91x91x1): Interpolated grid: dx=1.000 mm, dy=1.000 mm
Maximum value of SAR (interpolated) = 0.110 W/kg**Right Cheek Middle 1RB99/Zoom Scan (7x7x7)/Cube 0:** Measurement grid: dx=5mm, dy=5mm, dz=5mm

Reference Value = 1.288 V/m; Power Drift = 0.08 dB

Peak SAR (extrapolated) = 0.134 W/kg

SAR(1 g) = 0.078 W/kg; SAR(10 g) = 0.045 W/kg

Maximum value of SAR (measured) = 0.102 W/kg

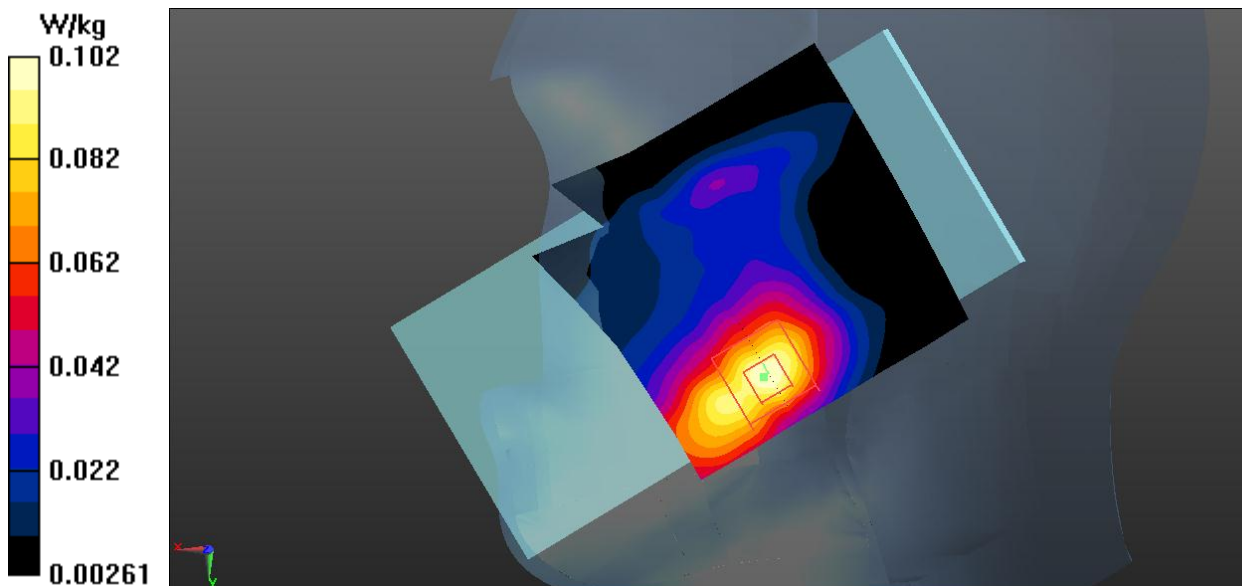

Fig.15 LTE Band 7 Head

LTE Band 7 Body

Date: 2022-4-20

Electronics: DAE4 Sn1527

Medium: Head 2550MHz

Medium parameters used: $f = 2510$ MHz; $\sigma = 1.885$ S/m; $\epsilon_r = 38.076$; $\rho = 1000$ kg/m³

Communication System: UID 0, LTE_FDD (0) Frequency: 2510 MHz Duty Cycle: 1:1

Probe: EX3DV4 - SN7683 ConvF (7.85, 7.85, 7.85)

Rear Side Low 1RB99/Area Scan (91x91x1): Interpolated grid: dx=1.000 mm, dy=1.000 mm

Maximum value of SAR (interpolated) = 1.26 W/kg

Rear Side Low 1RB99/Zoom Scan (7x7x7)/Cube 0: Measurement grid: dx=5mm, dy=5mm, dz=5mm

Reference Value = 3.841 V/m; Power Drift = -0.07 dB

Peak SAR (extrapolated) = 1.80 W/kg

SAR(1 g) = 0.626 W/kg; SAR(10 g) = 0.267 W/kg

Maximum value of SAR (measured) = 1.24 W/kg

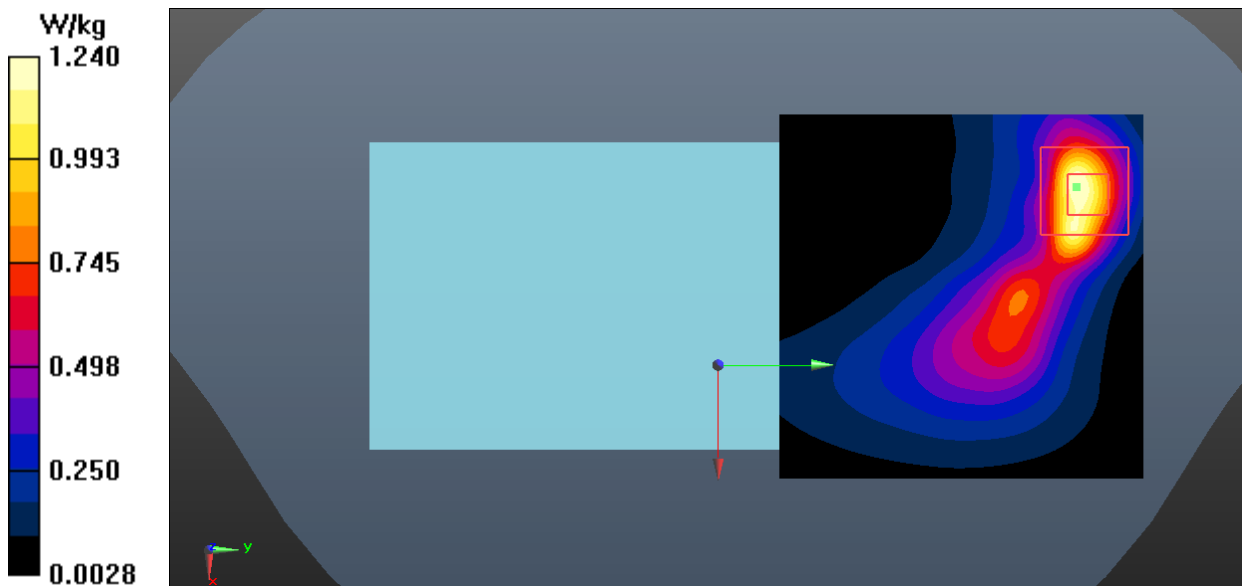

Fig.16 LTE Band 7 Body

LTE Band 12 Head

Date: 2022-3-25

Electronics: DAE4 Sn1527

Medium: Head 750MHz

Medium parameters used (interpolated): $f = 711$ MHz; $\sigma = 0.878$ S/m; $\epsilon_r = 40.979$; $\rho = 1000$ kg/m³

Communication System: UID 0, LTE_FDD (0) Frequency: 711 MHz Duty Cycle: 1:1

Probe: EX3DV4 - SN7683 ConvF (10.34, 10.34, 10.34)

Right Cheek High 1RB49/Area Scan (61x61x1): Interpolated grid: dx=1.500 mm, dy=1.500 mm
Maximum value of SAR (interpolated) = 0.193 W/kg**Right Cheek High 1RB49/Zoom Scan (5x5x7)/Cube 0:** Measurement grid: dx=8mm, dy=8mm, dz=5mm

Reference Value = 2.449 V/m; Power Drift = 0.16 dB

Peak SAR (extrapolated) = 0.208 W/kg

SAR(1 g) = 0.171 W/kg; SAR(10 g) = 0.136 W/kg

Maximum value of SAR (measured) = 0.190 W/kg

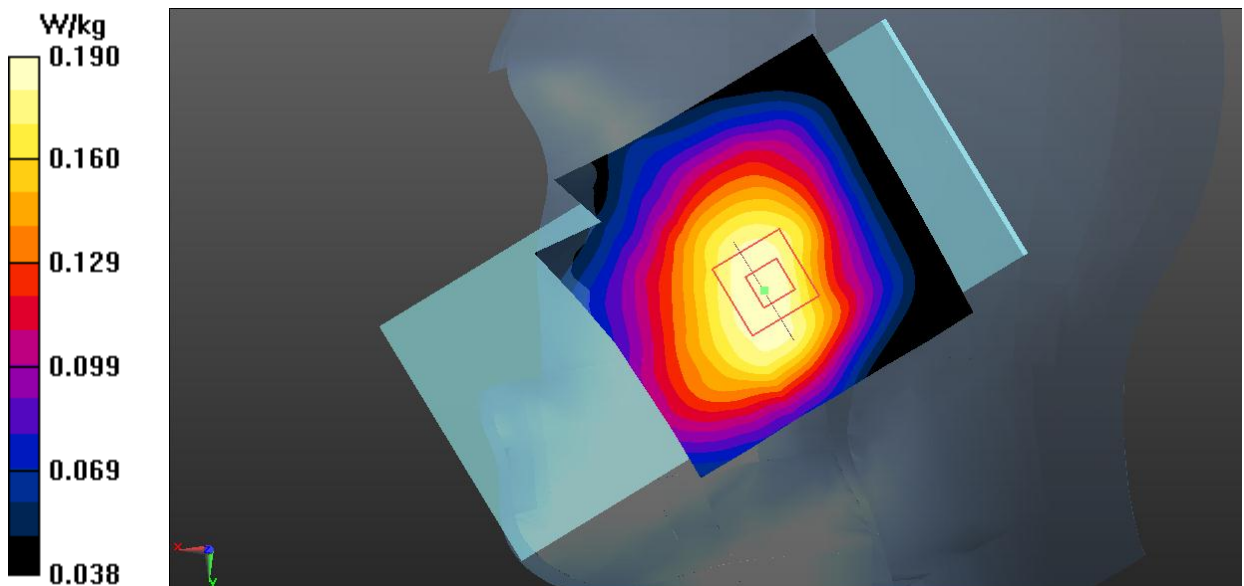

Fig.17 LTE Band 12 Head

LTE Band 12 Body

Date: 2022-3-25

Electronics: DAE4 Sn1527

Medium: Head 750MHz

Medium parameters used (interpolated): $f = 711$ MHz; $\sigma = 0.878$ S/m; $\epsilon_r = 40.979$; $\rho = 1000$ kg/m³

Communication System: UID 0, LTE_FDD (0) Frequency: 711 MHz Duty Cycle: 1:1

Probe: EX3DV4 - SN7683 ConvF (10.34, 10.34, 10.34)

Right Side High 1RB49/Area Scan (41x71x1): Interpolated grid: $dx=1.500$ mm, $dy=1.500$ mm

Maximum value of SAR (interpolated) = 0.360 W/kg

Right Side High 1RB49/Zoom Scan (5x5x7)/Cube 0: Measurement grid: $dx=8$ mm, $dy=8$ mm, $dz=5$ mm

Reference Value = 15.55 V/m; Power Drift = 0.01 dB

Peak SAR (extrapolated) = 0.406 W/kg

SAR(1 g) = 0.284 W/kg; SAR(10 g) = 0.198 W/kg

Maximum value of SAR (measured) = 0.350 W/kg

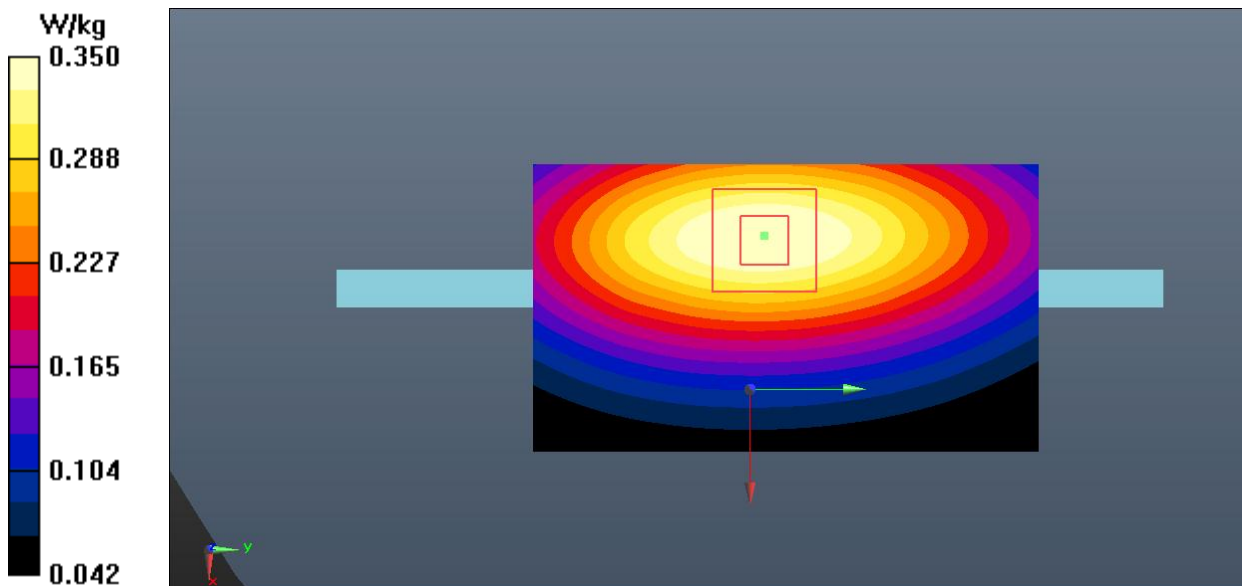

Fig.18 LTE Band 12 Body

LTE Band 13 Head

Date: 2022-3-25

Electronics: DAE4 Sn1527

Medium: Head 750MHz

Medium parameters used: $f = 782 \text{ MHz}$; $\sigma = 0.921 \text{ S/m}$; $\epsilon_r = 40.127$; $\rho = 1000 \text{ kg/m}^3$

Communication System: UID 0, LTE_FDD (0) Frequency: 782 MHz Duty Cycle: 1:1

Probe: EX3DV4 - SN7683 ConvF (10.34, 10.34, 10.34)

Left Cheek Middle 1RB0/Area Scan (61x61x1): Interpolated grid: $dx=1.500 \text{ mm}$, $dy=1.500 \text{ mm}$
Maximum value of SAR (interpolated) = 0.175 W/kg**Left Cheek Middle 1RB0/Zoom Scan (5x5x7)/Cube 0:** Measurement grid: $dx=8\text{mm}$, $dy=8\text{mm}$, $dz=5\text{mm}$

Reference Value = 4.444 V/m; Power Drift = 0.06 dB

Peak SAR (extrapolated) = 0.192 W/kg

SAR(1 g) = 0.151 W/kg; SAR(10 g) = 0.117 W/kg

Maximum value of SAR (measured) = 0.173 W/kg

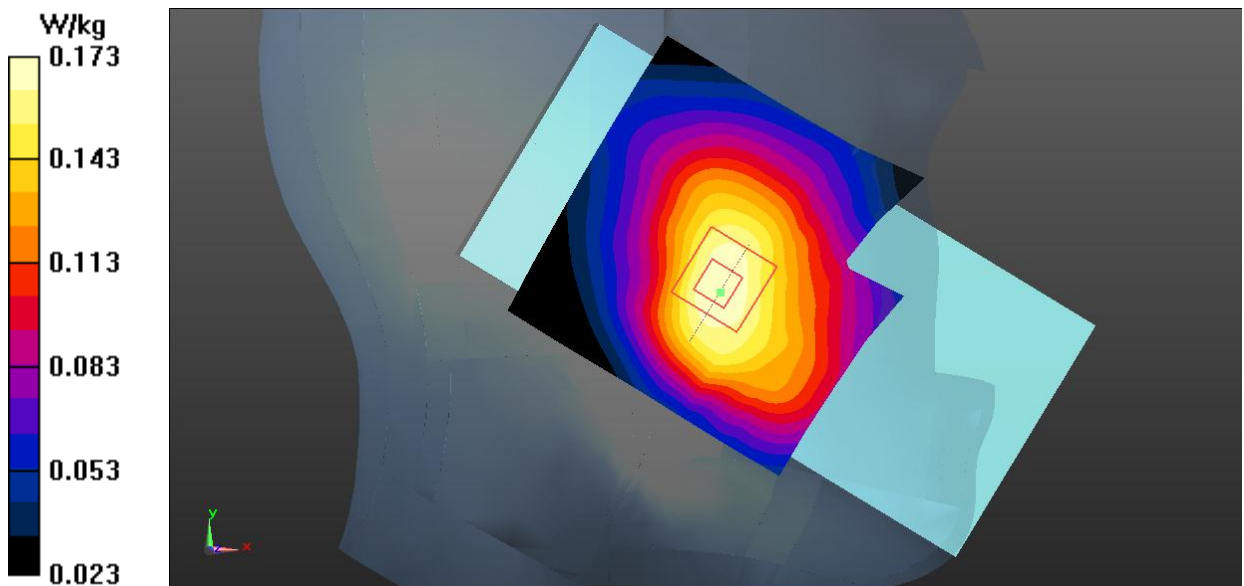

Fig.19 LTE Band 13 Head

LTE Band 13 Body

Date: 2022-3-25

Electronics: DAE4 Sn1527

Medium: Head 750MHz

Medium parameters used: $f = 782 \text{ MHz}$; $\sigma = 0.921 \text{ S/m}$; $\epsilon_r = 40.127$; $\rho = 1000 \text{ kg/m}^3$

Communication System: UID 0, LTE_FDD (0) Frequency: 782 MHz Duty Cycle: 1:1

Probe: EX3DV4 - SN7683 ConvF (10.34, 10.34, 10.34)

Rear Side Low 1RB0/Area Scan (61x101x1): Interpolated grid: $dx=1.500 \text{ mm}$, $dy=1.500 \text{ mm}$
 Maximum value of SAR (interpolated) = 0.340 W/kg

Rear Side Low 1RB0/Zoom Scan (5x5x7)/Cube 0: Measurement grid: $dx=8\text{mm}$, $dy=8\text{mm}$, $dz=5\text{mm}$

Reference Value = 15.41 V/m; Power Drift = -0.08 dB

Peak SAR (extrapolated) = 0.423 W/kg

SAR(1 g) = 0.243 W/kg; SAR(10 g) = 0.146 W/kg

Maximum value of SAR (measured) = 0.325 W/kg

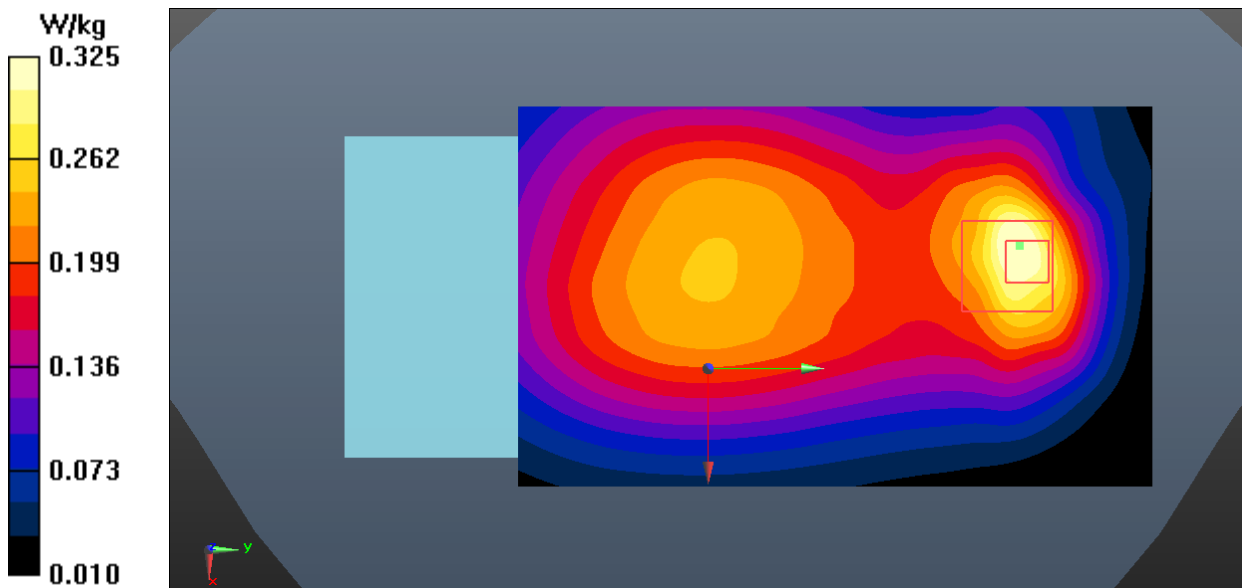

Fig.20 LTE Band 13 Body

LTE Band 28 Head

Date: 2022-3-25

Electronics: DAE4 Sn1527

Medium: Head 750MHz

Medium parameters used (interpolated): $f = 713$ MHz; $\sigma = 0.879$ S/m; $\epsilon_r = 40.955$; $\rho = 1000$ kg/m³

Communication System: UID 0, LTE_FDD (0) Frequency: 713 MHz Duty Cycle: 1:1

Probe: EX3DV4 - SN7683 ConvF (10.34, 10.34, 10.34)

Right Cheek Low 1RB99/Area Scan (61x61x1): Interpolated grid: $dx=1.500$ mm, $dy=1.500$ mm
 Maximum value of SAR (interpolated) = 0.192 W/kg

Right Cheek Low 1RB99/Zoom Scan (5x5x7)/Cube 0: Measurement grid: $dx=8$ mm, $dy=8$ mm, $dz=5$ mm

Reference Value = 2.770 V/m; Power Drift = 0.04 dB

Peak SAR (extrapolated) = 0.208 W/kg

SAR(1 g) = 0.170 W/kg; SAR(10 g) = 0.135 W/kg

Maximum value of SAR (measured) = 0.190 W/kg

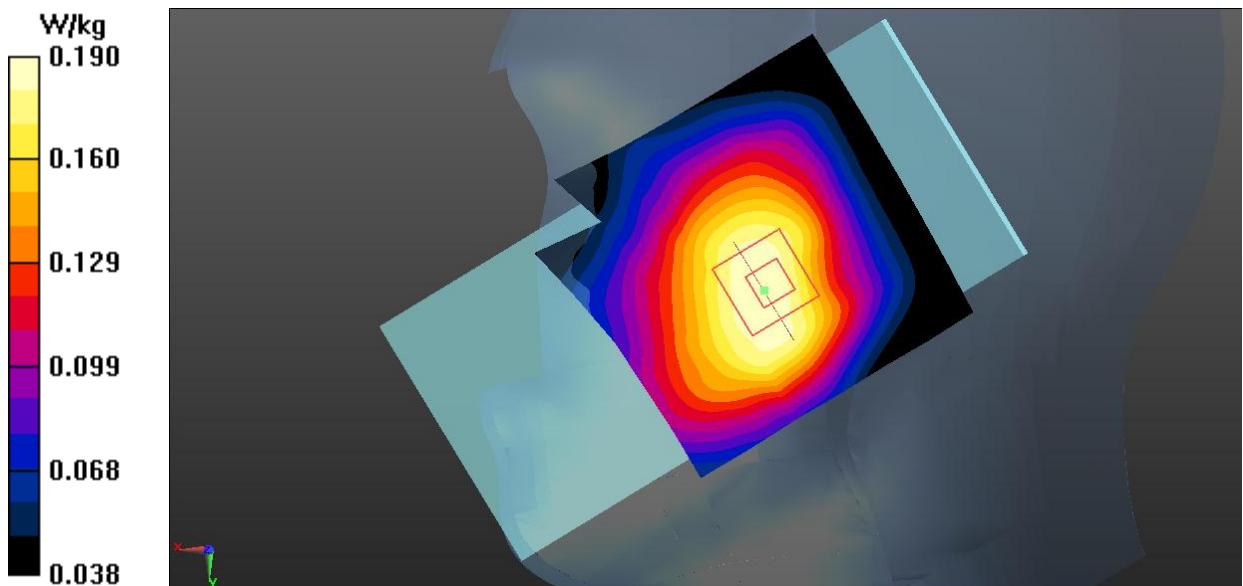

Fig.21 LTE Band 28 Head

LTE Band 28 Body

Date: 2022-3-25

Electronics: DAE4 Sn1527

Medium: Head 750MHz

Medium parameters used (interpolated): $f = 713 \text{ MHz}$; $\sigma = 0.879 \text{ S/m}$; $\epsilon_r = 40.955$; $\rho = 1000 \text{ kg/m}^3$

Communication System: UID 0, LTE_FDD (0) Frequency: 713 MHz Duty Cycle: 1:1

Probe: EX3DV4 - SN7683 ConvF (10.34, 10.34, 10.34)

Rear Side Low 1RB99/Area Scan (61x101x1): Interpolated grid: $dx=1.500 \text{ mm}$, $dy=1.500 \text{ mm}$

Maximum value of SAR (interpolated) = 0.402 W/kg

Rear Side Low 1RB99/Zoom Scan (5x5x7)/Cube 0: Measurement grid: $dx=8\text{mm}$, $dy=8\text{mm}$, $dz=5\text{mm}$

Reference Value = 19.82 V/m; Power Drift = 0.08 dB

Peak SAR (extrapolated) = 0.443 W/kg

SAR(1 g) = 0.351 W/kg; SAR(10 g) = 0.271 W/kg

Maximum value of SAR (measured) = 0.401 W/kg

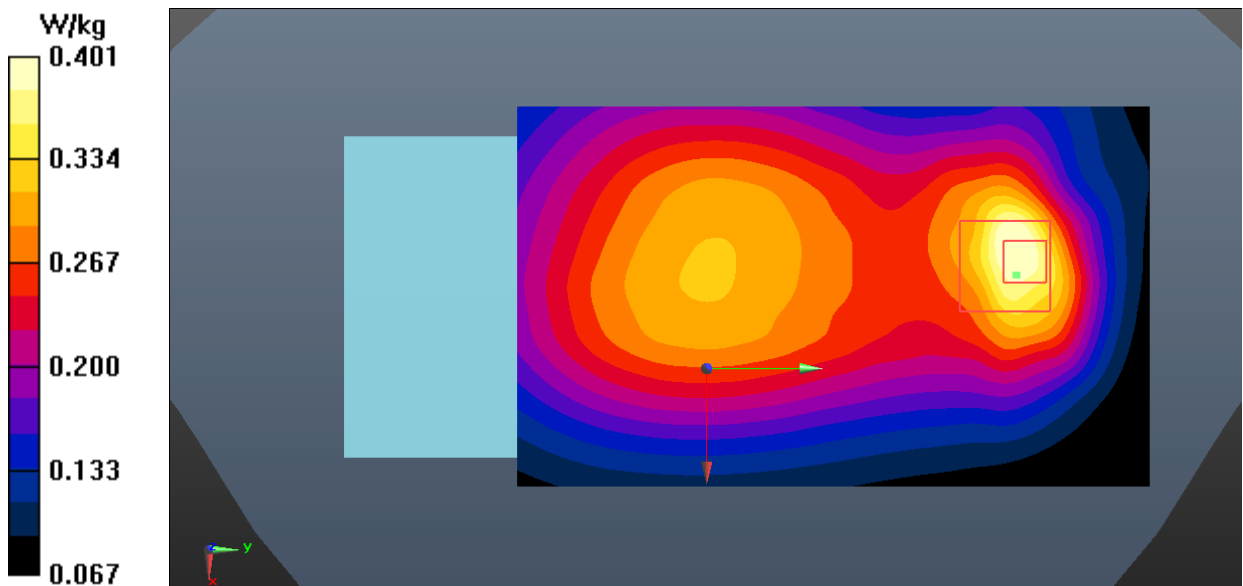

Fig.22 LTE Band 28 Body

LTE Band 66 Head

Date: 2022-4-17

Electronics: DAE4 Sn1527

Medium: Head 1750MHz

Medium parameters used: $f = 1770$ MHz; $\sigma = 1.376$ S/m; $\epsilon_r = 39.526$; $\rho = 1000$ kg/m³

Communication System: UID 0, LTE_FDD (0) Frequency: 1770 MHz Duty Cycle: 1:1

Probe: EX3DV4 - SN7683 ConvF (8.58, 8.58, 8.58)

Right Cheek High 1RB50/Area Scan (61x61x1): Interpolated grid: dx=1.500 mm, dy=1.500 mm
Maximum value of SAR (interpolated) = 0.145 W/kg**Right Cheek High 1RB50/Zoom Scan (5x5x7)/Cube 0:** Measurement grid: dx=8mm, dy=8mm, dz=5mm

Reference Value = 3.353 V/m; Power Drift = 0.04 dB

Peak SAR (extrapolated) = 0.156 W/kg

SAR(1 g) = 0.110 W/kg; SAR(10 g) = 0.074 W/kg

Maximum value of SAR (measured) = 0.133 W/kg

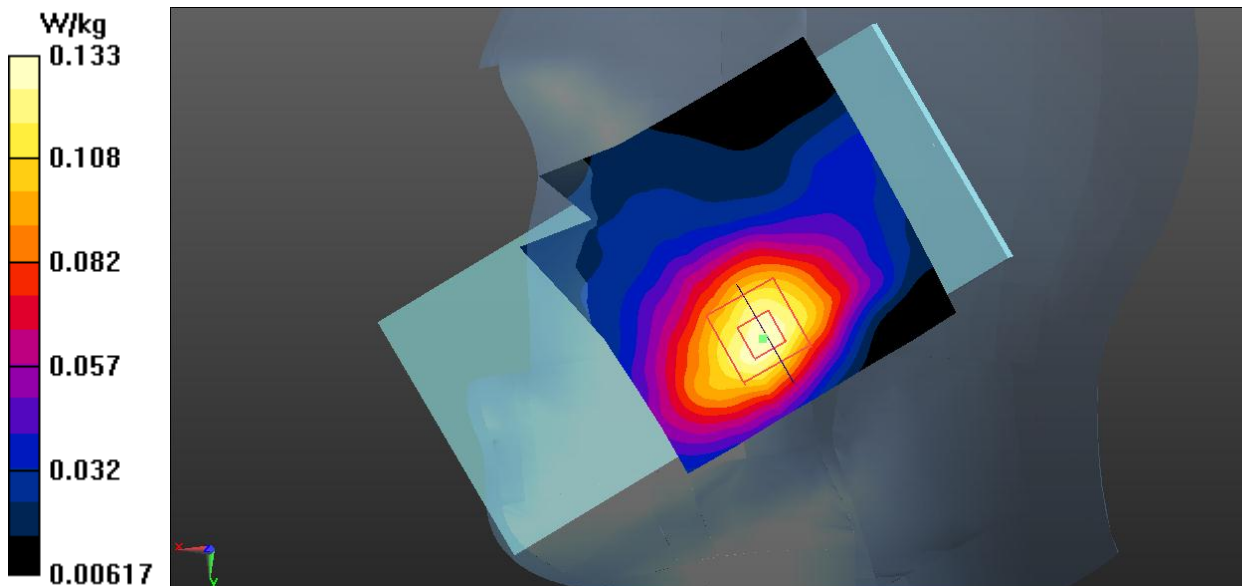

Fig.23 LTE Band 66 Head

LTE Band 66 Body

Date: 2022-4-17

Electronics: DAE4 Sn1527

Medium: Head 1750MHz

Medium parameters used: $f = 1770$ MHz; $\sigma = 1.376$ S/m; $\epsilon_r = 39.526$; $\rho = 1000$ kg/m³

Communication System: UID 0, LTE_FDD (0) Frequency: 1720 MHz Duty Cycle: 1:1

Probe: EX3DV4 - SN7683 ConvF (8.58, 8.58, 8.58)

Bottom Side Middle/Area Scan (41x71x1): Interpolated grid: dx=1.500 mm, dy=1.500 mm
Maximum value of SAR (interpolated) = 1.29 W/kg**Bottom Side Middle/Zoom Scan (5x5x7)/Cube 0:** Measurement grid: dx=8mm, dy=8mm, dz=5mm

Reference Value = 7.713 V/m; Power Drift = 0.03 dB

Peak SAR (extrapolated) = 1.66 W/kg

SAR(1 g) = 0.908 W/kg; SAR(10 g) = 0.490 W/kg

Maximum value of SAR (measured) = 1.27 W/kg

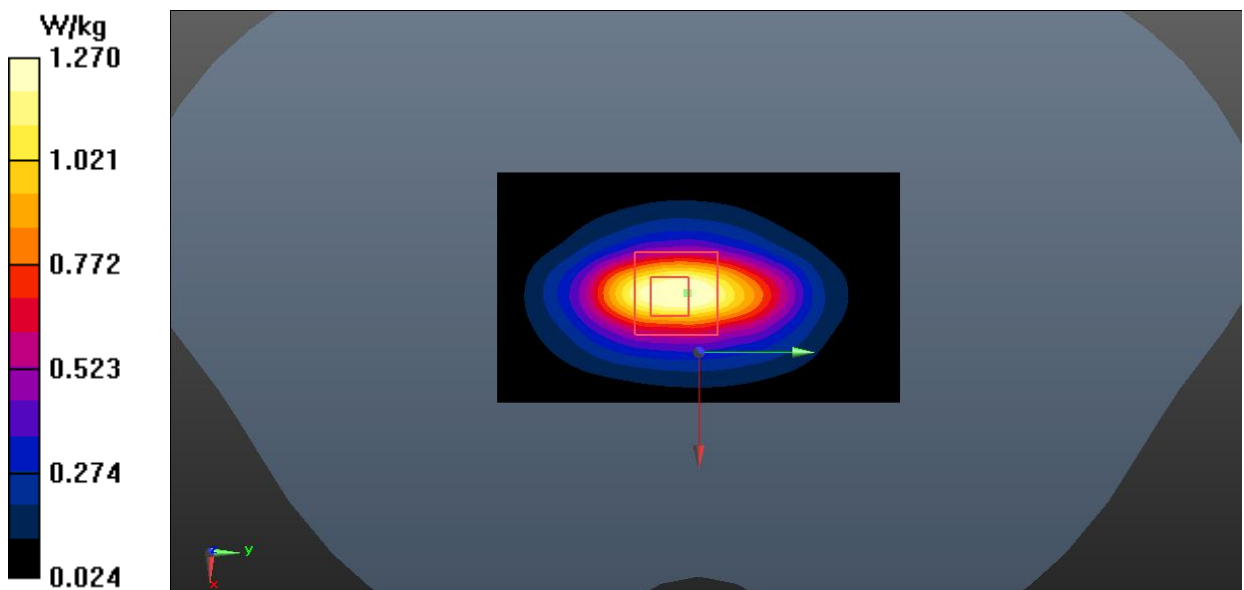
**Fig.24 LTE Band 66 Body**

Bluetooth Head

Date: 2022-4-9

Electronics: DAE4 Sn1527

Medium: Head 2450MHz

Medium parameters used (interpolated): $f = 2441$ MHz; $\sigma = 1.832$ S/m; $\epsilon_r = 38.279$; $\rho = 1000$ kg/m³

Communication System: UID 0, BT (0) Frequency: 2441 MHz Duty Cycle: 1:1

Probe: EX3DV4 - SN7683 ConvF (7.85, 7.85, 7.85)

Left Cheek Ch.39/Area Scan (91x111x1): Interpolated grid: $dx=1.000$ mm, $dy=1.000$ mm

Maximum value of SAR (interpolated) = 0.0960 W/kg

Left Cheek Ch.39/Zoom Scan (7x7x7)/Cube 0: Measurement grid: $dx=5$ mm, $dy=5$ mm, $dz=5$ mm

Reference Value = 2.656 V/m; Power Drift = -0.02 dB

Peak SAR (extrapolated) = 0.0830 W/kg

SAR(1 g) = 0.040 W/kg; SAR(10 g) = 0.020 W/kg

Maximum value of SAR (measured) = 0.0431 W/kg

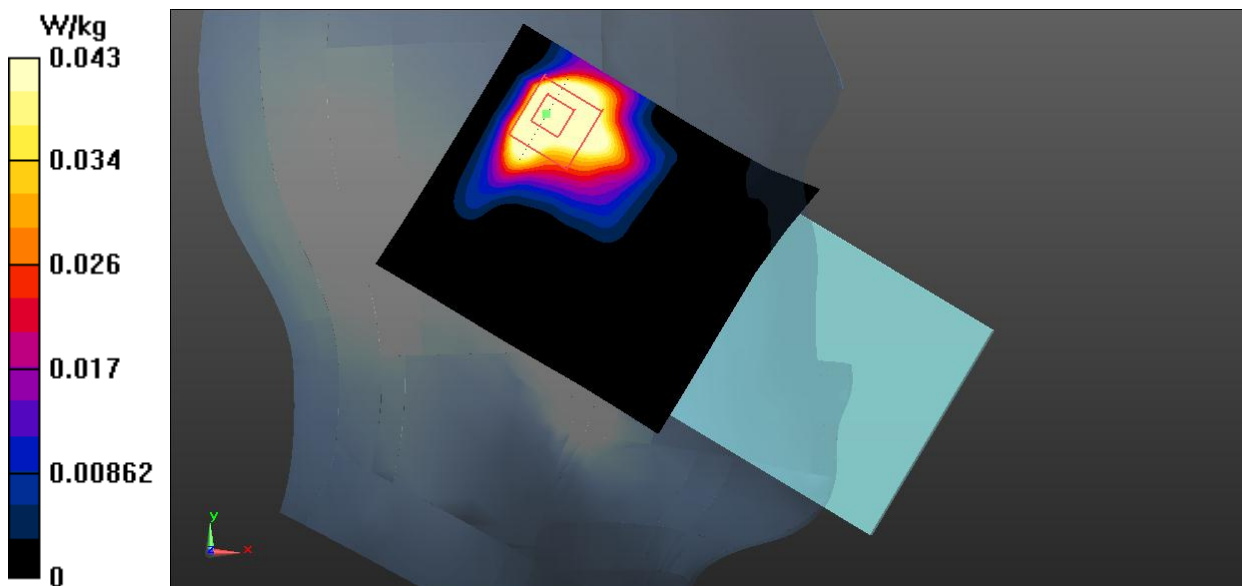

Fig.25 Bluetooth Head

Bluetooth Body

Date: 2022-4-9

Electronics: DAE4 Sn1527

Medium: Head 2450MHz

Medium parameters used (interpolated): $f = 2441$ MHz; $\sigma = 1.832$ S/m; $\epsilon_r = 38.279$; $\rho = 1000$ kg/m³

Communication System: UID 0, BT (0) Frequency: 2441 MHz Duty Cycle: 1:1

Probe: EX3DV4 - SN7683 ConvF (7.85, 7.85, 7.85)

Rear Side Ch.39/Area Scan (91x151x1): Interpolated grid: dx=1.000 mm, dy=1.000 mm

Maximum value of SAR (interpolated) = 0.0158 W/kg

Rear Side Ch.39/Zoom Scan (7x7x7)/Cube 0: Measurement grid: dx=5mm, dy=5mm, dz=5mm

Reference Value = 1.718 V/m; Power Drift = 0.07 dB

Peak SAR (extrapolated) = 0.0240 W/kg

SAR(1 g) = 0.012 W/kg; SAR(10 g) = 0.006 W/kg

Maximum value of SAR (measured) = 0.0141 W/kg

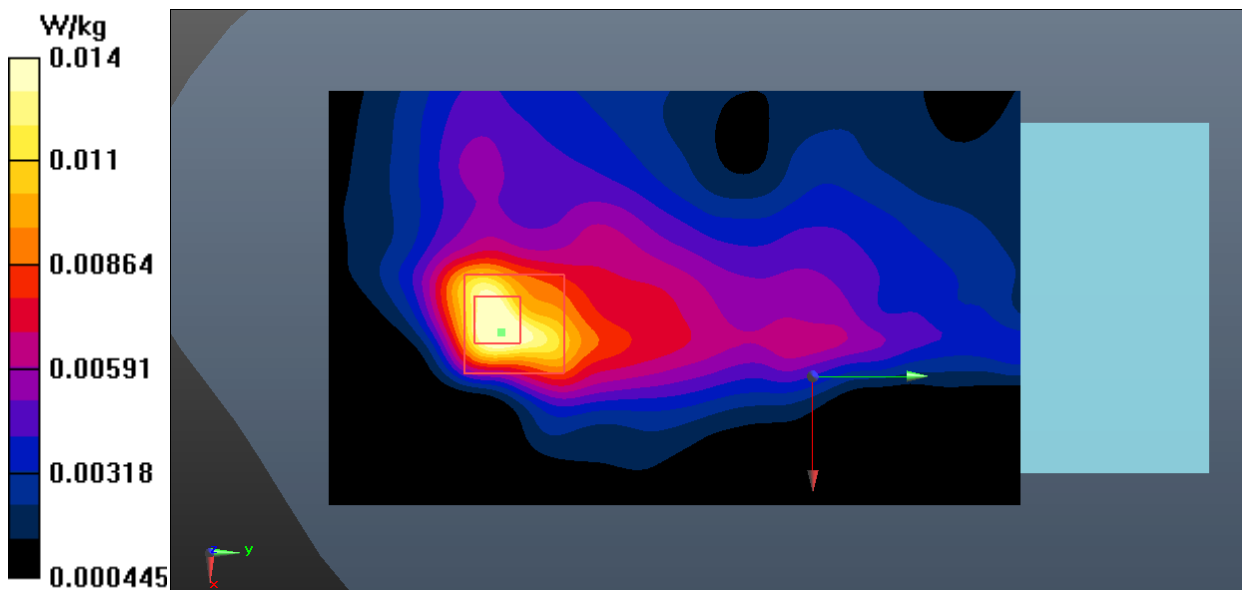

Fig.26 Bluetooth Body

WLAN 2.4GHz Head

Date: 2022-4-9

Electronics: DAE4 Sn1527

Medium: Head 2450MHz

Medium parameters used: $f = 2412$ MHz; $\sigma = 1.798$ S/m; $\epsilon_r = 38.374$; $\rho = 1000$ kg/m³

Communication System: UID 0, WIFI (0) Frequency: 2412 MHz Duty Cycle: 1:1

Probe: EX3DV4 - SN7683 ConvF (7.85, 7.85, 7.85)

Left Cheek Ch.1/Area Scan (91x91x1): Interpolated grid: dx=1.000 mm, dy=1.000 mm

Maximum value of SAR (interpolated) = 0.336 W/kg

Left Cheek Ch.1/Zoom Scan (7x7x7)/Cube 0: Measurement grid: dx=5mm, dy=5mm, dz=5mm

Reference Value = 6.326 V/m; Power Drift = 0.07 dB

Peak SAR (extrapolated) = 0.529 W/kg

SAR(1 g) = 0.248 W/kg; SAR(10 g) = 0.129 W/kg

Maximum value of SAR (measured) = 0.259 W/kg

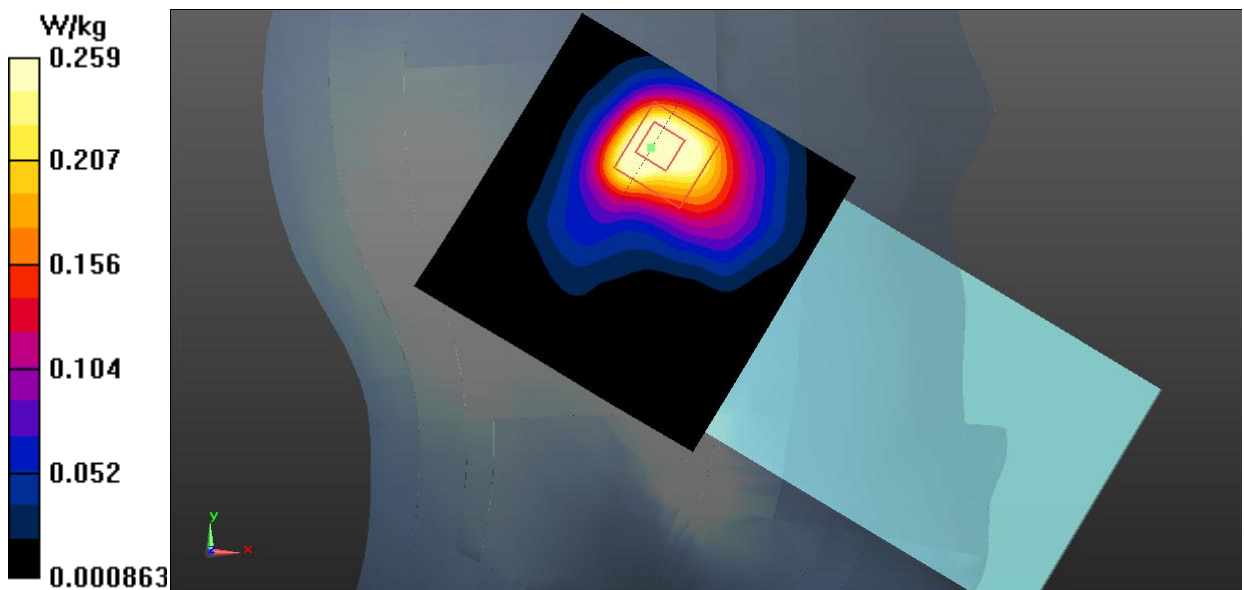

Fig.27 WLAN 2.4GHz Head

WLAN 2.4GHz Body

Date: 2022-4-9

Electronics: DAE4 Sn1527

Medium: Head 2450MHz

Medium parameters used: $f = 2412$ MHz; $\sigma = 1.798$ S/m; $\epsilon_r = 38.374$; $\rho = 1000$ kg/m³

Communication System: UID 0, WIFI (0) Frequency: 2412 MHz Duty Cycle: 1:1

Probe: EX3DV4 - SN7683 ConvF (7.85, 7.85, 7.85)

Top Side Ch.1/Area Scan (61x111x1): Interpolated grid: $dx=1.000$ mm, $dy=1.000$ mm

Maximum value of SAR (interpolated) = 0.0833 W/kg

Top Side Ch.1/Zoom Scan (7x7x7)/Cube 0: Measurement grid: $dx=5$ mm, $dy=5$ mm, $dz=5$ mm

Reference Value = 4.360 V/m; Power Drift = 0.04 dB

Peak SAR (extrapolated) = 0.115 W/kg

SAR(1 g) = 0.062 W/kg; SAR(10 g) = 0.032 W/kg

Maximum value of SAR (measured) = 0.0888 W/kg

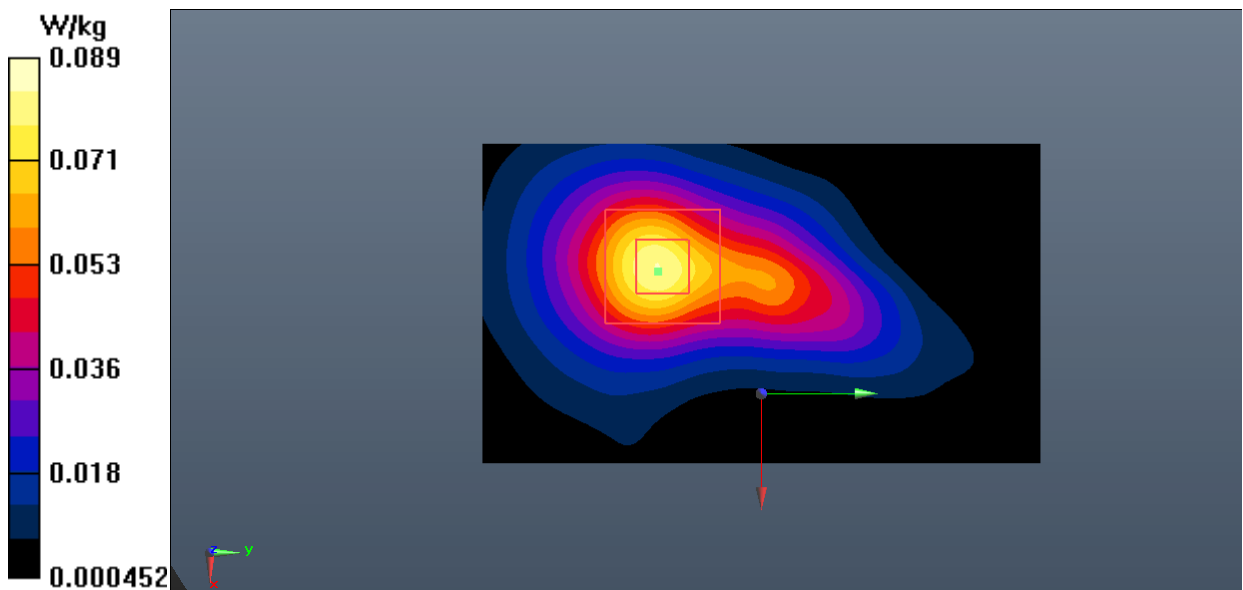

Fig.28 WLAN 2.4GHz Body

WLAN 5GHz Head

Date: 2022-4-10

Electronics: DAE4 Sn1527

Medium: Head 5250MHz

Medium parameters used: $f = 5300$ MHz; $\sigma = 4.726$ S/m; $\epsilon_r = 36.601$; $\rho = 1000$ kg/m³

Communication System: UID 0, WIFI 5G (0) Frequency: 5300 MHz Duty Cycle: 1:1

Probe: EX3DV4 - SN7683 ConvF (5.56, 5.56, 5.56)

Left Tilt Ch.60/Area Scan (81x81x1): Interpolated grid: dx=1.000 mm, dy=1.000 mm

Maximum value of SAR (interpolated) = 0.178 W/kg

Left Tilt Ch.60/Zoom Scan (8x8x21)/Cube 0: Measurement grid: dx=4mm, dy=4mm, dz=1.4mm

Reference Value = 1.994 V/m; Power Drift = 0.05 dB

Peak SAR (extrapolated) = 0.484 W/kg

SAR(1 g) = 0.143 W/kg; SAR(10 g) = 0.050 W/kg

Maximum value of SAR (measured) = 0.162 W/kg

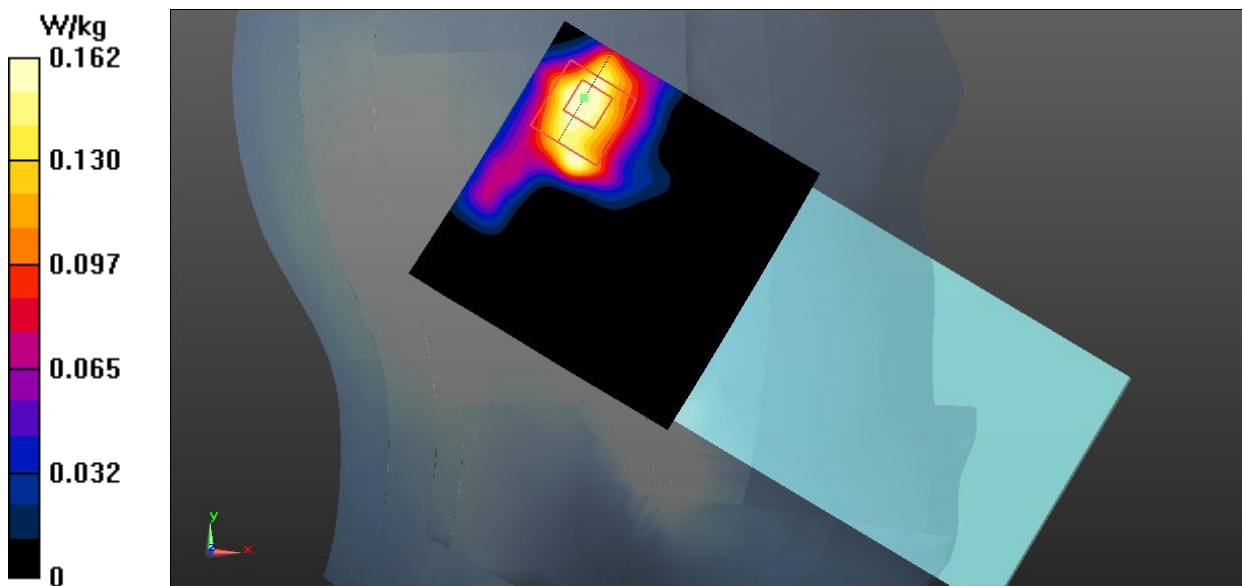
**Fig.29 WLAN 5GHz Head**

WLAN 5GHz Body

Date: 2022-4-10

Electronics: DAE4 Sn1527

Medium: Head 5250MHz

Medium parameters used: $f = 5180$ MHz; $\sigma = 4.564$ S/m; $\epsilon_r = 36.925$; $\rho = 1000$ kg/m³

Communication System: UID 0, WIFI 5G (0) Frequency: 5180 MHz Duty Cycle: 1:1

Probe: EX3DV4 - SN7683 ConvF (5.56, 5.56, 5.56)

Rear Side Ch.36/Area Scan (101x101x1): Interpolated grid: $dx=1.000$ mm, $dy=1.000$ mm

Maximum value of SAR (interpolated) = 0.337 W/kg

Rear Side Ch.36/Zoom Scan (8x8x21)/Cube 0: Measurement grid: $dx=4$ mm, $dy=4$ mm, $dz=1.4$ mm

Reference Value = 0.6670 V/m; Power Drift = 0.03 dB

Peak SAR (extrapolated) = 0.800 W/kg

SAR(1 g) = 0.184 W/kg; SAR(10 g) = 0.069 W/kg

Maximum value of SAR (measured) = 0.343 W/kg

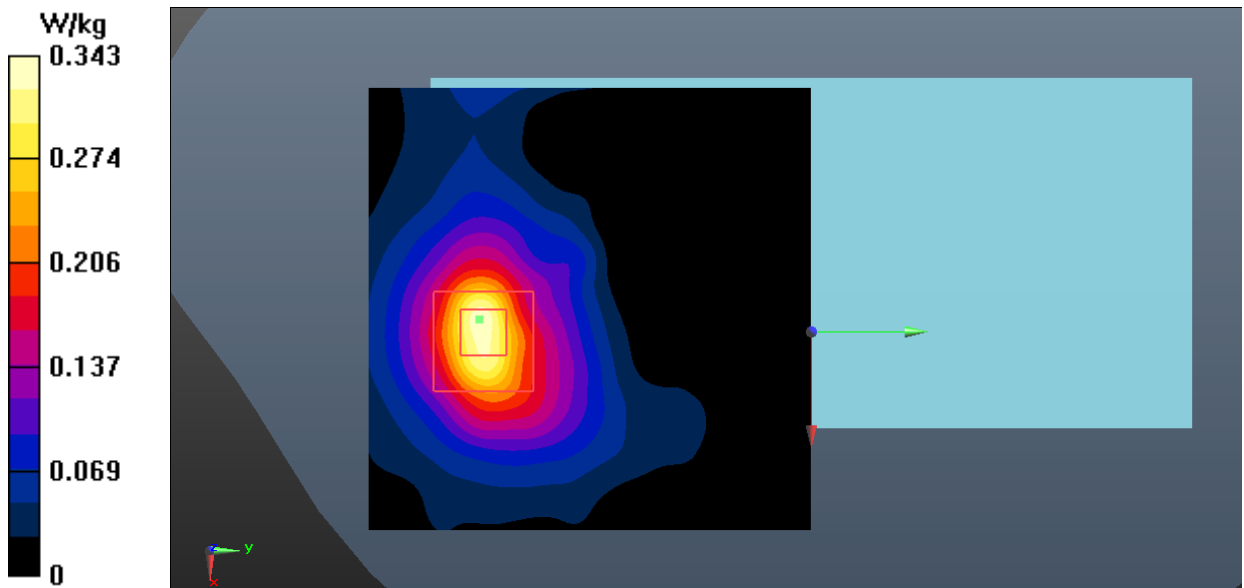
**Fig.30 WLAN 5GHz Body**

WLAN 5GHz Extremity

Date: 2022-4-10

Electronics: DAE4 Sn1527

Medium: Head 5250MHz

Medium parameters used: $f = 5300 \text{ MHz}$; $\sigma = 4.726 \text{ S/m}$; $\epsilon_r = 36.601$; $\rho = 1000 \text{ kg/m}^3$

Communication System: UID 0, WIFI 5G (0) Frequency: 5300 MHz Duty Cycle: 1:1

Probe: EX3DV4 - SN7683 ConvF (5.56, 5.56, 5.56)

Rear Side Ch.60/Area Scan (101x101x1): Interpolated grid: $dx=1.000 \text{ mm}$, $dy=1.000 \text{ mm}$

Maximum value of SAR (interpolated) = 4.84 W/kg

Rear Side Ch.60/Zoom Scan (8x8x21)/Cube 0: Measurement grid: $dx=4\text{mm}$, $dy=4\text{mm}$, $dz=1.4\text{mm}$

Reference Value = 0 V/m; Power Drift = 0.00 dB

Peak SAR (extrapolated) = 9.27 W/kg

SAR(1 g) = 1.86 W/kg; SAR(10 g) = 0.500 W/kg

Maximum value of SAR (measured) = 4.33 W/kg

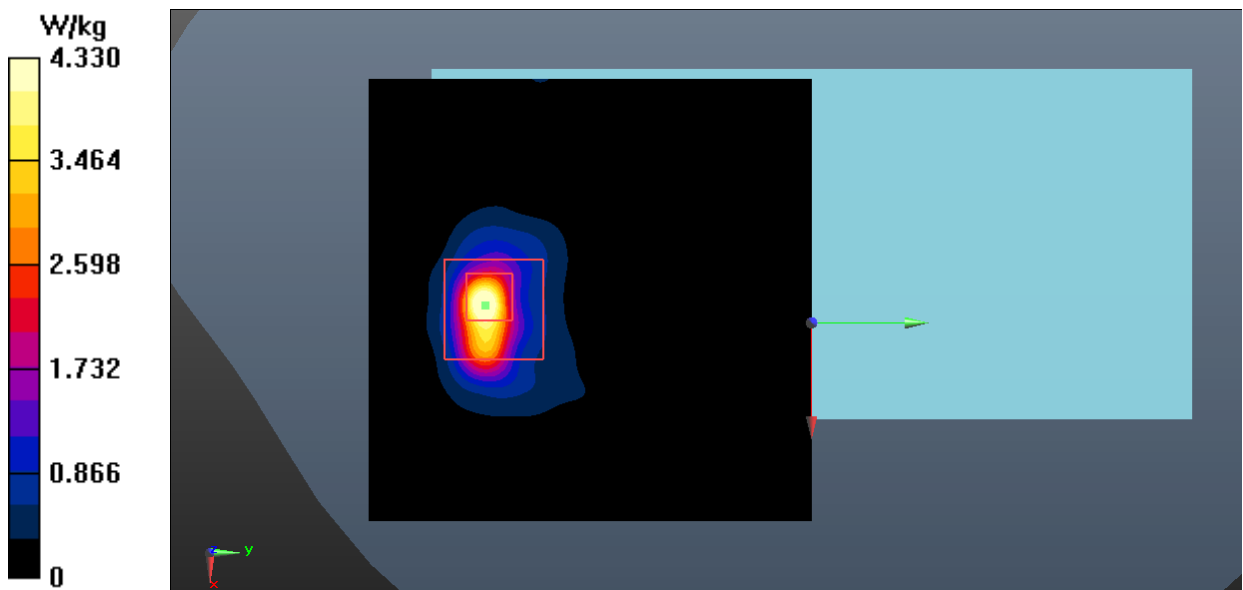

Fig.31 WLAN 5GHz Extremity

ANNEX B: SystemVerification Results

750MHz

Date: 2022-3-25

Electronics: DAE4 Sn1527

Medium: Head 750MHz

Medium parameters used: $f = 750 \text{ MHz}$; $\sigma = 0.903 \text{ S/m}$; $\epsilon_r = 40.511$; $\rho = 1000 \text{ kg/m}^3$

Communication System: CW_TMC Frequency: 750 MHz Duty Cycle: 1:1

Probe: EX3DV4 - SN7683 ConvF (10.34, 10.34, 10.34)

System Validation/Area Scan (81x161x1): Interpolated grid: $dx=1.000 \text{ mm}$, $dy=1.000 \text{ mm}$

Reference Value = 62.038 V/m; Power Drift = 0.08 dB

SAR(1 g) = 2.16 W/kg; SAR(10 g) = 1.42 W/kg

Maximum value of SAR (interpolated) = 2.78 W/kg

System Validation/Zoom Scan (7x7x7)/Cube 0: Measurement grid: $dx=5\text{mm}$, $dy=5\text{mm}$, $dz=5\text{mm}$

Reference Value = 62.038 V/m; Power Drift = 0.08 dB

Peak SAR (extrapolated) = 3.33 W/kg

SAR(1 g) = 2.20 W/kg; SAR(10 g) = 1.44 W/kg

Maximum value of SAR (measured) = 2.82 W/kg

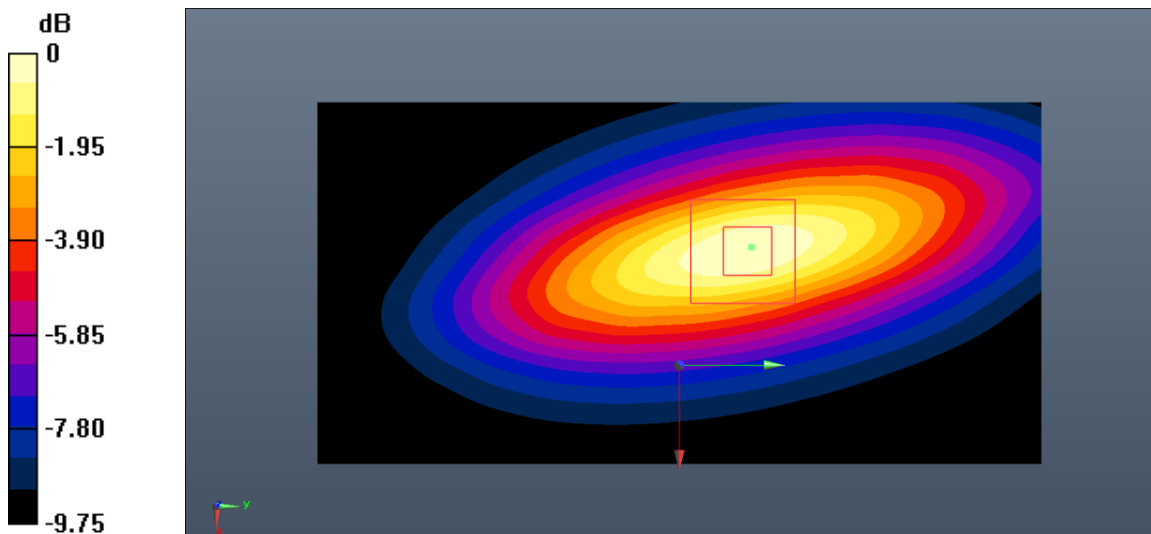

0 dB = 2.82 W/kg = 4.50 dB W/kg

Fig.B.1. Validation 750MHz 250mW

835MHz

Date: 2022-3-26

Electronics: DAE4 Sn1527

Medium: Head 835MHz

Medium parameters used: $f = 835 \text{ MHz}$; $\sigma = 0.916 \text{ S/m}$; $\epsilon_r = 40.238$; $\rho = 1000 \text{ kg/m}^3$

Communication System: CW_TMC Frequency: 835 MHz Duty Cycle: 1:1

Probe: EX3DV4 - SN7683 ConvF (10.34, 10.34, 10.34)

System Validation/Area Scan (91x161x1): Interpolated grid: $dx=1.000 \text{ mm}$, $dy=1.000 \text{ mm}$

Reference Value = 65.731 V/m; Power Drift = 0.13 dB

SAR(1 g) = 2.44 W/kg; SAR(10 g) = 1.58 W/kg

Maximum value of SAR (interpolated) = 3.37 W/kg

System Validation /Zoom Scan (7x7x7)/Cube 0: Measurement grid: $dx=5\text{mm}$, $dy=5\text{mm}$, $dz=5\text{mm}$

Reference Value = 65.731 V/m; Power Drift = 0.13 dB

Peak SAR (extrapolated) = 4.09 W/kg

SAR(1 g) = 2.49 W/kg; SAR(10 g) = 1.61 W/kg

Maximum value of SAR (measured) = 3.40 W/kg

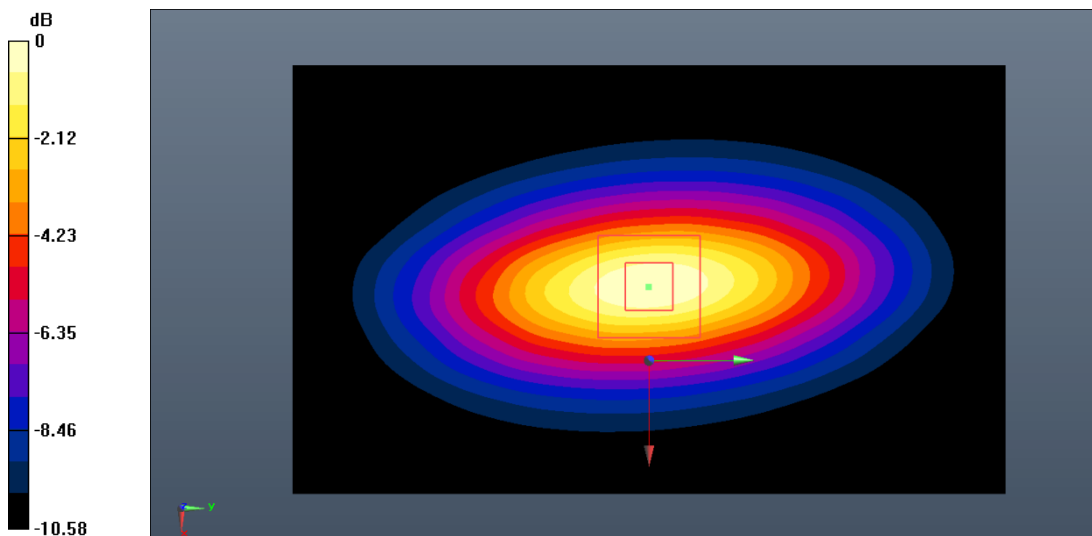

0 dB = 3.40 W/kg = 5.31 dB W/kg

Fig.B.2. Validation 835MHz 250mW

1750MHz

Date: 2022-4-17

Electronics: DAE4 Sn1527

Medium: Head 1750MHz

Medium parameters used: $f = 1750 \text{ MHz}$; $\sigma = 1.358 \text{ S/m}$; $\epsilon_r = 39.604$; $\rho = 1000 \text{ kg/m}^3$

Communication System: CW_TMC Frequency: 1750 MHz Duty Cycle: 1:1

Probe: EX3DV4 - SN7683 ConvF (8.58, 8.58, 8.58)

System Validation/Area Scan (81x121x1): Interpolated grid: $dx=1.000 \text{ mm}$, $dy=1.000 \text{ mm}$

Reference Value = 77.084 V/m; Power Drift = -0.06 dB

SAR(1 g) = 9.03 W/kg; SAR(10 g) = 4.81 W/kg

Maximum value of SAR (interpolated) = 10.9 W/kg

System Validation/Zoom Scan (7x7x7)/Cube0: Measurement grid: $dx=5\text{mm}$, $dy=5\text{mm}$, $dz=5\text{mm}$

Reference Value = 77.084 V/m; Power Drift = -0.06 dB

Peak SAR (extrapolated) = 21.1 W/kg

SAR(1 g) = 8.82 W/kg; SAR(10 g) = 4.74 W/kg

Maximum value of SAR (measured) = 10.7 W/kg

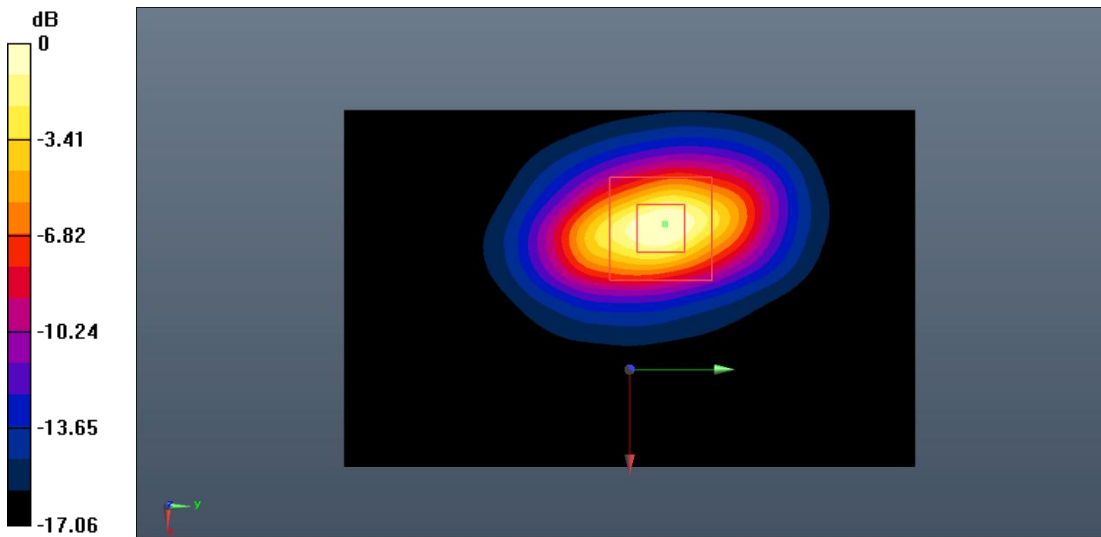

0 dB = 10.7 W/kg = 10.29 dB W/kg

Fig.B.3. Validation 1750MHz 250mW

1900MHz

Date: 2022-4-15

Electronics: DAE4 Sn1527

Medium: Head 1900MHz

Medium parameters used: $f = 1900 \text{ MHz}$; $\sigma = 1.425 \text{ S/m}$; $\epsilon_r = 39.273$; $\rho = 1000 \text{ kg/m}^3$

Communication System: CW_TMC Frequency: 1900 MHz Duty Cycle: 1:1

Probe: EX3DV4 - SN7683 ConvF (8.33, 8.33, 8.33)

System Validation/Area Scan (91x91x1): Interpolated grid: $dx=1.000 \text{ mm}$, $dy=1.000 \text{ mm}$

Reference Value = 84.012 V/m; Power Drift = 0.08 dB

SAR(1 g) = 10.2 W/kg; SAR(10 g) = 5.14 W/kg

Maximum value of SAR (interpolated) = 12.2 W/kg

System Validation/Zoom Scan (7x7x7)/Cube0: Measurement grid: $dx=5\text{mm}$, $dy=5\text{mm}$, $dz=5\text{mm}$

Reference Value = 84.012 V/m; Power Drift = 0.08 dB

Peak SAR (extrapolated) = 27.2 W/kg

SAR(1 g) = 10.4 W/kg; SAR(10 g) = 5.22 W/kg

Maximum value of SAR (measured) = 12.5 W/kg

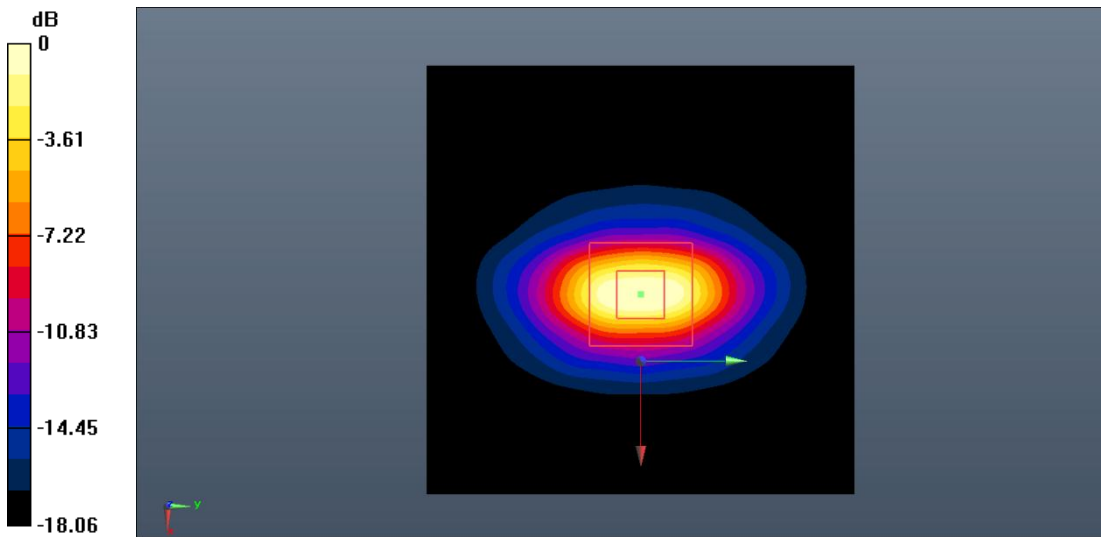

0 dB = 12.5 W/kg = 10.97 dB W/kg

Fig.B.4. Validation 1900MHz 250mW

2450MHz

Date: 2022-4-9

Electronics: DAE4 Sn1527

Medium: Head 2450MHz

Medium parameters used: $f = 2450$ MHz; $\sigma = 1.843$ S/m; $\epsilon_r = 38.249$; $\rho = 1000$ kg/m³

Communication System: CW_TMC Frequency: 2450 MHz Duty Cycle: 1:1

Probe: EX3DV4 - SN7683 ConvF (7.85, 7.85, 7.85)

System Validation/Area Scan (81x121x1): Interpolated grid: dx=1.000 mm, dy=1.000 mm

Reference Value = 92.418 V/m; Power Drift = 0.12 dB

SAR(1 g) = 13.6 W/kg; SAR(10 g) = 6.16 W/kg

Maximum value of SAR (interpolated) = 15.6 W/kg

System Validation/Zoom Scan (7x7x7)/Cube0: Measurement grid: dx=5mm, dy=5mm, dz=5mm

Reference Value = 92.418 V/m; Power Drift = 0.12 dB

Peak SAR (extrapolated) = 35.3 W/kg

SAR(1 g) = 13.9 W/kg; SAR(10 g) = 6.25 W/kg

Maximum value of SAR (measured) = 15.8 W/kg

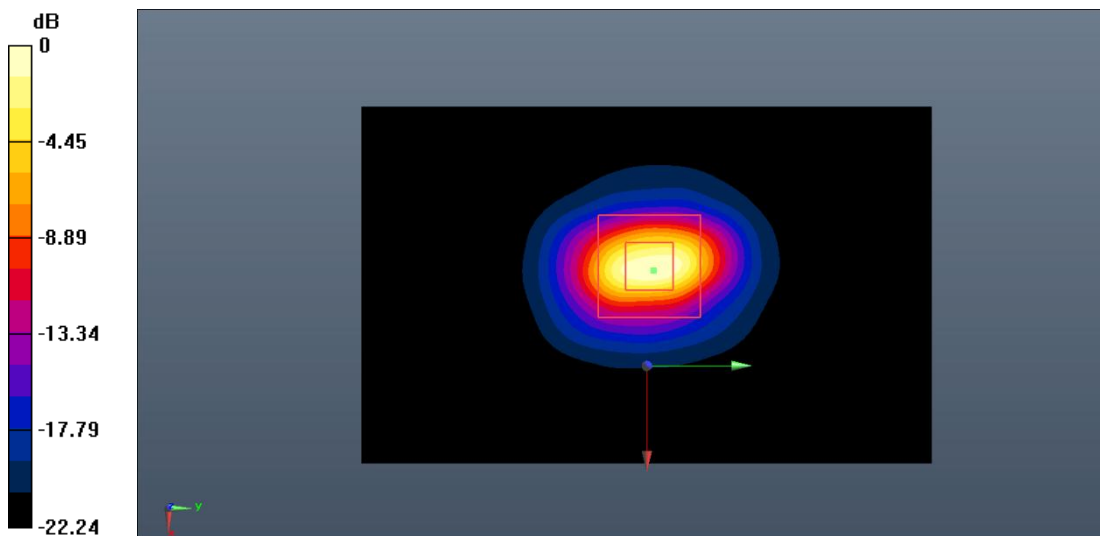

0 dB = 15.8 W/kg = 11.99 dB W/kg

Fig.B.5. Validation 2450MHz 250mW

2550MHz

Date: 2022-4-20

Electronics: DAE4 Sn1527

Medium: Head 2550MHz

Medium parameters used: $f = 2550$ MHz; $\sigma = 1.932$ S/m; $\epsilon_r = 37.944$; $\rho = 1000$ kg/m³

Communication System: CW_TMC Frequency: 2550 MHz Duty Cycle: 1:1

Probe: EX3DV4 - SN7683 ConvF (7.85, 7.85, 7.85)

System Validation/Area Scan (91x91x1): Interpolated grid: dx=1.000 mm, dy=1.000 mm

Reference Value = 94.242 V/m; Power Drift = 0.03 dB

SAR(1 g) = 14.1 W/kg; SAR(10 g) = 6.29 W/kg

Maximum value of SAR (interpolated) = 16.2 W/kg

System Validation/Zoom Scan (7x7x7)/Cube0: Measurement grid: dx=5mm, dy=5mm, dz=5mm

Reference Value = 94.242 V/m; Power Drift = 0.03 dB

Peak SAR (extrapolated) = 37.7 W/kg

SAR(1 g) = 14.3 W/kg; SAR(10 g) = 6.37 W/kg

Maximum value of SAR (measured) = 16.4 W/kg

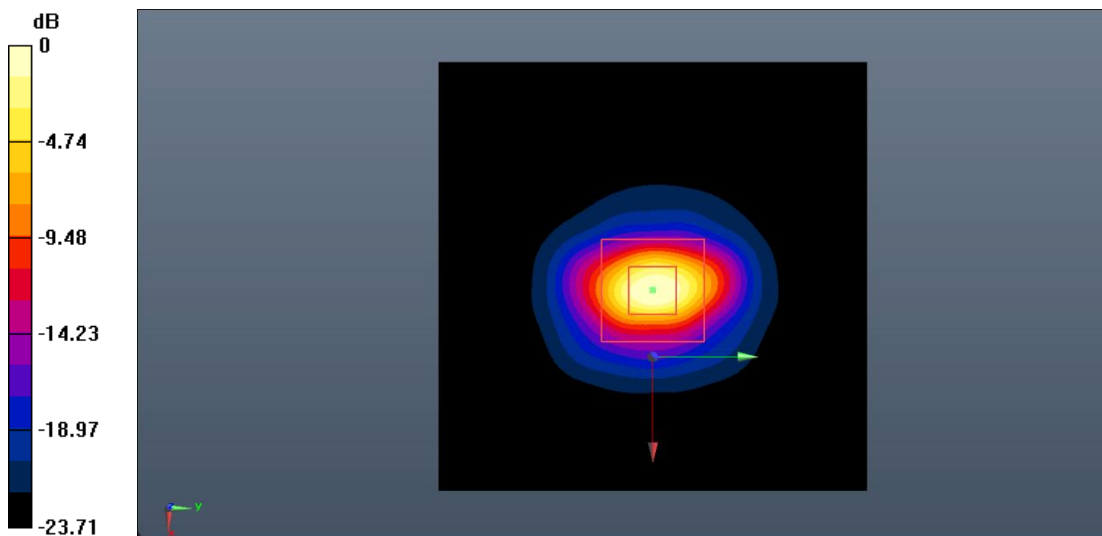

0 dB = 16.4 W/kg = 12.15 dB W/kg

Fig.B.6. Validation 2550MHz 250mW

5250MHz

Date: 2022-4-10

Electronics: DAE4 Sn1527

Medium: Head 5250MHz

Medium parameters used: $f = 5250$ MHz; $\sigma = 4.658$ S/m; $\epsilon_r = 36.736$; $\rho = 1000$ kg/m³

Communication System: CW_TMC Frequency: 5250 MHz Duty Cycle: 1:1

Probe: EX3DV4 - SN7683 ConvF (5.56, 5.56, 5.56)

System Validation/Area Scan (61x91x1): Interpolated grid: dx=1.000 mm, dy=1.000 mm

Reference Value = 64.032 V/m; Power Drift = -0.10 dB

SAR(1 g) = 7.74 W/kg; SAR(10 g) = 2.24 W/kg

Maximum value of SAR (interpolated) = 9.96 W/kg

System Validation/Zoom Scan (8x8x21)/Cube0: Measurement grid: dx=4mm, dy=4mm, dz=1.4mm

Reference Value = 64.032 V/m; Power Drift = -0.10 dB

Peak SAR (extrapolated) = 24.2 W/kg

SAR(1 g) = 7.62 W/kg; SAR(10 g) = 2.20 W/kg

Maximum value of SAR (measured) = 9.88 W/kg

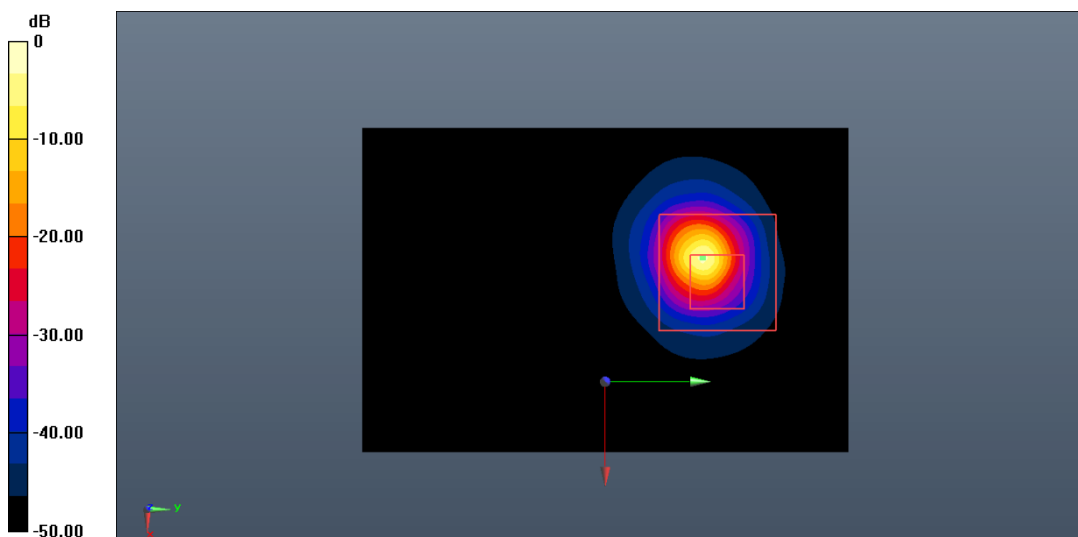

0 dB = 9.88 W/kg = 9.95 dB W/kg

Fig.B.7. Validation 5250MHz 100mW

5600MHz

Date: 2022-4-10

Electronics: DAE4 Sn1527

Medium: Head 5600MHz

Medium parameters used: $f = 5600$ MHz; $\sigma = 4.975$ S/m; $\epsilon_r = 36.373$; $\rho = 1000$ kg/m³

Communication System: CW_TMC Frequency: 5600 MHz Duty Cycle: 1:1

Probe: EX3DV4 - SN7683 ConvF (5.17, 5.17, 5.17)

System Validation/Area Scan (61x91x1): Interpolated grid: dx=1.000 mm, dy=1.000 mm

Reference Value = 63.545 V/m; Power Drift = -0.07 dB

SAR(1 g) = 7.65 W/kg; SAR(10 g) = 2.23 W/kg

Maximum value of SAR (interpolated) = 9.85 W/kg

System Validation/Zoom Scan (8x8x21)/Cube0: Measurement grid: dx=4mm, dy=4mm, dz=1.4mm

Reference Value = 63.545 V/m; Power Drift = -0.07 dB

Peak SAR (extrapolated) = 23.3 W/kg

SAR(1 g) = 7.59 W/kg; SAR(10 g) = 2.21 W/kg

Maximum value of SAR (measured) = 9.81 W/kg

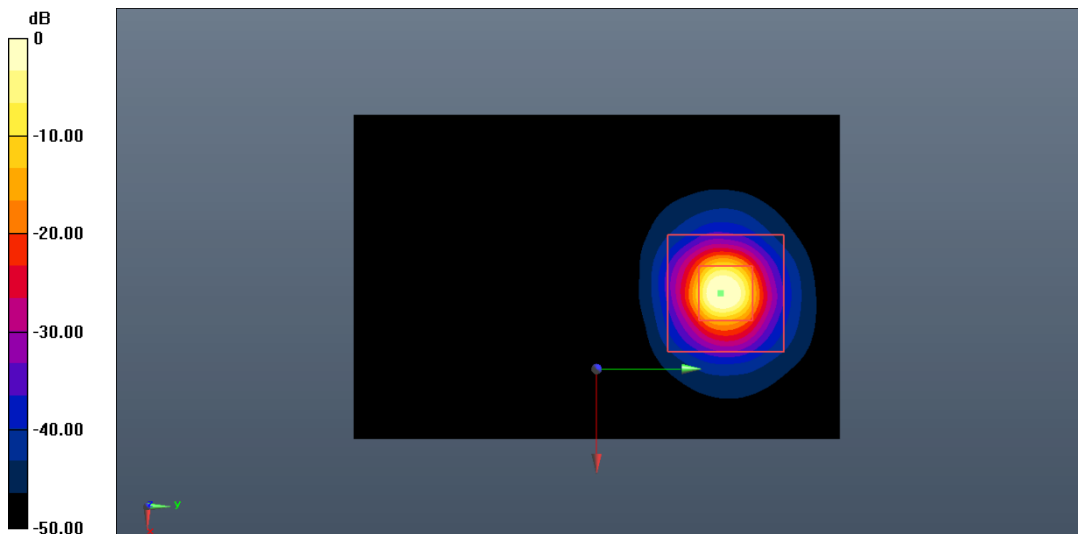

0 dB = 9.81 W/kg = 9.92 dB W/kg

Fig.B.8. Validation 5600MHz 100mW

5750MHz

Date: 2022-4-10

Electronics: DAE4 Sn1527

Medium: Head 5750MHz

Medium parameters used: $f = 5750 \text{ MHz}$; $\sigma = 5.316 \text{ S/m}$; $\epsilon_r = 34.882$; $\rho = 1000 \text{ kg/m}^3$

Communication System: CW_TMC Frequency: 5750 MHz Duty Cycle: 1:1

Probe: EX3DV4 - SN7683 ConvF (5.21, 5.21, 5.21)

System Validation/Area Scan (61x91x1): Interpolated grid: $dx=1.000 \text{ mm}$, $dy=1.000 \text{ mm}$

Reference Value = 67.133 V/m; Power Drift = 0.05 dB

SAR(1 g) = 7.88 W/kg; SAR(10 g) = 2.25 W/kg

Maximum value of SAR (interpolated) = 10.2 W/kg

System Validation/Zoom Scan (8x8x21)/Cube0: Measurement grid: $dx=4\text{mm}$, $dy=4\text{mm}$, $dz=1.4\text{mm}$

Reference Value = 67.133 V/m; Power Drift = 0.05 dB

Peak SAR (extrapolated) = 26.8 W/kg

SAR(1 g) = 8.14 W/kg; SAR(10 g) = 2.26 W/kg

Maximum value of SAR (measured) = 10.3 W/kg

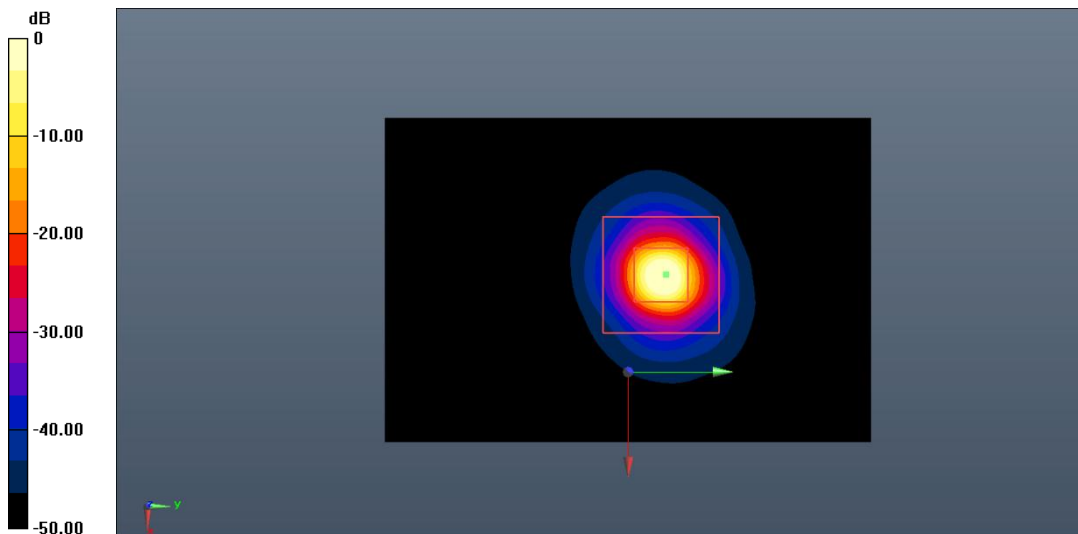

0 dB = 10.3 W/kg = 10.13 dB W/kg

Fig.B.9. Validation 5750MHz 100mW

ANNEX C: SAR Measurement Setup

C.1. Measurement Set-up

DASY5 system for performing compliance tests is illustrated above graphically. This system consists of the following items:

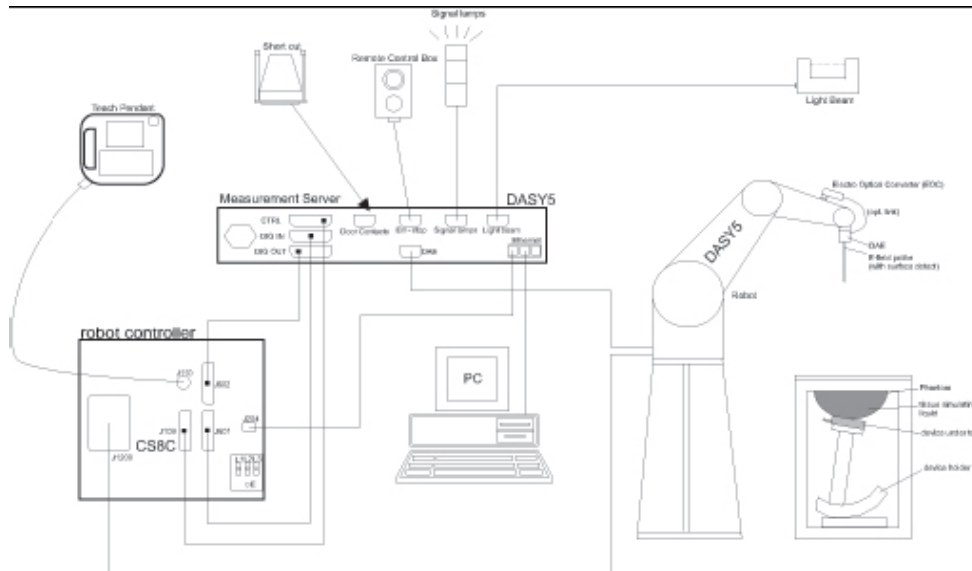

Picture C.1 SAR Lab Test Measurement Set-up

- A standard high precision 6-axis robot (Stäubli TX=RX family) with controller, teach pendant and software. An arm extension for accommodating the data acquisition electronics (DAE).
- An isotropic field probe optimized and calibrated for the targeted measurement.
- A data acquisition electronics (DAE) which performs the signal amplification, signal multiplexing, AD-conversion, offset measurements, mechanical surface detection, collision detection, etc. The unit is battery powered with standard or rechargeable batteries. The signal is optically transmitted to the EOC.
- The Electro-optical converter (EOC) performs the conversion from optical to electrical signals for the digital communication to the DAE. To use optical surface detection, a special version of the EOC is required. The EOC signal is transmitted to the measurement server.
- The function of the measurement server is to perform the time critical tasks such as signal filtering, control of the robot operation and fast movement interrupts.
- The Light Beam used is for probe alignment. This improves the (absolute) accuracy of the probe positioning.
- A computer running WinXP and the DASY5 software.
- Remote control and teach pendant as well as additional circuitry for robot safety such as
- warning lamps, etc.
- The phantom, the device holder and other accessories according to the targeted measurement.

C.2. DASY5 E-field Probe System

The SAR measurements were conducted with the dosimetric probe designed in the classical triangular configuration and optimized for dosimetric evaluation. The probe is constructed using the thick film technique; with printed resistive lines on ceramic substrates. The probe is equipped with an optical multifiber line ending at the front of the probe tip. It is connected to the EOC box on the robot arm and provides an automatic detection of the phantom surface. Half of the fibers are connected to a pulsed infrared transmitter, the other half to a synchronized receiver. As the probe approaches the surface, the reflection from the surface produces a coupling from the transmitting to the receiving fibers. This reflection increases first during the approach, reaches maximum and then decreases. If the probe is flatly touching the surface, the coupling is zero. The distance of the coupling maximum to the surface is independent of the surface reflectivity and largely independent of the surface to probe angle. The DASY5 software reads the reflection during a software approach and looks for the maximum using 2nd order curve fitting. The approach is stopped at reaching the maximum.

Probe Specifications:

Model:	ES3DV3, EX3DV4
Frequency	10MHz — 6.0GHz(EX3DV4)
Range:	10MHz — 4GHz(ES3DV3)
Calibration:	In head and body simulating tissue at Frequencies from 835 up to 5800MHz
Linearity:	± 0.2 dB(30 MHz to 6 GHz) for EX3DV4 ± 0.2 dB(30 MHz to 4 GHz) for ES3DV3
Dynamic Range:	10 mW/kg — 100W/kg
Probe Length:	330 mm
Probe Tip	
Length:	20 mm
Body Diameter:	12 mm
Tip Diameter:	2.5 mm (3.9 mm for ES3DV3)
Tip-Center:	1 mm (2.0mm for ES3DV3)
Application:	SAR Dosimetry Testing Compliance tests of mobile phones Dosimetry in strong gradient fields



Picture C.2 Near-field Probe



Picture C.3 E-field Probe

C.3. E-field Probe Calibration

Each E-Probe/Probe Amplifier combination has unique calibration parameters. A TEM cell calibration procedure is conducted to determine the proper amplifier settings to enter in the probe parameters. The amplifier settings are determined for a given frequency by subjecting the probe to a known E-field density (1 mW/cm²) using an RF Signal generator, TEM cell, and RF Power Meter.

The free space E-field from amplified probe outputs is determined in a test chamber. This calibration can be performed in a TEM cell if the frequency is below 1 GHz and in a waveguide or other methodologies above 1 GHz for free space. For the free space calibration, the probe is placed in the volumetric center of the cavity and at the proper orientation with the field. The probe is then rotated 360 degrees until the three channels show the maximum reading. The power density readings equates to 1 mW/ cm².

E-field temperature correlation calibration is performed in a flat phantom filled with the appropriate simulated brain tissue. The E-field in the medium correlates with the temperature rise in the dielectric medium. For temperature correlation calibration a RF transparent thermistor-based temperature probe is used in conjunction with the E-field probe.

$$SAR = C \frac{\Delta T}{\Delta t}$$

Where:

Δt = Exposure time (30 seconds),

C = Heat capacity of tissue (brain or muscle),

ΔT = Temperature increase due to RF exposure.

$$SAR = \frac{|E|^2 \cdot \sigma}{\rho}$$

Where:

σ = Simulated tissue conductivity,

ρ = Tissue density (kg/m³).

C.4. Other Test Equipment

C.4.1. Data Acquisition Electronics (DAE)

The data acquisition electronics consist of a highly sensitive electrometer-grade preamplifier with auto-zeroing, a channel and gain-switching multiplexer, a fast 16 bit AD-converter and a command decoder with a control logic unit. Transmission to the measurement server is accomplished through an optical downlink for data and status information, as well as an optical uplink for commands and the clock.

The mechanical probe mounting device includes two different sensor systems for frontal and sideways probe contacts. They are used for mechanical surface detection and probe collision detection.

The input impedance of the DAE is 200 MOhm; the inputs are symmetrical and floating. Common mode rejection is above 80 dB.



PictureC.4: DAE

C.4.2. Robot

The SPEAG DASY system uses the high precision robots (DASY5: RX160L) type from Stäubli SA (France). For the 6-axis controller system, the robot controller version from Stäubli is used. The Stäubli robot series have many features that are important for our application:

- High precision (repeatability 0.02mm)
- High reliability (industrial design)
- Low maintenance costs (virtually maintenance free due to direct drive gears; no belt drives)
- Jerk-free straight movements (brushless synchron motors; no stepper motors)
- Low ELF interference (motor control fields shielded via the closed metallic construction shields)



Picture C.5 DASY 5

C.4.3. Measurement Server

The Measurement server is based on a PC/104 CPU board with CPU (DASY5: 400 MHz, Intel Celeron), chipdisk (DASY5:128MB), RAM (DASY5:128MB). The necessary circuits for communication with the DAE electronic box, as well as the 16 bit AD converter system for optical detection and digital I/O interface are contained on the DASY I/O board, which is directly connected to the PC/104 bus of the CPU board.

The measurement server performs all real-time data evaluation of field measurements and surface detection, controls robot movements and handles safety operation. The PC operating system cannot interfere with these time critical processes. All connections are supervised by a watchdog, and disconnection of any of the cables to the measurement server will automatically disarm the robot and disable all program-controlled robot movements. Furthermore, the measurement server is equipped with an expansion port which is reserved for future applications. Please note that this expansion port does not have a standardized pinout, and therefore only devices provided by SPEAG can be connected. Devices from any other supplier could seriously damage the measurement server.



Picture C.6 Server for DASY 5

C.4.4. Device Holder for Phantom

The SAR in the phantom is approximately inversely proportional to the square of the distance between the source and the liquid surface. For a source at 5mm distance, a positioning uncertainty of $\pm 0.5\text{mm}$ would produce a SAR uncertainty of $\pm 20\%$. Accurate device positioning is therefore crucial for accurate and repeatable measurements. The positions in which the devices must be measured are defined by the standards.

The DASY device holder is designed to cope with the different positions given in the standard. It has two scales for device rotation (with respect to the body axis) and device inclination (with respect to the line between the ear reference points). The rotation centers for both scales is the ear reference point (ERP). Thus the device needs no repositioning when changing the angles.

The DASY device holder is constructed of low-loss POM material having the following dielectric

parameters: relative permittivity $\epsilon = 3$ and loss tangent $\delta = 0.02$. The amount of dielectric material has been reduced in the closest vicinity of the device, since measurements have suggested that the influence of the clamp on the test results could thus be lowered.

<Laptop Extension Kit>

The extension is lightweight and made of POM, acrylic glass and foam. It fits easily on the upper part of the Mounting Device in place of the phone positioner. The extension is fully compatible with the Twin-SAM and ELI phantoms.



Picture C.7-1: Device Holder

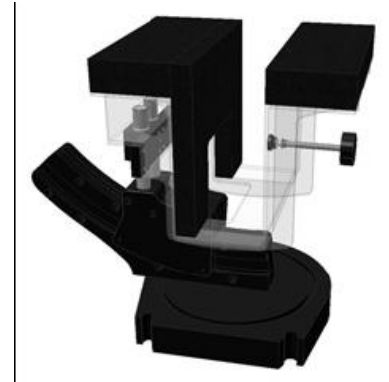

Picture C.7-2: Laptop Extension Kit

C.4.5. Phantom

The SAM Twin Phantom V4.0 is constructed of a fiberglass shell integrated in a table. The shape of the shell is based on data from an anatomical study designed to represent the 90th percentile of the population. The phantom enables the dissymmetric evaluation of SAR for both left and right handed handset usage, as well as body-worn usage using the flat phantom region. Reference markings on the Phantom allow the complete setup of all predefined phantom positions and measurement grids by manually teaching three points in the robot. The shell phantom has a 2mm shell thickness (except the ear region where shell thickness increases to 6 mm).

Shell Thickness: 2 ± 0.2 mm
Filling Volume: Approx. 25 liters
Dimensions: 810 x 1000 x 500 mm (H x L x W)
Available: Special



Picture C.8: SAM Twin Phantom

ANNEX D: Position of the wireless device in relation to the phantom

D.1. General considerations

This standard specifies two handset test positions against the head phantom – the “cheek” position and the “tilt” position.

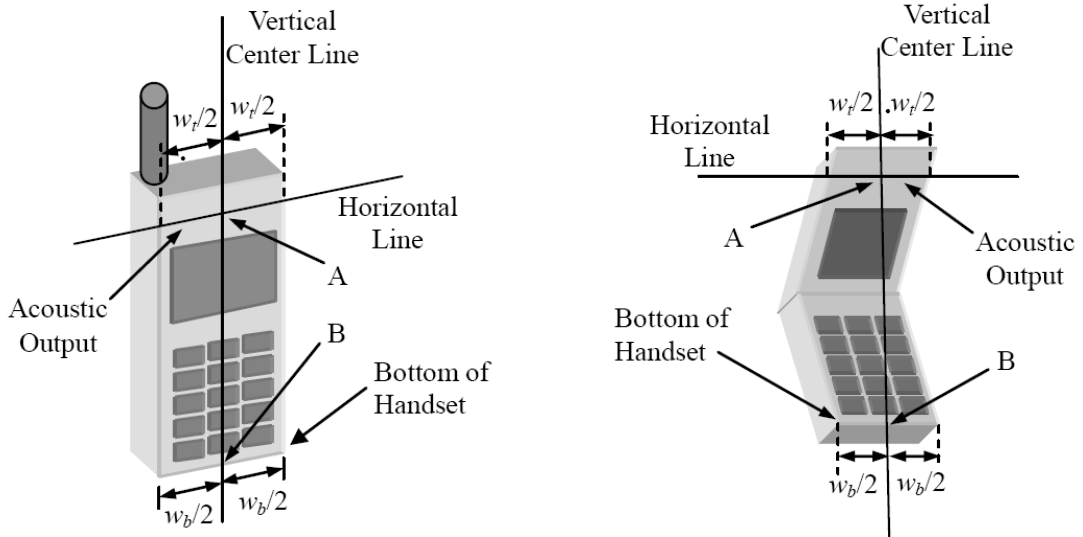

- w_t Width of the handset at the level of the acoustic
- w_b Width of the bottom of the handset
- A Midpoint of the width w_t of the handset at the level of the acoustic output
- B Midpoint of the width w_b of the bottom of the handset

Picture D.1-a Typical “fixed” case handset Picture D.1-b Typical “clam-shell” case handset

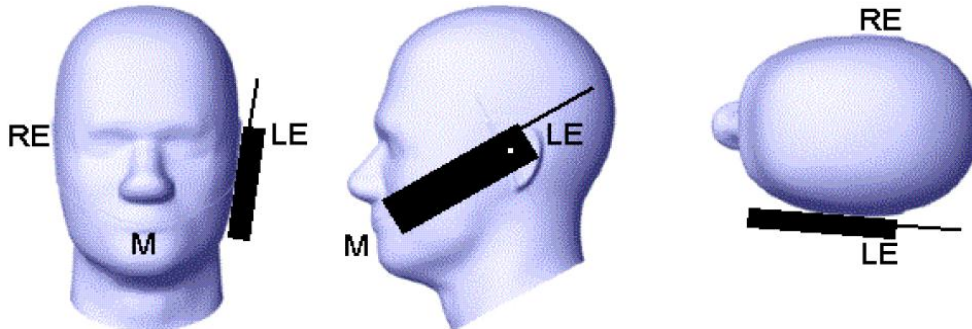

Picture D.2 Cheek position of the wireless device on the left side of SAM

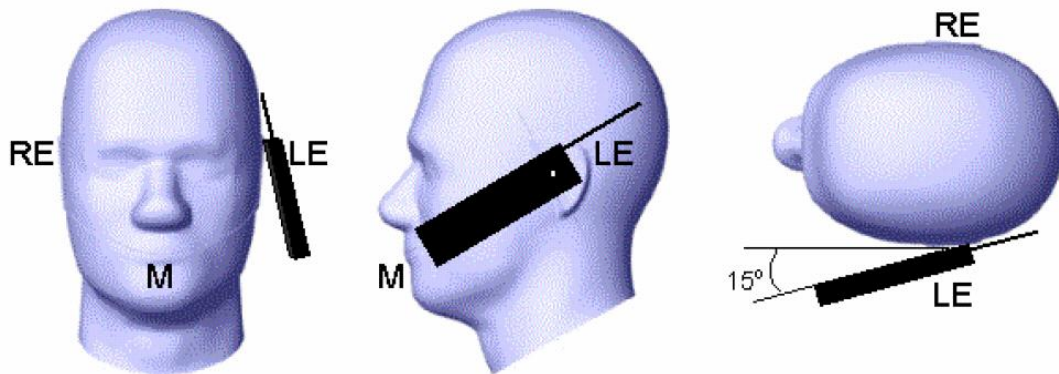

Picture D.3 Tilt position of the wireless device on the left side of SAM

D.2. Body-worn device

A typical example of a body-worn device is a mobile phone, wireless enabled PDA or other battery operated wireless device with the ability to transmit while mounted on a person's body using a carry accessory approved by the wireless device manufacturer.

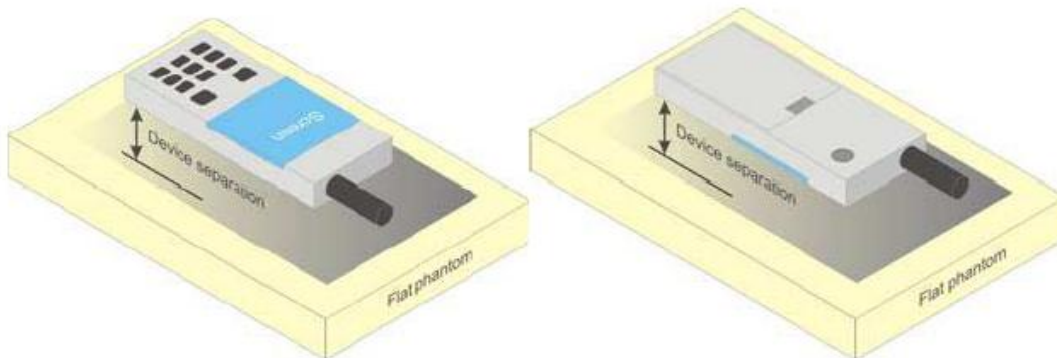

Picture D.4 Test positions for body-worn devices

D.3. Desktop device

A typical example of a desktop device is a wireless enabled desktop computer placed on a table or desk when used.

The DUT shall be positioned at the distance and in the orientation to the phantom that corresponds to the intended use as specified by the manufacturer in the user instructions. For devices that employ an external antenna with variable positions, tests shall be performed for all antenna positions specified. Picture 8.5 show positions for desktop device SAR tests. If the intended use is not specified, the device shall be tested directly against the flat phantom.

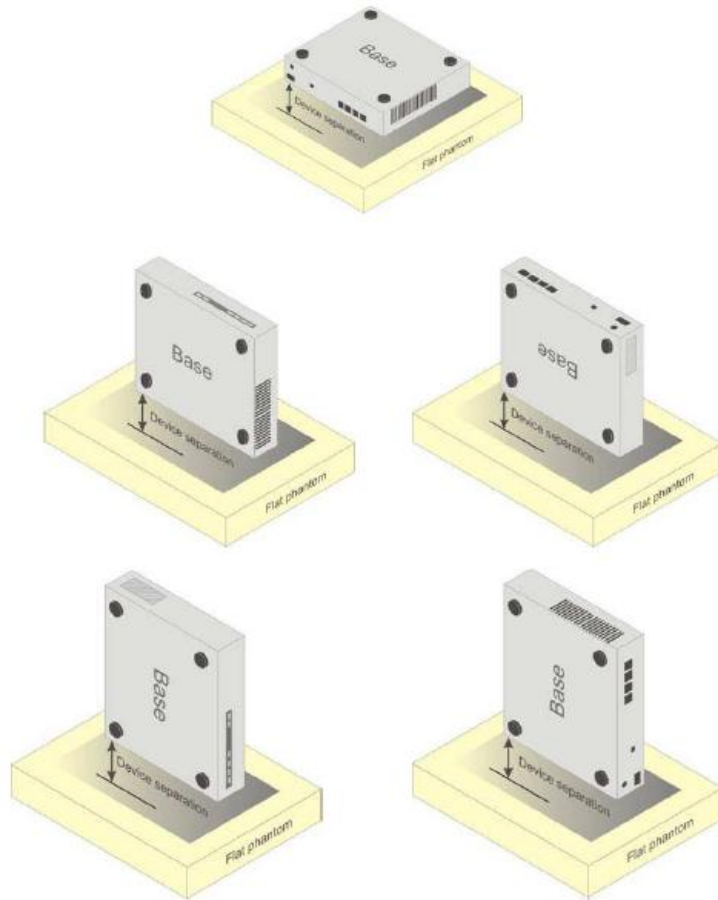

Picture D.5 Test positions for desktop devices

D.4. DUT Setup Photos

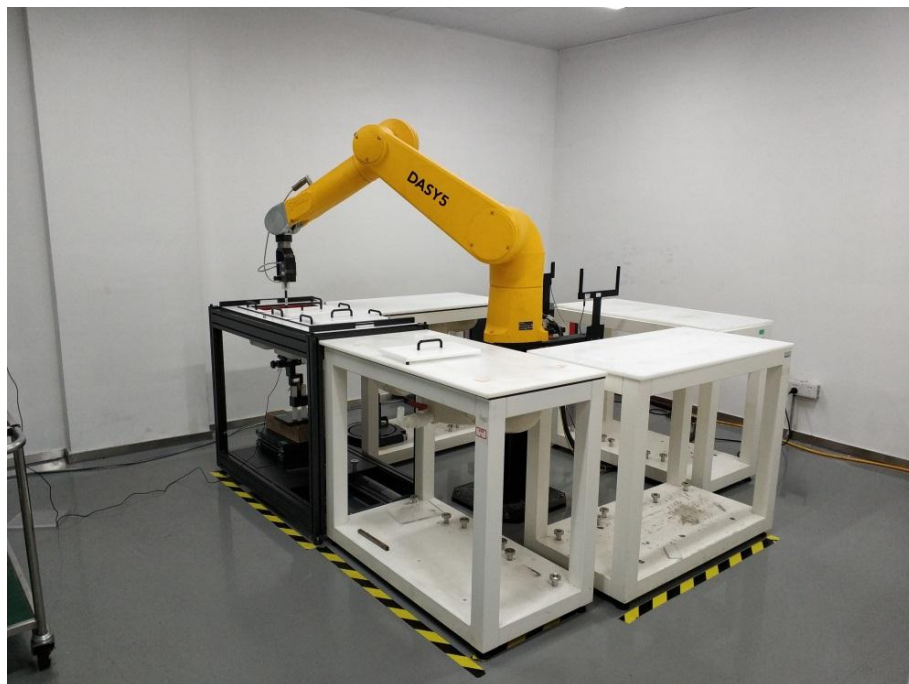

Picture D.6

ANNEX E: Equivalent Media Recipes

The liquid used for the frequency range of 700-6000 MHz consisted of water, sugar, salt, preventol, glycol monobutyl and Cellulose. The liquid has been previously proven to be suited for worst-case. The Table E.1 shows the detail solution. It's satisfying the latest tissue dielectric parameters requirements proposed by the IEEE 1528 and IEC 62209.

Table E.1: Composition of the Tissue Equivalent Matter

Frequency (MHz)	835	1750	1900	2450	2600	5200	5800
Water	41.45	55.242	55.242	58.79	58.79	65.53	66.10
Sugar	56.0	/	/	/	/	/	/
Salt	1.45	0.306	0.306	0.06	0.06		
Preventol	0.1	/	/	/	/	17.24	16.95
Cellulose	1.0	/	/	/	/	17.24	16.95
Glycol Monobutyl	/	44.452	44.452	41.15	41.15	/	/
Diethylenglycol monohexylether	/	/	/	/	/	/	/
Triton X-100	/	/	/	/	/	/	/
Dielectric Parameters Target Value	$\epsilon=41.5$ $\sigma=0.90$	$\epsilon=40.08$ $\sigma=1.37$	$\epsilon=40.0$ $\sigma=1.40$	$\epsilon=39.20$ $\sigma=1.80$	$\epsilon=39.01$ $\sigma=1.96$	$\epsilon=35.99$ $\sigma=4.66$	$\epsilon=35.30$ $\sigma=5.27$

Note: There is a little adjustment respectively for 750, 5300 and 5600, based on the recipe of closest frequency in table E.1

ANNEX F: System Validation

The SAR system must be validated against its performance specifications before it is deployed. When SAR probes, system components or software are changed, upgraded or recalibrated, these must be validated with the SAR system(s) that operates with such components.

Table F.1: System Validation

Probe SN.	Liquid name	Validation date	Frequency point	Status (OK or Not)
7683	Head 750MHz	2022-01-01	750MHz	OK
7683	Head 835MHz	2022-01-01	835MHz	OK
7683	Head 1750MHz	2021-10-20	1750MHz	OK
7683	Head 1900MHz	2022-01-01	1900MHz	OK
7683	Head 2450MHz	2022-01-03	2450MHz	OK
7683	Head 2550MHz	2022-01-03	2550MHz	OK
7683	Head 5250MHz	2022-01-02	5250MHz	OK
7683	Head 5600MHz	2022-01-02	5600MHz	OK
7683	Head 5750MHz	2022-01-02	5750MHz	OK

ANNEX G: DAE Calibration Certificate



In Collaboration with
TTL s p e a g
CALIBRATION LABORATORY



Add: No.52 HuaYuanBei Road, Haidian District, Beijing, 100191, China
Tel: +86-10-62304633-2512 Fax: +86-10-62304633-2504
E-mail: cttl@chinattl.com [Http://www.chinattl.cn](http://www.chinattl.cn)



中国认可
国际互认
校准
CALIBRATION
CNAS L0570

Client : **SAICT**

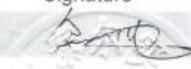
Certificate No: **Z22-60003**

CALIBRATION CERTIFICATE			
Object	DAE4 - SN: 1527		
Calibration Procedure(s)	FF-Z11-002-01 Calibration Procedure for the Data Acquisition Electronics (DAEx)		
Calibration date:	January 12, 2022		
<p>This calibration Certificate documents the traceability to national standards, which realize the physical units of measurements(SI). The measurements and the uncertainties with confidence probability are given on the following pages and are part of the certificate.</p> <p>All calibrations have been conducted in the closed laboratory facility: environment temperature(22±3)°C and humidity<70%.</p> <p>Calibration Equipment used (M&TE critical for calibration)</p>			
Primary Standards	ID #	Cal Date(Calibrated by, Certificate No.)	Scheduled Calibration
Process Calibrator 753	1971018	15-Jun-21 (CTTL, No.J21X04465)	Jun-22
Calibrated by:	Name Yu Zongying	Function SAR Test Engineer	Signature 
Reviewed by:	Lin Hao	SAR Test Engineer	
Approved by:	Qi Dianyuan	SAR Project Leader	
			Issued: January 14, 2022
This calibration certificate shall not be reproduced except in full without written approval of the laboratory.			



Add: No.52 HuaYuanBei Road, Haidian District, Beijing, 100191, China
Tel: +86-10-62304633-2512 Fax: +86-10-62304633-2504
E-mail: cttl@chinattl.com Http://www.chinattl.cn

Glossary:

DAE data acquisition electronics
Connector angle information used in DASY system to align probe sensor X to the robot coordinate system.

Methods Applied and Interpretation of Parameters:

- *DC Voltage Measurement:* Calibration Factor assessed for use in DASY system by comparison with a calibrated instrument traceable to national standards. The figure given corresponds to the full scale range of the voltmeter in the respective range.
- *Connector angle:* The angle of the connector is assessed measuring the angle mechanically by a tool inserted. Uncertainty is not required.
- The report provide only calibration results for DAE, it does not contain other performance test results.



Add: No.52 HuaYuanBei Road, Haidian District, Beijing, 100191, China
Tel: +86-10-62304633-2512 Fax: +86-10-62304633-2504
E-mail: cttl@chinattl.com Http://www.chinattl.cn

DC Voltage Measurement

A/D - Converter Resolution nominal

High Range: 1LSB = 6.1μV, full range = -100...+300 mV

Low Range: 1LSB = 61nV, full range = -1.....+3mV

DASY measurement parameters: Auto Zero Time: 3 sec; Measuring time: 3 sec

Calibration Factors	X	Y	Z
High Range	403.864 ± 0.15% (k=2)	403.585 ± 0.15% (k=2)	403.806 ± 0.15% (k=2)
Low Range	3.95854 ± 0.7% (k=2)	3.98858 ± 0.7% (k=2)	3.96746 ± 0.7% (k=2)

Connector Angle

Connector Angle to be used in DASY system	224° ± 1 °
---	------------



ANNEX H: Probe Calibration Certificate

EX3DV4-SN: 7683 (2021-12-29)



Add: No.52 HuaYuanBei Road, Haidian District, Beijing, 100191, China
Tel: +86-10-62304633-2512 Fax: +86-10-62304633-2504
E-mail: cttl@chinattl.com [Http://www.chinattl.cn](http://www.chinattl.cn)



中国认可
国际互认
校准
CALIBRATION
CNAS L0570

Client SAICT

Certificate No: Z21-60444

CALIBRATION CERTIFICATE

Object EX3DV4 - SN : 7683

Calibration Procedure(s) FF-Z11-004-02
Calibration Procedures for Dosimetric E-field Probes

Calibration date: December 29, 2021

This calibration Certificate documents the traceability to national standards, which realize the physical units of measurements(SI). The measurements and the uncertainties with confidence probability are given on the following pages and are part of the certificate.

All calibrations have been conducted in the closed laboratory facility: environment temperature(22±3)°C and humidity<70%.

Calibration Equipment used (M&TE critical for calibration)

Primary Standards	ID #	Cal Date(Calibrated by, Certificate No.)	Scheduled Calibration
Power Meter NRP2	101919	15-Jun-21(CTTL, No.J21X04466)	Jun-22
Power sensor NRP-Z91	101547	15-Jun-21(CTTL, No.J21X04466)	Jun-22
Power sensor NRP-Z91	101548	15-Jun-21(CTTL, No.J21X04466)	Jun-22
Reference 10dBAttenuator	18N50W-10dB	10-Feb-20(CTTL, No.J20X00525)	Feb-22
Reference 20dBAttenuator	18N50W-20dB	10-Feb-20(CTTL, No.J20X00526)	Feb-22
Reference Probe EX3DV4	SN 3617	27-Jan-21(SPEAG, No.EX3-3617_Jan21)	Jan-22
DAE4	SN 1555	20-Aug-21(SPEAG, No.DAE4-1555_Aug21/2)	Aug-22

Secondary Standards	ID #	Cal Date(Calibrated by, Certificate No.)	Scheduled Calibration
SignalGenerator MG3700A	6201052605	16-Jun-21(CTTL, No.J21X04467)	Jun-22
Network Analyzer E5071C	MY46110673	21-Jan-21(CTTL, No.J20X00515)	Jan-22

	Name	Function	Signature
Calibrated by:	Yu Zongying	SAR Test Engineer	
Reviewed by:	Lin Hao	SAR Test Engineer	
Approved by:	Qi Dianyuan	SAR Project Leader	

Issued: December 31, 2021

This calibration certificate shall not be reproduced except in full without written approval of the laboratory.



Add: No.52 HuaYuanBei Road, Haidian District, Beijing, 100191, China
 Tel: +86-10-62304633-2512 Fax: +86-10-62304633-2504
 E-mail: cttl@chinattl.com [Http://www.chinattl.cn](http://www.chinattl.cn)

Glossary:

TSL	tissue simulating liquid
NORM _{x,y,z}	sensitivity in free space
ConvF	sensitivity in TSL / NORM _{x,y,z}
DCP	diode compression point
CF	crest factor (1/duty_cycle) of the RF signal
A,B,C,D	modulation dependent linearization parameters
Polarization Φ	Φ rotation around probe axis
Polarization θ	θ rotation around an axis that is in the plane normal to probe axis (at measurement center), i $\theta=0$ is normal to probe axis
Connector Angle	information used in DASY system to align probe sensor X to the robot coordinate system

Calibration is Performed According to the Following Standards:

- a) IEEE Std 1528-2013, "IEEE Recommended Practice for Determining the Peak Spatial-Averaged Specific Absorption Rate (SAR) in the Human Head from Wireless Communications Devices: Measurement Techniques", June 2013
- b) IEC 62209-1, "Measurement procedure for the assessment of Specific Absorption Rate (SAR) from hand-held and body-mounted devices used next to the ear (frequency range of 300 MHz to 6 GHz)", July 2016
- c) IEC 62209-2, "Procedure to determine the Specific Absorption Rate (SAR) for wireless communication devices used in close proximity to the human body (frequency range of 30 MHz to 6 GHz)", March 2010
- d) KDB 865664, "SAR Measurement Requirements for 100 MHz to 6 GHz"

Methods Applied and Interpretation of Parameters:

- *NORM_{x,y,z}*: Assessed for E-field polarization $\theta=0$ ($f \leq 900\text{MHz}$ in TEM-cell; $f > 1800\text{MHz}$: waveguide). *NORM_{x,y,z}* are only intermediate values, i.e., the uncertainties of *NORM_{x,y,z}* does not effect the E^2 -field uncertainty inside TSL (see below ConvF).
- *NORM(f)_{x,y,z} = NORM_{x,y,z} * frequency_response* (see Frequency Response Chart). This linearization is implemented in DASY4 software versions later than 4.2. The uncertainty of the frequency response is included in the stated uncertainty of ConvF.
- *DCP_{x,y,z}*: DCP are numerical linearization parameters assessed based on the data of power sweep (no uncertainty required). DCP does not depend on frequency nor media.
- *PAR*: PAR is the Peak to Average Ratio that is not calibrated but determined based on the signal characteristics.
- *A_{x,y,z}; B_{x,y,z}; C_{x,y,z}; VR_{x,y,z}; A,B,C* are numerical linearization parameters assessed based on the data of power sweep for specific modulation signal. The parameters do not depend on frequency nor media. VR is the maximum calibration range expressed in RMS voltage across the diode.
- *ConvF and Boundary Effect Parameters*: Assessed in flat phantom using E-field (or Temperature Transfer Standard for $f \leq 800\text{MHz}$) and inside waveguide using analytical field distributions based on power measurements for $f > 800\text{MHz}$. The same setups are used for assessment of the parameters applied for boundary compensation (alpha, depth) of which typical uncertainty valued are given. These parameters are used in DASY4 software to improve probe accuracy close to the boundary. The sensitivity in TSL corresponds to *NORM_{x,y,z} * ConvF* whereby the uncertainty corresponds to that given for ConvF. A frequency dependent ConvF is used in DASY version 4.4 and higher which allows extending the validity from $\pm 50\text{MHz}$ to $\pm 100\text{MHz}$.
- *Spherical isotropy (3D deviation from isotropy)*: in a field of low gradients realized using a flat phantom exposed by a patch antenna.
- *Sensor Offset*: The sensor offset corresponds to the offset of virtual measurement center from the probe tip (on probe axis). No tolerance required.
- *Connector Angle*: The angle is assessed using the information gained by determining the *NORM_x* (no uncertainty required).



Add: No.52 HuaYuanBei Road, Haidian District, Beijing, 100191, China
 Tel: +86-10-62304633-2512 Fax: +86-10-62304633-2504
 E-mail: cttl@chinattl.com [Http://www.chinattl.cn](http://www.chinattl.cn)

DASY/EASY – Parameters of Probe: EX3DV4 – SN:7683

Basic Calibration Parameters

	Sensor X	Sensor Y	Sensor Z	Unc (k=2)
Norm($\mu\text{V}/(\text{V}/\text{m})^2$) ^A	0.63	0.65	0.64	$\pm 10.0\%$
DCP(mV) ^B	107.2	107.6	107.5	

Modulation Calibration Parameters

UID	Communication System Name		A dB	B dB· μV	C	D dB	VR mV	Unc ^E (k=2)
0	CW	X	0.0	0.0	1.0	0.00	203.5	$\pm 2.1\%$
		Y	0.0	0.0	1.0		205.8	
		Z	0.0	0.0	1.0		203.8	

The reported uncertainty of measurement is stated as the standard uncertainty of Measurement multiplied by the coverage factor $k=2$, which for a normal distribution Corresponds to a coverage probability of approximately 95%.

^A The uncertainties of Norm X, Y, Z do not affect the E²-field uncertainty inside TSL (see Page 4).

^B Numerical linearization parameter: uncertainty not required.

^E Uncertainty is determined using the max. deviation from linear response applying rectangular distribution and is expressed for the square of the field value.



Add: No.52 HuaYuanBei Road, Haidian District, Beijing, 100191, China
 Tel: +86-10-62304633-2512 Fax: +86-10-62304633-2504
 E-mail: cttl@chinattl.com [Http://www.chinattl.cn](http://www.chinattl.cn)

DASY/EASY – Parameters of Probe: EX3DV4 – SN:7683

Calibration Parameter Determined in Head Tissue Simulating Media

f [MHz] ^C	Relative Permittivity ^F	Conductivity (S/m) ^F	ConvF X	ConvF Y	ConvF Z	Alpha ^G	Depth ^G (mm)	Unct. (k=2)
750	41.9	0.89	10.34	10.34	10.34	0.20	1.19	±12.1%
1640	40.3	1.29	8.72	8.72	8.72	0.24	0.94	±12.1%
1900	40.0	1.40	8.33	8.33	8.33	0.29	0.95	±12.1%
2100	39.8	1.49	8.23	8.23	8.23	0.20	1.12	±12.1%
2300	39.5	1.67	8.07	8.07	8.07	0.62	0.69	±12.1%
2450	39.2	1.80	7.85	7.85	7.85	0.63	0.69	±12.1%
2600	39.0	1.96	7.55	7.55	7.55	0.49	0.83	±12.1%
3300	38.2	2.71	7.30	7.30	7.30	0.42	0.96	±13.3%
3500	37.9	2.91	7.01	7.01	7.01	0.42	1.00	±13.3%
3700	37.7	3.12	6.73	6.73	6.73	0.39	1.06	±13.3%
3900	37.5	3.32	6.61	6.61	6.61	0.40	1.25	±13.3%
4100	37.2	3.53	6.80	6.80	6.80	0.40	1.15	±13.3%
4400	36.9	3.84	6.61	6.61	6.61	0.35	1.35	±13.3%
4600	36.7	4.04	6.51	6.51	6.51	0.45	1.20	±13.3%
4800	36.4	4.25	6.46	6.46	6.46	0.45	1.20	±13.3%
4950	36.3	4.40	6.25	6.25	6.25	0.40	1.35	±13.3%
5250	35.9	4.71	5.56	5.56	5.56	0.45	1.40	±13.3%
5600	35.5	5.07	5.17	5.17	5.17	0.45	1.35	±13.3%
5750	35.4	5.22	5.21	5.21	5.21	0.55	1.20	±13.3%

^C Frequency validity above 300 MHz of ±100MHz only applies for DASY v4.4 and higher (Page 2), else it is restricted to ±50MHz. The uncertainty is the RSS of ConvF uncertainty at calibration frequency and the uncertainty for the indicated frequency band. Frequency validity below 300 MHz is ± 10, 25, 40, 50 and 70 MHz for ConvF assessments at 30, 64, 128, 150 and 220 MHz respectively. Above 5 GHz frequency validity can be extended to ± 110 MHz.

^F At frequency below 3 GHz, the validity of tissue parameters (ϵ and σ) can be relaxed to ±10% if liquid compensation formula is applied to measured SAR values. At frequencies above 3 GHz, the validity of tissue parameters (ϵ and σ) is restricted to ±5%. The uncertainty is the RSS of the ConvF uncertainty for indicated target tissue parameters.

^G Alpha/Depth are determined during calibration. SPEAG warrants that the remaining deviation due to the boundary effect after compensation is always less than ± 1% for frequencies below 3 GHz and below ± 2% for the frequencies between 3-6 GHz at any distance larger than half the probe tip diameter from the boundary.