

VARIANT FCC TEST REPORT (PART 24)

Applicant:	HMD Global Oy
Address:	Bertel Jungin aukio 9, 02600 Espoo, Finland

Manufacturer or Supplier:	HMD Global Oy
Address:	Bertel Jungin aukio 9, 02600 Espoo, Finland
Product:	Multi-band GSM/WCDMA/LTE phone with Bluetooth&WLAN
Brand Name:	NOKIA
Model Name:	TA-1404
FCC ID:	2AJOTTA-1404
Date of tests:	Nov. 25, 2021 ~ Oct. 10, 2022

The tests have been carried out according to the requirements of the following standard:

FCC PART 24, Subpart E **FCC PART 2**
 ANSI/TIA/EIA-603-D **ANSI/TIA/EIA-603-E** **ANSI C63.26-2015**

CONCLUSION: The submitted sample was found to COMPLY with the test requirement

Prepared by Simon Wang
Engineer / Mobile Department

Approved by Luke Lu
Manager / Mobile Department

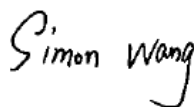

Date: Oct. 10, 2022



Date: Oct. 10, 2022

This report is governed by, and incorporates by reference, the Conditions of Testing as posted at the date of issuance of this report at <http://www.bureauveritas.com/home/about-us/our-business/cps/about-us/terms-conditions/> and is intended for your exclusive use. Any copying or replication of this report to or for any other person or entity, or use of our name or trademark, is permitted only with our prior written permission. This report sets forth our findings solely with respect to the test samples identified herein. The results set forth in this report are not indicative or representative of the quality or characteristics of the lot from which a test sample was taken or any similar or identical product unless specifically and expressly noted. Our report includes all of the tests requested by you and the results thereof based upon the information that you provided to us. Measurement uncertainty is only provided upon request for accredited tests. Statements of conformity are based on simple acceptance criteria without taking measurement uncertainty into account, unless otherwise requested in writing. You have 60 days from date of issuance of this report to notify us of any material error or omission caused by our negligence or if you require measurement uncertainty; provided, however, that such notice shall be in writing and shall specifically address the issue you wish to raise. A failure to raise such issue within the prescribed time shall constitute your unqualified acceptance of the completeness of this report, the tests conducted and the correctness of the report contents.



TABLE OF CONTENTS

RELEASE CONTROL RECORD	4
1 SUMMARY OF TEST RESULTS	5
1.1 MEASUREMENT UNCERTAINTY	5
1.2 TEST SITE AND INSTRUMENTS	6
2 GENERAL INFORMATION	8
2.1 GENERAL DESCRIPTION OF EUT	8
2.2 CONFIGURATION OF SYSTEM UNDER TEST	11
2.3 DESCRIPTION OF SUPPORT UNITS	12
2.4 TEST ITEM AND TEST CONFIGURATION.....	12
2.5 EUT OPERATING CONDITIONS	15
2.6 GENERAL DESCRIPTION OF APPLIED STANDARDS	15
3 TEST TYPES AND RESULTS	16
3.1 OUTPUT POWER MEASUREMENT	16
3.1.1 LIMITS OF OUTPUT POWER MEASUREMENT	16
3.1.2 TEST PROCEDURES	16
3.1.3 TEST SETUP	17
3.1.4 TEST RESULTS	17
3.2 FREQUENCY STABILITY MEASUREMENT	31
3.2.1 LIMITS OF FREQUENCY STABILITY MEASUREMENT	31
3.2.2 TEST PROCEDURE	31
3.2.3 TEST SETUP	31
3.2.4 TEST RESULTS	32
3.3 OCCUPIED BANDWIDTH MEASUREMENT	33
3.3.1 TEST PROCEDURES	33
3.3.2 TEST SETUP	33
3.3.3 TEST PROCEDURES	33
3.3.4 TEST RESULTS	34
3.4 BAND EDGE MEASUREMENTC	35
3.4.1 LIMITS OF BAND EDGE MEASUREMENT	35
3.4.2 TEST SETUP	35
3.4.3 TEST PROCEDURES	36
3.4.4. TEST RESULTS	37
3.5 CONDUCTED SPURIOUS EMISSIONS.....	38
3.5.1 LIMITS OF CONDUCTED SPURIOUS EMISSIONS MEASUREMENT	38
3.5.2 TEST PROCEDURE	38
3.5.3 TEST SETUP	38
3.5.4 TEST RESULTS	39
3.6 RADIATED EMISSION MEASUREMENT	40
3.6.1 LIMITS OF RADIATED EMISSION MEASUREMENT	40
3.6.2 TEST PROCEDURES.....	40



BUREAU
VERITAS

Test Report No.: W7L-P22090015-4RF05

3.6.3 DEVIATION FROM TEST STANDARD 40

3.6.4 TEST SETUP 41

3.6.5 TEST RESULTS 43

3.7 PEAK TO AVERAGE RATIO 79

3.7.1 LIMITS OF PEAK TO AVERAGE RATIO MEASUREMENT 79

3.7.2 TEST SETUP 79

3.7.3 TEST PROCEDURES 79

3.7.4 TEST RESULTS 80

4 INFORMATION ON THE TESTING LABORATORIES 81

5 MODIFICATIONS RECORDERS FOR ENGINEERING CHANGES TO THE EUT BY THE LAB..... 82

6 APPENDIX 83

PCS 1900 83

WCDMA BAND 2..... 103

LTE BAND 2 116



Test Report No.: W7L-P22090015-4RF05

RELEASE CONTROL RECORD

ISSUE NO.	REASON FOR CHANGE	DATE ISSUED
W7L-P21100018-1RF05	Original release	Dec. 13, 2021
W7L-P22090015-4RF05	Based on the original product changing the packaging factory of the chip and software version, removed Aohai_A829US adapter, BRL_CB - 36A USB cable, Saibao_CB - 12A USB cable, LEADER_HS-34 earphone, added Saibao_AC-2A USB cable. The new sample verify Power and RSE worst case (LTE B2), other test data is copied from the original test report W7L-P21100018-1RF05.	Oct. 10, 2022

1 SUMMARY OF TEST RESULTS

The EUT has been tested according to the following specifications:

APPLIED STANDARD: FCC Part 24 & Part 2		
STANDARD SECTION	TEST TYPE	RESULT
2.1046 24.232	Equivalent Isotropic Radiated Power	Compliance
2.1055 24.235	Frequency Stability	Compliance
2.1049 24.238(b)	Occupied Bandwidth	Compliance
24.232(d)	Peak to average ratio	Compliance
24.238(b)	Band Edge Measurements	Compliance
2.1051 24.238	Conducted Spurious Emissions	Compliance
2.1053 24.238	Radiated Spurious Emissions	Compliance

1.1 MEASUREMENT UNCERTAINTY

Where relevant, the following measurement uncertainty levels have been estimated for tests performed on the EUT as specified in CISPR 16-4-2:

MEASUREMENT	UNCERTAINTY
Frequency Stability	$\pm 76.97\text{Hz}$
Radiated emissions & Radiated Power (30MHz~1GMHz)	$\pm 4.98\text{dB}$
Radiated emissions & Radiated Power (1GMHz ~6GMHz)	$\pm 4.70\text{dB}$
Radiated emissions (6GMHz ~18GMHz)	$\pm 4.60\text{dB}$
Radiated emissions (18GMHz ~40GMHz)	$\pm 4.12\text{dB}$
Conducted emissions	$\pm 4.01\text{dB}$
Occupied Channel Bandwidth	$\pm 43.58\text{KHz}$
Conducted Output power	$\pm 2.06\text{dB}$
Band Edge Measurements	$\pm 4.70\text{dB}$
Peak to average ratio	$\pm 0.76\text{dB}$

This uncertainty represents an expanded uncertainty expressed at approximately the 95% confidence level using a coverage factor of $k=2$.



1.2 TEST SITE AND INSTRUMENTS

Equipment	Manufacturer	Model No.	Serial No.	Last Cal.	Next Cal.
MXE EMI Receiver	KEYSIGHT	N9038A-544	MY54450026	Apr. 22,21	Apr. 21,22
MXE EMI Receiver	KEYSIGHT	N9038A-544	MY54450026	Apr. 21,22	Apr. 20,23
EXA Signal Analyzer	KEYSIGHT	N9010A-544	MY54510355	Jun. 03,21	Jun. 02,22
EXA Signal Analyzer	KEYSIGHT	N9010A-544	MY54510355	Jun. 02,22	Jun. 01,23
Bilog Antenna 2	ETS-LINDGREN	3143B	00161965	Mar. 05,21	Mar. 04,22
Bilog Antenna 2	ETS-LINDGREN	3143B	00161965	Mar. 04,22	Mar. 03,23
Horn Antenna 1	ETS-LINDGREN	3117	00168728	Aug. 19,21	Aug. 18,22
Horn Antenna 1	ETS-LINDGREN	3117	00168728	Aug. 18,22	Aug. 17,23
Horn Antenna 2	ETS-LINDGREN	3117	00168692	Apr. 02,21	Apr. 01,22
Horn Antenna 2	ETS-LINDGREN	3117	00168692	Apr. 01,22	Mar. 31,23
Horn Antenna (18GHz-40GHz)	N/A	QWH-SL-18-40-K-SG/QMS-00361	15433	Aug. 25, 21	Aug. 24, 22
Horn Antenna (18GHz-40GHz)	N/A	QWH-SL-18-40-K-SG/QMS-00361	15433	Aug. 24, 22	Aug. 23, 23
Radio Communication Analyzer	ANRITSU	MT8820C	6201465426	Feb. 25,21	Feb. 24,22
Radio Communication Analyzer	ANRITSU	MT8820C	6201465426	Feb. 24,22	Feb. 23,23
Signal Pre-Amplifier	EMSI	EMC 9135	980249	Jun. 02,21	Jun. 01,22
Signal Pre-Amplifier	EMSI	EMC 9135	980249	Jun. 01,22	May. 31,23
Signal Pre-Amplifier	EMSI	EMC 012645B	980257	Jun. 03,21	Jun. 02,22
Signal Pre-Amplifier	EMSI	EMC 012645B	980257	Jun. 02,22	Jun. 01,23
Signal Pre-Amplifier	EMSI	EMC 184045B	980259	Apr. 22,21	Apr. 21,22
Signal Pre-Amplifier	EMSI	EMC 184045B	980259	Apr. 21,22	Apr. 20,23
3m Semi-anechoic Chamber	ETS-LINDGREN	9m*6m*6m	Euroshieldpn-CT0001143-1216	May. 19,20	May. 18,23
Test Software	E3	V 9.160323	N/A	N/A	N/A
Test Software	ADT	ADT_Radiated_V 7.6.15.9.2	N/A	N/A	N/A
10dB Attenuator	JFW/USA	50HF-010-SMA	1505	Jun. 03,21	Jun. 02,22
10dB Attenuator	JFW/USA	50HF-010-SMA	1505	Jun. 02,22	Jun. 01,23
Power Meter	Anritsu	ML2495A	1506002	Apr. 07,21	Apr. 06,22
Power Meter	Anritsu	ML2495A	1506002	Apr. 06,22	Apr. 05,23
Power Sensor	Anritsu	MA2411B	1339352	May. 07,21	May. 06,22
Power Sensor	Anritsu	MA2411B	1339352	May. 06,22	May. 05,23
Temperature Chamber	ESPEC	SH-242	93000855	Jun. 02,21	Jun. 01,22
Temperature Chamber	ESPEC	SH-242	93000855	Jun. 01,22	May. 31,23
MXG Analog Microvave Signal Generator	KEYSIGHT	N5183A	MY50143024	Mar. 05,21	Mar. 04,22
MXG Analog Microvave	KEYSIGHT	N5183A	MY50143024	Mar. 04,22	Mar. 03,23



**BUREAU
VERITAS**

Test Report No.: W7L-P22090015-4RF05

Signal Generator					
Power Divider	MCLI/USA	PS2-15	24880	N/A	N/A

- NOTE:**
1. The calibration interval of the above test instruments is 12 months or 36 months and the calibrations are traceable to CEPREI/CHINA, GRGT/CHINA and NIM/CHINA.
 2. The test was performed in 3m Semi-anechoic Chamber and RF Oven Room.
 3. The horn antenna is used only for the measurement of emission frequency above 1GHz if tested.
 4. The FCC Site Registration No. is 525120; The Designation No. is CN1171.



2 GENERAL INFORMATION

2.1 GENERAL DESCRIPTION OF EUT

PRODUCT	Multi-band GSM/WCDMA/LTE phone with Bluetooth&WLAN	
BRAND NAME	NOKIA	
MODEL NAME	TA-1404	
NOMINAL VOLTAGE	5.0Vdc(adapter or host equipment) 3.85Vdc (Li-ion, battery)	
MODULATION TYPE	GSM/GPRS: GMSK EDGE: 8PSK WCDMA: QPSK LTE: QPSK, 16QAM, 64QAM	
FREQUENCY RANGE	GSM/GPRS, EDGE	1850.2MHz ~ 1909.8MHz
	WCDMA	1852.4MHz ~ 1907.6MHz
	LTE Band 2 Channel Bandwidth: 1.4MHz	1850.7MHz ~ 1909.3MHz
	LTE Band 2 Channel Bandwidth: 3MHz	1851.5MHz ~ 1908.5MHz
	LTE Band 2 Channel Bandwidth: 5MHz	1852.5MHz ~ 1907.5MHz
	LTE Band 2 Channel Bandwidth: 10MHz	1855.0MHz ~ 1905.0MHz
	LTE Band 2 Channel Bandwidth: 15MHz	1857.5MHz ~ 1902.5MHz
	LTE Band 2 Channel Bandwidth: 20MHz	1860.0MHz ~ 1900.0MHz
	MAX. EIRP POWER	GSM/GPRS
EDGE		639.73mW
WCDMA		288.40mW
LTE Band 2 Channel Bandwidth: 1.4MHz		304.79mW
LTE Band 2 Channel Bandwidth: 3MHz		304.09mW
LTE Band 2 Channel Bandwidth: 5MHz		302.00mW
LTE Band 2 Channel Bandwidth: 10MHz		304.79mW
LTE Band 2 Channel Bandwidth: 15MHz		304.09mW



	LTE Band 2 Channel Bandwidth: 20MHz	306.20mW	
EMISSION DESIGNATOR	GSM/GPRS	249KGXW	
	EDGE	258KG7W	
	WCDMA	4M18F9W	
	LTE Band 2 Channel Bandwidth: 1.4MHz	QPSK: 1M12G7D	
		16QAM: 1M12W7D	
		64QAM: 1M12W7D	
	LTE Band 2 Channel Bandwidth: 3MHz	QPSK: 2M76G7D	
		16QAM: 2M77W7D	
		64QAM: 2M77W7D	
	LTE Band 2 Channel Bandwidth: 5MHz	QPSK: 4M56G7D	
		16QAM: 4M55W7D	
		64QAM: 4M56W7D	
	LTE Band 2 Channel Bandwidth: 10MHz	QPSK: 9M09G7D	
		16QAM: 9M08W7D	
64QAM: 9M06W7D			
LTE Band 2 Channel Bandwidth: 15MHz	QPSK: 13M6G7D		
	16QAM: 13M7W7D		
	64QAM: 13M7W7D		
LTE Band 2 Channel Bandwidth: 20MHz	QPSK: 18M2G7D		
	16QAM: 18M2W7D		
	64QAM: 18M2W7D		
ANTENNA TYPE	Fixed Internal Antenna with 0.9dBi gain for GSM1900/ WCDMA II/LTE B2		
HW VERSION	19655-1-11M12		
SW VERSION	00WW_1_520		
I/O PORTS	Refer to user's manual		
CABLE SUPPLIED	USB1 cable: unshielded without ferrite, 1.0meter USB2 cable: unshielded without ferrite, 1.0meter Earphone1: non-shielded cable, with w/o ferrite core, 1.2 meter		
EXTREME TEMPERATURE	0-40 °C		
EXTREME VOLTAGE	3.5V - 4.4V		

NOTE:

- For a more detailed features description, please refer to the manufacturer's specifications or the user's manual.



- 2. The EUT incorporates a SISO function. Physically, the EUT provides one completed transmitter and one receiver.

MODULATION MODE	TX FUNCTION
GSM/GPRS/EDGE	1TX/1RX
WCDMA	1TX/1RX
LTE	1TX/1RX

- 3. For the test results, the EUT had been tested with all conditions. But only the worst case was shown in test report.

List of Accessory:

ACCESSORIES	BRAND	MANUFACTURER	MODEL	SPECIFICATION
Battery	Nokia	Hunan Gaoyuan Battery Co., Ltd.	WT341	Capacity: 3.85 Vdc, 4900mAh
AC Adapter 1	Nokia	ShenZhenBaiJunDa ElectronicCO.,LTD.	AD-010U	I/P: 100-240Vac, 0.35A, O/P: 5.0Vdc, 2.0A
AC Adapter 2	Nokia	SHENZHEN TIANYIN ELECTRONICS CO., LTD.	CH-21U	I/P: 100-240Vac, 0.3A, O/P: 5.0Vdc, 2.0A
AC Adapter 3	Nokia	YuTong Electronics(HuiZhou) Co.,Ltd	PA-US5V2A-036	I/P: 100-240Vac, 0.5A, O/P: 5.0Vdc, 2.0A
Earphone 1	Nokia	Guangdong Wivtak Technology Co., Ltd.	HS-34	Signal Line, 1.2meter
USB Cable 1	Nokia	HUIZHOU WASHIN ELECTRONICS CO.,LTD	CB-36A	Signal Line, 1.0meter
USB Cable 2	Nokia	Saibao(Jiangi) Communication Industial Co.,Ltd	AC-2A	Signal Line, 1.0meter



2.2 CONFIGURATION OF SYSTEM UNDER TEST

FOR RADIATION EMISSION TEST

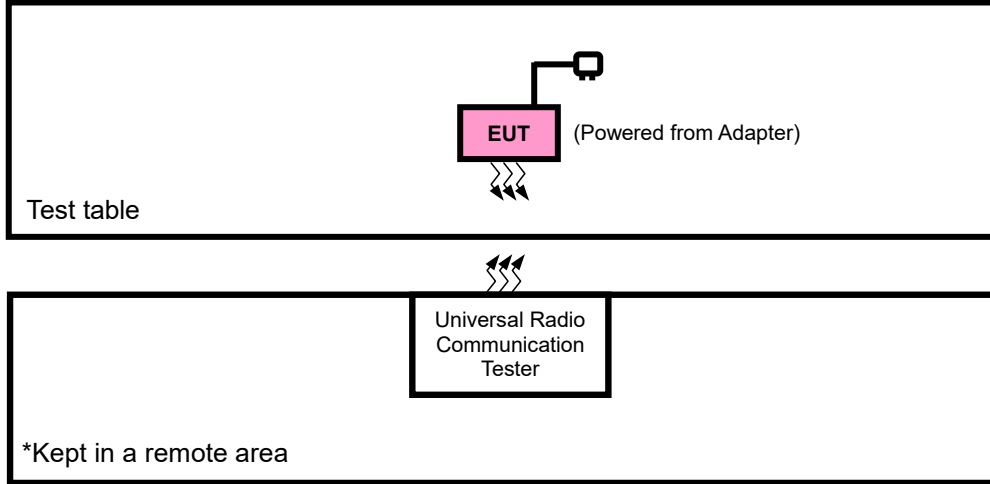



2.3 DESCRIPTION OF SUPPORT UNITS

The EUT has been tested as an independent unit together with other necessary accessories or support units. The following support units or accessories were used to form a representative test configuration during the tests.

NO.	PRODUCT	BRAND	MODEL NO.	SERIAL NO.	FCC ID
1	DC source	Kikusui/JP	PMX18-5A	0000001	N/A

NO.	SIGNAL CABLE DESCRIPTION OF THE ABOVE SUPPORT UNITS
1	DC Line: Unshielded, Detachable 1.0m

2.4 TEST ITEM AND TEST CONFIGURATION

Pre-Scan has been conducted to determine the worst-case mode from all possible combinations between available modulations, data rates, XYZ axis and antenna ports. The worst case in EIRP and radiated emission was found when positioned on X-plane for GSM/EDGE/ LTE. Following channel(s) was (were) selected for the final test as listed below:

EUT CONFIGURE MODE	DESCRIPTION
A	EUT + Adapter with GSM or WCDMA or LTE link

GSM MODE

EUT CONFIGURE MODE	TEST ITEM	AVAILABLE CHANNEL	TESTED CHANNEL	MODE
A	EIRP	512 to 810	512, 661, 810	GSM, EDGE
A	FREQUENCY STABILITY	512 to 810	512, 661, 810	GSM, EDGE
A	OCCUPIED BANDWIDTH	512 to 810	512, 661, 810	GSM, EDGE
A	PEAK TO AVERAGE RATIO	512 to 810	512, 661, 810	GSM, EDGE
A	BAND EDGE	512 to 810	512, 810	GSM, EDGE
A	CONDUCTED EMISSION	512 to 810	512, 661, 810	GSM, EDGE
A	RADIATED EMISSION	512 to 810	512, 661, 810	GSM, EDGE



**BUREAU
VERITAS**

Test Report No.: W7L-P22090015-4RF05

WCDMA

EUT CONFIGURE MODE	TEST ITEM	AVAILABLE CHANNEL	TESTED CHANNEL	MODE
A	EIRP	9262 to 9538	9262, 9400, 9538	WCDMA
A	FREQUENCY STABILITY	9262 to 9538	9262, 9538	WCDMA
A	OCCUPIED BANDWIDTH	9262 to 9538	9262, 9400, 9538	WCDMA
A	PEAK TO AVERAGE RATIO	9262 to 9538	9262, 9400, 9538	WCDMA
A	BAND EDGE	9262 to 9538	9262, 9538	WCDMA
A	CONDCUDED EMISSION	9262 to 9538	9262, 9400, 9538	WCDMA
A	RADIATED EMISSION	9262 to 9538	9262, 9400, 9538	WCDMA

LTE BAND 2 MODE

EUT CONFIGURE MODE	TEST ITEM	AVAILABLE CHANNEL	TESTED CHANNEL	CHANNEL BANDWIDTH	MODULATION	MODE
A	EIRP	18607 to 19193	18607, 18900, 19193	1.4MHz	QPSK,16QAM, 64QAM	1 RB / 0 RB Offset
		18615 to 19185	18615, 18900, 19185	3MHz	QPSK,16QAM, 64QAM	1 RB / 0 RB Offset
		18625 to 19175	18625, 18900, 19175	5MHz	QPSK,16QAM, 64QAM	1 RB / 0 RB Offset
		18650 to 19150	18650, 18900, 19150	10MHz	QPSK,16QAM, 64QAM	1 RB / 0 RB Offset
		18675 to 19125	18675, 18900, 19125	15MHz	QPSK,16QAM, 64QAM	1 RB / 0 RB Offset
		18700 to 19100	18700, 18900, 19100	20MHz	QPSK,16QAM, 64QAM	1 RB / 0 RB Offset
A	FREQUENCY STABILITY	18607 to 19193	18607, 19193	1.4MHz	QPSK	1 RB / 0 RB Offset
		18615 to 19185	18615, 19185	3MHz	QPSK	1 RB / 0 RB Offset
		18625 to 19175	18625, 19175	5MHz	QPSK	1 RB / 0 RB Offset
		18650 to 19150	18650, 19150	10MHz	QPSK	1 RB / 0 RB Offset
		18675 to 19125	18675, 19125	15MHz	QPSK	1 RB / 0 RB Offset
		18700 to 19100	18700, 19100	20MHz	QPSK	1 RB / 0 RB Offset
A	OCCUPIED BANDWIDTH	18607 to 19193	18607, 18900, 19193	1.4MHz	QPSK,16QAM, 64QAM	6 RB / 0 RB Offset
		18615 to 19185	18615, 18900, 19185	3MHz	QPSK,16QAM, 64QAM	15 RB / 0 RB Offset
		18625 to 19175	18625, 18900, 19175	5MHz	QPSK,16QAM, 64QAM	25 RB / 0 RB Offset
		18650 to 19150	18650, 18900, 19150	10MHz	QPSK,16QAM, 64QAM	50 RB / 0 RB Offset
		18675 to 19125	18675, 18900, 19125	15MHz	QPSK,16QAM, 64QAM	75 RB / 0 RB Offset
		18700 to 19100	18700, 18900, 19100	20MHz	QPSK,16QAM, 64QAM	100 RB / 0 RB Offset
A	PEAK TO AVERAGE RATIO	18607 to 19193	18607, 18900, 19193	1.4MHz	QPSK,16QAM, 64QAM	1 RB / 0 RB Offset
		18615 to 19185	18615, 18900, 19185	3MHz	QPSK,16QAM, 64QAM	1 RB / 0 RB Offset
		18625 to 19175	18625, 18900, 19175	5MHz	QPSK,16QAM, 64QAM	1 RB / 0 RB Offset
		18650 to 19150	18650, 18900, 19150	10MHz	QPSK,16QAM, 64QAM	1 RB / 0 RB Offset
		18675 to 19125	18675, 18900, 19125	15MHz	QPSK,16QAM, 64QAM	1 RB / 0 RB Offset
		18700 to 19100	18700, 18900, 19100	20MHz	QPSK,16QAM, 64QAM	1 RB / 0 RB Offset



**BUREAU
VERITAS**

Test Report No.: W7L-P22090015-4RF05

A	BAND EDGE	18607 to 19193	18607	1.4MHz	QPSK, 16QAM, 64QAM	1 RB / 0 RB Offset		
			19193	1.4MHz	QPSK, 16QAM, 64QAM	6 RB / 0 RB Offset		
		18615 to 19185	18615	3MHz	QPSK, 16QAM, 64QAM	1 RB / 5 RB Offset		
			19185	3MHz	QPSK, 16QAM, 64QAM	6 RB / 0 RB Offset		
		18625 to 19175	18625	5MHz	QPSK, 16QAM, 64QAM	1 RB / 0 RB Offset		
			19175	5MHz	QPSK, 16QAM, 64QAM	15 RB / 0 RB Offset		
		18650 to 19150	18650	10MHz	QPSK, 16QAM, 64QAM	1 RB / 14 RB Offset		
			19150	10MHz	QPSK, 16QAM, 64QAM	15 RB / 0 RB Offset		
		18675 to 19125	18675	15MHz	QPSK, 16QAM, 64QAM	1 RB / 0 RB Offset		
			19125	15MHz	QPSK, 16QAM, 64QAM	25 RB / 0 RB Offset		
		18700 to 19100	18700	20MHz	QPSK, 16QAM, 64QAM	1 RB / 24 RB Offset		
			19100	20MHz	QPSK, 16QAM, 64QAM	25 RB / 0 RB Offset		
		A	CONDCUDETED EMISSION	18607 to 19193	18607, 18900, 19193	1.4MHz	QPSK	1 RB / 0 RB Offset
				18615 to 19185	18615, 18900, 19185	3MHz	QPSK	1 RB / 0 RB Offset
				18625 to 19175	18625, 18900, 19175	5MHz	QPSK	1 RB / 0 RB Offset
				18650 to 19150	18650, 18900, 19150	10MHz	QPSK	1 RB / 0 RB Offset
18675 to 19125	18675, 18900, 19125			15MHz	QPSK	1 RB / 0 RB Offset		
18700 to 19100	18700, 18900, 19100			20MHz	QPSK	1 RB / 0 RB Offset		
A	RADIATED EMISSION	18607 to 19193	18900	1.4MHz	QPSK	1 RB / 0 RB Offset		
		18615 to 19185	18900	3MHz	QPSK	1 RB / 0 RB Offset		
		18625 to 19175	18900	5MHz	QPSK	1 RB / 0 RB Offset		
		18650 to 19150	18607, 18900, 19193	10MHz	QPSK	1 RB / 0 RB Offset		
		18675 to 19125	18900	15MHz	QPSK	1 RB / 0 RB Offset		
		18700 to 19100	18900	20MHz	QPSK	1 RB / 0 RB Offset		



TEST CONDITION:

TEST ITEM	ENVIRONMENTAL CONDITIONS	INPUT POWER	TESTED BY
EIRP	25deg. C, 57%RH	DC 5V By Adapter	Jace Hu
FREQUENCY STABILITY	23deg. C, 61%RH	DC5V By Adapter	James Fu
OCCUPIED BANDWIDTH	23deg. C, 61%RH	DC5V By Adapter	James Fu
PEAK TO AVERAGE RATIO	23deg. C, 61%RH	DC 5V By Adapter	James Fu
BAND EDGE	23deg. C, 61%RH	DC5V By Adapter	James Fu
CONDCUDED EMISSION	23deg. C, 61%RH	DC5V By Adapter	James Fu
RADIATED EMISSION	23deg. C, 70%RH	DC 3.85V By Battery	Jace Hu

2.5 EUT OPERATING CONDITIONS

The EUT makes a call to the communication simulator. The communication simulator station system controlled a EUT to export maximum output power under transmission mode and specific channel frequency

2.6 GENERAL DESCRIPTION OF APPLIED STANDARDS

The EUT is a RF product. According to the specifications of the manufacturer, it must comply with the requirements of the following standards:

FCC 47 CFR Part 2

FCC 47 CFR Part 24

KDB 971168 D01 Power Meas License Digital Systems v03r01

ANSI/TIA/EIA-603-D

ANSI/TIA/EIA-603-E

ANSI C63.26-2015

NOTE: All test items have been performed and recorded as per the above standards.

3 TEST TYPES AND RESULTS

3.1 OUTPUT POWER MEASUREMENT

3.1.1 LIMITS OF OUTPUT POWER MEASUREMENT

Mobile and portable stations are limited to 2 watts EIRP.

3.1.2 TEST PROCEDURES

EIRP MEASUREMENT:

Per KDB 971168 D01 Power Meas License Digital Systems v03r01 or subclause 5.2.5.5 of ANSI C63.26-2015, the relevant equation for determining the ERP or EIRP from the conducted RF output power measured using the guidance provided above is:

$$\text{ERP or EIRP} = P_{\text{Meas}} + G_{\text{T}} - L_{\text{C}}$$

Where:

ERP or EIRP = effective radiated power or equivalent isotropically radiated power, respectively

(expressed in the same units as P_{Meas} , typically dBW or dBm);

P_{Meas} = measured transmitter output power or PSD, in dBm or dBW;

G_{T} = gain of the transmitting antenna, in dBd (ERP) or dBi (EIRP);

L_{C} = signal attenuation in the connecting cable between the transmitter and antenna, in dB.

CONDUCTED POWER MEASUREMENT:

The EUT was set up for the maximum power with WCDMA link data modulation and link up with simulator. Set the EUT to transmit under low, middle and high channel and record the power level shown on simulator.



3.1.3 TEST SETUP

EIRP / ERP Measurement:

CONDUCTED POWER MEASUREMENT:

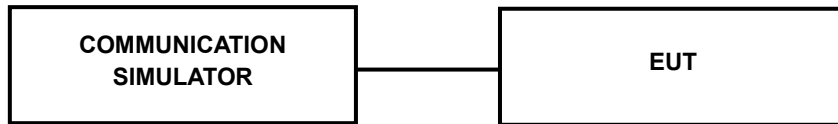

3.1.4 TEST RESULTS

CONDUCTED OUTPUT POWER (dBm)

Band	GSM1900		
Channel	512	661	810
Frequency	1850.2	1880	1909.8
GSM (GMSK, 1Tx-slot)	29.51	29.47	29.74
GPRS (GMSK, 1Tx-slot)	29.53	29.46	29.75
GPRS (GMSK, 2Tx-slot)	27.34	27.17	27.06
GPRS (GMSK, 3Tx-slot)	25.89	25.75	25.61
GPRS (GMSK, 4Tx-slot)	23.84	23.73	23.54
EDGE (8PSK, 1Tx-slot)	27.16	27.11	27.05
EDGE (8PSK, 2Tx-slot)	25.95	25.74	25.42
EDGE (8PSK, 3Tx-slot)	23.31	23.35	23.25
EDGE (8PSK, 4Tx-slot)	21.09	21.14	21.16

Band	WCDMA II		
Channel	9262	9400	9538
Frequency	1852.4	1880	1907.6
RMC 12.2K	23.65	23.70	23.68
HSDPA Subtest-1	22.63	22.62	22.67
HSDPA Subtest-2	22.55	22.58	22.62
HSDPA Subtest-3	22.10	22.06	22.15
HSDPA Subtest-4	22.03	22.01	22.07
DC-HSDPA Subtest-1	22.57	22.54	22.65
DC-HSDPA Subtest-2	22.54	22.56	22.54
DC-HSDPA Subtest-3	22.02	22.05	22.10
DC-HSDPA Subtest-4	22.07	22.06	22.08
HSUPA Subtest-1	22.59	22.68	22.63
HSUPA Subtest-2	20.58	20.65	20.66
HSUPA Subtest-3	21.50	21.63	21.61
HSUPA Subtest-4	20.56	20.57	20.64
HSUPA Subtest-5	22.51	22.62	22.55
HSPA+ Subtest-1	20.09	20.18	20.15



LTE BAND 2

Band/BW	Modulation	RB Size	RB Offset	Low CH 18607	Mid CH 18900	High CH 19193
				Frequency 1850.7 MHz	Frequency 1880 MHz	Frequency 1909.3 MHz
2/ 1.4	QPSK	1	0	23.81	23.75	23.66
		1	2	23.92	23.75	23.76
		1	5	23.94	23.85	23.76
		3	0	23.14	23.01	23.01
		3	1	23.10	22.96	22.82
		3	3	22.98	22.85	22.83
		6	0	22.55	22.41	22.29
	16QAM	1	0	22.70	22.59	22.53
		1	2	22.68	22.51	22.51
		1	5	22.65	22.49	22.48
		3	0	22.18	22.07	22.03
		3	1	22.16	22.09	22.02
		3	3	22.12	22.07	22.00
		6	0	21.74	21.64	21.58
	64QAM	1	0	21.81	21.76	21.73
		1	2	21.82	21.79	21.63
		1	5	21.65	21.52	21.53
		3	0	21.26	21.17	21.06
		3	1	21.20	21.18	20.99
		3	3	21.21	21.09	21.09
		6	0	20.79	20.65	20.59



**BUREAU
VERITAS**

Test Report No.: W7L-P22090015-4RF05

Band/BW	Modulation	RB Size	RB Offset	Low CH 18615	Mid CH 18900	High CH 19185
				Frequency 1851.5 MHz	Frequency 1880 MHz	Frequency 1908.5 MHz
2/3	QPSK	1	0	23.80	23.74	23.69
		1	7	23.93	23.73	23.76
		1	14	23.91	23.84	23.80
		8	0	22.66	22.54	22.48
		8	3	22.53	22.47	22.35
		8	7	22.49	22.38	22.38
		15	0	22.50	22.45	22.26
	16QAM	1	0	22.68	22.61	22.56
		1	7	22.62	22.57	22.48
		1	14	22.68	22.49	22.47
		8	0	21.64	21.56	21.50
		8	3	21.68	21.58	21.51
		8	7	21.59	21.57	21.49
		15	0	21.74	21.59	21.58
	64QAM	1	0	21.81	21.76	21.73
		1	7	21.82	21.79	21.62
		1	14	21.59	21.59	21.53
		8	0	20.80	20.68	20.56
		8	3	20.68	20.69	20.53
		8	7	20.72	20.62	20.52
		15	0	20.77	20.68	20.61



**BUREAU
VERITAS**

Test Report No.: W7L-P22090015-4RF05

Band/BW	Modulation	RB Size	RB Offset	Low CH 18625	Mid CH 18900	High CH 19175
				Frequency 1852.5 MHz	Frequency 1880 MHz	Frequency 1907.5 MHz
2 / 5	QPSK	1	0	23.80	23.80	23.65
		1	12	23.88	23.76	23.76
		1	24	23.90	23.85	23.76
		12	0	22.63	22.54	22.51
		12	6	22.53	22.46	22.34
		12	13	22.45	22.42	22.37
		25	0	22.52	22.42	22.23
	16QAM	1	0	22.67	22.65	22.56
		1	12	22.65	22.54	22.49
		1	24	22.68	22.49	22.48
		12	0	21.64	21.58	21.53
		12	6	21.71	21.54	21.55
		12	13	21.64	21.55	21.46
		25	0	21.74	21.58	21.61
	64QAM	1	0	21.87	21.79	21.67
		1	12	21.85	21.73	21.62
		1	24	21.66	21.54	21.53
		12	0	20.79	20.71	20.57
		12	6	20.74	20.62	20.54
		12	13	20.68	20.63	20.55
		25	0	20.81	20.62	20.63



**BUREAU
VERITAS**

Test Report No.: W7L-P22090015-4RF05

Band/BW	Modulation	RB Size	RB Offset	Low CH 18650	Mid CH 18900	High CH 19150
				Frequency 1855 MHz	Frequency 1880 MHz	Frequency 1905 MHz
2/ 10	QPSK	1	0	23.85	23.78	23.63
		1	24	23.91	23.78	23.72
		1	49	23.94	23.91	23.77
		25	0	22.64	22.54	22.52
		25	12	22.60	22.46	22.35
		25	25	22.45	22.36	22.37
		50	0	22.55	22.43	22.28
	16QAM	1	0	22.72	22.65	22.52
		1	24	22.66	22.54	22.51
		1	49	22.64	22.55	22.46
		25	0	21.70	21.54	21.57
		25	12	21.66	21.56	21.52
		25	25	21.63	21.56	21.49
		50	0	21.79	21.61	21.55
	64QAM	1	0	21.82	21.78	21.71
		1	24	21.88	21.74	21.63
		1	49	21.61	21.52	21.53
		25	0	20.83	20.71	20.56
		25	12	20.69	20.62	20.49
		25	25	20.74	20.66	20.56
		50	0	20.81	20.62	20.63



**BUREAU
VERITAS**

Test Report No.: W7L-P22090015-4RF05

Band/BW	Modulation	RB Size	RB Offset	Low CH 18675	Mid CH 18900	High CH 19125
				Frequency 1857.5 MHz	Frequency 1880 MHz	Frequency 1902.5 MHz
2/ 15	QPSK	1	0	23.78	23.78	23.66
		1	37	23.93	23.73	23.77
		1	74	23.88	23.88	23.76
		36	0	22.67	22.53	22.51
		36	19	22.59	22.41	22.35
		36	39	22.47	22.35	22.37
		75	0	22.55	22.45	22.23
	16QAM	1	0	22.68	22.58	22.52
		1	37	22.67	22.53	22.51
		1	74	22.68	22.50	22.44
		36	0	21.66	21.54	21.56
		36	19	21.72	21.52	21.56
		36	39	21.58	21.58	21.46
		75	0	21.78	21.58	21.62
	64QAM	1	0	21.82	21.76	21.74
		1	37	21.89	21.79	21.63
		1	74	21.59	21.53	21.53
		36	0	20.83	20.69	20.61
		36	19	20.73	20.69	20.49
		36	39	20.72	20.62	20.58
		75	0	20.82	20.64	20.62



BUREAU
VERITAS

Test Report No.: W7L-P22090015-4RF05

Band/BW	Modulation	RB Size	RB Offset	Low CH 18700	Mid CH 18900	High CH 19100
				Frequency 1860 MHz	Frequency 1880 MHz	Frequency 1900 MHz
2/ 20	QPSK	1	0	23.86	23.82	23.71
		1	50	23.95	23.81	23.78
		1	99	23.96	23.92	23.81
		50	0	22.70	22.59	22.53
		50	25	22.61	22.48	22.40
		50	50	22.53	22.43	22.39
		100	0	22.56	22.47	22.31
	16QAM	1	0	22.75	22.66	22.58
		1	50	22.70	22.59	22.53
		1	99	22.70	22.57	22.49
		50	0	21.72	21.62	21.58
		50	25	21.74	21.60	21.57
		50	50	21.66	21.62	21.51
		100	0	21.80	21.66	21.63
	64QAM	1	0	21.88	21.81	21.75
		1	50	21.90	21.81	21.68
		1	99	21.67	21.60	21.55
		50	0	20.84	20.73	20.64
		50	25	20.76	20.70	20.55
		50	50	20.76	20.67	20.60
		100	0	20.83	20.70	20.64



**BUREAU
VERITAS**

Test Report No.: W7L-P22090015-4RF05

EIRP POWER (dBm)

GSM

Channel	Frequency (MHz)	Conducted Power (dBm)	G _{T-Lc} (dB)	EIRP (dBm)	EIRP (mW)	Limit (W)
512	1850.2	29.53	0.9	30.43	1104.08	2
661	1880.0	29.47	0.9	30.37	1088.93	2
810	1909.8	29.75	0.9	30.65	1161.45	2

EDGE

Channel	Frequency (MHz)	Conducted Power (dBm)	G _{T-Lc} (dB)	EIRP (dBm)	EIRP (mW)	Limit (W)
512	1850.2	27.16	0.9	28.06	639.73	2
661	1880.0	27.11	0.9	28.01	632.41	2
810	1909.8	27.05	0.9	27.95	623.73	2

WCDMA

Channel	Frequency (MHz)	Conducted Power (dBm)	G _{T-Lc} (dB)	EIRP (dBm)	EIRP (mW)	Limit (W)
9262	1852.4	23.65	0.9	24.55	285.10	2
9400	1880	23.7	0.9	24.6	288.40	2
9538	1907.6	23.68	0.9	24.58	287.08	2



LTE BAND 2

CHANNEL BANDWIDTH: 1.4MHz QPSK

Channel	Frequency (MHz)	Conducted Power (dBm)	G _{T-Lc} (dB)	EIRP (dBm)	EIRP (mW)	Limit (W)
18607	1850.7	23.94	0.9	24.84	304.79	2
18900	1880.0	23.85	0.9	24.75	298.54	2
19193	1909.3	23.76	0.9	24.66	292.42	2

CHANNEL BANDWIDTH: 1.4MHz 16QAM

Channel	Frequency (MHz)	Conducted Power (dBm)	G _{T-Lc} (dB)	EIRP (dBm)	EIRP (mW)	Limit (W)
18607	1850.7	22.7	0.9	23.6	229.09	2
18900	1880.0	22.59	0.9	23.49	223.36	2
19193	1909.3	22.53	0.9	23.43	220.29	2

CHANNEL BANDWIDTH: 1.4MHz 64QAM

Channel	Frequency (MHz)	Conducted Power (dBm)	G _{T-Lc} (dB)	EIRP (dBm)	EIRP (mW)	Limit (W)
18607	1850.7	21.82	0.9	22.72	187.07	2
18900	1880.0	21.79	0.9	22.69	185.78	2
19193	1909.3	21.73	0.9	22.63	183.23	2



CHANNEL BANDWIDTH: 3MHz QPSK

Channel	Frequency (MHz)	Conducted Power (dBm)	G _{T-Lc} (dB)	EIRP (dBm)	EIRP (mW)	Limit (W)
18615	1851.5	23.93	0.9	24.83	304.09	2
18900	1880.0	23.84	0.9	24.74	297.85	2
19185	1908.5	23.8	0.9	24.7	295.12	2

CHANNEL BANDWIDTH: 3MHz 16QAM

Channel	Frequency (MHz)	Conducted Power (dBm)	G _{T-Lc} (dB)	EIRP (dBm)	EIRP (mW)	Limit (W)
18615	1851.5	22.68	0.9	23.58	228.03	2
18900	1880.0	22.61	0.9	23.51	224.39	2
19185	1908.5	22.56	0.9	23.46	221.82	2

CHANNEL BANDWIDTH: 3MHz 64QAM

Channel	Frequency (MHz)	Conducted Power (dBm)	G _{T-Lc} (dB)	EIRP (dBm)	EIRP (mW)	Limit (W)
18615	1851.5	21.82	0.9	22.72	187.07	2
18900	1880.0	21.79	0.9	22.69	185.78	2
19185	1908.5	21.73	0.9	22.63	183.23	2



CHANNEL BANDWIDTH: 5MHz QPSK

Channel	Frequency (MHz)	Conducted Power (dBm)	G _{T-Lc} (dB)	EIRP (dBm)	EIRP (mW)	Limit (W)
18625	1852.5	23.9	0.9	24.8	302.00	2
18900	1880.0	23.85	0.9	24.75	298.54	2
19175	1907.5	23.76	0.9	24.66	292.42	2

CHANNEL BANDWIDTH: 5MHz 16QAM

Channel	Frequency (MHz)	Conducted Power (dBm)	G _{T-Lc} (dB)	EIRP (dBm)	EIRP (mW)	Limit (W)
18625	1852.5	22.68	0.9	23.58	228.03	2
18900	1880.0	22.65	0.9	23.55	226.46	2
19175	1907.5	22.56	0.9	23.46	221.82	2

CHANNEL BANDWIDTH: 5MHz 64QAM

Channel	Frequency (MHz)	Conducted Power (dBm)	G _{T-Lc} (dB)	EIRP (dBm)	EIRP (mW)	Limit (W)
18625	1852.5	21.87	0.9	22.77	189.23	2
18900	1880.0	21.79	0.9	22.69	185.78	2
19175	1907.5	21.67	0.9	22.57	180.72	2



CHANNEL BANDWIDTH: 10MHz QPSK

Channel	Frequency (MHz)	Conducted Power (dBm)	G _{T-Lc} (dB)	EIRP (dBm)	EIRP (mW)	Limit (W)
18650	1855.0	23.94	0.9	24.84	304.79	2
18900	1880.0	23.91	0.9	24.81	302.69	2
19150	1905.0	23.77	0.9	24.67	293.09	2

CHANNEL BANDWIDTH: 10MHz 16QAM

Channel	Frequency (MHz)	Conducted Power (dBm)	G _{T-Lc} (dB)	EIRP (dBm)	EIRP (mW)	Limit (W)
18650	1855.0	22.72	0.9	23.62	230.14	2
18900	1880.0	22.65	0.9	23.55	226.46	2
19150	1905.0	22.52	0.9	23.42	219.79	2

CHANNEL BANDWIDTH: 10MHz 64QAM

Channel	Frequency (MHz)	Conducted Power (dBm)	G _{T-Lc} (dB)	EIRP (dBm)	EIRP (mW)	Limit (W)
18650	1855.0	21.88	0.9	22.78	189.67	2
18900	1880.0	21.78	0.9	22.68	185.35	2
19150	1905.0	21.71	0.9	22.61	182.39	2



CHANNEL BANDWIDTH: 15MHz QPSK

Channel	Frequency (MHz)	Conducted Power (dBm)	G _{T-Lc} (dB)	EIRP (dBm)	EIRP (mW)	Limit (W)
18675	1857.5	23.93	0.9	24.83	304.09	2
18900	1880.0	23.88	0.9	24.78	300.61	2
19125	1902.5	23.77	0.9	24.67	293.09	2

CHANNEL BANDWIDTH: 15MHz 16QAM

Channel	Frequency (MHz)	Conducted Power (dBm)	G _{T-Lc} (dB)	EIRP (dBm)	EIRP (mW)	Limit (W)
18675	1857.5	22.68	0.9	23.58	228.03	2
18900	1880.0	22.58	0.9	23.48	222.84	2
19125	1902.5	22.52	0.9	23.42	219.79	2

CHANNEL BANDWIDTH: 15MHz 64QAM

Channel	Frequency (MHz)	Conducted Power (dBm)	G _{T-Lc} (dB)	EIRP (dBm)	EIRP (mW)	Limit (W)
18675	1857.5	21.89	0.9	22.79	190.11	2
18900	1880.0	21.79	0.9	22.69	185.78	2
19125	1902.5	21.74	0.9	22.64	183.65	2



CHANNEL BANDWIDTH: 20MHz QPSK

Channel	Frequency (MHz)	Conducted Power (dBm)	G _{T-Lc} (dB)	EIRP (dBm)	EIRP (mW)	Limit (W)
18700	1860	23.96	0.9	24.86	306.20	2
18900	1880	23.92	0.9	24.82	303.39	2
19100	1900	23.81	0.9	24.71	295.80	2

CHANNEL BANDWIDTH: 20MHz 16QAM

Channel	Frequency (MHz)	Conducted Power (dBm)	G _{T-Lc} (dB)	EIRP (dBm)	EIRP (mW)	Limit (W)
18700	1860	22.75	0.9	23.65	231.74	2
18900	1880	22.66	0.9	23.56	226.99	2
19100	1900	22.58	0.9	23.48	222.84	2

CHANNEL BANDWIDTH: 20MHz 64QAM

Channel	Frequency (MHz)	Conducted Power (dBm)	G _{T-Lc} (dB)	EIRP (dBm)	EIRP (mW)	Limit (W)
18700	1860	21.9	0.9	22.8	190.55	2
18900	1880	21.81	0.9	22.71	186.64	2
19100	1900	21.75	0.9	22.65	184.08	2

REMARKS: ERP Output Power (dBm) = EIRP (dBm) -2.15(dB).



3.2 FREQUENCY STABILITY MEASUREMENT

3.2.1 LIMITS OF FREQUENCY STABILITY MEASUREMENT

The frequency stability shall be sufficient to ensure that the fundamental emission stays within the authorized frequency block.

3.2.2 TEST PROCEDURE

- Device is placed at the oven room. The oven room could control the temperatures and humidity. Power warm up is at least 15 min and power applied should perform before recording frequency error.
- EUT is connected the external power supply to control the DC input power. The test voltage range is from minimum to maximum working voltage. Each step shall be record the frequency error rate.
- The temperature range step is 10 degrees in this test items. All temperature levels shall be hold the $\pm 0.5^{\circ}\text{C}$ during the measurement testing. The each temperature step shall be at least 0.5 hours, consider the EUT could be test under the stability condition.

NOTE: The frequency error was recorded frequency error from the communication simulator.

3.2.3 TEST SETUP

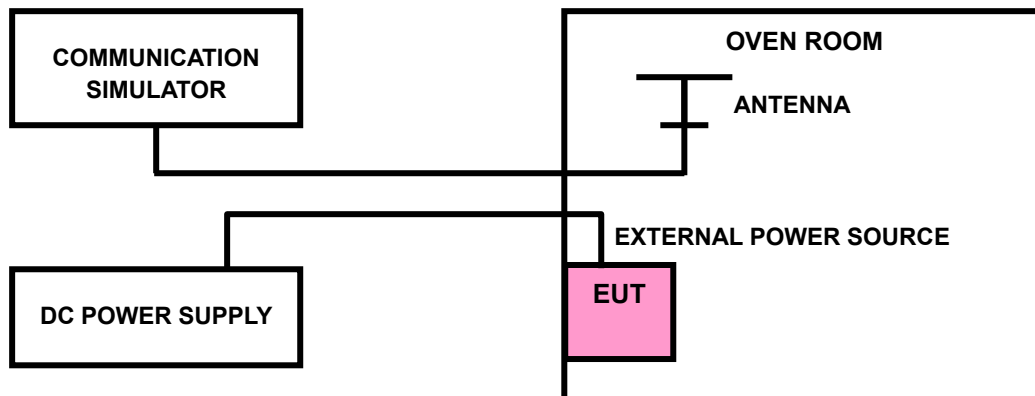



Test Report No.: W7L-P22090015-4RF05

3.2.4 TEST RESULTS

Please Refer to Appendix Of this test report.



3.3 OCCUPIED BANDWIDTH MEASUREMENT

3.3.1 TEST PROCEDURES

The EUT makes a call to the communication simulator. All measurements were done at low, middle and high operational frequency range. The communication simulator station system controlled a EUT to export maximum output power under transmission mode and specific channel frequency. Use OBW measurement function of Spectrum analyzer to measure 99 % occupied bandwidth.

3.3.2 TEST SETUP

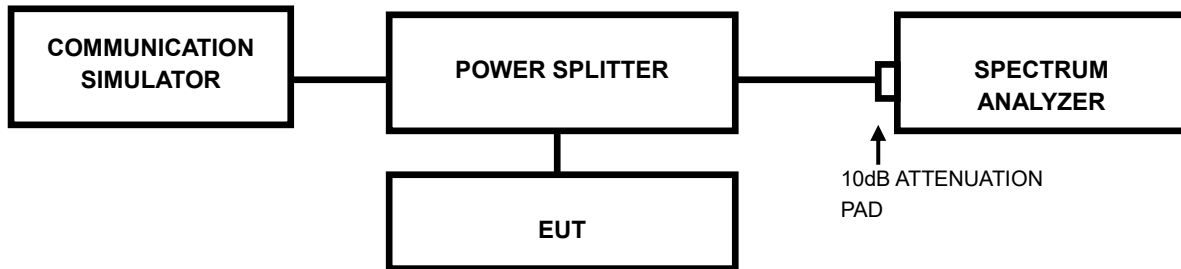

3.3.3 TEST PROCEDURES

- The conducted occupied bandwidth used the power splitter via EUT RF power connector between simulation base station and spectrum analyzer.
- Use OBW measurement function of Spectrum analyzer to measure 99 % occupied bandwidth.



Test Report No.: W7L-P22090015-4RF05

3.3.4 TEST RESULTS

Please Refer to Appendix Of this test report.



3.4 BAND EDGE MEASUREMENTC

3.4.1 LIMITS OF BAND EDGE MEASUREMENT

Power of any emission outside of the authorized operating frequency ranges must be attenuated below the transmitting power (P) by a factor of at least $43 + 10 \log(P)$ dB. In the 1 MHz bands immediately outside and adjacent to the frequency block a resolution bandwidth of at least one percent of the emission bandwidth of the fundamental emission of the transmitter may be employed.

3.4.2 TEST SETUP

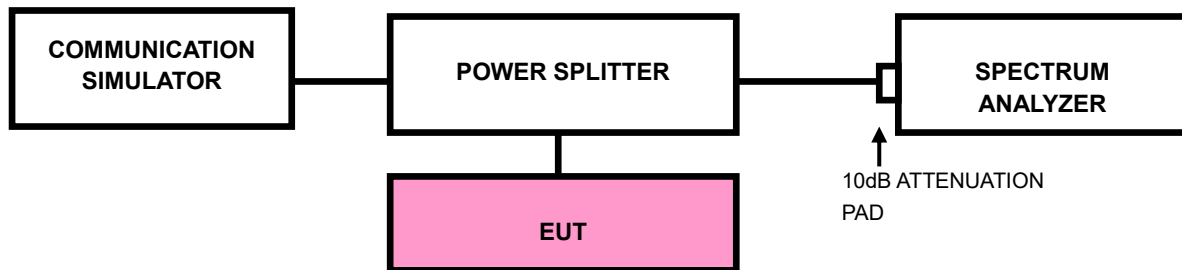



3.4.3 TEST PROCEDURES

- a. All measurements were done at low and high operational frequency range.
- b. The center frequency of spectrum is the band edge frequency and span is 1~5 MHz. RBW of the spectrum is 10kHz and VBW of the spectrum is 30kHz (GSM/GPRS/EDGE/LTE bandwidth for (1.4M/3M/5M/10M/15M/20M)1RB/0RB&1RB/MAXRB).
- c. The center frequency of spectrum is the band edge frequency and span is 10MHz. RBW of the spectrum is 100kHz and VBW of the spectrum is 300kHz (WCDMA).
- d. The center frequency of spectrum is the band edge frequency and span is 1~5 MHz. RBW of the spectrum is $\geq 1\% \cdot \text{EBW}$ kHz and VBW of the spectrum is $3 \cdot \text{RBW}$ kHz. (LTE bandwidth 1.4M/3M/5M/10M/15M/20MHz).
- e. Record the max trace plot into the test report.



Test Report No.: W7L-P22090015-4RF05

3.4.4. TEST RESULTS

Please Refer to Appendix Of this test report.



3.5 CONDUCTED SPURIOUS EMISSIONS

3.5.1 LIMITS OF CONDUCTED SPURIOUS EMISSIONS MEASUREMENT

The power of any emission outside of the authorized operating frequency ranges must be attenuated below the transmitting power (P) by a factor of at least $43 + 10 \log(P)$ dB. The emission limit equal to -13dBm .

3.5.2 TEST PROCEDURE

- The EUT makes a phone call to the communication simulator. All measurements were done at low, middle and high operational frequency range.
- Measuring frequency range is from 30 MHz to 19.1GHz. 10dB attenuation pad is connected with spectrum. RBW=1MHz and VBW=3MHz is used for conducted emission measurement.

3.5.3 TEST SETUP

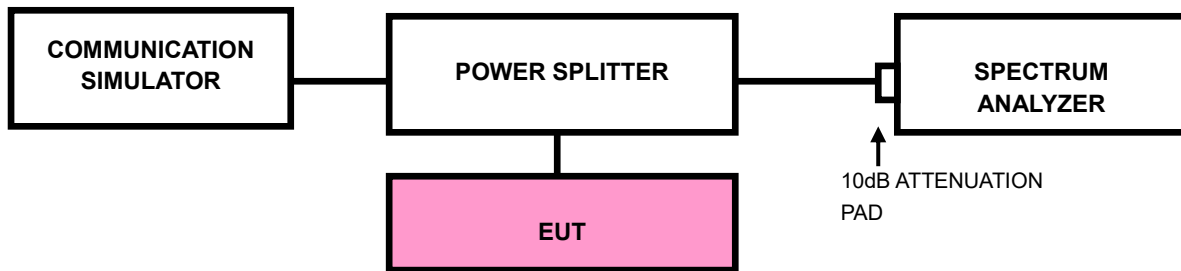



**BUREAU
VERITAS**

Test Report No.: W7L-P22090015-4RF05

3.5.4 TEST RESULTS

Please Refer to Appendix Of this test report.



3.6 RADIATED EMISSION MEASUREMENT

3.6.1 LIMITS OF RADIATED EMISSION MEASUREMENT

The power of any emission outside of the authorized operating frequency ranges must be attenuated below the transmitting power (P) by a factor of at least $43 + 10 \log(P)$ dB. The emission limit equal to -13dBm .

3.6.2 TEST PROCEDURES

- a. Substitution method is used for E.I.R.P measurement. In the semi-anechoic chamber, EUT placed on the 0.8m height of Turn Table, rotated the table around 360 degrees to search the maximum radiation power and receiver antenna shall be rotated vertical and horizontal polarization and moved height from 1m to 4m to find the maximum polar radiated power. The “Read Value” is the spectrum reading the maximum power value.
- b. The substitution horn antenna is substituted for EUT at the same position and signals generator export the CW signal to the substitution antenna via a TX cable. Rotated the Turn Table and moved receiving antenna to find the maximum radiation power. Adjust output power level of S.G to get a Value of spectrum reading equal to “Read Value “ of step a. Record the power level of S.G
- c. $\text{EIRP} = \text{Output power level of S.G} - \text{TX cable loss} + \text{Antenna gain of substitution horn}$.

NOTE: The resolution bandwidth and video bandwidth of test receiver/spectrum analyzer is 1MHz/3MHz.

3.6.3 DEVIATION FROM TEST STANDARD

No deviation



3.6.4 TEST SETUP

< Frequency Range below 30MHz >

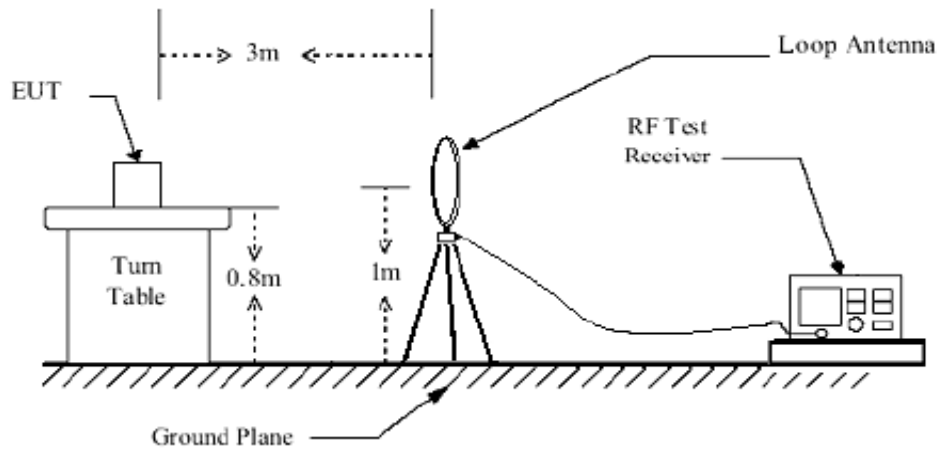

< Frequency Range 30MHz~1GHz >

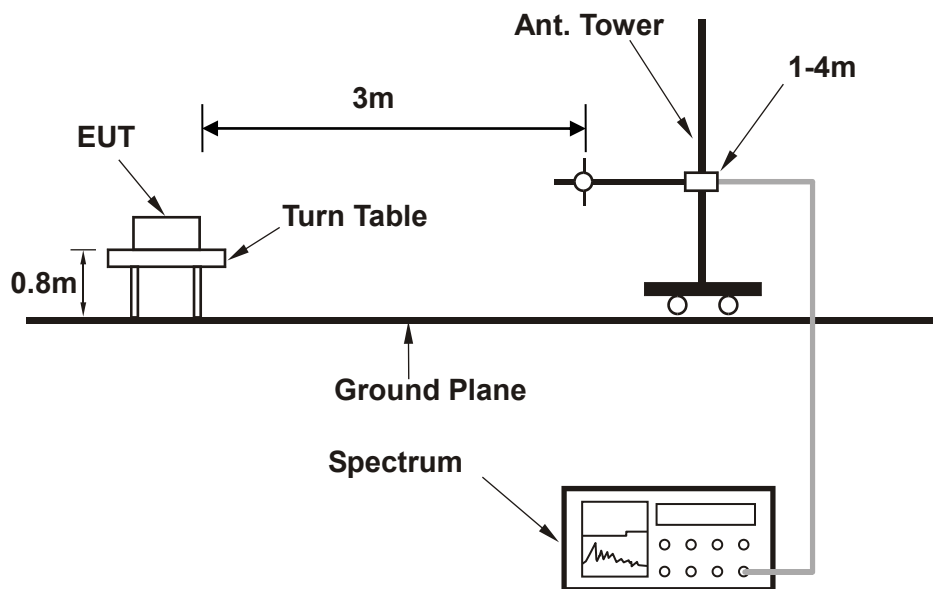



<Frequency Range above 1GHz>

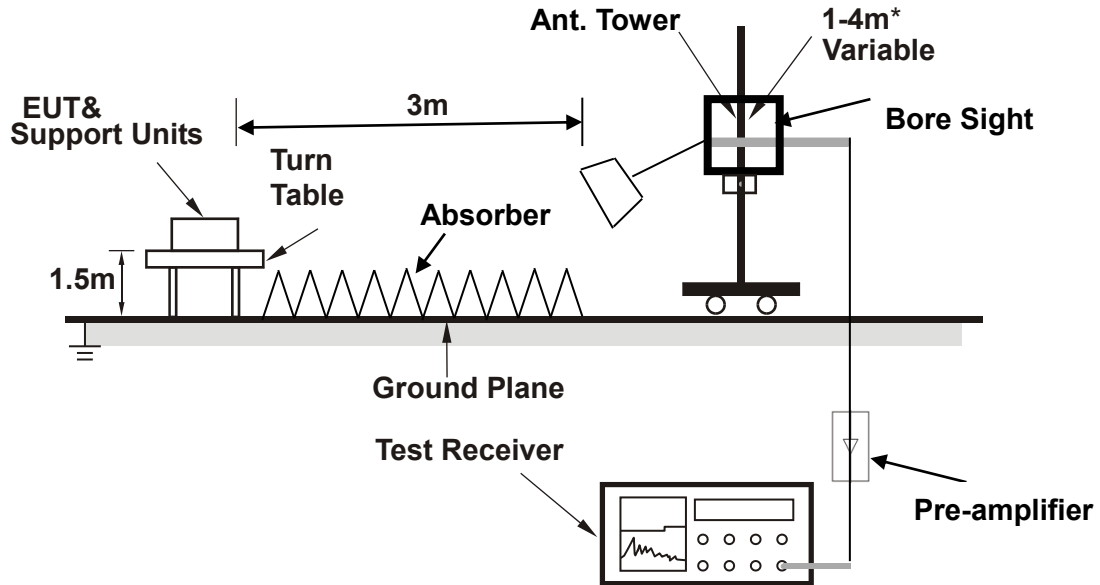

Note: Above 1G is a directional antenna

Depends on the EUT height and the antenna 3dB beamwidth both, refer to section 7.3 of CISPR 16-2-3.

For the actual test configuration, please refer to the attached file (Test Setup Photo).



3.6.5 TEST RESULTS

NOTE : The 9K~30MHz amplitude of spurious emissions attenuated more than 20 dB below the permissible value is not required in the report.

BELOW 1GHz WORST-CASE DATA

30 MHz – 1GHz data:

LTE Band 2

CHANNEL BANDWIDTH: 10MHz / QPSK

MODE	TX channel 18900	FREQUENCY RANGE	Below 1000MHz
ENVIRONMENTAL CONDITIONS	23deg. C, 70%RH	INPUT POWER	AC 120V/60Hz
TESTED BY	Jace Hu		
ANTENNA POLARITY & TEST DISTANCE: HORIZONTAL AT 3 M			

	Freq	Level	Read Level	Limit Line	Over Limit	Factor	Remark	Pol/Phase	
	MHz	dBm/m	dBm	dBm/m	dB	dB/m			
1	PP	56.190	-52.43	-34.35	-13.00	-39.43	-18.08	Peak	Horizontal
2		170.650	-61.28	-44.75	-13.00	-48.28	-16.53	Peak	Horizontal
3		201.690	-62.34	-45.12	-13.00	-49.34	-17.22	Peak	Horizontal
4		250.190	-62.83	-51.37	-13.00	-49.83	-11.46	Peak	Horizontal
5		312.270	-67.73	-55.57	-13.00	-54.73	-12.16	Peak	Horizontal
6		403.450	-68.54	-58.58	-13.00	-55.54	-9.96	Peak	Horizontal

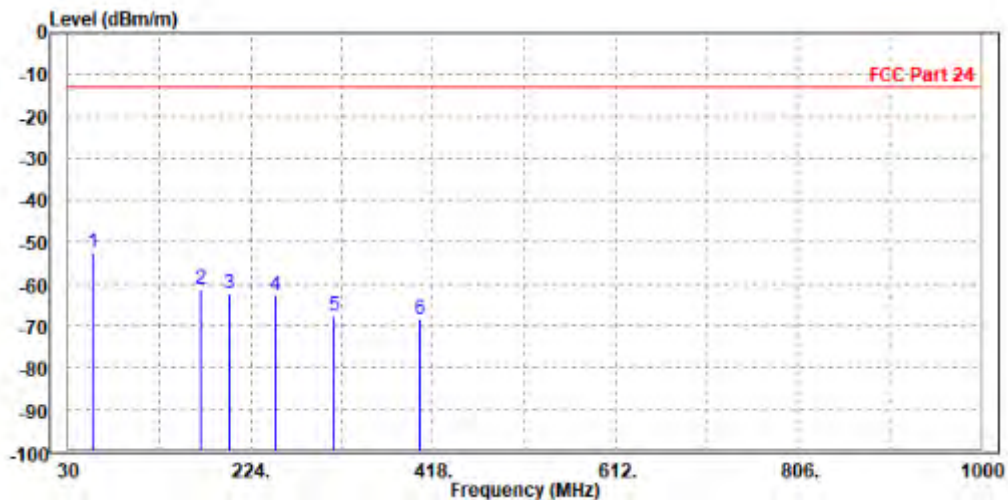



**BUREAU
VERITAS**

Test Report No.: W7L-P22090015-4RF05

MODE	TX channel 18900	FREQUENCY RANGE	Below 1000MHz
ENVIRONMENTAL CONDITIONS	23deg. C, 70%RH	INPUT POWER	AC 120V/60Hz
TESTED BY	Jace Hu		
ANTENNA POLARITY & TEST DISTANCE: VERTICAL AT 3 M			

	Freq	Level	Read Level	Limit	Over Limit	Factor	Remark	Pol/Phase
	MHz	dBm/m	dBm	dBm/m	dB	dB/m		
1 PP	55.220	-58.13	-33.80	-13.00	-45.13	-24.33	Peak	Vertical
2	99.840	-58.27	-51.76	-13.00	-45.27	-6.51	Peak	Vertical
3	175.500	-66.08	-47.82	-13.00	-53.08	-18.26	Peak	Vertical
4	209.450	-68.12	-50.93	-13.00	-55.12	-17.19	Peak	Vertical
5	311.300	-62.94	-52.33	-13.00	-49.94	-10.61	Peak	Vertical
6	377.260	-68.39	-58.98	-13.00	-55.39	-9.41	Peak	Vertical

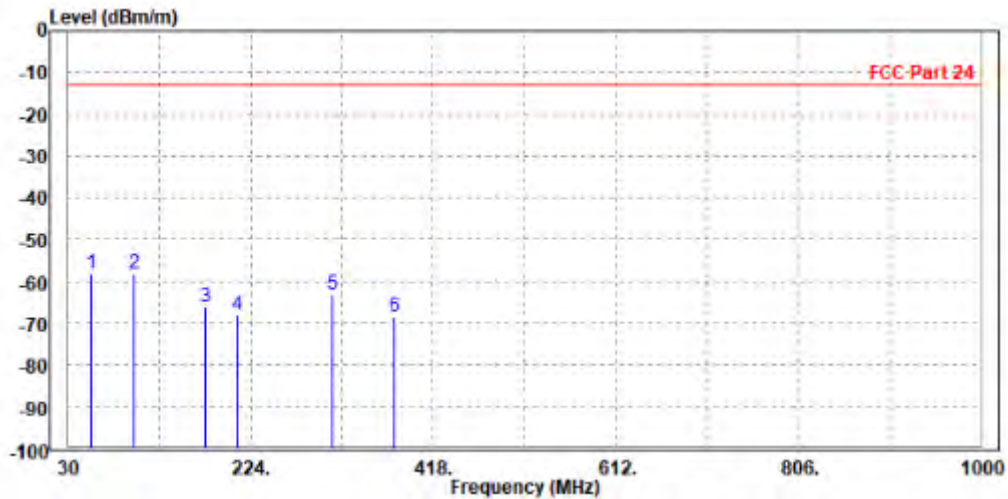



**BUREAU
VERITAS**

Test Report No.: W7L-P22090015-4RF05

ABOVE 1GHz DATA

Note: For higher frequency, the emission is too low to be detected.

WORST-CASE DATA

GSM 1900

CH 512

MODE	TX channel 512	FREQUENCY RANGE	Above 1000MHz
ENVIRONMENTAL CONDITIONS	23deg. C, 70%RH	INPUT POWER	AC 120V/60Hz
TESTED BY	Jace Hu		
ANTENNA POLARITY & TEST DISTANCE: HORIZONTAL AT 3 M			

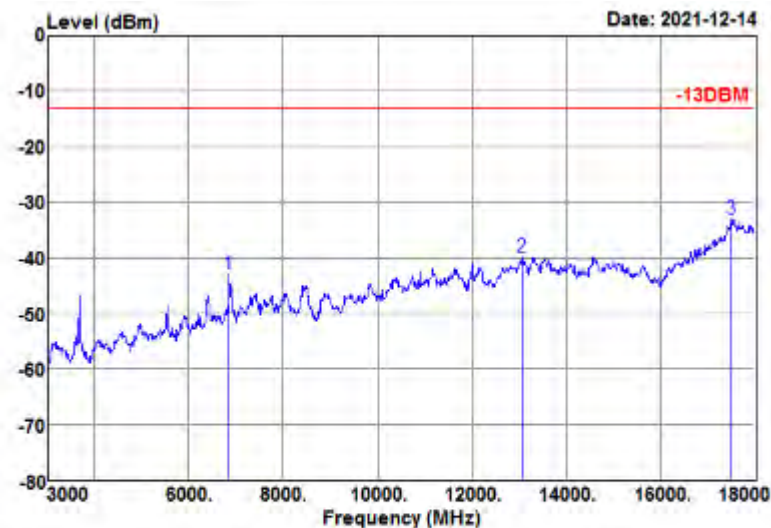
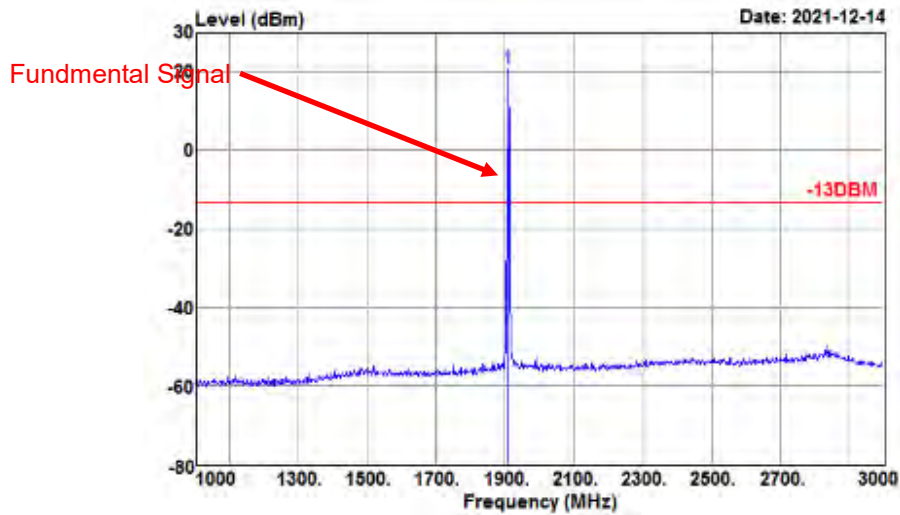

Freq MHz	Reading level dBm	Aux factor dB	level dBm	Limit level dBm	Over limit dB	Remark
6855.000	-60.95	17.91	-43.04	-13.00	-30.04	Peak
13050.000	-68.43	28.66	-39.77	-13.00	-26.77	Peak
17505.000	-68.86	35.81	-33.05	-13.00	-20.05	Peak



BUREAU
VERITAS

Test Report No.: W7L-P22090015-4RF05

MODE	TX channel 512	FREQUENCY RANGE	Above 1000MHz
ENVIRONMENTAL CONDITIONS	23deg. C, 70%RH	INPUT POWER	AC 120V/60Hz
TESTED BY	Jace Hu		
ANTENNA POLARITY & TEST DISTANCE: VERTICAL AT 3 M			

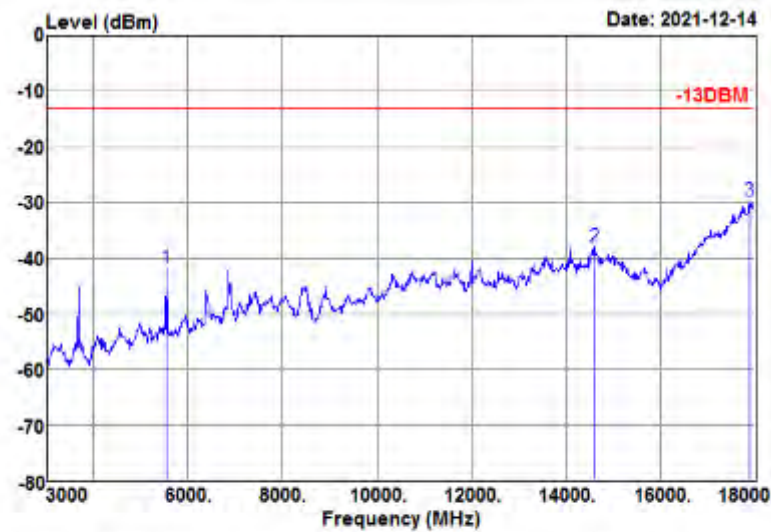
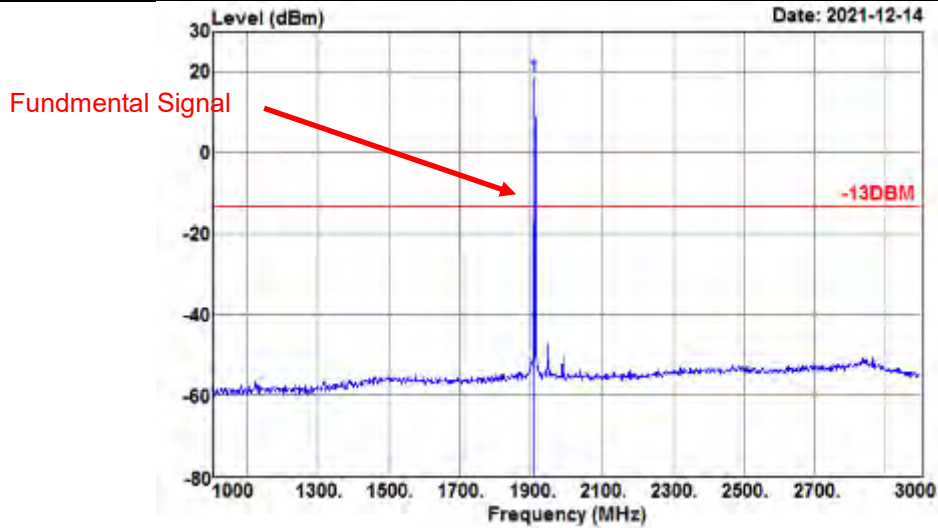

Freq MHz	Reading level dBm	Aux factor dB	level dBm	Limit level dBm	Over limit dB	Remark
5550.000	-55.10	13.23	-41.87	-13.00	-28.87	Peak
14610.000	-66.39	28.30	-38.09	-13.00	-25.09	Peak
17895.000	-69.35	39.55	-29.80	-13.00	-16.80	Peak



**BUREAU
VERITAS**

Test Report No.: W7L-P22090015-4RF05

CH 661

MODE	TX channel 661	FREQUENCY RANGE	Above 1000MHz
ENVIRONMENTAL CONDITIONS	23deg. C, 70%RH	INPUT POWER	AC 120V/60Hz
TESTED BY	Jace Hu		
ANTENNA POLARITY & TEST DISTANCE: HORIZONTAL AT 3 M			

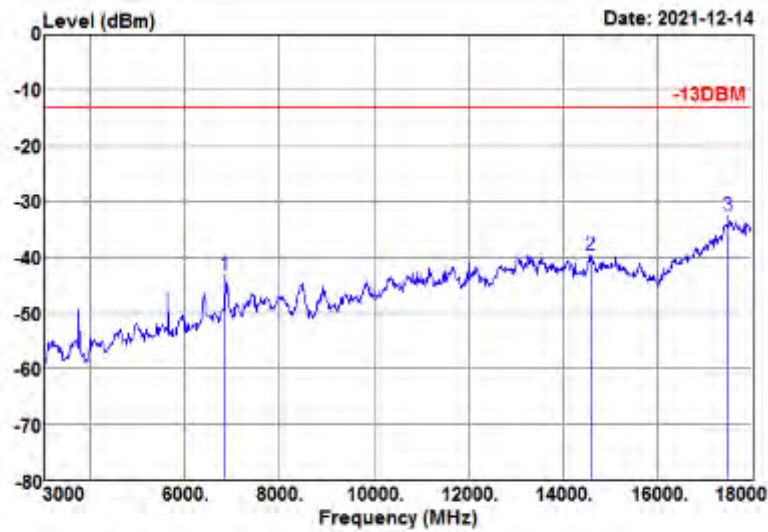

Freq MHz	Reading level dBm	Aux factor dB	level dBm	Limit level dBm	Over limit dB	Remark
6855.000	-61.14	17.91	-43.23	-13.00	-30.23	Peak
14580.000	-66.21	26.50	-39.71	-13.00	-26.71	Peak
17505.000	-68.45	35.81	-32.64	-13.00	-19.64	Peak



**BUREAU
VERITAS**

Test Report No.: W7L-P22090015-4RF05

MODE	TX channel 661	FREQUENCY RANGE	Above 1000MHz
ENVIRONMENTAL CONDITIONS	23deg. C, 70%RH	INPUT POWER	AC 120V/60Hz
TESTED BY	Jace Hu		
ANTENNA POLARITY & TEST DISTANCE: VERTICAL AT 3 M			

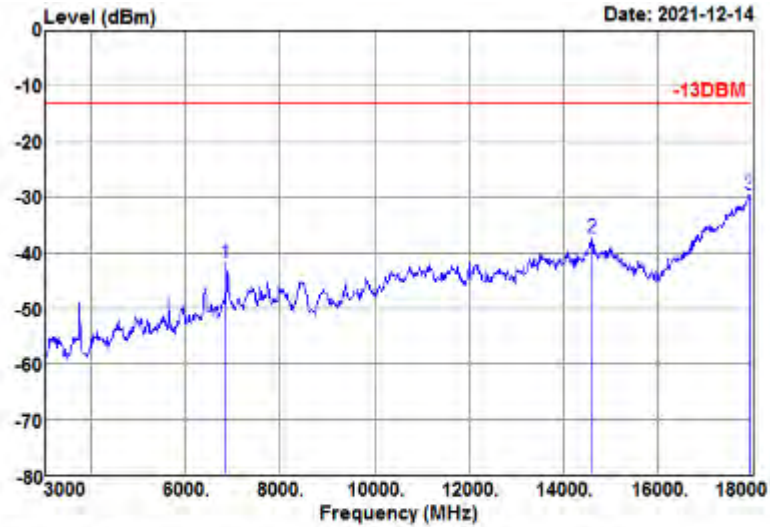

Freq MHz	Reading level dBm	Aux factor dB	level dBm	Limit level dBm	Over limit dB	Remark
6855.000	-60.11	18.25	-41.86	-13.00	-28.86	Peak
14610.000	-65.65	28.30	-37.35	-13.00	-24.35	Peak
17955.000	-69.53	40.04	-29.49	-13.00	-16.49	Peak



**BUREAU
VERITAS**

Test Report No.: W7L-P22090015-4RF05

CH 810

MODE	TX channel 810	FREQUENCY RANGE	Above 1000MHz
ENVIRONMENTAL CONDITIONS	23deg. C, 70%RH	INPUT POWER	AC 120V/60Hz
TESTED BY	Jace Hu		
ANTENNA POLARITY & TEST DISTANCE: HORIZONTAL AT 3 M			

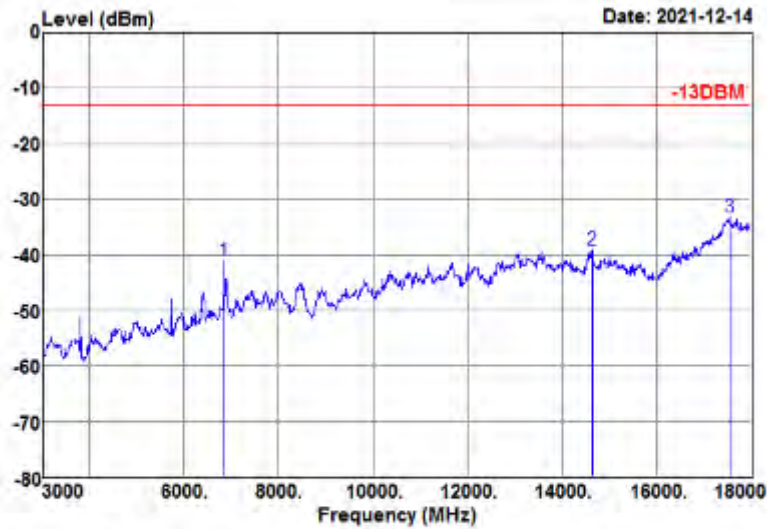

Freq MHz	Reading level dBm	Aux factor dB	level dBm	Limit level dBm	Over limit dB	Remark
6855.000	-58.97	17.91	-41.06	-13.00	-28.06	Peak
14640.000	-65.82	26.63	-39.19	-13.00	-26.19	Peak
17550.000	-69.03	35.75	-33.28	-13.00	-20.28	Peak



**BUREAU
VERITAS**

Test Report No.: W7L-P22090015-4RF05

MODE	TX channel 810	FREQUENCY RANGE	Above 1000MHz
ENVIRONMENTAL CONDITIONS	23deg. C, 70%RH	INPUT POWER	AC 120V/60Hz
TESTED BY	Jace Hu		
ANTENNA POLARITY & TEST DISTANCE: VERTICAL AT 3 M			

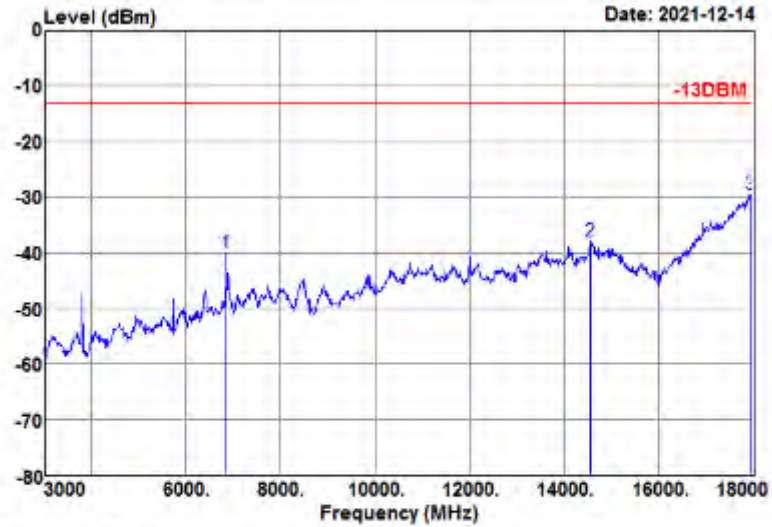

Freq MHz	Reading level dBm	Aux factor dB	level dBm	Limit level dBm	Over limit dB	Remark
6855.000	-58.33	18.25	-40.08	-13.00	-27.08	Peak
14565.000	-66.18	28.24	-37.94	-13.00	-24.94	Peak
17955.000	-69.45	40.04	-29.41	-13.00	-16.41	Peak



**BUREAU
VERITAS**

Test Report No.: W7L-P22090015-4RF05

EDGE 1900

CH 512

MODE	TX channel 512	FREQUENCY RANGE	Above 1000MHz
ENVIRONMENTAL CONDITIONS	23deg. C, 70%RH	INPUT POWER	AC 120V/60Hz
TESTED BY	Jace Hu		
ANTENNA POLARITY & TEST DISTANCE: HORIZONTAL AT 3 M			

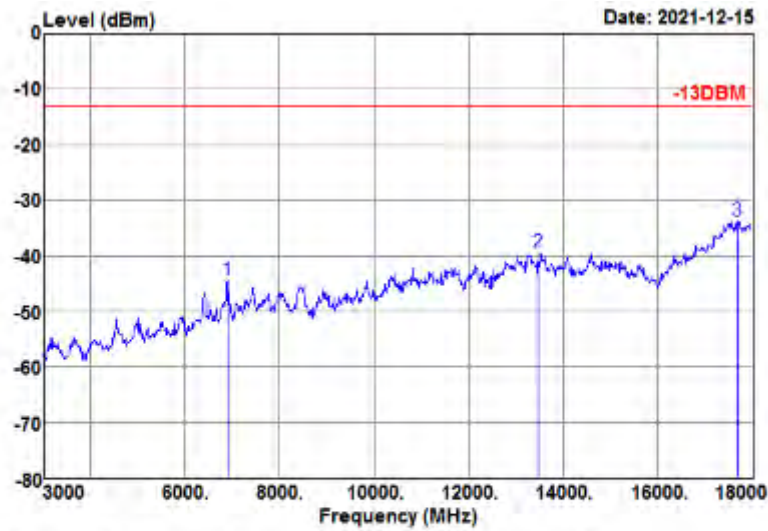

Freq MHz	Reading level dBm	Aux factor dB	level dBm	Limit level dBm	Over limit dB	Remark
6900.000	-62.44	18.08	-44.36	-13.00	-31.36	Peak
13470.000	-67.84	28.47	-39.37	-13.00	-26.37	Peak
17700.000	-69.17	35.53	-33.64	-13.00	-20.64	Peak



**BUREAU
VERITAS**

Test Report No.: W7L-P22090015-4RF05

MODE	TX channel 512	FREQUENCY RANGE	Above 1000MHz
ENVIRONMENTAL CONDITIONS	23deg. C, 70%RH	INPUT POWER	AC 120V/60Hz
TESTED BY	Jace Hu		
ANTENNA POLARITY & TEST DISTANCE: VERTICAL AT 3 M			

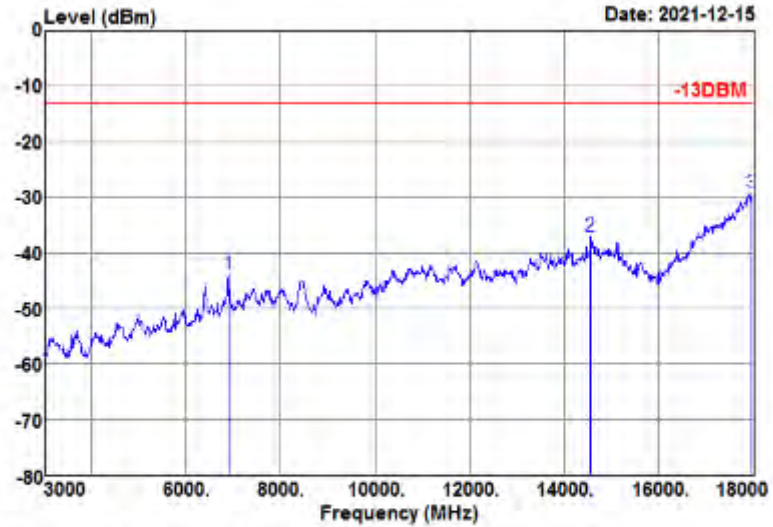

Freq MHz	Reading level dBm	Aux factor dB	level dBm	Limit level dBm	Over limit dB	Remark
6900.000	-62.38	18.41	-43.97	-13.00	-30.97	Peak
14565.000	-65.16	28.24	-36.92	-13.00	-23.92	Peak
17970.000	-69.47	40.16	-29.31	-13.00	-16.31	Peak



**BUREAU
VERITAS**

Test Report No.: W7L-P22090015-4RF05

CH 661

MODE	TX channel 661	FREQUENCY RANGE	Above 1000MHz
ENVIRONMENTAL CONDITIONS	23deg. C, 70%RH	INPUT POWER	AC 120V/60Hz
TESTED BY	Jace Hu		
ANTENNA POLARITY & TEST DISTANCE: HORIZONTAL AT 3 M			

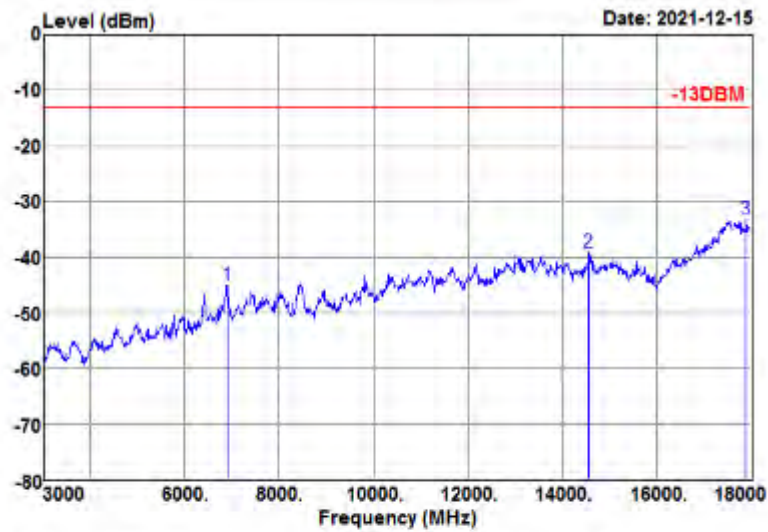

Freq MHz	Reading level dBm	Aux factor dB	level dBm	Limit level dBm	Over limit dB	Remark
6900.000	-63.06	18.08	-44.98	-13.00	-31.98	Peak
14565.000	-65.55	26.46	-39.09	-13.00	-26.09	Peak
17895.000	-68.55	35.25	-33.30	-13.00	-20.30	Peak



**BUREAU
VERITAS**

Test Report No.: W7L-P22090015-4RF05

MODE	TX channel 661	FREQUENCY RANGE	Above 1000MHz
ENVIRONMENTAL CONDITIONS	23deg. C, 70%RH	INPUT POWER	AC 120V/60Hz
TESTED BY	Jace Hu		
ANTENNA POLARITY & TEST DISTANCE: VERTICAL AT 3 M			

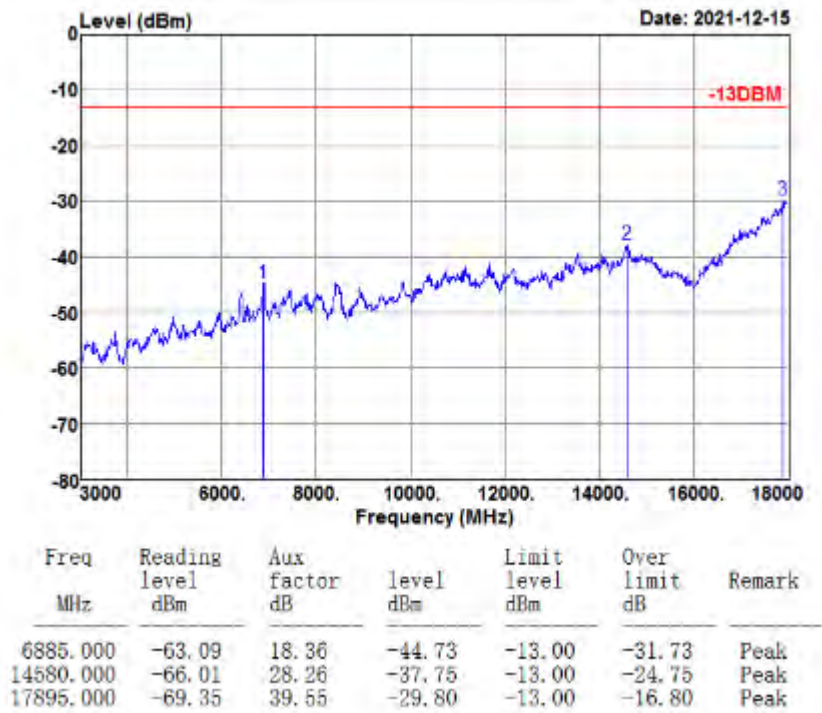



**BUREAU
VERITAS**

Test Report No.: W7L-P22090015-4RF05

CH 810

MODE	TX channel 810	FREQUENCY RANGE	Above 1000MHz
ENVIRONMENTAL CONDITIONS	23deg. C, 70%RH	INPUT POWER	AC 120V/60Hz
TESTED BY	Jace Hu		
ANTENNA POLARITY & TEST DISTANCE: HORIZONTAL AT 3 M			

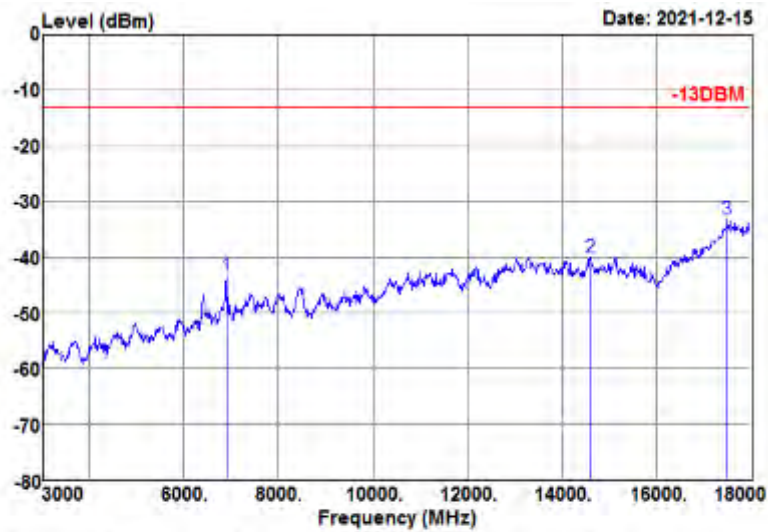

Freq MHz	Reading level dBm	Aux factor dB	level dBm	Limit level dBm	Over limit dB	Remark
6900.000	-61.39	18.08	-43.31	-13.00	-30.31	Peak
14610.000	-66.58	26.56	-40.02	-13.00	-27.02	Peak
17505.000	-69.16	35.81	-33.35	-13.00	-20.35	Peak



**BUREAU
VERITAS**

Test Report No.: W7L-P22090015-4RF05

MODE	TX channel 810	FREQUENCY RANGE	Above 1000MHz
ENVIRONMENTAL CONDITIONS	23deg. C, 70%RH	INPUT POWER	AC 120V/60Hz
TESTED BY	Jace Hu		
ANTENNA POLARITY & TEST DISTANCE: VERTICAL AT 3 M			

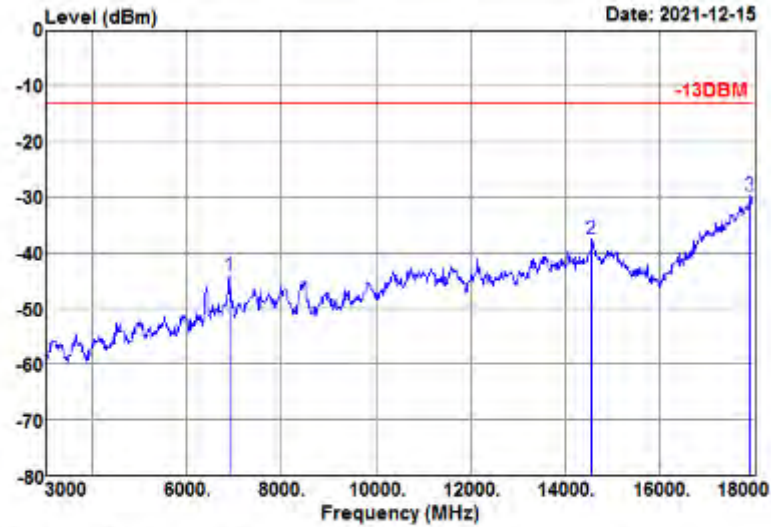

Freq MHz	Reading level dBm	Aux factor dB	level dBm	Limit level dBm	Over limit dB	Remark
6900.000	-62.42	18.41	-44.01	-13.00	-31.01	Peak
14565.000	-65.80	28.24	-37.56	-13.00	-24.56	Peak
17925.000	-69.50	39.79	-29.71	-13.00	-16.71	Peak



**BUREAU
VERITAS**

Test Report No.: W7L-P22090015-4RF05

WCDMA Band II

CH 9262

MODE	TX channel 9262	FREQUENCY RANGE	Above 1000MHz
ENVIRONMENTAL CONDITIONS	23deg. C, 70%RH	INPUT POWER	AC 120V/60Hz
TESTED BY	Jace Hu		
ANTENNA POLARITY & TEST DISTANCE: HORIZONTAL AT 3 M			

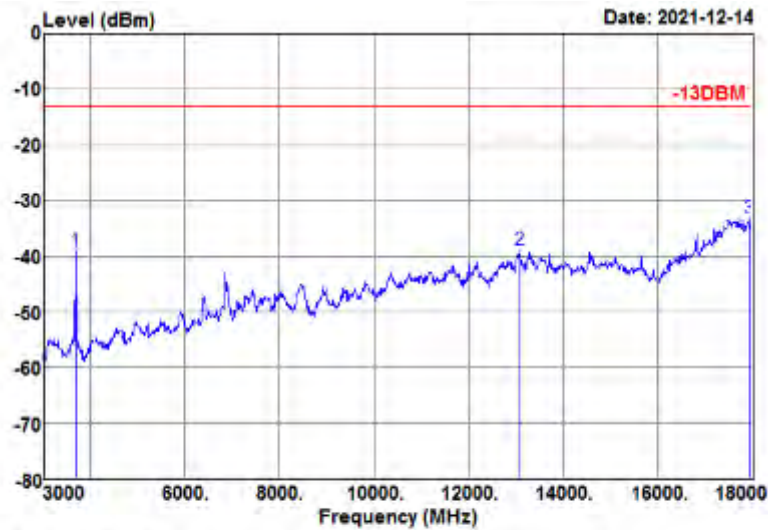
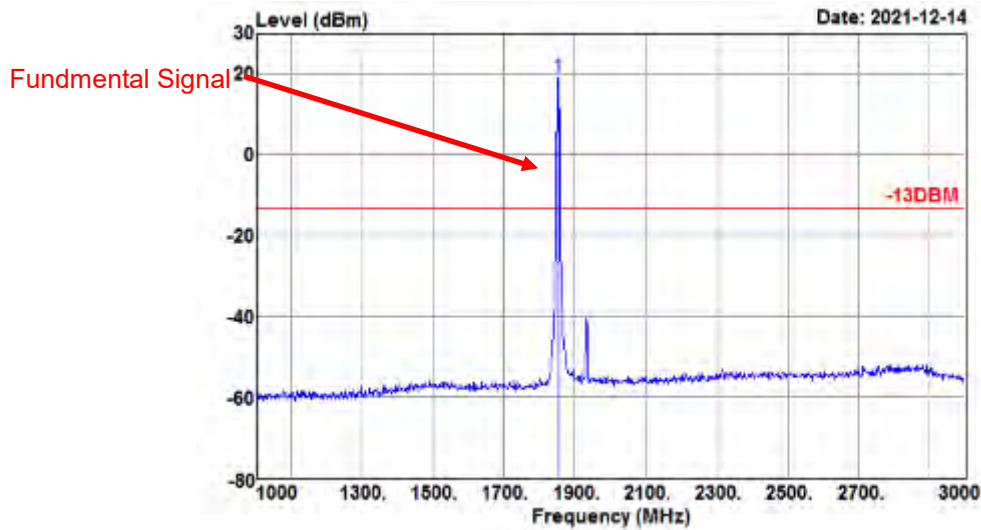

Freq MHz	Reading level dBm	Aux factor dB	level dBm	Limit level dBm	Over limit dB	Remark
3705.000	-47.91	8.63	-39.28	-13.00	-26.28	Peak
13080.000	-67.68	28.64	-39.04	-13.00	-26.04	Peak
17955.000	-68.48	35.16	-33.32	-13.00	-20.32	Peak



**BUREAU
VERITAS**

Test Report No.: W7L-P22090015-4RF05

MODE	TX channel 9262	FREQUENCY RANGE	Above 1000MHz
ENVIRONMENTAL CONDITIONS	23deg. C, 70%RH	INPUT POWER	AC 120V/60Hz
TESTED BY	Jace Hu		
ANTENNA POLARITY & TEST DISTANCE: VERTICAL AT 3 M			

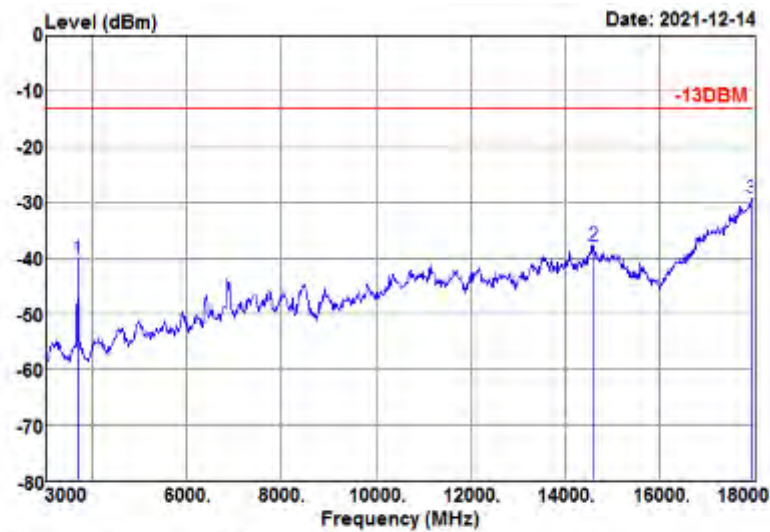
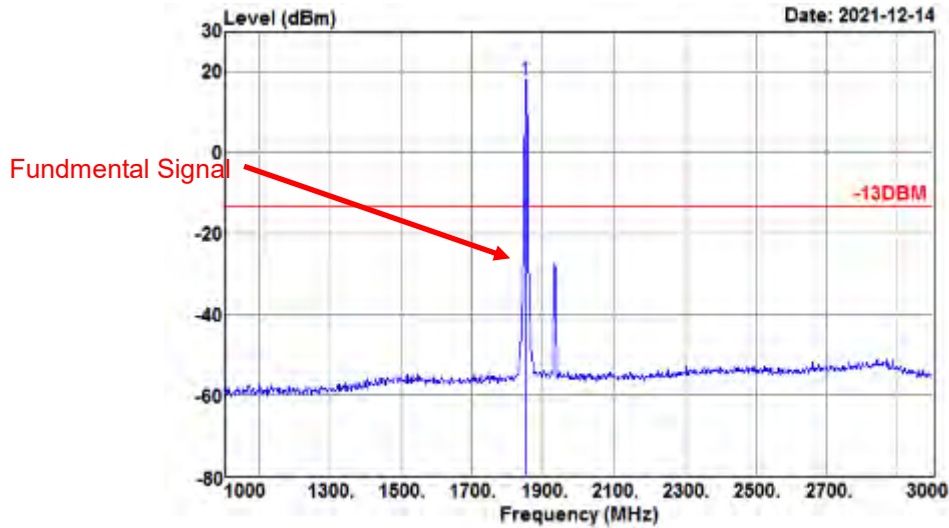

Freq MHz	Reading level dBm	Aux factor dB	level dBm	Limit level dBm	Over limit dB	Remark
3705.000	-48.72	8.64	-40.08	-13.00	-27.08	Peak
14610.000	-65.96	28.30	-37.66	-13.00	-24.66	Peak
17955.000	-69.22	40.04	-29.18	-13.00	-16.18	Peak



**BUREAU
VERITAS**

Test Report No.: W7L-P22090015-4RF05

CH 9400

MODE	TX channel 9400	FREQUENCY RANGE	Above 1000MHz
ENVIRONMENTAL CONDITIONS	23deg. C, 70%RH	INPUT POWER	AC 120V/60Hz
TESTED BY	Jace Hu		
ANTENNA POLARITY & TEST DISTANCE: HORIZONTAL AT 3 M			

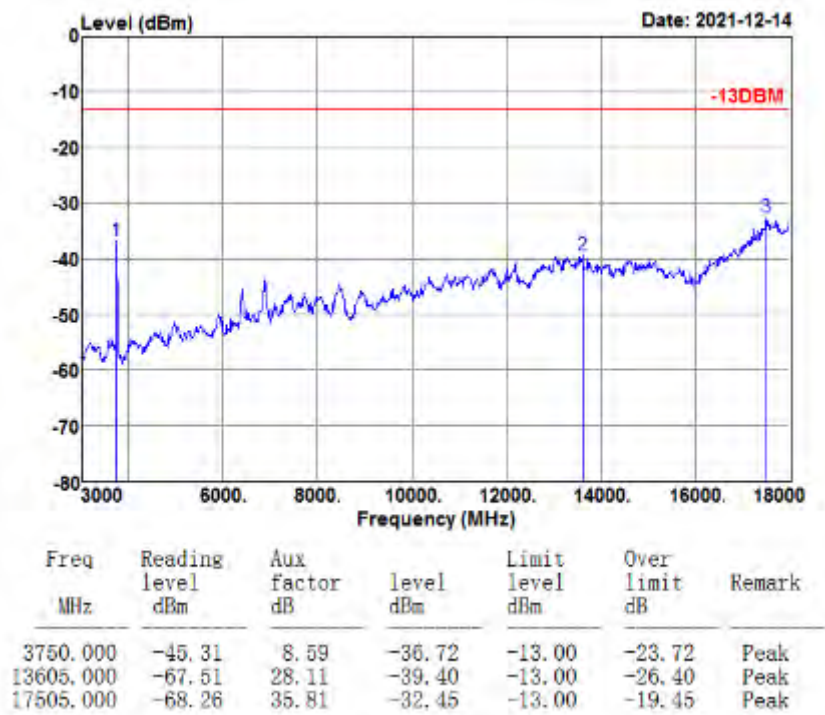



**BUREAU
VERITAS**

Test Report No.: W7L-P22090015-4RF05

MODE	TX channel 9400	FREQUENCY RANGE	Above 1000MHz
ENVIRONMENTAL CONDITIONS	23deg. C, 70%RH	INPUT POWER	AC 120V/60Hz
TESTED BY	Jace Hu		
ANTENNA POLARITY & TEST DISTANCE: VERTICAL AT 3 M			

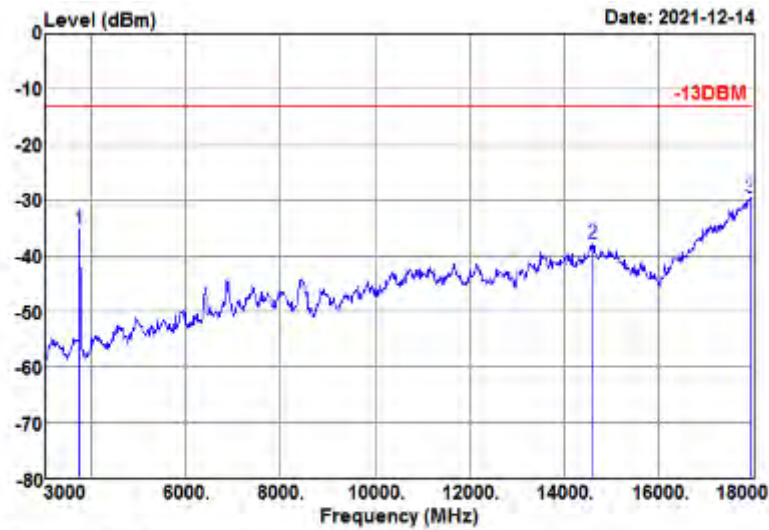

Freq MHz	Reading level dBm	Aux factor dB	level dBm	Limit level dBm	Over limit dB	Remark
3750.000	-43.74	8.66	-35.08	-13.00	-22.08	Peak
14625.000	-65.98	28.32	-37.66	-13.00	-24.66	Peak
17955.000	-69.57	40.04	-29.53	-13.00	-16.53	Peak



**BUREAU
VERITAS**

Test Report No.: W7L-P22090015-4RF05

CH 9538

MODE	TX channel 9538	FREQUENCY RANGE	Above 1000MHz
ENVIRONMENTAL CONDITIONS	23deg. C, 70%RH	INPUT POWER	AC 120V/60Hz
TESTED BY	Jace Hu		
ANTENNA POLARITY & TEST DISTANCE: HORIZONTAL AT 3 M			

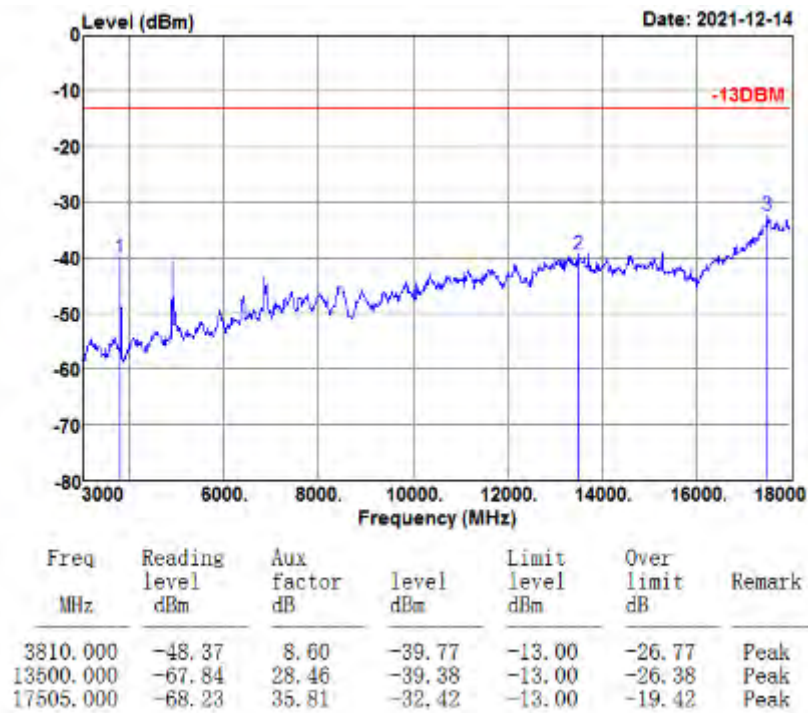



**BUREAU
VERITAS**

Test Report No.: W7L-P22090015-4RF05

MODE	TX channel 9538	FREQUENCY RANGE	Above 1000MHz
ENVIRONMENTAL CONDITIONS	23deg. C, 70%RH	INPUT POWER	AC 120V/60Hz
TESTED BY	Jace Hu		
ANTENNA POLARITY & TEST DISTANCE: VERTICAL AT 3 M			

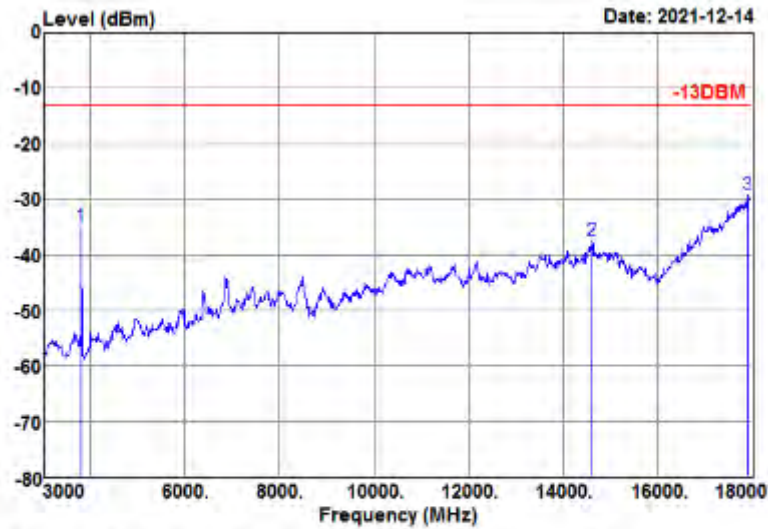

Freq MHz	Reading level dBm	Aux factor dB	level dBm	Limit level dBm	Over limit dB	Remark
3810.000	-43.50	8.70	-34.80	-13.00	-21.80	Peak
14625.000	-65.93	28.32	-37.61	-13.00	-24.61	Peak
17925.000	-69.14	39.79	-29.35	-13.00	-16.35	Peak



LTE Band 2

CHANNEL BANDWIDTH: 1.4MHz / QPSK

MODE	TX channel 18900	FREQUENCY RANGE	Above 1000MHz
ENVIRONMENTAL CONDITIONS	23deg. C, 70%RH	INPUT POWER	AC 120V/60Hz
TESTED BY	Jace Hu		
ANTENNA POLARITY & TEST DISTANCE: HORIZONTAL AT 3 M			

	Freq	Level	Read Level	Limit Line	Over Limit	Factor	Remark	Pol/Phase
	MHz	dBm/m	dBm	dBm/m	dB	dB/m		
1	PP 3760.000	-31.72	-39.71	-13.00	-18.72	7.99	Peak	Horizontal
2	5636.000	-43.17	-53.90	-13.00	-30.17	10.73	Peak	Horizontal

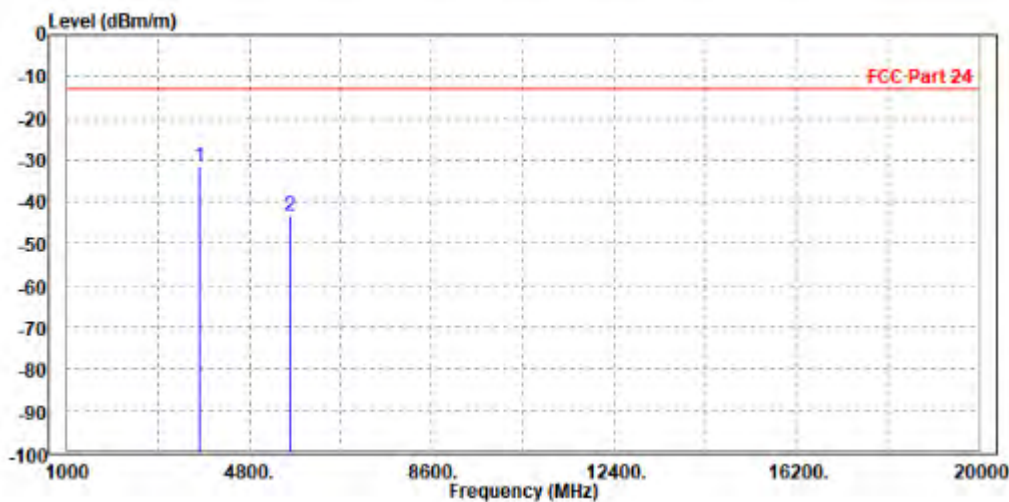



**BUREAU
VERITAS**

Test Report No.: W7L-P22090015-4RF05

MODE	TX channel 18900	FREQUENCY RANGE	Above 1000MHz
ENVIRONMENTAL CONDITIONS	23deg. C, 70%RH	INPUT POWER	AC 120V/60Hz
TESTED BY	Jace Hu		
ANTENNA POLARITY & TEST DISTANCE: VERTICAL AT 3 M			

	Freq	Level	Read Level	Limit Line	Over Limit	Factor	Remark	Pol/Phase
	MHz	dBm/m	dBm	dBm/m	dB	dB/m		
1	PP 3755.000	-32.63	-40.32	-13.00	-19.63	7.69	Peak	Vertical
2	5640.000	-48.55	-59.68	-13.00	-35.55	11.13	Peak	Vertical

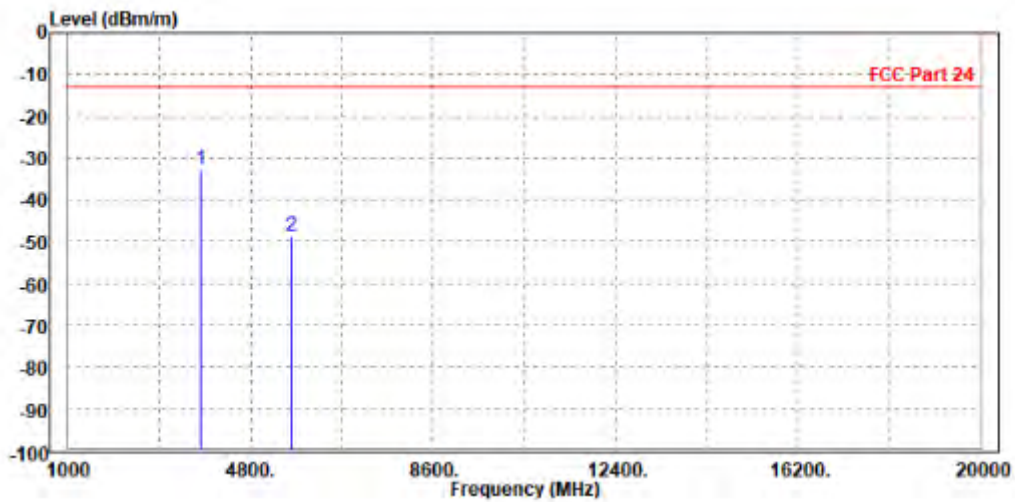



**BUREAU
VERITAS**

Test Report No.: W7L-P22090015-4RF05

CHANNEL BANDWIDTH: 3MHz / QPSK

MODE	TX channel 18900	FREQUENCY RANGE	Above 1000MHz
ENVIRONMENTAL CONDITIONS	23deg. C, 70%RH	INPUT POWER	AC 120V/60Hz
TESTED BY	Jace Hu		
ANTENNA POLARITY & TEST DISTANCE: HORIZONTAL AT 3 M			

	Freq	Level	Read Level	Limit Line	Over Limit	Factor	Remark	Pol/Phase
	MHz	dBm/m	dBm	dBm/m	dB	dB/m		
1	PP 3755.000	-34.02	-42.00	-13.00	-21.02	7.98	Peak	Horizontal
2	5640.000	-48.55	-59.29	-13.00	-35.55	10.74	Peak	Horizontal

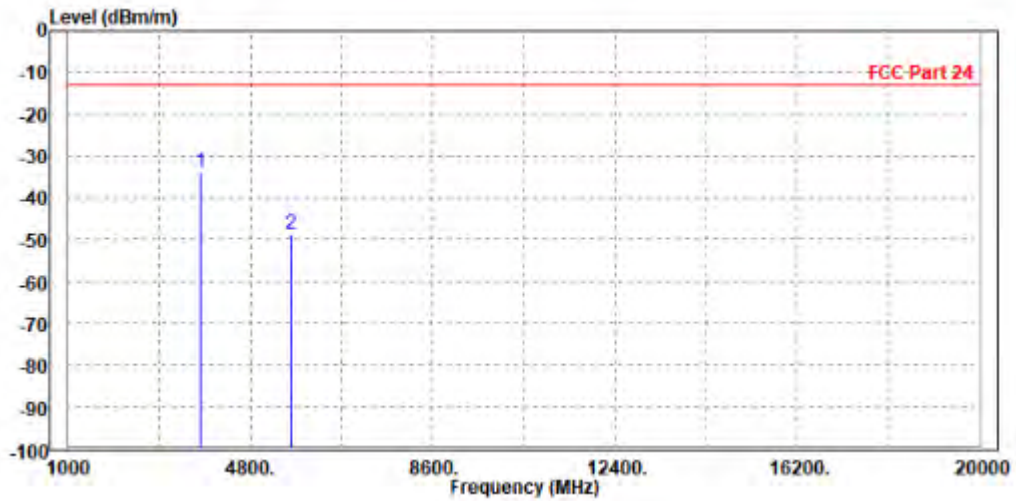



**BUREAU
VERITAS**

Test Report No.: W7L-P22090015-4RF05

MODE	TX channel 18900	FREQUENCY RANGE	Above 1000MHz
ENVIRONMENTAL CONDITIONS	23deg. C, 70%RH	INPUT POWER	AC 120V/60Hz
TESTED BY	Jace Hu		
ANTENNA POLARITY & TEST DISTANCE: VERTICAL AT 3 M			

	Freq	Level	Read Level	Limit Line	Over Limit	Factor	Remark	Pol/Phase
	MHz	dBm/m	dBm	dBm/m	dB	dB/m		
1	PP 3760.000	-32.97	-40.67	-13.00	-19.97	7.70	Peak	Vertical
2	5636.000	-50.50	-61.62	-13.00	-37.50	11.12	Peak	Vertical

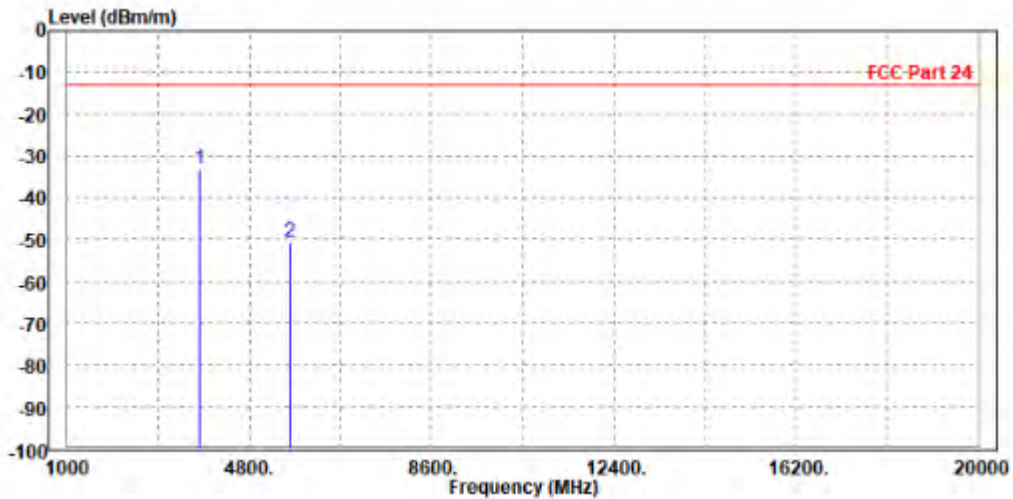



**BUREAU
VERITAS**

Test Report No.: W7L-P22090015-4RF05

CHANNEL BANDWIDTH: 5MHz / QPSK

MODE	TX channel 18900	FREQUENCY RANGE	Above 1000MHz
ENVIRONMENTAL CONDITIONS	23deg. C, 70%RH	INPUT POWER	AC 120V/60Hz
TESTED BY	Jace Hu		
ANTENNA POLARITY & TEST DISTANCE: HORIZONTAL AT 3 M			

	Freq	Level	Read Level	Limit Line	Over Limit	Factor	Remark	Po1/Phase
	MHz	dBm/m	dBm	dBm/m	dB	dB/m		
1	PP 3760.000	-34.81	-42.80	-13.00	-21.81	7.99	Peak	Horizontal
2	5636.000	-50.56	-61.29	-13.00	-37.56	10.73	Peak	Horizontal

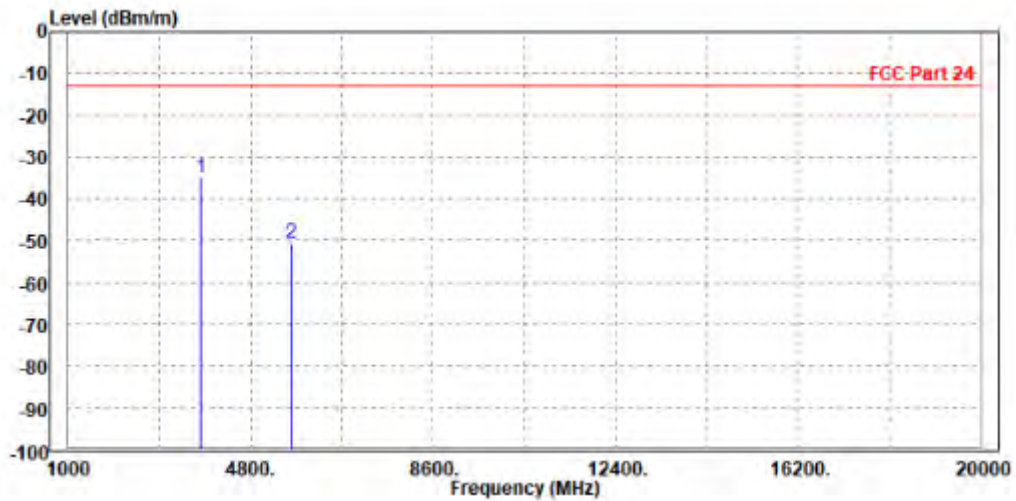



**BUREAU
VERITAS**

Test Report No.: W7L-P22090015-4RF05

MODE	TX channel 18900	FREQUENCY RANGE	Above 1000MHz
ENVIRONMENTAL CONDITIONS	23deg. C, 70%RH	INPUT POWER	AC 120V/60Hz
TESTED BY	Jace Hu		
ANTENNA POLARITY & TEST DISTANCE: VERTICAL AT 3 M			

	Freq	Level	Read Level	Limit Line	Over Limit	Factor	Remark	Pol/Phase
	MHz	dBm/m	dBm	dBm/m	dB	dB/m		
1 PP	3755.000	-36.04	-43.73	-13.00	-23.04	7.69	Peak	Vertical
2	5640.000	-51.00	-62.13	-13.00	-38.00	11.13	Peak	Vertical

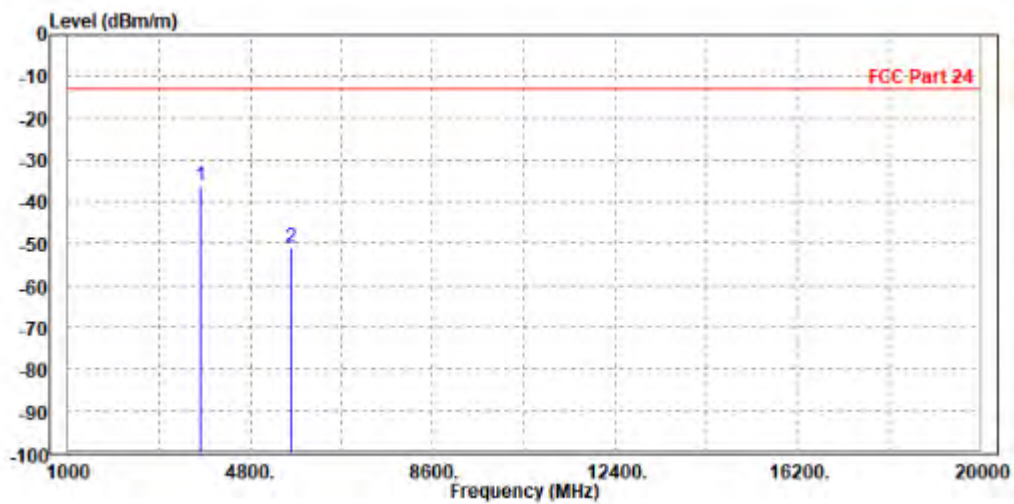



**BUREAU
VERITAS**

Test Report No.: W7L-P22090015-4RF05

CHANNEL BANDWIDTH: 10MHz / QPSK

CH18650

MODE	TX channel 18650	FREQUENCY RANGE	Above 1000MHz
ENVIRONMENTAL CONDITIONS	23deg. C, 70%RH	INPUT POWER	AC 120V/60Hz
TESTED BY	Jace Hu		
ANTENNA POLARITY & TEST DISTANCE: HORIZONTAL AT 3 M			

	Freq	Level	Read Level	Limit Line	Over Limit	Factor	Remark	Pol/Phase
	MHz	dBm/m	dBm	dBm/m	dB	dB/m		
1	PP 3717.000	-40.11	-47.99	-13.00	-27.11	7.88	Peak	Horizontal
2	5565.000	-52.20	-62.80	-13.00	-39.20	10.60	Peak	Horizontal

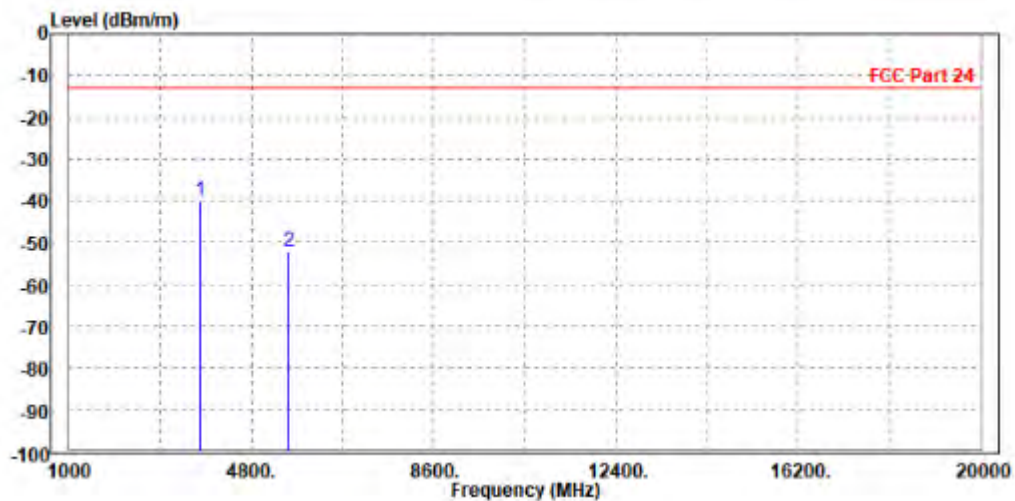



**BUREAU
VERITAS**

Test Report No.: W7L-P22090015-4RF05

MODE	TX channel 18650	FREQUENCY RANGE	Above 1000MHz
ENVIRONMENTAL CONDITIONS	23deg. C, 70%RH	INPUT POWER	AC 120V/60Hz
TESTED BY	Jace Hu		
ANTENNA POLARITY & TEST DISTANCE: VERTICAL AT 3 M			

	Freq	Level	Read Level	Limit Line	Over Limit	Factor	Remark	Pol/Phase
	MHz	dBm/m	dBm	dBm/m	dB	dB/m		
1	PP 3710.000	-37.15	-44.77	-13.00	-24.15	7.62	Peak	Vertical
2	5560.000	-52.03	-62.93	-13.00	-39.03	10.90	Peak	Vertical

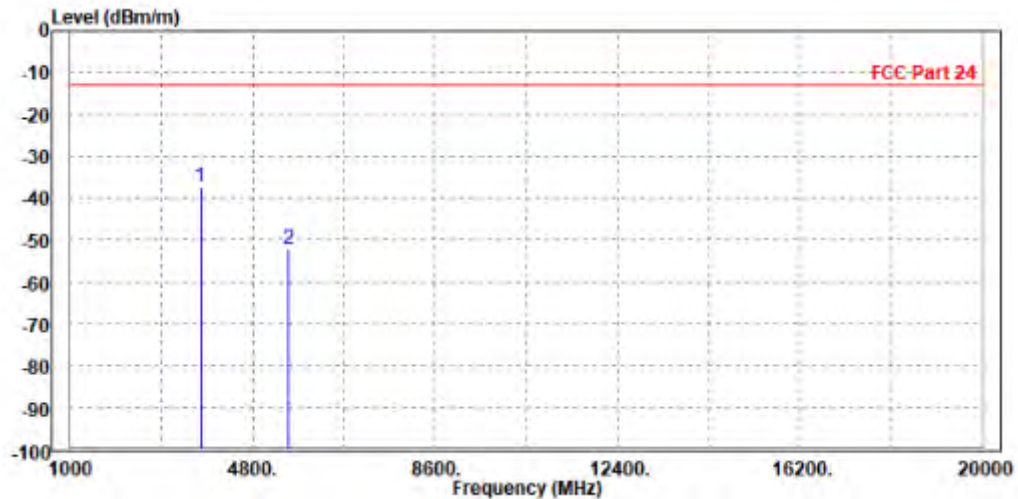



**BUREAU
VERITAS**

Test Report No.: W7L-P22090015-4RF05

CH18900

MODE	TX channel 18900	FREQUENCY RANGE	Above 1000MHz
ENVIRONMENTAL CONDITIONS	23deg. C, 70%RH	INPUT POWER	AC 120V/60Hz
TESTED BY	Jace Hu		
ANTENNA POLARITY & TEST DISTANCE: HORIZONTAL AT 3 M			

	Freq	Level	Read Level	Limit Line	Over Limit	Factor	Remark	Pol/Phase
	MHz	dBm/m	dBm	dBm/m	dB	dB/m		
1	PP 3760.000	-30.52	-38.51	-13.00	-17.52	7.99	Peak	Horizontal
2	5636.000	-47.25	-57.98	-13.00	-34.25	10.73	Peak	Horizontal

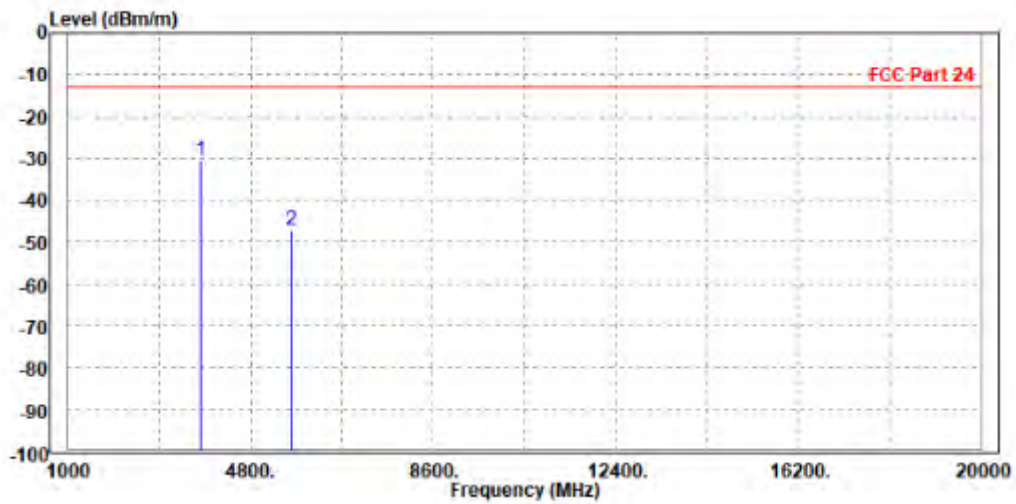



**BUREAU
VERITAS**

Test Report No.: W7L-P22090015-4RF05

MODE	TX channel 18900	FREQUENCY RANGE	Above 1000MHz
ENVIRONMENTAL CONDITIONS	23deg. C, 70%RH	INPUT POWER	AC 120V/60Hz
TESTED BY	Jace Hu		
ANTENNA POLARITY & TEST DISTANCE: VERTICAL AT 3 M			

	Freq	Level	Read Level	Limit Line	Over Limit	Factor	Remark	Pol/Phase
	MHz	dBm/m	dBm	dBm/m	dB	dB/m		
1	PP 3755.000	-29.96	-37.65	-13.00	-16.96	7.69	Peak	Vertical
2	5640.000	-48.43	-59.56	-13.00	-35.43	11.13	Peak	Vertical

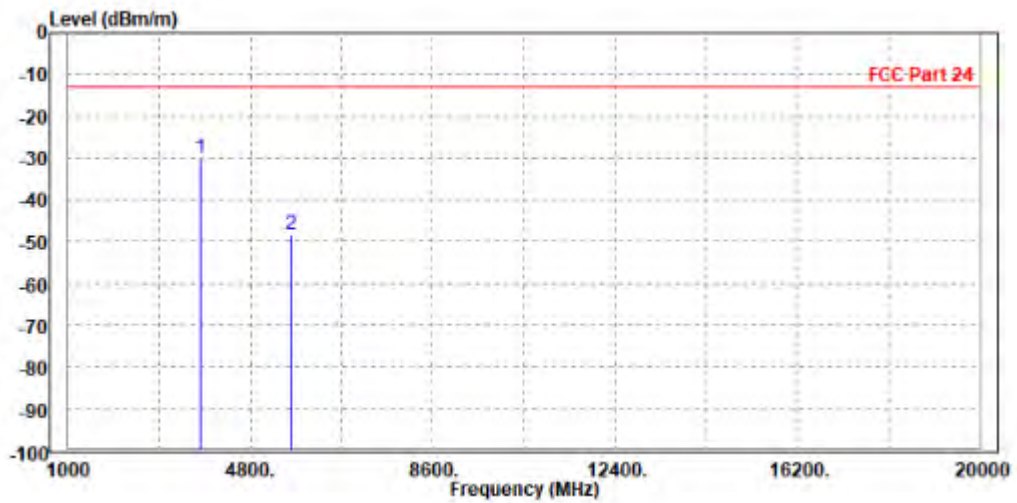



**BUREAU
VERITAS**

Test Report No.: W7L-P22090015-4RF05

CH19193

MODE	TX channel 19193	FREQUENCY RANGE	Above 1000MHz
ENVIRONMENTAL CONDITIONS	23deg. C, 70%RH	INPUT POWER	AC 120V/60Hz
TESTED BY	Jace Hu		
ANTENNA POLARITY & TEST DISTANCE: HORIZONTAL AT 3 M			

	Freq	Level	Read Level	Limit Line	Over Limit	Factor	Remark	Pol/Phase
	MHz	dBm/m	dBm	dBm/m	dB	dB/m		
1	PP 3810.000	-35.86	-43.98	-13.00	-22.86	8.12	Peak	Horizontal
2	5712.000	-48.94	-59.82	-13.00	-35.94	10.88	Peak	Horizontal

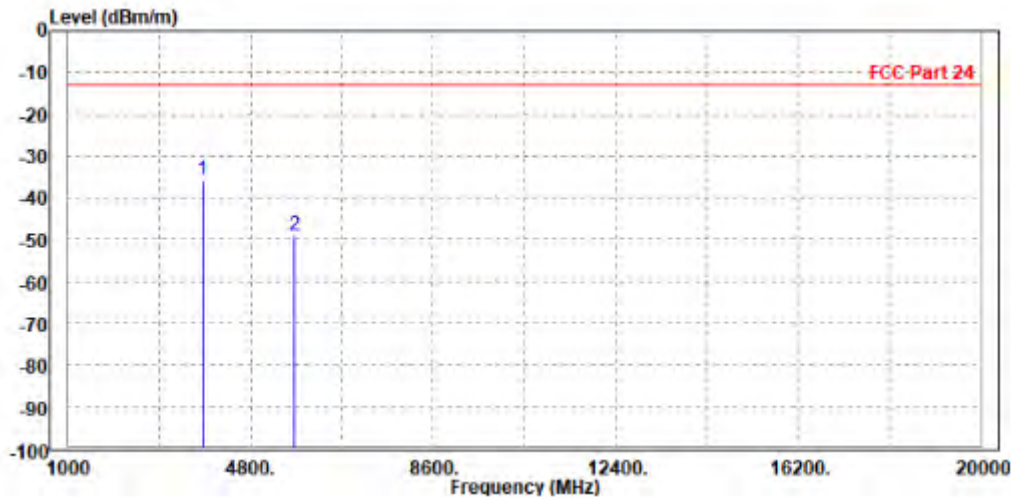



**BUREAU
VERITAS**

Test Report No.: W7L-P22090015-4RF05

MODE	TX channel 19193	FREQUENCY RANGE	Above 1000MHz
ENVIRONMENTAL CONDITIONS	23deg. C, 70%RH	INPUT POWER	AC 120V/60Hz
TESTED BY	Jace Hu		
ANTENNA POLARITY & TEST DISTANCE: VERTICAL AT 3 M			

	Freq	Level	Read Level	Limit Line	Over Limit	Factor	Remark	Pol/Phase
	MHz	dBm/m	dBm	dBm/m	dB	dB/m		
1	PP 3812.000	-36.29	-44.06	-13.00	-23.29	7.77	Peak	Vertical
2	5715.000	-49.59	-60.93	-13.00	-36.59	11.34	Peak	Vertical

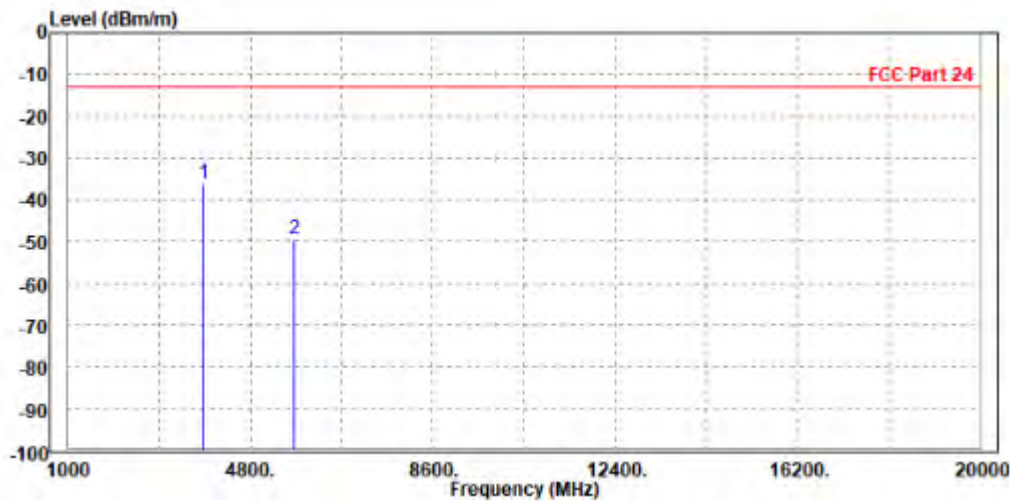



**BUREAU
VERITAS**

Test Report No.: W7L-P22090015-4RF05

CHANNEL BANDWIDTH: 15MHz / QPSK

MODE	TX channel 18900	FREQUENCY RANGE	Above 1000MHz
ENVIRONMENTAL CONDITIONS	23deg. C, 70%RH	INPUT POWER	AC 120V/60Hz
TESTED BY	Jace Hu		
ANTENNA POLARITY & TEST DISTANCE: HORIZONTAL AT 3 M			

	Freq	Level	Read Level	Limit Line	Over Limit	Factor	Remark	Pol/Phase
	MHz	dBm/m	dBm	dBm/m	dB	dB/m		
1 PP	3755.000	-39.23	-47.21	-13.00	-26.23	7.98	Peak	Horizontal
2	5640.000	-50.75	-61.49	-13.00	-37.75	10.74	Peak	Horizontal

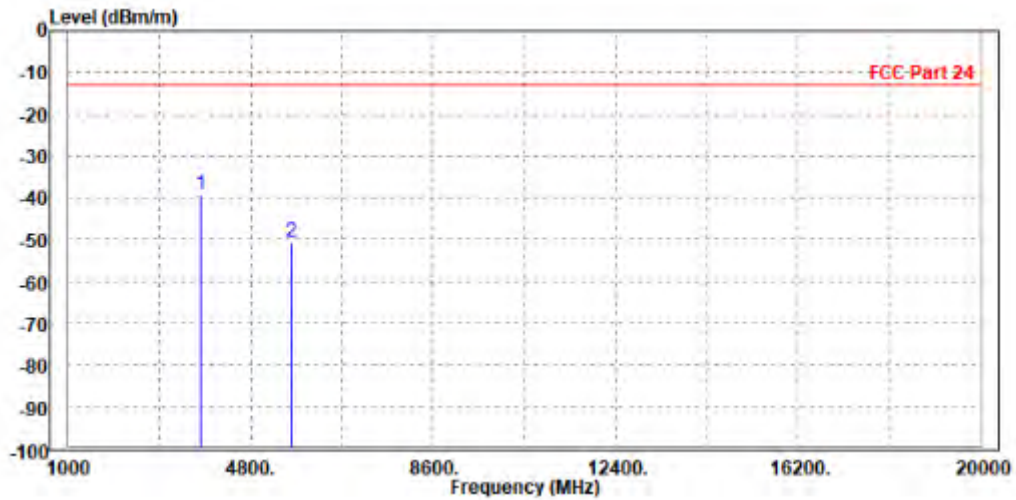



**BUREAU
VERITAS**

Test Report No.: W7L-P22090015-4RF05

MODE	TX channel 18900	FREQUENCY RANGE	Above 1000MHz
ENVIRONMENTAL CONDITIONS	23deg. C, 70%RH	INPUT POWER	AC 120V/60Hz
TESTED BY	Jace Hu		
ANTENNA POLARITY & TEST DISTANCE: VERTICAL AT 3 M			

	Freq	Level	Read Level	Limit Line	Over Limit	Factor	Remark	Pol/Phase
	MHz	dBm/m	dBm	dBm/m	dB	dB/m		
1	PP 3760.000	-40.72	-48.42	-13.00	-27.72	7.70	Peak	Vertical
2	5636.000	-51.05	-62.17	-13.00	-38.05	11.12	Peak	Vertical

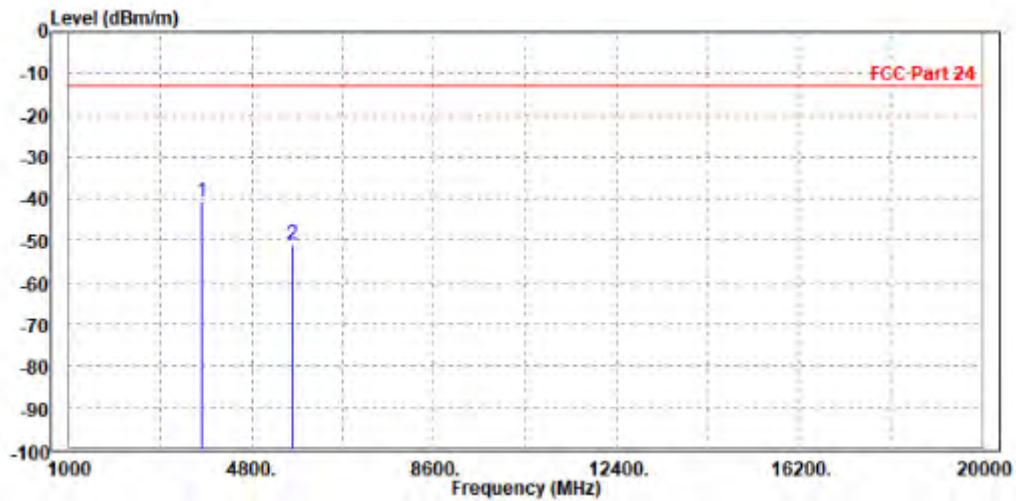



BUREAU
VERITAS

Test Report No.: W7L-P22090015-4RF05

CHANNEL BANDWIDTH: 20MHz / QPSK

MODE	TX channel 18900	FREQUENCY RANGE	Above 1000MHz
ENVIRONMENTAL CONDITIONS	23deg. C, 70%RH	INPUT POWER	AC 120V/60Hz
TESTED BY	Jace Hu		
ANTENNA POLARITY & TEST DISTANCE: HORIZONTAL AT 3 M			

	Freq	Level	Read Level	Limit Line	Over Limit	Factor	Remark	Pol/Phase
	MHz	dBm/m	dBm	dBm/m	dB	dB/m		
1	PP 3736.000	-31.41	-39.34	-13.00	-18.41	7.93	Peak	Horizontal
2	5640.000	-52.05	-62.79	-13.00	-39.05	10.74	Peak	Horizontal

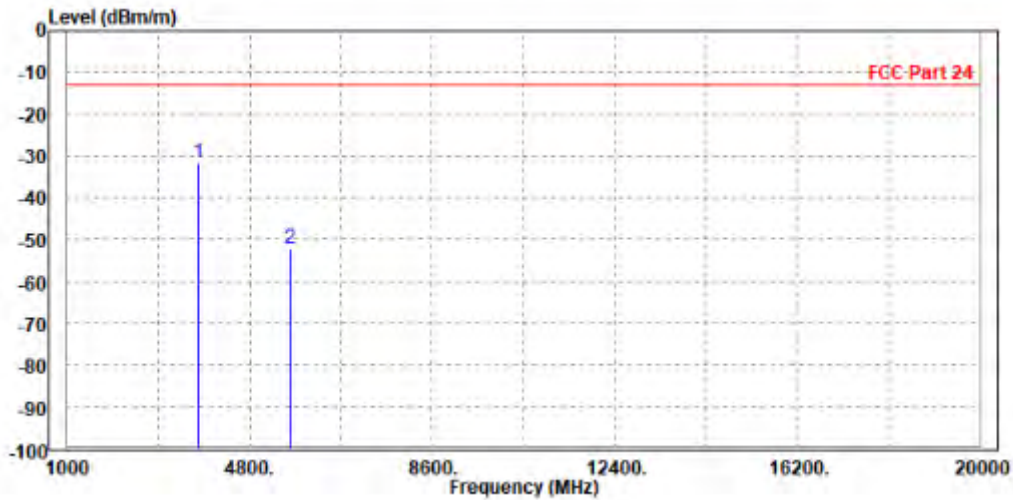



**BUREAU
VERITAS**

Test Report No.: W7L-P22090015-4RF05

MODE	TX channel 18900	FREQUENCY RANGE	Above 1000MHz
ENVIRONMENTAL CONDITIONS	23deg. C, 70%RH	INPUT POWER	AC 120V/60Hz
TESTED BY	Jace Hu		
ANTENNA POLARITY & TEST DISTANCE: VERTICAL AT 3 M			

	Freq	Level	Read Level	Limit Line	Over Limit	Factor	Remark	Pol/Phase
	MHz	dBm/m	dBm	dBm/m	dB	dB/m		
1	PP 3736.000	-30.67	-38.33	-13.00	-17.67	7.66	Peak	Vertical
2	5640.000	-51.90	-63.03	-13.00	-38.90	11.13	Peak	Vertical

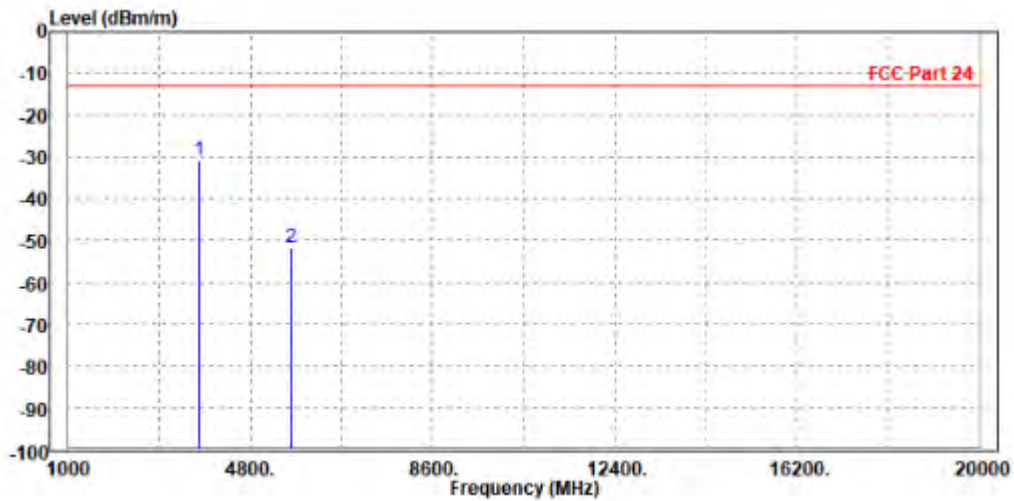



3.7 PEAK TO AVERAGE RATIO

3.7.1 LIMITS OF PEAK TO AVERAGE RATIO MEASUREMENT

In measuring transmissions in this band using an average power technique, the peak to-average ratio (PAR) of the transmission may not exceed 13 dB

3.7.2 TEST SETUP

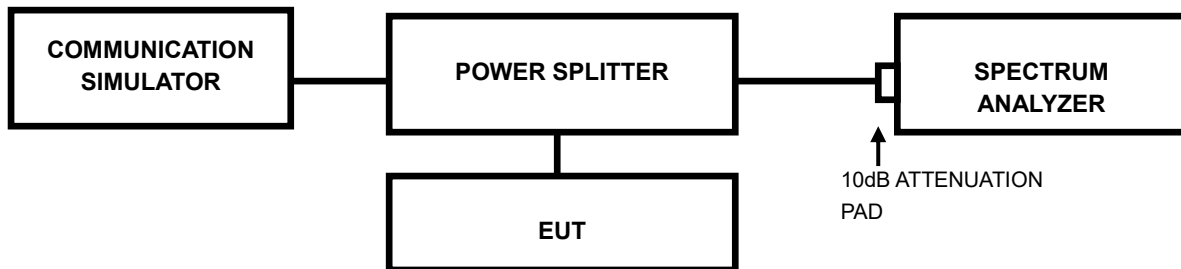

3.7.3 TEST PROCEDURES

1. Set resolution/measurement bandwidth \geq signal's occupied bandwidth;
2. Set the number of counts to a value that stabilizes the measured CCDF curve;
3. Record the maximum PAPR level associated with a probability of 0.1%.



**BUREAU
VERITAS**

Test Report No.: W7L-P22090015-4RF05

3.7.4 TEST RESULTS

Please Refer to Appendix Of this test report.



**BUREAU
VERITAS**

Test Report No.: W7L-P22090015-4RF05

4 INFORMATION ON THE TESTING LABORATORIES

We, BV 7LAYERS COMMUNICATIONS TECHNOLOGY (SHENZHEN) CO. LTD., were founded in 2015 to provide our best service in EMC, Radio, Telecom and Safety consultation. Our laboratories are accredited and approved according to ISO/IEC 17025.

If you have any comments, please feel free to contact us at the following:

Shenzhen EMC/RF Lab:

Tel: +86-755-88696566

Fax: +86-755-88696577

Email: customerservice.sw@bureauveritas.com

Web Site: www.adt.com.tw

The address and road map of all our labs can be found in our web site also.



Test Report No.: W7L-P22090015-4RF05

5 MODIFICATIONS RECORDERS FOR ENGINEERING CHANGES TO THE EUT BY THE LAB

No any modifications are made to the EUT by the lab during the test.



6 Appendix

PCS 1900

FREQUENCY STABILITY PCS1900 TEST RESULT

Band: PCS1900							
Network	Frequency (MHz)	Temp. (°C)	Voltage (VDC)	Freq. Error (Hz)	Freq. vs. Rated (ppm)		Verdict
					Result	Limit	
GSM	1850.2	20	3.27	28.93	0.02	-2.5 to 2.5	Pass
			3.85	1.03	0.00	-2.5 to 2.5	Pass
			4.43	2.03	0.00	-2.5 to 2.5	Pass
		-30	3.85	13.21	0.01	-2.5 to 2.5	Pass
		-20	3.85	13.49	0.01	-2.5 to 2.5	Pass
		-10	3.85	13.72	0.01	-2.5 to 2.5	Pass
		0	3.85	19.02	0.01	-2.5 to 2.5	Pass
		10	3.85	17.92	0.01	-2.5 to 2.5	Pass
		30	3.85	22.47	0.01	-2.5 to 2.5	Pass
		40	3.85	21.37	0.01	-2.5 to 2.5	Pass
	50	3.85	20.44	0.01	-2.5 to 2.5	Pass	
	1880	20	3.27	12.43	0.01	-2.5 to 2.5	Pass
			3.85	9.65	0.01	-2.5 to 2.5	Pass
			4.43	8.88	0.00	-2.5 to 2.5	Pass
		-30	3.85	19.37	0.01	-2.5 to 2.5	Pass
		-20	3.85	27.28	0.01	-2.5 to 2.5	Pass
		-10	3.85	26.09	0.01	-2.5 to 2.5	Pass
		0	3.85	16.50	0.01	-2.5 to 2.5	Pass
		10	3.85	13.08	0.01	-2.5 to 2.5	Pass
		30	3.85	13.27	0.01	-2.5 to 2.5	Pass
		40	3.85	19.60	0.01	-2.5 to 2.5	Pass
	50	3.85	7.52	0.00	-2.5 to 2.5	Pass	
	1909.8	20	3.27	4.78	0.00	-2.5 to 2.5	Pass
			3.85	9.36	0.00	-2.5 to 2.5	Pass
			4.43	16.40	0.01	-2.5 to 2.5	Pass
		-30	3.85	9.69	0.01	-2.5 to 2.5	Pass
		-20	3.85	11.91	0.01	-2.5 to 2.5	Pass
		-10	3.85	9.85	0.01	-2.5 to 2.5	Pass
		0	3.85	4.26	0.00	-2.5 to 2.5	Pass
		10	3.85	20.37	0.01	-2.5 to 2.5	Pass
30		3.85	9.72	0.01	-2.5 to 2.5	Pass	
40		3.85	15.66	0.01	-2.5 to 2.5	Pass	
50	3.85	9.78	0.01	-2.5 to 2.5	Pass		
EGSM	1850.2	20	3.27	-2.94	-0.00	-2.5 to 2.5	Pass
			3.85	12.43	0.01	-2.5 to 2.5	Pass
			4.43	12.72	0.01	-2.5 to 2.5	Pass
		-30	3.85	3.49	0.00	-2.5 to 2.5	Pass
		-20	3.85	-11.95	-0.01	-2.5 to 2.5	Pass
		-10	3.85	-3.94	-0.00	-2.5 to 2.5	Pass
		0	3.85	-1.00	-0.00	-2.5 to 2.5	Pass
		10	3.85	9.88	0.01	-2.5 to 2.5	Pass
		30	3.85	10.17	0.01	-2.5 to 2.5	Pass
		40	3.85	-7.13	-0.00	-2.5 to 2.5	Pass
	50	3.85	-9.98	-0.01	-2.5 to 2.5	Pass	
	1880	20	3.27	14.21	0.01	-2.5 to 2.5	Pass
			3.85	11.33	0.01	-2.5 to 2.5	Pass
			4.43	12.01	0.01	-2.5 to 2.5	Pass



**BUREAU
VERITAS**

Test Report No.: W7L-P22090015-4RF05

		-30	3.85	7.78	0.00	-2.5 to 2.5	Pass
		-20	3.85	12.59	0.01	-2.5 to 2.5	Pass
		-10	3.85	3.65	0.00	-2.5 to 2.5	Pass
		0	3.85	12.17	0.01	-2.5 to 2.5	Pass
		10	3.85	13.08	0.01	-2.5 to 2.5	Pass
		30	3.85	23.25	0.01	-2.5 to 2.5	Pass
		40	3.85	-5.36	-0.00	-2.5 to 2.5	Pass
		50	3.85	13.62	0.01	-2.5 to 2.5	Pass
	1909.8	20	3.27	-0.90	-0.00	-2.5 to 2.5	Pass
			3.85	5.94	0.00	-2.5 to 2.5	Pass
			4.43	-7.30	-0.00	-2.5 to 2.5	Pass
		-30	3.85	3.78	0.00	-2.5 to 2.5	Pass
		-20	3.85	13.37	0.01	-2.5 to 2.5	Pass
		-10	3.85	10.36	0.01	-2.5 to 2.5	Pass
		0	3.85	20.31	0.01	-2.5 to 2.5	Pass
		10	3.85	7.72	0.00	-2.5 to 2.5	Pass
		30	3.85	-7.72	-0.00	-2.5 to 2.5	Pass
		40	3.85	12.40	0.01	-2.5 to 2.5	Pass
		50	3.85	11.30	0.01	-2.5 to 2.5	Pass



BUREAU
VERITAS

Test Report No.: W7L-P22090015-4RF05

99% & 26DB BANDWIDTH 99%_OBW TEST RESULT

Band: PCS1900						
ENV	Mode		Frequency (MHz)	99% Occupied Bandwidth (MHz)		Verdict
	Network	Subset		Result		
NTNV	GSM	1 TX Slot	1850.2	0.245		Pass
			1880	0.249		Pass
			1909.8	0.244		Pass
	EGSM	1 TX Slot	1850.2	0.246		Pass
			1880	0.258		Pass
			1909.8	0.248		Pass



BUREAU
VERITAS

Test Report No.: W7L-P22090015-4RF05

TEST GRAPH

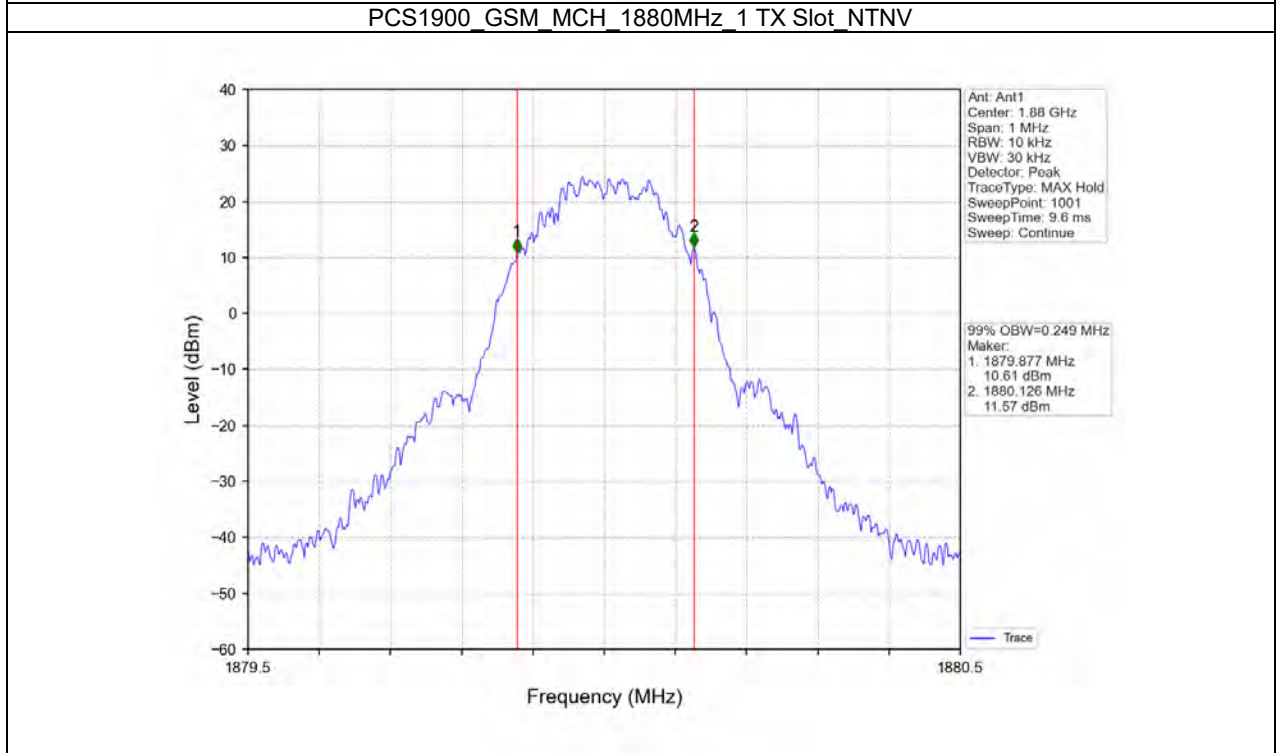
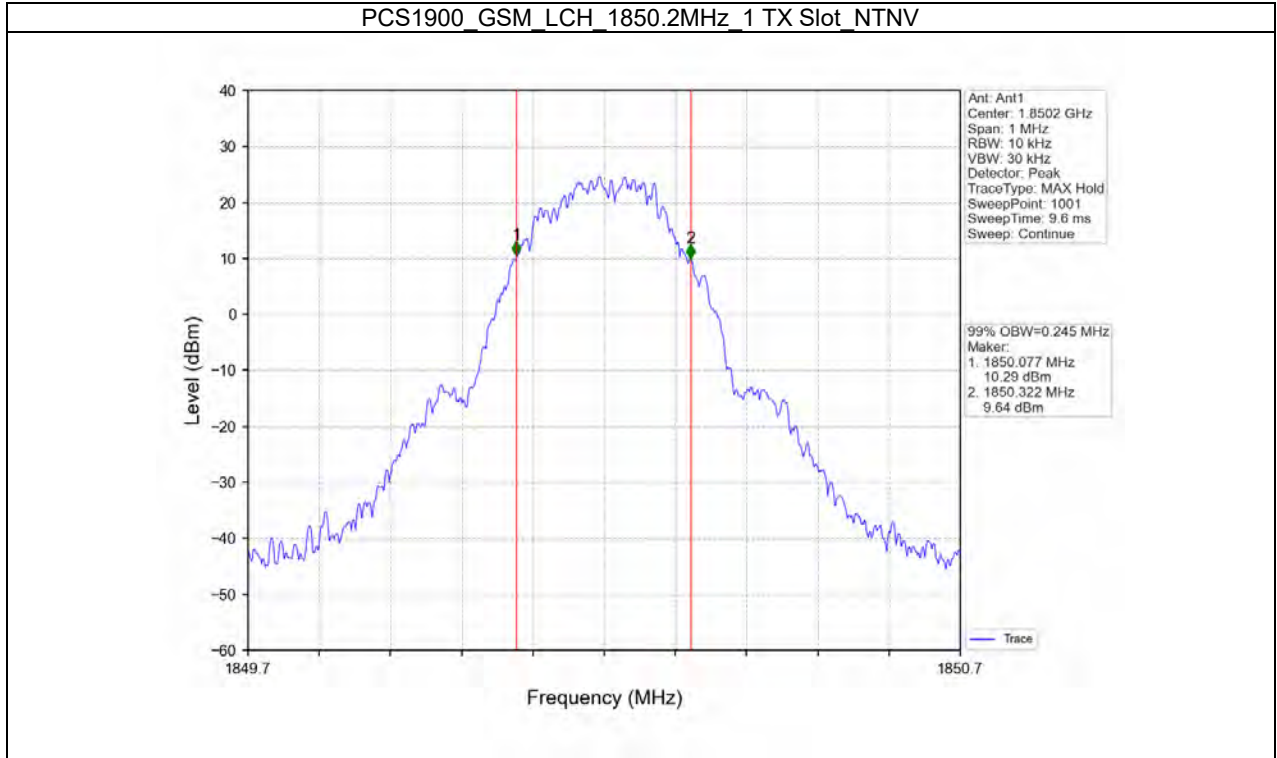



BUREAU
VERITAS

Test Report No.: W7L-P22090015-4RF05

PCS1900_GSM_HCH_1909.8MHz_1 TX Slot_NTNV

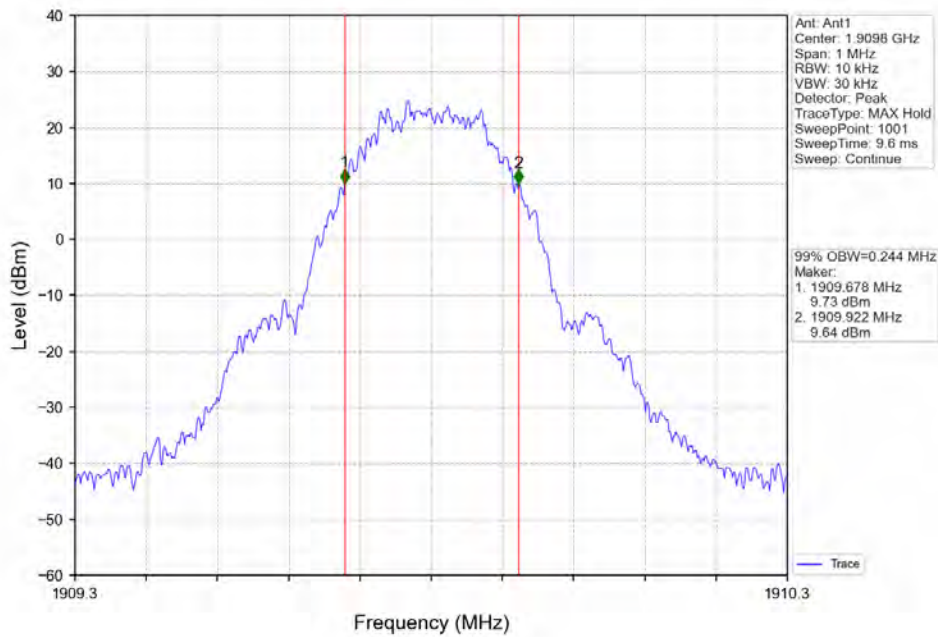

PCS1900_EGSM_LCH_1850.2MHz_1 TX Slot_NTNV

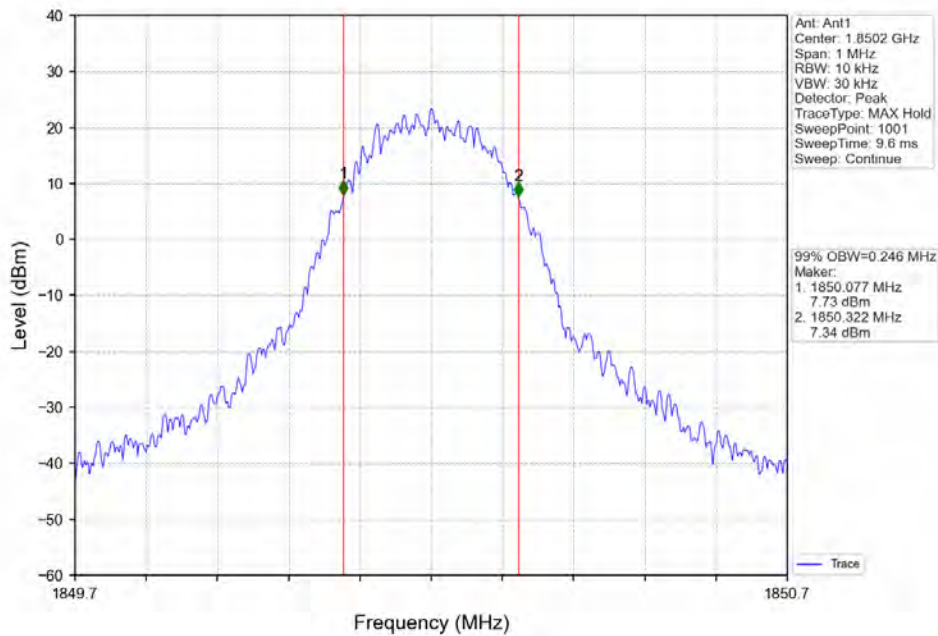



BUREAU
VERITAS

Test Report No.: W7L-P22090015-4RF05

PCS1900_EGSM_MCH_1880MHz_1 TX Slot_NTNV

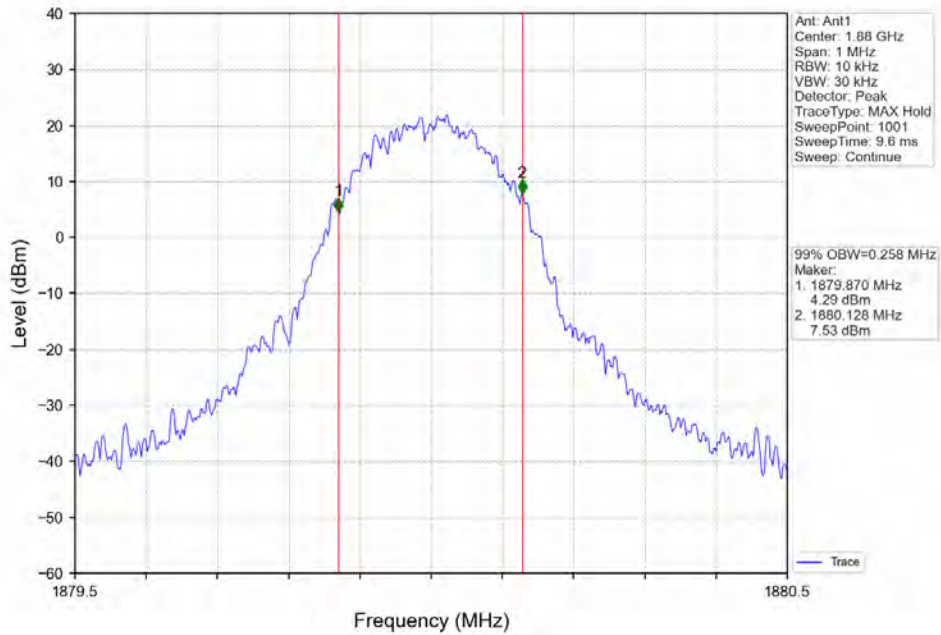

PCS1900_EGSM_HCH_1909.8MHz_1 TX Slot_NTNV

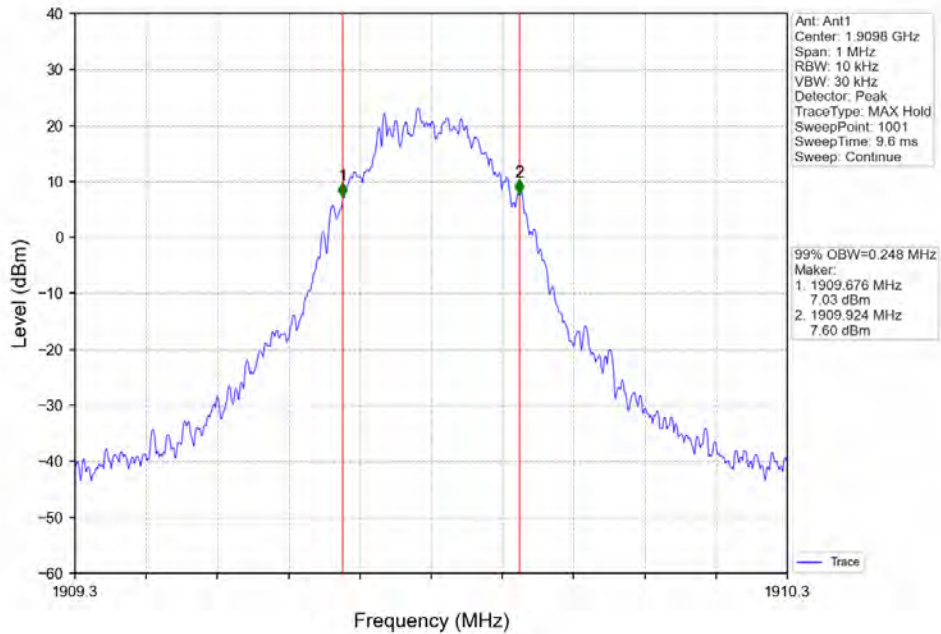



BUREAU
VERITAS

Test Report No.: W7L-P22090015-4RF05

26DB OBW TEST RESULT

Band: PCS1900					
ENV	Mode		Frequency (MHz)	26dB Bandwidth (MHz)	Verdict
	Network	Subset		Result	
NTNV	GSM	1 TX Slot	1850.2	0.322	Pass
			1880	0.314	Pass
			1909.8	0.320	Pass
	EGSM	1 TX Slot	1850.2	0.318	Pass
			1880	0.323	Pass
			1909.8	0.311	Pass



BUREAU
VERITAS

Test Report No.: W7L-P22090015-4RF05

TEST GRAPH

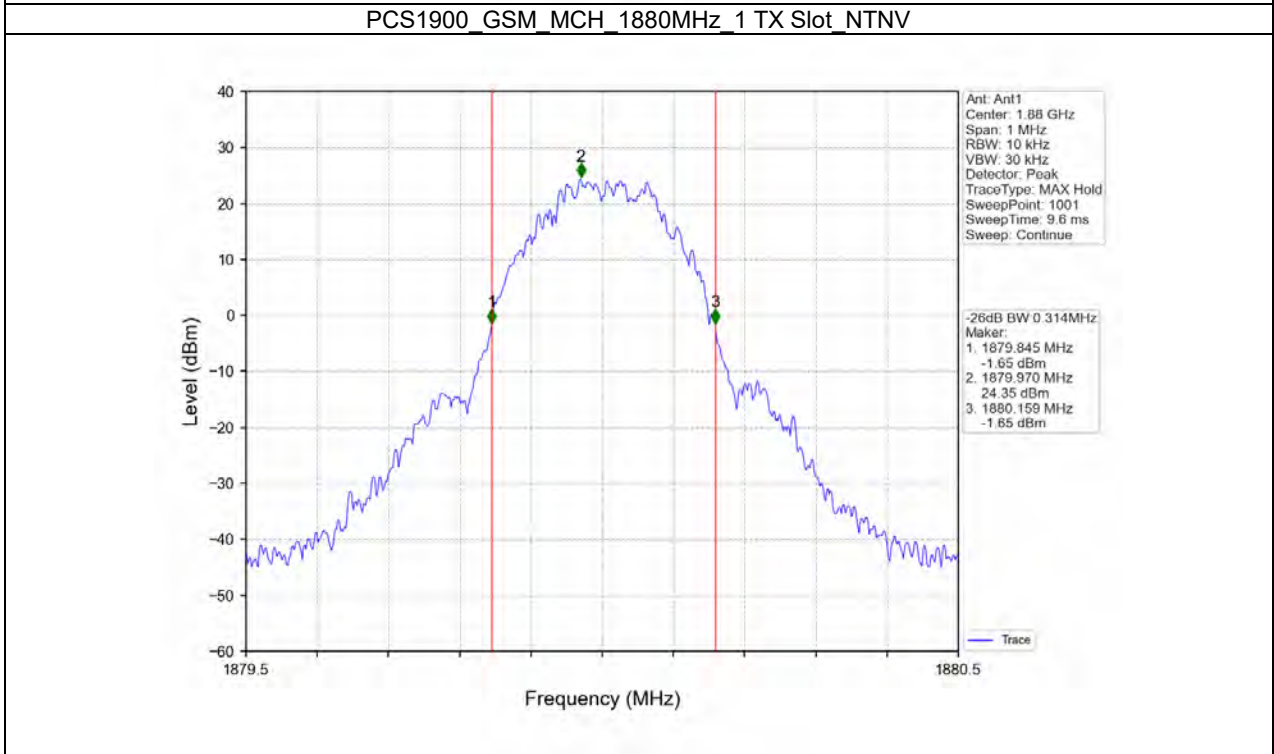
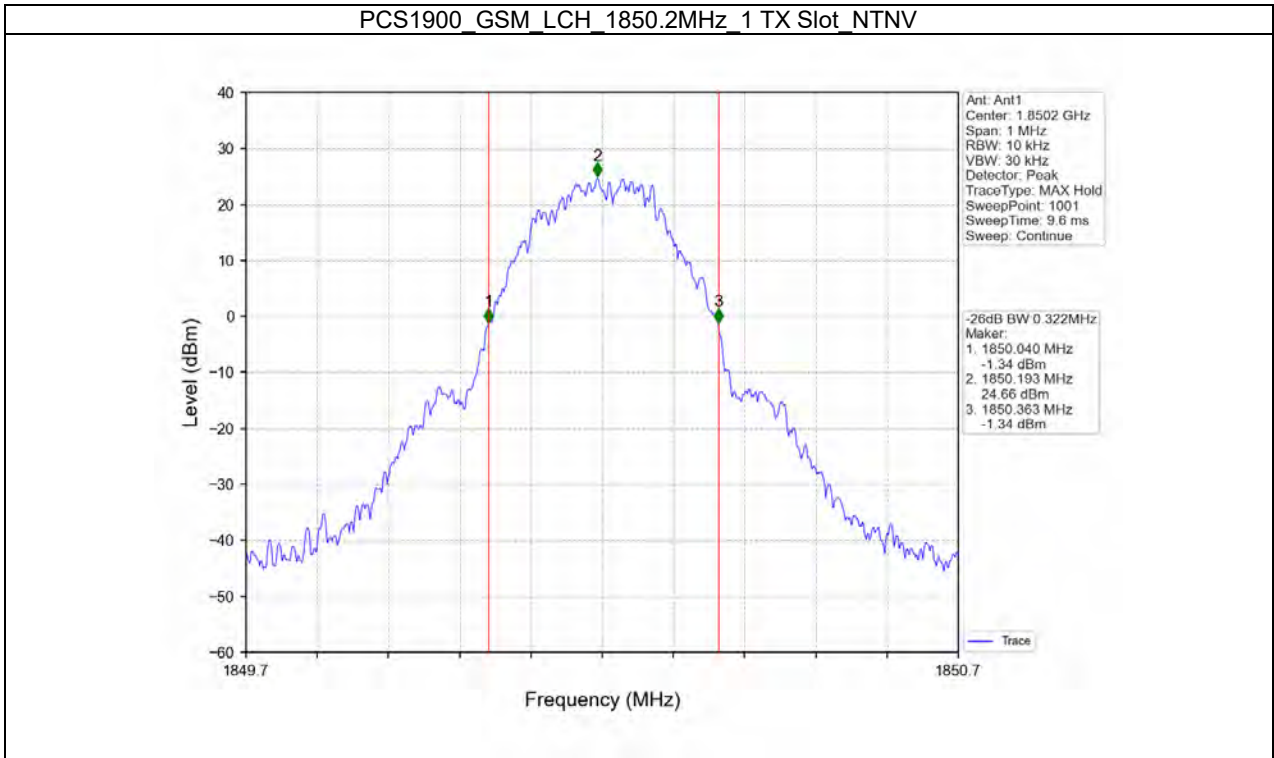



BUREAU
VERITAS

Test Report No.: W7L-P22090015-4RF05

PCS1900_GSM_HCH_1909.8MHz_1 TX Slot_NTNV

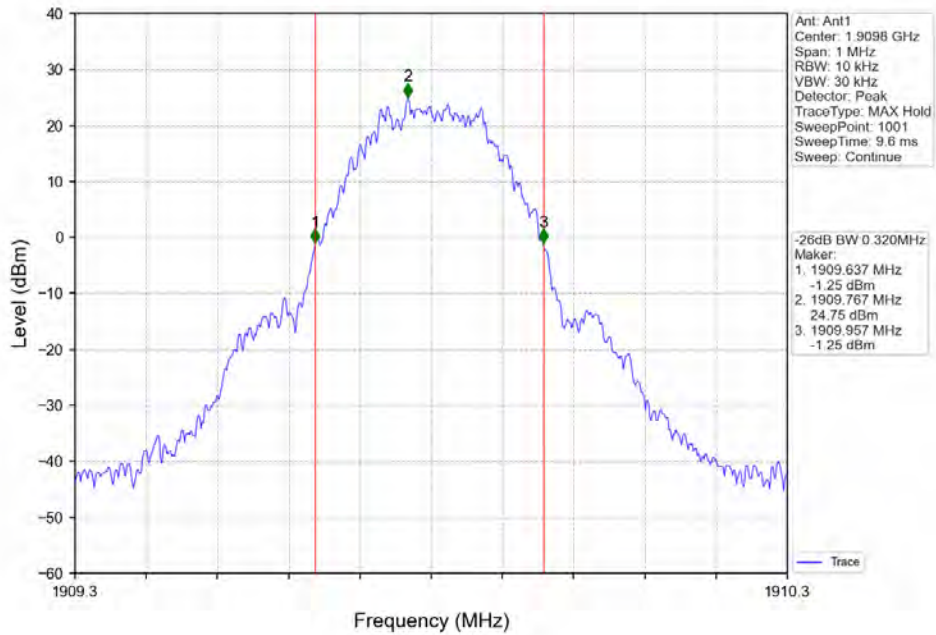

PCS1900_EGSM_LCH_1850.2MHz_1 TX Slot_NTNV

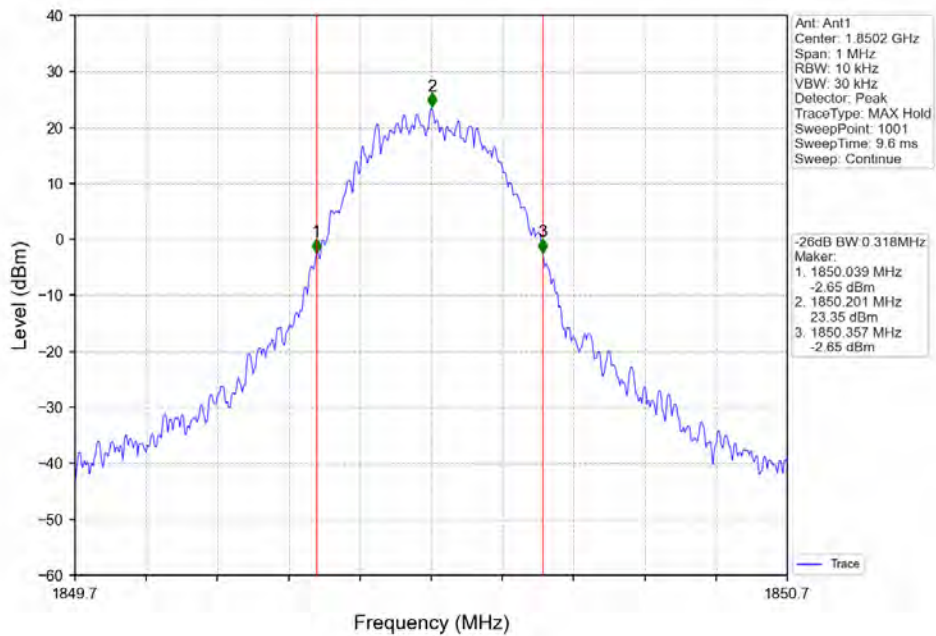



BUREAU
VERITAS

Test Report No.: W7L-P22090015-4RF05

PCS1900_EGSM_MCH_1880MHz_1 TX Slot_NTNV

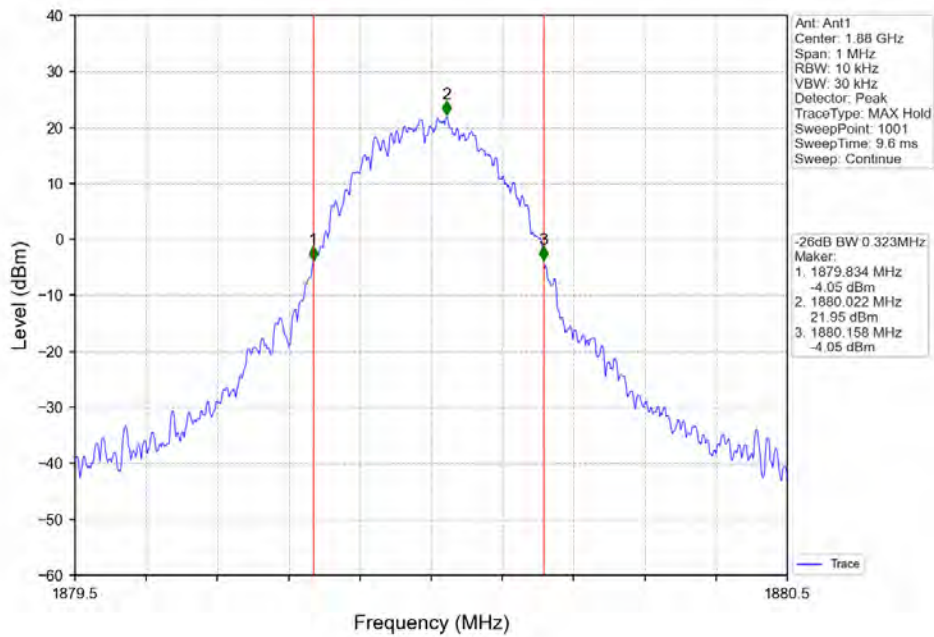

PCS1900_EGSM_HCH_1909.8MHz_1 TX Slot_NTNV

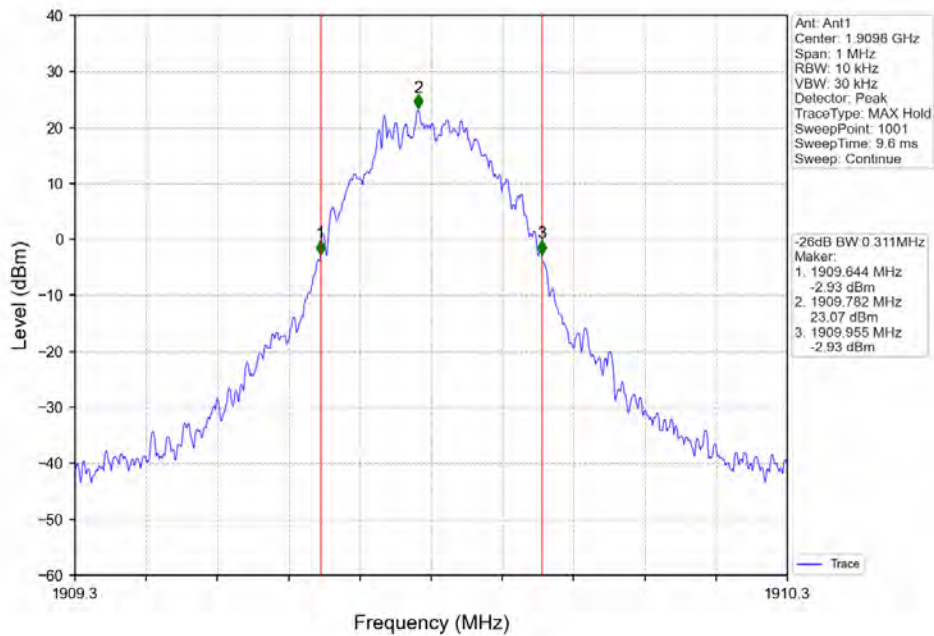



BUREAU
VERITAS

Test Report No.: W7L-P22090015-4RF05

PEAK-AVERAGE RATIO TEST RESULT

Band: PCS1900						
ENV	Mode		Frequency (MHz)	Peak-Average Ratio (dB)		Verdict
	Network	Subset		Result	Limit	
NTNV	GSM	4 TX Slots	1850.2	9.39	<=13	Pass
			1880	9.70	<=13	Pass
			1909.8	3.60	<=13	Pass
	EGSM	4 TX Slots	1850.2	11.82	<=13	Pass
			1880	6.63	<=13	Pass
			1909.8	7.29	<=13	Pass



BUREAU
VERITAS

Test Report No.: W7L-P22090015-4RF05

TEST GRAPH

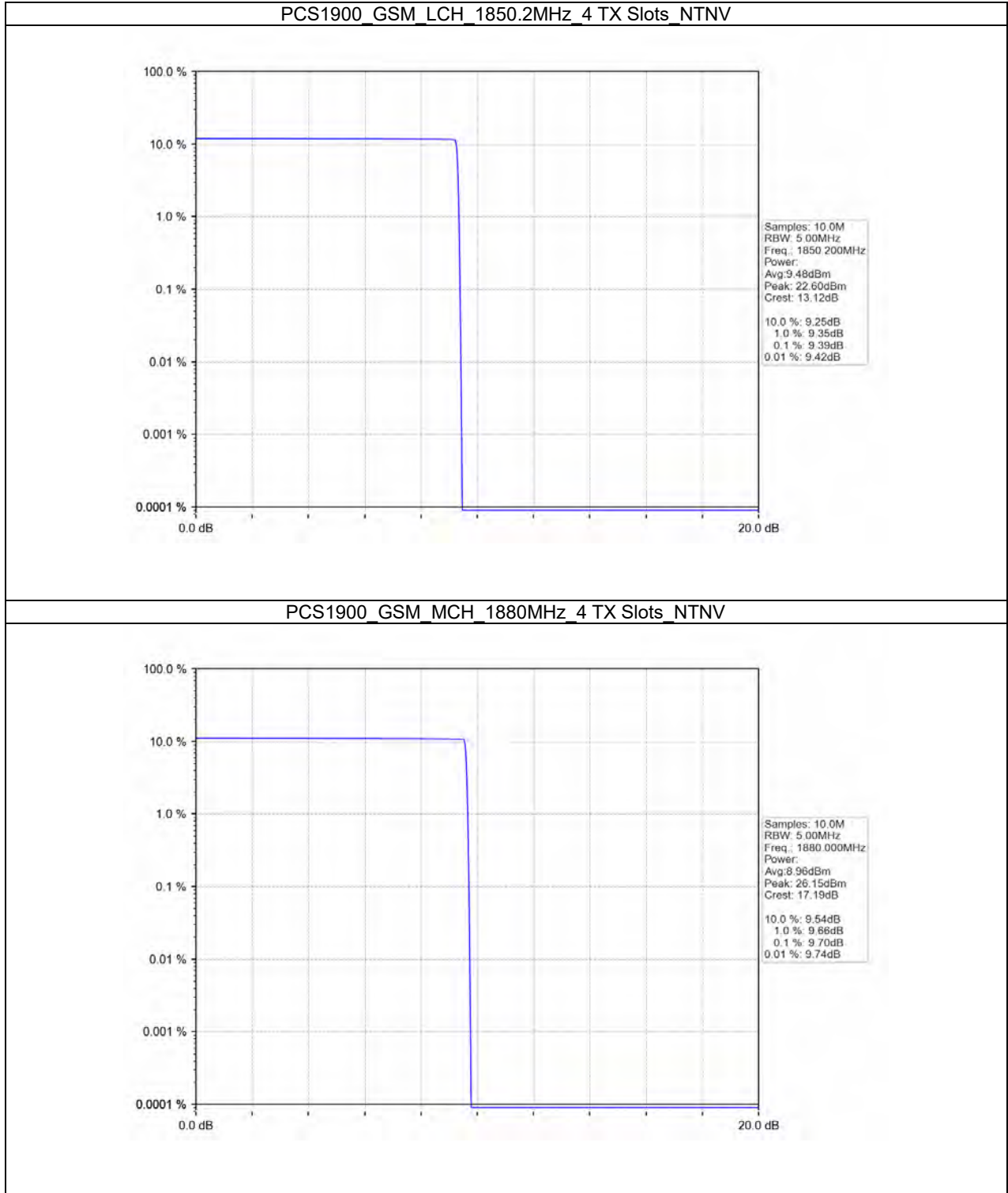



BUREAU
VERITAS

Test Report No.: W7L-P22090015-4RF05

PCS1900_GSM_HCH_1909.8MHz_4 TX Slots_NTNV

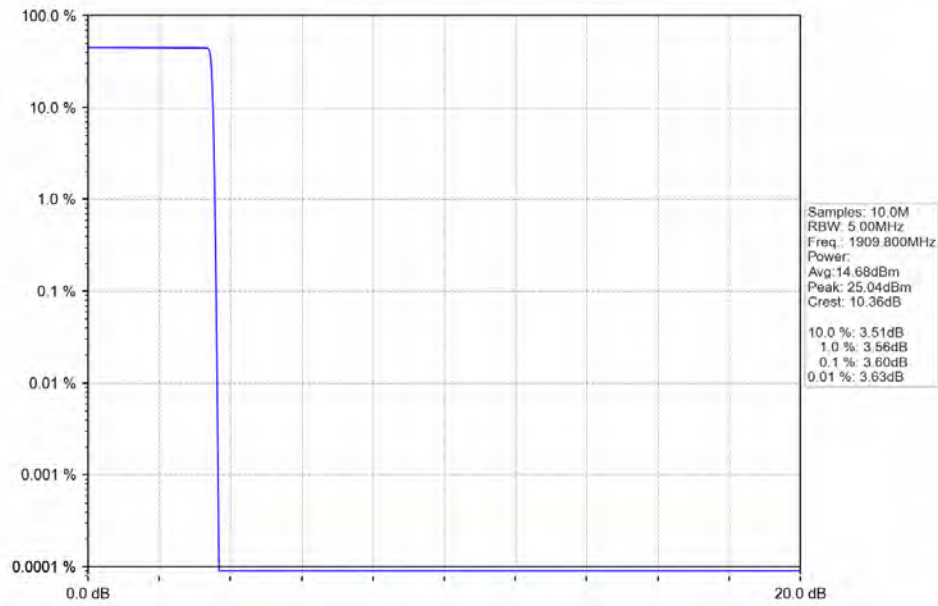

PCS1900_EGSM_LCH_1850.2MHz_4 TX Slots_NTNV

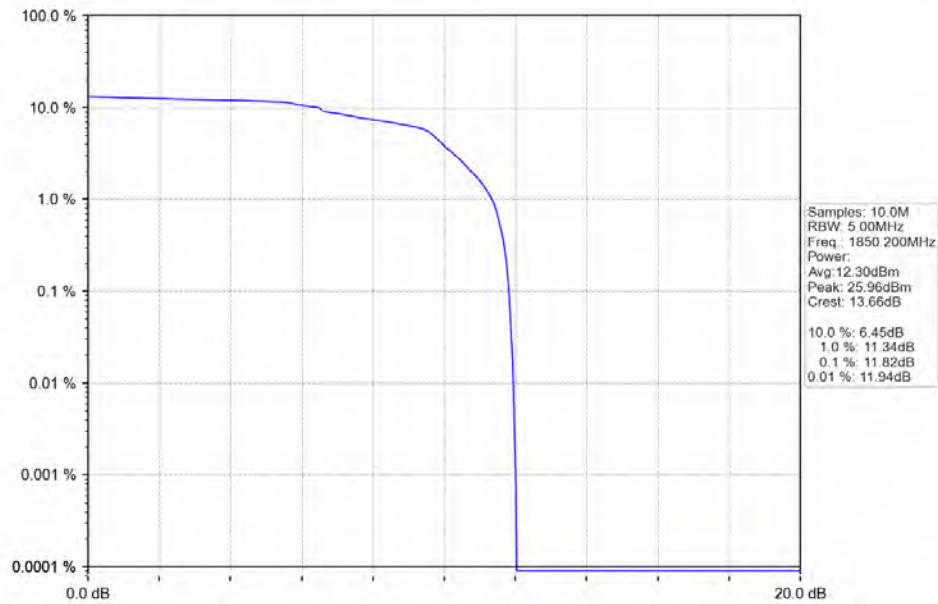



BUREAU
VERITAS

Test Report No.: W7L-P22090015-4RF05

PCS1900_EGSM_MCH_1880MHz_4 TX Slots_NTNV

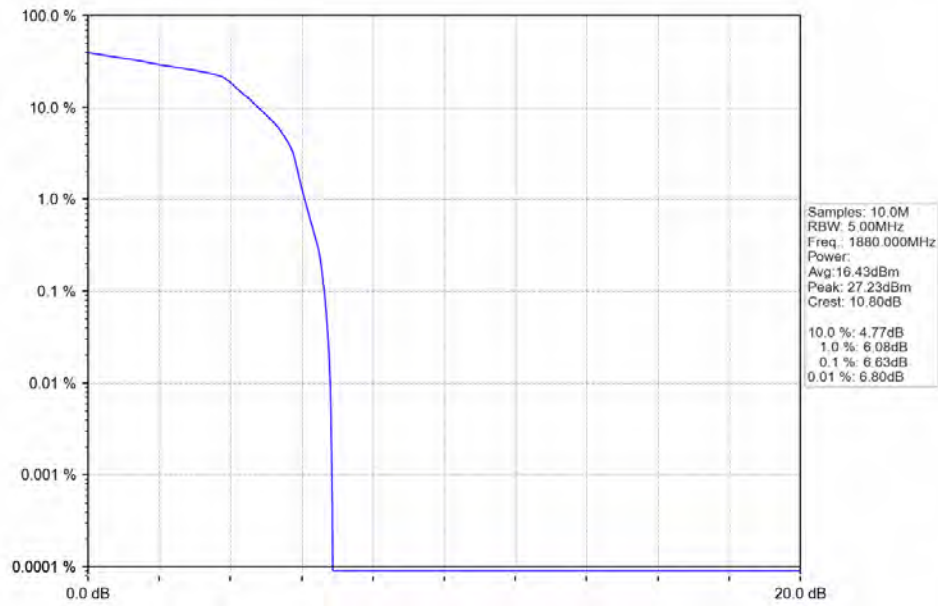

PCS1900_EGSM_HCH_1909.8MHz_4 TX Slots_NTNV

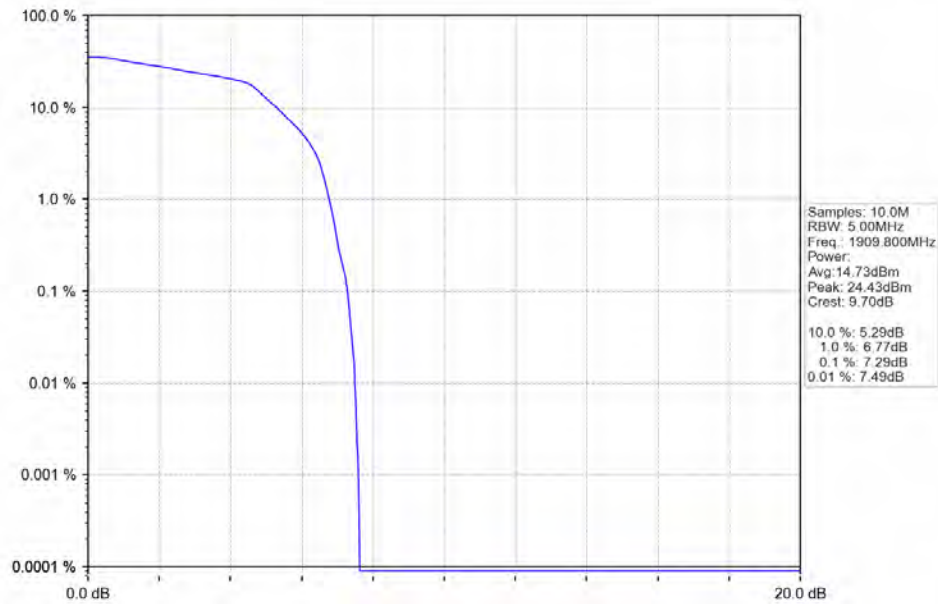



BUREAU
VERITAS

Test Report No.: W7L-P22090015-4RF05

SPURIOUS EMISSION TEST RESULT

Band: PCS1900						
ENV	Mode		Frequency (MHz)	Spurious Emission		Verdict
	Network	Subset		Result	Limit	
NTNV	GSM	1 TX Slot	1850.2	Refer To Test Graph	Pass	
			1880	Refer To Test Graph	Pass	
			1909.8	Refer To Test Graph	Pass	
	EGSM	1 TX Slot	1850.2	Refer To Test Graph	Pass	
			1880	Refer To Test Graph	Pass	
			1909.8	Refer To Test Graph	Pass	