



HAC RF TEST REPORT

No. I21Z61147-SEM01

For

HMD Global Oy

Smart Phone

Model Name: TA-1399

With

Hardware Version: V1.0

Software Version: 04US_0_033

FCC ID: 2AJOTTA-1399.

Results Summary: M Category = M3

Issued Date: 2021-09-09

Note:

The test results in this test report relate only to the devices specified in this report. This report shall not be reproduced except in full without the written approval of CTTL.

Test Laboratory:

CTTL, Telecommunication Technology Labs, CAICT

No. 51, Xueyuan Road, Haidian District, Beijing, P. R. China 100191.

Tel:+86(0)10-62304633-2512, Fax:+86(0)10-62304633-2504

Email: ctl_terminals@caict.ac.cn, website: www.caict.ac.cn



REPORT HISTORY

Report Number	Revision	Issue Date	Description
I21Z61147-SEM01	Rev.0	2021-09-09	Initial creation of test report

TABLE OF CONTENT

1 TEST LABORATORY	5
1.1 TESTING LOCATION	5
1.2 TESTING ENVIRONMENT.....	5
1.3 PROJECT DATA	5
1.4 SIGNATURE.....	5
2 CLIENT INFORMATION	6
2.1 APPLICANT INFORMATION.....	6
2.2 MANUFACTURER INFORMATION	6
3 EQUIPMENT UNDER TEST (EUT) AND ANCILLARY EQUIPMENT (AE)	7
3.1 ABOUT EUT.....	7
3.2 INTERNAL IDENTIFICATION OF EUT USED DURING THE TEST	7
3.3 INTERNAL IDENTIFICATION OF AE USED DURING THE TEST	7
3.4 AIR INTERFACES / BANDS INDICATING OPERATING MODES.....	8
4 MAXIMUM OUTPUT POWER	9
5 REFERENCE DOCUMENTS.....	11
5.1 REFERENCE DOCUMENTS FOR TESTING	11
6 OPERATIONAL CONDITIONS DURING TEST	12
6.1 HAC MEASUREMENT SET-UP.....	12
6.2 PROBE SPECIFICATION.....	13
6.3 TEST ARCH PHANTOM &PHONE POSITIONER	14
6.4 ROBOTIC SYSTEM SPECIFICATIONS	14
7 EUT ARRANGEMENT	15
7.1 WD RF EMISSION MEASUREMENTS REFERENCE AND PLANE	15
8 SYSTEM VALIDATION	16
8.1 VALIDATION PROCEDURE.....	16
8.2 VALIDATION RESULT	16
9 EVALUATION OF MIF	17
9.1 INTRODUCTION.....	17
9.2 MIF MEASUREMENT WITH THE AIA	18
9.3 TEST EQUIPMENT FOR THE MIF MEASUREMENT	18
9.4 DUT MIF RESULTS.....	18
10 EVALUATION FOR LOW-POWER EXEMPTION	20
10.1 PRODUCT TESTING THRESHOLD	20
10.2 CONDUCTED POWER.....	20
10.3 CONCLUSION.....	21
11 RF TEST PROCEDURES.....	22



12 MEASUREMENT RESULTS (E-FIELD)..... 23

13 ANSIC 63.19-2011 LIMITS 24

14 MEASUREMENT UNCERTAINTY 25

15 MAIN TEST INSTRUMENTS..... 26

16 CONCLUSION 26

ANNEX A TEST LAYOUT 27

ANNEX B TEST PLOTS 28

ANNEX C SYSTEM VALIDATION RESULT 38

ANNEX D PROBE CALIBRATION CERTIFICATE 42

ANNEX E DIPOLE CALIBRATION CERTIFICATE..... 51

1 Test Laboratory

1.1 Testing Location

CompanyName:	CTTL(Shouxiang)
Address:	No. 51 Shouxiang Science Building, Xueyuan Road, Haidian District, Beijing, P. R. China100191

1.2 Testing Environment

Temperature:	18°C~25°C,
Relative humidity:	30%~ 70%
Ground system resistance:	< 0.5 Ω
Ambient noise is checked and found very low and in compliance with requirement of standards. Reflection of surrounding objects is minimized and in compliance with requirement of standards.	

1.3 Project Data

Project Leader:	Qi Dianyuan
Test Engineer:	Lin Xiaojun
Testing Start Date:	August 16, 2021
Testing End Date:	September 05, 2021

1.4 Signature



Lin Xiaojun
(Prepared this test report)



Qi Dianyuan
(Reviewed this test report)



Lu Bingsong
Deputy Director of the laboratory
(Approved this test report)



2 Client Information

2.1 Applicant Information

Company Name:	HMD Global Oy
Address/Post:	Bertel Jungin aukio 9, 02600 Espoo, Finland
Contact Person:	Rosario Casillo
Contact Email:	rosario.casillo@hmdglobal.com
Telephone:	+393 316272922
Fax	

2.2 Manufacturer Information

Company Name:	HMD Global Oy
Address/Post:	Bertel Jungin aukio 9, 02600 Espoo, Finland
Contact Person:	Rosario Casillo
Contact Email:	rosario.casillo@hmdglobal.com
Telephone:	+393 316272922
Fax	

3 Equipment Under Test (EUT) and Ancillary Equipment (AE)

3.1 About EUT

Description:	Smart Phone
Model name:	TA-1399
Operating mode(s):	GSM850/900/1800/1900, WCDMA B1/B2/B4/B5/B8, 5G NR n25/n66/n71/n41, BT, Wi-Fi, LTE Band 1/2/3/4/5/7/8/12/13/17/20/25/26/38/39/40/41/66/71

3.2 Internal Identification of EUT used during the test

EUT ID*	IMEI	HW Version	SW Version
EUT1	354773220009975	V1.0	04US_0_033
EUT2	354773220013928	V1.0	04US_0_033
EUT3	354773220011401	V1.0	04US_0_033

*EUT ID: is used to identify the test sample in the lab internally.

Note: It is performed to test HAC with the EUT1-3

3.3 Internal Identification of AE used during the test

AE ID*	Description	Model	SN	Manufacturer
AE1	Battery	Rechargeable Li-ion Polymer Battery	/	TIANJIN LISHEN BATTERY JOINT-STOCK CO.,LTD.

*AE ID: is used to identify the test sample in the lab internally.

3.4 Air Interfaces / Bands Indicating Operating Modes

Air-interface	Band(MHz)	Type	C63.19/tested	Simultaneous Transmissions	Name of Voice Service
GSM	850	VO	Yes	BT, WLAN	CMRS Voice
	1900				
GPRS/EDGE	850	DT	Yes		Google duo
	1900				
WCDMA (UMTS)	850	VO	NO ⁽¹⁾	BT, WLAN	CMRS Voice
	1700				
	1900	DT	NO ⁽¹⁾		Google duo
LTE TDD	Band41	V/D	Yes	BT, WLAN	VoLTE, Google duo
LTE FDD	Band2/7/12/13/25/26/66/71	V/D	NO ⁽¹⁾	BT, WLAN	VoLTE, Google duo
NR	n25/n66/n71/n41	V/D	NO ⁽¹⁾	BT, WLAN	VoNR, Google duo
BT	2450	DT	NA	GSM,WCDMA ,LTE,NR	NA
WLAN	2450	V/D	Yes	GSM,WCDMA ,LTE,NR	VoWiFi, Google duo
WLAN	5G	V/D	NO ⁽¹⁾	GSM,WCDMA ,LTE,NR	VoWiFi, Google duo

NA: Not Applicable VO: Voice Only V/D: CMRS and IP Voice Service over Digital Transport

DT: Digital Transport

* HAC Rating was not based on concurrent voice and data modes, Non current mode was found to represent worst case rating for both M and T rating

Note1 = The air interface is exempted from testing by low power exemption that its average antenna input power plus its MIF is ≤ 17 dBm, and is rated as M4.

Note2= The device have similar frequency in some LTE bands : 5/26,4/66,12/17,38/41 since the supported frequency spans for the smaller LTE bands are completely cover by the larger LTE bands, therefore, only larger LTE bands were required to be tested for hearing-aid compliance.

4 Maximum Output Power

GSM 850MHz	Conducted Power (dBm)		
	Channel 251(848.8MHz)	Channel 190(836.6MHz)	Channel 128(824.2MHz)
Voice	33.5	33.5	33.5
EDGE	27.5	27.5	27.5
GSM 1900MHz	Conducted Power(dBm)		
	Channel 810(1909.8MHz)	Channel 661(1880MHz)	Channel 512(1850.2MHz)
Voice	30.5	30.5	30.5
EDGE	24.5	24.5	24.5
WCDMA 850MHz	Conducted Power (dBm)		
	Channel 4233(846.6MHz)	Channel 4182(836.4MHz)	Channel 4132(826.4MHz)
RMC	24.5	24.5	24.5
HSPA	23.5	23.5	23.5
WCDMA 1700MHz	Conducted Power (dBm)		
	Channel 1513 (1752.6MHz)	Channel 1412 (1732.4MHz)	Channel 1312 (1712.4MHz)
RMC	24.5	24.5	24.5
HSPA	23.5	23.5	23.5
WCDMA 1900MHz	Conducted Power (dBm)		
	Channel 9538(1907.6MHz)	Channel 9400(1880MHz)	Channel 9262(1852.4MHz)
RMC	24.5	24.5	24.5
HSPA	23.5	23.5	23.5
LTE Band2	Conducted Power (dBm)		
	Channel 19100(1900MHz)	Channel 18900(1880MHz)	Channel18700(1860MHz)
QPSK	24.7	24.7	24.7
LTE Band7	Conducted Power (dBm)		
	Channel 21350(2560MHz)	Channel 21100(2535MHz)	Channel20850(2510MHz)
QPSK	24.7	24.7	24.7
LTE Band12	Conducted Power (dBm)		
	Channel 23130(711MHz)	Channel 23095(707.5MHz)	Channel23060(704MHz)
QPSK	25	25	25
LTE Band13	Conducted Power (dBm)		
	Channel 23230(782MHz)		
QPSK	25		
LTE Band25	Conducted Power (dBm)		
	Channel 26590(1905MHz)	Channel 26365(1883MHz)	Channel 26140(1860MHz)
QPSK	24.8	24.8	24.8
LTE Band26	Conducted Power (dBm)		
	Channel 26965(841.5MHz)	Channel 26865(831.5MHz)	Channel 26775(822.5MHz)

QPSK	24.8	24.8	24.8
LTE Band41(Pow er Class 2)	Conducted Power (dBm)		
	Channel 41490(2680MHz)	Channel 40620(2593MHz)	Channel 39750(2506MHz)
QPSK	27.2	27.2	27.2
LTE Band41(Pow er Class 3)	Conducted Power (dBm)		
	Channel 41490(2680MHz)	Channel 40620(2593MHz)	Channel 39750(2506MHz)
QPSK	24.8	24.8	24.8
LTE Band66	Conducted Power (dBm)		
	Channel 132572(1770MHz)	Channel 132322(1745MHz)	Channel 133072(1720MHz)
QPSK	24.6	24.6	24.6
LTE Band71	Conducted Power (dBm)		
	Channel 133372(688MHz)	Channel 133322(683MHz)	Channel 133222(673MHz)
QPSK	24.8	24.8	24.8
2.4GHz 802.11b	Conducted Power (dBm)		
	Channel 11 (2462MHz)	Channel 6 (2437MHz)	Channel 1 (2412MHz)
	20.5	20.5	20.5
5GHz 802.11a	Tune up (dBm)		
	Channel 60 (5300MHz)	Channel 124 (5620MHz)	Channel 157 (5785MHz)
	21	21	21
5G NR N25	Conducted Power (dBm)		
	Channel 381000 (1905MHz)	Channel 376500 (1882.5MHz)	Channel 372000 (1860MHz)
	24.8	24.8	24.8
5G NR N66	Conducted Power (dBm)		
	Channel 354000 (1770MHz)	Channel 349000 (1745MHz)	Channel 344000 (1720MHz)
	24.9	24.9	24.9
5G NR N71	Conducted Power (dBm)		
	Channel 137600 (688MHz)	Channel 136100 (680.5MHz)	Channel 134600 (673MHz)
	25	25	25
5G NR N41	Conducted Power (dBm)		
	Channel 528000 (2640MHz)	Channel 518598 (2592.99MHz)	Channel 509202 (2546.01MHz)
	27.5	27.5	27.5

5 Reference Documents

5.1 Reference Documents for testing

The following document listed in this section is referred for testing.

Reference	Title	Version
ANSI C63.19-2011	American National Standard for Methods of Measurement of Compatibility between Wireless Communication Devices and Hearing Aids	2011 Edition
FCC 47 CFR §20.19	Hearing Aid Compatible Mobile Headsets	2015 Edition
KDB 285076 D01	Equipment Authorization Guidance for Hearing Aid Compatibility	v05r01

6 OPERATIONAL CONDITIONS DURING TEST

6.1 HAC MEASUREMENT SET-UP

These measurements are performed using the DASY5 NEO automated dosimetric assessment system. It is made by Schmid & Partner Engineering AG (SPEAG) in Zurich, Switzerland. It consists of high precision robotics system (Stäubli), robot controller, Intel Core2 computer, near-field probe, probe alignment sensor. The robot is a six-axis industrial robot performing precise movements. A cell controller system contains the power supply, robot controller, teach pendant (Joystick), and remote control, is used to drive the robot motors. The PC consists of the HP Intel Core2 1.86 GHz computer with Windows XP system and HAC Measurement Software DASY5 NEO, A/D interface card, monitor, mouse, and keyboard. The Stäubli Robot is connected to the cell controller to allow software manipulation of the robot. A data acquisition electronic (DAE) circuit performs the signal amplification, signal multiplexing, AD-conversion, offset measurements, mechanical surface detection, collision detection, etc. is connected to the Electro-optical coupler (EOC). The EOC performs the conversion from the optical into digital electric signal of the DAE and transfers data to the PC plug-in card.

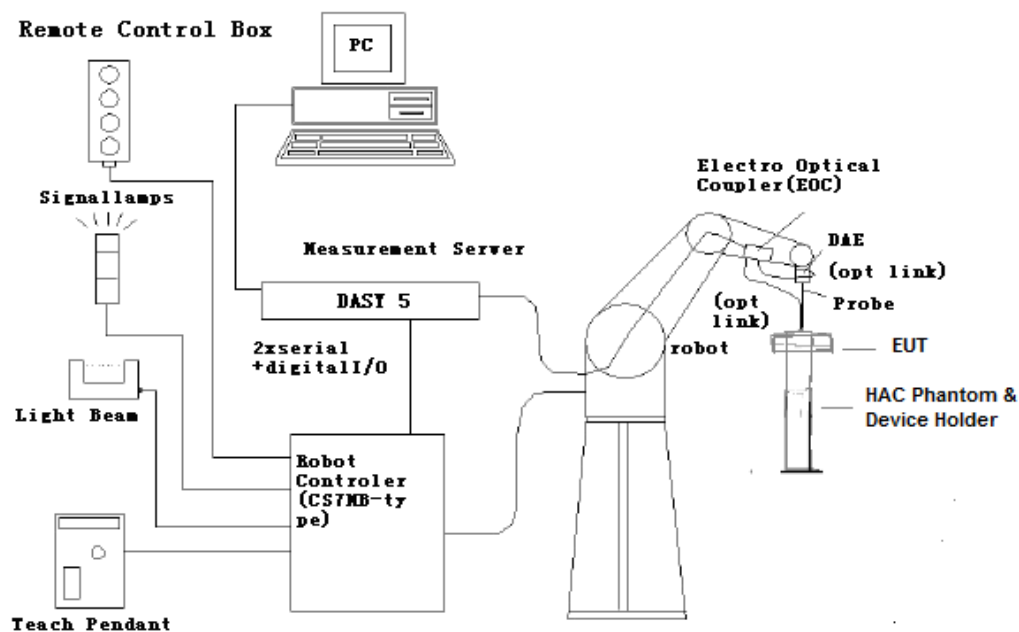

Fig. 1 HAC Test Measurement Set-up

The DAE4 consists of a highly sensitive electrometer-grade preamplifier with auto-zeroing, a channel and gain-switching multiplexer, a fast 16 bit AD-converter and a command decoder and control logic unit. Transmission to the PC-card is accomplished through an optical downlink for data and status information and an optical uplink for commands and clock lines. The mechanical probe mounting device includes two different sensor systems for frontal and sidewise probe contacts. They are also used for mechanical surface detection and probe collision detection. The robot uses its own controller with a built in VME-bus computer.

6.2 Probe Specification

E-Field Probe Description

Construction	One dipole parallel, two dipoles normal to probe axis Built-in shielding against static charges PEEK enclosure material
Calibration	In air from 100 MHz to 3.0 GHz (absolute accuracy $\pm 6.0\%$, $k=2$)
Frequency	40 MHz to > 6 GHz (can be extended to < 20 MHz) Linearity: ± 0.2 dB (100 MHz to 3 GHz)
Directivity	± 0.2 dB in air (rotation around probe axis) ± 0.4 dB in air (rotation normal to probe axis)
Dynamic Range	2 V/m to > 1000 V/m; Linearity: ± 0.2 dB
Dimensions	Overall length: 330 mm (Tip: 16 mm) Tip diameter: 8 mm (Body: 12 mm) Distance from probe tip to dipole centers: 2.5 mm
Application	General near-field measurements up to 6 GHz Field component measurements Fast automatic scanning in phantoms



[ER3DV6]

6.3 Test Arch Phantom & Phone Positioner

The Test Arch phantom should be positioned horizontally on a stable surface. Reference markings on the Phantom allow the complete setup of all predefined phantom positions and measurement grids by manually teaching three points in the robot. It enables easy and well defined positioning of the phone and validation dipoles as well as simple teaching of the robot (Dimensions: 370 x 370 x 370 mm).

The Phone Positioner supports accurate and reliable positioning of any phone with effect on near field $< \pm 0.5$ dB.

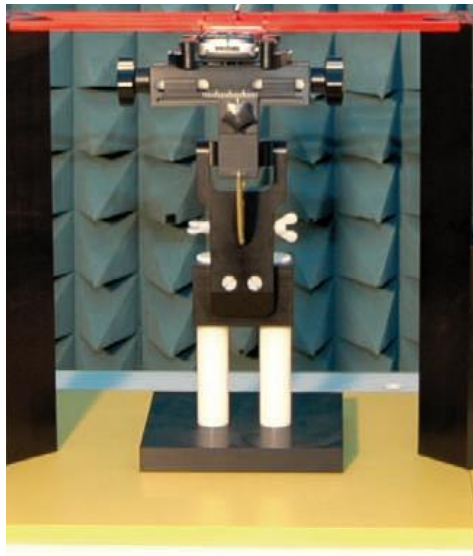

Fig. 2 HAC Phantom & Device Holder

6.4 Robotic System Specifications

Specifications

Positioner: Stäubli Unimation Corp. Robot Model: RX160L

Repeatability: ± 0.02 mm

No. of Axis: 6

Data Acquisition Electronic (DAE) System

Cell Controller

Processor: Intel Core2

Clock Speed: 1.86GHz

Operating System: Windows XP

Data Converter

Features: Signal Amplifier, multiplexer, A/D converter, and control logic

Software: DASY5 software

Connecting Lines: Optical downlink for data and status info.

Optical uplink for commands and clock

7 EUT ARRANGEMENT

7.1 WD RF Emission Measurements Reference and Plane

Figure 4 illustrates the references and reference plane that shall be used in the WD emissions measurement.

- The grid is 5 cm by 5 cm area that is divided into 9 evenly sized blocks or sub-grids.
- The grid is centered on the audio frequency output transducer of the WD (speaker or T-coil).
- The grid is located by reference to a reference plane. This reference plane is the planar area that contains the highest point in the area of the WD that normally rests against the user's ear
- The measurement plane is located parallel to the reference plane and 15 mm from it, out from the phone. The grid is located in the measurement plane.

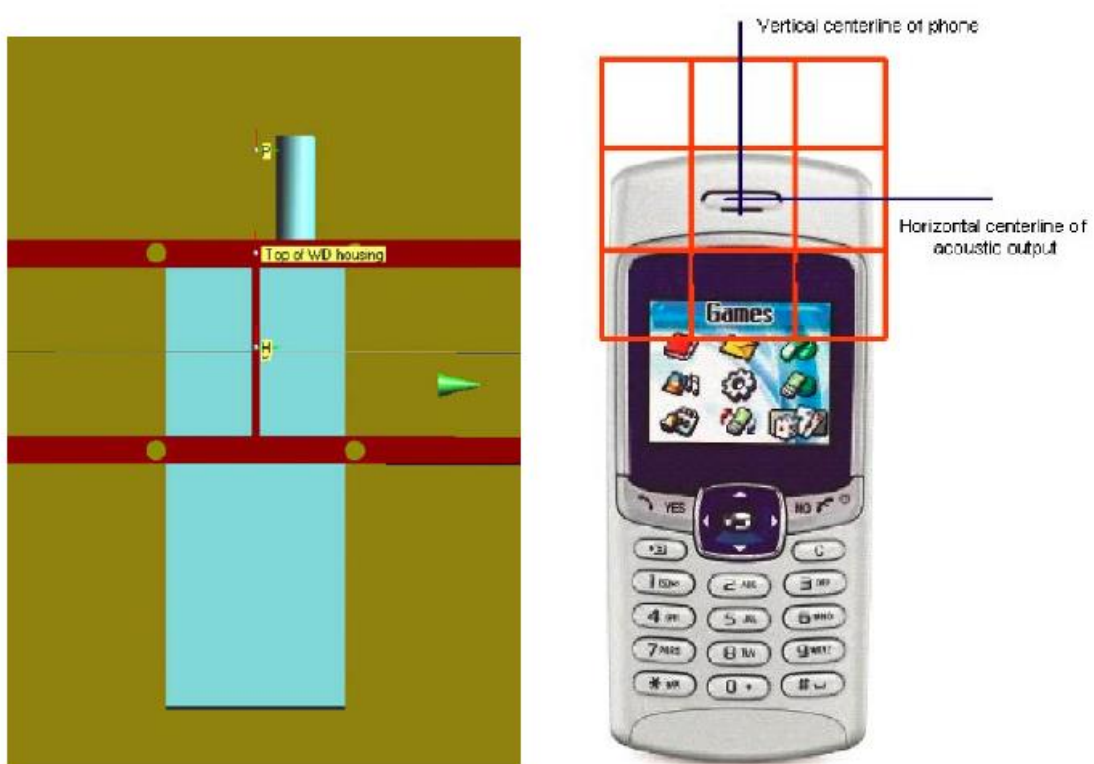

Fig. 3 WD reference and plane for RF emission measurements

8 SYSTEM VALIDATION

8.1 Validation Procedure

Place a dipole antenna meeting the requirements given in ANSI C63.19 in the position normally occupied by the WD. The dipole antenna serves as a known source for an electrical output. Position the E-field probes so that:

- The probes and their cables are parallel to the coaxial feed of the dipole antenna
- The probe cables and the coaxial feed of the dipole antenna approach the measurement area from opposite directions
- The center point of the probe element(s) are 15 mm from the closest surface of the dipole elements.

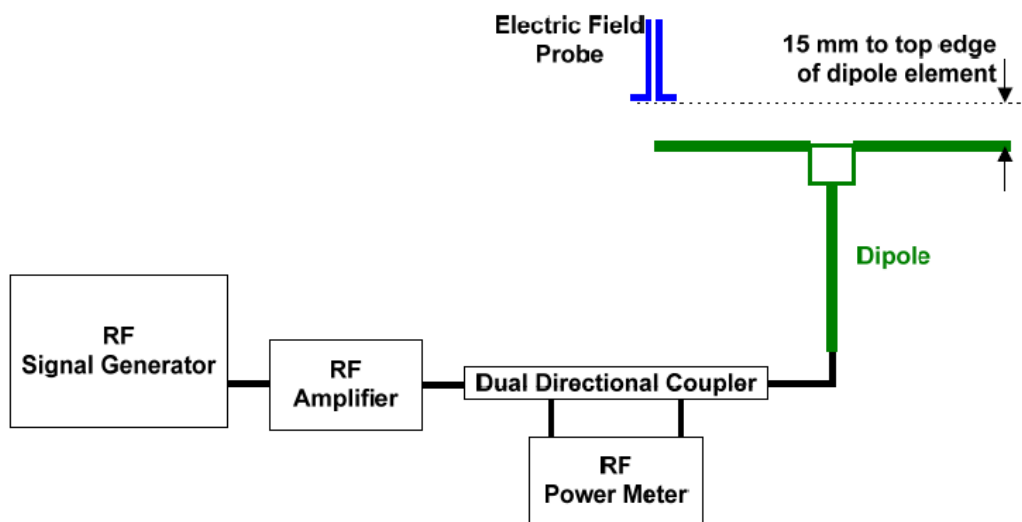

Fig. 4 Dipole Validation Setup

8.2 Validation Result

E-Field Scan						
Mode	Frequency (MHz)	Input Power (mW)	Measured ¹ Value(dBV/m)	Target ² Value(dBV/m)	Deviation ³ (%)	Limit ⁴ (%)
CW	835	100	40.63	40.90	-3.06	± 25
CW	1880	100	39.01	38.77	2.80	± 25
CW	2450	100	38.64	38.57	0.81	± 25
CW	2600	100	38.80	38.48	3.75	± 25

Notes:

1. Please refer to the attachment for detailed measurement data and plot.
2. Target value is provided by SPEAD in the calibration certificate of specific dipoles.
3. Deviation (%) = $100 * (\text{Measured value minus Target value}) / \text{Target value}$.
4. ANSI C63.19 requires values within $\pm 25\%$ are acceptable, of which 12% is deviation and 13% is measurement uncertainty. Values independently validated for the dipole actually used in the measurements should be used, when available.

9 Evaluation of MIF

9.1 Introduction

The MIF (Modulation Interference Factor) is used to classify E-field emission to determine Hearing Aid Compatibility (HAC). It scales the power-averaged signal to the RF audio interference level and is characteristic to a modulation scheme. The HAC standard preferred "indirect" measurement method is based on average field measurement with separate scaling by the MIF. With an Audio Interference Analyzer (AIA) designed by SPEAG specifically for the MIF measurement, these values have been verified by practical measurements on an RF signal modulated with each of the waveforms. The resulting deviations from the simulated values are within the requirements of the HAC standard.

The AIA (Audio Interference Analyzer) is a USB powered electronic sensor to evaluate signals in the frequency range 698MHz - 6 GHz. It contains RMS detector and audio frequency circuits for sampling of the RF envelope.

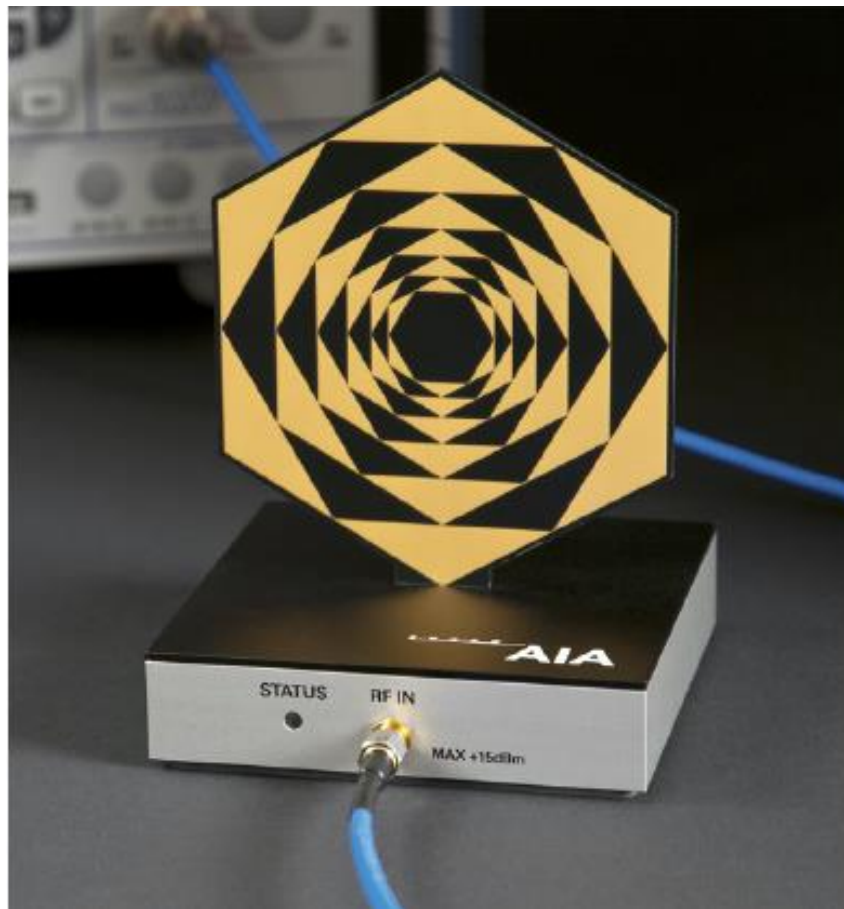

Fig. 5 AIA Front View

9.2 MIF measurement with the AIA

The MIF is measured with the AIA as follows:

1. Connect the AIA via USB to the DASY5 PC and verify the configuration settings.
2. Couple the RF signal to be evaluated to an AIA via cable or antenna.
3. Generate a MIF measurement job for the unknown signal and select the measurement port and timing settings.
4. Document the results via the post processor in a report.

9.3 Test equipment for the MIF measurement

No.	Name	Type	Serial Number	Manufacturer
01	Signal Generator	E4438C	MY49071430	Agilent
02	AIA	SE UMS 170 CB	1029	SPEAG
03	BTS	CMW500	166204	R&S

9.4 DUT MIF results

Based on the KDB285076D01v05, the handset can also use the MIF values predetermined by the test equipment manufacturer. MIF values applied in this test report were provided by the HAC equipment provider of SPEAG, and the worst values for all air interface are listed below to be determine the Low-power Exemption.

Typical MIF levels in ANSI C63.19-2011	
Transmission protocol	Modulation interference factor
GSM-FDD (TDMA, GMSK)	+3.63 dB
EDGE-FDD (TDMA, 8PSK, TN 0-1-2-3)	-1.82dB
UMTS-FDD(WCDMA, AMR)	-25.43dB
UMTS-FDD (HSPA)	-20.75dB
LTE-FDD (SC-FDMA, 1RB, 20MHz, QPSK)	-15.63 dB
LTE-FDD (SC-FDMA, 1RB, 20MHz, 16QAM)	-9.76 dB
LTE-FDD (SC-FDMA, 1RB, 20MHz, 64QAM)	-9.93 dB
LTE-TDD (SC-FDMA, 1RB, 20MHz, QPSK)	-1.62 dB
LTE-TDD (SC-FDMA, 1RB, 20MHz, 16QAM)	-1.44 dB
LTE-TDD (SC-FDMA, 1RB, 20MHz, 64QAM)	-1.54 dB
LTE-TDD(SC-FDMA,1RB,20MHz,QPSK,UL Subframe=2,3,4,7,8,9)	-3.41 dB
LTE-TDD(SC-FDMA,1RB,20MHz,16QAM,UL Subframe=2,3,4,7,8,9)	-3.17 dB
LTE-TDD(SC-FDMA,1RB,20MHz,64QAM,UL Subframe=2,3,4,7,8,9)	-3.31 dB
IEEE 802.11b WiFi 2.4 GHz (DSSS, 1 Mbps)	-5.90 dB
IEEE 802.11b WiFi 2.4 GHz (DSSS, 2 Mbps)	-5.17 dB
IEEE 802.11b WiFi 2.4 GHz (DSSS, 5.5 Mbps)	-3.37 dB
IEEE 802.11b WiFi 2.4 GHz (DSSS, 11 Mbps)	-2.02 dB

IEEE 802.11g WiFi 2.4 GHz (DSSS-OFDM, 6 Mbps)	-0.36dB
IEEE 802.11n (HT Greenfield, 6.5 Mbps, BPSK)	-15.80 dB
IEEE 802.11a/h WiFi 5 GHz (OFDM, 6 Mbps)	-5.82 dB
IEEE 802.11ac WiFi (20MHz, MCS0, 99pc duty cycle)	-12.23dB
5G NR (DFT-s-OFDM, 1 RB, 20 MHz, QPSK, 15 kHz)	-15.06dB
5G NR (CP-OFDM, 1 RB, 5 MHz, QPSK, 15 kHz)	-12.18dB
5G NR (CP-OFDM, 1 RB, 10 MHz, QPSK, 15 kHz)	-12.26dB
5G NR (CP-OFDM, 1 RB, 15 MHz, QPSK, 15 kHz)	-12.08dB
5G NR (CP-OFDM, 1 RB, 20 MHz, QPSK, 15 kHz)	-12.20dB
5G NR (CP-OFDM, 1 RB, 5 MHz, QPSK, 30 kHz)	-14.39dB
5G NR (CP-OFDM, 1 RB, 10 MHz, QPSK, 30 kHz)	-14.47dB
5G NR (CP-OFDM, 1 RB, 15 MHz, QPSK, 30 kHz)	-14.33dB
5G NR (CP-OFDM, 1 RB, 20 MHz, QPSK, 30 kHz)	-14.46dB
5G NR (CP-OFDM, 1 RB, 25 MHz, QPSK, 30 kHz)	-14.35dB
5G NR (CP-OFDM, 1 RB, 30 MHz, QPSK, 30 kHz)	-14.32dB
5G NR (CP-OFDM, 1 RB, 40 MHz, QPSK, 30 kHz)	-14.32dB
5G NR (CP-OFDM, 1 RB, 50 MHz, QPSK, 30 kHz)	-14.55dB
5G NR (CP-OFDM, 1 RB, 60 MHz, QPSK, 30 kHz)	-14.45dB
5G NR (CP-OFDM, 1 RB, 80 MHz, QPSK, 30 kHz)	-14.47dB
5G NR (CP-OFDM, 1 RB, 90 MHz, QPSK, 30 kHz)	-14.43dB
5G NR (CP-OFDM, 1 RB, 100 MHz, QPSK, 30 kHz)	-14.38dB
5G NR (DFT-s-OFDM, 1 RB, 5 MHz, QPSK, 15 kHz)	-15.06dB
5G NR (DFT-s-OFDM, 1 RB, 10 MHz, QPSK, 15 kHz)	-15.06dB
5G NR (DFT-s-OFDM, 1 RB, 15 MHz, QPSK, 15 kHz)	-15.06dB
5G NR (DFT-s-OFDM, 1 RB, 20 MHz, QPSK, 15 kHz)	-15.06dB

10 Evaluation for low-power exemption

10.1 Product testing threshold

There are two methods for exempting an RF air interface technology from testing. The first method requires evaluation of the MIF for the worst-case operating mode. An RF air interface technology of a device is exempt from testing when its average antenna input power plus its MIF is ≤ 17 dBm for any of its operating modes. The second method does not require determination of the MIF. The RF emissions testing exemption shall be applied to an RF air interface technology in a device whose peak antenna input power, averaged over intervals $\leq 50 \mu s$, is ≤ 23 dBm. An RF air interface technology that is exempted from testing by either method shall be rated as M4.

The first method is used to be exempt from testing for the RF air interface technology in this report.

10.2 Conducted power

Band	Average power (dBm)	MIF (dB)	Sum (dBm)	C63.19 Tested
GSM 850 - Voice	33.5	3.63	37.13	Yes
GSM 850 - EDGE	27.5	-1.82	25.68	Yes*
GSM 1900 - Voice	30.5	3.63	34.13	Yes
GSM 1900 - EDGE	24.5	-1.82	22.68	Yes*
WCDMA 850 - RMC	24.5	-25.43	-0.93	No
WCDMA 850 - HSPA	23.5	-20.75	2.75	No
WCDMA 1700 - RMC	24.5	-25.43	-0.93	No
WCDMA 1700 - HSPA	23.5	-20.75	2.75	No
WCDMA 1900 - RMC	24.5	-25.43	-0.93	No
WCDMA 1900 - HSPA	23.5	-20.75	2.75	No
LTE Band 2 QPSK	24.7	-15.63	9.07	No
LTE Band 7 QPSK	24.7	-15.63	9.07	No
LTE Band 12 QPSK	25	-15.63	9.37	No
LTE Band 13 QPSK	25	-15.63	9.37	No
LTE Band 25 QPSK	24.8	-15.63	9.17	No
LTE Band 26 QPSK	24.8	-15.63	9.17	No
LTE Band 66 QPSK	24.6	-15.63	8.97	No
LTE Band 71 QPSK	24.8	-15.63	9.17	No
LTE Band 41 PC2 QPSK	27.2	-1.62	25.58	Yes
LTE Band 41 PC3 QPSK	24.8	-3.41	21.39	Yes
LTE Band 2 16QAM	23.7	-9.76	13.94	No
LTE Band 7 16QAM	23.7	-9.76	13.94	No
LTE Band 12 16QAM	24	-9.76	14.24	No
LTE Band 13 16QAM	24	-9.76	14.24	No

LTE Band 25 16QAM	23.8	-9.76	14.04	No
LTE Band 26 16QAM	23.8	-9.76	14.04	No
LTE Band 66 16QAM	23.6	-9.76	13.84	No
LTE Band 71 16QAM	23.8	-9.76	14.04	No
LTE Band 41 PC2 16QAM	26.2	-1.44	24.76	Yes
LTE Band 41 PC3 16QAM	23.8	-3.17	20.63	Yes
LTE Band 2 64QAM	22.7	-9.93	12.77	No
LTE Band 7 64QAM	22.7	-9.93	12.77	No
LTE Band 12 64QAM	23	-9.93	13.07	No
LTE Band 13 64QAM	23	-9.93	13.07	No
LTE Band 25 64QAM	22.8	-9.93	12.87	No
LTE Band 26 64QAM	22.8	-9.93	12.87	No
LTE Band 66 64QAM	22.6	-9.93	12.67	No
LTE Band 71 64QAM	22.8	-9.93	12.87	No
LTE Band 41 PC2 64QAM	25.2	-1.54	23.66	Yes
LTE Band 41 PC3 64QAM	22.8	-3.31	19.49	Yes
NR n25	24.8	-12.08	12.72	No
NR n66	24.9	-12.08	12.82	No
NR n71	25	-12.08	12.92	No
NR n41	27.5	-12.08	15.42	No
WiFi-2.4G	20.5	-2.02	18.48	Yes
WiFi-5G	21	-5.82	15.18	No

*Note: For GSM bands, EDGE modes were not evaluated as Voice modes were found to the worst-case modes for the GSM air interface.

10.3 Conclusion

According to the above table, the sums of average power and MIF for WCDMA, LTE FDD WiFi 5G and NR are less than 17dBm. So it is measured for GSM LTE TDD bands and WiFi 2.4G. The WCDMA, LTE FDD WiFi 5G and NR are exempt from testing and rated as M4.

11 RF TEST PROCEDURES

The evaluation was performed with the following procedure:

- 1) Confirm proper operation of the field probe, probe measurement system and other instrumentation and the positioning system.
- 2) Position the WD in its intended test position. The gauge block can simplify this positioning.
- 3) Configure the WD normal operation for maximum rated RF output power, at the desired channel and other operating parameters (e.g., test mode), as intended for the test.
- 4) The center sub-grid shall be centered on the center of the T-Coil mode axial measurement point or the acoustic output, as appropriate. Locate the field probe at the initial test position in the 50 mm by 50 mm grid, which is contained in the measurement plane. If the field alignment method is used, align the probe for maximum field reception.
- 5) Record the reading.
- 6) Scan the entire 50 mm by 50 mm region in equally spaced increments and record the reading at each measurement point. The distance between measurement points shall be sufficient to assure the identification of the maximum reading.
- 7) Identify the five contiguous sub-grids around the center sub-grid whose maximum reading is the lowest of all available choices. This eliminates the three sub-grids with the maximum readings. Thus, the six areas to be used to determine the WD's highest emissions are identified.
- 8) Identify the maximum field reading within the non-excluded sub-grids identified in Step 7)
- 9) Evaluate the MIF and add to the maximum steady-state rms field-strength reading to obtain the RF audio interference level..
- 10) Compare this RF audio interference level with the categories and record the resulting WD category rating.

12 Measurement Results (E-Field)

Frequency		Measured Value(dBV/m)	Power Drift (dB)	Category
MHz	Channel			
GSM 850				
848.8	251	33.44	-0.04	M4
836.6	190	33.69	-0.08	M4
824.2	128	34.14	0.02	M4 (see Fig B.1)
GSM 1900				
1909.8	810	31.64	0.06	M3
1880	661	32.00	0.02	M3 (see Fig B.2)
1850.2	512	31.99	0.03	M3
LTE Band 41 PC2 QPSK				
2680	41490	23.93	-0.02	M4
2636.5	41055	23.86	0.03	M4
2593	40620	26.44	-0.05	M4 (see Fig B.3)
2549.5	40185	25.39	0.03	M4
2506	39750	25.12	-0.02	M4
LTE Band 41 PC2 16QAM				
2680	41490	24.36	-0.05	M4
2636.5	41055	24.74	-0.06	M4
2593	40620	25.81	-0.02	M4
2549.5	40185	25.13	0.08	M4
2506	39750	24.82	-0.07	M4
LTE Band 41 PC2 64QAM				
2680	41490	23.97	0.12	M4
2636.5	41055	24.41	0.01	M4
2593	40620	24.58	-0.02	M4
2549.5	40185	23.46	0.08	M4
2506	39750	23.15	-0.02	M4
LTE Band 41 PC3 QPSK				
2680	41490	21.28	0.14	M4
2636.5	41055	18.86	0.03	M4
2593	40620	23.85	-0.01	M4 (see Fig B.4)
2549.5	40185	22.41	-0.09	M4
2506	39750	22.62	0.01	M4
LTE Band 41 PC3 16QAM				
2680	41490	21.35	0.11	M4
2636.5	41055	21.82	0.05	M4
2593	40620	22.14	0.01	M4
2549.5	40185	20.53	-0.06	M4
2506	39750	21.15	-0.07	M4
LTE Band 41 PC3 64QAM				

2680	41490	20.82	0.09	M4
2636.5	41055	19.89	0.02	M4
2593	40620	22.21	-0.01	M4
2549.5	40185	21.74	-0.09	M4
2506	39750	20.82	-0.02	M4
WiFi2.4G 11b				
2462	11	23.27	0.03	M4(see Fig B.5)
2437	6	21.59	0.02	M4
2412	1	22.73	-0.03	M4

13 ANSIC 63.19-2011 LIMITS

WD RF audio interference level categories in logarithmic units

Emission categories	< 960 MHz	E-field emissions
Category M1	50 to 55	dB (V/m)
Category M2	45 to 50	dB (V/m)
Category M3	40 to 45	dB (V/m)
Category M4	< 40	dB (V/m)
Emission categories	> 960 MHz	E-field emissions
Category M1	40 to 45	dB (V/m)
Category M2	35 to 40	dB (V/m)
Category M3	30 to 35	dB (V/m)
Category M4	< 30	dB (V/m)

14 MEASUREMENT UNCERTAINTY

No.	Error source	Type	Uncertainty Value(%)	Prob. Dist.	k	c _i E	Standard Uncertainty (%) u_i ; (%)E	Degree of freedom V_{eff} or ν_i
Measurement System								
1	Probe Calibration	B	5.	N	1	1	5.1	∞
2	Axial Isotropy	B	4.7	R	$\sqrt{3}$	1	2.7	∞
3	Sensor Displacement	B	16.5	R	$\sqrt{3}$	1	9.5	∞
4	Boundary Effects	B	2.4	R	$\sqrt{3}$	1	1.4	∞
5	Linearity	B	4.7	R	$\sqrt{3}$	1	2.7	∞
6	Scaling to Peak Envelope Power	B	2.0	R	$\sqrt{3}$	1	1.2	∞
7	System Detection Limit	B	1.0	R	$\sqrt{3}$	1	0.6	∞
8	Readout Electronics	B	0.3	N	1	1	0.3	∞
9	Response Time	B	0.8	R	$\sqrt{3}$	1	0.5	∞
10	Integration Time	B	2.6	R	$\sqrt{3}$	1	1.5	∞
11	RF Ambient Conditions	B	3.0	R	$\sqrt{3}$	1	1.7	∞
12	RF Reflections	B	12.0	R	$\sqrt{3}$	1	6.9	∞
13	Probe Positioner	B	1.2	R	$\sqrt{3}$	1	0.7	∞
14	Probe Positioning	A	4.7	R	$\sqrt{3}$	1	2.7	∞
15	Extra. And Interpolation	B	1.0	R	$\sqrt{3}$	1	0.6	∞
Test Sample Related								
16	Device Positioning Vertical	B	4.7	R	$\sqrt{3}$	1	2.7	∞
17	Device Positioning Lateral	B	1.0	R	$\sqrt{3}$	1	0.6	∞
18	Device Holder and Phantom	B	2.4	R	$\sqrt{3}$	1	1.4	∞
19	Power Drift	B	5.0	R	$\sqrt{3}$	1	2.9	∞

20	AIA measurement	B	12	R	$\sqrt{3}$	1	6.9	∞
Phantom and Setup related								
21	Phantom Thickness	B	2.4	R	$\sqrt{3}$	1	1.4	∞
Combined standard uncertainty(%)							16.2	
Expanded uncertainty (confidence interval of 95 %)		$u_e = 2u_c$		N	k=2		32.4	

15 MAIN TEST INSTRUMENTS

Table 1: List of Main Instruments

No.	Name	Type	Serial Number	Calibration Date	Valid Period
01	Signal Generator	E4483C	MY49071430	February 01, 2021	One Year
02	Power meter	NRP2	106276	May 11, 2021	One year
03	Power sensor	NRP6A	101369		
04	Amplifier	60S1G4	0331848	No Calibration Requested	
05	E-Field Probe	EF3DV3	4060	May 21, 2021	One year
06	DAE	SPEAG DAE4	1524	September 30, 2020	One year
07	HAC Dipole	CD835V3	1030	July 09, 2021	One year
08	HAC Dipole	CD1880V3	1023	July 09, 2021	One year
09	HAC Dipole	CD2450V3	1025	July 09, 2021	One year
10	HAC Dipole	CD2600V3	1017	August 18, 2020	One year
11	BTS	CMW500	166204	October 20, 2020	One year
12	AIA	SE UMS 170 CB	1029	No Calibration Requested	

16 CONCLUSION

The HAC measurement indicates that the EUT complies with the HAC limits of the ANSIC63.19-2011. The total M-rating is **M3**.

END OF REPORT BODY

ANNEX A TEST LAYOUT

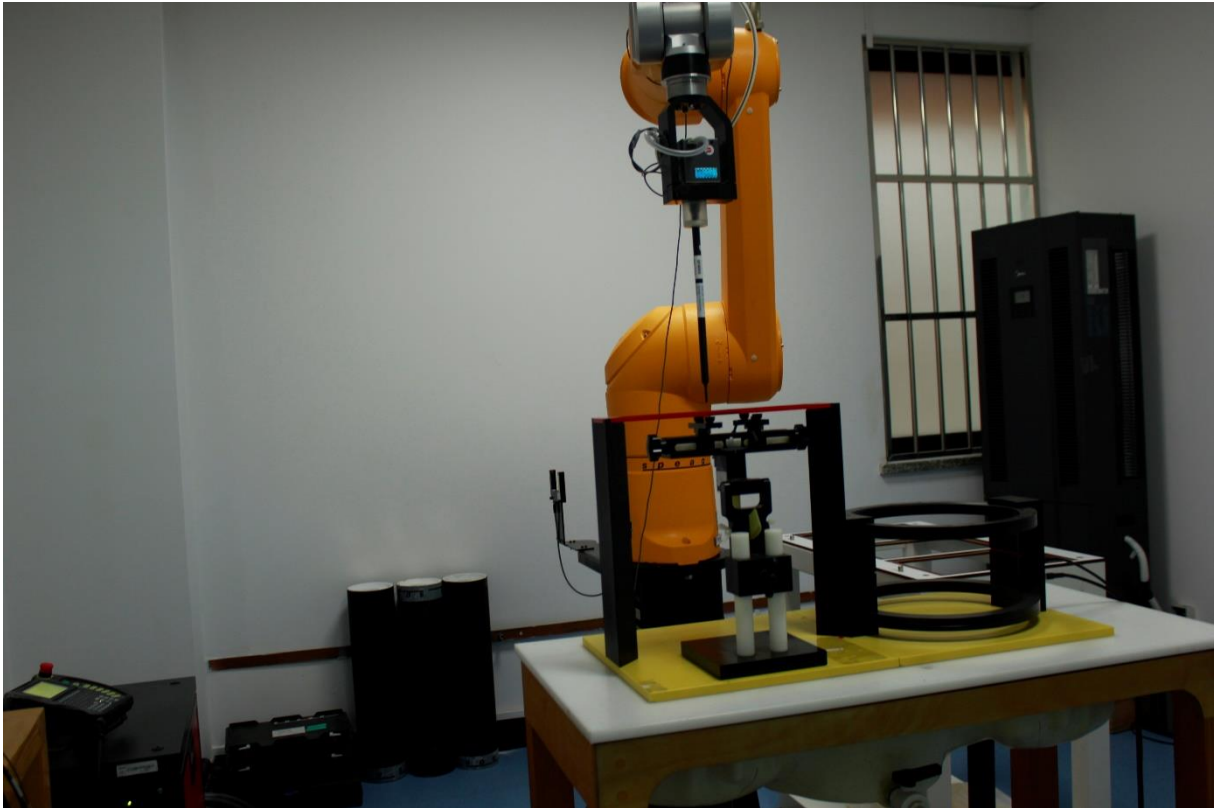

Picture A1:HAC RF System Layout

ANNEX B TEST PLOTS

HAC RF E-Field GSM 850 Low

Date: 2021-8-22

Electronics: DAE4 Sn1524

Medium: Air

Medium parameters used: $\sigma = 0$ mho/m, $\epsilon_r = 1$; $\rho = 1000$ kg/m³

Ambient Temperature: 22.0°C

Communication System: GSM 850; Frequency: 824.2 MHz; Duty Cycle: 1:8.3

Probe: EF3DV3 - SN4060;ConvF(1, 1, 1)

E Scan – ER3DV6 – 2011: 15 mm from Probe Center to the Device/Hearing

Aid Compatibility Test (101x101x1): Interpolated grid: dx=0.5000 mm,
dy=0.5000 mm

Device Reference Point: 0, 0, -6.3 mm

Reference Value = 36.83 V/m; Power Drift = 0.02 dB

Applied MIF = 3.53 dB

RF audio interference level = 34.14 dBV/m

Emission category: M4

MIF scaled E-field

Grid 1 M4 36.47 dBV/m	Grid 2 M4 36.58 dBV/m	Grid 3 M4 35.27 dBV/m
Grid 4 M4 33.22 dBV/m	Grid 5 M4 33.39 dBV/m	Grid 6 M4 32.62 dBV/m
Grid 7 M4 34.04 dBV/m	Grid 8 M4 34.14 dBV/m	Grid 9 M4 33.16 dBV/m

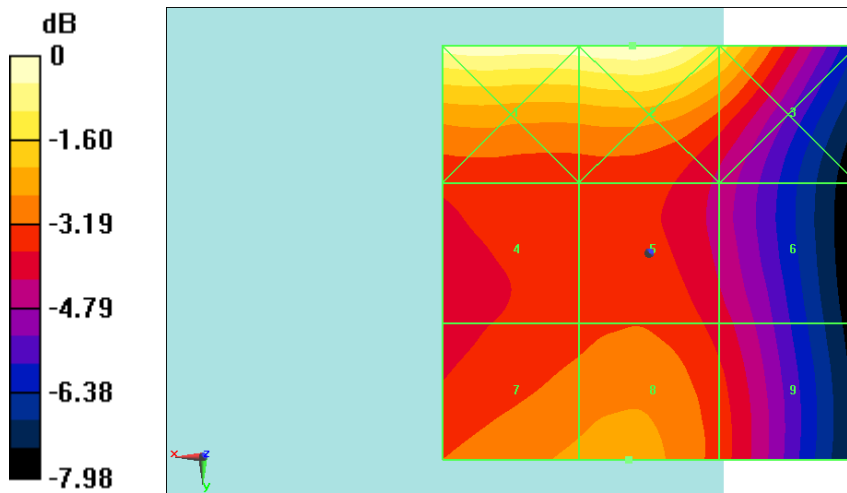

0 dB = 67.49 V/m = 36.58 dBV/m

Fig B.1 HAC RF E-Field GSM 850 Low

HAC RF E-Field GSM 1900 Middle

Date: 2021-9-02

Electronics: DAE4 Sn1524

Medium: Air

Medium parameters used: $\sigma = 0$ mho/m, $\epsilon_r = 1$; $\rho = 1000$ kg/m³

Ambient Temperature: 22.0°C

Communication System: PCS 1900; Frequency: 1880 MHz; Duty Cycle: 1:8.3

Probe: EF3DV3 - SN4060;ConvF(1, 1, 1)

E Scan - ER3DV6 - 2011: 15 mm from Probe Center to the Device 2 2

2/Hearing Aid Compatibility Test (101x101x1): Interpolated grid:

dx=0.5000 mm, dy=0.5000 mm

Device Reference Point: 0, 0, -6.3 mm

Reference Value = 35.99 V/m; Power Drift = 0.02 dB

Applied MIF = 3.40 dB

RF audio interference level = 32.00 dBV/m

Emission category: M3

MIF scaled E-field

Grid 1 M4 28.85 dBV/m	Grid 2 M3 31.75 dBV/m	Grid 3 M3 31.65 dBV/m
Grid 4 M4 29.78 dBV/m	Grid 5 M3 32 dBV/m	Grid 6 M3 31.91 dBV/m
Grid 7 M3 30.18 dBV/m	Grid 8 M3 31.85 dBV/m	Grid 9 M3 31.72 dBV/m

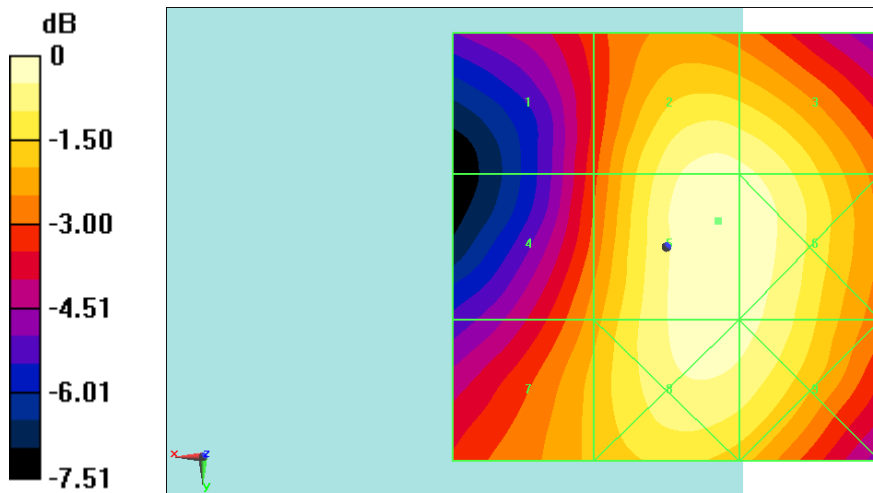

0 dB = 39.80 V/m = 32.00 dBV/m

Fig B.2 HAC RF E-Field GSM 1900 Middle

HAC RF E-Field LTE Band41 PC2 QPSK CH40620
Date: 2021-08-16

Electronics: DAE4 Sn1524

Medium: Air

 Medium parameters used: $\sigma = 0$ mho/m, $\epsilon_r = 1$; $\rho = 1000$ kg/m³

Ambient Temperature: 22.0°C

Communication System: LTE Band41; Frequency: 2593 MHz; Duty Cycle: 1:1.58

Probe: EF3DV3 - SN4060;ConvF(1, 1, 1)

E Scan - ER3DV6 - 2011: 15 mm from Probe Center to the Device

3/Hearing Aid Compatibility Test (101x101x1): Interpolated grid:

dx=0.5000 mm, dy=0.5000 mm

Device Reference Point: 0, 0, -6.3 mm

Reference Value = 28.25 V/m; Power Drift = -0.05 dB

Applied MIF = -1.76 dB

RF audio interference level = 26.44 dBV/m

Emission category: M4

MIF scaled E-field

Grid 1 M4 27.6 dBV/m	Grid 2 M4 27.61 dBV/m	Grid 3 M4 25.16 dBV/m
Grid 4 M4 26.28 dBV/m	Grid 5 M4 26.44 dBV/m	Grid 6 M4 24.93 dBV/m
Grid 7 M4 23.89 dBV/m	Grid 8 M4 24.11 dBV/m	Grid 9 M4 23.06 dBV/m

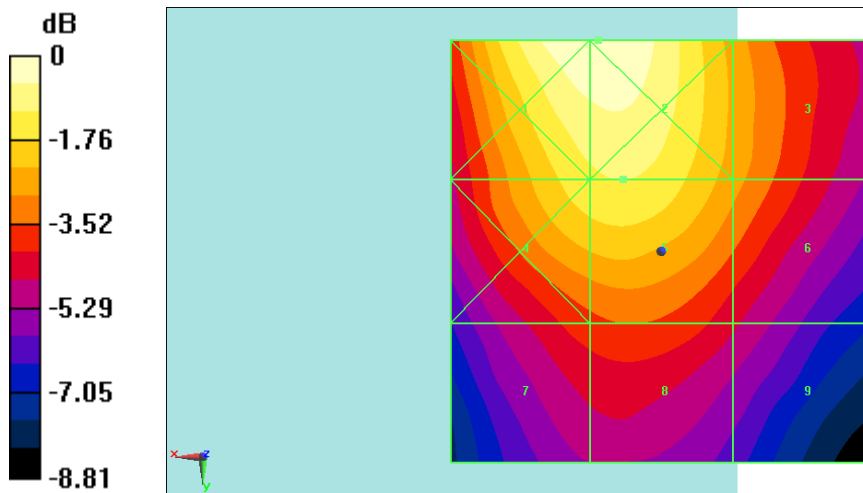

0 dB = 24.01 V/m = 27.61 dBV/m

Fig B.3 HAC RF E-Field LTE Band41 QPSK CH40620

HAC RF E-Field LTE Band41 PC3 QPSK CH40620
Date: 2021-08-16

Electronics: DAE4 Sn1524

Medium: Air

 Medium parameters used: $\sigma = 0$ mho/m, $\epsilon_r = 1$; $\rho = 1000$ kg/m³

Ambient Temperature: 22.0°C

Communication System: LTE Band41; Frequency: 2593 MHz; Duty Cycle: 1:1.58

Probe: EF3DV3 - SN4060;ConvF(1, 1, 1)

E Scan - ER3DV6 - 2011: 15 mm from Probe Center to the Device

3/Hearing Aid Compatibility Test (101x101x1): Interpolated grid:

dx=0.5000 mm, dy=0.5000 mm

Device Reference Point: 0, 0, -6.3 mm

Reference Value = 25.72 V/m; Power Drift = -0.01 dB

Applied MIF = -3.52 dB

RF audio interference level = 23.85 dBV/m

Emission category: M4

MIF scaled E-field

Grid 1 M4 24.92 dBV/m	Grid 2 M4 24.92 dBV/m	Grid 3 M4 22.44 dBV/m
Grid 4 M4 23.8 dBV/m	Grid 5 M4 23.85 dBV/m	Grid 6 M4 22.21 dBV/m
Grid 7 M4 22.09 dBV/m	Grid 8 M4 22.11 dBV/m	Grid 9 M4 20.63 dBV/m

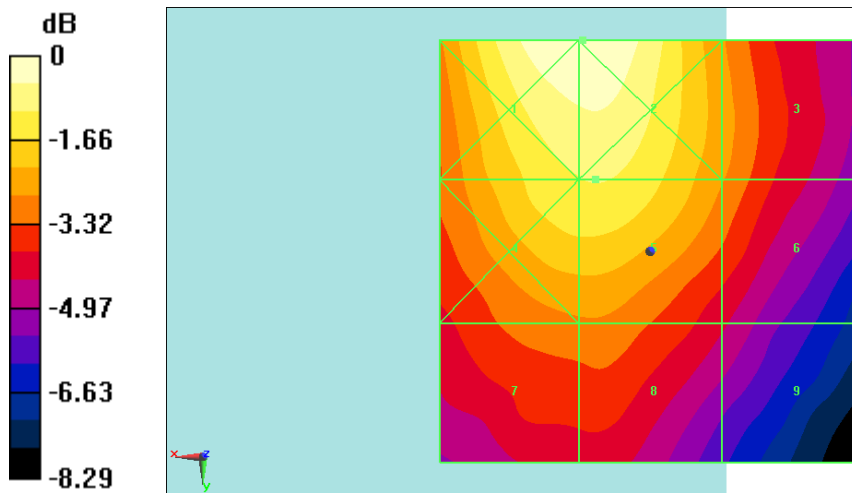

0 dB = 17.62 V/m = 24.92 dBV/m

Fig B.4 HAC RF E-Field LTE Band41 QPSK CH40620

HAC RF E-Field WiFi2.4G CH11

Date: 2021-09-05

Electronics: DAE4 Sn1524

Medium: Air

Medium parameters used: $\sigma = 0$ mho/m, $\epsilon_r = 1$; $\rho = 1000$ kg/m³

Ambient Temperature: 22.0°C

Communication System: WiFi2.4G; Frequency: 2412 MHz; Duty Cycle: 1:1

Probe: EF3DV3 - SN4060;ConvF(1, 1, 1)

/E Scan - ER3DV6 - 2011: 15 mm from Probe Center to the Device

2/Hearing Aid Compatibility Test (101x101x1): Interpolated grid:

dx=0.5000 mm, dy=0.5000 mm

Device Reference Point: 0, 0, -6.3 mm

Reference Value = 41.75 V/m; Power Drift = 0.03 dB

Applied MIF = -7.65 dB

RF audio interference level = 23.27 dBV/m

Emission category: **M4**

MIF scaled E-field

Grid 1 M4 20.41 dBV/m	Grid 2 M4 21.6 dBV/m	Grid 3 M4 21.55 dBV/m
Grid 4 M4 22.49 dBV/m	Grid 5 M4 23.27 dBV/m	Grid 6 M4 22.94 dBV/m
Grid 7 M4 22.8 dBV/m	Grid 8 M4 24.06 dBV/m	Grid 9 M4 23.65 dBV/m

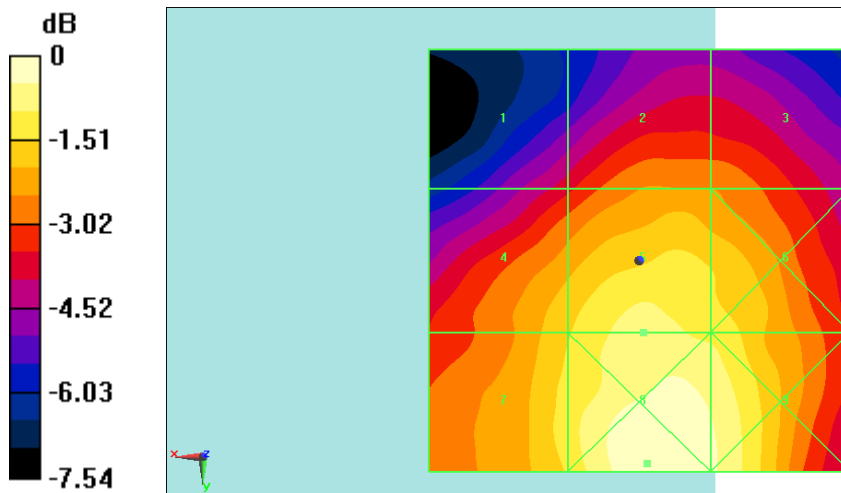

0 dB = 15.95 V/m = 24.06 dBV/m

Fig B.5 HAC RF E-Field WiFi2.4G 11b

ANNEX C SYSTEM VALIDATION RESULT

E SCAN of Dipole 835 MHz

Date: 2021-8-22

Electronics: DAE4 Sn1524

Medium: Air

Medium parameters used: $\sigma = 0$ mho/m, $\epsilon_r = 1$; $\rho = 1000$ kg/m³

Communication System: CW; Frequency: 835 MHz; Duty Cycle: 1:1

Probe: EF3DV3 - SN4060;ConvF(1, 1, 1)

E Scan - measurement distance from the probe sensor center to CD835 = 15mm/Hearing Aid Compatibility Test at 15mm distance (41x361x1): Interpolated grid: dx=0.5000 mm, dy=0.5000 mm

Device Reference Point: 0, 0, -6.3 mm

Reference Value = 128.4 V/m; Power Drift = 0.01 dB

Applied MIF = 0.00 dB

RF audio interference level = 40.63 dBV/m

Emission category: M3

MIF scaled E-field

Grid 1 M3 41.51 dBV/m	Grid 2 M3 41.51 dBV/m	Grid 3 M3 40.83 dBV/m
Grid 4 M4 36.29 dBV/m	Grid 5 M4 36.32 dBV/m	Grid 6 M4 36.11 dBV/m
Grid 7 M3 40.51 dBV/m	Grid 8 M3 40.63 dBV/m	Grid 9 M3 40.47 dBV/m

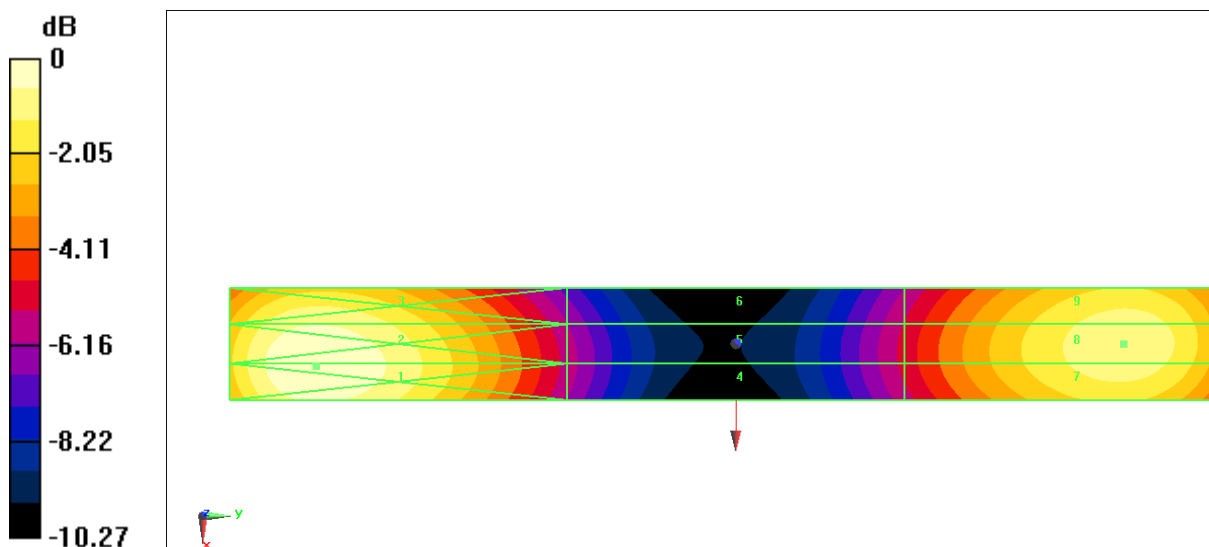

$$0 \text{ dB} = 119.0 \text{ V/m} = 41.51 \text{ dBV/m}$$

E SCAN of Dipole 1880MHz
Date: 2021-9-02

Electronics: DAE4 Sn1524

Medium: Air

 Medium parameters used: $\sigma = 0$ mho/m, $\epsilon_r = 1$; $\rho = 1000$ kg/m³

Communication System: CW; Frequency: 1880 MHz; Duty Cycle: 1:1

Probe: EF3DV3 - SN4060;ConvF(1, 1, 1)

**E Scan - measurement distance from the probe sensor center to CD1880 = 15mm
 2/Hearing Aid Compatibility Test at 15mm distance (41x181x1):** Interpolated grid:
 dx=0.5000 mm, dy=0.5000 mm

Device Reference Point: 0, 0, -6.3 mm

Reference Value = 133.2 V/m; Power Drift = 0.01 dB

Applied MIF = 0.00 dB

RF audio interference level = 39.01 dBV/m

Emission category: M2

MIF scaled E-field

Grid 1 M2 39.56 dBV/m	Grid 2 M2 39.55 dBV/m	Grid 3 M2 38.92 dBV/m
Grid 4 M2 37.06 dBV/m	Grid 5 M2 37.11 dBV/m	Grid 6 M2 37.03 dBV/m
Grid 7 M2 38.87 dBV/m	Grid 8 M2 39.01 dBV/m	Grid 9 M2 38.86 dBV/m

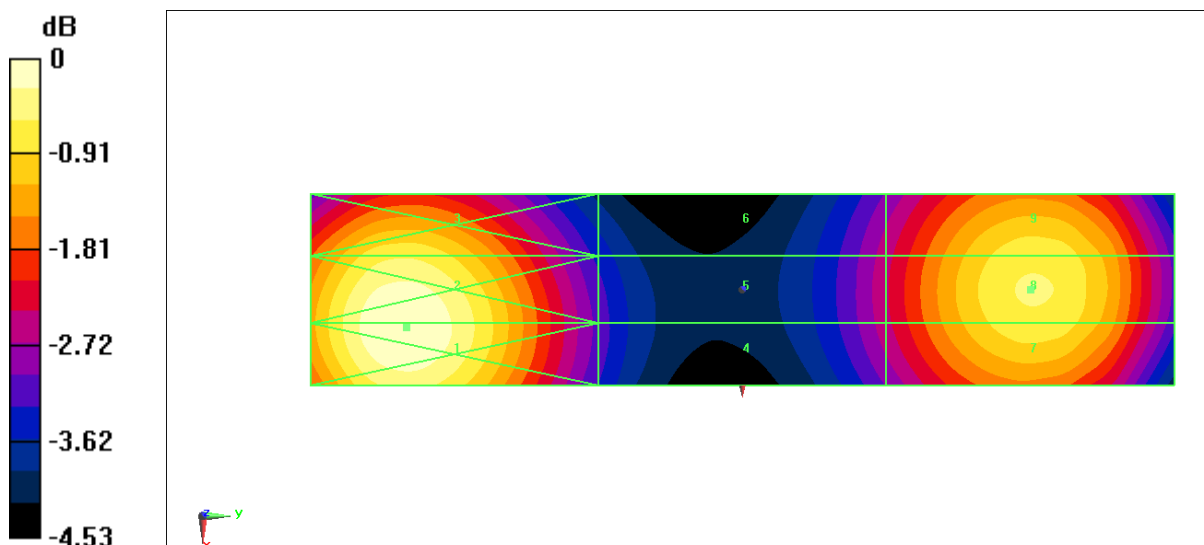

0 dB = 95.03 V/m = 39.56 dBV/m

E SCAN of Dipole 2450 MHz
Date: 2021-9-05

Electronics: DAE4 Sn1524

Medium: Air

 Medium parameters used: $\sigma = 0$ mho/m, $\epsilon_r = 1$; $\rho = 1000$ kg/m³

Communication System: CW; Frequency: 2450 MHz; Duty Cycle: 1:1

Probe: EF3DV3 - SN4060;ConvF(1, 1, 1)

E Scan - measurement distance from the probe sensor center to CD2450 = 15mm/Hearing Aid Compatibility Test at 15mm distance (41x181x1): Interpolated grid: dx=0.5000 mm, dy=0.5000 mm

Device Reference Point: 0, 0, -6.3 mm

Reference Value = 69.45 V/m; Power Drift = 0.01 dB

Applied MIF = 0.00 dB

RF audio interference level = 38.64 dBV/m

Emission category: M2

MIF scaled E-field

Grid 1 M2 38.75 dBV/m	Grid 2 M2 38.77 dBV/m	Grid 3 M2 38.36 dBV/m
Grid 4 M2 38.14 dBV/m	Grid 5 M2 38.18 dBV/m	Grid 6 M2 38.02 dBV/m
Grid 7 M2 38.57 dBV/m	Grid 8 M2 38.64 dBV/m	Grid 9 M2 38.44 dBV/m

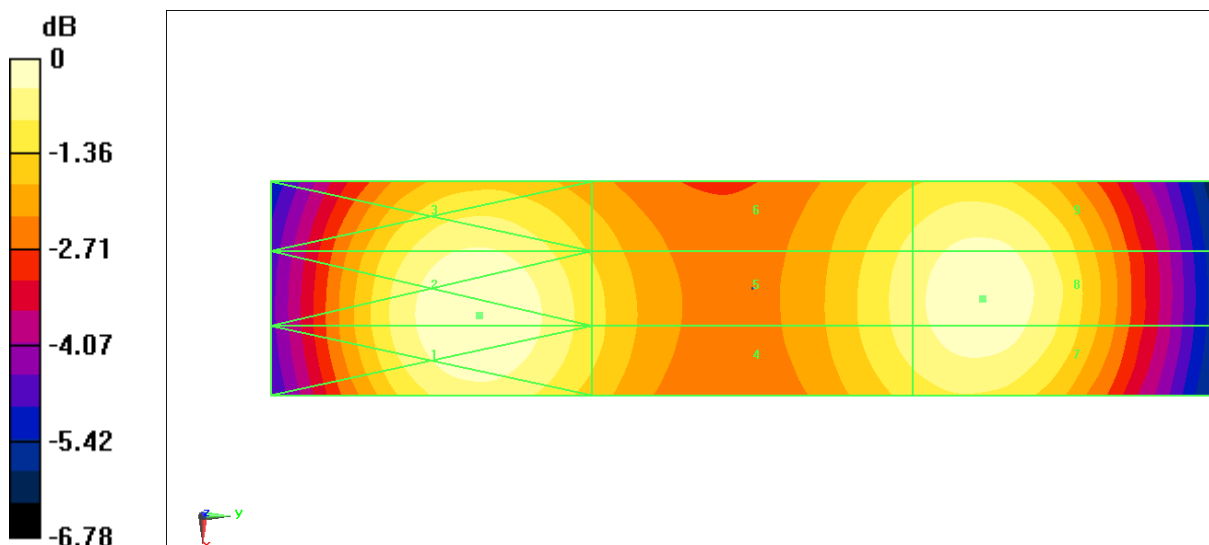

0 dB = 86.75 V/m = 38.77 dBV/m

E SCAN of Dipole 2600 MHz
Date: 2021-8-16

Electronics: DAE4 Sn1524

Medium: Air

 Medium parameters used: $\sigma = 0$ mho/m, $\epsilon_r = 1$; $\rho = 1000$ kg/m³

Communication System: CW; Frequency: 2600 MHz; Duty Cycle: 1:1

Probe: EF3DV3 - SN4060;ConvF(1, 1, 1)

Dipole E-Field measurement (E-field scan for ANSI C63.19-2007 & -2011 compliance)/E Scan - measurement distance from the probe sensor center to CD2600 = 15mm/Hearing Aid Compatibility Test at 15mm distance (41x141x1): Interpolated grid: dx=0.5000 mm, dy=0.5000 mm

Device Reference Point: 0, 0, -6.3 mm

Reference Value = 64.26 V/m; Power Drift = 0.01 dB

Applied MIF = 0.00 dB

RF audio interference level = 38.80 dBV/m

Emission category: M2

MIF scaled E-field

Grid 1 M2 38.95 dBV/m	Grid 2 M2 38.96 dBV/m	Grid 3 M2 38.59 dBV/m
Grid 4 M2 38.15 dBV/m	Grid 5 M2 38.18 dBV/m	Grid 6 M2 38.03 dBV/m
Grid 7 M2 38.72 dBV/m	Grid 8 M2 38.8 dBV/m	Grid 9 M2 38.58 dBV/m

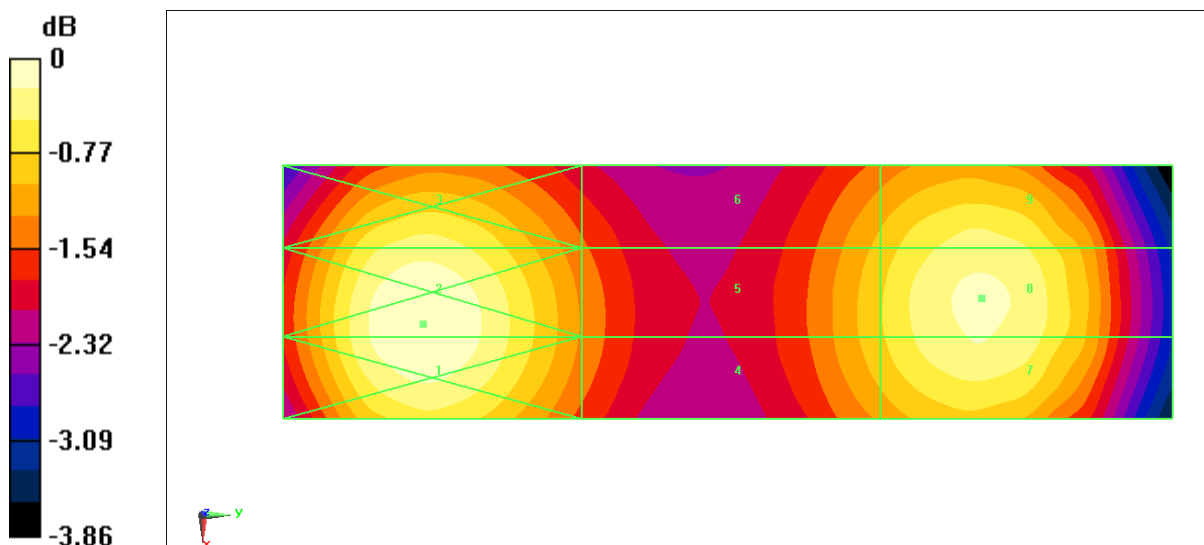

0 dB = 88.75 V/m = 38.96 dBV/m

ANNEX D PROBE CALIBRATION CERTIFICATE

Calibration Laboratory of
Schmid & Partner
Engineering AG
 Zeughausstrasse 43, 8004 Zurich, Switzerland



S Schweizerischer Kalibrierdienst
C Service suisse d'étalonnage
S Servizio svizzero di taratura
S Swiss Calibration Service

Accredited by the Swiss Accreditation Service (SAS)
 The Swiss Accreditation Service is one of the signatories to the EA
 Multilateral Agreement for the recognition of calibration certificates

Accreditation No.: SCS 0108

Client **CTTL-BJ (Auden)**

Certificate No: **EF3-4060_May21**

CALIBRATION CERTIFICATE

Object **EF3DV3- SN:4060**

Calibration procedure(s) **QA CAL-02.v9, QA CAL-25.v7**
 Calibration procedure for E-field probes optimized for close near field
 evaluations in air

Calibration date: **May 21, 2021**

This calibration certificate documents the traceability to national standards, which realize the physical units of measurements (SI).
 The measurements and the uncertainties with confidence probability are given on the following pages and are part of the certificate.

All calibrations have been conducted in the closed laboratory facility: environment temperature (22 ± 3)°C and humidity < 70%.

Calibration Equipment used (M&TE critical for calibration)

Primary Standards	ID	Cal Date (Certificate No.)	Scheduled Calibration
Power meter NRP	SN: 104778	09-Apr-21 (No. 217-03291/03292)	Apr-22
Power sensor NRP-Z91	SN: 103244	09-Apr-21 (No. 217-03291)	Apr-22
Power sensor NRP-Z91	SN: 103245	09-Apr-21 (No. 217-03292)	Apr-22
Reference 20 dB Attenuator	SN: CC2552 (20x)	09-Apr-21 (No. 217-03343)	Apr-22
DAE4	SN: 789	23-Dec-20 (No. DAE4-789_Dec20)	Dec-21
Reference Probe ER3DV6	SN: 2328	05-Oct-20 (No. ER3-2328_Oct20)	Oct-21
Secondary Standards	ID	Check Date (in house)	Scheduled Check
Power meter E4419B	SN: GB41293874	06-Apr-16 (in house check Jun-20)	In house check: Jun-22
Power sensor E4412A	SN: MY41498087	06-Apr-16 (in house check Jun-20)	In house check: Jun-22
Power sensor E4412A	SN: 000110210	06-Apr-16 (in house check Jun-20)	In house check: Jun-22
RF generator HP 8648C	SN: US3642U01700	04-Aug-99 (in house check Jun-20)	In house check: Jun-22
Network Analyzer E8358A	SN: US41080477	31-Mar-14 (in house check Oct-20)	In house check: Oct-21

	Name	Function	Signature
Calibrated by:	Jeffrey Katzman	Laboratory Technician	
Approved by:	Katja Pokovic	Technical Manager	

Issued: May 21, 2021

This calibration certificate shall not be reproduced except in full without written approval of the laboratory.

Calibration Laboratory of
Schmid & Partner
Engineering AG
 Zeughausstrasse 43, 8004 Zurich, Switzerland



S Schweizerischer Kalibrierdienst
C Service suisse d'étalonnage
S Servizio svizzero di taratura
S Swiss Calibration Service

Accredited by the Swiss Accreditation Service (SAS)
The Swiss Accreditation Service is one of the signatories to the EA
Multilateral Agreement for the recognition of calibration certificates

Accreditation No.: **SCS 0108**

Glossary:

NORM _{x,y,z}	sensitivity in free space
DCP	diode compression point
CF	crest factor (1/duty_cycle) of the RF signal
A, B, C, D	modulation dependent linearization parameters
E _n	incident E-field orientation normal to probe axis
E _p	incident E-field orientation parallel to probe axis
Polarization φ	φ rotation around probe axis
Polarization θ	θ rotation around an axis that is in the plane normal to probe axis (at measurement center). i.e., θ = 0 is normal to probe axis
Connector Angle	information used in DASY system to align probe sensor X to the robot coordinate system

Calibration is Performed According to the Following Standards:

- a) IEEE Std 1309-2005, "IEEE Standard for calibration of electromagnetic field sensors and probes, excluding antennas, from 9 kHz to 40 GHz", December 2005
- b) CTIA Test Plan for Hearing Aid Compatibility, Rev 3.1.1, May 2017

Methods Applied and Interpretation of Parameters:

- **NORM_{x,y,z}**: Assessed for E-field polarization θ = 0 for XY sensors and θ = 90 for Z sensor (f ≤ 900 MHz in TEM-cell; f > 1800 MHz: R22 waveguide).
- **NORM(f)_{x,y,z} = NORM_{x,y,z} * frequency_response** (see Frequency Response Chart).
- **DCP_{x,y,z}**: DCP are numerical linearization parameters assessed based on the data of power sweep with CW signal (no uncertainty required). DCP does not depend on frequency nor media.
- **PAR**: PAR is the Peak to Average Ratio that is not calibrated but determined based on the signal characteristics
- **A_{x,y,z}; B_{x,y,z}; C_{x,y,z}; D_{x,y,z}; VR_{x,y,z}**: A, B, C, D are numerical linearization parameters assessed based on the data of power sweep for specific modulation signal. The parameters do not depend on frequency nor media. VR is the maximum calibration range expressed in RMS voltage across the diode.
- **Spherical isotropy (3D deviation from isotropy)**: in a locally homogeneous field realized using an open waveguide setup.
- **Sensor Offset**: The sensor offset corresponds to the offset of virtual measurement center from the probe tip (on probe axis). No tolerance required.
- **Connector Angle**: The angle is assessed using the information gained by determining the **NORM_x** (no uncertainty required).

EF3DV3 – SN:4060

May 21, 2021

DASY/EASY - Parameters of Probe: EF3DV3 - SN:4060

Basic Calibration Parameters

	Sensor X	Sensor Y	Sensor Z	Unc (k=2)
Norm ($\mu\text{V}/(\text{V}/\text{m})^2$)	0.79	0.74	1.27	$\pm 10.1\%$
DCP (mV) ^B	95.0	97.0	94.2	

Calibration results for Frequency Response (30 MHz – 6 GHz)

Frequency MHz	Target E-Field V/m	Measured E-field (En) V/m	Deviation E-normal in %	Measured E-field (Ep) V/m	Deviation E-normal in %	Unc (k=2) %
30	77.2	77.3	0.2%	77.1	-0.1%	$\pm 5.1\%$
100	77.2	78.3	1.4%	78.4	1.6%	$\pm 5.1\%$
450	77.1	78.2	1.4%	78.4	1.7%	$\pm 5.1\%$
600	77.1	77.8	0.9%	77.8	1.0%	$\pm 5.1\%$
750	77.0	77.5	0.7%	77.5	0.7%	$\pm 5.1\%$
1800	143.1	139.1	-2.7%	139.6	-2.4%	$\pm 5.1\%$
2000	135.0	131.3	-2.7%	131.6	-2.5%	$\pm 5.1\%$
2200	127.7	123.5	-3.3%	124.5	-2.5%	$\pm 5.1\%$
2500	125.5	122.4	-2.5%	123.6	-1.5%	$\pm 5.1\%$
3000	79.3	75.6	-4.7%	76.6	-3.4%	$\pm 5.1\%$
3500	256.3	246.2	-3.9%	242.9	-4.7%	$\pm 5.1\%$
3700	249.5	239.6	-4.0%	238.1	-4.6%	$\pm 5.1\%$
5200	50.7	51.3	1.3%	51.4	1.4%	$\pm 5.1\%$
5500	49.7	49.4	-0.5%	48.0	-3.4%	$\pm 5.1\%$
5800	48.9	48.6	-0.7%	49.5	1.3%	$\pm 5.1\%$

The reported uncertainty of measurement is stated as the standard uncertainty of measurement multiplied by the coverage factor k=2, which for a normal distribution corresponds to a coverage probability of approximately 95%.

^B Numerical linearization parameter: uncertainty not required.

^E Uncertainty is determined using the max. deviation from linear response applying rectangular distribution and is expressed for the square of the field value.

EF3DV3 – SN:4060

May 21, 2021

DASY/EASY - Parameters of Probe: EF3DV3 - SN:4060

Calibration Results for Modulation Response

UID	Communication System Name		A dB	B dB/μV	C	D dB	VR mV	Max dev.	Max Unc ^E (k=2)
0	CW	X	0.00	0.00	1.00	0.00	128.0	± 3.0 %	± 4.7 %
		Y	0.00	0.00	1.00		122.6		
		Z	0.00	0.00	1.00		126.8		
10352-AAA	Pulse Waveform (200Hz, 10%)	X	2.34	64.67	9.12	10.00	60.0	± 2.8 %	± 9.6 %
		Y	3.40	68.47	11.14		60.0		
		Z	2.56	65.64	9.75		60.0		
10353-AAA	Pulse Waveform (200Hz, 20%)	X	1.17	62.34	7.11	6.99	80.0	± 1.0 %	± 9.6 %
		Y	2.12	67.49	9.84		80.0		
		Z	1.28	63.31	7.74		80.0		
10354-AAA	Pulse Waveform (200Hz, 40%)	X	0.76	62.99	6.54	3.98	95.0	± 0.8 %	± 9.6 %
		Y	8.48	81.16	13.43		95.0		
		Z	0.81	63.88	7.07		95.0		
10355-AAA	Pulse Waveform (200Hz, 60%)	X	3.06	72.89	9.44	2.22	120.0	± 0.9 %	± 9.6 %
		Y	20.00	93.01	16.68		120.0		
		Z	20.00	83.16	11.95		120.0		
10387-AAA	QPSK Waveform, 1 MHz	X	1.99	71.10	17.30	1.00	150.0	± 2.0 %	± 9.6 %
		Y	1.93	70.25	16.95		150.0		
		Z	1.93	70.86	17.01		150.0		
10388-AAA	QPSK Waveform, 10 MHz	X	2.40	70.11	17.24	0.00	150.0	± 1.0 %	± 9.6 %
		Y	2.46	70.31	17.25		150.0		
		Z	2.31	69.59	16.93		150.0		
10396-AAA	64-QAM Waveform, 100 kHz	X	2.06	67.11	17.82	3.01	150.0	± 1.1 %	± 9.6 %
		Y	2.36	69.41	18.81		150.0		
		Z	2.02	66.55	17.38		150.0		
10399-AAA	64-QAM Waveform, 40 MHz	X	3.50	67.36	16.25	0.00	150.0	± 1.1 %	± 9.6 %
		Y	3.59	67.71	16.35		150.0		
		Z	3.45	67.13	16.11		150.0		
10414-AAA	WLAN CCDF, 64-QAM, 40MHz	X	4.72	65.68	15.83	0.00	150.0	± 1.9 %	± 9.6 %
		Y	4.68	65.48	15.66		150.0		
		Z	4.67	65.58	15.76		150.0		

Note: For details on UID parameters see Appendix

The reported uncertainty of measurement is stated as the standard uncertainty of measurement multiplied by the coverage factor k=2, which for a normal distribution corresponds to a coverage probability of approximately 95%.

^B Numerical linearization parameter: uncertainty not required.

^E Uncertainty is determined using the max. deviation from linear response applying rectangular distribution and is expressed for the square of the field value.



EF3DV3 – SN:4060

May 21, 2021

DASY/EASY - Parameters of Probe: EF3DV3 - SN:4060**Sensor Frequency Model Parameters**

	Sensor X	Sensor Y	Sensor Z
Frequency Corr. (LF)	0.22	0.23	4.73
Frequency Corr. (HF)	2.82	2.82	2.82

Sensor Model Parameters

	C1 fF	C2 fF	α V ⁻¹	T1 ms.V ⁻²	T2 ms.V ⁻¹	T3 ms	T4 V ⁻²	T5 V ⁻¹	T6
X	37.2	247.97	37.40	5.87	0.02	4.95	0.12	0.10	1.00
Y	38.0	248.69	36.33	4.88	0.00	4.96	1.01	0.00	1.00
Z	35.3	236.35	37.63	4.53	0.04	4.96	0.00	0.13	1.00

Other Probe Parameters

Sensor Arrangement	Rectangular
Connector Angle (°)	144.4
Mechanical Surface Detection Mode	enabled
Optical Surface Detection Mode	disabled
Probe Overall Length	337 mm
Probe Body Diameter	12 mm
Tip Length	25 mm
Tip Diameter	4 mm
Probe Tip to Sensor X Calibration Point	1.5 mm
Probe Tip to Sensor Y Calibration Point	1.5 mm
Probe Tip to Sensor Z Calibration Point	1.5 mm

EF3DV3 – SN:4060

May 21, 2021

Receiving Pattern (ϕ), $\vartheta = 0^\circ$

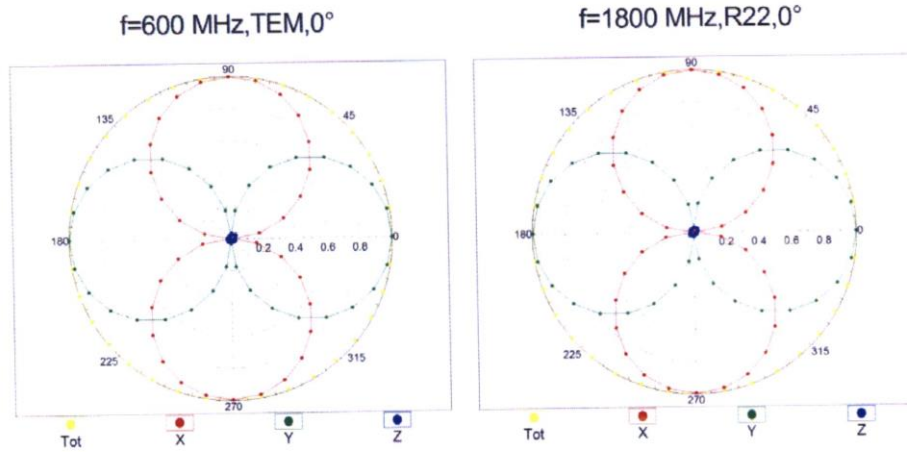

Receiving Pattern (ϕ), $\vartheta = 90^\circ$

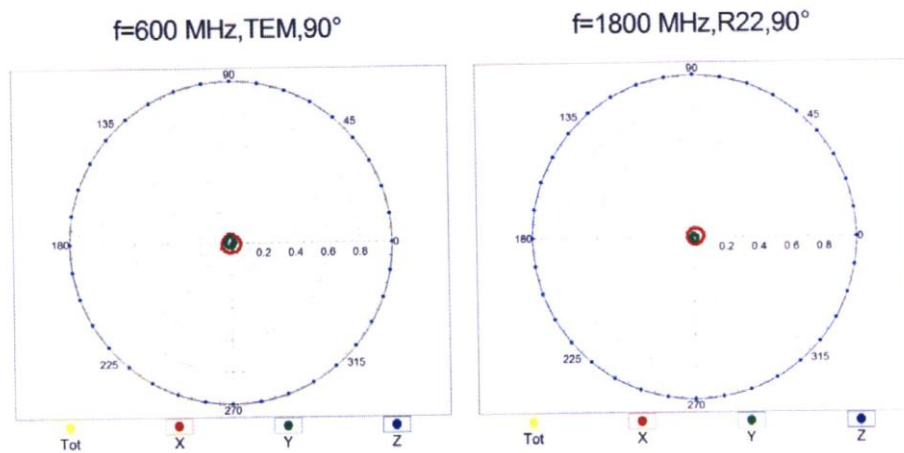

Receiving Pattern (ϕ), $\vartheta = 0^\circ$

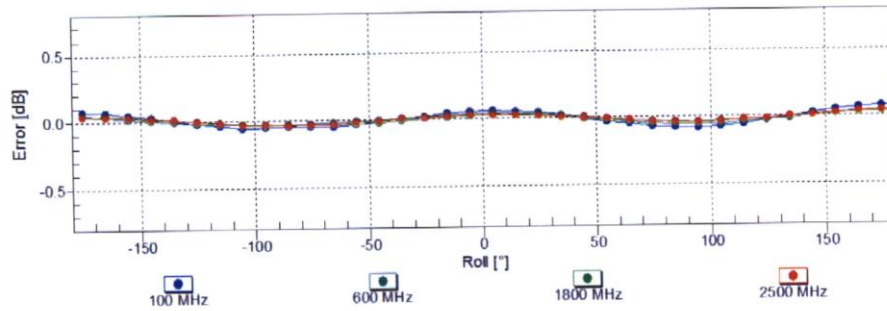

Uncertainty of Axial Isotropy Assessment: $\pm 0.5\%$ ($k=2$)

Receiving Pattern (ϕ), $\vartheta = 90^\circ$

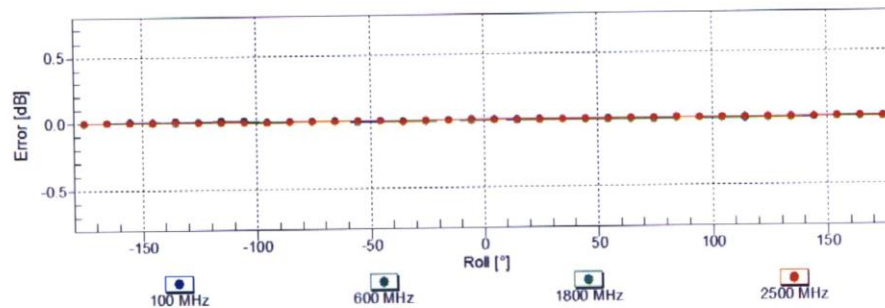

Uncertainty of Axial Isotropy Assessment: $\pm 0.5\%$ ($k=2$)

EF3DV3 – SN:4060

May 21, 2021

Dynamic Range f(E-field) (TEM cell, f = 900 MHz)

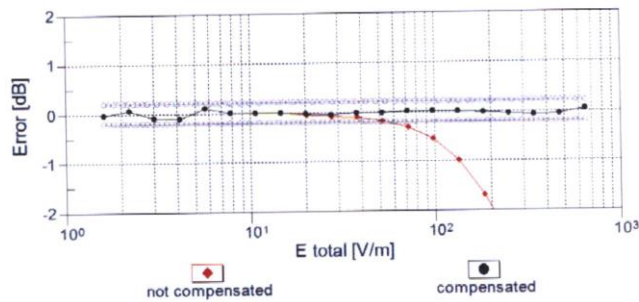
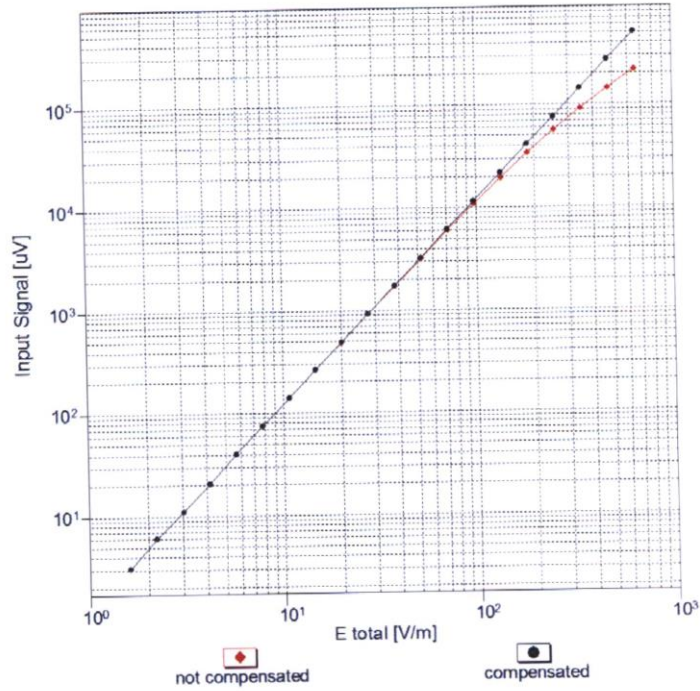

Uncertainty of Linearity Assessment: $\pm 0.6\%$ (k=2)

EF3DV3 – SN:4060

May 21, 2021

Deviation from Isotropy in Air Error (ϕ, θ), $f = 900$ MHz

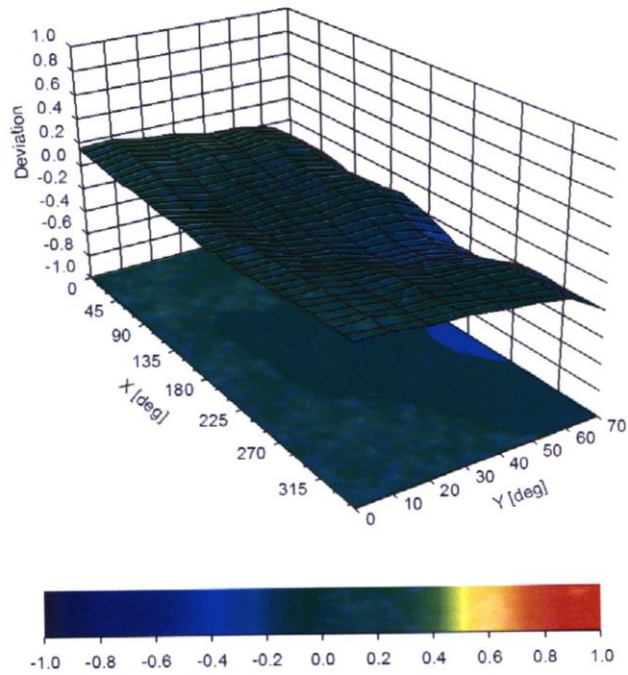

Uncertainty of Spherical Isotropy Assessment: $\pm 2.6\%$ ($k=2$)