

TEST REPORT

Application No.: SZCR2104020473AT(ZR/2021/30022)
Applicant: HMD Global Oy
Address of Applicant: Bertel Jungin aukio 9, 02600 Espoo, Finland
Manufacturer: Development Zone, Qingdao, China
Address of Manufacturer: Bertel Jungin aukio 9, 02600 Espoo, Finland
Equipment Under Test (EUT):
EUT Name: Smart Phone
Model No.: TA-1371
Trademark: NOKIA
FCC ID: 2AJOTTA-1371
Standard(s) : FCC Part 96.47
FCC KDB 940660 D01 Part 96 CBRS Eqpt v02
WINNF-TS-0122-V1.0.1 CBRS CBSD Test Specification
WINNF-18-IN-00178 CBRS End User Device as UUT Test Guidelines
Date of Receipt: 2021-05-24
Date of Test: 2021-05-24 to 2021-05-28
Date of Issue: 2021-05-28



| | |
|---------------------|--------------|
| Test Result: | Pass* |
|---------------------|--------------|

* In the configuration tested, the EUT complied with the standards specified above.

Keny Xu
EMC Laboratory Manager



| <i>Revision Record</i> | | | | |
|------------------------|----------------|-------------|-----------------|---------------|
| <i>Version</i> | <i>Chapter</i> | <i>Date</i> | <i>Modifier</i> | <i>Remark</i> |
| 01 | | 2021-05-28 | | Original |
| | | | | |
| | | | | |

| | | | |
|---------------------------------|--|---|--|
| Authorized for issue by: | | | |
| | |  | |
| | | <hr/> Jacky Li /Project Engineer | |
| | |  | |
| | | <hr/> Eric Fu /Reviewer | |



Unless otherwise agreed in writing, this document is issued by the Company subject to its General Conditions of Service printed overleaf, available on request or accessible at <http://www.sgs.com/en/Terms-and-Conditions.aspx> and, for electronic format documents, subject to Terms and Conditions for Electronic Documents at <http://www.sgs.com/en/Terms-and-Conditions/Terms-e-Documents.aspx>. Attention is drawn to the limitation of liability, indemnification and jurisdiction issues defined therein. Any holder of this document is advised that information contained hereon reflects the Company's findings at the time of its intervention only and within the limits of Client's instructions, if any. The Company's sole responsibility is to its Client and this document does not exonerate parties to a transaction from exercising all their rights and obligations under the transaction documents. This document cannot be reproduced except in full, without prior written approval of the Company. Any unauthorized alteration, forgery or falsification of the content or appearance of this document is unlawful and offenders may be prosecuted to the fullest extent of the law. Unless otherwise stated the results shown in this test report refer only to the sample(s) tested and such sample(s) are retained for 30 days only.

Attention: To check the authenticity of testing /inspection report & certificate, please contact us at telephone: (86-755) 8307 1443, or email: CN.Doccheck@sgs.com

2 Test Summary

| Item | Standard | Test Case ID | Result |
|--|----------|--------------|--------|
| End User Device additional requirement | 96.47 | / | Pass |

The UUT is an End User Device. According to the specifications of the manufacturer, it must comply with the requirements of the following standards:

Test standards:

FCC Part 96.47

FCC KDB 940660 D01 Part 96 CBRS Eqpt v02

WINNF-TS-0122-V1.0.1 CBRS CBSD Test Specification

WINNF-18-IN-00178 CBRS End User Device as UUT Test Guidelines



Unless otherwise agreed in writing, this document is issued by the Company subject to its General Conditions of Service printed overleaf, available on request or accessible at <http://www.sgs.com/en/Terms-and-Conditions.aspx> and, for electronic format documents, subject to Terms and Conditions for Electronic Documents at <http://www.sgs.com/en/Terms-and-Conditions/Terms-e-Documents.aspx>. Attention is drawn to the limitation of liability, indemnification and jurisdiction issues defined therein. Any holder of this document is advised that information contained hereon reflects the Company's findings at the time of its intervention only and within the limits of Client's instructions, if any. The Company's sole responsibility is to its Client and this document does not exonerate parties to a transaction from exercising all their rights and obligations under the transaction documents. This document cannot be reproduced except in full, without prior written approval of the Company. Any unauthorized alteration, forgery or falsification of the content or appearance of this document is unlawful and offenders may be prosecuted to the fullest extent of the law. Unless otherwise stated the results shown in this test report refer only to the sample(s) tested and such sample(s) are retained for 30 days only.

Attention: To check the authenticity of testing / inspection report & certificate, please contact us at telephone: (86-755) 8307 1443, or email: CN.Doccheck@sgs.com

3 Contents

| | Page |
|---|------|
| 1 COVER PAGE | 1 |
| 2 TEST SUMMARY | 3 |
| 3 CONTENTS | 4 |
| 4 GENERAL INFORMATION | 5 |
| 4.1 DETAILS OF E.U.T. | 5 |
| 4.2 MEASUREMENT UNCERTAINTY | 5 |
| 4.3 DESCRIPTION OF SUPPORT UNITS | 6 |
| 4.4 TEST LOCATION | 6 |
| 5 EQUIPMENT LIST | 7 |
| 6 TEST METHOD AND ENVIRONMENT | 8 |
| 6.1 END USER DEVICE CONFORMANCE AND PERFORMANCE | 8 |
| 6.2 TEST ENVIRONMENT | 8 |
| 6.3 TEST REQUIREMENT | 8 |
| 6.4 TEST PROCEDURE | 8 |
| 6.5 TEST SETUP | 9 |
| 6.6 TEST RESULT | 10 |
| 7 PHOTOGRAPHS | 12 |
| 7.1 EUT CONSTRUCTIONAL DETAILS (EUT PHOTOS) | 12 |



Unless otherwise agreed in writing, this document is issued by the Company subject to its General Conditions of Service printed overleaf, available on request or accessible at <http://www.sgs.com/en/Terms-and-Conditions.aspx> and, for electronic format documents, subject to Terms and Conditions for Electronic Documents at <http://www.sgs.com/en/Terms-and-Conditions/Terms-e-Documents.aspx>. Attention is drawn to the limitation of liability, indemnification and jurisdiction issues defined therein. Any holder of this document is advised that information contained hereon reflects the Company's findings at the time of its intervention only and within the limits of Client's instructions, if any. The Company's sole responsibility is to its Client and this document does not exonerate parties to a transaction from exercising all their rights and obligations under the transaction documents. This document cannot be reproduced except in full, without prior written approval of the Company. Any unauthorized alteration, forgery or falsification of the content or appearance of this document is unlawful and offenders may be prosecuted to the fullest extent of the law. Unless otherwise stated the results shown in this test report refer only to the sample(s) tested and such sample(s) are retained for 30 days only.

4 General Information

4.1 Details of E.U.T.

| | |
|------------------------------|---|
| Power supply: | DC 3.87V by internal rechargeable battery which can be charged by AC/DC adapter |
| Sample Type: | End User device |
| Transmitter Frequency Band: | LTE Band 48 |
| Transmitter Frequency Range: | 3550~3700MHz |
| Hardware Version: | V1.00 |
| Software Version: | 00WW_1_01A |
| Antenna Gain: | -1.27dBi(ANT2); -1.81dBi(ANT3); |

4.2 Measurement Uncertainty

| No. | Item | Measurement Uncertainty |
|-----|--------------------|---------------------------|
| 1 | Radio Frequency | $\pm 7.25 \times 10^{-8}$ |
| 2 | RF conducted power | $\pm 0.75\text{dB}$ |
| 3 | Temperature test | $\pm 1^\circ\text{C}$ |
| 4 | Humidity test | $\pm 3\%$ |
| 5 | Supply voltages | $\pm 1.5\%$ |
| 6 | Time | $\pm 3\%$ |



4.3 Description of Support Units

| Description | Manufacturer | Model No. | Serial No. |
|--------------|-------------------------|---|---------------------|
| EPC | Lanner Electronics Inc. | LICA-1513A | LR202002004052 |
| Router | TP-LINK | TL-R860+ | 1175379002425 |
| Base station | Japan Radio Co., Ltd. | JRL-113BT48 (FCC ID: CKEJRL-113BT48) | 1202000240199PP0147 |

4.4 Test Location

All tests were performed at:

SGS-CSTC Standards Technical Services Co., Ltd., Shenzhen Branch

No. 1 Workshop, M-10, Middle Section, Science & Technology Park, Shenzhen, Guangdong, China.
518057.

Tel: +86 755 2601 2053 Fax: +86 755 2671 0594

No tests were sub-contracted.



Unless otherwise agreed in writing, this document is issued by the Company subject to its General Conditions of Service printed overleaf, available on request or accessible at <http://www.sgs.com/en/Terms-and-Conditions.aspx> and, for electronic format documents, subject to Terms and Conditions for Electronic Documents at <http://www.sgs.com/en/Terms-and-Conditions/Terms-e-Documents.aspx>. Attention is drawn to the limitation of liability, indemnification and jurisdiction issues defined therein. Any holder of this document is advised that information contained hereon reflects the Company's findings at the time of its intervention only and within the limits of Client's instructions, if any. The Company's sole responsibility is to its Client and this document does not exonerate parties to a transaction from exercising all their rights and obligations under the transaction documents. This document cannot be reproduced except in full, without prior written approval of the Company. Any unauthorized alteration, forgery or falsification of the content or appearance of this document is unlawful and offenders may be prosecuted to the fullest extent of the law. Unless otherwise stated the results shown in this test report refer only to the sample(s) tested and such sample(s) are retained for 30 days only.

Attention: To check the authenticity of testing / inspection report & certificate, please contact us at telephone: (86-755) 8307 1443, or email: CN.Doccheck@sgs.com

5 Equipment List

| Test Equipment | Manufacturer | Model No. | Inventory No. | Cal Date | Cal Due Date |
|------------------------------------|--|-------------------|--------------------|------------|--------------|
| Laptop (With SAS Test harness) | Lenovo | Pro-13API 2019 | REF. No.SEA1800 | / | / |
| Spectrum Analyzer | Keysight | N9020A | SEM004-17 | 2021-05-21 | 2022-05-20 |
| Shield Room | SAEMC | MSR433 | SEM001-11 | 2021-03-13 | 2022-03-12 |
| Coaxial Cable | SGS | N/A | SEM031-01 | 2020-07-11 | 2021-07-10 |
| Attenuator | Weinschel Associates | WA41 | SEM021-09 | N/A | N/A |
| Humidity/ Temperature Indicator | Shanghai Meteorological Industry Factory | ZJ1-2B | SEM002-03 | 2020-09-27 | 2021-09-26 |



Unless otherwise agreed in writing, this document is issued by the Company subject to its General Conditions of Service printed overleaf, available on request or accessible at <http://www.sgs.com/en/Terms-and-Conditions.aspx> and, for electronic format documents, subject to Terms and Conditions for Electronic Documents at <http://www.sgs.com/en/Terms-and-Conditions/Terms-e-Documents.aspx>. Attention is drawn to the limitation of liability, indemnification and jurisdiction issues defined therein. Any holder of this document is advised that information contained hereon reflects the Company's findings at the time of its intervention only and within the limits of Client's instructions, if any. The Company's sole responsibility is to its Client and this document does not exonerate parties to a transaction from exercising all their rights and obligations under the transaction documents. This document cannot be reproduced except in full, without prior written approval of the Company. Any unauthorized alteration, forgery or falsification of the content or appearance of this document is unlawful and offenders may be prosecuted to the fullest extent of the law. Unless otherwise stated the results shown in this test report refer only to the sample(s) tested and such sample(s) are retained for 30 days only.

Attention: To check the authenticity of testing / inspection report & certificate, please contact us at telephone: (86-755) 8307 1443, or email: CN.Doccheck@sgs.com

6 Test Method and Environment

6.1 End User Device Conformance and Performance

Test Requirement: FCC Part 96.47
Test Method: WINNF-18-IN-00178 CBRS End User Device as UUT Test Guidelines

6.2 Test Environment

Environmental Conditions: 25deg. C, 65%RH

6.3 Test Requirement

FCC Part 96.47

- a). End User Devices may operate only if they can positively receive and decode an authorization signal transmitted by a CBSD, including the frequencies and power limits for their operation.
- b). An End User Device must discontinue operations, change frequencies, or change its operational power level within 10 seconds of receiving instructions from its associated CBSD.

6.4 Test Procedure

Following procedure can be done by applying WINNF-TS-0122-V1.0.1 CBRS CBSD Test Specification, use the certified Base station (FCC ID: CKEJRL-113BT48) as companion device to show compliance with Part 96.47 requirement for End User Device (EUD):

1. Setup with frequency 3590-3610MHz and power level 18dBm/MHz;
2. Enable CBSD service ;
3. Check EUD Tx Frequency and power;
4. Disable AP service ;
5. Check EUD stops transmission within 10seconds;
6. Setup with 3620-3640MHz & power level 10dBm/MHz;
7. Enable CBSD service;
8. Check EUD Tx Frequency and power;
9. Disable CBSD service;
10. Check EUD stops transmission within 10seconds.



6.5 Test Setup

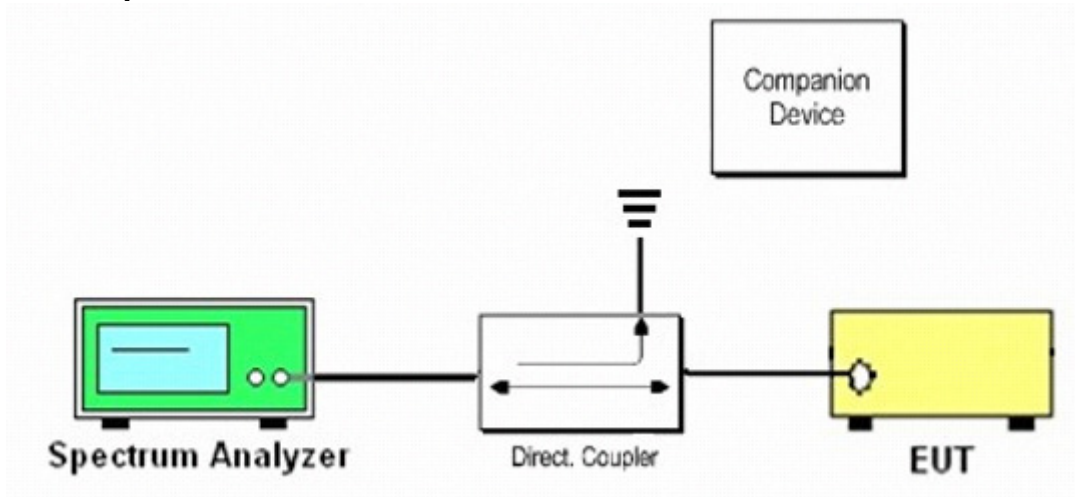

End User Device as UUT, the companion device is certified CBRS (FCC ID: CKEJRL-113BT48)



Unless otherwise agreed in writing, this document is issued by the Company subject to its General Conditions of Service printed overleaf, available on request or accessible at <http://www.sgs.com/en/Terms-and-Conditions.aspx> and, for electronic format documents, subject to Terms and Conditions for Electronic Documents at <http://www.sgs.com/en/Terms-and-Conditions/Terms-e-Documents.aspx>. Attention is drawn to the limitation of liability, indemnification and jurisdiction issues defined therein. Any holder of this document is advised that information contained hereon reflects the Company's findings at the time of its intervention only and within the limits of Client's instructions, if any. The Company's sole responsibility is to its Client and this document does not exonerate parties to a transaction from exercising all their rights and obligations under the transaction documents. This document cannot be reproduced except in full, without prior written approval of the Company. Any unauthorized alteration, forgery or falsification of the content or appearance of this document is unlawful and offenders may be prosecuted to the fullest extent of the law. Unless otherwise stated the results shown in this test report refer only to the sample(s) tested and such sample(s) are retained for 30 days only.

6.6 Test Result

[Step 1] Setup with frequency 3590-3610MHz and power level 18dBm/MHz

[Step 3] Check EUD Tx Frequency and power

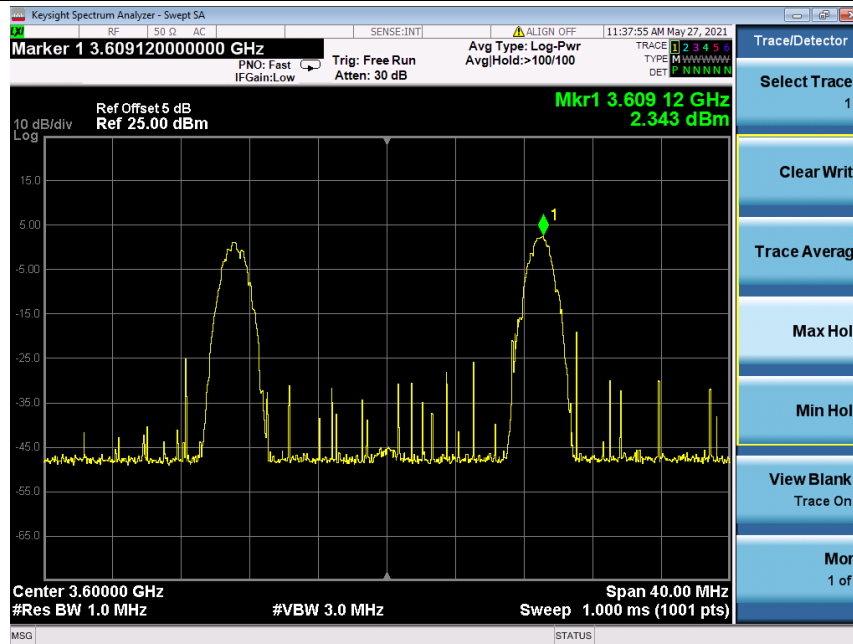

EIRP PSD=2.343+0.9=3.243dBm/MHz, antenna gain is 0.9dBi

[Step 5] EUD stops transmission within 10 seconds of receiving instructions from its associated CBSD.

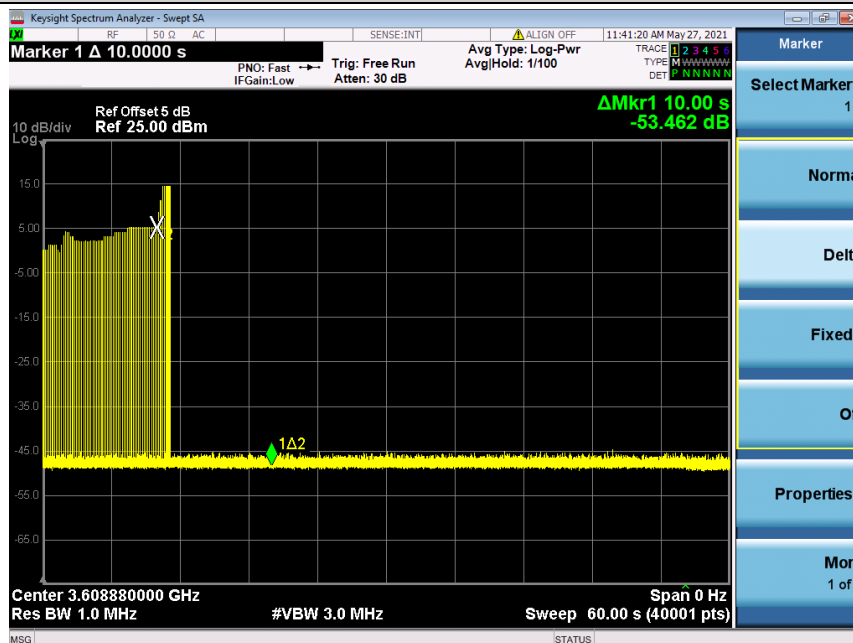

Unless otherwise agreed in writing, this document is issued by the Company subject to its General Conditions of Service printed overleaf, available on request or accessible at <http://www.sgs.com/en/Terms-and-Conditions.aspx> and, for electronic format documents, subject to Terms and Conditions for Electronic Documents at <http://www.sgs.com/en/Terms-and-Conditions/Terms-e-Documents.aspx>. Attention is drawn to the limitation of liability, indemnification and jurisdiction issues defined therein. Any holder of this document is advised that information contained hereon reflects the Company's findings at the time of its intervention only and within the limits of Client's instructions, if any. The Company's sole responsibility is to its Client and this document does not exonerate parties to a transaction from exercising all their rights and obligations under the transaction documents. This document cannot be reproduced except in full, without prior written approval of the Company. Any unauthorized alteration, forgery or falsification of the content or appearance of this document is unlawful and offenders may be prosecuted to the fullest extent of the law. Unless otherwise stated the results shown in this test report refer only to the sample(s) tested and such sample(s) are retained for 30 days only.

[Step 6] Setup with frequency 3620-3640MHz and power level 10dBm/MHz

[Step 8] Check EUD Tx Frequency and power

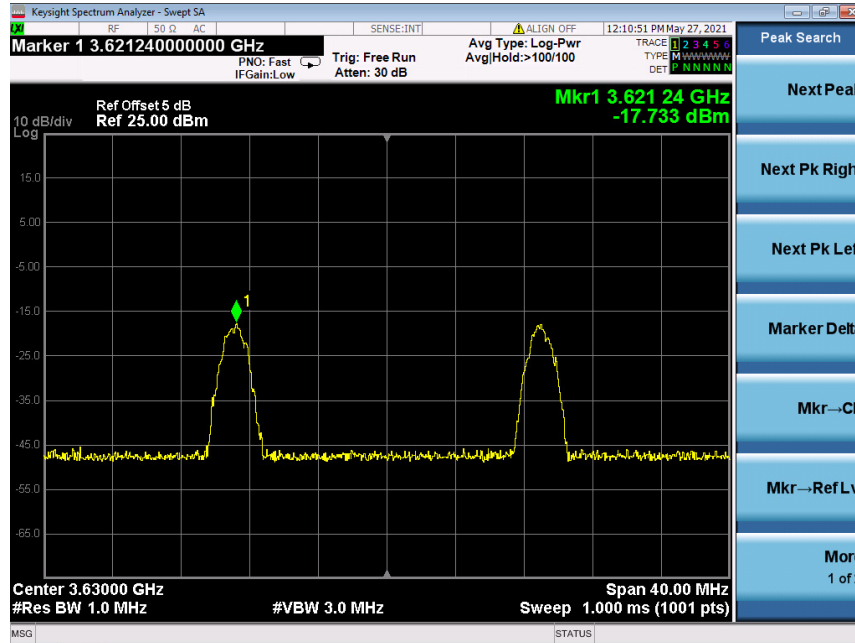

EIRP PSD=-17.733+0.9=-16.833dBm/MHz, antenna gain is 0.9dBi

[Step 10] EUD stops transmission within 10 seconds of receiving instructions from its associated CBSD.

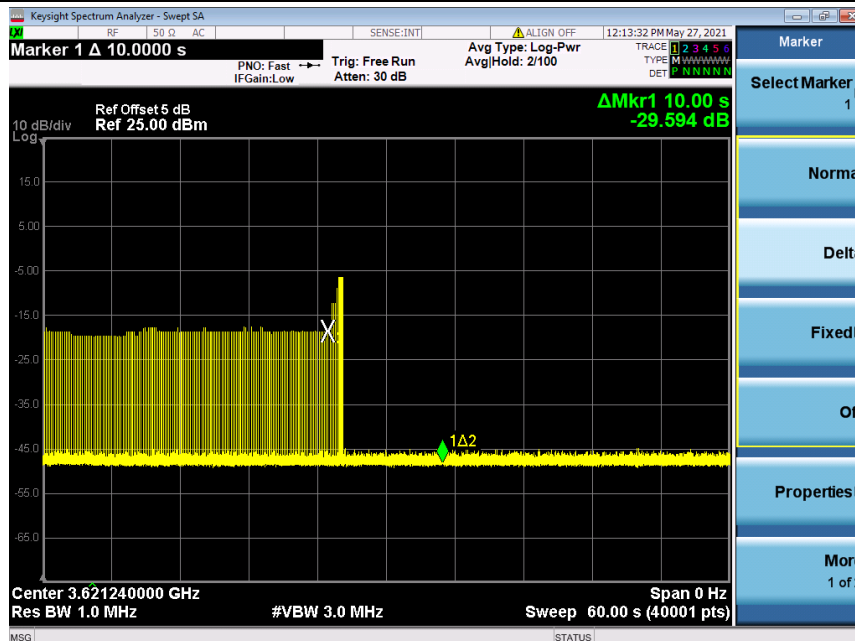

Unless otherwise agreed in writing, this document is issued by the Company subject to its General Conditions of Service printed overleaf, available on request or accessible at <http://www.sgs.com/en/Terms-and-Conditions.aspx> and, for electronic format documents, subject to Terms and Conditions for Electronic Documents at <http://www.sgs.com/en/Terms-and-Conditions/Terms-e-Documents.aspx>. Attention is drawn to the limitation of liability, indemnification and jurisdiction issues defined therein. Any holder of this document is advised that information contained hereon reflects the Company's findings at the time of its intervention only and within the limits of Client's instructions, if any. The Company's sole responsibility is to its Client and this document does not exonerate parties to a transaction from exercising all their rights and obligations under the transaction documents. This document cannot be reproduced except in full, without prior written approval of the Company. Any unauthorized alteration, forgery or falsification of the content or appearance of this document is unlawful and offenders may be prosecuted to the fullest extent of the law. Unless otherwise stated the results shown in this test report refer only to the sample(s) tested and such sample(s) are retained for 30 days only.



7 Photographs

7.1 EUT Constructional Details (EUT Photos)

Please Refer to external and internal photos for details.

- End of the Report -



Unless otherwise agreed in writing, this document is issued by the Company subject to its General Conditions of Service printed overleaf, available on request or accessible at <http://www.sgs.com/en/Terms-and-Conditions.aspx> and, for electronic format documents, subject to Terms and Conditions for Electronic Documents at <http://www.sgs.com/en/Terms-and-Conditions/Terms-e-Documents.aspx>. Attention is drawn to the limitation of liability, indemnification and jurisdiction issues defined therein. Any holder of this document is advised that information contained hereon reflects the Company's findings at the time of its intervention only and within the limits of Client's instructions, if any. The Company's sole responsibility is to its Client and this document does not exonerate parties to a transaction from exercising all their rights and obligations under the transaction documents. This document cannot be reproduced except in full, without prior written approval of the Company. Any unauthorized alteration, forgery or falsification of the content or appearance of this document is unlawful and offenders may be prosecuted to the fullest extent of the law. Unless otherwise stated the results shown in this test report refer only to the sample(s) tested and such sample(s) are retained for 30 days only.

Attention: To check the authenticity of testing / inspection report & certificate, please contact us at telephone: (86-755) 8307 1443, or email: CN.Doccheck@sgs.com