



# TEST REPORT

No.I20N03261-HAC T-coil

For

HMD Global Oy

Multi-band GSM/WCDMA/LTE phone with Bluetooth, WLAN

Model Name: TA-1347

With

Hardware Version: 99652\_1\_11

Software Version: 000T\_0\_060

FCC ID: 2AJOTTA-1347

Results Summary: T Category = T3

Issued Date: 2021-01-29

**Designation Number: CN1210**

**Note:**

The test results in this test report relate only to the devices specified in this report. This report shall not be reproduced except in full without the written approval of SAICT.

**Test Laboratory:**

**SAICT, Shenzhen Academy of Information and Communications Technology**

Building G, Shenzhen International Innovation Center, No.1006 Shennan Road, Futian District, Shenzhen, Guangdong, P. R. China 518000.

Tel:+86(0)755-33322000, Fax:+86(0)755-33322001

Email: yewu@saict.ac.cn. www.saict.ac.cn



## **REPORT HISTORY**

| <b>Report Number</b> | <b>Revision</b> | <b>Description</b> | <b>Issue Date</b> |
|----------------------|-----------------|--------------------|-------------------|
| I20N03261-HAC T-coil | Rev.0           | 1st edition        | 2021-01-29        |



## CONTENTS

|   |           |
|---|-----------|
| <b>1. SUMMARY OF TEST REPORT</b>                                  | <b>5</b>  |
| 1.1. TEST ITEMS   | 5         |
| 1.2. TEST STANDARDS   | 5         |
| 1.3. TEST RESULT  | 5         |
| 1.4. TESTING LOCATION   | 5         |
| 1.5. PROJECT DATA   | 5         |
| 1.6. SIGNATURE  | 5         |
| <b>2. CLIENT INFORMATION</b>                                      | <b>6</b>  |
| 2.1. APPLICANT INFORMATION  | 6         |
| 2.2. MANUFACTURER INFORMATION                                     | 6         |
| <b>3. EQUIPMENT UNDER TEST (EUT) AND ANCILLARY EQUIPMENT (AE)</b> | <b>7</b>  |
| 3.1. ABOUT EUT  | 7         |
| 3.2. INTERNAL IDENTIFICATION OF EUT USED DURING THE TEST          | 7         |
| 3.3. INTERNAL IDENTIFICATION OF AE USED DURING THE TEST           | 7         |
| 3.4. AIR INTERFACES AND OPERATING MODES                           | 7         |
| <b>4. REFERENCE DOCUMENTS</b>                                     | <b>8</b>  |
| <b>5. OPERATIONAL CONDITIONS DURING TEST</b>                      | <b>9</b>  |
| 5.1. HAC MEASUREMENT SET-UP                                       | 9         |
| 5.2. AM1D PROBE   | 11        |
| 5.3. AMCC   | 11        |
| 5.4. AMMI   | 11        |
| 5.5. TEST ARCH PHANTOM & PHONE POSITIONER                         | 12        |
| 5.6. ROBOTIC SYSTEM SPECIFICATIONS                                | 13        |
| 5.7. T-COIL MEASUREMENT POINTS AND REFERENCE PLANE                | 13        |
| <b>6. T-COIL TEST PROCEDURES</b>                                  | <b>15</b> |
| <b>7. T-COIL PERFORMANCE REQUIREMENTS</b>                         | <b>16</b> |
| 7.1. T-COIL COUPLING FIELD INTENSITY                              | 16        |
| 7.2. FREQUENCY RESPONSE   | 16        |
| 7.3. SIGNAL QUALITY   | 17        |
| <b>8. T-COIL TESTING FOR CMRS VOICE</b>                           | <b>18</b> |
| 8.1. GSM TESTS RESULTS  | 18        |
| 8.2. WCDMA TESTS RESULTS  | 18        |
| <b>9. T-COIL TESTING FOR VOLTE</b>                                | <b>19</b> |
| 9.1. TEST SYSTEM SETUP FOR VOLTE OVER IMS T-COIL TESTING          | 19        |
| 9.2. CODEC CONFIGURATION  | 20        |
| 9.3. RADIO CONFIGURATION  | 20        |
| 9.4. VOLTE TESTS RESULTS  | 21        |
| <b>10. T-COIL TESTING FOR VOWIFI</b>                              | <b>22</b> |
| 10.1. TEST SYSTEM SETUP FOR VOWIFI OVER IMS T-COIL TESTING        | 22        |
| 10.2. CODEC CONFIGURATION   | 23        |
| 10.3. RADIO CONFIGURATION   | 23        |
| 10.4. VOWIFI TESTS RESULTS  | 23        |
| <b>11. T-COIL TESTING FOR OTT VOIP CALLING</b>                    | <b>24</b> |
| 11.1. TEST SYSTEM SETUP FOR OTT VOIP T-COIL TESTING               | 24        |
| 11.2. TEST DATA SUMMARY   | 26        |
| <b>12. MEASUREMENT UNCERTAINTY</b>                                | <b>28</b> |



|   |            |
|---|------------|
| <b>13. MAIN TEST INSTRUMENTS</b> .....              | <b>29</b>  |
| <b>ANNEX A: TEST PLOTS</b> .....                    | <b>30</b>  |
| <b>ANNEX B: FREQUENCY RESPONSE CURVES</b> .....     | <b>110</b> |
| <b>ANNEX C: PROBE CALIBRATION CERTIFICATE</b> ..... | <b>120</b> |
| <b>ANNEX D: DAE CALIBRATION CERTIFICATE</b> .....   | <b>123</b> |



## 1. Summary of Test Report

### 1.1. Test Items

Description: Multi-band GSM/WCDMA/LTE phone with Bluetooth, WLAN  
Model Name: TA-1347  
Applicant's name: HMD Global Oy  
Manufacturer's Name: HMD Global Oy

### 1.2. Test Standards

ANSI C63.19-2011

### 1.3. Test Result

Pass

### 1.4. Testing Location

Address: Building G, Shenzhen International Innovation Center, No.1006 Shennan Road,  
Futian District, Shenzhen, Guangdong, P. R. China

### 1.5. Project Data

Testing Start Date: 2021-01-03

Testing End Date: 2021-01-05

### 1.6. Signature

Li Yongfu

(Prepared this test report)

Zhang Yunzhan

(Reviewed this test report)

Cao Junfei

(Approved this test report)



## 2. Client Information

### 2.1. Applicant Information

|               |   |
|---------------|---|
| Company Name: | HMD Global Oy                             |
| Address:      | Bertel Jungin aukio 902600 Espoo, Finland |
| City:         | /   |
| Country:      | /   |
| Telephone:    | /   |

### 2.2. Manufacturer Information

|               |   |
|---------------|---|
| Company Name: | HMD Global Oy                             |
| Address:      | Bertel Jungin aukio 902600 Espoo, Finland |
| City:         | /   |
| Country:      | /   |
| Telephone:    | /   |



### 3. Equipment Under Test (EUT) and Ancillary Equipment (AE)

#### 3.1. About EUT

|                               |   |
|-------------------------------|---|
| Description:                  | Multi-band GSM/WCDMA/LTE phone with Bluetooth, WLAN                               |
| Mode Name:                    | TA-1347   |
| Condition of EUT as received: | No obvious damage in appearance   |
| Operating mode(s) :           | GSM 850/1900, WCDMA Band 2/4/5<br>LTE Band 2/4/5/7/12/17/66, Bluetooth, WLAN 2.4G |

#### 3.2. Internal Identification of EUT used during the test

| EUT ID* | IMEI            | HW Version | SW Version | Receipt Date |
|---------|-----------------|------------|------------|--------------|
| UT14aa  | 359358480002301 | 99652_1_11 | 000T_0_060 | 2021-01-01   |
| UT15aa  | 359358480002269 | 99652_1_11 | 000T_0_060 | 2021-01-01   |

\*EUT ID: is used to identify the test sample in the lab internally.

**Note:** It is performed to test HAC with the UT14aa&15aa.

#### 3.3. Internal Identification of AE used during the test

| AE ID* | Description | Model | Manufacturer                         |
|--------|-------------|-------|--------------------------------------|
| AE1    | Battery     | W340  | Guangdong Fenghua New Energy Co.,Ltd |
| AE2    | Headset     | HS-34 | New Leader Industry Co.,Ltd          |

\*AE ID: is used to identify the test sample in the lab internally.

#### 3.4. Air Interfaces and Operating Modes

| Air-interface | Band(MHz)        | Type | C63.19 / tested | Simultaneous Transmissions | Name of Voice Service | Power Reduction |
|---------------|------------------|------|-----------------|----------------------------|-----------------------|-----------------|
| GSM           | 850 /1900        | VO   | Yes             | BT,WLAN                    | CMRS Voice            | No              |
| EDGE          | 850 /1900        | VD   | Yes             | BT,WLAN                    | Google Duo            |                 |
| WCDMA         | B2 / B4/ B5      | VO   | Yes             | BT,WLAN                    | CMRS Voice            | No              |
|               | HSPA             | VD   | Yes             | BT,WLAN                    | Google Duo            |                 |
| LTE (FDD)     | 2/4/5/7/12/17/66 | VD   | Yes             | BT,WLAN                    | VoLTE<br>Google Duo   | No              |
| WLAN          | 2.4G             | VD   | Yes             | WWAN                       | VoWIFI<br>Google Duo  | No              |
| Bluetooth     | 2.4G             | DT   | No              | WWAN                       | NA                    | No              |

VO: Voice Only

VD: CMRS and IP Voice Service over Digital Transport

DT: Digital Transport only (no voice)

\* HAC Rating was not based on concurrent voice and data modes; Non-current mode was found to represent worst case rating for both M and T rating



#### 4. Reference Documents

The following document listed in this section is referred for testing.

| Reference        | Title  | Version |
|------------------|--|---------|
| ANSI C63.19-2011 | American National Standard for Methods of Measurement of Compatibility between Wireless Communication Devices and Hearing Aids                 | 2011    |
| KDB 285076 D01   | Equipment Authorization Guidance for Hearing Aid Compatibility   | v05     |
| KDB 285076 D02   | Guidance for performing T-Coil tests for air interfaces supporting voice over IP (e.g., LTE and WiFi) to support CMRS based telephone services | v03     |



## 5. Operational Conditions during Test

### 5.1. HAC Measurement Set-up

These measurements are performed using the DASY5 NEO automated dosimetric assessment system. It is made by Schmid & Partner Engineering AG (SPEAG) in Zurich, Switzerland. It consists of high precision robotics system (Stäubli), robot controller, Intel Core2 computer, near-field probe, probe alignment sensor. The robot is a six-axis industrial robot performing precise movements. A cell controller system contains the power supply, robot controller, teach pendant (Joystick), and remote control, is used to drive the robot motors. The PC consists of the HP Intel Core2 1.86 GHz computer with Windows XP system and HAC Measurement Software DASY5 NEO, A/D interface card, monitor, mouse, and keyboard. The Stäubli Robot is connected to the cell controller to allow software manipulation of the robot. A data acquisition electronic (DAE) circuit performs the signal amplification; signal multiplexing, AD-conversion, offset measurements, mechanical surface detection, collision detection, etc. is connected to the Electro-optical coupler (EOC). The EOC performs the conversion from the optical into digital electric signal of the DAE and transfers data to the PC plug-in card.

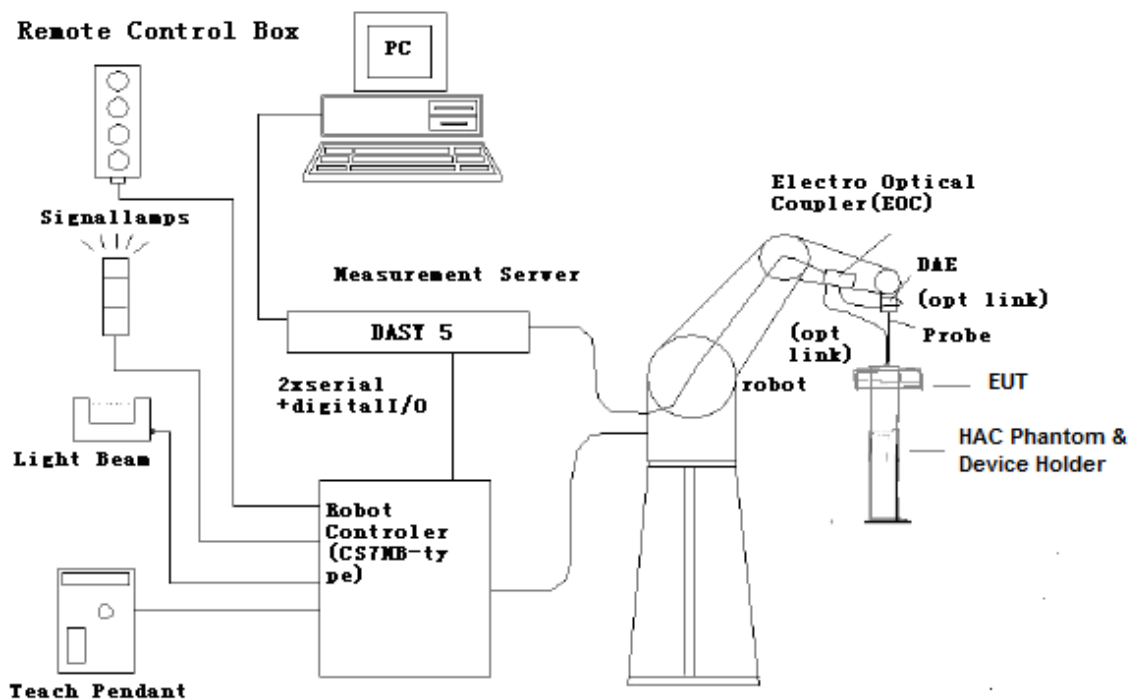

Figure 5.1 HAC Test Measurement Set-up

The DAE4 consists of a highly sensitive electrometer-grade preamplifier with auto-zeroing, a channel and gain-switching multiplexer, a fast 16 bit AD-converter and a command decoder and control logic unit. Transmission to the PC-card is accomplished through an optical downlink for data and status information and an optical uplink for commands and clock lines. The mechanical probe mounting device includes two different sensor systems for frontal and sidewise probe contacts. They are also used for mechanical surface detection and probe collision detection. The robot uses its own controller with a built in VME-bus computer.

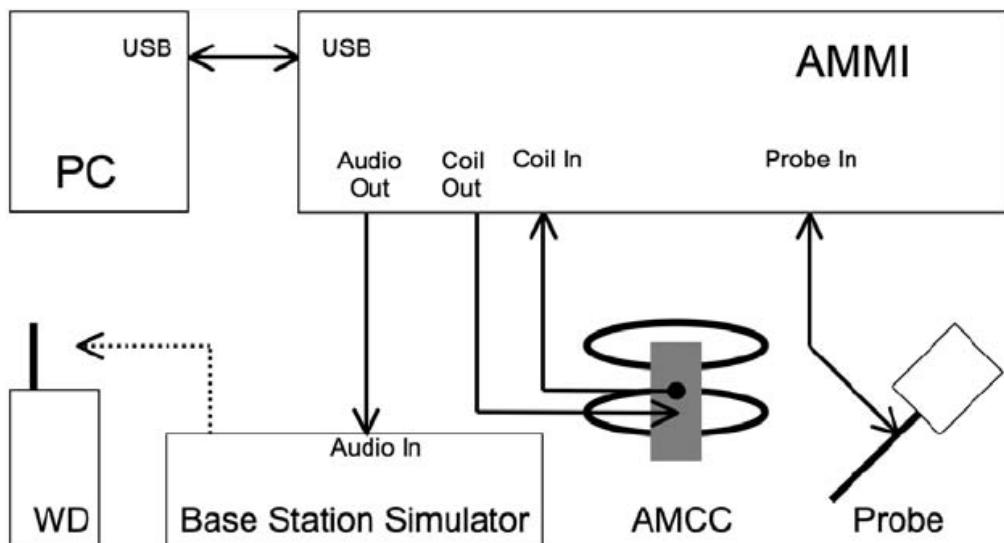

Figure 5.2 T-Coil setup with HAC Test Arch and AMCC

### 5.2. AM1D probe

The AM1D probe is an active probe with a single sensor. It is fully RF-shielded and has a rounded tip 6mm in diameter incorporating a pickup coil with its center offset 3mm from the tip and the sides. The symmetric signal preamplifier in the probe is fed via the shielded symmetric output cable from the AMMI with a 48V "phantom" voltage supply. The 7-pin connector on the back in the axis of the probe does not carry any signals. It is mounted to the DAE for the correct orientation of the sensor. If the probe axis is tilted 54.7 degree from the vertical, the sensor is approximately vertical when the signal connector is at the underside of the probe (cable hanging downwards).

Specification:

|                        |   |
|------------------------|---|
| <b>Frequency range</b> | 0.1~20kHz (RF sensitivity < -100dB, fully RF shielded)        |
| <b>Sensitivity</b>     | < -50dB A/m @ 1kHz  |
| <b>Pre-amplifier</b>   | 40dB, symmetric   |
| <b>Dimensions</b>      | Tip diameter/length: 6/290mm, sensor according to ANSI-C63.19 |

### 5.3. AMCC

The Audio Magnetic Calibration coil is a Helmholtz Coil designed for calibration of the AM1D probe. The two horizontal coils generate a homogeneous magnetic field in the z direction. The DC input resistance is adjusted by a series resistor to approximately 50Ohm, and a shunt resistor of 10Ohm permits monitoring the current with a scale of 1:10

Port description:

| Signal       | Connector | Resistance                              |
|--------------|-----------|---|
| Coil In      | BNC       | Typically 50Ohm                         |
| Coil Monitor | BNO       | 10Ohm±1% (100mV corresponding to 1 A/m) |

Specification:

|                   |  |
|-------------------|--|
| <b>Dimensions</b> | 370 x 370 x 196 mm, according to ANSI-C63.19 |
|-------------------|--|

### 5.4. AMMI



Figure 5.3 AMMI front panel

The Audio Magnetic Measuring Instrument (AMMI) is a desktop 19-inch unit containing a sampling unit, a waveform generator for test and calibration signals, and a USB interface.

Specification:

|                               |   |
|-------------------------------|---|
| <b>Sampling rate</b>          | 48 kHz / 24 bit   |
| <b>Dynamic range</b>          | 85 dB   |
| <b>Test signal generation</b> | User selectable and predefined (vis PC)                                   |
| <b>Calibration</b>            | Auto-calibration / full system calibration using AMCC with monitor output |
| <b>Dimensions</b>             | 482 x 65 x 270 mm   |

### 5.5. Test Arch Phantom & Phone Positioner

The Test Arch phantom should be positioned horizontally on a stable surface. Reference markings on the Phantom allow the complete setup of all predefined phantom positions and measurement grids by manually teaching three points in the robot. It enables easy and well defined positioning of the phone and validation dipoles as well as simple teaching of the robot (Dimensions: 370 x 370 x 370 mm).

The Phone Positioner supports accurate and reliable positioning of any phone with effect on near field  $\leq \pm 0.5$  dB.

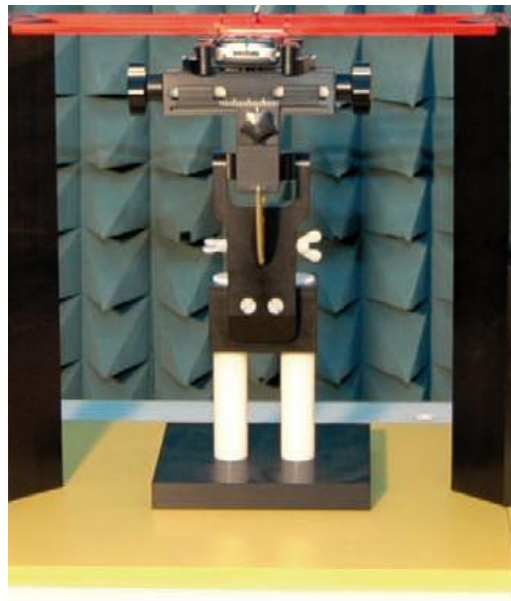

Figure 5.4 HAC Phantom & Device Holder



## 5.6. Robotic System Specifications

### Specifications

**Positioner:** Stäubli Unimation Corp. Robot Model: RX160L

**Repeatability:**  $\pm 0.02$  mm

**No. of Axis:** 6

### Data Acquisition Electronic (DAE) System

#### Cell Controller

**Processor:** Intel Core2

**Clock Speed:** 1.86 GHz

**Operating System:** Windows XP

#### Data Converter

**Features:** Signal Amplifier, multiplexer, A/D converter, and control logic

**Software:** DASY5 software

**Connecting Lines:** Optical downlink for data and status info.

Optical uplink for commands and clock

## 5.7. T-Coil measurement points and reference plane

Figure 6.5 illustrates the standard probe orientations. Position 1 is the perpendicular orientation of the probe coil; orientation 2 is the transverse orientations. The space between the measurement positions is not fixed. It is recommended that a scan of the WD be done for each probe coil orientation and that the maximum level recorded be used as the reading for that orientation of the probe coil.

- 1) The reference plane is the planar area that contains the highest point in the area of the phone that normally rests against the user's ear. It is parallel to the centerline of the receiver area of the phone and is defined by the points of the receiver-end of the WD handset, which, in normal handset use, rest against the ear.
- 2) The measurement plane is parallel to, and 10 mm in front of, the reference plane.
- 3) The reference axis is normal to the reference plane and passes through the center of the receiver speaker section (or the center of the hole array); or may be centered on a secondary inductive source. The actual location of the measurement point shall be noted in the test report as the measurement reference point.
- 4) The measurement points may be located where the axial and radial field intensity measurements are optimum with regard to the requirements. However, the measurement points should be near the acoustic output of the WD and shall be located in the same half of the phone as the WD receiver. In a WD handset with a centered receiver and a circularly symmetrical magnetic field, the measurement axis and the reference axis would coincide.
- 5) The relative spacing of each measurement orientation is not fixed. The axial and two radial orientations should be chosen to select the optimal position.
- 6) The measurement point for the axial position is located 10 mm from the reference plane on the measurement axis. The actual location of the measurement point shall be noted in test reports and designated as the measurement reference point.

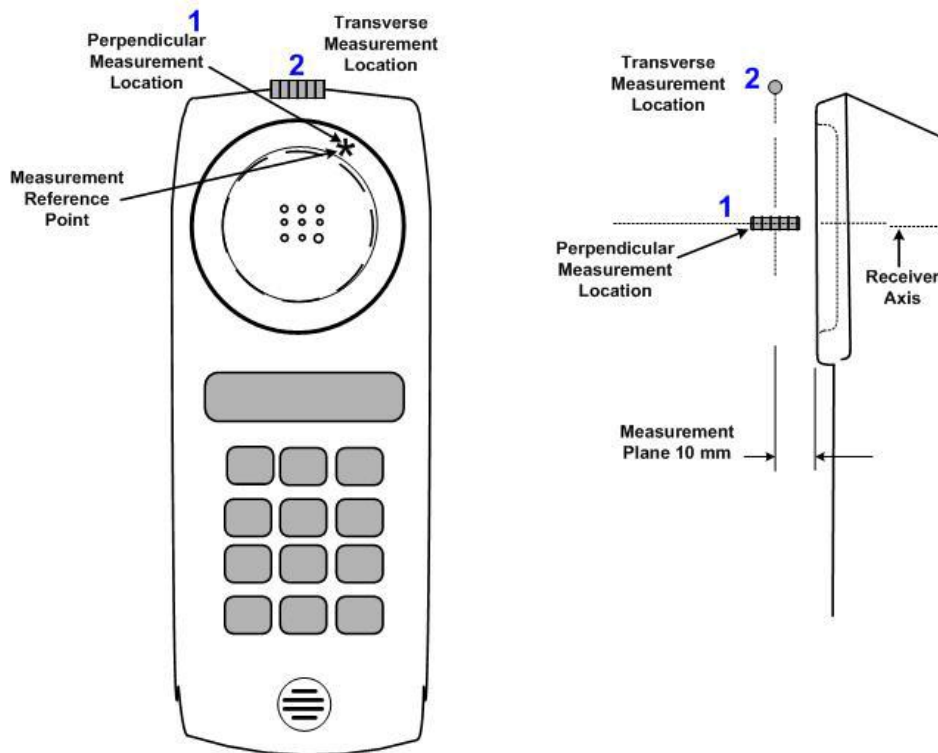

Figure 5.5 Axis and planes for WD audio frequency magnetic field measurements

## 6. T-Coil Test Procedures

**The following illustrate a typical test scan over a wireless communications device:**

- 1) Geometry and signal check: system probe alignment, proper operation of the field probe, probe measurement system, other instrumentation, and the positioning system was confirmed. A surface calibration was performed before each setup change to ensure repeatable spacing and proper maintenance of the measurement plane using the test Arch.
- 2) Set the reference drive level of signal voice defined in C63.19 per 7.4.2.1.
- 3) The ambient and test system background noise (dB A/m) was measured as well as ABM2 over the full measurement. The maximum noise level must be at least 10dB below the limit.
- 4) The DUT was positioned in its intended test position, acoustic output point of the device perpendicular to the field probe.
- 5) The DUT operation for maximum rated RF output power was configured and connected by using of coaxial cable connection to the base station simulator at the test channel and other normal operating parameters as intended for the test. The battery was ensured to be fully charged before each test. The center sub-grid was centered over the center of the acoustic output (also audio band magnetic output, if applicable). The DUT audio output was positioned tangent (as physically possible) to the measurement plane.
- 6) The DUT's RF emission field was eliminated from T-coil results by using a well RF-shielding of the probe, AM1D, and by using of coaxial cable connection to a Base Station Simulator. One test channel was pre-measurement to avoid this possibility.
- 7) Determined the optimal measurement locations for the DUT by following the three steps, coarse resolution scan, fine resolution scans, and point measurement, as described in C63.19 per 7.4.4.2. At each measurement locations, samples in the measurement window duration were evaluated to get ABM1 and the signal spectrum. The noise measurement was performed after the scan with the signal, the same happened, just with the voice signal switched off. The ABM2 was calculated from this second scan.
- 8) All results resulting from a measurement point in a T-Coil job were calculated from the signal samples during this window interval. ABM values were averaged over the sequence of there samples.
- 9) At an optimal point measurement, the SNR ( $S+N/N$ ) was calculated for perpendicular and transverse orientation, and the frequency response was measured for perpendicular.
- 10) Corrected for the frequency response after the DUT measurement since the DASY5 system had known the spectrum of the input signal by using a reference job.
- 11) In SEMCAD post processing, the spectral points are in addition scaled with the high-pass (half-band) and the A-weighting, bandwidth compensated factor (BWC) and those results are final as shown in this report.
- 12) A validation of the test setup and instrumentation may be performed using a TMFS or Helmholtz coil. Measure the emissions and confirm that they are within the specified tolerance.

## 7. T-Coil Performance Requirements

In order to be rated for T-Coil use, a WD shall meet the requirements for signal level and signal quality contained in this part.

### 7.1. T-Coil coupling field intensity

When measured as specified in ANSI C63.19, the T-Coil signal shall be  $\geq -18$  dB (A/m) at 1 kHz, in a 1/3 octave band filter for all orientations.

### 7.2. Frequency response

The frequency response of the axial component of the magnetic field, measured in 1/3 octave bands, shall follow the response curve specified in this sub-clause, over the frequency range 300 Hz to 3000 Hz. Figure 7.1 and Figure 7.2 provide the boundaries for the specified frequency. These response curves are for true field strength measurements of the T-Coil signal. Thus the 6 dB/octave probe response has been corrected from the raw readings.

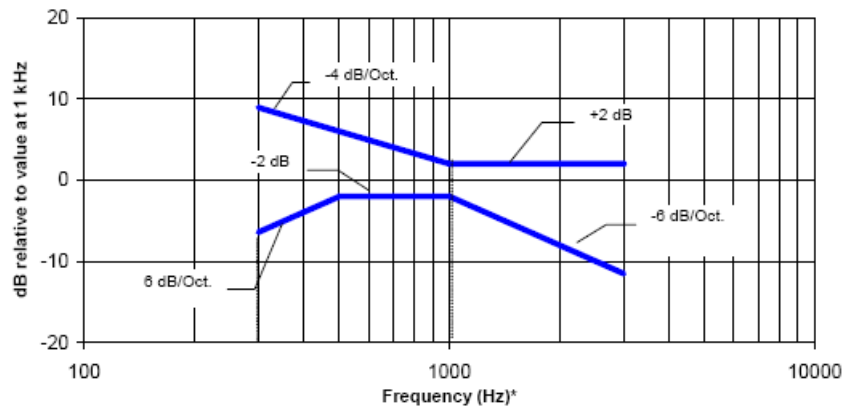

NOTE—Frequency response is between 300 Hz and 3000 Hz.

Figure 7.1—Magnetic field frequency response for WDs with a field  $\leq -15$  dB (A/m) at 1 kHz

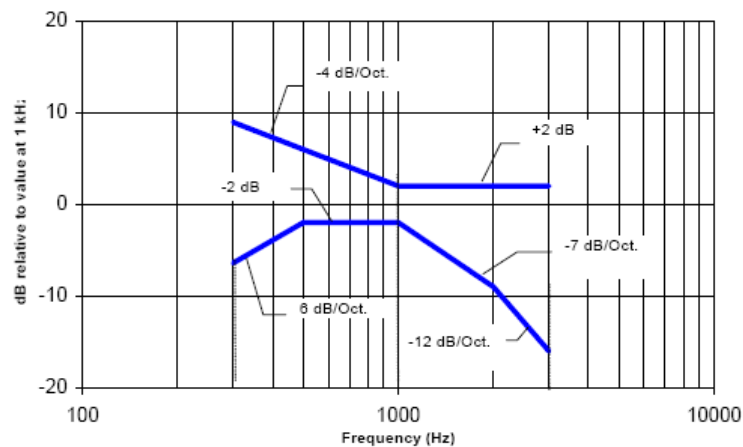

NOTE—Frequency response is between 300 Hz and 3000 Hz.

Figure 7.2—Magnetic field frequency response for WDs with a field that exceeds  $-15$  dB(A/m) at 1 kHz





### 7.3. Signal quality

This part provides the signal quality requirement for the intended T-Coil signal from a WD. Only the RF immunity of the hearing aid is measured in T-Coil mode. It is assumed that a hearing aid can have no immunity to an interference signal in the audio band, which is the intended reception band for this mode. So, the only criteria that can be measured is the RF immunity in T-Coil mode. This is measured using the same procedure as for the audio coupling mode and at the same levels. The worst signal quality of the three T-Coil signal measurements shall be used to determine the T-Coil mode category per Table 1

**Table 1: T-Coil signal quality categories**

| <b>Category</b> | <b>Telephone parameters<br/>WD signal quality<br/>[(signal + noise) – to – noise ratio in decibels]</b> |
|-----------------|---|
| Category T1     | 0 dB to 10 dB   |
| Category T2     | 10 dB to 20 dB  |
| Category T3     | 20 dB to 30 dB  |
| Category T4     | > 30 dB   |

## 8. T-Coil testing for CMRS Voice

### General Note:

1. The middle channel of each frequency band is used for T-Coil testing according ANSI C63.19 2011.
2. Choose worst case from radio configuration investigation. After investigation was performed to determine the audio codec configuration to be used for testing, the following tests results which the worst case codec would be remarked to be used for the testing for the handset.

### 8.1. GSM Tests Results

#### <Codec Investigation>

| codec          | FR VR        | HR V1 | Orientation | Band / Channel |
|----------------|--------------|-------|-------------|----------------|
| ABM 1 (dBA/m)  | -2.16        | -1.75 | Axial       | GSM850 / 190   |
| ABM 2 (dBA/m)  | -6.94        | -6.33 |             |                |
| SNR (dB)       | <b>25.78</b> | 26.42 |             |                |
| Freq. Response | Pass         | Pass  |             |                |

#### <Summary Tests Results>

| Plot No. | Air Interface | Mode       | Channel | Probe Position | ABM1 dB(A/m) | ABM2 dB(A/m) | SNR (dB) | T Rating | Frequency Response |
|----------|---------------|------------|---------|----------------|--------------|--------------|----------|----------|--------------------|
| 1        | GSM850        | CMRS Voice | 190     | Axial (Z)      | -2.16        | -6.94        | 25.78    | T3       | Pass               |
|          |               |            |         | Transverse (Y) | -10.54       | -15.73       | 30.86    | T4       |                    |
| 2        | GSM1900       | CMRS Voice | 661     | Axial (Z)      | -1.21        | -12.39       | 31.32    | T4       | Pass               |
|          |               |            |         | Transverse (Y) | -12.74       | -21.32       | 33.95    | T4       |                    |

### 8.2. WCDMA Tests Results

#### <Codec Investigation>

| codec          | AMR 12.2Kbps | AMR 7.95Kbps | AMR 4.75Kbps | Orientation | Band / Channel |
|----------------|--------------|--------------|--------------|-------------|----------------|
| ABM 1 (dBA/m)  | -0.29        | -0.47        | -0.68        | Axial       | Band 2 / 9400  |
| ABM 2 (dBA/m)  | -27.04       | -27.56       | -28.82       |             |                |
| SNR (dB)       | 49.86        | 49.25        | <b>47.88</b> |             |                |
| Freq. Response | Pass         | Pass         | Pass         |             |                |

#### <Summary Tests Results>

| Plot No. | Air Interface | Mode         | Channel | Probe Position | ABM1 dB(A/m) | ABM2 dB(A/m) | SNR (dB) | T Rating | Frequency Response |
|----------|---------------|--------------|---------|----------------|--------------|--------------|----------|----------|--------------------|
| 3        | WCDMA B2      | AMR 4.75Kbps | 9400    | Axial (Z)      | -0.68        | -28.82       | 47.88    | T4       | Pass               |
|          |               |              |         | Transverse (Y) | -9.03        | -35.11       | 40.94    | T4       |                    |
| 4        | WCDMA B4      | AMR 4.75Kbps | 1413    | Axial (Z)      | -0.61        | -28.26       | 47.79    | T4       | Pass               |
|          |               |              |         | Transverse (Y) | -9.34        | -33.37       | 40.78    | T4       |                    |
| 5        | WCDMA B5      | AMR 4.75Kbps | 4182    | Axial (Z)      | -0.50        | -28.61       | 49.00    | T4       | Pass               |
|          |               |              |         | Transverse (Y) | -9.30        | -34.38       | 41.12    | T4       |                    |

## 9. T-Coil testing for VoLTE

### 9.1. Test System Setup for VoLTE over IMS T-coil Testing

The general test setup used for VoLTE over IMS is shown below. The callbox used when performing VoLTE over IMS T-coil measurements is a CMW500. The Data Application Unit (DAU) of the CMW500 was used to simulate the IP Multimedia Subsystem (IMS) server. According to C63 and KDB 285076 D02v03, VoLTE input level is -20dBm0.

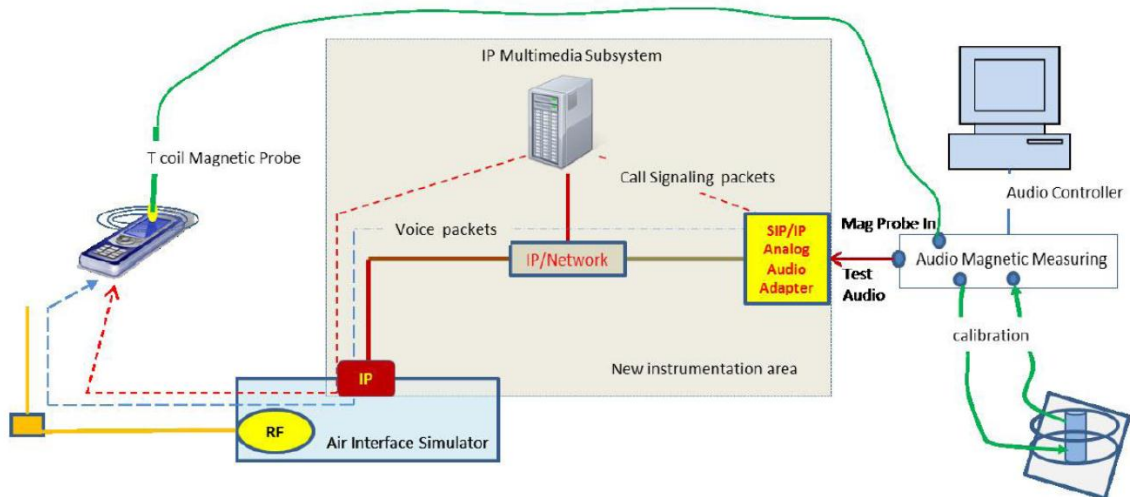

**Figure 9.1 Test Setup for VoLTE over IMS T-coil Measurements**

No correction gain factors were measured for VoLTE due to the Rohde & Schwarz CMW500, hosting a calibrated audio board. The gains used to measure VoLTE are set to 100. The following software/firmware was used to simulate the VoLTE server for testing:

| Firmware          | License Keys | Software Name         |
|-------------------|--------------|-----------------------|
| V3.7.50 for LTE   | KS500        | LTE FDD R8 SIG BASIC  |
|                   | KS550        | LTE TDD R8 SIG BASIC  |
|                   | KA100        | IP APPL ENABLING IPv4 |
|                   | KA150        | IP APPL ENABLING IPv6 |
| V3.7.20 for Audio | KAA20        | IP APPL IMS BASIC     |
|                   | KM050        | DATA APPL MEAS        |
|                   | KS104        | EVS SPEECH CODEC      |



### 9.2. Codec Configuration

An investigation was performed to determine the audio codec configuration to be used for testing. NB AMR 4.75Kbps setting was used for the audio codec on the CMW500 for VoLTE over IMS T-coil testing. See below table for comparisons between different codecs and codec data rates:

#### <AMR Codec Investigation>

| Codec          | NB AMR<br>4.75Kbps | NB AMR<br>12.2Kbps | WB AMR<br>6.60Kbps | WB AMR<br>14.25Kbps | Orientation | Band / BW /<br>Channel |
|----------------|--------------------|--------------------|--------------------|---------------------|-------------|------------------------|
| ABM 1 (dBA/m)  | 0.93               | 0.68               | 0.73               | 0.60                | Axial       | B2 / 20M /<br>18900    |
| ABM 2 (dBA/m)  | -22.10             | -21.48             | -21.69             | -21.35              |             |                        |
| SNR (dB)       | <b>45.95</b>       | 46.52              | 46.20              | 46.98               |             |                        |
| Freq. Response | Pass               | Pass               | Pass               | Pass                |             |                        |

#### <EVS Codec Investigation>

| Codec          | EVS WB<br>5.9Kbps | EVS WB<br>13.2Kbps | EVS NB<br>5.9Kbps | EVS NB<br>13.2Kbps | Orientation | Band / BW /<br>Channel |
|----------------|-------------------|--------------------|-------------------|--------------------|-------------|------------------------|
| ABM 1 (dBA/m)  | 0.71              | 0.54               | 0.75              | 0.58               | Axial       | B2 / 20M /<br>18900    |
| ABM 2 (dBA/m)  | -21.38            | -20.83             | -21.24            | -21.09             |             |                        |
| SNR (dB)       | 46.48             | 47.11              | 46.32             | 46.85              |             |                        |
| Freq. Response | Pass              | Pass               | Pass              | Pass               |             |                        |

### 9.3. Radio Configuration

An investigation was performed to determine the modulation, the bandwidth configuration and RB configuration to be used for testing. For LTE-FDD bands, 10MHz BW, QPSK, 1RB, 0RB offset was used for the testing as the worst-case configuration for the handset. See below table for comparisons between different radio configurations:

#### <Radio Configuration Investigation>

| Air Interface | Bandwidth (MHz) | Modulation | RB size | RB offset | channel | ABM1 dB (A/m) | ABM2 dB(A/m) | SNR (dB)     |
|---------------|-----------------|------------|---------|-----------|---------|---------------|--------------|--------------|
| LTE B2        | 20              | QPSK       | 1       | 0         | 18900   | 0.93          | -22.10       | 45.95        |
| LTE B2        | 20              | QPSK       | 50      | 0         | 18900   | 1.33          | -20.58       | 46.64        |
| LTE B2        | 20              | QPSK       | 100     | 0         | 18900   | 1.45          | -20.22       | 47.19        |
| LTE B2        | 20              | 16QAM      | 1       | 0         | 18900   | 1.20          | 21.95        | 46.28        |
| LTE B2        | 20              | 64QAM      | 1       | 0         | 18900   | 1.39          | -21.65       | 46.77        |
| LTE B2        | 15              | QPSK       | 1       | 0         | 18900   | 1.13          | -22.01       | 46.15        |
| LTE B2        | 10              | QPSK       | 1       | 0         | 18900   | 0.85          | -22.26       | <b>45.47</b> |
| LTE B2        | 5               | QPSK       | 1       | 0         | 18900   | 0.91          | -22.23       | 45.88        |
| LTE B2        | 3               | QPSK       | 1       | 0         | 18900   | 1.04          | -21.93       | 46.04        |
| LTE B2        | 1.4             | QPSK       | 1       | 0         | 18900   | 1.18          | -21.84       | 46.19        |



9.4. VoLTE Tests Results

<Summary Tests Results>

| Plot No. | Air Interface | Mode                              | Channel | Probe Position  | ABM1 dB (A/m) | ABM2 dB (A/m) | SNR (dB) | T Rating | Frequency Response |
|----------|---------------|-----------------------------------|---------|-----------------|---------------|---------------|----------|----------|--------------------|
| 6        | LTE B2        | 10M_QPSK_1RB_0<br>NB AMR 4.75Kbps | 18900   | Axial (Z)       | 0.85          | -22.26        | 45.47    | T4       | Pass               |
|          |               |                                   |         | Transversal (Y) | -7.81         | -30.06        | 41.61    | T4       |                    |
| 7        | LTE B4        | 10M_QPSK_1RB_0<br>NB AMR 4.75Kbps | 20175   | Axial (Z)       | 0.88          | -23.55        | 45.06    | T4       | Pass               |
|          |               |                                   |         | Transversal (Y) | -7.75         | -30.65        | 41.73    | T4       |                    |
| 8        | LTE B5        | 10M_QPSK_1RB_0<br>NB AMR 4.75Kbps | 20525   | Axial (Z)       | 0.92          | -25.38        | 46.09    | T4       | Pass               |
|          |               |                                   |         | Transversal (Y) | -7.60         | -30.64        | 42.17    | T4       |                    |
| 9        | LTE B7        | 10M_QPSK_1RB_0<br>NB AMR 4.75Kbps | 21100   | Axial (Z)       | 0.84          | -24.13        | 44.89    | T4       | Pass               |
|          |               |                                   |         | Transversal (Y) | -7.75         | -30.01        | 41.24    | T4       |                    |
| 10       | LTE B12       | 10M_QPSK_1RB_0<br>NB AMR 4.75Kbps | 23095   | Axial (Z)       | 1.00          | -25.23        | 46.44    | T4       | Pass               |
|          |               |                                   |         | Transversal (Y) | -7.73         | -30.82        | 42.00    | T4       |                    |
| 11       | LTE B17       | 10M_QPSK_1RB_0<br>NB AMR 4.75Kbps | 23790   | Axial (Z)       | 1.09          | -25.24        | 46.37    | T4       | Pass               |
|          |               |                                   |         | Transversal (Y) | -7.63         | -30.31        | 41.90    | T4       |                    |
| 12       | LTE B66       | 10M_QPSK_1RB_0<br>NB AMR 4.75Kbps | 132322  | Axial (Z)       | 0.92          | -24.48        | 45.49    | T4       | Pass               |
|          |               |                                   |         | Transversal (Y) | -7.82         | -30.00        | 41.61    | T4       |                    |

## 10. T-Coil testing for VoWiFi

### 10.1. Test System Setup for VoWiFi over IMS T-coil Testing

The general test setup used for VoWiFi over IMS, or CMRS WiFi Calling, is shown below. The callbox used when performing VoWiFi over IMS T-coil measurements is a CMW500. The Data Application Unit (DAU) of the CMW500 was used to simulate the IP Multimedia Subsystem (IMS) server.

According to C63 and KDB 285076 D02v03, VoWiFi input level is -20dBm0.

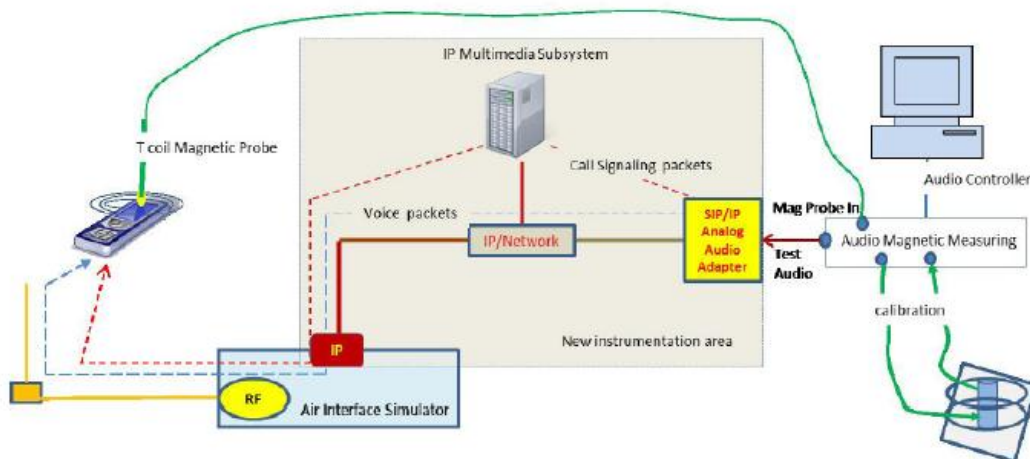

**Figure 10.1 Test Setup for VoWiFi over IMS T-coil Measurements**

No correction gain factors were measured for VoWiFi due to the Rohde & Schwarz CMW500, hosting a calibrated audio board. The gains used to measure VoWiFi are set to 100.

| Firmware          | License Keys | Software Name         |
|-------------------|--------------|-----------------------|
| V3.7.40 for WLAN  | KS650        | WLAN A/B/G SIG BASIC  |
|                   | KS651        | WLAN N SIG BASIC      |
|                   | KA100        | IP APPL ENABLING IPv4 |
|                   | KA150        | IP APPL ENABLING IPv6 |
| V3.7.20 for Audio | KAA20        | IP APPL IMS BASIC     |
|                   | KM050        | DATA APPL MEAS        |
|                   | KS104        | EVS SPEECH CODEC      |



### 10.2. Codec Configuration

An investigation was performed to determine the audio codec configuration to be used for testing. NB AMR 4.75Kbps setting was used for the audio codec on the CMW500 for VoWiFi over IMS T-coil testing. See below table for comparisons between different codecs and codec data rates:

#### <AMR Codec Investigation>

| Codec          | NB AMR<br>4.75Kbps | NB AMR<br>12.2Kbps | WB AMR<br>6.60Kbps | WB AMR<br>14.25Kbps | Orientation | Band / BW /<br>Channel |
|----------------|--------------------|--------------------|--------------------|---------------------|-------------|------------------------|
| ABM 1 (dBA/m)  | 1.28               | 1.59               | 1.35               | 1.73                | Axial       | WLAN 2.4G /<br>20 / 6  |
| ABM 2 (dBA/m)  | -19.56             | -17.76             | -18.42             | -17.13              |             |                        |
| SNR (dB)       | <b>49.10</b>       | 50.28              | 49.56              | 51.07               |             |                        |
| Freq. Response | Pass               | Pass               | Pass               | Pass                |             |                        |

#### <EVS Codec Investigation>

| Codec          | EVS WB<br>5.9Kbps | EVS WB<br>13.2Kbps | EVS NB<br>5.9Kbps | EVS NB<br>13.2Kbps | Orientation | Band / BW /<br>Channel |
|----------------|-------------------|--------------------|-------------------|--------------------|-------------|------------------------|
| ABM 1 (dBA/m)  | 1.41              | 1.68               | 1.61              | 1.85               | Axial       | WLAN 2.4G /<br>20 / 6  |
| ABM 2 (dBA/m)  | -17.96            | -17.42             | -17.53            | -16.87             |             |                        |
| SNR (dB)       | 49.89             | 50.66              | 50.34             | 51.28              |             |                        |
| Freq. Response | Pass              | Pass               | Pass              | Pass               |             |                        |

### 10.3. Radio Configuration

An investigation was performed on all applicable data rates and modulations to determine the radio configuration to be used for testing. See below table for comparisons between different radios configurations in each 802.11 standard:

| Mode         | Bandwidth | Data<br>rate | channel | ABM1<br>dB (A/m) | ABM2<br>dB (A/m) | SNR (dB)     |
|--------------|-----------|--------------|---------|------------------|------------------|--------------|
| 802.11b      | 20        | 1M           | 6       | 1.28             | -19.56           | <b>49.10</b> |
| 802.11b      | 20        | 11M          | 6       | -1.66            | -17.57           | 50.41        |
| 802.11g      | 20        | 6M           | 6       | 1.34             | -18.98           | 49.64        |
| 802.11g      | 20        | 54M          | 6       | 1.71             | -17.45           | 50.63        |
| 802.11n-HT20 | 20        | MCS0         | 6       | 1.47             | -18.02           | 50.08        |
| 802.11n-HT20 | 20        | MCS7         | 6       | -1.82            | -17.08           | 51.15        |

### 10.4. VoWiFi Tests Results

| Plot<br>No. | Air<br>Interface | Mode                             | Channel | Probe<br>Position | ABM1<br>dB (A/m) | ABM2<br>dB (A/m) | SNR<br>(dB) | T<br>Rating | Frequency<br>Response |
|-------------|------------------|----------------------------------|---------|-------------------|------------------|------------------|-------------|-------------|-----------------------|
| 13          | WLAN<br>2.4G     | 80211b -1Mbps<br>NB AMR 4.75Kbps | 6       | Axial (Z)         | 1.28             | -19.56           | 49.10       | T4          | Pass                  |
|             |                  |                                  |         | Transversal (Y)   | -9.34            | -28.89           | 35.90       | T4          |                       |

## 11. T-Coil testing for OTT VoIP Calling

### 11.1. Test System Setup for OTT VoIP T-coil Testing

#### General Note:

The yellow highlight section has been approved for reuse. Regards the protocols, Google Duo, the highlighting section of the test set up, reference levels used, codec(s) and the fact that an investigation was done to determine the worst-case codec/rate documented in the test results below.

#### OTT VoIP Application

Google Duo is a pre-installed application on the DUT which allows for VoIP calls in a head-to-ear scenario. Duo uses the OPUS audio codec and supports a bitrate range of 6kbps to 75kbps. All air interfaces capable of a data connection were evaluated with Google Duo. When HAC testing we are using the Google Duo version is 26.0.179825522.alpha.DEV and the bitrate configuration can find at settings → Voice call parameters settings → Audio codec bitrate(6-75kbps).

#### Test Procedure and Equipment Setup

The test procedure for OTT testing is identical to the section above, except for how the signal is sent to the DUT, as outlined in the diagram below.

The AMMI is connected to the support device's Mic via Audio Data Line. The support device is connected to the Internet via Wi-Fi and the DUT is connected to the mobile base station via the technology under test. Using the DUT's OTT application, a VoIP call is established with the support device. The test signal is sent from the DASY PC to the AMMI, from the AMMI to the support device, and finally to the DUT. To exercise the license antenna, the DUT was simultaneously connected to an external AP and to a mobile base station.

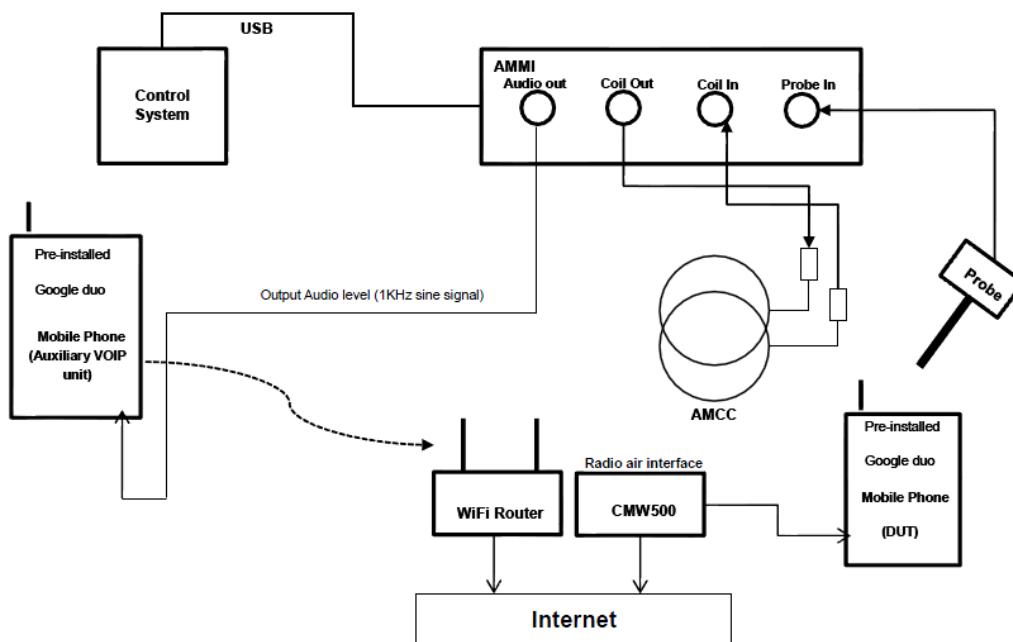





### **Audio Level Settings**

According to KDB 285076 D02, the average speech level of -20dBm0 shall be used for protocols not specifically listed in Table 7.1 of ANSI C63.19-2001.

Determine Input Audio level is based on the Added additional dBFS level readout by Google Duo customizes application and three steps need to do.

1. Input a gain value to readout the -23dBFS level as reference. (0dBFS = 3.14 dBm0)
2. Adjust gain level to readout the dBFS level until it changes to -24dBFS.
3. Based on the step 1 and 2, and then calculate the gain value(dB) by interpolation to get the -20dBm0 corresponding gain value.

### **Codec Bit-rate Investigation**

An investigation between the various bit-rate configurations (Low/Mid/High bit rates for Narrowband, Wideband, and EVS) are documented (ABM1, ABM2, SNNR, frequency response) to determine the worst case bit-rate for each voice service type. The tables below compare the varying bit-rate configurations

### **Air Interface Investigation**

Using the worst-case bit-rate and Radio Configuration found in §9.2, a limited set of bands/channel/ bandwidths were then tested to confirm that there is no effect to the T-rating when changing the band/channel/bandwidth, it is necessary to report only a set band/channel/bandwidth for each orientation for a voice service/air interface.



## 11.2. Test Data Summary

### <Codec Investigation> - EDGE

| codec          | Bitrate 6Kbps | Bitrate 40Kbps | Bitrate 75Kbps | Orientation | Band / Channel |
|----------------|---------------|----------------|----------------|-------------|----------------|
| ABM 1 (dBA/m)  | 9.56          | 9.13           | 8.79           | Axial       | GSM850 / 190   |
| ABM 2 (dBA/m)  | -23.35        | -23.78         | -24.11         |             |                |
| SNR (dB)       | 55.17         | 54.92          | <b>54.65</b>   |             |                |
| Freq. Response | Pass          | Pass           | Pass           |             |                |

For GSM, it is observed that 75Kbps is the worst case.

### <Codec Investigation> -HSPA

| codec          | Bitrate 6Kbps | Bitrate 40Kbps | Bitrate 75Kbps | Orientation | Band / Channel |
|----------------|---------------|----------------|----------------|-------------|----------------|
| ABM 1 (dBA/m)  | 10.31         | 9.94           | 9.63           | Axial       | Band 2 / 9400  |
| ABM 2 (dBA/m)  | -24.73        | -25.28         | -25.62         |             |                |
| SNR (dB)       | 54.86         | 54.12          | <b>53.75</b>   |             |                |
| Freq. Response | Pass          | Pass           | Pass           |             |                |

For WCDMA, it is observed that 75Kbps is the worst case.

### <Codec Investigation> - LTE FDD

| codec          | Bitrate 6Kbps | Bitrate 40Kbps | Bitrate 75Kbps | Orientation | Band / Channel |
|----------------|---------------|----------------|----------------|-------------|----------------|
| ABM 1 (dBA/m)  | 8.67          | 8.14           | 7.85           | Axial       | B7 / 21100     |
| ABM 2 (dBA/m)  | -21.75        | -22.14         | -23.68         |             |                |
| SNR (dB)       | 53.64         | 53.09          | <b>52.56</b>   |             |                |
| Freq. Response | Pass          | Pass           | Pass           |             |                |

For FDD-LTE, it is observed that 75Kbps is the worst case.

### <Codec Investigation> - WLAN 2.4G

| codec          | Bitrate 6Kbps | Bitrate 40Kbps | Bitrate 75Kbps | Orientation | Band / Channel |
|----------------|---------------|----------------|----------------|-------------|----------------|
| ABM 1 (dBA/m)  | 8.93          | 8.47           | 8.09           | Axial       | WLAN 2.4G / 6  |
| ABM 2 (dBA/m)  | -20.68        | -21.04         | -21.79         |             |                |
| SNR (dB)       | 57.15         | 56.88          | <b>56.30</b>   |             |                |
| Freq. Response | Pass          | Pass           | Pass           |             |                |

For WLAN 2.4G, it is observed that 75Kbps is the worst case.



<Summary Tests Results>

Due to OTT service are all is established over the internet protocol for the voice service, and on both services use the identical RF air interface for the WLAN and LTE, therefore according to VOLTE and VoWiFi summary test results, the worst case air interface is used for OTT T-Coil testing.

| Plot No. | Air Interface | Mode   | Channel | Probe Position | ABM1 dB (A/m) | ABM2 dB (A/m) | SNR (dB) | T Rating | Frequency Response |
|----------|---------------|--------|---------|----------------|---------------|---------------|----------|----------|--------------------|
| 14       | GSM850        | EDGE   | 190     | Axial (Z)      | 8.79          | -24.11        | 54.65    | T4       | Pass               |
|          |               |        |         | Transverse (Y) | 1.16          | -29.44        | 49.02    | T4       |                    |
| 15       | GSM1900       | EDGE   | 661     | Axial (Z)      | 9.11          | -23.35        | 56.78    | T4       | Pass               |
|          |               |        |         | Transverse (Y) | 1.47          | -28.46        | 49.84    | T4       |                    |
| 16       | WCDMA Band 2  | HSPA   | 9400    | Axial (Z)      | 9.63          | -25.62        | 53.75    | T4       | Pass               |
|          |               |        |         | Transverse (Y) | 0.42          | -31.05        | 44.93    | T4       |                    |
| 17       | WCDMA Band 4  | HSPA   | 1413    | Axial (Z)      | 9.48          | -25.74        | 53.58    | T4       | Pass               |
|          |               |        |         | Transverse (Y) | 0.39          | -31.22        | 44.62    | T4       |                    |
| 18       | WCDMA Band 5  | HSPA   | 4082    | Axial (Z)      | 9.85          | -24.48        | 55.14    | T4       | Pass               |
|          |               |        |         | Transverse (Y) | 0.87          | -30.27        | 45.74    | T4       |                    |
| 19       | LTE B7        | QPSK   | 21100   | Axial (Z)      | 7.85          | -23.68        | 52.56    | T4       | Pass               |
|          |               |        |         | Transverse (Y) | -0.38         | -29.31        | 48.65    | T4       |                    |
| 20       | 2.4GHz WLAN   | 80211b | 6       | Axial (Z)      | 8.09          | -21.79        | 56.30    | T4       | Pass               |
|          |               |        |         | Transverse (Y) | 0.73          | -29.72        | 46.67    | T4       |                    |

## 12. Measurement Uncertainty

| No.                                   | Error source                         | Type                                       | Uncertainty Value<br>$u_i$ (%) | Prob. Dist. | Div.       | ABM1<br>$c_i$ | ABM2<br>$c_i$ | Std. Unc. ABM1<br>$u_i$ (%) | Std. Unc. ABM2<br>$u_i$ (%) |
|---------------------------------------|--------------------------------------|--|--------------------------------|-------------|------------|---------------|---------------|-----------------------------|-----------------------------|
| 1                                     | System Repeatability                 | A  | 0.016                          | N           | 1          | 1             | 1             | 0.016                       | 0.016                       |
| <b>Probe Sensitivity</b>              |                                      |  |                                |             |            |               |               |                             |                             |
| 2                                     | Reference Level                      | B  | 3.0                            | R           | $\sqrt{3}$ | 1             | 1             | 3.0                         | 3.0                         |
| 3                                     | AMCC Geometry                        | B  | 0.4                            | R           | $\sqrt{3}$ | 1             | 1             | 0.2                         | 0.2                         |
| 4                                     | AMCC Current                         | B  | 0.6                            | R           | $\sqrt{3}$ | 1             | 1             | 0.4                         | 0.4                         |
| 5                                     | Probe Positioning during Calibration | B  | 0.1                            | R           | $\sqrt{3}$ | 1             | 1             | 0.1                         | 0.1                         |
| 6                                     | Noise Contribution                   | B  | 0.7                            | R           | $\sqrt{3}$ | 0.014<br>3    | 1             | 0.0                         | 0.4                         |
| 7                                     | Frequency Slope                      | B  | 5.9                            | R           | $\sqrt{3}$ | 0.1           | 1             | 0.3                         | 3.5                         |
| <b>Probe System</b>                   |                                      |  |                                |             |            |               |               |                             |                             |
| 8                                     | Repeatability / Drift                | B  | 1.0                            | R           | $\sqrt{3}$ | 1             | 1             | 0.6                         | 0.6                         |
| 9                                     | Linearity / Dynamic Range            | B  | 0.6                            | N           | 1          | 1             | 1             | 0.4                         | 0.4                         |
| 10                                    | Acoustic Noise                       | B  | 1.0                            | R           | $\sqrt{3}$ | 0.1           | 1             | 0.1                         | 0.6                         |
| 11                                    | Probe Angle                          | B  | 2.3                            | R           | $\sqrt{3}$ | 1             | 1             | 1.4                         | 1.4                         |
| 12                                    | Spectral Processing                  | B  | 0.9                            | R           | $\sqrt{3}$ | 1             | 1             | 0.5                         | 0.5                         |
| 13                                    | Integration Time                     | B  | 0.6                            | N           | 1          | 1             | 5             | 0.6                         | 3.0                         |
| 14                                    | Field Distribution                   | B  | 0.2                            | R           | $\sqrt{3}$ | 1             | 1             | 0.1                         | 0.1                         |
| <b>Test Signal</b>                    |                                      |  |                                |             |            |               |               |                             |                             |
| 15                                    | Ref. Signal Spectral Response        | B  | 0.6                            | R           | $\sqrt{3}$ | 0             | 1             | 0.0                         | 0.4                         |
| <b>Positioning</b>                    |                                      |  |                                |             |            |               |               |                             |                             |
| 16                                    | Probe Positioning                    | B  | 1.9                            | R           | $\sqrt{3}$ | 1             | 1             | 1.1                         | 1.1                         |
| 17                                    | Phantom Thickness                    | B  | 0.9                            | R           | $\sqrt{3}$ | 1             | 1             | 0.5                         | 0.5                         |
| 18                                    | DUT Positioning                      | B  | 1.9                            | R           | $\sqrt{3}$ | 1             | 1             | 1.1                         | 1.1                         |
| <b>External Contributions</b>         |                                      |  |                                |             |            |               |               |                             |                             |
| 19                                    | RF Interference                      | B  | 0.0                            | R           | $\sqrt{3}$ | 1             | 0.3           | 0.0                         | 0.0                         |
| 20                                    | Test Signal Variation                | B  | 2.0                            | R           | $\sqrt{3}$ | 1             | 1             | 1.2                         | 1.2                         |
| Combined Std. Uncertainty (ABM Field) |                                      | $u_c = \sqrt{\sum_{i=1}^{20} c_i^2 u_i^2}$ |                                |             |            |               |               | 4.1                         | 6.1                         |
| Expanded Std. Uncertainty             |                                      | $u_e = 2u_c$                               |                                | N           | $k = 2$    |               |               | <b>8.2</b>                  | <b>12.2</b>                 |



### 13. Main Test Instruments

Table 13-1: List of Main Instruments

| No. | Name                            | Type   | Serial Number | Calibration Date | Valid Period |
|-----|---------------------------------|--------|---------------|------------------|--------------|
| 01  | Audio Magnetic 1D Field Probe   | AM1DV3 | 3086          | 2018-02-22       | Three year   |
| 02  | Audio Magnetic Calibration Coil | AMCC   | 1105          | /                | /            |
| 03  | Audio Measuring Instrument      | AMMI   | 1121          | /                | /            |
| 04  | HAC Test Arch                   | N/A    | 1150          | /                | /            |
| 05  | DAE                             | DAE4   | 1527          | 2020-11-16       | One year     |
| 06  | BTS                             | CMW500 | 152499        | 2020-07-17       | One year     |
| 07  | Software                        | DASY5  | 52.8.8.1222   | /                | /            |



## ANNEX A: Test Plots

### T-Coil GSM 850 Axial

Date: 2021-1-3

Electronics: DAE4 Sn1527

Medium: Air

Medium parameters used:  $\sigma = 0$  S/m,  $\epsilon_r = 1$ ;  $\rho = 1$  kg/m<sup>3</sup>

Ambient Temperature: 22.0°C

Communication System: GSM Frequency: 836.6 MHz Duty Cycle: 1:8.3

Probe: AM1DV3 - 3086

**z (axial) 4.2mm 50 x 50/ABM Interpolated Signal(x,y,z) (101x101x1):** Interpolated grid:

dx=1.000 mm, dy=1.000 mm

Signal Type: Audio File (.wav) 48k\_voice\_1kHz\_1s.wav

Output Gain: 100

Measure Window Start: 300ms

Measure Window Length: 1000ms

BWC applied: 0.15 dB

Device Reference Point: 0, 0, -6.3 mm

#### Cursor:

ABM1 = -0.43 dBA/m

BWC Factor = 0.15 dB

Location: 4, -9, 3.7 mm

**z (axial) 4.2mm 50 x 50/ABM Interpolated SNR(x,y,z) (101x101x1):** Interpolated grid: dx=1.000

mm, dy=1.000 mm

Signal Type: Audio File (.wav) 48k\_voice\_1kHz\_1s.wav

Output Gain: 100

Measure Window Start: 300ms

Measure Window Length: 1000ms

BWC applied: 0.15 dB

Device Reference Point: 0, 0, -6.3 mm

#### Cursor:

ABM1/ABM2 = 25.78 dB

ABM1 comp = -2.16 dBA/m

BWC Factor = 0.15 dB

Location: -1, -9, 3.7 mm

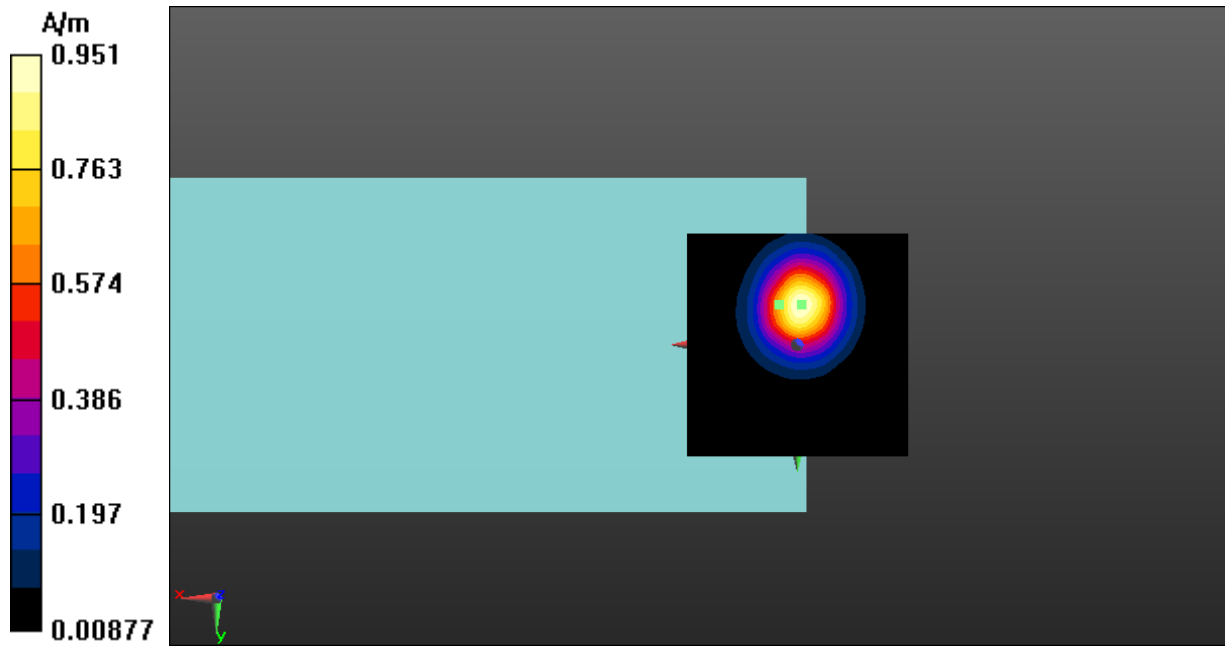

Fig A.1 T-Coil GSM 850-Z



**T-Coil GSM 850 Transverse**

Date: 2021-1-3

Electronics: DAE4 Sn1527

Medium: Air

Medium parameters used:  $\sigma = 0$  S/m,  $\epsilon_r = 1$ ;  $\rho = 1$  kg/m<sup>3</sup>

Ambient Temperature: 22.0°C

Communication System: GSM Frequency: 836.6 MHz Duty Cycle: 1:8.3

Probe: AM1DV3 - 3086

**y (transversal) 4.2mm 50 x 50/ABM Interpolated Signal(x,y,z) (101x101x1):** Interpolated grid:

dx=1.000 mm, dy=1.000 mm

Signal Type: Audio File (.wav) 48k\_voice\_1kHz\_1s.wav

Output Gain: 100

Measure Window Start: 300ms

Measure Window Length: 1000ms

BWC applied: 0.15 dB

Device Reference Point: 0, 0, -6.3 mm

**Cursor:**

ABM1 = -8.48 dBA/m

BWC Factor = 0.15 dB

Location: 4, -16.5, 3.7 mm

**y (transversal) 4.2mm 50 x 50/ABM Interpolated SNR(x,y,z) (101x101x1):** Interpolated grid:

dx=1.000 mm, dy=1.000 mm

Signal Type: Audio File (.wav) 48k\_voice\_1kHz\_1s.wav

Output Gain: 100

Measure Window Start: 300ms

Measure Window Length: 1000ms

BWC applied: 0.15 dB

Device Reference Point: 0, 0, -6.3 mm

**Cursor:**

ABM1/ABM2 = 30.86 dB

ABM1 comp = -10.54 dBA/m

BWC Factor = 0.15 dB

Location: -2, -16, 3.7 mm



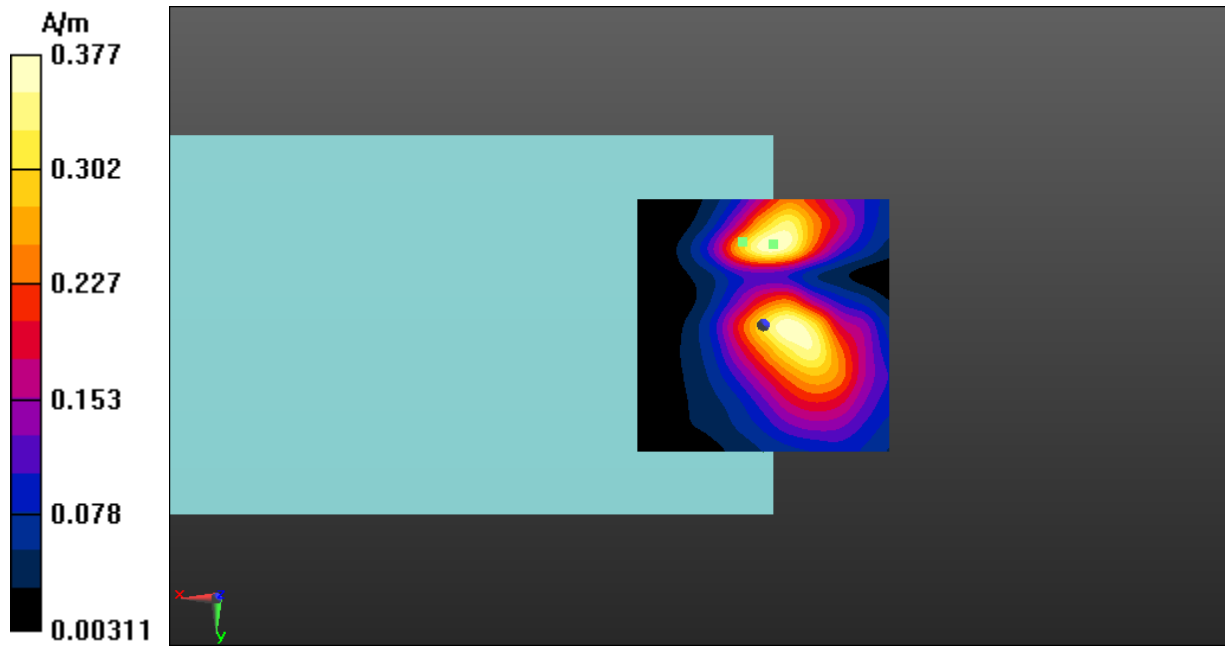

Fig A.1 T-Coil GSM 850-Y



**T-Coil GSM 1900 Axial**

Date: 2021-1-3

Electronics: DAE4 Sn1527

Medium: Air

Medium parameters used:  $\sigma = 0$  S/m,  $\epsilon_r = 1$ ;  $\rho = 1$  kg/m<sup>3</sup>

Ambient Temperature: 22.0°C

Communication System: GSM Frequency: 1880 MHz Duty Cycle: 1:8.3

Probe: AM1DV3 - 3086

**z (axial) 4.2mm 50 x 50/ABM Interpolated Signal(x,y,z) (101x101x1):** Interpolated grid:

dx=1.000 mm, dy=1.000 mm

Signal Type: Audio File (.wav) 48k\_voice\_1kHz\_1s.wav

Output Gain: 100

Measure Window Start: 300ms

Measure Window Length: 1000ms

BWC applied: 0.15 dB

Device Reference Point: 0, 0, -6.3 mm

**Cursor:**

ABM1 = -0.24 dBA/m

BWC Factor = 0.15 dB

Location: 3.5, -9.5, 3.7 mm

**z (axial) 4.2mm 50 x 50/ABM Interpolated SNR(x,y,z) (101x101x1):** Interpolated grid: dx=1.000

mm, dy=1.000 mm

Signal Type: Audio File (.wav) 48k\_voice\_1kHz\_1s.wav

Output Gain: 100

Measure Window Start: 300ms

Measure Window Length: 1000ms

BWC applied: 0.15 dB

Device Reference Point: 0, 0, -6.3 mm

**Cursor:**

ABM1/ABM2 = 31.32 dB

ABM1 comp = -1.21 dBA/m

BWC Factor = 0.15 dB

Location: 0, -9, 3.7 mm

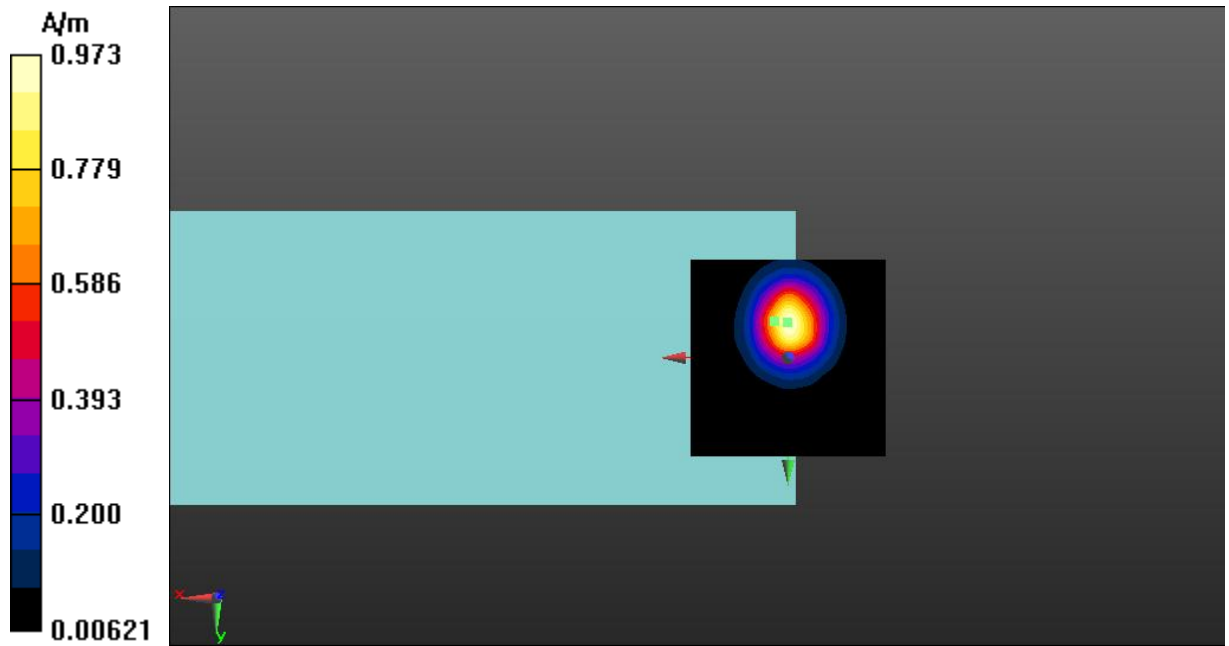

Fig A.2 T-Coil GSM 1900-Z



**T-Coil GSM 1900 Transverse**

Date: 2021-1-3

Electronics: DAE4 Sn1527

Medium: Air

Medium parameters used:  $\sigma = 0$  S/m,  $\epsilon_r = 1$ ;  $\rho = 1$  kg/m<sup>3</sup>

Ambient Temperature: 22.0°C

Communication System: GSM Frequency: 1880 MHz Duty Cycle: 1:8.3

Probe: AM1DV3 - 3086

**y (transversal) 4.2mm 50 x 50/ABM Interpolated Signal(x,y,z) (101x101x1):** Interpolated grid:

dx=1.000 mm, dy=1.000 mm

Signal Type: Audio File (.wav) 48k\_voice\_1kHz\_1s.wav

Output Gain: 100

Measure Window Start: 300ms

Measure Window Length: 1000ms

BWC applied: 0.15 dB

Device Reference Point: 0, 0, -6.3 mm

**Cursor:**

ABM1 = -8.77 dBA/m

BWC Factor = 0.15 dB

Location: 3, 0.5, 3.7 mm

**y (transversal) 4.2mm 50 x 50/ABM Interpolated SNR(x,y,z) (101x101x1):** Interpolated grid:

dx=1.000 mm, dy=1.000 mm

Signal Type: Audio File (.wav) 48k\_voice\_1kHz\_1s.wav

Output Gain: 100

Measure Window Start: 300ms

Measure Window Length: 1000ms

BWC applied: 0.15 dB

Device Reference Point: 0, 0, -6.3 mm

**Cursor:**

ABM1/ABM2 = 33.95 dB

ABM1 comp = -12.74 dBA/m

BWC Factor = 0.15 dB

Location: -5, 4, 3.7 mm

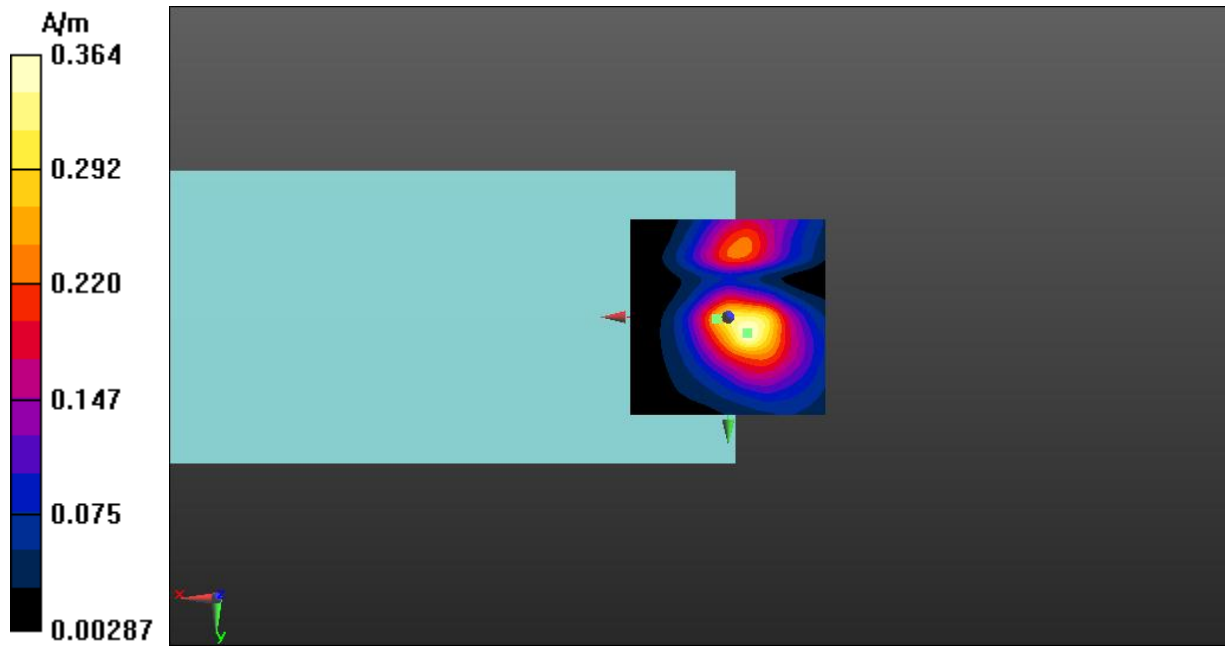

Fig A.2 T-Coil GSM 1900-Y



**T-Coil WCDMA Band 2 Axial**

Date: 2021-1-3

Electronics: DAE4 Sn1527

Medium: Air

Medium parameters used:  $\sigma = 0$  S/m,  $\epsilon_r = 1$ ;  $\rho = 1$  kg/m<sup>3</sup>

Ambient Temperature: 22.0°C

Communication System: WCDMA Frequency: 1880 MHz Duty Cycle: 1:1

Probe: AM1DV3 - 3086

**z (axial) 4.2mm 50 x 50/ABM Interpolated Signal(x,y,z) (101x101x1):** Interpolated grid:

dx=1.000 mm, dy=1.000 mm

Signal Type: Audio File (.wav) 48k\_voice\_1kHz\_1s.wav

Output Gain: 100

Measure Window Start: 300ms

Measure Window Length: 1000ms

BWC applied: 0.15 dB

Device Reference Point: 0, 0, -6.3 mm

**Cursor:**

ABM1 = -0.68 dBA/m

BWC Factor = 0.15 dB

Location: 3.5, -9, 3.7 mm

**z (axial) 4.2mm 50 x 50/ABM Interpolated SNR(x,y,z) (101x101x1):** Interpolated grid: dx=1.000

mm, dy=1.000 mm

Signal Type: Audio File (.wav) 48k\_voice\_1kHz\_1s.wav

Output Gain: 100

Measure Window Start: 300ms

Measure Window Length: 1000ms

BWC applied: 0.15 dB

Device Reference Point: 0, 0, -6.3 mm

**Cursor:**

ABM1/ABM2 = 47.88 dB

ABM1 comp = -0.68 dBA/m

BWC Factor = 0.15 dB

Location: 3.5, -9.5, 3.7 mm

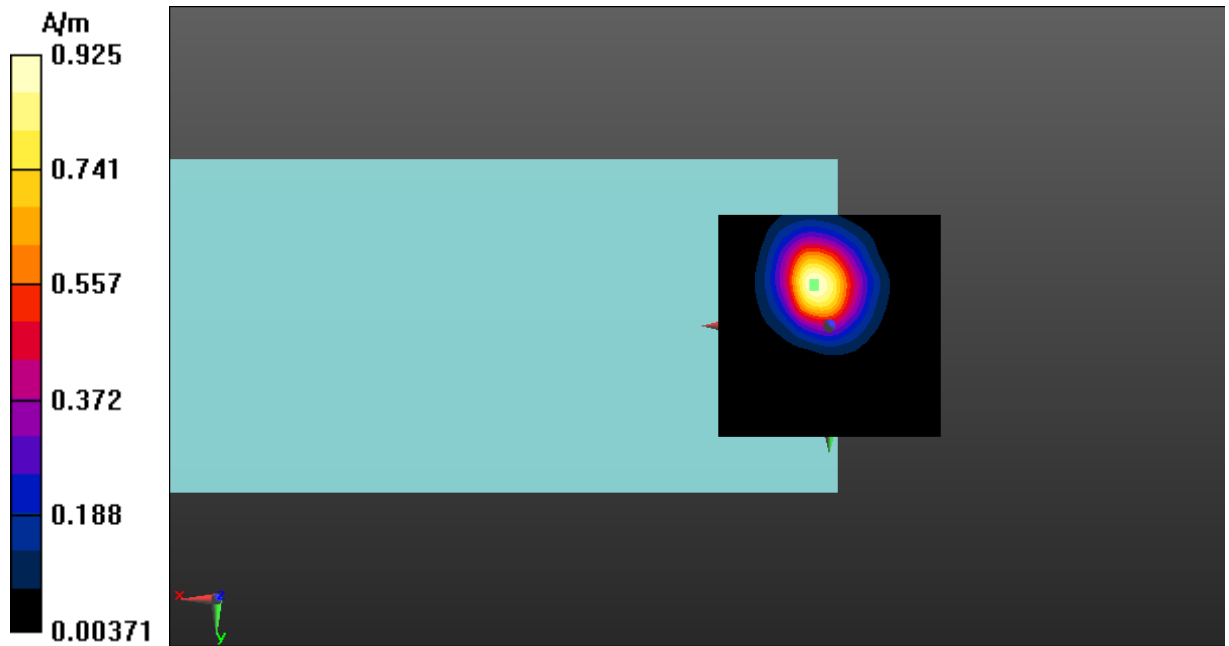

Fig A.3 T-Coil WCDMA Band 2-Z



**T-Coil WCDMA Band 2 Transverse**

Date: 2021-1-3

Electronics: DAE4 Sn1527

Medium: Air

Medium parameters used:  $\sigma = 0$  S/m,  $\epsilon_r = 1$ ;  $\rho = 1$  kg/m<sup>3</sup>

Ambient Temperature: 22.0°C

Communication System: WCDMA Frequency: 1880 MHz Duty Cycle: 1:1

Probe: AM1DV3 - 3086

**y (transversal) 4.2mm 50 x 50/ABM Interpolated Signal(x,y,z) (101x101x1):** Interpolated grid:

dx=1.000 mm, dy=1.000 mm

Signal Type: Audio File (.wav) 48k\_voice\_1kHz\_1s.wav

Output Gain: 100

Measure Window Start: 300ms

Measure Window Length: 1000ms

BWC applied: 0.15 dB

Device Reference Point: 0, 0, -6.3 mm

**Cursor:**

ABM1 = -8.69 dBA/m

BWC Factor = 0.15 dB

Location: 3, -17, 3.7 mm

**y (transversal) 4.2mm 50 x 50/ABM Interpolated SNR(x,y,z) (101x101x1):** Interpolated grid:

dx=1.000 mm, dy=1.000 mm

Signal Type: Audio File (.wav) 48k\_voice\_1kHz\_1s.wav

Output Gain: 100

Measure Window Start: 300ms

Measure Window Length: 1000ms

BWC applied: 0.15 dB

Device Reference Point: 0, 0, -6.3 mm

**Cursor:**

ABM1/ABM2 = 40.94 dB

ABM1 comp = -9.03 dBA/m

BWC Factor = 0.15 dB

Location: 0.5, -17.5, 3.7 mm



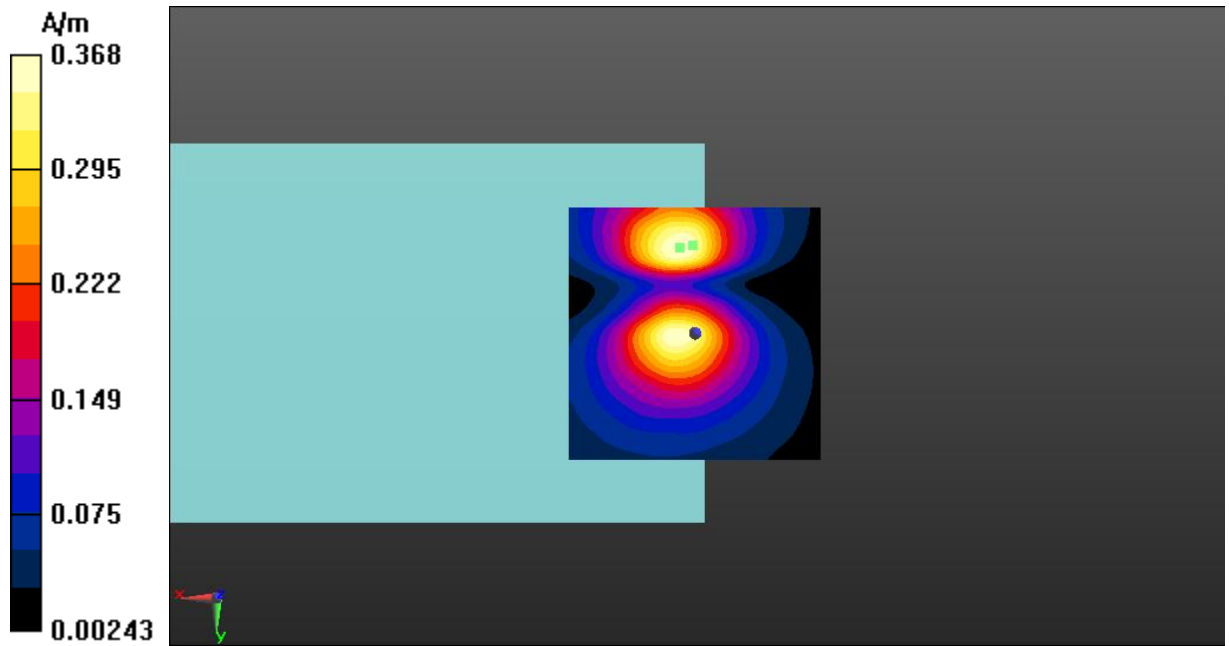

Fig A.3 T-Coil WCDMA Band 2-Y



**T-Coil WCDMA Band 4 Axial**

Date: 2021-1-3

Electronics: DAE4 Sn1527

Medium: Air

Medium parameters used:  $\sigma = 0$  S/m,  $\epsilon_r = 1$ ;  $\rho = 1$  kg/m<sup>3</sup>

Ambient Temperature: 22.0°C

Communication System: WCDMA Frequency: 1732.6 MHz Duty Cycle: 1:1

Probe: AM1DV3 - 3086

**z (axial) 4.2mm 50 x 50/ABM Interpolated Signal(x,y,z) (101x101x1):** Interpolated grid:

dx=1.000 mm, dy=1.000 mm

Signal Type: Audio File (.wav) 48k\_voice\_1kHz\_1s.wav

Output Gain: 100

Measure Window Start: 300ms

Measure Window Length: 1000ms

BWC applied: 0.15 dB

Device Reference Point: 0, 0, -6.3 mm

**Cursor:**

ABM1 = -0.57 dBA/m

BWC Factor = 0.15 dB

Location: 4, -9.5, 3.7 mm

**z (axial) 4.2mm 50 x 50/ABM Interpolated SNR(x,y,z) (101x101x1):** Interpolated grid: dx=1.000

mm, dy=1.000 mm

Signal Type: Audio File (.wav) 48k\_voice\_1kHz\_1s.wav

Output Gain: 100

Measure Window Start: 300ms

Measure Window Length: 1000ms

BWC applied: 0.15 dB

Device Reference Point: 0, 0, -6.3 mm

**Cursor:**

ABM1/ABM2 = 47.79 dB

ABM1 comp = -0.61 dBA/m

BWC Factor = 0.15 dB

Location: 3.5, -10, 3.7 mm

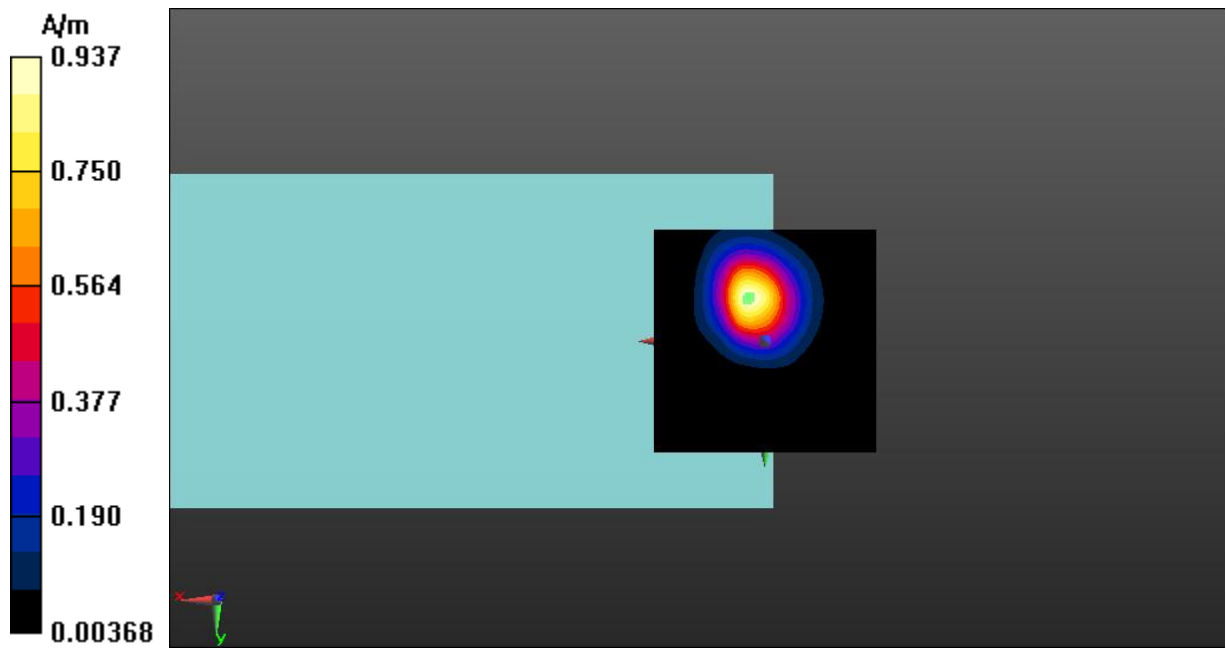

Fig A.4 T-Coil WCDMA Band 4-Z



**T-Coil WCDMA Band 4 Transverse**

Date: 2021-1-3

Electronics: DAE4 Sn1527

Medium: Air

Medium parameters used:  $\sigma = 0$  S/m,  $\epsilon_r = 1$ ;  $\rho = 1$  kg/m<sup>3</sup>

Ambient Temperature: 22.0°C

Communication System: WCDMA Frequency: 1732.6 MHz Duty Cycle: 1:1

Probe: AM1DV3 - 3086

**y (transversal) 4.2mm 50 x 50/ABM Interpolated Signal(x,y,z) (101x101x1):** Interpolated grid:

dx=1.000 mm, dy=1.000 mm

Signal Type: Audio File (.wav) 48k\_voice\_1kHz\_1s.wav

Output Gain: 100

Measure Window Start: 300ms

Measure Window Length: 1000ms

BWC applied: 0.15 dB

Device Reference Point: 0, 0, -6.3 mm

**Cursor:**

ABM1 = -8.72 dBA/m

BWC Factor = 0.15 dB

Location: 4, 0.5, 3.7 mm

**y (transversal) 4.2mm 50 x 50/ABM Interpolated SNR(x,y,z) (101x101x1):** Interpolated grid:

dx=1.000 mm, dy=1.000 mm

Signal Type: Audio File (.wav) 48k\_voice\_1kHz\_1s.wav

Output Gain: 100

Measure Window Start: 300ms

Measure Window Length: 1000ms

BWC applied: 0.15 dB

Device Reference Point: 0, 0, -6.3 mm

**Cursor:**

ABM1/ABM2 = 40.78 dB

ABM1 comp = -9.34 dBA/m

BWC Factor = 0.15 dB

Location: 0.5, -18, 3.7 mm

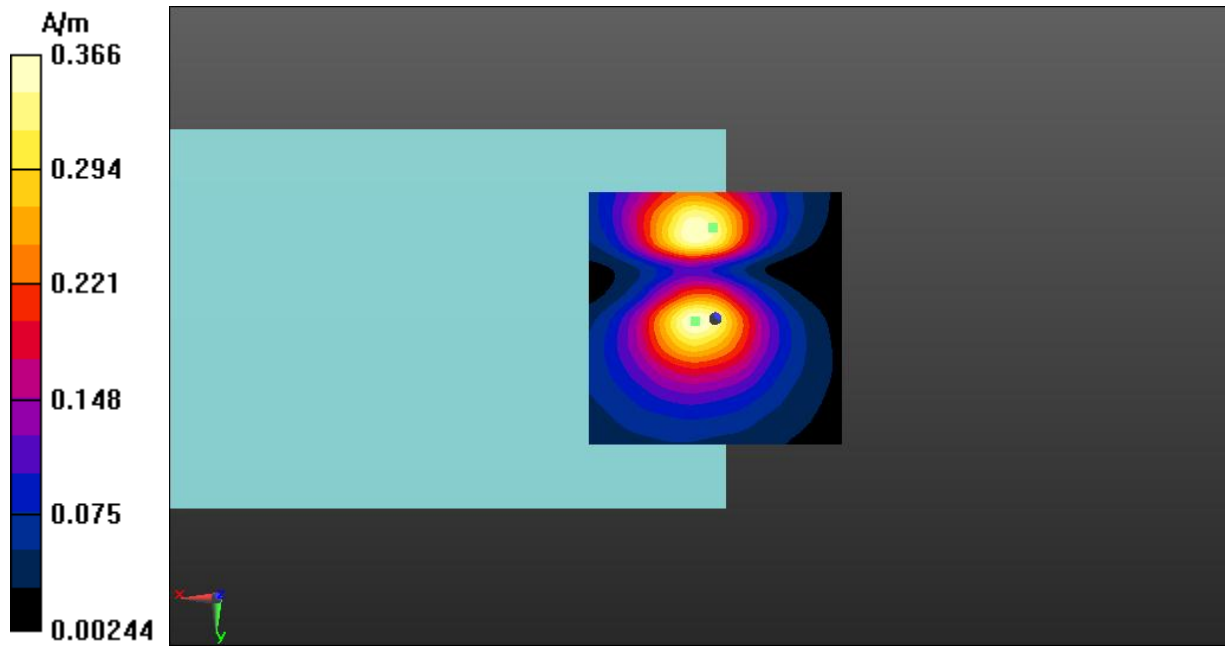

Fig A.4 T-Coil WCDMA Band 4-Y



**T-Coil WCDMA Band 5 Axial**

Date: 2021-1-3

Electronics: DAE4 Sn1527

Medium: Air

Medium parameters used:  $\sigma = 0$  S/m,  $\epsilon_r = 1$ ;  $\rho = 1$  kg/m<sup>3</sup>

Ambient Temperature: 22.0°C

Communication System: WCDMA Frequency: 836.4 MHz Duty Cycle: 1:1

Probe: AM1DV3 - 3086

**z (axial) 4.2mm 50 x 50/ABM Interpolated Signal(x,y,z) (101x101x1):** Interpolated grid:

dx=1.000 mm, dy=1.000 mm

Signal Type: Audio File (.wav) 48k\_voice\_1kHz\_1s.wav

Output Gain: 100

Measure Window Start: 300ms

Measure Window Length: 1000ms

BWC applied: 0.15 dB

Device Reference Point: 0, 0, -6.3 mm

**Cursor:**

ABM1 = -0.50 dBA/m

BWC Factor = 0.15 dB

Location: 4, -9.5, 3.7 mm

**z (axial) 4.2mm 50 x 50/ABM Interpolated SNR(x,y,z) (101x101x1):** Interpolated grid: dx=1.000

mm, dy=1.000 mm

Signal Type: Audio File (.wav) 48k\_voice\_1kHz\_1s.wav

Output Gain: 100

Measure Window Start: 300ms

Measure Window Length: 1000ms

BWC applied: 0.15 dB

Device Reference Point: 0, 0, -6.3 mm

**Cursor:**

ABM1/ABM2 = 49.00 dB

ABM1 comp = -0.50 dBA/m

BWC Factor = 0.15 dB

Location: 4, -9.5, 3.7 mm

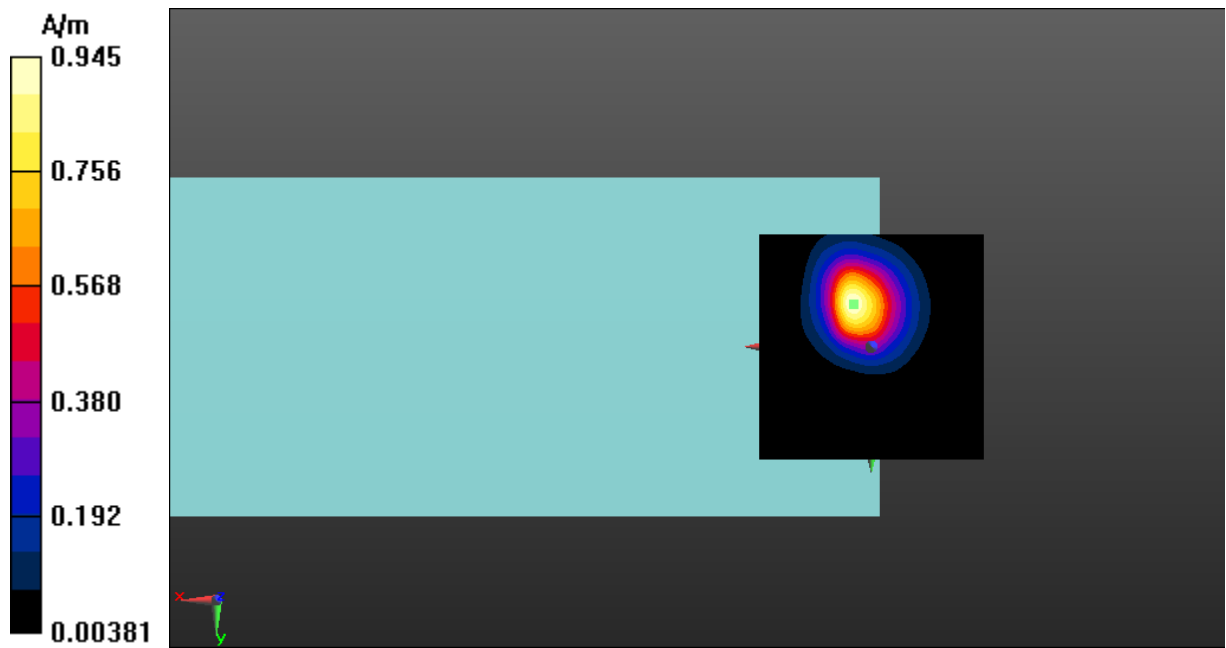

Fig A.5 T-Coil WCDMA Band 5-Z



**T-Coil WCDMA Band 5 Transverse**

Date: 2021-1-3

Electronics: DAE4 Sn1527

Medium: Air

Medium parameters used:  $\sigma = 0$  S/m,  $\epsilon_r = 1$ ;  $\rho = 1$  kg/m<sup>3</sup>

Ambient Temperature: 22.0°C

Communication System: WCDMA Frequency: 836.4 MHz Duty Cycle: 1:1

Probe: AM1DV3 - 3086

**y (transversal) 4.2mm 50 x 50/ABM Interpolated Signal(x,y,z) (101x101x1):** Interpolated grid:

dx=1.000 mm, dy=1.000 mm

Signal Type: Audio File (.wav) 48k\_voice\_1kHz\_1s.wav

Output Gain: 100

Measure Window Start: 300ms

Measure Window Length: 1000ms

BWC applied: 0.15 dB

Device Reference Point: 0, 0, -6.3 mm

**Cursor:**

ABM1 = -8.74 dBA/m

BWC Factor = 0.15 dB

Location: 4, -17, 3.7 mm

**y (transversal) 4.2mm 50 x 50/ABM Interpolated SNR(x,y,z) (101x101x1):** Interpolated grid:

dx=1.000 mm, dy=1.000 mm

Signal Type: Audio File (.wav) 48k\_voice\_1kHz\_1s.wav

Output Gain: 100

Measure Window Start: 300ms

Measure Window Length: 1000ms

BWC applied: 0.15 dB

Device Reference Point: 0, 0, -6.3 mm

**Cursor:**

ABM1/ABM2 = 41.12 dB

ABM1 comp = -9.30 dBA/m

BWC Factor = 0.15 dB

Location: 0.5, -17, 3.7 mm



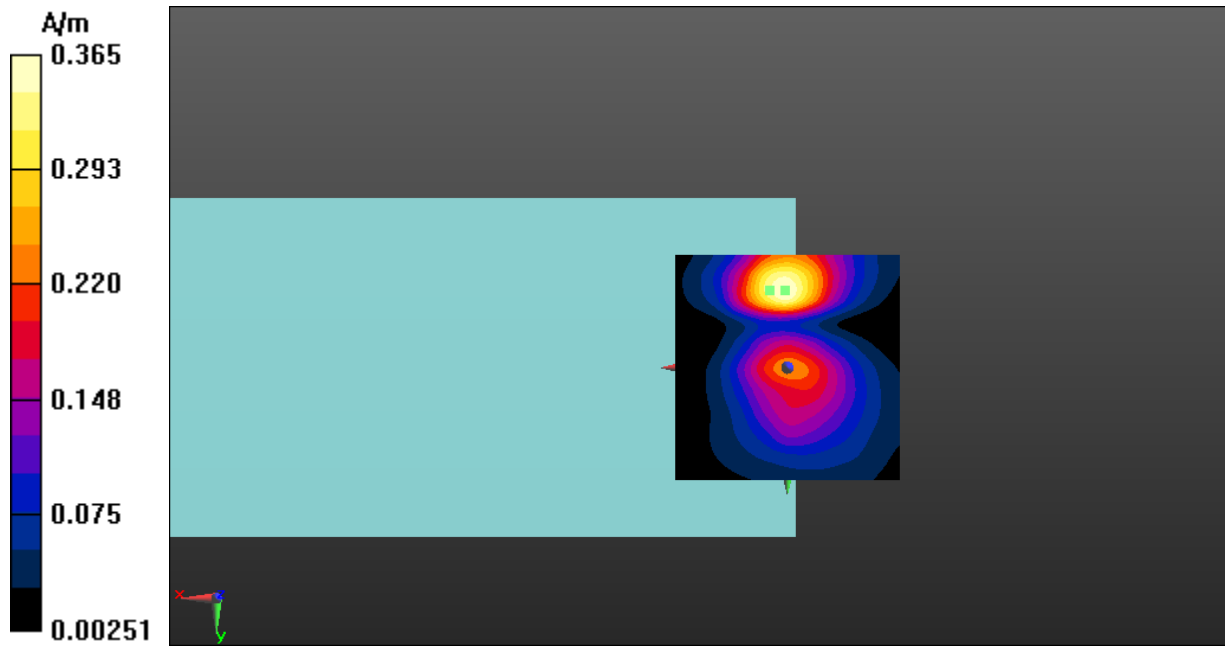

Fig A.5 T-Coil WCDMA Band 5-Y



**T-Coil LTE-Band 2 Axial**

Date: 2021-1-4

Electronics: DAE4 Sn1527

Medium: Air

Medium parameters used:  $\sigma = 0$  S/m,  $\epsilon_r = 1$ ;  $\rho = 1$  kg/m<sup>3</sup>

Ambient Temperature: 22.0°C

Communication System: UID 0, LTE\_FDD (0) Frequency: 1880 MHz Duty Cycle: 1:1

Probe: AM1DV3 - 3086

**z (axial) 4.2mm 50 x 50/ABM Interpolated Signal(x,y,z) (101x101x1):** Interpolated grid:

dx=1.000 mm, dy=1.000 mm

Signal Type: Audio File (.wav) 48k\_voice\_1kHz\_1s.wav

Output Gain: 100

Measure Window Start: 300ms

Measure Window Length: 1000ms

BWC applied: 0.15 dB

Device Reference Point: 0, 0, -6.3 mm

**Cursor:**

ABM1 = 1.29 dBA/m

BWC Factor = 0.15 dB

Location: 4, -9.5, 3.7 mm

**z (axial) 4.2mm 50 x 50/ABM Interpolated SNR(x,y,z) (101x101x1):** Interpolated grid: dx=1.000

mm, dy=1.000 mm

Signal Type: Audio File (.wav) 48k\_voice\_1kHz\_1s.wav

Output Gain: 100

Measure Window Start: 300ms

Measure Window Length: 1000ms

BWC applied: 0.15 dB

Device Reference Point: 0, 0, -6.3 mm

**Cursor:**

ABM1/ABM2 = 45.47 dB

ABM1 comp = 0.85 dBA/m

BWC Factor = 0.15 dB

Location: 2, -10, 3.7 mm

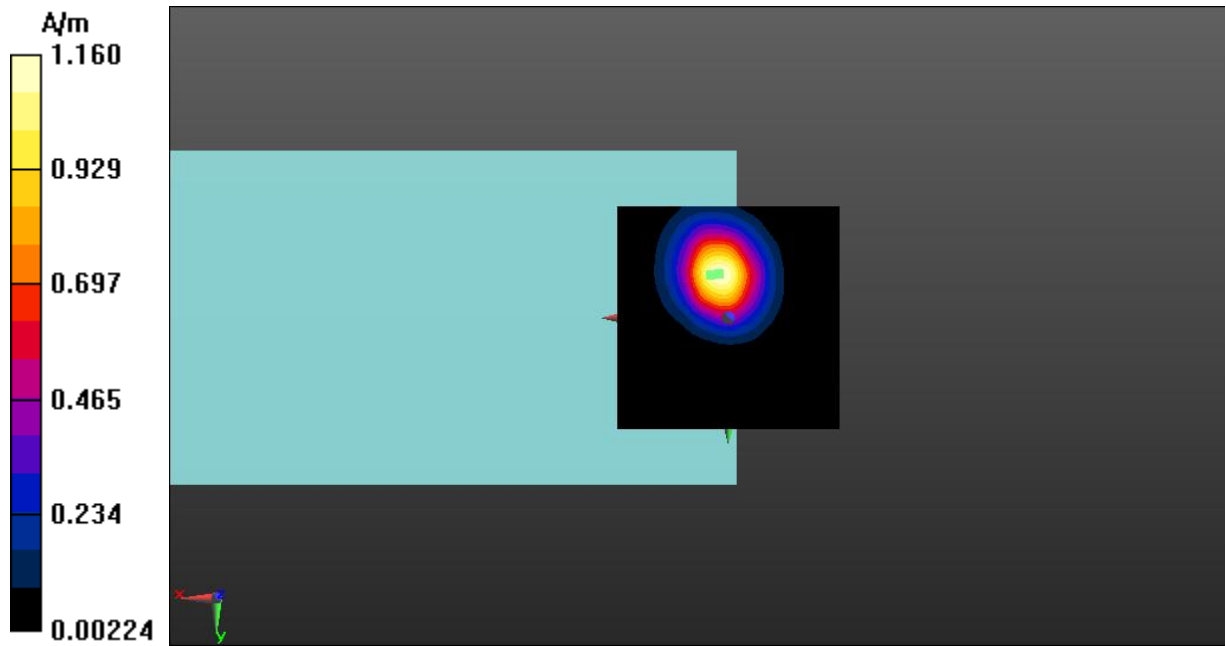

Fig A.6 T-Coil LTE-Band 2-Z



**T-Coil LTE-Band 2 Transverse**

Date: 2021-1-4

Electronics: DAE4 Sn1527

Medium: Air

Medium parameters used:  $\sigma = 0$  S/m,  $\epsilon_r = 1$ ;  $\rho = 1$  kg/m<sup>3</sup>

Ambient Temperature: 22.0°C

Communication System: UID 0, LTE\_FDD (0) Frequency: 1880 MHz Duty Cycle: 1:1

Probe: AM1DV3 - 3086

**y (transversal) 4.2mm 50 x 50/ABM Interpolated Signal(x,y,z) (101x101x1):** Interpolated grid:

dx=1.000 mm, dy=1.000 mm

Signal Type: Audio File (.wav) 48k\_voice\_1kHz\_1s.wav

Output Gain: 100

Measure Window Start: 300ms

Measure Window Length: 1000ms

BWC applied: 0.15 dB

Device Reference Point: 0, 0, -6.3 mm

**Cursor:**

ABM1 = -7.20 dBA/m

BWC Factor = 0.15 dB

Location: 4, -17, 3.7 mm

**y (transversal) 4.2mm 50 x 50/ABM Interpolated SNR(x,y,z) (101x101x1):** Interpolated grid:

dx=1.000 mm, dy=1.000 mm

Signal Type: Audio File (.wav) 48k\_voice\_1kHz\_1s.wav

Output Gain: 100

Measure Window Start: 300ms

Measure Window Length: 1000ms

BWC applied: 0.15 dB

Device Reference Point: 0, 0, -6.3 mm

**Cursor:**

ABM1/ABM2 = 41.61 dB

ABM1 comp = -7.81 dBA/m

BWC Factor = 0.15 dB

Location: 0.5, -17, 3.7 mm

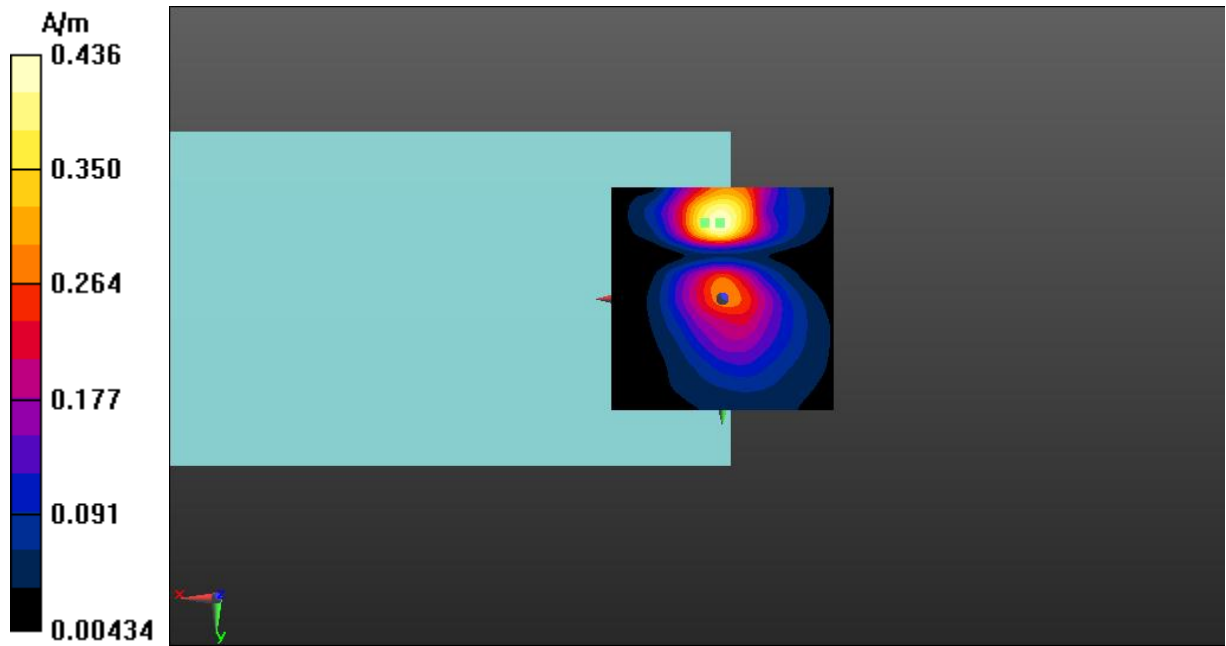

Fig A.6 T-Coil LTE-Band 2-Y



**T-Coil LTE-Band 4 Axial**

Date: 2021-1-4

Electronics: DAE4 Sn1527

Medium: Air

Medium parameters used:  $\sigma = 0$  S/m,  $\epsilon_r = 1$ ;  $\rho = 1$  kg/m<sup>3</sup>

Ambient Temperature: 22.0°C

Communication System: UID 0, LTE\_FDD (0) Frequency: 1732.5 MHz Duty Cycle: 1:1

Probe: AM1DV3 - 3086

**z (axial) 4.2mm 50 x 50/ABM Interpolated Signal(x,y,z) (101x101x1):** Interpolated grid:

dx=1.000 mm, dy=1.000 mm

Signal Type: Audio File (.wav) 48k\_voice\_1kHz\_1s.wav

Output Gain: 100

Measure Window Start: 300ms

Measure Window Length: 1000ms

BWC applied: 0.16 dB

Device Reference Point: 0, 0, -6.3 mm

**Cursor:**

ABM1 = 1.34 dBA/m

BWC Factor = 0.16 dB

Location: 4, -9.5, 3.7 mm

**z (axial) 4.2mm 50 x 50/ABM Interpolated SNR(x,y,z) (101x101x1):** Interpolated grid: dx=1.000

mm, dy=1.000 mm

Signal Type: Audio File (.wav) 48k\_voice\_1kHz\_1s.wav

Output Gain: 100

Measure Window Start: 300ms

Measure Window Length: 1000ms

BWC applied: 0.16 dB

Device Reference Point: 0, 0, -6.3 mm

**Cursor:**

ABM1/ABM2 = 45.06 dB

ABM1 comp = 0.88 dBA/m

BWC Factor = 0.16 dB

Location: 1.5, -10, 3.7 mm

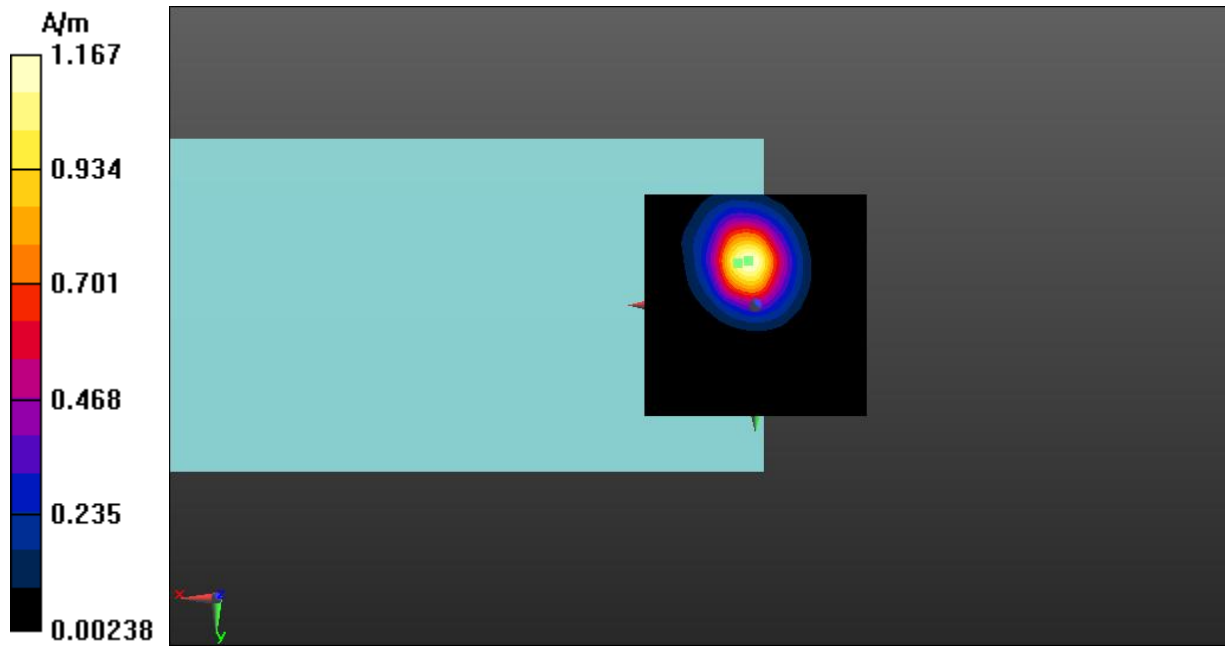

Fig A.7 T-Coil LTE-Band 4-Z



**T-Coil LTE-Band 4 Transverse**

Date: 2021-1-4

Electronics: DAE4 Sn1527

Medium: Air

Medium parameters used:  $\sigma = 0$  S/m,  $\epsilon_r = 1$ ;  $\rho = 1$  kg/m<sup>3</sup>

Ambient Temperature: 22.0°C

Communication System: UID 0, LTE\_FDD (0) Frequency: 1732.5 MHz Duty Cycle: 1:1

Probe: AM1DV3 - 3086

**y (transversal) 4.2mm 50 x 50/ABM Interpolated Signal(x,y,z) (101x101x1):** Interpolated grid:

dx=1.000 mm, dy=1.000 mm

Signal Type: Audio File (.wav) 48k\_voice\_1kHz\_1s.wav

Output Gain: 100

Measure Window Start: 300ms

Measure Window Length: 1000ms

BWC applied: 0.16 dB

Device Reference Point: 0, 0, -6.3 mm

**Cursor:**

ABM1 = -7.01 dBA/m

BWC Factor = 0.16 dB

Location: 4, -17, 3.7 mm

**y (transversal) 4.2mm 50 x 50/ABM Interpolated SNR(x,y,z) (101x101x1):** Interpolated grid:

dx=1.000 mm, dy=1.000 mm

Signal Type: Audio File (.wav) 48k\_voice\_1kHz\_1s.wav

Output Gain: 100

Measure Window Start: 300ms

Measure Window Length: 1000ms

BWC applied: 0.16 dB

Device Reference Point: 0, 0, -6.3 mm

**Cursor:**

ABM1/ABM2 = 41.73 dB

ABM1 comp = -7.75 dBA/m

BWC Factor = 0.16 dB

Location: 0.5, -17.5, 3.7 mm



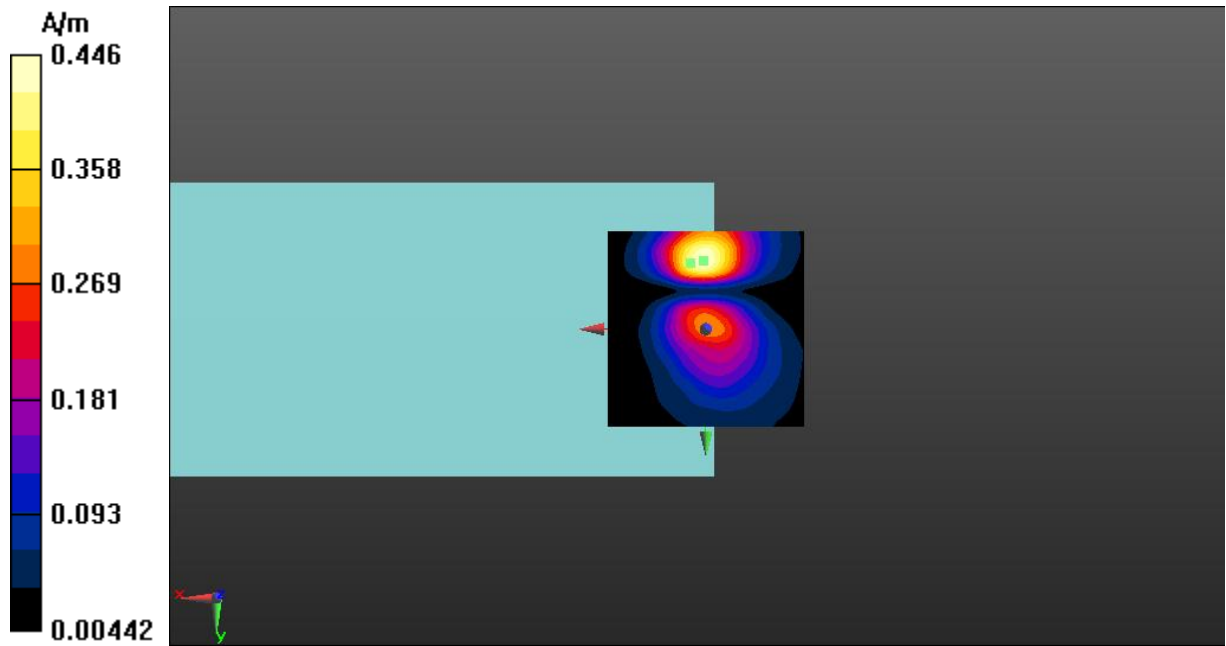

Fig A.7 T-Coil LTE-Band 4-Y



**T-Coil LTE-Band 5 Axial**

Date: 2021-1-4

Electronics: DAE4 Sn1527

Medium: Air

Medium parameters used:  $\sigma = 0$  S/m,  $\epsilon_r = 1$ ;  $\rho = 1$  kg/m<sup>3</sup>

Ambient Temperature: 22.0°C

Communication System: UID 0, LTE\_FDD (0) Frequency: 836.5 MHz Duty Cycle: 1:1

Probe: AM1DV3 - 3086

**z (axial) 4.2mm 50 x 50/ABM Interpolated Signal(x,y,z) (101x101x1):** Interpolated grid:

dx=1.000 mm, dy=1.000 mm

Signal Type: Audio File (.wav) 48k\_voice\_1kHz\_1s.wav

Output Gain: 100

Measure Window Start: 300ms

Measure Window Length: 1000ms

BWC applied: 0.16 dB

Device Reference Point: 0, 0, -6.3 mm

**Cursor:**

ABM1 = 1.24 dBA/m

BWC Factor = 0.16 dB

Location: 4, -9.5, 3.7 mm

**z (axial) 4.2mm 50 x 50/ABM Interpolated SNR(x,y,z) (101x101x1):** Interpolated grid: dx=1.000

mm, dy=1.000 mm

Signal Type: Audio File (.wav) 48k\_voice\_1kHz\_1s.wav

Output Gain: 100

Measure Window Start: 300ms

Measure Window Length: 1000ms

BWC applied: 0.16 dB

Device Reference Point: 0, 0, -6.3 mm

**Cursor:**

ABM1/ABM2 = 46.09 dB

ABM1 comp = 0.92 dBA/m

BWC Factor = 0.16 dB

Location: 2, -10, 3.7 mm

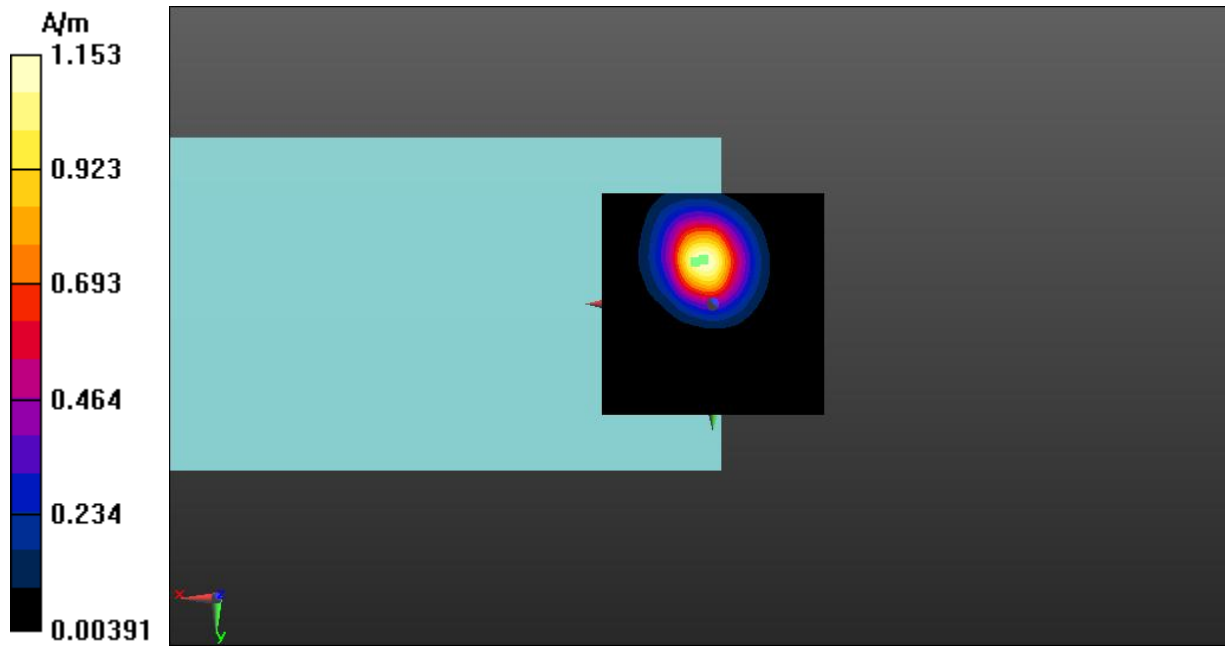

Fig A.8 T-Coil LTE-Band 5-Z



**T-Coil LTE-Band 5 Transverse**

Date: 2021-1-4

Electronics: DAE4 Sn1527

Medium: Air

Medium parameters used:  $\sigma = 0$  S/m,  $\epsilon_r = 1$ ;  $\rho = 1$  kg/m<sup>3</sup>

Ambient Temperature: 22.0°C

Communication System: UID 0, LTE\_FDD (0) Frequency: 836.5 MHz Duty Cycle: 1:1

Probe: AM1DV3 - 3086

**y (transversal) 4.2mm 50 x 50/ABM Interpolated Signal(x,y,z) (101x101x1):** Interpolated grid:

dx=1.000 mm, dy=1.000 mm

Signal Type: Audio File (.wav) 48k\_voice\_1kHz\_1s.wav

Output Gain: 100

Measure Window Start: 300ms

Measure Window Length: 1000ms

BWC applied: 0.16 dB

Device Reference Point: 0, 0, -6.3 mm

**Cursor:**

ABM1 = -7.20 dBA/m

BWC Factor = 0.16 dB

Location: 3, -0.5, 3.7 mm

**y (transversal) 4.2mm 50 x 50/ABM Interpolated SNR(x,y,z) (101x101x1):** Interpolated grid:

dx=1.000 mm, dy=1.000 mm

Signal Type: Audio File (.wav) 48k\_voice\_1kHz\_1s.wav

Output Gain: 100

Measure Window Start: 300ms

Measure Window Length: 1000ms

BWC applied: 0.16 dB

Device Reference Point: 0, 0, -6.3 mm

**Cursor:**

ABM1/ABM2 = 42.17 dB

ABM1 comp = -7.60 dBA/m

BWC Factor = 0.16 dB

Location: 0.5, -17.5, 3.7 mm

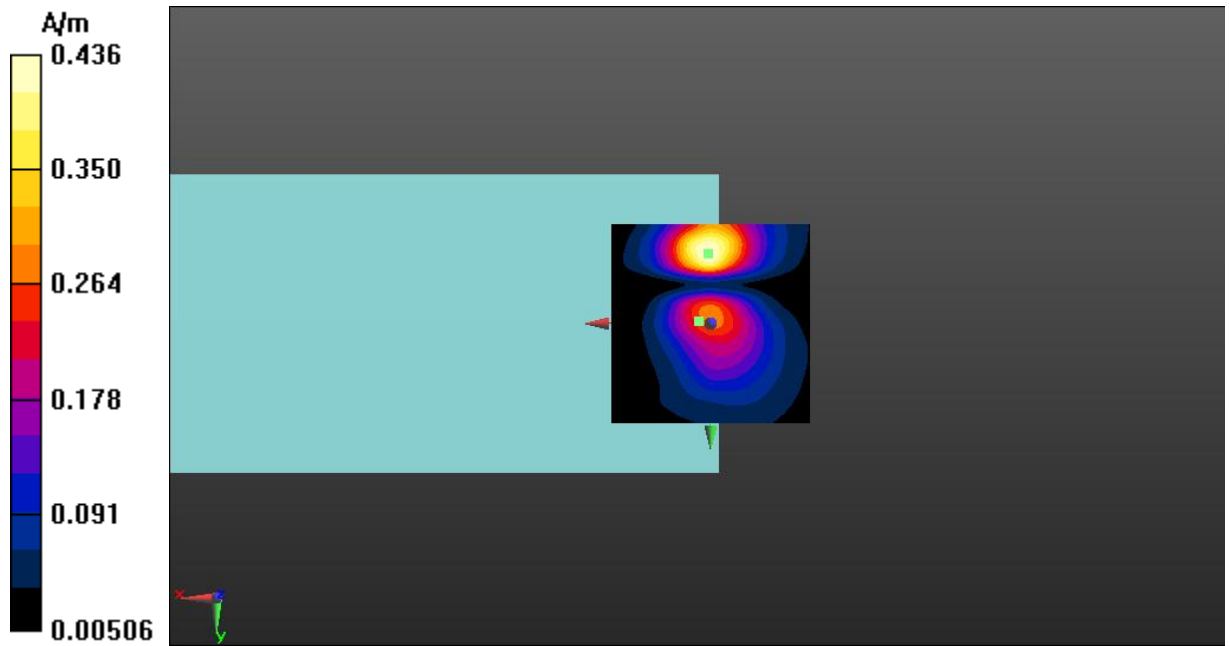

Fig A.8 T-Coil LTE-Band 5-Y



**T-Coil LTE-Band 7 Axial**

Date: 2021-1-4

Electronics: DAE4 Sn1527

Medium: Air

Medium parameters used:  $\sigma = 0$  S/m,  $\epsilon_r = 1$ ;  $\rho = 1$  kg/m<sup>3</sup>

Ambient Temperature: 22.0°C

Communication System: UID 0, LTE\_FDD (0) Frequency: 2535 MHz Duty Cycle: 1:1

Probe: AM1DV3 - 3086

**z (axial) 4.2mm 50 x 50/ABM Interpolated Signal(x,y,z) (101x101x1):** Interpolated grid:

dx=1.000 mm, dy=1.000 mm

Signal Type: Audio File (.wav) 48k\_voice\_1kHz\_1s.wav

Output Gain: 100

Measure Window Start: 300ms

Measure Window Length: 1000ms

BWC applied: 0.16 dB

Device Reference Point: 0, 0, -6.3 mm

**Cursor:**

ABM1 = 1.34 dBA/m

BWC Factor = 0.16 dB

Location: 4, -9.5, 3.7 mm

**z (axial) 4.2mm 50 x 50/ABM Interpolated SNR(x,y,z) (101x101x1):** Interpolated grid: dx=1.000

mm, dy=1.000 mm

Signal Type: Audio File (.wav) 48k\_voice\_1kHz\_1s.wav

Output Gain: 100

Measure Window Start: 300ms

Measure Window Length: 1000ms

BWC applied: 0.16 dB

Device Reference Point: 0, 0, -6.3 mm

**Cursor:**

ABM1/ABM2 = 44.89 dB

ABM1 comp = 0.84 dBA/m

BWC Factor = 0.16 dB

Location: 1.5, -10, 3.7 mm

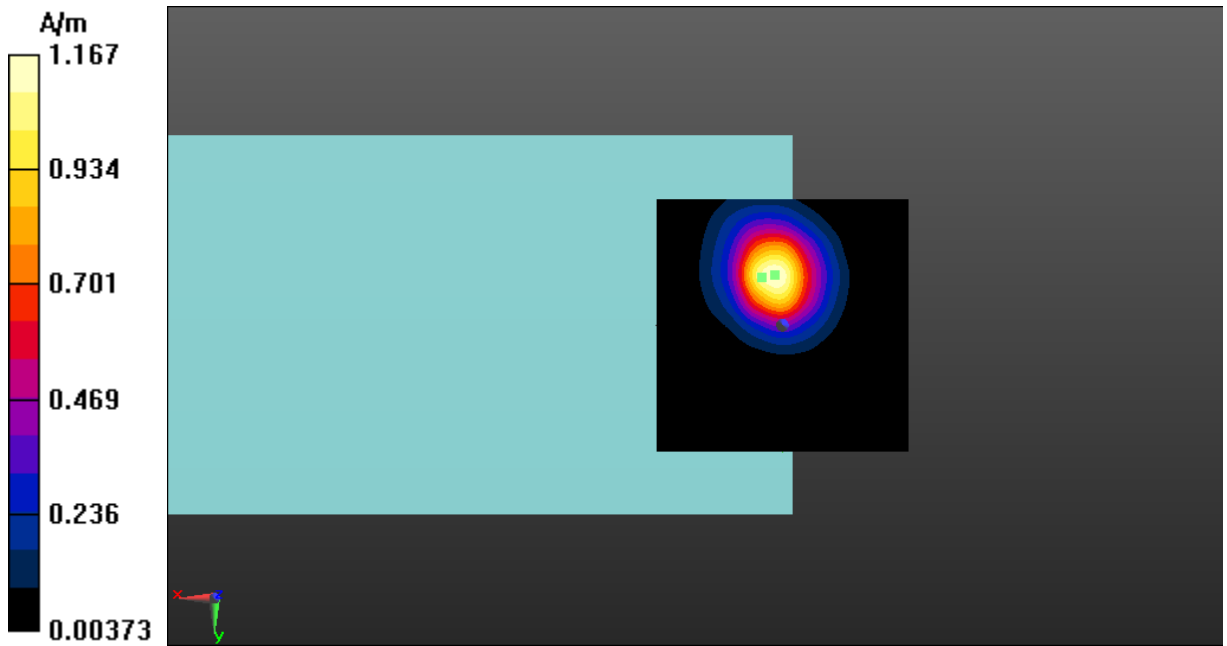

Fig A.9 T-Coil LTE-Band 7-Z



**T-Coil LTE-Band 7 Transverse**

Date: 2021-1-4

Electronics: DAE4 Sn1527

Medium: Air

Medium parameters used:  $\sigma = 0$  S/m,  $\epsilon_r = 1$ ;  $\rho = 1$  kg/m<sup>3</sup>

Ambient Temperature: 22.0°C

Communication System: UID 0, LTE\_FDD (0) Frequency: 2535 MHz Duty Cycle: 1:1

Probe: AM1DV3 - 3086

**y (transversal) 4.2mm 50 x 50/ABM Interpolated Signal(x,y,z) (101x101x1):** Interpolated grid:

dx=1.000 mm, dy=1.000 mm

Signal Type: Audio File (.wav) 48k\_voice\_1kHz\_1s.wav

Output Gain: 100

Measure Window Start: 300ms

Measure Window Length: 1000ms

BWC applied: 0.16 dB

Device Reference Point: 0, 0, -6.3 mm

**Cursor:**

ABM1 = -6.95 dBA/m

BWC Factor = 0.16 dB

Location: 4, -0.5, 3.7 mm

**y (transversal) 4.2mm 50 x 50/ABM Interpolated SNR(x,y,z) (101x101x1):** Interpolated grid:

dx=1.000 mm, dy=1.000 mm

Signal Type: Audio File (.wav) 48k\_voice\_1kHz\_1s.wav

Output Gain: 100

Measure Window Start: 300ms

Measure Window Length: 1000ms

BWC applied: 0.16 dB

Device Reference Point: 0, 0, -6.3 mm

**Cursor:**

ABM1/ABM2 = 41.24 dB

ABM1 comp = -7.75 dBA/m

BWC Factor = 0.16 dB

Location: 0, -18.5, 3.7 mm



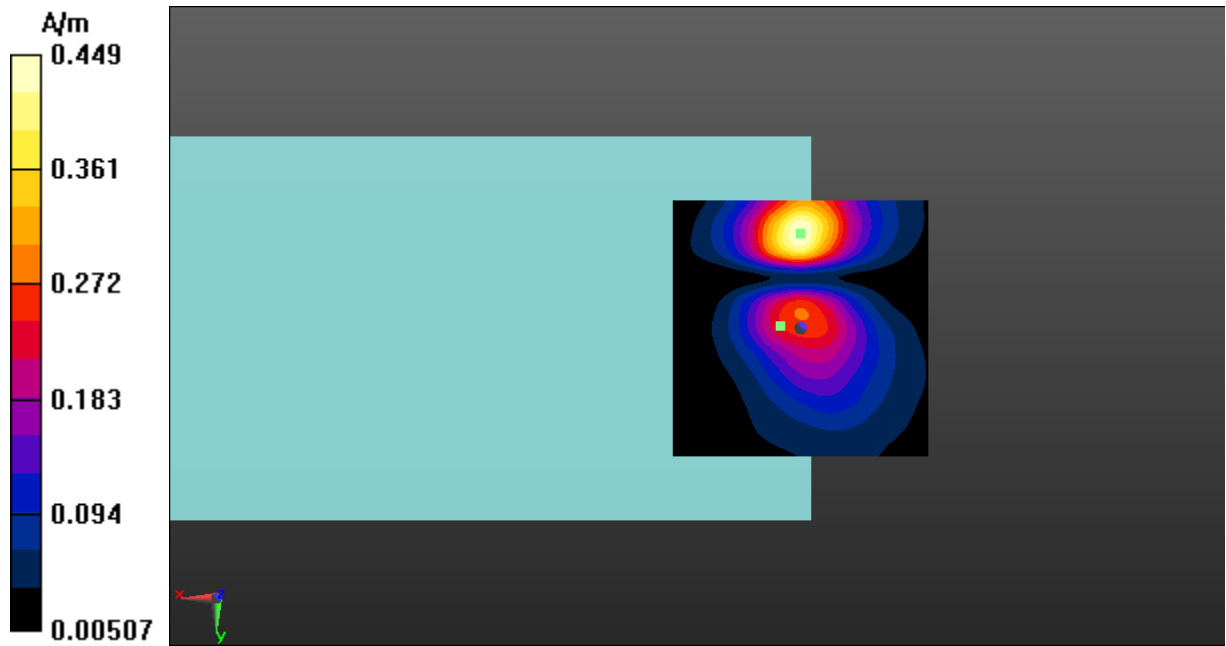

Fig A.9 T-Coil LTE-Band 7-Y



**T-Coil LTE-Band 12 Axial**

Date: 2021-1-4

Electronics: DAE4 Sn1527

Medium: Air

Medium parameters used:  $\sigma = 0$  S/m,  $\epsilon_r = 1$ ;  $\rho = 1$  kg/m<sup>3</sup>

Ambient Temperature: 22.0°C

Communication System: UID 0, LTE\_FDD (0) Frequency: 707.5 MHz Duty Cycle: 1:1

Probe: AM1DV3 - 3086

**z (axial) 4.2mm 50 x 50/ABM Interpolated Signal(x,y,z) (101x101x1):** Interpolated grid:

dx=1.000 mm, dy=1.000 mm

Signal Type: Audio File (.wav) 48k\_voice\_1kHz\_1s.wav

Output Gain: 100

Measure Window Start: 300ms

Measure Window Length: 1000ms

BWC applied: 0.16 dB

Device Reference Point: 0, 0, -6.3 mm

**Cursor:**

ABM1 = 1.24 dBA/m

BWC Factor = 0.16 dB

Location: 3.5, -9.5, 3.7 mm

**z (axial) 4.2mm 50 x 50/ABM Interpolated SNR(x,y,z) (101x101x1):** Interpolated grid: dx=1.000

mm, dy=1.000 mm

Signal Type: Audio File (.wav) 48k\_voice\_1kHz\_1s.wav

Output Gain: 100

Measure Window Start: 300ms

Measure Window Length: 1000ms

BWC applied: 0.16 dB

Device Reference Point: 0, 0, -6.3 mm

**Cursor:**

ABM1/ABM2 = 46.44 dB

ABM1 comp = 1.00 dBA/m

BWC Factor = 0.16 dB

Location: 2, -10, 3.7 mm

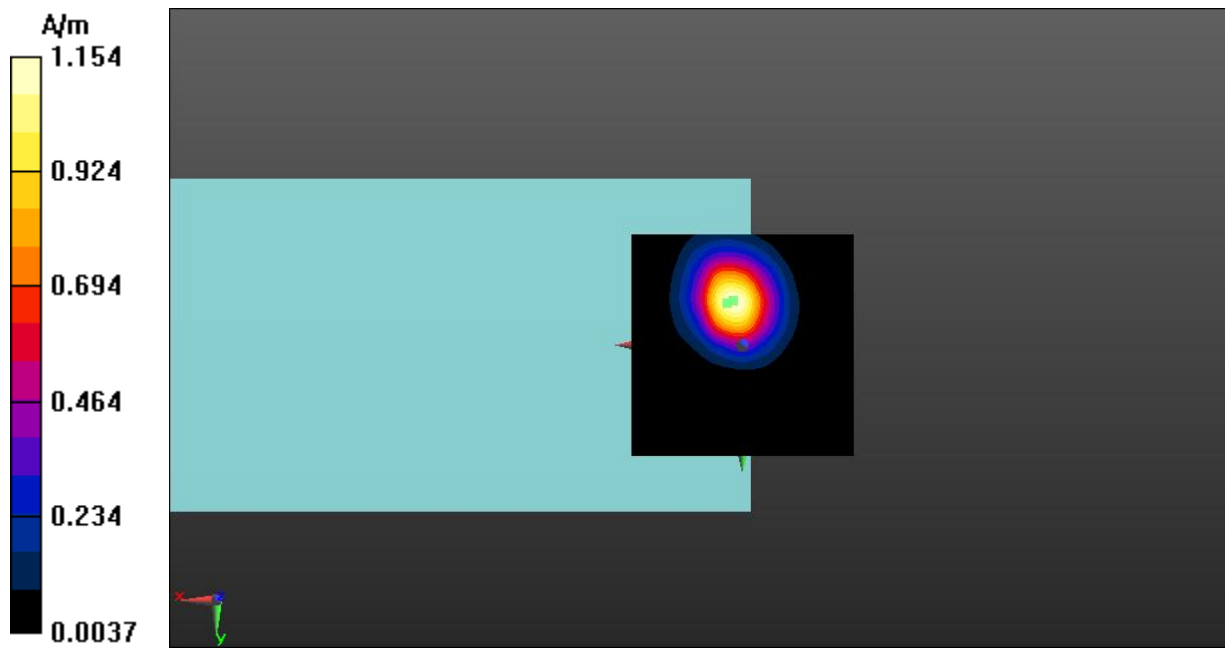

Fig A.10 T-Coil LTE-Band 12-Z



**T-Coil LTE-Band 12 Transverse**

Date: 2021-1-4

Electronics: DAE4 Sn1527

Medium: Air

Medium parameters used:  $\sigma = 0$  S/m,  $\epsilon_r = 1$ ;  $\rho = 1$  kg/m<sup>3</sup>

Ambient Temperature: 22.0°C

Communication System: UID 0, LTE\_FDD (0) Frequency: 707.5 MHz Duty Cycle: 1:1

Probe: AM1DV3 - 3086

**y (transversal) 4.2mm 50 x 50/ABM Interpolated Signal(x,y,z) (101x101x1):** Interpolated grid:

dx=1.000 mm, dy=1.000 mm

Signal Type: Audio File (.wav) 48k\_voice\_1kHz\_1s.wav

Output Gain: 100

Measure Window Start: 300ms

Measure Window Length: 1000ms

BWC applied: 0.16 dB

Device Reference Point: 0, 0, -6.3 mm

**Cursor:**

ABM1 = -6.79 dBA/m

BWC Factor = 0.16 dB

Location: 4, -0.5, 3.7 mm

**y (transversal) 4.2mm 50 x 50/ABM Interpolated SNR(x,y,z) (101x101x1):** Interpolated grid:

dx=1.000 mm, dy=1.000 mm

Signal Type: Audio File (.wav) 48k\_voice\_1kHz\_1s.wav

Output Gain: 100

Measure Window Start: 300ms

Measure Window Length: 1000ms

BWC applied: 0.16 dB

Device Reference Point: 0, 0, -6.3 mm

**Cursor:**

ABM1/ABM2 = 42.00 dB

ABM1 comp = -7.73 dBA/m

BWC Factor = 0.16 dB

Location: 0.5, -18, 3.7 mm

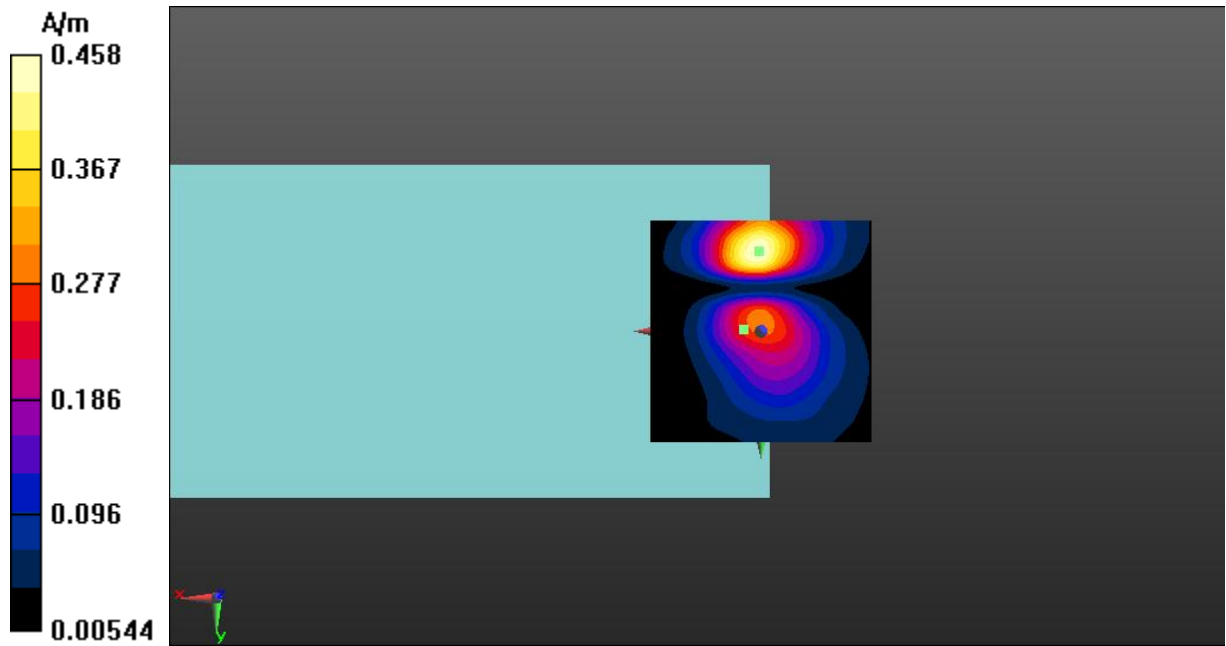

Fig A.10 T-Coil LTE-Band 12-Y



**T-Coil LTE-Band 17 Axial**

Date: 2021-1-4

Electronics: DAE4 Sn1527

Medium: Air

Medium parameters used:  $\sigma = 0$  S/m,  $\epsilon_r = 1$ ;  $\rho = 1$  kg/m<sup>3</sup>

Ambient Temperature: 22.0°C

Communication System: UID 0, LTE\_FDD (0) Frequency: 710 MHz Duty Cycle: 1:1

Probe: AM1DV3 - 3086

**z (axial) 4.2mm 50 x 50/ABM Interpolated Signal(x,y,z) (101x101x1):** Interpolated grid:

dx=1.000 mm, dy=1.000 mm

Signal Type: Audio File (.wav) 48k\_voice\_1kHz\_1s.wav

Output Gain: 100

Measure Window Start: 300ms

Measure Window Length: 1000ms

BWC applied: 0.16 dB

Device Reference Point: 0, 0, -6.3 mm

**Cursor:**

ABM1 = 1.32 dBA/m

BWC Factor = 0.16 dB

Location: 4, -10, 3.7 mm

**z (axial) 4.2mm 50 x 50/ABM Interpolated SNR(x,y,z) (101x101x1):** Interpolated grid: dx=1.000

mm, dy=1.000 mm

Signal Type: Audio File (.wav) 48k\_voice\_1kHz\_1s.wav

Output Gain: 100

Measure Window Start: 300ms

Measure Window Length: 1000ms

BWC applied: 0.16 dB

Device Reference Point: 0, 0, -6.3 mm

**Cursor:**

ABM1/ABM2 = 46.37 dB

ABM1 comp = 1.09 dBA/m

BWC Factor = 0.16 dB

Location: 2.5, -10, 3.7 mm

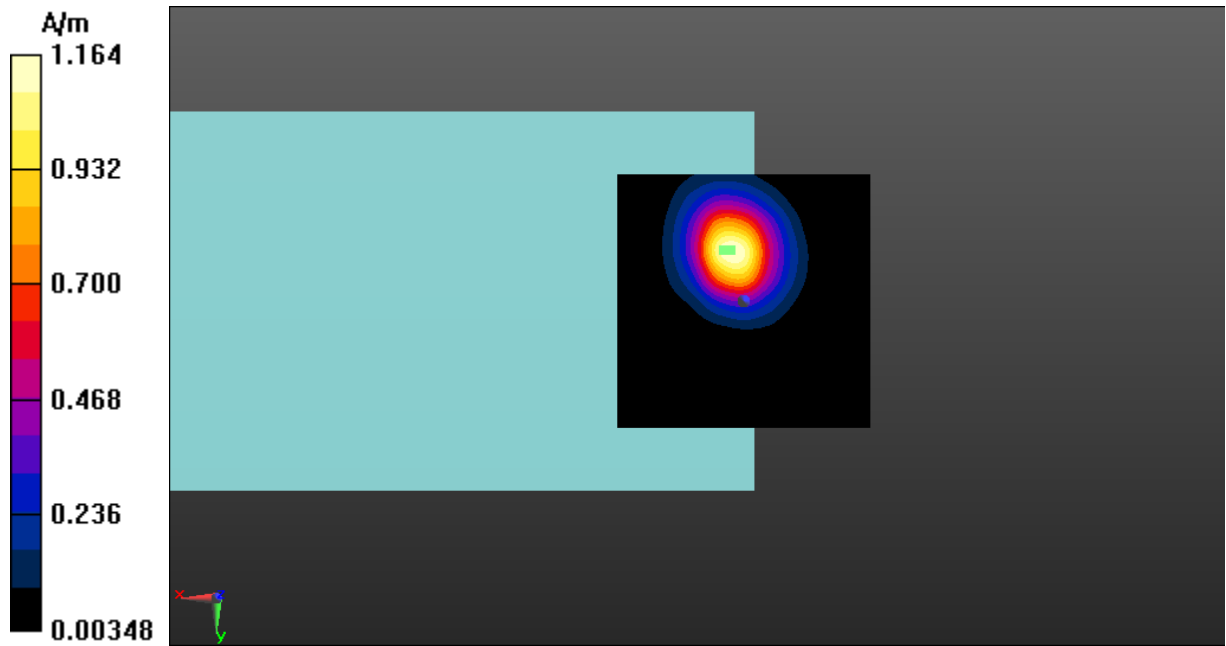

Fig A.11 T-Coil LTE-Band 17-Z



**T-Coil LTE-Band 17 Transverse**

Date: 2021-1-4

Electronics: DAE4 Sn1527

Medium: Air

Medium parameters used:  $\sigma = 0$  S/m,  $\epsilon_r = 1$ ;  $\rho = 1$  kg/m<sup>3</sup>

Ambient Temperature: 22.0°C

Communication System: UID 0, LTE\_FDD (0) Frequency: 710 MHz Duty Cycle: 1:1

Probe: AM1DV3 - 3086

**y (transversal) 4.2mm 50 x 50/ABM Interpolated Signal(x,y,z) (101x101x1):** Interpolated grid:

dx=1.000 mm, dy=1.000 mm

Signal Type: Audio File (.wav) 48k\_voice\_1kHz\_1s.wav

Output Gain: 100

Measure Window Start: 300ms

Measure Window Length: 1000ms

BWC applied: 0.16 dB

Device Reference Point: 0, 0, -6.3 mm

**Cursor:**

ABM1 = -7.08 dBA/m

BWC Factor = 0.16 dB

Location: 2.5, -0.5, 3.7 mm

**y (transversal) 4.2mm 50 x 50/ABM Interpolated SNR(x,y,z) (101x101x1):** Interpolated grid:

dx=1.000 mm, dy=1.000 mm

Signal Type: Audio File (.wav) 48k\_voice\_1kHz\_1s.wav

Output Gain: 100

Measure Window Start: 300ms

Measure Window Length: 1000ms

BWC applied: 0.16 dB

Device Reference Point: 0, 0, -6.3 mm

**Cursor:**

ABM1/ABM2 = 41.90 dB

ABM1 comp = -7.63 dBA/m

BWC Factor = 0.16 dB

Location: 0.5, -18, 3.7 mm



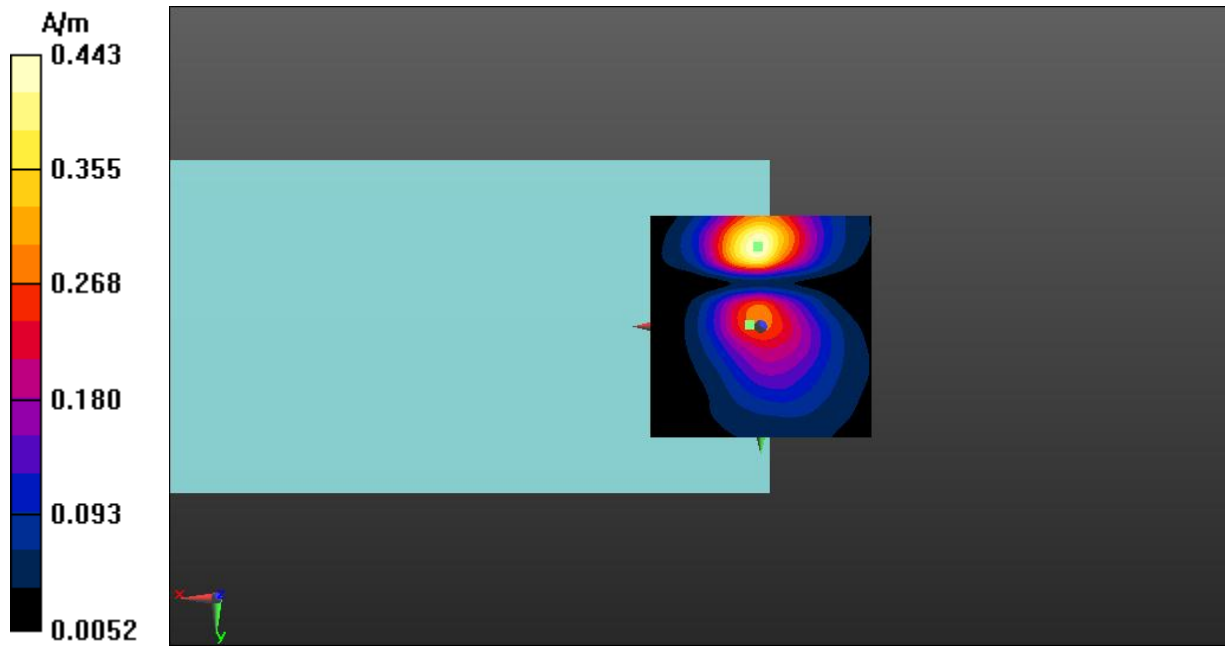

Fig A.11 T-Coil LTE-Band 17-Y



**T-Coil LTE-Band 66 Axial**

Date: 2021-1-4

Electronics: DAE4 Sn1527

Medium: Air

Medium parameters used:  $\sigma = 0$  S/m,  $\epsilon_r = 1$ ;  $\rho = 1$  kg/m<sup>3</sup>

Ambient Temperature: 22.0°C

Communication System: UID 0, LTE\_FDD (0) Frequency: 1745 MHz Duty Cycle: 1:1

Probe: AM1DV3 - 3086

**z (axial) 4.2mm 50 x 50/ABM Interpolated Signal(x,y,z) (101x101x1):** Interpolated grid:

dx=1.000 mm, dy=1.000 mm

Signal Type: Audio File (.wav) 48k\_voice\_1kHz\_1s.wav

Output Gain: 100

Measure Window Start: 300ms

Measure Window Length: 1000ms

BWC applied: 0.16 dB

Device Reference Point: 0, 0, -6.3 mm

**Cursor:**

ABM1 = 1.27 dBA/m

BWC Factor = 0.16 dB

Location: 3.5, -9.5, 3.7 mm

**z (axial) 4.2mm 50 x 50/ABM Interpolated SNR(x,y,z) (101x101x1):** Interpolated grid: dx=1.000

mm, dy=1.000 mm

Signal Type: Audio File (.wav) 48k\_voice\_1kHz\_1s.wav

Output Gain: 100

Measure Window Start: 300ms

Measure Window Length: 1000ms

BWC applied: 0.16 dB

Device Reference Point: 0, 0, -6.3 mm

**Cursor:**

ABM1/ABM2 = 45.49 dB

ABM1 comp = 0.92 dBA/m

BWC Factor = 0.16 dB

Location: 1.5, -10, 3.7 mm

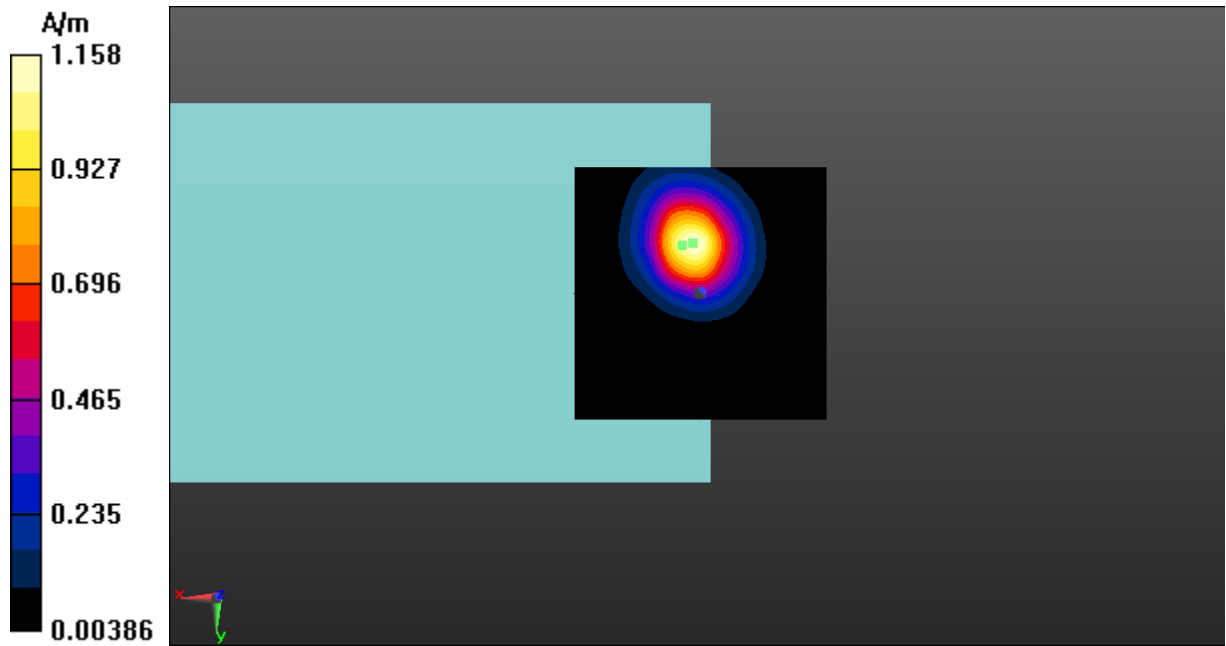

Fig A.12 T-Coil LTE-Band 66-Z



**T-Coil LTE-Band 66 Transverse**

Date: 2021-1-4

Electronics: DAE4 Sn1527

Medium: Air

Medium parameters used:  $\sigma = 0$  S/m,  $\epsilon_r = 1$ ;  $\rho = 1$  kg/m<sup>3</sup>

Ambient Temperature: 22.0°C

Communication System: UID 0, LTE\_FDD (0) Frequency: 1745 MHz Duty Cycle: 1:1

Probe: AM1DV3 - 3086

**y (transversal) 4.2mm 50 x 50/ABM Interpolated Signal(x,y,z) (101x101x1):** Interpolated grid:

dx=1.000 mm, dy=1.000 mm

Signal Type: Audio File (.wav) 48k\_voice\_1kHz\_1s.wav

Output Gain: 100

Measure Window Start: 300ms

Measure Window Length: 1000ms

BWC applied: 0.16 dB

Device Reference Point: 0, 0, -6.3 mm

**Cursor:**

ABM1 = -7.11 dBA/m

BWC Factor = 0.16 dB

Location: 3, -0.5, 3.7 mm

**y (transversal) 4.2mm 50 x 50/ABM Interpolated SNR(x,y,z) (101x101x1):** Interpolated grid:

dx=1.000 mm, dy=1.000 mm

Signal Type: Audio File (.wav) 48k\_voice\_1kHz\_1s.wav

Output Gain: 100

Measure Window Start: 300ms

Measure Window Length: 1000ms

BWC applied: 0.16 dB

Device Reference Point: 0, 0, -6.3 mm

**Cursor:**

ABM1/ABM2 = 41.61 dB

ABM1 comp = -7.82 dBA/m

BWC Factor = 0.16 dB

Location: 0.5, -17.5, 3.7 mm

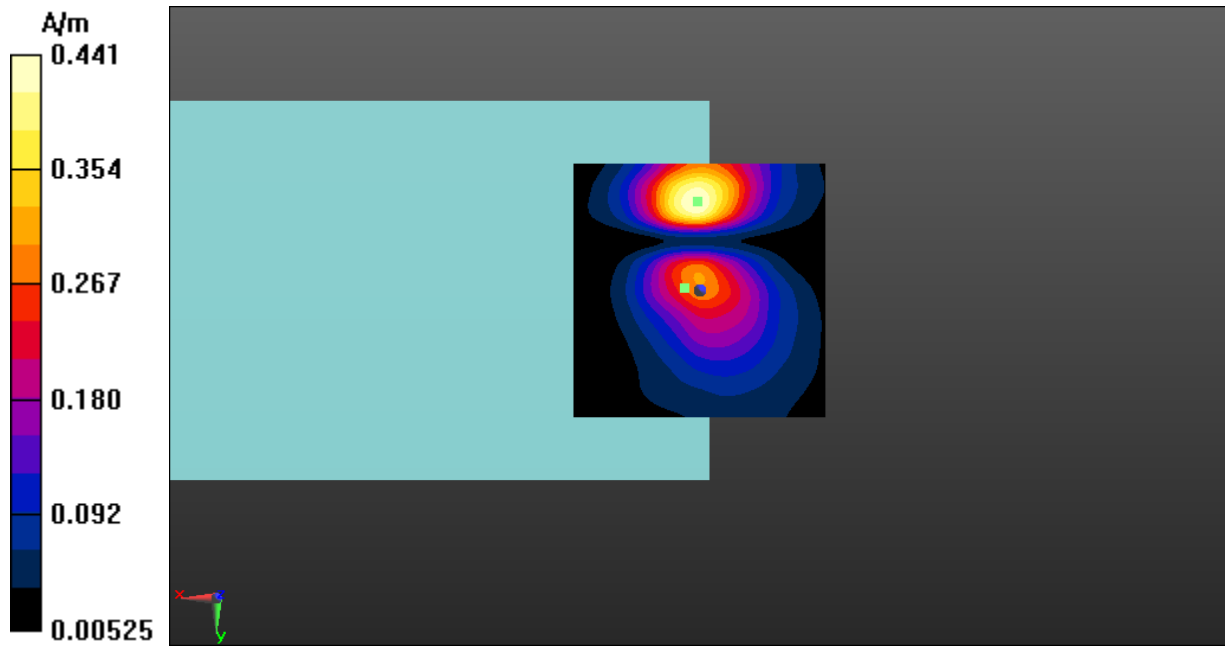

Fig A.12 T-Coil LTE-Band 66-Y



**T-Coil WLAN 2.4G Axial**

Date: 2021-1-5

Electronics: DAE4 Sn1527

Medium: Air

Medium parameters used:  $\sigma = 0$  S/m,  $\epsilon_r = 1$ ;  $\rho = 1$  kg/m<sup>3</sup>

Ambient Temperature: 22.0°C

Communication System: WLAN Frequency: 2437 MHz Duty Cycle: 1:1

Probe: AM1DV3 - 3086

**z (axial) 4.2mm 50 x 50/ABM Interpolated Signal(x,y,z) (101x101x1):** Interpolated grid:

dx=1.000 mm, dy=1.000 mm

Signal Type: Audio File (.wav) 48k\_voice\_1kHz\_1s.wav

Output Gain: 100

Measure Window Start: 300ms

Measure Window Length: 1000ms

BWC applied: 0.15 dB

Device Reference Point: 0, 0, -6.3 mm

**Cursor:**

ABM1 = 1.34 dBA/m

BWC Factor = 0.15 dB

Location: 4.5, -9.5, 3.7 mm

**z (axial) 4.2mm 50 x 50/ABM Interpolated SNR(x,y,z) (101x101x1):** Interpolated grid: dx=1.000

mm, dy=1.000 mm

Signal Type: Audio File (.wav) 48k\_voice\_1kHz\_1s.wav

Output Gain: 100

Measure Window Start: 300ms

Measure Window Length: 1000ms

BWC applied: 0.15 dB

Device Reference Point: 0, 0, -6.3 mm

**Cursor:**

ABM1/ABM2 = 49.10 dB

ABM1 comp = 1.28 dBA/m

BWC Factor = 0.15 dB

Location: 5, -10, 3.7 mm

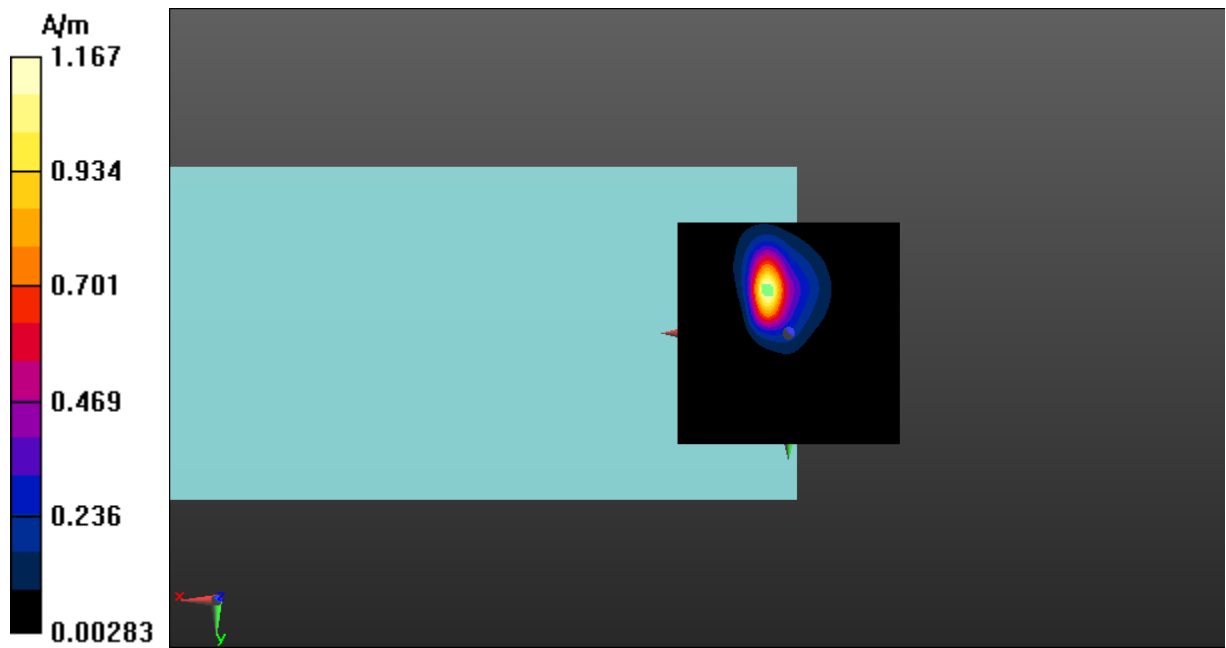

Fig A.13 T-Coil WLAN 2.4G-Z



**T-Coil WLAN 2.4G Transverse**

Date: 2021-1-5

Electronics: DAE4 Sn1527

Medium: Air

Medium parameters used:  $\sigma = 0$  S/m,  $\epsilon_r = 1$ ;  $\rho = 1$  kg/m<sup>3</sup>

Ambient Temperature: 22.0°C

Communication System: WLAN Frequency: 2437 MHz Duty Cycle: 1:1

Probe: AM1DV3 - 3086

**y (transversal) 4.2mm 50 x 50/ABM Interpolated Signal(x,y,z) (101x101x1):** Interpolated grid:

dx=1.000 mm, dy=1.000 mm

Signal Type: Audio File (.wav) 48k\_voice\_1kHz\_1s.wav

Output Gain: 100

Measure Window Start: 300ms

Measure Window Length: 1000ms

BWC applied: 0.15 dB

Device Reference Point: 0, 0, -6.3 mm

**Cursor:**

ABM1 = -7.07 dBA/m

BWC Factor = 0.15 dB

Location: 4, -0.5, 3.7 mm

**y (transversal) 4.2mm 50 x 50/ABM Interpolated SNR(x,y,z) (101x101x1):** Interpolated grid:

dx=1.000 mm, dy=1.000 mm

Signal Type: Audio File (.wav) 48k\_voice\_1kHz\_1s.wav

Output Gain: 100

Measure Window Start: 300ms

Measure Window Length: 1000ms

BWC applied: 0.15 dB

Device Reference Point: 0, 0, -6.3 mm

**Cursor:**

ABM1/ABM2 = 35.90 dB

ABM1 comp = -9.34 dBA/m

BWC Factor = 0.15 dB

Location: -2, -18.5, 3.7 mm



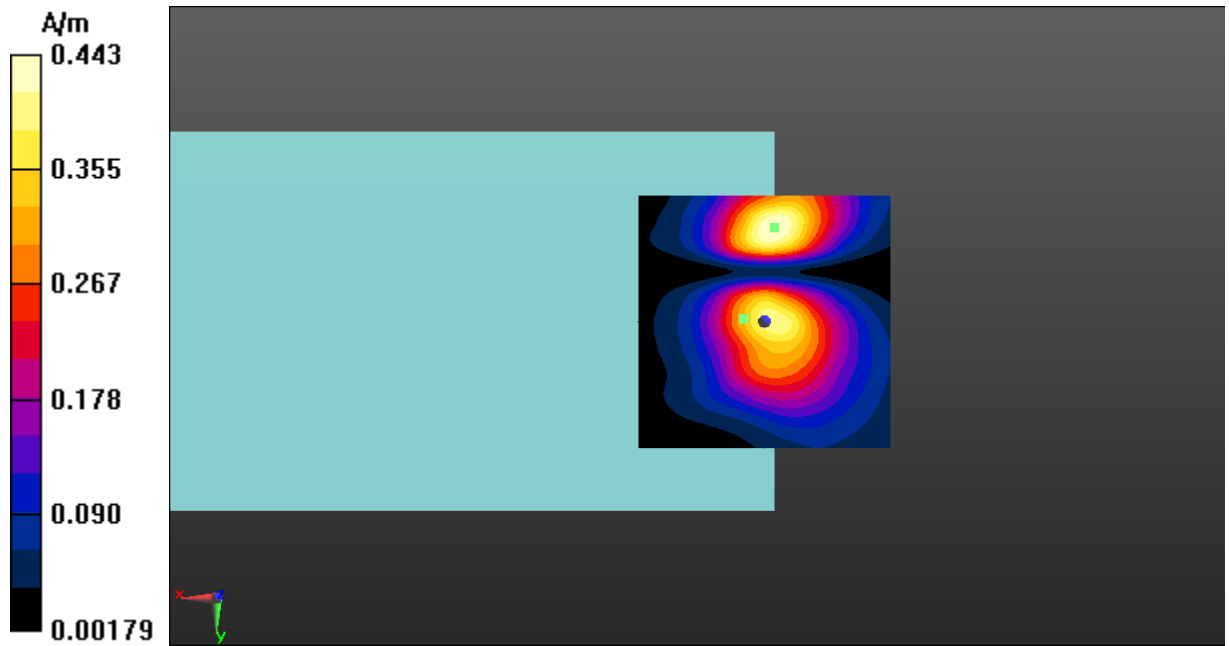

Fig A.13 T-Coil WLAN 2.4G-Y



**T-Coil (Google Duo) GSM 850 Axial**

Date: 2021-1-5

Electronics: DAE4 Sn1527

Medium: Air

Medium parameters used:  $\sigma = 0$  S/m,  $\epsilon_r = 1$ ;  $\rho = 1$  kg/m<sup>3</sup>

Ambient Temperature: 22.0°C

Communication System: GSM Frequency: 836.6 MHz Duty Cycle: 1:8.3

Probe: AM1DV3 - 3086

**z (axial) 4.2mm 50 x 50/ABM Interpolated Signal(x,y,z) (101x101x1):** Interpolated grid:

dx=1.000 mm, dy=1.000 mm

Signal Type: Audio File (.wav) 48k\_voice\_1kHz\_1s.wav

Output Gain: 100

Measure Window Start: 300ms

Measure Window Length: 1000ms

BWC applied: 0.16 dB

Device Reference Point: 0, 0, -6.3 mm

**Cursor:**

ABM1 = 8.79 dBA/m

BWC Factor = 0.16 dB

Location: 1.5, -9.5, 3.7 mm

**z (axial) 4.2mm 50 x 50/ABM Interpolated SNR(x,y,z) (101x101x1):** Interpolated grid: dx=1.000

mm, dy=1.000 mm

Signal Type: Audio File (.wav) 48k\_voice\_1kHz\_1s.wav

Output Gain: 100

Measure Window Start: 300ms

Measure Window Length: 1000ms

BWC applied: 0.16 dB

Device Reference Point: 0, 0, -6.3 mm

**Cursor:**

ABM1/ABM2 = 54.65 dB

ABM1 comp = 8.79 dBA/m

BWC Factor = 0.16 dB

Location: 1.5, -9.5, 3.7 mm

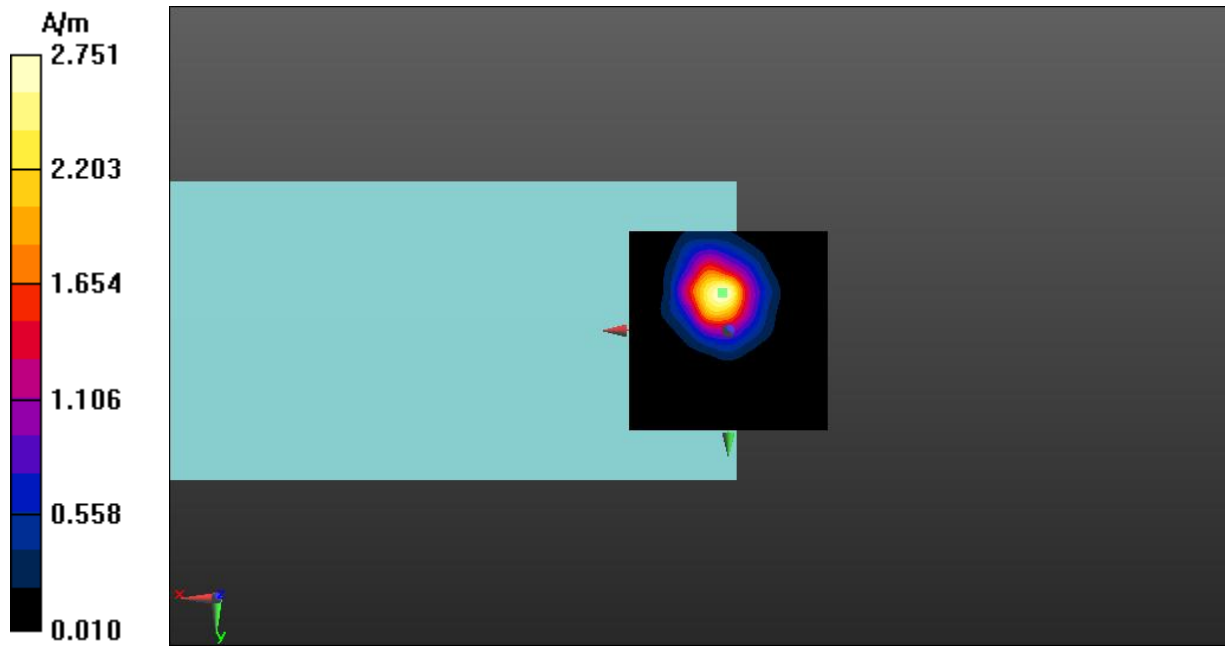

Fig A.14 T-Coil GSM 850-Z



**T-Coil (Google Duo) GSM 850 Transverse**

Date: 2021-1-5

Electronics: DAE4 Sn1527

Medium: Air

Medium parameters used:  $\sigma = 0$  S/m,  $\epsilon_r = 1$ ;  $\rho = 1$  kg/m<sup>3</sup>

Ambient Temperature: 22.0°C

Communication System: GSM Frequency: 836.6 MHz Duty Cycle: 1:8.3

Probe: AM1DV3 - 3086

**y (transversal) 4.2mm 50 x 50/ABM Interpolated Signal(x,y,z) (101x101x1):** Interpolated grid:

dx=1.000 mm, dy=1.000 mm

Signal Type: Audio File (.wav) 48k\_voice\_1kHz\_1s.wav

Output Gain: 100

Measure Window Start: 300ms

Measure Window Length: 1000ms

BWC applied: 0.16 dB

Device Reference Point: 0, 0, -6.3 mm

**Cursor:**

ABM1 = 1.59 dBA/m

BWC Factor = 0.16 dB

Location: 4.5, -15.5, 3.7 mm

**y (transversal) 4.2mm 50 x 50/ABM Interpolated SNR(x,y,z) (101x101x1):** Interpolated grid:

dx=1.000 mm, dy=1.000 mm

Signal Type: Audio File (.wav) 48k\_voice\_1kHz\_1s.wav

Output Gain: 100

Measure Window Start: 300ms

Measure Window Length: 1000ms

BWC applied: 0.16 dB

Device Reference Point: 0, 0, -6.3 mm

**Cursor:**

ABM1/ABM2 = 49.02 dB

ABM1 comp = 1.16 dBA/m

BWC Factor = 0.16 dB

Location: 3, -16, 3.7 mm

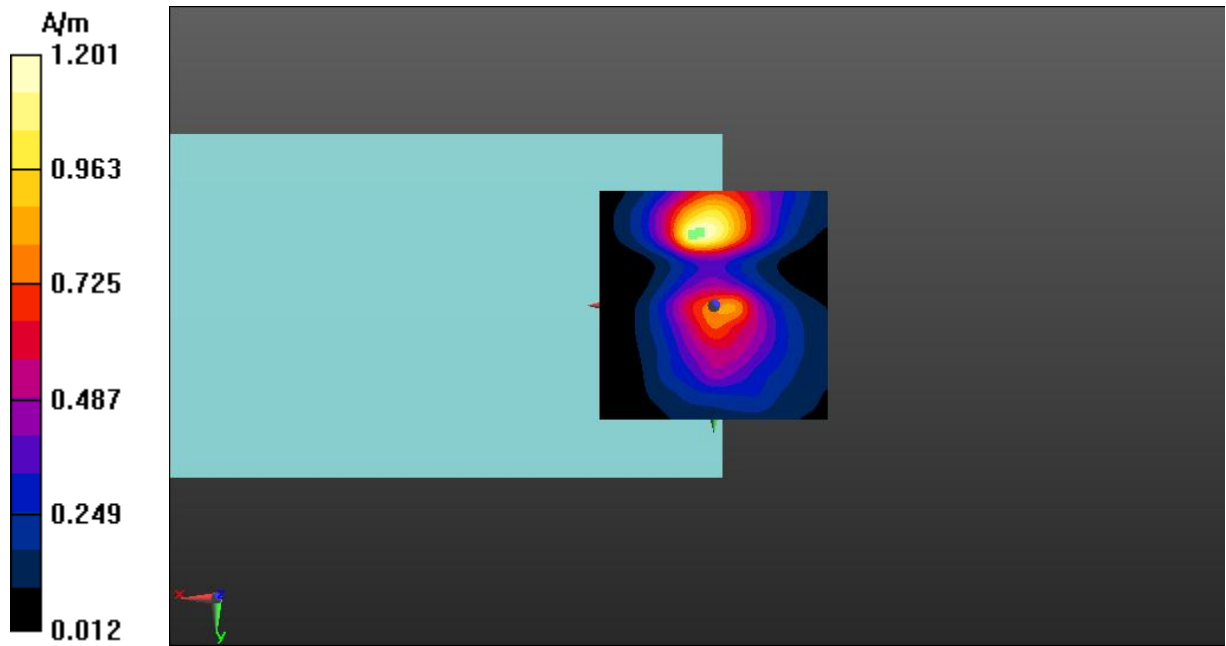

Fig A.14 T-Coil GSM 850-Y



**T-Coil (Google Duo) GSM 1900 Axial**

Date: 2021-1-5

Electronics: DAE4 Sn1527

Medium: Air

Medium parameters used:  $\sigma = 0$  S/m,  $\epsilon_r = 1$ ;  $\rho = 1$  kg/m<sup>3</sup>

Ambient Temperature: 22.0°C

Communication System: GSM Frequency: 1880 MHz Duty Cycle: 1:8.3

Probe: AM1DV3 - 3086

**z (axial) 4.2mm 50 x 50/ABM Interpolated Signal(x,y,z) (101x101x1):** Interpolated grid:

dx=1.000 mm, dy=1.000 mm

Signal Type: Audio File (.wav) 48k\_voice\_1kHz\_1s.wav

Output Gain: 100

Measure Window Start: 300ms

Measure Window Length: 1000ms

BWC applied: 0.16 dB

Device Reference Point: 0, 0, -6.3 mm

**Cursor:**

ABM1 = 9.43 dBA/m

BWC Factor = 0.16 dB

Location: 0.5, 1, 3.7 mm

**z (axial) 4.2mm 50 x 50/ABM Interpolated SNR(x,y,z) (101x101x1):** Interpolated grid: dx=1.000

mm, dy=1.000 mm

Signal Type: Audio File (.wav) 48k\_voice\_1kHz\_1s.wav

Output Gain: 100

Measure Window Start: 300ms

Measure Window Length: 1000ms

BWC applied: 0.16 dB

Device Reference Point: 0, 0, -6.3 mm

**Cursor:**

ABM1/ABM2 = 56.78 dB

ABM1 comp = 9.11 dBA/m

BWC Factor = 0.16 dB

Location: -1, 1, 3.7 mm

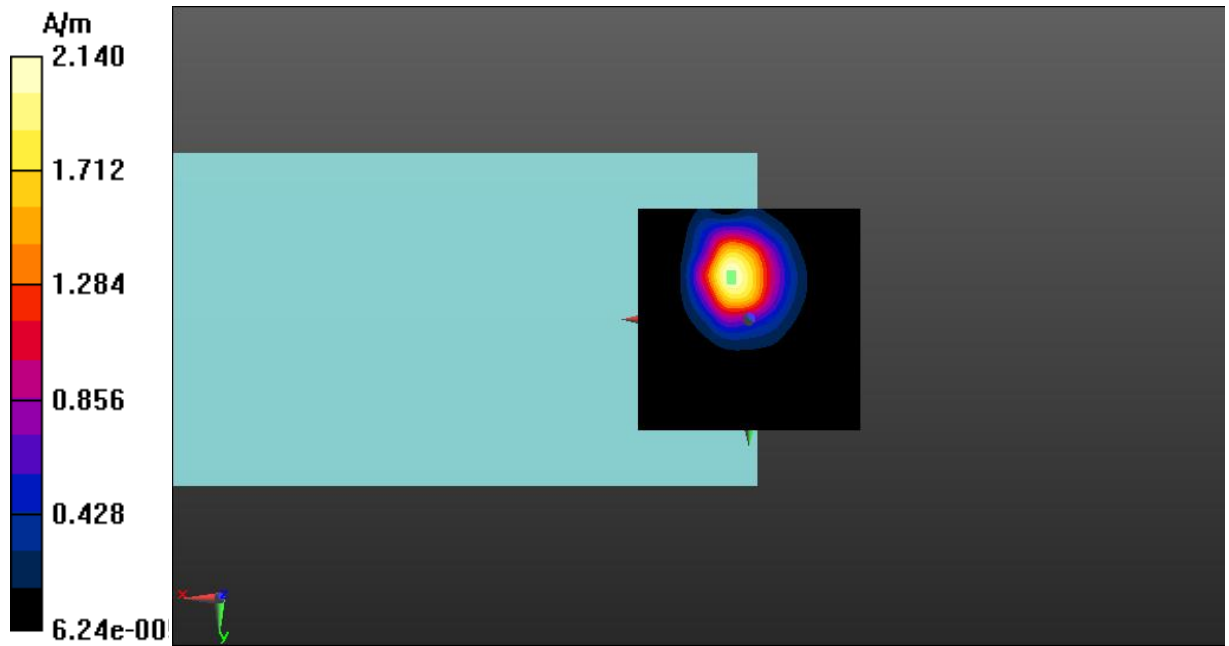

Fig A.15 T-Coil GSM 1900-Z



**T-Coil (Google Duo) GSM 1900 Transverse**

Date: 2021-1-5

Electronics: DAE4 Sn1527

Medium: Air

Medium parameters used:  $\sigma = 0$  S/m,  $\epsilon_r = 1$ ;  $\rho = 1$  kg/m<sup>3</sup>

Ambient Temperature: 22.0°C

Communication System: GSM Frequency: 1880 MHz Duty Cycle: 1:8.3

Probe: AM1DV3 - 3086

**y (transversal) 4.2mm 50 x 50/ABM Interpolated Signal(x,y,z) (101x101x1):** Interpolated grid:

dx=1.000 mm, dy=1.000 mm

Signal Type: Audio File (.wav) 48k\_voice\_1kHz\_1s.wav

Output Gain: 100

Measure Window Start: 300ms

Measure Window Length: 1000ms

BWC applied: 0.16 dB

Device Reference Point: 0, 0, -6.3 mm

**Cursor:**

ABM1 = 2.06 dBA/m

BWC Factor = 0.16 dB

Location: 1, 8.5, 3.7 mm

**T-Coil/GSM1800/y (transversal) 4.2mm 50 x 50/ABM Interpolated SNR(x,y,z) (101x101x1):**

Interpolated grid: dx=1.000 mm, dy=1.000 mm

Signal Type: Audio File (.wav) 48k\_voice\_1kHz\_1s.wav

Output Gain: 37.15

Measure Window Start: 300ms

Measure Window Length: 1000ms

BWC applied: 0.16 dB

Device Reference Point: 0, 0, -6.3 mm

**Cursor:**

ABM1/ABM2 = 49.84 dB

ABM1 comp = 1.47 dBA/m

BWC Factor = 0.16 dB

Location: -4, 6.5, 3.7 mm



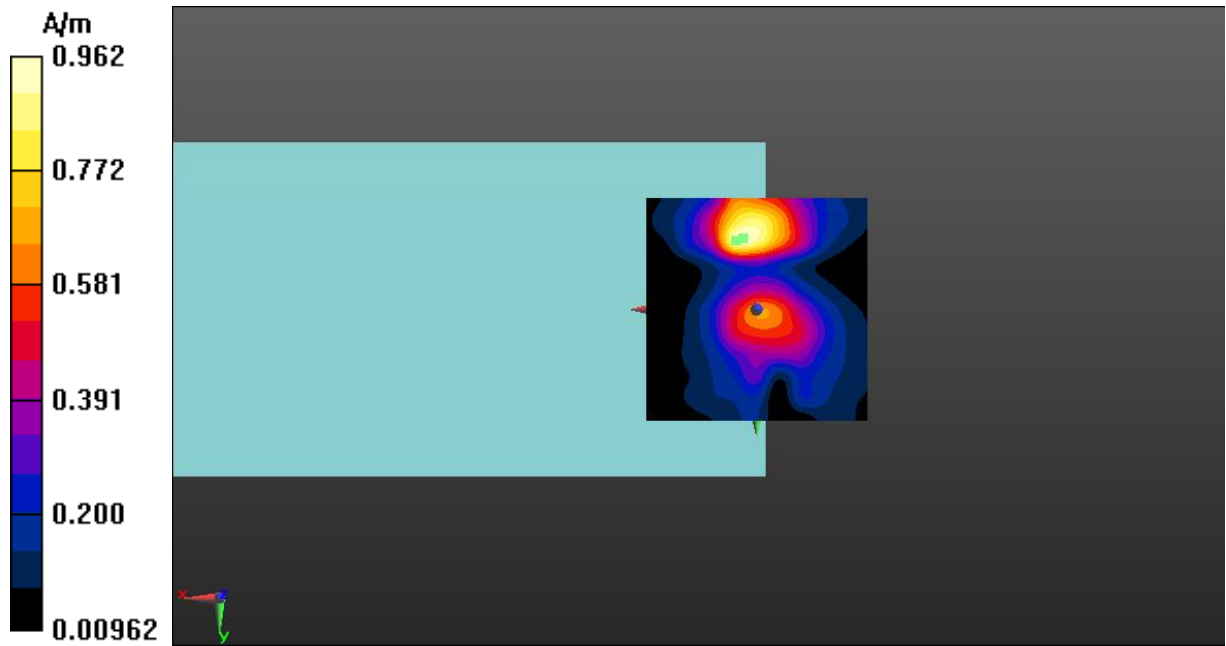

Fig A.15 T-Coil GSM 1900-Y



**T-Coil (Google Duo) WCDMA Band 2 Axial**

Date: 2021-1-5

Electronics: DAE4 Sn1527

Medium: Air

Medium parameters used:  $\sigma = 0$  S/m,  $\epsilon_r = 1$ ;  $\rho = 1$  kg/m<sup>3</sup>

Ambient Temperature: 22.0°C

Communication System: WCDMA Frequency: 1880 MHz Duty Cycle: 1:1

Probe: AM1DV3 - 3086

**z (axial) 4.2mm 50 x 50/ABM Interpolated Signal(x,y,z) (101x101x1):** Interpolated grid:

dx=1.000 mm, dy=1.000 mm

Signal Type: Audio File (.wav) 48k\_voice\_1kHz\_1s.wav

Output Gain: 100

Measure Window Start: 300ms

Measure Window Length: 1000ms

BWC applied: 0.15 dB

Device Reference Point: 0, 0, -6.3 mm

**Cursor:**

ABM1 = 9.71 dBA/m

BWC Factor = 0.15 dB

Location: 4, -9, 3.7 mm

**z (axial) 4.2mm 50 x 50/ABM Interpolated SNR(x,y,z) (101x101x1):** Interpolated grid: dx=1.000

mm, dy=1.000 mm

Signal Type: Audio File (.wav) 48k\_voice\_1kHz\_1s.wav

Output Gain: 100

Measure Window Start: 300ms

Measure Window Length: 1000ms

BWC applied: 0.15 dB

Device Reference Point: 0, 0, -6.3 mm

**Cursor:**

ABM1/ABM2 = 53.75 dB

ABM1 comp = 9.63 dBA/m

BWC Factor = 0.15 dB

Location: 4, -10, 3.7 mm

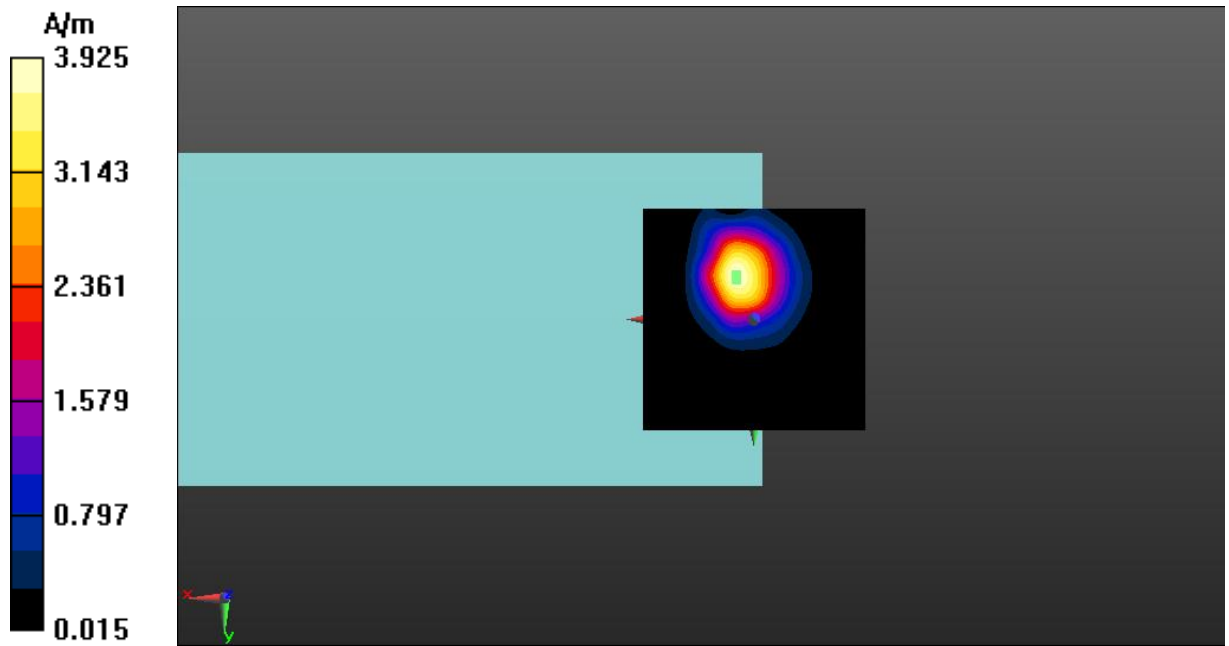

Fig A.16 T-Coil WCDMA Band 2-Z



**T-Coil (Google Duo) WCDMA Band 2 Transverse**

Date: 2021-1-5

Electronics: DAE4 Sn1527

Medium: Air

Medium parameters used:  $\sigma = 0$  S/m,  $\epsilon_r = 1$ ;  $\rho = 1$  kg/m<sup>3</sup>

Ambient Temperature: 22.0°C

Communication System: WCDMA Frequency: 1880 MHz Duty Cycle: 1:1

Probe: AM1DV3 - 3086

**y (transversal) 4.2mm 50 x 50/ABM Interpolated Signal(x,y,z) (101x101x1):** Interpolated grid:

dx=1.000 mm, dy=1.000 mm

Signal Type: Audio File (.wav) 48k\_voice\_1kHz\_1s.wav

Output Gain: 100

Measure Window Start: 300ms

Measure Window Length: 1000ms

BWC applied: 0.15 dB

Device Reference Point: 0, 0, -6.3 mm

**Cursor:**

ABM1 = 0.95 dBA/m

BWC Factor = 0.15 dB

Location: 4.5, -15.5, 3.7 mm

**y (transversal) 4.2mm 50 x 50/ABM Interpolated SNR(x,y,z) (101x101x1):** Interpolated grid:

dx=1.000 mm, dy=1.000 mm

Signal Type: Audio File (.wav) 48k\_voice\_1kHz\_1s.wav

Output Gain: 100

Measure Window Start: 300ms

Measure Window Length: 1000ms

BWC applied: 0.15 dB

Device Reference Point: 0, 0, -6.3 mm

**Cursor:**

ABM1/ABM2 = 44.93 dB

ABM1 comp = 0.42 dBA/m

BWC Factor = 0.15 dB

Location: 3, -16, 3.7 mm

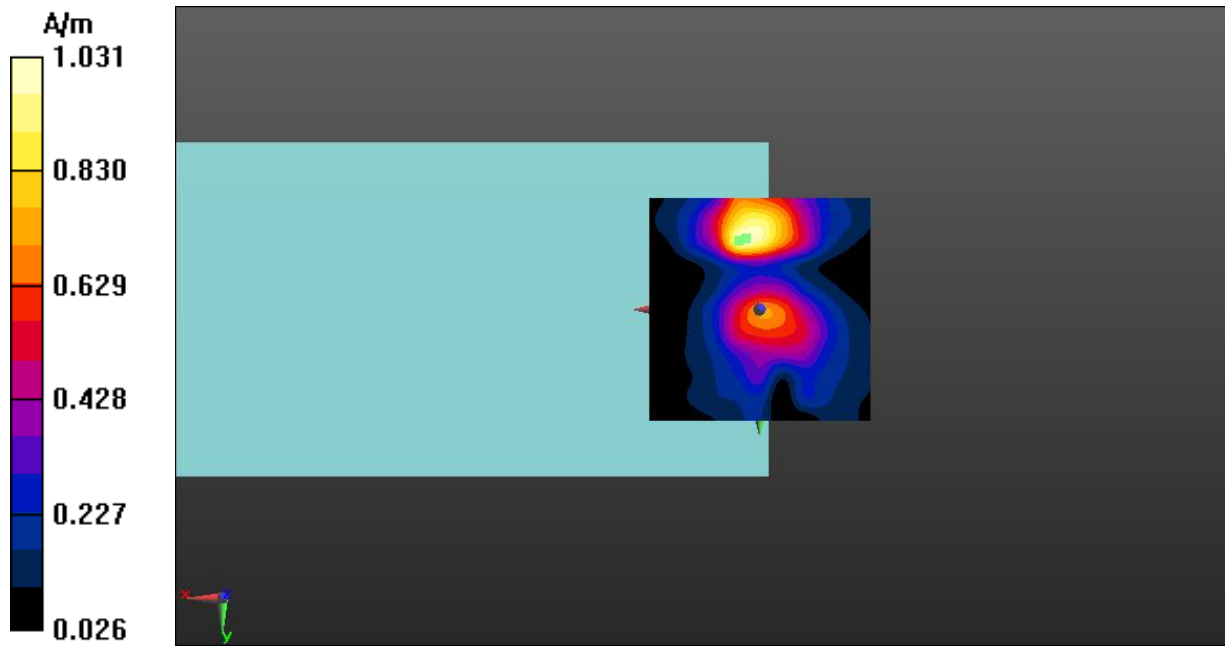

Fig A.16 T-Coil WCDMA Band 2-Y



**T-Coil (Google Duo) WCDMA Band 4 Axial**

Date: 2021-1-5

Electronics: DAE4 Sn1527

Medium: Air

Medium parameters used:  $\sigma = 0$  S/m,  $\epsilon_r = 1$ ;  $\rho = 1$  kg/m<sup>3</sup>

Ambient Temperature: 22.0°C

Communication System: WCDMA Frequency: 1732.6 MHz Duty Cycle: 1:1

Probe: AM1DV3 - 3086

**z (axial) 4.2mm 50 x 50/ABM Interpolated Signal(x,y,z) (101x101x1):** Interpolated grid:

dx=1.000 mm, dy=1.000 mm

Signal Type: Audio File (.wav) 48k\_voice\_1kHz\_1s.wav

Output Gain: 100

Measure Window Start: 300ms

Measure Window Length: 1000ms

BWC applied: 0.16 dB

Device Reference Point: 0, 0, -6.3 mm

**Cursor:**

ABM1 = 9.56 dBA/m

BWC Factor = 0.16 dB

Location: 0.5, 0.5, 3.7 mm

**z (axial) 4.2mm 50 x 50/ABM Interpolated SNR(x,y,z) (101x101x1):** Interpolated grid: dx=1.000

mm, dy=1.000 mm

Signal Type: Audio File (.wav) 48k\_voice\_1kHz\_1s.wav

Output Gain: 100

Measure Window Start: 300ms

Measure Window Length: 1000ms

BWC applied: 0.16 dB

Device Reference Point: 0, 0, -6.3 mm

**Cursor:**

ABM1/ABM2 = 53.58 dB

ABM1 comp = 9.48 dBA/m

BWC Factor = 0.16 dB

Location: -6, -1.5, 3.7 mm

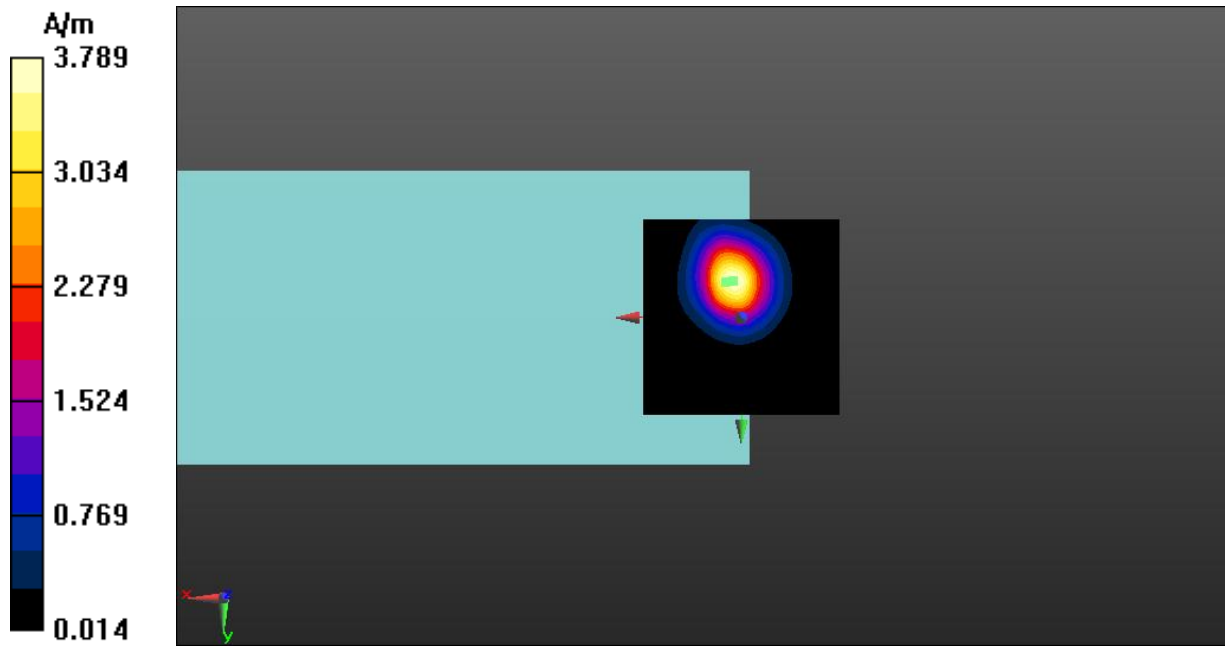

Fig A.17 T-Coil WCDMA Band 4-Z



**T-Coil (Google Duo) WCDMA Band 4 Transverse**

Date: 2021-1-5

Electronics: DAE4 Sn1527

Medium: Air

Medium parameters used:  $\sigma = 0$  S/m,  $\epsilon_r = 1$ ;  $\rho = 1$  kg/m<sup>3</sup>

Ambient Temperature: 22.0°C

Communication System: WCDMA Frequency: 1732.6 MHz Duty Cycle: 1:1

Probe: AM1DV3 - 3086

**y (transversal) 4.2mm 50 x 50/ABM Interpolated Signal(x,y,z) (101x101x1):** Interpolated grid:

dx=1.000 mm, dy=1.000 mm

Signal Type: Audio File (.wav) 48k\_voice\_1kHz\_1s.wav

Output Gain: 100

Measure Window Start: 300ms

Measure Window Length: 1000ms

BWC applied: 0.16 dB

Device Reference Point: 0, 0, -6.3 mm

**Cursor:**

ABM1 = 0.86 dBA/m

BWC Factor = 0.16 dB

Location: 0, 10, 3.7 mm

**y (transversal) 4.2mm 50 x 50/ABM Interpolated SNR(x,y,z) (101x101x1):** Interpolated grid:

dx=1.000 mm, dy=1.000 mm

Signal Type: Audio File (.wav) 48k\_voice\_1kHz\_1s.wav

Output Gain: 100

Measure Window Start: 300ms

Measure Window Length: 1000ms

BWC applied: 0.16 dB

Device Reference Point: 0, 0, -6.3 mm

**Cursor:**

ABM1/ABM2 = 44.62 dB

ABM1 comp = 0.39 dBA/m

BWC Factor = 0.16 dB

Location: -2.5, 6, 3.7 mm



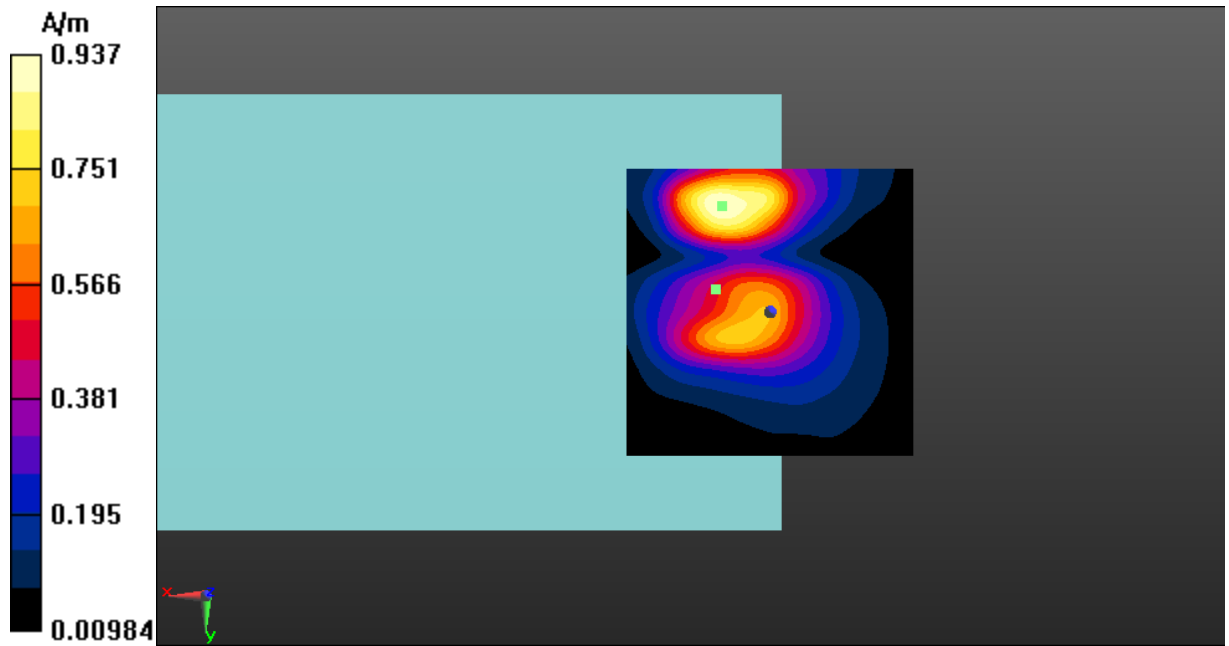

Fig A.17 T-Coil WCDMA Band 4-Y



**T-Coil (Google Duo) WCDMA Band 5 Axial**

Date: 2021-1-5

Electronics: DAE4 Sn1527

Medium: Air

Medium parameters used:  $\sigma = 0$  S/m,  $\epsilon_r = 1$ ;  $\rho = 1$  kg/m<sup>3</sup>

Ambient Temperature: 22.0°C

Communication System: WCDMA Frequency: 836.4 MHz Duty Cycle: 1:1

Probe: AM1DV3 - 3086

**z (axial) 4.2mm 50 x 50/ABM Interpolated Signal(x,y,z) (101x101x1):** Interpolated grid:

dx=1.000 mm, dy=1.000 mm

Signal Type: Audio File (.wav) 48k\_voice\_1kHz\_1s.wav

Output Gain: 100

Measure Window Start: 300ms

Measure Window Length: 1000ms

BWC applied: 0.16 dB

Device Reference Point: 0, 0, -6.3 mm

**Cursor:**

ABM1 = 9.88 dBA/m

BWC Factor = 0.16 dB

Location: 4.5, -9.5, 3.7 mm

**z (axial) 4.2mm 50 x 50/ABM Interpolated SNR(x,y,z) (101x101x1):** Interpolated grid: dx=1.000

mm, dy=1.000 mm

Signal Type: Audio File (.wav) 48k\_voice\_1kHz\_1s.wav

Output Gain: 100

Measure Window Start: 300ms

Measure Window Length: 1000ms

BWC applied: 0.16 dB

Device Reference Point: 0, 0, -6.3 mm

**Cursor:**

ABM1/ABM2 = 55.14 dB

ABM1 comp = 9.85 dBA/m

BWC Factor = 0.16 dB

Location: 4.5, -10, 3.7 mm

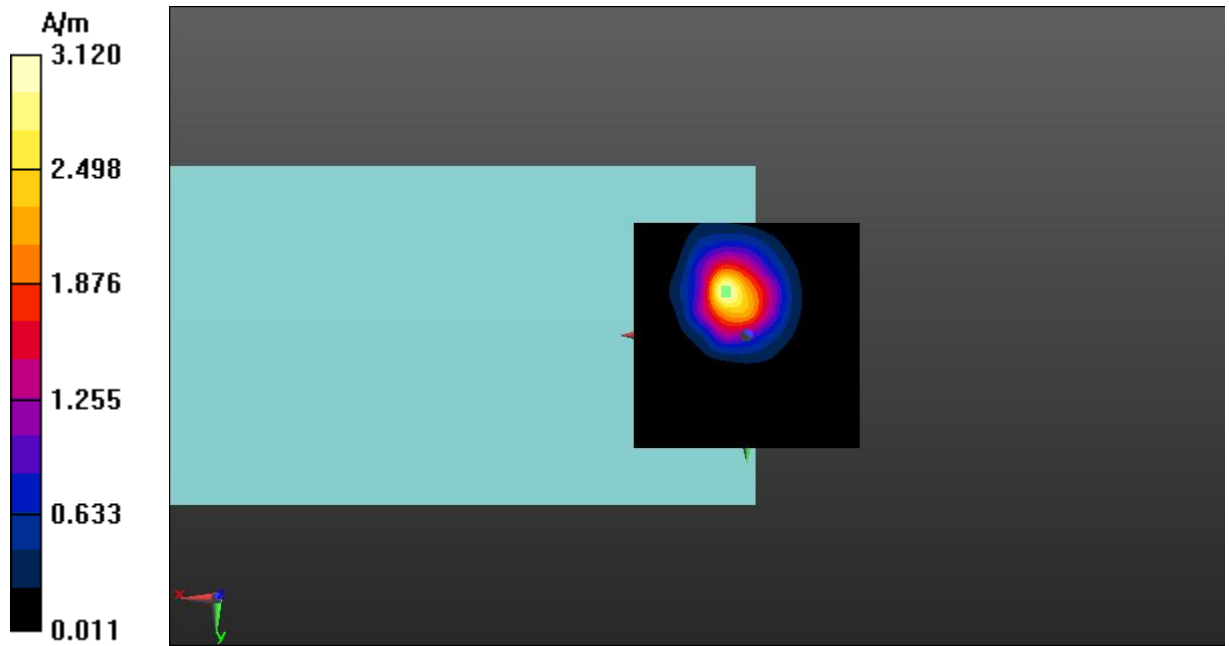

Fig A.18 T-Coil WCDMA Band 5-Z



**T-Coil (Google Duo) WCDMA Band 5 Transverse**

Date: 2021-1-5

Electronics: DAE4 Sn1527

Medium: Air

Medium parameters used:  $\sigma = 0$  S/m,  $\epsilon_r = 1$ ;  $\rho = 1$  kg/m<sup>3</sup>

Ambient Temperature: 22.0°C

Communication System: WCDMA Frequency: 836.4 MHz Duty Cycle: 1:1

Probe: AM1DV3 - 3086

**y (transversal) 4.2mm 50 x 50/ABM Interpolated Signal(x,y,z) (101x101x1):** Interpolated grid:

dx=1.000 mm, dy=1.000 mm

Signal Type: Audio File (.wav) 48k\_voice\_1kHz\_1s.wav

Output Gain: 100

Measure Window Start: 300ms

Measure Window Length: 1000ms

BWC applied: 0.16 dB

Device Reference Point: 0, 0, -6.3 mm

**Cursor:**

ABM1 = 1.28 dBA/m

BWC Factor = 0.16 dB

Location: 0.5, 10, 3.7 mm

**y (transversal) 4.2mm 50 x 50/ABM Interpolated SNR(x,y,z) (101x101x1):** Interpolated grid:

dx=1.000 mm, dy=1.000 mm

Signal Type: Audio File (.wav) 48k\_voice\_1kHz\_1s.wav

Output Gain: 100

Measure Window Start: 300ms

Measure Window Length: 1000ms

BWC applied: 0.16 dB

Device Reference Point: 0, 0, -6.3 mm

**Cursor:**

ABM1/ABM2 = 45.74 dB

ABM1 comp = 0.87 dBA/m

BWC Factor = 0.16 dB

Location: -2, 6, 3.7 mm

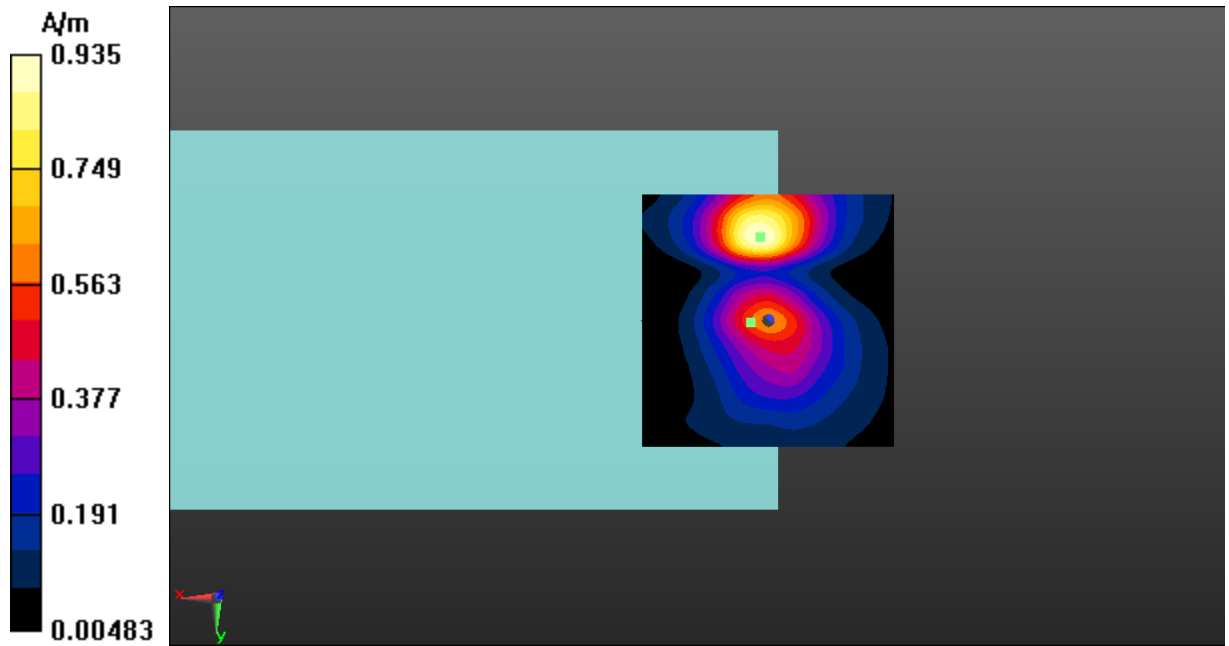

Fig A.18 T-Coil WCDMA Band 5-Y



**T-Coil (Google Duo) LTE-Band 7 Axial**

Date: 2021-1-5

Electronics: DAE4 Sn1527

Medium: Air

Medium parameters used:  $\sigma = 0$  S/m,  $\epsilon_r = 1$ ;  $\rho = 1$  kg/m<sup>3</sup>

Ambient Temperature: 22.0°C

Communication System: UID 0, LTE\_FDD (0) Frequency: 2535 MHz Duty Cycle: 1:1.58

Probe: AM1DV3 - 3086

**z (axial) 4.2mm 50 x 50/ABM Interpolated Signal(x,y,z) (101x101x1):** Interpolated grid:

dx=1.000 mm, dy=1.000 mm

Signal Type: Audio File (.wav) 48k\_voice\_1kHz\_1s.wav

Output Gain: 100

Measure Window Start: 300ms

Measure Window Length: 1000ms

BWC applied: 0.15 dB

Device Reference Point: 0, 0, -6.3 mm

**Cursor:**

ABM1 = 8.34 dBA/m

BWC Factor = 0.15 dB

Location: 3.5, -9, 3.7 mm

**z (axial) 4.2mm 50 x 50/ABM Interpolated SNR(x,y,z) (101x101x1):** Interpolated grid: dx=1.000

mm, dy=1.000 mm

Signal Type: Audio File (.wav) 48k\_voice\_1kHz\_1s.wav

Output Gain: 100

Measure Window Start: 300ms

Measure Window Length: 1000ms

BWC applied: 0.15 dB

Device Reference Point: 0, 0, -6.3 mm

**Cursor:**

ABM1/ABM2 = 52.56 dB

ABM1 comp = 7.85 dBA/m

BWC Factor = 0.15 dB

Location: 1, -9, 3.7 mm

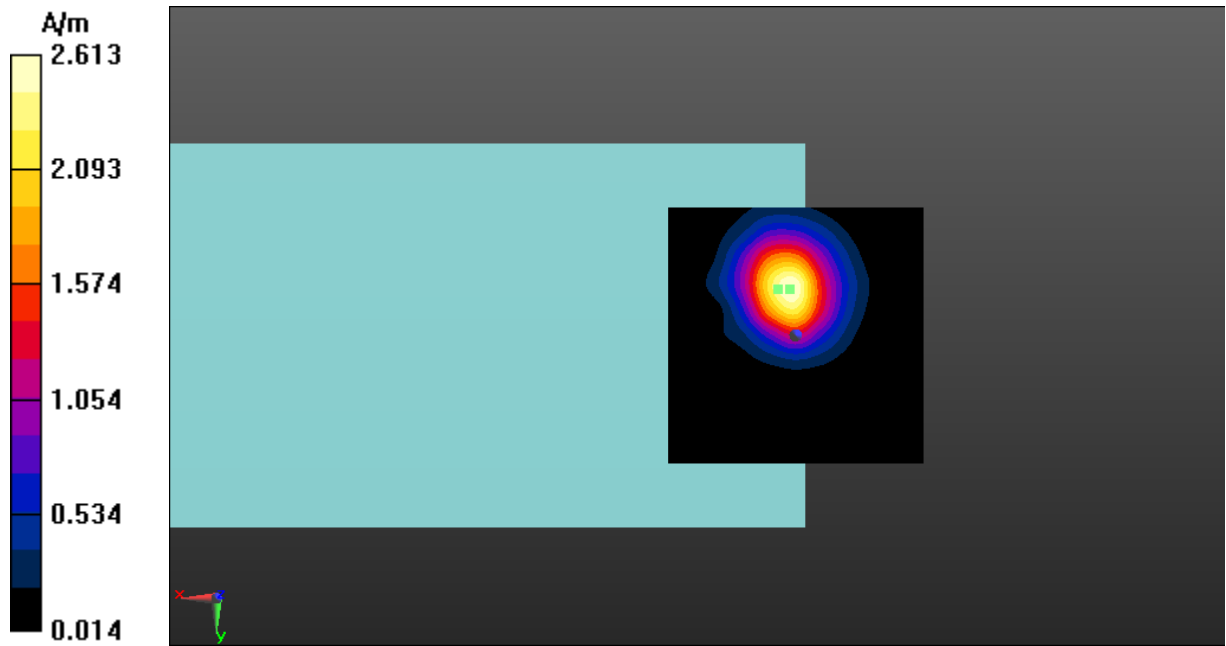

Fig A.19 T-Coil LTE-Band 7-Z



**T-Coil (Google Duo) LTE-Band 7 Transverse**

Date: 2021-1-5

Electronics: DAE4 Sn1527

Medium: Air

Medium parameters used:  $\sigma = 0$  S/m,  $\epsilon_r = 1$ ;  $\rho = 1$  kg/m<sup>3</sup>

Ambient Temperature: 22.0°C

Communication System: UID 0, LTE\_FDD (0) Frequency: 2535 MHz Duty Cycle: 1:1.58

Probe: AM1DV3 - 3086

**y (transversal) 4.2mm 50 x 50/ABM Interpolated Signal(x,y,z) (101x101x1):** Interpolated grid:

dx=1.000 mm, dy=1.000 mm

Signal Type: Audio File (.wav) 48k\_voice\_1kHz\_1s.wav

Output Gain: 100

Measure Window Start: 300ms

Measure Window Length: 1000ms

BWC applied: 0.15 dB

Device Reference Point: 0, 0, -6.3 mm

**Cursor:**

ABM1 = 0.88 dBA/m

BWC Factor = 0.15 dB

Location: 4, 0.5, 3.7 mm

**y (transversal) 4.2mm 50 x 50/ABM Interpolated SNR(x,y,z) (101x101x1):** Interpolated grid:

dx=1.000 mm, dy=1.000 mm

Signal Type: Audio File (.wav) 48k\_voice\_1kHz\_1s.wav

Output Gain: 100

Measure Window Start: 300ms

Measure Window Length: 1000ms

BWC applied: 0.15 dB

Device Reference Point: 0, 0, -6.3 mm

**Cursor:**

ABM1/ABM2 = 48.65 dB

ABM1 comp = -0.38 dBA/m

BWC Factor = 0.15 dB

Location: 0, -17, 3.7 mm



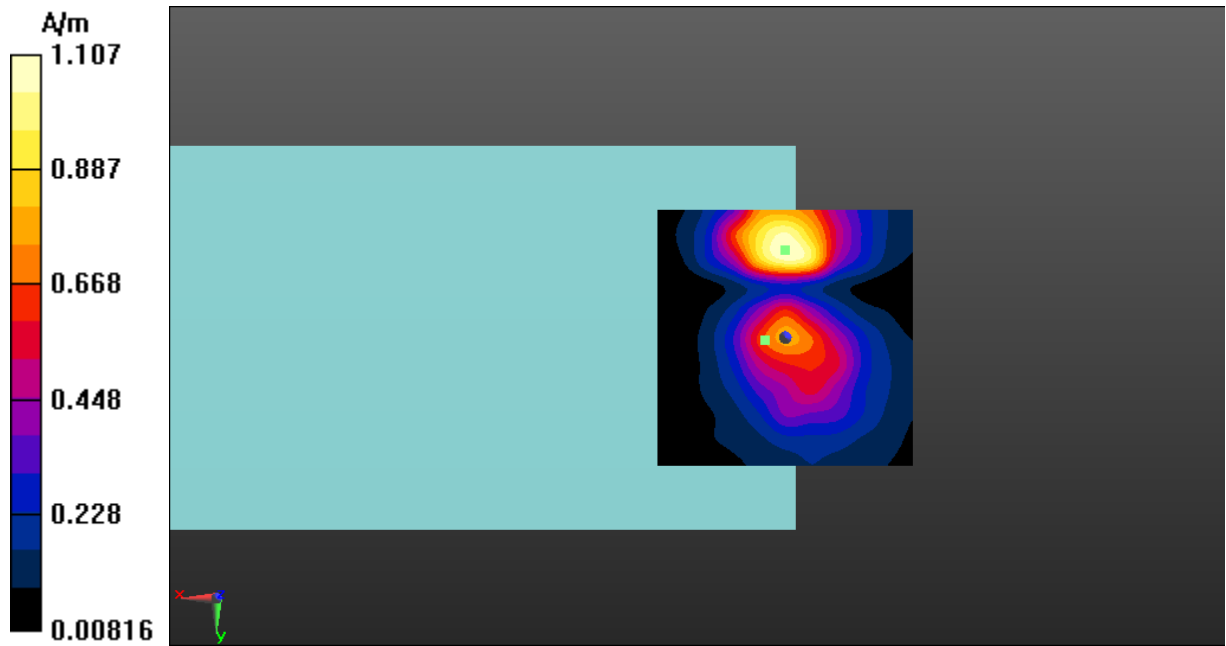

Fig A.19 T-Coil LTE-Band 7-Y



**T-Coil (Google Duo) WLAN 2.4G Axial**

Date: 2021-1-5

Electronics: DAE4 Sn1527

Medium: Air

Medium parameters used:  $\sigma = 0$  S/m,  $\epsilon_r = 1$ ;  $\rho = 1$  kg/m<sup>3</sup>

Ambient Temperature: 22.0°C

Communication System: WLAN Frequency: 2437 MHz Duty Cycle: 1:1

Probe: AM1DV3 - 3086

**z (axial) 4.2mm 50 x 50/ABM Interpolated Signal(x,y,z) (101x101x1):** Interpolated grid:

dx=1.000 mm, dy=1.000 mm

Signal Type: Audio File (.wav) 48k\_voice\_1kHz\_1s.wav

Output Gain: 100

Measure Window Start: 300ms

Measure Window Length: 1000ms

BWC applied: 0.15 dB

Device Reference Point: 0, 0, -6.3 mm

**Cursor:**

ABM1 = 8.15 dBA/m

BWC Factor = 0.15 dB

Location: 4, -8.5, 3.7 mm

**z (axial) 4.2mm 50 x 50/ABM Interpolated SNR(x,y,z) (101x101x1):** Interpolated grid: dx=1.000

mm, dy=1.000 mm

Signal Type: Audio File (.wav) 48k\_voice\_1kHz\_1s.wav

Output Gain: 100

Measure Window Start: 300ms

Measure Window Length: 1000ms

BWC applied: 0.15 dB

Device Reference Point: 0, 0, -6.3 mm

**Cursor:**

ABM1/ABM2 = 56.30 dB

ABM1 comp = 8.09 dBA/m

BWC Factor = 0.15 dB

Location: 4.5, -9.5, 3.7 mm

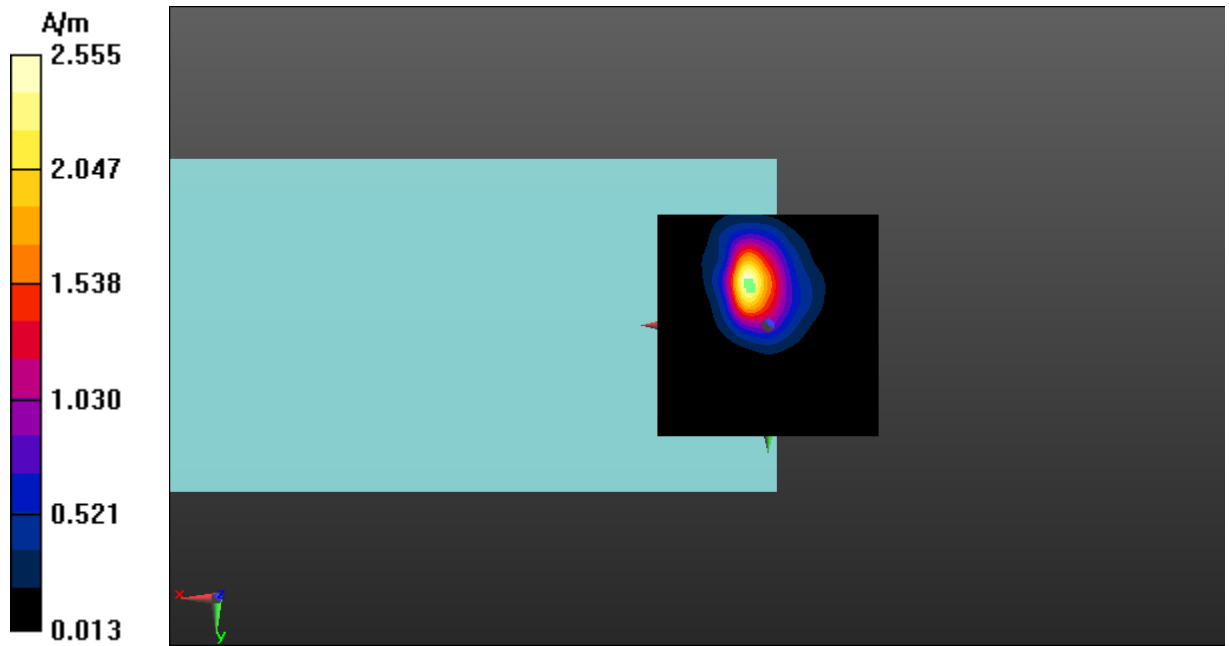

Fig A.20 T-Coil WLAN 2.4G-Z



**T-Coil (Google Duo) WLAN 2.4G Transverse**

Date: 2021-1-5

Electronics: DAE4 Sn1527

Medium: Air

Medium parameters used:  $\sigma = 0$  S/m,  $\epsilon_r = 1$ ;  $\rho = 1$  kg/m<sup>3</sup>

Ambient Temperature: 22.0°C

Communication System: WLAN Frequency: 2437 MHz Duty Cycle: 1:1

Probe: AM1DV3 - 3086

**y (transversal) 4.2mm 50 x 50/ABM Interpolated Signal(x,y,z) (101x101x1):** Interpolated grid:

dx=1.000 mm, dy=1.000 mm

Signal Type: Audio File (.wav) 48k\_voice\_1kHz\_1s.wav

Output Gain: 100

Measure Window Start: 300ms

Measure Window Length: 1000ms

BWC applied: 0.15 dB

Device Reference Point: 0, 0, -6.3 mm

**Cursor:**

ABM1 = 2.07 dBA/m

BWC Factor = 0.15 dB

Location: 4, -16, 3.7 mm

**y (transversal) 4.2mm 50 x 50/ABM Interpolated SNR(x,y,z) (101x101x1):** Interpolated grid:

dx=1.000 mm, dy=1.000 mm

Signal Type: Audio File (.wav) 48k\_voice\_1kHz\_1s.wav

Output Gain: 100

Measure Window Start: 300ms

Measure Window Length: 1000ms

BWC applied: 0.15 dB

Device Reference Point: 0, 0, -6.3 mm

**Cursor:**

ABM1/ABM2 = 46.67 dB

ABM1 comp = 0.73 dBA/m

BWC Factor = 0.15 dB

Location: -0.5, -16, 3.7 mm

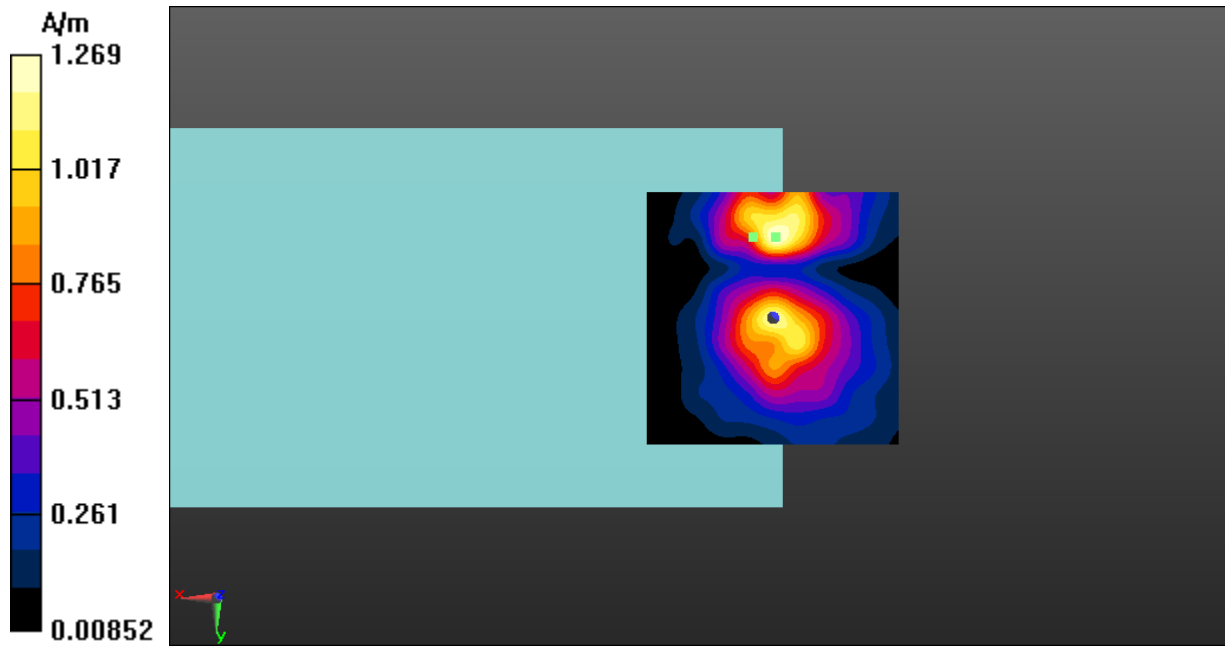

Fig A.20 T-Coil WLAN 2.4G-Y

## ANNEX B: Frequency Response Curves

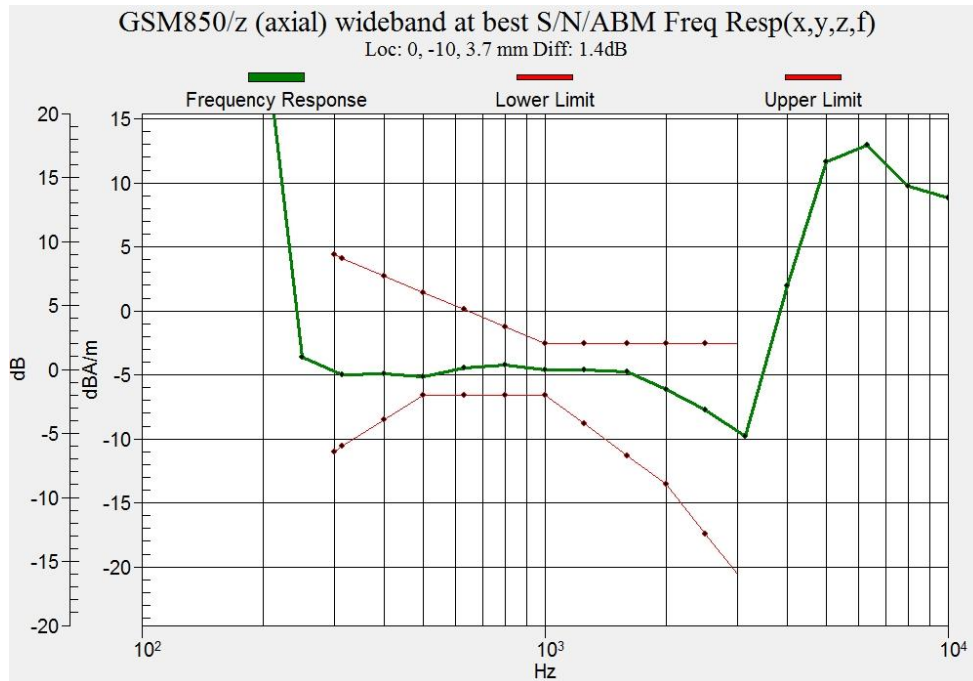

Figure B.1 Frequency Response of GSM 850

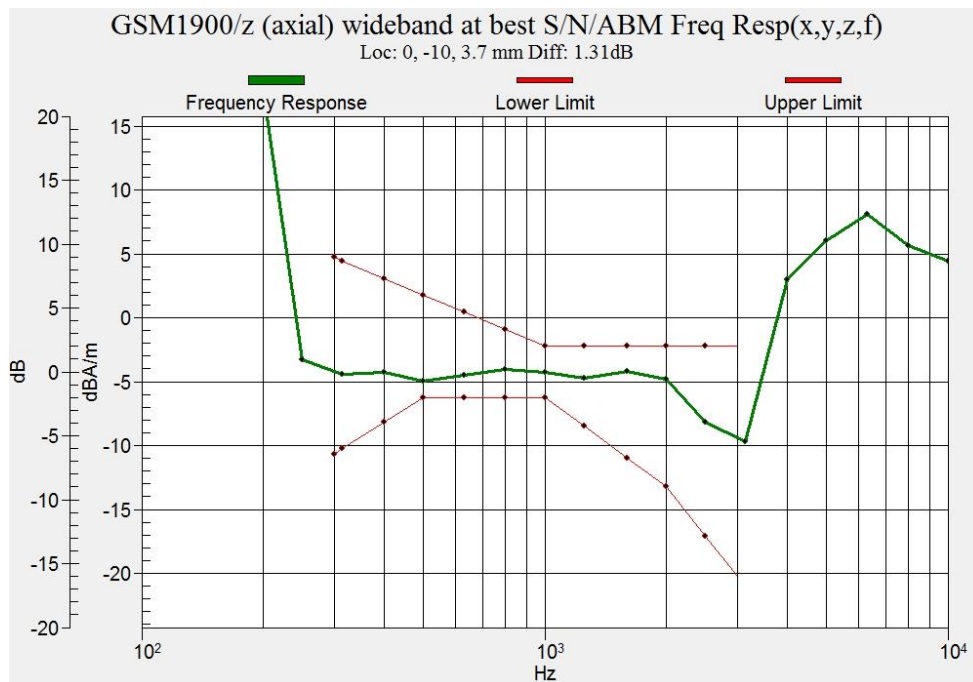

Figure B.2 Frequency Response of GSM 1900

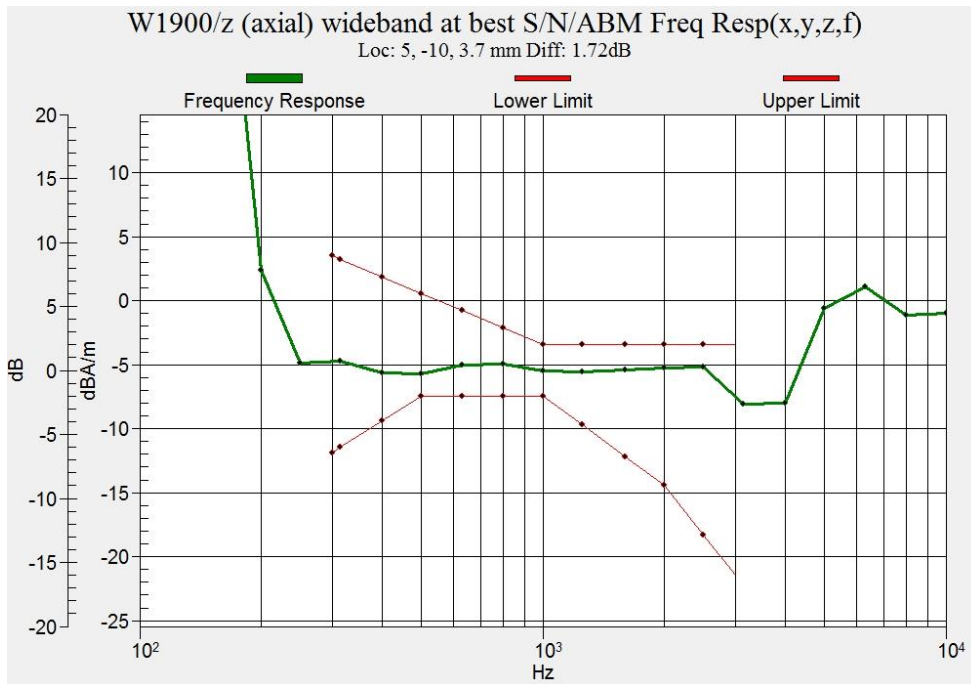

Figure B.3 Frequency Response of WCDMA Band 2

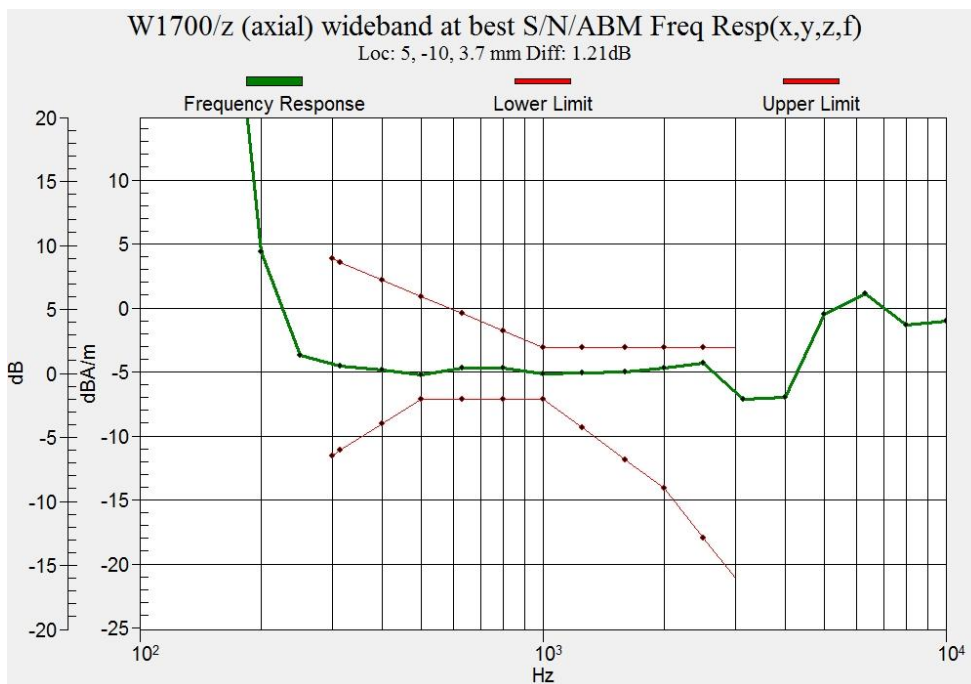

Figure B.4 Frequency Response of WCDMA Band 4



Figure B.5 Frequency Response of WCDMA Band 5

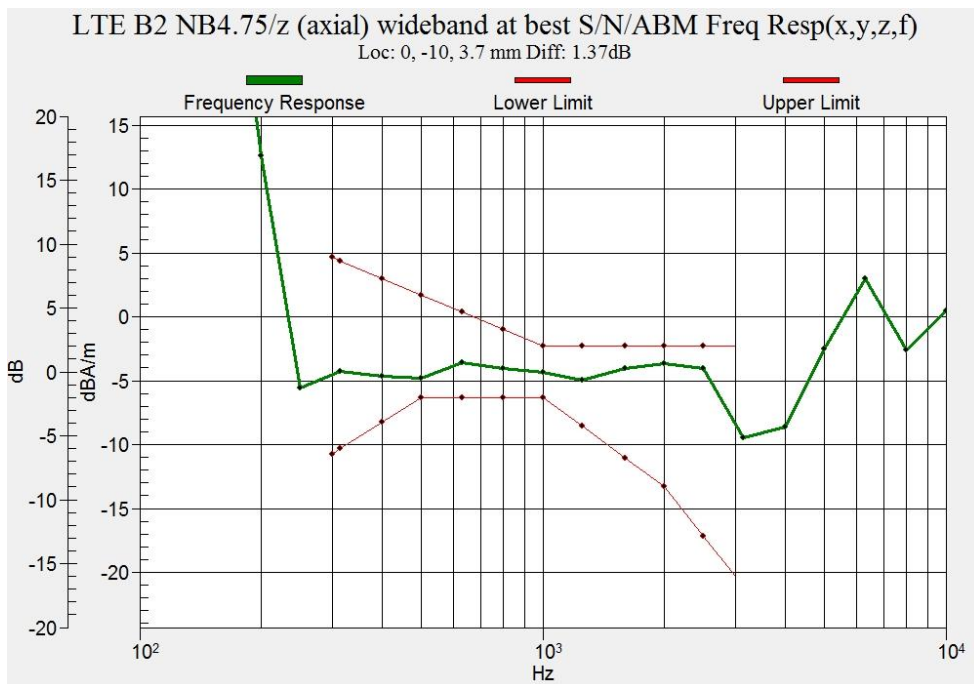

Figure B.6 Frequency Response of LTE B2



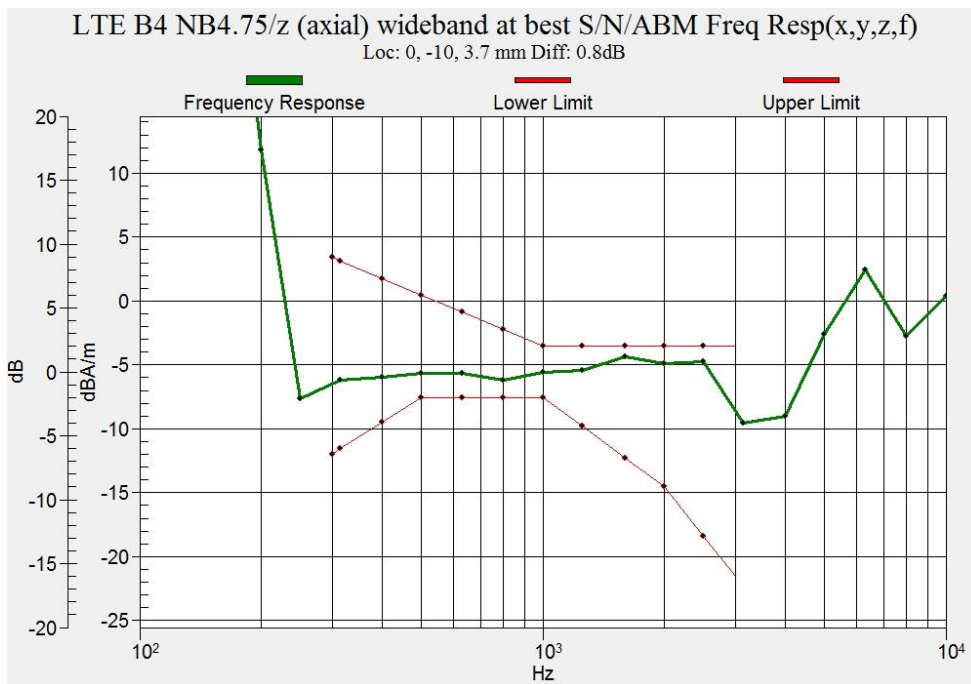

Figure B.7 Frequency Response of LTE Band 4

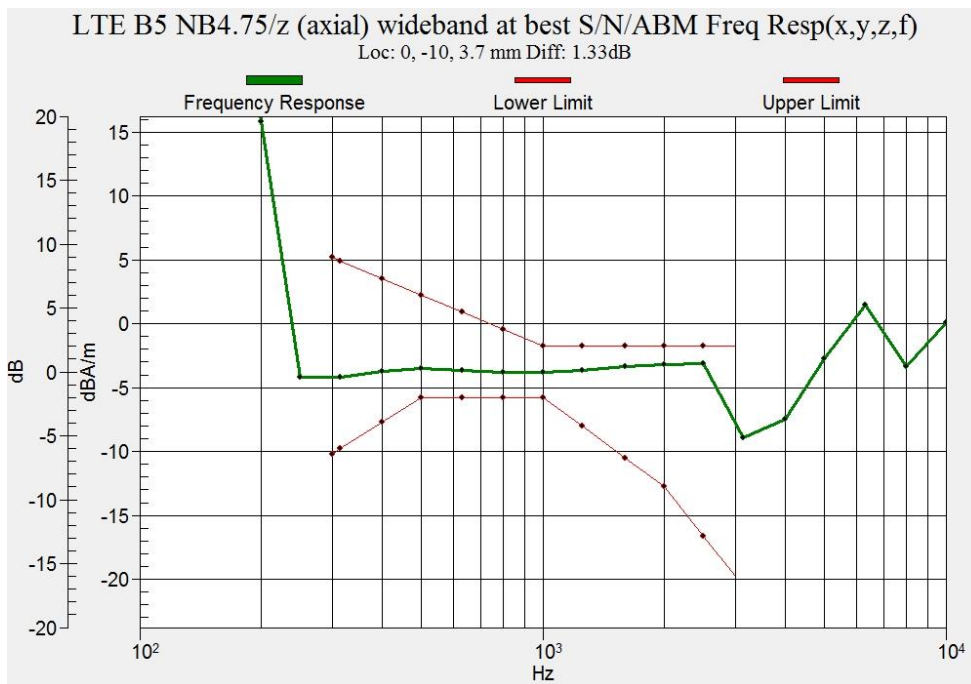

Figure B.8 Frequency Response of LTE Band 5

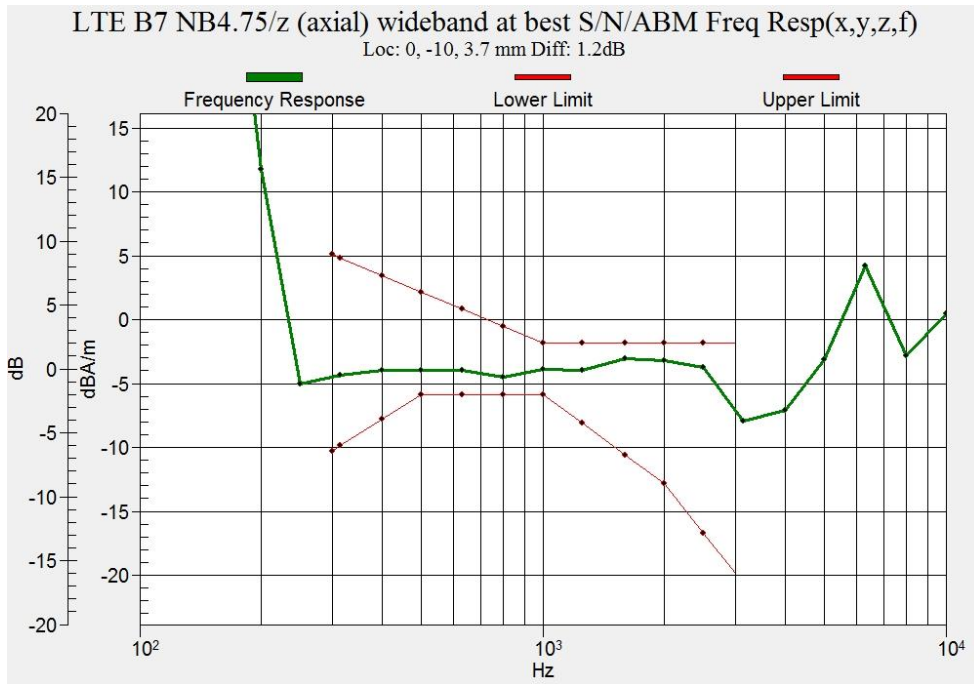

Figure B.9 Frequency Response of LTE Band 7

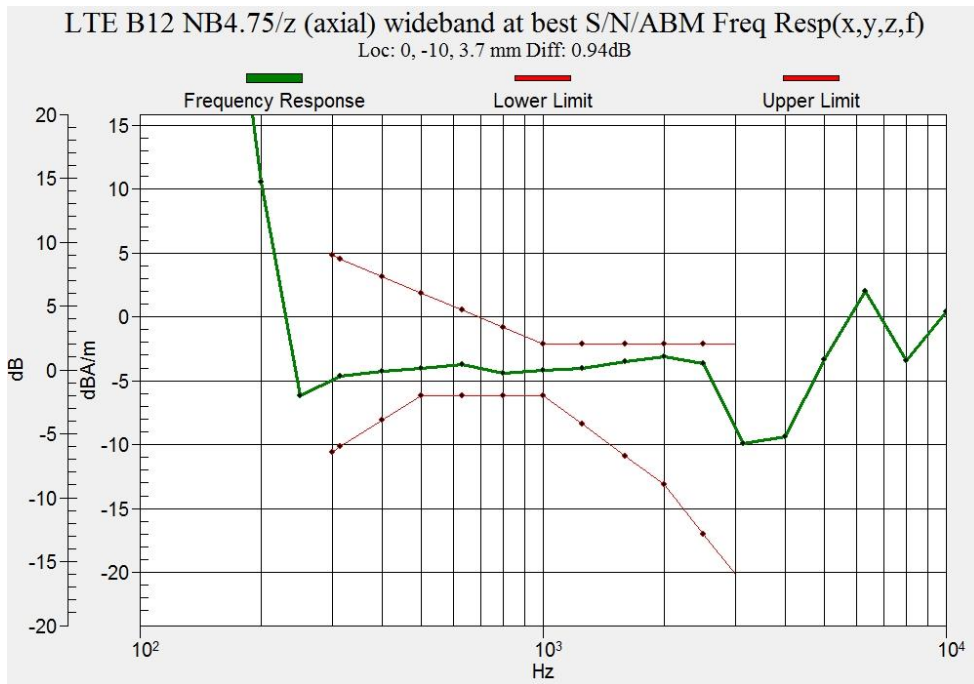

Figure B.10 Frequency Response of LTE Band12

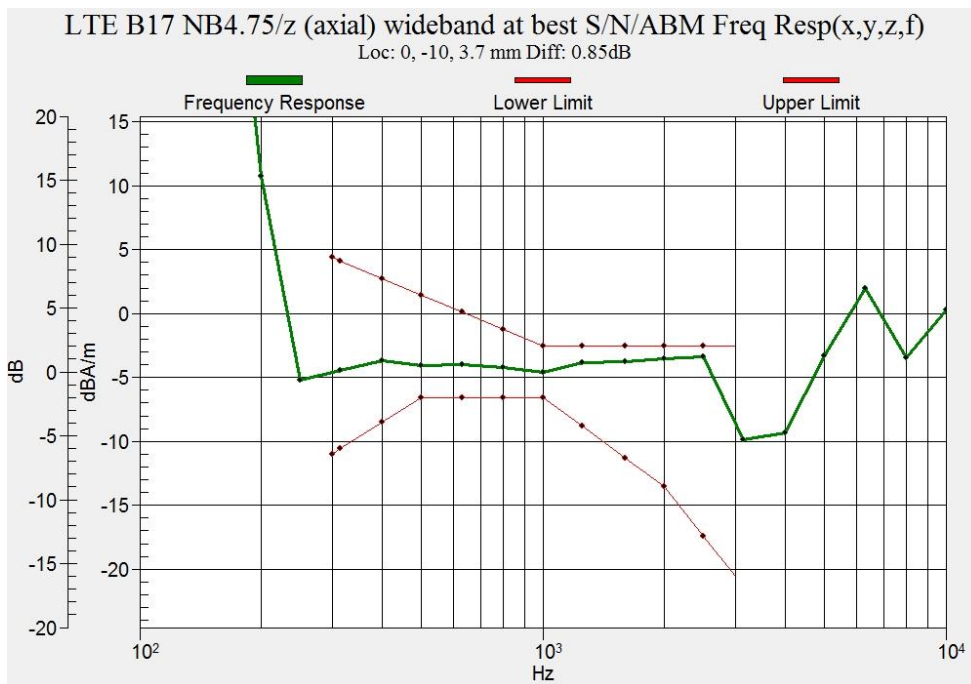

Figure B.11 Frequency Response of LTE Band 17

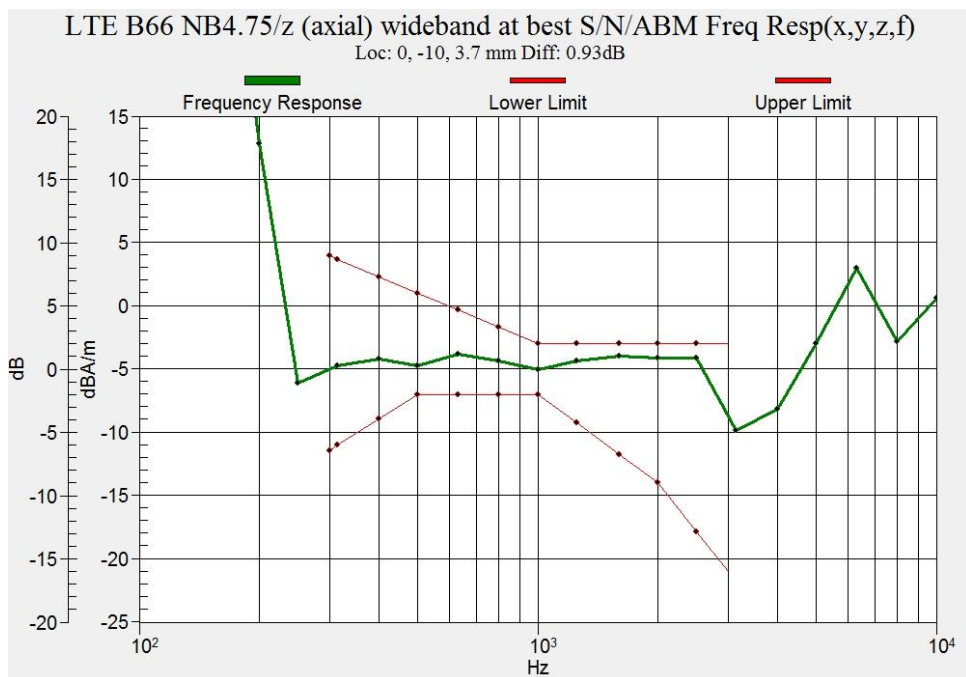

Figure B.12 Frequency Response of LTE Band 66

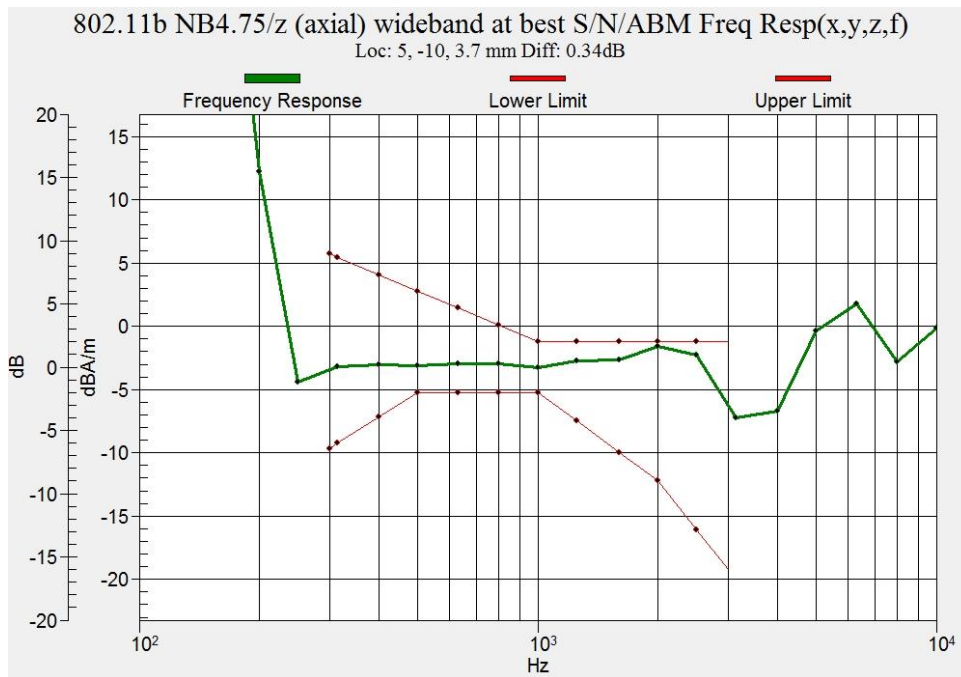

Figure B.13 Frequency Response of WLAN 2.4G

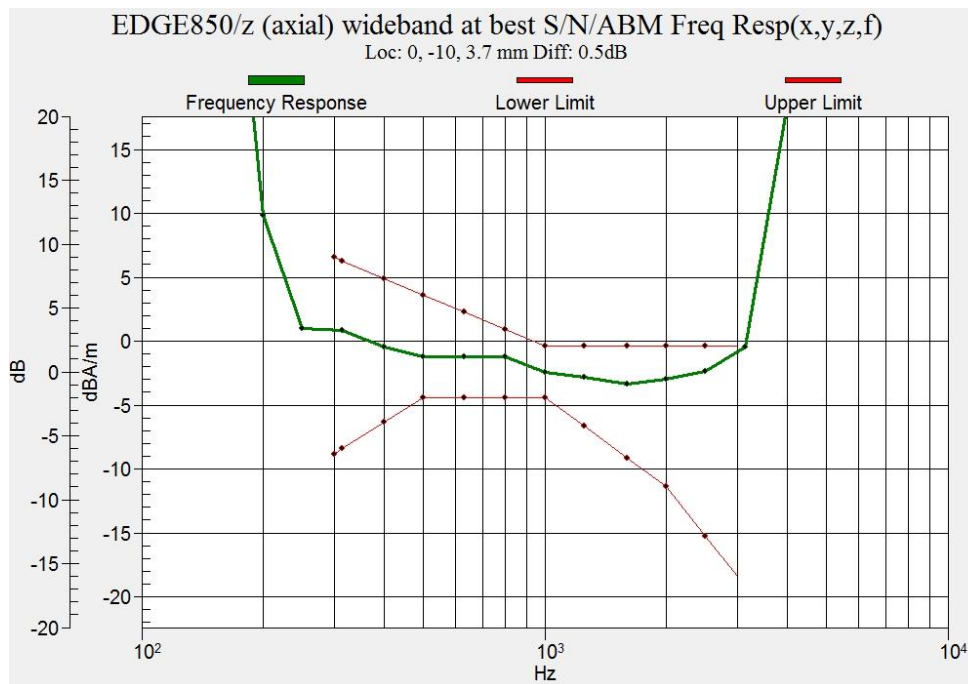

Figure B.14 Frequency Response of GSM 850 (Google Duo)

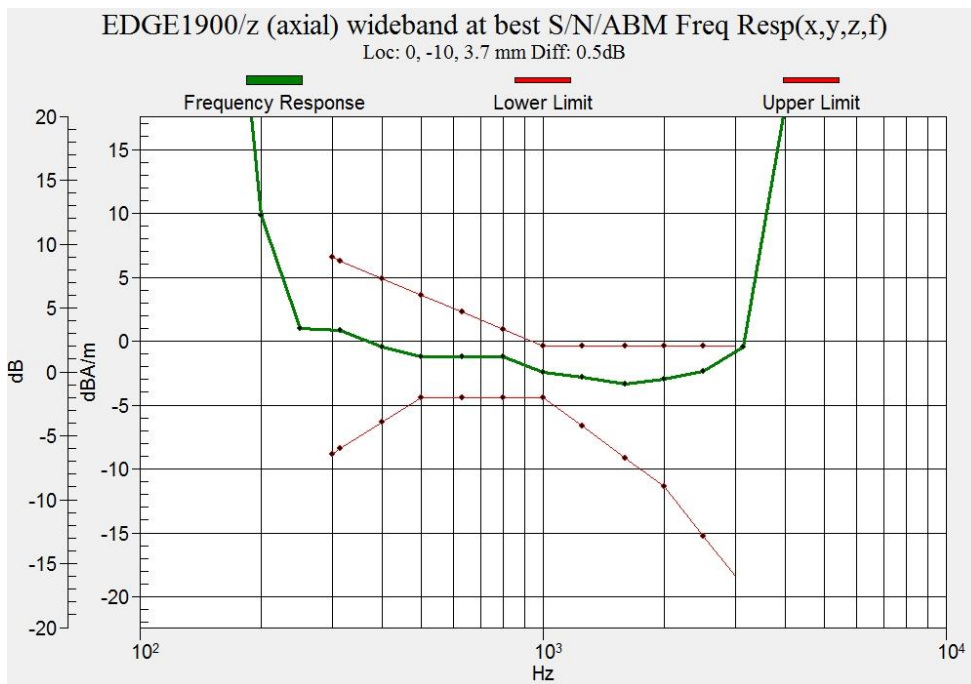

Figure B.15 Frequency Response of GSM 1900 (Google Duo)

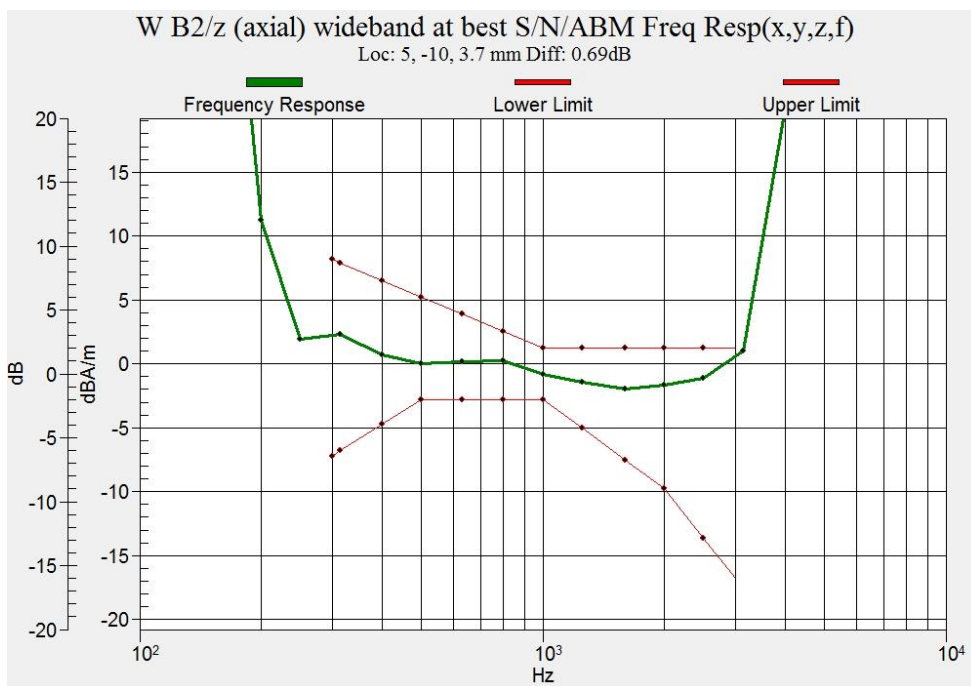

Figure B.16 Frequency Response of WCDMA Band 2 (Google Duo)

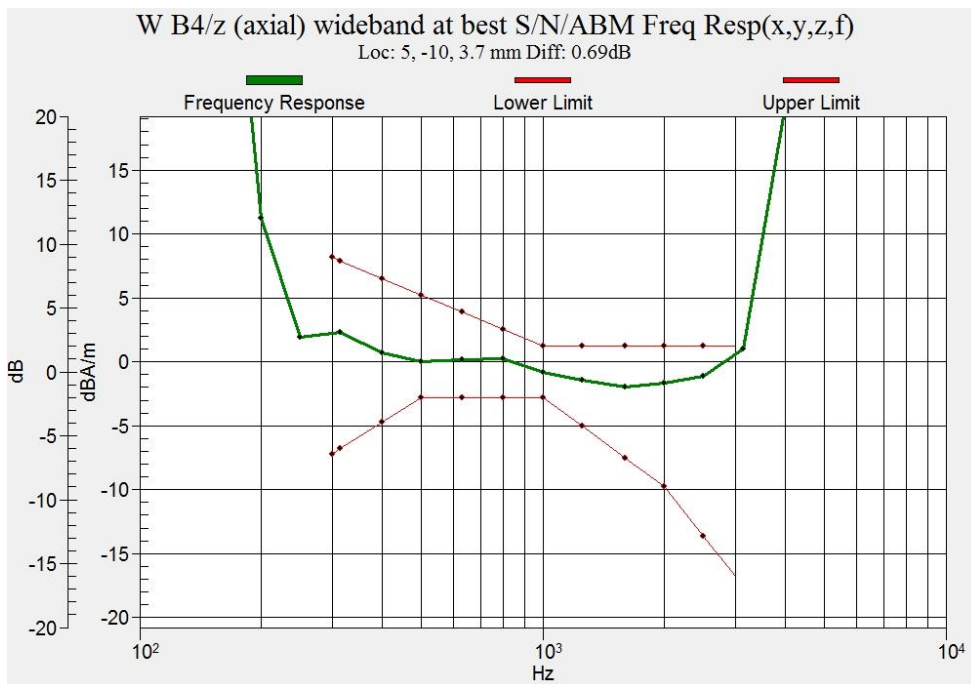

Figure B.17 Frequency Response of WCDMA Band 4 (Google Duo)

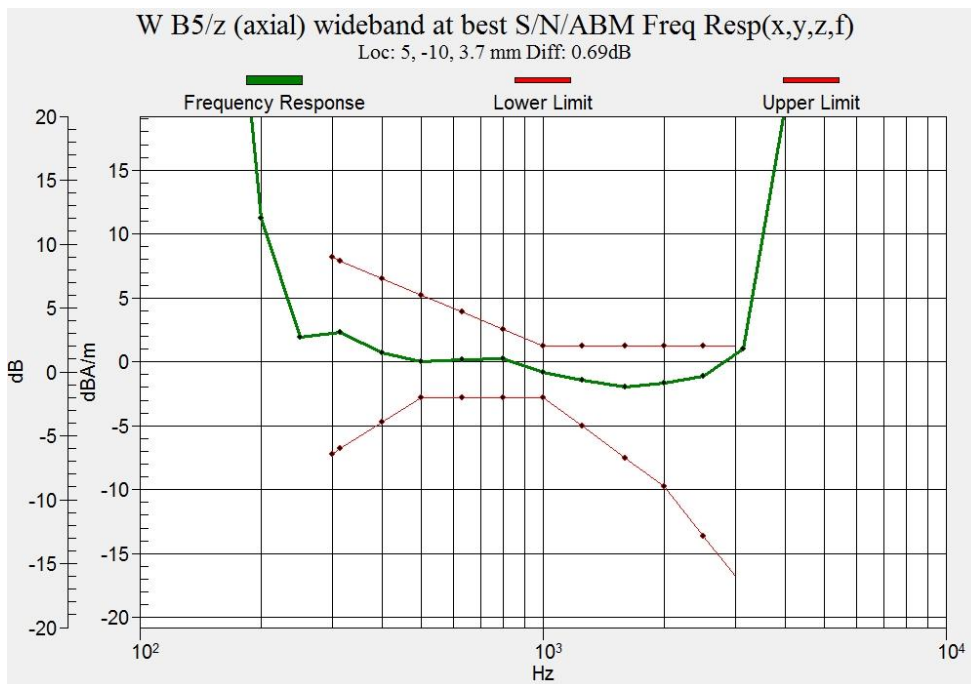

Figure B.18 Frequency Response of WCDMA Band 5 (Google Duo)

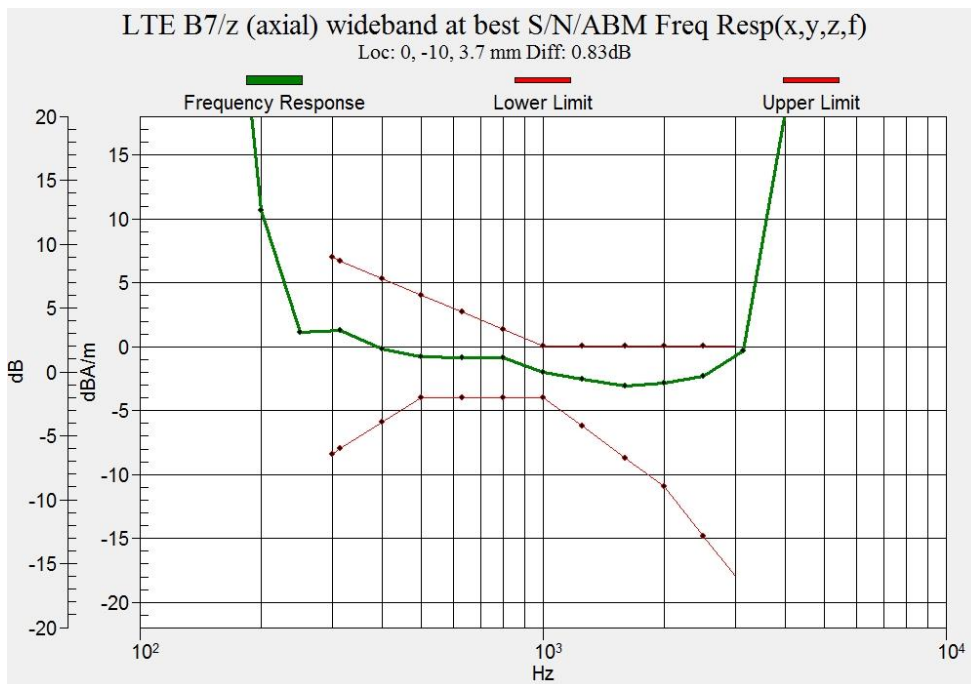

Figure B.19 Frequency Response of LTE Band 7 (Google Duo)

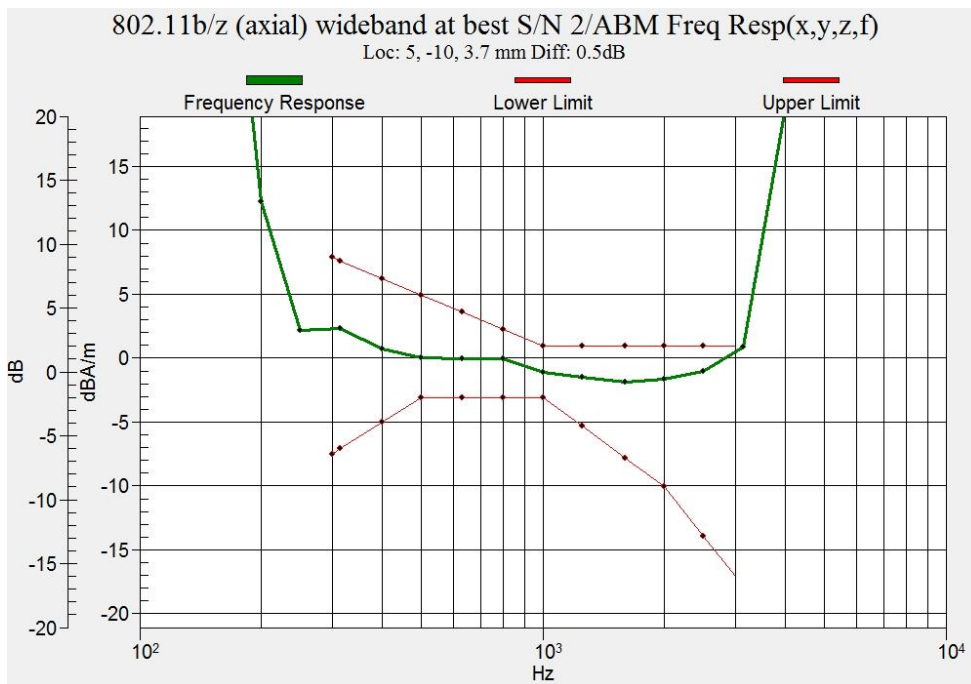

Figure B.20 Frequency Response of WLAN 2.4G (Google Duo)

## ANNEX C: Probe Calibration Certificate

**Calibration Laboratory of**  
**Schmid & Partner**  
**Engineering AG**  
 Zeughausstrasse 43, 8004 Zurich, Switzerland



**S** Schweizerischer Kalibrierdienst  
**C** Service suisse d'étalonnage  
**S** Servizio svizzero di taratura  
**S** Swiss Calibration Service

Accredited by the Swiss Accreditation Service (SAS)  
 The Swiss Accreditation Service is one of the signatories to the EA  
 Multilateral Agreement for the recognition of calibration certificates

Accreditation No.: **SCS 0108**

Client **CTTL-SZ (Auden)**

Certificate No: **AM1DV3-3086\_Feb18**

### CALIBRATION CERTIFICATE

Object: **AM1DV3 - SN: 3086**

Calibration procedure(s): **QA CAL-24.v4**  
 Calibration procedure for AM1D magnetic field probes and TMFS in the audio range

Calibration date: **February 22, 2018**

This calibration certificate documents the traceability to national standards, which realize the physical units of measurements (SI). The measurements and the uncertainties with confidence probability are given on the following pages and are part of the certificate.

All calibrations have been conducted in the closed laboratory facility: environment temperature (22 ± 3)°C and humidity < 70%.

Calibration Equipment used (M&TE critical for calibration)

| Primary Standards               | ID #        | Cal Date (Certificate No.)        | Scheduled Calibration |
|---------------------------------|-------------|-----------------------------------|-----------------------|
| Keithley Multimeter Type 2001   | SN: 0810278 | 31-Aug-17 (No. 21092)             | Aug-18                |
| Reference Probe AM1DV2          | SN: 1008    | 03-Jan-18 (No. AM1DV2-1008_Jan18) | Jan-19                |
| DAE4                            | SN: 781     | 17-Jan-18 (No. DAE4-781_Jan18)    | Jan-19                |
| Secondary Standards             | ID #        | Check Date (in house)             | Scheduled Check       |
| AMCC                            | SN: 1050    | 01-Oct-13 (in house check Oct-17) | Oct-19                |
| AMMI Audio Measuring Instrument | SN: 1062    | 26-Sep-12 (in house check Oct-17) | Oct-19                |

|                |                       |                                   |  |
|----------------|-----------------------|-----------------------------------|--|
| Calibrated by: | Name<br>Leif Klynsner | Function<br>Laboratory Technician | Signature<br> |
| Approved by:   | Katja Pokovic         | Technical Manager                 |               |

Issued: February 23, 2018

This calibration certificate shall not be reproduced except in full without written approval of the laboratory.



**[References**

- [1] ANSI-C63.19-2007  
American National Standard for Methods of Measurement of Compatibility between Wireless Communications Devices and Hearing Aids.
- [2] ANSI-C63.19-2011  
American National Standard, Methods of Measurement of Compatibility between Wireless Communications Devices and Hearing Aids.
- [3] DASY5 manual, Chapter: Hearing Aid Compatibility (HAC) T-Coil Extension

**Description of the AM1D probe**

The AM1D Audio Magnetic Field Probe is a fully shielded magnetic field probe for the frequency range from 100 Hz to 20 kHz. The pickup coil is compliant with the dimensional requirements of [1+2]. The probe includes a symmetric low noise amplifier for the signal available at the shielded 3 pin connector at the side. Power is supplied via the same connector (phantom power supply) and monitored via the LED near the connector. The 7 pin connector at the end of the probe does not carry any signals, but determines the angle of the sensor when mounted on the DAE. The probe supports mechanical detection of the surface.

The single sensor in the probe is arranged in a tilt angle allowing measurement of 3 orthogonal field components when rotating the probe by 120° around its axis. It is aligned with the perpendicular component of the field, if the probe axis is tilted nominally 35.3° above the measurement plane, using the connector rotation and sensor angle stated below.

The probe is fully RF shielded when operated with the matching signal cable (shielded) and allows measurement of audio magnetic fields in the close vicinity of RF emitting wireless devices according to [1+2] without additional shielding.

**Handling of the item**

The probe is manufactured from stainless steel. In order to maintain the performance and calibration of the probe, it must not be opened. The probe is designed for operation in air and shall not be exposed to humidity or liquids. For proper operation of the surface detection and emergency stop functions in a DASY system, the probe must be operated with the special probe cup provided (larger diameter).

**Methods Applied and Interpretation of Parameters**

- *Coordinate System:* The AM1D probe is mounted in the DASY system for operation with a HAC Test Arch phantom with AMCC Helmholtz calibration coil according to [3], with the tip pointing to "southwest" orientation.
- *Functional Test:* The functional test preceding calibration includes test of Noise level  
RF immunity (1 kHz AM modulated signal). The shield of the probe cable must be well connected. Frequency response verification from 100 Hz to 10 kHz.
- *Connector Rotation:* The connector at the end of the probe does not carry any signals and is used for fixation to the DAE only. The probe is operated in the center of the AMCC Helmholtz coil using a 1 kHz magnetic field signal. Its angle is determined from the two minima at nominally +120° and -120° rotation, so the sensor in the tip of the probe is aligned to the vertical plane in z-direction, corresponding to the field maximum in the AMCC Helmholtz calibration coil.
- *Sensor Angle:* The sensor tilting in the vertical plane from the ideal vertical direction is determined from the two minima at nominally +120° and -120°. DASY system uses this angle to align the sensor for radial measurements to the x and y axis in the horizontal plane.

*Sensitivity:* With the probe sensor aligned to the z-field in the AMCC, the output of the probe is compared to the magnetic field in the AMCC at 1 kHz. The field in the AMCC Helmholtz coil is given by the geometry and the current through the coil, which is monitored on the precision shunt resistor of the coil.



**AM1D probe identification and configuration data**

|           |   |
|-----------|---|
| Item      | <b>AM1DV3</b> Audio Magnetic 1D Field Probe |
| Type No   | SP AM1 001 BA                               |
| Serial No | <b>3086</b>                                 |

|                    |                                    |
|--------------------|------------------------------------|
| Overall length     | 296 mm                             |
| Tip diameter       | 6.0 mm (at the tip)                |
| Sensor offset      | 3.0 mm (centre of sensor from tip) |
| Internal Amplifier | 20 dB                              |

|                       |  |
|-----------------------|--|
| Manufacturer / Origin | Schmid & Partner Engineering AG, Zurich, Switzerland |
| Manufacturing date    | May 28, 2010   |

**Calibration data**

|                          |                  |                          |                 |
|--------------------------|------------------|--------------------------|-----------------|
| Connector rotation angle | (in DASY system) | <b>204.7°</b>            | +/- 3.6 ° (k=2) |
| Sensor angle             | (in DASY system) | <b>0.95 °</b>            | +/- 0.5 ° (k=2) |
| Sensitivity at 1 kHz     | (in DASY system) | <b>0.00743 V / (A/m)</b> | +/- 2.2 % (k=2) |

The reported uncertainty of measurement is stated as the standard uncertainty of measurement multiplied by the coverage factor k=2, which for a normal distribution corresponds to a coverage probability of approximately 95%.



# ANNEX D: DAE Calibration Certificate

## DAE4 SN: 1527 Calibration Certificate



Add: No.51 Xueyuan Road, Haidian District, Beijing, 100191, China  
Tel: +86-10-62304633-2512 Fax: +86-10-62304633-2504  
E-mail: cttl@chinattl.com Http://www.chinattl.cn



中国认可  
国际互认  
校准  
CALIBRATION  
CNAS L0570

Client : **CTTL(South Branch)**

Certificate No: **Z20-60433**

| CALIBRATION CERTIFICATE   |  |  |                       |
|---|--|--|-----------------------|
| Object  | DAE4 - SN: 1527  |  |                       |
| Calibration Procedure(s)  | FF-Z11-002-01<br>Calibration Procedure for the Data Acquisition Electronics (DAEx) |  |                       |
| Calibration date:   | November 06, 2020  |  |                       |
| This calibration Certificate documents the traceability to national standards, which realize the physical units of measurements(SI). The measurements and the uncertainties with confidence probability are given on the following pages and are part of the certificate. |  |  |                       |
| All calibrations have been conducted in the closed laboratory facility: environment temperature(22±3)°C and humidity<70%.   |  |  |                       |
| Calibration Equipment used (M&TE critical for calibration)  |  |  |                       |
| Primary Standards   | ID #   | Cal Date(Calibrated by, Certificate No.) | Scheduled Calibration |
| Process Calibrator 753  | 1971018  | 16-Jun-20 (CTTL, No.J20X04342)           | Jun-21                |
| Calibrated by:  | Name   | Function                                 | Signature             |
|   | Yu Zongying  | SAR Test Engineer                        |                       |
| Reviewed by:  | Lin Hao  | SAR Test Engineer                        |                       |
| Approved by:  | Qi Dianyuan  | SAR Project Leader                       |                       |
| Issued: November 08, 2020   |  |  |                       |
| This calibration certificate shall not be reproduced except in full without written approval of the laboratory.   |  |  |                       |

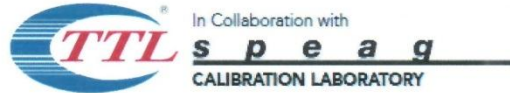

Add: No.51 Xueyuan Road, Haidian District, Beijing, 100191, China  
Tel: +86-10-62304633-2512 Fax: +86-10-62304633-2504  
E-mail: cttl@chinattl.com Http://www.chinattl.cn

**Glossary:**

DAE data acquisition electronics  
Connector angle information used in DASY system to align probe sensor X to the robot coordinate system.

**Methods Applied and Interpretation of Parameters:**

- *DC Voltage Measurement:* Calibration Factor assessed for use in DASY system by comparison with a calibrated instrument traceable to national standards. The figure given corresponds to the full scale range of the voltmeter in the respective range.
- *Connector angle:* The angle of the connector is assessed measuring the angle mechanically by a tool inserted. Uncertainty is not required.
- The report provide only calibration results for DAE, it does not contain other performance test results.



Add: No.51 Xueyuan Road, Haidian District, Beijing, 100191, China  
Tel: +86-10-62304633-2512 Fax: +86-10-62304633-2504  
E-mail: cttl@chinattl.com Http://www.chinattl.cn

**DC Voltage Measurement**

A/D - Converter Resolution nominal

High Range: 1LSB = 6.1 $\mu$ V, full range = -100...+300 mV  
Low Range: 1LSB = 61nV, full range = -1.....+3mV

DASY measurement parameters: Auto Zero Time: 3 sec; Measuring time: 3 sec

| Calibration Factors | X                         | Y                         | Z                         |
|---------------------|---------------------------|---------------------------|---------------------------|
| High Range          | 403.863 $\pm$ 0.15% (k=2) | 403.582 $\pm$ 0.15% (k=2) | 403.801 $\pm$ 0.15% (k=2) |
| Low Range           | 3.95875 $\pm$ 0.7% (k=2)  | 3.98892 $\pm$ 0.7% (k=2)  | 3.96720 $\pm$ 0.7% (k=2)  |

**Connector Angle**

|   |                          |
|---|--------------------------|
| Connector Angle to be used in DASY system | 223.5 $\pm$ 1 $^{\circ}$ |
|---|--------------------------|

**\*\*\*END OF REPORT\*\*\***