



TEST REPORT

No.I20N03311-HAC RF

For

HMD Global Oy

Multi-band GSM/WCDMA/LTE phone with Bluetooth, WLAN

Model Name: TA-1343

With

Hardware Version: 99652_1_11

Software Version: 000T_0_060

FCC ID: 2AJOTTA-1343

Results Summary: M Category = M3

Issued Date: 2021-02-01

Designation Number: CN1210

Note:

The test results in this test report relate only to the devices specified in this report. This report shall not be reproduced except in full without the written approval of SAICT.

Test Laboratory:

SAICT, Shenzhen Academy of Information and Communications Technology

Building G, Shenzhen International Innovation Center, No.1006 Shennan Road, Futian District, Shenzhen, Guangdong, P. R. China 518000.

Tel:+86(0)755-33322000, Fax:+86(0)755-33322001

Email: yewu@caict.ac.cn www.saict.ac.cn



REPORT HISTORY

Report Number	Revision	Description	Issue Date
I20N03311-HAC RF	Rev.0	1st edition	2021-02-01



CONTENTS

1. SUMMARY OF TEST REPORT	5
1.1. TEST ITEMS	5
1.2. TEST STANDARDS	5
1.3. TEST RESULT	5
1.4. TESTING LOCATION	5
1.5. PROJECT DATA	5
1.6. SIGNATURE	5
2. CLIENT INFORMATION	6
2.1. APPLICANT INFORMATION	6
2.2. MANUFACTURER INFORMATION	6
3. EQUIPMENT UNDER TEST (EUT) AND ANCILLARY EQUIPMENT (AE)	7
3.1. ABOUT EUT	7
3.2. INTERNAL IDENTIFICATION OF EUT USED DURING THE TEST	7
3.3. INTERNAL IDENTIFICATION OF AE USED DURING THE TEST	7
3.4. AIR INTERFACES / BANDS INDICATING OPERATING MODES	7
4. REFERENCE DOCUMENTS	8
5. OPERATIONAL CONDITIONS DURING TEST	9
5.1. HAC MEASUREMENT SET-UP	9
5.2. PROBE SPECIFICATION	10
5.3. TEST ARCH PHANTOM & PHONE POSITIONER	11
5.4. ROBOTIC SYSTEM SPECIFICATIONS	11
6. EUT ARRANGEMENT	12
6.1. WD RF EMISSION MEASUREMENTS REFERENCE AND PLANE	12
7. SYSTEM VALIDATION	13
7.1. VALIDATION PROCEDURE	13
7.2. VALIDATION RESULT	13
8. MODULATION INTERFERENCE FACTOR (MIF)	14
9. EVALUATION FOR LOW-POWER EXEMPTION	16
9.1. PRODUCT TESTING THRESHOLD	16
9.2. CONDUCTED POWER	16
10. RF TEST PROCEDURES	17
11. MEASUREMENT RESULTS (E-FIELD)	18
12. ANSI C 63.19-2011 LIMITS	18
13. MEASUREMENT UNCERTAINTY	19



14. MAIN TEST INSTRUMENTS.....	20
ANNEX A: RF EMISSION TEST PLOT	21
ANNEX B: SYSTEM VALIDATION RESULT	27
ANNEX C: PROBE CALIBRATION CERTIFICATE	29
ANNEX D: DAE CALIBRATION CERTIFICATE.....	39
ANNEX E: DIPOLE CALIBRATION CERTIFICATE.....	42
ANNEX F: UID SPECIFICATION	52



1. Summary of Test Report

1.1. Test Items

Description: Multi-band GSM/WCDMA/LTE phone with Bluetooth, WLAN
Model Name: TA-1343
Applicant's name: HMD Global Oy
Manufacturer's Name: HMD Global Oy

1.2. Test Standards

ANSI C63.19-2011

1.3. Test Result

Pass

1.4. Testing Location

Address: Building G, Shenzhen International Innovation Center, No.1006 Shennan Road, Futian District, Shenzhen, Guangdong, P. R. China

1.5. Project Data

Testing Start Date: 2021-01-13

Testing End Date: 2021-01-13

1.6. Signature

Li Yongfu

(Prepared this test report)

Zhang Yunzhan

(Reviewed this test report)

Cao Junfei

(Approved this test report)



2. Client Information

2.1. Applicant Information

Company Name:	HMD Global Oy
Address:	Bertel Jungin aukio 902600 Espoo, Finland
City:	/
Country:	/
Telephone:	/

2.2. Manufacturer Information

Company Name:	HMD Global Oy
Address:	Bertel Jungin aukio 902600 Espoo, Finland
City:	/
Country:	/
Telephone:	/



3. Equipment under Test (EUT) and Ancillary Equipment (AE)

3.1. About EUT

Description:	Multi-band GSM/WCDMA/LTE phone with Bluetooth, WLAN
Mode Name:	TA-1343
Condition of EUT as received:	No obvious damage in appearance
Operating mode(s) :	GSM 850/1900, WCDMA Band 2/4/5 LTE Band 2/4/5/7/12/17/66, Bluetooth, WLAN 2.4G

3.2. Internal Identification of EUT used during the test

EUT ID*	IMEI	HW Version	SW Version	Receipt Date
UT11aa	359180470002485	99652_1_11	000T_0_060	2021-01-05
UT12aa	359180470002443	99652_1_11	000T_0_060	2021-01-05

*EUT ID: is used to identify the test sample in the lab internally.

Note: It is performed to test HAC with the UT11aa&12aa.

3.3. Internal Identification of AE used during the test

AE ID*	Description	Model	Manufacturer
AE1	Battery	W340	Guangdong Fenghua New Energy Co.,Ltd
AE2	Headset	HS-34	New Leader Industry Co.,Ltd

*AE ID: is used to identify the test sample in the lab internally.

3.4. Air Interfaces / Bands Indicating Operating Modes

Air-interface	Band(MHz)	Type	C63.19 / tested	Simultaneous Transmissions	Name of Voice Service	Power Reduction
GSM	850 /1900	VO	Yes	BT,WLAN	CMRS Voice	No
EDGE	850 /1900	VD	Yes	BT,WLAN	Google Duo	
WCDMA	B2 / B4/ B5	VO	Yes	BT,WLAN	CMRS Voice	No
	HSPA	VD	Yes	BT,WLAN	Google Duo	
LTE (FDD)	2/4/5/7/12/17/66	VD	Yes	BT,WLAN	VoLTE Google Duo	No
WLAN	2.4G	VD	Yes	WWAN	VoWIFI Google Duo	No
Bluetooth	2.4G	DT	No	WWAN	NA	No

VO: Voice CMRS/PSTN Service Only

VD: Voice CMRS/PSTN and Data Service

DT: Digital Transport

* HAC Rating was not based on concurrent voice and data modes; Non-current mode was found to represent worst case rating for both M and T rating



4. Reference Documents

The following document listed in this section is referred for testing.

Reference	Title	Version
ANSI C63.19-2011	American National Standard for Methods of Measurement of Compatibility between Wireless Communication Devices and Hearing Aids	2011
KDB 285076 D01	Equipment Authorization Guidance for Hearing Aid Compatibility	v05
KDB 285076 D02	Guidance for performing T-Coil tests for air interfaces supporting voice over IP (e.g., LTE and WiFi) to support CMRS based telephone services	v03

5. Operational Conditions During Test

5.1. HAC Measurement Set-up

These measurements are performed using the DASY5 NEO automated dosimetric assessment system. It is made by Schmid & Partner Engineering AG (SPEAG) in Zurich, Switzerland. It consists of high precision robotics system (Stäubli), robot controller, Intel Core2 computer, near-field probe, probe alignment sensor. The robot is a six-axis industrial robot performing precise movements. A cell controller system contains the power supply, robot controller, teach pendant (Joystick), and remote control, is used to drive the robot motors. The PC consists of the HP Intel Core2 1.86 GHz computer with Windows XP system and HAC Measurement Software DASY5 NEO, A/D interface card, monitor, mouse, and keyboard. The Stäubli Robot is connected to the cell controller to allow software manipulation of the robot. A data acquisition electronic (DAE) circuit performs the signal amplification, signal multiplexing, AD-conversion, offset measurements, mechanical surface detection, collision detection, etc. is connected to the Electro-optical coupler (EOC). The EOC performs the conversion from the optical into digital electric signal of the DAE and transfers data to the PC plug-in card.

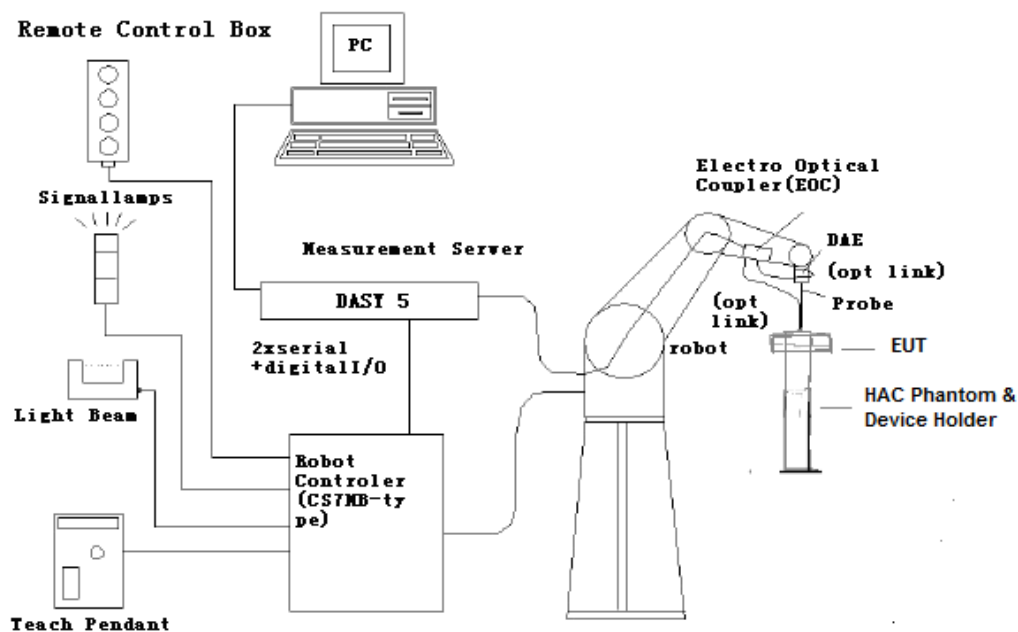

Fig. 1 HAC Test Measurement Set-up

The DAE4 consists of a highly sensitive electrometer-grade preamplifier with auto-zeroing, a channel and gain-switching multiplexer, a fast 16 bit AD-converter and a command decoder and control logic unit. Transmission to the PC-card is accomplished through an optical downlink for data and status information and an optical uplink for commands and clock lines. The mechanical probe mounting device includes two different sensor systems for frontal and sidewise probe contacts. They are also used for mechanical surface detection and probe collision detection. The robot uses its own controller with a built in VME-bus computer.

5.2. Probe Specification

E-Field Probe Description

Construction	<p>One dipole parallel, two dipoles normal to probe axis</p> <p>Built-in shielding against static charges</p> <p>PEEK enclosure material</p>
Calibration	<p>In air from 100 MHz to 3.0 GHz (absolute accuracy $\pm 6.0\%$, $k=2$)</p>
Frequency	<p>40 MHz to > 6 GHz (can be extended to < 20 MHz)</p> <p>Linearity: ± 0.2 dB (100 MHz to 3 GHz)</p>
Directivity	<p>± 0.2 dB in air (rotation around probe axis)</p> <p>± 0.4 dB in air (rotation normal to probe axis)</p>
Dynamic Range	<p>2 V/m to > 1000 V/m; Linearity: ± 0.2 dB</p>
Dimensions	<p>Overall length: 330 mm (Tip: 16 mm)</p> <p>Tip diameter: 8 mm (Body: 12 mm)</p> <p>Distance from probe tip to dipole centers: 2.5 mm</p>
Application	<p>General near-field measurements up to 6 GHz</p> <p>Field component measurements</p> <p>Fast automatic scanning in phantoms</p>



[ER3DV6]

5.3. Test Arch Phantom & Phone Positioner

The Test Arch phantom should be positioned horizontally on a stable surface. Reference markings on the Phantom allow the complete setup of all predefined phantom positions and measurement grids by manually teaching three points in the robot. It enables easy and well defined positioning of the phone and validation dipoles as well as simple teaching of the robot (Dimensions: 370 x 370 x 370 mm).

The Phone Positioner supports accurate and reliable positioning of any phone with effect on near field $\leq \pm 0.5$ dB.

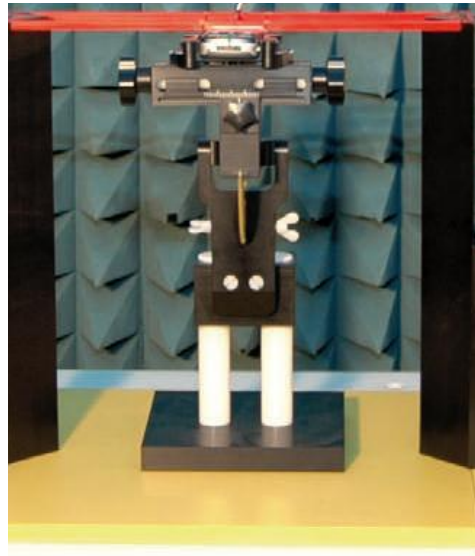

Fig. 2 HAC Phantom & Device Holder

5.4. Robotic System Specifications

Specifications

Positioner: Stäubli Unimation Corp. Robot Model: RX160XL

Repeatability: ± 0.02 mm

No. of Axis: 6

Data Acquisition Electronic (DAE) System

Cell Controller

Processor: Intel Core2

Clock Speed: 1.86 GHz

Operating System: Windows XP

Data Converter

Features: Signal Amplifier, multiplexer, A/D converter, and control logic

Software: DASY5 software

Connecting Lines: Optical downlink for data and status info.

Optical uplink for commands and clock

6. EUT Arrangement

6.1. WD RF Emission Measurements Reference and Plane

Figure 4 illustrates the references and reference plane that shall be used in the WD emissions measurement.

- The grid is 5 cm by 5 cm area that is divided into 9 evenly sized blocks or sub-grids.
- The grid is centered on the audio frequency output transducer of the WD (speaker or T-coil).
- The grid is located by reference to a reference plane. This reference plane is the planar area that contains the highest point in the area of the WD that normally rests against the user's ear
- The measurement plane is located parallel to the reference plane and 15 mm from it, out from the phone. The grid is located in the measurement plane.

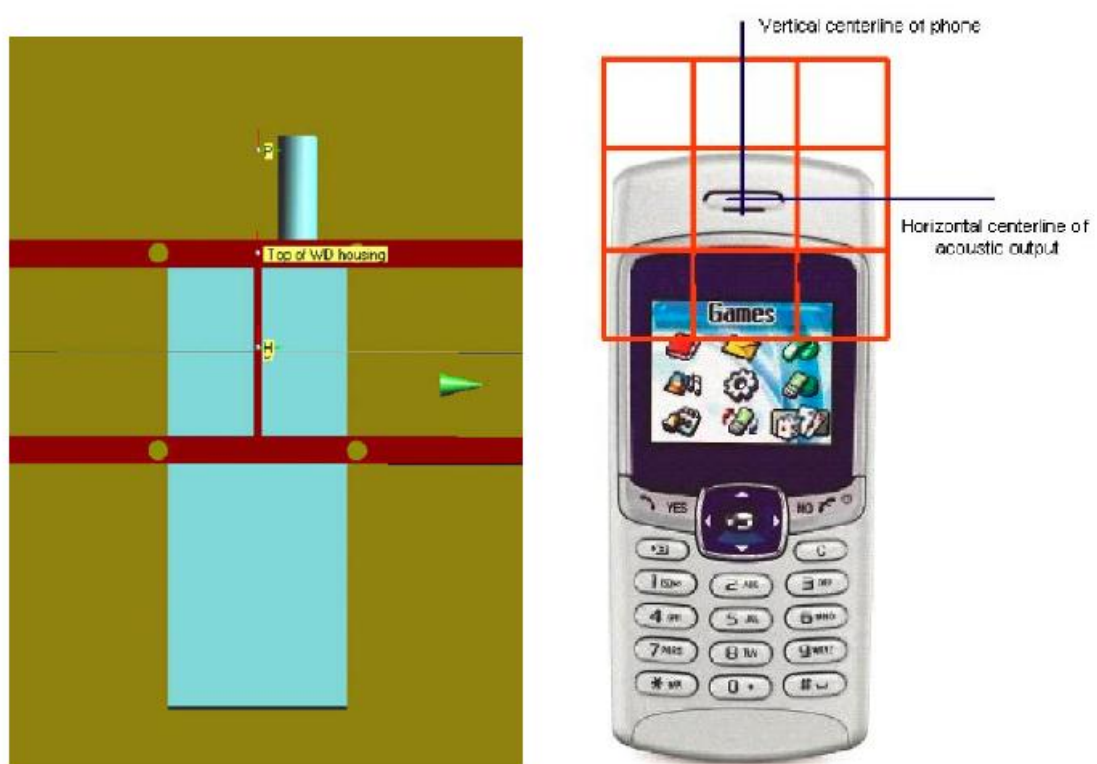

Fig. 3 WD reference and plane for RF emission measurements

7. System Validation

7.1. Validation Procedure

Place a dipole antenna meeting the requirements given in ANSI C63.19 in the position normally occupied by the WD. The dipole antenna serves as a known source for an electrical output. Position the E-field probes so that:

- The probes and their cables are parallel to the coaxial feed of the dipole antenna
- The probe cables and the coaxial feed of the dipole antenna approach the measurement area from opposite directions
- The center point of the probe element(s) are 15 mm from the closest surface of the dipole elements.

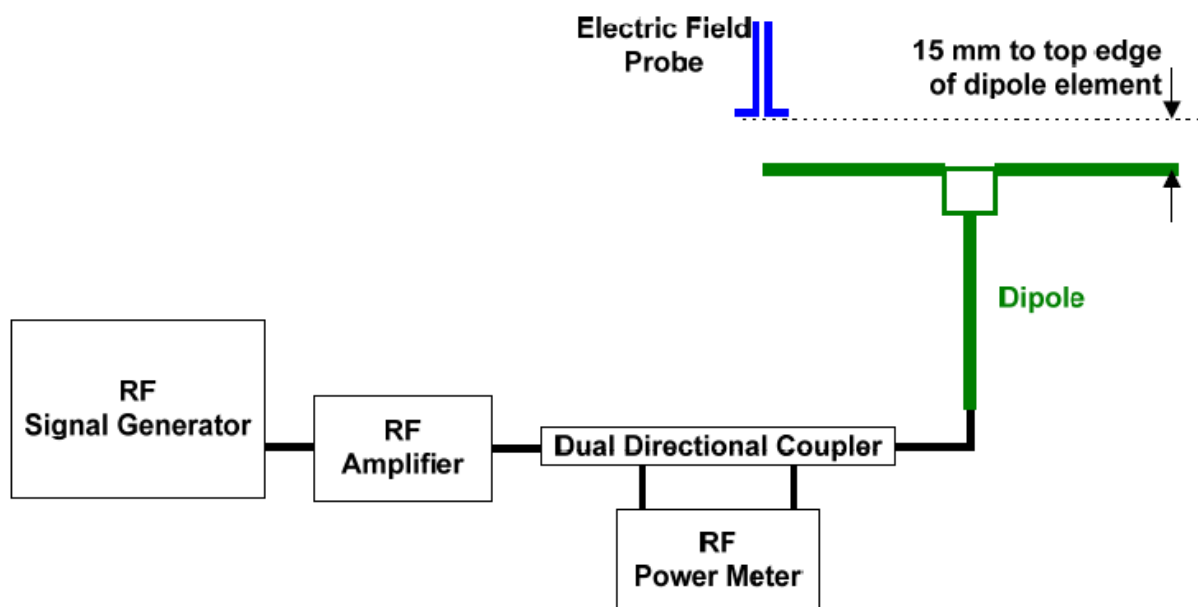

Fig. 4 Dipole Validation Setup

7.2. Validation Result

E-Field Scan						
Mode	Frequency (MHz)	Input Power (mW)	Measured ¹ Value(dBV/m)	Target ² Value(dBV/m)	Deviation ³ (%)	Limit ⁴ (%)
CW	835	100	43.69	40.72	7.3	±25
CW	1880	100	39.45	39.06	1.0	±25

Notes:

1. Please refer to the attachment for detailed measurement data and plot.
2. Target value is provided by SPEAD in the calibration certificate of specific dipoles.
3. Deviation (%) = $100 * (\text{Measured value minus Target value}) / \text{Target value}$.
4. ANSI C63.19 requires values within $\pm 25\%$ are acceptable, of which 12% is deviation and 13% is measurement uncertainty. Values independently validated for the dipole actually used in the measurements should be used, when available.



8. Modulation Interference Factor (MIF)

The HAC Standard ANSI C63.19-2011 defines a new scaling using the Modulation Interference Factor (MIF) which replaces the need for the Articulation Weighting Factor (AWF) during the evaluation and is applicable to any modulation scheme.

The Modulation Interference factor (MIF, in dB) is added to the measured average E-field (in dBV/m) and converts it to the RF Audio Interference level (in dBV/m). This level considers the audible amplitude modulation components in the RF E-field. CW fields without amplitude modulation are assumed to not interfere with the hearing aid electronics. Modulations without time slots and low fluctuations at low frequencies have low MIF values, TDMA modulations with narrow transmission and repetition rates of few 100 Hz have high MIF values and give similar classifications as ANSI C63-2007.

Definitions

ER3D, E-field probes have a bandwidth <10 kHz and can therefore not evaluate the RF envelope in the full audio band. DAS52 is therefore using the “indirect” measurement method according to ANSI C63.19-2011 which is the primary method. These near field probes read the averaged E-field measurement. Especially for the new high peak-to-average (PAR) signal types, the probes shall be linearized by probe modulation response (PMR) calibration in order to not overestimate the field reading.

The evaluation method or the MIF is defined in ANSI C63.19-2011 section D.7. An RMS demodulated RF signal is fed to a spectral filter (similar to an A weighting filter) and forwarded to a temporal filter acting as a quasi-peak detector. The averaged output of these filtering is called to a 1 kHz 80% AM signal as reference. MIF measurement requires additional instrumentation and is not well suited for evaluation by the end user with reasonable uncertainty It may alternatively be determined through analysis and simulation, because it is constraint and characteristic for a communication signal. DAS52 uses well defined signals for PMR calibration. The MIF of these signals has been determined by simulation and is automatically applied.

MIF values were not tested by a probe or as specified in the standards but are based on analysis provided by SPEAG for all the air interfaces (GSM, WCDMA, CDMA, LTE). The data included in this report are for the worst case operating modes. The UIDs used are listed below:

UID	Communication System Name	MIF (dB)
10021	GSM-FDD (TDMA, GMSK)	3.63
10025	EDGE-FDD (TDMA, 8PSK, TN 0)	3.75
10011	UMTS-FDD (WCDMA)	-27.23
10097	UMTS-FDD (HSDPA)	-20.75
10170	LTE-FDD(SC-FDMA, 1RB, 20MHz, 16-QAM)	-9.76
10176	LTE-FDD(SC-FDMA, 1RB, 10MHz, 16-QAM)	-9.76
10061	IEEE 802.11b WiFi 2.4 GHz (DSSS, 11 Mbps)	-2.02



A PMR calibrated probe is linearized for the selected waveform over the full dynamic range within the uncertainty specified in its calibration certificate. ER3D, EF3D and EU2D E-field probes have a bandwidth <10 kHz and can therefore not evaluate the RF envelope in the full audio band. DAS52 is therefore using the "indirect" measurement method according to ANSI C63.19-2011 which is the primary method. These near field probes read the averaged E-field measurement. Especially for the new high peak-to-average (PAR) signal types, the probes shall be linearized by PMR calibration in order to not overestimate the field reading.

The MIF measurement uncertainty is estimated as follows, for modulation frequencies from slotted waveforms with fundamental frequency and at least 2 harmonics within 10 kHz:

0.2 dB for MIF -7 to +5 dB,

0.5 dB for MIF -13 to +11 dB

1 dB for MIF > -20 dB

9. Evaluation for low-power exemption

9.1. Product testing threshold

There are two methods for exempting an RF air interface technology from testing. The first method requires evaluation of the MIF for the worst-case operating mode. An RF air interface technology of a device is exempt from testing when its average antenna input power plus its MIF is ≤ 17 dBm for any of its operating modes. The second method does not require determination of the MIF. The RF emissions testing exemption shall be applied to an RF air interface technology in a device whose peak antenna input power, averaged over intervals $\leq 50 \mu s$, is ≤ 23 dBm. An RF air interface technology that is exempted from testing by either method shall be rated as M4.

The first method is used to be exempt from testing for the RF air interface technology in this report.

9.2. Conducted power

Band	power (dBm)	MIF (dB)	Sum (dBm)	HAC Test
GSM 850	34.5	3.63	38.13	Yes
EGPRS 850	29.0	3.75	32.75	Yes
GSM 1900	31.0	3.63	34.63	Yes
EGPRS 1900	29.5	3.75	33.25	Yes
WCDMA B2	25.0	-27.23	-2.23	No
WCDMA B2-HSDPA	23.5	-27.75	-4.25	No
WCDMA B4	25.0	-27.23	-2.23	No
WCDMA B4-HSDPA	23.5	-27.75	-4.25	No
WCDMA B5	25.0	-27.23	-2.23	No
WCDMA B5-HSDPA	23.5	-27.75	-4.25	No
LTE Band 2	25.0	-9.76	15.24	No
LTE Band 4	25.0	-9.76	15.24	No
LTE Band 5	25.0	-9.76	15.24	No
LTE Band 7	24.5	-9.76	14.74	No
LTE Band 12	25.0	-9.76	15.24	No
LTE Band 17	25.0	-9.76	15.24	No
LTE Band 66	25.0	-9.76	15.24	No
WLAN 2.4G	18.5	-2.02	16.48	No

Note:

1. Power = Max tune-up limit
2. EGPRS data modes are not necessary due the GSM Voice mode is the worst case.



10. RF Test Procedures

The evaluation was performed with the following procedure:

- 1) Confirm proper operation of the field probe, probe measurement system and other instrumentation and the positioning system.
- 2) Position the WD in its intended test position. The gauge block can simplify this positioning.
- 3) Configure the WD normal operation for maximum rated RF output power, at the desired channel and other operating parameters (e.g., test mode), as intended for the test.
- 4) The center sub-grid shall be centered on the center of the T-Coil mode axial measurement point or the acoustic output, as appropriate. Locate the field probe at the initial test position in the 50 mm by 50 mm grid, which is contained in the measurement plane. If the field alignment method is used, align the probe for maximum field reception.
- 5) Record the reading.
- 6) Scan the entire 50 mm by 50 mm region in equally spaced increments and record the reading at each measurement point. The distance between measurement points shall be sufficient to assure the identification of the maximum reading.
- 7) Identify the five contiguous sub-grids around the center sub-grid whose maximum reading is the lowest of all available choices. This eliminates the three sub-grids with the maximum readings. Thus, the six areas to be used to determine the WD's highest emissions are identified.
- 8) Identify the maximum field reading within the non-excluded sub-grids identified in Step 7)
- 9) Evaluate the MIF and add to the maximum steady-state rms field-strength reading to obtain the RF audio interference level..
- 10) Compare this RF audio interference level with the categories and record the resulting WD category rating.

11. Measurement Results (E-Field)

Frequency		Measured Value (dBV/m)	Power Drift (dB)	Category
MHz	Channel			
GSM 850				
848.8	251	35.72	0.08	M4 (see Fig A.1)
836.6	190	35.38	0.10	M4 (see Fig A.2)
824.2	128	34.76	0.04	M4 (see Fig A.3)
GSM 1900				
1909.8	810	31.35	0.05	M3 (see Fig A.4)
1880.0	661	31.99	0.03	M3 (see Fig A.5)
1850.2	512	32.03	0.02	M3 (see Fig A.6)

12. ANSI C 63.19-2011 Limits

WD RF audio interference level categories in logarithmic units

Emission categories	< 960 MHz	
	E-field emissions	
/		
Category M1	50 to 55	dB (V/m)
Category M2	45 to 50	dB (V/m)
Category M3	40 to 45	dB (V/m)
Category M4	< 40	dB (V/m)
Emission categories	> 960 MHz	
	E-field emissions	
/		
Category M1	40 to 45	dB (V/m)
Category M2	35 to 40	dB (V/m)
Category M3	30 to 35	dB (V/m)
Category M4	< 30	dB (V/m)

13. Measurement Uncertainty

No.	Error source	Type	Uncertainty Value (%)	Prob. Dist.	k	c_i E	Standard Uncertainty (%) u_i (%) E	Degree of freedom V_{eff} OR V_i	source
1	System repeatability	A	0.24	N	1	1	0.24	9	Measurement
Measurement System									
2	Probe Calibration	B	10.1	N	1	1	10.1	∞	Manufacturer
3	Axial Isotropy	B	0.5	R	$\sqrt{3}$	1	0.5	∞	Cal report
4	Sensor Displacement	B	16.5	R	$\sqrt{3}$	1	9.5	∞	Manufacturer
5	Boundary Effects	B	2.4	R	$\sqrt{3}$	1	1.4	∞	Manufacturer
6	Linearity	B	0.6	R	$\sqrt{3}$	1	0.35	∞	Cal report
7	Scaling to Peak Envelope Power	B	2.0	R	$\sqrt{3}$	1	1.2	∞	Standard
8	System Detection Limit	B	1.0	R	$\sqrt{3}$	1	0.6	∞	Manufacturer
9	Readout Electronics	B	0.3	N	1	1	0.3	∞	Manufacturer
10	Response Time	B	0.8	R	$\sqrt{3}$	1	0.5	∞	Manufacturer
11	Integration Time	B	2.6	R	$\sqrt{3}$	1	1.5	∞	Manufacturer
12	RF Ambient Conditions	B	3.0	R	$\sqrt{3}$	1	1.7	∞	Measurement
13	RF Reflections	B	12.0	R	$\sqrt{3}$	1	6.9	∞	Measurement
14	Probe Positioner	A	1.2	R	$\sqrt{3}$	1	0.7	∞	Manufacturer
15	Probe Positioning	A	4.7	R	$\sqrt{3}$	1	2.7	∞	Manufacturer
16	Extra. And Interpolation	B	1.0	R	$\sqrt{3}$	1	0.6	∞	Manufacturer
Test Sample Related									
17	Device Positioning Vertical	B	4.7	R	$\sqrt{3}$	1	2.7	∞	Manufacturer
18	Device Positioning Lateral	B	1.0	R	$\sqrt{3}$	1	0.6	∞	Manufacturer
19	Device Holder and Phantom	B	2.4	R	$\sqrt{3}$	1	1.4	∞	Manufacturer
20	Power Drift	B	5.0	R	$\sqrt{3}$	1	2.9	∞	Measurement
Phantom and Setup related									
21	Phantom Thickness	B	2.4	R	$\sqrt{3}$	1	1.4	∞	Manufacturer
PMF related									
22	Monitor amplitude	B	3.5	R	$\sqrt{3}$	1	2.02	∞	Manufacturer
23	Setup repeatability	A	2.3	N	1	1	2.3	9	Manufacturer
24	Sensor amplitude	B	12	R	$\sqrt{3}$	1	6.93	∞	Manufacturer
Combined standard uncertainty(%)							18.3		
Expanded uncertainty (confidence interval of 95 %)		$u_e = 2u_c$		N	k=2		36.6		

14. Main Test Instruments

Table 14-1: List of Main Instruments

No.	Name	Type	Serial Number	Calibration Date	Valid Period
01	Signal Generator	E8257D	MY47461211	2020-01-15	One year
02	Power meter	E4418B	MY50000366	2020-12-13	One year
03	Power sensor	E9304A	MY50000188		
04	Amplifier	VTL5400	0404	/	
05	HAC Test Arch	N/A	1150	/	
06	DAE	DAE4	1527	2020-11-06	One year
07	E-Field Probe	ER3DV6	2424	2018-02-23	Three year
08	HAC Dipole	CD835V3	1165	2018-07-19	Three year
09	HAC Dipole	CD1880V3	1149	2018-07-19	Three year
10	BTS	CMW500	152499	2020-07-17	One year
11	Software	DASY5	52.8.8.1222	/	/

ANNEX A: RF Emission Test Plot

HAC RF E-Field GSM 850 High

Date: 2021-1-13

Electronics: DAE4 Sn1527

Medium: Air

Medium parameters used: $\sigma = 0$ S/m, $\epsilon_r = 1$; $\rho = 1000$ kg/m³

Ambient Temperature: 22.0°C Liquid Temperature: 21.5°C

Communication System: UID 0, GSM Frequency: 848.8 MHz Duty Cycle: 1:8.3

Probe: ER3DV6 - SN2424 ConvF (1, 1, 1);

E Scan - ER3DV6 - 2011: 15 mm from Probe Center to the Device/Hearing Aid Compatibility Test (101x101x1): Interpolated grid: dx=0.5000 mm, dy=0.5000 mm

Device Reference Point: 0, 0, -6.3 mm

Reference Value = 52.85 V/m; Power Drift = 0.08 dB

Applied MIF = 3.63 dB

RF audio interference level = 35.72 dBV/m

Emission category: M4

MIF scaled E-field

Grid 1 M4 35.14 dBV/m	Grid 2 M4 35.72 dBV/m	Grid 3 M4 35.48 dBV/m
Grid 4 M4 34.99 dBV/m	Grid 5 M4 35.72 dBV/m	Grid 6 M4 35.54 dBV/m
Grid 7 M4 34.78 dBV/m	Grid 8 M4 35.69 dBV/m	Grid 9 M4 35.31 dBV/m

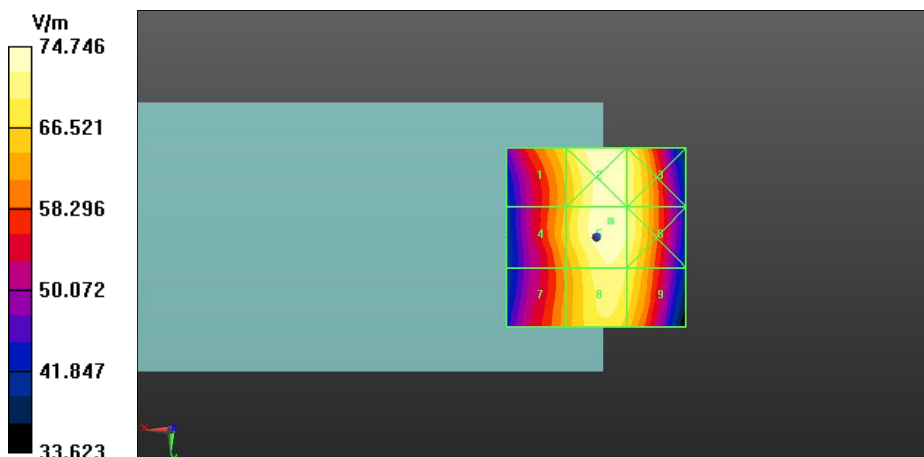

Fig A.1 HAC RF E-Field GSM850

HAC RF E-Field GSM 850 Middle

Date: 2021-1-13

Electronics: DAE4 Sn1527

Medium: Air

Medium parameters used: $\sigma = 0$ S/m, $\epsilon_r = 1$; $\rho = 1000$ kg/m³

Ambient Temperature: 22.0°C Liquid Temperature: 21.5°C

Communication System: UID 0, GSM Frequency: 836.6 MHz Duty Cycle: 1:8.3

Probe: ER3DV6 - SN2424 ConvF (1, 1, 1);

E Scan - ER3DV6 - 2011: 15 mm from Probe Center to the Device/Hearing Aid Compatibility

Test (101x101x1): Interpolated grid: dx=0.5000 mm, dy=0.5000 mm

Device Reference Point: 0, 0, -6.3 mm

Reference Value = 51.74 V/m; Power Drift = 0.10 dB

Applied MIF = 3.63 dB

RF audio interference level = 35.38 dBV/m

Emission category: M4

MIF scaled E-field

Grid 1 M4 34.82 dBV/m	Grid 2 M4 35.33 dBV/m	Grid 3 M4 35.19 dBV/m
Grid 4 M4 34.66 dBV/m	Grid 5 M4 35.38 dBV/m	Grid 6 M4 35.22 dBV/m
Grid 7 M4 34.54 dBV/m	Grid 8 M4 35.25 dBV/m	Grid 9 M4 35.04 dBV/m

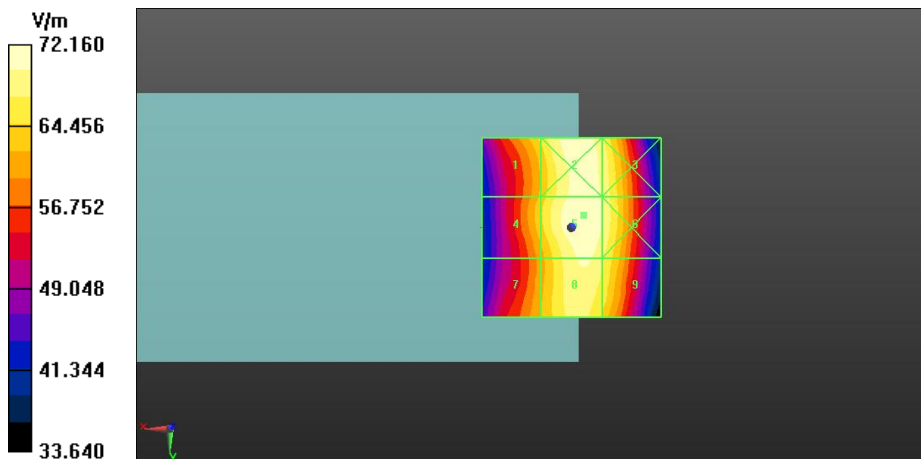

Fig A.2 HAC RF E-Field GSM850

HAC RF E-Field GSM 850 Low

Date: 2021-1-13

Electronics: DAE4 Sn1527

Medium: Air

Medium parameters used: $\sigma = 0 \text{ S/m}$, $\epsilon_r = 1$; $\rho = 1000 \text{ kg/m}^3$

Ambient Temperature: 22.0°C Liquid Temperature: 21.5°C

Communication System: UID 0, GSM Frequency: 824.2 MHz Duty Cycle: 1:8.3

Probe: ER3DV6 - SN2424 ConvF (1, 1, 1);

E Scan - ER3DV6 - 2011: 15 mm from Probe Center to the Device/Hearing Aid Compatibility

Test (101x101x1): Interpolated grid: dx=0.5000 mm, dy=0.5000 mm

Device Reference Point: 0, 0, -6.3 mm

Reference Value = 46.91 V/m; Power Drift = 0.04 dB

Applied MIF = 3.63 dB

RF audio interference level = 34.76 dBV/m

Emission category: M4

MIF scaled E-field

Grid 1 M4 34.15 dBV/m	Grid 2 M4 34.74 dBV/m	Grid 3 M4 34.56 dBV/m
Grid 4 M4 34.09 dBV/m	Grid 5 M4 34.76 dBV/m	Grid 6 M4 34.61 dBV/m
Grid 7 M4 33.94 dBV/m	Grid 8 M4 34.63 dBV/m	Grid 9 M4 34.45 dBV/m

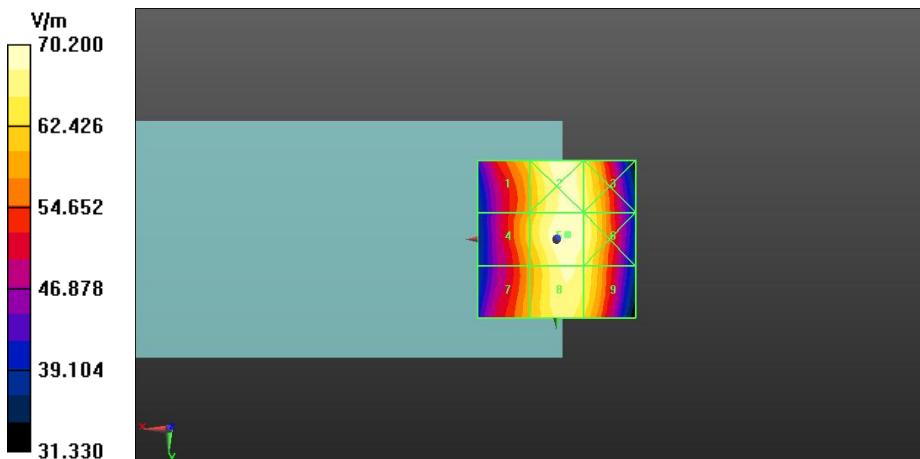

Fig A.3 HAC RF E-Field GSM850

HAC RF E-Field GSM 1900 High

Date: 2021-1-13

Electronics: DAE4 Sn1527

Medium: Air

Medium parameters used: $\sigma = 0 \text{ S/m}$, $\epsilon_r = 1$; $\rho = 1000 \text{ kg/m}^3$

Ambient Temperature: 22.0°C Liquid Temperature: 21.5°C

Communication System: UID 0, GSM Frequency: 1909.8 MHz Duty Cycle: 1:8.3

Probe: ER3DV6 - SN2424 ConvF (1, 1, 1);

E Scan - ER3DV6 - 2011: 15 mm from Probe Center to the Device/Hearing Aid Compatibility

Test (101x101x1): Interpolated grid: dx=0.5000 mm, dy=0.5000 mm

Device Reference Point: 0, 0, -6.3 mm

Reference Value = 27.07 V/m; Power Drift = 0.05 dB

Applied MIF = 3.63 dB

RF audio interference level = 31.35 dBV/m

Emission category: M3

MIF scaled E-field

Grid 1 M4 26.06 dBV/m	Grid 2 M3 30.64 dBV/m	Grid 3 M3 30.78 dBV/m
Grid 4 M4 26.92 dBV/m	Grid 5 M3 31.35 dBV/m	Grid 6 M3 31.41 dBV/m
Grid 7 M4 27.18 dBV/m	Grid 8 M3 31.39 dBV/m	Grid 9 M3 31.44 dBV/m

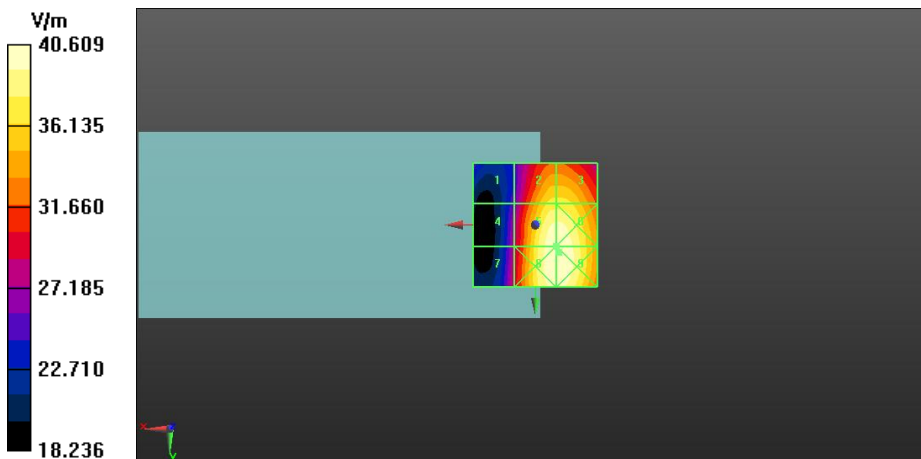

Fig A.4 HAC RF E-Field GSM1900

HAC RF E-Field GSM 1900 Middle

Date: 2021-1-13

Electronics: DAE4 Sn1527

Medium: Air

Medium parameters used: $\sigma = 0$ S/m, $\epsilon_r = 1$; $\rho = 1000$ kg/m³

Ambient Temperature: 22.0°C Liquid Temperature: 21.5°C

Communication System: UID 0, GSM Frequency: 1880 MHz Duty Cycle: 1:8.3

Probe: ER3DV6 - SN2424 ConvF (1, 1, 1);

E Scan - ER3DV6 - 2011: 15 mm from Probe Center to the Device/Hearing Aid Compatibility

Test (101x101x1): Interpolated grid: dx=0.5000 mm, dy=0.5000 mm

Device Reference Point: 0, 0, -6.3 mm

Reference Value = 29.68 V/m; Power Drift = 0.03 dB

Applied MIF = 3.63 dB

RF audio interference level = 31.99 dBV/m

Emission category: M3

MIF scaled E-field

Grid 1 M4 27.02 dBV/m	Grid 2 M3 31.05 dBV/m	Grid 3 M3 31.08 dBV/m
Grid 4 M4 27.96 dBV/m	Grid 5 M3 31.99 dBV/m	Grid 6 M3 32.01 dBV/m
Grid 7 M4 28.38 dBV/m	Grid 8 M3 32.05 dBV/m	Grid 9 M3 32.08 dBV/m

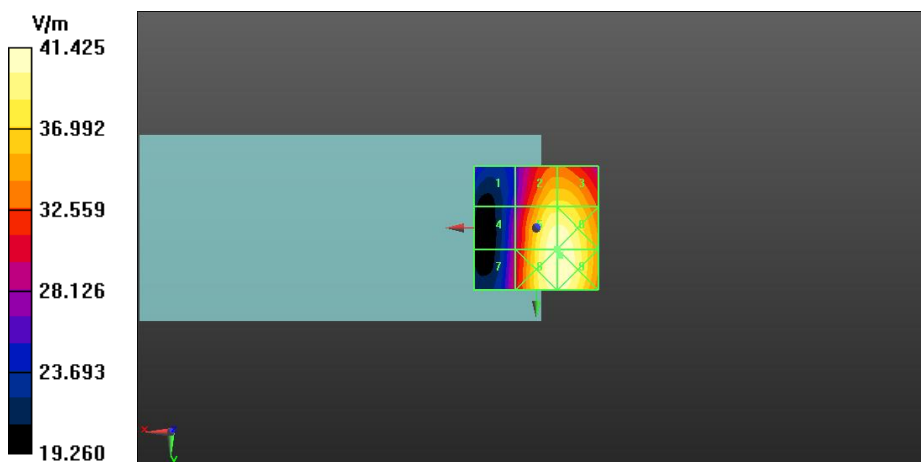

Fig A.5 HAC RF E-Field GSM1900

HAC RF E-Field GSM 1900 Low

Date: 2021-1-13

Electronics: DAE4 Sn1527

Medium: Air

Medium parameters used: $\sigma = 0 \text{ S/m}$, $\epsilon_r = 1$; $\rho = 1000 \text{ kg/m}^3$

Ambient Temperature: 22.0°C Liquid Temperature: 21.5°C

Communication System: UID 0, GSM Frequency: 1850.2 MHz Duty Cycle: 1:8.3

Probe: ER3DV6 - SN2424 ConvF (1, 1, 1);

E Scan - ER3DV6 - 2011: 15 mm from Probe Center to the Device/Hearing Aid Compatibility

Test (101x101x1): Interpolated grid: dx=0.5000 mm, dy=0.5000 mm

Device Reference Point: 0, 0, -6.3 mm

Reference Value = 30.29 V/m; Power Drift = 0.02 dB

Applied MIF = 3.63 dB

RF audio interference level = 32.03 dBV/m

Emission category: M3

MIF scaled E-field

Grid 1 M4 27.38 dBV/m	Grid 2 M3 31.13 dBV/m	Grid 3 M3 31.18 dBV/m
Grid 4 M4 28.42 dBV/m	Grid 5 M3 32.03 dBV/m	Grid 6 M3 32.04 dBV/m
Grid 7 M4 28.79 dBV/m	Grid 8 M3 32.11 dBV/m	Grid 9 M3 32.08 dBV/m

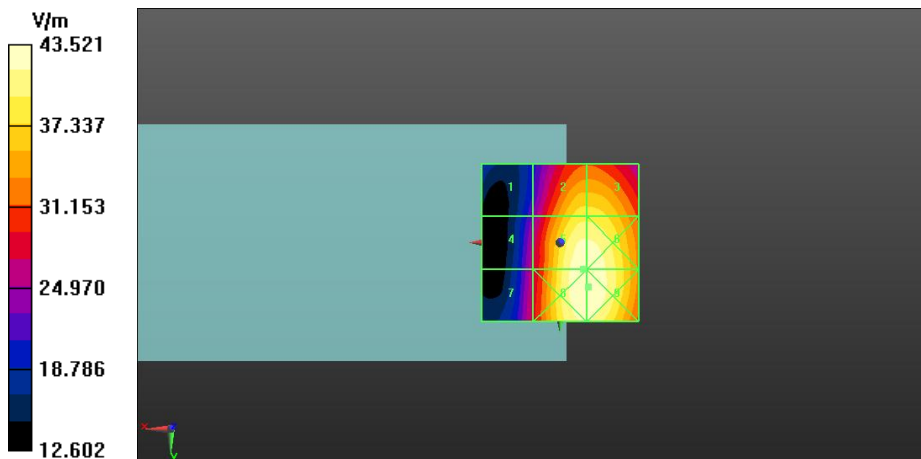

Fig A.6 HAC RF E-Field GSM1900

ANNEX B: System Validation Result

835 MHz

Date: 2021-1-13

Electronics: DAE4 Sn1527

Medium: Air

Medium parameters used: $\sigma = 0$ mho/m, $\epsilon_r = 1$; $\rho = 1000$ kg/m³

Communication System: CW; Frequency: 835 MHz; Duty Cycle: 1:1

Probe: ER3DV6 - SN2424; ConvF (1, 1, 1)

E Scan - measurement distance from the probe sensor center to CD835 Dipole = 15mm

/Hearing Aid Compatibility Test (41x361x1): Interpolated grid: dx=0.5000 mm, dy=0.5000 mm

Device Reference Point: 0, 0, -6.3 mm

Reference Value = 120.8 V/m; Power Drift = 0.03 dB

Applied MIF = 0.00 dB

RF audio interference level = 43.69 dBV/m

Emission category: M3

MIF scaled E-field

Grid 1 M3 43.05 dBV/m	Grid 2 M3 43.51 dBV/m	Grid 3 M3 43.41 dBV/m
Grid 4 M4 38.52 dBV/m	Grid 5 M4 38.87 dBV/m	Grid 6 M4 38.79 dBV/m
Grid 7 M3 43.16 dBV/m	Grid 8 M3 43.69 dBV/m	Grid 9 M3 43.48 dBV/m

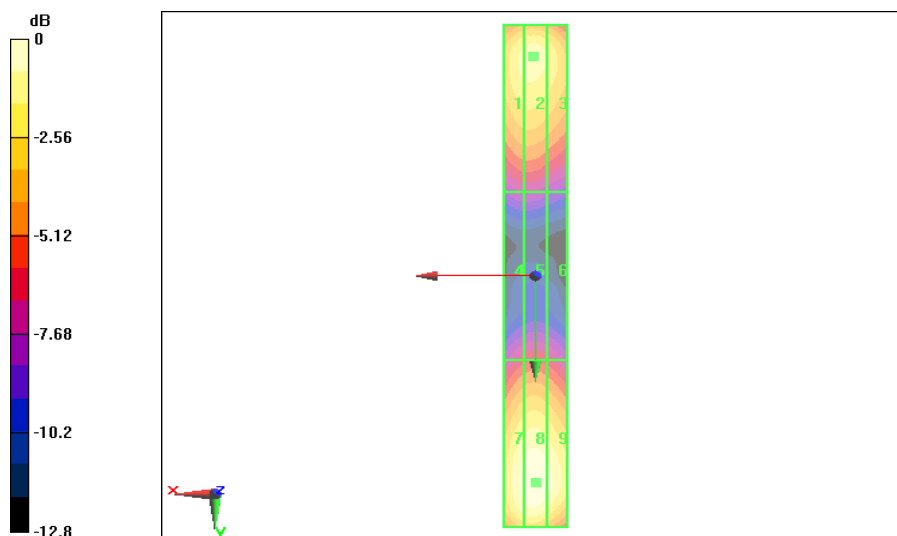

0 dB = 43.69 dBV/m

1880 MHz

Date: 2021-1-13

Electronics: DAE4 Sn1527

Medium: Air

Medium parameters used: $\sigma = 0$ mho/m, $\epsilon_r = 1$; $\rho = 1000$ kg/m³

Communication System: CW; Frequency: 1880 MHz; Duty Cycle: 1:1

Probe: ER3DV6 - SN2424; ConvF (1, 1, 1)

E Scan - measurement distance from the probe sensor center to CD1880 Dipole = 15mm

/Hearing Aid Compatibility Test (41x181x1): Interpolated grid: dx=0.5000 mm, dy=0.5000 mm

Device Reference Point: 0, 0, -6.3 mm

Reference Value = 131.4 V/m; Power Drift = 0.07 dB

Applied MIF = 0.00 dB

RF audio interference level = 39.45 dBV/m

Emission category: M2

MIF scaled E-field

Grid 1 M2 38.98 dBV/m	Grid 2 M2 39.45 dBV/m	Grid 3 M2 39.33 dBV/m
Grid 4 M2 37.36 dBV/m	Grid 5 M2 37.52 dBV/m	Grid 6 M2 37.47 dBV/m
Grid 7 M2 38.94 dBV/m	Grid 8 M2 39.39 dB V/m	Grid 9 M2 39.29 dBV/m

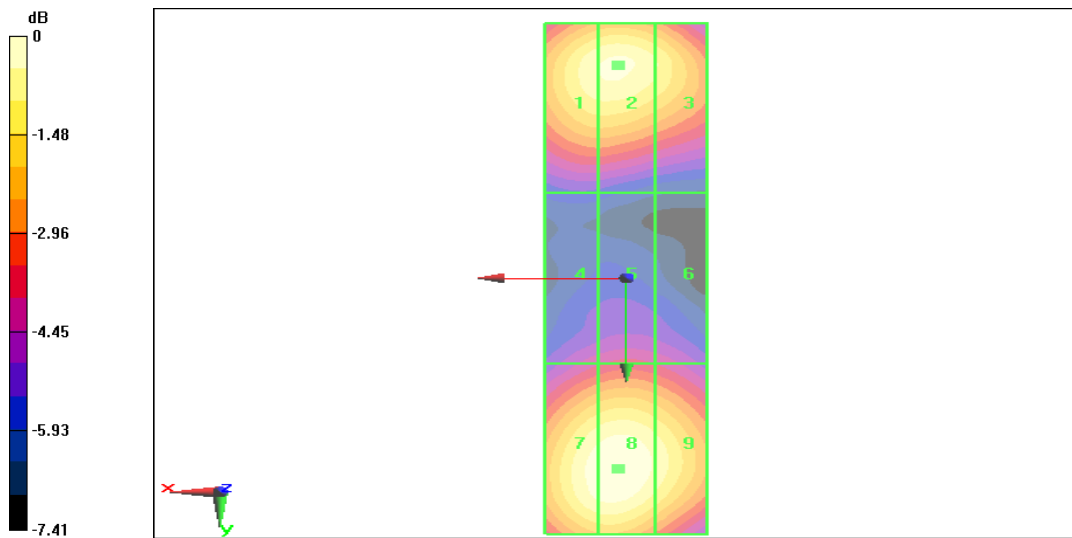

0 dB = 39.45 dBV/m



ANNEX C: Probe Calibration Certificate

E_Probe ER3DV6

Calibration Laboratory of
Schmid & Partner
Engineering AG
 Zeughausstrasse 43, 8004 Zurich, Switzerland



S Schweizerischer Kalibrierdienst
C Service suisse d'étalonnage
S Servizio svizzero di taratura
 Swiss Calibration Service

Accredited by the Swiss Accreditation Service (SAS)
 The Swiss Accreditation Service is one of the signatories to the EA
 Multilateral Agreement for the recognition of calibration certificates

Accreditation No.: SCS 0108

Client **CTTL-SZ (Auden)**

Certificate No: **ER3-2424_Feb18**

CALIBRATION CERTIFICATE

Object: **ER3DV6 - SN:2424**

Calibration procedure(s): **QA CAL-02.v8, QA CAL-25.v6
 Calibration procedure for E-field probes optimized for close near field evaluations in air**

Calibration date: **February 23, 2018**

This calibration certificate documents the traceability to national standards, which realize the physical units of measurements (SI).
 The measurements and the uncertainties with confidence probability are given on the following pages and are part of the certificate.

All calibrations have been conducted in the closed laboratory facility: environment temperature (22 ± 3)°C and humidity < 70%.

Calibration Equipment used (M&TE critical for calibration)

Primary Standards	ID	Cal Date (Certificate No.)	Scheduled Calibration
Power meter NRP	SN: 104778	04-Apr-17 (No. 217-02521/02522)	Apr-18
Power sensor NRP-Z91	SN: 103244	04-Apr-17 (No. 217-02521)	Apr-18
Power sensor NRP-Z91	SN: 103245	04-Apr-17 (No. 217-02525)	Apr-18
Reference 20 dB Attenuator	SN: S5277 (20x)	07-Apr-17 (No. 217-02528)	Apr-18
Reference Probe ER3DV6	SN: 2328	10-Oct-17 (No. ER3-2328_Oct17)	Oct-18
DAE4	SN: 789	2-Aug-17 (No. DAE4-789_Aug17)	Aug-18
Secondary Standards	ID	Check Date (in house)	Scheduled Check
Power meter E4419B	SN: GB41293874	06-Apr-16 (in house check Jun-16)	In house check: Jun-18
Power sensor E4412A	SN: MY41498087	06-Apr-16 (in house check Jun-16)	In house check: Jun-18
Power sensor E4412A	SN: 000110210	06-Apr-16 (in house check Jun-16)	In house check: Jun-18
RF generator HP 8648C	SN: US3642U01700	04-Aug-99 (in house check Jun-16)	In house check: Jun-18
Network Analyzer HP 8753E	SN: US37390585	18-Oct-01 (in house check Oct-17)	In house check: Oct-18

Calibrated by: **Jeton Kastrati** (Name), **Laboratory Technician** (Function), *[Signature]* (Signature)

Approved by: **Katja Pokovic** (Name), **Technical Manager** (Function), *[Signature]* (Signature)

Issued: February 23, 2018

This calibration certificate shall not be reproduced except in full without written approval of the laboratory.

Calibration Laboratory of
 Schmid & Partner
 Engineering AG
 Zeughausstrasse 43, 8004 Zurich, Switzerland



S Schweizerischer Kalibrierdienst
C Service suisse d'étalonnage
S Servizio svizzero di taratura
 Swiss Calibration Service

Accredited by the Swiss Accreditation Service (SAS)
 The Swiss Accreditation Service is one of the signatories to the EA
 Multilateral Agreement for the recognition of calibration certificates

Accreditation No.: **SCS 0108**

Glossary:

NORM_{x,y,z} sensitivity in free space
DCP diode compression point
CF crest factor (1/duty_cycle) of the RF signal
A, B, C, D modulation dependent linearization parameters
Polarization φ φ rotation around probe axis
Polarization ϑ ϑ rotation around an axis that is in the plane normal to probe axis (at measurement center),
 i.e., $\vartheta = 0$ is normal to probe axis
Connector Angle information used in DASY system to align probe sensor X to the robot coordinate system

Calibration is Performed According to the Following Standards:

- a) IEEE Std 1309-2005, "IEEE Standard for calibration of electromagnetic field sensors and probes, excluding antennas, from 9 kHz to 40 GHz", December 2005
- b) CTIA Test Plan for Hearing Aid Compatibility, Rev 3.0, November 2013

Methods Applied and Interpretation of Parameters:

- **NORM_{x,y,z}**: Assessed for E-field polarization $\vartheta = 0$ for XY sensors and $\vartheta = 90$ for Z sensor ($f \leq 900$ MHz in TEM-cell; $f > 1800$ MHz: R22 waveguide).
- **NORM(f)_{x,y,z}** = **NORM_{x,y,z}** * *frequency_response* (see Frequency Response Chart).
- **DCP_{x,y,z}**: DCP are numerical linearization parameters assessed based on the data of power sweep with CW signal (no uncertainty required). DCP does not depend on frequency nor media.
- **PAR**: PAR is the Peak to Average Ratio that is not calibrated but determined based on the signal characteristics
- **A_{x,y,z}; B_{x,y,z}; C_{x,y,z}; D_{x,y,z}; VR_{x,y,z}**: A, B, C, D are numerical linearization parameters assessed based on the data of power sweep for specific modulation signal. The parameters do not depend on frequency nor media. VR is the maximum calibration range expressed in RMS voltage across the diode.
- **Spherical isotropy (3D deviation from isotropy)**: in a locally homogeneous field realized using an open waveguide setup.
- **Sensor Offset**: The sensor offset corresponds to the offset of virtual measurement center from the probe tip (on probe axis). No tolerance required.
- **Connector Angle**: The angle is assessed using the information gained by determining the **NORM_x** (no uncertainty required).



ER3DV6 – SN:2424

February 23, 2018

Probe ER3DV6

SN:2424

Manufactured: November 12, 2007
Calibrated: February 23, 2018

Calibrated for DASY/EASY Systems
(Note: non-compatible with DASY2 system!)



ER3DV6 – SN:2424

February 23, 2018

DASY/EASY - Parameters of Probe: ER3DV6 - SN:2424

Basic Calibration Parameters

	Sensor X	Sensor Y	Sensor Z	Unc (k=2)
Norm ($\mu\text{V}/(\text{V}/\text{m})^2$)	1.46	1.51	1.82	$\pm 10.1 \%$
DCP (mV) ⁵	100.0	98.3	100.6	

Modulation Calibration Parameters

UID	Communication System Name		A dB	B dB/ μV	C	D dB	VR mV	Unc ^E (k=2)
0	CW	X	0.0	0.0	1.0	0.00	189.6	$\pm 3.5 \%$
		Y	0.0	0.0	1.0		204.8	
		Z	0.0	0.0	1.0		200.6	
10021-DAC	GSM-FDD (TDMA, GMSK)	X	21.68	99.9	28.7	9.39	106.2	$\pm 2.2 \%$
		Y	19.41	99.7	28.8		111.3	
		Z	24.71	99.5	28.2		119.2	
10061-CAB	IEEE 802.11g WiFi 2.4 GHz (DSSS, 11 Mbps)	X	8.35	84.6	25.4	3.60	146.9	$\pm 1.9 \%$
		Y	4.81	74.8	21.7		112.9	
		Z	6.43	78.8	22.9		111.9	
10077-CAB	IEEE 802.11g WiFi 2.4 GHz (DSSS/OFDM, 54 Mbps)	X	13.28	77.7	29.3	11.00	139.0	$\pm 3.8 \%$
		Y	11.65	73.4	26.9		100.8	
		Z	11.41	72.1	25.6		99.2	
10172-CAD	LTE-TDD (SC-FDMA, 1 RB, 20 MHz, QPSK)	X	9.48	80.8	29.7	9.21	125.2	$\pm 3.8 \%$
		Y	9.49	81.9	30.6		134.1	
		Z	10.82	83.6	30.5		136.8	
10173-CAD	LTE-TDD (SC-FDMA, 1 RB, 20 MHz, 16-QAM)	X	9.87	81.2	29.9	9.48	125.1	$\pm 2.5 \%$
		Y	10.11	83.1	31.3		134.2	
		Z	11.30	84.2	30.8		136.9	
10295-AAB	CDMA2000, RC1, SO3, 1/8th Rate 25 fr.	X	16.69	99.5	40.3	12.49	96.6	$\pm 2.5 \%$
		Y	15.42	99.3	41.1		100.6	
		Z	17.91	99.9	39.8		104.3	

The reported uncertainty of measurement is stated as the standard uncertainty of measurement multiplied by the coverage factor k=2, which for a normal distribution corresponds to a coverage probability of approximately 95%.

^B Numerical linearization parameter; uncertainty not required.
^E Uncertainty is determined using the max. deviation from linear response applying rectangular distribution and is expressed for the square of the field value.

ER3DV6 – SN:2424

February 23, 2018

Frequency Response of E-Field (TEM-Cell:ifi110 EXX, Waveguide: R22)

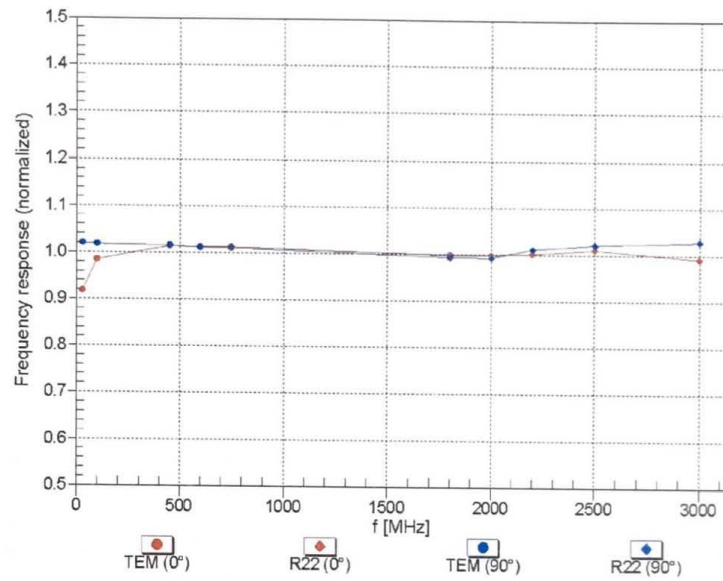

Uncertainty of Frequency Response of E-field: $\pm 6.3\%$ (k=2)

ER3DV6 – SN:2424

February 23, 2018

Receiving Pattern (ϕ), $\vartheta = 0^\circ$

f=600 MHz, TEM, 0°

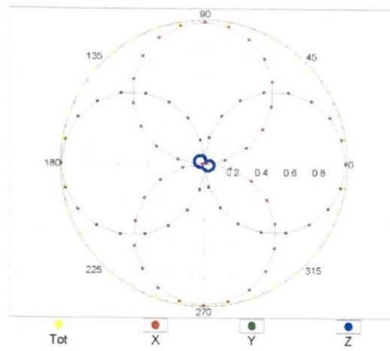

f=2500 MHz, R22, 0°

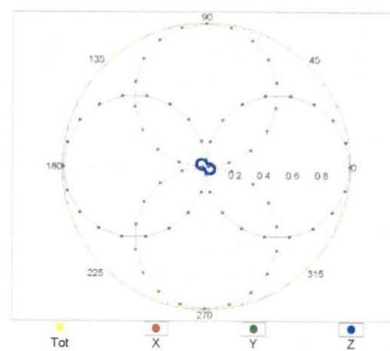

Receiving Pattern (ϕ), $\vartheta = 90^\circ$

f=600 MHz, TEM, 90°

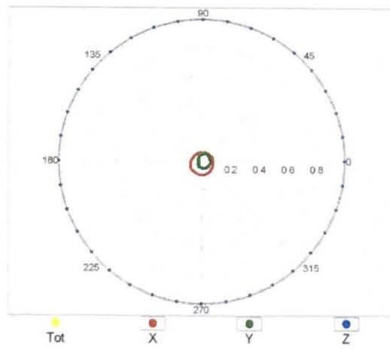

f=2500 MHz, R22, 90°

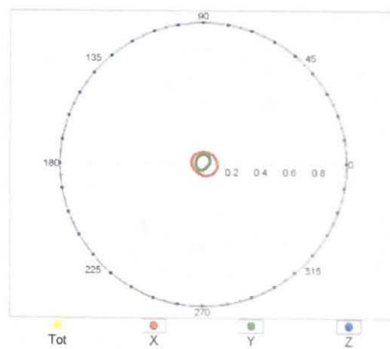

ER3DV6 – SN:2424

February 23, 2018

Receiving Pattern (ϕ), $\vartheta = 0^\circ$

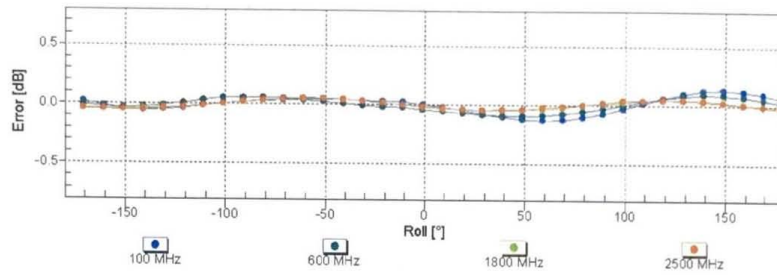

Uncertainty of Axial Isotropy Assessment: $\pm 0.5\%$ ($k=2$)

Receiving Pattern (ϕ), $\vartheta = 90^\circ$

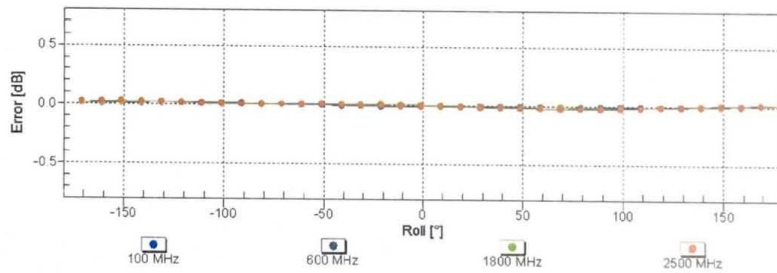

Uncertainty of Axial Isotropy Assessment: $\pm 0.5\%$ ($k=2$)

ER3DV6 – SN:2424

February 23, 2018

Dynamic Range f(E-field) (TEM cell , f = 900 MHz)

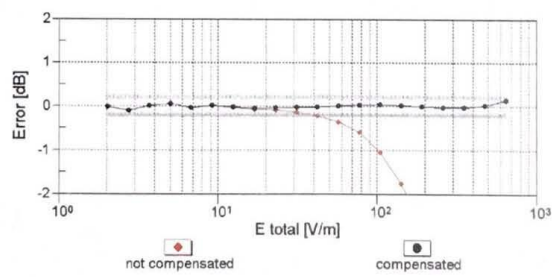
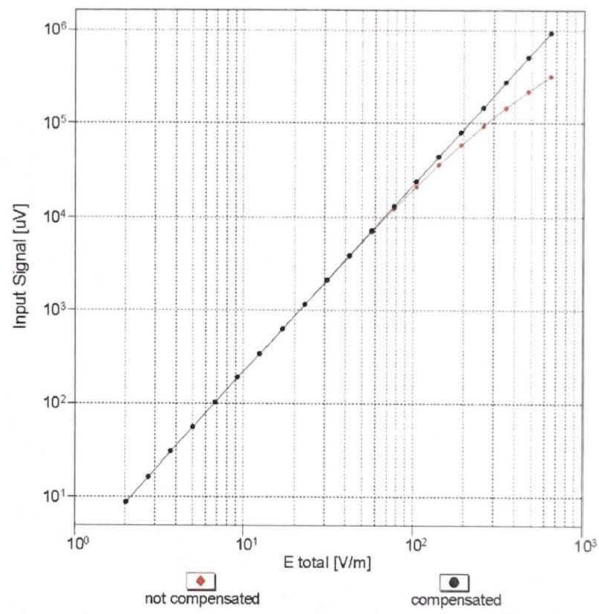

Uncertainty of Linearity Assessment: $\pm 0.6\%$ (k=2)

ER3DV6 – SN:2424

February 23, 2018

Deviation from Isotropy in Air Error (ϕ, θ), $f = 900$ MHz

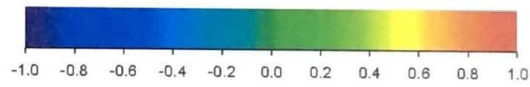
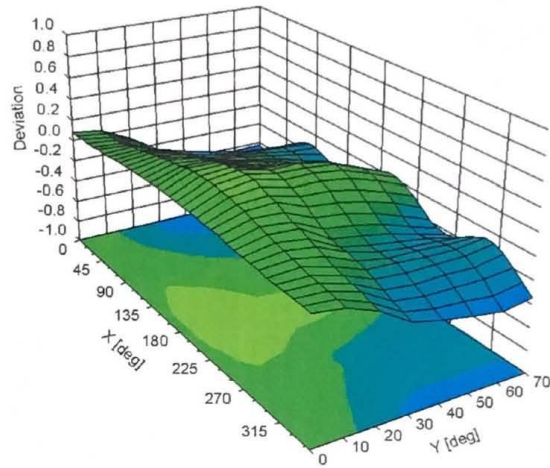

Uncertainty of Spherical Isotropy Assessment: $\pm 2.6\%$ ($k=2$)



ER3DV6 – SN:2424

February 23, 2018

DASY/EASY - Parameters of Probe: ER3DV6 - SN:2424

Other Probe Parameters

Sensor Arrangement	Rectangular
Connector Angle (°)	-11.2
Mechanical Surface Detection Mode	enabled
Optical Surface Detection Mode	disabled
Probe Overall Length	337 mm
Probe Body Diameter	10 mm
Tip Length	10 mm
Tip Diameter	8 mm
Probe Tip to Sensor X Calibration Point	2.5 mm
Probe Tip to Sensor Y Calibration Point	2.5 mm
Probe Tip to Sensor Z Calibration Point	2.5 mm



ANNEX D: DAE Calibration Certificate

DAE4 SN: 1527 Calibration Certificate



Add: No.51 Xueyuan Road, Haidian District, Beijing, 100191, China
Tel: +86-10-62304633-2512 Fax: +86-10-62304633-2504
E-mail: cttl@chinattl.com Http://www.chinattl.cn



中国认可
国际互认
校准
CALIBRATION
CNAS L0570

Client : **CTTL(South Branch)**

Certificate No: **Z20-60433**

CALIBRATION CERTIFICATE

Object: **DAE4 - SN: 1527**

Calibration Procedure(s): **FF-Z11-002-01
Calibration Procedure for the Data Acquisition Electronics (DAEx)**

Calibration date: **November 06, 2020**

This calibration Certificate documents the traceability to national standards, which realize the physical units of measurements(SI). The measurements and the uncertainties with confidence probability are given on the following pages and are part of the certificate.

All calibrations have been conducted in the closed laboratory facility: environment temperature(22±3)°C and humidity<70%.

Calibration Equipment used (M&TE critical for calibration)

Primary Standards	ID #	Cal Date(Calibrated by, Certificate No.)	Scheduled Calibration
Process Calibrator 753	1971018	16-Jun-20 (CTTL, No.J20X04342)	Jun-21

	Name	Function	Signature
Calibrated by:	Yu Zongying	SAR Test Engineer	
Reviewed by:	Lin Hao	SAR Test Engineer	
Approved by:	Qi Dianyuan	SAR Project Leader	

Issued: November 08, 2020

This calibration certificate shall not be reproduced except in full without written approval of the laboratory.



Add: No.51 Xueyuan Road, Haidian District, Beijing, 100191, China
Tel: +86-10-62304633-2512 Fax: +86-10-62304633-2504
E-mail: cttl@chinattl.com Http://www.chinattl.cn

Glossary:

DAE data acquisition electronics
Connector angle information used in DASY system to align probe sensor X to the robot coordinate system.

Methods Applied and Interpretation of Parameters:

- *DC Voltage Measurement:* Calibration Factor assessed for use in DASY system by comparison with a calibrated instrument traceable to national standards. The figure given corresponds to the full scale range of the voltmeter in the respective range.
- *Connector angle:* The angle of the connector is assessed measuring the angle mechanically by a tool inserted. Uncertainty is not required.
- The report provide only calibration results for DAE, it does not contain other performance test results.



Add: No.51 Xueyuan Road, Haidian District, Beijing, 100191, China
Tel: +86-10-62304633-2512 Fax: +86-10-62304633-2504
E-mail: cttl@chinattl.com Http://www.chinattl.cn

DC Voltage Measurement

A/D - Converter Resolution nominal

High Range: 1LSB = 6.1μV, full range = -100...+300 mV
Low Range: 1LSB = 61nV, full range = -1.....+3mV

DASY measurement parameters: Auto Zero Time: 3 sec; Measuring time: 3 sec

Calibration Factors	X	Y	Z
High Range	403.863 ± 0.15% (k=2)	403.582 ± 0.15% (k=2)	403.801 ± 0.15% (k=2)
Low Range	3.95875 ± 0.7% (k=2)	3.98892 ± 0.7% (k=2)	3.96720 ± 0.7% (k=2)

Connector Angle

Connector Angle to be used in DASY system	223.5° ± 1 °
---	--------------



ANNEX E: Dipole Calibration Certificate

Dipole 835 MHz

**Calibration Laboratory of
Schmid & Partner
Engineering AG**
Zeughausstrasse 43, 8004 Zurich, Switzerland



S Schweizerischer Kalibrierdienst
C Service suisse d'étalonnage
S Servizio svizzero di taratura
S Swiss Calibration Service

Accredited by the Swiss Accreditation Service (SAS)
The Swiss Accreditation Service is one of the signatories to the EA
Multilateral Agreement for the recognition of calibration certificates

Accreditation No.: SCS 0108

Client **CTTL (Auden)**

Certificate No: **CD835V3-1165_Jul18**

CALIBRATION CERTIFICATE			
Object	CD835V3 - SN: 1165		
Calibration procedure(s)	QA CAL-20.v6 Calibration procedure for dipoles in air		
Calibration date:	July 19, 2018		
This calibration certificate documents the traceability to national standards, which realize the physical units of measurements (SI). The measurements and the uncertainties with confidence probability are given on the following pages and are part of the certificate.			
All calibrations have been conducted in the closed laboratory facility: environment temperature (22 ± 3)°C and humidity < 70%.			
Calibration Equipment used (M&TE critical for calibration)			
Primary Standards	ID #	Cal Date (Certificate No.)	Scheduled Calibration
Power meter NRP	SN: 104778	04-Apr-18 (No. 217-02672/02673)	Apr-19
Power sensor NRP-Z91	SN: 103244	04-Apr-18 (No. 217-02672)	Apr-19
Power sensor NRP-Z91	SN: 103245	04-Apr-18 (No. 217-02673)	Apr-19
Reference 20 dB Attenuator	SN: 5058 (20k)	04-Apr-18 (No. 217-02682)	Apr-19
Type-N mismatch combination	SN: 5047.2 / 06327	04-Apr-18 (No. 217-02683)	Apr-19
Probe EF3DV3	SN: 4013	05-Mar-18 (No. EF3-4013_Mar18)	Mar-19
Probe H3DV6	SN: 6065	30-Dec-17 (No. H3-6065_Dec17)	Dec-18
DAE4	SN: 781	17-Jan-18 (No. DAE4-781_Jan18)	Jan-19
Secondary Standards	ID #	Check Date (in house)	Scheduled Check
Power meter Agilent 4419B	SN: GB42420191	09-Oct-09 (in house check Oct-17)	In house check: Oct-20
Power sensor HP E4412A	SN: US38485102	05-Jan-10 (in house check Oct-17)	In house check: Oct-20
Power sensor HP 8482A	SN: US37295597	09-Oct-09 (in house check Oct-17)	In house check: Oct-20
RF generator R&S SMT-06	SN: 832283/011	27-Aug-12 (in house check Oct-17)	In house check: Oct-20
Network Analyzer Agilent E8358A	SN: US41080477	31-Mar-14 (in house check Oct-17)	In house check: Oct-18
Calibrated by:	Name Leif Klynsner	Function Laboratory Technician	Signature
Approved by:	Name Katja Pokovic	Function Technical Manager	Signature
			Issued: July 19, 2018
This calibration certificate shall not be reproduced except in full without written approval of the laboratory.			

**Calibration Laboratory of
Schmid & Partner
Engineering AG**
Zeughausstrasse 43, 8004 Zurich, Switzerland



S Schweizerischer Kalibrierdienst
S Service suisse d'étalonnage
S Servizio svizzero di taratura
S Swiss Calibration Service

Accredited by the Swiss Accreditation Service (SAS)
The Swiss Accreditation Service is one of the signatories to the EA
Multilateral Agreement for the recognition of calibration certificates

Accreditation No.: **SCS 0108**

References

- [1] ANSI-C63.19-2011
American National Standard, Methods of Measurement of Compatibility between Wireless Communications Devices and Hearing Aids.

Methods Applied and Interpretation of Parameters:

- **Coordinate System:** y-axis is in the direction of the dipole arms. z-axis is from the basis of the antenna (mounted on the table) towards its feed point between the two dipole arms. x-axis is normal to the other axes. In coincidence with the standards [1], the measurement planes (probe sensor center) are selected to be at a distance of 15 mm above the top metal edge of the dipole arms.
- **Measurement Conditions:** Further details are available from the hardcopies at the end of the certificate. All figures stated in the certificate are valid at the frequency indicated. The forward power to the dipole connector is set with a calibrated power meter connected and monitored with an auxiliary power meter connected to a directional coupler. While the dipole under test is connected, the forward power is adjusted to the same level.
- **Antenna Positioning:** The dipole is mounted on a HAC Test Arch phantom using the matching dipole positioner with the arms horizontal and the feeding cable coming from the floor. The measurements are performed in a shielded room with absorbers around the setup to reduce the reflections. It is verified before the mounting of the dipole under the Test Arch phantom, that its arms are perfectly in a line. It is installed on the HAC dipole positioner with its arms parallel below the dielectric reference wire and able to move elastically in vertical direction without changing its relative position to the top center of the Test Arch phantom. The vertical distance to the probe is adjusted after dipole mounting with a DASY5 Surface Check job. Before the measurement, the distance between phantom surface and probe tip is verified. The proper measurement distance is selected by choosing the matching section of the HAC Test Arch phantom with the proper device reference point (upper surface of the dipole) and the matching grid reference point (tip of the probe) considering the probe sensor offset. The vertical distance to the probe is essential for the accuracy.
- **Feed Point Impedance and Return Loss:** These parameters are measured using a HP 8753E Vector Network Analyzer. The impedance is specified at the SMA connector of the dipole. The influence of reflections was eliminated by applying the averaging function while moving the dipole in the air, at least 70cm away from any obstacles.
- **E-field distribution:** E field is measured in the x-y-plane with an isotropic ER3D-field probe with 100 mW forward power to the antenna feed point. In accordance with [1], the scan area is 20mm wide, its length exceeds the dipole arm length (180 or 90mm). The sensor center is 15 mm (in z) above the metal top of the dipole arms. Two 3D maxima are available near the end of the dipole arms. Assuming the dipole arms are perfectly in one line, the average of these two maxima (in subgrid 2 and subgrid 8) is determined to compensate for any non-parallelity to the measurement plane as well as the sensor displacement. The E-field value stated as calibration value represents the maximum of the interpolated 3D-E-field, in the plane above the dipole surface.

The reported uncertainty of measurement is stated as the standard uncertainty of measurement multiplied by the coverage factor $k=2$, which for a normal distribution corresponds to a coverage probability of approximately 95%.

Measurement Conditions

DASY system configuration, as far as not given on page 1.

DASY Version	DASY5	V52.10.1
Phantom	HAC Test Arch	
Distance Dipole Top - Probe Center	15 mm	
Scan resolution	dx, dy = 5 mm	
Frequency	835 MHz ± 1 MHz	
Input power drift	< 0.05 dB	

Maximum Field values at 835 MHz

E-field 15 mm above dipole surface	condition	Interpolated maximum
Maximum measured above high end	100 mW input power	108.7 V/m = 40.72 dBV/m
Maximum measured above low end	100 mW input power	108.6 V/m = 40.72 dBV/m
Averaged maximum above arm	100 mW input power	108.7 V/m ± 12.8 % (k=2)

Appendix (Additional assessments outside the scope of SCS 0108)

Antenna Parameters

Frequency	Return Loss	Impedance
800 MHz	16.4 dB	40.0 Ω - 9.2 jΩ
835 MHz	25.5 dB	53.7 Ω + 4.0 jΩ
880 MHz	17.8 dB	60.3 Ω - 9.8 jΩ
900 MHz	16.5 dB	51.6 Ω - 15.3 jΩ
945 MHz	21.7 dB	43.9 Ω + 4.8 jΩ

3.2 Antenna Design and Handling

The calibration dipole has a symmetric geometry with a built-in two stub matching network, which leads to the enhanced bandwidth.

The dipole is built of standard semirigid coaxial cable. The internal matching line is open ended. The antenna is therefore open for DC signals.

Do not apply force to dipole arms, as they are liable to bend. The soldered connections near the feedpoint may be damaged. After excessive mechanical stress or overheating, check the impedance characteristics to ensure that the internal matching network is not affected.

After long term use with 40W radiated power, only a slight warming of the dipole near the feedpoint can be measured.

Impedance Measurement Plot

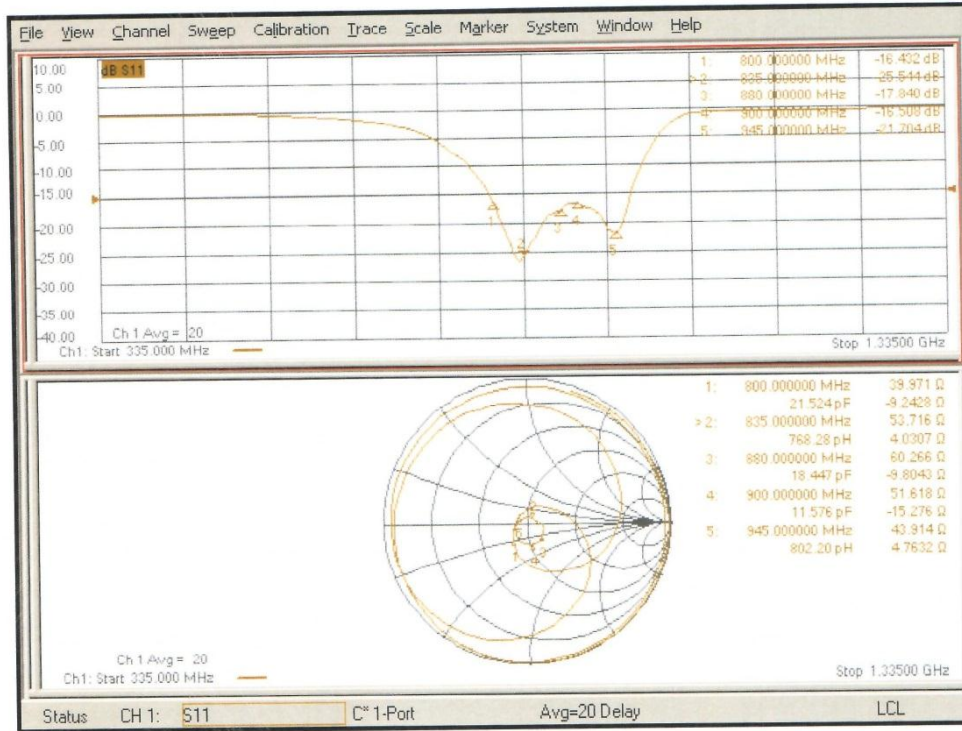

DASY5 E-field Result

Date: 19.07.2018

Test Laboratory: SPEAG Lab2

DUT: HAC-Dipole 835 MHz; Type: CD835V3; Serial: CD835V3 - SN: 1165

Communication System: UID 0 - CW ; Frequency: 835 MHz
 Medium parameters used: $\sigma = 0$ S/m, $\epsilon_r = 1$; $\rho = 0$ kg/m³
 Phantom section: RF Section
 Measurement Standard: DASY5 (IEEE/IEC/ANSI C63.19-2011)

DASY52 Configuration:

- Probe: EF3DV3 - SN4013; ConvF(1, 1, 1) @ 835 MHz; Calibrated: 05.03.2018
- Sensor-Surface: (Fix Surface)
- Electronics: DAE4 Sn781; Calibrated: 17.01.2018
- Phantom: HAC Test Arch with AMCC; Type: SD HAC P01 BA; Serial: 1070
- DASY52 52.10.1(1476); SEMCAD X 14.6.11(7439)

Dipole E-Field measurement @ 835MHz/E-Scan - 835MHz d=15mm/Hearing Aid Compatibility Test (41x361x1):

Interpolated grid: dx=0.5000 mm, dy=0.5000 mm
 Device Reference Point: 0, 0, -6.3 mm
 Reference Value = 130.9 V/m; Power Drift = 0.02 dB
 Applied MIF = 0.00 dB
 RF audio interference level = 40.73 dBV/m
Emission category: M3

MIF scaled E-field

Grid 1 M3 40.28 dBV/m	Grid 2 M3 40.72 dBV/m	Grid 3 M3 40.67 dBV/m
Grid 4 M4 35.61 dBV/m	Grid 5 M4 35.96 dBV/m	Grid 6 M4 35.94 dBV/m
Grid 7 M3 40.41 dBV/m	Grid 8 M3 40.73 dBV/m	Grid 9 M3 40.67 dBV/m

