



TEST REPORT

No. I20N03311-NFC

for

HMD Global Oy

Multi-band GSM/WCDMA/LTE phone with Bluetooth, WLAN

Model Name: TA-1343

with

Hardware Version: 99652_1_11

Software Version: 000T_0_060

FCC ID: 2AJOTTA-1343

Issued Date: 2021-01-31

Designation Number: CN1210

Note:

The test results in this test report relate only to the devices specified in this report. This report shall not be reproduced except in full without the written approval of SAICT.

Test Laboratory:

SAICT, Shenzhen Academy of Information and Communications Technology

Building G, Shenzhen International Innovation Center, No.1006 Shennan Road, Futian District, Shenzhen, Guangdong, P. R. China 518000.

Tel:+86(0)755-33322000, Fax:+86(0)755-33322001

Email: yewu@caict.ac.cn. www.saict.ac.cn



CONTENTS

1. SUMMARY OF TEST REPORT.....	3
1.1. TEST ITEMS.....	3
1.2. TEST STANDARDS	3
1.3. TEST RESULT	3
1.4. TESTING LOCATION	3
1.5. PROJECT DATA	3
1.6. SIGNATURE	3
2. CLIENT INFORMATION.....	4
2.1. APPLICANT INFORMATION	4
2.2. MANUFACTURER INFORMATION	4
3. EQUIPMENT UNDER TEST (EUT) AND ANCILLARY EQUIPMENT (AE)	5
3.1. ABOUT EUT	5
3.2. INTERNAL IDENTIFICATION OF EUT USED DURING THE TEST	5
3.3. INTERNAL IDENTIFICATION OF AE USED DURING THE TEST	5
3.4. GENERAL DESCRIPTION.....	6
3.5. EUT SET-UPS.....	6
4. REFERENCE DOCUMENTS	7
4.1. DOCUMENTS SUPPLIED BY APPLICANT	7
4.2. REFERENCE DOCUMENTS FOR TESTING.....	7
5. TEST RESULTS	8
5.1. TESTING ENVIRONMENT.....	8
5.2. TEST RESULTS	8
5.3. STATEMENTS.....	8
6. TEST EQUIPMENTS UTILIZED	9
7. LABORATORY ENVIRONMENT.....	10
ANNEX A: MEASUREMENT RESULTS.....	11
A.1. ELECTRIC FIELD STRENGTH OF FUNDAMENTAL AND OUTSIDE THE ALLOCATED BANDS.....	11
A.2. ELECTRIC FIELD RADIATED EMISSIONS (<30MHz)	13
A.3. ELECTRIC FIELD RADIATED EMISSIONS (\geq 30MHz).....	15
A.4. FREQUENCY TOLERANCE.....	18
A.5. 20dB BANDWIDTH.....	20
A.6. CONDUCTED EMISSION	22



1. Summary of Test Report

1.1. Test Items

Description	Multi-band GSM/WCDMA/LTE phone with Bluetooth, WLAN
Model Name	TA-1343
Applicant's name	HMD Global Oy
Manufacturer's Name	HMD Global Oy

1.2. Test Standards

FCC Part15-2019; ANSI C63.10-2013; ANSI C63.4-2014

1.3. Test Result

Pass

Please refer to "5.2. Test Results"

1.4. Testing Location

Address: Building G, Shenzhen International Innovation Center, No.1006 Shennan Road, Futian District, Shenzhen, Guangdong, P. R. China

1.5. Project data

Testing Start Date:	2020-12-11
Testing End Date:	2021-01-29

1.6. Signature

Lin Zechuang
(Prepared this test report)

Tang Weisheng
(Reviewed this test report)

Zhang Bojun
(Approved this test report)



2. Client Information

2.1. Applicant Information

Company Name: HMD Global Oy
Address/Post: Bertel Jungin aukio 902600 Espoo, Finland
Contact: Rosario Casillo
Email: Rosario.Casillo@hmdglobal.com
Tel.: /
Fax: /

2.2. Manufacturer Information

Company Name: HMD Global Oy
Address/Post: Bertel Jungin aukio 902600 Espoo, Finland
Contact: Rosario Casillo
Email: Rosario.Casillo@hmdglobal.com
Tel.: /
Fax: /



3. Equipment Under Test (EUT) and Ancillary Equipment (AE)

3.1. About EUT

Description	Multi-band GSM/WCDMA/LTE phone with Bluetooth, WLAN
Model Name	TA-1343
Frequency	13.56MHz
Antenna type	Integrated antenna
Extreme Temperature	-10°C/+45°C
Operation Voltage	3.6VDC to 4.4VDC (nominal: 3.85VDC)
Power source	Battery
FCC ID	2AJOTTA-1343
Condition of EUT as received	No abnormality in appearance

Note1: According to the customer's description, TA-1343 is a variant of TA-1347. The difference between them is that the TA-1343 supports dual SIM, while the TA-1347 only supports single SIM. This difference does not affect the following test cases. All results were from the initial model. The initial model report number is I20N03261-NFC.

Note2: Components list, please refer to documents of the manufacturer; it is also included in the original test record of Shenzhen Academy of Information and Communications Technology.

3.2. Internal Identification of EUT used during the test

EUT ID*	IMEI	HW Version	SW Version	Receive Date
UT04aa	359358480000005	99652_1_11	000T_0_060	2020-12-11
UT21aa	359358480002699	99652_1_11	000T_0_060	2021-01-03
UT16aa	359358480002236	99652_1_11	000T_0_060	2021-01-03

*EUT ID: is used to identify the test sample in the lab internally.

UT04aa is used for conduction test, UT21aa is used for radiation test, and UT16aa is used for Conducted Emission test.

3.3. Internal Identification of AE used during the test

AE ID*	Description	SN
AE1	Battery	/
AE2	Charger	/
AE3	Data Cable	/
AE4	Headset	/
AE5	Power Supply	/
AE6	NFC Card	/

AE1

Model	WT340
Manufacturer	Guangdong Fenghua New Energy Co.,Ltd
Capacity	4900mAh



Nominal Voltage	3.85V
AE2-1	
Model	PA-US5V2A-036
Manufacturer	Yutong Electronics(Huizhou) Co., Ltd
AE2-2	
Model	CH-21U
Manufacturer	Shenzhen Tianyin Electronics Co., Ltd
AE3-1	
Model	CB-36A
Manufacturer	ShenZhen BRL Technology Co., Ltd
AE3-2	
Model	CB-36A
Manufacturer	Huizhou Washin Electronics co.,LTD
AE4	
Model	HS-34
Manufacturer	New Leader Industry Co.,Ltd

*AE ID: is used to identify the test sample in the lab internally.

3.4. General Description

Equipment under Test (EUT) is a model of Multi-band GSM/WCDMA/LTE phone with Bluetooth, WLAN with integrated antenna and battery.

It consists of normal options: Lithium Battery, Charger, USB Cable and Headset.

Manual and specifications of the EUT were provided to fulfil the test.

Samples undergoing test were selected by the client.

3.5. EUT Set-ups

EUT Set-up No.	Combination of EUT and AE	Remarks
Set. NFC01	EUT+AE5+AE6	NFC RF, TX test
Set. NFC02	EUT+AE5	NFC RF, RX test

CE_test.apk is installed in the EUT which helps to control the NFC signal transmitting.

The Transmit State of NFC: the NFC function is on. The EUT will transmit the NFC data and command continuously during the test.

The Transmit State without modulation: The EUT will transmit the CW signal at the operating frequency.



4. Reference Documents

4.1. Documents supplied by applicant

EUT feature information is supplied by the applicant or manufacturer, which is the basis of testing.

4.2. Reference Documents for testing

The following documents listed in this section are referred for testing.

Reference	Title	Version
CFR 47 Part 15	FCC CFR 47,Part 15,Subpart C	2019
ANSI C63.10	American National Standard of Procedures for Compliance Testing of Unlicensed Wireless Devices	2013
ANSI C63.4	American National Standard for Methods of Measurement of Radio-Noise Emissions from Low-Voltage Electrical and Electronic Equipment in the Range of 9 kHz to 40 GHz.	2014

5. Test Results

5.1. Testing Environment

Normal Temperature: 15~35°C

Relative Humidity: 20~75%

5.2. Test Results

No	Test Cases	Clause in Regulation	Section in This Report	Verdict
1	Electric Field Strength of Fundamental Emissions	CFR 47 § 15.225(a)	A.1	P
2	Electric Field Strength of Outside the Allocated Bands	CFR 47 § 15.225(b) CFR 47 § 15.225(c)		P
3	Electric Field Radiated Emissions	CFR 47 § 15.209	A.2	P
		CFR 47 § 15.225(d)	A.3	P
4	Frequency Tolerance	CFR 47 § 15.225(e)	A.4	P
5	20dB Bandwidth	CFR 47 § 15.215(c)	A.5	P
6	Conducted Emissions	CFR 47 § 15.207	A.6	P
The measurement is carried out according to ANSI C63.10 and ANSI C63.4. See ANNEX A for details.				

5.3. Statements

The test cases listed in Section 5.2 of this report for the EUT specified in Section 3 were performed by SAICT according to the reference documents in Section 4.

The EUT meets all applicable requirements of the regulations and standards in Section 4.2.

This report only deals with the NFC function among the features described in section 3.

6. Test Equipments Utilized

Conducted test system

No.	Equipment	Model	Serial Number	Manufacturer	Calibration Due date	Calibration Period
1	Vector Signal Analyzer	FSV40	100903	Rohde & Schwarz	2021-12-30	1 year
2	DC Power Supply	ZUP60-14	6MY-847Z13 -0001	TDK-Lambda	2021-02-26	1 year

Climate chamber

No.	Equipment	Model	Serial Number	Manufacturer	Calibration Due date	Calibration Period
1	Climate chamber	SU-242	93008165	ESPEC	2021-03-25	1 year

Radiated emission test system

No.	Equipment	Model	Serial Number	Manufacturer	Calibration Due date	Calibration Period
1	Test Receiver	ESR7	101676	Rohde & Schwarz	2021-11-25	1 year
2	BiLog Antenna	3142E	00224831	ETS-Lindgren	2021-05-17	3 years
3	Loop Antenna	HLA6120	35779	TESEQ	2022-04-25	3 years
4	Chamber	FACT3-2.0	1285	ETS-Lindgren	2021-07-19	2 years
5	Software	EMC32	V10.01.00	Rohde & Schwarz	/	/

7. Laboratory Environment

Semi-anechoic chambe

Temperature	Min. = 15 °C, Max. = 35 °C
Relative humidity	Min. = 20 %, Max. = 75 %
Shielding effectiveness	0.014MHz-1MHz> 60 dB; 1MHz-18000MHz>90 dB
Electrical insulation	> 2MΩ
Ground system resistance	< 4 Ω
Normalised site attenuation (NSA)	< ±4 dB, 3 m distance, from 30 to 1000 MHz

Shielded room

Temperature	Min. = 15 °C, Max. = 35 °C
Relative humidity	Min. = 20 %, Max. = 75 %
Shielding effectiveness	0.014MHz-1MHz> 60 dB; 1MHz-1000MHz>90 dB
Electrical insulation	> 2MΩ
Ground system resistance	< 4 Ω

Fully-anechoic chamber

Temperature	Min. = 15 °C, Max. = 35 °C
Relative humidity	Min. = 20 %, Max. = 75 %
Shielding effectiveness	0.014MHz-1MHz> 60 dB; 1MHz-18000MHz>90 dB
Electrical insulation	> 2MΩ
Ground system resistance	< 4 Ω
Voltage Standing Wave Ratio (VSWR)	≤ 6 dB, from 1 to 18 GHz, 3 m distance
Uniformity of field strength	Between 0 and 6 dB, from 80 to 6000 MHz

ANNEX A: MEASUREMENT RESULTS

A.1. Electric Field Strength of Fundamental and Outside the Allocated bands

A.1.1. Reference

See CFR 47 § 15.225

A.1.2. Measurement Methods

The transmitter carrier output levels (E-Field) from the EUT are measured in a semi-anechoic chamber. The EUT is placed on a non-conductive stand of 80cm high, and at a measurement distance of 3m from the receiving antenna. The center of the receiving loop antenna is 1.0 meter above the ground. The E-field is measured with a shielded loop antenna connected to a measurement receiver. Detected E-field was maximized by rotating the EUT through 360° and adjusting the receiving antenna polarizations. The maximization processes were repeated with the EUT positioned respectively in its three orthogonal axes. The measurements were performed with the peak detector and if required, the quasi-peak detector.

The measurement bandwidth is:

Frequency of Emission (MHz)	RBW/VBW
12.56-14.56	10/30 kHz

The E-field measured at 3m is calculated as:

$$E\text{-field (dB}\mu\text{V/m)} = Rx \text{ (dB}\mu\text{V)} + \text{Cable Loss (dB)} + AF@3m \text{ (dB/m)}$$

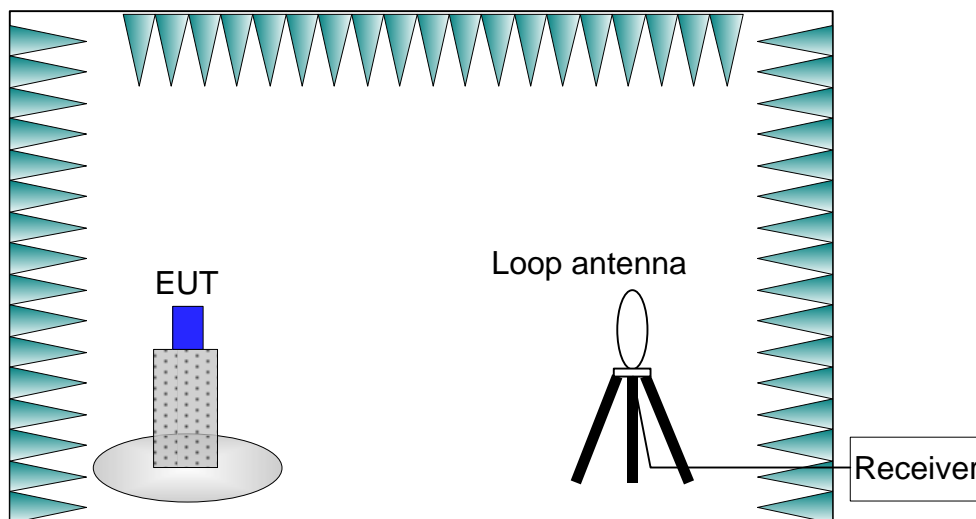

A.1.3. EUT Operating Mode and Test Conditions

The measurement of EUT is carried out under the transmit state of NFC (See 3.5).

The EUT is powered by a travel adapter.

During the measurements, the ambient temperature of the electromagnetic anechoic chamber is in the range of 15 ~ 25°C.

A.1.4. Limits

Frequency Range (MHz)	E-field Strength Limit @ 30 m ($\mu\text{V/m}$)	E-field Strength Limit @ 3 m ($\text{dB}\mu\text{V/m}$)
13.560 \pm 0.007	+15,848	124
13.410 to 13.553 13.567 to 13.710	+334	90
13.110 to 13.410 13.710 to 14.010	+106	81

Note: Where the limits have been defined at one distance, and a signal level measured at another, the limits have been extrapolated using the following formula:
 Extrapolation (dB) = 40 * log₁₀(Measurement Distance / Specification Distance)

A.1.5. Measurement Results

Measurement results of normal conditions see Figure A-1 for different set-ups of EUT. The result displayed take into account applicable antenna factors and cable losses.

Conclusions: PASS.

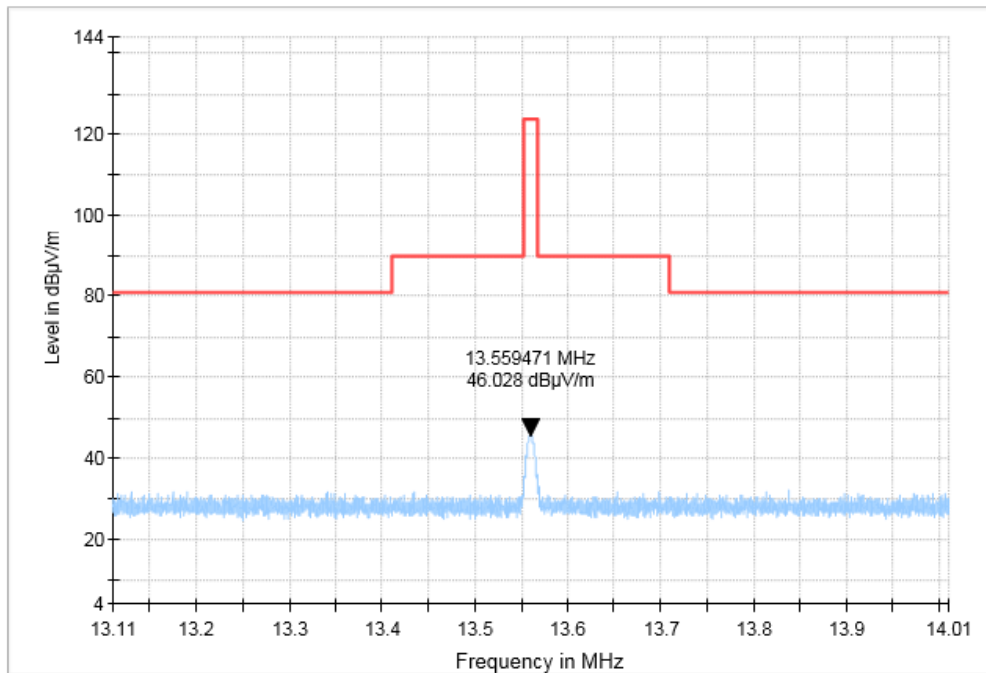

Figure A-1 Electric Field Strength

A.1.6. Measurement Uncertainty

Measurement uncertainty: $U = 1.74$ dB, $k=2$.

A.2. Electric Field Radiated Emissions (<30MHz)

A.2.1. Reference

See CFR 47 § 15.209

See CFR 47 § 15.225(d)

A.2.2. Measurement Methods

The transmitter carrier output levels (E-Field) from the EUT are measured in a semi-anechoic chamber. The EUT is placed on a non-conductive stand of 80cm high, and at a measurement distance of 3m from the receiving antenna. The center of the receiving loop antenna is 1.0 meter above the ground. The E-field is measured with a shielded loop antenna connected to a measurement receiver. Detected E-field was maximized by rotating the EUT through 360° and adjusting the receiving antenna polarizations. The maximization processes were repeated with the EUT positioned respectively in its three orthogonal axes. The measurements were performed with the peak detector and if required, the quasi-peak detector.

The measurement bandwidth is:

Frequency of Emission (MHz)	RBW/VBW
0.009-0.15	100/300 Hz
0.15-30	10/30 kHz

The E-field measured at 3m is calculated as:

$$\text{E-field (dB}\mu\text{V/m)} = \text{Rx (dB}\mu\text{V)} + \text{Cable Loss (dB)} + \text{AF@3m (dB/m)}$$

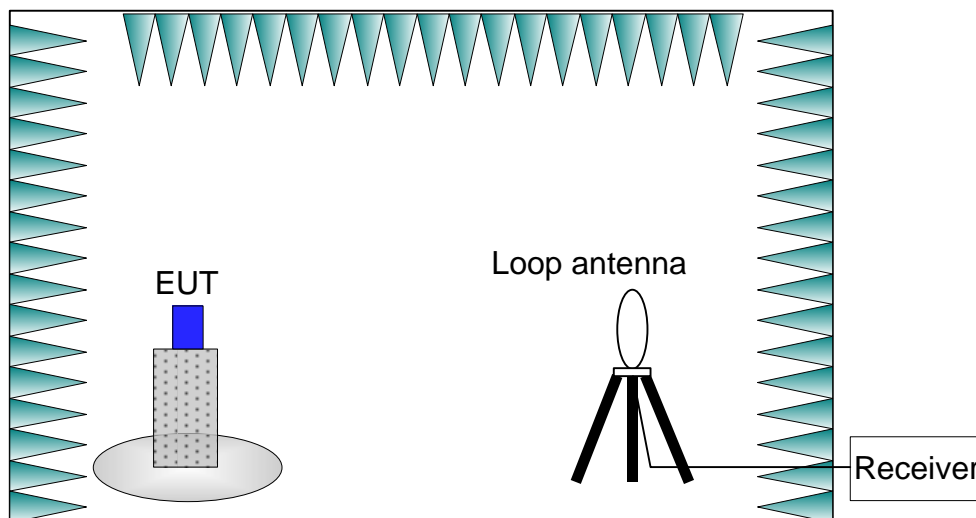

A.2.3. EUT Operating Mode and Test Conditions

The measurement of EUT is carried out under the transmit state of NFC (See 3.5).

The EUT is powered by a travel adapter.

During the measurements, the ambient temperature of the electromagnetic anechoic chamber is

in the range of 15 ~ 25°C.

A.2.4. Limits

Frequency Range (MHz)	E-field Strength Limit @ 30m (mV/m)	E-field Strength Limit @ 3m (dBµV/m)
0.009-0.490	2400/F(kHz)	129-94
0.490-1.705	24000/F(kHz)	74-63
1.705-30	30	70

Note: Where the limits have been defined at one distance, and a signal level measured at another, the limits have been extrapolated using the following formula:
 Extrapolation (dB) = 40 * log₁₀(Measurement Distance / Specification Distance)

A.2.5. Measurement Results

Measurement results of normal conditions see Figure A-2 for different set-ups of EUT. The result displayed take into account applicable antenna factors and cable losses.

Conclusions: PASS.

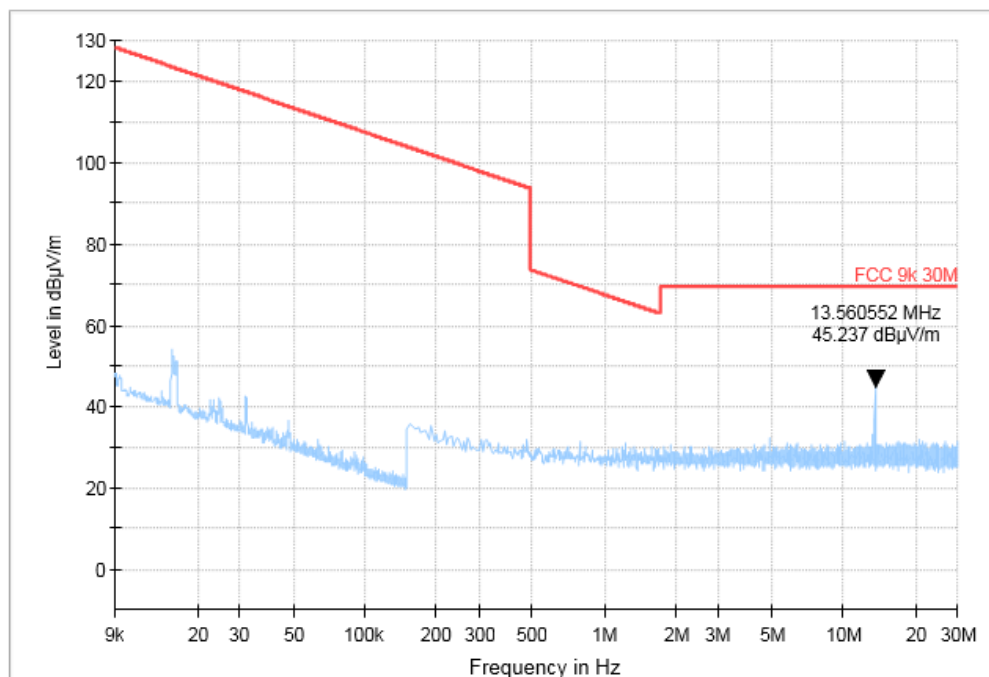

Figure A-2 Transmit State (9k-30M)

A.2.6. Measurement Uncertainty

Measurement uncertainty: $U = 1.74$ dB, $k=2$.

A.3. Electric Field Radiated Emissions ($\geq 30\text{MHz}$)

A.3.1. Reference

See CFR 47 § 15.209

See CFR 47 § 15.225(d)

A.3.2. Measurement Methods

The electric field radiated emissions from the EUT are measured in a semi-anechoic chamber. The EUT is placed on a non-conductive stand of 80cm high, and at a measurement distance of 10m from the receiving antenna. The receiving antennas connected to a measurement receiver comply with the standard requirements. In order to search for maximum field strength emitted from the EUT, the receiving antenna can be moved between the height of 1.0 m to 4.0 m. Detected E-field was maximized at each frequency by rotating the EUT through 360° and adjusting the receiving antenna positions for both vertical and horizontal antenna polarizations. The maximization processes were repeated with the EUT positioned respectively in its three orthogonal axes. The measurements were performed with the peak detector and if required, the quasi-peak detector.

The measurement bandwidth is:

Frequency of Emission (MHz)	RBW/VBW
30-1000	120kHz

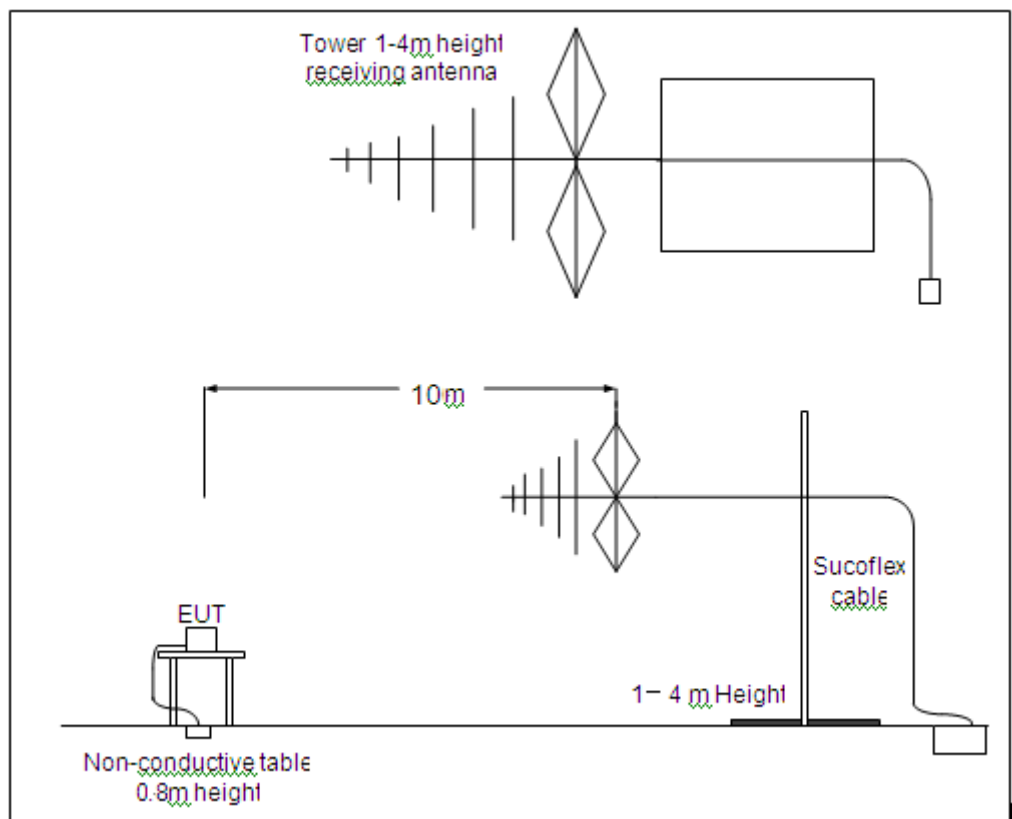

A.3.3. EUT Operating Mode and Test Conditions

The measurement of EUT is carried out under the transmit state of NFC (See 3.5).

EUT had been connected to a travel adapter.

During the measurements, the ambient temperature of the electromagnetic anechoic chamber is in the range of 15 ~ 25°C.

A.3.4. Limits

Frequency Range (MHz)	E-field Strength Limit @ 3m (mV/m)	E-field Strength Limit @ 3m (dB μ V/m)	E-field Strength Limit @ 10m (dB μ V/m)
30-88	100	40	30
88-216	150	43.5	33.5
216-960	200	46	36
960-1000	500	54	44

A.3.5. Measurement Results

Measurement results of normal conditions see Figure A-3 for different set-ups of EUT. The result displayed take into account applicable antenna factors and cable losses.

Conclusions: PASS.

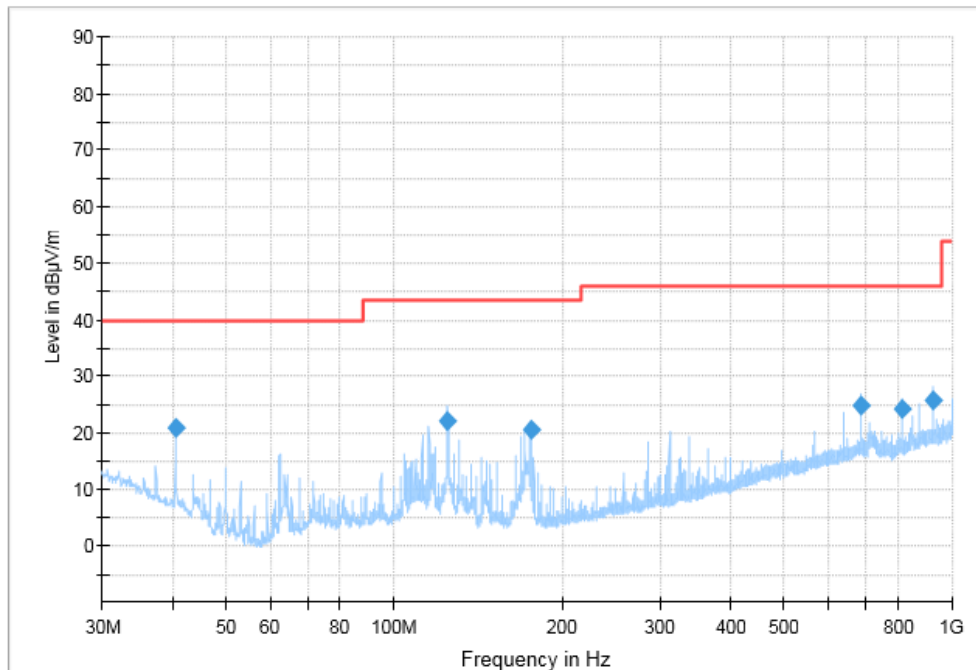

Figure A-3 Transmit State (30M-1G)

**Measurement Results:**

Frequency (MHz)	QuasiPeak (dB μ V/m)	Limit (dB μ V/m)	Margin (dB)	Pol	Corr. (dB/m)
40.690000	20.90	40.00	19.10	V	-29.6
124.986111	22.03	43.50	21.47	V	-31.6
176.274444	20.69	43.50	22.81	H	-31.9
687.532222	24.79	46.00	21.21	V	-19.7
812.514444	24.27	46.00	21.73	V	-18.5
923.012778	25.65	46.00	20.35	H	-16.8

A.3.6. Measurement Uncertainty

Measurement uncertainty: $U=4.84$ dB, $k=2$

A.4. Frequency Tolerance

A.4.1. Reference

See CFR 47 § 15.225(e)

A.4.2. Measurement Methods

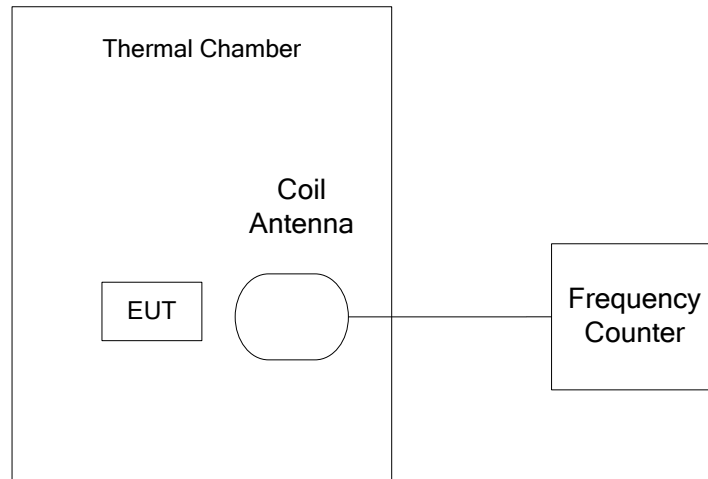

The transmitter output signal was picked up by coil antenna connected to the frequency counter. The center frequency was measured with 30Hz RBW and 1kHz span. During the test, the EUT was placed in a thermal chamber until thermal balance and lasting appropriate time.

A.4.3. EUT Operating Mode and Test Conditions

The measurement of EUT is carried out under the transmit state of without modulation (See 3.5). EUT had been not connected to a travel adapter. Operation Temperature: T min, T nom, and T max with V nom. Operation Voltage: V min and V max with T nom.

A.4.4. Test Layouts

See A.4.2.

A.4.5. Limits

The frequency tolerance of the carrier signal shall be maintained within +/- 0.01% of the operating frequency.

A.4.6. Measurement Results

Measurement results see Table A-1 for different test conditions.

Conclusions: PASS.

**Table A-1: Frequency Stability VS Temperature and Voltage**

Temperature	Voltage	Frequency Error (MHz)			
		Startup	2 Min Later	5 Min Later	10 Min Later
T min	V nom	13.559822	13.559823	13.559822	13.559822
T max	V nom	13.559841	13.559841	13.559840	13.559840
T nom	V nom	13.559802	13.559801	13.559801	13.559801

Temperature	Voltage	Frequency Error (%)			
		Startup	2 Min Later	5 Min Later	10 Min Later
T min	V nom	0.002	0.002	0.002	0.002
T max	V nom	0.002	0.002	0.002	0.002
T nom	V nom	0.002	0.002	0.002	0.002

A.4.7. Measurement UncertaintyMeasurement uncertainty: $U = 77 \text{ Hz}$, $k=2$

A.5. 20dB Bandwidth

A.5.1. Reference

See CFR 47 § 15.215(c)

A.5.2. Measurement Methods

The transmitter output signal was picked up by coil antenna to the spectrum analyzer.

The transmitter output signal was picked up by coil antenna connected to the spectrum analyzer. The bandwidth of the center frequency was measured with 100Hz RBW, 300Hz VBW and 10kHz span.

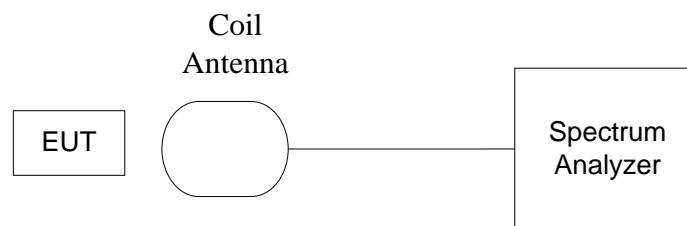

A.5.3. EUT Operating Mode and Test Conditions

The measurement of EUT is carried out under the transmit state of NFC and without modulation (See 3.5).

EUT had been not connected to a travel adapter.

During the measurements, the ambient temperature is in the range of 15 ~ 25°C.

A.5.4. Test Layouts

See A.5.2.

A.5.5. Limits

The 20dB bandwidth shall be less than 80% of the permitted frequency band. For 13.56 MHz NFC, the permitted frequency band is 10 kHz, so the limit is 11.2 kHz.

A.5.6. Measurement Results

Measurement results see Figure A-4.

Conclusions: PASS.

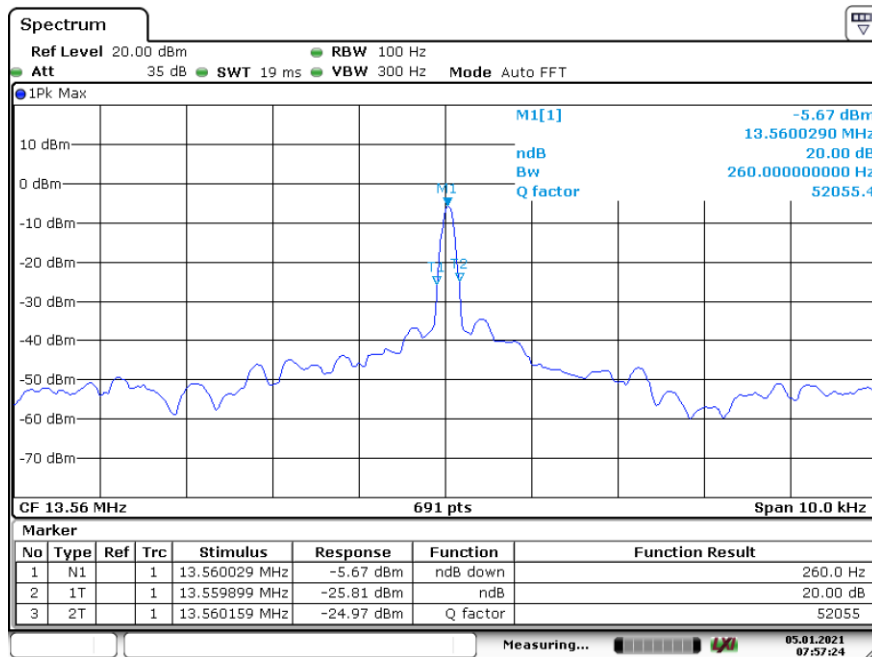

Figure A-4 20dB Bandwidth

A.5.7. Measurement Uncertainty

Measurement uncertainty: $U = 77 \text{ Hz}$, $k=2$

A.6. Conducted emission

A.6.1. Reference

See CFR 47 § 15.207

A.6.2. Measurement Methods

The conducted emissions from the AC port of the EUT are measured in a shielding room. The EUT is connected to a Line Impedance Stabilization Network (LISN). An overview sweep with peak detection was performed. The measurements were performed with a quasi-peak detector and if required, an average detector.

The conducted emission measurements were made with the following detector of the test receiver: Quasi-Peak / Average Detector.

The measurement bandwidth is:

Frequency of Emission (MHz)	RBW/VBW
0.15-30	9kHz

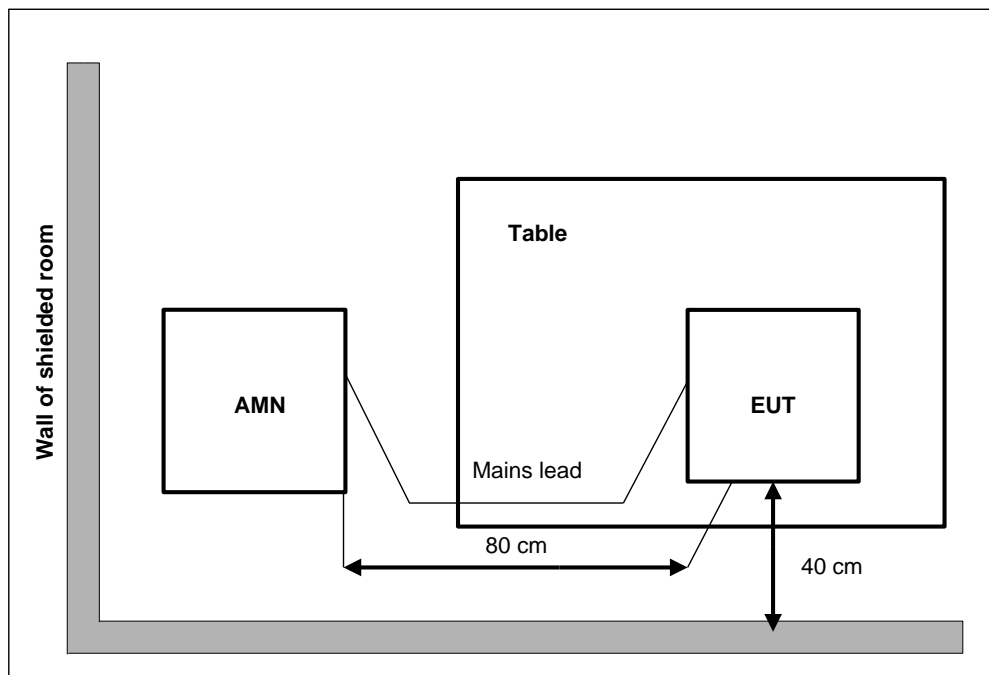

A.6.3. EUT Operating Mode and Test Conditions

The measurement of EUT is carried out under the transmit state of NFC (See 3.5).

The EUT is powered by a travel adapter.

During the measurements, the ambient temperature is in the range of 15 ~ 25°C.

**A.6.4. Limits**

Frequency range(MHz)	Quasi-peak Limit (dB μ V)	Average Limit (dB μ V)
0.15 to 0.5	66 to 56	56 to 46
0.5 to 5	56	46
5 to 30	60	50

A.6.5. Measurement Results

Measurement results see Figure A-5, Figure A-6, Figure A-7 and Figure A-8.

Conclusions: PASS.

Note: The measurement result at 13.56MHz is the fundamental emission of NFC signal.

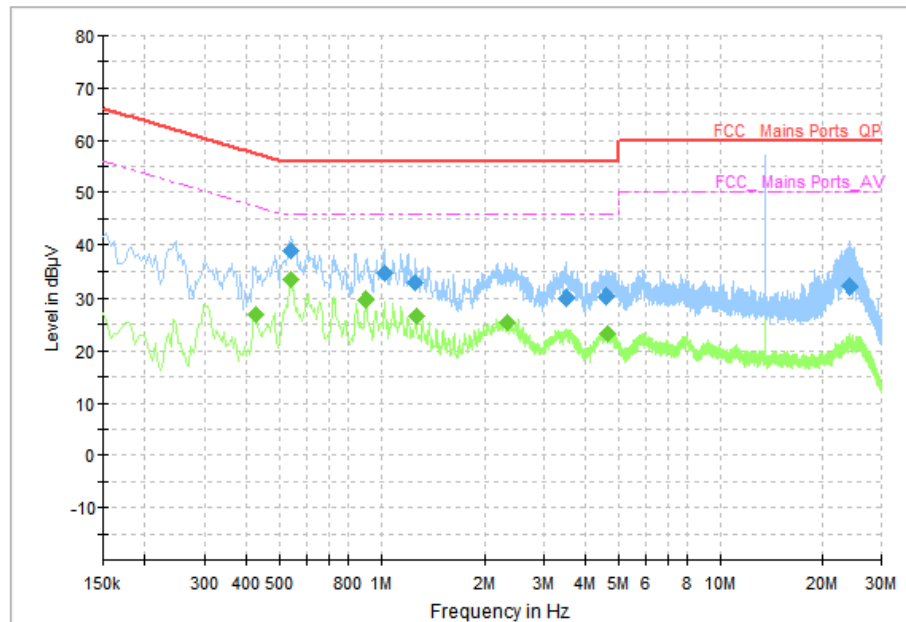

Figure A-5 Conducted Emission (Traffic), LE 1M, A2-1, A3-1

Measurement Results: Quasi Peak

Frequency (MHz)	QuasiPeak (dBµV)	Limit (dBµV)	Margin (dB)	Line	Filter	Corr. (dB)
0.542000	38.78	56.00	17.22	L1	ON	10
1.022000	34.52	56.00	21.48	L1	ON	10
1.258000	32.63	56.00	23.37	L1	ON	10
3.482000	30.11	56.00	25.89	L1	ON	10
4.586000	30.17	56.00	25.83	L1	ON	10
24.182000	32.06	60.00	27.94	N	ON	10

Measurement Results: Average

Frequency (MHz)	Average (dBµV)	Limit (dBµV)	Margin (dB)	Line	Filter	Corr. (dB)
0.426000	26.82	47.33	20.51	L1	ON	10
0.542000	33.48	46.00	12.52	L1	ON	10
0.902000	29.62	46.00	16.38	L1	ON	10
1.270000	26.70	46.00	19.30	L1	ON	10
2.350000	25.47	46.00	20.53	L1	ON	10
4.614000	23.24	46.00	22.76	L1	ON	10

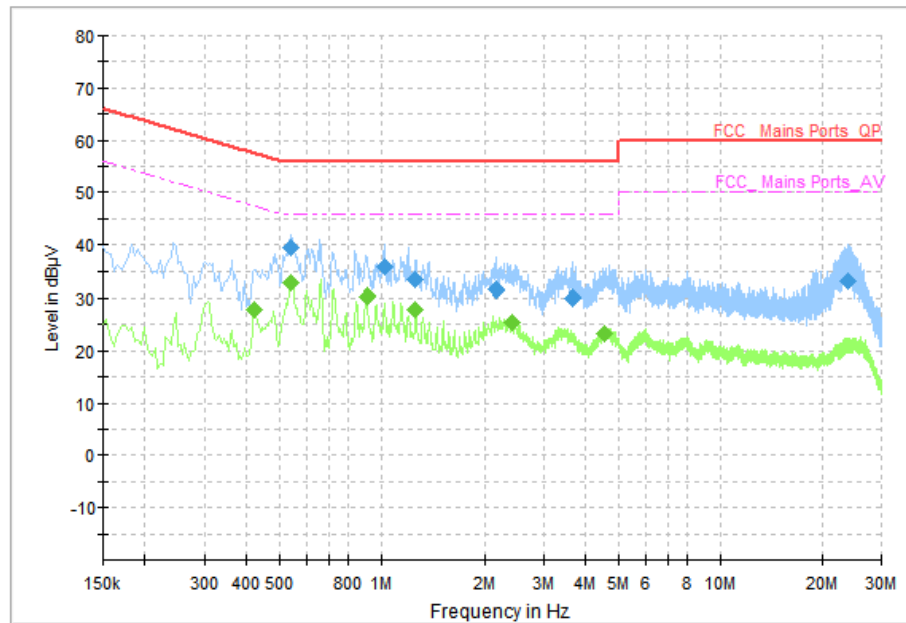

Figure A-6 Conducted Emission (Idle), LE 1M, A2-1, A3-1

Measurement Results: Quasi Peak

Frequency (MHz)	QuasiPeak (dBµV)	Limit (dBµV)	Margin (dB)	Line	Filter	Corr. (dB)
0.542000	39.42	56.00	16.58	L1	ON	10
1.022000	35.91	56.00	20.09	L1	ON	10
1.262000	33.25	56.00	22.75	L1	ON	10
2.162000	31.52	56.00	24.48	L1	ON	10
3.662000	30.02	56.00	25.98	L1	ON	10
23.898000	32.94	60.00	27.06	N	ON	10

Measurement Results: Average

Frequency (MHz)	Average (dBµV)	Limit (dBµV)	Margin (dB)	Line	Filter	Corr. (dB)
0.422000	27.96	47.41	19.45	L1	ON	10
0.538000	32.87	46.00	13.13	L1	ON	10
0.906000	30.19	46.00	15.81	L1	ON	10
1.262000	27.91	46.00	18.09	L1	ON	10
2.414000	25.39	46.00	20.61	L1	ON	10
4.554000	23.17	46.00	22.84	L1	ON	10

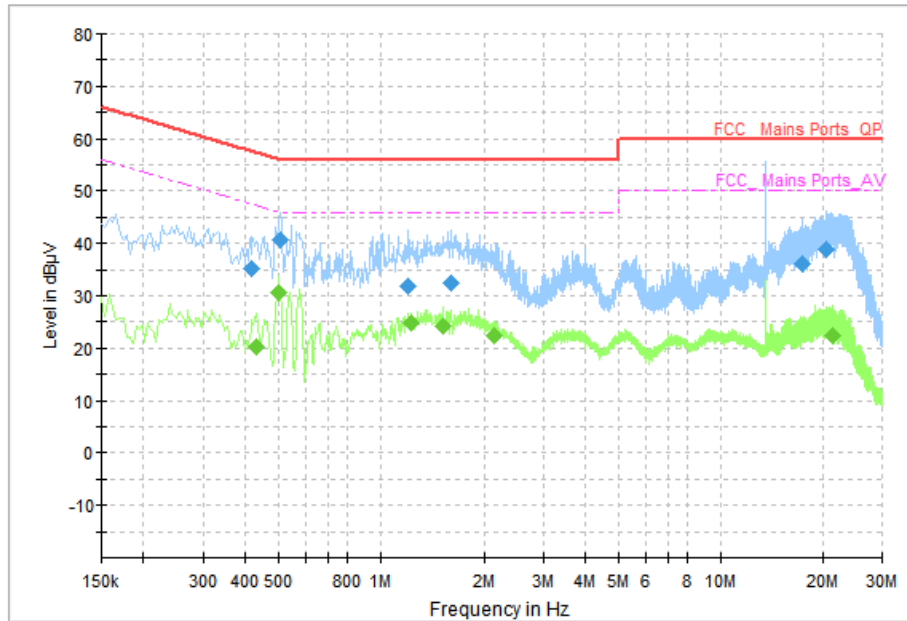

Figure A-7 Conducted Emission (Traffic), LE 1M, A2-2, A3-2

Measurement Results: Quasi Peak

Frequency (MHz)	QuasiPeak (dBµV)	Limit (dBµV)	Margin (dB)	Line	Filter	Corr. (dB)
0.418000	35.13	57.49	22.36	L1	ON	10
0.506000	40.61	56.00	15.39	L1	ON	10
1.210000	31.70	56.00	24.30	L1	ON	10
1.598000	32.42	56.00	23.58	L1	ON	10
17.502000	36.19	60.00	23.81	L1	ON	10
20.518000	38.75	60.00	21.25	L1	ON	10

Measurement Results: Average

Frequency (MHz)	Average (dBµV)	Limit (dBµV)	Margin (dB)	Line	Filter	Corr. (dB)
0.430000	20.25	47.25	27.00	N	ON	10
0.502000	30.66	46.00	15.34	N	ON	10
1.226000	24.72	46.00	21.28	N	ON	10
1.514000	24.21	46.00	21.79	N	ON	10
2.142000	22.28	46.00	23.72	N	ON	10
21.510000	22.32	50.00	27.68	L1	ON	10

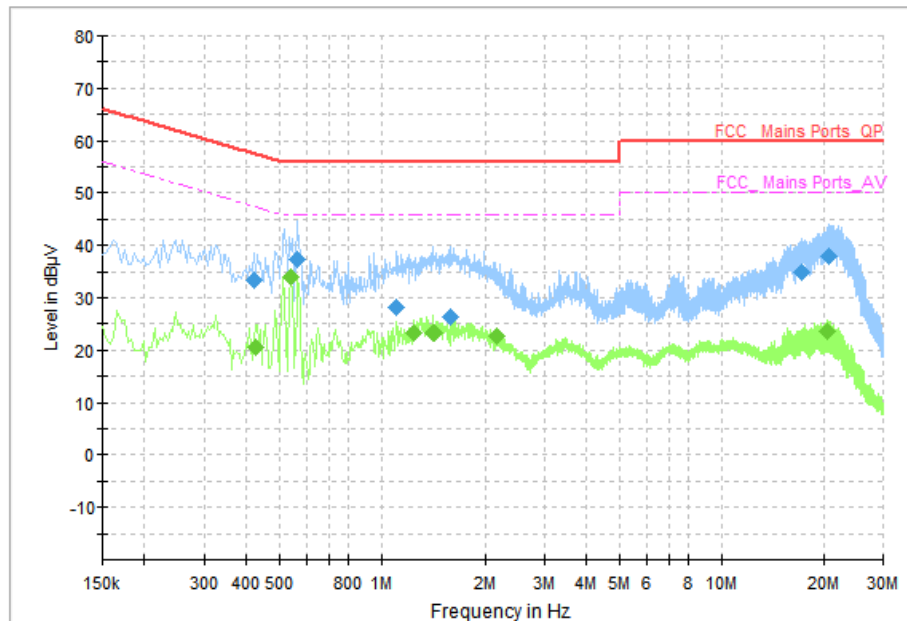

Figure A-8 Conducted Emission (Idle), LE 1M, A2-2, A3-2

Measurement Results: Quasi Peak

Frequency (MHz)	QuasiPeak (dBµV)	Limit (dBµV)	Margin (dB)	Line	Filter	Corr. (dB)
0.422000	33.46	57.41	23.95	L1	ON	10
0.566000	37.28	56.00	18.72	L1	ON	10
1.106000	28.27	56.00	27.73	L1	ON	10
1.578000	26.37	56.00	29.63	L1	ON	10
17.226000	34.89	60.00	25.11	L1	ON	10
20.726000	37.84	60.00	22.16	L1	ON	10

Measurement Results: Average

Frequency (MHz)	Average (dBµV)	Limit (dBµV)	Margin (dB)	Line	Filter	Corr. (dB)
0.426000	20.62	47.33	26.71	N	ON	10
0.538000	33.85	46.00	12.15	N	ON	10
1.242000	23.38	46.00	22.62	N	ON	10
1.422000	23.44	46.00	22.56	N	ON	10
2.170000	22.68	46.00	23.32	N	ON	10
20.530000	23.48	50.00	26.52	L1	ON	10

A.6.6. Measurement Uncertainty

 Measurement uncertainty: $U = 3.0$ dB, $k=2$
*****END OF REPORT*****