

**Calibration Laboratory of
Schmid & Partner
Engineering AG**
Zeughausstrasse 43, 8004 Zurich, Switzerland



S Schweizerischer Kalibrierdienst
S Service suisse d'étalonnage
C Servizio svizzero di taratura
S Swiss Calibration Service

Accredited by the Swiss Accreditation Service (SAS)

The Swiss Accreditation Service is one of the signatories to the EA
Multilateral Agreement for the recognition of calibration certificates

Accreditation No.: SCS 0108

References

- [1] ANSI-C63.19-2011
American National Standard, Methods of Measurement of Compatibility between Wireless Communications
Devices and Hearing Aids.

Methods Applied and Interpretation of Parameters:

- *Coordinate System:* y-axis is in the direction of the dipole arms. z-axis is from the basis of the antenna (mounted on the table) towards its feed point between the two dipole arms. x-axis is normal to the other axes. In coincidence with the standards [1], the measurement planes (probe sensor center) are selected to be at a distance of 15 mm above the top metal edge of the dipole arms.
- *Measurement Conditions:* Further details are available from the hardcopies at the end of the certificate. All figures stated in the certificate are valid at the frequency indicated. The forward power to the dipole connector is set with a calibrated power meter connected and monitored with an auxiliary power meter connected to a directional coupler. While the dipole under test is connected, the forward power is adjusted to the same level.
- *Antenna Positioning:* The dipole is mounted on a HAC Test Arch phantom using the matching dipole positioner with the arms horizontal and the feeding cable coming from the floor. The measurements are performed in a shielded room with absorbers around the setup to reduce the reflections. It is verified before the mounting of the dipole under the Test Arch phantom, that its arms are perfectly in a line. It is installed on the HAC dipole positioner with its arms parallel below the dielectric reference wire and able to move elastically in vertical direction without changing its relative position to the top center of the Test Arch phantom. The vertical distance to the probe is adjusted after dipole mounting with a DASY5 Surface Check job. Before the measurement, the distance between phantom surface and probe tip is verified. The proper measurement distance is selected by choosing the matching section of the HAC Test Arch phantom with the proper device reference point (upper surface of the dipole) and the matching grid reference point (tip of the probe) considering the probe sensor offset. The vertical distance to the probe is essential for the accuracy.
- *Feed Point Impedance and Return Loss:* These parameters are measured using a HP 8753E Vector Network Analyzer. The impedance is specified at the SMA connector of the dipole. The influence of reflections was eliminating by applying the averaging function while moving the dipole in the air, at least 70cm away from any obstacles.
- *E-field distribution:* E field is measured in the x-y-plane with an isotropic ER3D-field probe with 100 mW forward power to the antenna feed point. In accordance with [1], the scan area is 20mm wide, its length exceeds the dipole arm length (180 or 90mm). The sensor center is 15 mm (in z) above the metal top of the dipole arms. Two 3D maxima are available near the end of the dipole arms. Assuming the dipole arms are perfectly in one line, the average of these two maxima (in subgrid 2 and subgrid 8) is determined to compensate for any non-parallelity to the measurement plane as well as the sensor displacement. The E-field value stated as calibration value represents the maximum of the interpolated 3D-E-field, in the plane above the dipole surface.

The reported uncertainty of measurement is stated as the standard uncertainty of measurement multiplied by the coverage factor $k=2$, which for a normal distribution corresponds to a coverage probability of approximately 95%.

Measurement Conditions

DASY system configuration, as far as not given on page 1.

DASY Version	DASY5	V52.10.1
Phantom	HAC Test Arch	
Distance Dipole Top - Probe Center	15 mm	
Scan resolution	dx, dy = 5 mm	
Frequency	1880 MHz ± 1 MHz	
Input power drift	< 0.05 dB	

Maximum Field values at 1880 MHz

E-field 15 mm above dipole surface	condition	Interpolated maximum
Maximum measured above high end	100 mW input power	89.8 V/m = 39.06 dBV/m
Maximum measured above low end	100 mW input power	89.3 V/m = 39.02 dBV/m
Averaged maximum above arm	100 mW input power	89.5 V/m ± 12.8 % (k=2)

Appendix (Additional assessments outside the scope of SCS 0108)

Antenna Parameters

Frequency	Return Loss	Impedance
1730 MHz	23.9 dB	53.9 Ω + 5.4 jΩ
1880 MHz	22.5 dB	54.7 Ω + 6.3 jΩ
1900 MHz	23.4 dB	55.6 Ω + 4.5 jΩ
1950 MHz	30.3 dB	52.9 Ω - 1.3 jΩ
2000 MHz	21.3 dB	44.2 Ω + 5.7 jΩ

3.2 Antenna Design and Handling

The calibration dipole has a symmetric geometry with a built-in two stub matching network, which leads to the enhanced bandwidth.

The dipole is built of standard semirigid coaxial cable. The internal matching line is open ended. The antenna is therefore open for DC signals.

Do not apply force to dipole arms, as they are liable to bend. The soldered connections near the feedpoint may be damaged. After excessive mechanical stress or overheating, check the impedance characteristics to ensure that the internal matching network is not affected.

After long term use with 40W radiated power, only a slight warming of the dipole near the feedpoint can be measured.

Impedance Measurement Plot

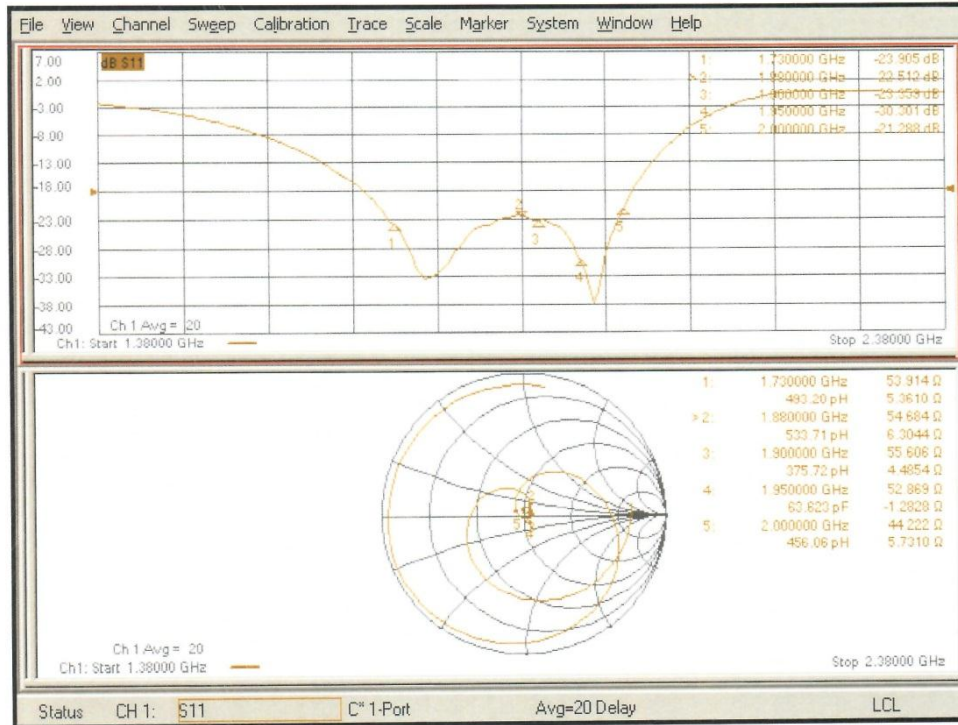

DASY5 E-field Result

Date: 19.07.2018

Test Laboratory: SPEAG Lab2

DUT: HAC Dipole 1880 MHz; Type: CD1880V3; Serial: CD1880V3 - SN: 1149

Communication System: UID 0 - CW ; Frequency: 1880 MHz
 Medium parameters used: $\sigma = 0$ S/m, $\epsilon_r = 1$; $\rho = 0$ kg/m³
 Phantom section: RF Section
 Measurement Standard: DASY5 (IEEE/IEC/ANSI C63.19-2011)

DASY52 Configuration:

- Probe: EF3DV3 - SN4013; ConvF(1, 1, 1) @ 1880 MHz; Calibrated: 05.03.2018
- Sensor-Surface: (Fix Surface)
- Electronics: DAE4 Sn781; Calibrated: 17.01.2018
- Phantom: HAC Test Arch with AMCC; Type: SD HAC P01 BA; Serial: 1070
- DASY52 52.10.1(1476); SEMCAD X 14.6.11(7439)

Dipole E-Field measurement @ 1880MHz/E-Scan - 1880MHz d=15mm/Hearing Aid Compatibility Test (41x181x1):

Interpolated grid: dx=0.5000 mm, dy=0.5000 mm
 Device Reference Point: 0, 0, -6.3 mm
 Reference Value = 160.1 V/m; Power Drift = -0.04 dB
 Applied MIF = 0.00 dB
 RF audio interference level = 39.06 dBV/m
Emission category: M2

MIF scaled E-field

Grid 1 M2 38.67 dBV/m	Grid 2 M2 39.06 dBV/m	Grid 3 M2 39.01 dBV/m
Grid 4 M2 36 dBV/m	Grid 5 M2 36.15 dBV/m	Grid 6 M2 36.1 dBV/m
Grid 7 M2 38.79 dBV/m	Grid 8 M2 39.02 dBV/m	Grid 9 M2 38.91 dBV/m

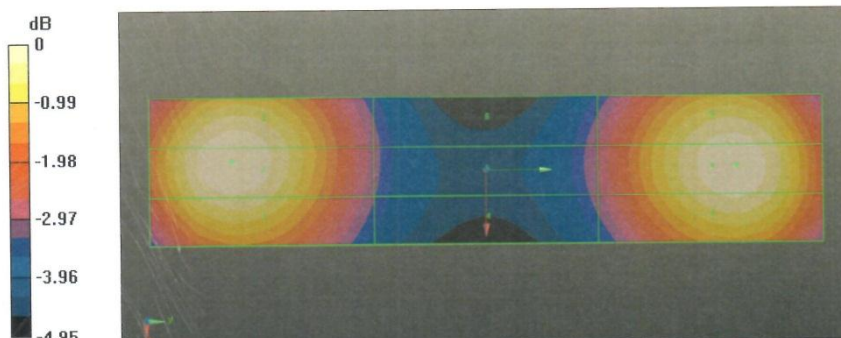

0 dB = 89.78 V/m = 39.06 dBV/m

ANNEX F: UID Specification

**Calibration Laboratory of
Schmid & Partner
Engineering AG**
Zeughausstrasse 43, 8004 Zurich, Switzerland

Name:	GSM-FDD (TDMA, GMSK)
Group:	GSM
UID:	10021-DAC
PAR: ¹	9.39 dB
MIF: ²	3.63 dB
Standard Reference:	ETSI TS 100 909 V8.9.0 (2005-01) FCC OET KDB 941225, D03 and D04 Periodic pulsed modulation
Category:	Periodic pulsed modulation
Modulation:	GMSK
Frequency Band:	GSM 450 (450.4 - 457.6 MHz) GSM 480 (478.8 - 486.0 MHz) GSM 710 (698.0 - 716.0 MHz) GSM 750 (747.0 - 763.0 MHz) GSM 850 (824.0 - 849.0 MHz) P-GSM 900 (890.0 - 915.0 MHz) E-GSM 900 (880.0 - 915.0 MHz) R-GSM 900 (876.0 - 915.0 MHz) DCS 1800 (1710.0 - 1785.0 MHz) PCS 1900 (1850.0 - 1910.0 MHz) ER-GSM 900 (873.0 - 915.0 MHz) Validation band (0.0 - 6000.0 MHz)
Detailed Specification:	Active Slot: TN0 Data: PN9 continuous Frame: composed out of 8 Slots Multiframe: 26th (IDLE) Frame set blank Slottype & -timing: Normal burst for GMSK
Bandwidth:	0.2 MHz
Integration Time:	120.0 ms

¹ PAR (0.1%) in accordance with FCC KDB 971168, Section 6.0 "Measurement of the Peak-to-Average Power Ratio (PAPR)"
² Modulation Interference Factor (MIF) value valid only in conjunction with advanced probe response linearization calibration for the same communication system (same UID and version).

**Calibration Laboratory of
Schmid & Partner
Engineering AG**
Zeughausstrasse 43, 8004 Zurich, Switzerland

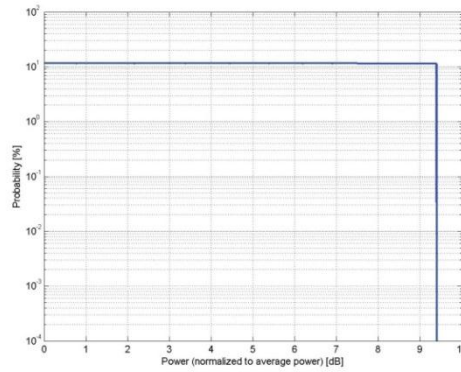

Complementary Cumulative Distribution Function (CCDF)

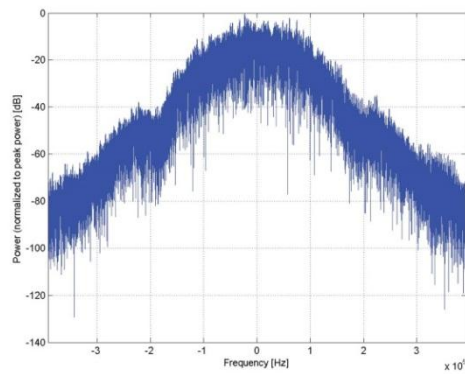

Frequency Domain

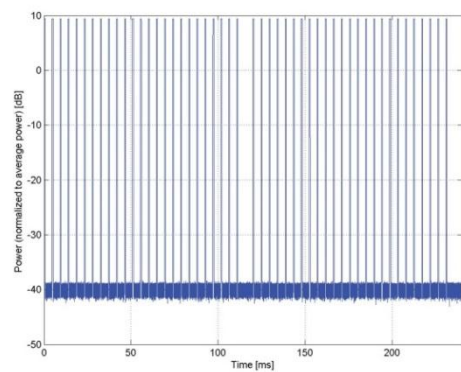

Time Domain

**Calibration Laboratory of
Schmid & Partner
Engineering AG
Zeughausstrasse 43, 8004 Zurich, Switzerland**

Name:	UMTS-FDD (WCDMA)
Group:	WCDMA
UID:	10011-CAB
PAR: ¹	2.91 dB
MIF: ²	-27.23 dB
Standard Reference:	3GPP TS 25.141 Annex A
Category:	FCC OET KDB 941225 D01 SAR test for 3G devices v02
Modulation:	Random amplitude modulation
Frequency Band:	QPSK
	Band 1, UTRA/FDD (1920.0-1980.0 MHz, 20000)
	Band 2, UTRA/FDD (1850.0-1910.0 MHz, 20001)
	Band 3, UTRA/FDD (1710.0-1785.0 MHz, 20002)
	Band 4, UTRA/FDD (1710.0-1755.0 MHz, 20003)
	Band 5, UTRA/FDD (824.0-849.0 MHz, 20004)
	Band 6, UTRA/FDD (830.0-840.0 MHz, 20005)
	Band 7, UTRA/FDD (2500.0-2570.0 MHz, 20006)
	Band 8, UTRA/FDD (880.0-915.0 MHz, 20007)
	Band 9, UTRA/FDD (1749.9-1784.9 MHz, 20008)
	Band 10, UTRA/FDD (1710.0-1770.0 MHz, 20009)
	Band 11, UTRA/FDD (1427.9-1452.9 MHz, 20010)
	Band 12, UTRA/FDD (698.0-716.0 MHz, 20011)
	Band 13, UTRA/FDD (777.0-787.0 MHz, 20012)
	Band 14, UTRA/FDD (788.0-798.0 MHz, 20013)
	Band 19, UTRA/FDD (830.0-845.0 MHz, 20130)
	Band 20, UTRA/FDD (832.0-862.0 MHz, 20131)
	Band 21, UTRA/FDD (1447.9-1462.9 MHz, 20132)
	Band 22, UTRA/FDD (3410.0-3490.0 MHz, 20217)
	Band 25, UTRA/FDD (1850.0-1915.0 MHz, 20218)
	Band 26, UTRA/FDD (814.0-849.0 MHz, 20219)
Detailed Specification:	Dedicated Channel Type: RMC
	Bitrate: 12.2 kbps
	DPDCH: 60 kbps
	DPCCH: 15 kbps
	DPCCH/DPDCH power ratio: -5.46 dB
Bandwidth:	5.0 MHz
Integration Time:	100.0 ms

¹ PAR (0.1%) in accordance with FCC KDB 971168, Section 6.0 "Measurement of the Peak-to-Average Power Ratio (PAPR)"
² Modulation Interference Factor (MIF) value valid only in conjunction with advanced probe response linearization calibration for the same communication system (same UID and version).

**Calibration Laboratory of
Schmid & Partner
Engineering AG**
Zeughausstrasse 43, 8004 Zurich, Switzerland

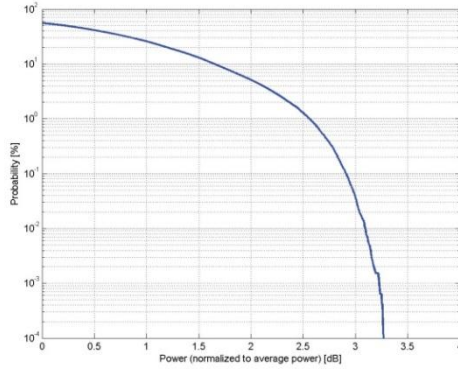

Complementary Cumulative Distribution Function (CCDF)

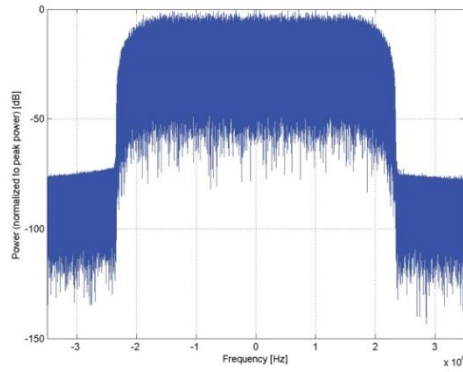

Frequency Domain

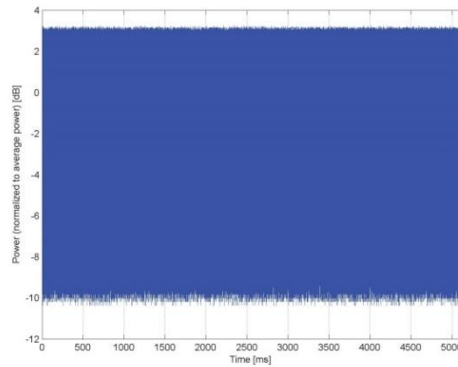

Time Domain

**Calibration Laboratory of
Schmid & Partner
Engineering AG**
Zeughausstrasse 43, 8004 Zurich, Switzerland

Name:	LTE-FDD (SC-FDMA, 1 RB, 10 MHz, 16-QAM)
Group:	LTE-FDD
UID:	10176-CAE
PAR: ¹	6.52 dB
MIF: ²	-9.76 dB
Standard Reference:	3GPP / ETSI TS 136.101 V8.4.0 3GPP / ETSI TS 136.213 V8.4.0 FCC OET KDB 941225 D05 SAR for LTE Devices v01 Random amplitude modulation
Category:	16-QAM
Modulation:	
Frequency Band:	Band 1, E-UTRA/FDD (1920.0 - 1980.0 MHz) Band 2, E-UTRA/FDD (1850.0 - 1910.0 MHz) Band 3, E-UTRA/FDD (1710.0 - 1785.0 MHz) Band 4, E-UTRA/FDD (1710.0 - 1755.0 MHz) Band 5, E-UTRA/FDD (824.0 - 849.0 MHz) Band 6, E-UTRA/FDD (830.0 - 840.0 MHz) Band 7, E-UTRA/FDD (2500.0 - 2570.0 MHz) Band 8, E-UTRA/FDD (880.0 - 915.0 MHz) Band 9, E-UTRA/FDD (1749.9 - 1784.9 MHz) Band 10, E-UTRA/FDD (1710.0 - 1770.0 MHz) Band 11, E-UTRA/FDD (1427.9 - 1447.9 MHz) Band 12, E-UTRA/FDD (699.0 - 716.0 MHz) Band 13, E-UTRA/FDD (777.0 - 787.0 MHz) Band 14, E-UTRA/FDD (788.0 - 798.0 MHz) Band 17, E-UTRA/FDD (704.0 - 716.0 MHz) Band 18, E-UTRA/FDD (815.0 - 830.0 MHz) Band 19, E-UTRA/FDD (830.0 - 845.0 MHz) Band 20, E-UTRA/FDD (832.0 - 862.0 MHz) Band 21, E-UTRA/FDD (1447.9 - 1462.9 MHz) Band 22, E-UTRA/FDD (3410.0 - 3490.0 MHz) Band 23, E-UTRA/FDD (2000.0 - 2020.0 MHz) Band 24, E-UTRA/FDD (1626.5 - 1660.5 MHz) Band 25, E-UTRA/FDD (1850.0 - 1915.0 MHz) Band 26 E-UTRA/FDD (814.0 - 849.0 MHz) Band 27 E-UTRA/FDD (807.0 - 824.0 MHz) Band 28 E-UTRA/FDD (703.0 - 748.0 MHz) Band 30, E-UTRA/FDD (2305.0 - 2315.0 MHz) Band 65, E-UTRA/FDD (1920.0 - 2010.0 MHz) Band 66, E-UTRA/FDD (1710.0 - 1780.0 MHz) Band 68, E-UTRA/FDD (698.0 - 728.0 MHz) Band 70, E-UTRA/FDD (1695.0 - 1710.0 MHz) Band 71, E-UTRA/FDD (663.0 - 698.0 MHz) Validation band (0.0 - 6000.0 MHz)
Detailed Specification:	Modulation Scheme: SC-FDMA Number of PUSCHs: 1 Settings for Subframe #0 to #9: Modulation Scheme: QPSK Data Type: UL-SCH Number RB: 1 Transport Block Size: 256 TBS Index: 14 MCS Index: 15 Data Type: PN9
Bandwidth:	10.0 MHz
Integration Time:	10.0 ms

¹ PAR (0.1%) in accordance with FCC KDB 971168, Section 6.0 "Measurement of the Peak-to-Average Power Ratio (PAPR)"
² Modulation Interference Factor (MIF) value valid only in conjunction with advanced probe response linearization calibration for the same communication system (same UID and version).

**Calibration Laboratory of
Schmid & Partner
Engineering AG**
Zeughausstrasse 43, 8004 Zurich, Switzerland

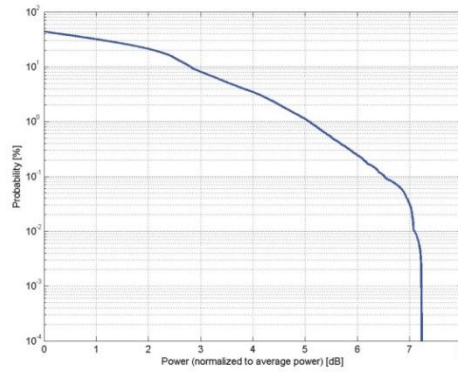

Complementary Cumulative Distribution Function (CCDF)

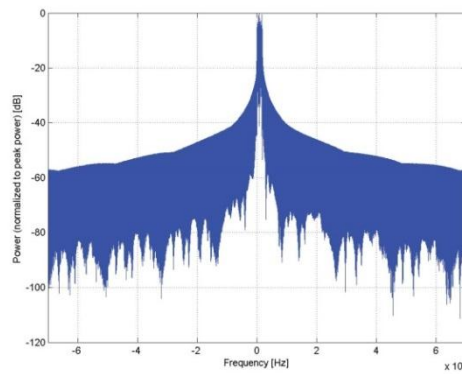

Frequency Domain

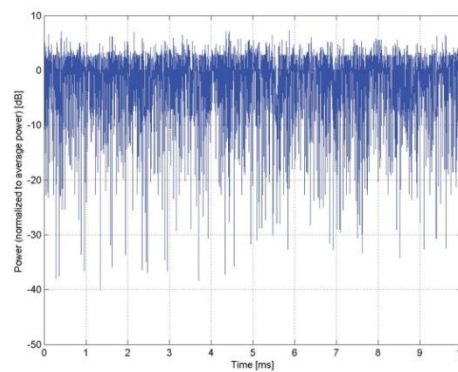

Time Domain



**Calibration Laboratory of
Schmid & Partner
Engineering AG
Zeughausstrasse 43, 8004 Zurich, Switzerland**

Name:	LTE-FDD (SC-FDMA, 1 RB, 20 MHz, 16-QAM)
Group:	LTE-FDD
UID:	10170-CAD
PAR: ¹	6.52 dB
MIF: ²	-9.76 dB
Standard Reference:	3GPP / ETSI TS 136.101 V8.4.0 3GPP / ETSI TS 136.213 V8.4.0 FCC OET KDB 941225 D05 SAR for LTE Devices v01
Category:	Random amplitude modulation
Modulation:	16-QAM
Frequency Band:	Band 1, E-UTRA/FDD (1920.0 - 1980.0 MHz) Band 2, E-UTRA/FDD (1850.0 - 1910.0 MHz) Band 3, E-UTRA/FDD (1710.0 - 1785.0 MHz) Band 4, E-UTRA/FDD (1710.0 - 1755.0 MHz) Band 7, E-UTRA/FDD (2500.0 - 2570.0 MHz) Band 9, E-UTRA/FDD (1749.9 - 1784.9 MHz) Band 10, E-UTRA/FDD (1710.0 - 1770.0 MHz) Band 20, E-UTRA/FDD (832.0 - 862.0 MHz) Band 22, E-UTRA/FDD (3410.0 - 3490.0 MHz) Band 23, E-UTRA/FDD (2000.0 - 2020.0 MHz) Band 25, E-UTRA/FDD (1850.0 - 1915.0 MHz) Band 28 E-UTRA/FDD (703.0 - 748.0 MHz) Band 65, E-UTRA/FDD (1920.0 - 2010.0 MHz) Band 66, E-UTRA/FDD (1710.0 - 1780.0 MHz) Band 70, E-UTRA/FDD (1695.0 - 1710.0 MHz) Band 71, E-UTRA/FDD (663.0 - 698.0 MHz) Validation band (0.0 - 6000.0 MHz)
Detailed Specification:	Modulation Scheme: SC-FDMA Number of PUSCHs: 1 Settings for Subframe #0 to #9: Modulation Scheme: 16QAM Data Type: UL-SCH Number RB: 1 Transport Block Size: 256 TBS Index: 14 MCS Index: 15 Data Type: PN9
Bandwidth:	20.0 MHz
Integration Time:	10.0 ms

¹ PAR (0.1%) in accordance with FCC KDB 971168, Section 6.0 "Measurement of the Peak-to-Average Power Ratio (PAPR)"
² Modulation Interference Factor (MIF) value valid only in conjunction with advanced probe response linearization calibration for the same communication system (same UID and version).

**Calibration Laboratory of
Schmid & Partner
Engineering AG**
Zeughausstrasse 43, 8004 Zurich, Switzerland

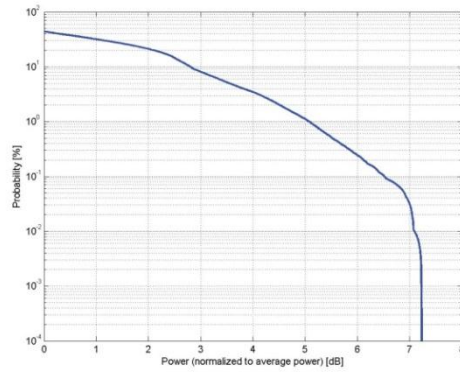

Complementary Cumulative Distribution Function (CCDF)

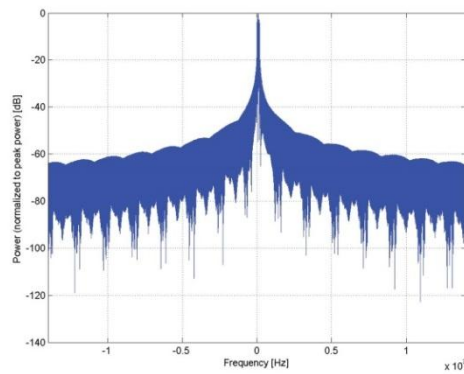

Frequency Domain

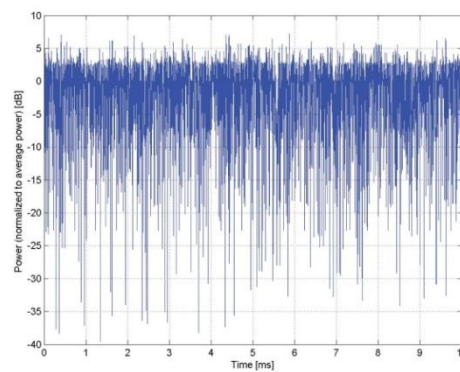

Time Domain



**Calibration Laboratory of
Schmid & Partner
Engineering AG
Zeughausstrasse 43, 8004 Zurich, Switzerland**

Name:	IEEE 802.11b WiFi 2.4 GHz (DSSS, 11 Mbps)
Group:	WLAN
UID:	10061-CAB
PAR: ¹	3.60 dB
MIF: ²	-2.02 dB
Standard Reference:	IEEE 802.11b-1999 , Part 11, FCC SAR meas for 802 11 a b g v01r02 (248227 D01)
Category:	Random amplitude modulation
Modulation:	DQPSK
Frequency Band:	WLAN 2.4GHz (2412.0-2484.0 MHz, 20230)
Detailed Specification:	Data Rate: 11 Mbps Spreading, Coding: CCK PPDU format: Long Preamble & Heading PSDU Length: 1024 PSDU Data: PN9
Bandwidth:	20.0 MHz
Integration Time:	1.5 ms

¹ PAR (0.1%) in accordance with FCC KDB 971168, Section 6.0 "Measurement of the Peak-to-Average Power Ratio (PAPR)"

² Modulation Interference Factor (MIF) value valid only in conjunction with advanced probe response linearization calibration for the same communication system (same UID and version).

**Calibration Laboratory of
Schmid & Partner
Engineering AG**
Zeughausstrasse 43, 8004 Zurich, Switzerland

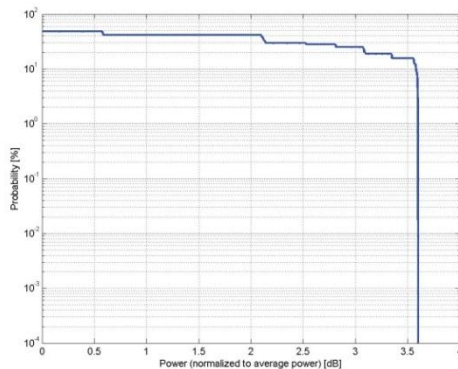

Complementary Cumulative Distribution Function (CCDF)

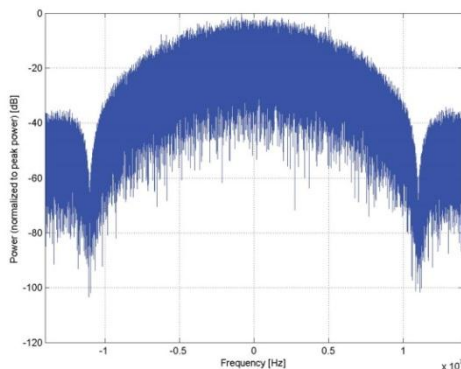

Frequency Domain

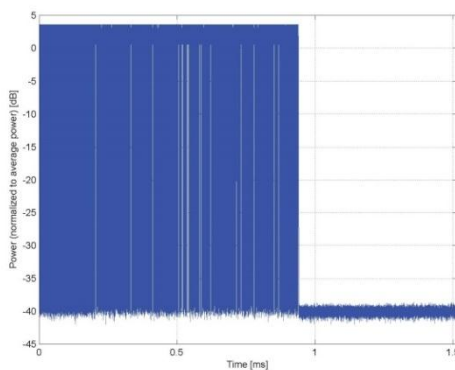

Time Domain

ANNEX G: Spot Check Test

As the test lab for TA-1339 from HMD Global Oy, we, Shenzhen Academy of Information and Communications Technology, declare on our sole responsibility that, according to “Justification Letter” provided by applicant, only the Spot check test should be performed. The test results are as below.

G.1. Internal Identification of EUT used during the spot check test

EUT ID*	IMEI	HW Version	SW Version	Receipt Date
UT01aa	357321211569966	V01B	000T_0_513	2022-01-05

G.2. Measurement results

GSM 850 Test Results

Spot check data					Original data
Frequency		Measured Value (dBV/m)	Power Drift (dB)	Category	
MHz	Channel				
848.8	251	35.94	0.01	M4 (see Fig A.1)	35.45
836.6	190	36.55	0.04	M4 (see Fig A.2)	35.86
824.2	128	36.85	0.06	M4 (see Fig A.3)	35.87

G.3. Graph Results for Spot Check

HAC RF E-Field GSM 850 High

Date: 2022-1-16

Electronics: DAE4 Sn786

Medium: Air

Medium parameters used: $\sigma = 0$ S/m, $\epsilon_r = 1$; $\rho = 1000$ kg/m³

Communication System: UID 0, GSM Frequency: 848.8 MHz Duty Cycle: 1:8.3

Probe: ER3DV6 - SN2424; ConvF (1, 1, 1)

E Scan - ER3DV6 - 2011: 15 mm from Probe Center to the Device /Hearing Aid Compatibility

Test (101x101x1): Interpolated grid: dx=0.5000 mm, dy=0.5000 mm

Device Reference Point: 0, 0, -6.3 mm

Reference Value = 51.70 V/m; Power Drift = 0.01 dB

Applied MIF = 3.63 dB

RF audio interference level = 35.94 dBV/m

Emission category: M4

MIF scaled E-field

Grid 1 M4 34.67 dBV/m	Grid 2 M4 35.33 dBV/m	Grid 3 M4 34.87 dBV/m
Grid 4 M4 34.96 dBV/m	Grid 5 M4 35.94 dBV/m	Grid 6 M4 35.69 dBV/m
Grid 7 M4 35.04 dBV/m	Grid 8 M4 36.42 dBV/m	Grid 9 M4 36.13 dBV/m

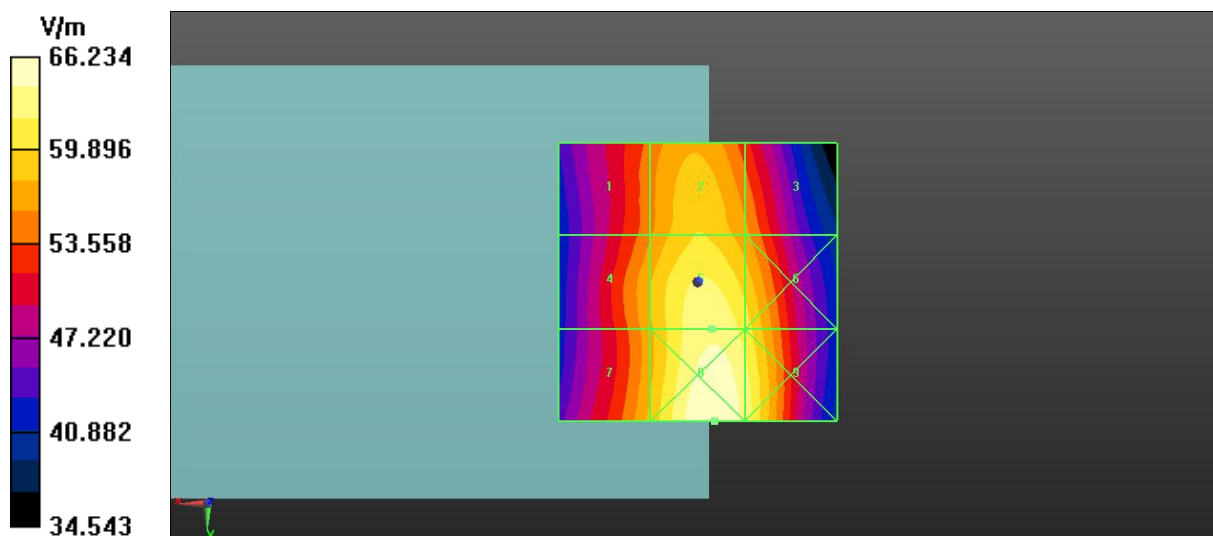

HAC RF E-Field GSM 850 Middle

Date: 2022-1-16

Electronics: DAE4 Sn786

Medium: Air

Medium parameters used: $\sigma = 0$ S/m, $\epsilon_r = 1$; $\rho = 1000$ kg/m³

Communication System: UID 0, GSM Frequency: 836.6 MHz Duty Cycle: 1:8.3

Probe: ER3DV6 - SN2424; ConvF (1, 1, 1)

E Scan - ER3DV6 - 2011: 15 mm from Probe Center to the Device /Hearing Aid Compatibility

Test (101x101x1): Interpolated grid: dx=0.5000 mm, dy=0.5000 mm

Device Reference Point: 0, 0, -6.3 mm

Reference Value = 55.97 V/m; Power Drift = 0.04 dB

Applied MIF = 3.63 dB

RF audio interference level = 36.55 dBV/m

Emission category: M4

MIF scaled E-field

Grid 1 M4 35.36 dBV/m	Grid 2 M4 36.04 dBV/m	Grid 3 M4 35.52 dBV/m
Grid 4 M4 35.73 dBV/m	Grid 5 M4 36.55 dBV/m	Grid 6 M4 36.19 dBV/m
Grid 7 M4 35.82 dBV/m	Grid 8 M4 36.88 dBV/m	Grid 9 M4 36.49 dBV/m

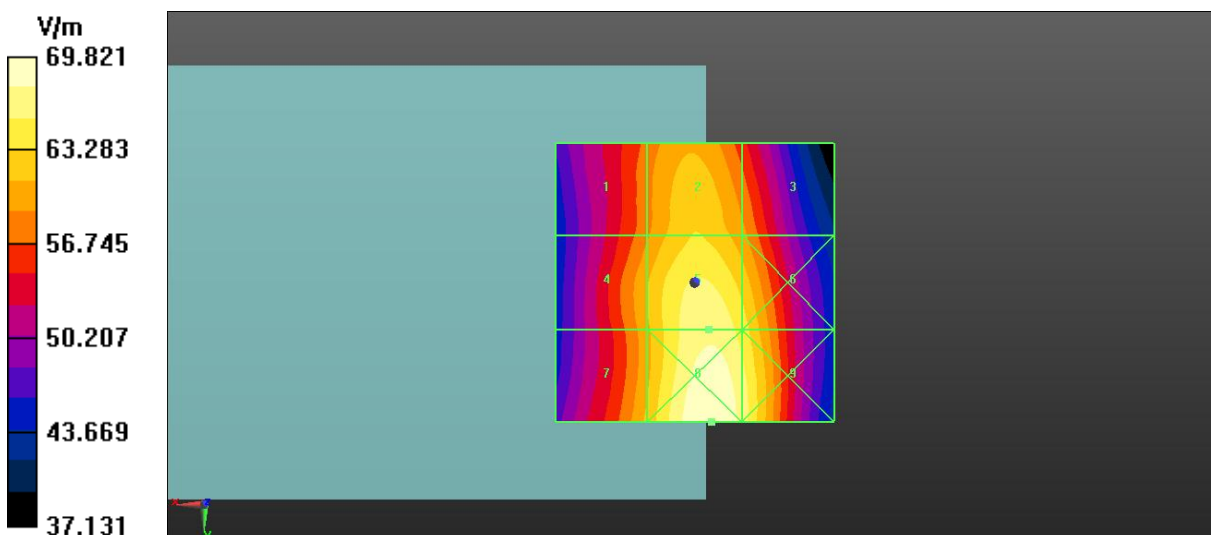

HAC RF E-Field GSM 850 Low

Date: 2022-1-16

Electronics: DAE4 Sn786

Medium: Air

Medium parameters used: $\sigma = 0$ S/m, $\epsilon_r = 1$; $\rho = 1000$ kg/m³

Communication System: UID 0, GSM Frequency: 824.2 MHz Duty Cycle: 1:8.3

Probe: ER3DV6 - SN2424; ConvF (1, 1, 1)

E Scan - ER3DV6 - 2011: 15 mm from Probe Center to the Device /Hearing Aid Compatibility

Test (101x101x1): Interpolated grid: dx=0.5000 mm, dy=0.5000 mm

Device Reference Point: 0, 0, -6.3 mm

Reference Value = 58.62 V/m; Power Drift = 0.06 dB

Applied MIF = 3.63 dB

RF audio interference level = 36.85 dBV/m

Emission category: M4

MIF scaled E-field

Grid 1 M4 35.84 dBV/m	Grid 2 M4 36.49 dBV/m	Grid 3 M4 35.95 dBV/m
Grid 4 M4 36.14 dBV/m	Grid 5 M4 36.85 dBV/m	Grid 6 M4 36.46 dBV/m
Grid 7 M4 36.21 dBV/m	Grid 8 M4 37.08 dBV/m	Grid 9 M4 36.65 dBV/m

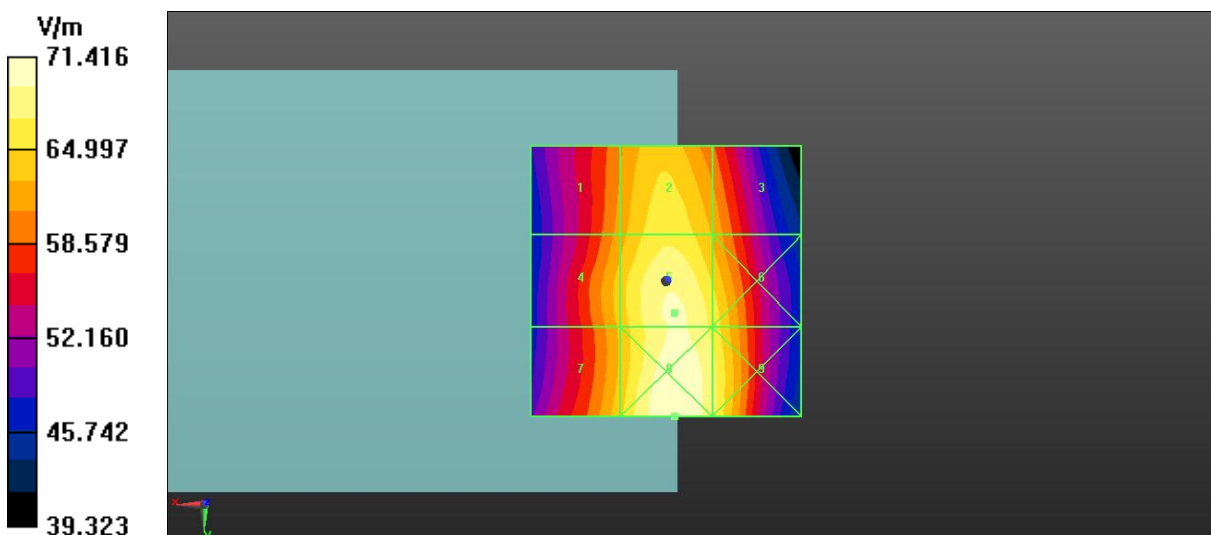

G.4. System Verification Results for Spot Check

835 MHz

Date: 2022-1-16

Electronics: DAE4 Sn786

Medium: Air

Medium parameters used: $\sigma = 0$ mho/m, $\epsilon_r = 1$; $\rho = 1000$ kg/m³

Communication System: CW; Frequency: 835 MHz; Duty Cycle: 1:1

Probe: ER3DV6 - SN2424; ConvF (1, 1, 1)

E Scan - measurement distance from the probe sensor center to CD835 Dipole = 15mm

/Hearing Aid Compatibility Test (41x361x1): Interpolated grid: dx=0.5000 mm, dy=0.5000 mm

Device Reference Point: 0, 0, -6.3 mm

Reference Value = 120.8 V/m; Power Drift = 0.03 dB

Applied MIF = 0.00 dB

RF audio interference level = 43.64 dBV/m

Emission category: M3

MIF scaled E-field

Grid 1 M3 42.98 dBV/m	Grid 2 M3 43.43 dBV/m	Grid 3 M3 43.38 dBV/m
Grid 4 M4 38.57 dBV/m	Grid 5 M4 38.92 dBV/m	Grid 6 M4 38.86 dBV/m
Grid 7 M3 43.09 dBV/m	Grid 8 M3 43.64 dBV/m	Grid 9 M3 43.51 dBV/m

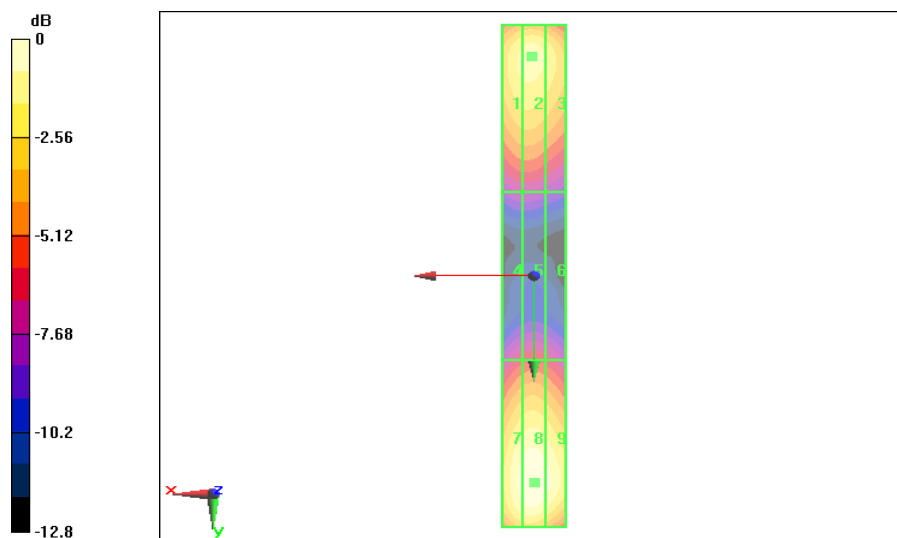

0 dB = 43.64 dBV/m

END OF REPORT