



# TEST REPORT

No.I21N00548-SAR

For

**HMD Global Oy**

**Smart Phone**

**Model Name: TA-1339**

With

**Hardware Version: V01**

**Software Version: 00WW\_0\_070**

**FCC ID: 2AJOTTA-1339**

**Issued Date: 2021-04-08**

**Designation Number: CN1210**

**Note:**

The test results in this test report relate only to the devices specified in this report. This report shall not be reproduced except in full without the written approval of SAICT.

**Test Laboratory:**

**SAICT, Shenzhen Academy of Information and Communications Technology**

Building G, Shenzhen International Innovation Center, No.1006 Shennan Road, Futian District, Shenzhen, Guangdong, P. R. China 518000.

Tel:+86(0)755-33322000, Fax:+86(0)755-33322001

Email: yewu@saict.ac.cn. www.saict.ac.cn



## **REPORT HISTORY**

<b>Report Number</b>	<b>Revision</b>	<b>Description</b>	<b>Issue Date</b>
I21N00548-SAR	Rev.0	1st edition	2021-04-08



## TCONTENTS

<b>1. SUMMARY OF TEST REPORT .....</b>	<b>5</b>
1.1. TEST ITEMS .....	5
1.2. TEST STANDARDS .....	5
1.3. TEST RESULT.....	5
1.4. TESTING LOCATION .....	5
1.5. PROJECT DATA .....	5
1.6. SIGNATURE .....	5
<b>2. STATEMENT OF COMPLIANCE .....</b>	<b>6</b>
<b>3. CLIENT INFORMATION .....</b>	<b>9</b>
3.1. APPLICANT INFORMATION.....	9
3.2. MANUFACTURER INFORMATION .....	9
<b>4. EQUIPMENT UNDER TEST (EUT) AND ANCILLARY EQUIPMENT (AE) .....</b>	<b>10</b>
4.1. ABOUT EUT .....	10
4.2. INTERNAL IDENTIFICATION OF EUT USED DURING THE TEST .....	11
4.3. INTERNAL IDENTIFICATION OF AE USED DURING THE TEST .....	11
<b>5. TEST METHODOLOGY .....</b>	<b>12</b>
5.1. APPLICABLE LIMIT REGULATIONS.....	12
5.2. APPLICABLE MEASUREMENT STANDARDS .....	12
<b>6. SPECIFIC ABSORPTION RATE (SAR).....</b>	<b>13</b>
6.1. INTRODUCTION.....	13
6.2. SAR DEFINITION.....	13
<b>7. TISSUE SIMULATING LIQUIDS .....</b>	<b>14</b>
7.1. TARGETS FOR TISSUE SIMULATING LIQUID .....	14
7.2. DIELECTRIC PERFORMANCE .....	14
<b>8. SYSTEM VERIFICATION .....</b>	<b>18</b>
8.1. SYSTEM SETUP.....	18
8.2. SYSTEM VERIFICATION .....	19
<b>9. MEASUREMENT PROCEDURES .....</b>	<b>20</b>
9.1. TESTS TO BE PERFORMED.....	20
9.2. GENERAL MEASUREMENT PROCEDURE .....	22
9.3. WCDMA MEASUREMENT PROCEDURES FOR SAR .....	23
9.4. SAR MEASUREMENT FOR LTE.....	24
9.5. BLUETOOTH & WLAN MEASUREMENT PROCEDURES FOR SAR.....	24
9.6. POWER DRIFT.....	25
<b>10. CONDUCTED OUTPUT POWER .....</b>	<b>26</b>



10.1. GSM MEASUREMENT RESULT ..... 26

10.2. WCDMA MEASUREMENT RESULT ..... 28

10.3. LTE MEASUREMENT RESULT ..... 31

10.4. BLUETOOTH AND WLAN MEASUREMENT RESULT ..... 72

**11. SIMULTANEOUS TX SAR CONSIDERATIONS ..... 73**

11.1. INTRODUCTION ..... 73

11.2. TRANSMIT ANTENNA SEPARATION DISTANCES ..... 73

11.3. SAR MEASUREMENT POSITIONS ..... 74

11.4. STANDALONE SAR TEST EXCLUSION CONSIDERATIONS ..... 74

**12. EVALUATION OF SIMULTANEOUS ..... 75**

**13. SUMMARY OF TEST RESULTS ..... 76**

13.1. TESTING ENVIRONMENT ..... 76

13.2. SAR RESULTS ..... 77

13.3. WLAN EVALUATION FOR 2.4G ..... 88

**14. SAR MEASUREMENT VARIABILITY ..... 90**

**15. MEASUREMENT UNCERTAINTY ..... 91**

15.1. MEASUREMENT UNCERTAINTY FOR NORMAL SAR TESTS (300MHZ~3GHZ) ..... 91

**16. MAIN TEST INSTRUMENTS ..... 92**

**ANNEX A: GRAPH RESULTS ..... 93**

**ANNEX B: SYSTEM VERIFICATION RESULTS ..... 117**

**ANNEX C: SAR MEASUREMENT SETUP ..... 123**

**ANNEX D: POSITION OF THE WIRELESS DEVICE IN RELATION TO THE PHANTOM ..... 129**

**ANNEX E: EQUIVALENT MEDIA RECIPES ..... 132**

**ANNEX F: SYSTEM VALIDATION ..... 133**

**ANNEX G: DAE CALIBRATION CERTIFICATE ..... 134**

**ANNEX H: PROBE CALIBRATION CERTIFICATE ..... 137**

**ANNEX I: DIPOLE CALIBRATION CERTIFICATE ..... 147**

**ANNEX J: EXTENDED CALIBRATION SAR DIPOLE ..... 195**



## 1. Summary of Test Report

### 1.1. Test Items

Description: Smart Phone  
Model Name: TA-1339  
Applicant's name: HMD Global Oy  
Manufacturer's Name: HMD Global Oy

### 1.2. Test Standards

ANSI C95.1:1992, IEEE 1528:2013

### 1.3. Test Result

Pass. Please refer to "13. Summary of Test Results"

### 1.4. Testing Location

Address: Building G, Shenzhen International Innovation Center, No.1006 Shennan Road,  
Futian District, Shenzhen, Guangdong, P. R. China

### 1.5. Project Data

Testing Start Date: 2021-03-04

Testing End Date: 2021-03-25

### 1.6. Signature

Li Yongfu

(Prepared this test report)

Zhang Yunzhan

(Reviewed this test report)

Cao Junfei

(Approved this test report)

## 2. Statement of Compliance

The maximum results of Specific Absorption Rate (SAR) found during testing for HMD Global Oy Smart Phone TA-1339 are as follows:

**Table 2.1: Highest Reported SAR for Head (1g)**

Exposure Configuration	Technology Band	Highest Reported SAR 1g(W/Kg)	Equipment Class
Head (Separation Distance 0mm)	GSM850	0.30	PCE
	GSM1900	0.04	
	WCDMA Band 2	0.06	
	WCDMA Band 4	0.26	
	WCDMA Band 5	0.33	
	LTE Band 2	0.10	
	LTE Band 5	0.23	
	LTE Band 7	0.13	
	LTE Band 12	0.07	
	LTE Band 28	0.13	
	LTE Band 66	0.18	
	WLAN 2.4GHz	<b>0.74</b>	DTS

**Table 2.2: Highest Reported SAR for Hotspot (1g)**

Exposure Configuration	Technology Band	Highest Reported SAR 1g(W/Kg)	Equipment Class
Hotspot (Separation Distance 10mm)	GSM850	0.42	PCE
	GSM1900	0.61	
	WCDMA Band 2	1.05	
	WCDMA Band 4	0.43	
	WCDMA Band 5	0.37	
	LTE Band 2	1.12	
	LTE Band 5	0.29	
	LTE Band 7	<b>1.16</b>	
	LTE Band 12	0.15	
	LTE Band 28	0.25	
	LTE Band 66	1.10	
	WLAN 2.4GHz	0.21	DTS

**Table 2.3: Highest Reported SAR for Body-worn (1g)**

Exposure Configuration	Technology Band	Highest Reported SAR 1g(W/Kg)	Equipment Class
Body-worn (Separation Distance 10mm)	GSM850	0.42	PCE
	GSM1900	0.61	
	WCDMA Band 2	1.05	
	WCDMA Band 4	0.43	
	WCDMA Band 5	0.37	
	LTE Band 2	1.12	
	LTE Band 5	0.29	
	LTE Band 7	<b>1.16</b>	
	LTE Band 12	0.15	
	LTE Band 28	0.25	
	LTE Band 66	1.10	
	WLAN2.4GHz	0.21	DTS

The SAR values found for the Mobile Phone are below the maximum recommended levels of 1.6 W/Kg as averaged over any 1g tissue according to the ANSI C95.1-1992.

The measurement together with the test system set-up is described in annex C of this test report. A detailed description of the equipment under test can be found in chapter 4 of this test report.

The highest reported SAR value is obtained at the case of **(Table 2.1 & 2.2 & 2.3)**, and the value is: **1.16 W/kg (1g)**.

**Table2.4: The sum of reported SAR values for main antenna and WLAN**

/	Position	Main Antenna (W/kg)	WLAN (W/kg)	Sum (W/kg)
Highest reported SAR value for Head	Right Cheek	0.32	0.74	1.06
Highest reported SAR value for Hotspot	Rear	1.16	0.21	1.37
Highest reported SAR value for Body-worn	Rear	1.16	0.21	1.37

Note: the test positions of above tables are for the worse case that has been evaluated.

**Table2.5: The sum of reported SAR values for main antenna and Bluetooth**

/	Position	Main Antenna (W/kg)	Bluetooth (W/kg)	Sum (W/kg)
Highest reported SAR value for Head	Left Cheek	0.33	0.26	0.59
Highest reported SAR value for Hotspot	Rear	1.16	0.13	1.29
Highest reported SAR value for Body-worn	Rear	1.16	0.13	1.29

Note: the test positions of above tables are for the worse case that has been evaluated.

According to the above tables, the highest sum of reported SAR values is **1.37 W/kg (1g)**.

The detail for simultaneous transmission consideration is described in chapter 12.





### 3. Client Information

#### 3.1. Applicant Information

Company Name:	HMD Global Oy
Address:	Bertel Jungin aukio 9, 02600 Espoo, Finland
City:	/
Country:	/
Telephone:	+393 31 6272922

#### 3.2. Manufacturer Information

Company Name:	HMD Global Oy
Address:	Bertel Jungin aukio 9, 02600 Espoo, Finland
City:	/
Country:	/
Telephone:	+393 31 6272922

## 4. Equipment under Test (EUT) and Ancillary Equipment (AE)

### 4.1. About EUT

Description:	Smart Phone
Model Name:	TA-1339
Operating mode(s):	GSM850/1900, WCDMA Band2/4/5, LTE Band2/4/5/7/12/17/28/66, Bluetooth, WLAN2.4G
Condition of EUT as received:	No obvious damage in appearance
Tested Tx Frequency:	824 – 849MHz (GSM 850)
	1850 – 1910MHz (GSM 1900)
	1850 – 1910MHz (WCDMA Band 2)
	1710 – 1755MHz (WCDMA Band 4)
	824 – 849MHz (WCDMA Band 5)
	1850 – 1910MHz (LTE Band 2)
	1700 – 1755MHz (LTE Band 4)
	824 – 849MHz (LTE Band 5)
	2500 – 2570MHz (LTE Band 7)
	699 – 716MHz (LTE Band 12)
	704 – 716MHz (LTE Band 17)
	703 – 748MHz (LTE Band 28)
	1710 – 1780MHz (LTE Band 66)
2402 – 2480MHz (Bluetooth)	
2412 – 2462MHz (WLAN 2.4G)	
GPRS / EGPRS Multislot Class:	12
GPRS capability Class:	B
Test device Production information:	Production unit
Device type:	Portable device
Antenna type:	Integrated antenna
Hotspot mode:	Support
Product Dimensions:	Long 169.9mm; Wide 77.9mm; Overall Diagonal 177mm
Display Diagonal:	161mm
<b>Remark:</b> 1. This device does not support DTM operation. 2. DIV antenna has only signaled receiving function. 3. There is one power reduction level of WWAN antenna. 4. For WWAN transmitter. Body exposure condition: Reduced power level 1 – GSM1900, WCDMA Band 2/4, LTE Band 2/4/66 While the device is transmitting at the WWAN antenna and receiver is not working, power reduction enabled for those bands.	

**4.2. Internal Identification of EUT used during the test**

EUT ID*	IMEI	HW Version	SW Version	Receipt Date
UT01aa	357321210002548	V01	00WW_0_070	2021-02-22
UT02aa	357321210000849	V01	00WW_0_070	2021-02-22
UT11aa	357321210003322	V01	00WW_0_070	2021-02-22

\*EUT ID: is used to identify the test sample in the lab internally.

**Note:** It is performed to test SAR with the UT01aa & UT02aa, and conducted power with the UT11aa.

**4.3. Internal Identification of AE used during the test**

AE ID*	Description	Model	Manufacturer
AE1	Battery	BL-29CI	Fenghua Battery Co., Ltd.
AE2	Headset	JWEP1199-M01H(178210504)	JUWEI ELECTRONICS CO., LTD

\*AE ID: is used to identify the test sample in the lab internally.



## 5. Test Methodology

### 5.1. Applicable Limit Regulations

**ANSI C95.1:1992** IEEE Standard for Safety Levels with Respect to Human Exposure to Radio Frequency Electromagnetic Fields, 3 kHz to 300 GHz.

It specifies the maximum exposure limit of **1.6 W/kg** as averaged over any 1 gram of tissue for portable devices being used within 20 cm of the user in the uncontrolled environment.

### 5.2. Applicable Measurement Standards

**IEEE 1528:2013** Recommended Practice for Determining the Peak Spatial-Average Specific Absorption Rate (SAR) in the Human Head from Wireless Communications Devices: Experimental Techniques.

**KDB 447498 D01 General RF Exposure Guidance v06** RF Exposure Procedures and Equipment Authorization Policies for Mobile and Portable Devices

**KDB 648474 D04 Handset SAR v01r03** SAR Evaluation Considerations for Wireless Handsets.

**KDB 941225 D01 SAR test for 3G devices v03r01** SAR Measurement Procedures for 3G Devices

**KDB 941225 D05 SAR for LTE Devices v02r05** SAR Evaluation Considerations for LTE Devices

**KDB 941225 D06 Hot Spot SAR v02r01** SAR Evaluation Procedures for Portable Devices with Wireless Router Capabilities

**KDB 248227 D01 802.11 Wi-Fi SAR v02r02** SAR Guidance for IEEE 802.11 (Wi-Fi) Transmitters.

**KDB 865664 D01 SAR measurement 100 MHz to 6 GHz v01r04** SAR Measurement Requirements for 100 MHz to 6 GHz.

**KDB 865664 D02 RF Exposure Reporting v01r02** RF Exposure Compliance Reporting and Documentation Considerations

**KDB 941225 D07 UMPC Mini Tablet v01r02** SAR Evaluation Procedures for UMPC Mini-Tablet Devices

**TCB workshop April 2019; RF Exposure Procedures (Tissue Simulating Liquids)**

## 6. Specific Absorption Rate (SAR)

### 6.1. Introduction

SAR is related to the rate at which energy is absorbed per unit mass in an object exposed to a radio field. The SAR distribution in a biological body is complicated and is usually carried out by experimental techniques or numerical modeling. The standard recommends limits for two tiers of groups, occupational/controlled and general population/uncontrolled, based on a person's awareness and ability to exercise control over his or her exposure. In general, occupational/controlled exposure limits are higher than the limits for general population/uncontrolled.

### 6.2. SAR Definition

The SAR definition is the time derivative (rate) of the incremental energy ( $dW$ ) absorbed by (dissipated in) an incremental mass ( $dm$ ) contained in a volume element ( $dv$ ) of a given density ( $\rho$ ). The equation description is as below:

$$SAR = \frac{d}{dt} \left( \frac{dW}{dm} \right) = \frac{d}{dt} \left( \frac{dW}{\rho dv} \right)$$

SAR is expressed in units of Watts per kilogram (W/kg)

SAR measurement can be either related to the temperature elevation in tissue by

$$SAR = c \left( \frac{\delta T}{\delta t} \right)$$

Where:  $C$  is the specific heat capacity,  $\delta T$  is the temperature rise and  $\delta t$  is the exposure duration, or related to the electrical field in the tissue by

$$SAR = \frac{\sigma |E|^2}{\rho}$$

Where:  $\sigma$  is the conductivity of the tissue,  $\rho$  is the mass density of tissue and  $E$  is the RMS electrical field strength.

However for evaluating SAR of low power transmitter, electrical field measurement is typically applied.

## 7. Tissue Simulating Liquids

### 7.1. Targets for tissue simulating liquid

**Table 7.1: Targets for tissue simulating liquid**

Frequency (MHz)	Liquid Type	Conductivity ( $\sigma$ )	$\pm 5\%$ Range	Permittivity ( $\epsilon$ )	$\pm 5\%$ Range
750	Head	0.89	0.85~0.93	41.9	39.8~44.0
835	Head	0.90	0.86~0.95	41.5	39.4~43.6
1750	Head	1.37	1.30~1.44	40.1	38.1~42.1
1900	Head	1.40	1.33~1.47	40.0	38.0~42.0
2450	Head	1.80	1.71~1.89	39.2	37.2~41.2
2550	Head	1.91	1.81~2.01	39.1	37.1~41.0

### 7.2. Dielectric Performance

**Table 7.2: Dielectric Performance of Tissue Simulating Liquid**

Measurement Date (yyyy-mm-dd)	Type	Frequency	Conductivity $\sigma$ (S/m)	Drift (%)	Permittivity $\epsilon$	Drift (%)
2021-03-05	Head	750	0.896	0.67	40.95	-2.27
2021-03-04	Head	835	0.918	2.00	40.73	-1.86
2021-03-17	Head	1750	1.359	-0.80	40.54	1.10
2021-03-25	Head	1900	1.424	1.71	39.42	-1.45
2021-03-06	Head	2450	1.820	1.11	38.63	-1.45
2021-03-08	Head	2550	1.941	1.62	38.48	-1.59

Note: The liquid temperature is 22.0°C.

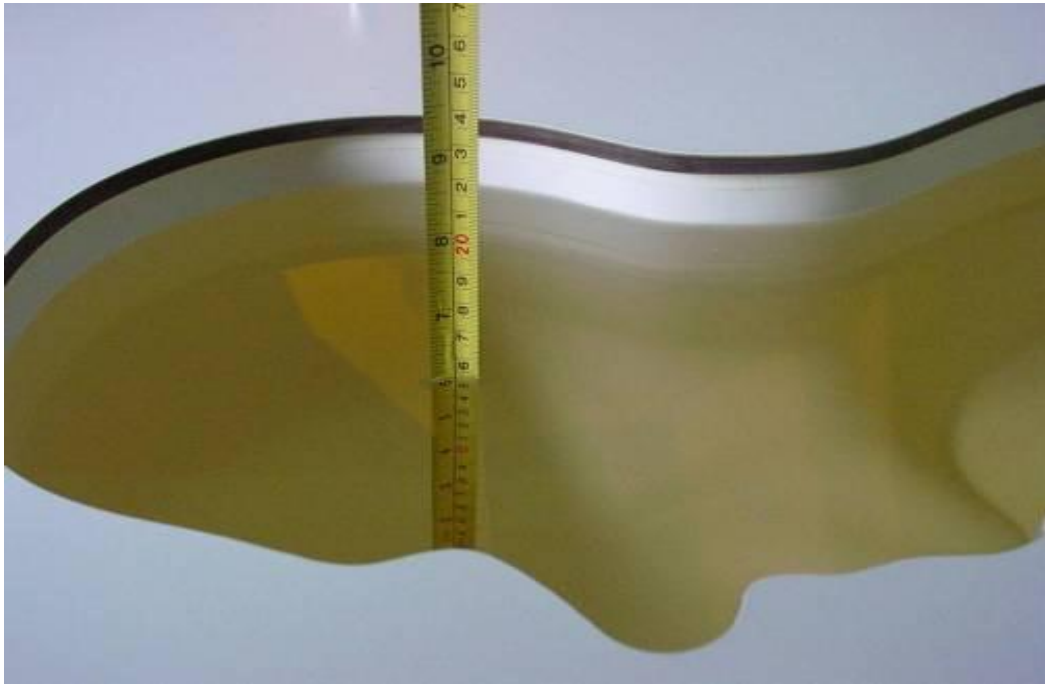

**Picture 7-1: Liquid depth in the Head Phantom (750MHz)**



**Picture 7-2: Liquid depth in the Head Phantom (835MHz)**

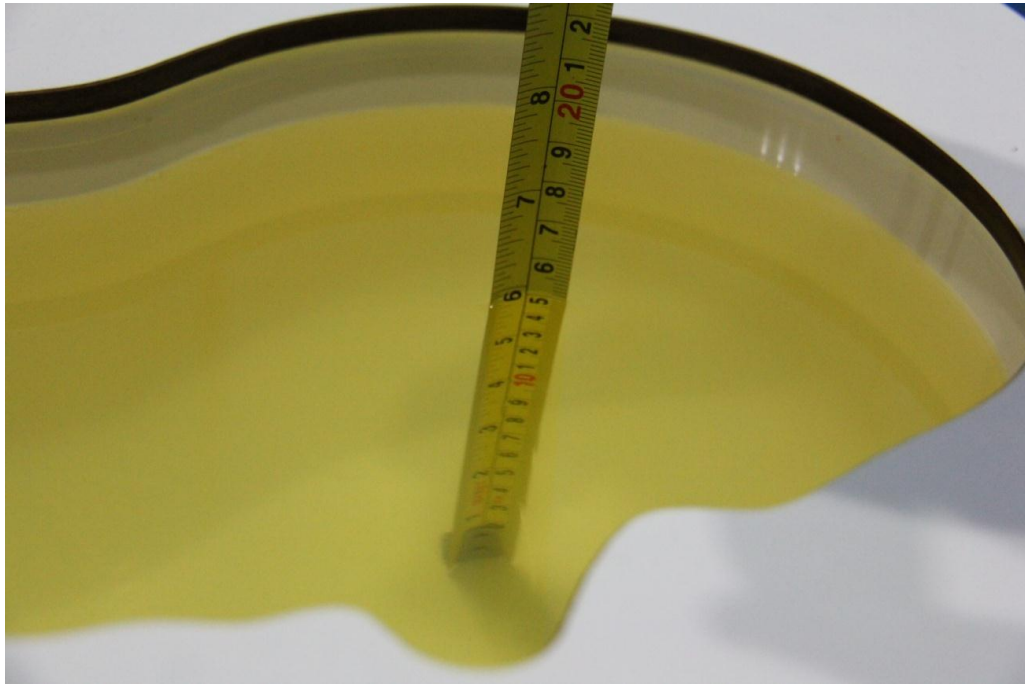

**Picture 7-3: Liquid depth in the Head Phantom (1750MHz)**



**Picture 7-4: Liquid depth in the Head Phantom (1900MHz)**



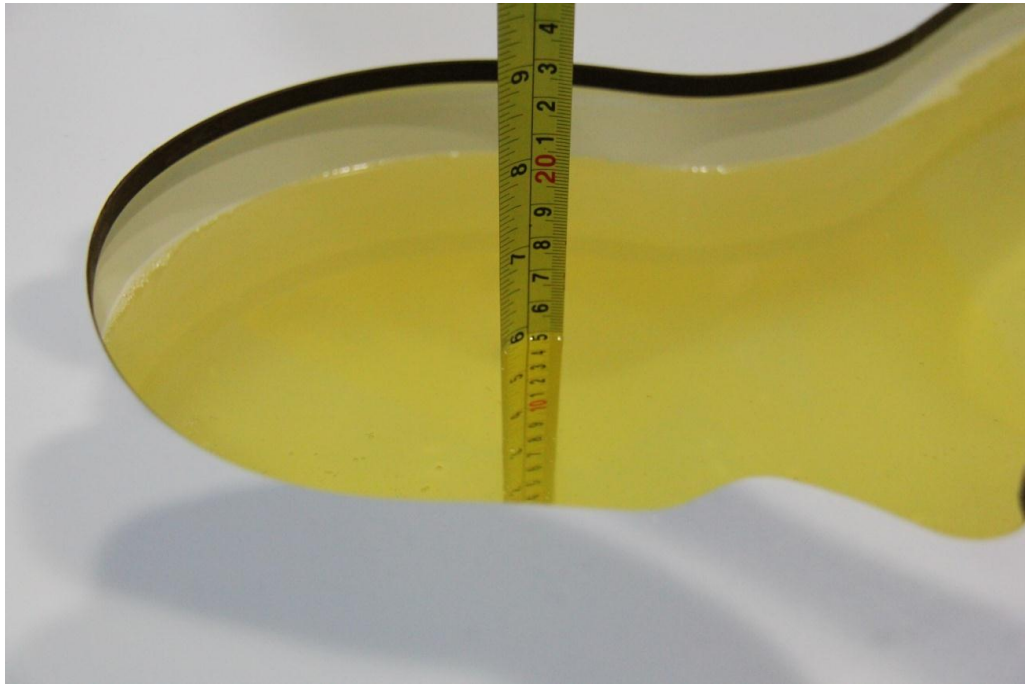

**Picture 7-5: Liquid depth in the Head Phantom(2450MHz)**

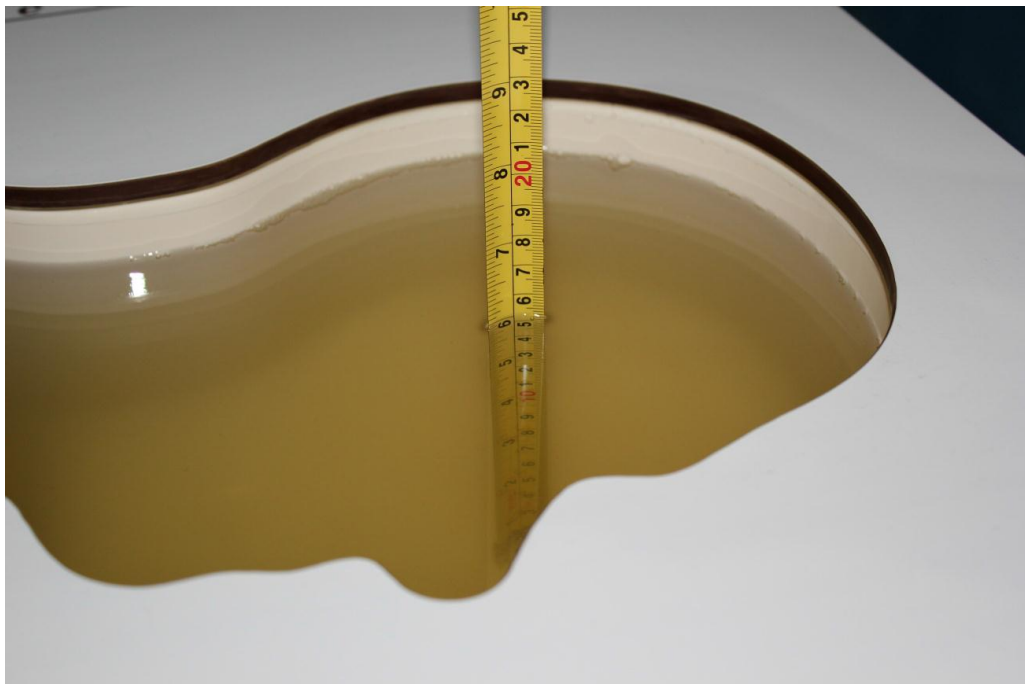

**Picture 7-6: Liquid depth in the Head Phantom(2550MHz)**

## 8. System verification

### 8.1. System Setup

In the simplified setup for system evaluation, the DUT is replaced by a calibrated dipole and the power source is replaced by a continuous wave that comes from a signal generator. The calibrated dipole must be placed beneath the flat phantom section of the SAM twin phantom with the correct distance holder. The distance holder should touch the phantom surface with a light pressure at the reference marking and be oriented parallel to the long side of the phantom. The equipment setup is shown below:

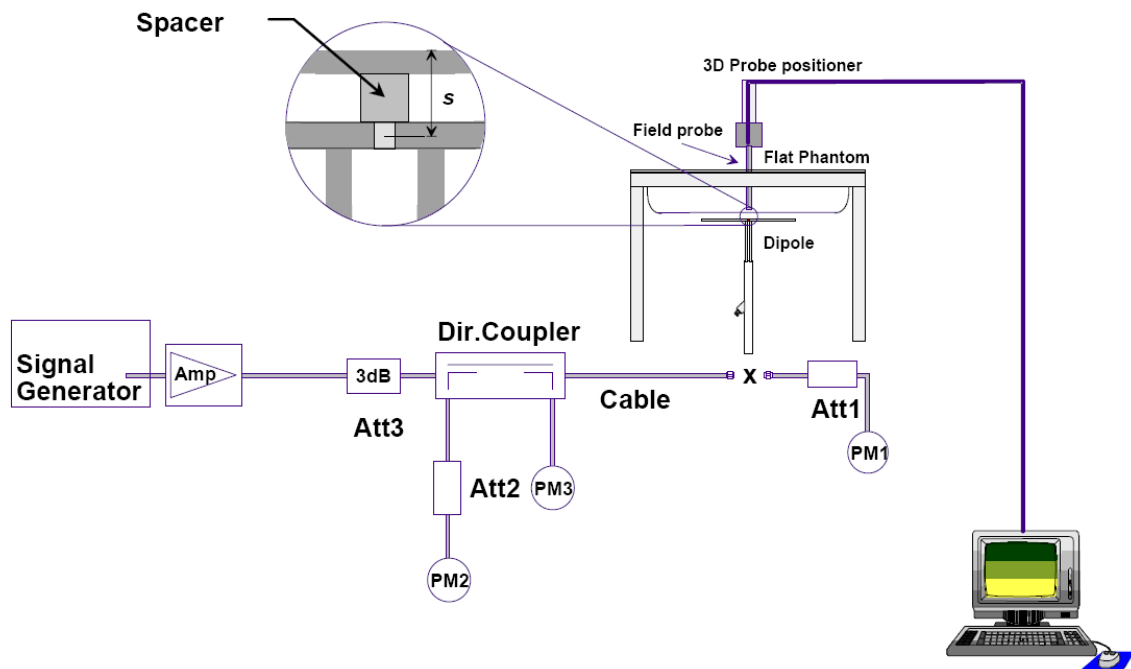

Picture 8.1 System Setup for System Evaluation

For the dipole below 3GHz, the output power on dipole port must be calibrated to 24 dBm (250mW) before dipole is connected.

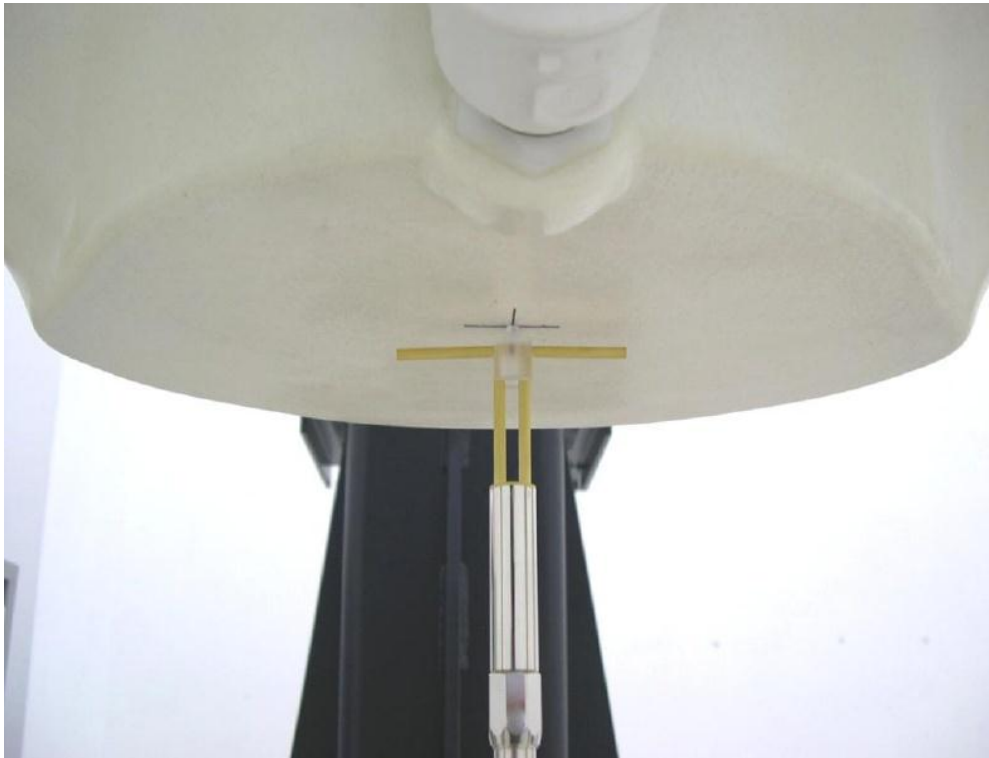

Picture 8.2 Photo of Dipole Setup

## 8.2. System Verification

SAR system verification is required to confirm measurement accuracy, according to the tissue dielectric media, probe calibration points and other system operating parameters required for measuring the SAR of a test device. The system verification must be performed for each frequency band and within the valid range of each probe calibration point required for testing the device.

Table 8.1: System Verification of Head

Measurement Date	Frequency (MHz)	Target value (W/kg)		Measured value (W/kg)				Deviation (%)	
		10 g	1 g	/		Normalize to 1W		10 g	1 g
				10 g	1 g	10 g	1 g		
2021-03-05	750 MHz	5.70	8.53	1.44	2.18	5.76	8.72	1.05	2.23
2021-03-04	835 MHz	6.29	9.62	1.61	2.49	6.44	9.96	2.38	3.53
2021-03-17	1750 MHz	19.30	36.40	4.78	8.92	19.12	35.68	-0.93	-1.98
2021-03-25	1900 MHz	21.00	40.50	5.33	10.5	21.32	42.00	1.52	3.70
2021-03-06	2450 MHz	24.10	52.00	6.15	13.5	24.60	54.00	2.07	3.85
2021-03-08	2550 MHz	26.50	57.80	6.81	15.1	27.24	60.40	2.79	4.50

## 9. Measurement Procedures

### 9.1. Tests to be performed

In order to determine the highest value of the peak spatial-average SAR of a handset, all device positions, configurations and operational modes shall be tested for each frequency band according to steps 1 to 3 below. A flowchart of the test process is shown in picture 9.1.

**Step 1:** The tests described in 9.2 shall be performed at the channel that is closest to the center of the transmit frequency band ( $f_c$ ) for:

- a) all device positions (cheek and tilt, for both left and right sides of the SAM phantom, as described in annex D),
- b) all configurations for each device position in a), e.g., antenna extended and retracted, and
- c) all operational modes, e.g., analogue and digital, for each device position in a) and configuration in b) in each frequency band.

If more than three frequencies need to be tested according to 11.1 (i.e.,  $N_c > 3$ ), then all frequencies, configurations and modes shall be tested for all of the above test conditions.

**Step 2:** For the condition providing highest peak spatial-average SAR determined in Step 1, perform all tests described in 9.2 at all other test frequencies, i.e., lowest and highest frequencies. In addition, for all other conditions (device position, configuration and operational mode) where the peak spatial-average SAR value determined in Step 1 is within 3 dB of the applicable SAR limit, it is recommended that all other test frequencies shall be tested as well.

**Step 3:** Examine all data to determine the highest value of the peak spatial-average SAR found in Steps 1 to 2.

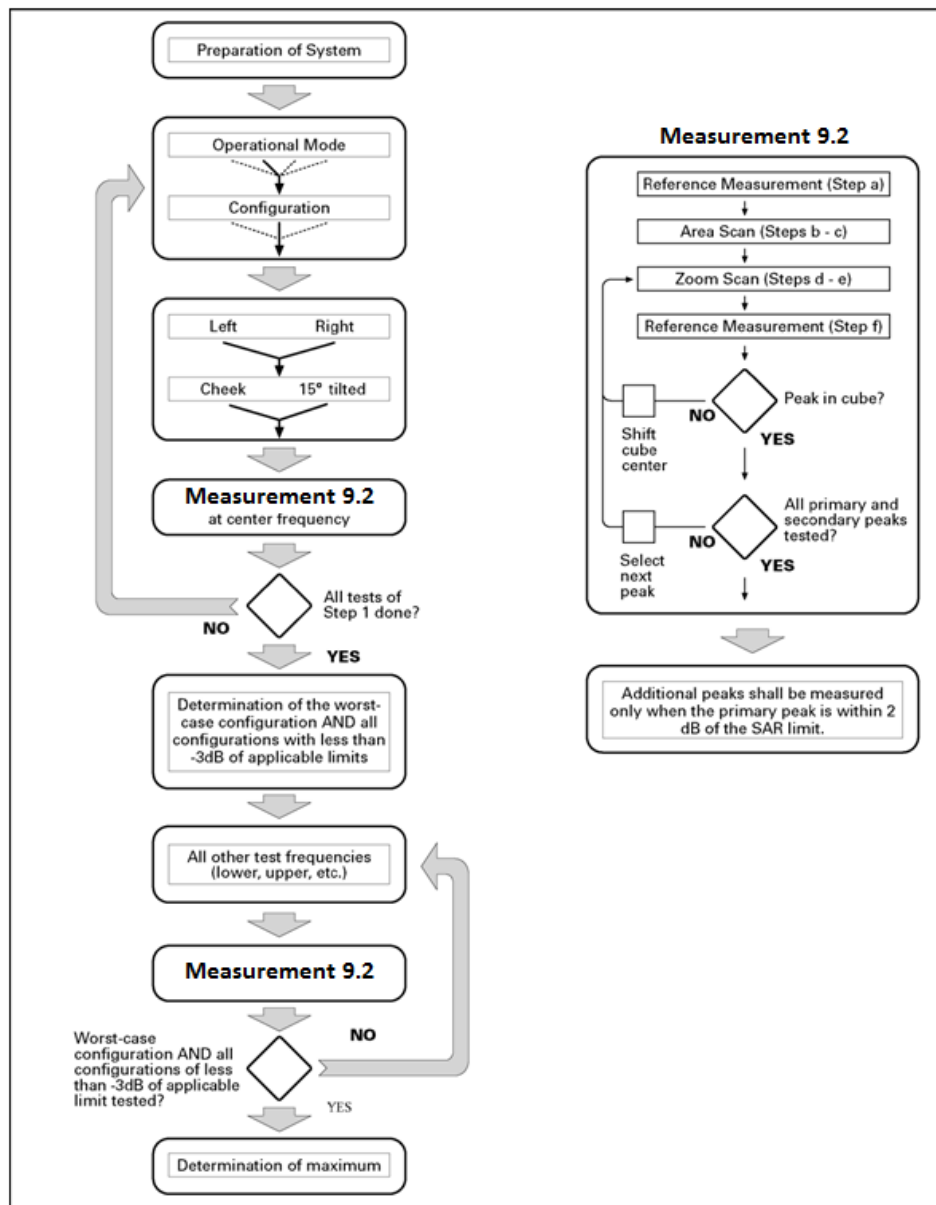

Picture 9.1 Block diagram of the tests to be performed

## 9.2. General Measurement Procedure

The area and zoom scan resolutions specified in the table below must be applied to the SAR measurements and fully documented in SAR reports to qualify for TCB approval. Probe boundary effect error compensation is required for measurements with the probe tip closer than half a probe tip diameter to the phantom surface. Both the probe tip diameter and sensor offset distance must satisfy measurement protocols; to ensure probe boundary effect errors are minimized and the higher fields closest to the phantom surface can be correctly measured and extrapolated to the phantom surface for computing 1-g SAR. Tolerances of the post-processing algorithms must be verified by the test laboratory for the scan resolutions used in the SAR measurements, according to the reference distribution functions specified in IEEE Std 1528-2013. The results should be documented as part of the system validation records and may be requested to support test results when all the measurement parameters in the following table are not satisfied.

		$\leq 3$ GHz	$> 3$ GHz
Maximum distance from closest measurement point (geometric center of probe sensors) to phantom surface		$5 \pm 1$ mm	$\frac{1}{2} \cdot \delta \cdot \ln(2) \pm 0.5$ mm
Maximum probe angle from probe axis to phantom surface normal at the measurement location		$30^\circ \pm 1^\circ$	$20^\circ \pm 1^\circ$
Maximum area scan spatial resolution: $\Delta x_{Area}, \Delta y_{Area}$		$\leq 2$ GHz: $\leq 15$ mm 2 – 3 GHz: $\leq 12$ mm	3 – 4 GHz: $\leq 12$ mm 4 – 6 GHz: $\leq 10$ mm
		When the x or y dimension of the test device, in the measurement plane orientation, is smaller than the above, the measurement resolution must be $\leq$ the corresponding x or y dimension of the test device with at least one measurement point on the test device.	
Maximum zoom scan spatial resolution: $\Delta x_{Zoom}, \Delta y_{Zoom}$		$\leq 2$ GHz: $\leq 8$ mm 2 – 3 GHz: $\leq 5$ mm*	3 – 4 GHz: $\leq 5$ mm* 4 – 6 GHz: $\leq 4$ mm*
Maximum zoom scan spatial resolution, normal to phantom surface	uniform grid: $\Delta z_{Zoom}(n)$	$\leq 5$ mm	3 – 4 GHz: $\leq 4$ mm 4 – 5 GHz: $\leq 3$ mm 5 – 6 GHz: $\leq 2$ mm
	graded grid $\Delta z_{Zoom}(1)$ : between 1 <sup>st</sup> two points closest to phantom surface	$\leq 4$ mm	3 – 4 GHz: $\leq 3$ mm 4 – 5 GHz: $\leq 2.5$ mm 5 – 6 GHz: $\leq 2$ mm
	$\Delta z_{Zoom}(n>1)$ : between subsequent points	$\leq 1.5 \cdot \Delta z_{Zoom}(n-1)$	
Minimum zoom scan volume	x, y, z	$\geq 30$ mm	3 – 4 GHz: $\geq 28$ mm 4 – 5 GHz: $\geq 25$ mm 5 – 6 GHz: $\geq 22$ mm
<p>Note: <math>\delta</math> is the penetration depth of a plane-wave at normal incidence to the tissue medium; see draft standard IEEE P1528-2011 for details.</p> <p>* When zoom scan is required and the <i>reported</i> SAR from the area scan based 1-g SAR estimation procedures of KDB 447498 is <math>\leq 1.4</math> W/kg, <math>\leq 8</math> mm, <math>\leq 7</math> mm and <math>\leq 5</math> mm zoom scan resolution may be applied, respectively, for 2 GHz to 3 GHz, 3 GHz to 4 GHz and 4 GHz to 6 GHz.</p>			

### 9.3. WCDMA Measurement Procedures for SAR

The following procedures are applicable to WCDMA handsets operating under 3GPP Release99, Release 5 and Release 6. The default test configuration is to measure SAR with an established radio link between the DUT and a communication test set using a 12.2kbps RMC (reference measurement channel) configured in Test Loop Mode 1. SAR is selectively confirmed for other physical channel configurations (DPCCH & DPDCH<sub>n</sub>), HSDPA and HSPA (HSUPA/HSDPA) modes according to output power, exposure conditions and device operating capabilities. Both uplink and downlink should be configured with the same RMC or AMR, when required. SAR for Release 5 HSDPA and Release 6 HSPA are measured using the applicable FRC (fixed reference channel) and E-DCH reference channel configurations. Maximum output power is verified according to applicable versions of 3GPP TS 34.121 and SAR must be measured according to these maximum output conditions. When Maximum Power Reduction (MPR) is not implemented according to Cubic Metric (CM) requirements for Release 6 HSPA, the following procedures do not apply.

#### For Release 5 HSDPA Data Devices:

Sub-test	$\beta_c$	$\beta_d$	$\beta_d$ (SF)	$\beta_c / \beta_d$	$\beta_{hs}$	CM/dB
1	2/15	15/15	64	2/15	4/15	0.0
2	12/15	15/15	64	12/15	24/25	1.0
3	15/15	8/15	64	15/8	30/15	1.5
4	15/15	4/15	64	15/4	30/15	1.5

#### For Release 6 HSPA Data Devices

Sub-test	$\beta_c$	$\beta_d$	$\beta_d$ (SF)	$\beta_c / \beta_d$	$\beta_{hs}$	$\beta_{ec}$	$\beta_{ed}$	$\beta_{ed}$ (SF)	$\beta_{ed}$ (codes)	CM (dB)	MPR (dB)	AG Index	E-TFCI
1	11/15	15/15	64	11/15	22/15	209/225	1039/225	4	1	1.0	0.0	20	75
2	6/15	15/15	64	6/15	12/15	12/15	12/15	4	1	3.0	2.0	12	67
3	15/15	9/15	64	15/9	30/15	30/15	$\beta_{ed1}:47/15$ $\beta_{ed2}:47/15$	4	2	2.0	1.0	15	92
4	2/15	15/15	64	2/15	4/15	4/15	56/75	4	1	3.0	2.0	17	71
5	15/15	15/15	64	15/15	24/15	30/15	134/15	4	1	1.0	0.0	21	81

#### 9.4. SAR Measurement for LTE

SAR tests for LTE are performed with a base station simulator, Anristu MT8820C. Closed loop power control was used so the UE transmits with maximum output power during SAR testing. All powers were measured with the Anristu MT8820C. It is performed for conducted power and SAR based on the KDB941225 D05.

SAR is evaluated separately according to the following procedures for the different test positions in each exposure condition – head, body, body-worn accessories and other use conditions. The procedures in the following subsections are applied separately to test each LTE frequency band.

1) QPSK with 1 RB allocation

Start with the largest channel bandwidth and measure SAR for QPSK with 1 RB allocation, using the RB offset and required test channel combination with the highest maximum output power among RB offsets at the upper edge, middle and lower edge of each required test channel. When the reported SAR is  $\leq 0.8$  W/kg, testing of the remaining RB offset configurations and required test channels is not required for 1 RB allocation; otherwise, SAR is required for the remaining required test channels and only for the RB offset configuration with the highest output power for that channel. When the reported SAR of a required test channel is  $> 1.45$  W/kg, SAR is required for all three RB offset configurations for that required test channel.

2) QPSK with 50% RB allocation

The procedures required for 1 RB allocation in 1) are applied to measure the SAR for QPSK with 50% RB allocation.

3) QPSK with 100% RB allocation

For QPSK with 100% RB allocation, SAR is not required when the highest maximum output power for 100 % RB allocation is less than the highest maximum output power in 50% and 1 RB allocations and the highest reported SAR for 1 RB and 50% RB allocation in 1) and 2) are  $\leq 0.8$  W/kg. Otherwise, SAR is measured for the highest output power channel; and if the reported SAR is  $> 1.45$  W/kg, the remaining required test channels must also be tested.

#### 9.5. Bluetooth & WLAN Measurement Procedures for SAR

Normal network operating configurations are not suitable for measuring the SAR of 802.11 transmitters in general. Unpredictable fluctuations in network traffic and antenna diversity conditions can introduce undesirable variations in SAR results. The SAR for these devices should be measured using chipset based test mode software to ensure that the results are consistent and reliable.

Chipset based test mode software is hardware dependent and generally varies among manufacturers. The device operating parameters established in a test mode for SAR measurements must be identical to those programmed in production units, including output power levels, amplifier gain settings and other RF performance tuning parameters. The test frequencies should correspond to actual channel frequencies defined for domestic use. SAR for devices with switched diversity should be measured with only one antenna transmitting at a time during each SAR measurement, according to a fixed modulation and data rate. The same data pattern should be used for all measurements.





## 9.6. Power Drift

To control the output power stability during the SAR test, DASY5 system calculates the power drift by measuring the E-field at the same location at the beginning and at the end of the measurement for each test position. These drift values can be found in Section 14 labeled as: (Power Drift [dB]). This ensures that the power drift during one measurement is within 5%.

## 10. Conducted Output Power

### 10.1. GSM Measurement result

During the process of testing, the EUT was controlled via Agilent Digital Radio Communication tester (E5515C) to ensure the maximum power transmission and proper modulation. This result contains conducted output power for the EUT. In all cases, the measured peak output power should be greater and within 5% than EMI measurement.

**Table 10.1: The conducted power measurement results for GSM**

GSM 850MHz	Tune up	Conducted Power(dBm)		
		Channel 251(848.8MHz)	Channel 190(836.6MHz)	Channel 128(824.2MHz)
	<b>33.0</b>	31.95	31.89	31.95
GSM 1900MHz	Tune up	Conducted Power(dBm)		
		Channel 810(1909.8MHz)	Channel 661(1880MHz)	Channel 512(1850.2MHz)
	<b>30.0</b>	28.88	28.85	29.05

**Table 10.2: The conducted power measurement results for GPRS and EGPRS**

GPRS850/ EGPRS850	Tune up	Measured Power (dBm)			calculation	Average Power (dBm)		
		251	190	128		251	190	128
1Tx-slots	<b>33.0</b>	31.93	31.88	31.94	-9.03dB	22.90	22.85	22.91
<b>2Tx-slots</b>	<b>31.0</b>	<b>29.90</b>	<b>29.84</b>	<b>29.93</b>	-6.02dB	23.88	23.82	23.91
3Tx-slots	<b>29.0</b>	28.05	27.99	28.08	-4.26dB	23.79	23.73	23.82
4Tx-slots	<b>27.0</b>	25.87	25.81	25.89	-3.01dB	22.86	22.80	22.88
EGPRS 850 (8PSK)	Tune up	Measured Power (dBm)			calculation	Measured Power (dBm)		
		251	190	128		251	190	128
1Tx-slots	<b>26.0</b>	24.50	25.16	25.06	-9.03dB	15.47	16.13	16.03
2Tx-slots	<b>26.0</b>	24.37	24.92	24.94	-6.02dB	18.35	18.90	18.92
3Tx-slots	<b>24.5</b>	23.02	23.47	23.70	-4.26dB	18.76	19.21	19.44
4Tx-slots	<b>22.0</b>	20.54	21.10	21.19	-3.01dB	17.53	18.09	18.18

Full Power								
GPRS1900/ EGPRS1900	Tune up	Measured Power (dBm)			calculation	Average Power (dBm)		
		810	661	512		810	661	512
1Tx-slots	<b>30.0</b>	29.04	29.30	29.36	-9.03dB	20.01	20.27	20.33
2Tx-slots	<b>28.5</b>	26.98	27.34	27.66	-6.02dB	20.96	21.32	21.64
3Tx-slots	<b>26.0</b>	24.44	24.79	25.18	-4.26dB	20.18	20.53	20.92
4Tx-slots	<b>24.0</b>	22.37	22.76	23.16	-3.01dB	19.36	19.75	20.15
EGPRS 1900 (8PSK)	Tune up	Measured Power (dBm)			calculation	Measured Power (dBm)		
		810	661	512		810	661	512
1Tx-slots	<b>26.5</b>	25.74	25.42	25.08	-9.03dB	16.71	16.39	16.05
2Tx-slots	<b>26.5</b>	25.54	25.19	24.95	-6.02dB	19.52	19.17	18.93
3Tx-slots	<b>25.0</b>	24.12	23.74	23.61	-4.26dB	19.86	19.48	19.35
4Tx-slots	<b>22.5</b>	21.62	21.19	21.06	-3.01dB	18.61	18.18	18.05
Reduced power level 1								
GPRS1900/ EGPRS1900	Tune up	Measured Power (dBm)			calculation	Average Power (dBm)		
		810	661	512		810	661	512
1Tx-slots	<b>28.5</b>	27.02	27.20	27.60	-9.03dB	17.99	18.17	18.57
2Tx-slots	<b>25.0</b>	23.53	23.70	24.18	-6.02dB	17.51	17.68	18.16
3Tx-slots	<b>24.5</b>	22.96	23.19	23.66	-4.26dB	18.70	18.93	19.40
<b>4Tx-slots</b>	<b>23.5</b>	<b>22.36</b>	<b>22.60</b>	<b>23.04</b>	-3.01dB	<b>19.35</b>	<b>19.59</b>	<b>20.03</b>
EGPRS 1900 (8PSK)	Tune up	Measured Power (dBm)			calculation	Measured Power (dBm)		
		810	661	512		810	661	512
1Tx-slots	<b>24.0</b>	23.58	22.83	22.55	-9.03dB	14.55	13.80	13.52
2Tx-slots	<b>19.0</b>	18.24	17.85	17.88	-6.02dB	12.22	11.83	11.86
3Tx-slots	<b>18.0</b>	17.16	16.99	16.83	-4.26dB	12.90	12.73	12.57
4Tx-slots	<b>17.0</b>	16.11	15.85	15.63	-3.01dB	13.10	12.84	12.62

Note:

1) Division Factors

To average the power, the division factor is as follows:

1TX-slot = 1 transmit time slot out of 8 time slots=> conducted power divided by (8/1) => -9.03dB

2TX-slots = 2 transmit time slots out of 8 time slots=> conducted power divided by (8/2) => -6.02dB

3TX-slots = 3 transmit time slots out of 8 time slots=> conducted power divided by (8/3) => -4.26dB

4TX-slots = 4 transmit time slots out of 8 time slots=> conducted power divided by (8/4) => -3.01dB

**According to the conducted power as above, the body measurements are performed with 2Txslots for 850MHz and 4Txslots 1900MHz.**

## 10.2. WCDMA Measurement result

Table 10.3: T The conducted power measurement results WCDMA

Full Power					
Item	band	WCDMA Band 2			
	ARFCN	Tune up	9538 (1907.6MHz)	9400 (1880MHz)	9262 (1852.4MHz)
WCDMA	\	24.5	23.5	23.6	23.7
HSUPA	1	21.0	19.5	19.5	20.0
	2	21.0	20.0	20.1	20.4
	3	21.0	19.7	19.8	20.2
	4	21.0	20.3	20.3	20.7
	5	23.5	22.2	22.2	22.6
HSDPA	1	23.5	22.2	22.3	22.7
	2	23.5	21.9	21.9	22.4
	3	23.5	21.7	21.7	22.3
	4	23.5	21.7	21.7	22.3
DC-HSDPA	1	23.5	22.2	22.4	22.5
	2	23.5	21.9	22.0	22.2
	3	23.5	21.7	21.8	21.9
	4	23.5	21.7	21.7	21.8
Reduced power level 1					
Item	band	WCDMA Band 2			
	ARFCN	Tune up	9538 (1907.6MHz)	9400 (1880MHz)	9262 (1852.4MHz)
WCDMA	\	20.5	19.6	19.6	19.7
HSUPA	1	18.0	17.0	16.9	16.5
	2	18.0	17.0	16.8	17.1
	3	18.0	17.2	16.9	16.8
	4	18.0	17.1	16.8	17.3
	5	20.0	18.9	18.9	19.3
HSDPA	1	20.0	18.9	19.0	19.3
	2	20.0	18.6	18.7	19.0
	3	20.0	18.3	18.5	18.8
	4	20.0	18.3	18.5	18.8
DC-HSDPA	1	20.0	18.9	19.0	19.1
	2	20.0	18.6	18.7	18.8
	3	20.0	18.4	18.5	18.6
	4	20.0	18.3	18.5	18.7

<b>Full Power</b>					
Item	band	WCDMA Band 4			
	ARFCN	Tune up	1513 (1752.6MHz)	1413 (1732.6MHz)	1312 (1712.4MHz)
WCDMA	\	25.0	24.4	24.6	24.8
HSUPA	1	22.0	20.5	20.9	21.4
	2	22.0	20.3	20.7	21.1
	3	22.0	20.5	20.9	21.3
	4	22.0	20.6	20.9	21.4
	5	24.0	22.6	23.1	23.4
HSDPA	1	24.0	22.2	22.7	23.0
	2	24.0	22.7	23.2	23.5
	3	24.0	22.6	23.1	23.4
	4	24.0	22.6	23.2	23.4
DC-HSDPA	1	24.0	22.3	22.6	22.9
	2	24.0	22.4	23.0	23.2
	3	24.0	22.5	22.8	23.2
	4	24.0	22.6	22.9	23.3
<b>Reduced power level 1</b>					
Item	band	WCDMA Band 4			
	ARFCN	Tune up	1513 (1752.6MHz)	1413 (1732.6MHz)	1312 (1712.4MHz)
WCDMA	\	23.0	22.5	22.6	22.8
HSUPA	1	20.0	18.4	19.1	19.4
	2	20.0	18.2	18.7	18.5
	3	20.0	18.4	19.1	19.5
	4	20.0	18.4	19.2	19.5
	5	22.0	20.7	21.2	21.5
HSDPA	1	22.0	20.2	20.9	21.2
	2	22.0	20.9	21.2	21.5
	3	22.0	20.8	21.2	21.6
	4	22.0	20.9	21.2	21.3
DC-HSDPA	1	22.0	20.6	20.9	21.1
	2	22.0	20.8	21.0	21.3
	3	22.0	20.7	20.9	21.2
	4	22.0	20.8	21.0	21.1

Item	band	WCDMA Band 5			
	ARFCN	Tune up	4233 (846.6MHz)	4182 (836.4MHz)	4132 (826.4MHz)
WCDMA	\	24.5	23.5	23.4	23.3
HSUPA	1	21.0	20.0	20.3	20.1
	2	21.0	20.4	20.7	20.5
	3	21.0	20.0	20.3	20.2
	4	21.0	20.2	20.4	20.3
	5	23.0	21.9	22.0	22.0
HSDPA	1	23.0	22.1	22.3	22.2
	2	23.0	21.9	22.0	22.0
	3	23.0	21.5	21.5	21.5
	4	23.0	21.5	21.6	21.6
DC-HSDPA	1	23.0	22.2	22.2	22.2
	2	23.0	21.9	22.0	22.1
	3	23.0	21.4	21.5	21.6
	4	23.0	21.6	21.6	21.6

### 10.3. LTE Measurement result

According to April 2015 TCB workshop, SAR Test exclusion can be applied for testing overlapping LTE Bands as follows:

- The maximum out power, including tolerance, for the smaller band must be  $\leq$  the larger band to qualify for SAR test exclusion.
- The channel bandwidth and other operating parameters for the smaller band must be fully supported by the larger band.

LTE Band 4 (1710-1755 MHz) is covered by LTE Band 66 (1710-1780 MHz)

LTE Band 17 (704-716 MHz) is covered by LTE Band 12 (699-716 MHz)

**Table 10.4: The conducted Power for LTE**

Full Power								
LTE Band 2			Actual output Power (dBm)			Tune up		
Band -width	RB No. / RB offset	Frequency	Modulation			Modulation		
			QPSK	16QAM	64QAM	QPSK	16QAM	64QAM
1.4 MHz	1RB_5	1909.3MHz	23.03	22.56	22.15	24.0	23.0	22.5
		1880.0MHz	23.10	22.71	22.16	24.0	23.0	22.5
		1850.7MHz	23.02	22.51	22.05	24.0	23.0	22.5
	1RB_3	1909.3MHz	22.94	22.44	21.77	24.0	23.0	22.5
		1880.0MHz	23.00	22.40	21.65	24.0	23.0	22.5
		1850.7MHz	22.93	22.30	21.83	24.0	23.0	22.5
	1RB_0	1909.3MHz	23.01	22.48	22.00	24.0	23.0	22.5
		1880.0MHz	23.13	22.61	22.19	24.0	23.0	22.5
		1850.7MHz	22.97	22.51	21.89	24.0	23.0	22.5
	3RB_3	1909.3MHz	23.05	22.62	22.23	24.0	23.0	22.5
		1880.0MHz	23.13	22.74	22.15	24.0	23.0	22.5
		1850.7MHz	22.97	22.49	21.97	24.0	23.0	22.5
	3RB_1	1909.3MHz	22.99	22.37	21.72	24.0	23.0	22.5
		1880.0MHz	23.07	22.37	21.65	24.0	23.0	22.5
		1850.7MHz	22.89	22.37	21.83	24.0	23.0	22.5
	3RB_0	1909.3MHz	23.00	22.46	21.98	24.0	23.0	22.5
		1880.0MHz	23.08	22.63	22.15	24.0	23.0	22.5
		1850.7MHz	23.00	22.43	21.89	24.0	23.0	22.5
	6RB_0	1909.3MHz	22.60	21.48	20.45	23.0	22.0	21.5
		1880.0MHz	22.35	21.37	20.21	23.0	22.0	21.5
		1850.7MHz	22.50	21.44	20.49	23.0	22.0	21.5



Full Power								
LTE Band 2			Actual output Power (dBm)			Tune up		
Band -width	RB No. / RB offset	Frequency	Modulation			Modulation		
			QPSK	16QAM	64QAM	QPSK	16QAM	64QAM
3 MHz	1RB_14	1908.5MHz	23.00	22.56	22.15	24.0	23.0	22.5
		1880.0MHz	23.09	22.70	22.15	24.0	23.0	22.5
		1851.5MHz	22.98	22.52	21.98	24.0	23.0	22.5
	1RB_7	1908.5MHz	22.96	22.41	21.72	24.0	23.0	22.5
		1880.0MHz	23.02	22.42	21.72	24.0	23.0	22.5
		1851.5MHz	22.95	22.37	21.74	24.0	23.0	22.5
	1RB_0	1908.5MHz	22.98	22.47	21.98	24.0	23.0	22.5
		1880.0MHz	23.07	22.69	22.17	24.0	23.0	22.5
		1851.5MHz	22.91	22.47	21.93	24.0	23.0	22.5
	8RB_7	1908.5MHz	22.49	21.54	20.64	23.0	22.0	21.5
		1880.0MHz	22.52	21.51	20.45	23.0	22.0	21.5
		1851.5MHz	22.53	21.50	20.55	23.0	22.0	21.5
	8RB_4	1908.5MHz	22.36	21.56	20.71	23.0	22.0	21.5
		1880.0MHz	22.55	21.59	20.74	23.0	22.0	21.5
		1851.5MHz	22.41	21.59	20.64	23.0	22.0	21.5
	8RB_0	1908.5MHz	22.47	21.51	20.59	23.0	22.0	21.5
		1880.0MHz	22.55	21.62	20.70	23.0	22.0	21.5
		1851.5MHz	22.45	21.51	20.51	23.0	22.0	21.5
	15RB_0	1908.5MHz	22.59	21.48	20.46	23.0	22.0	21.5
		1880.0MHz	22.39	21.42	20.22	23.0	22.0	21.5
		1851.5MHz	22.48	21.41	20.46	23.0	22.0	21.5





Full Power								
LTE Band 2			Actual output Power (dBm)			Tune up		
Band -width	RB No. / RB offset	Frequency	Modulation			Modulation		
			QPSK	16QAM	64QAM	QPSK	16QAM	64QAM
5 MHz	1RB_24	1907.5MHz	23.05	22.58	22.22	24.0	23.0	22.5
		1880.0MHz	23.15	22.67	22.12	24.0	23.0	22.5
		1852.5MHz	23.03	22.47	21.98	24.0	23.0	22.5
	1RB_12	1907.5MHz	22.89	22.36	21.74	24.0	23.0	22.5
		1880.0MHz	22.99	22.36	21.69	24.0	23.0	22.5
		1852.5MHz	22.89	22.32	21.82	24.0	23.0	22.5
	1RB_0	1907.5MHz	22.99	22.48	22.06	24.0	23.0	22.5
		1880.0MHz	23.11	22.71	22.18	24.0	23.0	22.5
		1852.5MHz	23.01	22.51	21.90	24.0	23.0	22.5
	12RB_13	1907.5MHz	22.57	21.57	20.61	23.0	22.0	21.5
		1880.0MHz	22.52	21.54	20.48	23.0	22.0	21.5
		1852.5MHz	22.59	21.53	20.62	23.0	22.0	21.5
	12RB_6	1907.5MHz	22.38	21.53	20.71	23.0	22.0	21.5
		1880.0MHz	22.60	21.63	20.73	23.0	22.0	21.5
		1852.5MHz	22.43	21.55	20.67	23.0	22.0	21.5
	12RB_0	1907.5MHz	22.50	21.55	20.58	23.0	22.0	21.5
		1880.0MHz	22.50	21.63	20.73	23.0	22.0	21.5
		1852.5MHz	22.52	21.47	20.60	23.0	22.0	21.5
	25RB_0	1907.5MHz	22.59	21.57	20.47	23.0	22.0	21.5
		1880.0MHz	22.44	21.41	20.25	23.0	22.0	21.5
		1852.5MHz	22.49	21.46	20.49	23.0	22.0	21.5



Full Power								
LTE Band 2			Actual output Power (dBm)			Tune up		
Band -width	RB No. / RB offset	Frequency	Modulation			Modulation		
			QPSK	16QAM	64QAM	QPSK	16QAM	64QAM
10 MHz	1RB_49	1905.0MHz	23.02	22.62	22.18	24.0	23.0	22.5
		1880.0MHz	23.08	22.65	22.15	24.0	23.0	22.5
		1855.0MHz	23.00	22.54	21.98	24.0	23.0	22.5
	1RB_24	1905.0MHz	22.98	22.43	21.75	24.0	23.0	22.5
		1880.0MHz	23.05	22.36	21.70	24.0	23.0	22.5
		1855.0MHz	22.89	22.31	21.80	24.0	23.0	22.5
	1RB_0	1905.0MHz	23.00	22.48	22.03	24.0	23.0	22.5
		1880.0MHz	23.10	22.68	22.24	24.0	23.0	22.5
		1855.0MHz	22.93	22.47	21.93	24.0	23.0	22.5
	25RB_25	1905.0MHz	22.57	21.52	20.60	23.0	22.0	21.5
		1880.0MHz	22.55	21.49	20.42	23.0	22.0	21.5
		1855.0MHz	22.55	21.59	20.62	23.0	22.0	21.5
	25RB_12	1905.0MHz	22.41	21.55	20.77	23.0	22.0	21.5
		1880.0MHz	22.54	21.63	20.81	23.0	22.0	21.5
		1855.0MHz	22.45	21.50	20.65	23.0	22.0	21.5
	25RB_0	1905.0MHz	22.49	21.54	20.60	23.0	22.0	21.5
		1880.0MHz	22.57	21.60	20.71	23.0	22.0	21.5
		1855.0MHz	22.45	21.52	20.59	23.0	22.0	21.5
	50RB_0	1905.0MHz	22.57	21.51	20.50	23.0	22.0	21.5
		1880.0MHz	22.35	21.35	20.22	23.0	22.0	21.5
		1855.0MHz	22.43	21.41	20.42	23.0	22.0	21.5



Full Power								
LTE Band 2			Actual output Power (dBm)			Tune up		
Band -width	RB No. / RB offset	Frequency	Modulation			Modulation		
			QPSK	16QAM	64QAM	QPSK	16QAM	64QAM
15 MHz	1RB_74	1902.5MHz	22.98	22.56	22.17	24.0	23.0	22.5
		1880.0MHz	23.14	22.68	22.13	24.0	23.0	22.5
		1857.5MHz	23.01	22.52	21.99	24.0	23.0	22.5
	1RB_37	1902.5MHz	22.90	22.36	21.70	24.0	23.0	22.5
		1880.0MHz	23.03	22.42	21.69	24.0	23.0	22.5
		1857.5MHz	22.93	22.37	21.74	24.0	23.0	22.5
	1RB_0	1902.5MHz	23.02	22.45	22.05	24.0	23.0	22.5
		1880.0MHz	23.14	22.67	22.21	24.0	23.0	22.5
		1857.5MHz	22.94	22.45	21.95	24.0	23.0	22.5
	36RB_38	1902.5MHz	22.57	21.57	20.65	23.0	22.0	21.5
		1880.0MHz	22.62	21.52	20.48	23.0	22.0	21.5
		1857.5MHz	22.50	21.55	20.55	23.0	22.0	21.5
	36RB_19	1902.5MHz	22.43	21.56	20.78	23.0	22.0	21.5
		1880.0MHz	22.56	21.61	20.77	23.0	22.0	21.5
		1857.5MHz	22.48	21.59	20.67	23.0	22.0	21.5
	36RB_0	1902.5MHz	22.54	21.58	20.55	23.0	22.0	21.5
		1880.0MHz	22.50	21.59	20.65	23.0	22.0	21.5
		1857.5MHz	22.48	21.48	20.59	23.0	22.0	21.5
	75RB_0	1902.5MHz	22.54	21.54	20.49	23.0	22.0	21.5
		1880.0MHz	22.39	21.41	20.20	23.0	22.0	21.5
		1857.5MHz	22.48	21.41	20.45	23.0	22.0	21.5

Full Power								
LTE Band 2			Actual output Power (dBm)			Tune up		
Band -width	RB No. / RB offset	Frequency	Modulation			Modulation		
			QPSK	16QAM	64QAM	QPSK	16QAM	64QAM
20 MHz	1RB_99	1900.0MHz	23.08	22.64	22.23	<b>24.0</b>	<b>23.0</b>	<b>22.5</b>
		1880.0MHz	23.15	22.74	22.19	<b>24.0</b>	<b>23.0</b>	<b>22.5</b>
		1860.0MHz	23.05	22.55	22.06	<b>24.0</b>	<b>23.0</b>	<b>22.5</b>
	1RB_50	1900.0MHz	22.99	22.45	21.77	<b>24.0</b>	<b>23.0</b>	<b>22.5</b>
		1880.0MHz	23.08	22.42	21.73	<b>24.0</b>	<b>23.0</b>	<b>22.5</b>
		1860.0MHz	22.98	22.38	21.84	<b>24.0</b>	<b>23.0</b>	<b>22.5</b>
	1RB_0	1900.0MHz	23.06	22.50	22.08	<b>24.0</b>	<b>23.0</b>	<b>22.5</b>
		1880.0MHz	<b>23.17</b>	22.71	22.25	<b>24.0</b>	<b>23.0</b>	<b>22.5</b>
		1860.0MHz	23.01	22.53	21.98	<b>24.0</b>	<b>23.0</b>	<b>22.5</b>
	50RB_50	1900.0MHz	22.58	21.59	20.68	<b>23.0</b>	<b>22.0</b>	<b>21.5</b>
		1880.0MHz	<b>22.62</b>	21.57	20.50	<b>23.0</b>	<b>22.0</b>	<b>21.5</b>
		1860.0MHz	22.59	21.60	20.65	<b>23.0</b>	<b>22.0</b>	<b>21.5</b>
	50RB_25	1900.0MHz	22.46	21.62	20.79	<b>23.0</b>	<b>22.0</b>	<b>21.5</b>
		1880.0MHz	22.61	21.67	20.82	<b>23.0</b>	<b>22.0</b>	<b>21.5</b>
		1860.0MHz	22.49	21.60	20.70	<b>23.0</b>	<b>22.0</b>	<b>21.5</b>
	50RB_0	1900.0MHz	22.57	21.59	20.60	<b>23.0</b>	<b>22.0</b>	<b>21.5</b>
		1880.0MHz	22.59	21.65	20.74	<b>23.0</b>	<b>22.0</b>	<b>21.5</b>
		1860.0MHz	22.54	21.54	20.60	<b>23.0</b>	<b>22.0</b>	<b>21.5</b>
	100RB_0	1900.0MHz	22.63	21.58	20.52	<b>23.0</b>	<b>22.0</b>	<b>21.5</b>
		1880.0MHz	22.45	21.43	20.29	<b>23.0</b>	<b>22.0</b>	<b>21.5</b>
		1860.0MHz	22.53	21.49	20.50	<b>23.0</b>	<b>22.0</b>	<b>21.5</b>

Reduced power level 1								
LTE Band 2			Actual output Power (dBm)			Tune up		
Band -width	RB No. / RB offset	Frequency	Modulation			Modulation		
			QPSK	16QAM	64QAM	QPSK	16QAM	64QAM
1.4 MHz	1RB_5	1909.3MHz	19.88	19.26	18.55	21.0	20.0	19.5
		1880.0MHz	19.80	19.08	18.58	21.0	20.0	19.5
		1850.7MHz	19.73	19.15	18.52	21.0	20.0	19.5
	1RB_3	1909.3MHz	19.74	19.04	18.43	21.0	20.0	19.5
		1880.0MHz	19.79	19.27	18.64	21.0	20.0	19.5
		1850.7MHz	19.72	19.12	18.51	21.0	20.0	19.5
	1RB_0	1909.3MHz	19.69	19.16	18.41	21.0	20.0	19.5
		1880.0MHz	19.96	19.15	18.57	21.0	20.0	19.5
		1850.7MHz	19.79	19.05	18.43	21.0	20.0	19.5
	3RB_3	1909.3MHz	19.85	19.27	18.47	21.0	20.0	19.5
		1880.0MHz	19.79	19.06	18.55	21.0	20.0	19.5
		1850.7MHz	19.79	19.17	18.54	21.0	20.0	19.5
	3RB_1	1909.3MHz	19.70	19.01	18.44	21.0	20.0	19.5
		1880.0MHz	19.86	19.25	18.69	21.0	20.0	19.5
		1850.7MHz	19.72	19.08	18.48	21.0	20.0	19.5
	3RB_0	1909.3MHz	19.74	19.08	18.40	21.0	20.0	19.5
		1880.0MHz	19.96	19.19	18.56	21.0	20.0	19.5
		1850.7MHz	19.73	19.05	18.43	21.0	20.0	19.5
	6RB_0	1909.3MHz	18.98	18.72	18.45	20.0	19.0	18.5
		1880.0MHz	18.98	18.71	18.34	20.0	19.0	18.5
		1850.7MHz	18.88	18.47	18.08	20.0	19.0	18.5



Reduced power level 1								
LTE Band 2			Actual output Power (dBm)			Tune up		
Band -width	RB No. / RB offset	Frequency	Modulation			Modulation		
			QPSK	16QAM	64QAM	QPSK	16QAM	64QAM
3 MHz	1RB_14	1908.5MHz	19.86	19.24	18.55	21.0	20.0	19.5
		1880.0MHz	19.78	19.09	18.57	21.0	20.0	19.5
		1851.5MHz	19.76	19.20	18.46	21.0	20.0	19.5
	1RB_7	1908.5MHz	19.68	18.99	18.35	21.0	20.0	19.5
		1880.0MHz	19.82	19.28	18.69	21.0	20.0	19.5
		1851.5MHz	19.73	19.15	18.53	21.0	20.0	19.5
	1RB_0	1908.5MHz	19.70	19.13	18.44	21.0	20.0	19.5
		1880.0MHz	19.92	19.22	18.53	21.0	20.0	19.5
		1851.5MHz	19.77	19.05	18.47	21.0	20.0	19.5
	8RB_7	1908.5MHz	19.04	18.56	18.14	20.0	19.0	18.5
		1880.0MHz	19.07	18.67	18.24	20.0	19.0	18.5
		1851.5MHz	19.03	18.60	18.16	20.0	19.0	18.5
	8RB_4	1908.5MHz	19.02	18.54	18.00	20.0	19.0	18.5
		1880.0MHz	18.98	18.53	18.06	20.0	19.0	18.5
		1851.5MHz	18.88	18.39	17.90	20.0	19.0	18.5
	8RB_0	1908.5MHz	19.02	18.65	18.25	20.0	19.0	18.5
		1880.0MHz	19.02	18.47	18.08	20.0	19.0	18.5
		1851.5MHz	18.93	18.50	18.04	20.0	19.0	18.5
	15RB_0	1908.5MHz	19.01	18.67	18.46	20.0	19.0	18.5
		1880.0MHz	19.01	18.75	18.36	20.0	19.0	18.5
		1851.5MHz	18.88	18.55	18.05	20.0	19.0	18.5



Reduced power level 1								
LTE Band 2			Actual output Power (dBm)			Tune up		
Band -width	RB No. / RB offset	Frequency	Modulation			Modulation		
			QPSK	16QAM	64QAM	QPSK	16QAM	64QAM
5 MHz	1RB_24	1907.5MHz	19.86	19.19	18.55	21.0	20.0	19.5
		1880.0MHz	19.76	19.08	18.54	21.0	20.0	19.5
		1852.5MHz	19.80	19.10	18.50	21.0	20.0	19.5
	1RB_12	1907.5MHz	19.68	18.97	18.40	21.0	20.0	19.5
		1880.0MHz	19.87	19.19	18.67	21.0	20.0	19.5
		1852.5MHz	19.78	19.08	18.47	21.0	20.0	19.5
	1RB_0	1907.5MHz	19.78	19.12	18.40	21.0	20.0	19.5
		1880.0MHz	19.95	19.17	18.59	21.0	20.0	19.5
		1852.5MHz	19.78	19.07	18.41	21.0	20.0	19.5
	12RB_13	1907.5MHz	19.05	18.56	18.08	20.0	19.0	18.5
		1880.0MHz	18.99	18.64	18.17	20.0	19.0	18.5
		1852.5MHz	19.02	18.53	18.16	20.0	19.0	18.5
	12RB_6	1907.5MHz	19.05	18.57	17.99	20.0	19.0	18.5
		1880.0MHz	18.96	18.60	18.09	20.0	19.0	18.5
		1852.5MHz	18.94	18.46	17.93	20.0	19.0	18.5
	12RB_0	1907.5MHz	19.01	18.57	18.21	20.0	19.0	18.5
		1880.0MHz	19.00	18.49	18.09	20.0	19.0	18.5
		1852.5MHz	18.98	18.54	18.06	20.0	19.0	18.5
	25RB_0	1907.5MHz	18.96	18.69	18.46	20.0	19.0	18.5
		1880.0MHz	19.02	18.76	18.34	20.0	19.0	18.5
		1852.5MHz	18.92	18.52	18.10	20.0	19.0	18.5



Reduced power level 1								
LTE Band 2			Actual output Power (dBm)			Tune up		
Band -width	RB No. / RB offset	Frequency	Modulation			Modulation		
			QPSK	16QAM	64QAM	QPSK	16QAM	64QAM
10 MHz	1RB_49	1905.0MHz	19.79	19.23	18.52	21.0	20.0	19.5
		1880.0MHz	19.78	19.06	18.49	21.0	20.0	19.5
		1855.0MHz	19.83	19.12	18.46	21.0	20.0	19.5
	1RB_24	1905.0MHz	19.70	19.06	18.39	21.0	20.0	19.5
		1880.0MHz	19.85	19.19	18.69	21.0	20.0	19.5
		1855.0MHz	19.71	19.09	18.47	21.0	20.0	19.5
	1RB_0	1905.0MHz	19.78	19.12	18.41	21.0	20.0	19.5
		1880.0MHz	19.92	19.16	18.54	21.0	20.0	19.5
		1855.0MHz	19.74	19.14	18.40	21.0	20.0	19.5
	25RB_25	1905.0MHz	19.04	18.57	18.15	20.0	19.0	18.5
		1880.0MHz	19.00	18.65	18.18	20.0	19.0	18.5
		1855.0MHz	19.03	18.54	18.14	20.0	19.0	18.5
	25RB_12	1905.0MHz	19.05	18.51	18.08	20.0	19.0	18.5
		1880.0MHz	18.94	18.56	18.06	20.0	19.0	18.5
		1855.0MHz	18.92	18.40	17.93	20.0	19.0	18.5
	25RB_0	1905.0MHz	18.99	18.62	18.24	20.0	19.0	18.5
		1880.0MHz	19.04	18.54	18.07	20.0	19.0	18.5
		1855.0MHz	18.94	18.53	18.05	20.0	19.0	18.5
	50RB_0	1905.0MHz	19.01	18.74	18.39	20.0	19.0	18.5
		1880.0MHz	19.00	18.69	18.35	20.0	19.0	18.5
		1855.0MHz	18.92	18.49	18.04	20.0	19.0	18.5





Reduced power level 1								
LTE Band 2			Actual output Power (dBm)			Tune up		
Band -width	RB No. / RB offset	Frequency	Modulation			Modulation		
			QPSK	16QAM	64QAM	QPSK	16QAM	64QAM
15 MHz	1RB_74	1902.5MHz	19.84	19.27	18.47	21.0	20.0	19.5
		1880.0MHz	19.84	19.09	18.56	21.0	20.0	19.5
		1857.5MHz	19.80	19.14	18.55	21.0	20.0	19.5
	1RB_37	1902.5MHz	19.69	18.96	18.42	21.0	20.0	19.5
		1880.0MHz	19.85	19.20	18.66	21.0	20.0	19.5
		1857.5MHz	19.79	19.17	18.50	21.0	20.0	19.5
	1RB_0	1902.5MHz	19.69	19.13	18.46	21.0	20.0	19.5
		1880.0MHz	19.91	19.20	18.57	21.0	20.0	19.5
		1857.5MHz	19.81	19.10	18.47	21.0	20.0	19.5
	36RB_38	1902.5MHz	19.00	18.50	18.07	20.0	19.0	18.5
		1880.0MHz	19.04	18.70	18.20	20.0	19.0	18.5
		1857.5MHz	19.03	18.57	18.16	20.0	19.0	18.5
	36RB_19	1902.5MHz	18.99	18.54	18.06	20.0	19.0	18.5
		1880.0MHz	18.94	18.62	18.03	20.0	19.0	18.5
		1857.5MHz	18.96	18.41	17.92	20.0	19.0	18.5
	36RB_0	1902.5MHz	19.01	18.63	18.22	20.0	19.0	18.5
		1880.0MHz	18.99	18.47	18.04	20.0	19.0	18.5
		1857.5MHz	18.92	18.52	18.11	20.0	19.0	18.5
	75RB_0	1902.5MHz	18.99	18.68	18.39	20.0	19.0	18.5
		1880.0MHz	18.99	18.73	18.34	20.0	19.0	18.5
		1857.5MHz	18.92	18.57	18.02	20.0	19.0	18.5

Reduced power level 1								
LTE Band 2			Actual output Power (dBm)			Tune up		
Band -width	RB No. / RB offset	Frequency	Modulation			Modulation		
			QPSK	16QAM	64QAM	QPSK	16QAM	64QAM
20 MHz	1RB_99	1900.0MHz	<b>19.89</b>	19.29	18.57	<b>21.0</b>	<b>20.0</b>	<b>19.5</b>
		1880.0MHz	19.85	19.13	18.58	<b>21.0</b>	<b>20.0</b>	<b>19.5</b>
		1860.0MHz	<b>19.83</b>	19.20	18.56	<b>21.0</b>	<b>20.0</b>	<b>19.5</b>
	1RB_50	1900.0MHz	19.75	19.06	18.44	<b>21.0</b>	<b>20.0</b>	<b>19.5</b>
		1880.0MHz	19.88	19.28	18.71	<b>21.0</b>	<b>20.0</b>	<b>19.5</b>
		1860.0MHz	19.79	19.17	18.54	<b>21.0</b>	<b>20.0</b>	<b>19.5</b>
	1RB_0	1900.0MHz	19.78	19.17	18.49	<b>21.0</b>	<b>20.0</b>	<b>19.5</b>
		1880.0MHz	<b>19.98</b>	19.24	18.61	<b>21.0</b>	<b>20.0</b>	<b>19.5</b>
		1860.0MHz	19.82	19.14	18.49	<b>21.0</b>	<b>20.0</b>	<b>19.5</b>
	50RB_50	1900.0MHz	<b>19.07</b>	18.57	18.15	<b>20.0</b>	<b>19.0</b>	<b>18.5</b>
		1880.0MHz	<b>19.08</b>	18.72	18.26	<b>20.0</b>	<b>19.0</b>	<b>18.5</b>
		1860.0MHz	<b>19.04</b>	18.61	18.21	<b>20.0</b>	<b>19.0</b>	<b>18.5</b>
	50RB_25	1900.0MHz	19.06	18.58	18.09	<b>20.0</b>	<b>19.0</b>	<b>18.5</b>
		1880.0MHz	19.01	18.63	18.09	<b>20.0</b>	<b>19.0</b>	<b>18.5</b>
		1860.0MHz	18.97	18.49	17.99	<b>20.0</b>	<b>19.0</b>	<b>18.5</b>
	50RB_0	1900.0MHz	19.03	18.66	18.29	<b>20.0</b>	<b>19.0</b>	<b>18.5</b>
		1880.0MHz	19.05	18.54	18.10	<b>20.0</b>	<b>19.0</b>	<b>18.5</b>
		1860.0MHz	19.01	18.60	18.12	<b>20.0</b>	<b>19.0</b>	<b>18.5</b>
	100RB_0	1900.0MHz	19.05	18.75	18.47	<b>20.0</b>	<b>19.0</b>	<b>18.5</b>
		1880.0MHz	<b>19.06</b>	18.78	18.36	<b>20.0</b>	<b>19.0</b>	<b>18.5</b>
		1860.0MHz	18.94	18.57	18.11	<b>20.0</b>	<b>19.0</b>	<b>18.5</b>



LTE Band 5			Actual output Power (dBm)			Tune up		
Band -width	RB No. / RB offset	Frequency	Modulation			Modulation		
			QPSK	16QAM	64QAM	QPSK	16QAM	64QAM
1.4 MHz	1RB_5	848.3MHz	23.09	22.10	21.12	24.0	23.0	22.0
		836.5MHz	23.18	22.05	21.01	24.0	23.0	22.0
		824.7MHz	22.88	22.03	21.09	24.0	23.0	22.0
	1RB_3	848.3MHz	23.16	22.07	21.17	24.0	23.0	22.0
		836.5MHz	22.97	21.80	20.82	24.0	23.0	22.0
		824.7MHz	23.00	21.94	20.95	24.0	23.0	22.0
	1RB_0	848.3MHz	23.19	22.23	21.30	24.0	23.0	22.0
		836.5MHz	22.86	21.95	21.07	24.0	23.0	22.0
		824.7MHz	23.04	22.08	21.14	24.0	23.0	22.0
	3RB_3	848.3MHz	23.02	22.09	21.11	24.0	23.0	22.0
		836.5MHz	23.13	21.99	20.97	24.0	23.0	22.0
		824.7MHz	22.94	21.98	21.07	24.0	23.0	22.0
	3RB_1	848.3MHz	23.17	22.11	21.17	24.0	23.0	22.0
		836.5MHz	22.89	21.84	20.87	24.0	23.0	22.0
		824.7MHz	22.93	21.93	20.90	24.0	23.0	22.0
	3RB_0	848.3MHz	23.14	22.26	21.29	24.0	23.0	22.0
		836.5MHz	22.88	22.02	21.03	24.0	23.0	22.0
		824.7MHz	22.97	22.09	21.22	24.0	23.0	22.0
	6RB_0	848.3MHz	22.01	20.96	19.88	23.0	22.0	21.0
		836.5MHz	21.80	20.71	19.77	23.0	22.0	21.0
		824.7MHz	21.99	21.01	20.06	23.0	22.0	21.0



LTE Band 5			Actual output Power (dBm)			Tune up		
Band -width	RB No. / RB offset	Frequency	Modulation			Modulation		
			QPSK	16QAM	64QAM	QPSK	16QAM	64QAM
3 MHz	1RB_14	847.5MHz	23.08	22.13	21.18	24.0	23.0	22.0
		836.5MHz	23.15	22.02	21.05	24.0	23.0	22.0
		825.5MHz	22.89	22.04	21.01	24.0	23.0	22.0
	1RB_7	847.5MHz	23.17	22.09	21.08	24.0	23.0	22.0
		836.5MHz	22.93	21.84	20.89	24.0	23.0	22.0
		825.5MHz	22.99	21.94	20.98	24.0	23.0	22.0
	1RB_0	847.5MHz	23.21	22.20	21.29	24.0	23.0	22.0
		836.5MHz	22.86	22.01	21.02	24.0	23.0	22.0
		825.5MHz	22.99	22.05	21.18	24.0	23.0	22.0
	8RB_7	847.5MHz	21.87	21.17	20.48	23.0	22.0	21.0
		836.5MHz	22.00	21.14	20.42	23.0	22.0	21.0
		825.5MHz	21.82	21.05	20.26	23.0	22.0	21.0
	8RB_4	847.5MHz	21.95	21.02	20.20	23.0	22.0	21.0
		836.5MHz	21.81	21.04	20.21	23.0	22.0	21.0
		825.5MHz	21.89	21.04	20.11	23.0	22.0	21.0
	8RB_0	847.5MHz	21.93	21.19	20.53	23.0	22.0	21.0
		836.5MHz	21.80	21.02	20.37	23.0	22.0	21.0
		825.5MHz	21.77	21.06	20.31	23.0	22.0	21.0
	15RB_0	847.5MHz	21.97	20.89	19.90	23.0	22.0	21.0
		836.5MHz	21.71	20.79	19.79	23.0	22.0	21.0
		825.5MHz	22.06	21.08	20.06	23.0	22.0	21.0



LTE Band 5			Actual output Power (dBm)			Tune up		
Band -width	RB No. / RB offset	Frequency	Modulation			Modulation		
			QPSK	16QAM	64QAM	QPSK	16QAM	64QAM
5 MHz	1RB_24	846.5MHz	23.00	22.09	21.19	24.0	23.0	22.0
		836.5MHz	23.15	22.02	21.01	24.0	23.0	22.0
		826.5MHz	22.92	21.99	21.07	24.0	23.0	22.0
	1RB_12	846.5MHz	23.10	22.07	21.11	24.0	23.0	22.0
		836.5MHz	22.90	21.79	20.88	24.0	23.0	22.0
		826.5MHz	22.98	21.95	20.97	24.0	23.0	22.0
	1RB_0	846.5MHz	23.20	22.27	21.23	24.0	23.0	22.0
		836.5MHz	22.92	21.97	21.03	24.0	23.0	22.0
		826.5MHz	23.05	22.09	21.12	24.0	23.0	22.0
	12RB_13	846.5MHz	21.91	21.23	20.53	23.0	22.0	21.0
		836.5MHz	21.93	21.14	20.43	23.0	22.0	21.0
		826.5MHz	21.83	21.06	20.22	23.0	22.0	21.0
	12RB_6	846.5MHz	21.96	21.03	20.13	23.0	22.0	21.0
		836.5MHz	21.90	21.06	20.17	23.0	22.0	21.0
		826.5MHz	21.82	21.04	20.19	23.0	22.0	21.0
	12RB_0	846.5MHz	21.94	21.17	20.57	23.0	22.0	21.0
		836.5MHz	21.81	21.06	20.31	23.0	22.0	21.0
		826.5MHz	21.83	21.02	20.36	23.0	22.0	21.0
	25RB_0	846.5MHz	22.01	20.93	19.89	23.0	22.0	21.0
		836.5MHz	21.75	20.76	19.79	23.0	22.0	21.0
		826.5MHz	22.02	21.02	20.13	23.0	22.0	21.0



LTE Band 5			Actual output Power (dBm)			Tune up		
Band -width	RB No. / RB offset	Frequency	Modulation			Modulation		
			QPSK	16QAM	64QAM	QPSK	16QAM	64QAM
10 MHz	1RB_49	844.0MHz	23.09	22.16	21.19	<b>24.0</b>	<b>23.0</b>	<b>22.0</b>
		836.5MHz	<b>23.23</b>	22.05	21.07	<b>24.0</b>	<b>23.0</b>	<b>22.0</b>
		829.0MHz	22.96	22.06	21.11	<b>24.0</b>	<b>23.0</b>	<b>22.0</b>
	1RB_24	844.0MHz	23.19	22.16	21.18	<b>24.0</b>	<b>23.0</b>	<b>22.0</b>
		836.5MHz	22.98	21.85	20.89	<b>24.0</b>	<b>23.0</b>	<b>22.0</b>
		829.0MHz	23.02	21.96	20.98	<b>24.0</b>	<b>23.0</b>	<b>22.0</b>
	1RB_0	844.0MHz	23.22	22.29	21.33	<b>24.0</b>	<b>23.0</b>	<b>22.0</b>
		836.5MHz	22.95	22.04	21.08	<b>24.0</b>	<b>23.0</b>	<b>22.0</b>
		829.0MHz	23.06	22.11	21.22	<b>24.0</b>	<b>23.0</b>	<b>22.0</b>
	25RB_25	844.0MHz	21.97	21.25	20.54	<b>23.0</b>	<b>22.0</b>	<b>21.0</b>
		836.5MHz	<b>22.02</b>	21.20	20.49	<b>23.0</b>	<b>22.0</b>	<b>21.0</b>
		829.0MHz	21.89	21.15	20.32	<b>23.0</b>	<b>22.0</b>	<b>21.0</b>
	25RB_12	844.0MHz	22.00	21.07	20.22	<b>23.0</b>	<b>22.0</b>	<b>21.0</b>
		836.5MHz	21.90	21.12	20.25	<b>23.0</b>	<b>22.0</b>	<b>21.0</b>
		829.0MHz	21.92	21.09	20.20	<b>23.0</b>	<b>22.0</b>	<b>21.0</b>
	25RB_0	844.0MHz	22.01	21.26	20.60	<b>23.0</b>	<b>22.0</b>	<b>21.0</b>
		836.5MHz	21.85	21.08	20.41	<b>23.0</b>	<b>22.0</b>	<b>21.0</b>
		829.0MHz	21.86	21.12	20.41	<b>23.0</b>	<b>22.0</b>	<b>21.0</b>
	50RB_0	844.0MHz	22.03	20.99	19.96	<b>23.0</b>	<b>22.0</b>	<b>21.0</b>
		836.5MHz	21.80	20.80	19.86	<b>23.0</b>	<b>22.0</b>	<b>21.0</b>
		829.0MHz	22.07	21.10	20.13	<b>23.0</b>	<b>22.0</b>	<b>21.0</b>



Full Power								
LTE Band 7			Actual output Power (dBm)			Tune up		
Band -width	RB No. / RB offset	Frequency	Modulation			Modulation		
			QPSK	16QAM	64QAM	QPSK	16QAM	64QAM
5 MHz	1RB_24	2567.4MHz	21.83	21.25	20.70	22.5	22.0	21.0
		2535.0MHz	21.82	21.29	20.81	22.5	22.0	21.0
		2502.5MHz	21.83	21.26	20.86	22.5	22.0	21.0
	1RB_12	2567.4MHz	21.58	20.95	20.38	22.5	22.0	21.0
		2535.0MHz	21.71	21.12	20.54	22.5	22.0	21.0
		2502.5MHz	21.51	20.93	20.35	22.5	22.0	21.0
	1RB_0	2567.4MHz	21.53	20.90	20.23	22.5	22.0	21.0
		2535.0MHz	21.76	21.13	20.63	22.5	22.0	21.0
		2502.5MHz	21.57	20.93	20.29	22.5	22.0	21.0
	12RB_13	2567.4MHz	21.06	20.05	19.06	22.0	21.0	20.0
		2535.0MHz	21.31	20.26	19.22	22.0	21.0	20.0
		2502.5MHz	21.27	20.29	19.27	22.0	21.0	20.0
	12RB_6	2567.4MHz	21.01	19.97	18.99	22.0	21.0	20.0
		2535.0MHz	21.09	20.21	19.21	22.0	21.0	20.0
		2502.5MHz	21.12	20.15	19.19	22.0	21.0	20.0
	12RB_0	2567.4MHz	21.05	20.08	19.14	22.0	21.0	20.0
		2535.0MHz	21.21	20.32	19.51	22.0	21.0	20.0
		2502.5MHz	21.20	20.22	19.29	22.0	21.0	20.0
	25RB_0	2567.4MHz	20.97	20.14	19.16	22.0	21.0	20.0
		2535.0MHz	21.16	20.28	19.44	22.0	21.0	20.0
		2502.5MHz	21.20	20.27	19.29	22.0	21.0	20.0



Full Power								
LTE Band 7			Actual output Power (dBm)			Tune up		
Band -width	RB No. / RB offset	Frequency	Modulation			Modulation		
			QPSK	16QAM	64QAM	QPSK	16QAM	64QAM
10 MHz	1RB_49	2565.0MHz	21.81	21.21	20.69	22.5	22.0	21.0
		2535.0MHz	21.77	21.23	20.82	22.5	22.0	21.0
		2505.0MHz	21.80	21.35	20.85	22.5	22.0	21.0
	1RB_24	2565.0MHz	21.59	20.92	20.33	22.5	22.0	21.0
		2535.0MHz	21.71	21.04	20.48	22.5	22.0	21.0
		2505.0MHz	21.47	20.87	20.38	22.5	22.0	21.0
	1RB_0	2565.0MHz	21.53	20.87	20.24	22.5	22.0	21.0
		2535.0MHz	21.75	21.12	20.55	22.5	22.0	21.0
		2505.0MHz	21.53	20.88	20.26	22.5	22.0	21.0
	25RB_25	2565.0MHz	21.06	20.10	19.02	22.0	21.0	20.0
		2535.0MHz	21.27	20.30	19.23	22.0	21.0	20.0
		2505.0MHz	21.29	20.24	19.24	22.0	21.0	20.0
	25RB_12	2565.0MHz	21.00	19.97	19.02	22.0	21.0	20.0
		2535.0MHz	21.17	20.16	19.16	22.0	21.0	20.0
		2505.0MHz	21.11	20.20	19.26	22.0	21.0	20.0
	25RB_0	2565.0MHz	21.09	20.09	19.05	22.0	21.0	20.0
		2535.0MHz	21.25	20.36	19.52	22.0	21.0	20.0
		2505.0MHz	21.16	20.25	19.26	22.0	21.0	20.0
	50RB_0	2565.0MHz	20.98	20.15	19.20	22.0	21.0	20.0
		2535.0MHz	21.14	20.29	19.46	22.0	21.0	20.0
		2505.0MHz	21.21	20.26	19.35	22.0	21.0	20.0





Full Power								
LTE Band 7			Actual output Power (dBm)			Tune up		
Band -width	RB No. / RB offset	Frequency	Modulation			Modulation		
			QPSK	16QAM	64QAM	QPSK	16QAM	64QAM
15 MHz	1RB_74	2562.5MHz	21.82	21.22	20.71	22.5	22.0	21.0
		2535.0MHz	21.78	21.30	20.82	22.5	22.0	21.0
		2507.5MHz	21.83	21.32	20.88	22.5	22.0	21.0
	1RB_37	2562.5MHz	21.53	20.94	20.36	22.5	22.0	21.0
		2535.0MHz	21.66	21.10	20.53	22.5	22.0	21.0
		2507.5MHz	21.51	20.86	20.39	22.5	22.0	21.0
	1RB_0	2562.5MHz	21.56	20.88	20.27	22.5	22.0	21.0
		2535.0MHz	21.78	21.14	20.58	22.5	22.0	21.0
		2507.5MHz	21.49	20.94	20.29	22.5	22.0	21.0
	36RB_38	2562.5MHz	21.08	20.08	19.01	22.0	21.0	20.0
		2535.0MHz	21.27	20.32	19.26	22.0	21.0	20.0
		2507.5MHz	21.28	20.28	19.24	22.0	21.0	20.0
	36RB_19	2562.5MHz	20.94	20.03	19.00	22.0	21.0	20.0
		2535.0MHz	21.10	20.23	19.16	22.0	21.0	20.0
		2507.5MHz	21.11	20.18	19.27	22.0	21.0	20.0
	36RB_0	2562.5MHz	21.06	20.12	19.11	22.0	21.0	20.0
		2535.0MHz	21.23	20.36	19.56	22.0	21.0	20.0
		2507.5MHz	21.12	20.31	19.34	22.0	21.0	20.0
	75RB_0	2562.5MHz	20.97	20.11	19.12	22.0	21.0	20.0
		2535.0MHz	21.22	20.29	19.44	22.0	21.0	20.0
		2507.5MHz	21.20	20.25	19.28	22.0	21.0	20.0



Full Power								
LTE Band 7			Actual output Power (dBm)			Tune up		
Band -width	RB No. / RB offset	Frequency	Modulation			Modulation		
			QPSK	16QAM	64QAM	QPSK	16QAM	64QAM
20 MHz	1RB_99	2560.0MHz	21.85	21.27	20.78	<b>22.5</b>	<b>22.0</b>	<b>21.0</b>
		2535.0MHz	21.83	21.31	20.83	<b>22.5</b>	<b>22.0</b>	<b>21.0</b>
		2510.0MHz	<b>21.87</b>	21.36	20.93	<b>22.5</b>	<b>22.0</b>	<b>21.0</b>
	1RB_50	2560.0MHz	21.60	21.00	20.41	<b>22.5</b>	<b>22.0</b>	<b>21.0</b>
		2535.0MHz	21.73	21.13	20.57	<b>22.5</b>	<b>22.0</b>	<b>21.0</b>
		2510.0MHz	21.54	20.95	20.43	<b>22.5</b>	<b>22.0</b>	<b>21.0</b>
	1RB_0	2560.0MHz	21.59	20.95	20.30	<b>22.5</b>	<b>22.0</b>	<b>21.0</b>
		2535.0MHz	21.79	21.21	20.64	<b>22.5</b>	<b>22.0</b>	<b>21.0</b>
		2510.0MHz	21.58	20.96	20.33	<b>22.5</b>	<b>22.0</b>	<b>21.0</b>
	50RB_50	2560.0MHz	21.15	20.15	19.07	<b>22.0</b>	<b>21.0</b>	<b>20.0</b>
		2535.0MHz	21.31	20.34	19.30	<b>22.0</b>	<b>21.0</b>	<b>20.0</b>
		2510.0MHz	<b>21.33</b>	20.32	19.29	<b>22.0</b>	<b>21.0</b>	<b>20.0</b>
	50RB_25	2560.0MHz	21.02	20.05	19.03	<b>22.0</b>	<b>21.0</b>	<b>20.0</b>
		2535.0MHz	21.18	20.25	19.26	<b>22.0</b>	<b>21.0</b>	<b>20.0</b>
		2510.0MHz	21.17	20.24	19.29	<b>22.0</b>	<b>21.0</b>	<b>20.0</b>
	50RB_0	2560.0MHz	21.13	20.14	19.15	<b>22.0</b>	<b>21.0</b>	<b>20.0</b>
		2535.0MHz	21.29	20.41	19.59	<b>22.0</b>	<b>21.0</b>	<b>20.0</b>
		2510.0MHz	21.22	20.31	19.35	<b>22.0</b>	<b>21.0</b>	<b>20.0</b>
	100RB_0	2560.0MHz	21.00	20.16	19.20	<b>22.0</b>	<b>21.0</b>	<b>20.0</b>
		2535.0MHz	21.22	20.36	19.49	<b>22.0</b>	<b>21.0</b>	<b>20.0</b>
		2510.0MHz	21.23	20.33	19.36	<b>22.0</b>	<b>21.0</b>	<b>20.0</b>



LTE Band 12			Actual output Power (dBm)			Tune up		
Band -width	RB No. / RB offset	Frequency	Modulation			Modulation		
			QPSK	16QAM	64QAM	QPSK	16QAM	64QAM
1.4 MHz	1RB_5	715.3MHz	23.10	22.34	21.53	24.0	23.0	22.0
		707.5MHz	23.20	22.14	21.60	24.0	23.0	22.0
		699.7MHz	22.96	22.32	21.72	24.0	23.0	22.0
	1RB_3	715.3MHz	22.97	22.33	21.59	24.0	23.0	22.0
		707.5MHz	22.92	22.16	21.37	24.0	23.0	22.0
		699.7MHz	23.09	22.34	21.61	24.0	23.0	22.0
	1RB_0	715.3MHz	22.99	22.43	21.81	24.0	23.0	22.0
		707.5MHz	23.07	22.43	21.64	24.0	23.0	22.0
		699.7MHz	23.12	22.43	21.76	24.0	23.0	22.0
	3RB_3	715.3MHz	23.03	22.35	21.54	24.0	23.0	22.0
		707.5MHz	23.15	22.13	21.57	24.0	23.0	22.0
		699.7MHz	23.02	22.33	21.65	24.0	23.0	22.0
	3RB_1	715.3MHz	22.92	22.31	21.57	24.0	23.0	22.0
		707.5MHz	22.91	22.22	21.38	24.0	23.0	22.0
		699.7MHz	23.03	22.36	21.64	24.0	23.0	22.0
	3RB_0	715.3MHz	23.02	22.42	21.78	24.0	23.0	22.0
		707.5MHz	23.14	22.41	21.73	24.0	23.0	22.0
		699.7MHz	23.19	22.43	21.72	24.0	23.0	22.0
	6RB_0	715.3MHz	22.30	21.18	19.95	23.0	22.0	21.0
		707.5MHz	22.39	21.20	19.95	23.0	22.0	21.0
		699.7MHz	22.43	21.32	20.17	23.0	22.0	21.0



LTE Band 12			Actual output Power (dBm)			Tune up		
Band -width	RB No. / RB offset	Frequency	Modulation			Modulation		
			QPSK	16QAM	64QAM	QPSK	16QAM	64QAM
3 MHz	1RB_14	714.5MHz	23.01	22.31	21.55	24.0	23.0	22.0
		707.5MHz	23.15	22.12	21.55	24.0	23.0	22.0
		700.5MHz	22.99	22.32	21.68	24.0	23.0	22.0
	1RB_7	714.5MHz	22.93	22.28	21.60	24.0	23.0	22.0
		707.5MHz	22.93	22.15	21.39	24.0	23.0	22.0
		700.5MHz	23.11	22.37	21.56	24.0	23.0	22.0
	1RB_0	714.5MHz	23.02	22.38	21.79	24.0	23.0	22.0
		707.5MHz	23.10	22.41	21.73	24.0	23.0	22.0
		700.5MHz	23.17	22.47	21.75	24.0	23.0	22.0
	8RB_7	714.5MHz	22.30	21.32	20.09	23.0	22.0	21.0
		707.5MHz	22.35	21.34	20.29	23.0	22.0	21.0
		700.5MHz	22.31	21.23	20.20	23.0	22.0	21.0
	8RB_4	714.5MHz	22.39	21.20	20.16	23.0	22.0	21.0
		707.5MHz	22.32	21.07	19.85	23.0	22.0	21.0
		700.5MHz	22.40	21.30	20.04	23.0	22.0	21.0
	8RB_0	714.5MHz	22.36	21.19	20.08	23.0	22.0	21.0
		707.5MHz	22.32	21.07	19.90	23.0	22.0	21.0
		700.5MHz	22.37	21.34	20.03	23.0	22.0	21.0
15RB_0	714.5MHz	22.30	21.17	19.98	23.0	22.0	21.0	
	707.5MHz	22.39	21.19	19.89	23.0	22.0	21.0	
	700.5MHz	22.43	21.27	20.18	23.0	22.0	21.0	

LTE Band 12			Actual output Power (dBm)			Tune up		
Band -width	RB No. / RB offset	Frequency	Modulation			Modulation		
			QPSK	16QAM	64QAM	QPSK	16QAM	64QAM
5 MHz	1RB_24	713.5MHz	23.04	22.28	21.61	24.0	23.0	22.0
		707.5MHz	23.16	22.19	21.55	24.0	23.0	22.0
		701.5MHz	23.01	22.31	21.67	24.0	23.0	22.0
	1RB_12	713.5MHz	22.95	22.31	21.57	24.0	23.0	22.0
		707.5MHz	22.93	22.17	21.38	24.0	23.0	22.0
		701.5MHz	23.10	22.40	21.61	24.0	23.0	22.0
	1RB_0	713.5MHz	22.97	22.43	21.78	24.0	23.0	22.0
		707.5MHz	23.12	22.39	21.72	24.0	23.0	22.0
		701.5MHz	23.11	22.49	21.73	24.0	23.0	22.0
	12RB_13	713.5MHz	22.37	21.26	20.19	23.0	22.0	21.0
		707.5MHz	22.38	21.38	20.21	23.0	22.0	21.0
		701.5MHz	22.31	21.31	20.17	23.0	22.0	21.0
	12RB_6	713.5MHz	22.42	21.20	20.14	23.0	22.0	21.0
		707.5MHz	22.35	21.09	19.87	23.0	22.0	21.0
		701.5MHz	22.37	21.24	20.11	23.0	22.0	21.0
	12RB_0	713.5MHz	22.30	21.20	20.17	23.0	22.0	21.0
		707.5MHz	22.31	21.05	19.90	23.0	22.0	21.0
		701.5MHz	22.35	21.31	20.07	23.0	22.0	21.0
	25RB_0	713.5MHz	22.35	21.23	19.93	23.0	22.0	21.0
		707.5MHz	22.33	21.18	19.93	23.0	22.0	21.0
		701.5MHz	22.42	21.28	20.17	23.0	22.0	21.0

LTE Band 12			Actual output Power (dBm)			Tune up		
Band -width	RB No. / RB offset	Frequency	Modulation			Modulation		
			QPSK	16QAM	64QAM	QPSK	16QAM	64QAM
10 MHz	1RB_49	711.0MHz	23.10	22.38	21.62	<b>24.0</b>	<b>23.0</b>	<b>22.0</b>
		707.5MHz	<b>23.21</b>	22.22	21.61	<b>24.0</b>	<b>23.0</b>	<b>22.0</b>
		704.0MHz	23.05	22.37	21.74	<b>24.0</b>	<b>23.0</b>	<b>22.0</b>
	1RB_24	711.0MHz	22.98	22.34	21.67	<b>24.0</b>	<b>23.0</b>	<b>22.0</b>
		707.5MHz	22.96	22.23	21.45	<b>24.0</b>	<b>23.0</b>	<b>22.0</b>
		704.0MHz	23.13	22.41	21.65	<b>24.0</b>	<b>23.0</b>	<b>22.0</b>
	1RB_0	711.0MHz	23.06	22.47	21.81	<b>24.0</b>	<b>23.0</b>	<b>22.0</b>
		707.5MHz	23.15	22.47	21.74	<b>24.0</b>	<b>23.0</b>	<b>22.0</b>
		704.0MHz	23.20	22.52	21.76	<b>24.0</b>	<b>23.0</b>	<b>22.0</b>
	25RB_25	711.0MHz	22.38	21.33	20.19	<b>23.0</b>	<b>22.0</b>	<b>21.0</b>
		707.5MHz	<b>22.45</b>	21.43	20.29	<b>23.0</b>	<b>22.0</b>	<b>21.0</b>
		704.0MHz	22.40	21.31	20.24	<b>23.0</b>	<b>22.0</b>	<b>21.0</b>
	25RB_12	711.0MHz	22.43	21.23	20.20	<b>23.0</b>	<b>22.0</b>	<b>21.0</b>
		707.5MHz	22.35	21.12	19.92	<b>23.0</b>	<b>22.0</b>	<b>21.0</b>
		704.0MHz	22.41	21.33	20.14	<b>23.0</b>	<b>22.0</b>	<b>21.0</b>
	25RB_0	711.0MHz	22.38	21.28	20.18	<b>23.0</b>	<b>22.0</b>	<b>21.0</b>
		707.5MHz	22.38	21.14	20.00	<b>23.0</b>	<b>22.0</b>	<b>21.0</b>
		704.0MHz	22.37	21.38	20.12	<b>23.0</b>	<b>22.0</b>	<b>21.0</b>
	50RB_0	711.0MHz	22.36	21.25	20.02	<b>23.0</b>	<b>22.0</b>	<b>21.0</b>
		707.5MHz	22.40	21.21	19.97	<b>23.0</b>	<b>22.0</b>	<b>21.0</b>
		704.0MHz	22.49	21.32	20.25	<b>23.0</b>	<b>22.0</b>	<b>21.0</b>



LTE Band 28			Actual output Power (dBm)			Tune up		
Band -width	RB No. / RB offset	Frequency	Modulation			Modulation		
			QPSK	16QAM	64QAM	QPSK	16QAM	64QAM
3 MHz	1RB_14	746.5MHz	22.67	22.19	21.61	24.0	23.0	22.0
		719.5MHz	22.94	22.41	21.91	24.0	23.0	22.0
		704.5MHz	22.95	22.39	21.74	24.0	23.0	22.0
	1RB_7	746.5MHz	22.73	22.30	21.74	24.0	23.0	22.0
		719.5MHz	22.73	22.38	21.74	24.0	23.0	22.0
		704.5MHz	22.91	22.42	21.95	24.0	23.0	22.0
	1RB_0	746.5MHz	22.64	22.03	21.52	24.0	23.0	22.0
		719.5MHz	22.89	22.23	21.63	24.0	23.0	22.0
		704.5MHz	22.89	22.22	21.72	24.0	23.0	22.0
	8RB_7	746.5MHz	22.28	21.20	20.19	23.0	22.0	21.0
		719.5MHz	22.45	21.62	20.75	23.0	22.0	21.0
		704.5MHz	22.44	21.51	20.65	23.0	22.0	21.0
	8RB_4	746.5MHz	22.33	21.22	20.10	23.0	22.0	21.0
		719.5MHz	22.43	21.33	20.03	23.0	22.0	21.0
		704.5MHz	22.46	21.26	20.06	23.0	22.0	21.0
	8RB_0	746.5MHz	22.16	20.82	19.70	23.0	22.0	21.0
		719.5MHz	22.37	21.09	19.79	23.0	22.0	21.0
		704.5MHz	22.43	21.20	19.87	23.0	22.0	21.0
15RB_0	746.5MHz	22.28	21.20	20.12	23.0	22.0	21.0	
	719.5MHz	22.09	20.91	19.87	23.0	22.0	21.0	
	704.5MHz	22.39	21.29	20.18	23.0	22.0	21.0	



LTE Band 28			Actual output Power (dBm)			Tune up		
Band -width	RB No. / RB offset	Frequency	Modulation			Modulation		
			QPSK	16QAM	64QAM	QPSK	16QAM	64QAM
5 MHz	1RB_24	745.5MHz	22.66	22.15	21.60	24.0	23.0	22.0
		720.5MHz	22.92	22.40	21.95	24.0	23.0	22.0
		705.5MHz	22.95	22.40	21.74	24.0	23.0	22.0
	1RB_12	745.5MHz	22.74	22.32	21.71	24.0	23.0	22.0
		720.5MHz	22.79	22.41	21.76	24.0	23.0	22.0
		705.5MHz	22.86	22.41	21.91	24.0	23.0	22.0
	1RB_0	745.5MHz	22.68	22.05	21.55	24.0	23.0	22.0
		720.5MHz	22.91	22.27	21.67	24.0	23.0	22.0
		705.5MHz	22.93	22.24	21.70	24.0	23.0	22.0
	12RB_13	745.5MHz	22.24	21.25	20.25	23.0	22.0	21.0
		720.5MHz	22.45	21.57	20.77	23.0	22.0	21.0
		705.5MHz	22.49	21.51	20.60	23.0	22.0	21.0
	12RB_6	745.5MHz	22.29	21.17	20.09	23.0	22.0	21.0
		720.5MHz	22.43	21.28	20.01	23.0	22.0	21.0
		705.5MHz	22.46	21.21	20.10	23.0	22.0	21.0
	12RB_0	745.5MHz	22.16	20.79	19.69	23.0	22.0	21.0
		720.5MHz	22.42	21.05	19.77	23.0	22.0	21.0
		705.5MHz	22.47	21.21	19.90	23.0	22.0	21.0
	25RB_0	745.5MHz	22.29	21.22	20.13	23.0	22.0	21.0
		720.5MHz	22.14	20.96	19.87	23.0	22.0	21.0
		705.5MHz	22.39	21.23	20.22	23.0	22.0	21.0





LTE Band 28			Actual output Power (dBm)			Tune up		
Band -width	RB No. / RB offset	Frequency	Modulation			Modulation		
			QPSK	16QAM	64QAM	QPSK	16QAM	64QAM
10 MHz	1RB_49	743MHz	22.66	22.16	21.59	24.0	23.0	22.0
		723MHz	22.93	22.36	21.87	24.0	23.0	22.0
		708MHz	22.94	22.42	21.77	24.0	23.0	22.0
	1RB_24	743MHz	22.76	22.35	21.77	24.0	23.0	22.0
		723MHz	22.79	22.40	21.80	24.0	23.0	22.0
		708MHz	22.87	22.42	21.92	24.0	23.0	22.0
	1RB_0	743MHz	22.65	22.01	21.53	24.0	23.0	22.0
		723MHz	22.91	22.29	21.66	24.0	23.0	22.0
		708MHz	22.91	22.31	21.67	24.0	23.0	22.0
	25RB_25	743MHz	22.29	21.24	20.19	23.0	22.0	21.0
		723MHz	22.49	21.61	20.79	23.0	22.0	21.0
		708MHz	22.47	21.44	20.61	23.0	22.0	21.0
	25RB_12	743MHz	22.36	21.21	20.07	23.0	22.0	21.0
		723MHz	22.44	21.26	19.98	23.0	22.0	21.0
		708MHz	22.43	21.28	20.14	23.0	22.0	21.0
	25RB_0	743MHz	22.14	20.80	19.66	23.0	22.0	21.0
		723MHz	22.38	21.13	19.75	23.0	22.0	21.0
		708MHz	22.45	21.18	19.92	23.0	22.0	21.0
	50RB_0	743MHz	22.28	21.18	20.07	23.0	22.0	21.0
		723MHz	22.06	20.93	19.89	23.0	22.0	21.0
		708MHz	22.30	21.28	20.14	23.0	22.0	21.0



LTE Band 28			Actual output Power (dBm)			Tune up		
Band -width	RB No. / RB offset	Frequency	Modulation			Modulation		
			QPSK	16QAM	64QAM	QPSK	16QAM	64QAM
15 MHz	1RB_74	740.5MHz	22.72	22.19	21.62	24.0	23.0	22.0
		725.5MHz	22.96	22.36	21.87	24.0	23.0	22.0
		710.5MHz	22.96	22.34	21.82	24.0	23.0	22.0
	1RB_37	740.5MHz	22.80	22.30	21.69	24.0	23.0	22.0
		725.5MHz	22.79	22.34	21.77	24.0	23.0	22.0
		710.5MHz	22.87	22.45	21.92	24.0	23.0	22.0
	1RB_0	740.5MHz	22.68	22.01	21.48	24.0	23.0	22.0
		725.5MHz	22.90	22.25	21.64	24.0	23.0	22.0
		710.5MHz	22.94	22.30	21.70	24.0	23.0	22.0
	36RB_38	740.5MHz	22.30	21.28	20.24	23.0	22.0	21.0
		725.5MHz	22.47	21.62	20.71	23.0	22.0	21.0
		710.5MHz	22.42	21.50	20.66	23.0	22.0	21.0
	36RB_19	740.5MHz	22.31	21.15	20.14	23.0	22.0	21.0
		725.5MHz	22.52	21.32	20.00	23.0	22.0	21.0
		710.5MHz	22.46	21.28	20.13	23.0	22.0	21.0
	36RB_0	740.5MHz	22.19	20.80	19.66	23.0	22.0	21.0
		725.5MHz	22.32	21.10	19.77	23.0	22.0	21.0
		710.5MHz	22.43	21.22	19.85	23.0	22.0	21.0
	75RB_0	740.5MHz	22.33	21.25	20.06	23.0	22.0	21.0
		725.5MHz	22.12	20.92	19.89	23.0	22.0	21.0
		710.5MHz	22.32	21.24	20.20	23.0	22.0	21.0



LTE Band 28			Actual output Power (dBm)			Tune up		
Band -width	RB No. / RB offset	Frequency	Modulation			Modulation		
			QPSK	16QAM	64QAM	QPSK	16QAM	64QAM
20 MHz	1RB_99	738MHz	22.74	22.22	21.63	24.0	23.0	22.0
		728MHz	<b>22.98</b>	22.45	21.97	24.0	23.0	22.0
		713MHz	22.97	22.42	21.83	24.0	23.0	22.0
	1RB_50	738MHz	22.83	22.35	21.79	24.0	23.0	22.0
		728MHz	22.81	22.41	21.83	24.0	23.0	22.0
		713MHz	22.94	22.46	21.90	24.0	23.0	22.0
	1RB_0	738MHz	22.74	22.09	21.56	24.0	23.0	22.0
		728MHz	22.93	22.32	21.69	24.0	23.0	22.0
		713MHz	22.95	22.32	21.76	24.0	23.0	22.0
	50RB_50	738MHz	22.34	21.30	20.27	23.0	22.0	21.0
		728MHz	<b>22.54</b>	21.66	20.79	23.0	22.0	21.0
		713MHz	22.50	21.54	20.68	23.0	22.0	21.0
	50RB_25	738MHz	22.38	21.24	20.15	23.0	22.0	21.0
		728MHz	22.53	21.34	20.07	23.0	22.0	21.0
		713MHz	22.50	21.31	20.15	23.0	22.0	21.0
	50RB_0	738MHz	22.21	20.88	19.70	23.0	22.0	21.0
		728MHz	22.42	21.14	19.84	23.0	22.0	21.0
		713MHz	22.47	21.23	19.92	23.0	22.0	21.0
	100RB_0	738MHz	22.36	21.28	20.15	23.0	22.0	21.0
		728MHz	22.15	21.00	19.90	23.0	22.0	21.0
		713MHz	22.39	21.33	20.23	23.0	22.0	21.0



Full Power								
LTE Band 66			Actual output Power (dBm)			Tune up		
Band -width	RB No. / RB offset	Frequency	Modulation			Modulation		
			QPSK	16QAM	64QAM	QPSK	16QAM	64QAM
1.4 MHz	1RB_5	1779.3MHz	22.95	21.99	20.95	24.0	23.0	22.0
		1745.0MHz	22.87	21.79	20.80	24.0	23.0	22.0
		1710.7MHz	23.26	22.20	21.06	24.0	23.0	22.0
	1RB_3	1779.3MHz	22.97	21.90	20.91	24.0	23.0	22.0
		1745.0MHz	22.92	21.91	20.89	24.0	23.0	22.0
		1710.7MHz	23.10	21.99	20.85	24.0	23.0	22.0
	1RB_0	1779.3MHz	22.96	21.83	20.66	24.0	23.0	22.0
		1745.0MHz	22.96	21.61	20.45	24.0	23.0	22.0
		1710.7MHz	23.20	21.97	20.81	24.0	23.0	22.0
	3RB_3	1779.3MHz	22.97	22.00	20.97	24.0	23.0	22.0
		1745.0MHz	22.86	21.77	20.75	24.0	23.0	22.0
		1710.7MHz	23.23	22.17	21.12	24.0	23.0	22.0
	3RB_1	1779.3MHz	22.99	21.88	20.87	24.0	23.0	22.0
		1745.0MHz	22.88	21.87	20.94	24.0	23.0	22.0
		1710.7MHz	23.04	22.02	20.93	24.0	23.0	22.0
	3RB_0	1779.3MHz	23.04	21.81	20.62	24.0	23.0	22.0
		1745.0MHz	22.89	21.68	20.38	24.0	23.0	22.0
		1710.7MHz	23.19	21.99	20.78	24.0	23.0	22.0
	6RB_0	1779.3MHz	22.00	21.15	20.36	23.0	22.0	21.0
		1745.0MHz	21.96	21.20	20.40	23.0	22.0	21.0
		1710.7MHz	21.98	21.15	20.23	23.0	22.0	21.0



Full Power								
LTE Band 66			Actual output Power (dBm)			Tune up		
Band -width	RB No. / RB offset	Frequency	Modulation			Modulation		
			QPSK	16QAM	64QAM	QPSK	16QAM	64QAM
3 MHz	1RB_14	1778.5MHz	23.02	21.97	20.97	24.0	23.0	22.0
		1745.0MHz	22.80	21.79	20.81	24.0	23.0	22.0
		1711.5MHz	23.25	22.18	21.11	24.0	23.0	22.0
	1RB_7	1778.5MHz	22.97	21.87	20.91	24.0	23.0	22.0
		1745.0MHz	22.84	21.87	20.95	24.0	23.0	22.0
		1711.5MHz	23.06	22.01	20.88	24.0	23.0	22.0
	1RB_0	1778.5MHz	23.02	21.88	20.69	24.0	23.0	22.0
		1745.0MHz	22.92	21.62	20.37	24.0	23.0	22.0
		1711.5MHz	23.12	22.01	20.81	24.0	23.0	22.0
	8RB_7	1778.5MHz	21.98	20.96	19.84	23.0	22.0	21.0
		1745.0MHz	22.05	21.09	19.93	23.0	22.0	21.0
		1711.5MHz	22.10	21.00	20.02	23.0	22.0	21.0
	8RB_4	1778.5MHz	21.87	20.97	19.81	23.0	22.0	21.0
		1745.0MHz	21.90	20.84	19.76	23.0	22.0	21.0
		1711.5MHz	22.02	20.94	19.90	23.0	22.0	21.0
	8RB_0	1778.5MHz	21.95	20.83	19.84	23.0	22.0	21.0
		1745.0MHz	22.03	20.85	19.75	23.0	22.0	21.0
		1711.5MHz	22.08	20.95	19.84	23.0	22.0	21.0
	15RB_0	1778.5MHz	22.07	21.17	20.36	23.0	22.0	21.0
		1745.0MHz	22.03	21.16	20.33	23.0	22.0	21.0
		1711.5MHz	22.00	21.16	20.23	23.0	22.0	21.0