



TEST REPORT

No.I20N03224-SAR

For

HMD Global Oy

Multi-band GSM/WCDMA/LTE phone with Bluetooth, WLAN

Model Name: TA-1338

With

Hardware Version: 99652_1_11

Software Version: 000T_0_080

FCC ID: 2AJOTTA-1338

Issued Date: 2021-01-21

Designation Number: CN1210

Note:

The test results in this test report relate only to the devices specified in this report. This report shall not be reproduced except in full without the written approval of SAICT.

Test Laboratory:

SAICT, Shenzhen Academy of Information and Communications Technology

Building G, Shenzhen International Innovation Center, No.1006 Shennan Road, Futian District, Shenzhen, Guangdong, P. R. China 518000.

Tel:+86(0)755-33322000, Fax:+86(0)755-33322001

Email: yewu@caict.ac.cn. www.saict.ac.cn



REPORT HISTORY

Report Number	Revision	Description	Issue Date
I20N03224-SAR	Rev.0	1st edition	2021-01-21



TCONTENTS

1. SUMMARY OF TEST REPORT	5
1.1. TEST ITEMS	5
1.2. TEST STANDARDS	5
1.3. TEST RESULT.....	5
1.4. TESTING LOCATION	5
1.5. PROJECT DATA	5
1.6. SIGNATURE	5
2. STATEMENT OF COMPLIANCE	6
3. CLIENT INFORMATION	9
3.1. APPLICANT INFORMATION.....	9
3.2. MANUFACTURER INFORMATION	9
4. EQUIPMENT UNDER TEST (EUT) AND ANCILLARY EQUIPMENT (AE)	10
4.1. ABOUT EUT	10
4.2. INTERNAL IDENTIFICATION OF EUT USED DURING THE TEST	11
4.3. INTERNAL IDENTIFICATION OF AE USED DURING THE TEST	11
5. TEST METHODOLOGY	12
5.1. APPLICABLE LIMIT REGULATIONS.....	12
5.2. APPLICABLE MEASUREMENT STANDARDS	12
6. SPECIFIC ABSORPTION RATE (SAR).....	13
6.1. INTRODUCTION.....	13
6.2. SAR DEFINITION.....	13
7. TISSUE SIMULATING LIQUIDS	14
7.1. TARGETS FOR TISSUE SIMULATING LIQUID	14
7.2. DIELECTRIC PERFORMANCE	14
8. SYSTEM VERIFICATION	18
8.1. SYSTEM SETUP.....	18
8.2. SYSTEM VERIFICATION	19
9. MEASUREMENT PROCEDURES	20
9.1. TESTS TO BE PERFORMED.....	20
9.2. GENERAL MEASUREMENT PROCEDURE	22
9.3. WCDMA MEASUREMENT PROCEDURES FOR SAR	23
9.4. SAR MEASUREMENT FOR LTE.....	24
9.5. BLUETOOTH & WLAN MEASUREMENT PROCEDURES FOR SAR.....	24
9.6. POWER DRIFT.....	25
9.7. PROXIMITY SENSOR CONSIDERATIONS	25



10. CONDUCTED OUTPUT POWER26

10.1. GSM MEASUREMENT RESULT 26

10.2. WCDMA MEASUREMENT RESULT 28

10.3. LTE MEASUREMENT RESULT 31

10.4. BLUETOOTH AND WLAN MEASUREMENT RESULT 85

11. SIMULTANEOUS TX SAR CONSIDERATIONS86

11.1. INTRODUCTION 86

11.2. TRANSMIT ANTENNA SEPARATION DISTANCES 86

11.3. SAR MEASUREMENT POSITIONS 87

11.4. STANDALONE SAR TEST EXCLUSION CONSIDERATIONS 87

12. EVALUATION OF SIMULTANEOUS88

13. SUMMARY OF TEST RESULTS89

13.1. TESTING ENVIRONMENT 89

13.2. SAR RESULTS 90

13.3. WLAN EVALUATION FOR 2.4G 106

13.4. PRODUCT SPECIFIC 10G SAR 107

14. SAR MEASUREMENT VARIABILITY108

15. MEASUREMENT UNCERTAINTY109

15.1. MEASUREMENT UNCERTAINTY FOR NORMAL SAR TESTS (300MHZ~3GHZ) 109

16. MAIN TEST INSTRUMENTS 110

ANNEX A: GRAPH RESULTS 111

ANNEX B: SYSTEMVERIFICATION RESULTS137

ANNEX C: SAR MEASUREMENT SETUP143

ANNEX D: POSITION OF THE WIRELESS DEVICE IN RELATION TO THE PHANTOM149

ANNEX E: EQUIVALENT MEDIA RECIPES152

ANNEX F: SYSTEM VALIDATION153

ANNEX G: DAE CALIBRATION CERTIFICATE154

ANNEX H: PROBE CALIBRATION CERTIFICATE157

ANNEX I: DIPOLE CALIBRATION CERTIFICATE167

ANNEX J: EXTENDED CALIBRATION SAR DIPOLE215

ANNEX K: SENSOR TRIGGERING DATA SUMMARY217

1. Summary of Test Report

1.1. Test Items

Description: Multi-band GSM/WCDMA/LTE phone with Bluetooth, WLAN
Model Name: TA-1338
Applicant's name: HMD Global Oy
Manufacturer's Name: HMD Global Oy

1.2. Test Standards

ANSI C95.1:1992, IEEE 1528:2013

1.3. Test Result

Pass. Please refer to "13. Summary of Test Results"

1.4. Testing Location

Address: Building G, Shenzhen International Innovation Center, No.1006 Shennan Road,
Futian District, Shenzhen, Guangdong, P. R. China

1.5. Project Data

Testing Start Date: 2020-12-21

Testing End Date: 2021-01-02

1.6. Signature



Li Yongfu

(Prepared this test report)



Zhang Yunzhan

(Reviewed this test report)



Cao Junfei

(Approved this test report)

2. Statement of Compliance

The maximum results of Specific Absorption Rate (SAR) found during testing for HMD Global Oy Multi-band GSM/WCDMA/LTE phone with Bluetooth, WLAN TA-1338 are as follows:

Table 2.1: Highest Reported SAR for Head (1g)

Exposure Configuration	Technology Band	Highest Reported SAR 1g(W/Kg)	Equipment Class
Head	GSM850	0.29	PCE
	GSM1900	0.13	
	WCDMA Band 2	0.27	
	WCDMA Band 4	0.17	
	WCDMA Band 5	0.28	
	LTE Band 2	0.29	
	LTE Band 4	0.14	
	LTE Band 5	0.27	
	LTE Band 7	0.08	
	LTE Band 12	0.15	
	LTE Band 17	0.16	
	LTE Band 66	0.23	
	WLAN 2.4GHz	0.72	DTS

Table 2.2: Highest Reported SAR for Hotspot (1g)

Exposure Configuration	Technology Band	Highest Reported SAR 1g(W/Kg)	Equipment Class
Hotspot	GSM850	0.37	PCE
	GSM1900	0.58	
	WCDMA Band 2	0.68	
	WCDMA Band 4	1.15	
	WCDMA Band 5	0.37	
	LTE Band 2	0.77	
	LTE Band 4	1.02	
	LTE Band 5	0.35	
	LTE Band 7	1.29	
	LTE Band 12	0.31	
	LTE Band 17	0.31	
	LTE Band 66	1.01	
	WLAN 2.4GHz	0.34	DTS

Table 2.3: Highest Reported SAR for Body-worn (1g)

Exposure Configuration	Technology Band	Highest Reported SAR 1g(W/Kg)	Equipment Class
Body-worn	GSM850	0.37	PCE
	GSM1900	0.50	
	WCDMA Band 2	0.60	
	WCDMA Band 4	0.97	
	WCDMA Band 5	0.37	
	LTE Band 2	0.62	
	LTE Band 4	0.76	
	LTE Band 5	0.35	
	LTE Band 7	0.91	
	LTE Band 12	0.31	
	LTE Band 17	0.31	
	LTE Band 66	0.66	
	WLAN2.4GHz	0.34	DTS

The SAR values found for the Mobile Phone are below the maximum recommended levels of 1.6 W/Kg as averaged over any 1g tissue according to the ANSI C95.1-1992.

The measurement together with the test system set-up is described in annex C of this test report. A detailed description of the equipment under test can be found in chapter 4 of this test report.

The highest reported SAR value is obtained at the case of **(Table 2.1 & 2.2 & 2.3)**, and the value is: **1.29 W/kg (1g)**.

Table2.4: The sum of reported SAR values for main antenna and WLAN

/	Position	Main Antenna (W/kg)	WLAN (W/kg)	Sum (W/kg)
Highest reported SAR value for Head	Left Cheek	0.29	0.72	1.01
Highest reported SAR value for Hotspot	Bottom	1.29	/	1.29
Highest reported SAR value for Body-worn	Rear	0.91	0.34	1.25

Note: the test positions of above tables are for the worse case that has been evaluated.

Table2.5: The sum of reported SAR values for main antenna and Bluetooth

/	Position	Main Antenna (W/kg)	Bluetooth (W/kg)	Sum (W/kg)
Highest reported SAR value for Head	Left Cheek	0.29	0.19	0.48
Highest reported SAR value for Hotspot	Bottom	1.29	0.09	1.38
Highest reported SAR value for Body-worn	Front	0.97	0.09	1.06

Note: the test positions of above tables are for the worse case that has been evaluated.

According to the above tables, the highest sum of reported SAR values is **1.38 W/kg (1g)**.

The detail for simultaneous transmission consideration is described in chapter 12.



3. Client Information

3.1. Applicant Information

Company Name:	HMD Global Oy
Address:	Bertel Jungin aukio 902600 Espoo, Finland
City:	/
Country:	/
Telephone:	/

3.2. Manufacturer Information

Company Name:	HMD Global Oy
Address:	Bertel Jungin aukio 902600 Espoo, Finland
City:	/
Country:	/
Telephone:	/

4. Equipment under Test (EUT) and Ancillary Equipment (AE)

4.1. About EUT

Description:	Multi-band GSM/WCDMA/LTE phone with Bluetooth, WLAN
Model Name:	TA-1338
Operating mode(s):	GSM850/1900, WCDMA Band2/4/5, LTE Band2/4/5/7/12/17/66, Bluetooth, WLAN2.4G
Condition of EUT as received:	No obvious damage in appearance
Tested Tx Frequency:	824 – 849MHz (GSM 850)
	1850 – 1910MHz (GSM 1900)
	1850 – 1910MHz (WCDMA Band 2)
	1710 – 1755MHz (WCDMA Band 4)
	824 – 849MHz (WCDMA Band 5)
	1850 – 1910MHz (LTE Band 2)
	1700 – 1755MHz (LTE Band 4)
	824 – 849MHz (LTE Band 5)
	2500 – 2570MHz (LTE Band 7)
	699 – 716MHz (LTE Band 12)
	704 – 716MHz (LTE Band 17)
	1710 – 1780MHz (LTE Band 66)
	2402 – 2480MHz (Bluetooth)
2412 – 2462MHz (WLAN 2.4G)	
GPRS / EGPRS Multislot Class:	12
GPRS capability Class:	B
Test device Production information:	Production unit
Device type:	Portable device
Antenna type:	Integrated antenna
Hotspot mode:	Support
Product Dimensions:	Long 164.86mm ;Wide 76mm ; Overall Diagonal 174mm
Display Diagonal:	164.2mm
Remark:	
1. This device does not support DTM operation.	
2. DIV antenna has only signaled receiving function.	

4.2. Internal Identification of EUT used during the test

EUT ID*	IMEI	HW Version	SW Version
UT02aa	358457300003506	99652_1_11	000T_0_080
UT03aa	358457300003282	99652_1_11	000T_0_080
UT11aa	358457300006707	99652_1_11	000T_0_080
UT13aa	358457300007200	99652_1_11	000T_0_080

*EUT ID: is used to identify the test sample in the lab internally.

Note: It is performed to test SAR with the UT11aa&13aa, and conducted power with the UT02aa&03aa.

4.3. Internal Identification of AE used during the test

AE ID*	Description	Model	Manufacturer
AE1	Battery	WT340	Guangdong Fenghua New Energy Co.,Ltd
AE2	Headset	HS-34	New Leader Industry Co.,Ltd

*AE ID: is used to identify the test sample in the lab internally.



5. Test Methodology

5.1. Applicable Limit Regulations

ANSI C95.1:1992: IEEE Standard for Safety Levels with Respect to Human Exposure to Radio Frequency Electromagnetic Fields, 3 kHz to 300 GHz.

It specifies the maximum exposure limit of **1.6 W/kg** as averaged over any 1 gram of tissue for portable devices being used within 20 cm of the user in the uncontrolled environment.

5.2. Applicable Measurement Standards

IEEE 1528:2013: Recommended Practice for Determining the Peak Spatial-Average Specific Absorption Rate (SAR) in the Human Head from Wireless Communications Devices: Experimental Techniques.

KDB 447498 D01 General RF Exposure Guidance v06: Mobile and Portable Devices RF Exposure Procedures and Equipment Authorization Policies.

KDB 648474 D04 Handset SAR v01r03: SAR Evaluation Considerations for Wireless Handsets.

KDB 941225 D01 SAR test for 3G devices v03r01: SAR Measurement Procedures for 3G Devices

KDB 941225 D05 SAR for LTE Devices v02r05: SAR Evaluation Considerations for LTE Devices

KDB 941225 D06 Hot Spot SAR v02r01: SAR Evaluation Procedures for Portable Devices with Wireless Router Capabilities

KDB 248227 D01 802.11 Wi-Fi SAR v02r02: SAR Guidance for IEEE 802.11 (Wi-Fi) Transmitters.

KDB 865664 D01 SAR measurement 100 MHz to 6 GHz v01r04: SAR Measurement Requirements for 100 MHz to 6 GHz.

KDB 865664 D02 RF Exposure Reporting v01r02: RF Exposure Compliance Reporting and Documentation Considerations

TCB workshop April 2019; RF Exposure Procedures (Tissue Simulating Liquids)

6. Specific Absorption Rate (SAR)

6.1. Introduction

SAR is related to the rate at which energy is absorbed per unit mass in an object exposed to a radio field. The SAR distribution in a biological body is complicated and is usually carried out by experimental techniques or numerical modeling. The standard recommends limits for two tiers of groups, occupational/controlled and general population/uncontrolled, based on a person's awareness and ability to exercise control over his or her exposure. In general, occupational/controlled exposure limits are higher than the limits for general population/uncontrolled.

6.2. SAR Definition

The SAR definition is the time derivative (rate) of the incremental energy (dW) absorbed by (dissipated in) an incremental mass (dm) contained in a volume element (dv) of a given density (ρ). The equation description is as below:

$$SAR = \frac{d}{dt} \left(\frac{dW}{dm} \right) = \frac{d}{dt} \left(\frac{dW}{\rho dv} \right)$$

SAR is expressed in units of Watts per kilogram (W/kg)

SAR measurement can be either related to the temperature elevation in tissue by

$$SAR = c \left(\frac{\delta T}{\delta t} \right)$$

Where: C is the specific heat capacity, δT is the temperature rise and δt is the exposure duration, or related to the electrical field in the tissue by

$$SAR = \frac{\sigma |E|^2}{\rho}$$

Where: σ is the conductivity of the tissue, ρ is the mass density of tissue and E is the RMS electrical field strength.

However for evaluating SAR of low power transmitter, electrical field measurement is typically applied.

7. Tissue Simulating Liquids

7.1. Targets for tissue simulating liquid

Table 7.1: Targets for tissue simulating liquid

Frequency (MHz)	Liquid Type	Conductivity (σ)	$\pm 5\%$ Range	Permittivity (ϵ)	$\pm 5\%$ Range
750	Head	0.89	0.85~0.93	41.9	39.8~44.0
835	Head	0.90	0.86~0.95	41.5	39.4~43.6
1750	Head	1.37	1.30~1.44	40.1	38.1~42.1
1900	Head	1.40	1.33~1.47	40.0	38.0~42.0
2450	Head	1.80	1.71~1.89	39.2	37.2~41.2
2550	Head	1.91	1.81~2.01	39.1	37.1~41.0

7.2. Dielectric Performance

Table 7.2: Dielectric Performance of Tissue Simulating Liquid

Measurement Date (yyyy-mm-dd)	Type	Frequency	Conductivity σ (S/m)	Drift (%)	Permittivity ϵ	Drift (%)
2020-12-29	Head	750	0.906	1.80	41.14	-1.81
2020-12-21	Head	835	0.885	-1.67	41.93	1.04
2021-01-01	Head	1750	1.388	1.31	39.57	-1.32
2021-01-02	Head	1900	1.435	2.50	39.12	-2.20
2020-12-26	Head	2450	1.848	2.67	38.48	-1.84
2020-12-30	Head	2550	1.949	2.04	38.25	-2.17

Note: The liquid temperature is 22.0°C.

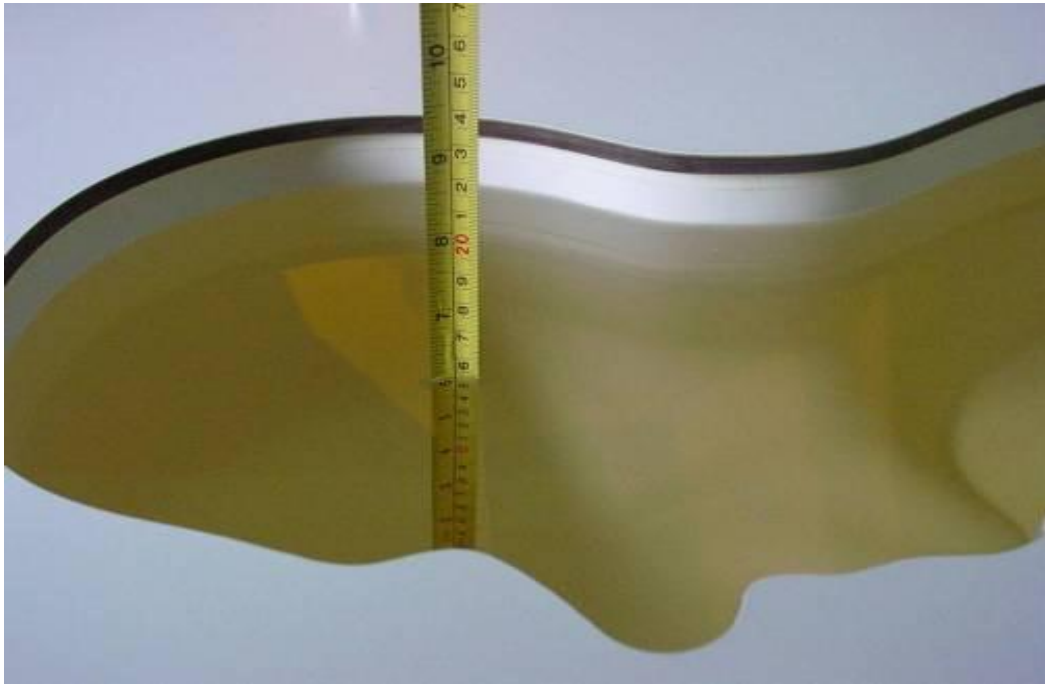

Picture 7-1: Liquid depth in the Head Phantom (750MHz)



Picture 7-2: Liquid depth in the Head Phantom (835MHz)

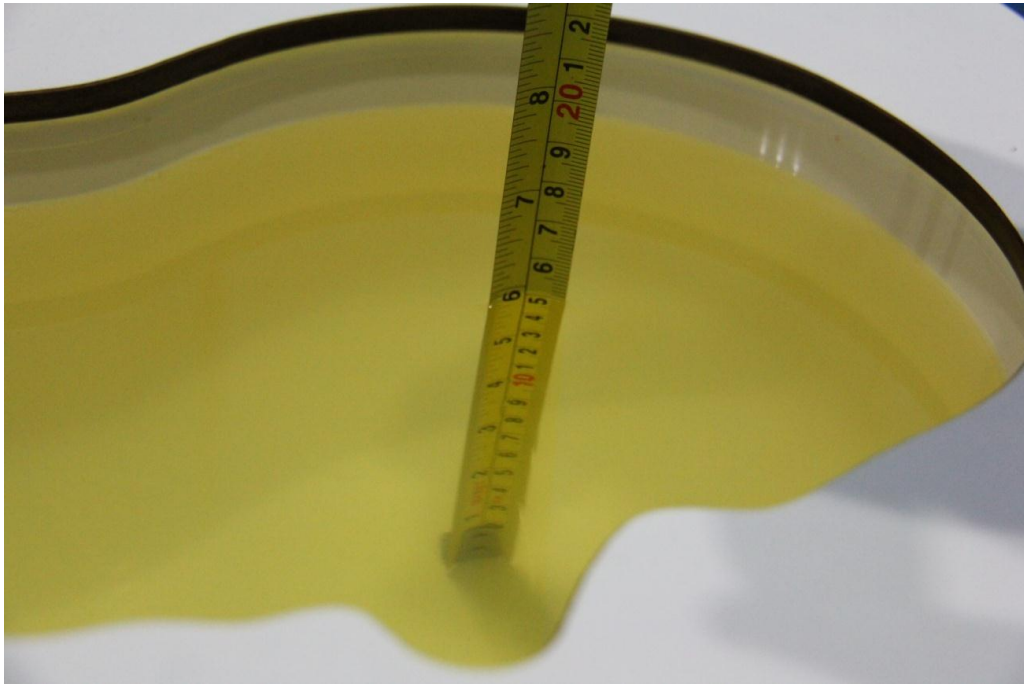

Picture 7-3: Liquid depth in the Head Phantom (1750MHz)



Picture 7-4: Liquid depth in the Head Phantom (1900MHz)

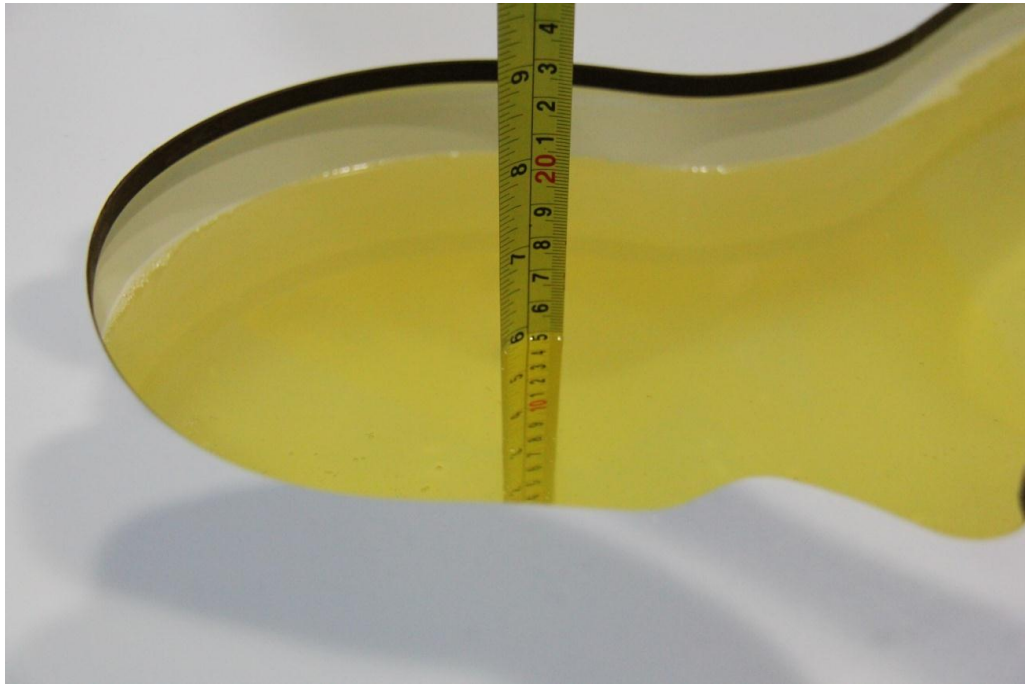

Picture 7-5: Liquid depth in the Head Phantom(2450MHz)

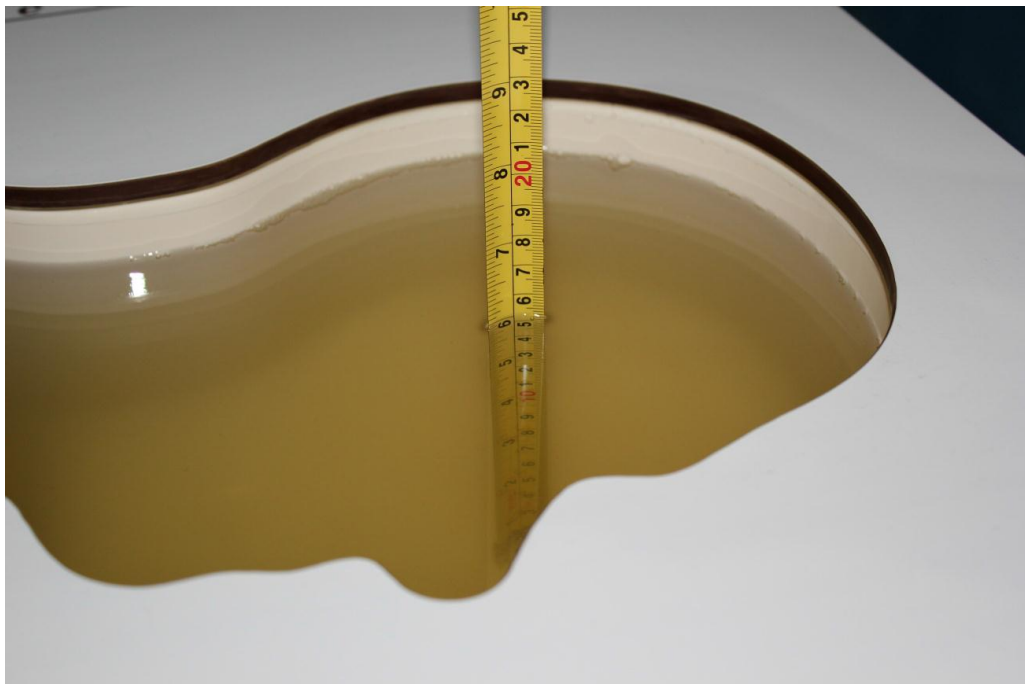

Picture 7-6: Liquid depth in the Head Phantom(2550MHz)

8. System verification

8.1. System Setup

In the simplified setup for system evaluation, the DUT is replaced by a calibrated dipole and the power source is replaced by a continuous wave that comes from a signal generator. The calibrated dipole must be placed beneath the flat phantom section of the SAM twin phantom with the correct distance holder. The distance holder should touch the phantom surface with a light pressure at the reference marking and be oriented parallel to the long side of the phantom. The equipment setup is shown below:

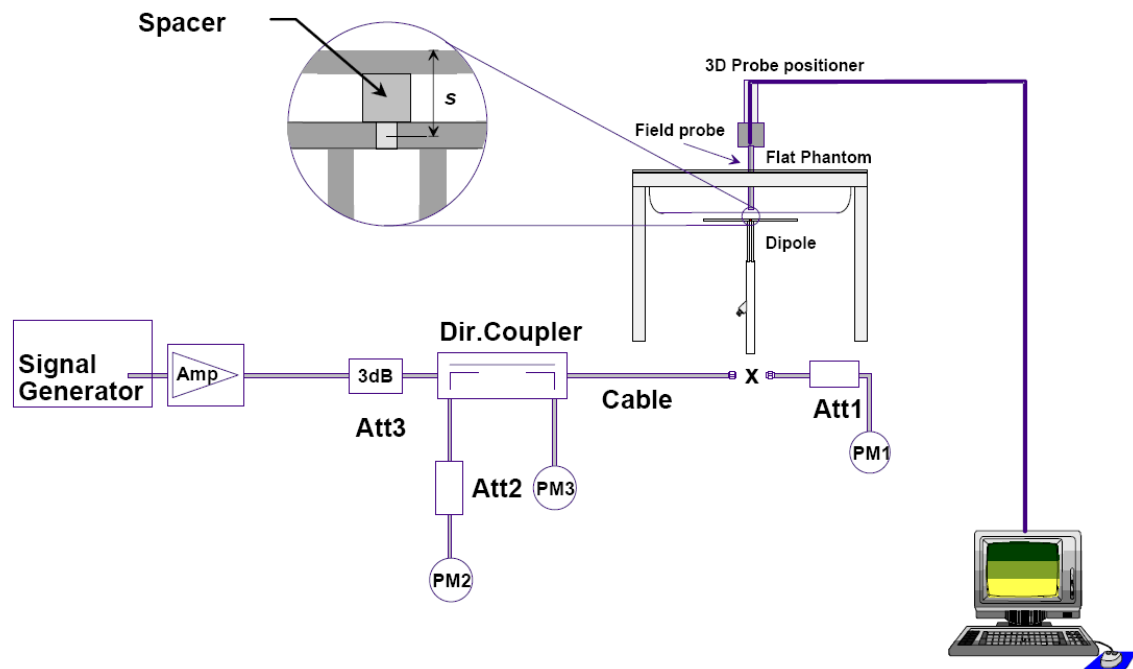

Picture 8.1 System Setup for System Evaluation

For the dipole below 3GHz, the output power on dipole port must be calibrated to 24 dBm (250mW) before dipole is connected.

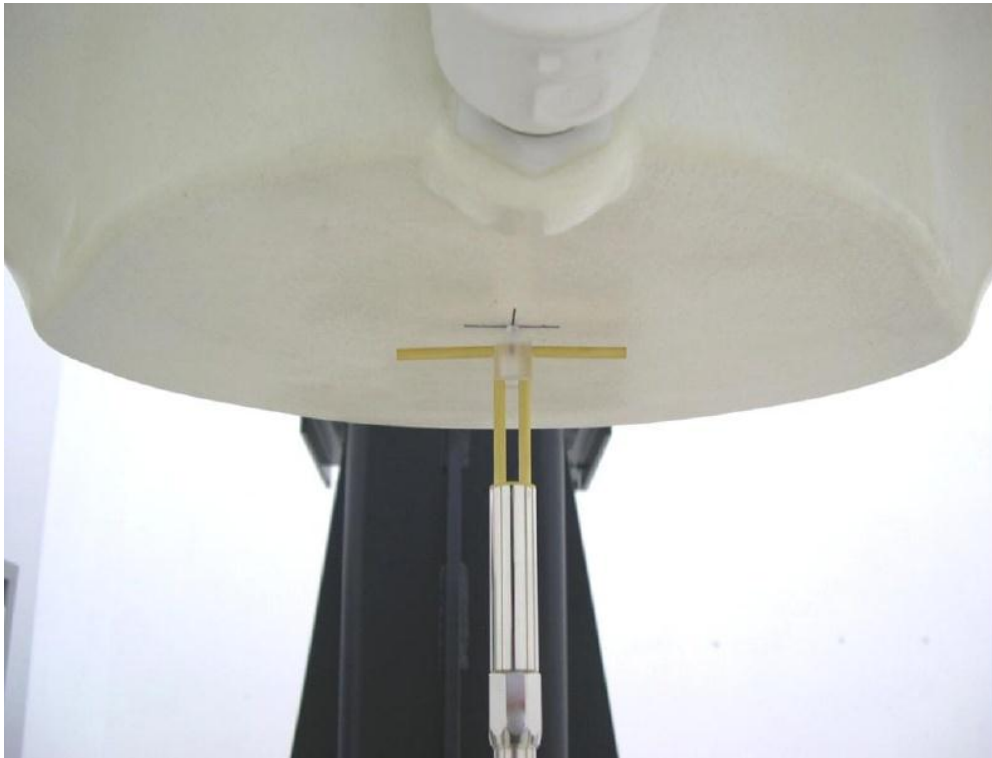

Picture 8.2 Photo of Dipole Setup

8.2. System Verification

SAR system verification is required to confirm measurement accuracy, according to the tissue dielectric media, probe calibration points and other system operating parameters required for measuring the SAR of a test device. The system verification must be performed for each frequency band and within the valid range of each probe calibration point required for testing the device.

Table 8.1: System Verification of Head

Measurement Date	Frequency (MHz)	Target value (W/kg)		Measured value (W/kg)				Deviation (%)	
		10 g	1 g	/		Normalize to 1W		10 g	1 g
				10 g	1 g	10 g	1 g		
2020-12-29	750 MHz	5.70	8.53	1.45	2.21	5.80	8.84	1.75	3.63
2020-12-21	835 MHz	6.29	9.62	1.54	2.30	6.16	9.20	-2.07	-4.37
2021-01-01	1750 MHz	19.30	36.40	4.88	9.36	19.52	37.44	1.14	2.86
2021-01-02	1900 MHz	21.00	40.50	5.42	10.6	21.68	42.40	3.24	4.69
2020-12-26	2450 MHz	24.10	52.00	6.17	13.5	24.68	54.00	2.41	3.85
2020-12-30	2550 MHz	26.50	57.80	6.83	15.1	27.32	60.40	3.09	4.50

9. Measurement Procedures

9.1. Tests to be performed

In order to determine the highest value of the peak spatial-average SAR of a handset, all device positions, configurations and operational modes shall be tested for each frequency band according to steps 1 to 3 below. A flowchart of the test process is shown in picture 9.1.

Step 1: The tests described in 9.2 shall be performed at the channel that is closest to the center of the transmit frequency band (f_c) for:

- a) all device positions (cheek and tilt, for both left and right sides of the SAM phantom, as described in annex D),
- b) all configurations for each device position in a), e.g., antenna extended and retracted, and
- c) all operational modes, e.g., analogue and digital, for each device position in a) and configuration in b) in each frequency band.

If more than three frequencies need to be tested according to 11.1 (i.e., $N_c > 3$), then all frequencies, configurations and modes shall be tested for all of the above test conditions.

Step 2: For the condition providing highest peak spatial-average SAR determined in Step 1, perform all tests described in 9.2 at all other test frequencies, i.e., lowest and highest frequencies. In addition, for all other conditions (device position, configuration and operational mode) where the peak spatial-average SAR value determined in Step 1 is within 3 dB of the applicable SAR limit, it is recommended that all other test frequencies shall be tested as well.

Step 3: Examine all data to determine the highest value of the peak spatial-average SAR found in Steps 1 to 2.

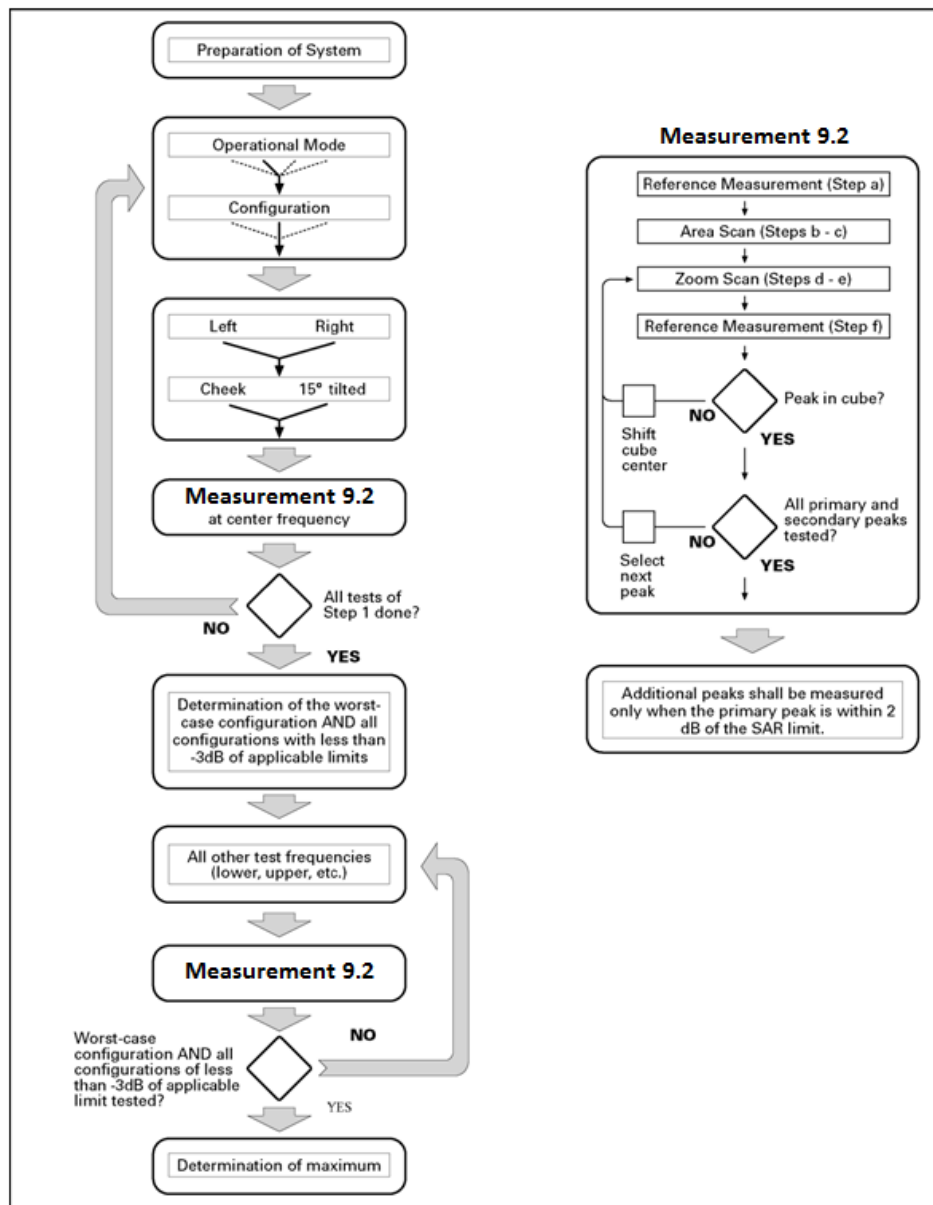

Picture 9.1 Block diagram of the tests to be performed

9.2. General Measurement Procedure

The area and zoom scan resolutions specified in the table below must be applied to the SAR measurements and fully documented in SAR reports to qualify for TCB approval. Probe boundary effect error compensation is required for measurements with the probe tip closer than half a probe tip diameter to the phantom surface. Both the probe tip diameter and sensor offset distance must satisfy measurement protocols; to ensure probe boundary effect errors are minimized and the higher fields closest to the phantom surface can be correctly measured and extrapolated to the phantom surface for computing 1-g SAR. Tolerances of the post-processing algorithms must be verified by the test laboratory for the scan resolutions used in the SAR measurements, according to the reference distribution functions specified in IEEE Std 1528-2013. The results should be documented as part of the system validation records and may be requested to support test results when all the measurement parameters in the following table are not satisfied.

		≤ 3 GHz	> 3 GHz	
Maximum distance from closest measurement point (geometric center of probe sensors) to phantom surface		5 ± 1 mm	$\frac{1}{2} \cdot \delta \cdot \ln(2) \pm 0.5$ mm	
Maximum probe angle from probe axis to phantom surface normal at the measurement location		$30^\circ \pm 1^\circ$	$20^\circ \pm 1^\circ$	
Maximum area scan spatial resolution: $\Delta x_{Area}, \Delta y_{Area}$		≤ 2 GHz: ≤ 15 mm 2 – 3 GHz: ≤ 12 mm	3 – 4 GHz: ≤ 12 mm 4 – 6 GHz: ≤ 10 mm	
		When the x or y dimension of the test device, in the measurement plane orientation, is smaller than the above, the measurement resolution must be \leq the corresponding x or y dimension of the test device with at least one measurement point on the test device.		
Maximum zoom scan spatial resolution: $\Delta x_{Zoom}, \Delta y_{Zoom}$		≤ 2 GHz: ≤ 8 mm 2 – 3 GHz: ≤ 5 mm*	3 – 4 GHz: ≤ 5 mm* 4 – 6 GHz: ≤ 4 mm*	
Maximum zoom scan spatial resolution, normal to phantom surface	uniform grid: $\Delta z_{Zoom}(n)$	≤ 5 mm	3 – 4 GHz: ≤ 4 mm 4 – 5 GHz: ≤ 3 mm 5 – 6 GHz: ≤ 2 mm	
	graded grid	$\Delta z_{Zoom}(1)$: between 1 st two points closest to phantom surface	≤ 4 mm	3 – 4 GHz: ≤ 3 mm 4 – 5 GHz: ≤ 2.5 mm 5 – 6 GHz: ≤ 2 mm
		$\Delta z_{Zoom}(n>1)$: between subsequent points	$\leq 1.5 \cdot \Delta z_{Zoom}(n-1)$	
Minimum zoom scan volume	x, y, z	≥ 30 mm	3 – 4 GHz: ≥ 28 mm 4 – 5 GHz: ≥ 25 mm 5 – 6 GHz: ≥ 22 mm	
<p>Note: δ is the penetration depth of a plane-wave at normal incidence to the tissue medium; see draft standard IEEE P1528-2011 for details.</p> <p>* When zoom scan is required and the <i>reported</i> SAR from the area scan based 1-g SAR estimation procedures of KDB 447498 is ≤ 1.4 W/kg, ≤ 8 mm, ≤ 7 mm and ≤ 5 mm zoom scan resolution may be applied, respectively, for 2 GHz to 3 GHz, 3 GHz to 4 GHz and 4 GHz to 6 GHz.</p>				

9.3. WCDMA Measurement Procedures for SAR

The following procedures are applicable to WCDMA handsets operating under 3GPP Release99, Release 5 and Release 6. The default test configuration is to measure SAR with an established radio link between the DUT and a communication test set using a 12.2kbps RMC (reference measurement channel) configured in Test Loop Mode 1. SAR is selectively confirmed for other physical channel configurations (DPCCH & DPDCH_n), HSDPA and HSPA (HSUPA/HSDPA) modes according to output power, exposure conditions and device operating capabilities. Both uplink and downlink should be configured with the same RMC or AMR, when required. SAR for Release 5 HSDPA and Release 6 HSPA are measured using the applicable FRC (fixed reference channel) and E-DCH reference channel configurations. Maximum output power is verified according to applicable versions of 3GPP TS 34.121 and SAR must be measured according to these maximum output conditions. When Maximum Power Reduction (MPR) is not implemented according to Cubic Metric (CM) requirements for Release 6 HSPA, the following procedures do not apply.

For Release 5 HSDPA Data Devices:

Sub-test	β_c	β_d	β_d (SF)	β_c / β_d	β_{hs}	CM/dB
1	2/15	15/15	64	2/15	4/15	0.0
2	12/15	15/15	64	12/15	24/25	1.0
3	15/15	8/15	64	15/8	30/15	1.5
4	15/15	4/15	64	15/4	30/15	1.5

For Release 6 HSPA Data Devices

Sub-test	β_c	β_d	β_d (SF)	β_c / β_d	β_{hs}	β_{ec}	β_{ed}	β_{ed} (SF)	β_{ed} (codes)	CM (dB)	MPR (dB)	AG Index	E-TFCI
1	11/15	15/15	64	11/15	22/15	209/225	1039/225	4	1	1.0	0.0	20	75
2	6/15	15/15	64	6/15	12/15	12/15	12/15	4	1	3.0	2.0	12	67
3	15/15	9/15	64	15/9	30/15	30/15	$\beta_{ed1}:47/15$ $\beta_{ed2}:47/15$	4	2	2.0	1.0	15	92
4	2/15	15/15	64	2/15	4/15	4/15	56/75	4	1	3.0	2.0	17	71
5	15/15	15/15	64	15/15	24/15	30/15	134/15	4	1	1.0	0.0	21	81

9.4. SAR Measurement for LTE

SAR tests for LTE are performed with a base station simulator, Anristu MT8820C. Closed loop power control was used so the UE transmits with maximum output power during SAR testing. All powers were measured with the Anristu MT8820C. It is performed for conducted power and SAR based on the KDB941225 D05.

SAR is evaluated separately according to the following procedures for the different test positions in each exposure condition – head, body, body-worn accessories and other use conditions. The procedures in the following subsections are applied separately to test each LTE frequency band.

1) QPSK with 1 RB allocation

Start with the largest channel bandwidth and measure SAR for QPSK with 1 RB allocation, using the RB offset and required test channel combination with the highest maximum output power among RB offsets at the upper edge, middle and lower edge of each required test channel. When the reported SAR is ≤ 0.8 W/kg, testing of the remaining RB offset configurations and required test channels is not required for 1 RB allocation; otherwise, SAR is required for the remaining required test channels and only for the RB offset configuration with the highest output power for that channel. When the reported SAR of a required test channel is > 1.45 W/kg, SAR is required for all three RB offset configurations for that required test channel.

2) QPSK with 50% RB allocation

The procedures required for 1 RB allocation in 1) are applied to measure the SAR for QPSK with 50% RB allocation.

3) QPSK with 100% RB allocation

For QPSK with 100% RB allocation, SAR is not required when the highest maximum output power for 100 % RB allocation is less than the highest maximum output power in 50% and 1 RB allocations and the highest reported SAR for 1 RB and 50% RB allocation in 1) and 2) are ≤ 0.8 W/kg. Otherwise, SAR is measured for the highest output power channel; and if the reported SAR is > 1.45 W/kg, the remaining required test channels must also be tested.

9.5. Bluetooth & WLAN Measurement Procedures for SAR

Normal network operating configurations are not suitable for measuring the SAR of 802.11 transmitters in general. Unpredictable fluctuations in network traffic and antenna diversity conditions can introduce undesirable variations in SAR results. The SAR for these devices should be measured using chipset based test mode software to ensure that the results are consistent and reliable.

Chipset based test mode software is hardware dependent and generally varies among manufacturers. The device operating parameters established in a test mode for SAR measurements must be identical to those programmed in production units, including output power levels, amplifier gain settings and other RF performance tuning parameters. The test frequencies should correspond to actual channel frequencies defined for domestic use. SAR for devices with switched diversity should be measured with only one antenna transmitting at a time during each SAR measurement, according to a fixed modulation and data rate. The same data pattern should be used for all measurements.



9.6. Power Drift

To control the output power stability during the SAR test, DASY5 system calculates the power drift by measuring the E-field at the same location at the beginning and at the end of the measurement for each test position. These drift values can be found in Section 14 labeled as: (Power Drift [dB]). This ensures that the power drift during one measurement is within 5%.

9.7. Proximity Sensor Considerations

This device uses a proximity sensor that share the same metallic electrode as the transmitting antenna to facilitate triggering in typical user interactivity with the device. Due to the operating configurations and exposure conditions required by the device, the proximity sensor is used to indicate when the tablet is held close to a user's body exposure condition. It utilizes the proximity sensor to reduce the output power in specific wireless and operating modes to ensure SAR compliance for the following scenarios: To reduce the output power of main antennas during body operating configurations. . It is also set an output power leveled to the lowest one to make sure that in any case of SAR sensor hardware failure the SAR requirements can still be satisfied.

Sensor triggering distance summary data is included in Appendix K.

10. Conducted Output Power

10.1. GSM Measurement result

During the process of testing, the EUT was controlled via Agilent Digital Radio Communication tester (E5515C) to ensure the maximum power transmission and proper modulation. This result contains conducted output power for the EUT. In all cases, the measured peak output power should be greater and within 5% than EMI measurement.

Table 10.1: The conducted power measurement results for GSM

GSM 850MHz	Tune up	Conducted Power(dBm)		
		Channel 251(848.8MHz)	Channel 190(836.6MHz)	Channel 128(824.2MHz)
	34.5	32.99	32.98	32.90
GSM 1900MHz	Tune up	Conducted Power(dBm)		
		Channel 810(1909.8MHz)	Channel 661(1880MHz)	Channel512(1850.2MHz)
	31.0	30.19	30.20	30.22

Table 10.2: The conducted power measurement results for GPRS and EGPRS

GPRS850/ EGPRS850	Tune up	Measured Power (dBm)			calculation	Average Power (dBm)		
		251	190	128		251	190	128
1Tx-slots	34.5	32.97	32.97	32.87	-9.03dB	23.94	23.94	23.84
2Tx-slots	33.0	32.02	32.02	31.94	-6.02dB	26.00	26.00	25.92
3Tx-slots	31.0	30.03	30.03	29.92	-4.26dB	25.77	25.77	25.66
4Tx-slots	29.5	28.91	28.91	28.76	-3.01dB	25.90	25.90	25.75
EGPRS 850 (8PSK)	Tune up	Measured Power (dBm)			calculation	Measured Power (dBm)		
		251	190	128		251	190	128
1Tx-slots	29.0	28.28	28.28	28.20	-9.03dB	19.25	19.25	19.17
2Tx-slots	28.0	27.06	27.06	26.96	-6.02dB	21.04	21.04	20.94
3Tx-slots	26.0	24.77	24.77	24.81	-4.26dB	20.51	20.51	20.55
4Tx-slots	24.5	23.40	23.40	23.50	-3.01dB	20.39	20.39	20.49

Full Power								
GPRS1900/ EGPRS1900	Tune up	Measured Power (dBm)			calculation	Average Power (dBm)		
		810	661	512		810	661	512
1Tx-slots	31.0	30.18	30.18	30.20	-9.03dB	21.15	21.15	21.17
2Tx-slots	30.0	29.28	29.28	29.27	-6.02dB	23.26	23.26	23.25
3Tx-slots	28.0	27.29	27.29	27.27	-4.26dB	23.03	23.03	23.01
4Tx-slots	26.5	26.25	26.25	26.23	-3.01dB	23.24	23.24	23.22
EGPRS 1900 (8PSK)	Tune up	Measured Power (dBm)			calculation	Measured Power (dBm)		
		810	661	512		810	661	512
1Tx-slots	29.5	28.75	28.75	28.99	-9.03dB	19.72	19.72	19.96
2Tx-slots	28.5	27.64	27.64	27.65	-6.02dB	21.62	21.62	21.63
3Tx-slots	26.0	25.29	25.29	25.27	-4.26dB	21.03	21.03	21.01
4Tx-slots	24.5	24.02	24.02	24.06	-3.01dB	21.01	21.01	21.05
Sensor on								
GPRS1900/ EGPRS1900	Tune up	Measured Power (dBm)			calculation	Average Power (dBm)		
		810	661	512		810	661	512
1Tx-slots	31.0	29.82	29.85	29.88	-9.03dB	20.79	20.82	20.85
2Tx-slots	28.0	27.10	27.09	27.15	-6.02dB	21.08	21.07	21.13
3Tx-slots	26.0	25.10	25.10	25.15	-4.26dB	20.84	20.84	20.89
4Tx-slots	24.5	24.01	24.04	24.07	-3.01dB	21.00	21.03	21.06
EGPRS 1900 (8PSK)	Tune up	Measured Power (dBm)			calculation	Measured Power (dBm)		
		810	661	512		810	661	512
1Tx-slots	29.0	28.52	28.39	28.48	-9.03dB	19.49	19.36	19.45
2Tx-slots	26.0	25.05	24.95	24.98	-6.02dB	19.03	18.93	18.96
3Tx-slots	23.5	22.75	22.65	22.66	-4.26dB	18.49	18.39	18.40
4Tx-slots	22.0	21.57	21.50	21.51	-3.01dB	18.56	18.49	18.50

Note:

1) Division Factors

To average the power, the division factor is as follows:

1TX-slot = 1 transmit time slot out of 8 time slots=> conducted power divided by (8/1) => -9.03dB

2TX-slots = 2 transmit time slots out of 8 time slots=> conducted power divided by (8/2) => -6.02dB

3TX-slots = 3 transmit time slots out of 8 time slots=> conducted power divided by (8/3) => -4.26dB

4TX-slots = 4 transmit time slots out of 8 time slots=> conducted power divided by (8/4) => -3.01dB

According to the conducted power as above, the body measurements are performed with 2Txslots for 850MHz and 1900MHz.

10.2. WCDMA Measurement result

Table 10.3: T The conducted power measurement results WCDMA

Full Power					
Item	band	WCDMA Band 2			
	ARFCN	Tune up	9538 (1907.6MHz)	9400 (1880MHz)	9262 (1852.4MHz)
WCDMA	\	25.0	24.3	24.3	24.4
HSUPA	1	22.5	21.9	21.8	21.9
	2	22.0	21.4	21.3	21.4
	3	23.0	22.4	22.3	22.3
	4	21.5	20.9	20.8	20.9
	5	23.0	22.3	22.3	22.4
HSDPA	1	23.5	23.4	23.3	23.3
	2	23.5	23.3	23.3	23.3
	3	23.5	22.8	22.7	22.8
	4	23.5	22.8	22.8	22.8
DC-HSDPA	1	23.5	22.9	22.9	23.0
	2	23.5	22.8	22.9	23.0
	3	23.5	22.3	22.4	22.5
	4	23.5	22.4	22.4	22.4
Sensor on					
Item	band	WCDMA Band 2			
	ARFCN	Tune up	9538 (1907.6MHz)	9400 (1880MHz)	9262 (1852.4MHz)
WCDMA	\	22.0	20.9	20.9	21.0
HSUPA	1	19.5	18.5	18.5	18.6
	2	19.0	18.0	18.0	18.0
	3	20.0	18.9	18.9	19.1
	4	18.5	17.5	17.5	17.6
	5	20.0	18.8	18.9	19.1
HSDPA	1	20.5	19.9	19.9	20.0
	2	20.5	19.8	19.9	19.9
	3	20.5	19.3	19.4	19.5
	4	20.5	19.3	19.4	19.5
DC-HSDPA	1	20.5	19.9	19.9	19.9
	2	20.5	19.8	19.8	19.9
	3	20.5	19.3	19.4	19.5
	4	20.5	19.3	19.3	19.4

Full Power					
Item	band	WCDMA Band 4			
	ARFCN	Tune up	1513 (1752.6MHz)	1413 (1732.6MHz)	1312 (1712.4MHz)
WCDMA	\	25.0	23.8	23.9	23.9
HSUPA	1	22.5	21.3	21.4	21.5
	2	22.0	20.9	20.9	20.9
	3	23.0	21.9	21.9	21.9
	4	21.5	20.4	20.4	20.4
	5	23.0	21.8	21.9	21.9
HSDPA	1	23.5	22.8	22.9	22.9
	2	23.5	22.7	22.8	22.9
	3	23.5	22.3	22.4	22.4
	4	23.5	22.3	22.4	22.4
DC-HSDPA	1	23.5	22.7	22.8	22.9
	2	23.5	22.7	22.7	22.8
	3	23.5	22.2	22.3	22.4
	4	23.5	22.3	22.3	22.3
Sensor on					
Item	band	WCDMA Band 4			
	ARFCN	Tune up	1513 (1752.6MHz)	1413 (1732.6MHz)	1312 (1712.4MHz)
WCDMA	\	20.0	18.4	18.5	18.4
HSUPA	1	18.0	17.0	17.0	16.9
	2	18.5	15.4	15.5	15.4
	3	17.5	16.5	16.5	16.4
	4	18.5	15.0	15.0	14.9
	5	17.5	16.5	16.5	16.3
HSDPA	1	18.5	17.5	17.5	17.4
	2	18.5	17.4	17.4	17.3
	3	18.5	16.9	16.9	16.9
	4	18.5	16.9	16.9	16.9
DC-HSDPA	1	18.5	17.6	17.6	17.6
	2	18.5	17.5	17.6	17.5
	3	18.5	17.1	17.1	17.2
	4	18.5	17.0	17.1	17.2

Item	band	WCDMA Band 5			
	ARFCN	Tune up	4233 (846.6MHz)	4182 (836.4MHz)	4132 (826.4MHz)
WCDMA	\	25.0	24.2	24.1	24.1
HSUPA	1	22.5	21.7	21.6	21.6
	2	22.0	21.2	21.1	21.2
	3	23.0	22.2	22.2	22.1
	4	21.5	20.7	20.7	20.6
	5	23.0	22.1	22.1	22.1
HSDPA	1	23.5	23.2	23.2	23.1
	2	23.5	23.2	23.1	23.1
	3	23.5	22.7	22.6	22.7
	4	23.5	22.7	22.6	22.6
DC-HSDPA	1	23.5	23.0	23.0	22.9
	2	23.5	23.0	22.9	22.9
	3	23.5	22.6	22.5	22.4
	4	23.5	22.5	22.5	22.5

10.3. LTE Measurement result

Table 10.4: The conducted Power for LTE

Full Power								
LTE Band 2			Actual output Power (dBm)			Tune up		
Band -width	RB No. / RB offset	Frequency	Modulation			Modulation		
			QPSK	16QAM	64QAM	QPSK	16QAM	64QAM
1.4 MHz	1RB_5	1909.3MHz	23.64	22.32	21.99	25.0	24.0	23.0
		1880.0MHz	23.19	22.49	22.06	25.0	24.0	23.0
		1850.7MHz	23.04	22.27	21.87	25.0	24.0	23.0
	1RB_3	1909.3MHz	23.76	22.52	22.08	25.0	24.0	23.0
		1880.0MHz	23.35	22.62	22.14	25.0	24.0	23.0
		1850.7MHz	23.15	22.43	21.95	25.0	24.0	23.0
	1RB_0	1909.3MHz	23.63	22.40	21.98	25.0	24.0	23.0
		1880.0MHz	23.23	22.50	22.07	25.0	24.0	23.0
		1850.7MHz	23.02	22.26	21.84	25.0	24.0	23.0
	3RB_3	1909.3MHz	23.29	22.24	22.07	25.0	24.0	23.0
		1880.0MHz	23.31	22.31	22.06	25.0	24.0	23.0
		1850.7MHz	23.19	22.08	21.86	25.0	24.0	23.0
	3RB_1	1909.3MHz	23.36	22.32	22.11	25.0	24.0	23.0
		1880.0MHz	23.38	22.35	22.14	25.0	24.0	23.0
		1850.7MHz	23.25	22.15	21.88	25.0	24.0	23.0
	3RB_0	1909.3MHz	23.27	22.26	22.04	25.0	24.0	23.0
		1880.0MHz	23.31	22.28	22.12	25.0	24.0	23.0
		1850.7MHz	23.15	22.08	21.81	25.0	24.0	23.0
	6RB_0	1909.3MHz	22.34	21.42	21.01	24.0	23.0	22.0
		1880.0MHz	22.34	21.82	21.01	24.0	23.0	22.0
		1850.7MHz	22.19	21.45	20.85	24.0	23.0	22.0



Full Power								
LTE Band 2			Actual output Power (dBm)			Tune up		
Band -width	RB No. / RB offset	Frequency	Modulation			Modulation		
			QPSK	16QAM	64QAM	QPSK	16QAM	64QAM
3 MHz	1RB_14	1908.5MHz	23.71	22.51	22.05	25.0	24.0	23.0
		1880.0MHz	23.26	22.56	22.11	25.0	24.0	23.0
		1851.5MHz	23.10	22.73	21.99	25.0	24.0	23.0
	1RB_7	1908.5MHz	23.89	22.64	22.19	25.0	24.0	23.0
		1880.0MHz	23.38	22.68	22.16	25.0	24.0	23.0
		1851.5MHz	23.26	22.59	22.15	25.0	24.0	23.0
	1RB_0	1908.5MHz	23.73	22.57	22.01	25.0	24.0	23.0
		1880.0MHz	23.25	22.48	22.06	25.0	24.0	23.0
		1851.5MHz	23.12	22.55	21.97	25.0	24.0	23.0
	8RB_7	1908.5MHz	22.31	21.40	21.11	24.0	23.0	22.0
		1880.0MHz	22.32	21.92	21.14	24.0	23.0	22.0
		1851.5MHz	22.38	21.66	20.93	24.0	23.0	22.0
	8RB_4	1908.5MHz	22.36	21.42	21.08	24.0	23.0	22.0
		1880.0MHz	22.74	21.90	21.14	24.0	23.0	22.0
		1851.5MHz	22.39	21.78	20.91	24.0	23.0	22.0
	8RB_0	1908.5MHz	22.31	21.40	21.05	24.0	23.0	22.0
		1880.0MHz	22.78	21.91	21.11	24.0	23.0	22.0
		1851.5MHz	22.44	21.55	20.89	24.0	23.0	22.0
	15RB_0	1908.5MHz	22.32	21.36	21.01	24.0	23.0	22.0
		1880.0MHz	22.74	21.89	21.05	24.0	23.0	22.0
		1851.5MHz	22.38	21.60	20.87	24.0	23.0	22.0



Full Power								
LTE Band 2			Actual output Power (dBm)			Tune up		
Band -width	RB No. / RB offset	Frequency	Modulation			Modulation		
			QPSK	16QAM	64QAM	QPSK	16QAM	64QAM
5 MHz	1RB_24	1907.5MHz	23.64	22.39	22.01	25.0	24.0	23.0
		1880.0MHz	23.15	22.41	22.07	25.0	24.0	23.0
		1852.5MHz	23.23	22.48	21.85	25.0	24.0	23.0
	1RB_12	1907.5MHz	23.95	22.72	22.34	25.0	24.0	23.0
		1880.0MHz	23.44	22.77	22.32	25.0	24.0	23.0
		1852.5MHz	23.40	22.73	22.08	25.0	24.0	23.0
	1RB_0	1907.5MHz	23.64	22.46	22.05	25.0	24.0	23.0
		1880.0MHz	23.17	22.43	22.07	25.0	24.0	23.0
		1852.5MHz	23.02	22.46	21.82	25.0	24.0	23.0
	12RB_13	1907.5MHz	22.75	21.32	21.02	24.0	23.0	22.0
		1880.0MHz	22.33	21.53	21.11	24.0	23.0	22.0
		1852.5MHz	22.17	21.29	20.95	24.0	23.0	22.0
	12RB_6	1907.5MHz	22.49	21.39	21.07	24.0	23.0	22.0
		1880.0MHz	22.48	21.58	21.14	24.0	23.0	22.0
		1852.5MHz	22.23	21.63	20.94	24.0	23.0	22.0
	12RB_0	1907.5MHz	22.32	21.32	20.99	24.0	23.0	22.0
		1880.0MHz	22.28	21.50	21.04	24.0	23.0	22.0
		1852.5MHz	22.18	21.57	20.86	24.0	23.0	22.0
	25RB_0	1907.5MHz	22.37	21.40	21.00	24.0	23.0	22.0
		1880.0MHz	22.41	21.86	21.06	24.0	23.0	22.0
		1852.5MHz	22.22	21.69	20.90	24.0	23.0	22.0



Full Power								
LTE Band 2			Actual output Power (dBm)			Tune up		
Band -width	RB No. / RB offset	Frequency	Modulation			Modulation		
			QPSK	16QAM	64QAM	QPSK	16QAM	64QAM
10 MHz	1RB_49	1905.0MHz	23.74	22.50	22.04	25.0	24.0	23.0
		1880.0MHz	23.24	22.49	22.12	25.0	24.0	23.0
		1855.0MHz	23.45	22.84	22.04	25.0	24.0	23.0
	1RB_24	1905.0MHz	23.77	22.54	22.10	25.0	24.0	23.0
		1880.0MHz	23.59	22.76	22.22	25.0	24.0	23.0
		1855.0MHz	23.23	22.73	22.06	25.0	24.0	23.0
	1RB_0	1905.0MHz	23.76	22.41	22.06	25.0	24.0	23.0
		1880.0MHz	23.46	22.45	22.19	25.0	24.0	23.0
		1855.0MHz	23.23	22.62	21.97	25.0	24.0	23.0
	25RB_25	1905.0MHz	22.90	21.41	21.04	24.0	23.0	22.0
		1880.0MHz	22.80	21.72	21.09	24.0	23.0	22.0
		1855.0MHz	22.25	21.66	20.96	24.0	23.0	22.0
	25RB_12	1905.0MHz	22.85	21.48	21.01	24.0	23.0	22.0
		1880.0MHz	22.71	21.75	21.02	24.0	23.0	22.0
		1855.0MHz	22.63	21.72	20.93	24.0	23.0	22.0
	25RB_0	1905.0MHz	22.74	21.46	21.09	24.0	23.0	22.0
		1880.0MHz	22.76	21.85	21.04	24.0	23.0	22.0
		1855.0MHz	22.45	21.73	20.92	24.0	23.0	22.0
	50RB_0	1905.0MHz	22.68	21.43	21.02	24.0	23.0	22.0
		1880.0MHz	22.85	21.76	21.05	24.0	23.0	22.0
		1855.0MHz	22.69	21.75	20.94	24.0	23.0	22.0



Full Power								
LTE Band 2			Actual output Power (dBm)			Tune up		
Band -width	RB No. / RB offset	Frequency	Modulation			Modulation		
			QPSK	16QAM	64QAM	QPSK	16QAM	64QAM
15 MHz	1RB_74	1902.5MHz	23.64	22.93	21.85	25.0	24.0	23.0
		1880.0MHz	23.61	22.87	21.83	25.0	24.0	23.0
		1857.5MHz	23.62	22.84	21.95	25.0	24.0	23.0
	1RB_37	1902.5MHz	23.74	22.88	21.90	25.0	24.0	23.0
		1880.0MHz	23.80	23.08	22.04	25.0	24.0	23.0
		1857.5MHz	23.70	22.94	22.03	25.0	24.0	23.0
	1RB_0	1902.5MHz	23.68	22.82	21.81	25.0	24.0	23.0
		1880.0MHz	23.72	23.00	21.96	25.0	24.0	23.0
		1857.5MHz	23.56	22.77	21.87	25.0	24.0	23.0
	36RB_38	1902.5MHz	22.89	21.85	21.05	24.0	23.0	22.0
		1880.0MHz	22.90	21.83	21.11	24.0	23.0	22.0
		1857.5MHz	22.81	21.71	20.95	24.0	23.0	22.0
	36RB_19	1902.5MHz	22.86	21.85	21.03	24.0	23.0	22.0
		1880.0MHz	22.88	21.85	21.04	24.0	23.0	22.0
		1857.5MHz	22.77	21.79	20.95	24.0	23.0	22.0
	36RB_0	1902.5MHz	22.90	21.88	21.04	24.0	23.0	22.0
		1880.0MHz	22.88	21.86	21.05	24.0	23.0	22.0
		1857.5MHz	22.78	21.71	20.90	24.0	23.0	22.0
	75RB_0	1902.5MHz	22.94	21.90	21.04	24.0	23.0	22.0
		1880.0MHz	22.85	21.87	21.04	24.0	23.0	22.0
		1857.5MHz	22.77	21.76	20.91	24.0	23.0	22.0

Full Power								
LTE Band 2			Actual output Power (dBm)			Tune up		
Band -width	RB No. / RB offset	Frequency	Modulation			Modulation		
			QPSK	16QAM	64QAM	QPSK	16QAM	64QAM
20 MHz	1RB_99	1900.0MHz	23.46	22.75	21.64	25.0	24.0	23.0
		1880.0MHz	23.44	22.60	21.72	25.0	24.0	23.0
		1860.0MHz	23.39	22.77	21.72	25.0	24.0	23.0
	1RB_50	1900.0MHz	23.79	22.91	22.13	25.0	24.0	23.0
		1880.0MHz	23.89	23.16	22.05	25.0	24.0	23.0
		1860.0MHz	23.77	23.01	21.99	25.0	24.0	23.0
	1RB_0	1900.0MHz	23.47	22.72	21.66	25.0	24.0	23.0
		1880.0MHz	23.60	22.82	21.75	25.0	24.0	23.0
		1860.0MHz	23.43	22.69	21.65	25.0	24.0	23.0
	50RB_50	1900.0MHz	22.77	21.81	20.93	24.0	23.0	22.0
		1880.0MHz	22.89	21.85	21.09	24.0	23.0	22.0
		1860.0MHz	22.76	21.78	21.02	24.0	23.0	22.0
	50RB_25	1900.0MHz	22.87	21.85	20.99	24.0	23.0	22.0
		1880.0MHz	22.87	21.86	21.04	24.0	23.0	22.0
		1860.0MHz	22.79	21.80	21.00	24.0	23.0	22.0
	50RB_0	1900.0MHz	23.00	21.92	21.11	24.0	23.0	22.0
		1880.0MHz	22.78	21.79	21.02	24.0	23.0	22.0
		1860.0MHz	22.75	21.79	20.94	24.0	23.0	22.0
	100RB_0	1900.0MHz	22.88	21.87	21.00	24.0	23.0	22.0
		1880.0MHz	22.83	21.82	21.07	24.0	23.0	22.0
		1860.0MHz	22.74	21.72	20.95	24.0	23.0	22.0



Sensor on								
LTE Band 2			Actual output Power (dBm)			Tune up		
Band -width	RB No. / RB offset	Frequency	Modulation			Modulation		
			QPSK	16QAM	64QAM	QPSK	16QAM	64QAM
1.4 MHz	1RB_5	1909.3MHz	20.60	19.84	18.75	22.0	21.0	20.0
		1880.0MHz	20.64	19.89	18.88	22.0	21.0	20.0
		1850.7MHz	20.65	19.95	18.93	22.0	21.0	20.0
	1RB_3	1909.3MHz	20.71	20.02	18.90	22.0	21.0	20.0
		1880.0MHz	20.80	19.98	18.99	22.0	21.0	20.0
		1850.7MHz	20.73	20.07	19.02	22.0	21.0	20.0
	1RB_0	1909.3MHz	20.56	19.82	18.78	22.0	21.0	20.0
		1880.0MHz	20.60	19.85	18.84	22.0	21.0	20.0
		1850.7MHz	20.64	19.96	18.83	22.0	21.0	20.0
	3RB_3	1909.3MHz	20.68	19.81	18.83	22.0	21.0	20.0
		1880.0MHz	20.71	19.71	18.84	22.0	21.0	20.0
		1850.7MHz	20.73	19.79	18.90	22.0	21.0	20.0
	3RB_1	1909.3MHz	20.73	19.70	18.87	22.0	21.0	20.0
		1880.0MHz	20.73	19.79	18.94	22.0	21.0	20.0
		1850.7MHz	20.78	19.88	18.93	22.0	21.0	20.0
	3RB_0	1909.3MHz	20.68	19.67	18.78	22.0	21.0	20.0
		1880.0MHz	20.71	19.74	18.90	22.0	21.0	20.0
		1850.7MHz	20.73	19.75	18.93	22.0	21.0	20.0
	6RB_0	1909.3MHz	19.68	18.54	17.75	21.0	20.0	19.0
		1880.0MHz	19.65	18.83	17.71	21.0	20.0	19.0
		1850.7MHz	19.73	18.83	17.80	21.0	20.0	19.0



Sensor on								
LTE Band 2			Actual output Power (dBm)			Tune up		
Band -width	RB No. / RB offset	Frequency	Modulation			Modulation		
			QPSK	16QAM	64QAM	QPSK	16QAM	64QAM
3 MHz	1RB_14	1908.5MHz	20.60	19.98	18.67	22.0	21.0	20.0
		1880.0MHz	20.62	20.02	18.75	22.0	21.0	20.0
		1851.5MHz	20.68	20.04	18.90	22.0	21.0	20.0
	1RB_7	1908.5MHz	20.81	20.28	18.81	22.0	21.0	20.0
		1880.0MHz	20.76	20.24	19.05	22.0	21.0	20.0
		1851.5MHz	20.83	20.17	18.98	22.0	21.0	20.0
	1RB_0	1908.5MHz	20.61	20.05	18.69	22.0	21.0	20.0
		1880.0MHz	20.64	20.06	18.74	22.0	21.0	20.0
		1851.5MHz	20.66	20.09	18.88	22.0	21.0	20.0
	8RB_7	1908.5MHz	19.63	18.76	17.67	21.0	20.0	19.0
		1880.0MHz	19.65	18.72	17.74	21.0	20.0	19.0
		1851.5MHz	19.71	18.81	17.75	21.0	20.0	19.0
	8RB_4	1908.5MHz	19.67	18.78	17.77	21.0	20.0	19.0
		1880.0MHz	19.72	18.77	17.76	21.0	20.0	19.0
		1851.5MHz	19.71	18.82	17.84	21.0	20.0	19.0
	8RB_0	1908.5MHz	19.67	18.77	17.72	21.0	20.0	19.0
		1880.0MHz	19.62	18.76	17.74	21.0	20.0	19.0
		1851.5MHz	19.72	18.78	17.81	21.0	20.0	19.0
	15RB_0	1908.5MHz	19.62	18.68	17.63	21.0	20.0	19.0
		1880.0MHz	19.62	18.71	17.61	21.0	20.0	19.0
		1851.5MHz	19.69	18.73	17.65	21.0	20.0	19.0



Sensor on								
LTE Band 2			Actual output Power (dBm)			Tune up		
Band -width	RB No. / RB offset	Frequency	Modulation			Modulation		
			QPSK	16QAM	64QAM	QPSK	16QAM	64QAM
5 MHz	1RB_24	1907.5MHz	20.44	19.89	18.72	22.0	21.0	20.0
		1880.0MHz	20.49	19.88	18.72	22.0	21.0	20.0
		1852.5MHz	20.52	19.93	18.79	22.0	21.0	20.0
	1RB_12	1907.5MHz	20.90	20.05	19.09	22.0	21.0	20.0
		1880.0MHz	20.72	20.19	19.11	22.0	21.0	20.0
		1852.5MHz	20.76	20.36	19.04	22.0	21.0	20.0
	1RB_0	1907.5MHz	20.47	19.84	18.74	22.0	21.0	20.0
		1880.0MHz	20.51	19.92	18.73	22.0	21.0	20.0
		1852.5MHz	20.57	19.91	18.79	22.0	21.0	20.0
	12RB_13	1907.5MHz	19.66	18.67	17.61	21.0	20.0	19.0
		1880.0MHz	19.64	18.61	17.63	21.0	20.0	19.0
		1852.5MHz	19.71	18.71	17.67	21.0	20.0	19.0
	12RB_6	1907.5MHz	19.71	18.75	17.77	21.0	20.0	19.0
		1880.0MHz	19.73	18.73	17.72	21.0	20.0	19.0
		1852.5MHz	19.76	18.75	17.75	21.0	20.0	19.0
	12RB_0	1907.5MHz	19.64	18.67	17.67	21.0	20.0	19.0
		1880.0MHz	19.62	18.63	17.64	21.0	20.0	19.0
		1852.5MHz	19.71	18.66	17.69	21.0	20.0	19.0
	25RB_0	1907.5MHz	19.66	18.74	17.62	21.0	20.0	19.0
		1880.0MHz	19.59	18.66	17.61	21.0	20.0	19.0
		1852.5MHz	19.70	18.72	17.70	21.0	20.0	19.0



Sensor on								
LTE Band 2			Actual output Power (dBm)			Tune up		
Band -width	RB No. / RB offset	Frequency	Modulation			Modulation		
			QPSK	16QAM	64QAM	QPSK	16QAM	64QAM
10 MHz	1RB_49	1905.0MHz	20.60	20.06	18.86	22.0	21.0	20.0
		1880.0MHz	20.63	20.15	18.65	22.0	21.0	20.0
		1855.0MHz	20.64	20.04	18.82	22.0	21.0	20.0
	1RB_24	1905.0MHz	20.69	20.19	18.85	22.0	21.0	20.0
		1880.0MHz	20.77	20.20	18.92	22.0	21.0	20.0
		1855.0MHz	20.85	20.19	18.98	22.0	21.0	20.0
	1RB_0	1905.0MHz	20.57	20.02	18.63	22.0	21.0	20.0
		1880.0MHz	20.68	20.04	18.74	22.0	21.0	20.0
		1855.0MHz	20.69	20.07	18.88	22.0	21.0	20.0
	25RB_25	1905.0MHz	19.69	18.73	17.68	21.0	20.0	19.0
		1880.0MHz	19.64	18.69	17.67	21.0	20.0	19.0
		1855.0MHz	19.73	18.76	17.75	21.0	20.0	19.0
	25RB_12	1905.0MHz	19.71	18.74	17.68	21.0	20.0	19.0
		1880.0MHz	19.73	18.73	17.65	21.0	20.0	19.0
		1855.0MHz	19.77	18.81	17.78	21.0	20.0	19.0
	25RB_0	1905.0MHz	19.74	18.77	17.71	21.0	20.0	19.0
		1880.0MHz	19.66	18.71	17.66	21.0	20.0	19.0
		1855.0MHz	19.74	18.79	17.73	21.0	20.0	19.0
	50RB_0	1905.0MHz	19.73	18.75	17.70	21.0	20.0	19.0
		1880.0MHz	19.66	18.68	17.66	21.0	20.0	19.0
		1855.0MHz	19.74	18.76	17.73	21.0	20.0	19.0



Sensor on								
LTE Band 2			Actual output Power (dBm)			Tune up		
Band -width	RB No. / RB offset	Frequency	Modulation			Modulation		
			QPSK	16QAM	64QAM	QPSK	16QAM	64QAM
15 MHz	1RB_74	1902.5MHz	20.53	19.86	18.77	22.0	21.0	20.0
		1880.0MHz	20.51	19.84	18.64	22.0	21.0	20.0
		1857.5MHz	20.39	19.95	18.64	22.0	21.0	20.0
	1RB_37	1902.5MHz	20.63	19.93	18.85	22.0	21.0	20.0
		1880.0MHz	20.68	19.94	18.87	22.0	21.0	20.0
		1857.5MHz	20.73	20.02	18.81	22.0	21.0	20.0
	1RB_0	1902.5MHz	20.49	19.78	18.72	22.0	21.0	20.0
		1880.0MHz	20.59	19.87	18.78	22.0	21.0	20.0
		1857.5MHz	20.63	19.90	18.70	22.0	21.0	20.0
	36RB_38	1902.5MHz	19.69	18.69	17.62	21.0	20.0	19.0
		1880.0MHz	19.66	18.67	17.62	21.0	20.0	19.0
		1857.5MHz	19.68	18.71	17.67	21.0	20.0	19.0
	36RB_19	1902.5MHz	19.67	18.66	17.61	21.0	20.0	19.0
		1880.0MHz	19.71	18.73	17.64	21.0	20.0	19.0
		1857.5MHz	19.79	18.79	17.77	21.0	20.0	19.0
	36RB_0	1902.5MHz	19.71	18.68	17.68	21.0	20.0	19.0
		1880.0MHz	19.69	18.69	17.64	21.0	20.0	19.0
		1857.5MHz	19.77	18.77	17.74	21.0	20.0	19.0
	75RB_0	1902.5MHz	19.69	18.70	17.62	21.0	20.0	19.0
		1880.0MHz	19.69	18.72	17.66	21.0	20.0	19.0
		1857.5MHz	19.72	18.73	17.69	21.0	20.0	19.0



Sensor on								
LTE Band 2			Actual output Power (dBm)			Tune up		
Band -width	RB No. / RB offset	Frequency	Modulation			Modulation		
			QPSK	16QAM	64QAM	QPSK	16QAM	64QAM
20 MHz	1RB_99	1900.0MHz	20.37	19.76	18.58	22.0	21.0	20.0
		1880.0MHz	20.34	19.75	18.48	22.0	21.0	20.0
		1860.0MHz	20.41	19.74	18.53	22.0	21.0	20.0
	1RB_50	1900.0MHz	20.66	20.07	18.90	22.0	21.0	20.0
		1880.0MHz	20.77	20.18	18.94	22.0	21.0	20.0
		1860.0MHz	20.83	20.11	19.09	22.0	21.0	20.0
	1RB_0	1900.0MHz	20.33	19.69	18.49	22.0	21.0	20.0
		1880.0MHz	20.41	19.91	18.64	22.0	21.0	20.0
		1860.0MHz	20.46	19.79	18.71	22.0	21.0	20.0
	50RB_50	1900.0MHz	19.58	18.62	17.51	21.0	20.0	19.0
		1880.0MHz	19.72	18.65	17.65	21.0	20.0	19.0
		1860.0MHz	19.67	18.66	17.61	21.0	20.0	19.0
	50RB_25	1900.0MHz	19.63	18.68	17.61	21.0	20.0	19.0
		1880.0MHz	19.72	18.75	17.71	21.0	20.0	19.0
		1860.0MHz	19.79	18.78	17.73	21.0	20.0	19.0
	50RB_0	1900.0MHz	19.81	18.79	17.75	21.0	20.0	19.0
		1880.0MHz	19.76	18.73	17.65	21.0	20.0	19.0
		1860.0MHz	19.80	18.79	17.75	21.0	20.0	19.0
	100RB_0	1900.0MHz	19.68	18.70	17.64	21.0	20.0	19.0
		1880.0MHz	19.73	18.73	17.67	21.0	20.0	19.0
		1860.0MHz	19.72	18.75	17.69	21.0	20.0	19.0



Full Power								
LTE Band 4			Actual output Power (dBm)			Tune up		
Band -width	RB No. / RB offset	Frequency	Modulation			Modulation		
			QPSK	16QAM	64QAM	QPSK	16QAM	64QAM
1.4 MHz	1RB_5	1754.3MHz	23.50	22.40	21.76	25.0	24.0	23.0
		1754.3MHz	23.10	22.35	21.80	25.0	24.0	23.0
		1710.7MHz	23.10	22.69	21.75	25.0	24.0	23.0
	1RB_3	1754.3MHz	23.65	22.48	21.91	25.0	24.0	23.0
		1754.3MHz	23.18	22.48	21.90	25.0	24.0	23.0
		1710.7MHz	23.22	22.61	21.88	25.0	24.0	23.0
	1RB_0	1754.3MHz	23.53	22.43	21.82	25.0	24.0	23.0
		1754.3MHz	23.08	22.34	21.71	25.0	24.0	23.0
		1710.7MHz	23.10	22.61	21.79	25.0	24.0	23.0
	3RB_3	1754.3MHz	23.58	22.11	21.77	25.0	24.0	23.0
		1754.3MHz	23.20	22.29	21.74	25.0	24.0	23.0
		1710.7MHz	23.19	22.45	21.81	25.0	24.0	23.0
	3RB_1	1754.3MHz	23.18	22.17	21.84	25.0	24.0	23.0
		1754.3MHz	23.25	22.47	21.80	25.0	24.0	23.0
		1710.7MHz	23.29	22.32	21.91	25.0	24.0	23.0
	3RB_0	1754.3MHz	23.09	22.16	21.77	25.0	24.0	23.0
		1754.3MHz	23.19	22.17	21.77	25.0	24.0	23.0
		1710.7MHz	23.19	22.45	21.85	25.0	24.0	23.0
	6RB_0	1754.3MHz	22.12	21.37	20.71	24.0	23.0	22.0
		1754.3MHz	22.60	21.82	20.78	24.0	23.0	22.0
		1710.7MHz	22.34	21.83	20.81	24.0	23.0	22.0

Full Power								
LTE Band 4			Actual output Power (dBm)			Tune up		
Band -width	RB No. / RB offset	Frequency	Modulation			Modulation		
			QPSK	16QAM	64QAM	QPSK	16QAM	64QAM
3 MHz	1RB_14	1753.5MHz	23.49	22.52	21.88	25.0	24.0	23.0
		1732.5MHz	23.18	22.38	21.72	25.0	24.0	23.0
		1711.5MHz	23.15	22.82	21.75	25.0	24.0	23.0
	1RB_7	1753.5MHz	23.69	22.52	22.10	25.0	24.0	23.0
		1732.5MHz	23.36	22.62	21.90	25.0	24.0	23.0
		1711.5MHz	23.51	22.98	21.91	25.0	24.0	23.0
	1RB_0	1753.5MHz	23.55	22.31	21.90	25.0	24.0	23.0
		1732.5MHz	23.14	22.57	21.70	25.0	24.0	23.0
		1711.5MHz	23.18	22.90	21.76	25.0	24.0	23.0
	8RB_7	1753.5MHz	22.59	21.32	20.66	24.0	23.0	22.0
		1732.5MHz	22.54	21.74	20.76	24.0	23.0	22.0
		1711.5MHz	22.55	21.77	20.80	24.0	23.0	22.0
	8RB_4	1753.5MHz	22.61	21.60	20.71	24.0	23.0	22.0
		1732.5MHz	22.68	21.78	20.79	24.0	23.0	22.0
		1711.5MHz	22.70	21.79	20.84	24.0	23.0	22.0
	8RB_0	1753.5MHz	22.63	21.54	20.72	24.0	23.0	22.0
		1732.5MHz	22.66	21.72	20.77	24.0	23.0	22.0
		1711.5MHz	22.68	21.81	20.82	24.0	23.0	22.0
15RB_0	1753.5MHz	22.52	21.52	20.70	24.0	23.0	22.0	
	1732.5MHz	22.65	21.72	20.75	24.0	23.0	22.0	
	1711.5MHz	22.68	21.75	20.74	24.0	23.0	22.0	

Full Power								
LTE Band 4			Actual output Power (dBm)			Tune up		
Band -width	RB No. / RB offset	Frequency	Modulation			Modulation		
			QPSK	16QAM	64QAM	QPSK	16QAM	64QAM
5 MHz	1RB_24	1752.5MHz	23.44	22.38	21.64	25.0	24.0	23.0
		1732.5MHz	23.41	22.43	21.72	25.0	24.0	23.0
		1712.5MHz	23.52	22.65	21.80	25.0	24.0	23.0
	1RB_12	1752.5MHz	23.72	22.51	21.97	25.0	24.0	23.0
		1732.5MHz	23.32	22.78	21.94	25.0	24.0	23.0
		1712.5MHz	23.57	22.95	22.07	25.0	24.0	23.0
	1RB_0	1752.5MHz	23.51	22.41	21.75	25.0	24.0	23.0
		1732.5MHz	23.35	22.59	21.78	25.0	24.0	23.0
		1712.5MHz	23.40	22.69	21.88	25.0	24.0	23.0
	12RB_13	1752.5MHz	22.64	21.18	20.69	24.0	23.0	22.0
		1732.5MHz	22.65	21.59	20.73	24.0	23.0	22.0
		1712.5MHz	22.73	21.77	20.80	24.0	23.0	22.0
	12RB_6	1752.5MHz	22.64	21.23	20.81	24.0	23.0	22.0
		1732.5MHz	22.69	21.73	20.78	24.0	23.0	22.0
		1712.5MHz	22.75	21.78	20.85	24.0	23.0	22.0
	12RB_0	1752.5MHz	22.64	21.41	20.73	24.0	23.0	22.0
		1732.5MHz	22.72	21.72	20.78	24.0	23.0	22.0
		1712.5MHz	22.67	21.74	20.74	24.0	23.0	22.0
	25RB_0	1752.5MHz	22.44	21.45	20.67	24.0	23.0	22.0
		1732.5MHz	22.30	21.70	20.74	24.0	23.0	22.0
		1712.5MHz	22.72	21.78	20.79	24.0	23.0	22.0



Full Power								
LTE Band 4			Actual output Power (dBm)			Tune up		
Band -width	RB No. / RB offset	Frequency	Modulation			Modulation		
			QPSK	16QAM	64QAM	QPSK	16QAM	64QAM
10 MHz	1RB_49	1750.0MHz	23.56	22.87	21.84	25.0	24.0	23.0
		1732.5MHz	23.44	22.54	21.81	25.0	24.0	23.0
		1715.0MHz	23.68	22.84	21.86	25.0	24.0	23.0
	1RB_24	1750.0MHz	23.70	22.94	21.94	25.0	24.0	23.0
		1732.5MHz	23.35	22.51	22.00	25.0	24.0	23.0
		1715.0MHz	23.76	22.93	21.98	25.0	24.0	23.0
	1RB_0	1750.0MHz	23.66	22.75	21.91	25.0	24.0	23.0
		1732.5MHz	23.64	22.75	21.91	25.0	24.0	23.0
		1715.0MHz	23.70	22.85	21.83	25.0	24.0	23.0
	25RB_25	1750.0MHz	22.67	21.27	20.79	24.0	23.0	22.0
		1732.5MHz	22.71	21.71	20.77	24.0	23.0	22.0
		1715.0MHz	22.82	21.83	20.81	24.0	23.0	22.0
	25RB_12	1750.0MHz	22.68	21.37	20.72	24.0	23.0	22.0
		1732.5MHz	22.74	21.74	20.79	24.0	23.0	22.0
		1715.0MHz	22.77	21.79	20.78	24.0	23.0	22.0
	25RB_0	1750.0MHz	22.74	21.54	20.77	24.0	23.0	22.0
		1732.5MHz	22.82	21.81	20.86	24.0	23.0	22.0
		1715.0MHz	22.78	21.78	20.77	24.0	23.0	22.0
	50RB_0	1750.0MHz	22.71	21.48	20.80	24.0	23.0	22.0
		1732.5MHz	22.77	21.82	20.81	24.0	23.0	22.0
		1715.0MHz	22.76	21.78	20.83	24.0	23.0	22.0



Full Power								
LTE Band 4			Actual output Power (dBm)			Tune up		
Band -width	RB No. / RB offset	Frequency	Modulation			Modulation		
			QPSK	16QAM	64QAM	QPSK	16QAM	64QAM
15 MHz	1RB_74	1747.5MHz	23.53	22.77	21.83	25.0	24.0	23.0
		1732.5MHz	23.53	22.81	21.81	25.0	24.0	23.0
		1717.5MHz	23.55	22.84	21.78	25.0	24.0	23.0
	1RB_37	1747.5MHz	23.64	22.90	21.95	25.0	24.0	23.0
		1732.5MHz	23.65	22.92	21.95	25.0	24.0	23.0
		1717.5MHz	23.69	22.99	21.89	25.0	24.0	23.0
	1RB_0	1747.5MHz	23.61	22.84	21.92	25.0	24.0	23.0
		1732.5MHz	23.61	22.87	21.92	25.0	24.0	23.0
		1717.5MHz	23.60	22.93	21.88	25.0	24.0	23.0
	36RB_38	1747.5MHz	22.68	21.69	20.79	24.0	23.0	22.0
		1732.5MHz	22.67	21.69	20.74	24.0	23.0	22.0
		1717.5MHz	22.70	21.73	20.76	24.0	23.0	22.0
	36RB_19	1747.5MHz	22.69	21.74	20.78	24.0	23.0	22.0
		1732.5MHz	22.73	21.74	20.78	24.0	23.0	22.0
		1717.5MHz	22.72	21.74	20.78	24.0	23.0	22.0
	36RB_0	1747.5MHz	22.73	21.78	20.80	24.0	23.0	22.0
		1732.5MHz	22.76	21.75	20.82	24.0	23.0	22.0
		1717.5MHz	22.74	21.72	20.77	24.0	23.0	22.0
	75RB_0	1747.5MHz	22.71	21.77	20.78	24.0	23.0	22.0
		1732.5MHz	22.74	21.75	20.76	24.0	23.0	22.0
		1717.5MHz	22.72	21.72	20.76	24.0	23.0	22.0



Full Power								
LTE Band 4			Actual output Power (dBm)			Tune up		
Band -width	RB No. / RB offset	Frequency	Modulation			Modulation		
			QPSK	16QAM	64QAM	QPSK	16QAM	64QAM
20 MHz	1RB_99	1745.0MHz	23.29	22.57	21.54	25.0	24.0	23.0
		1732.5MHz	23.36	22.60	21.69	25.0	24.0	23.0
		1720.0MHz	23.30	22.52	21.62	25.0	24.0	23.0
	1RB_50	1745.0MHz	23.79	23.00	21.86	25.0	24.0	23.0
		1732.5MHz	23.70	22.92	22.00	25.0	24.0	23.0
		1720.0MHz	23.72	22.88	21.94	25.0	24.0	23.0
	1RB_0	1745.0MHz	23.42	22.67	21.60	25.0	24.0	23.0
		1732.5MHz	23.40	22.67	21.65	25.0	24.0	23.0
		1720.0MHz	23.51	22.62	21.70	25.0	24.0	23.0
	50RB_50	1745.0MHz	22.65	21.71	20.74	24.0	23.0	22.0
		1732.5MHz	22.60	21.63	20.67	24.0	23.0	22.0
		1720.0MHz	22.69	21.69	20.66	24.0	23.0	22.0
	50RB_25	1745.0MHz	22.85	21.79	20.82	24.0	23.0	22.0
		1732.5MHz	22.77	21.77	20.78	24.0	23.0	22.0
		1720.0MHz	22.77	21.75	20.75	24.0	23.0	22.0
	50RB_0	1745.0MHz	22.78	21.88	20.87	24.0	23.0	22.0
		1732.5MHz	22.83	21.81	20.86	24.0	23.0	22.0
		1720.0MHz	22.75	21.76	20.74	24.0	23.0	22.0
	100RB_0	1745.0MHz	22.71	21.79	20.80	24.0	23.0	22.0
		1732.5MHz	22.71	21.77	20.75	24.0	23.0	22.0
		1720.0MHz	22.73	21.69	20.69	24.0	23.0	22.0



Sensor on								
LTE Band 4			Actual output Power (dBm)			Tune up		
Band -width	RB No. / RB offset	Frequency	Modulation			Modulation		
			QPSK	16QAM	64QAM	QPSK	16QAM	64QAM
1.4 MHz	1RB_5	1754.3MHz	18.45	17.71	16.71	20.0	19.0	18.0
		1754.3MHz	18.44	17.63	16.71	20.0	19.0	18.0
		1710.7MHz	18.32	17.58	16.51	20.0	19.0	18.0
	1RB_3	1754.3MHz	18.57	17.87	16.89	20.0	19.0	18.0
		1754.3MHz	18.56	17.78	16.89	20.0	19.0	18.0
		1710.7MHz	18.45	17.79	16.69	20.0	19.0	18.0
	1RB_0	1754.3MHz	18.46	17.71	16.65	20.0	19.0	18.0
		1754.3MHz	18.44	17.73	16.68	20.0	19.0	18.0
		1710.7MHz	18.32	17.55	16.49	20.0	19.0	18.0
	3RB_3	1754.3MHz	18.55	17.56	16.61	20.0	19.0	18.0
		1754.3MHz	18.54	17.54	16.68	20.0	19.0	18.0
		1710.7MHz	18.45	17.45	16.54	20.0	19.0	18.0
	3RB_1	1754.3MHz	18.54	17.64	16.73	20.0	19.0	18.0
		1754.3MHz	18.59	17.59	16.70	20.0	19.0	18.0
		1710.7MHz	18.46	17.50	16.54	20.0	19.0	18.0
	3RB_0	1754.3MHz	18.52	17.57	16.67	20.0	19.0	18.0
		1754.3MHz	18.52	17.53	16.62	20.0	19.0	18.0
		1710.7MHz	18.43	17.45	16.59	20.0	19.0	18.0
	6RB_0	1754.3MHz	17.53	16.60	15.52	19.0	18.0	17.0
		1754.3MHz	17.56	16.64	15.49	19.0	18.0	17.0
		1710.7MHz	17.41	16.50	15.43	19.0	18.0	17.0



Sensor on								
LTE Band 4			Actual output Power (dBm)			Tune up		
Band -width	RB No. / RB offset	Frequency	Modulation			Modulation		
			QPSK	16QAM	64QAM	QPSK	16QAM	64QAM
3 MHz	1RB_14	1753.5MHz	18.50	17.82	16.65	20.0	19.0	18.0
		1732.5MHz	18.44	17.89	16.71	20.0	19.0	18.0
		1711.5MHz	18.37	17.73	16.67	20.0	19.0	18.0
	1RB_7	1753.5MHz	18.66	18.13	16.92	20.0	19.0	18.0
		1732.5MHz	18.61	17.98	16.92	20.0	19.0	18.0
		1711.5MHz	18.44	17.87	16.87	20.0	19.0	18.0
	1RB_0	1753.5MHz	18.49	17.93	16.70	20.0	19.0	18.0
		1732.5MHz	18.53	17.83	16.68	20.0	19.0	18.0
		1711.5MHz	18.43	17.74	16.67	20.0	19.0	18.0
	8RB_7	1753.5MHz	17.49	16.63	15.56	19.0	18.0	17.0
		1732.5MHz	17.46	16.57	15.61	19.0	18.0	17.0
		1711.5MHz	17.38	16.44	15.44	19.0	18.0	17.0
	8RB_4	1753.5MHz	17.54	16.63	15.61	19.0	18.0	17.0
		1732.5MHz	17.50	16.60	15.64	19.0	18.0	17.0
		1711.5MHz	17.43	16.45	15.44	19.0	18.0	17.0
	8RB_0	1753.5MHz	17.53	16.62	15.63	19.0	18.0	17.0
		1732.5MHz	17.51	16.59	15.54	19.0	18.0	17.0
		1711.5MHz	17.36	16.46	15.45	19.0	18.0	17.0
	15RB_0	1753.5MHz	17.47	16.50	15.50	19.0	18.0	17.0
		1732.5MHz	17.43	16.55	15.56	19.0	18.0	17.0
		1711.5MHz	17.35	16.42	15.42	19.0	18.0	17.0



Sensor on								
LTE Band 4			Actual output Power (dBm)			Tune up		
Band -width	RB No. / RB offset	Frequency	Modulation			Modulation		
			QPSK	16QAM	64QAM	QPSK	16QAM	64QAM
5 MHz	1RB_24	1752.5MHz	18.36	17.75	16.46	20.0	19.0	18.0
		1732.5MHz	18.44	17.73	16.56	20.0	19.0	18.0
		1712.5MHz	18.29	17.72	16.48	20.0	19.0	18.0
	1RB_12	1752.5MHz	18.67	18.14	16.81	20.0	19.0	18.0
		1732.5MHz	18.68	17.94	16.86	20.0	19.0	18.0
		1712.5MHz	18.49	18.01	16.71	20.0	19.0	18.0
	1RB_0	1752.5MHz	18.45	17.78	16.59	20.0	19.0	18.0
		1732.5MHz	18.45	17.81	16.58	20.0	19.0	18.0
		1712.5MHz	18.29	17.61	16.49	20.0	19.0	18.0
	12RB_13	1752.5MHz	17.45	16.50	15.53	19.0	18.0	17.0
		1732.5MHz	17.46	16.45	15.52	19.0	18.0	17.0
		1712.5MHz	17.37	16.34	15.39	19.0	18.0	17.0
	12RB_6	1752.5MHz	17.52	16.60	15.61	19.0	18.0	17.0
		1732.5MHz	17.53	16.55	15.64	19.0	18.0	17.0
		1712.5MHz	17.43	16.45	15.51	19.0	18.0	17.0
	12RB_0	1752.5MHz	17.49	16.52	15.58	19.0	18.0	17.0
		1732.5MHz	17.50	16.51	15.55	19.0	18.0	17.0
		1712.5MHz	17.36	16.37	15.42	19.0	18.0	17.0
	25RB_0	1752.5MHz	17.48	16.48	15.57	19.0	18.0	17.0
		1732.5MHz	17.48	16.45	15.53	19.0	18.0	17.0
		1712.5MHz	17.35	16.35	15.41	19.0	18.0	17.0



Sensor on								
LTE Band 4			Actual output Power (dBm)			Tune up		
Band -width	RB No. / RB offset	Frequency	Modulation			Modulation		
			QPSK	16QAM	64QAM	QPSK	16QAM	64QAM
10 MHz	1RB_49	1750.0MHz	18.44	17.91	16.75	20.0	19.0	18.0
		1732.5MHz	18.46	17.82	16.67	20.0	19.0	18.0
		1715.0MHz	18.40	17.81	16.56	20.0	19.0	18.0
	1RB_24	1750.0MHz	18.65	18.06	16.92	20.0	19.0	18.0
		1732.5MHz	18.66	18.00	16.81	20.0	19.0	18.0
		1715.0MHz	18.51	17.92	16.63	20.0	19.0	18.0
	1RB_0	1750.0MHz	18.51	17.91	16.82	20.0	19.0	18.0
		1732.5MHz	18.53	17.88	16.66	20.0	19.0	18.0
		1715.0MHz	18.39	17.75	16.50	20.0	19.0	18.0
	25RB_25	1750.0MHz	17.52	16.57	15.55	19.0	18.0	17.0
		1732.5MHz	17.51	16.51	15.53	19.0	18.0	17.0
		1715.0MHz	17.46	16.49	15.49	19.0	18.0	17.0
	25RB_12	1750.0MHz	17.55	16.63	15.66	19.0	18.0	17.0
		1732.5MHz	17.58	16.56	15.64	19.0	18.0	17.0
		1715.0MHz	17.48	16.45	15.52	19.0	18.0	17.0
	25RB_0	1750.0MHz	17.60	16.60	15.68	19.0	18.0	17.0
		1732.5MHz	17.56	16.59	15.66	19.0	18.0	17.0
		1715.0MHz	17.43	16.44	15.45	19.0	18.0	17.0
	50RB_0	1750.0MHz	17.54	16.62	15.59	19.0	18.0	17.0
		1732.5MHz	17.52	16.54	15.53	19.0	18.0	17.0
		1715.0MHz	17.40	16.41	15.45	19.0	18.0	17.0



Sensor on								
LTE Band 4			Actual output Power (dBm)			Tune up		
Band -width	RB No. / RB offset	Frequency	Modulation			Modulation		
			QPSK	16QAM	64QAM	QPSK	16QAM	64QAM
15 MHz	1RB_74	1747.5MHz	18.34	17.73	16.49	20.0	19.0	18.0
		1732.5MHz	18.37	17.83	16.66	20.0	19.0	18.0
		1717.5MHz	18.30	17.74	16.57	20.0	19.0	18.0
	1RB_37	1747.5MHz	18.54	17.90	16.71	20.0	19.0	18.0
		1732.5MHz	18.50	17.93	16.68	20.0	19.0	18.0
		1717.5MHz	18.45	17.89	16.67	20.0	19.0	18.0
	1RB_0	1747.5MHz	18.50	17.84	16.82	20.0	19.0	18.0
		1732.5MHz	18.41	17.82	16.66	20.0	19.0	18.0
		1717.5MHz	18.28	17.75	16.56	20.0	19.0	18.0
	36RB_38	1747.5MHz	17.57	16.50	15.55	19.0	18.0	17.0
		1732.5MHz	17.50	16.47	15.53	19.0	18.0	17.0
		1717.5MHz	17.42	16.39	15.43	19.0	18.0	17.0
	36RB_19	1747.5MHz	17.56	16.56	15.65	19.0	18.0	17.0
		1732.5MHz	17.51	16.56	15.58	19.0	18.0	17.0
		1717.5MHz	17.49	16.45	15.46	19.0	18.0	17.0
	36RB_0	1747.5MHz	17.57	16.59	15.60	19.0	18.0	17.0
		1732.5MHz	17.55	16.54	15.57	19.0	18.0	17.0
		1717.5MHz	17.47	16.43	15.46	19.0	18.0	17.0
	75RB_0	1747.5MHz	17.55	16.55	15.58	19.0	18.0	17.0
		1732.5MHz	17.48	16.52	15.51	19.0	18.0	17.0
		1717.5MHz	17.44	16.40	15.41	19.0	18.0	17.0



Sensor on								
LTE Band 4			Actual output Power (dBm)			Tune up		
Band -width	RB No. / RB offset	Frequency	Modulation			Modulation		
			QPSK	16QAM	64QAM	QPSK	16QAM	64QAM
20 MHz	1RB_99	1745.0MHz	18.15	17.47	16.44	20.0	19.0	18.0
		1732.5MHz	18.24	17.56	16.47	20.0	19.0	18.0
		1720.0MHz	18.16	17.42	16.39	20.0	19.0	18.0
	1RB_50	1745.0MHz	18.56	17.96	16.87	20.0	19.0	18.0
		1732.5MHz	18.57	17.94	16.85	20.0	19.0	18.0
		1720.0MHz	18.45	17.78	16.73	20.0	19.0	18.0
	1RB_0	1745.0MHz	18.31	17.63	16.47	20.0	19.0	18.0
		1732.5MHz	18.20	17.53	16.43	20.0	19.0	18.0
		1720.0MHz	18.16	17.40	16.29	20.0	19.0	18.0
	50RB_50	1745.0MHz	17.53	16.51	15.54	19.0	18.0	17.0
		1732.5MHz	17.40	16.43	15.42	19.0	18.0	17.0
		1720.0MHz	17.33	16.35	15.36	19.0	18.0	17.0
	50RB_25	1745.0MHz	17.57	16.60	15.61	19.0	18.0	17.0
		1732.5MHz	17.49	16.54	15.54	19.0	18.0	17.0
		1720.0MHz	17.43	16.50	15.51	19.0	18.0	17.0
	50RB_0	1745.0MHz	17.66	16.71	15.72	19.0	18.0	17.0
		1732.5MHz	17.58	16.58	15.58	19.0	18.0	17.0
		1720.0MHz	17.38	16.38	15.45	19.0	18.0	17.0
	100RB_0	1745.0MHz	17.55	16.61	15.61	19.0	18.0	17.0
		1732.5MHz	17.53	16.48	15.52	19.0	18.0	17.0
		1720.0MHz	17.39	16.35	15.39	19.0	18.0	17.0



LTE Band 5			Actual output Power (dBm)			Tune up		
Band -width	RB No. / RB offset	Frequency	Modulation			Modulation		
			QPSK	16QAM	64QAM	QPSK	16QAM	64QAM
1.4 MHz	1RB_5	848.3MHz	23.57	22.75	21.87	25.0	24.0	23.0
		836.5MHz	23.57	22.77	21.89	25.0	24.0	23.0
		824.7MHz	23.61	22.91	21.99	25.0	24.0	23.0
	1RB_3	848.3MHz	23.67	22.85	21.99	25.0	24.0	23.0
		836.5MHz	23.71	22.83	21.99	25.0	24.0	23.0
		824.7MHz	23.70	22.99	22.20	25.0	24.0	23.0
	1RB_0	848.3MHz	23.57	22.75	21.88	25.0	24.0	23.0
		836.5MHz	23.57	22.70	21.93	25.0	24.0	23.0
		824.7MHz	23.62	22.88	22.02	25.0	24.0	23.0
	3RB_3	848.3MHz	23.66	22.64	21.88	25.0	24.0	23.0
		836.5MHz	23.70	22.67	21.89	25.0	24.0	23.0
		824.7MHz	23.77	22.74	22.01	25.0	24.0	23.0
	3RB_1	848.3MHz	23.75	22.72	21.99	25.0	24.0	23.0
		836.5MHz	23.73	22.69	21.93	25.0	24.0	23.0
		824.7MHz	23.76	22.78	22.07	25.0	24.0	23.0
	3RB_0	848.3MHz	23.73	22.68	21.92	25.0	24.0	23.0
		836.5MHz	23.68	22.65	21.90	25.0	24.0	23.0
		824.7MHz	23.68	22.71	22.02	25.0	24.0	23.0
	6RB_0	848.3MHz	22.76	21.80	20.87	24.0	23.0	22.0
		836.5MHz	22.73	21.78	20.83	24.0	23.0	22.0
		824.7MHz	22.72	21.86	20.86	24.0	23.0	22.0



LTE Band 5			Actual output Power (dBm)			Tune up		
Band -width	RB No. / RB offset	Frequency	Modulation			Modulation		
			QPSK	16QAM	64QAM	QPSK	16QAM	64QAM
3 MHz	1RB_14	847.5MHz	23.66	22.92	22.00	25.0	24.0	23.0
		836.5MHz	23.66	22.88	22.00	25.0	24.0	23.0
		825.5MHz	23.72	23.08	22.06	25.0	24.0	23.0
	1RB_7	847.5MHz	23.86	23.03	22.11	25.0	24.0	23.0
		836.5MHz	23.80	23.09	22.14	25.0	24.0	23.0
		825.5MHz	23.81	23.13	22.15	25.0	24.0	23.0
	1RB_0	847.5MHz	23.69	22.93	21.96	25.0	24.0	23.0
		836.5MHz	23.68	22.93	21.93	25.0	24.0	23.0
		825.5MHz	23.72	22.98	22.05	25.0	24.0	23.0
	8RB_7	847.5MHz	22.71	21.80	20.83	24.0	23.0	22.0
		836.5MHz	22.66	21.77	20.86	24.0	23.0	22.0
		825.5MHz	22.72	21.80	20.98	24.0	23.0	22.0
	8RB_4	847.5MHz	22.72	21.83	20.91	24.0	23.0	22.0
		836.5MHz	22.71	21.79	20.92	24.0	23.0	22.0
		825.5MHz	22.75	21.85	21.01	24.0	23.0	22.0
	8RB_0	847.5MHz	22.73	21.81	20.95	24.0	23.0	22.0
		836.5MHz	22.66	21.73	20.83	24.0	23.0	22.0
		825.5MHz	22.72	21.84	20.94	24.0	23.0	22.0
	15RB_0	847.5MHz	22.72	21.78	20.85	24.0	23.0	22.0
		836.5MHz	22.69	21.71	20.79	24.0	23.0	22.0
		825.5MHz	22.73	21.81	20.80	24.0	23.0	22.0