



## TEST REPORT FCC Part 27

**Report Reference No.**.....: **HK2009012691-9E**

**FCC ID**.....: **2AJOTTA-1318**

Compiled by  
( position+printedname+signature)....: File administrators Gary Qian

Supervised by  
(position+printedname+signature).....: Technique principal Eden Hu

Approved by  
(position+printedname+signature).....: Manager Jason Zhou

Date of issue.....: Oct. 25, 2020

**Testing Laboratory Name** .....: **Shenzhen HUAKE Testing Technology Co., Ltd.**

Address .....: 1F, B2 Building, Junfeng Zhongcheng Zhizao Innovation Park,  
Heping Community, Fuhai Street, Bao' an District, Shenzhen, China

**Applicant's name**.....: **HMD global Oy**

Address .....: Bertel Jungin aukio 9, 02600 Espoo Finland

**Test specification** .....

Standard .....: **FCC CFR Title 47 Part 2, Part 27**

TRF Originator.....: Shenzhen HUAKE Testing Technology Co., Ltd.

**Shenzhen HUAKE Testing Technology Co., Ltd. All rights reserved.**

This publication may be reproduced in whole or in part for non-commercial purposes as long as the Shenzhen HUAKE Testing Technology Co., Ltd. as copyright owner and source of the material. Shenzhen HUAKE Testing Technology Co., Ltd. takes no responsibility for and will not assume liability for damages resulting from the reader's interpretation of the reproduced material due to its placement and context.

**Test item description** .....: Mobile Phone

Trade Mark .....: NOKIA

**Manufacturer**.....: HMD global Oy

Model/Type reference.....: TA-1318

Listed Models .....: N/A

Modulation Type .....: QPSK, 16QAM

Rating .....: DC 3.8V from Battery or DC 5V from Adapter

Hardware version .....: V2.0

Software version.....: V2.0

Result.....: **PASS**

**TEST REPORT**

<b>Test Report No. :</b>	<b>HK2009012691-9E</b>	Oct. 25, 2020
		Date of issue

Equipment under Test : Mobile Phone

Model /Type : TA-1318

Listed Models : N/A

**Applicant** : HMD global Oy

Address : Bertel Jungin aukio 9, 02600 Espoo Finland

**Manufacturer** : HMD global Oy

Address : Bertel Jungin aukio 9, 02600 Espoo Finland

<b>Test Result:</b>	<b>PASS</b>
---------------------	-------------

The test report merely corresponds to the test sample.

It is not permitted to copy extracts of these test result without the written permission of the test laboratory.



## Revision History

Revision	Issue Date	Revisions	Revised By
V1.0	2020-09-14	Initial Issue	Jason Zhou



## Contents

<b>1</b>	<b><u>TEST STANDARDS</u></b> .....	<b>5</b>
<b>2</b>	<b><u>SUMMARY</u></b> .....	<b>6</b>
2.1	General Remarks	6
2.2	Product Description	6
2.3	Equipment under Test	6
2.4	Short description of the Equipment under Test (EUT)	6
2.5	Normal Accessory setting	7
2.6	EUT configuration	7
2.7	Related Submittal(s) / Grant (s)	7
2.8	Modifications	7
2.9	General Test Conditions/Configurations	7
<b>3</b>	<b><u>TEST ENVIRONMENT</u></b> .....	<b>8</b>
3.1	Address of the test laboratory	8
3.2	Test Description	8
3.3	Equipments Used during the Test	9
<b>4</b>	<b><u>TEST CONDITIONS AND RESULTS</u></b> .....	<b>10</b>
4.1	Output Power	10
4.2	Peak-to-Average Ratio (PAR)	16
4.3	Occupied Bandwidth and Emission Bandwidth	21
4.4	Band Edge compliance	26
4.5	Spurious Emission on Antenna Port	31
4.6	Radiated Spurious Emission	44
4.7	Frequency Stability	50
<b>5</b>	<b><u>TEST SETUP PHOTOS OF THE EUT</u></b> .....	<b>52</b>
	<b><u>EXTERNAL AND INTERNAL PHOTOS OF THE EUT</u></b> .....	<b>52</b>



# **1 TEST STANDARDS**

The tests were performed according to following standards:

[FCC Part 2](#): FREQUENCY ALLOCATIONS AND RADIO TREATY MATTERS; GENERAL RULES AND REGULATIONS

[FCC Part 27](#): MISCELLANEOUS WIRELESS COMMUNICATIONS SERVICES

[ANSI/TIA-603-E-2016](#): Land Mobile FM or PM Communications Equipment Measurement and Performance Standards.

[ANSI C63.26-2015](#): IEEE/ANSI Standard for Compliance Testing of Transmitters Used in Licensed Radio Services

[FCC KDB 971168D01 v03r01](#): Power Meas License Digital Systems



## 2 SUMMARY

### 2.1 General Remarks

Date of receipt of test sample	:	Aug. 28, 2020
Testing commenced on	:	Aug. 29, 2020
Testing concluded on	:	Oct. 25, 2020

### 2.2 Product Description

The HMD global Oy's Model: TA-1318 or the "EUT" as referred to in this report; more general information as follows, for more details, refer to the user's manual of the EUT.

Name of EUT	Mobile Phone
Model/Type reference:	TA-1318
List Model:	N/A
Power supply:	DC 3.8V from Battery or DC 5V from Adapter
Adapter Information	Input: 100-240V~50/60Hz 0.3A, Output: 5V 1000mA
Modulation Type	QPSK, 16QAM
Antenna Type	Internal Antenna
Antenna Gain	1dBi
Operation Frequency Band	LTE Band 7
Operation frequency	LTE Band 7: 2500 to 2570 MHz
LTE Release	R8
Extreme temp. Tolerance	-30°C to +50°C
Extreme vol. Limits	3.42VDC to 4.18VDC (nominal: 3.8VDC)

### 2.3 Equipment under Test

#### Power supply system utilised

Power supply voltage	:	<input type="radio"/> 120V/ 60 Hz	<input type="radio"/> 115V/60Hz
		<input type="radio"/> 12 V DC	<input type="radio"/> 24 V DC
		<input checked="" type="radio"/> Other (specified in blank below)	

DC 3.8V from Battery or DC 5V from Adapter

### 2.4 Short description of the Equipment under Test (EUT)

#### 2.4.1 General Description

TA-1318 is subscriber equipment in the LTE system. LTE frequency band is band 41; The Mobile Phone implements such functions as RF signal receiving/transmitting, LTE protocol processing, voice, video MMS service, etc. Externally it provides microSD card interface, earphone port (to provide voice service) and SIM card interface.



## 2.5 Normal Accessory setting

Fully charged battery was used during the test.

## 2.6 EUT configuration

The following peripheral devices and interface cables were connected during the measurement:

● - supplied by the manufacturer

○ - supplied by the lab

<input type="radio"/>	Power Cable	Length (m) :	/
		Shield :	/
		Detachable :	/
<input type="radio"/>	Multimeter	Manufacturer :	/
		Model No. :	/

## 2.7 Related Submittal(s) / Grant (s)

This submittal(s) (test report) is intended for FCC ID: 2AJOTTA-1318 filing to comply with FCC Part 27, Rules.

## 2.8 Modifications

No modifications were implemented to meet testing criteria.

## 2.9 General Test Conditions/Configurations

### 2.9.1 Test Environment

Environment Parameter	Selected Values During Tests	
Relative Humidity	Ambient	
Temperature	TN	Ambient
Voltage	VL	3.42V
	VN	3.8V
	VH	4.18V

NOTE: VL=lower extreme test voltage VN=nominal voltage  
VH=upper extreme test voltage TN=normal temperature



### **3 TEST ENVIRONMENT**

#### **3.1 Address of the test laboratory**

Test Firm : Shenzhen HUAKE Testing Technology Co., Ltd.

Address : 1F, B2 Building, Junfeng Zhongcheng Zhizao Innovation Park, Fuhai Street, Bao'an District, Shenzhen City, China

FCC designation number : CN1229

test firm registration number : 616276

#### **3.2 Test Description**

<b>Test Item</b>	<b>FCC Rule No.</b>	<b>Verdict</b>
Effective(Isotropic)RadiatedOutputPower	Part 2.1046 27.50(h)(2)	Pass
Peak-AverageRatio	Part 2.1046	Pass
ModulationCharacteristics	§2.1047	N/A
Bandwidth	Part 2.1049	Pass
BandEdgesCompliance	Part 2.1051 27.53(m)	Pass
SpuriousEmissionatAntennaTerminals	Part 2.1051 27.53(m)	Pass
Field Strengthof Spurious Radiation	Part 2.1053 27.53(m)	Pass
Frequency Stability	Part 2.1055 27.54	Pass

NOTE 1: For the verdict, the "N/A" denotes "not applicable", the "N/T" denotes "not tested".

Remark:

1. The measurement uncertainty is not included in the test result.





### 3.3 Equipments Used during the Test

Test Equipment	Manufacturer	Model No.	Serial No.	Calibration Date	Calibration Due Date
LISN	R&S	ENV216	HKE-059	2019/12/26	2020/12/25
LISN	R&S	ENV216	HKE-002	2019/12/26	2020/12/25
Receiver	R&S	ESCI 7	HKE-010	2019/12/26	2020/12/25
Spectrum analyzer	R&S	FSP40	HKE-025	2019/12/26	2020/12/25
Spectrum analyzer	Agilent	N9020A	HKE-048	2019/12/26	2020/12/25
RF automatic control unit	Tonscend	JS0806-1	HKE-060	2019/12/26	2020/12/25
Loop antenna	Schwarzbeck	FMZB 1519 B	HKE-014	2019/12/26	2020/12/25
Bilog Broadband Antenna	Schwarzbeck	VULB9163	HKE-012	2019/12/26	2020/12/25
Horn antenna	Schwarzbeck	9120D	HKE-013	2019/12/26	2020/12/25
High gain antenna	Schwarzbeck	LB-180400KF	HKE-054	2019/12/26	2020/12/25
Preamplifier	EMCI	EMC051845SE	HKE-015	2019/12/26	2020/12/25
Preamplifier	Agilent	83051A	HKE-016	2019/12/26	2020/12/25
Preamplifier	Schwarzbeck	BBV 9743	HKE-006	2019/12/26	2020/12/25
Temperature and humidity meter	Boyang	HTC-1	HKE-075	2019/12/26	2020/12/25
High-low temperature chamber	Guangke	HT-80L	HKE-118	2019/12/26	2020/12/25
High pass filter unit	Tonscend	JS0806-F	HKE-055	2019/12/26	2020/12/25
RF Cable(below1GHz)	Times	9kHz-1GHz	HKE-117	2019/12/26	2020/12/25
RF Cable(above 1GHz)	Times	1-40G	HKE-034	2019/12/26	2020/12/25
Power meter	Agilent	E4419B	HKE-085	2019/12/26	2020/12/25
Power Sensor	Agilent	E9300A	HKE-086	2019/12/26	2020/12/25
Conducted test software	Tonscend	TS+ Rev 2.5.0.0	HKE-081	N/A	N/A
Radiated test software	Tonscend	TS+ Rev 2.5.0.0	HKE-082	N/A	N/A
RF test software	Tonscend	JS1120-B Version 2.6	HKE-083	N/A	N/A
RF test software	Tonscend	JS1120-4	HKE-113	N/A	N/A
RF test software	Tonscend	JS1120-3	HKE-114	N/A	N/A
RF test software	Tonscend	JS1120-1	HKE-115	N/A	N/A
Wireless Communication Test Set	R&S	CMW500	HKE-026	2019/12/26	2020/12/25
Wireless Communication Test Set	R&S	CMU200	HKE-029	2019/12/26	2020/12/25



## **4 TEST CONDITIONS AND RESULTS**

### **4.1 Output Power**

#### **4.1.1 Conducted Output Power**

##### **TEST APPLICABLE**

Part 27.50(h)(2), during the process of testing, the EUT was controlled via R&S Digital Radio Communication tester (CMW500) to ensure max power transmission and proper modulation. This result contains output power measurements for the EUT. In all cases, output power is within the specified limits.

##### **TEST CONFIGURATION**

Conducted Power Measurement:

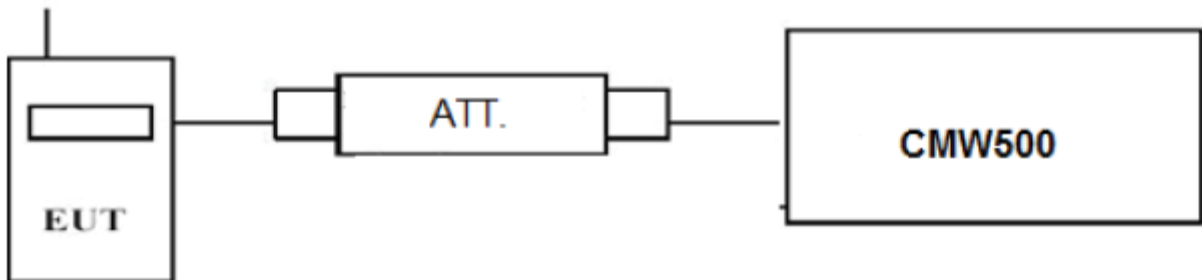

##### **TEST PROCEDURE**

###### **Conducted Power Measurement:**

- a) Place the EUT on a bench and set it in transmitting mode.
- b) Connect a low loss RF cable from the antenna port to a CMW500 by an Att.
- c) EUT Communicate with CMW500 then selects a channel for testing.
- d) Add a correction factor to the display CMW500, and then test.

##### **TEST RESULTS**



EUT:	Mobile Phone	Test Date:	Sept. 10, 2020
Temperature:	25°C	Tested by:	Gary Qian
Humidity:	55 % RH	Test Voltage	Normal Voltage
Operation Mode:	Normal Voltage- Tx Mode		

Remark:

1. We measured all RB Configuration refer 3GPP TS136 521 for each Channel Bandwidth of LTE Band 7;

LTE Band 7				
TX Channel Bandwidth	Frequency (MHz)	RB Size/Offset	Burst Average Power [dBm]	
			QPSK	16QAM
5 MHz	2502.5	1 RB low	23.07	21.69
		1 RB mid	23.11	21.73
		1 RB high	23.17	21.67
		50% RB low	21.98	21.13
		50% RB mid	21.99	21.13
		50% RB high	22.05	21.22
	2535	100% RB	22.05	21.32
		1 RB low	23.20	22.48
		1 RB mid	23.14	22.46
		1 RB high	23.11	22.52
		50% RB low	22.30	21.42
		50% RB mid	22.30	21.50
	2567.5	50% RB high	22.35	21.53
		100% RB	22.23	21.36
		1 RB low	23.31	21.57
		1 RB mid	23.37	21.56
		1 RB high	23.36	21.56
		50% RB low	22.19	21.36
10 MHz	2505	50% RB mid	22.16	21.33
		50% RB high	22.26	21.37
		100% RB	22.20	21.43
		1 RB low	23.18	21.49
		1 RB mid	23.24	21.59
		1 RB high	23.20	21.63
	2535	50% RB low	22.21	21.31
		50% RB mid	22.22	21.43
		50% RB high	22.13	21.40
		100% RB	22.15	21.27
		1 RB low	23.17	22.87
		1 RB mid	23.31	23.05
	2565	1 RB high	23.17	22.93
		50% RB low	22.23	21.41
		50% RB mid	22.23	21.41
		50% RB high	22.26	21.42
		100% RB	22.30	21.49
		1 RB low	23.08	21.89
15 MHz	2507.5	1 RB mid	23.15	21.88
		1 RB high	23.13	22.03
		50% RB low	22.24	21.26
		50% RB mid	22.18	21.27
		50% RB high	22.15	21.33
		100% RB	22.19	21.31
15 MHz	2507.5	1 RB low	23.31	22.48
		1 RB mid	23.19	22.47
		1 RB high	23.24	22.52
		50% RB low	22.48	22.39
		50% RB mid	22.37	22.52



		50% RB high	22.65	22.62	
		100% RB	22.21	21.35	
	2535	1 RB low	23.16	22.90	
		1 RB mid	23.22	22.98	
		1 RB high	23.25	23.01	
		50% RB low	22.98	23.00	
		50% RB mid	22.99	22.89	
		50% RB high	22.89	22.98	
		100% RB	22.23	21.47	
		2562.5	1 RB low	23.05	21.84
	1 RB mid		23.07	21.92	
	1 RB high		23.10	21.93	
	50% RB low		21.98	21.93	
	50% RB mid		21.96	21.98	
	50% RB high		21.98	22.02	
	100% RB		22.14	21.41	
	20 MHz	2510	1 RB low	23.38	22.81
			1 RB mid	23.40	22.80
1 RB high			23.56	22.97	
50% RB low			22.18	21.23	
50% RB mid			22.19	21.41	
50% RB high			22.20	21.19	
100% RB			22.16	21.37	
2535			1 RB low	23.43	22.22
		1 RB mid	23.43	22.25	
		1 RB high	23.57	22.19	
		50% RB low	22.29	21.43	
		50% RB mid	22.37	21.54	
		50% RB high	22.26	21.42	
		100% RB	22.37	21.46	
2560		1 RB low	23.39	22.01	
		1 RB mid	23.35	21.98	
		1 RB high	23.33	21.98	
		50% RB low	22.14	21.41	
		50% RB mid	22.13	21.42	
		50% RB high	22.11	21.40	
		100% RB	22.08	21.35	

## 4.1.2. Radiated Output Power

### LIMIT

This is the test for the maximum radiated power from the EUT.

### TEST CONFIGURATION

Radiated Power Measurement:

remark : 0.8m for below 1GHz, 1.5m for above 1GHz

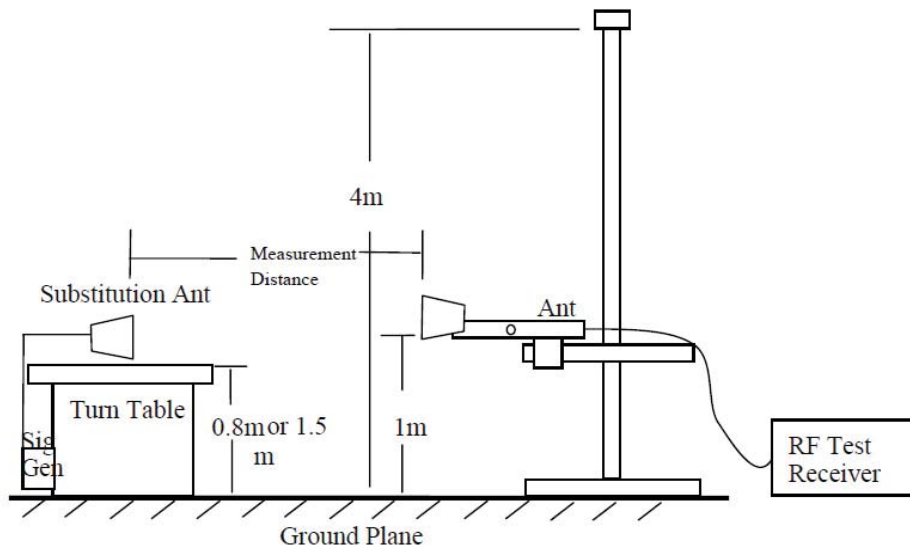

### TEST PROCEDURE

The EUT was setup according to EIA/TIA 603D

- a. The EUT shall be placed at the specified height on a support, and in the position closest to normal use as declared by provider.
- b. The test antenna shall be oriented initially for vertical polarization and shall be chosen to correspond to the frequency of the transmitter.
- c. The output of the test antenna shall be connected to the measuring receiver.
- d. The transmitter shall be switched on and the measuring receiver shall be tuned to the frequency of the transmitter under test.
- e. The test antenna shall be raised and lowered through the specified range of height until a maximum signal level is detected by the measuring receiver.
- f. The transmitter shall then be rotated through 360° in the horizontal plane, until the maximum signal level is detected by the measuring receiver.
- g. The test antenna shall be raised and lowered again through the specified range of height until a maximum signal level is detected by the measuring receiver.
- h. The maximum signal level detected by the measuring receiver shall be noted.
- i. The transmitter shall be replaced by a substitution antenna.
- j. The substitution antenna shall be orientated for vertical polarization and the length of the substitution antenna shall be adjusted to correspond to the frequency of the transmitter.
- k. The substitution antenna shall be connected to a calibrated signal generator.
- l. If necessary, the input attenuator setting of the measuring receiver shall be adjusted in order to increase the sensitivity of the measuring receiver.
- m. The test antenna shall be raised and lowered through the specified range of height to ensure that the maximum signal is received.
- n. The input signal to the substitution antenna shall be adjusted to the level that produces a level detected by the measuring receiver, that is equal to the level noted while the transmitter radiated power was measured, corrected for the change of input attenuator setting of the measuring receiver.
- o. The measurement shall be repeated with the test antenna and the substitution antenna orientated for horizontal polarization.
- p. The measure of the effective radiated power is the larger of the two levels recorded at the input to the substitution antenna, corrected for gain of the substitution antenna if necessary.
- q. Test site anechoic chamber refer to ANSI C63.4.



**TEST RESULTS**

EUT:	Mobile Phone	Test Date:	Sept. 10, 2020
Temperature:	25°C	Tested by:	Gary Qian
Humidity:	55 % RH	Test Voltage	Normal Voltage
Operation Mode:	Normal Voltage- Tx Mode		

**Radiated Measurement:**

Remark:

1. We measured all RB Configuration refer 3GPP TS136 521 for each Channel Bandwidth of LTE Band 7; recorded worst case for each Channel Bandwidth of LTE Band 7.
2.  $EIRP = P_s(dBm) - P_{cl}(dB) + G_a(dBi)$
3. We measured both Horizontal and Vertical direction, recorded worst case direction.

*LTE Band 7\_Channel Bandwidth 5MHz\_QPSK\_1RB#0*

Frequency (MHz)	$P_s$ (dBm)	$P_{cl}$ (dB)	$G_a$ Antenna Gain(dB)	Burst Average EIRP (dBm)	Limit (dBm)	Margin (dB)	Polarization
2502.5	7.29	3.41	15.12	19	33.01	14.01	V
2535	7.62	3.49	15.12	19.25	33.01	13.76	V
2567.5	7.04	3.55	15.12	18.61	33.01	14.4	V

*LTE Band 7\_Channel Bandwidth 10MHz\_QPSK\_1RB#0*

Frequency (MHz)	$P_s$ (dBm)	$P_{cl}$ (dB)	$G_a$ Antenna Gain(dB)	Burst Average EIRP (dBm)	Limit (dBm)	Margin (dB)	Polarization
2505	7.54	3.41	15.12	19.25	33.01	13.76	V
2535	7.63	3.49	15.12	19.26	33.01	13.75	V
2565	7.42	3.55	15.12	18.99	33.01	14.02	V

*LTE Band 7\_Channel Bandwidth 15MHz\_QPSK\_1RB#0*

Frequency (MHz)	$P_s$ (dBm)	$P_{cl}$ (dB)	$G_a$ Antenna Gain(dB)	Burst Average EIRP (dBm)	Limit (dBm)	Margin (dB)	Polarization
2507.5	7.56	3.41	15.12	19.27	33.01	13.74	V
2535	7.69	3.49	15.12	19.32	33.01	13.69	V
2562.5	7.35	3.55	15.12	18.92	33.01	14.09	V

*LTE Band 7\_Channel Bandwidth 20MHz\_QPSK\_1RB#0*

Frequency (MHz)	$P_s$ (dBm)	$P_{cl}$ (dB)	$G_a$ Antenna Gain(dB)	Burst Average EIRP (dBm)	Limit (dBm)	Margin (dB)	Polarization
2510	7.44	3.41	15.12	19.15	33.01	13.86	V
2535	8.11	3.49	15.12	19.74	33.01	13.27	V
2560	6.72	3.55	15.12	18.29	33.01	14.72	V

*LTE Band 7\_Channel Bandwidth 5MHz\_16QAM\_1RB#0*

Frequency (MHz)	P <sub>s</sub> (dBm)	P <sub>cl</sub> (dB)	G <sub>a</sub> Antenna Gain(dB)	Burst Average EIRP (dBm)	Limit (dBm)	Margin (dB)	Polarization
2502.5	7.49	3.41	15.12	19.2	33.01	13.81	V
2535	7.37	3.49	15.12	19	33.01	14.01	V
2567.5	6.76	3.55	15.12	18.33	33.01	14.68	V

*LTE Band 7\_Channel Bandwidth 10MHz\_16QAM\_1RB#0*

Frequency (MHz)	P <sub>s</sub> (dBm)	P <sub>cl</sub> (dB)	G <sub>a</sub> Antenna Gain(dB)	Burst Average EIRP (dBm)	Limit (dBm)	Margin (dB)	Polarization
2505	6.98	3.41	15.12	18.69	33.01	14.32	V
2535	8.13	3.49	15.12	19.76	33.01	13.25	V
2565	7.55	3.55	15.12	19.12	33.01	13.89	V

*LTE Band 7\_Channel Bandwidth 15MHz\_16QAM\_1RB#0*

Frequency (MHz)	P <sub>s</sub> (dBm)	P <sub>cl</sub> (dB)	G <sub>a</sub> Antenna Gain(dB)	Burst Average EIRP (dBm)	Limit (dBm)	Margin (dB)	Polarization
2507.5	7.48	3.41	15.12	19.19	33.01	13.82	V
2535	8.22	3.49	15.12	19.85	33.01	13.16	V
2562.5	7.42	3.55	15.12	18.99	33.01	14.02	V

*LTE Band 7\_Channel Bandwidth 20MHz\_16QAM\_1RB#0*

Frequency (MHz)	P <sub>s</sub> (dBm)	P <sub>cl</sub> (dB)	G <sub>a</sub> Antenna Gain(dB)	Burst Average EIRP (dBm)	Limit (dBm)	Margin (dB)	Polarization
2510	7.09	3.41	15.12	18.8	33.01	14.21	V
2535	7.42	3.49	15.12	19.05	33.01	13.96	V
2560	7.15	3.55	15.12	18.72	33.01	14.29	V



## 4.2 Peak-to-Average Ratio (PAR)

### LIMIT

The Peak-to-Average Ratio (PAR) of the transmission may not exceed 13 dB.

### TEST CONFIGURATION

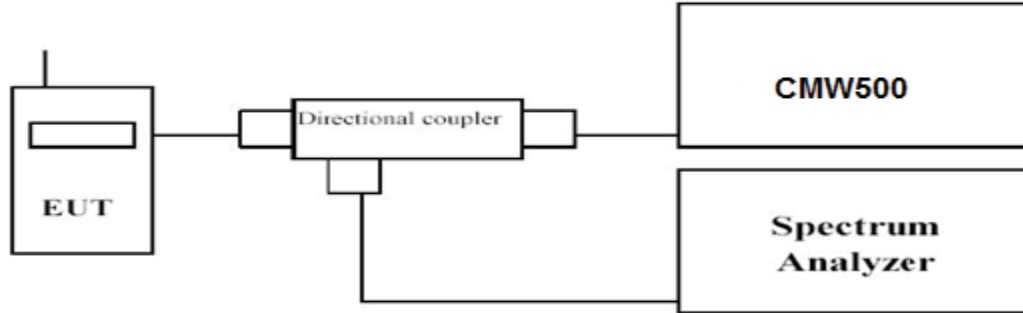

### TEST PROCEDURE

1. Refer to instrument's analyzer instruction manual for details on how to use the power statistics/CCDF function;
2. Set resolution/measurement bandwidth  $\geq$  signal's occupied bandwidth;
3. Set the number of counts to a value that stabilizes the measured CCDF curve;
4. Set the measurement interval as follows:
  - 1). for continuous transmissions, set to 1 ms,
  - 2). for burst transmissions, employ an external trigger that is synchronized with the EUT burst timing sequence, or use the internal burst trigger with a trigger level that allows the burst to stabilize and set the measurement interval to a time that is less than or equal to the burst duration.
5. Record the maximum PAPR level associated with a probability of 0.1%.

### TEST RESULTS

EUT:	Mobile Phone	Test Date:	Sept. 06, 2020
Temperature:	25 <sup>0</sup> C	Tested by:	Gary Qian
Humidity:	55 % RH	Test Voltage	Normal Voltage
Operation Mode:	Normal Voltage- Tx Mode		

Remark:

1. We measured all RB Configuration refer 3GPP TS136 521 for each Channel Bandwidth of LTE Band 7; recorded worst case for each Channel Bandwidth of LTE Band 7.

LTE Band 7				
TX Channel Bandwidth	Frequency (MHz)	RB Size/Offset	PAPR(dB)	
			QPSK	16QAM
5 MHz	2502.5	1RB#0	4.93	5.77
	2535		5.30	5.80
	2567.5		5.05	5.77
10 MHz	2505	1RB#0	4.94	5.92
	2535		5.03	5.78
	2565		4.87	5.74
15 MHz	2507.5	1RB#0	4.93	5.78
	2535		5.11	5.98
	2562.5		4.90	5.65
20 MHz	2510	1RB#0	4.65	5.49
	2535		5.02	5.76
	2560		4.72	5.43





LTE Band 7-5MHz Channel Bandwidth PAPR

QPSK

16QAM

Low Channel

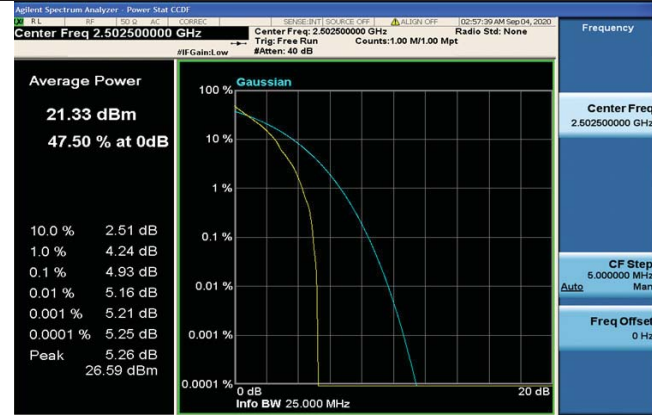

1RB#0

1RB#0

Middle Channel

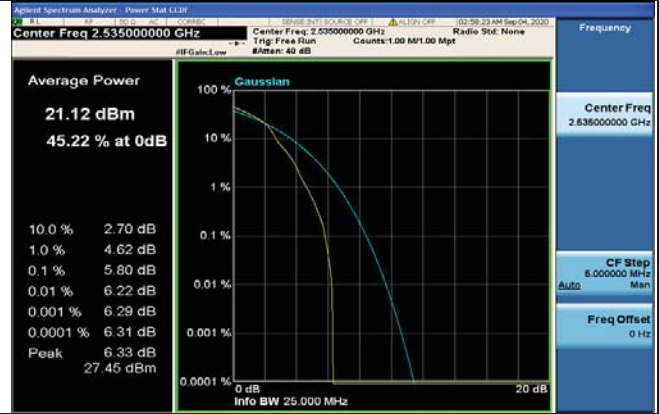
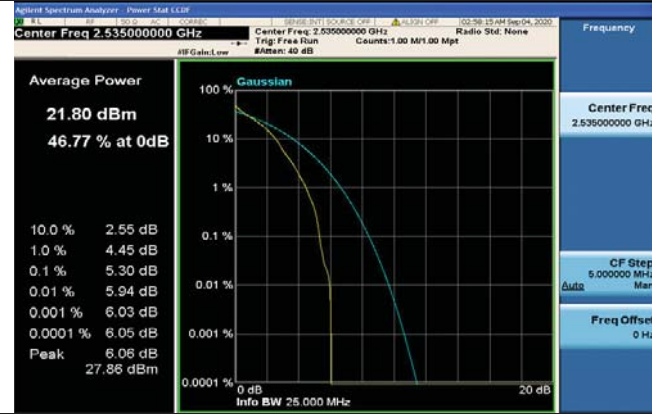

1RB#0

1RB#0

High Channel

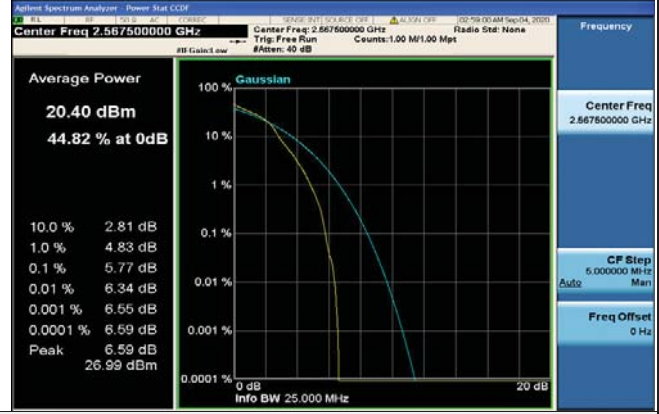
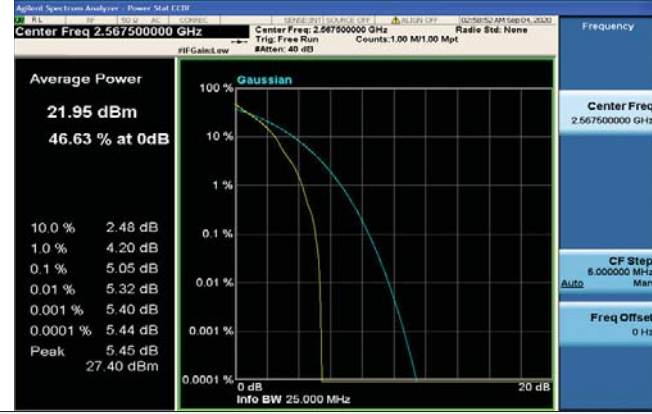

1RB#0

1RB#0



LTE Band 7-10MHz Channel Bandwidth PAPP

QPSK

16QAM

Low Channel

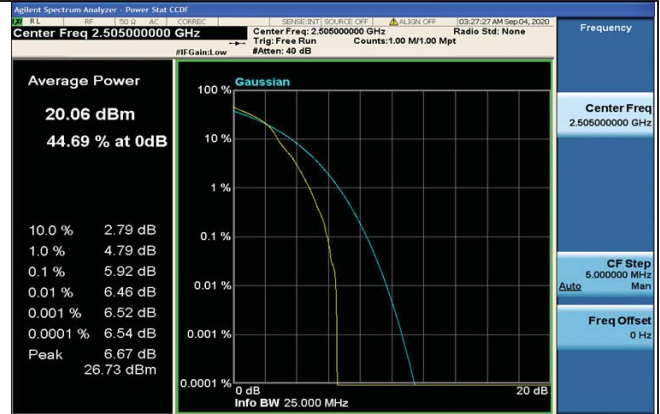
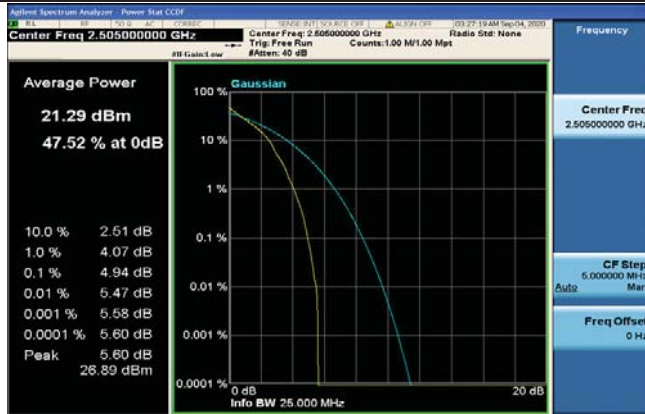

1RB#0

1RB#0

Middle Channel

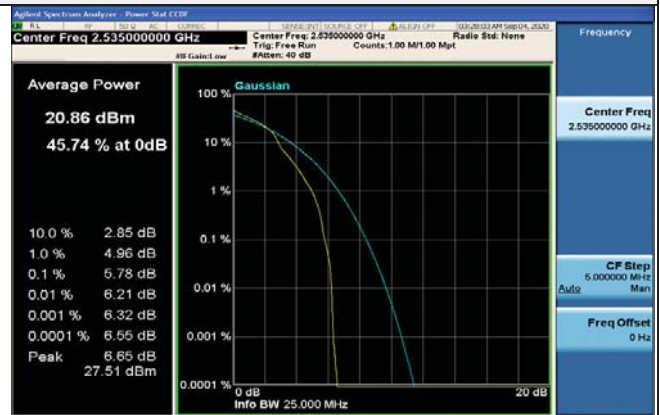
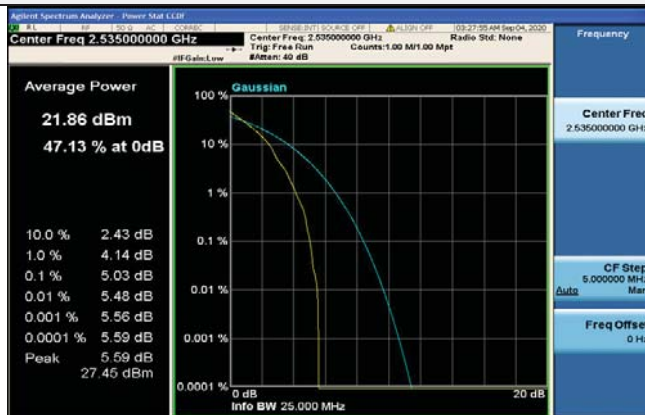

1RB#0

1RB#0

High Channel

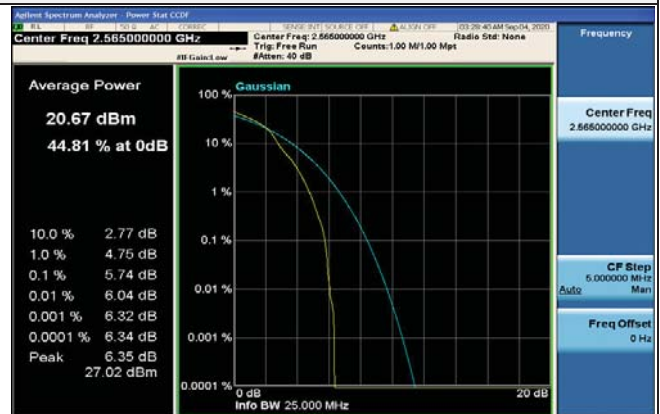
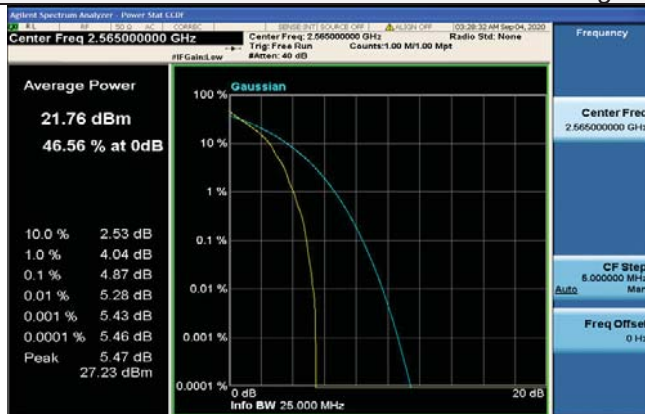

1RB#0

1RB#0



LTE Band 7- 15 MHz Channel Bandwidth PAPP

QPSK

16QAM

Low Channel

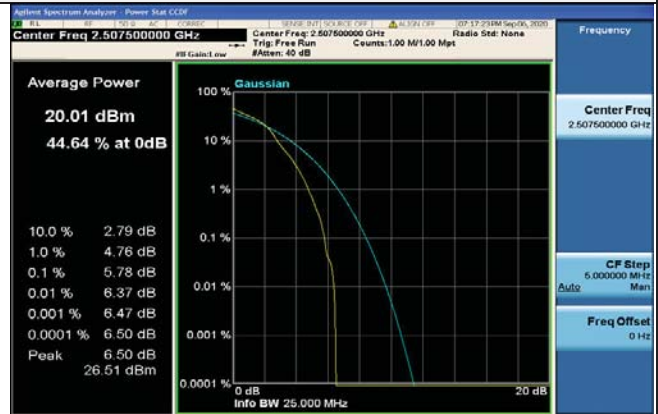
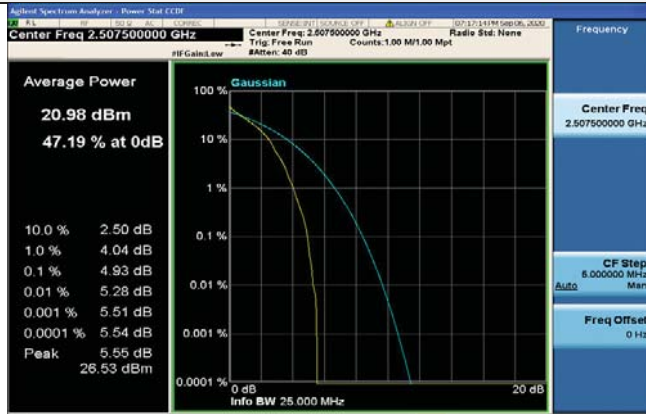

1RB#0

1RB#0

Middle Channel

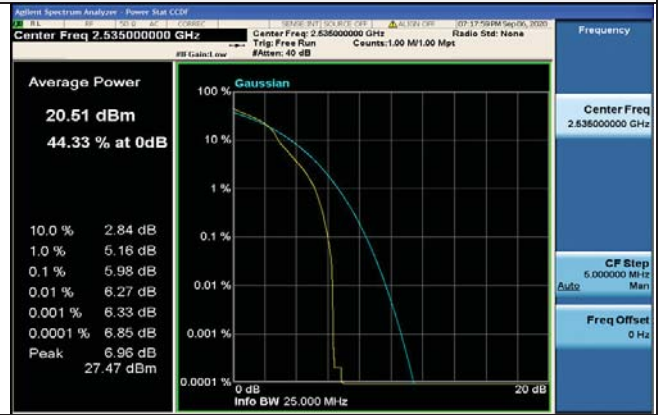
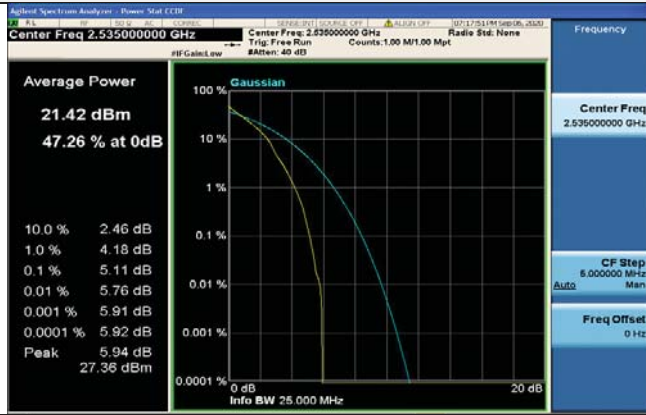

1RB#0

1RB#0

High Channel

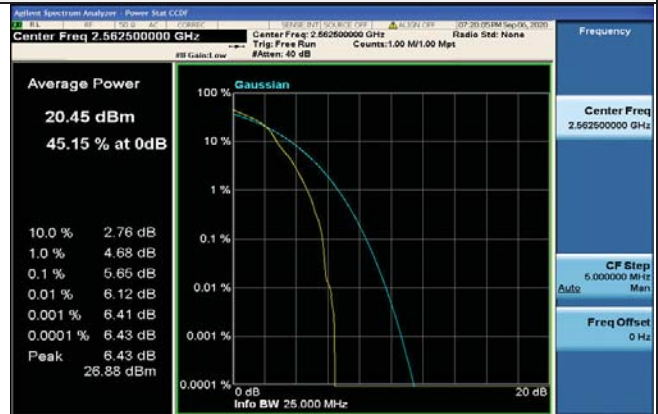
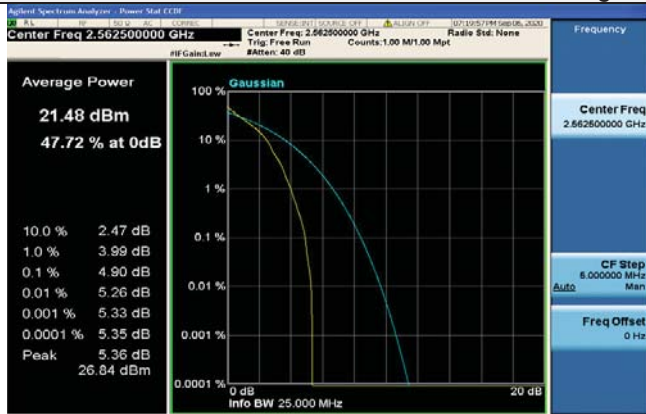

1RB#0

1RB#0





LTE Band 7-20MHz Channel Bandwidth PAPP

QPSK

16QAM

Low Channel

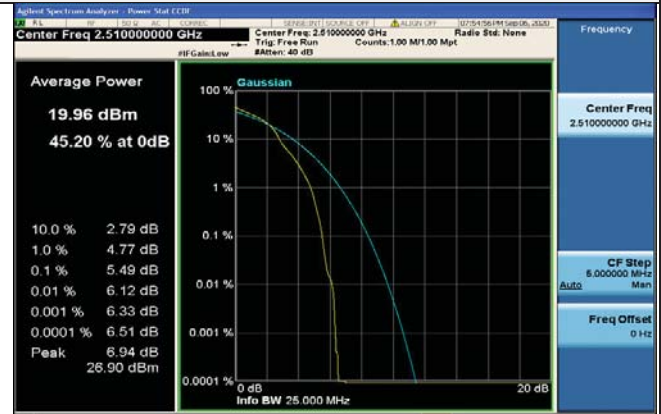
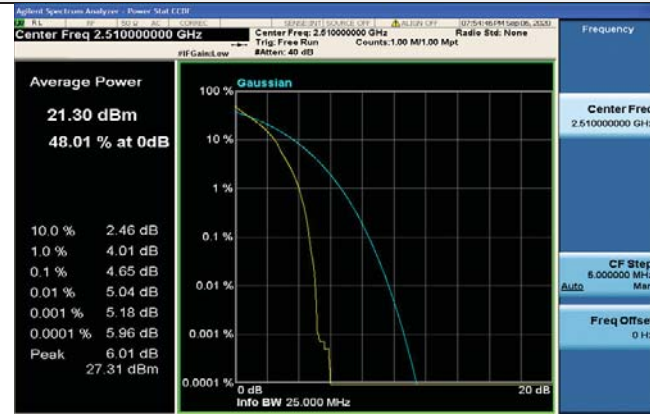

1RB#0

1RB#0

Middle Channel

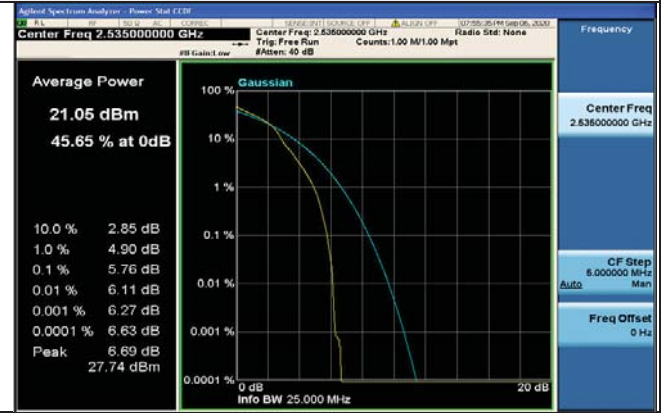

1RB#0

1RB#0

High Channel

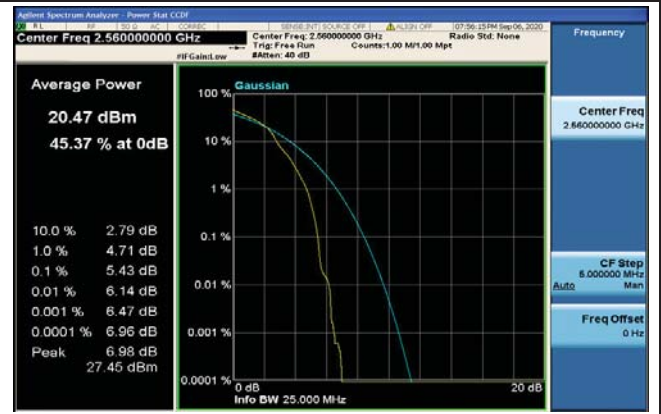
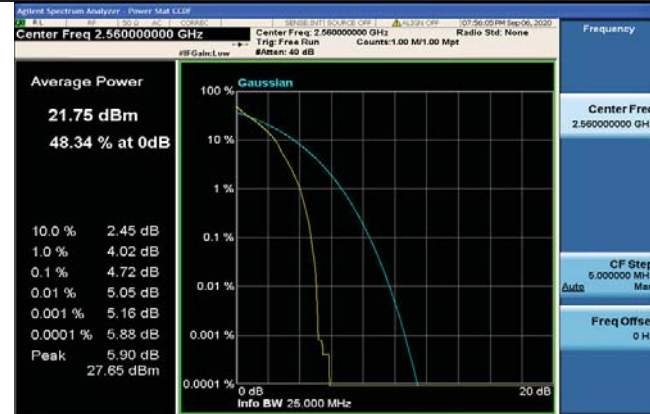

1RB#0

1RB#0



### 4.3 Occupied Bandwidth and Emission Bandwidth

**LIMIT**

N/A

**TEST CONFIGURATION**

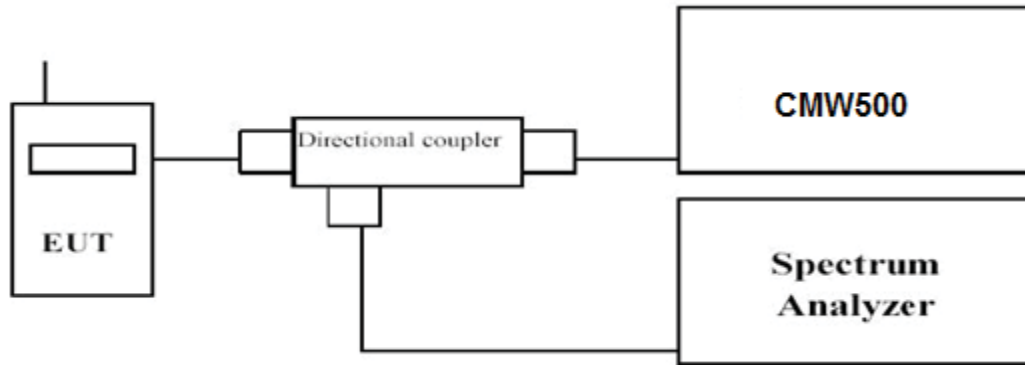

**TEST PROCEDURE**

The transmitter output was connected to a calibrated coaxial cable and coupler, the other end of which was connected to a spectrum analyzer. The occupied bandwidth was measured with the spectrum analyzer at low, middle and high channel in each band. The -26dBc Emission bandwidth was also measured and recorded. Set RBW was set to about 1% of emission BW, VBW ≥ 3 times RBW. -26dBc display line was placed on the screen (or 99% bandwidth), the occupied bandwidth is the delta frequency between the two points where the display line intersects the signal trace.

**TEST RESULTS**

EUT:	Mobile Phone	Test Date:	Sept. 06, 2020
Temperature:	25°C	Tested by:	Gary Qian
Humidity:	55 % RH	Test Voltage	Normal Voltage
Operation Mode:	Normal Voltage- Tx Mode		

*Remark:*

1. We were tested all RB Configuration refer 3GPP TS136 521 for each Channel Bandwidth of LTE Band 7; recorded worst case for each Channel Bandwidth of LTE Band 7.

LTE Band 7						
TX Channel Bandwidth	RB Size/Offset	Frequency (MHz)	99% Occupied bandwidth (MHz)		-26dBc Emission bandwidth (MHz)	
			QPSK	16QAM	QPSK	16QAM
5 MHz	25RB#0	2502.5	4.5002	4.4987	4.921	4.952
		2535	4.4977	4.5024	4.965	4.996
		2567.5	4.5024	4.5062	4.941	4.893
10 MHz	50RB#0	2505	8.9738	8.9639	9.565	9.578
		2535	8.9751	8.9741	9.585	9.589
		2565	8.9847	8.9724	9.577	9.609
15 MHz	75RB#0	2507.5	13.430	13.432	14.29	14.28
		2535	13.469	13.471	14.33	14.35
		2562.5	13.485	13.469	14.33	14.27
20 MHz	100RB#0	2510	17.951	17.935	19.02	19.00
		2535	17.955	17.969	18.99	18.98
		2560	17.982	17.969	19.05	19.01



LTE Band 7-5MHz Channel Bandwidth Occupied Bandwidth and Emission Bandwidth

QPSK

16QAM

Low Channel

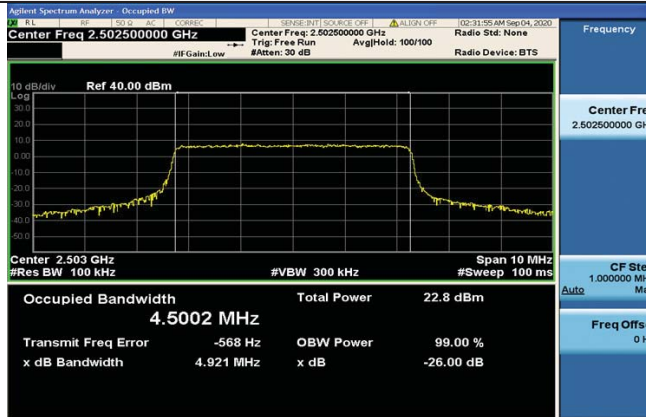

25RB#0

25RB#0

Middle Channel

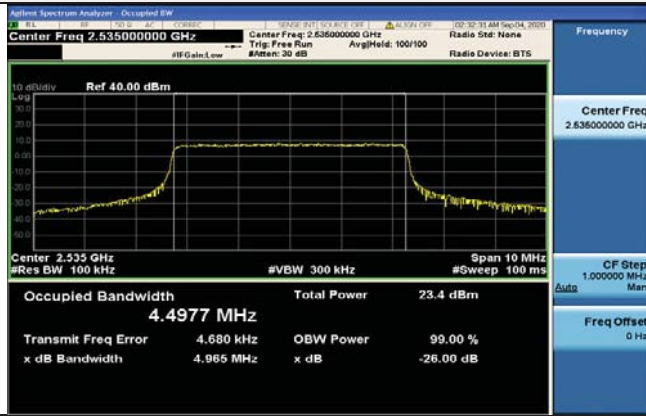

25RB#0

25RB#0

High Channel

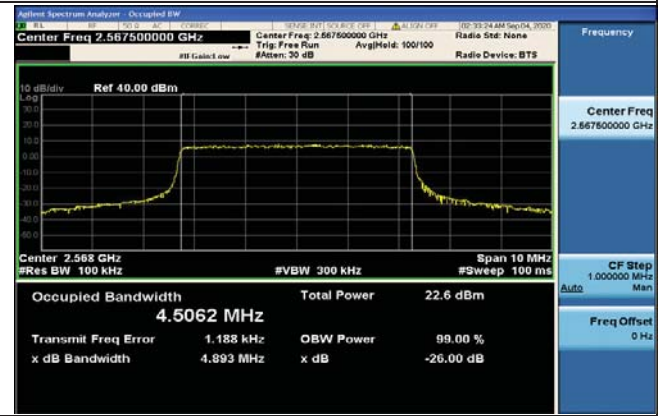
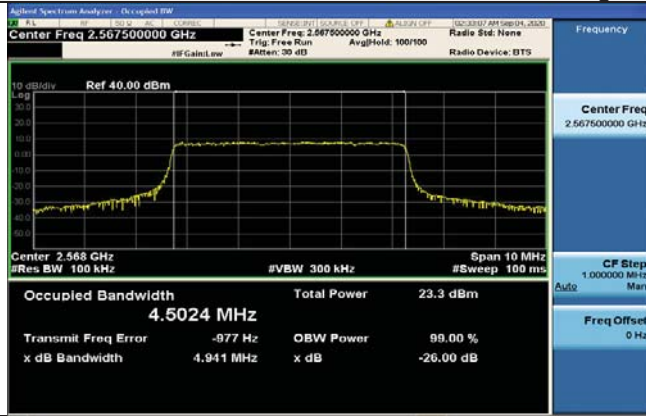

25RB#0

25RB#0





LTE Band 7-10MHz Channel Bandwidth Occupied Spectrum Bandwidth and Emission Bandwidth

QPSK

16QAM

Low Channel

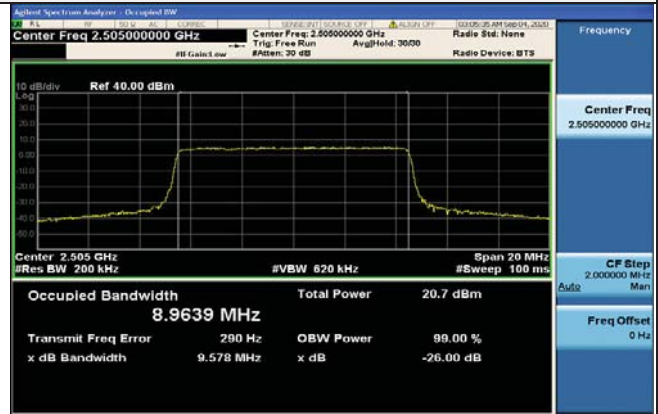
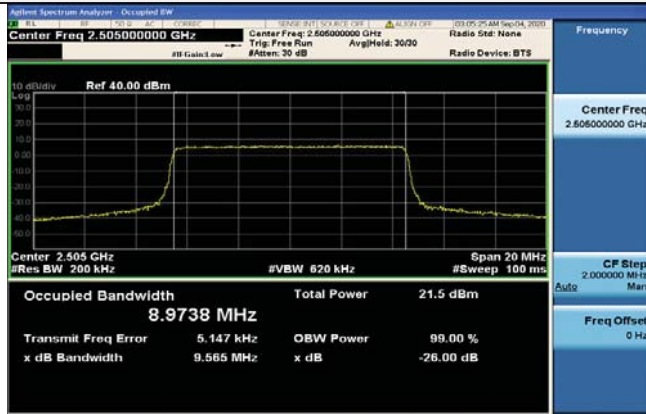

50RB#0

50RB#0

Middle Channel

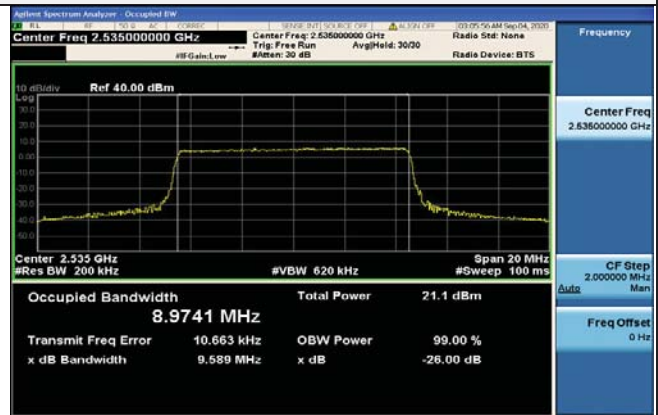
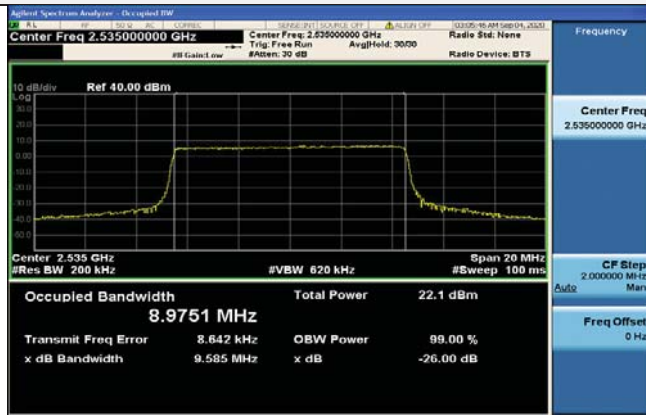

50RB#0

50RB#0

High Channel

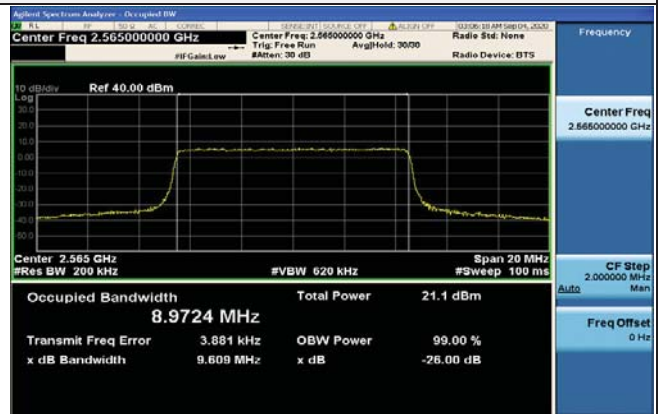
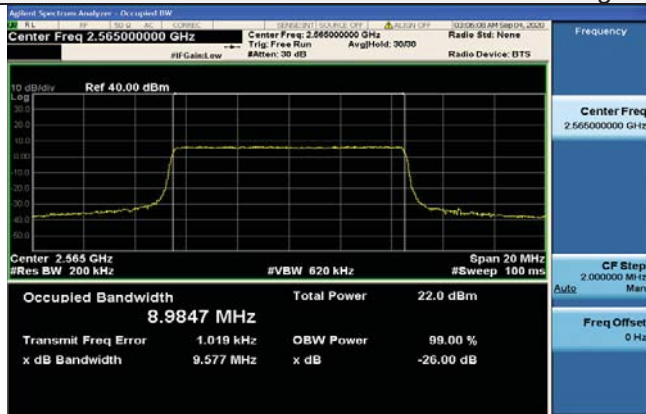

50RB#0

50RB#0



LTE Band 7-15MHz Channel Bandwidth Occupied Bandwidth and Emission Bandwidth

QPSK

16QAM

Low Channel

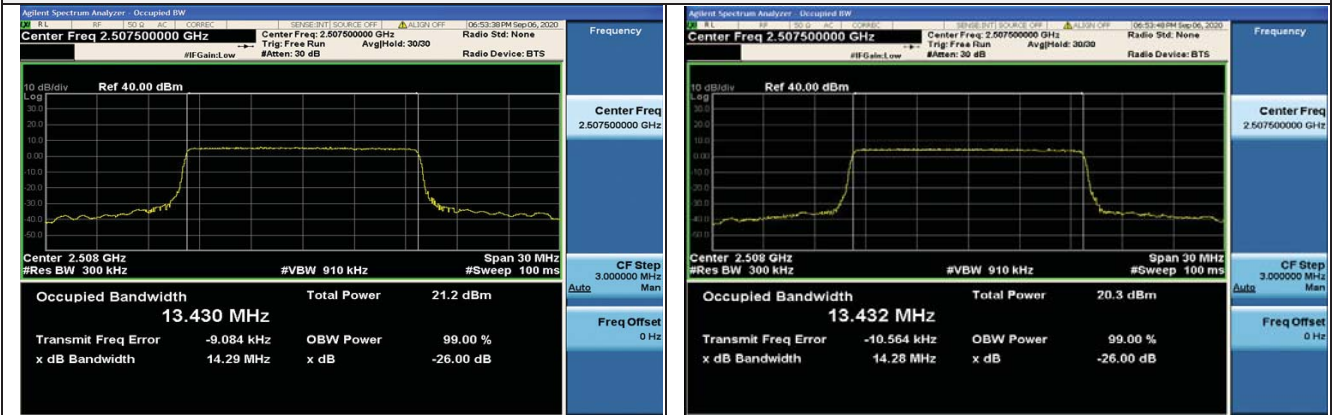

75RB#0

75RB#0

Middle Channel

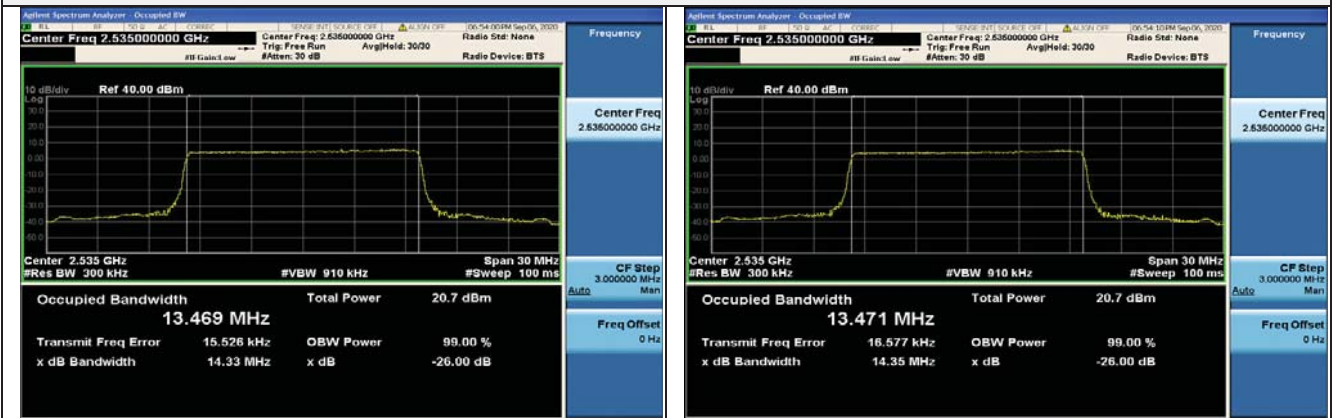

75RB#0

75RB#0

High Channel

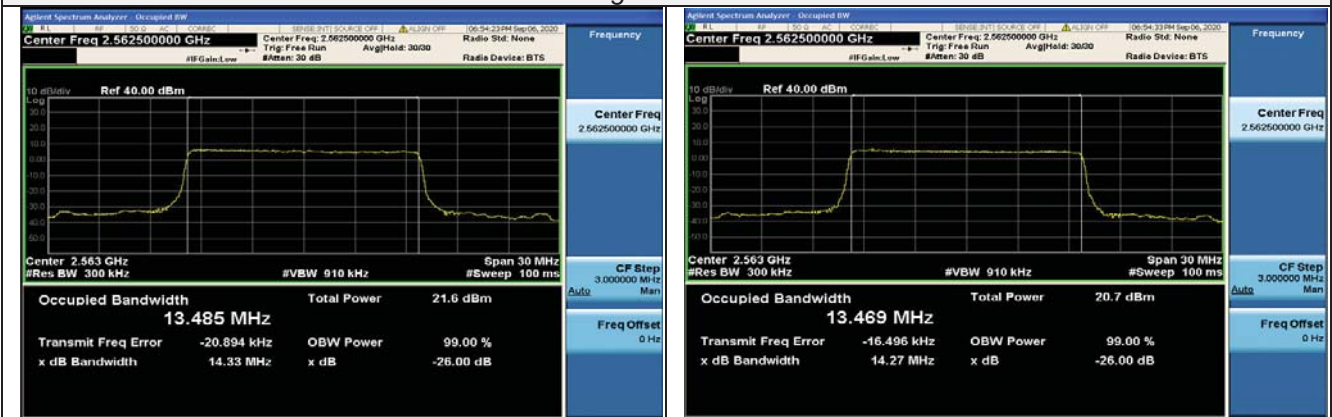

75RB#0

75RB#0





LTE Band 7-20MHz Channel Bandwidth Occupied Bandwidth and Emission Bandwidth

QPSK

16QAM

Low Channel

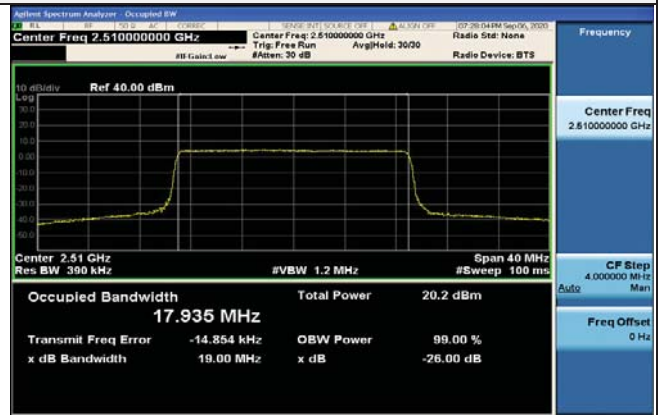
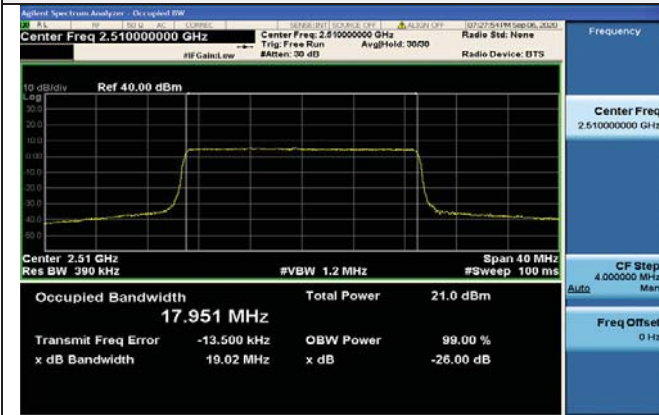

100RB#0

100RB#0

Middle Channel

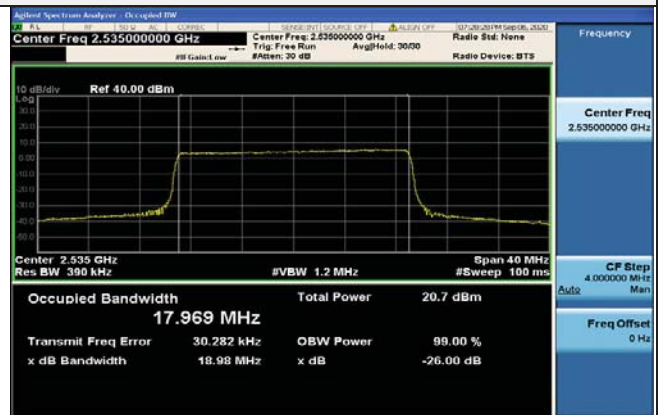
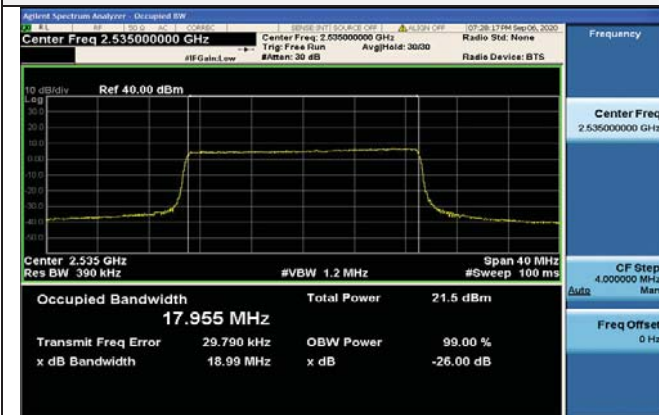

100RB#0

100RB#0

High Channel

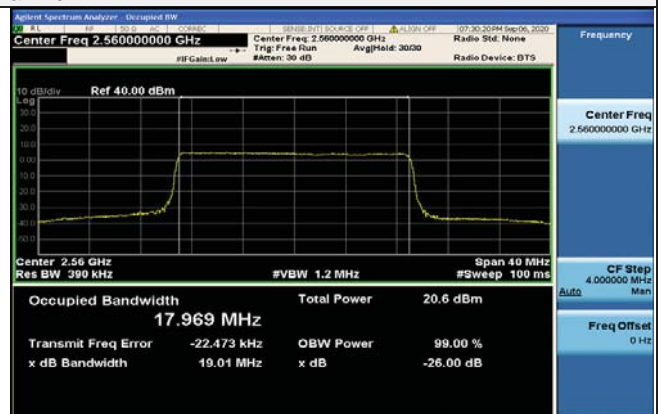
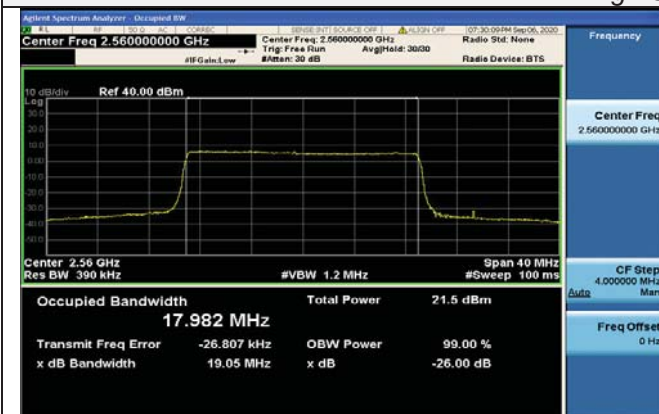

100RB#0

100RB#0