



FCC PART 24TEST REPORT
Part 22H Subpart E

Report Reference No. : HK2009012691-8E

FCC ID. : 2AJOTTA-1318

Compiled by

(position+printedname+signature).. : File administrators Gary Qian

Supervised by

(position+printedname+signature)... : Technique principal Eden Hu

Approved by

(position+printedname+signature)... : Manager Jason Zhou

Date of issue : Sept. 12, 2020

Testing Laboratory Name : **Shenzhen HUAKE Testing Technology Co., Ltd.**

Address : 1F, B2 Building, Junfeng Zhongcheng Zhizao Innovation Park,
Heping Community, Fuhai Street, Bao' an District, Shenzhen,China

Applicant's name : HMD global Oy

Address : Bertel Jungin aukio 9, 02600 Espoo Finland

Test specification :

Standard : **FCC CFR Title 47 Part 2, Part 22H**

TRF Originator : Shenzhen HUAKE Testing Technology Co., Ltd.

Shenzhen HUAKE Testing Technology Co., Ltd.All rights reserved.

This publication may be reproduced in whole or in part for non-commercial purposes as long as the Shenzhen HUAKE Testing Technology Co., Ltd.as copyright owner and source of the material. Shenzhen HUAKE Testing Technology Co., Ltd.takes no responsibility for and will not assume liability for damages resulting from the reader's interpretation of the reproduced material due to its placement and context.

Test item description..... : Mobile Phone

Trade Mark..... : NOKIA

Manufacturer : HMD global Oy

Model/Type reference..... : TA-1318

Listed Models : N/A

Modulation Type : QPSK,16QAM

Rating..... : DC 3.8V from battery or DC 5V from adapter

Hardware version..... : V2.0

Software version : V2.0

Result..... : **PASS**

**TEST REPORT**

Test Report No. :	HK2009012691-8E	Sept. 12, 2020
		Date of issue

Equipment under Test : Mobile Phone

Model /Type : TA-1318

Listed Models : N/A

Applicant : HMD global Oy

Address : Bertel Jungin aukio 9, 02600 Espoo Finland

Manufacturer : HMD global Oy

Address : Bertel Jungin aukio 9, 02600 Espoo Finland

Test Result:	PASS
---------------------	-------------

The test report merely corresponds to the test sample.
It is not permitted to copy extracts of these test result without the written permission of the test laboratory.



Revision History

Revision	Issue Date	Revisions	Revised By
V1.0	Sept. 12, 2020	Initial Issue	Jasou Zhou



Contents

<u>1</u>	<u>TEST STANDARDS.....</u>	<u>5</u>
<u>2</u>	<u>SUMMARY</u>	<u>6</u>
2.1	General Remarks	6
2.2	Product Description	6
2.3	Equipment under Test	6
2.4	Normal Accessory setting	6
2.5	EUT configuration	6
2.6	Related Submittal(s) / Grant (s)	7
2.7	Modifications	7
2.8	GeneralTest Conditions/Configurations	7
<u>3</u>	<u>TEST ENVIRONMENT.....</u>	<u>8</u>
3.1	Address of the test laboratory	8
3.2	Environmental conditions	8
3.3	Test Description	8
3.4	Equipments Used during the Test	9
<u>4</u>	<u>TEST CONDITIONS AND RESULTS.....</u>	<u>10</u>
4.1	Output Power	10
4.2	Peak-to-Average Ratio (PAR)	15
4.3	Occupied Bandwidth and Emission Bandwidth	20
4.4	Band Edge compliance	25
4.5	Spurious Emssionon Antenna Port	30
4.6	Radiated Spurious Emssion	43
4.7	Frequency Stability	49
<u>5</u>	<u>TEST SETUP PHOTOS OF THE EUT</u>	<u>52</u>



1 TEST STANDARDS

The tests were performed according to following standards:

[FCC Part 2](#): FREQUENCY ALLOCATIONS AND RADIO TREATY MATTERS; GENERAL RULES AND REGULATIONS

[FCC Part 22 Subpart H](#): PRIVATE LAND MOBILE RADIO SERVICES.

[ANSI/TIA-603-E-2016](#): Land Mobile FM or PM Communications Equipment Measurement and Performance Standards.

[ANSI C63.26-2015](#): IEEE/ANSI Standard for Compliance Testing of Transmitters Used in Licensed Radio Services

[FCC KDB 971168D01 v03r01](#) Power Meas License Digital Systems



2 SUMMARY

2.1 General Remarks

Date of receipt of test sample	:	Aug. 28, 2020
Testing commenced on	:	Aug. 29, 2020
Testing concluded on	:	Sept. 12, 2020

2.2 Product Description

Name of EUT	Mobile Phone
Model/Type reference:	TA-1318
List Model:	N/A
Power supply:	DC 3.8V from battery or DC 5V from adapter
Adapter Information	Input: 100-240V, 50/60Hz, 0.35A; Output: 5V, 1000mA
Modulation Type	QPSK, 16QAM
Antenna Type	Internal Antenna
Operation Frequency Band	LTE BAND 5
Operation frequency	LTE BAND 5: 824~849 MHz
LTE Release	R8
Extreme temp. Tolerance	-30°C to +50°C
Extreme vol. Limits	3.23VDC to 4.37VDC (nominal: 3.8VDC)

2.3 Equipment under Test

Power supply system utilised

Power supply voltage	:	<input type="radio"/> 120V/ 60 Hz	<input type="radio"/> 115V/60Hz
		<input type="radio"/> 12 V DC	<input type="radio"/> 24 V DC
		<input checked="" type="radio"/> Other (specified in blank below)	

DC 3.8V from battery or DC 5V from adapter

2.4 Normal Accessory setting

Fully charged battery was used during the test.

2.5 EUT configuration

The following peripheral devices and interface cables were connected during the measurement:

● - supplied by the manufacturer

○ - supplied by the lab

<input type="radio"/> Power Cable	Length (m) :	/
	Shield :	/
	Detachable :	/
<input type="radio"/> Multimeter	Manufacturer :	/
	Model No. :	/



2.6 Related Submittal(s) / Grant (s)

This submittal(s) (test report) is intended for FCC ID: 2AJOTTA-1318 filing to comply with FCC Part 22H, Rules.

2.7 Modifications

No modifications were implemented to meet testing criteria.

2.8 General Test Conditions/Configurations

2.10.1 Test Environment

Environment Parameter	Selected Values During Tests	
Relative Humidity	Ambient	
Temperature	TN	Ambient
Voltage	VL	3.42V
	VN	3.8V
	VH	4.12V

NOTE: VL=lower extreme test voltage VN=nominal voltage
VH=upper extreme test voltage TN=normal temperature



3 TEST ENVIRONMENT

3.1 Address of the test laboratory

Shenzhen HUAKE Testing Technology Co., Ltd.
Add.: 1F, B2 Building, JunfengZhongchengZhizao Innovation Park, Heping Community, Fuhai Street,
Bao'an District, Shenzhen, China

3.2 Environmental conditions

During the measurement the environmental conditions were within the listed ranges:

Temperature:	15-35 ° C
Humidity:	30-60 %
Atmospheric pressure:	950-1050mbar

3.3 Test Description

Band 5 (824~849 MHz)

Test Item	FCC Rule No.	Requirements	Verdict
Effective(Isotropic) Radiated Output Power	§2.1046, §22.913(a)(2)	EIRP ≤ 2W	Pass
Peak-Average Ratio	§24.232(d)	FCC: Limit ≤ 13dB	Pass
Modulation Characteristics	§2.1047	Digital Modulation	Pass
Bandwidth	§2.1049	OBW: No limit. EBW: No limit.	Pass
Band Edges Compliance	§2.1051, §24.238	≤ -13dBm/1%*EBW, In 1MHz bands immediately outside and adjacent to The frequency block.	Pass
Spurious Emission at Antenna Terminals	§2.1051, §24.238	≤ -13dBm/1MHz, from 9kHz to 10th harmonics but outside authorized Operating frequency ranges.	Pass
Field Strength of Spurious Radiation	Clause 7 of KDB971168 D01 v02r02	≤ -13dBm/1MHz.	Pass
Frequency Stability	§2.1055, §22.355, §24.235	FCC: within authorized frequency block.	Pass

NOTE 1: For the verdict, the "N/A" denotes "not applicable", the "N/T" denotes "not tested".

Remark:

1. The measurement uncertainty is not included in the test result.



3.4 Equipments Used during the Test

Test Equipment	Manufacturer	Model No.	Serial No.	Calibration Date	Calibration Due Date
LISN	R&S	ENV216	HKE-059	2019/12/26	2020/12/25
LISN	R&S	ENV216	HKE-002	2019/12/26	2020/12/25
Receiver	R&S	ESCI 7	HKE-010	2019/12/26	2020/12/25
Spectrum analyzer	R&S	FSP40	HKE-025	2019/12/26	2020/12/25
Spectrum analyzer	Agilent	N9020A	HKE-048	2019/12/26	2020/12/25
RF automatic control unit	Tonscend	JS0806-1	HKE-060	2019/12/26	2020/12/25
Loop antenna	Schwarzbeck	FMZB 1519 B	HKE-014	2019/12/26	2020/12/25
Bilog Broadband Antenna	Schwarzbeck	VULB9163	HKE-012	2019/12/26	2020/12/25
Horn antenna	Schwarzbeck	9120D	HKE-013	2019/12/26	2020/12/25
High gain antenna	Schwarzbeck	LB-180400KF	HKE-054	2019/12/26	2020/12/25
Preamplifier	EMCI	EMC051845SE	HKE-015	2019/12/26	2020/12/25
Preamplifier	Agilent	83051A	HKE-016	2019/12/26	2020/12/25
Preamplifier	Schwarzbeck	BBV 9743	HKE-006	2019/12/26	2020/12/25
Temperature and humidity meter	Boyang	HTC-1	HKE-075	2019/12/26	2020/12/25
High-low temperature chamber	Guangke	HT-80L	HKE-118	2019/12/26	2020/12/25
High pass filter unit	Tonscend	JS0806-F	HKE-055	2019/12/26	2020/12/25
RF Cable(below 1GHz)	Times	9kHz-1GHz	HKE-117	2019/12/26	2020/12/25
RF Cable(above 1GHz)	Times	1-40G	HKE-034	2019/12/26	2020/12/25
Power meter	Agilent	E4419B	HKE-085	2019/12/26	2020/12/25
Power Sensor	Agilent	E9300A	HKE-086	2019/12/26	2020/12/25
Conducted test software	Tonscend	TS+ Rev 2.5.0.0	HKE-081	N/A	N/A
Radiated test software	Tonscend	TS+ Rev 2.5.0.0	HKE-082	N/A	N/A
RF test software	Tonscend	JS1120-B Version 2.6	HKE-083	N/A	N/A
RF test software	Tonscend	JS1120-4	HKE-113	N/A	N/A
RF test software	Tonscend	JS1120-3	HKE-114	N/A	N/A
RF test software	Tonscend	JS1120-1	HKE-115	N/A	N/A
Wireless Communication Test Set	R&S	CMW500	HKE-026	2019/12/26	2020/12/25
Wireless Communication Test Set	R&S	CMU200	HKE-029	2019/12/26	2020/12/25
High gain antenna	Schwarzbeck	LB-180400KF	HKE-054	2019/12/26	2020/12/25



4 TEST CONDITIONS AND RESULTS

4.1 Output Power

4.1.1 Conducted Output Power

TEST APPLICABLE

During the process of testing, the EUT was controlled via R&S Digital Radio Communication tester (CMW500) to ensure max power transmission and proper modulation. This result contains output power and EIRP measurements for the EUT. In all cases, output power is within the specified limits.

TEST CONFIGURATION

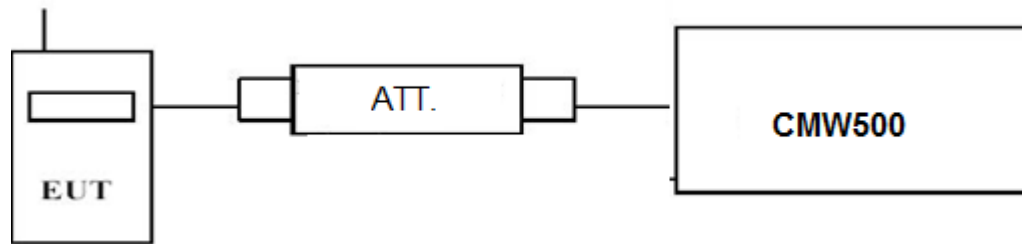

TEST PROCEDURE

Conducted Power Measurement:

- Place the EUT on a bench and set it in transmitting mode.
- Connect a low loss RF cable from the antenna port to a CMW500 by an Att.
- EUT Communicate with CMW500 then selects a channel for testing.
- Add a correction factor to the display CMW500, and then test.

TEST RESULTS

compliance *

Remark:

- We measured all RB Configuration refer 3GPP TS136 521 for each Channel Bandwidth of LTE FDD Band 5;

LTE FDD Band 5				
TX Channel Bandwidth	Frequency (MHz)	RB Size/Offset	Burst Average Power [dBm]	
			QPSK	16QAM
1.4 MHz	824.7	1 RB low	24.28	23.44
		1 RB high	24.27	23.43
		50% RB mid	24.34	22.81
		100% RB	24.40	22.90
	836.5	1 RB low	24.50	24.01
		1 RB high	24.66	24.00
		50% RB mid	24.67	23.39
		100% RB	24.61	23.40
	848.3	1 RB low	24.63	22.99
		1 RB high	24.63	22.89
		50% RB mid	24.67	23.12
		100% RB	24.66	23.12
3 MHz	825.5	1 RB low	24.28	23.41
		1 RB high	24.29	23.36
		50% RB mid	23.47	22.79
		100% RB	23.32	22.46
	836.5	1 RB low	24.62	23.58
		1 RB high	24.58	23.67
		50% RB mid	23.49	22.71



	847.5	100% RB	23.62	22.73
		1 RB low	24.62	23.04
		1 RB high	24.66	23.05
		50% RB mid	23.50	22.75
		100% RB	23.61	22.88
5 MHz	826.5	1 RB low	24.39	23.08
		1 RB high	24.49	23.10
		50% RB mid	23.31	22.41
		100% RB	23.36	22.38
	836.5	1 RB low	24.85	22.87
		1 RB high	24.78	23.11
		50% RB mid	23.55	22.58
		100% RB	23.45	22.54
	846.5	1 RB low	24.71	23.75
		1 RB high	24.68	23.77
		50% RB mid	23.62	22.88
		100% RB	23.69	22.86
10 MHz	829.0	1 RB low	24.47	22.95
		1 RB high	24.46	22.72
		50% RB mid	23.41	22.65
		100% RB	23.47	22.64
	836.5	1 RB low	24.73	24.04
		1 RB high	24.68	24.15
		50% RB mid	23.84	22.79
		100% RB	23.49	22.55
	844.0	1 RB low	24.59	23.62
		1 RB high	24.64	23.59
		50% RB mid	23.52	22.56
		100% RB	23.60	22.61

4.1.2. Radiated Output Power

LIMIT

This is the test for the maximum radiated power from the EUT.

Rule Part 22H.232(b) specifies, "Mobile/portable stations are limited to 7 watts e.i.r.p.

TEST CONFIGURATION

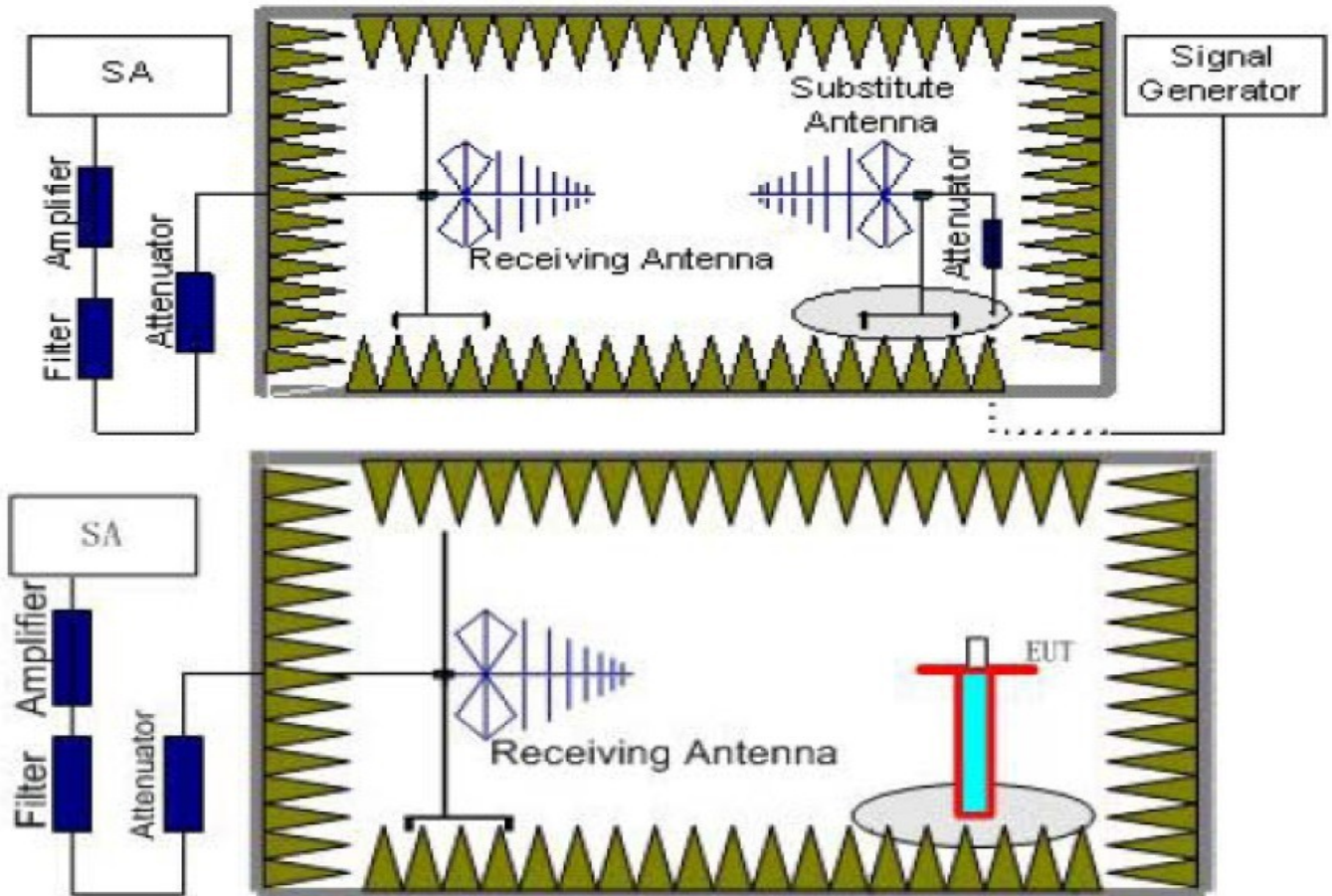

TEST PROCEDURE

1. EUT was placed on a 0.1 meter high non-conductive stand at a 3 meter test distance from the receive antenna. A receiving antenna was placed on the antenna mast 3 meters from the EUT for emission measurements. The height of receiving antenna is 0.1m. Detected emissions were maximized at each frequency by rotating the EUT through 360° and adjusting the receiving antenna polarization. The radiated emission measurements of all transmit frequencies in three channels (High, Middle, Low) were measured with peak detector.
2. A log-periodic antenna or double-ridged waveguide horn antenna shall be substituted in place of the EUT. The log-periodic antenna will be driven by a signal generator and the level will be adjusted till the same power value on the spectrum analyzer or receiver. The level of the spurious emissions can be calculated through the level of the signal generator, cable loss, the gain of the substitution antenna and the reading of the spectrum analyzer or receiver.
3. The EUT is then put into continuously transmitting mode at its maximum power level during the test. Set Test Receiver or Spectrum RBW=1MHz, VBW=3MHz, And the maximum value of the receiver should be recorded as (P_r).
4. The EUT shall be replaced by a substitution antenna. In the chamber, an substitution antenna for the frequency band of interest is placed at the reference point of the chamber. An RF Signal source for the frequency band of interest is connected to the substitution antenna with a cable that has been constructed to not interfere with the radiation pattern of the antenna. A power (P_{Mea}) is applied to the input of the substitution antenna, and adjust the level of the signal generator output until the value of the receiver reach the previously recorded (P_r). The power of signal source (P_{Mea}) is recorded. The test should be performed by rotating the test item and adjusting the receiving antenna polarization.



5. An amplifier should be connected to the Signal Source output port. And the cable should be connect between the Amplifier and the Substitution Antenna. The cable loss (P_{cl}), the Substitution Antenna Gain (G_a) and the Amplifier Gain (P_{Ag}) should be recorded after test.

The measurement results are obtained as described below: $Power(EIRP) = P_{Mea} - P_{Ag} - P_{cl} + G_a$

We used SMF100A microwave signal generator which signal level can up to 33dBm, so we not used power Amplifier for substitution test; The measurement results are amend as described below:

$$Power(EIRP) = P_{Mea} - P_{cl} + G_a$$

6. This value is EIRP since the measurement is calibrated using an antenna of known gain (2.15 dBi) and known input power.
7. ERP can be calculated from EIRP by subtracting the gain of the dipole, $ERP = EIRP - 2.15dBi$.

TEST RESULTS

Radiated Measurement:

Remark:

1. We measured all RB Configuration refer 3GPP TS136 521 for each Channel Bandwidth of LTE FDD Band 5; recorded worst case for each Channel Bandwidth of LTE FDD Band 5.
2. $EIRP = P_{Mea}(dBm) - P_{cl}(dB) + P_{Ag}(dB) + G_a(dBi)$
3. We measured both Horizontal and Vertical direction, recorded worst case direction.

LTE FDD Band 5_Channel Bandwidth 1.4MHz_QPSK

Frequency (MHz)	P_{Mea} (dBm)	P_{cl} (dB)	G_a Antenna Gain(dB)	P_{Ag} (dB)	ERP (dBm)	Limit (dBm)	Margin (dB)	Polarization
824.7	-19.87	3.41	10.24	33.60	20.56	38.45	17.89	V
836.5	-19.76	3.49	10.24	33.60	20.59	38.45	17.86	V
848.3	-20.39	3.55	10.23	33.60	19.89	38.45	18.56	V

LTE FDD Band 5_Channel Bandwidth 3MHz_QPSK

Frequency (MHz)	P_{Mea} (dBm)	P_{cl} (dB)	G_a Antenna Gain(dB)	P_{Ag} (dB)	ERP (dBm)	Limit (dBm)	Margin (dB)	Polarization
825.5	-19.74	3.41	10.24	33.60	20.69	38.45	17.76	V
836.5	-19.78	3.49	10.24	33.60	20.57	38.45	17.88	V
847.5	-20.28	3.55	10.23	33.60	20	38.45	18.45	V

LTE FDD Band 5_Channel Bandwidth 5MHz_QPSK

Frequency (MHz)	P_{Mea} (dBm)	P_{cl} (dB)	G_a Antenna Gain(dB)	P_{Ag} (dB)	ERP (dBm)	Limit (dBm)	Margin (dB)	Polarization
826.5	-19.3	3.41	10.24	33.60	21.13	38.45	17.32	V
836.5	-19.59	3.49	10.24	33.60	20.76	38.45	17.69	V
846.5	-19.74	3.55	10.23	33.60	20.54	38.45	17.91	V

LTE FDD Band 5_Channel Bandwidth 10MHz_QPSK

Frequency (MHz)	P_{Mea} (dBm)	P_{cl} (dB)	G_a Antenna Gain(dB)	P_{Ag} (dB)	ERP (dBm)	Limit (dBm)	Margin (dB)	Polarization
829.0	-19.49	3.41	10.24	33.60	20.94	38.45	17.51	V
836.5	-20.18	3.49	10.24	33.60	20.17	38.45	18.28	V
844.0	-20.27	3.55	10.23	33.60	20.01	38.45	18.44	V

*LTE FDD Band 5_Channel Bandwidth 1.4MHz_16QAM*

Frequency (MHz)	P _{Mea} (dBm)	P _{cl} (dB)	G _a Antenna Gain(dB)	P _{Aq} (dB)	ERP (dBm)	Limit (dBm)	Margin (dB)	Polarization
824.7	-19.34	3.41	10.24	33.60	21.09	38.45	17.36	V
836.5	-19.36	3.49	10.24	33.60	20.99	38.45	17.46	V
848.3	-19.84	3.55	10.23	33.60	20.44	38.45	18.01	V

LTE FDD Band 5_Channel Bandwidth 3MHz_16QAM

Frequency (MHz)	P _{Mea} (dBm)	P _{cl} (dB)	G _a Antenna Gain(dB)	P _{Aq} (dB)	ERP (dBm)	Limit (dBm)	Margin (dB)	Polarization
825.5	-19.63	3.41	10.24	33.60	20.8	38.45	17.65	V
836.5	-19.38	3.49	10.24	33.60	20.97	38.45	17.48	V
847.5	-20.38	3.55	10.23	33.60	19.9	38.45	18.55	V

LTE FDD Band 5_Channel Bandwidth 5MHz_16QAM

Frequency (MHz)	P _{Mea} (dBm)	P _{cl} (dB)	G _a Antenna Gain(dB)	P _{Aq} (dB)	ERP (dBm)	Limit (dBm)	Margin (dB)	Polarization
826.5	-19.36	3.41	10.24	33.60	21.07	38.45	17.38	V
836.5	-19.61	3.49	10.24	33.60	20.74	38.45	17.71	V
846.5	-19.87	3.55	10.23	33.60	20.41	38.45	18.04	V

LTE FDD Band 5_Channel Bandwidth 10MHz_16QAM

Frequency (MHz)	P _{Mea} (dBm)	P _{cl} (dB)	G _a Antenna Gain(dB)	P _{Aq} (dB)	ERP (dBm)	Limit (dBm)	Margin (dB)	Polarization
829.0	-19.3	3.41	10.24	33.60	21.13	38.45	17.32	V
836.5	-19.46	3.49	10.24	33.60	20.89	38.45	17.56	V
844.0	-19.55	3.55	10.23	33.60	20.73	38.45	17.72	V



4.2 Peak-to-Average Ratio (PAR)

LIMIT

The Peak-to-Average Ratio (PAR) of the transmission may not exceed 13 dB.

TEST CONFIGURATION

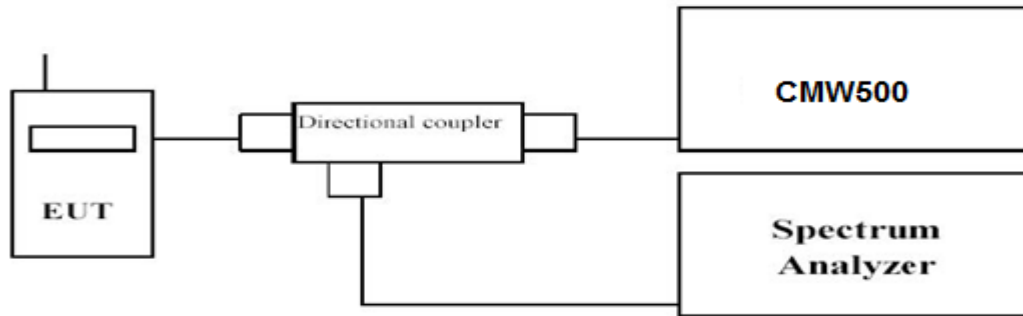

TEST PROCEDURE

1. Refer to instrument's analyzer instruction manual for details on how to use the power statistics/CCDF function;
2. Set resolution/measurement bandwidth \geq signal's occupied bandwidth;
3. Set the number of counts to a value that stabilizes the measured CCDF curve;
4. Set the measurement interval as follows:
 - 1). for continuous transmissions, set to 1 ms,
 - 2). for burst transmissions, employ an external trigger that is synchronized with the EUT burst timing sequence, or use the internal burst trigger with a trigger level that allows the burst to stabilize and set the measurement interval to a time that is less than or equal to the burst duration.
5. Record the maximum PAPR level associated with a probability of 0.1%.

TEST RESULTS

Remark:

1. We measured all RB Configuration refer 3GPP TS136 521 for each Channel Bandwidth of LTE FDD Band 5; recorded worst case for each Channel Bandwidth of LTE FDD Band 5.

LTE FDD Band 5				
TX Channel Bandwidth	Frequency (MHz)	RB Size/Offset	PAPR(dB)	
			QPSK	16QAM
1.4 MHz	824.7	1RB#0	3.66	4.36
	836.5		3.88	4.77
	848.3		4.06	5.59
3 MHz	825.5	1RB#0	3.75	4.55
	836.5		4.06	4.93
	847.5		3.84	5.30
5 MHz	826.5	1RB#0	3.70	5.14
	836.5		4.09	5.64
	846.5		3.59	4.33
10 MHz	829.0	1RB#0	3.82	4.95
	836.5		4.75	5.64
	844.0		3.25	3.84



LTE FDD Band 5- 1.4 MHz Channel Bandwidth PAPR

QPSK

16QAM

Low Channel

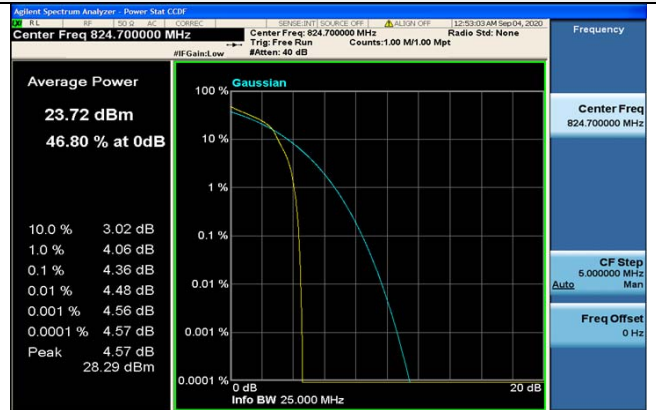
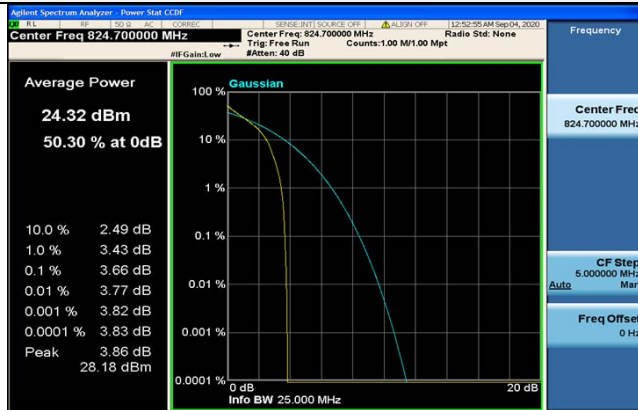

1RB#0

1RB#0

Middle Channel

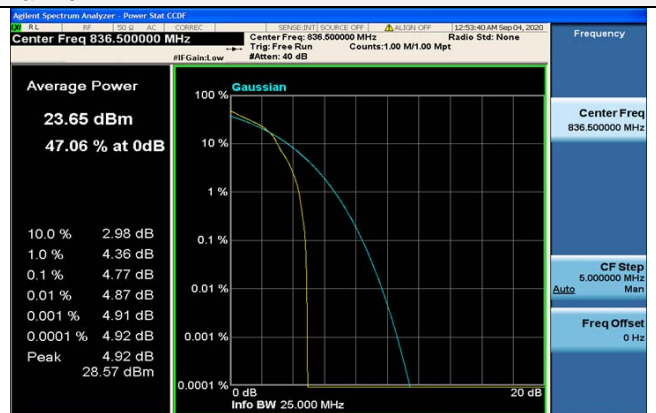
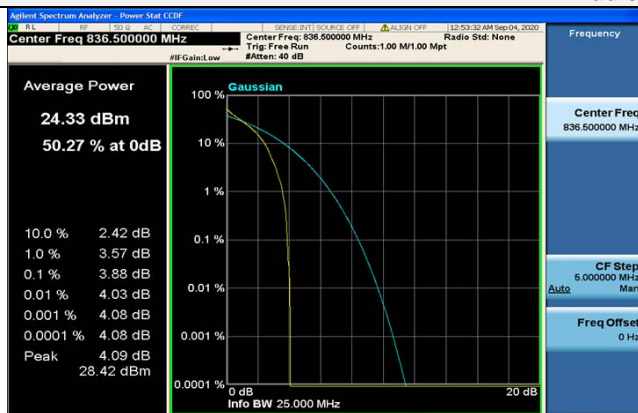

1RB#0

1RB#0

High Channel

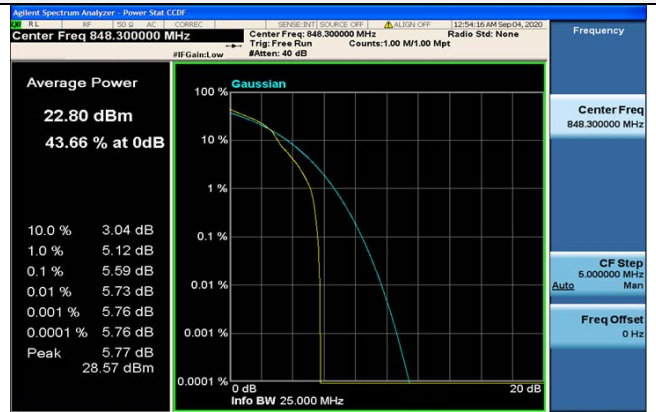

1RB#0

1RB#0



LTE FDD Band 5-3MHz Channel Bandwidth PAPR

QPSK

16QAM

Low Channel

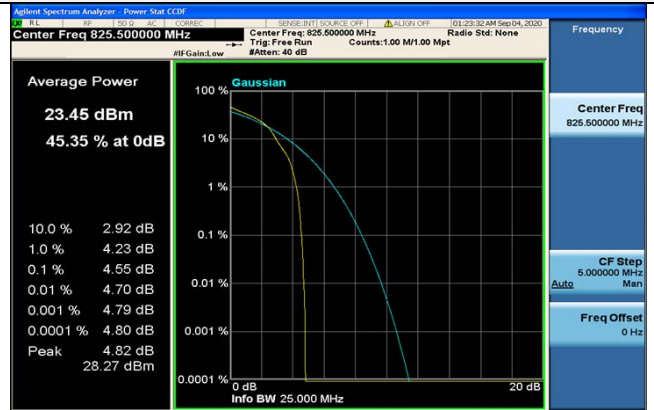
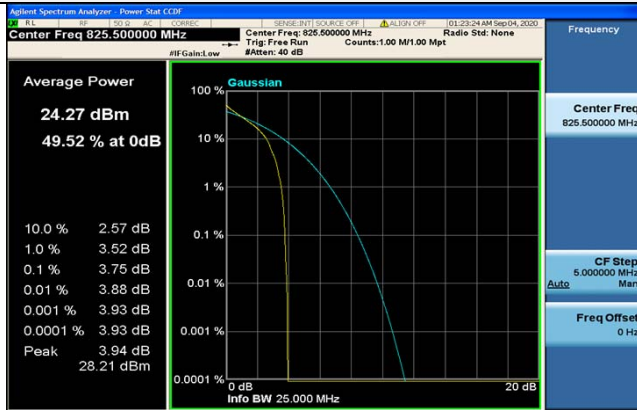

1RB#0

1RB#0

Middle Channel

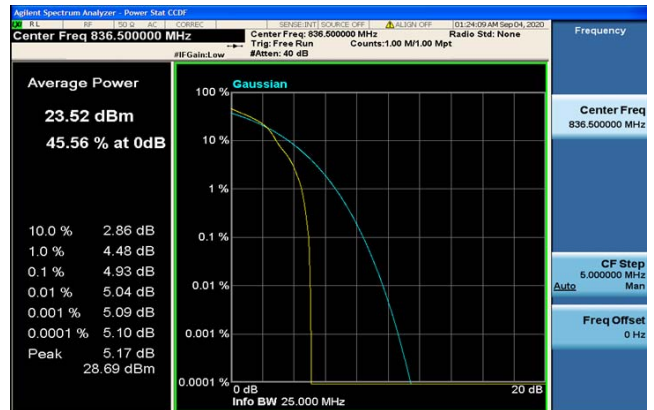
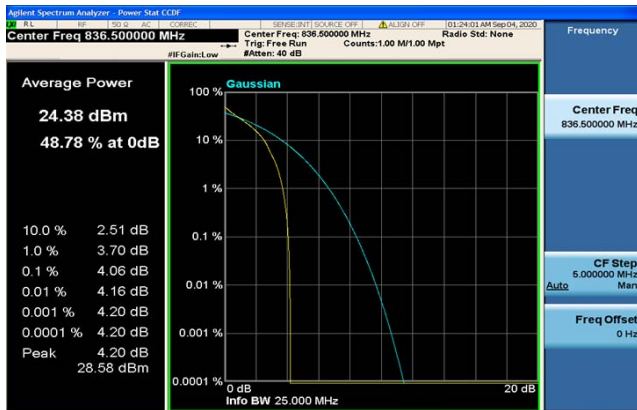

1RB#0

1RB#0

High Channel

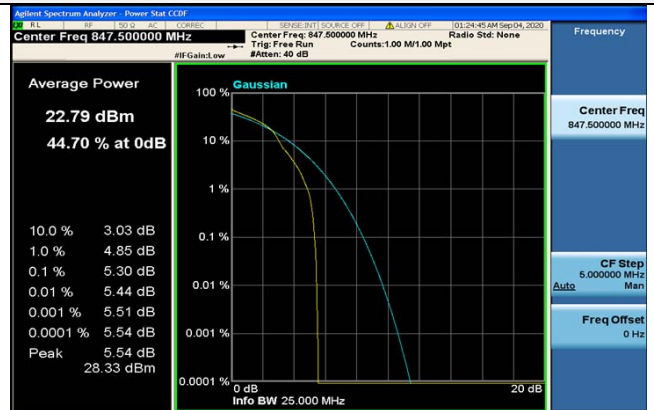

1RB#0

1RB#0



LTE FDD Band 5-5MHz Channel Bandwidth PAPR

QPSK

16QAM

Low Channel

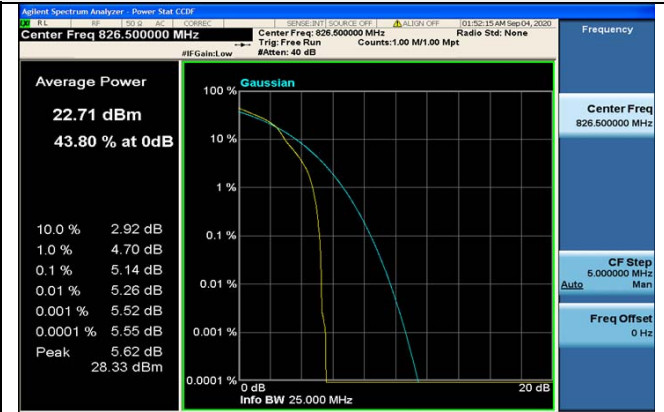
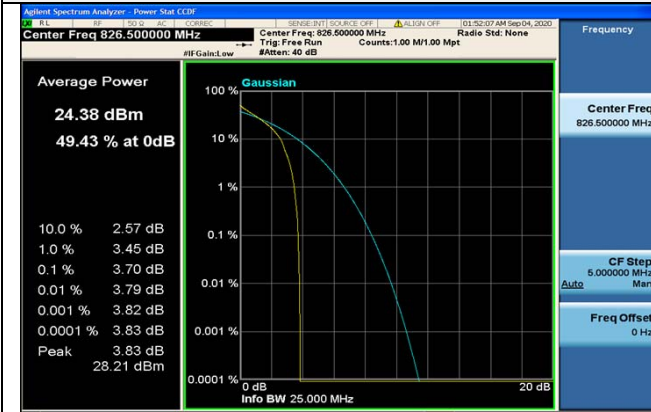

1RB#0

1RB#0

Middle Channel

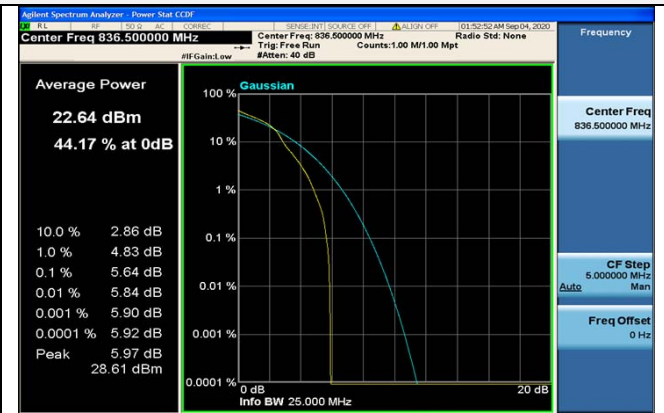
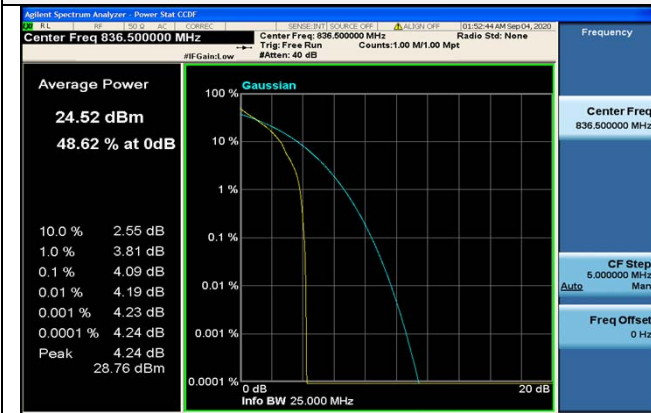

1RB#0

1RB#0

High Channel

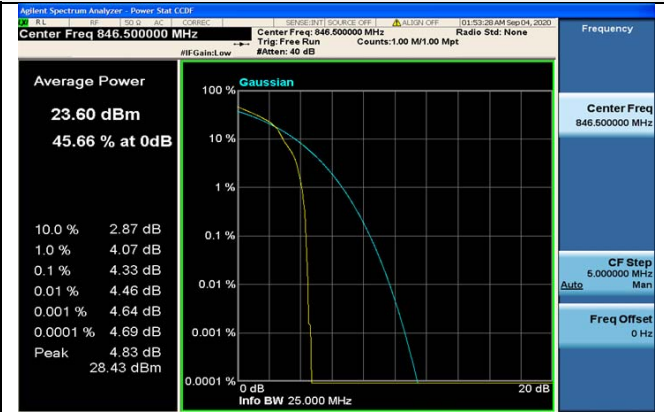
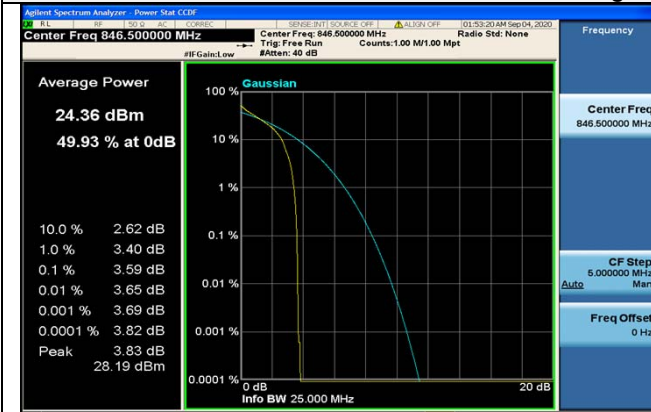

1RB#0

1RB#0



LTE FDD Band 5-10MHz Channel Bandwidth PAPR

QPSK

16QAM

Low Channel

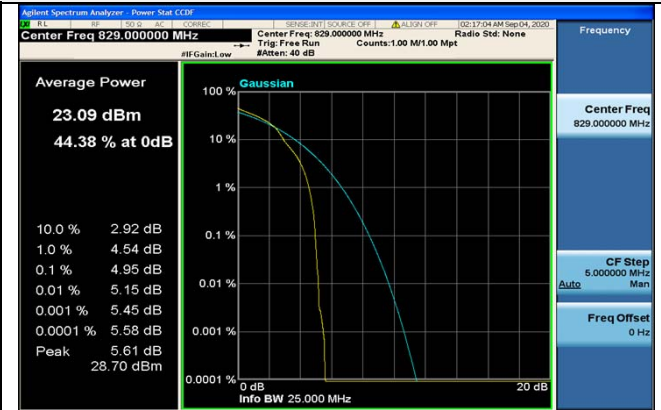

1RB#0

1RB#0

Middle Channel

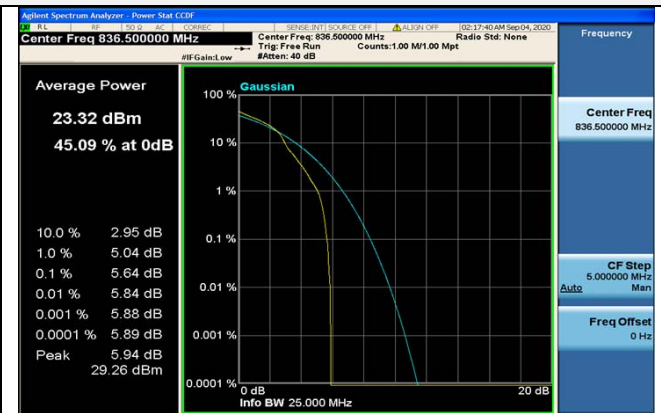
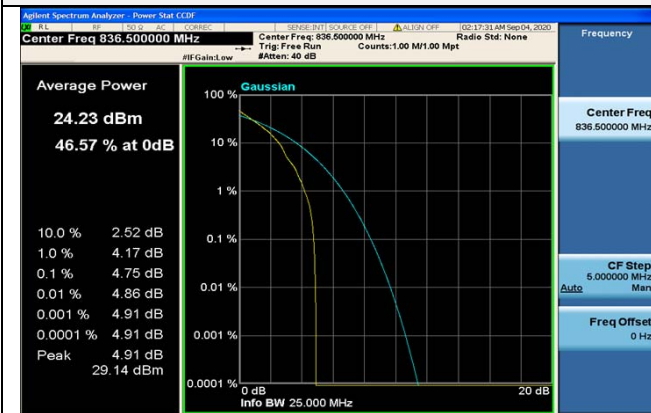

1RB#0

1RB#0

High Channel

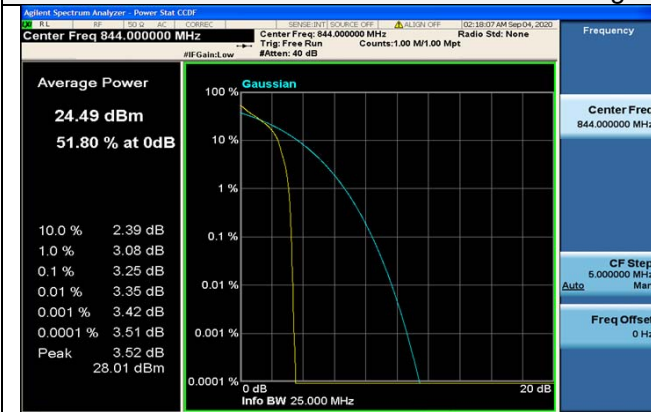

1RB#0

1RB#0



4.3 Occupied Bandwidth and Emission Bandwidth

LIMIT

N/A

TEST CONFIGURATION

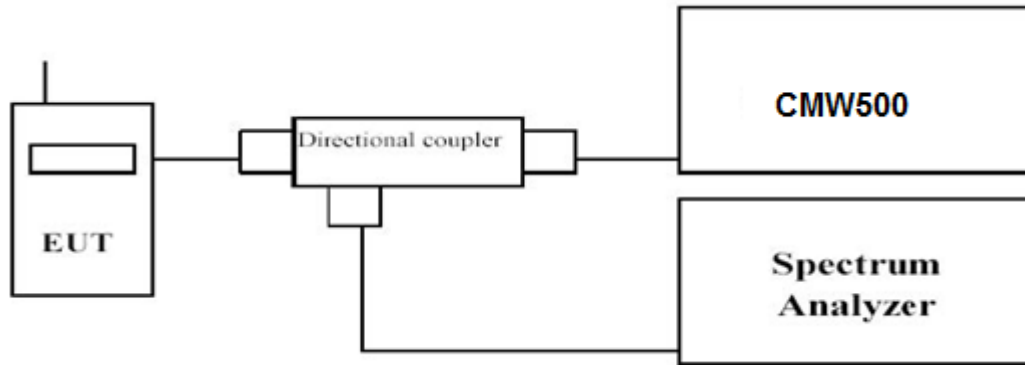

TEST PROCEDURE

The transmitter output was connected to a calibrated coaxial cable and coupler, the other end of which was connected to a spectrum analyzer. The occupied bandwidth was measured with the spectrum analyzer at low, middle and high channel in each band. The -26dBc Emission bandwidth was also measured and recorded. Set RBW was set to about 1% of emission BW, VBW ≥ 3 times RBW. -26dBc display line was placed on the screen (or 99% bandwidth), the occupied bandwidth is the delta frequency between the two points where the display line intersects the signal trace.

TEST RESULTS

Remark:

1. We were tested all RB Configuration refer 3GPP TS136 521 for each Channel Bandwidth of LTE FDD Band 5; recorded worst case for each Channel Bandwidth of LTE FDD Band 5.

LTE FDD Band 5						
TX Channel Bandwidth	RB Size/Offset	Frequency (MHz)	-26dBc Emission bandwidth (MHz)		99% Occupied bandwidth (MHz)	
			QPSK	16QAM	QPSK	16QAM
1.4 MHz	6RB#0	824.7	1.239	1.242	1.0920	1.0935
		836.5	1.241	1.235	1.0889	1.0905
		848.3	1.230	1.246	1.0929	1.0909
3 MHz	15RB#0	825.5	2.969	2.957	2.6984	2.6931
		836.5	2.984	2.951	2.6974	2.6884
		847.5	2.972	2.978	2.6998	2.6995
5 MHz	25RB#0	826.5	4.937	4.937	4.5010	4.5023
		836.5	4.949	4.899	4.4983	4.4987
		846.5	4.988	5.020	4.5037	4.5016
10 MHz	50RB#0	829.0	9.605	9.615	8.9883	8.9804
		836.5	9.558	9.557	8.9597	8.9561
		844.0	9.580	9.600	8.9849	8.9753



LTE FDD Band 5- 1.4 MHz Channel Bandwidth Occupied Bandwidth and Emission Bandwidth

QPSK

16QAM

Low Channel

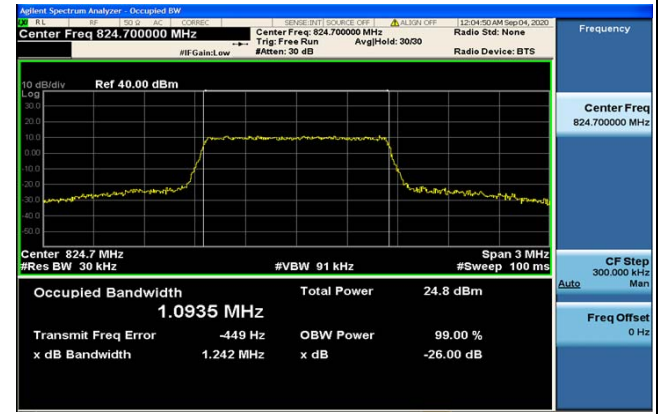
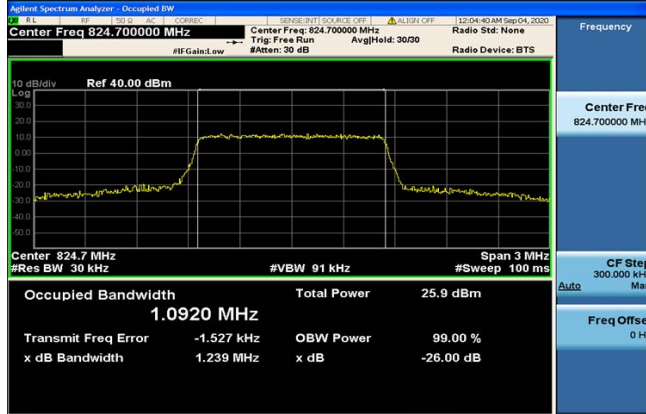

6RB#0

6RB#0

Middle Channel

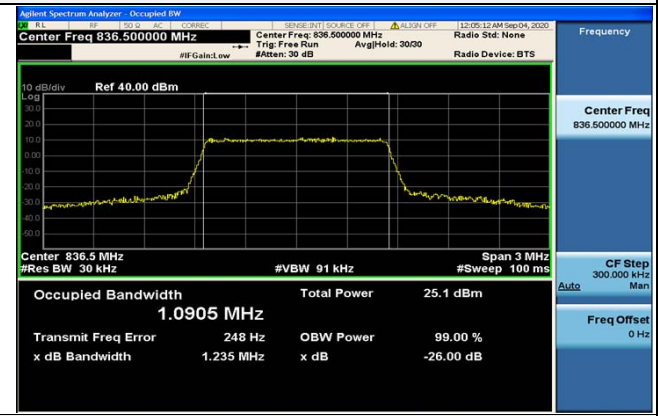
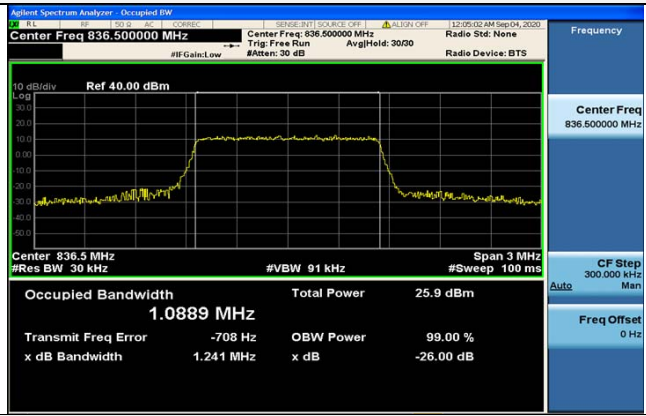

6RB#0

6RB#0

High Channel

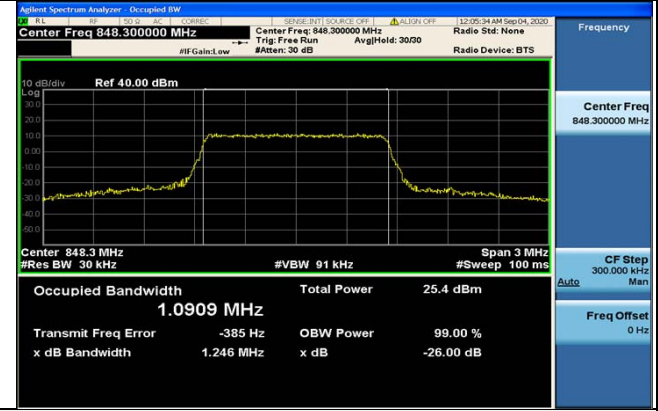
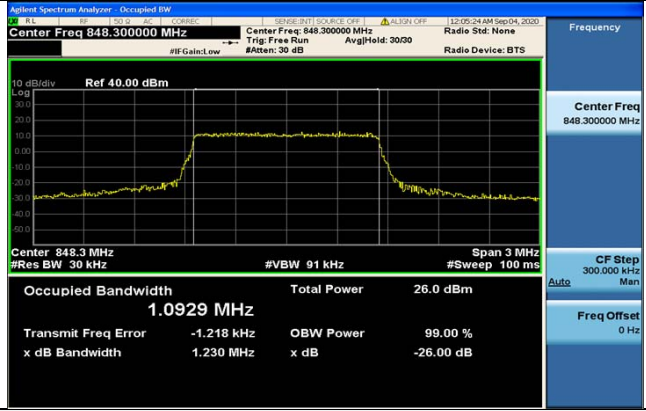

6RB#0

6RB#0



LTE FDD Band 5-3MHz Channel Bandwidth Occupied Bandwidth and Emission Bandwidth

QPSK

16QAM

Low Channel

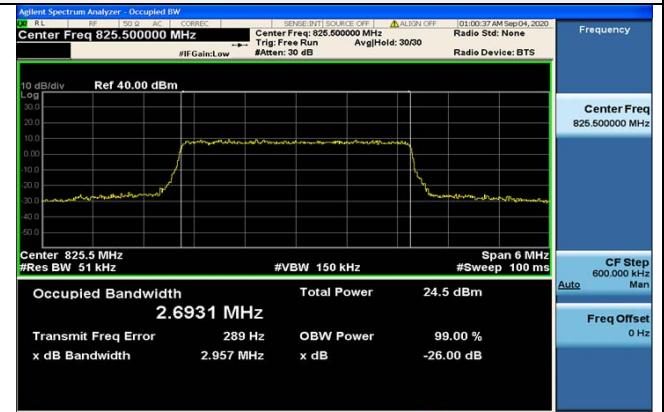
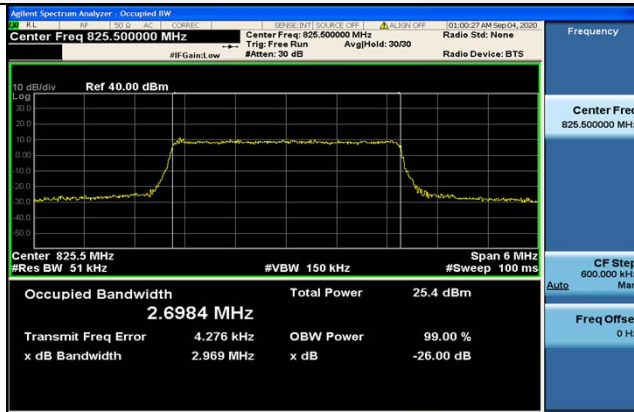

15RB#0

15RB#0

Middle Channel

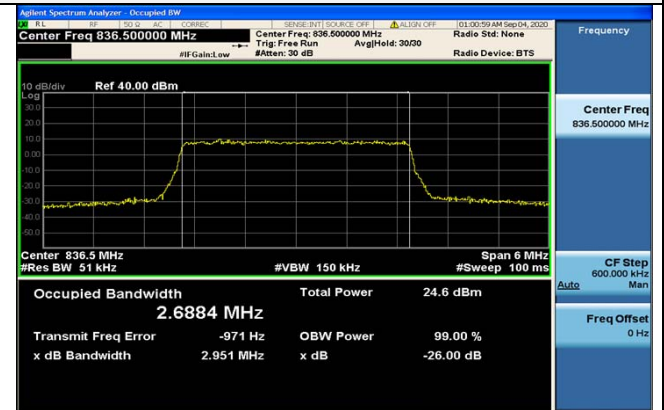
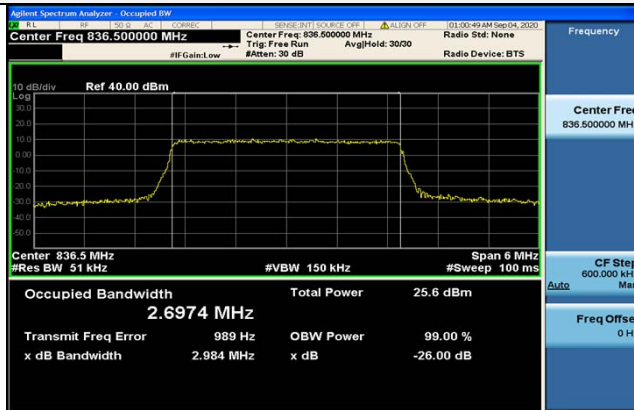

15RB#0

15RB#0

High Channel

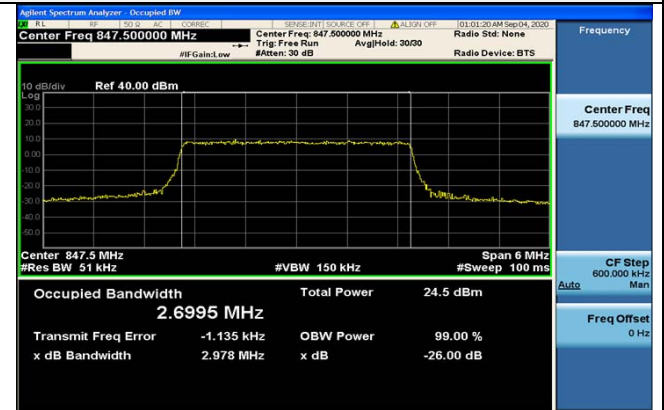
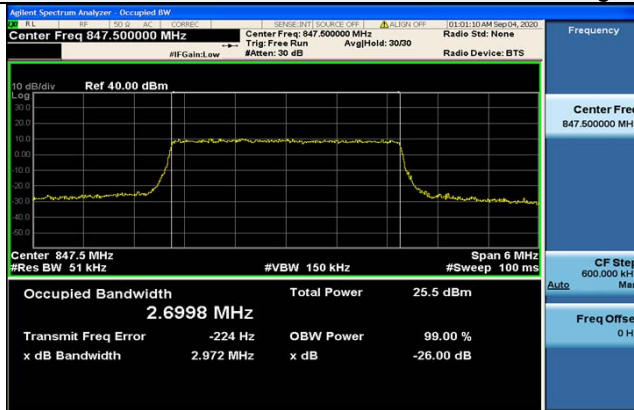

15RB#0

15RB#0



LTE FDD Band 5-5MHz Channel Bandwidth Occupied Bandwidth and Emission Bandwidth

QPSK

16QAM

Low Channel

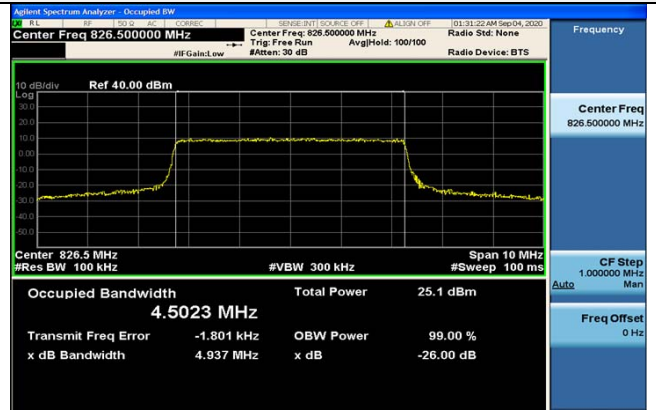
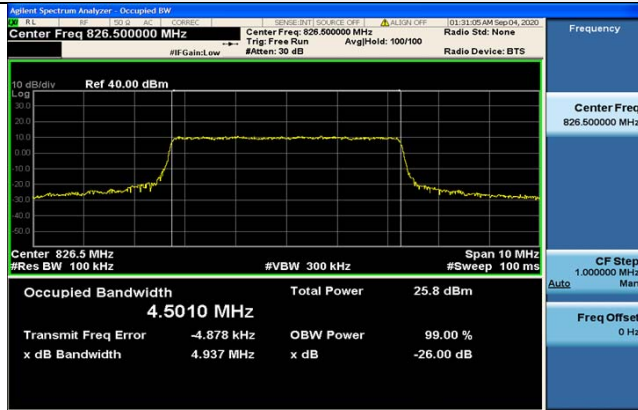

25RB#0

25RB#0

Middle Channel

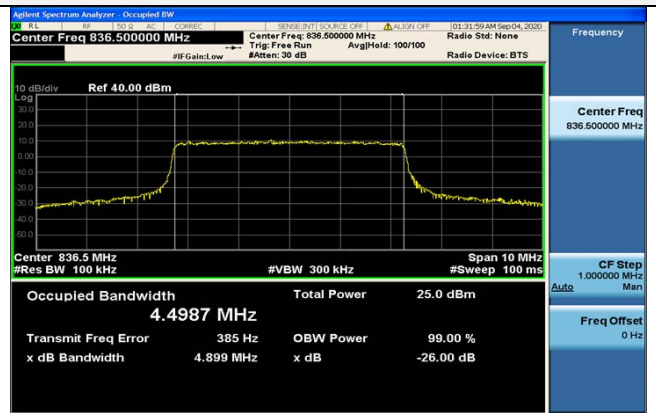
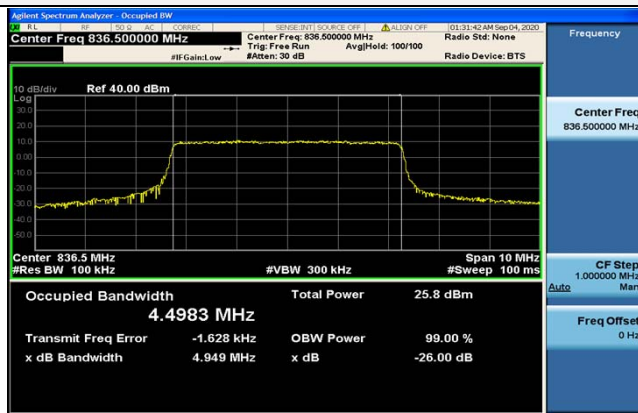

25RB#0

25RB#0

High Channel

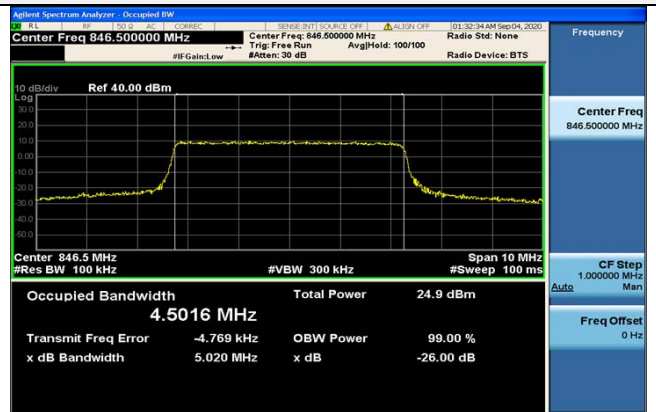
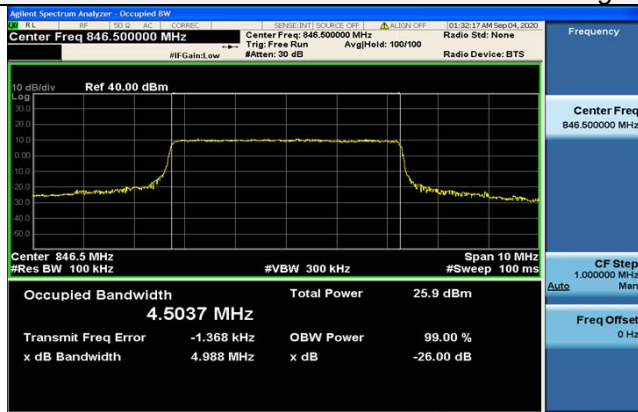

25RB#0

25RB#0



LTE FDD Band 5-10MHz Channel Bandwidth Occupied Bandwidth and Emission Bandwidth

QPSK

16QAM

Low Channel

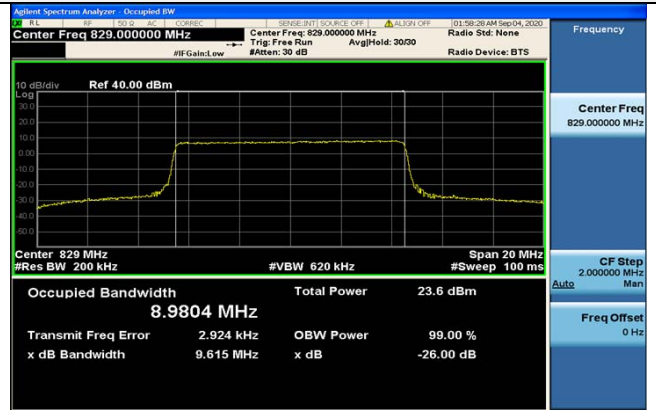
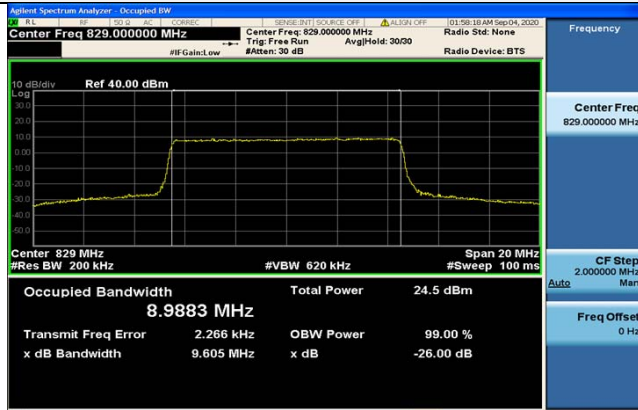

50RB#0

50RB#0

Middle Channel

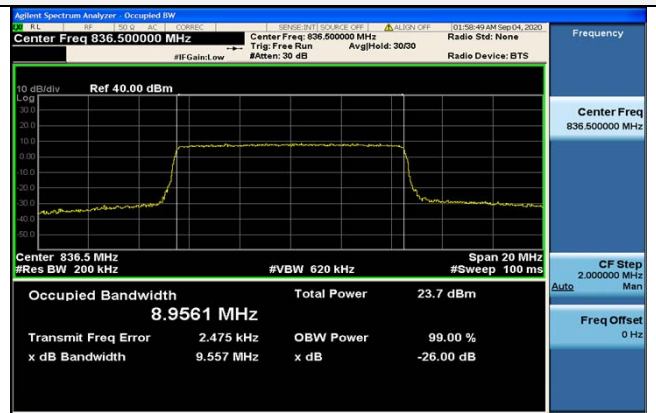
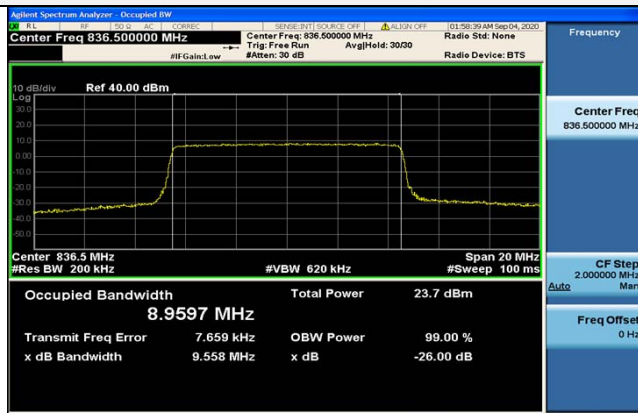

50RB#0

50RB#0

High Channel

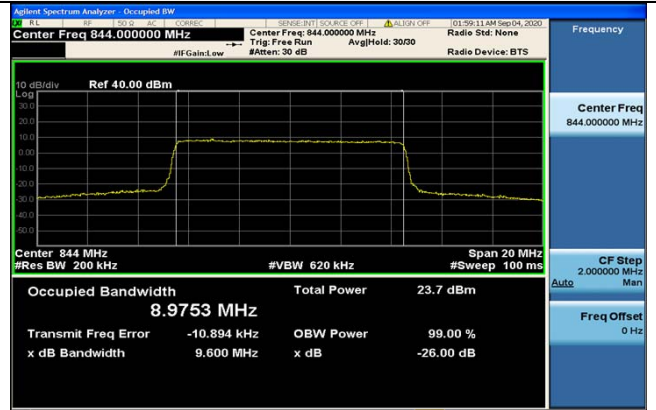
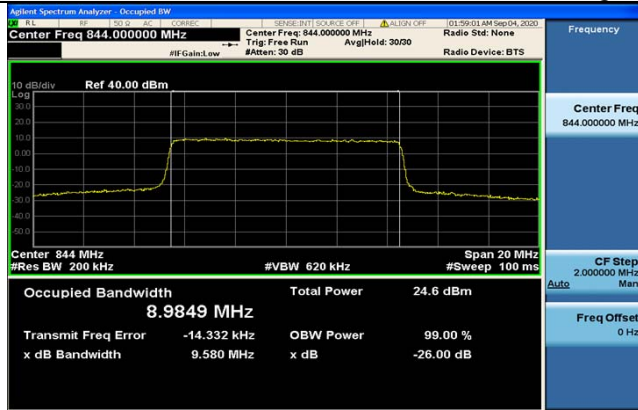

50RB#0

50RB#0



4.4 Band Edge compliance

LIMIT

Per FCC §24.238 the power of any emission outside of the authorized operating frequency ranges must be attenuated below the transmitting power (P) by a factor of at least $43 + 10\log(P)$ dB.

TEST CONFIGURATION

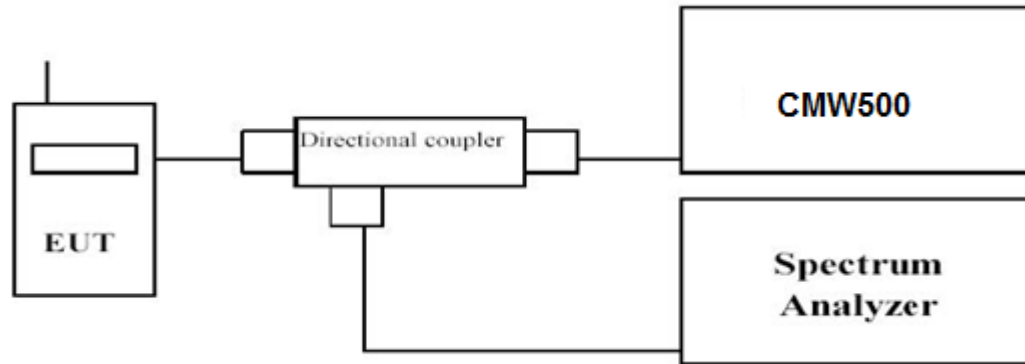

TEST PROCEDURE

1. The transmitter output port was connected to base station.
2. The RF output of EUT was connected to the power meter by RF cable and attenuator, the path loss was compensated to the results for each measurement.
3. Set EUT at maximum power through base station.
4. Select lowest and highest channels for each band and different modulation.
5. Measure Band edge using RMS (Average) detector by spectrum

TEST RESULTS

Remark:

1. We were tested all RB Configuration refer 3GPP TS136 521 for each Channel Bandwidth of LTE FDD Band 5; recorded worst case for each Channel Bandwidth of LTE FDD Band 5.



LTE FDD Band 5- 1.4 MHz Channel Bandwidth Band Edge Compliance

QPSK

16QAM

Low Channel



6RB#0

6RB#0

High Channel



6RB#0

6RB#0



LTE FDD Band 5-3MHz Channel Bandwidth Band Edge Compliance

QPSK

16QAM

Low Channel



15RB#0



15RB#0

High Channel



15RB#0



15RB#0



LTE FDD Band 5-5MHz Channel Bandwidth Band Edge Compliance
QPSK 16QAM

Low Channel



25RB#0



25RB#0

High Channel



25RB#0



25RB#0



LTE FDD Band 5– 10 MHz Channel Bandwidth Band Edge Compliance

QPSK

16QAM

Low Channel



50RB#0



50RB#0

High Channel



50RB#0



50RB#0



4.5 Spurious Emission on Antenna Port

LIMIT

Per FCC §24.238, the power of any emission outside of the authorized operating frequency ranges must be attenuated below the transmitting power (P) by a factor of at least $43 + 10\log(P)$ dB.

TEST CONFIGURATION

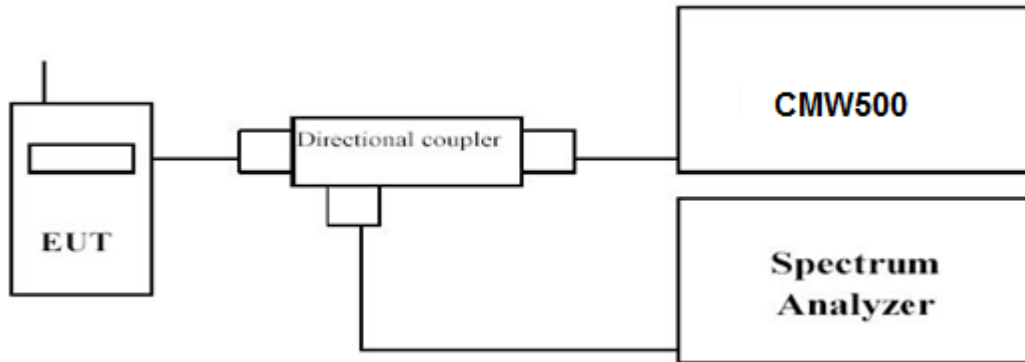

TEST PROCEDURE

The EUT was setup according to EIA/TIA 603D

- a. Place the EUT on a bench and set it in transmitting mode.
- b. Connect a low loss RF cable from the antenna port to a spectrum analyzer and CMW500 by a Directional Couple.
- c. EUT Communicate with CMW500, then select a channel for testing.
- d. Add a correction factor to the display of spectrum, and then test.
- e. The resolution bandwidth of the spectrum analyzer was set sufficient scans were taken to show the out of band Emission if any up to 10th harmonic.
- f. Please refer to following tables for test antenna conducted emissions.

Working Frequency	Sub range (GHz)	RBW	VBW	Sweep time (s)
LTE FDD Band 5	0.01~20	1 MHz	3 MHz	Auto

TEST RESULTS

Remark:

1. We were tested all RB Configuration refer 3GPP TS136 521 for each Channel Bandwidth of LTE FDD Band 5; recorded worst case at the QPSK Mode for each Channel Bandwidth of LTE FDD Band 5



LTE FDD Band 5-1.4MHz Channel Bandwidth
Low Channel

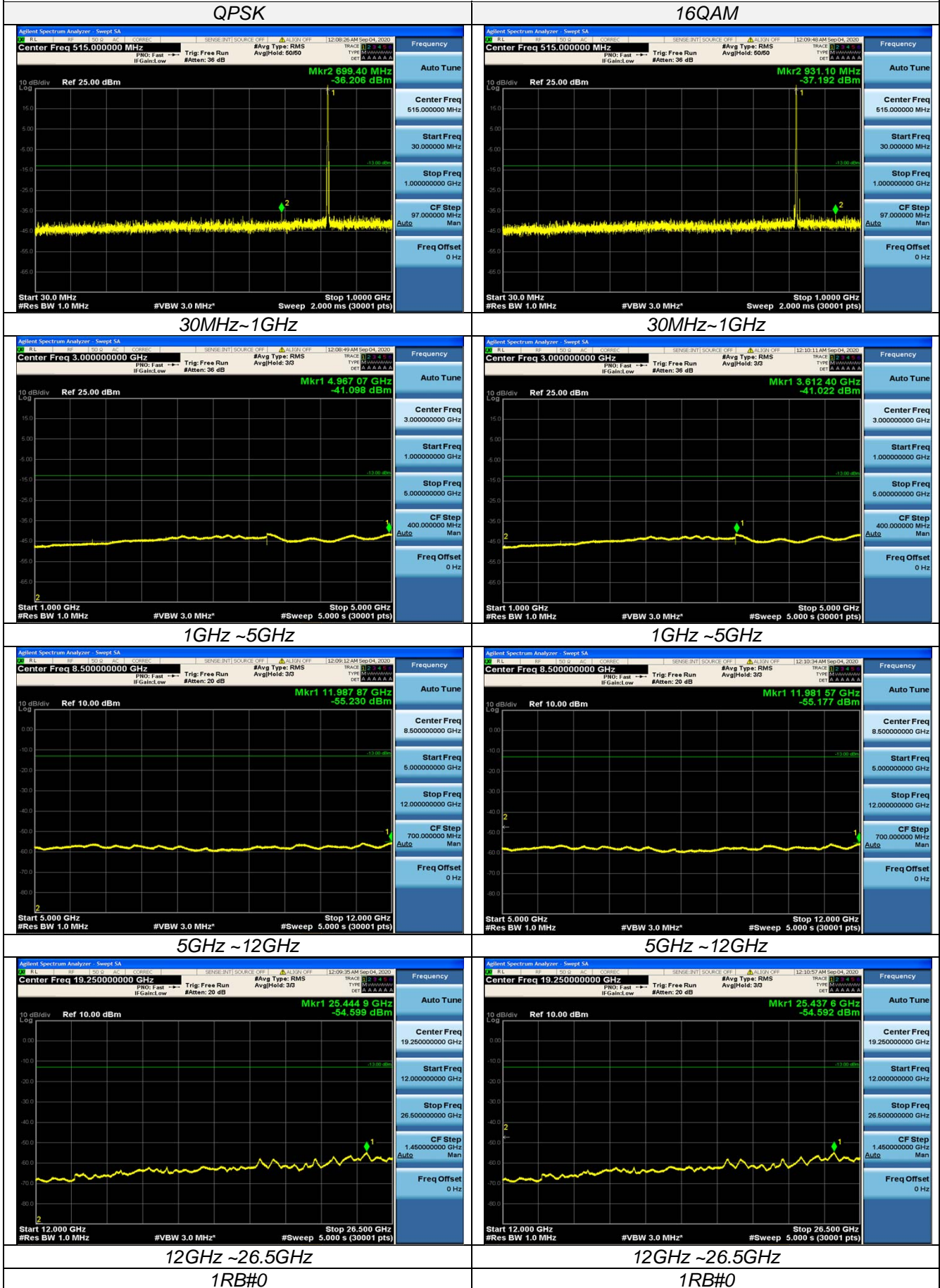

1RB#0

1RB#0



LTE FDD Band 5-1.4MHz Channel Bandwidth
Middle Channel

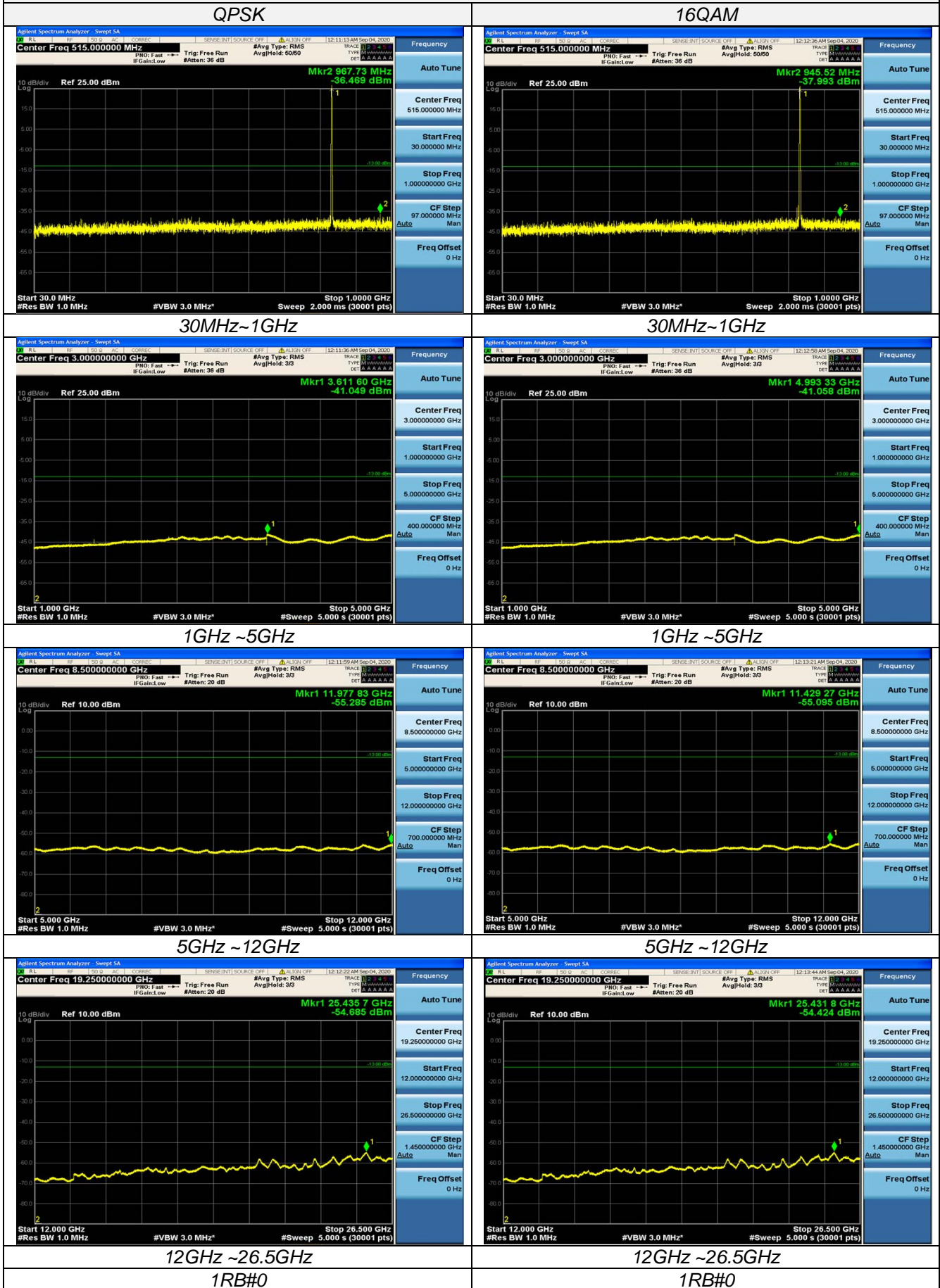



LTE FDD Band 5-1.4MHz Channel Bandwidth High Channel

QPSK

16QAM

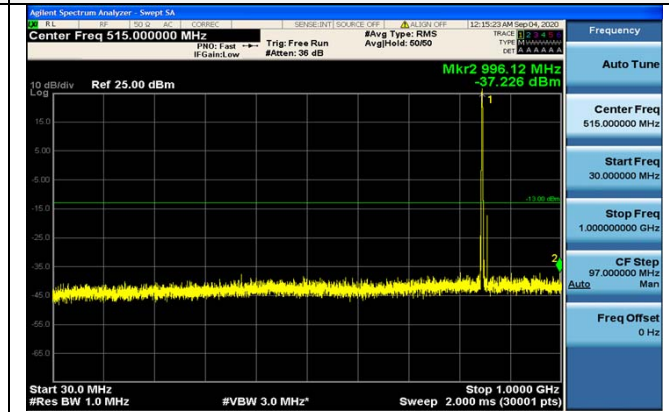
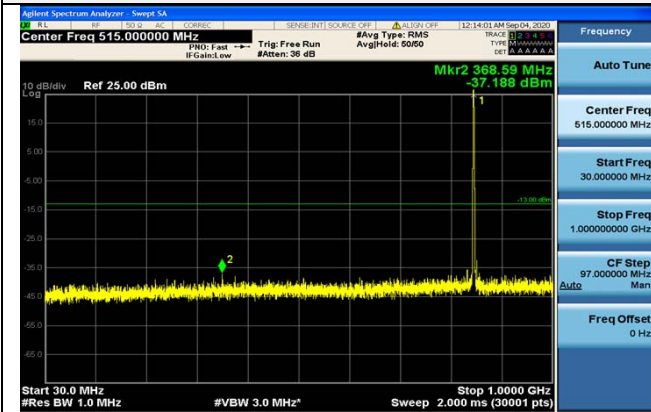

30MHz~1GHz

30MHz~1GHz

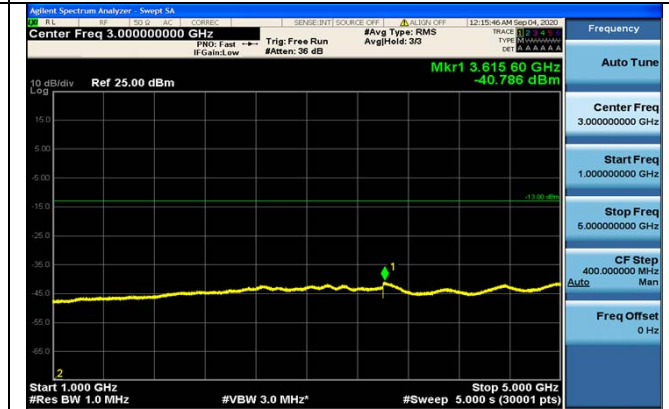

1GHz ~5GHz

1GHz ~5GHz



5GHz ~12GHz

5GHz ~12GHz



12GHz ~26.5GHz
1RB#0

12GHz ~26.5GHz
1RB#0



LTE FDD Band 5-3MHz Channel Bandwidth Low Channel

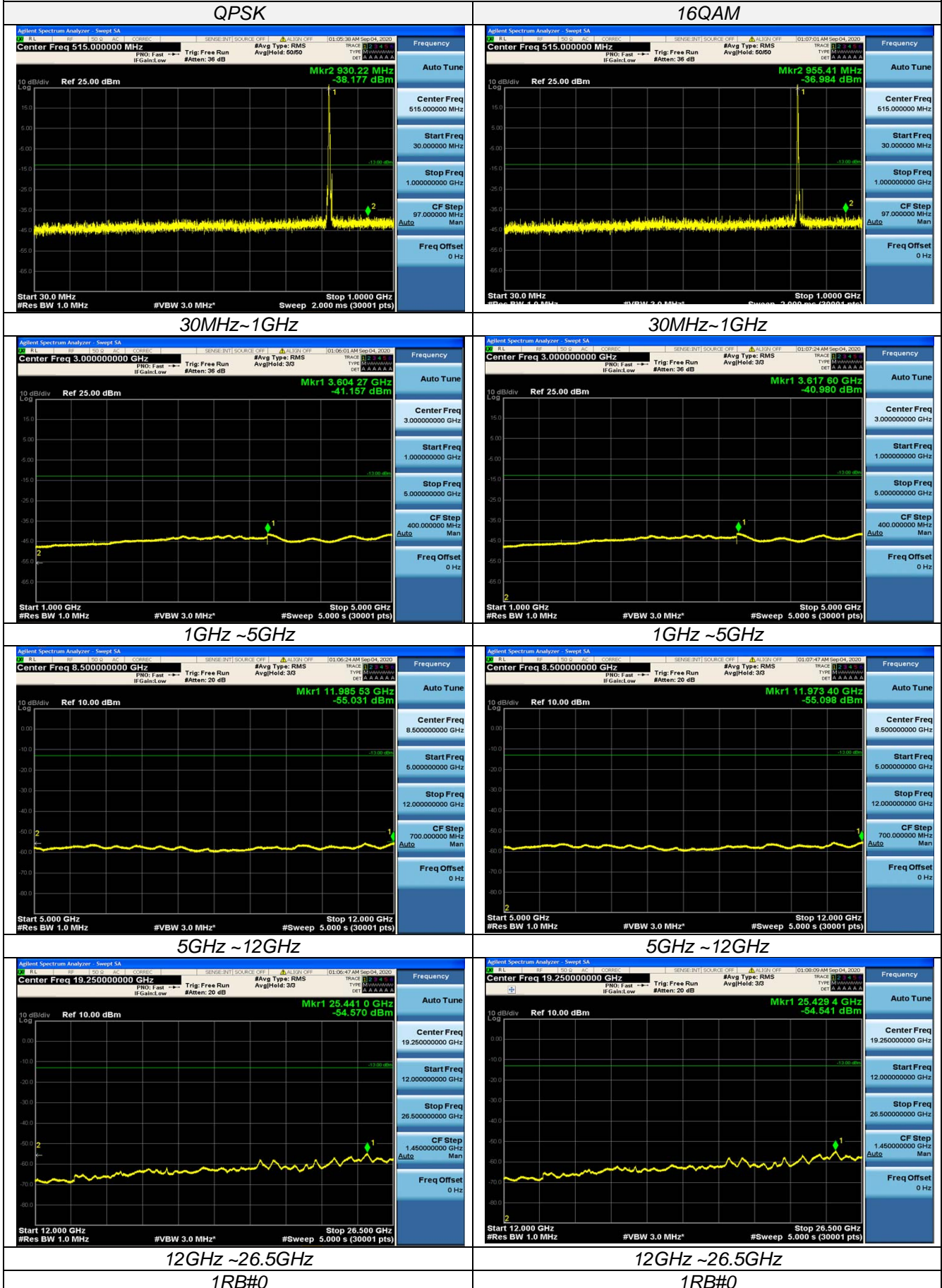



LTE FDD Band 5-3MHz Channel Bandwidth
Middle Channel

QPSK

16QAM

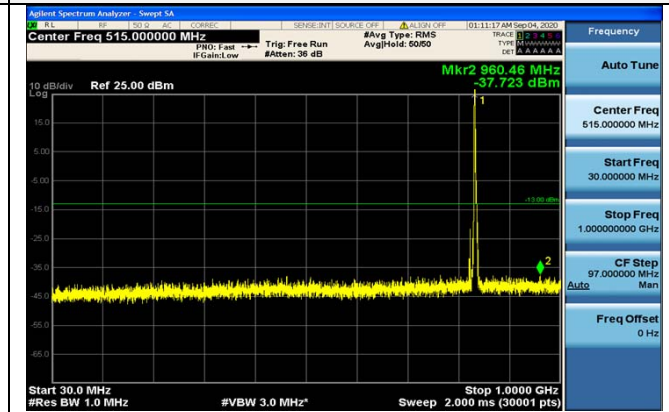
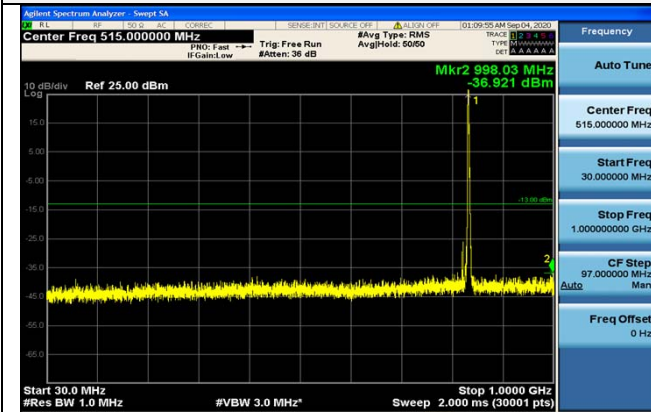

30MHz~1GHz

30MHz~1GHz



1GHz ~5GHz

1GHz ~5GHz

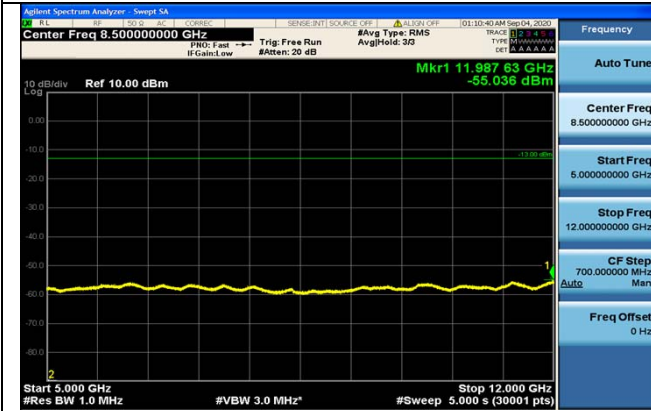

5GHz ~12GHz

5GHz ~12GHz



12GHz ~26.5GHz

12GHz ~26.5GHz

1RB#0

1RB#0