

FCC TEST REPORT

(PART 27)

Applicant:	HMD Global Oy
Address:	Bertel Jungin aukio 9, 02600 Espoo, Finland

Manufacturer or Supplier:	HMD Global Oy
Address:	Bertel Jungin aukio 9, 02600 Espoo, Finland
Product:	GSM/WCDMA/LTE Mobile Phone
Brand Name:	Nokia
Model Name:	TA-1316
FCC ID:	2AJOTTA-1316
Date of tests:	Jul. 07, 2020 ~ Jul. 20, 2020

The tests have been carried out according to the requirements of the following standard:

- FCC Part 27, Subpart C, M ANSI/TIA/EIA-603-D
 FCC Part 2 ANSI/TIA/EIA-603-E ANSI C63.26-2015

CONCLUSION: The submitted sample was found to COMPLY with the test requirement

Prepared by Alex Chen Engineer / Mobile Department	Approved by Luke Lu Manager / Mobile Department
	
Date: Jul. 30, 2020	Date: Jul. 30, 2020
<small>This report is governed by, and incorporates by reference, CPS Conditions of Service as posted at the date of issuance of this report at http://www.bureauveritas.com/home/about-us/our-business/cps/about-us/terms-conditions and is intended for your exclusive use. Any copying or replication of this report to or for any other person or entity, or use of our name or trademark, is permitted only with our prior written permission. This report sets forth our findings solely with respect to the test samples identified herein. The results set forth in this report are not indicative or representative of the quality or characteristics of the lot from which a test sample was taken or any similar or identical product unless specifically and expressly noted. Our report includes all of the tests requested by you and the results thereof based upon the information that you provided to us. Measurement uncertainty is only provided upon request for accredited tests. You have 60 days from date of issuance of this report to notify us of any material error or omission caused by our negligence or if you require measurement uncertainty; provided, however, that such notice shall be in writing and shall specifically address the issue you wish to raise. A failure to raise such issue within the prescribed time shall constitute your unqualified acceptance of the completeness of this report, the tests conducted and the correctness of the report contents.</small>	



TABLE OF CONTENTS

RELEASE CONTROL RECORD	3
1 SUMMARY OF TEST RESULTS	4
1.1 MEASUREMENT UNCERTAINTY	4
1.2 TEST SITE AND INSTRUMENTS	5
2 GENERAL INFORMATION	6
2.1 GENERAL DESCRIPTION OF EUT	6
2.2 CONFIGURATION OF SYSTEM UNDER TEST	8
2.3 DESCRIPTION OF SUPPORT UNITS	9
2.4 TEST ITEM AND TEST CONFIGURATION	9
2.5 GENERAL DESCRIPTION OF APPLIED STANDARDS	13
3 TEST TYPES AND RESULTS	14
3.1 OUTPUT POWER MEASUREMENT	14
3.1.1 LIMITS OF OUTPUT POWER MEASUREMENT	14
3.1.2 TEST PROCEDURES	14
3.1.3 TEST SETUP	15
3.1.4 TEST RESULTS	16
3.2 FREQUENCY STABILITY MEASUREMENT	24
3.2.1 LIMITS OF FREQUENCY STABILITY MEASUREMENT	24
3.2.2 TEST PROCEDURE	24
3.2.3 TEST SETUP	24
3.2.4 TEST RESULTS	25
3.3 OCCUPIED BANDWIDTH MEASUREMENT	33
3.3.1 LIMITS OF OCCUPIED BANDWIDTH MEASUREMENT	33
3.3.2 TEST SETUP	33
3.3.3 TEST PROCEDURES	33
3.3.4 TEST RESULTS	34
3.4 BAND EDGE MEASUREMENT	42
3.4.1 LIMITS OF BAND EDGE MEASUREMENT	42
3.4.2 TEST SETUP	42
3.4.3 TEST PROCEDURES	43
3.4.4 TEST RESULTS	44
3.5 CONDUCTED SPURIOUS EMISSIONS	60
3.5.1 LIMITS OF CONDUCTED SPURIOUS EMISSIONS MEASUREMENT	60
3.5.2 TEST PROCEDURE	60
3.5.3 TEST SETUP	60
3.5.4 TEST RESULTS	61
3.6 RADIATED EMISSION MEASUREMENT	69
3.6.1 LIMITS OF RADIATED EMISSION MEASUREMENT	69
3.6.2 TEST PROCEDURES	69
3.6.3 DEVIATION FROM TEST STANDARD	69
3.6.4 TEST SETUP	70
3.6.5 TEST RESULTS	71
4 INFORMATION ON THE TESTING LABORATORIES	97
5 APPENDIX A – MODIFICATIONS RECORDERS FOR ENGINEERING CHANGES TO THE EUT BY THE LAB	98

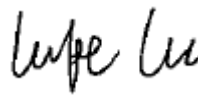

Test Report No.: RF200706W004-3

RELEASE CONTROL RECORD

ISSUE NO.	REASON FOR CHANGE	DATE ISSUED
RF200706W004-3	Original release	Jul. 30, 2020

1 SUMMARY OF TEST RESULTS

The EUT has been tested according to the following specifications:

APPLIED STANDARD: FCC Part 27 & Part 2		
STANDARD SECTION	TEST TYPE AND LIMIT	RESULT
2.1046 27.50(h)(2)	Equivalent Isotropically Radiated Power	Compliance
2.1055 27.54	Frequency Stability	Compliance
2.1049 27.53(m)(6)	Occupied Bandwidth	Compliance
2.1051 27.53(m)(4)(6)	Band Edge Measurements	Compliance
2.1051 27.53(m)(4)(6)	Conducted Spurious Emissions	Compliance
2.1053 27.53(m)(4)(6)	Radiated Spurious Emissions	Compliance

1.1 MEASUREMENT UNCERTAINTY

Where relevant, the following measurement uncertainty levels have been estimated for tests performed on the EUT as specified in CISPR 16-4-2:

MEASUREMENT	UNCERTAINTY
Frequency Stability	± 76.97Hz
Radiated emissions & Radiated Power (30MHz~1GMHz)	±4.98dB
Radiated emissions & Radiated Power (1GMHz ~6GMHz)	±4.70dB
Radiated emissions (6GMHz ~18GMHz)	±4.60dB
Radiated emissions (18GMHz ~40GMHz)	±4.12dB
Conducted emissions	±4.01dB
Occupied Channel Bandwidth	±43.58KHz
Conducted Output power	±2.06dB
Band Edge Measurements	±4.70dB

This uncertainty represents an expanded uncertainty expressed at approximately the 95% confidence level using a coverage factor of k=2.

1.2 TEST SITE AND INSTRUMENTS

Equipment	Manufacturer	Model No.	Serial No.	Last Cal.	Next Cal.
MXE EMI Receiver	KEYSIGHT	N9038A-544	MY54450026	Apr. 27,20	Apr. 26,21
EXA Signal Analyzer	KEYSIGHT	N9010A-526	MY54510322	Feb. 26,20	Feb. 25,21
Bilog Antenna	ETS-LINDGREN	3143B	00161965	Mar. 27,20	Mar. 26,21
Horn Antenna (1GHz-18GHz)	ETS-LINDGREN	3117	00168692	Mar. 27,20	Mar. 26,21
Horn Antenna (18GHz-40GHz)	N/A	QWH-SL-18-40 -K-SG/QMS-00 361	15433	Nov. 24, 19	Nov. 23, 20
Radio Communication Analyzer	ANRITSU	MT8820C	6201465426	Feb. 27,20	Feb. 26,21
Signal Pre-Amplifier	EMSI	EMC 9135	980249	Jun. 02,20	Jun. 01,21
Signal Pre-Amplifier	EMSI	EMC 012645B	980257	Jun. 02,20	Jun. 01,21
Signal Pre-Amplifier	EMSI	EMC 184045B	980259	Apr. 30,20	Apr. 29,21
3m Semi-anechoic Chamber	ETS-LINDGREN	9m*6m*6m	Euroshieldpn- CT0001143-1216	May. 19,20	May. 18,23
Test Software	E3	V 9.160323	N/A	N/A	N/A
Test Software	ADT	ADT_Radiated _V7.6.15.9.2	N/A	N/A	N/A
10dB Attenuator	JFW/USA	50HF-010-SM A	1505	Jun. 03,20	Jun. 02,21
Power Meter	Anritsu	ML2495A	1506002	Feb. 26,20	Feb. 25,21
Power Sensor	Anritsu	MA2411B	1339352	Feb. 26,20	Feb. 25,21
Humid & Temp Programmable Tester	Juyi	ITH-120-45-CP -AR	IAA1504-001	Jun. 02,20	Jun. 01,21
MXG Analog Microvave Signal Generator	KEYSIGHT	N5183A	MY50143024	Mar. 11,20	Mar. 10,21
Power Divider	MCLI/USA	PS2-15	24880	N/A	N/A

- NOTE:**
1. The calibration interval of the above test instruments is 12 months or 36 months and the calibrations are traceable to CEPREI/CHINA, GRGT/CHINA and NIM/CHINA.
 2. The test was performed in 3m Semi-anechoic Chamber and RF Oven Room.
 3. The horn antenna is used only for the measurement of emission frequency above 1GHz if tested.
 4. The FCC Site Registration No. is 525120; The Designation No. is CN1171.

2 GENERAL INFORMATION

2.1 GENERAL DESCRIPTION OF EUT

PRODUCT	GSM/WCDMA/LTE Mobile Phone	
BRAND NAME	Nokia	
MODEL NAME	TA-1316	
POWER SUPPLY	5.0Vdc (adapter or host equipment) 3.7Vdc (Li-ion, battery)	
MODULATION TECHNOLOGY	LTE	QPSK, 16QAM
FREQUENCY RANGE	LTE Band 7 Channel Bandwidth: 5MHz	2502.5MHz ~ 2567.5MHz
	LTE Band 7 Channel Bandwidth: 10MHz	2505MHz ~ 2565MHz
	LTE Band 7 Channel Bandwidth: 15MHz	2507.5MHz ~ 2562.5MHz
	LTE Band 7 Channel Bandwidth: 20MHz	2510MHz ~ 2560MHz
	LTE Band 38 Channel Bandwidth: 5MHz	2572.5MHz ~ 2617.5MHz
	LTE Band 38 Channel Bandwidth: 10MHz	2575MHz ~ 2615MHz
	LTE Band 38 Channel Bandwidth: 15MHz	2577.5MHz ~ 2612.5MHz
	LTE Band 38 Channel Bandwidth: 20MHz	2580MHz ~ 2610MHz
EMISSION DESIGNATOR	LTE Band 7 Channel Bandwidth: 5MHz	QPSK: 4M49G7D
		16QAM: 4M48W7D
	LTE Band 7 Channel Bandwidth: 10MHz	QPSK: 8M96G7D
		16QAM: 8M96W7D
	LTE Band 7 Channel Bandwidth: 15MHz	QPSK: 13M4G7D
		16QAM: 13M5W7D
	LTE Band 7 Channel Bandwidth: 20MHz	QPSK: 17M9G7D
		16QAM: 17M9W7D
	LTE Band 38 Channel Bandwidth: 5MHz	QPSK: 4M49G7D
		16QAM: 4M48W7D
	LTE Band 38 Channel Bandwidth: 10MHz	QPSK: 8M96G7D
		16QAM: 8M95W7D
	LTE Band 38 Channel Bandwidth: 15MHz	QPSK: 13M4G7D
		16QAM: 13M4W7D
	LTE Band 38 Channel Bandwidth: 20MHz	QPSK: 17M9G7D
		16QAM: 17M9W7D



MAX. EIRP POWER	LTE Band 7 Channel Bandwidth: 5MHz	73mW
	LTE Band 7 Channel Bandwidth: 10MHz	75mW
	LTE Band 7 Channel Bandwidth: 15MHz	76mW
	LTE Band 7 Channel Bandwidth: 20MHz	76mW
	LTE Band 38 Channel Bandwidth: 5MHz	93mW
	LTE Band 38 Channel Bandwidth: 10MHz	93mW
	LTE Band 38 Channel Bandwidth: 15MHz	92mW
	LTE Band 38 Channel Bandwidth: 20MHz	94mW
ANTENNA TYPE	Fixed Internal Antenna with -2.41dBi gain	
HW VERSION	0215	
SW VERSION	0.2026.11.10	
I/O PORTS	Refer to user's manual	
CABLE SUPPLIED	USB cable: non-shielded, detachable, 1meter Earphone: non-shielded, detachable, 1.5meter	

NOTE:

- For a more detailed features description, please refer to the manufacturer's specifications or the user's manual.
- For the test results, the EUT had been tested with all conditions. But only the worst case was shown in test report.

List of Accessory:

ACCESSORIES	BRAND	MODEL	MANUFACTURER	SPECIFICATION
Battery 1	Nokia	BL-4WL	TM	Power Rating:3.7 Vdc, 1150 mAh
AC Adapter 1	Nokia	AC-18U	DVE	I/P: 100 - 240 Vac, 100mA, O/P: 5Vdc, 550 mA
AC Adapter 2	Nokia	AC-18U	Aohai	I/P: 100 - 240 Vac, 100mA, O/P: 5Vdc, 550 mA
Earphone 1	Nokia	WH-108	RTF	1.5m non-shielded cable w/ core
USB Cable 1	Nokia	CA-190CD	RTF	1m non-shielded cable w/ core

2.2 CONFIGURATION OF SYSTEM UNDER TEST

FOR RADIATION EMISSION TEST

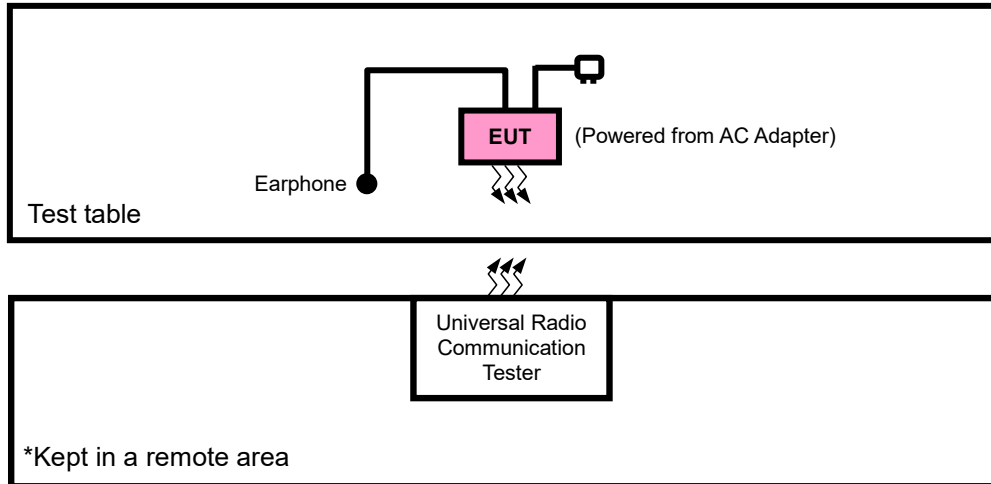

2.3 DESCRIPTION OF SUPPORT UNITS

The EUT has been tested as an independent unit together with other necessary accessories or support units. The following support units or accessories were used to form a representative test configuration during the tests.

NO.	PRODUCT	BRAND	MODEL NO.	SERIAL NO.	FCC ID
1	DC source	LONG WEI	PS-6403D	010934269	N/A

NO.	SIGNAL CABLE DESCRIPTION OF THE ABOVE SUPPORT UNITS
1	DC Line: Unshielded, Detachable 1.8m

2.4 TEST ITEM AND TEST CONFIGURATION

Pre-Scan has been conducted to determine the worst-case mode from all possible combinations between available modulations, data rates, XYZ axis and antenna ports. The worst case was found when positioned on Y-plane for EIRP and X-axis for radiated emission. Following channel(s) was (were) selected for the final test as listed below:

EUT CONFIGURE MODE	DESCRIPTION
A	EUT + Adapter + USB Cable with LTE link
B	EUT + Battery with LTE link

LTE BAND 7 MODE

EUT CONFIGURE MODE	TEST ITEM	AVAILABLE CHANNEL	TESTED CHANNEL	CHANNEL BANDWIDTH	MODULATION	MODE		
B	EIRP	20775 to 21425	20775, 21100, 21425	5MHz	QPSK, 16QAM	1 RB / 0 RB Offset		
		20800 to 21400	20800, 21100, 21400	10MHz	QPSK, 16QAM	1 RB / 0RB Offset		
		20825 to 21375	20825, 21100, 21375	15MHz	QPSK, 16QAM	1 RB / 0 RB Offset		
		20850 to 21350	20850, 21100, 21350	20MHz	QPSK, 16QAM	1 RB / 0 RB Offset		
B	FREQUENCY STABILITY	20775 to 21425	20775, 21425	5MHz	QPSK	1 RB / 0 RB Offset		
		20800 to 21400	20800, 21400	10MHz	QPSK	1 RB / 0RB Offset		
		20825 to 21375	20825, 21375	15MHz	QPSK	1 RB / 0 RB Offset		
		20850 to 21350	20850, 21350	20MHz	QPSK	1 RB / 0 RB Offset		
B	OCCUPIED BANDWIDTH	20775 to 21425	20775, 21100, 21425	5MHz	QPSK, 16QAM	25 RB / 0 RB Offset		
		20800 to 21400	20800, 21100, 21400	10MHz	QPSK, 16QAM	50 RB / 0 RB Offset		
		20825 to 21375	20825, 21100, 21375	15MHz	QPSK, 16QAM	75 RB / 0 RB Offset		
		20850 to 21350	20850, 21100, 21350	20MHz	QPSK, 16QAM	100 RB / 0 RB Offset		
B	BAND EDGE	20775 to 21425	20775	5MHz	QPSK, 16QAM	1 RB / 0 RB Offset		
			21425	5MHz	QPSK, 16QAM	25 RB / 0 RB Offset		
		20800 to 21400	20800	10MHz	QPSK, 16QAM	1 RB / 24 RB Offset		
			21400	10MHz	QPSK, 16QAM	25 RB / 0 RB Offset		
		20825 to 21375	20825	15MHz	QPSK, 16QAM	1 RB / 0 RB Offset		
			21375	15MHz	QPSK, 16QAM	50 RB / 0 RB Offset		
		20850 to 21350	20825	15MHz	QPSK, 16QAM	1 RB / 74 RB Offset		
			21375	15MHz	QPSK, 16QAM	75 RB / 0 RB Offset		
		20850 to 21350	20850	20MHz	QPSK, 16QAM	1 RB / 0 RB Offset		
			21350	20MHz	QPSK, 16QAM	100 RB / 0 RB Offset		
		B	CONDCUDET ED EMISSION	20775 to 21425	20775, 21100, 21425	5MHz	QPSK	1 RB / 0 RB Offset
				20800 to 21400	20800, 21100, 21400	10MHz	QPSK	1 RB / 0RB Offset
20825 to 21375	20825, 21100, 21375			15MHz	QPSK	1 RB / 0 RB Offset		
20850 to 21350	20850, 21100, 21350			20MHz	QPSK	1 RB / 0 RB Offset		
A	RADIATED EMISSION	20775 to 21425	21100	5MHz	QPSK	1 RB / 0 RB Offset		
		20800 to 21400	21100	10MHz	QPSK	1 RB / 0 RB Offset		
		20825 to 21375	21100	15MHz	QPSK	1 RB / 0 RB Offset		
		20850 to 21350	20850, 21100, 21350	20MHz	QPSK	1 RB / 0 RB Offset		

Note: This device was tested under all bandwidths, RB configurations and modulations. The worst case was found in QPSK modulation.

LTE BAND 38 MODE

EUT CONFIGURE MODE	TEST ITEM	AVAILABLE CHANNEL	TESTED CHANNEL	CHANNEL BANDWIDTH	MODULATION	MODE
B	EIRP	3775 to 38225	3775, 38000, 38225	5MHz	QPSK, 16QAM	1 RB / 0 RB Offset
		37800 to 38200	37800, 38000, 38200	10MHz	QPSK, 16QAM	1 RB / 0RB Offset
		37825 to 38175	37825, 38000, 38175	15MHz	QPSK, 16QAM	1 RB / 0 RB Offset
		37850 to38150	37850, 38000, 38150	20MHz	QPSK, 16QAM	1 RB / 0 RB Offset
B	FREQUENCY STABILITY	3775 to 38225	3775, 38225	5MHz	QPSK	1 RB / 0 RB Offset
		37800 to 38200	37800, 38200	10MHz	QPSK	1 RB / 0RB Offset
		37825 to 38175	37825, 38175	15MHz	QPSK	1 RB / 0 RB Offset
		37850 to38150	37850, 38150	20MHz	QPSK	1 RB / 0 RB Offset
B	OCCUPIED BANDWIDTH	3775 to 38225	3775, 38000, 38225	5MHz	QPSK, 16QAM	25 RB / 0 RB Offset
		37800 to 38200	37800, 38000, 38200	10MHz	QPSK, 16QAM	50 RB / 0 RB Offset
		37825 to 38175	37825, 38000, 38175	15MHz	QPSK, 16QAM	75 RB / 0 RB Offset
		37850 to38150	37850, 38000, 38150	20MHz	QPSK, 16QAM	100 RB / 0 RB Offset
B	BAND EDGE	3775 to 38225	3775	5MHz	QPSK, 16QAM	1 RB / 0 RB Offset
			38825	5MHz	QPSK, 16QAM	25 RB / 0 RB Offset
		37800 to 38200	37800	10MHz	QPSK, 16QAM	1 RB / 24 RB Offset
			38200	10MHz	QPSK, 16QAM	25 RB / 0 RB Offset
		37825 to 38175	37825	15MHz	QPSK, 16QAM	1 RB / 0 RB Offset
			38175	15MHz	QPSK, 16QAM	50 RB / 0 RB Offset
		37850 to38150	37825	15MHz	QPSK, 16QAM	1 RB / 49 RB Offset
			38175	15MHz	QPSK, 16QAM	50 RB / 0 RB Offset
		37850 to38150	37825	15MHz	QPSK, 16QAM	1 RB / 0 RB Offset
			38175	15MHz	QPSK, 16QAM	75 RB / 0 RB Offset
		37850 to38150	37850	20MHz	QPSK, 16QAM	1 RB / 0 RB Offset
			38150	20MHz	QPSK, 16QAM	100 RB / 0 RB Offset
B	CONDCUDET ED EMISSION	3775 to 38225	3775, 38000, 38225	5MHz	QPSK	1 RB / 0 RB Offset
		37800 to 38200	37800, 38000, 38200	10MHz	QPSK	1 RB / 0RB Offset
		37825 to 38175	37825, 38000, 38175	15MHz	QPSK	1 RB / 0 RB Offset
		37850 to38150	37850, 38000, 38150	20MHz	QPSK	1 RB / 0 RB Offset
A	RADIATED EMISSION	3775 to 38225	38000	5MHz	QPSK	1 RB / 0 RB Offset
		37800 to 38200	37800, 38000, 38200	10MHz	QPSK	1 RB / 0RB Offset
		37825 to 38175	38000	15MHz	QPSK	1 RB / 0 RB Offset
		37850 to38150	38000	20MHz	QPSK	1 RB / 0 RB Offset

Note: This device was tested under all bandwidths, RB configurations and modulations. The worst case was found in QPSK modulation.



Test Report No.: RF200706W004-3

TEST CONDITION:

TEST ITEM	ENVIRONMENTAL CONDITIONS	INPUT POWER	TESTED BY
EIRP	23deg. C, 70%RH	DC 5V By Adapter	Star Le
FREQUENCY STABILITY	23deg. C, 70%RH	DC 3.6V/3.7V/4.2V	Kevin Zhang
OCCUPIED BANDWIDTH	23deg. C, 70%RH	DC 3.7V By Battery	Kevin Zhang
BAND EDGE	23deg. C, 70%RH	DC 3.7V By Battery	Kevin Zhang
CONDCUDETED EMISSION	23deg. C, 70%RH	DC 3.7V By Battery	Kevin Zhang
RADIATED EMISSION	23deg. C, 70%RH	DC 5V By Adapter	Star Le



Test Report No.: RF200706W004-3

2.5 GENERAL DESCRIPTION OF APPLIED STANDARDS

The EUT is a RF product. According to the specifications of the manufacturer, it must comply with the requirements of the following standards:

FCC 47 CFR Part 2

FCC 47 CFR Part 27

KDB 971168 D01 Power Meas License Digital Systems v03r01

ANSI/TIA/EIA-603-D

ANSI/TIA/EIA-603-E

ANSI C63.26-2015

NOTE: All test items have been performed and recorded as per the above standards.

3 TEST TYPES AND RESULTS

3.1 OUTPUT POWER MEASUREMENT

3.1.1 LIMITS OF OUTPUT POWER MEASUREMENT

The radiated peak output power shall be according to the specific rule Part 27.50(h)(2) that “User stations are limited to 2 watts” and 27.50(i) specific that “Peak transmit power must be measure over any interval of continuous transmission using instrumentation calibration in terms of rms-equivalent voltage.”

3.1.2 TEST PROCEDURES

EIRP MEASUREMENT:

Per KDB 971168 D01 Power Meas License Digital Systems v03r01 or subclause 5.2.5.5 of ANSI C63.26-2015, the relevant equation for determining the ERP or EIRP from the conducted RF output power measured using the guidance provided above is:

$$\text{ERP or EIRP} = P_{\text{Meas}} + G_{\text{T}} - L_{\text{C}}$$

Where:

ERP or EIRP = effective radiated power or equivalent isotropically radiated power, respectively

(expressed in the same units as P_{Meas} , typically dBW or dBm);

P_{Meas} = measured transmitter output power or PSD, in dBm or dBW;

G_{T} = gain of the transmitting antenna, in dBd (ERP) or dBi (EIRP);

L_{C} = signal attenuation in the connecting cable between the transmitter and antenna, in dB.

CONDUCTED POWER MEASUREMENT:

- a. The EUT was set up for the maximum power with LTE link data modulation and link up with simulator.
- b. Set the EUT to transmit under low, middle and high channel and record the power level shown on simulator.

3.1.3 TEST SETUP

CONDUCTED POWER MEASUREMENT:

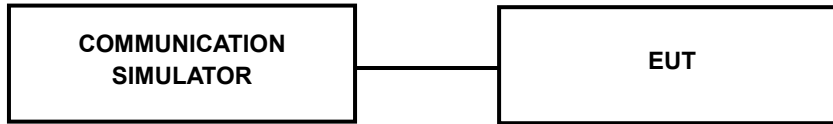

For the actual test configuration, please refer to the attached file (Test Setup Photo).

3.1.4 TEST RESULTS

AVERAGE CONDUCTED OUTPUT POWER (dBm)

LTE band 7

Band/BW	Modulation	RB Size	RB Offset	Low CH 20775	Mid CH 21100	High CH 21425	MPR
				Frequency 2502.5 MHz	Frequency 2535 MHz	Frequency 2567.5 MHz	
7/ 5	QPSK	1	0	20.89	21.10	20.98	0
		1	12	20.97	21.14	21.06	0
		1	24	20.76	20.96	20.89	0
		12	0	19.93	20.15	20.01	1
		12	6	19.95	20.25	20.07	1
		12	13	19.86	20.08	19.98	1
		25	0	19.92	20.19	20.02	1
	16QAM	1	0	20.29	20.54	20.43	1
		1	12	20.21	20.50	20.33	1
		1	24	20.12	20.29	20.21	1
		12	0	19.60	19.85	19.69	2
		12	6	19.53	19.80	19.62	2
		12	13	19.49	19.74	19.63	2
		25	0	19.60	19.82	19.70	2

Band/BW	Modulation	RB Size	RB Offset	Low CH 20800	Mid CH 21100	High CH 21400	MPR
				Frequency 2505 MHz	Frequency 2535 MHz	Frequency 2565 MHz	
7/ 10	QPSK	1	0	20.86	21.13	20.98	0
		1	24	20.97	21.14	21.07	0
		1	49	20.73	21.00	20.85	0
		25	0	19.94	20.14	20.04	1
		25	12	20.01	20.19	20.07	1
		25	25	19.84	20.05	19.97	1
		50	0	19.97	20.19	19.99	1
	16QAM	1	0	20.29	20.51	20.39	1
		1	24	20.26	20.46	20.36	1
		1	49	20.12	20.30	20.18	1
		25	0	19.62	19.83	19.75	2
		25	12	19.57	19.74	19.67	2
		25	25	19.48	19.75	19.60	2
		50	0	19.64	19.81	19.74	2

Band/BW	Modulation	RB Size	RB Offset	Low CH 20825	Mid CH 21100	High CH 21375	MPR
				Frequency 2507.5 MHz	Frequency 2535 MHz	Frequency 2562.5 MHz	
7/ 15	QPSK	1	0	20.93	21.13	20.95	0
		1	37	20.95	21.19	21.02	0
		1	74	20.79	21.03	20.86	0
		36	0	19.91	20.15	20.05	1
		36	19	20.02	20.24	20.07	1
		36	39	19.82	20.06	19.97	1
		75	0	19.97	20.17	20.04	1
	16QAM	1	0	20.33	20.58	20.39	1
		1	37	20.25	20.47	20.36	1
		1	74	20.08	20.35	20.20	1
		36	0	19.66	19.83	19.76	2
		36	19	19.51	19.78	19.63	2
		36	39	19.53	19.73	19.63	2
		75	0	19.65	19.84	19.67	2

Band/BW	Modulation	RB Size	RB Offset	Low CH 20850	Mid CH 21100	High CH 21350	MPR
				Frequency 2510 MHz	Frequency 2535 MHz	Frequency 2560 MHz	
7/ 20	QPSK	1	0	20.94	21.17	21.03	0
		1	50	20.99	21.22	21.08	0
		1	99	20.81	21.04	20.90	0
		50	0	19.97	20.20	20.06	1
		50	25	20.03	20.26	20.12	1
		50	50	19.90	20.13	19.99	1
		100	0	19.98	20.21	20.07	1
	16QAM	1	0	20.36	20.59	20.45	1
		1	50	20.29	20.52	20.38	1
		1	99	20.14	20.37	20.23	1
		50	0	19.68	19.91	19.77	2
		50	25	19.59	19.82	19.68	2
		50	50	19.56	19.79	19.65	2
		100	0	19.66	19.89	19.75	2

LTE band 38

Band/BW	Modulation	RB Size	RB Offset	Low CH 3775	Mid CH 38000	High CH 38225	MPR
				Frequency 2572.5 MHz	Frequency 2595 MHz	Frequency 2617.5MHz	
38/ 5	QPSK	1	0	21.78	21.92	22.10	0
		1	12	21.77	21.87	22.09	0
		1	24	21.71	21.84	22.07	0
		12	0	20.85	21.00	21.16	1
		12	6	20.77	21.00	21.12	1
		12	13	20.78	20.93	21.13	1
		25	0	20.80	21.00	21.13	1
	16QAM	1	0	21.24	21.42	21.61	1
		1	12	21.26	21.48	21.61	1
		1	24	21.23	21.33	21.55	1
		12	0	19.96	20.14	20.28	2
		12	6	20.03	20.23	20.35	2
		12	13	19.92	20.10	20.29	2
		25	0	19.95	20.10	20.28	2

Band/BW	Modulation	RB Size	RB Offset	Low CH 37800	Mid CH 38000	High CH 38200	MPR
				Frequency 2575 MHz	Frequency 2595 MHz	Frequency 2615 MHz	
38/ 10	QPSK	1	0	21.75	21.95	22.10	0
		1	24	21.77	21.87	22.10	0
		1	49	21.68	21.88	22.03	0
		25	0	20.86	20.99	21.19	1
		25	12	20.83	20.94	21.12	1
		25	25	20.76	20.90	21.12	1
		50	0	20.85	21.00	21.10	1
	16QAM	1	0	21.24	21.39	21.57	1
		1	24	21.31	21.44	21.64	1
		1	49	21.23	21.34	21.52	1
		25	0	19.98	20.12	20.34	2
		25	12	20.07	20.17	20.40	2
		25	25	19.91	20.11	20.26	2
		50	0	19.99	20.09	20.32	2

Band/BW	Modulation	RB Size	RB Offset	Low CH 37825	Mid CH 38000	High CH 38175	MPR
				Frequency 2577.5 MHz	Frequency 2595 MHz	Frequency 2612.5MHz	
38/ 15	QPSK	1	0	21.82	21.95	22.07	0
		1	37	21.75	21.92	22.05	0
		1	74	21.74	21.91	22.04	0
		36	0	20.83	21.00	21.20	1
		36	19	20.84	20.99	21.12	1
		36	39	20.74	20.91	21.12	1
		75	0	20.85	20.98	21.15	1
	16QAM	1	0	21.28	21.46	21.57	1
		1	37	21.30	21.45	21.64	1
		1	74	21.19	21.39	21.54	1
		36	0	20.02	20.12	20.35	2
		36	19	20.01	20.21	20.36	2
		36	39	19.96	20.09	20.29	2
		75	0	20.00	20.12	20.25	2

Band/BW	Modulation	RB Size	RB Offset	Low CH 37850	Mid CH 38000	High CH 38150	MPR
				Frequency 2580 MHz	Frequency 2595 MHz	Frequency 2610 MHz	
38/ 20	QPSK	1	0	21.83	21.99	22.15	0
		1	50	21.79	21.95	22.11	0
		1	99	21.76	21.92	22.08	0
		50	0	20.89	21.05	21.21	1
		50	25	20.85	21.01	21.17	1
		50	50	20.82	20.98	21.14	1
		100	0	20.86	21.02	21.18	1
	16QAM	1	0	21.31	21.47	21.63	1
		1	50	21.34	21.50	21.66	1
		1	99	21.25	21.41	21.57	1
		50	0	20.04	20.20	20.36	2
		50	25	20.09	20.25	20.41	2
		50	50	19.99	20.15	20.31	2
		100	0	20.01	20.17	20.33	2

EIRP

LTE BAND 7

CHANNEL BANDWIDTH: 5MHz QPSK

Channel	Frequency (MHz)	Conducted Power (dBm)	G _T -L _C (dB)	EIRP (dBm)	EIRP (mW)	Limit (W)
20775	2502.5	20.97	-2.41	18.56	71.78	1
21100	2535.0	21.04	-2.41	18.63	72.95	1
21425	2567.5	21.06	-2.41	18.65	73.28	1

CHANNEL BANDWIDTH: 5MHz 16QAM

Channel	Frequency (MHz)	Conducted Power (dBm)	G _T -L _C (dB)	EIRP (dBm)	EIRP (mW)	Limit (W)
20775	2502.5	20.29	-2.41	17.88	61.38	1
21100	2535.0	20.54	-2.41	18.13	65.01	1
21425	2567.5	20.43	-2.41	18.02	63.39	1

CHANNEL BANDWIDTH: 10MHz QPSK

Channel	Frequency (MHz)	Conducted Power (dBm)	G _T -L _C (dB)	EIRP (dBm)	EIRP (mW)	Limit (W)
20800	2505.0	20.97	-2.41	18.56	71.78	1
21100	2535.0	21.14	-2.41	18.73	74.64	1
21400	2565.0	21.07	-2.41	18.66	73.45	1

CHANNEL BANDWIDTH: 10MHz 16QAM

Channel	Frequency (MHz)	Conducted Power (dBm)	G _T -L _C (dB)	EIRP (dBm)	EIRP (mW)	Limit (W)
20800	2505.0	20.29	-2.41	17.88	61.38	1
21100	2535.0	20.51	-2.41	18.10	64.57	1
21400	2565.0	20.39	-2.41	17.98	62.81	1

CHANNEL BANDWIDTH: 15MHz QPSK

Channel	Frequency (MHz)	Conducted Power (dBm)	G _{T-LC} (dB)	EIRP (dBm)	EIRP (mW)	Limit (W)
20825	2507.5	20.95	-2.41	18.54	71.45	1
21100	2535.0	21.19	-2.41	18.78	75.51	1
21375	2562.5	21.02	-2.41	18.61	72.61	1

CHANNEL BANDWIDTH: 15MHz 16QAM

Channel	Frequency (MHz)	Conducted Power (dBm)	G _{T-LC} (dB)	EIRP (dBm)	EIRP (mW)	Limit (W)
20825	2507.5	20.33	-2.41	17.92	61.94	1
21100	2535.0	20.58	-2.41	18.17	65.61	1
21375	2562.5	20.39	-2.41	17.98	62.81	1

CHANNEL BANDWIDTH: 20MHz QPSK

Channel	Frequency (MHz)	Conducted Power (dBm)	G _{T-LC} (dB)	EIRP (dBm)	EIRP (mW)	Limit (W)
20850	2510.0	20.99	-2.41	18.58	72.11	1
21100	2535.0	21.22	-2.41	18.81	76.03	1
21350	2560.0	21.08	-2.41	18.67	73.62	1

CHANNEL BANDWIDTH: 20MHz 16QAM

Channel	Frequency (MHz)	Conducted Power (dBm)	G _{T-LC} (dB)	EIRP (dBm)	EIRP (mW)	Limit (W)
20850	2510.0	20.36	-2.41	17.95	62.37	1
21100	2535.0	20.59	-2.41	18.18	65.77	1
21350	2560.0	20.45	-2.41	18.04	63.68	1

REMARKS: ERP Output Power (dBm) = EIRP (dBm) -2.15(dB).



BUREAU
VERITAS

Test Report No.: RF200706W004-3

LTE BAND 38

CHANNEL BANDWIDTH: 5MHz QPSK

Channel	Frequency (MHz)	Conducted Power (dBm)	G _T -L _C (dB)	EIRP (dBm)	EIRP (mW)	Limit (W)
37775	2572.5	21.78	-2.41	19.37	86.50	2
38000	2595.0	21.92	-2.41	19.51	89.33	2
38225	2617.5	22.10	-2.41	19.69	93.11	2

CHANNEL BANDWIDTH: 5MHz 16QAM

Channel	Frequency (MHz)	Conducted Power (dBm)	G _T -L _C (dB)	EIRP (dBm)	EIRP (mW)	Limit (W)
37775	2572.5	21.26	-2.41	18.85	76.74	2
38000	2595.0	21.48	-2.41	19.07	80.72	2
38225	2617.5	21.61	-2.41	19.20	83.18	2

CHANNEL BANDWIDTH: 10MHz QPSK

Channel	Frequency (MHz)	Conducted Power (dBm)	G _T -L _C (dB)	EIRP (dBm)	EIRP (mW)	Limit (W)
37800	2575.0	21.77	-2.41	19.36	86.30	2
38000	2595.0	21.95	-2.41	19.54	89.95	2
38200	2615.0	22.10	-2.41	19.69	93.11	2

CHANNEL BANDWIDTH: 10MHz 16QAM

Channel	Frequency (MHz)	Conducted Power (dBm)	G _T -L _C (dB)	EIRP (dBm)	EIRP (mW)	Limit (W)
37800	2575.0	21.31	-2.41	18.90	77.62	2
38000	2595.0	21.44	-2.41	19.03	79.98	2
38200	2615.0	21.64	-2.41	19.23	83.75	2

CHANNEL BANDWIDTH: 15MHz QPSK

Channel	Frequency (MHz)	Conducted Power (dBm)	G _T -L _C (dB)	EIRP (dBm)	EIRP (mW)	Limit (W)
37825	2577.5	21.82	-2.41	19.41	87.30	2
38000	2595.0	21.95	-2.41	19.54	89.95	2
38175	2612.5	22.07	-2.41	19.66	92.47	2

CHANNEL BANDWIDTH: 15MHz 16QAM

Channel	Frequency (MHz)	Conducted Power (dBm)	G _T -L _C (dB)	EIRP (dBm)	EIRP (mW)	Limit (W)
37825	2577.5	21.30	-2.41	18.89	77.45	2
38000	2595.0	21.46	-2.41	19.05	80.35	2
38175	2612.5	21.64	-2.41	19.23	83.75	2

CHANNEL BANDWIDTH: 20MHz QPSK

Channel	Frequency (MHz)	Conducted Power (dBm)	G _T -L _C (dB)	EIRP (dBm)	EIRP (mW)	Limit (W)
37850	2580.0	21.83	-2.41	19.42	87.50	2
38000	2595.0	21.99	-2.41	19.58	90.78	2
38150	2610.0	22.15	-2.41	19.74	94.19	2

CHANNEL BANDWIDTH: 20MHz 16QAM

Channel	Frequency (MHz)	Conducted Power (dBm)	G _T -L _C (dB)	EIRP (dBm)	EIRP (mW)	Limit (W)
37850	2580.0	21.34	-2.41	18.93	78.16	2
38000	2595.0	21.50	-2.41	19.09	81.10	2
38150	2610.0	21.66	-2.41	19.25	84.14	2

REMARKS: ERP Output Power (dBm) = EIRP (dBm) -2.15(dB).

3.2 FREQUENCY STABILITY MEASUREMENT

3.2.1 LIMITS OF FREQUENCY STABILITY MEASUREMENT

The frequency stability shall be sufficient to ensure that the fundamental emissions stay within the authorized bands of operation.

3.2.2 TEST PROCEDURE

- a. Device is placed at the oven room. The oven room could control the temperatures and humidity. Power warm up is at least 15 min and power applied should perform before recording frequency error.
- b. EUT is connected the external power supply to control the DC input power. The test voltage range is from minimum to maximum working voltage. Each step shall be record the frequency error rate.
- c. The temperature range step is 10 degrees in this test items. All temperature levels shall be hold the $\pm 0.5^{\circ}\text{C}$ during the measurement testing. The each temperature step shall be at least 0.5 hours, consider the EUT could be test under the stability condition.

NOTE: The frequency error was recorded frequency error from the communication simulator.

3.2.3 TEST SETUP

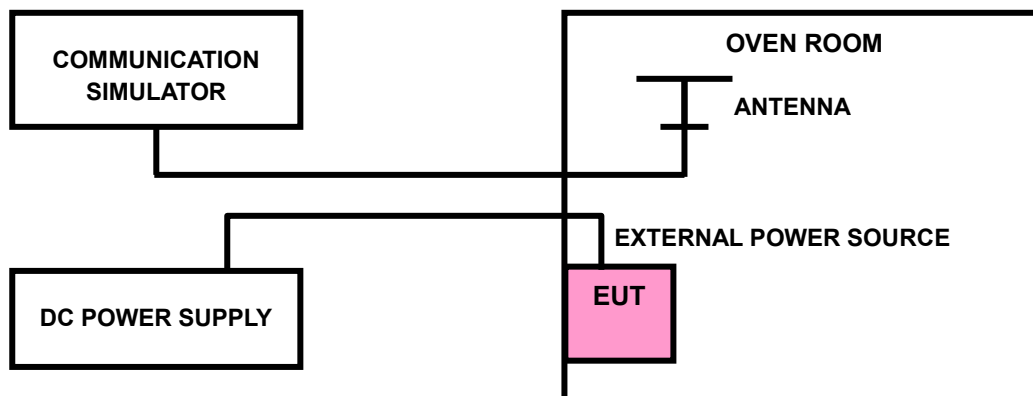

3.2.4 TEST RESULTS

LTE BAND 7

FREQUENCY ERROR VS. VOLTAGE

VOLTAGE (Volts)	5MHz		LIMIT (ppm)
	FREQUENCY ERROR (ppm)		
	Low Channel	High Channel	
V _{nor}	0.0021	0.0025	2.5
V _{min}	-0.0023	-0.0030	2.5
V _{max}	0.0021	0.0021	2.5

NOTE: The applicant defined the normal working voltage of the battery is from V_{min} Vdc to V_{max} Vdc.

FREQUENCY ERROR vs. TEMPERATURE.

TEMP. (°C)	5MHz		LIMIT (ppm)
	FREQUENCY ERROR (ppm)		
	Low Channel	High Channel	
-30	-0.0120	-0.0118	2.5
-20	-0.0100	-0.0105	2.5
-10	-0.0084	-0.0081	2.5
0	-0.0075	-0.0073	2.5
10	-0.0052	-0.0049	2.5
20	-0.0039	-0.0039	2.5
30	-0.0035	-0.0035	2.5
40	-0.0020	-0.0017	2.5
50	-0.0002	-0.0003	2.5

FREQUENCY ERROR VS. VOLTAGE

VOLTAGE (Volts)	10MHz		LIMIT (ppm)
	FREQUENCY ERROR (ppm)		
	Low Channel	High Channel	
V _{nor}	0.0026	0.0024	2.5
V _{min}	-0.0031	-0.0030	2.5
V _{max}	0.0025	0.0026	2.5

NOTE: The applicant defined the normal working voltage of the battery is from V_{min} Vdc to V_{max} Vdc.

FREQUENCY ERROR vs. TEMPERATURE.

TEMP. (°C)	10MHz		LIMIT (ppm)
	FREQUENCY ERROR (ppm)		
	Low Channel	High Channel	
-30	-0.0117	-0.0111	2.5
-20	-0.0103	-0.0101	2.5
-10	-0.0086	-0.0081	2.5
0	-0.0075	-0.0074	2.5
10	-0.0052	-0.0047	2.5
20	-0.0042	-0.0038	2.5
30	-0.0034	-0.0038	2.5
40	-0.0019	-0.0021	2.5
50	-0.0004	-0.0004	2.5

FREQUENCY ERROR VS. VOLTAGE

VOLTAGE (Volts)	15MHz		LIMIT (ppm)
	FREQUENCY ERROR (ppm)		
	Low Channel	High Channel	
V _{nor}	0.0026	0.0024	2.5
V _{min}	-0.0031	-0.0031	2.5
V _{max}	0.0025	0.0025	2.5

NOTE: The applicant defined the normal working voltage of the battery is from V_{min} Vdc to V_{max} Vdc.

FREQUENCY ERROR vs. TEMPERATURE.

TEMP. (°C)	15MHz		LIMIT (ppm)
	FREQUENCY ERROR (ppm)		
	Low Channel	High Channel	
-30	-0.0122	-0.0114	2.5
-20	-0.0100	-0.0108	2.5
-10	-0.0084	-0.0083	2.5
0	-0.0075	-0.0074	2.5
10	-0.0046	-0.0052	2.5
20	-0.0042	-0.0038	2.5
30	-0.0035	-0.0029	2.5
40	-0.0017	-0.0019	2.5
50	-0.0003	-0.0002	2.5

FREQUENCY ERROR VS. VOLTAGE

VOLTAGE (Volts)	20MHz		LIMIT (ppm)
	FREQUENCY ERROR (ppm)		
	Low Channel	High Channel	
V _{nor}	0.0026	0.0024	2.5
V _{min}	-0.0031	-0.0030	2.5
V _{max}	0.0024	0.0024	2.5

NOTE: The applicant defined the normal working voltage of the battery is from V_{min} Vdc to V_{max} Vdc.

FREQUENCY ERROR vs. TEMPERATURE.

TEMP. (°C)	20MHz		LIMIT (ppm)
	FREQUENCY ERROR (ppm)		
	Low Channel	High Channel	
-30	-0.0123	-0.0115	2.5
-20	-0.0109	-0.0104	2.5
-10	-0.0082	-0.0080	2.5
0	-0.0075	-0.0076	2.5
10	-0.0045	-0.0046	2.5
20	-0.0044	-0.0044	2.5
30	-0.0031	-0.0026	2.5
40	-0.0021	-0.0020	2.5
50	-0.0002	-0.0002	2.5

LTE BAND 38

FREQUENCY ERROR VS. VOLTAGE

VOLTAGE (Volts)	5MHz		LIMIT (ppm)
	FREQUENCY ERROR (ppm)		
	Low Channel	High Channel	
V _{nor}	0.0009	0.0011	2.5
V _{min}	-0.0008	-0.0012	2.5
V _{max}	0.0009	0.0009	2.5

NOTE: The applicant defined the normal working voltage of the battery is from V_{min} Vdc to V_{max} Vdc.

FREQUENCY ERROR vs. TEMPERATURE.

TEMP. (°C)	5MHz		LIMIT (ppm)
	FREQUENCY ERROR (ppm)		
	Low Channel	High Channel	
-30	-0.0058	-0.0049	2.5
-20	-0.0050	-0.0043	2.5
-10	-0.0044	-0.0037	2.5
0	-0.0037	-0.0031	2.5
10	-0.0031	-0.0026	2.5
20	-0.0023	-0.0019	2.5
30	-0.0015	-0.0012	2.5
40	-0.0010	-0.0009	2.5
50	-0.0002	-0.0002	2.5

FREQUENCY ERROR VS. VOLTAGE

VOLTAGE (Volts)	10MHz		LIMIT (ppm)
	FREQUENCY ERROR (ppm)		
	Low Channel	High Channel	
V _{nor}	0.0009	0.0013	2.5
V _{min}	-0.0011	-0.0012	2.5
V _{max}	0.0009	0.0009	2.5

NOTE: The applicant defined the normal working voltage of the battery is from V_{min} Vdc to V_{max} Vdc.

FREQUENCY ERROR vs. TEMPERATURE.

TEMP. (°C)	10MHz		LIMIT (ppm)
	FREQUENCY ERROR (ppm)		
	Low Channel	High Channel	
-30	-0.0057	-0.0049	2.5
-20	-0.0050	-0.0042	2.5
-10	-0.0043	-0.0037	2.5
0	-0.0033	-0.0028	2.5
10	-0.0027	-0.0023	2.5
20	-0.0021	-0.0018	2.5
30	-0.0014	-0.0012	2.5
40	-0.0008	-0.0007	2.5
50	-0.0002	-0.0002	2.5

FREQUENCY ERROR VS. VOLTAGE

VOLTAGE (Volts)	15MHz		LIMIT (ppm)
	FREQUENCY ERROR (ppm)		
	Low Channel	High Channel	
V _{nor}	0.0010	0.0010	2.5
V _{min}	-0.0013	-0.0013	2.5
V _{max}	0.0009	0.0011	2.5

NOTE: The applicant defined the normal working voltage of the battery is from V_{min} Vdc to V_{max} Vdc.

FREQUENCY ERROR vs. TEMPERATURE.

TEMP. (°C)	15MHz		LIMIT (ppm)
	FREQUENCY ERROR (ppm)		
	Low Channel	High Channel	
-30	-0.0056	-0.0048	2.5
-20	-0.0048	-0.0041	2.5
-10	-0.0042	-0.0036	2.5
0	-0.0032	-0.0028	2.5
10	-0.0026	-0.0022	2.5
20	-0.0019	-0.0016	2.5
30	-0.0013	-0.0011	2.5
40	-0.0009	-0.0008	2.5
50	-0.0002	-0.0002	2.5

FREQUENCY ERROR VS. VOLTAGE

VOLTAGE (Volts)	20MHz		LIMIT (ppm)
	FREQUENCY ERROR (ppm)		
	Low Channel	High Channel	
V _{nor}	0.0011	0.0013	2.5
V _{min}	-0.0012	-0.0012	2.5
V _{max}	0.0010	0.0012	2.5

NOTE: The applicant defined the normal working voltage of the battery is from V_{min} Vdc to V_{max} Vdc.

FREQUENCY ERROR vs. TEMPERATURE.

TEMP. (°C)	20MHz		LIMIT (ppm)
	FREQUENCY ERROR (ppm)		
	Low Channel	High Channel	
-30	-0.0052	-0.0044	2.5
-20	-0.0043	-0.0037	2.5
-10	-0.0040	-0.0034	2.5
0	-0.0033	-0.0028	2.5
10	-0.0025	-0.0022	2.5
20	-0.0019	-0.0017	2.5
30	-0.0011	-0.0009	2.5
40	-0.0005	-0.0005	2.5
50	-0.0002	-0.0002	2.5

3.3 OCCUPIED BANDWIDTH MEASUREMENT

3.3.1 LIMITS OF OCCUPIED BANDWIDTH MEASUREMENT

The width of a frequency band such that, below the lower and above the upper frequency limits, the mean powers emitted are each equal to a specified percentage 0.5 % of the total mean power of a given emission.

3.3.2 TEST SETUP

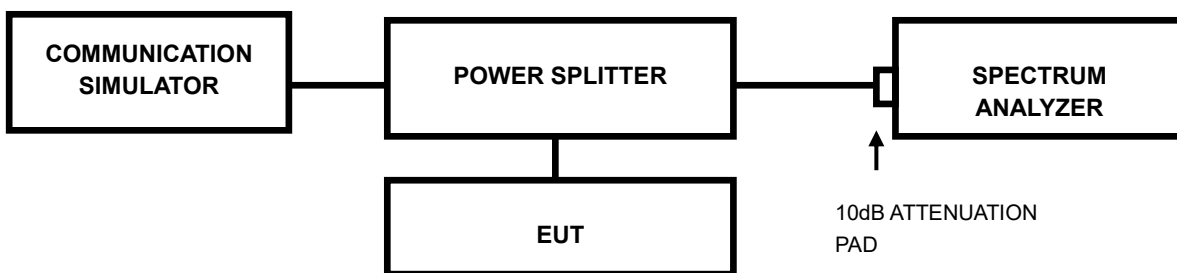

3.3.3 TEST PROCEDURES

- The conducted occupied bandwidth used the power splitter via EUT RF power connector between simulation base station and spectrum analyzer.
- Use OBW measurement function of Spectrum analyzer to measure 99 % occupied bandwidth.

3.3.4 TEST RESULTS

LTE BAND 7					
CHANNEL BANDWIDTH: 5MHz					
CHANNEL	FREQUENCY (MHz)	99% OCCUPIED BANDWIDTH (MHz)		26dB BANDWIDTH (MHz)	
		QPSK	16QAM	QPSK	16QAM
20775	2502.5	4.49	4.48	4.92	4.93
21100	2535	4.47	4.47	4.87	4.91
21425	2567.5	4.49	4.47	4.92	4.85

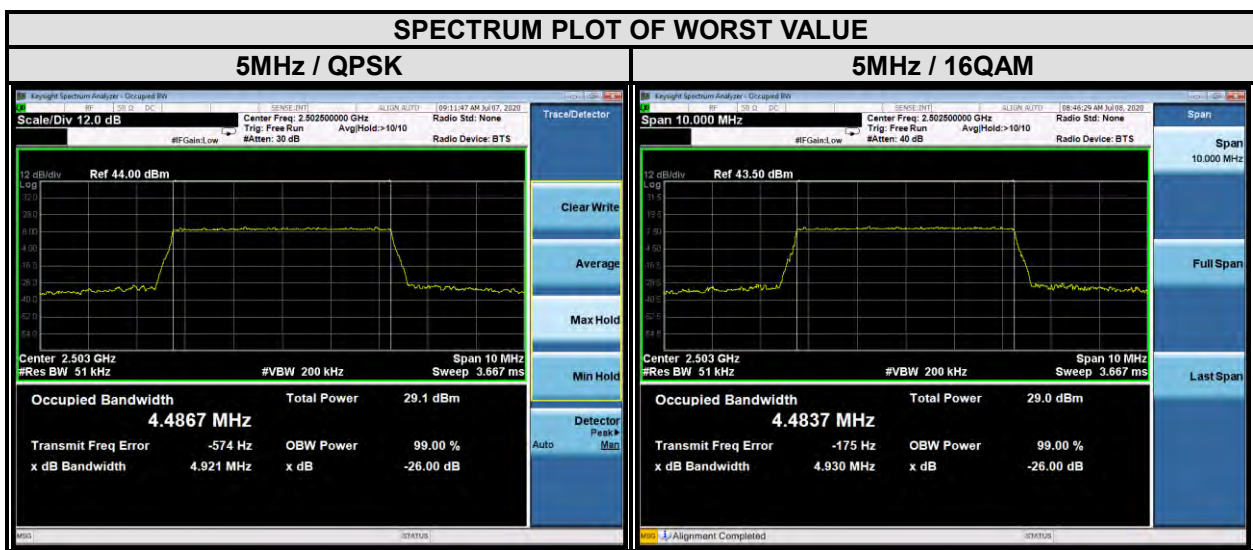

LTE BAND 7					
CHANNEL BANDWIDTH: 10MHz					
CHANNEL	FREQUENCY (MHz)	99% OCCUPIED BANDWIDTH (MHz)		26dB BANDWIDTH (MHz)	
		QPSK	16QAM	QPSK	16QAM
20800	2505	8.96	8.96	9.77	9.77
21100	2535	8.95	8.96	9.73	9.74
21400	2565	8.95	8.94	9.72	9.74

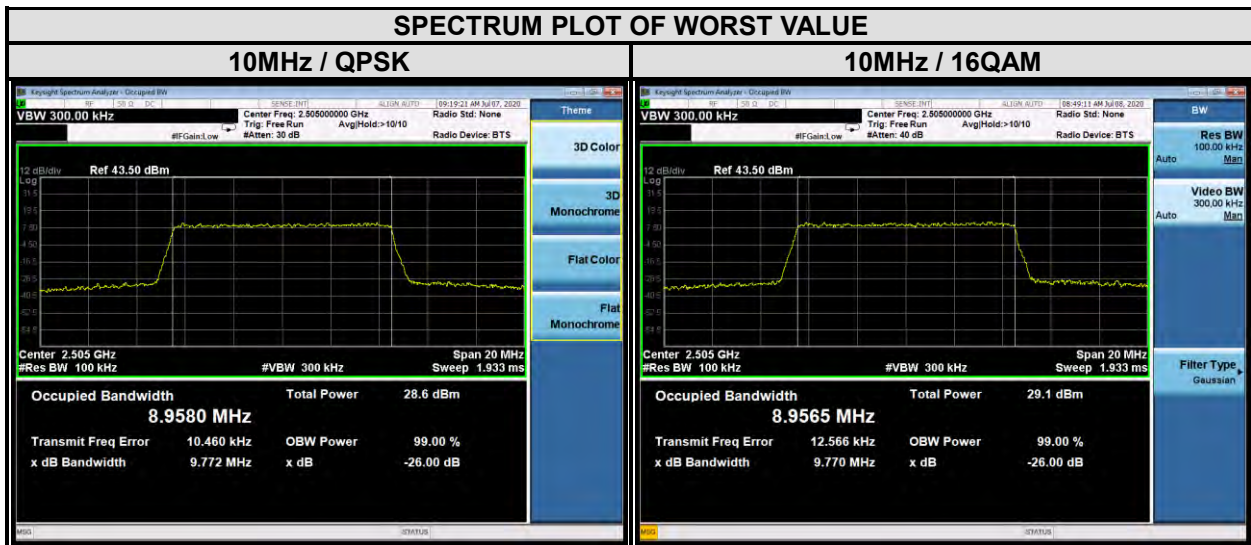

LTE BAND 7					
CHANNEL BANDWIDTH: 15MHz					
CHANNEL	FREQUENCY (MHz)	99% OCCUPIED BANDWIDTH (MHz)		26dB BANDWIDTH (MHz)	
		QPSK	16QAM	QPSK	16QAM
20825	2507.5	13.41	13.43	14.74	14.66
21100	2535	13.40	13.44	14.67	14.83
21375	2562.5	13.42	13.45	14.63	14.63

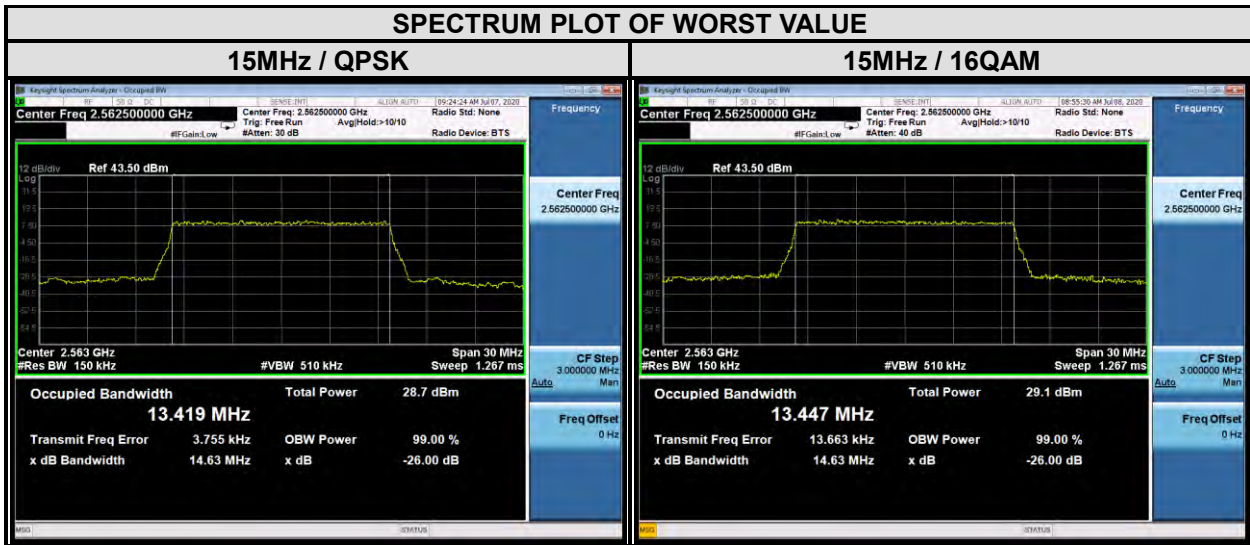

LTE BAND 7					
CHANNEL BANDWIDTH: 20MHz					
CHANNEL	FREQUENCY (MHz)	99% OCCUPIED BANDWIDTH (MHz)		26dB BANDWIDTH (MHz)	
		QPSK	16QAM	QPSK	16QAM
20850	2510	17.87	17.92	19.25	19.50
21100	2535	17.89	17.92	19.35	19.57
21350	2560	17.92	17.92	19.40	19.40

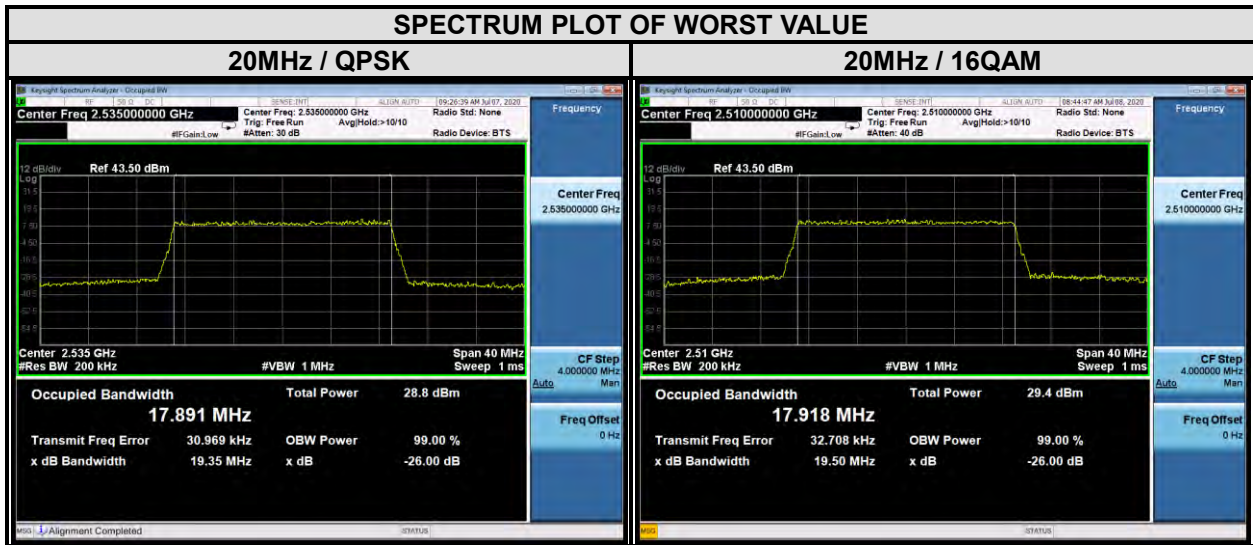

LTE BAND 38					
CHANNEL BANDWIDTH:5MHz					
CHANNEL	FREQUENCY (MHz)	99% OCCUPIED BANDWIDTH (MHz)		26dB BANDWIDTH (MHz)	
		QPSK	16QAM	QPSK	16QAM
37775	2572.5	4.49	4.47	4.88	4.91
38000	2595	4.46	4.48	4.86	4.88
38225	2617.5	4.47	4.46	4.94	4.91

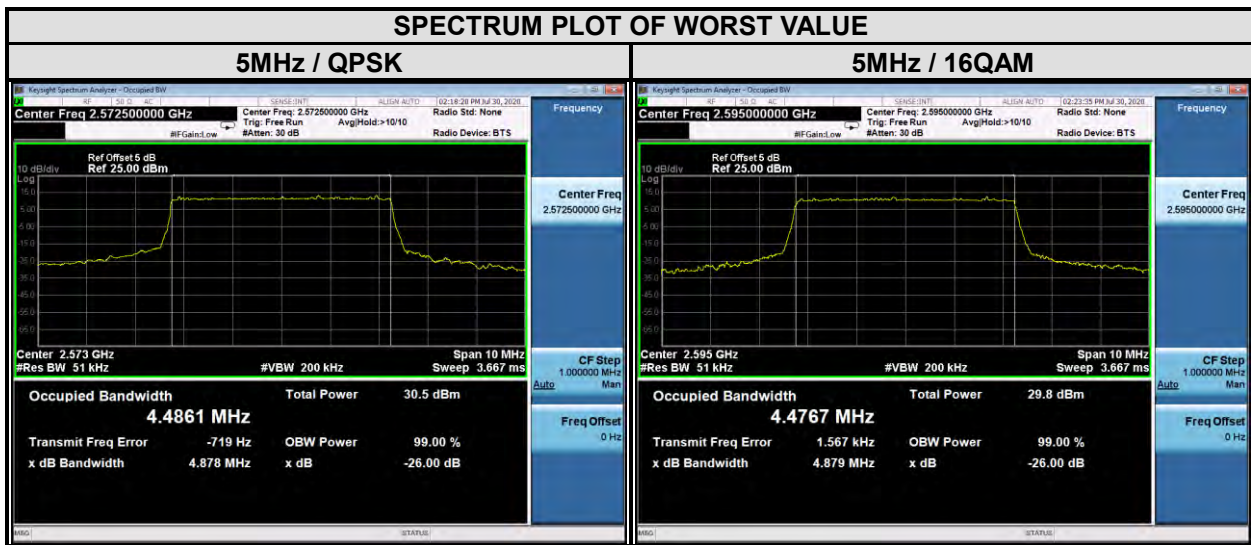

LTE BAND 38					
CHANNEL BANDWIDTH: 10MHz					
CHANNEL	FREQUENCY (MHz)	99% OCCUPIED BANDWIDTH (MHz)		26dB BANDWIDTH (MHz)	
		QPSK	16QAM	QPSK	16QAM
37800	2575	8.95	8.94	9.81	9.74
38000	2595	8.96	8.95	9.91	9.76
38200	2615	8.96	8.94	9.93	9.68

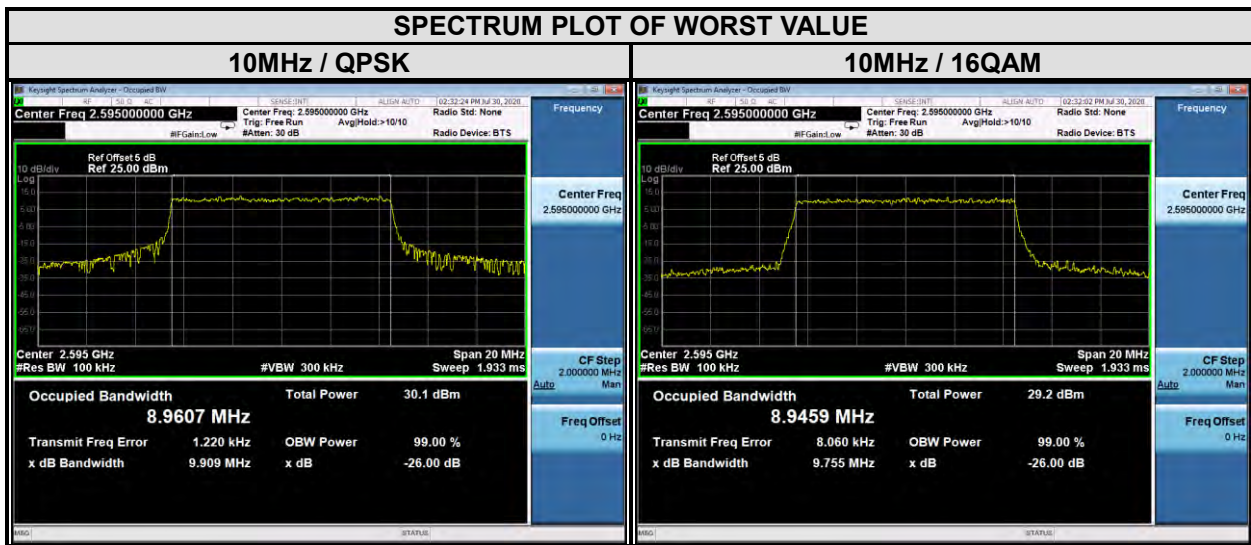

LTE BAND 38					
CHANNEL BANDWIDTH: 15MHz					
CHANNEL	FREQUENCY (MHz)	99% OCCUPIED BANDWIDTH (MHz)		26dB BANDWIDTH (MHz)	
		QPSK	16QAM	QPSK	16QAM
37825	2577.5	13.41	13.43	14.60	14.69
38000	2595	13.43	13.43	14.58	14.39
38175	2612.5	13.43	13.43	14.60	14.67

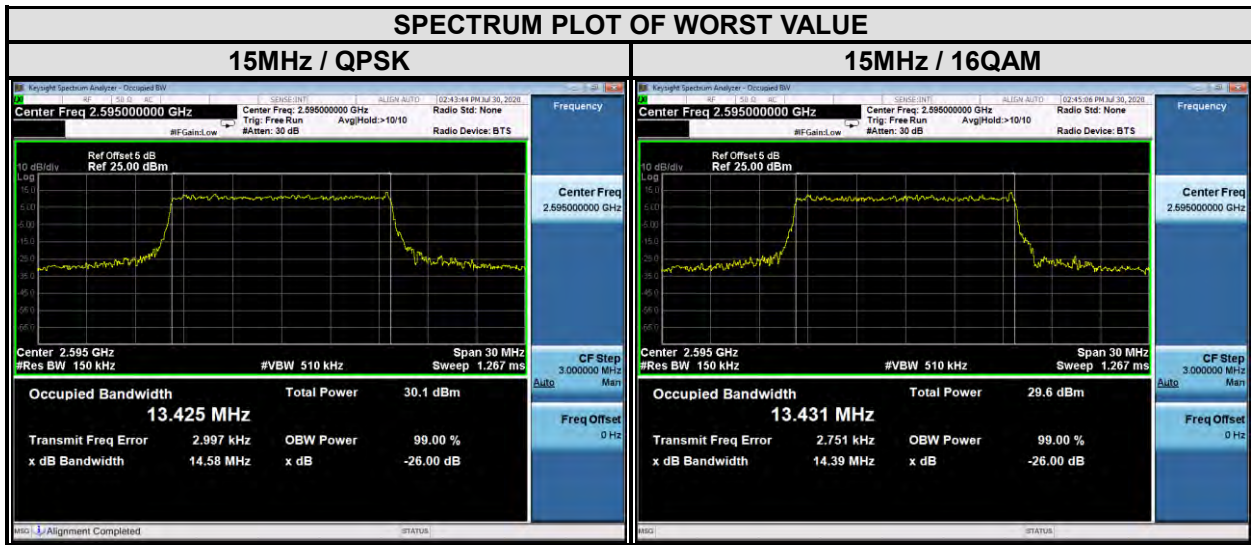

LTE BAND 38					
CHANNEL BANDWIDTH: 20MHz					
CHANNEL	FREQUENCY (MHz)	99% OCCUPIED BANDWIDTH (MHz)		26dB BANDWIDTH (MHz)	
		QPSK	16QAM	QPSK	16QAM
37850	2580	17.89	17.89	19.32	19.56
38000	2595	17.89	17.87	19.25	19.47
38150	2610	17.93	17.89	19.35	19.40

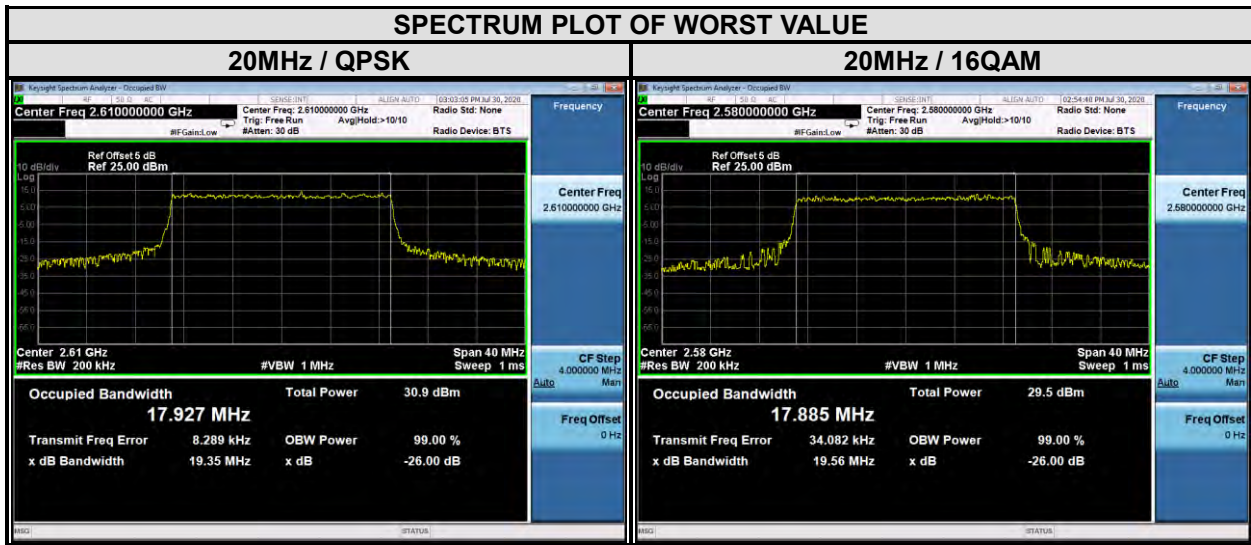

3.4 BAND EDGE MEASUREMENT

2.4.1 LIMITS OF BAND EDGE MEASUREMENT

According to FCC 27.53(m)(4) specified that For mobile digital stations, the attenuation factor shall be not less than $40 + 10 \log (P)$ dB on all frequencies between the channel edge and 5 megahertz from the channel edge, $43 + 10 \log (P)$ dB on all frequencies between 5 megahertz and X megahertz from the channel edge, and $55 + 10 \log (P)$ dB on all frequencies more than X megahertz from the channel edge, where X is the greater of 6 megahertz or the actual emission bandwidth as defined in paragraph (m)(6) of this section. In addition, the attenuation factor shall not be less that $43 + 10 \log (P)$ dB on all frequencies between 2490.5 MHz and 2496 MHz and $55 + 10 \log (P)$ dB at or below 2490.5 MHz. Mobile Satellite Service licensees operating on frequencies below 2495 MHz may also submit a documented interference complaint against BRS licensees operating on channel BRS Channel 1 on the same terms and conditions as adjacent channel BRS or EBS licensees. For mobile digital stations, in the 1 megahertz bands immediately outside and adjacent to the frequency block a resolution bandwidth of at least two percent may be employed.

2.4.2 TEST SETUP

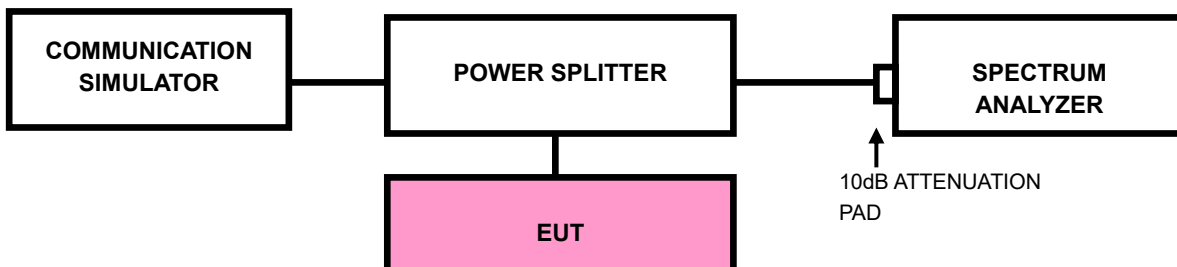

2.4.3 TEST PROCEDURES

- a. The EUT was set up for the maximum peak power with LTE link data modulation. The power was measured with R&S Spectrum Analyzer. All measurements were done at 2 channels (low and high operational frequency range.).
- b. The band edge measurement used the power splitter via EUT RF power connector between simulation base station and spectrum analyzer.
- c. The center frequency of spectrum is the band edge frequency and span is 35MHz. RBW of the spectrum is 100kHz and VBW of the spectrum is 300kHz (Channel bandwidth 5MHz).
- d. The center frequency of spectrum is the band edge frequency and span is 50MHz. RBW of the spectrum is 200kHz and VBW of the spectrum is 1MHz (Channel bandwidth 10MHz).
- e. The center frequency of spectrum is the band edge frequency and span is 60MHz. RBW of the spectrum is 300kHz and VBW of the spectrum is 1MHz (Channel bandwidth 15MHz).
- f. The center frequency of spectrum is the band edge frequency and span is 80MHz. RBW of the spectrum is 500kHz and VBW of the spectrum is 2MHz (Channel bandwidth 20MHz).
- g. Record the max trace plot into the test report.

2.4.4 TEST RESULTS

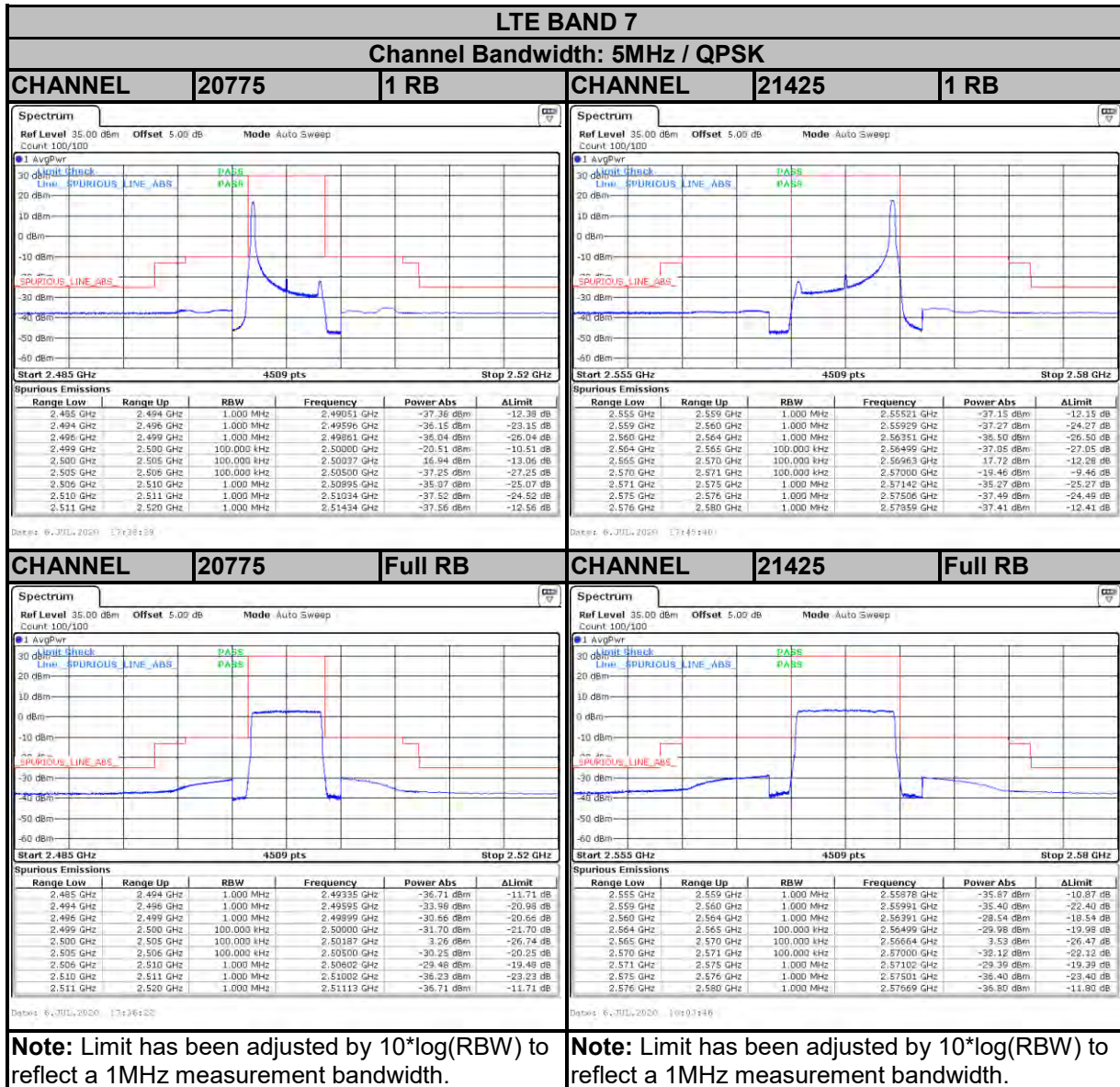

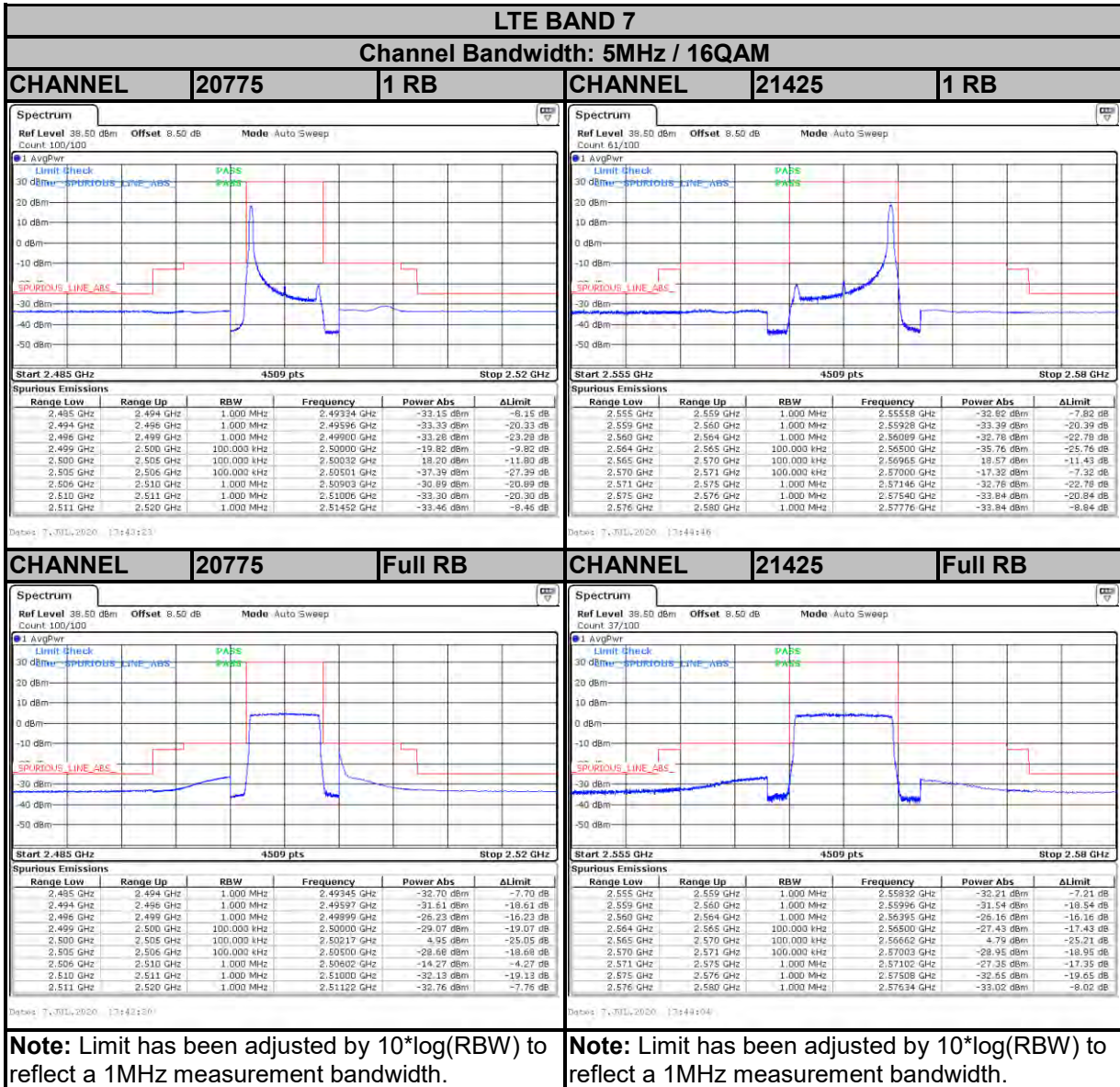



LTE BAND 7
Channel Bandwidth: 10MHz / QPSK

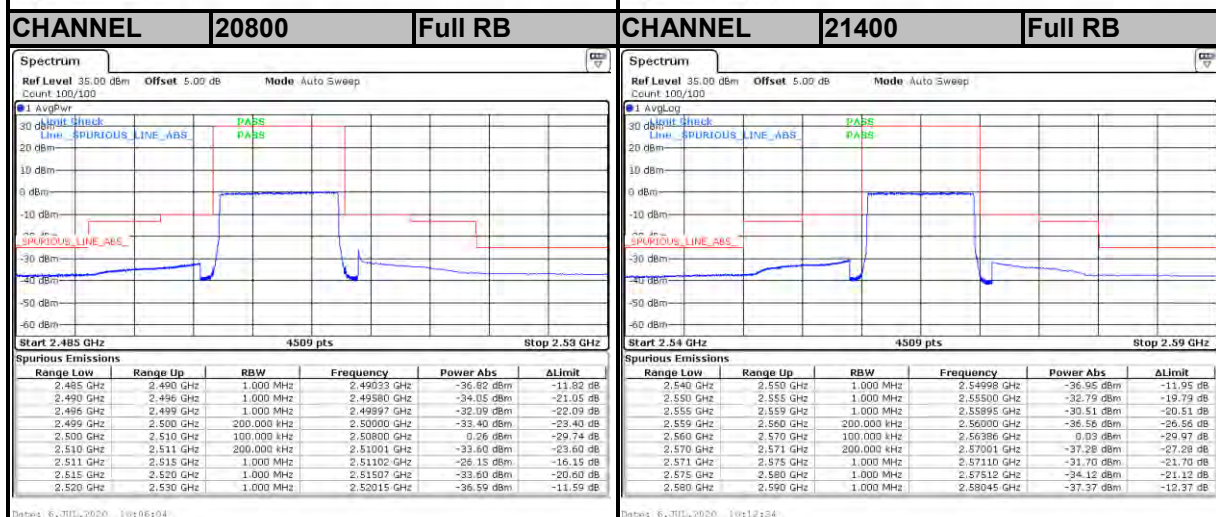
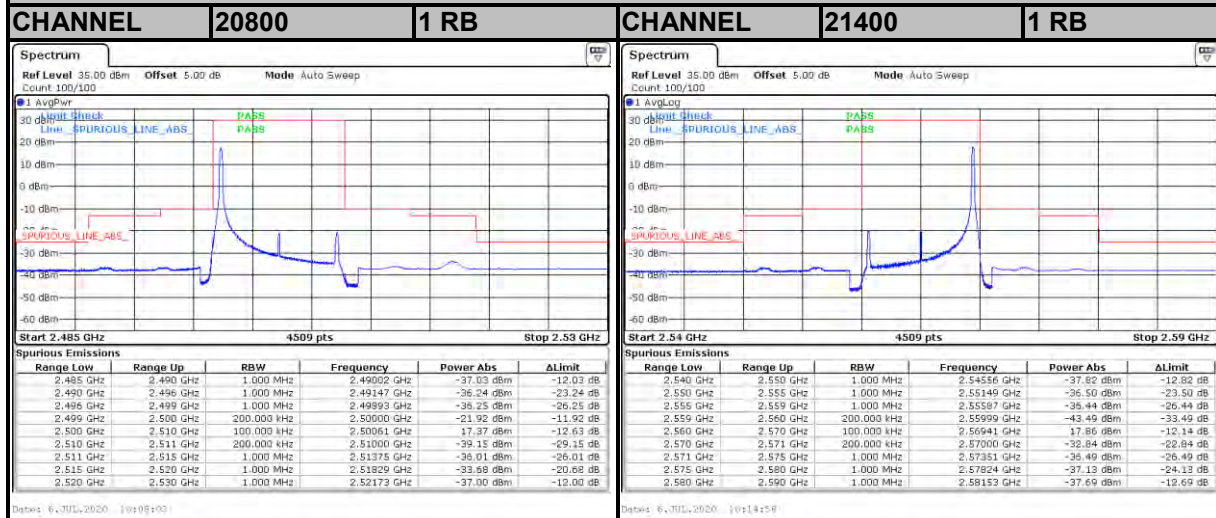

Note: Limit has been adjusted by $10 \cdot \log(\text{RBW})$ to reflect a 1MHz measurement bandwidth.



Test Report No.: RF200706W004-3

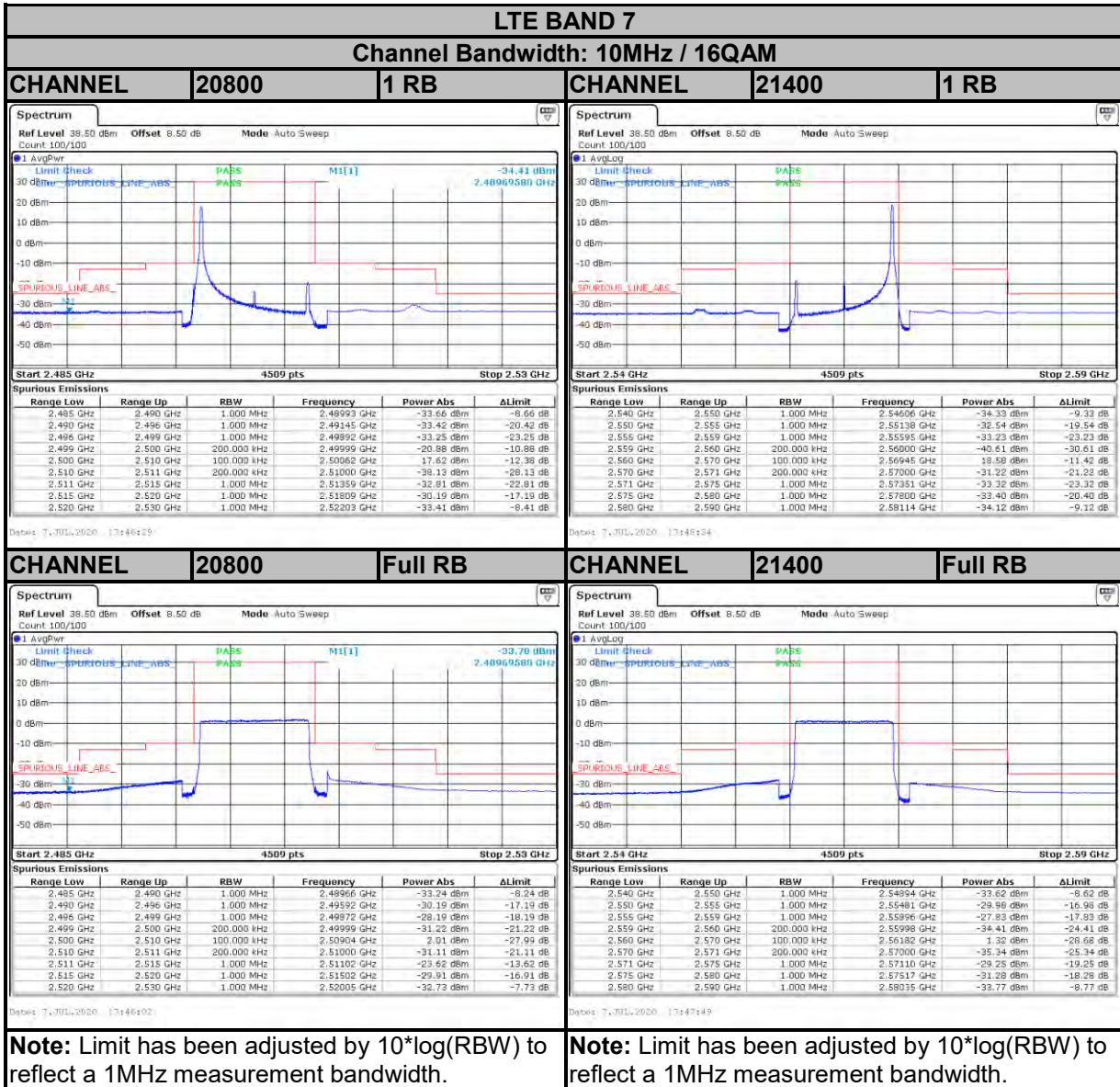



Test Report No.: RF200706W004-3

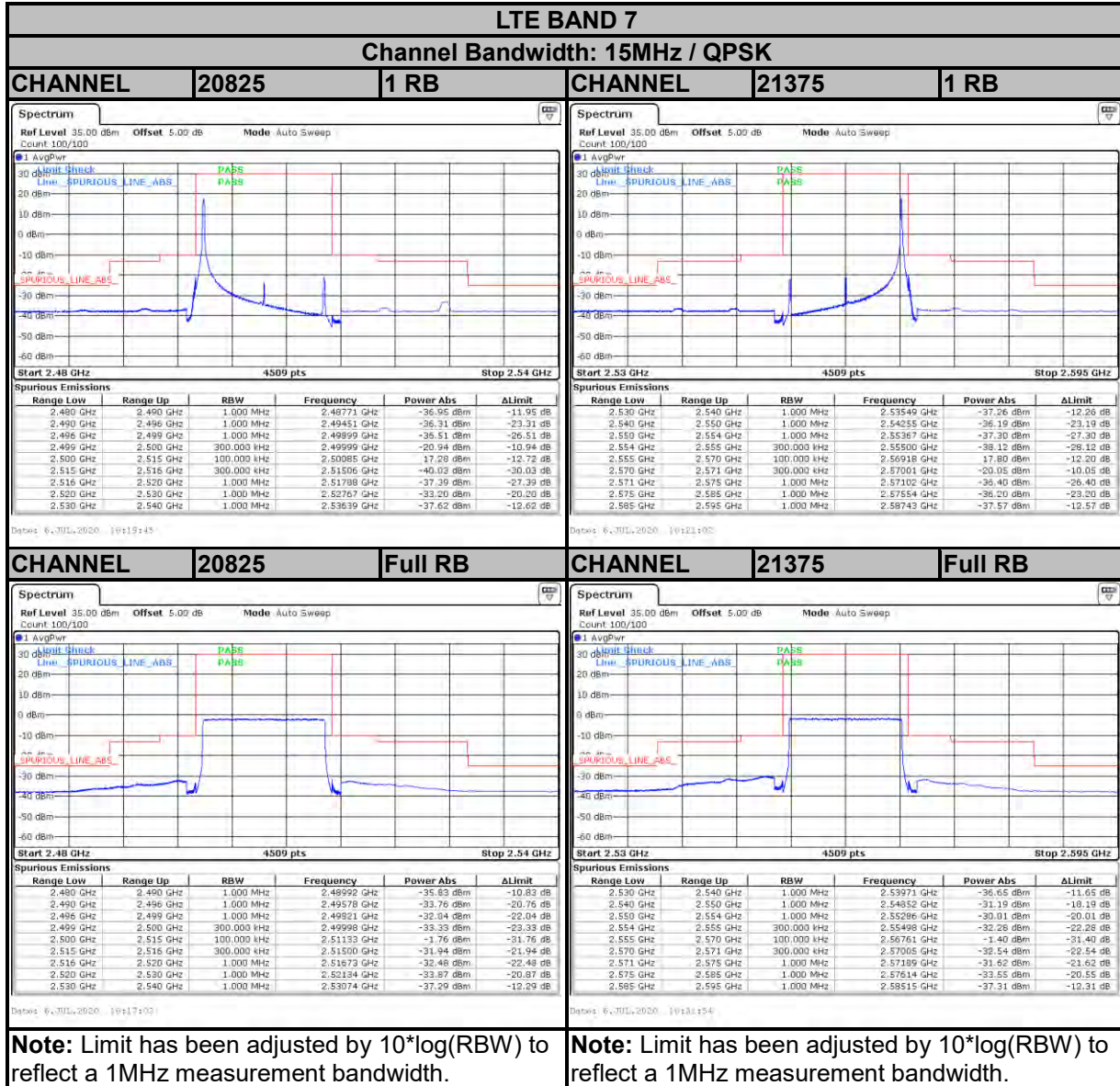

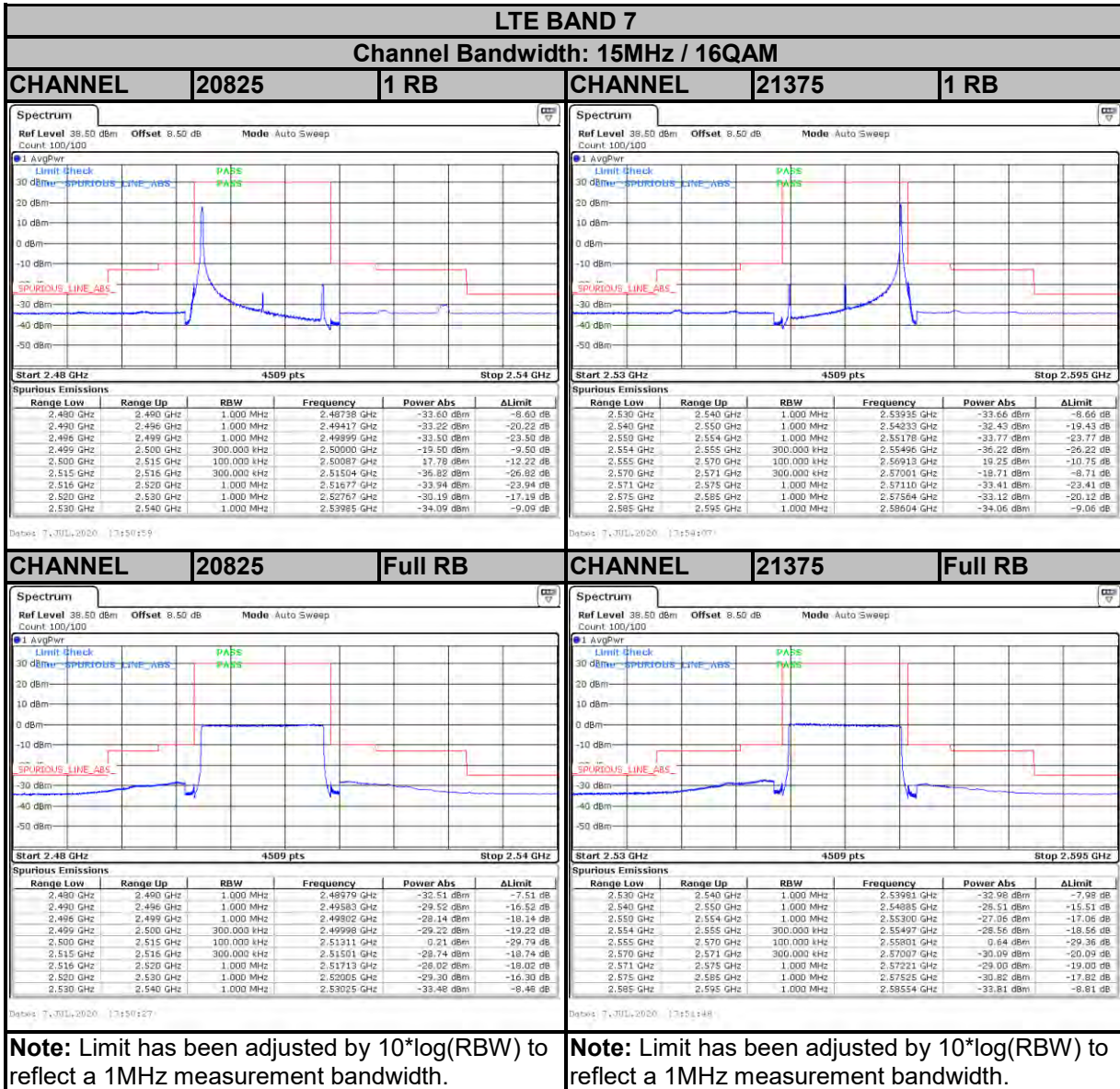

Note: Limit has been adjusted by $10 \cdot \log(\text{RBW})$ to reflect a 1MHz measurement bandwidth.

Note: Limit has been adjusted by $10 \cdot \log(\text{RBW})$ to reflect a 1MHz measurement bandwidth.

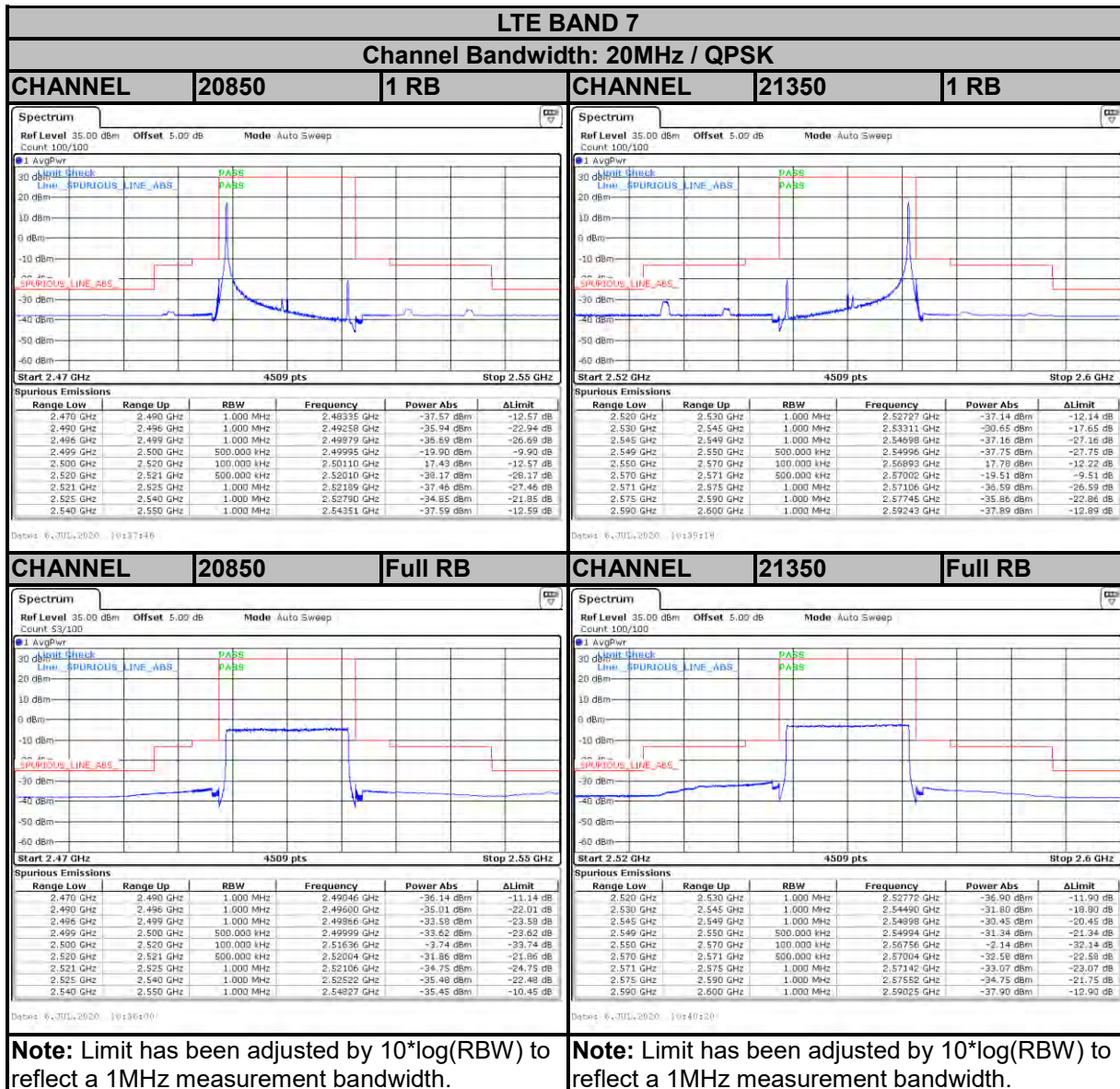

Note: Limit has been adjusted by $10 \cdot \log(\text{RBW})$ to reflect a 1MHz measurement bandwidth.

Note: Limit has been adjusted by $10 \cdot \log(\text{RBW})$ to reflect a 1MHz measurement bandwidth.



Test Report No.: RF200706W004-3

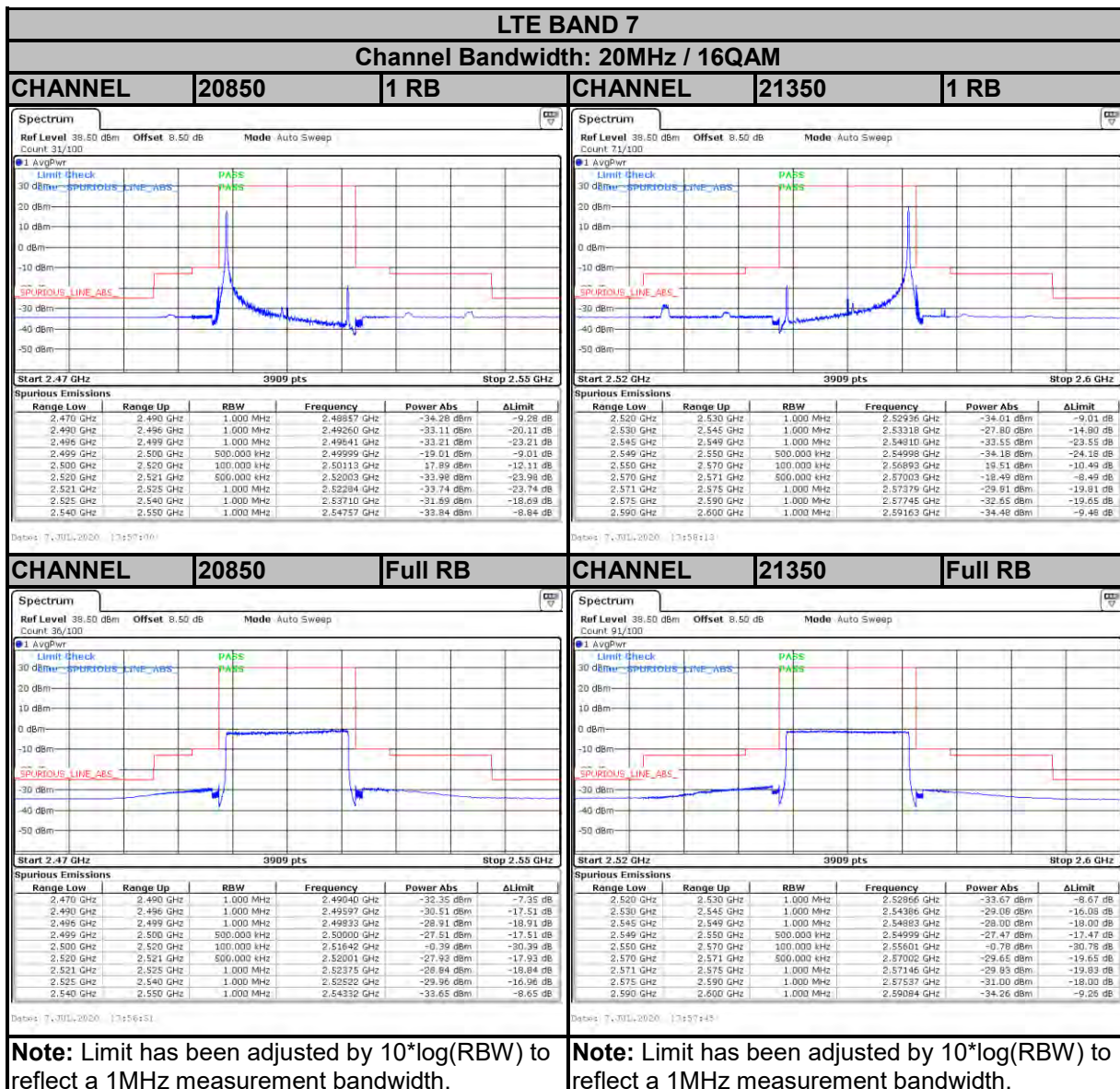

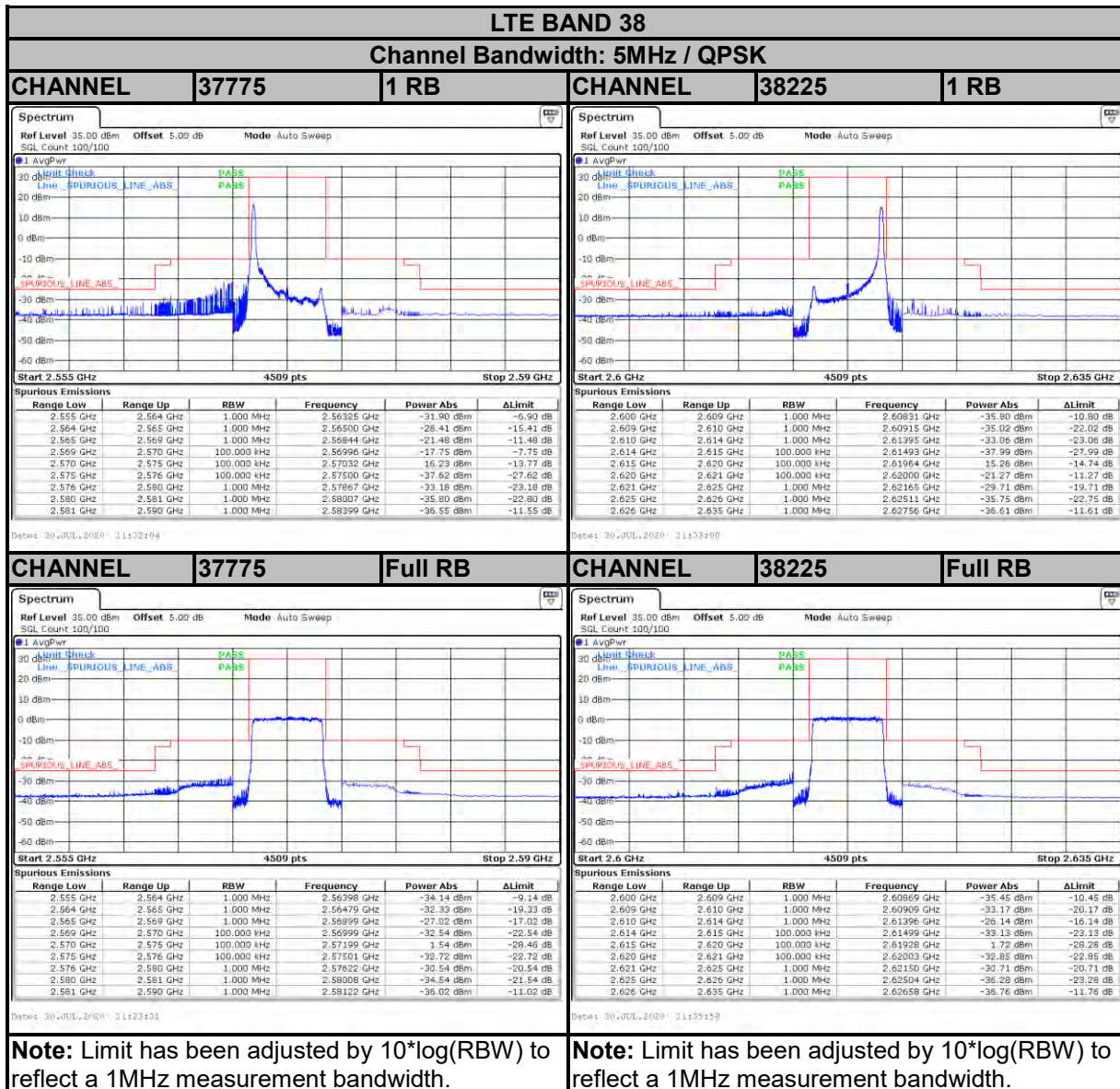



**BUREAU
VERITAS**

Test Report No.: RF200706W004-3

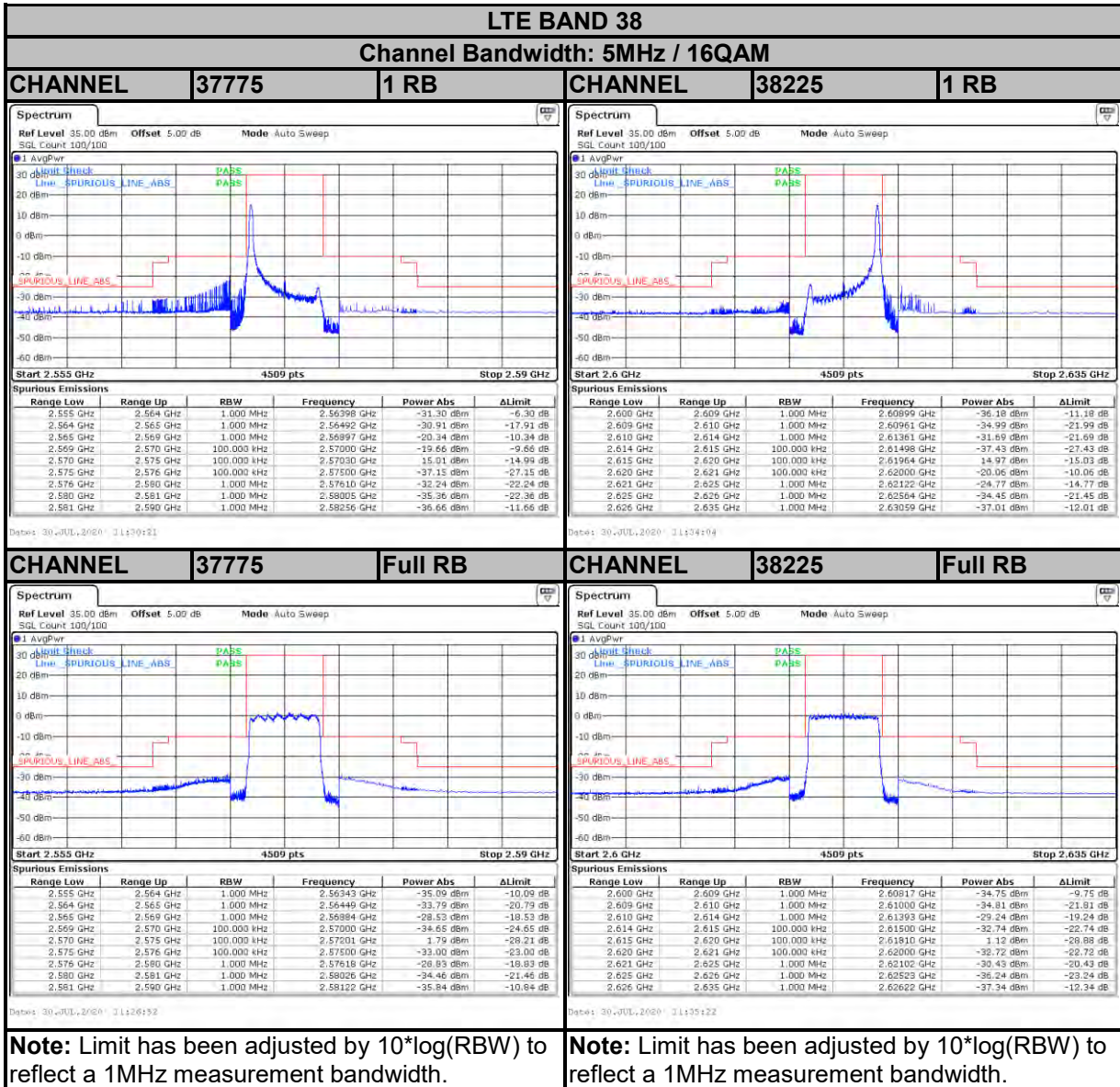

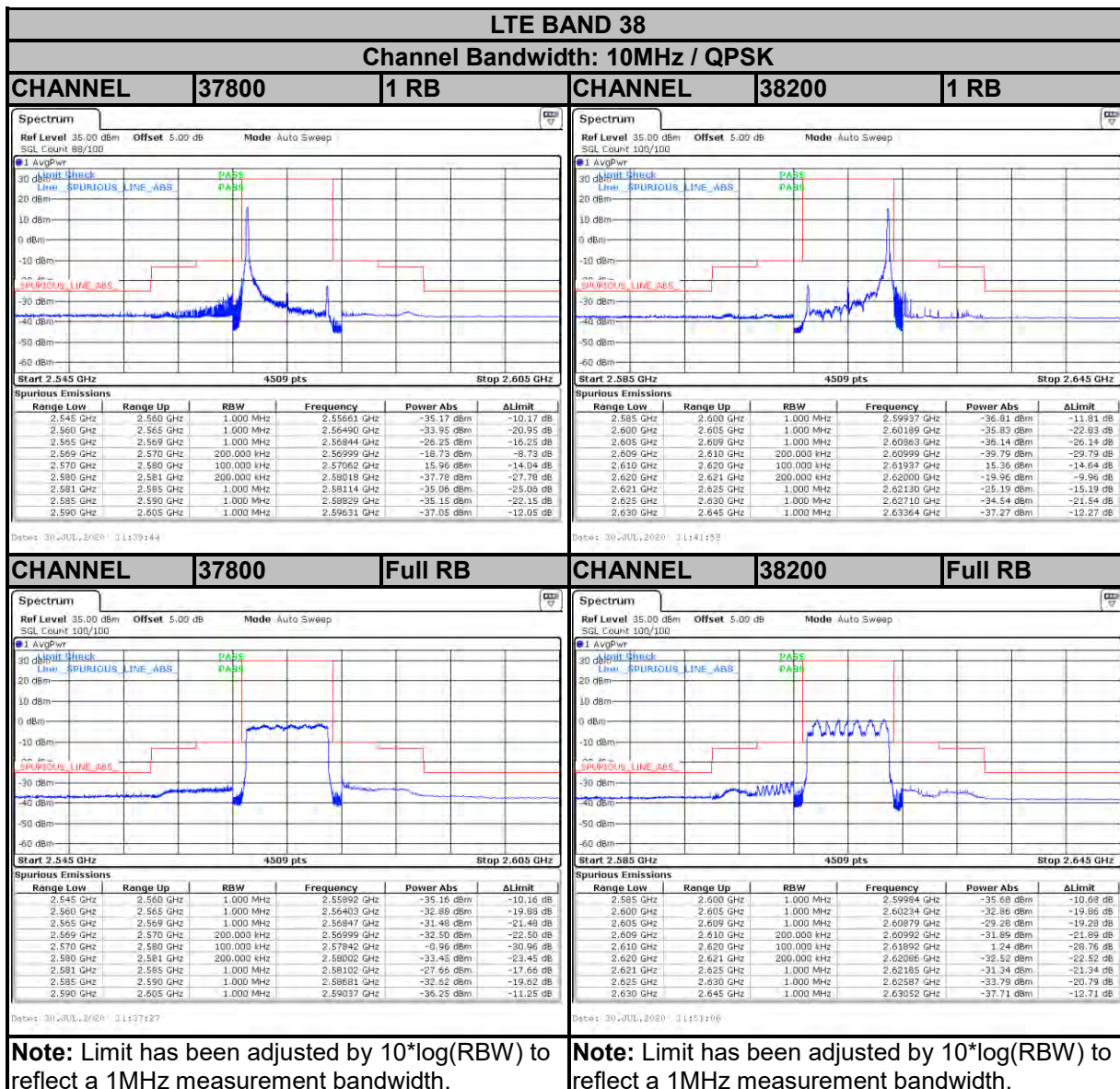

Note: Limit has been adjusted by $10 \cdot \log(\text{RBW})$ to reflect a 1MHz measurement bandwidth.

Note: Limit has been adjusted by $10 \cdot \log(\text{RBW})$ to reflect a 1MHz measurement bandwidth.



Test Report No.: RF200706W004-3

LTE BAND 38

Channel Bandwidth: 10MHz / 16QAM

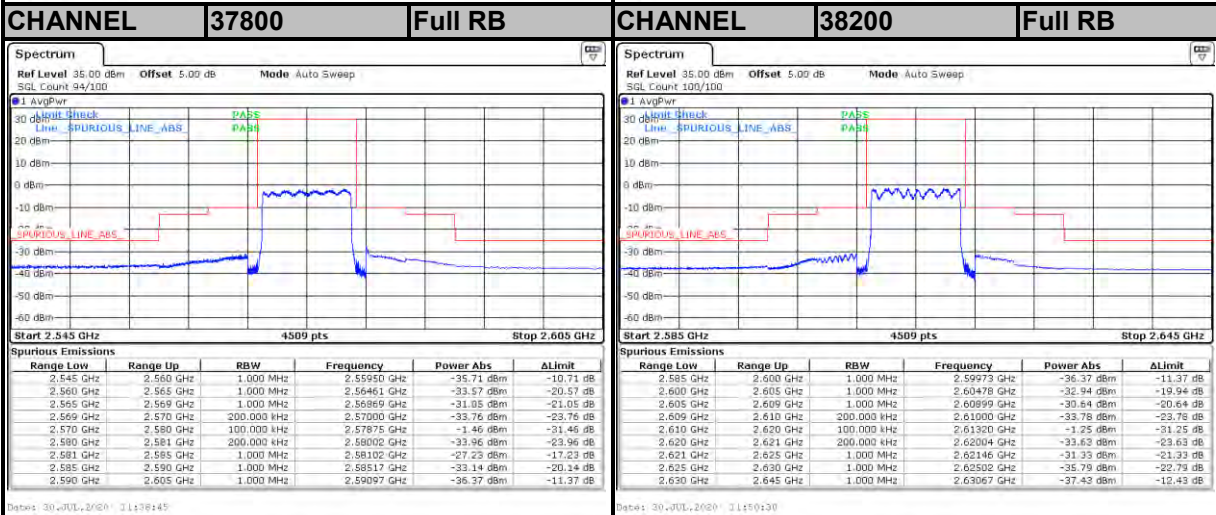
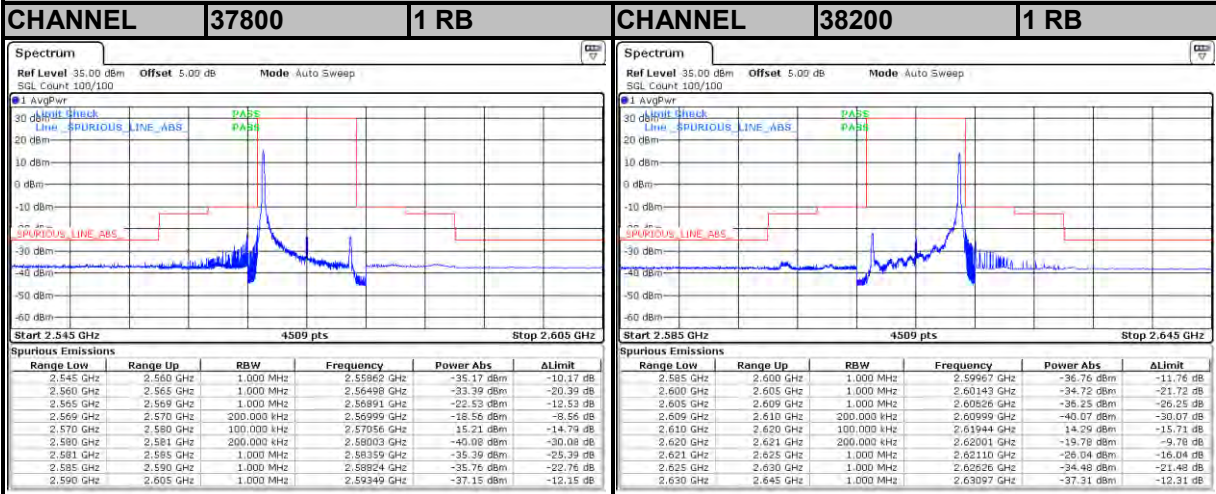

Note: Limit has been adjusted by 10*log(RBW) to reflect a 1MHz measurement bandwidth.

Note: Limit has been adjusted by 10*log(RBW) to reflect a 1MHz measurement bandwidth.



Test Report No.: RF200706W004-3

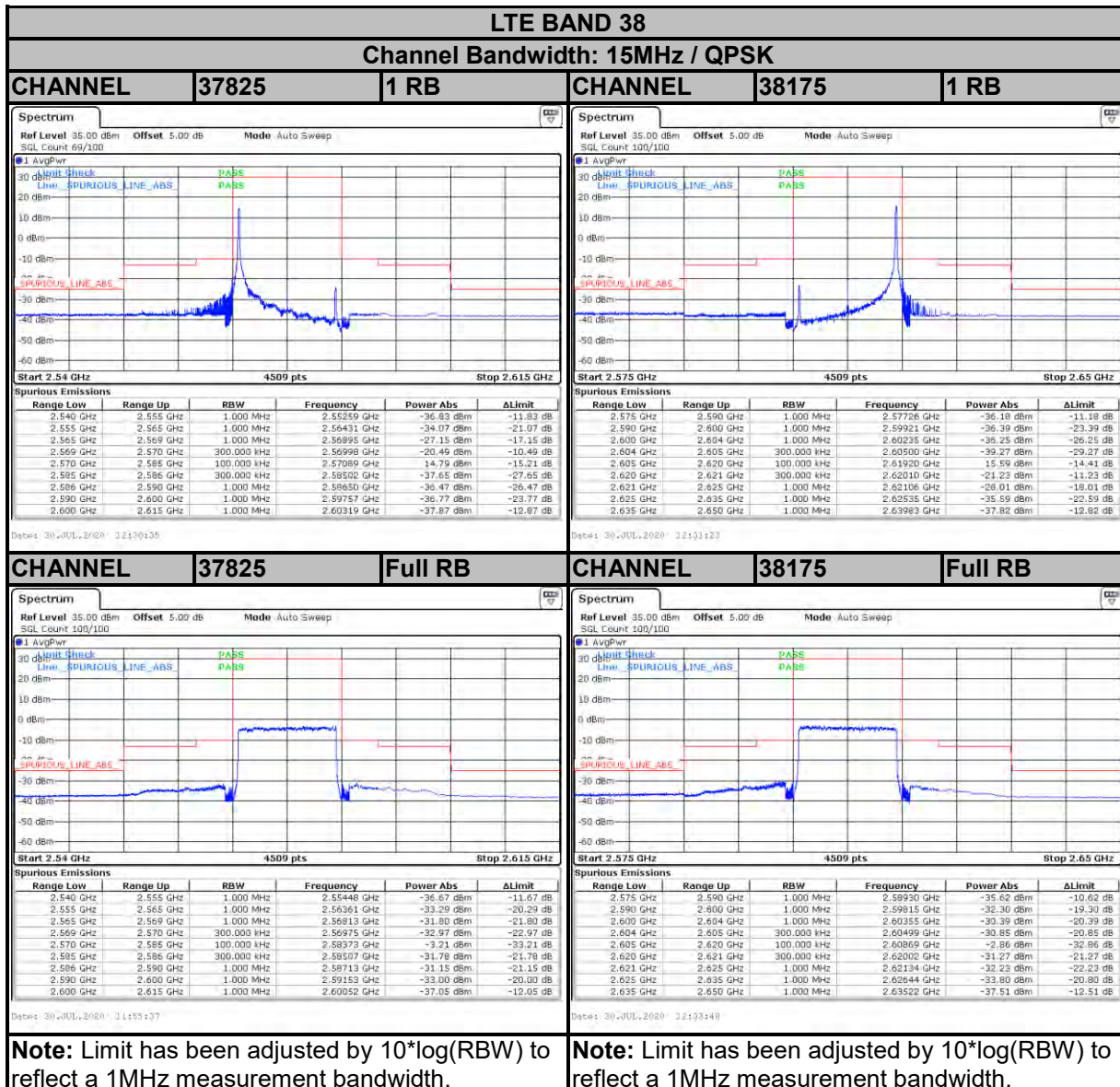

Note: Limit has been adjusted by $10 \cdot \log(\text{RBW})$ to reflect a 1MHz measurement bandwidth.

Note: Limit has been adjusted by $10 \cdot \log(\text{RBW})$ to reflect a 1MHz measurement bandwidth.



Test Report No.: RF200706W004-3

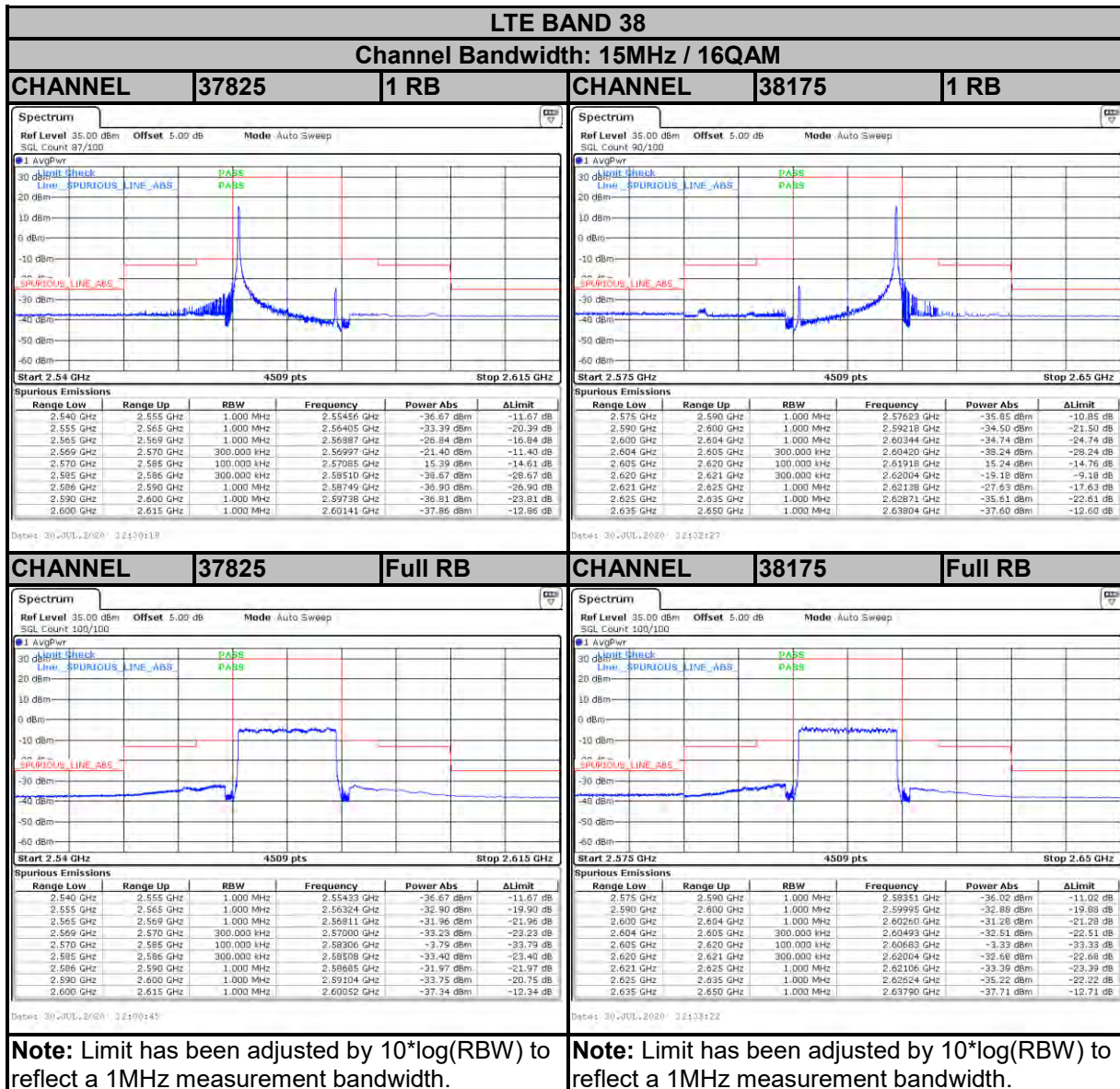

Note: Limit has been adjusted by $10 \cdot \log(\text{RBW})$ to reflect a 1MHz measurement bandwidth.

Note: Limit has been adjusted by $10 \cdot \log(\text{RBW})$ to reflect a 1MHz measurement bandwidth.

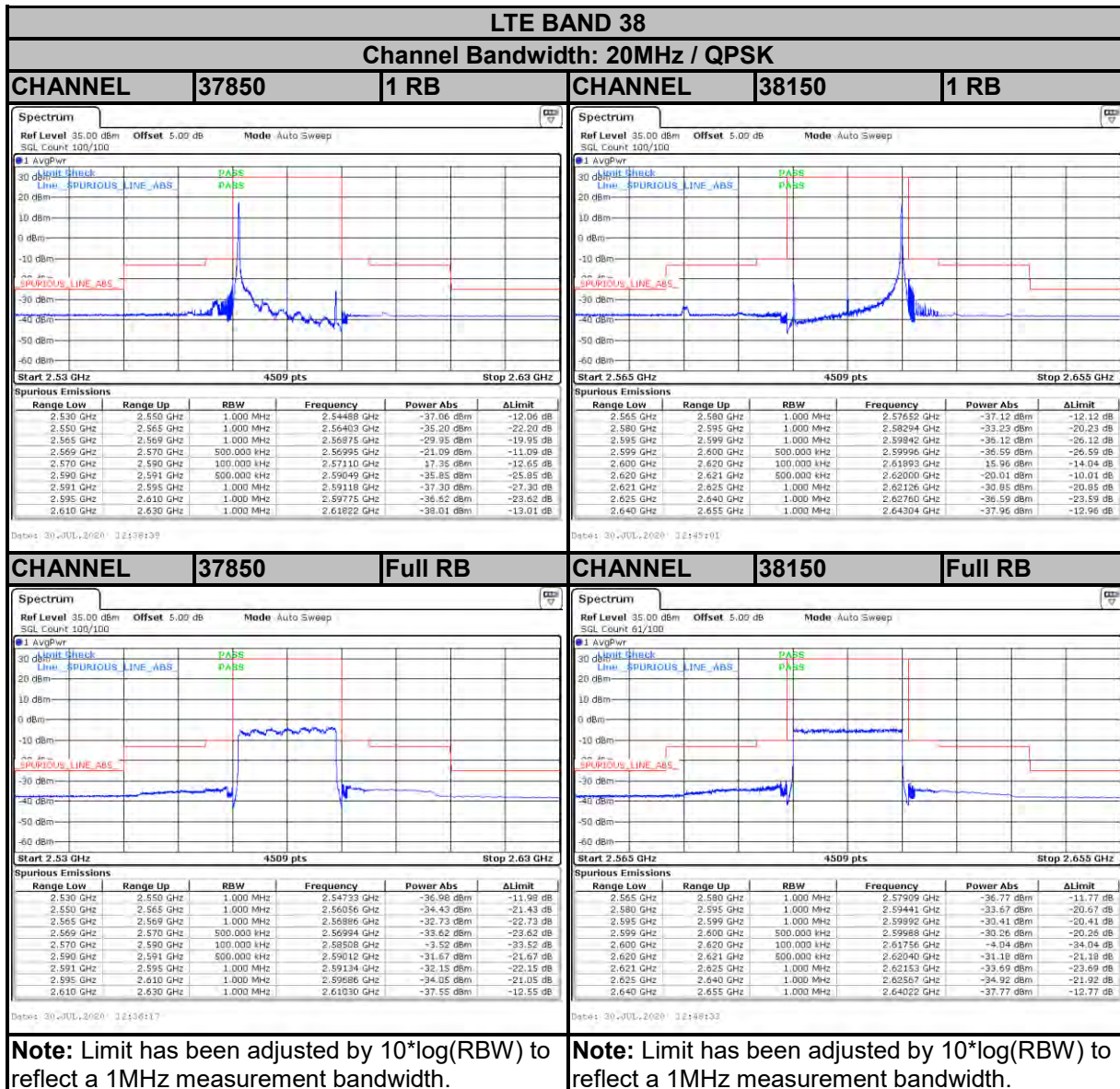

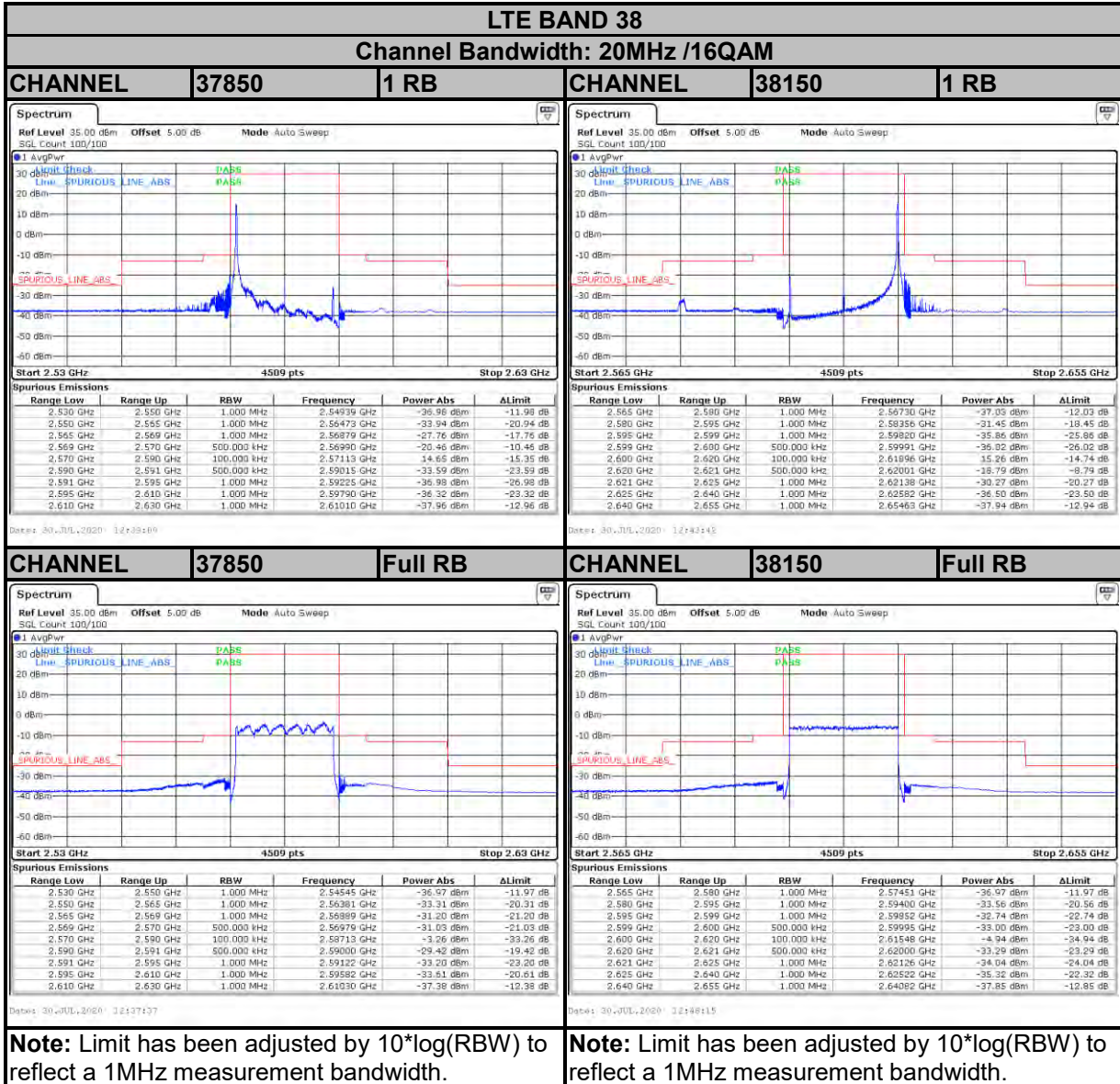

2.5 CONDUCTED SPURIOUS EMISSIONS

3.5.1 LIMITS OF CONDUCTED SPURIOUS EMISSIONS MEASUREMENT

The power of any emission outside a licensee's frequency block shall be attenuated below the transmitter power (P) by at least $55 + 10 \log_{10}(P)$ dB. The limit of emission is equal to -25dBm.

3.5.2 TEST PROCEDURE

- a. The EUT makes a phone call to the communication simulator. All measurements were done at low, middle and high operational frequency range.
- b. Measuring frequency range is from 30MHz~26GHz for LTE Band 7 & 30MHz~27GHz for LTE Band 38. 10dB attenuation pad is connected with spectrum. RBW=1MHz and VBW=3MHz are used for conducted emission measurement.

3.5.3 TEST SETUP

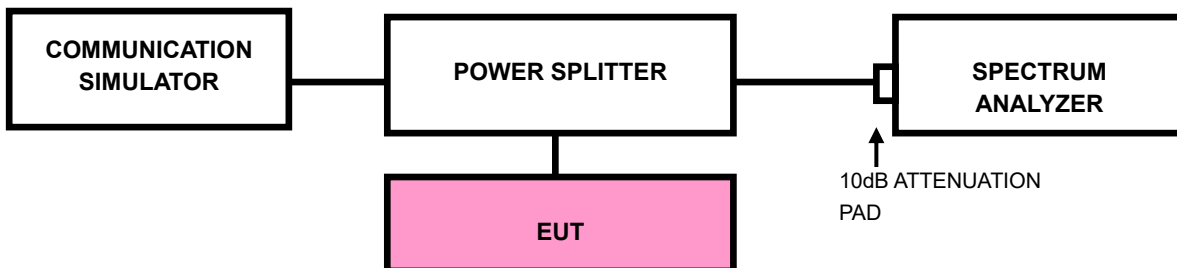



BUREAU VERITAS

Test Report No.: RF200706W004-3

3.5.4 TEST RESULTS

LTE BAND 7

5MHz / QPSK

CHANNEL 20775

FREQUENCY RANG2E : 30MHz~25.7GHz

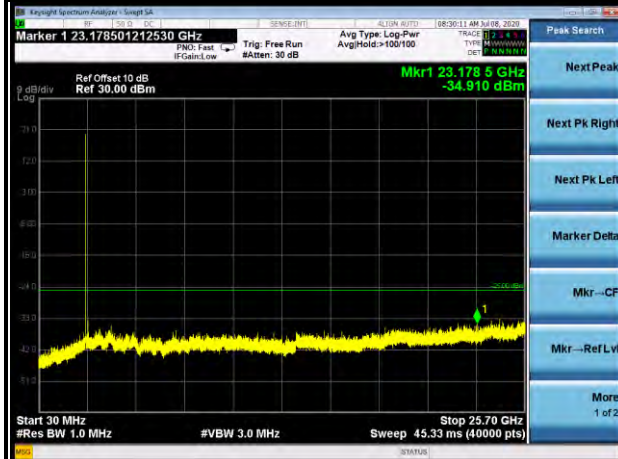

CHANNEL 21100

FREQUENCY RANG2E : 30MHz~25.7GHz

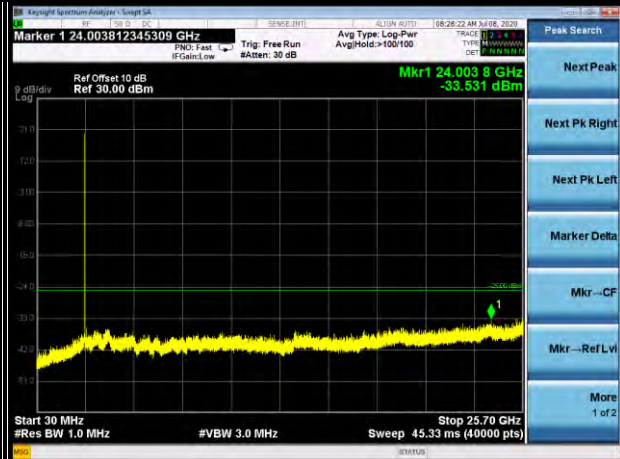

CHANNEL 21425

FREQUENCY RANG2E : 30MHz~25.7GHz

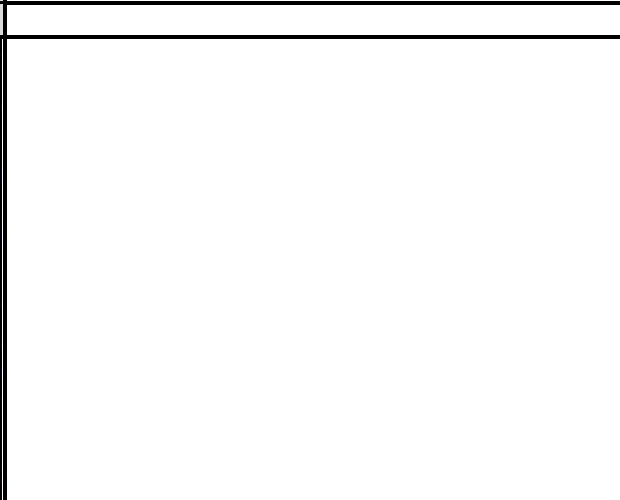
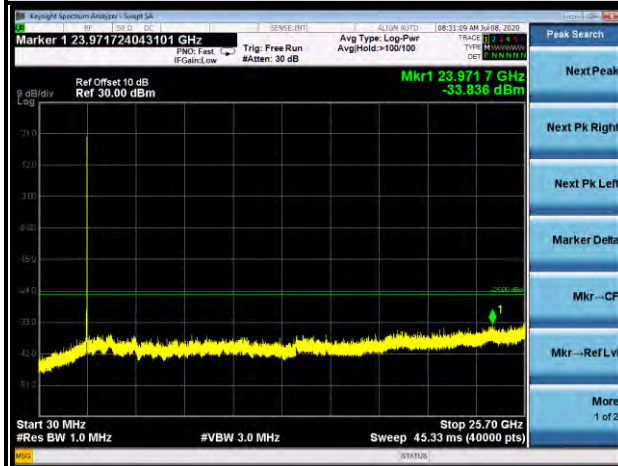

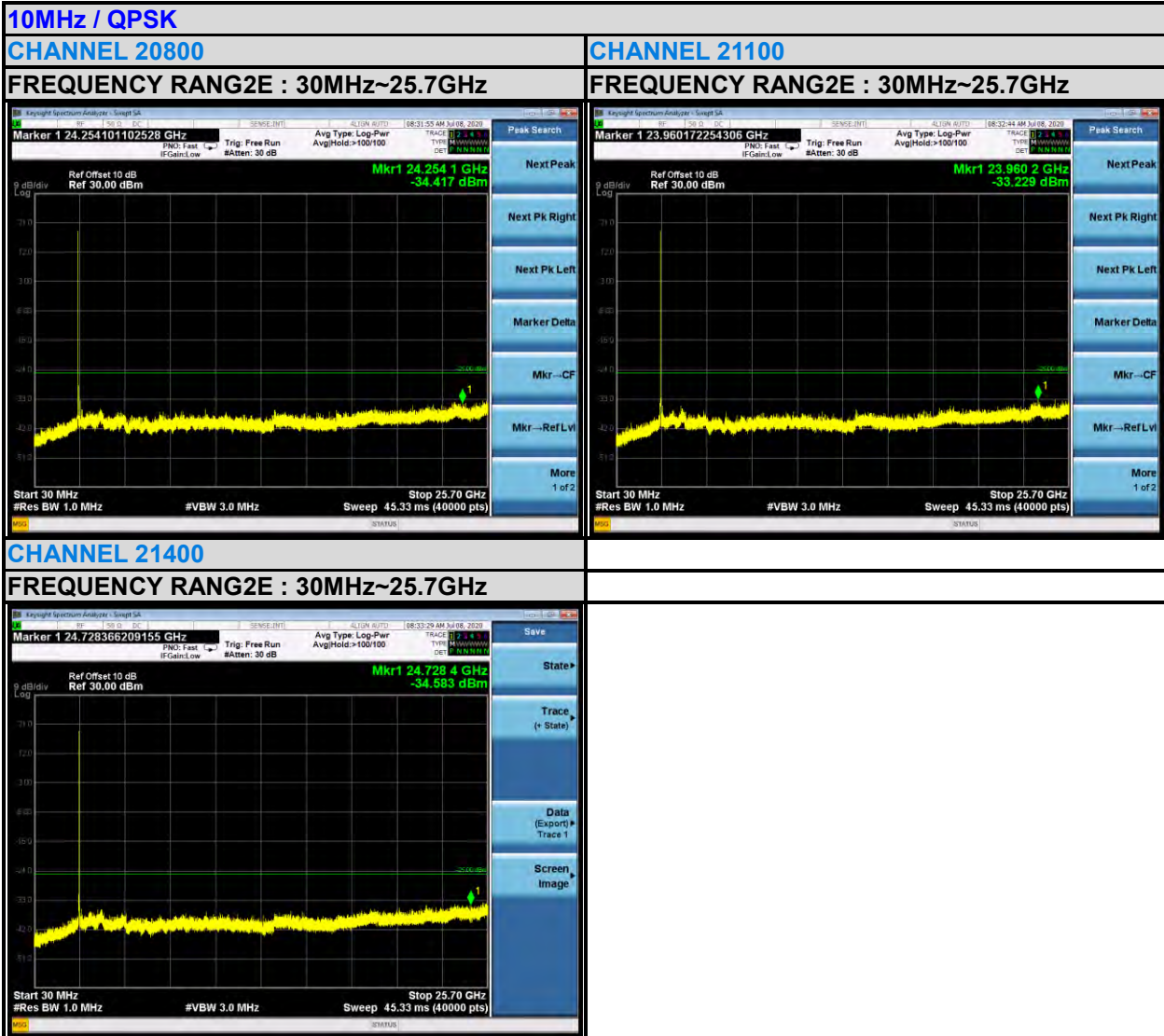



Test Report No.: RF200706W004-3

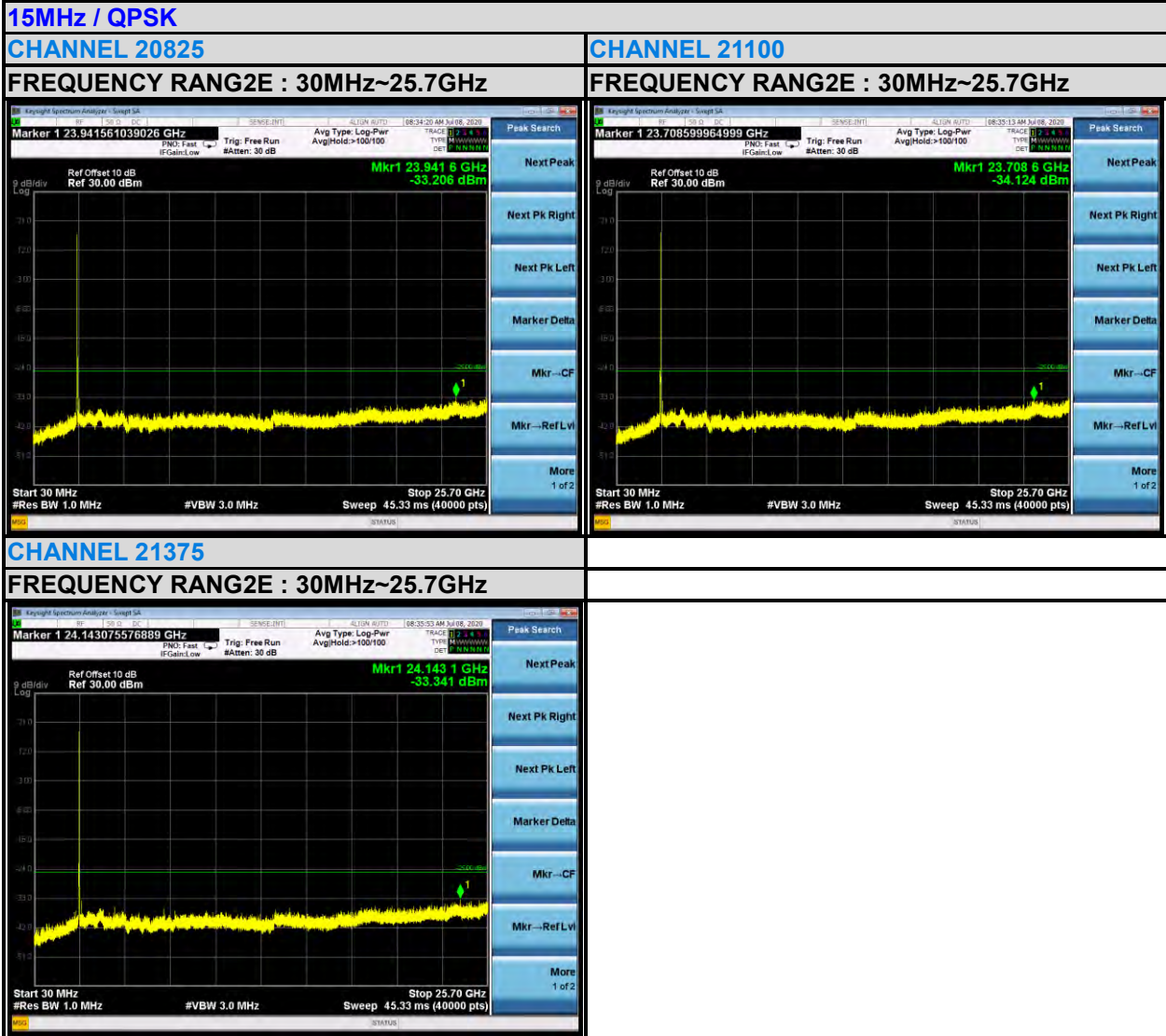

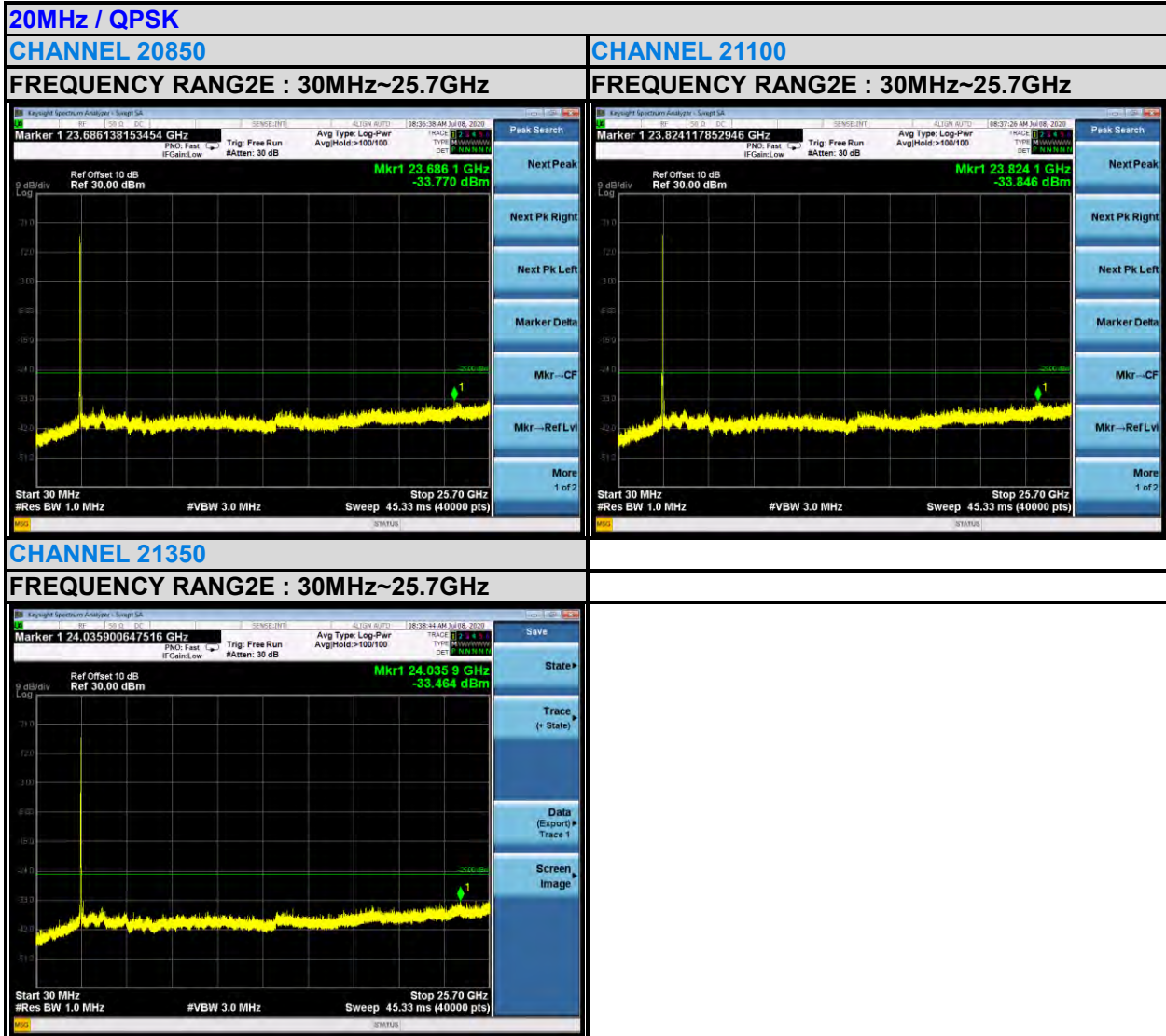



BUREAU VERITAS

Test Report No.: RF200706W004-3

LTE BAND 38

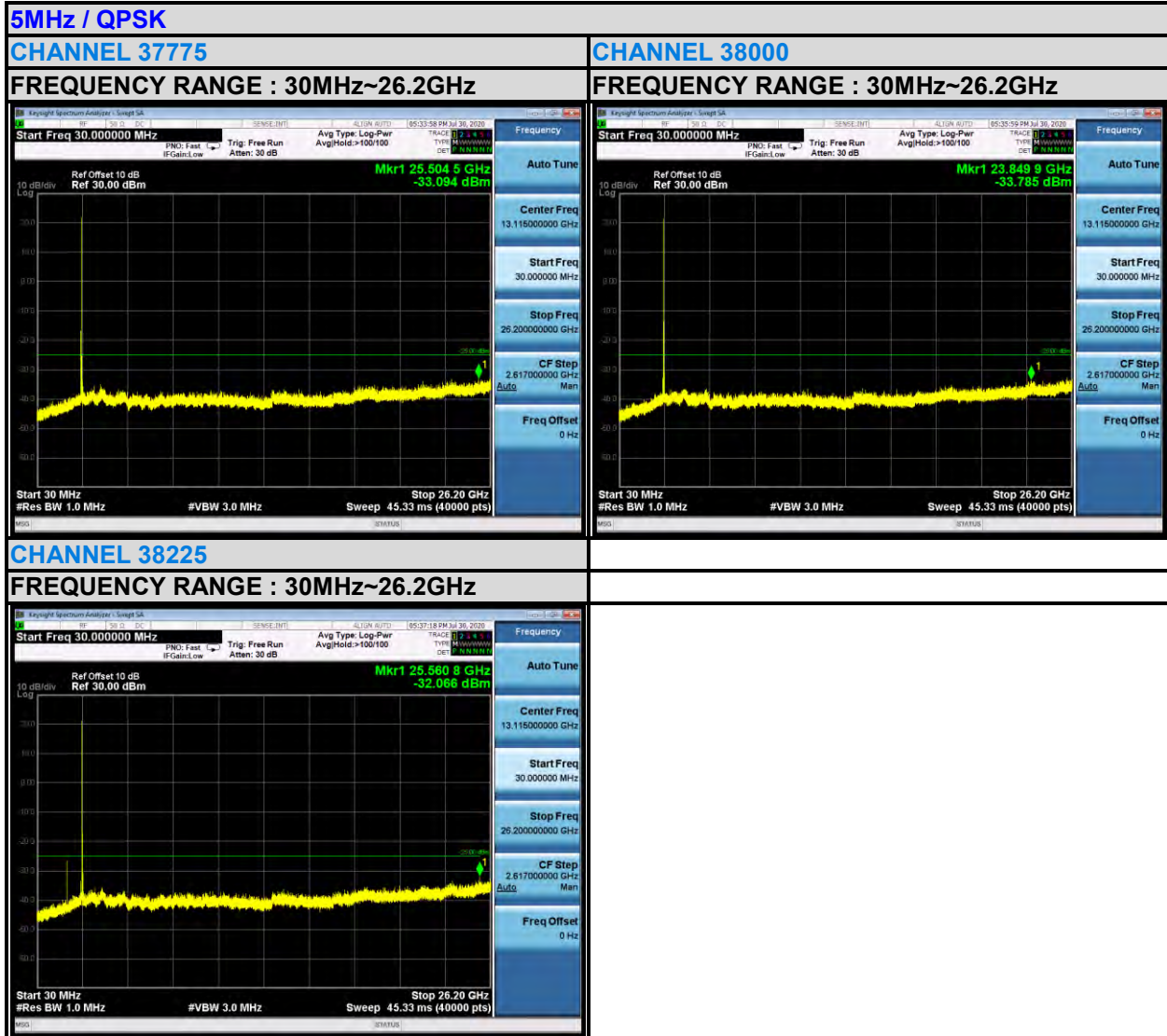

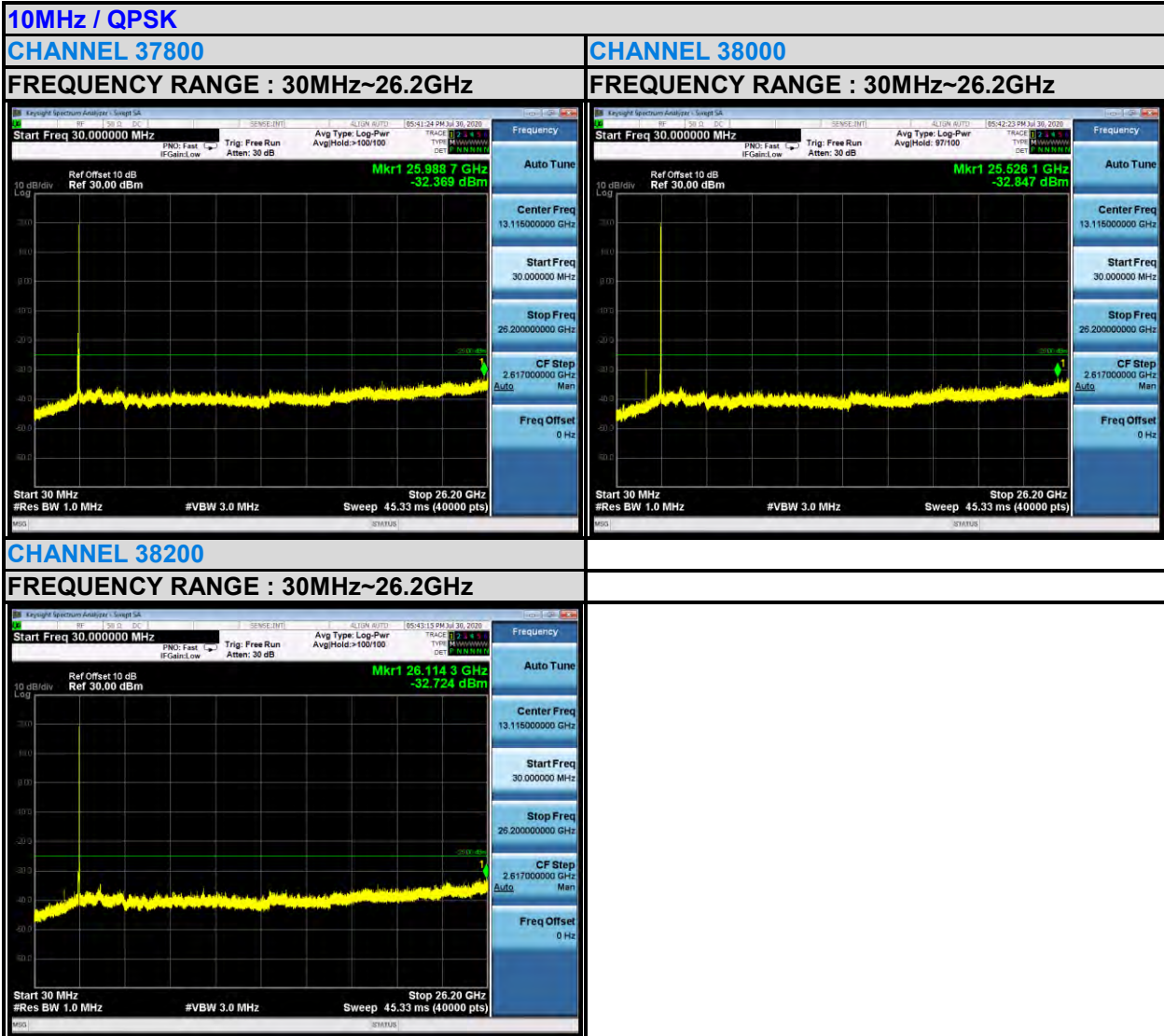

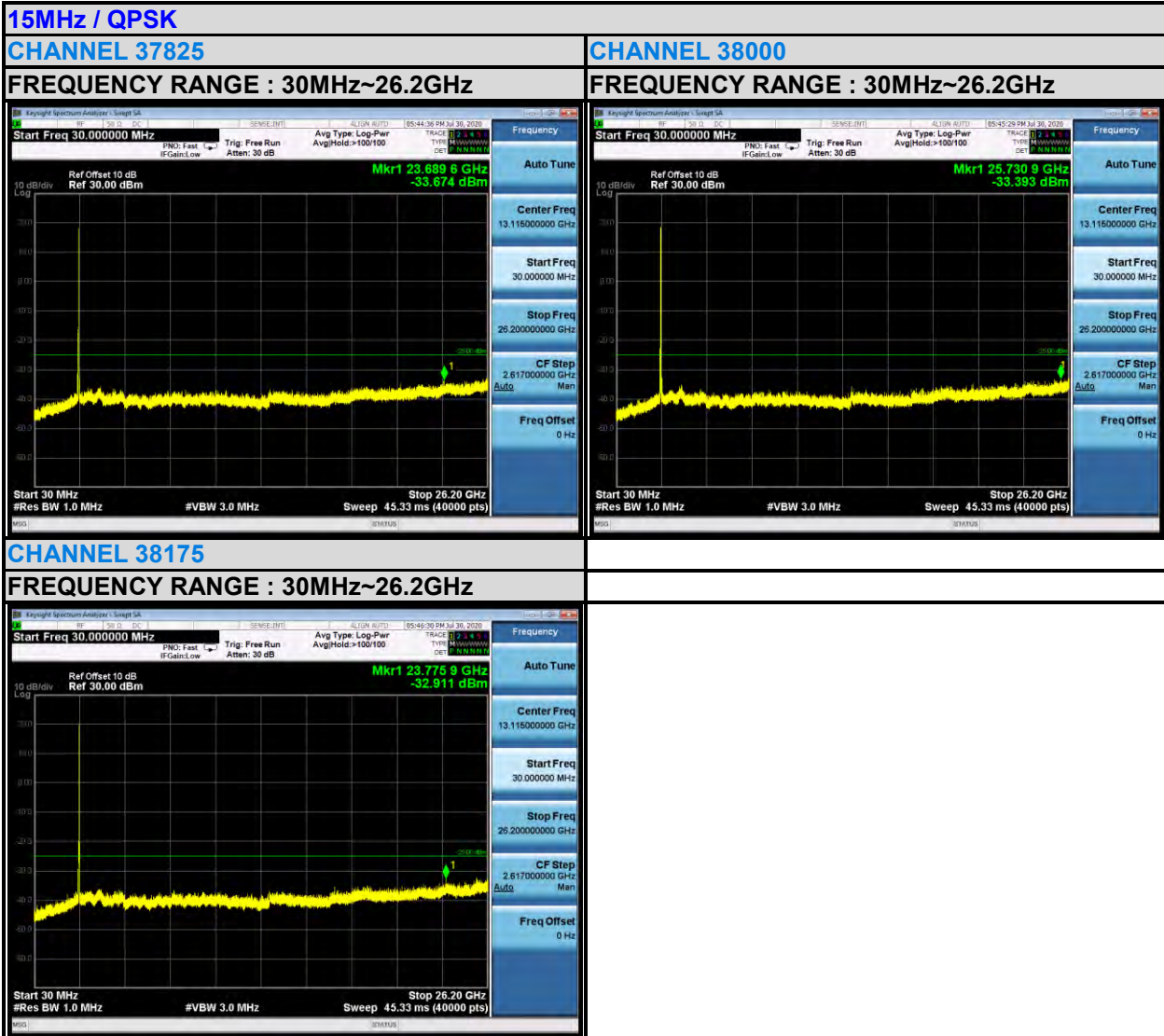

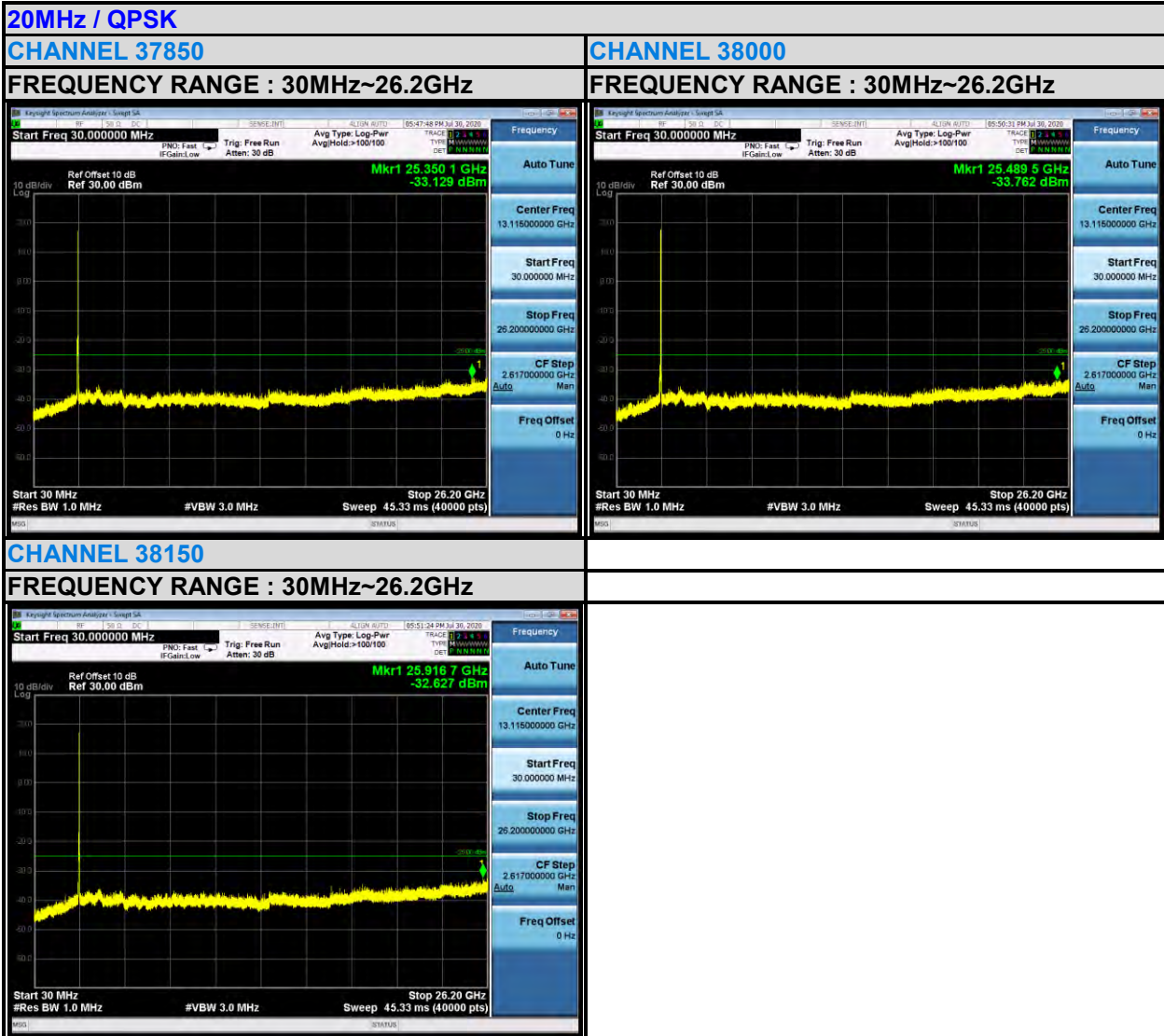

3.6 RADIATED EMISSION MEASUREMENT

3.6.1 LIMITS OF RADIATED EMISSION MEASUREMENT

The power of any emission outside a licensee's frequency block shall be attenuated below the transmitter power (P) by at least $55 + 10 \log_{10}(P)$ dB. The limit of emission is equal to -25dBm.

3.6.2 TEST PROCEDURES

- a. Substitution method is used for E.I.R.P measurement. In the semi-anechoic chamber, EUT placed on the 0.8m height of Turn Table, rotated the table around 360 degrees to search the maximum radiation power and receiver antenna shall be rotated vertical and horizontal polarization and moved height from 1m to 4m to find the maximum polar radiated power. The "Read Value" is the spectrum reading the maximum power value.
- b. The substitution horn antenna is substituted for EUT at the same position and signals generator export the CW signal to the substitution antenna via a TX cable. Rotated the Turn Table and moved receiving antenna to find the maximum radiation power. Adjust output power level of S.G to get a Value of spectrum reading equal to "Read Value " of step a. Record the power level of S.G.
- c. $EIRP = \text{Output power level of S.G} - \text{TX cable loss} + \text{Antenna gain of substitution horn}$.
- d. E.R.P power can be calculated form E.I.R.P power by subtracting the gain of dipole,
 $E.R.P \text{ power} = E.I.P.R \text{ power} - 2.15\text{dBi}$.

NOTE: The resolution bandwidth of spectrum analyzer is 1 MHz and the video bandwidth is 3 MHz.

3.6.3 DEVIATION FROM TEST STANDARD

No deviation

3.6.4 TEST SETUP

< Frequency Range 30MHz~1GHz >

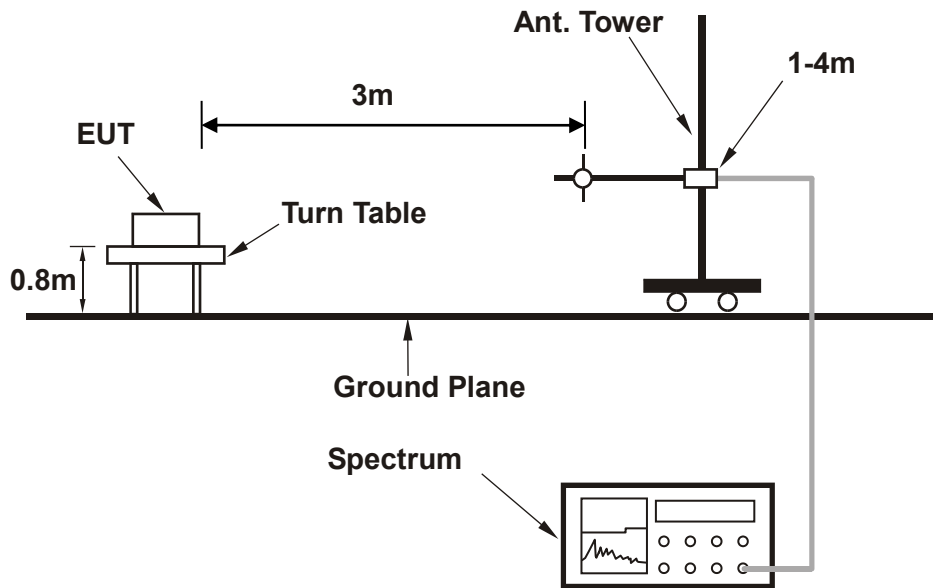

<Frequency Range above 1GHz>

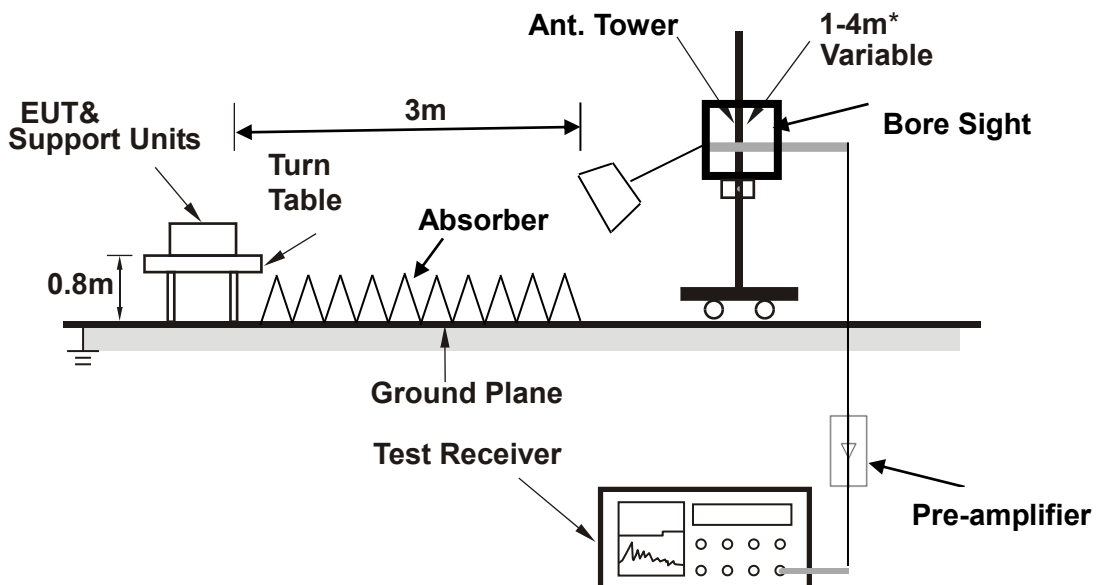

Note: Above 1G is a directional antenna depends on the EUT height and the antenna 3dB beamwidth both, refer to section 7.3 of CISPR 16-2-3.

For the actual test configuration, please refer to the attached file (Test Setup Photo).

3.6.5 TEST RESULTS

BELOW 1GHz WORST-CASE DATA

LTE Band 38

CHANNEL BANDWIDTH: 10MHz / QPSK

MODE	TX channel 38000	FREQUENCY RANGE	Below 1000MHz
ENVIRONMENTAL CONDITIONS	23deg. C, 70%RH	INPUT POWER	DC 5Vfrom adapter
TESTED BY	Star Le		
ANTENNA POLARITY & TEST DISTANCE: HORIZONTAL AT 3 M			

	Freq	Level	Read Level	Limit Line	Over Limit	Factor	Remark	Pol/Phase	
	MHz	dBm/m	dBm	dBm/m	dB	dB/m			
1	PP	32.120	-46.79	-63.22	-25.00	-21.79	16.43	Peak	Horizontal
2		70.250	-48.80	-36.55	-25.00	-23.80	-12.25	Peak	Horizontal
3		156.120	-70.41	-51.69	-25.00	-45.41	-18.72	Peak	Horizontal
4		256.020	-77.20	-61.22	-25.00	-52.20	-15.98	Peak	Horizontal
5		416.330	-65.03	-54.58	-25.00	-40.03	-10.45	Peak	Horizontal
6		549.360	-69.20	-59.65	-25.00	-44.20	-9.55	Peak	Horizontal

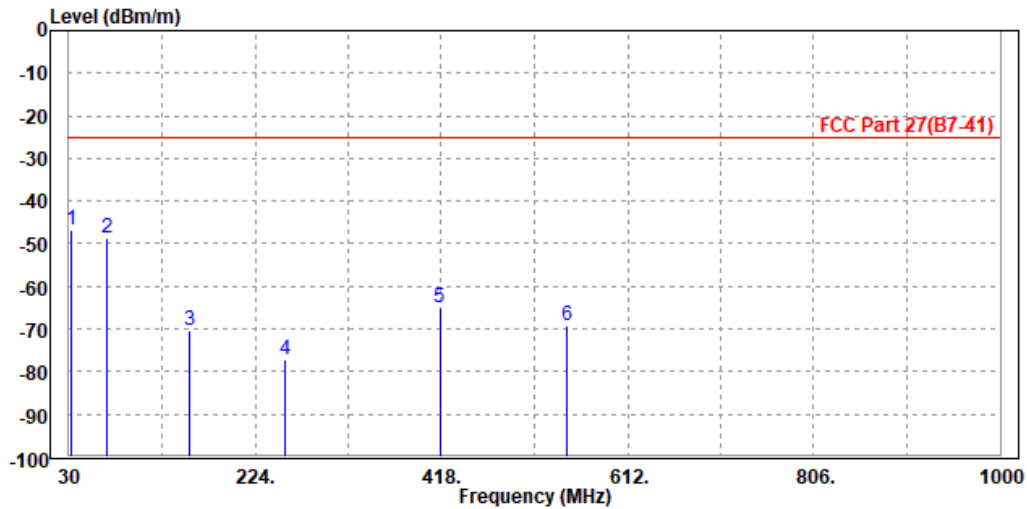



Test Report No.: RF200706W004-3

MODE	TX channel 38000	FREQUENCY RANGE	Below 1000MHz
ENVIRONMENTAL CONDITIONS	23deg. C, 70%RH	INPUT POWER	DC 5Vfrom adapter
TESTED BY	Star Le		
ANTENNA POLARITY & TEST DISTANCE: VERTICAL AT 3 M			

	Freq	Level	Read Level	Limit Line	Over Limit	Factor	Remark	Pol/Phase
	MHz	dBm/m	dBm	dBm/m	dB	dB/m		
1	33.020	-58.29	-59.60	-25.00	-33.29	1.31	Peak	Vertical
2 PP	90.010	-46.99	-36.45	-25.00	-21.99	-10.54	Peak	Vertical
3	98.550	-48.34	-37.69	-25.00	-23.34	-10.65	Peak	Vertical
4	259.650	-64.73	-53.25	-25.00	-39.73	-11.48	Peak	Vertical
5	360.150	-65.22	-54.14	-25.00	-40.22	-11.08	Peak	Vertical
6	546.220	-64.54	-57.25	-25.00	-39.54	-7.29	Peak	Vertical

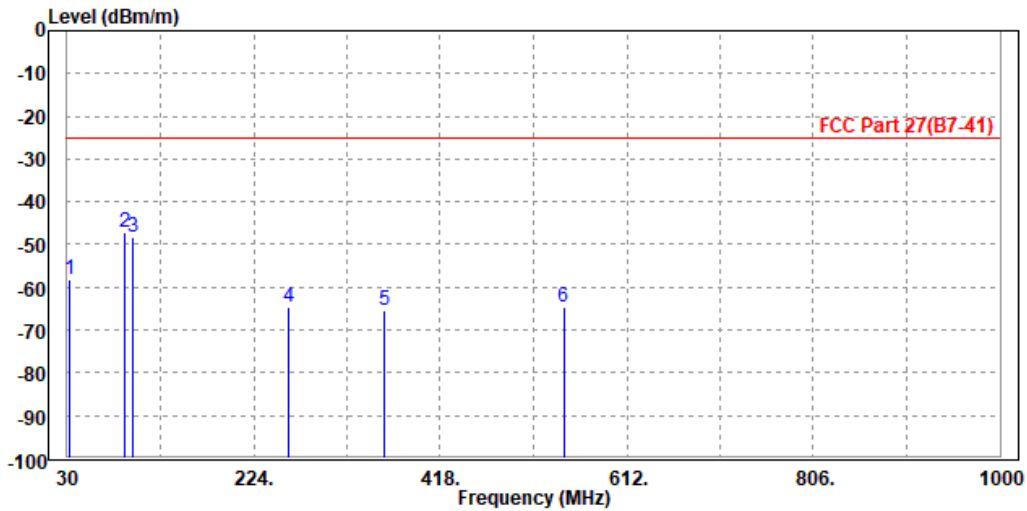



Test Report No.: RF200706W004-3

ABOVE 1GHz

Note: For higher frequency, the emission is too low to be detected.

LTE Band 7

CHANNEL BANDWIDTH: 5MHz / QPSK

MODE	TX channel 21100	FREQUENCY RANGE	Above 1000MHz
ENVIRONMENTAL CONDITIONS	23deg. C, 70%RH	INPUT POWER	DC 5V from adapter
TESTED BY	Star Le		
ANTENNA POLARITY & TEST DISTANCE: HORIZONTAL AT 3 M			

	Freq	Level	Read Level	Limit Line	Over Limit	Factor	Remark	Pol/Phase
	MHz	dBm/m	dBm	dBm/m	dB	dB/m		
1	PP 5070.000	-51.29	-60.02	-25.00	-26.29	8.73	Peak	Horizontal
2	7605.000	-53.00	-64.40	-25.00	-28.00	11.40	Peak	Horizontal

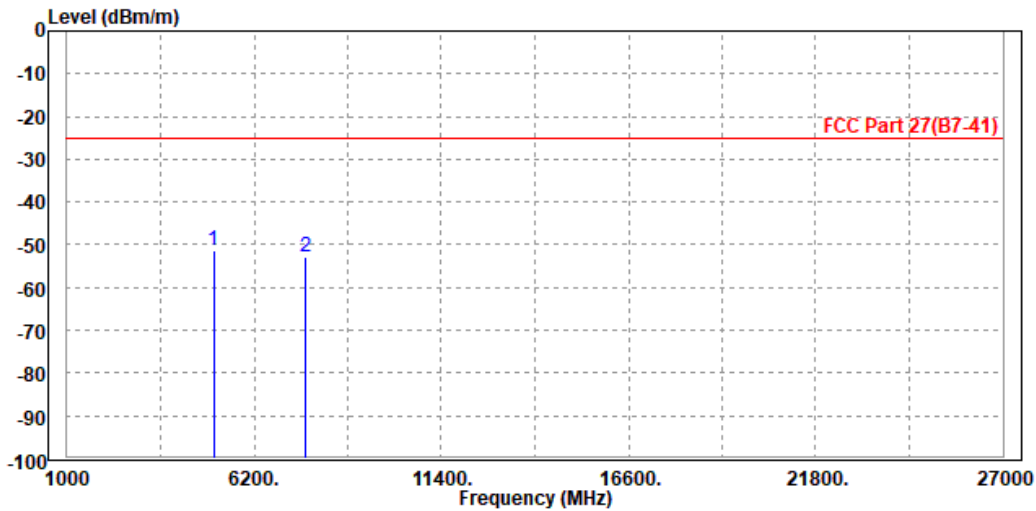



Test Report No.: RF200706W004-3

MODE	TX channel 21100	FREQUENCY RANGE	Above 1000MHz
ENVIRONMENTAL CONDITIONS	23deg. C, 70%RH	INPUT POWER	DC 5V from adapter
TESTED BY	Star Le		
ANTENNA POLARITY & TEST DISTANCE: VERTICAL AT 3 M			

	Freq	Level	Read Level	Limit Line	Over Limit	Factor	Remark	Pol/Phase
	MHz	dBm/m	dBm	dBm/m	dB	dB/m		
1	5070.000	-51.56	-61.43	-25.00	-26.56	9.87	Peak	Vertical
2	PP 7604.000	-50.33	-63.11	-25.00	-25.33	12.78	Peak	Vertical

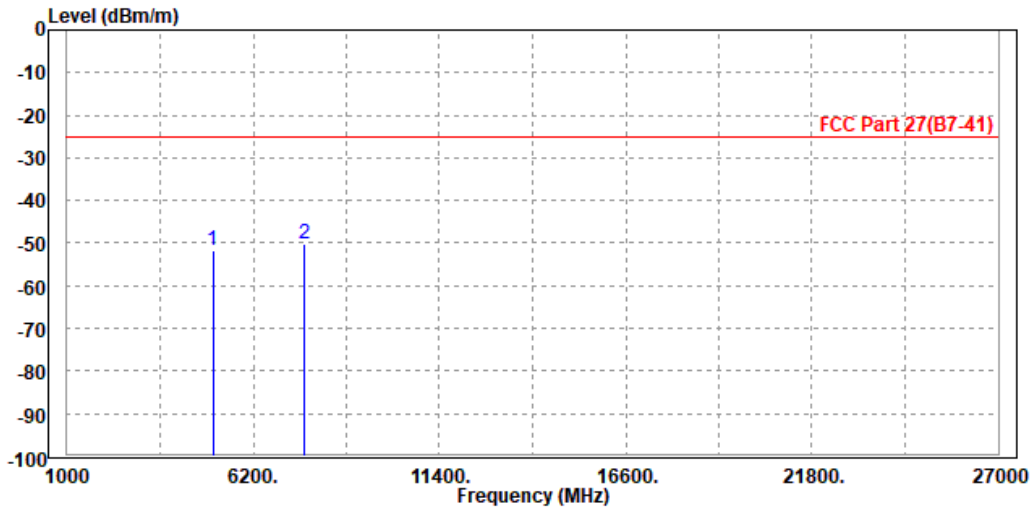



BUREAU VERITAS

Test Report No.: RF200706W004-3

CHANNEL BANDWIDTH: 10MHz / QPSK
CH 20800

MODE	TX channel 20800	FREQUENCY RANGE	Above 1000MHz
ENVIRONMENTAL CONDITIONS	23deg. C, 70%RH	INPUT POWER	DC 5V from adapter
TESTED BY	Star Le		
ANTENNA POLARITY & TEST DISTANCE: HORIZONTAL AT 3 M			

	Freq	Level	Read Level	Limit Line	Over Limit	Factor	Remark	Pol/Phase
	MHz	dBm/m	dBm	dBm/m	dB	dB/m		
1	PP 5004.000	-52.61	-61.15	-25.00	-27.61	8.54	Peak	Horizontal
2	7515.000	-53.40	-64.77	-25.00	-28.40	11.37	Peak	Horizontal

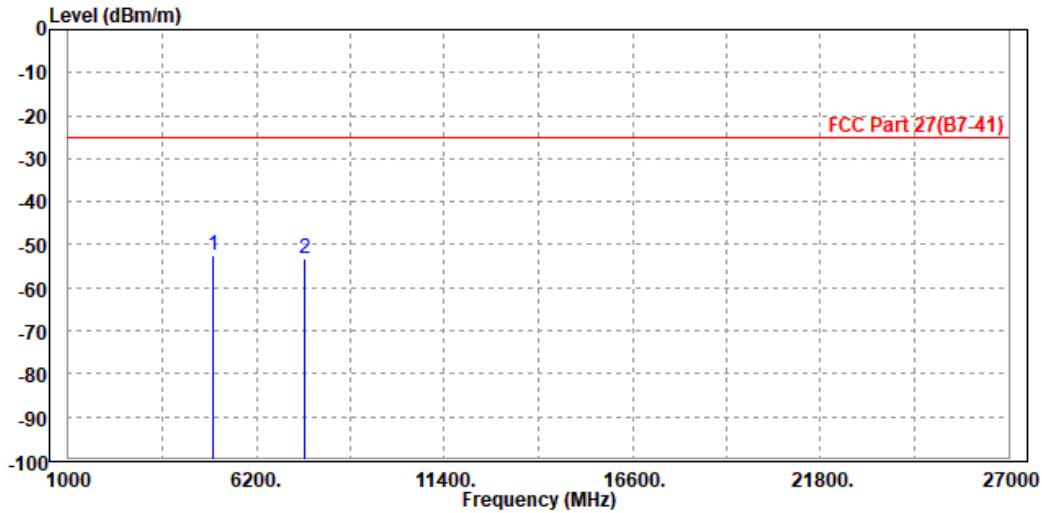



Test Report No.: RF200706W004-3

MODE	TX channel 20800	FREQUENCY RANGE	Above 1000MHz
ENVIRONMENTAL CONDITIONS	23deg. C, 70%RH	INPUT POWER	DC 5V from adapter
TESTED BY	Star Le		
ANTENNA POLARITY & TEST DISTANCE: VERTICAL AT 3 M			

	Freq	Level	Read Level	Limit Line	Over Limit	Factor	Remark	Pol/Phase
	MHz	dBm/m	dBm	dBm/m	dB	dB/m		
1	PP 5004.000	-50.66	-60.56	-25.00	-25.66	9.90	Peak	Vertical
2	7515.000	-51.14	-63.88	-25.00	-26.14	12.74	Peak	Vertical

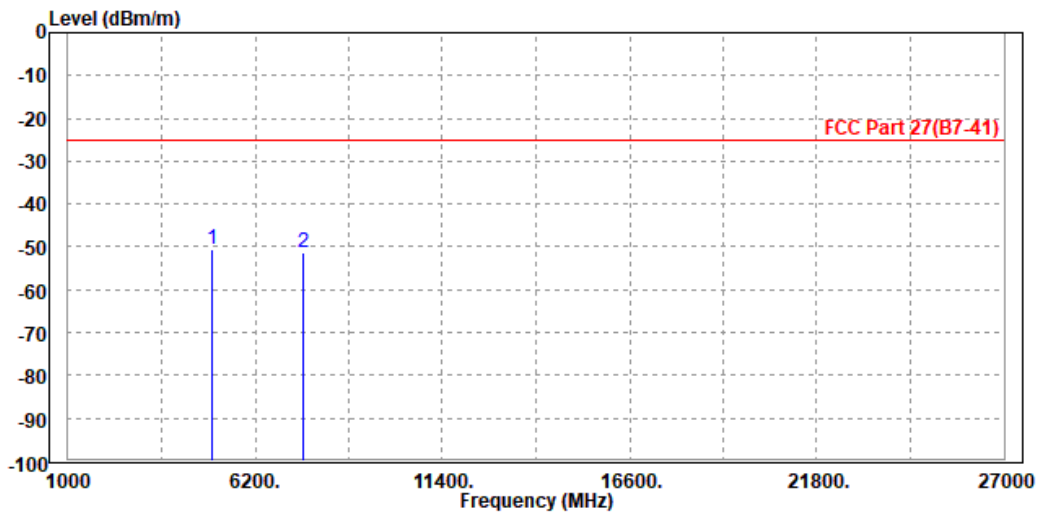



Test Report No.: RF200706W004-3

CH 21100

MODE	TX channel 21100	FREQUENCY RANGE	Above 1000MHz
ENVIRONMENTAL CONDITIONS	23deg. C, 70%RH	INPUT POWER	DC 5V from adapter
TESTED BY	Star Le		
ANTENNA POLARITY & TEST DISTANCE: HORIZONTAL AT 3 M			

	Freq	Level	Read Level	Limit Line	Over Limit	Factor	Remark	Pol/Phase
	MHz	dBm/m	dBm	dBm/m	dB	dB/m		
1	5070.000	-53.31	-62.04	-25.00	-28.31	8.73	Peak	Horizontal
2 PP	7605.000	-52.15	-63.55	-25.00	-27.15	11.40	Peak	Horizontal

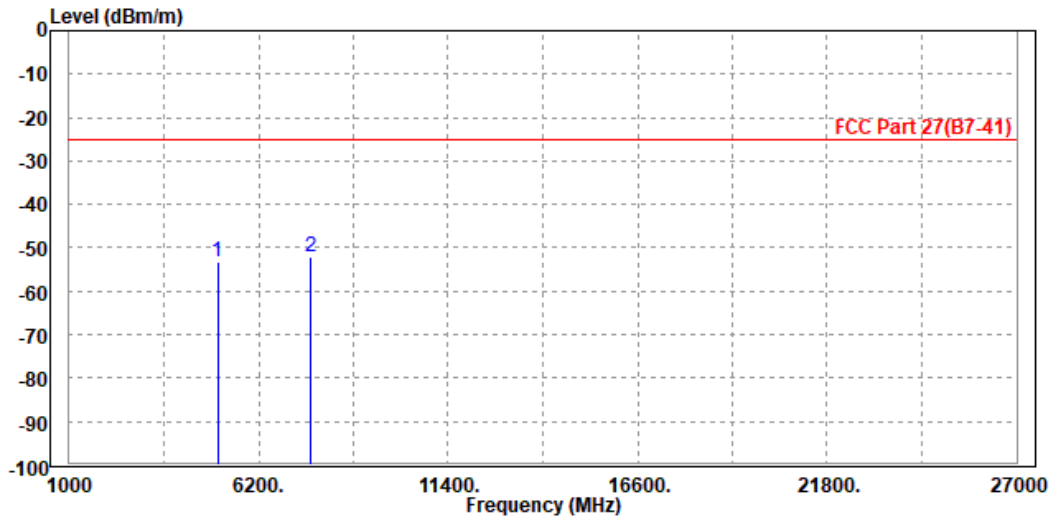



Test Report No.: RF200706W004-3

MODE	TX channel 21100	FREQUENCY RANGE	Above 1000MHz
ENVIRONMENTAL CONDITIONS	23deg. C, 70%RH	INPUT POWER	DC 5V from adapter
TESTED BY	Star Le		
ANTENNA POLARITY & TEST DISTANCE: VERTICAL AT 3 M			

	Read	Limit	Over				
Freq	Level	Level	Line	Limit	Factor	Remark	Pol/Phase
MHz	dBm/m	dBm	dBm/m	dB	dB/m		
1 PP 5070.000	-48.67	-58.54	-25.00	-23.67	9.87	Peak	Vertical
2 7604.000	-52.66	-65.44	-25.00	-27.66	12.78	Peak	Vertical

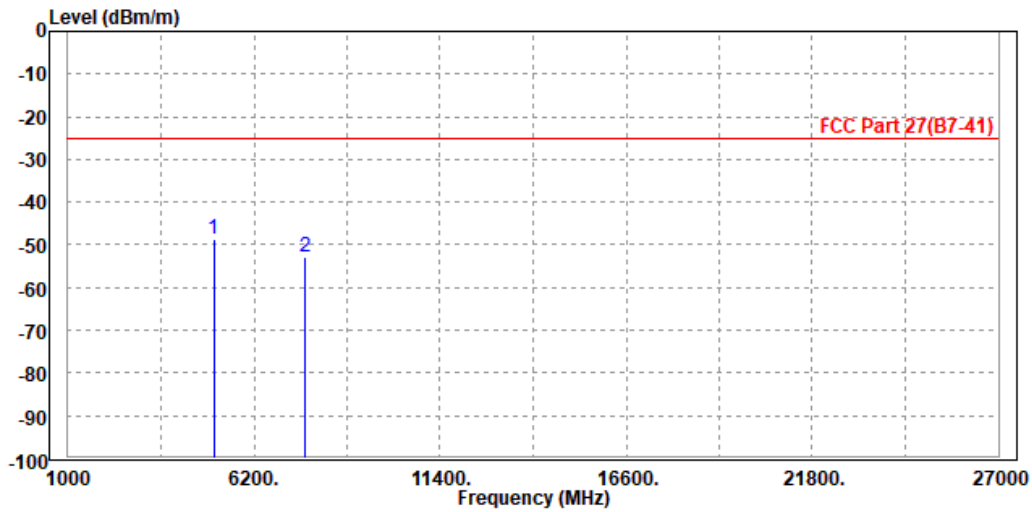



Test Report No.: RF200706W004-3

CH 21400

MODE	TX channel 21400	FREQUENCY RANGE	Above 1000MHz
ENVIRONMENTAL CONDITIONS	23deg. C, 70%RH	INPUT POWER	DC 5V from adapter
TESTED BY	Star Le		
ANTENNA POLARITY & TEST DISTANCE: HORIZONTAL AT 3 M			

	Freq	Level	Read Level	Limit Line	Over Limit	Factor	Remark	Pol/Phase
	MHz	dBm/m	dBm	dBm/m	dB	dB/m		
1	PP 5134.000	-52.72	-61.65	-25.00	-27.72	8.93	Peak	Horizontal
2	7695.000	-52.85	-64.29	-25.00	-27.85	11.44	Peak	Horizontal

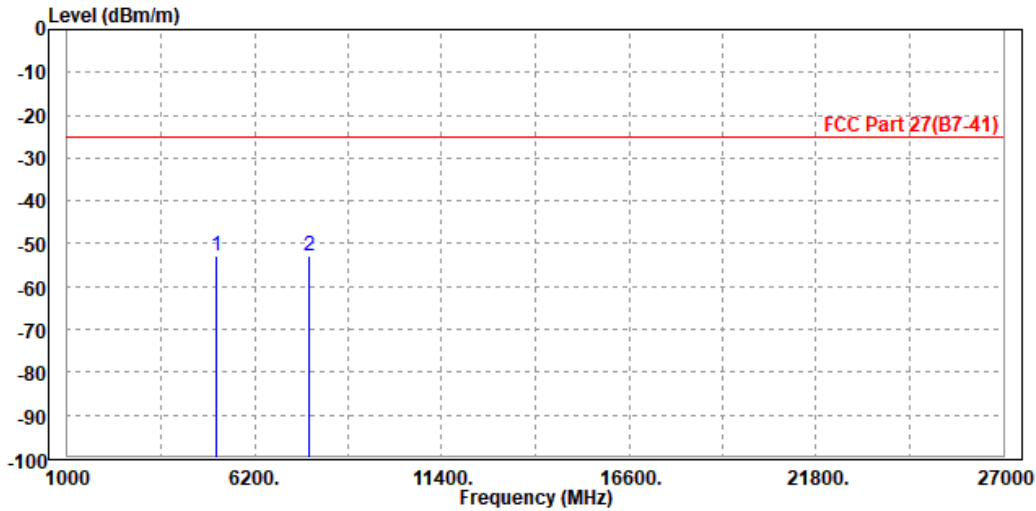



Test Report No.: RF200706W004-3

MODE	TX channel 21400	FREQUENCY RANGE	Above 1000MHz
ENVIRONMENTAL CONDITIONS	23deg. C, 70%RH	INPUT POWER	DC 5V from adapter
TESTED BY	Star Le		
ANTENNA POLARITY & TEST DISTANCE: VERTICAL AT 3 M			

	Freq	Level	Read Level	Limit Line	Over Limit	Factor	Remark	Pol/Phase
	MHz	dBm/m	dBm	dBm/m	dB	dB/m		
1	5134.000	-51.94	-61.79	-25.00	-26.94	9.85	Peak	Vertical
2	PP 7695.000	-50.15	-62.96	-25.00	-25.15	12.81	Peak	Vertical

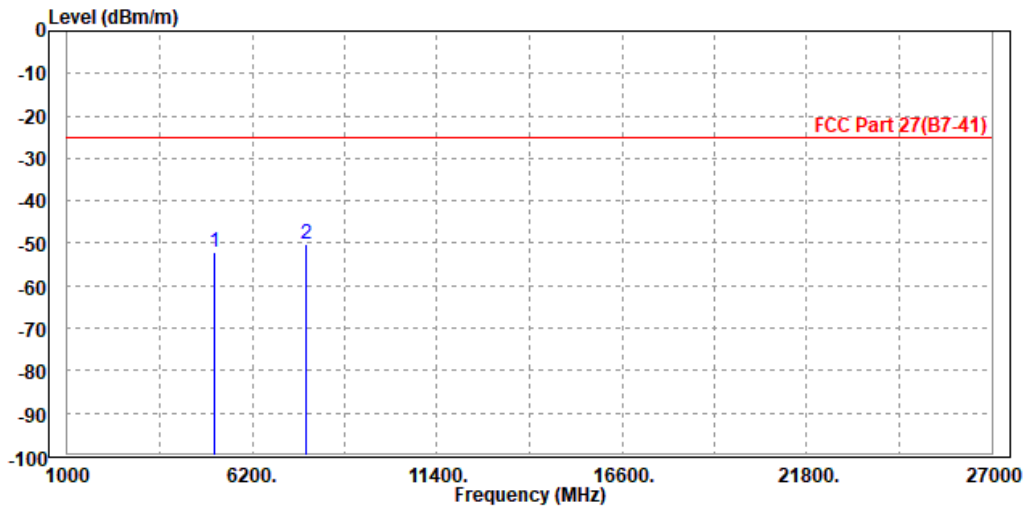



Test Report No.: RF200706W004-3

CHANNEL BANDWIDTH: 15MHz / QPSK

MODE	TX channel 21100	FREQUENCY RANGE	Above 1000MHz
ENVIRONMENTAL CONDITIONS	23deg. C, 70%RH	INPUT POWER	DC 5V from adapter
TESTED BY	Star Le		
ANTENNA POLARITY & TEST DISTANCE: HORIZONTAL AT 3 M			

	Read	Limit	Over				
Freq	Level	Level	Line	Limit	Factor	Remark	Pol/Phase
MHz	dBm/m	dBm	dBm/m	dB	dB/m		
1 PP 5070.000	-51.94	-60.67	-25.00	-26.94	8.73	Peak	Horizontal
2 7604.000	-52.31	-63.71	-25.00	-27.31	11.40	Peak	Horizontal

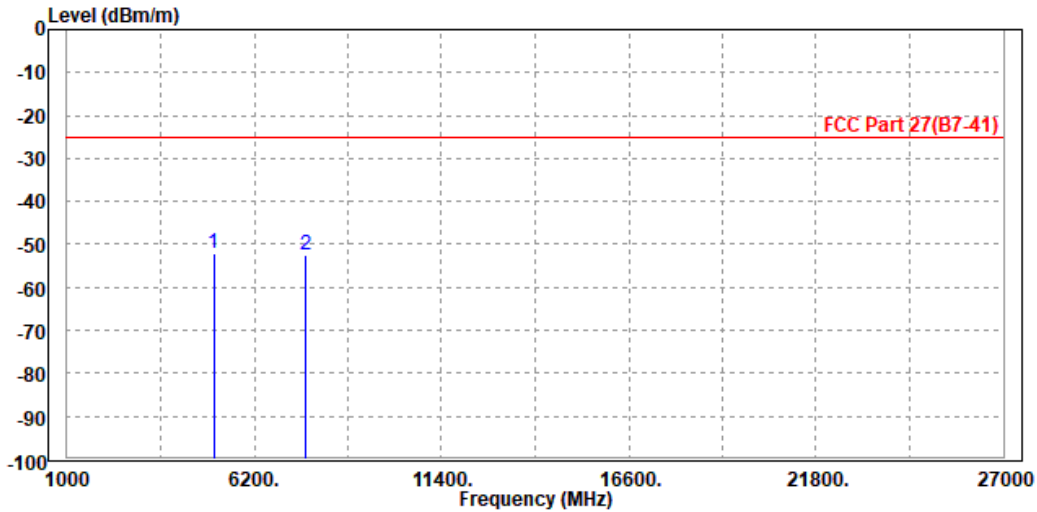



Test Report No.: RF200706W004-3

MODE	TX channel 21100	FREQUENCY RANGE	Above 1000MHz
ENVIRONMENTAL CONDITIONS	23deg. C, 70%RH	INPUT POWER	DC 5V from adapter
TESTED BY	Star Le		
ANTENNA POLARITY & TEST DISTANCE: VERTICAL AT 3 M			

	Freq	Level	Read Level	Limit Line	Over Limit	Factor	Remark	Pol/Phase
	MHz	dBm/m	dBm	dBm/m	dB	dB/m		
1	5070.000	-51.84	-61.71	-25.00	-26.84	9.87	Peak	Vertical
2 PP	7605.000	-49.73	-62.51	-25.00	-24.73	12.78	Peak	Vertical

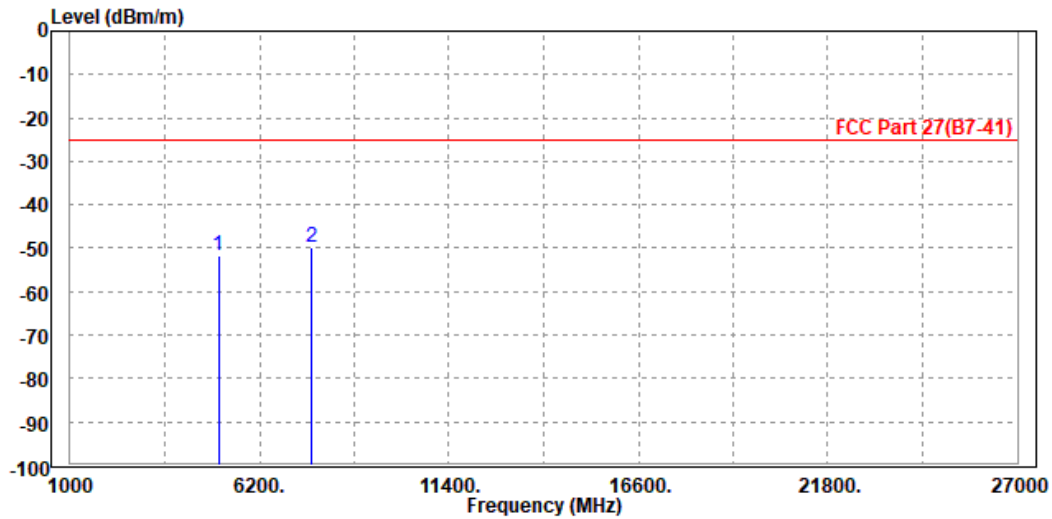



Test Report No.: RF200706W004-3

CHANNEL BANDWIDTH: 20MHz / QPSK

MODE	TX channel 21100	FREQUENCY RANGE	Above 1000MHz
ENVIRONMENTAL CONDITIONS	23deg. C, 70%RH	INPUT POWER	DC 5Vfrom adapter
TESTED BY	Star Le		
ANTENNA POLARITY & TEST DISTANCE: HORIZONTAL AT 3 M			

	Freq	Level	Read Level	Limit Line	Over Limit	Factor	Remark	Pol/Phase
	MHz	dBm/m	dBm	dBm/m	dB	dB/m		
1	5070.000	-52.47	-61.20	-25.00	-27.47	8.73	Peak	Horizontal
2 PP	7605.000	-52.33	-63.73	-25.00	-27.33	11.40	Peak	Horizontal

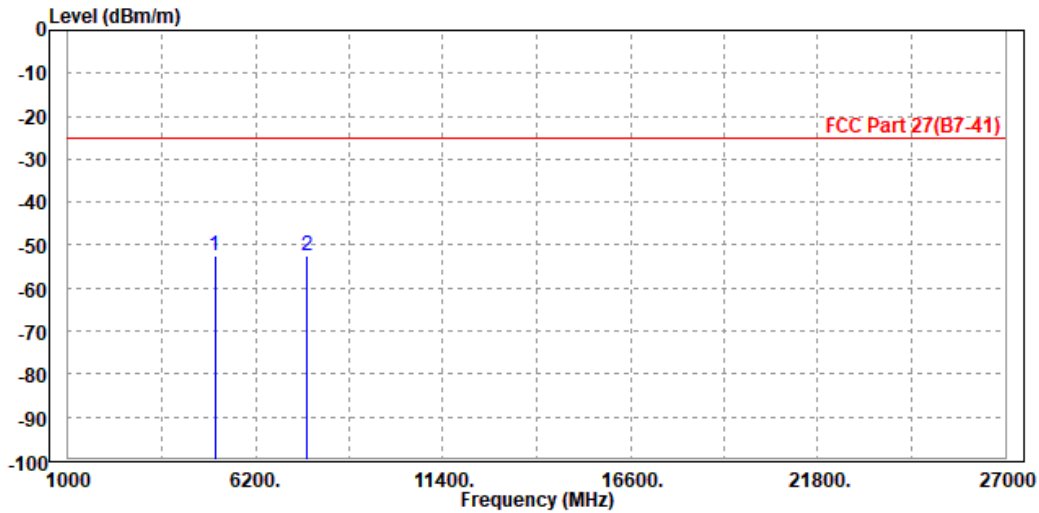



Test Report No.: RF200706W004-3

MODE	TX channel 21100	FREQUENCY RANGE	Above 1000MHz
ENVIRONMENTAL CONDITIONS	23deg. C, 70%RH	INPUT POWER	DC 5Vfrom adapter
TESTED BY	Star Le		
ANTENNA POLARITY & TEST DISTANCE: VERTICAL AT 3 M			

	Read	Limit	Over				
Freq	Level	Level	Line	Limit	Factor	Remark	Pol/Phase
MHz	dBm/m	dBm	dBm/m	dB	dB/m		
1 PP 5070.000	-49.65	-59.52	-25.00	-24.65	9.87	Peak	Vertical
2 7605.000	-49.89	-62.67	-25.00	-24.89	12.78	Peak	Vertical

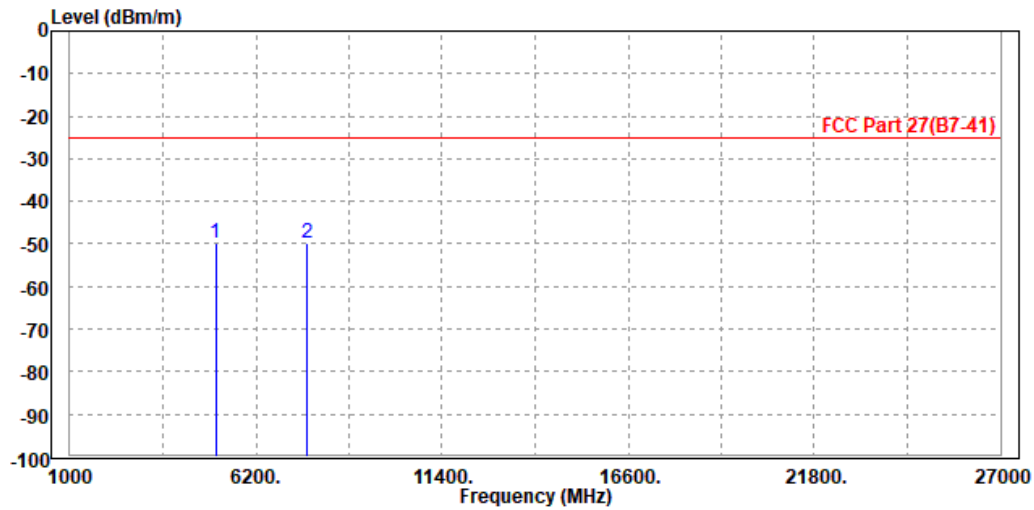



Test Report No.: RF200706W004-3

LTE Band 38

CHANNEL BANDWIDTH: 5MHz / QPSK

MODE	TX channel 38000	FREQUENCY RANGE	Above 1000MHz
ENVIRONMENTAL CONDITIONS	23deg. C, 70%RH	INPUT POWER	DC 5V from adapter
TESTED BY	Star Le		
ANTENNA POLARITY & TEST DISTANCE: HORIZONTAL AT 3 M			

	Freq	Level	Read Level	Limit Line	Over Limit	Factor	Remark	Pol/Phase
	MHz	dBm/m	dBm	dBm/m	dB	dB/m		
1	PP 5186.000	-48.37	-57.45	-25.00	-23.37	9.08	Peak	Horizontal
2	7785.000	-48.58	-60.06	-25.00	-23.58	11.48	Peak	Horizontal

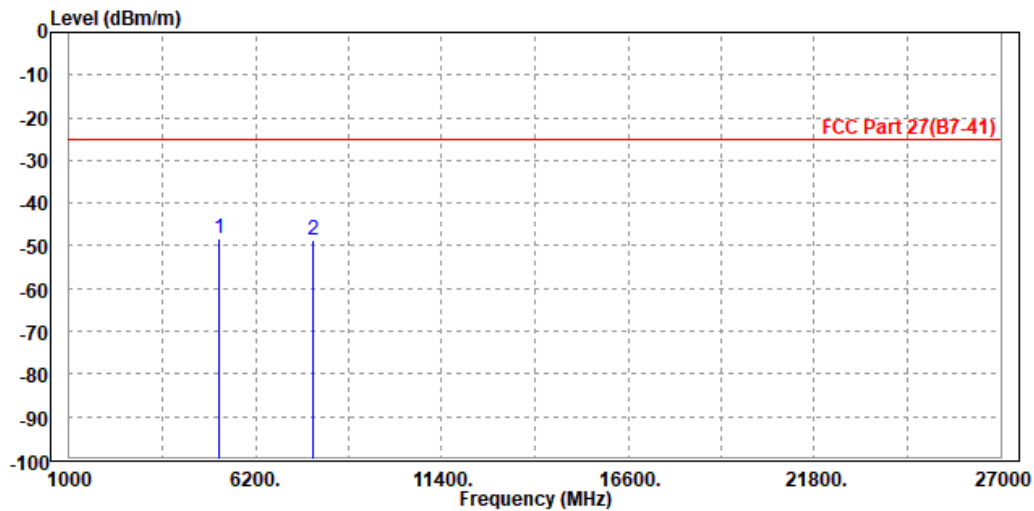



Test Report No.: RF200706W004-3

MODE	TX channel 38000	FREQUENCY RANGE	Above 1000MHz
ENVIRONMENTAL CONDITIONS	23deg. C, 70%RH	INPUT POWER	DC 5V from adapter
TESTED BY	Star Le		
ANTENNA POLARITY & TEST DISTANCE: VERTICAL AT 3 M			

	Freq	Level	Read Level	Limit Line	Over Limit	Factor	Remark	Pol/Phase
	MHz	dBm/m	dBm	dBm/m	dB	dB/m		
1	5186.000	-48.47	-58.30	-25.00	-23.47	9.83	Peak	Vertical
2	PP 7785.000	-48.25	-61.10	-25.00	-23.25	12.85	Peak	Vertical

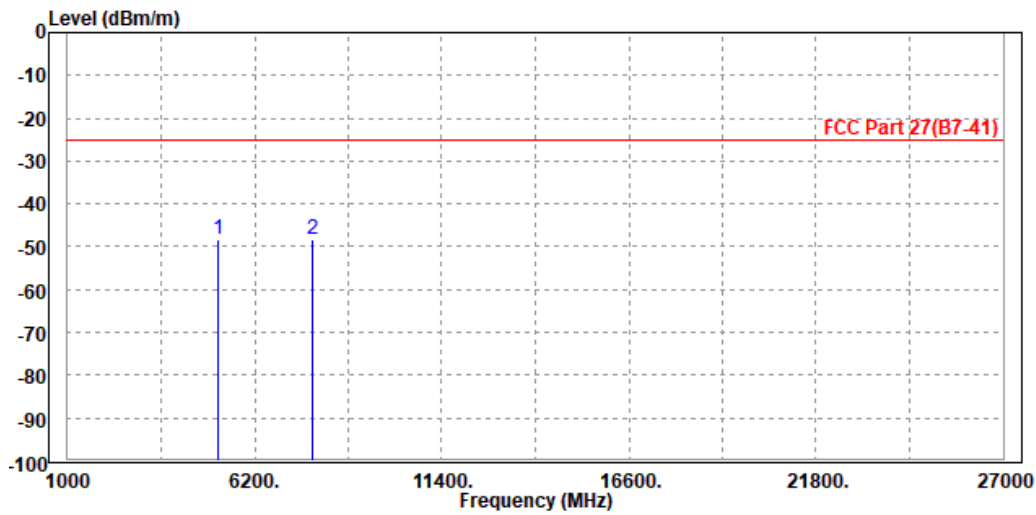



Test Report No.: RF200706W004-3

CHANNEL BANDWIDTH: 10MHz / QPSK

CH 37800

MODE	TX channel 37800	FREQUENCY RANGE	Above 1000MHz
ENVIRONMENTAL CONDITIONS	23deg. C, 70%RH	INPUT POWER	DC 5V from adapter
TESTED BY	Star Le		
ANTENNA POLARITY & TEST DISTANCE: HORIZONTAL AT 3 M			

	Read	Limit	Over			
Freq	Level	Level	Line	Limit	Factor	Remark
MHz	dBm/m	dBm	dBm/m	dB	dB/m	Pol/Phase
1 PP 5160.000	-49.26	-58.26	-25.00	-24.26	9.00	Peak Horizontal
2 7725.000	-49.37	-60.82	-25.00	-24.37	11.45	Peak Horizontal

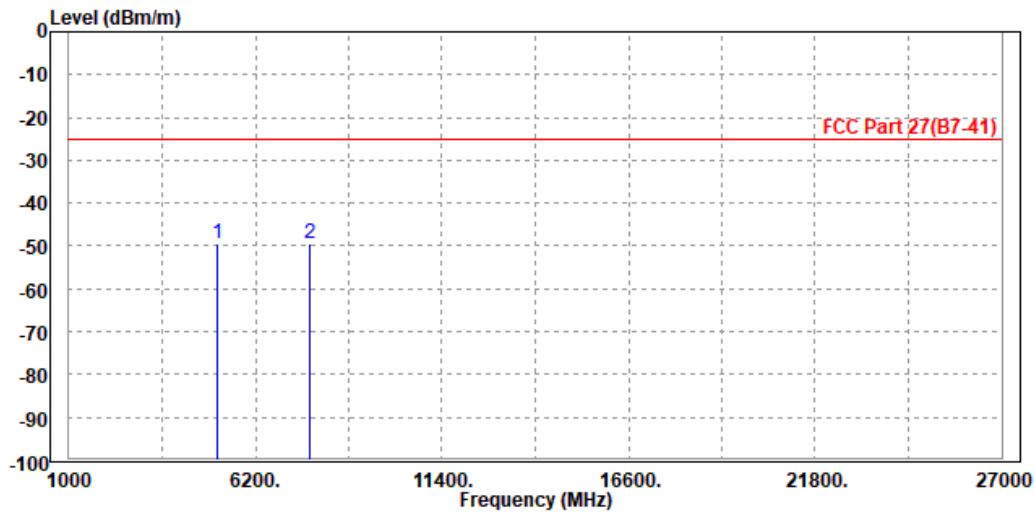



Test Report No.: RF200706W004-3

MODE	TX channel 37800	FREQUENCY RANGE	Above 1000MHz
ENVIRONMENTAL CONDITIONS	23deg. C, 70%RH	INPUT POWER	DC 5V from adapter
TESTED BY	Star Le		
ANTENNA POLARITY & TEST DISTANCE: HORIZONTAL AT 3 M			

	Freq	Level	Read Level	Limit Line	Over Limit	Factor	Remark	Pol/Phase
	MHz	dBm/m	dBm	dBm/m	dB	dB/m		
1	5160.000	-48.40	-58.24	-25.00	-23.40	9.84	Peak	Vertical
2 PP	7725.000	-47.77	-60.60	-25.00	-22.77	12.83	Peak	Vertical

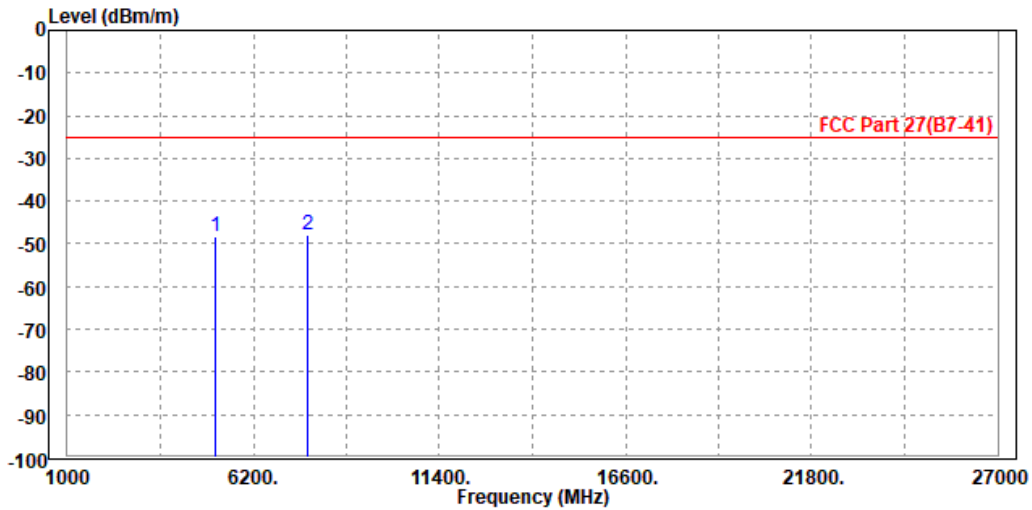



Test Report No.: RF200706W004-3

CH 38000

MODE	TX channel 38000	FREQUENCY RANGE	Above 1000MHz
ENVIRONMENTAL CONDITIONS	23deg. C, 70%RH	INPUT POWER	DC 5V from adapter
TESTED BY	Star Le		
ANTENNA POLARITY & TEST DISTANCE: HORIZONTAL AT 3 M			

	Freq	Level	Read Level	Limit Line	Over Limit	Factor	Remark	Pol/Phase
	MHz	dBm/m	dBm	dBm/m	dB	dB/m		
1	PP 5186.000	-48.07	-57.15	-25.00	-23.07	9.08	Peak	Horizontal
2	7785.000	-48.99	-60.47	-25.00	-23.99	11.48	Peak	Horizontal

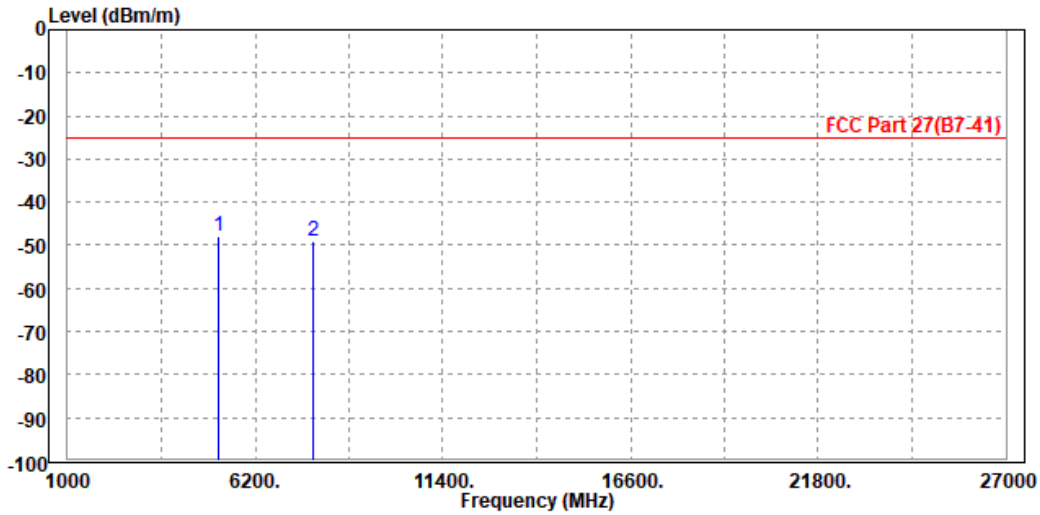



Test Report No.: RF200706W004-3

MODE	TX channel 38000	FREQUENCY RANGE	Above 1000MHz
ENVIRONMENTAL CONDITIONS	23deg. C, 70%RH	INPUT POWER	DC 5V from adapter
TESTED BY	Star Le		
ANTENNA POLARITY & TEST DISTANCE: VERTICAL AT 3 M			

	Freq	Level	Read Level	Limit Line	Over Limit	Factor	Remark	Pol/Phase
	MHz	dBm/m	dBm	dBm/m	dB	dB/m		
1	PP 5186.000	-47.12	-56.95	-25.00	-22.12	9.83	Peak	Vertical
2	7785.000	-47.15	-60.00	-25.00	-22.15	12.85	Peak	Vertical

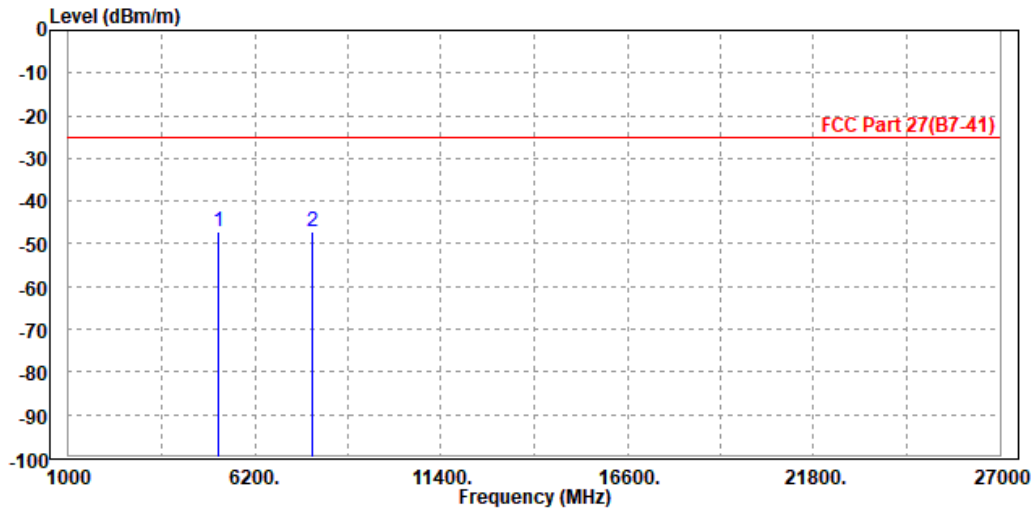



Test Report No.: RF200706W004-3

CH 38200

MODE	TX channel 38200	FREQUENCY RANGE	Above 1000MHz
ENVIRONMENTAL CONDITIONS	23deg. C, 70%RH	INPUT POWER	DC 5V from adapter
TESTED BY	Star Le		
ANTENNA POLARITY & TEST DISTANCE: HORIZONTAL AT 3 M			

	Freq	Level	Read Level	Limit Line	Over Limit	Factor	Remark	Pol/Phase
	MHz	dBm/m	dBm	dBm/m	dB	dB/m		
1	5238.000	-49.33	-58.57	-25.00	-24.33	9.24	Peak	Horizontal
2 PP	7845.000	-46.86	-58.36	-25.00	-21.86	11.50	Peak	Horizontal

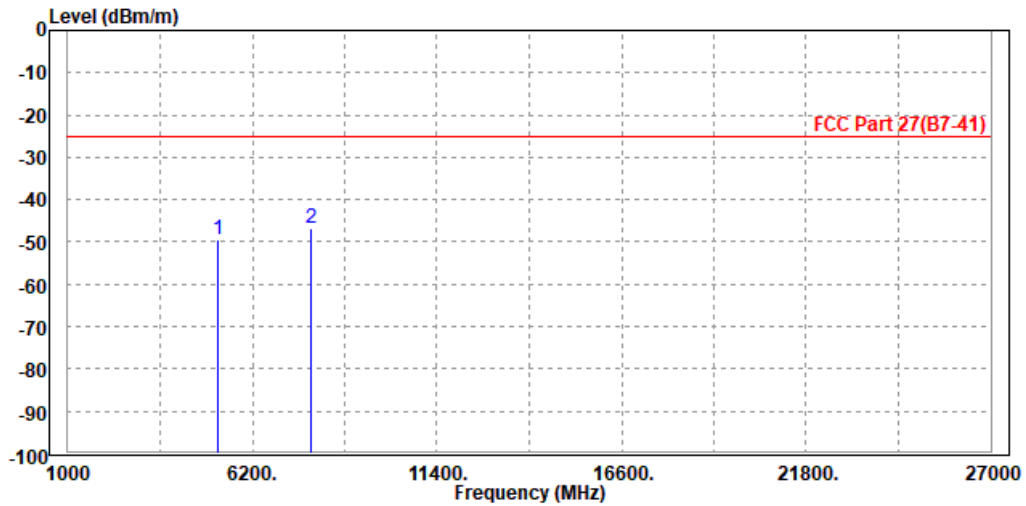



Test Report No.: RF200706W004-3

MODE	TX channel 38200	FREQUENCY RANGE	Above 1000MHz
ENVIRONMENTAL CONDITIONS	23deg. C, 70%RH	INPUT POWER	DC 5V from adapter
TESTED BY	Star Le		
ANTENNA POLARITY & TEST DISTANCE: HORIZONTAL AT 3 M			

	Freq	Level	Read Level	Limit Line	Over Limit	Factor	Remark	Pol/Phase
	MHz	dBm/m	dBm	dBm/m	dB	dB/m		
1	5238.000	-50.12	-59.93	-25.00	-25.12	9.81	Peak	Vertical
2 PP	7845.000	-44.17	-57.04	-25.00	-19.17	12.87	Peak	Vertical

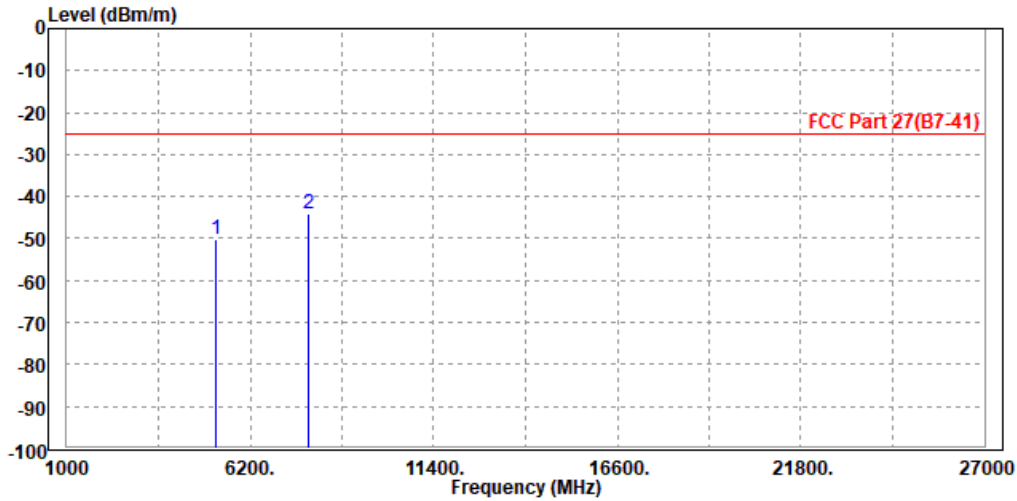



Test Report No.: RF200706W004-3

CHANNEL BANDWIDTH: 15MHz / QPSK

MODE	TX channel 38000	FREQUENCY RANGE	Above 1000MHz
ENVIRONMENTAL CONDITIONS	23deg. C, 70%RH	INPUT POWER	DC 5V from adapter
TESTED BY	Star Le		
ANTENNA POLARITY & TEST DISTANCE: HORIZONTAL AT 3 M			

	Freq	Level	Read Level	Limit Line	Over Limit	Factor	Remark	Pol/Phase
	MHz	dBm/m	dBm	dBm/m	dB	dB/m		
1	5186.000	-49.83	-58.91	-25.00	-24.83	9.08	Peak	Horizontal
2 PP	7785.000	-49.42	-60.90	-25.00	-24.42	11.48	Peak	Horizontal

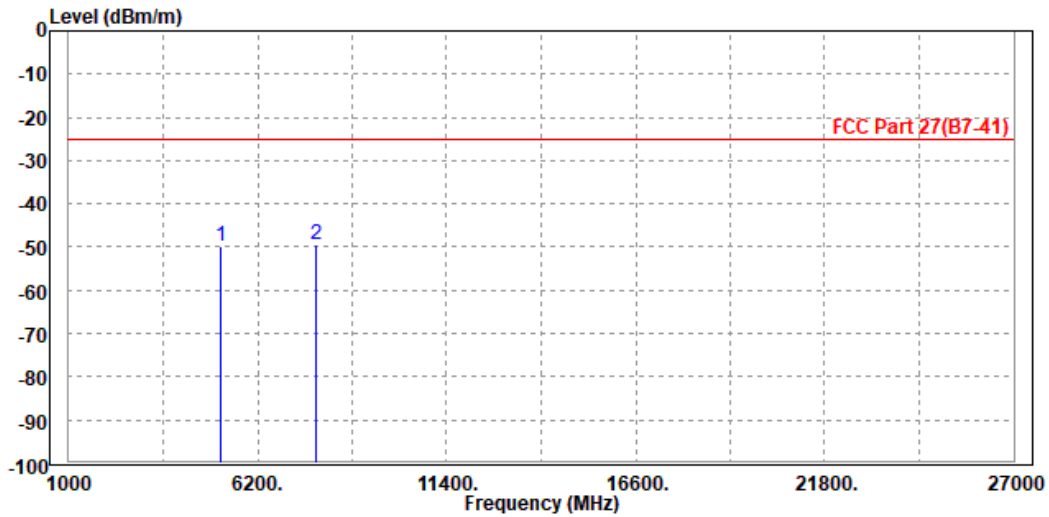



Test Report No.: RF200706W004-3

MODE	TX channel 38000	FREQUENCY RANGE	Above 1000MHz
ENVIRONMENTAL CONDITIONS	23deg. C, 70%RH	INPUT POWER	DC 5V from adapter
TESTED BY	Star Le		
ANTENNA POLARITY & TEST DISTANCE: VERTICAL AT 3 M			

	Freq	Level	Read Level	Limit Line	Over Limit	Factor	Remark	Pol/Phase
	MHz	dBm/m	dBm	dBm/m	dB	dB/m		
1	5186.000	-49.55	-59.38	-25.00	-24.55	9.83	Peak	Vertical
2 PP	7785.000	-48.57	-61.42	-25.00	-23.57	12.85	Peak	Vertical

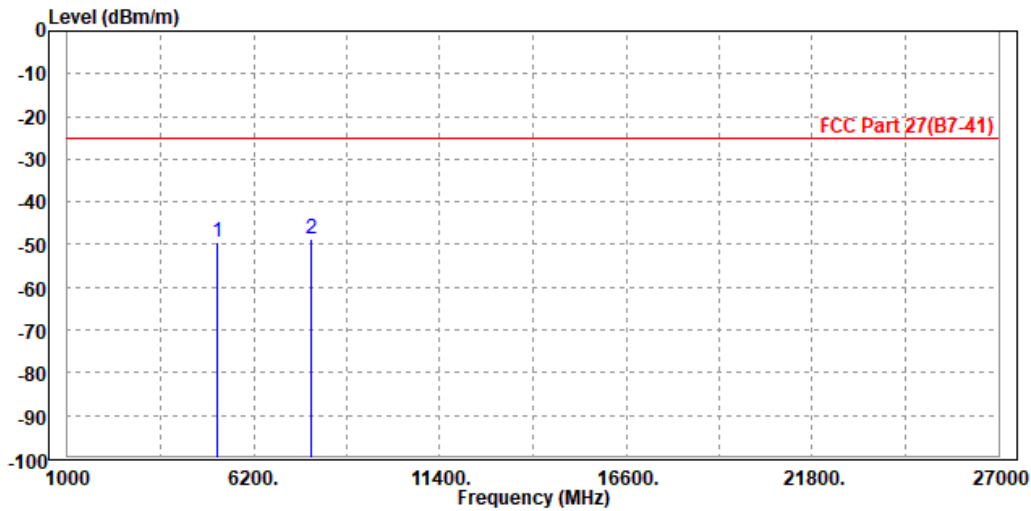



Test Report No.: RF200706W004-3

CHANNEL BANDWIDTH: 20MHz / QPSK

MODE	TX channel 38000	FREQUENCY RANGE	Above 1000MHz
ENVIRONMENTAL CONDITIONS	23deg. C, 70%RH	INPUT POWER	DC 5V from adapter
TESTED BY	Star Le		
ANTENNA POLARITY & TEST DISTANCE: HORIZONTAL AT 3 M			

	Freq	Level	Read Level	Limit Line	Over Limit	Factor	Remark	Pol/Phase
	MHz	dBm/m	dBm	dBm/m	dB	dB/m		
1	5186.000	-50.61	-59.69	-25.00	-25.61	9.08	Peak	Horizontal
2 PP	7785.000	-50.12	-61.60	-25.00	-25.12	11.48	Peak	Horizontal

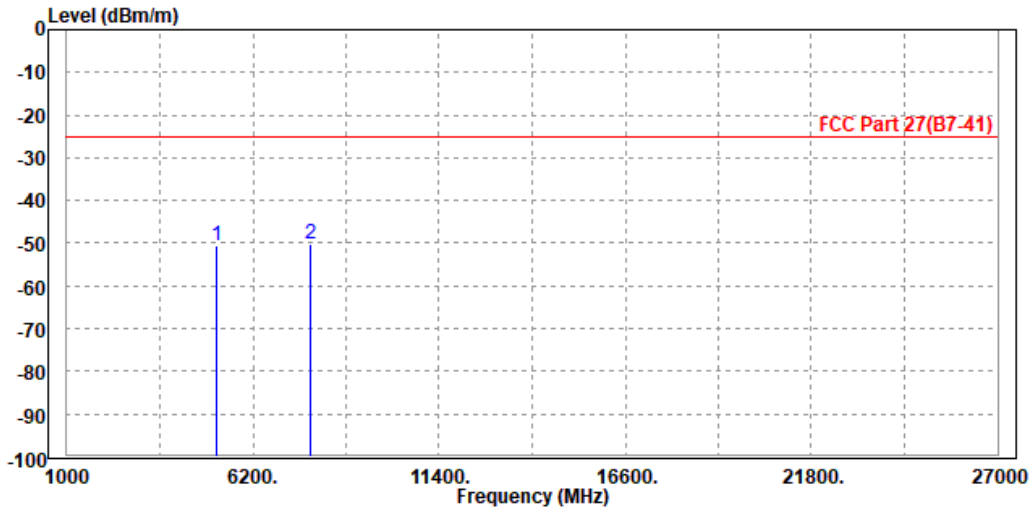



Test Report No.: RF200706W004-3

MODE	TX channel 38000	FREQUENCY RANGE	Above 1000MHz
ENVIRONMENTAL CONDITIONS	23deg. C, 70%RH	INPUT POWER	DC 5V from adapter
TESTED BY	Star Le		
ANTENNA POLARITY & TEST DISTANCE: VERTICAL AT 3 M			

	Freq	Level	Read Level	Limit Line	Over Limit	Factor	Remark	Pol/Phase
	MHz	dBm/m	dBm	dBm/m	dB	dB/m		
1	5186.000	-49.69	-59.52	-25.00	-24.69	9.83	Peak	Vertical
2 PP	7785.000	-47.35	-60.20	-25.00	-22.35	12.85	Peak	Vertical

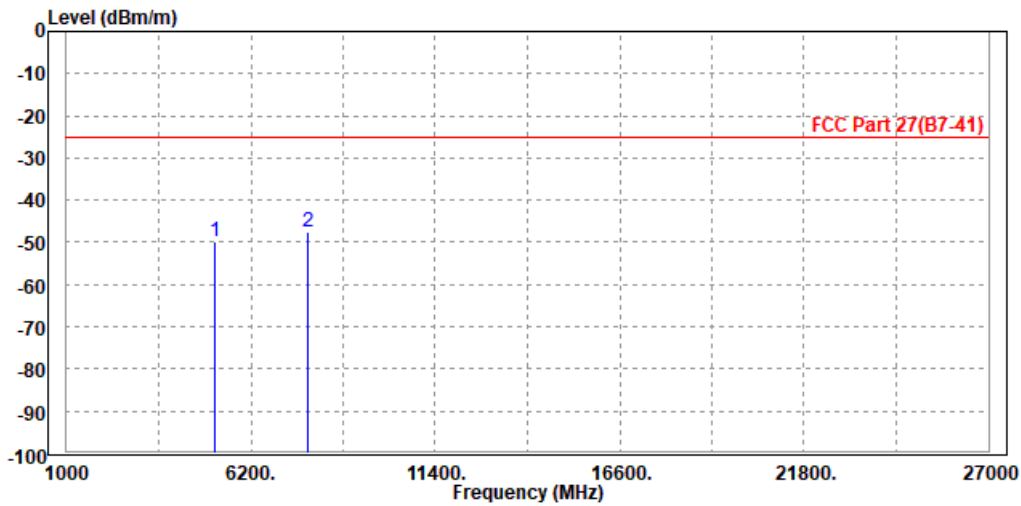



Test Report No.: RF200706W004-3

4 INFORMATION ON THE TESTING LABORATORIES

We, BV 7LAYERS COMMUNICATIONS TECHNOLOGY (SHENZHEN) CO. LTD., were founded in 2015 to provide our best service in EMC, Radio, Telecom and Safety consultation. Our laboratories are accredited and approved according to ISO/IEC 17025.

If you have any comments, please feel free to contact us at the following:

Shenzhen EMC/RF Lab:

Tel: +86-755-88696566

Fax: +86-755-88696577

Email: customerservice.dg@cn.bureauveritas.com

Web Site: www.adt.com.tw

The address and road map of all our labs can be found in our web site also.



Test Report No.: RF200706W004-3

5 APPENDIX A – MODIFICATIONS RECORDERS FOR ENGINEERING CHANGES TO THE EUT BY THE LAB

No any modifications are made to the EUT by the lab during the test.

---END---