



SAR TEST REPORT

No. I20Z61291-SEM01

For

HMD Global Oy

GSM/WCDMA/LTE phone

Model name: TA-1307

With

Hardware Version: 0142

Software Version: 0.2031.10.06

FCC ID: 2AJOTTA-1307

Issued Date: 2020-9-30

Note:

The test results in this test report relate only to the devices specified in this report. This report shall not be reproduced except in full without the written approval of CTTL.

The report must not be used by the client to claim product certification, approval, or endorsement by NVLAP, NIST, or any agency of the U.S. Government.

Test Laboratory:

CTTL, Telecommunication Technology Labs, CAICT

No. 51, Xueyuan Road, Haidian District, Beijing, P. R. China 100191.

Tel:+86(0)10-62304633-2512, Fax:+86(0)10-62304633-2504

Email: ctl_terminals@caict.ac.cn, website: www.caict.ac.cn



No.I20Z61291-SEM01

REPORT HISTORY

Report Number	Revision	Issue Date	Description
I20Z61291-SEM01	Rev.0	2020-9-30	Initial creation of test report



TABLE OF CONTENT

1 TEST LABORATORY	5
1.1 TESTING LOCATION	5
1.2 TESTING ENVIRONMENT.....	5
1.3 PROJECT DATA	5
1.4 SIGNATURE.....	5
2 STATEMENT OF COMPLIANCE	6
3 CLIENT INFORMATION.....	8
3.1 APPLICANT INFORMATION	8
3.2 MANUFACTURER INFORMATION	8
4 EQUIPMENT UNDER TEST (EUT) AND ANCILLARY EQUIPMENT (AE)	9
4.1 ABOUT EUT.....	9
4.2 INTERNAL IDENTIFICATION OF EUT USED DURING THE TEST	9
4.3 INTERNAL IDENTIFICATION OF AE USED DURING THE TEST	9
5 TEST METHODOLOGY	10
5.1 APPLICABLE LIMIT REGULATIONS.....	10
5.2 APPLICABLE MEASUREMENT STANDARDS	10
7 TISSUE SIMULATING LIQUIDS	11
7.1 TARGETS FOR TISSUE SIMULATING LIQUID.....	11
7.2 DIELECTRIC PERFORMANCE	11
8 SYSTEM VERIFICATION.....	15
8.1 SYSTEM SETUP.....	15
8.2 SYSTEM VERIFICATION.....	16
9 MEASUREMENT PROCEDURES	17
9.1 TESTS TO BE PERFORMED	17
6 SPECIFIC ABSORPTION RATE (SAR).....	19
6.1 INTRODUCTION.....	19
6.2 SAR DEFINITION.....	19
9.2 GENERAL MEASUREMENT PROCEDURE.....	20
9.3 WCDMA MEASUREMENT PROCEDURES FOR SAR	21
9.4 SAR MEASUREMENT FOR LTE.....	22
9.5 BLUETOOTH & WI-FI MEASUREMENT PROCEDURES FOR SAR	24
9.6 POWER DRIFT.....	24
10 AREA SCAN BASED 1-G SAR	25
10.1 REQUIREMENT OF KDB.....	25
10.2 FAST SAR ALGORITHMS.....	25



11 CONDUCTED OUTPUT POWER.....	26
11.1 GSM MEASUREMENT RESULT	26
11.2 WCDMA MEASUREMENT RESULT	28
11.3 LTE MEASUREMENT RESULT	30
11.4 WI-FI AND BT MEASUREMENT RESULT	52
12 SIMULTANEOUS TX SAR CONSIDERATIONS	53
12.1 INTRODUCTION.....	53
12.2 TRANSMIT ANTENNA SEPARATION DISTANCES.....	53
12.3 SAR MEASUREMENT POSITIONS	54
12.4 STANDALONE SAR TEST EXCLUSION CONSIDERATIONS	54
13 EVALUATION OF SIMULTANEOUS.....	55
14 SAR TEST RESULT	56
14.1 SAR RESULTS FOR FAST SAR	57
14.2 SAR RESULTS FOR STANDARD PROCEDURE	69
14.3 WLAN EVALUATION FOR 2.4G	75
14.4 BT EVALUATION.....	78
15 SAR MEASUREMENT VARIABILITY.....	78
16 MEASUREMENT UNCERTAINTY	81
16.1 MEASUREMENT UNCERTAINTY FOR NORMAL SAR TESTS (300MHZ~3GHZ).....	81
16.2 MEASUREMENT UNCERTAINTY FOR NORMAL SAR TESTS (3~6GHZ)	82
16.3 MEASUREMENT UNCERTAINTY FOR FAST SAR TESTS (300MHZ~3GHZ).....	83
16.4 MEASUREMENT UNCERTAINTY FOR FAST SAR TESTS (3~6GHZ)	84
17 MAIN TEST INSTRUMENTS	85
ANNEX A GRAPH RESULTS.....	86
ANNEX B SYSTEM VERIFICATION RESULTS.....	124
ANNEX C SAR MEASUREMENT SETUP	131
ANNEX D POSITION OF THE WIRELESS DEVICE IN RELATION TO THE PHANTOM	137
ANNEX E EQUIVALENT MEDIA RECIPES	140
ANNEX F SYSTEM VALIDATION	141
ANNEX G PROBE CALIBRATION CERTIFICATE	142
ANNEX H DIPOLE CALIBRATION CERTIFICATE.....	165
ANNEX I ACCREDITATION CERTIFICATE.....	213

1 Test Laboratory

1.1 Testing Location

Company Name:	CTTL(Shouxiang)
Address:	No. 51 Shouxiang Science Building, Xueyuan Road, Haidian District, Beijing, P. R. China100191

1.2 Testing Environment

Temperature:	18°C~25°C,
Relative humidity:	30%~ 70%
Ground system resistance:	< 0.5 Ω
Ambient noise & Reflection:	< 0.012 W/kg

1.3 Project Data

Project Leader:	Qi Dianyuan
Test Engineer:	Lin Xiaojun
Testing Start Date:	September 22, 2020
Testing End Date:	September 27,, 2020

1.4 Signature



Lin Xiaojun

(Prepared this test report)

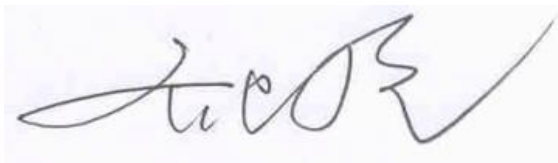

Qi Dianyuan

(Reviewed this test report)

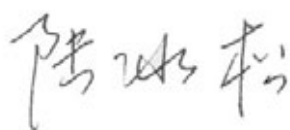

Lu Bingsong

Deputy Director of the laboratory

(Approved this test report)

2 Statement of Compliance

The maximum results of SAR found during testing for HMD Global Oy GSM/WCDMA/LTE phone TA-1307 are as follows:

Table 2.1: Highest Reported SAR (1g)

Exposure Configuration	Technology Band	Highest Reported SAR 1g(W/kg)	Equipment Class
Head (Separation Distance 0mm)	GSM 850	0.54	PCE
	PCS 1900	0.84	
	UMTS FDD 2	0.93	
	UMTS FDD 4	1.19	
	UMTS FDD 5	0.90	
	LTE Band 2	0.94	
	LTE Band 4	1.10	
	LTE Band 5	0.82	
	LTE Band 7	1.20	
	LTE Band 28	0.45	
WLAN 2.4 GHz	0.17	DTS	
Hotspot (Separation Distance 10mm)	GSM 850	0.75	PCE
	PCS 1900	1.31	
	UMTS FDD 2	0.91	
	UMTS FDD 4	1.07	
	UMTS FDD 5	1.25	
	LTE Band 2	1.15	
	LTE Band 4	1.22	
	LTE Band 5	0.99	
	LTE Band 7	0.73	
	LTE Band 28	0.40	
WLAN 2.4 GHz	0.07	DTS	
Body-worn (Separation Distance 15mm)	GSM1900	0.79	PCE
	WCDMA1900	1.06	
	WCDMA1700	0.75	
	LTE Band2	1.02	
	LTE Band4	0.81	
LTE Band7	0.61		

The SAR values found for the Mobile Phone are below the maximum recommended levels of 1.6 W/kg as averaged over any 1g tissue according to the ANSI C95.1-1992.

For body operation, this device has been tested and meets FCC RF exposure guidelines when used with any accessory that contains no metal and which provides a minimum separation distance of 10 mm for hotspot and 15mm for body worn between this device and the body of the user. Use of other accessories may not ensure compliance with FCC RF exposure guidelines.

The EUT battery must be fully charged and checked periodically during the test to ascertain uniform power output.

The measurement together with the test system set-up is described in annex C of this test report. A detailed description of the equipment under test can be found in chapter 4 of this test report. The highest reported SAR value is obtained at the case of (Table 2.1), and the values are: **1.31 W/kg(1g)**.

Table 2.2: The sum of reported SAR values for main antenna and WiFi.4G

	Position	Main antenna	WiFi	Sum
Highest reported SAR value for Head	Right head, Cheek	1.20	0.17	1.37
Highest reported SAR value for Hotspot	Bottom 10mm	1.31	0.00	1.31
Highest reported SAR value for Hotspot	Rear 10mm	1.25	0.07	1.32
Highest reported SAR value for Body	Rear 15mm	1.06	0.07	1.13

Table 2.4: The sum of reported SAR values for main antenna and BT

	Position	Main antenna	BT	Sum
Maximum reported SAR value for Head	Right head, Cheek	1.20	<0.01	1.20
Maximum reported SAR value for Hotspot	Bottom 10mm	1.31	<0.01	1.31
Highest reported SAR value for Body	Rear 15mm	1.06	<0.01	1.06

According to the above tables, the highest sum of reported SAR values is **1.37W/kg (1g)**. The detail for simultaneous transmission consideration is described in chapter 13.



3 Client Information

3.1 Applicant Information

Company Name:	HMD Global Oy
Address/Post:	Bertel Jungin aukio 9, 02600 Espoo, FINLAND
Contact Person:	Mikko Kahlos
Contact Email:	mikko.kahlos@hmdglobal.com
Telephone:	+358 408036126
Fax	011112220

3.2 Manufacturer Information

Company Name:	HMD Global Oy
Address/Post:	Bertel Jungin aukio 9, 02600 Espoo, FINLAND
Contact Person:	Mikko Kahlos
Contact Email:	mikko.kahlos@hmdglobal.com
Telephone:	+358 408036126
Fax	011112220

4 Equipment Under Test (EUT) and Ancillary Equipment (AE)

4.1 About EUT

Description:	GSM/WCDMA/LTE phone
Model name:	TA-1307
Operating mode(s):	GSM 850/900/1800/1900, WCDMA850/900/1700/1900/2100, BT, Wi-Fi(2.4G) LTE Band 2/3/4/5/7/28
Tested Tx Frequency:	824 – 849 MHz (GSM 850)
	1850 – 1910 MHz (GSM 1900)
	824–849 MHz (WCDMA 850 Band V)
	1710 – 1755 MHz (WCDMA 1700 Band IV)
	1850–1910 MHz (WCDMA1900 Band II)
	1850.7 – 1909.3 MHz(LTE Band 2)
	1710 – 1755 MHz(LTE Band4)
	824.7 – 848.3 MHz(LTE Band 5)
	2502.5 – 2567.5 MHz(LTE Band 7)
	704.5 – 746.5MHz(LTE Band 28)
2412 – 2462 MHz (Wi-Fi 2.4G)	
GPRS/EGPRS Multislot Class:	33
GPRS capability Class:	B
Test device Production information:	Production unit
Device type:	Portable device
Antenna type:	Integrated antenna
Hotspot mode:	Support

4.2 Internal Identification of EUT used during the test

EUT ID*	IMEI	HW	SW Version
EUT1	004402972490928	0142	0.2031.10.06
EUT2	004402972491108	0142	0.2031.10.06
EUT3	004402972490985	0142	0.2031.10.06

*EUT ID: is used to identify the test sample in the lab internally.

Note: It is performed to test SAR with the EUT1 and conducted power with the EUT2~3.

4.3 Internal Identification of AE used during the test

AE ID*	Description	Model	SN	Manufacturer
AE1	Battery	BL-4XL	/	ZHONGSHAN TIANMAO BATTERY CO., LTD
AE2	Headset	WH-108	/	Rongtaifeng

*AE ID: is used to identify the test sample in the lab internally.

5 TEST METHODOLOGY

5.1 Applicable Limit Regulations

ANSI C95.1–1992:IEEE Standard for Safety Levels with Respect to Human Exposure to Radio Frequency Electromagnetic Fields, 3 kHz to 300 GHz.

It specifies the maximum exposure limit of **1.6 W/kg** as averaged over any 1 gram of tissue for portable devices being used within 20 cm of the user in the uncontrolled environment.

5.2 Applicable Measurement Standards

IEEE 1528–2013: Recommended Practice for Determining the Peak Spatial-Average Specific Absorption Rate (SAR) in the Human Head from Wireless Communications Devices: Measurement Techniques.

KDB447498 D01: General RF Exposure Guidance v06: Mobile and Portable Devices RF Exposure Procedures and Equipment Authorization Policies.

KDB648474 D04 Handset SAR v01r03: SAR Evaluation Considerations for Wireless Handsets.

KDB941225 D01 SAR test for 3G devices v03r01: SAR Measurement Procedures for 3G Devices

KDB941225 D05 SAR for LTE Devices v02r05: SAR Evaluation Considerations for LTE Devices

KDB941225 D06 Hotspot Mode SAR v02r01: SAR Evaluation Procedures for Portable Devices with Wireless Router Capabilities

KDB248227 D01 802.11 Wi-Fi SAR v02r02: SAR GUIDANCE FOR IEEE 802.11 (Wi-Fi) TRANSMITTERS

KDB865664 D01 SAR measurement 100 MHz to 6 GHz v01r04: SAR Measurement Requirements for 100 MHz to 6 GHz.

KDB865664 D02 RF Exposure Reporting v01r02: RF Exposure Compliance Reporting and Documentation Considerations

7 Tissue Simulating Liquids

7.1 Targets for tissue simulating liquid

Table 7.1: Targets for tissue simulating liquid

Frequency(MHz)	Liquid Type	Conductivity(σ)	$\pm 5\%$ Range	Permittivity(ϵ)	$\pm 5\%$ Range
750	Head	0.89	0.85~0.93	41.94	39.8~44.0
835	Head	0.90	0.86~0.95	41.5	39.4~43.6
1750	Head	1.37	1.30~1.44	40.08	38.1~42.1
1900	Head	1.40	1.33~1.47	40.0	38.0~42.0
2450	Head	1.80	1.71~1.89	39.2	37.2~41.2
2600	Head	1.96	1.86~2.06	39.01	37.1~41.0

7.2 Dielectric Performance

Table 7.2: Dielectric Performance of Tissue Simulating Liquid

Measurement Date yyyy/mm/dd	Frequency	Type	Permittivity ϵ	Drift (%)	Conductivity σ (S/m)	Drift (%)
2020/9/22	750 MHz	Head	42.5	1.34	0.89	0.00
2020/9/23	835 MHz	Head	40.69	-1.95	0.888	-1.33
2020/9/24	1750 MHz	Head	40.2	0.30	1.354	-1.17
2020/9/25	1900 MHz	Head	39.38	-1.55	1.411	0.79
2020/9/26	2450 MHz	Head	39.83	1.61	1.818	1.00
2020/9/27	2600 MHz	Head	39.01	0.00	1.956	-0.20

Note: The liquid temperature is 22.0°C

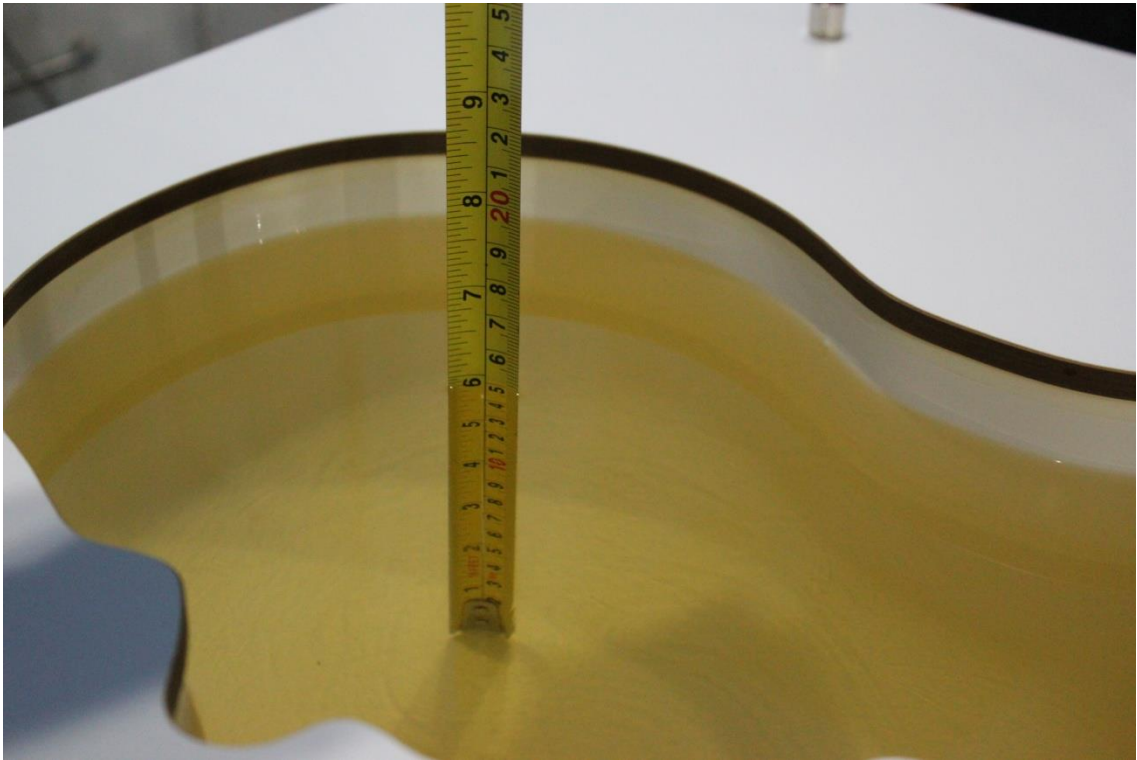

Picture 7-1 Liquid depth in the Head Phantom (750MHz)

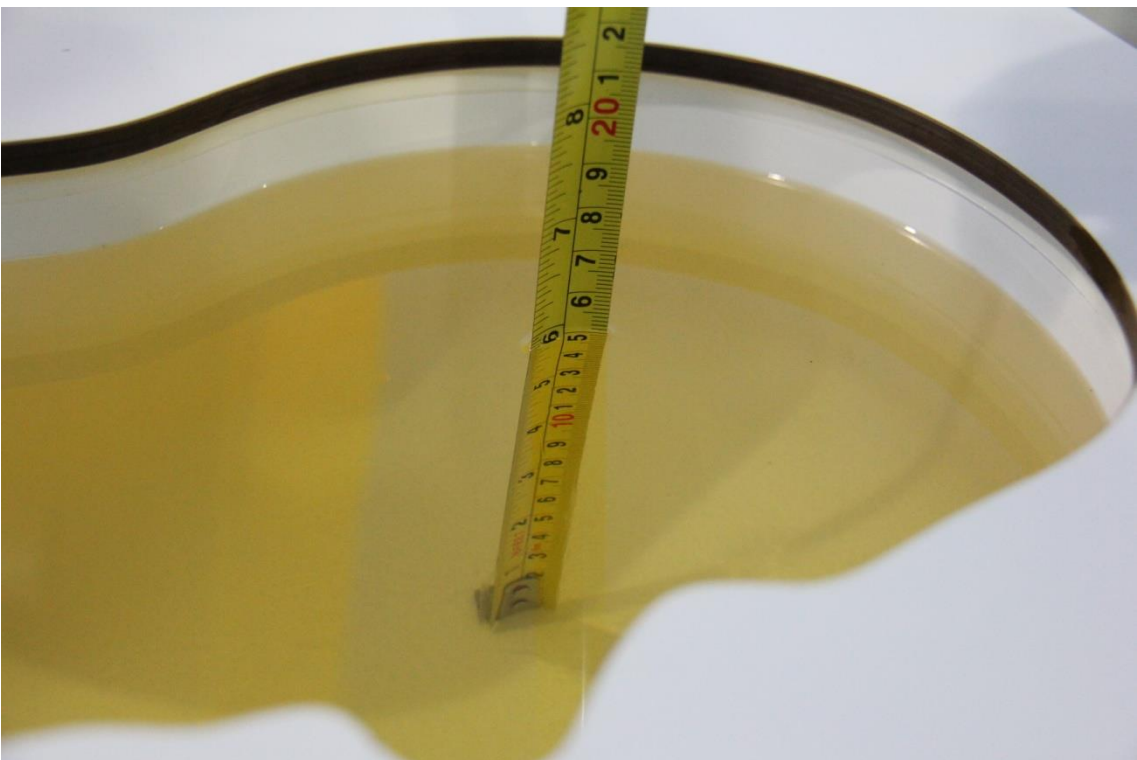

Picture 7-2 Liquid depth in the Head Phantom (835 MHz)

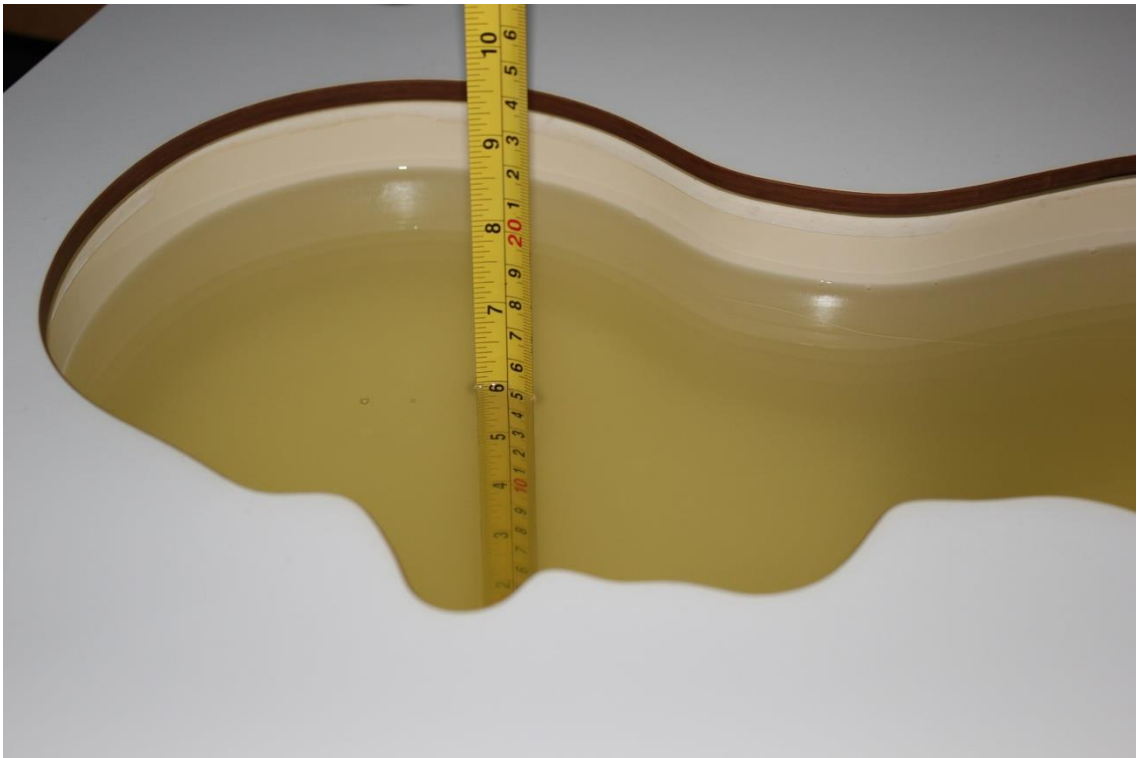

Picture 7-3 Liquid depth in the Head Phantom (1750 MHz)



Picture 7-4 Liquid depth in the Head Phantom (1900 MHz)

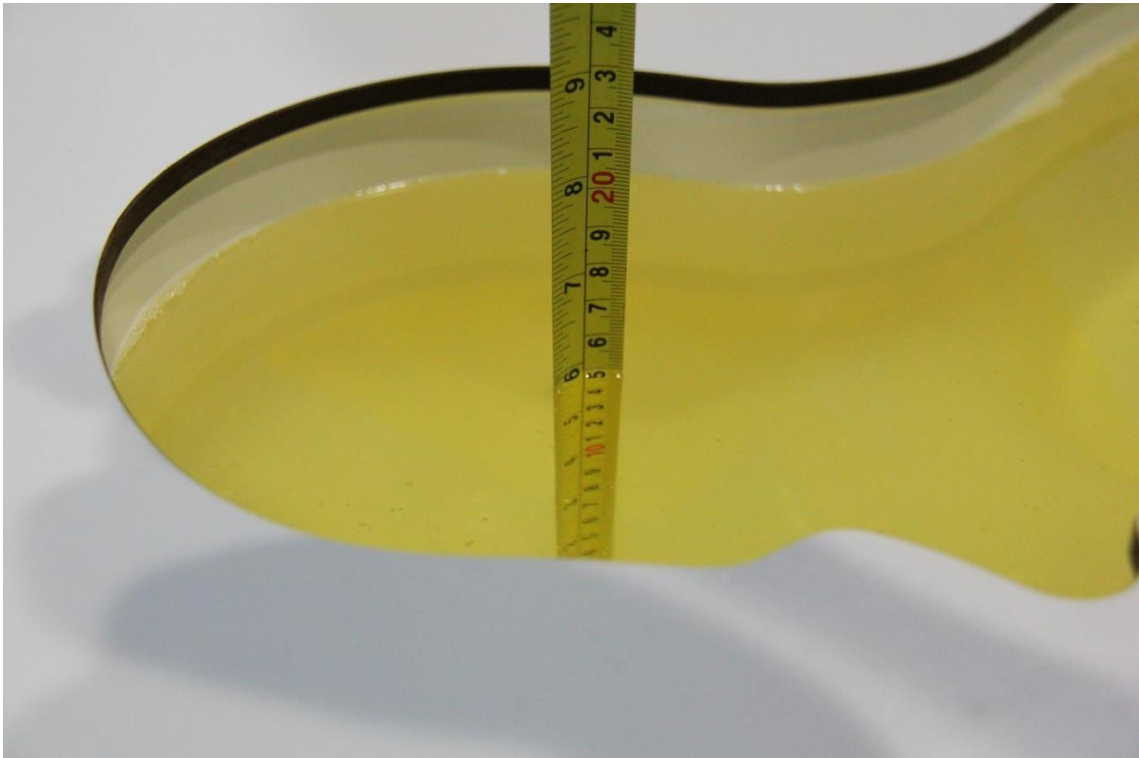

Picture 7-5 Liquid depth in the Head Phantom (2450MHz)



Picture 7-6 Liquid depth in the Head Phantom (2600 MHz)

8 System verification

8.1 System Setup

In the simplified setup for system evaluation, the DUT is replaced by a calibrated dipole and the power source is replaced by a continuous wave that comes from a signal generator. The calibrated dipole must be placed beneath the flat phantom section of the SAM twin phantom with the correct distance holder. The distance holder should touch the phantom surface with a light pressure at the reference marking and be oriented parallel to the long side of the phantom. The equipment setup is shown below:

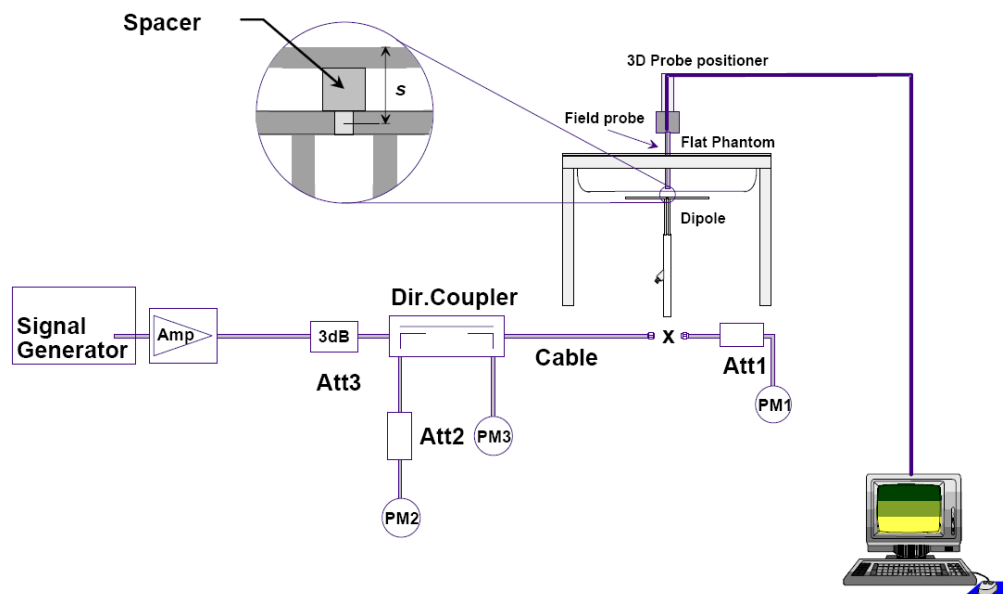

Picture 8.1 System Setup for System Evaluation



Picture 8.2 Photo of Dipole Setup

8.2 System Verification

SAR system verification is required to confirm measurement accuracy, according to the tissue dielectric media, probe calibration points and other system operating parameters required for measuring the SAR of a test device. The system verification must be performed for each frequency band and within the valid range of each probe calibration point required for testing the device.

The system verification results are required that the area scan estimated 1-g SAR is within 3% of the zoom scan 1-g SAR. The details are presented in annex B.

Table 8.1: System Verification of Head

Measurement Date (yyyy-mm-dd)	Frequency	Target value (W/kg)		Measured value (W/kg)		Deviation	
		10 g Average	1 g Average	10 g Average	1 g Average	10 g Average	1 g Average
2020/9/22	750 MHz	5.53	8.47	5.44	8.64	-1.63%	2.01%
2020/9/23	835 MHz	6.25	9.60	6.2	9.72	-0.80%	1.25%
2020/9/24	1750 MHz	19.1	36.5	19.48	36.36	1.99%	-0.38%
2020/9/25	1900 MHz	20.6	39.6	20.52	39.96	-0.39%	0.91%
2020/9/26	2450 MHz	24.5	52.5	24.8	52.00	1.22%	-0.95%
2020/9/27	2600 MHz	25.3	57.0	25.36	56.8	0.24%	-0.35%

9 Measurement Procedures

9.1 Tests to be performed

In order to determine the highest value of the peak spatial-average SAR of a handset, all device positions, configurations and operational modes shall be tested for each frequency band according to steps 1 to 3 below. A flowchart of the test process is shown in picture 9.1.

Step 1: The tests described in 9.2 shall be performed at the channel that is closest to the centre of the transmit frequency band (f_c) for:

- a) all device positions (cheek and tilt, for both left and right sides of the SAM phantom, as described in annex D),
- b) all configurations for each device position in a), e.g., antenna extended and retracted, and
- c) all operational modes, e.g., analogue and digital, for each device position in a) and configuration in b) in each frequency band.

If more than three frequencies need to be tested according to 11.1 (i.e., $N_c > 3$), then all frequencies, configurations and modes shall be tested for all of the above test conditions.

Step 2: For the condition providing highest peak spatial-average SAR determined in Step 1, perform all tests described in 9.2 at all other test frequencies, i.e., lowest and highest frequencies. In addition, for all other conditions (device position, configuration and operational mode) where the peak spatial-average SAR value determined in Step 1 is within 3 dB of the applicable SAR limit, it is recommended that all other test frequencies shall be tested as well.

Step 3: Examine all data to determine the highest value of the peak spatial-average SAR found in Steps 1 to 2.

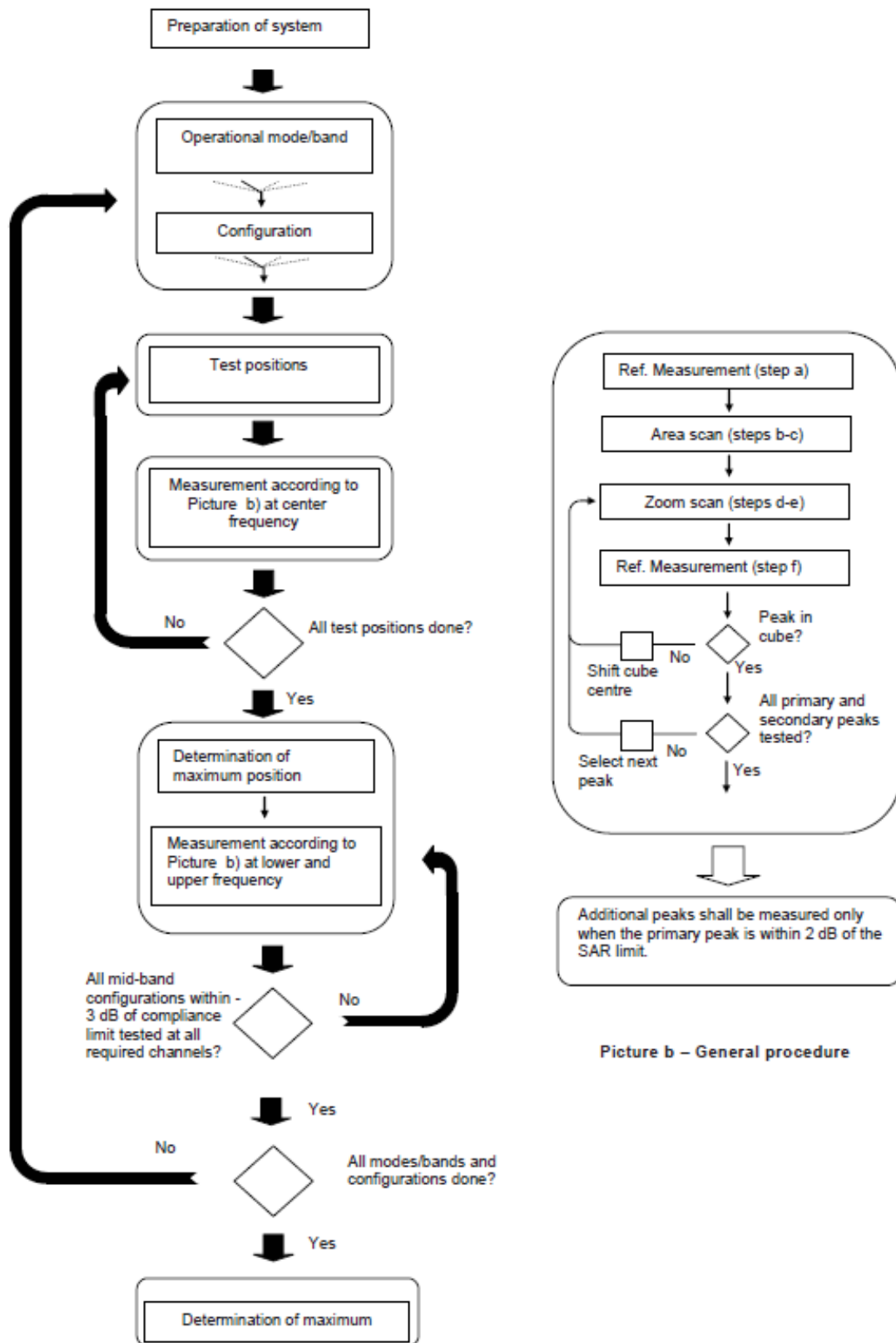

Picture a – Tests to be performed

Picture b – General procedure

Picture 9.1 Block diagram of the tests to be performed

6 Specific Absorption Rate (SAR)

6.1 Introduction

SAR is related to the rate at which energy is absorbed per unit mass in an object exposed to a radio field. The SAR distribution in a biological body is complicated and is usually carried out by experimental techniques or numerical modeling. The standard recommends limits for two tiers of groups, occupational/controlled and general population/uncontrolled, based on a person's awareness and ability to exercise control over his or her exposure. In general, occupational/controlled exposure limits are higher than the limits for general population/uncontrolled.

6.2 SAR Definition

The SAR definition is the time derivative (rate) of the incremental energy (dW) absorbed by (dissipated in) an incremental mass (dm) contained in a volume element (dv) of a given density (ρ). The equation description is as below:

$$SAR = \frac{d}{dt} \left(\frac{dW}{dm} \right) = \frac{d}{dt} \left(\frac{dW}{\rho dv} \right)$$

SAR is expressed in units of Watts per kilogram (W/kg)

SAR measurement can be either related to the temperature elevation in tissue by

$$SAR = c \left(\frac{\delta T}{\delta t} \right)$$

Where: C is the specific heat capacity, δT is the temperature rise and δt is the exposure duration, or related to the electrical field in the tissue by

$$SAR = \frac{\sigma |E|^2}{\rho}$$

Where: σ is the conductivity of the tissue, ρ is the mass density of tissue and E is the RMS electrical field strength.

However for evaluating SAR of low power transmitter, electrical field measurement is typically applied.

9.2 General Measurement Procedure

The area and zoom scan resolutions specified in the table below must be applied to the SAR measurements and fully documented in SAR reports to qualify for TCB approval. Probe boundary effect error compensation is required for measurements with the probe tip closer than half a probe tip diameter to the phantom surface. Both the probe tip diameter and sensor offset distance must satisfy measurement protocols; to ensure probe boundary effect errors are minimized and the higher fields closest to the phantom surface can be correctly measured and extrapolated to the phantom surface for computing 1-g SAR. Tolerances of the post-processing algorithms must be verified by the test laboratory for the scan resolutions used in the SAR measurements, according to the reference distribution functions specified in IEEE Std 1528-2003. The results should be documented as part of the system validation records and may be requested to support test results when all the measurement parameters in the following table are not satisfied.

		≤ 3 GHz	> 3 GHz
Maximum distance from closest measurement point (geometric center of probe sensors) to phantom surface		5 ± 1 mm	$\frac{1}{2} \cdot \delta \cdot \ln(2) \pm 0.5$ mm
Maximum probe angle from probe axis to phantom surface normal at the measurement location		$30^\circ \pm 1^\circ$	$20^\circ \pm 1^\circ$
Maximum area scan spatial resolution: Δx_{Area} , Δy_{Area}		≤ 2 GHz: ≤ 15 mm 2 – 3 GHz: ≤ 12 mm	3 – 4 GHz: ≤ 12 mm 4 – 6 GHz: ≤ 10 mm
		When the x or y dimension of the test device, in the measurement plane orientation, is smaller than the above, the measurement resolution must be \leq the corresponding x or y dimension of the test device with at least one measurement point on the test device.	
Maximum zoom scan spatial resolution: Δx_{Zoom} , Δy_{Zoom}		≤ 2 GHz: ≤ 8 mm 2 – 3 GHz: ≤ 5 mm*	3 – 4 GHz: ≤ 5 mm* 4 – 6 GHz: ≤ 4 mm*
Maximum zoom scan spatial resolution, normal to phantom surface	uniform grid: $\Delta z_{Zoom}(n)$	≤ 5 mm	3 – 4 GHz: ≤ 4 mm 4 – 5 GHz: ≤ 3 mm 5 – 6 GHz: ≤ 2 mm
	graded grid $\Delta z_{Zoom}(1)$: between 1 st two points closest to phantom surface	≤ 4 mm	3 – 4 GHz: ≤ 3 mm 4 – 5 GHz: ≤ 2.5 mm 5 – 6 GHz: ≤ 2 mm
	$\Delta z_{Zoom}(n>1)$: between subsequent points	$\leq 1.5 \cdot \Delta z_{Zoom}(n-1)$	
Minimum zoom scan volume	x, y, z	≥ 30 mm	3 – 4 GHz: ≥ 28 mm 4 – 5 GHz: ≥ 25 mm 5 – 6 GHz: ≥ 22 mm
Note: δ is the penetration depth of a plane-wave at normal incidence to the tissue medium; see draft standard IEEE P1528-2011 for details. * When zoom scan is required and the <u>reported</u> SAR from the area scan based 1-g SAR estimation procedures of KDB 447498 is ≤ 1.4 W/kg, ≤ 8 mm, ≤ 7 mm and ≤ 5 mm zoom scan resolution may be applied, respectively, for 2 GHz to 3 GHz, 3 GHz to 4 GHz and 4 GHz to 6 GHz.			

9.3 WCDMA Measurement Procedures for SAR

The following procedures are applicable to WCDMA handsets operating under 3GPP Release99, Release 5 and Release 6. The default test configuration is to measure SAR with an established radio link between the DUT and a communication test set using a 12.2kbps RMC (reference measurement channel) configured in Test Loop Mode 1. SAR is selectively confirmed for other physical channel configurations (DPCCH & DPDCH_n), HSDPA and HSPA (HSUPA/HSDPA) modes according to output power, exposure conditions and device operating capabilities. Both uplink and downlink should be configured with the same RMC or AMR, when required. SAR for Release 5 HSDPA and Release 6 HSPA are measured using the applicable FRC (fixed reference channel) and E-DCH reference channel configurations. Maximum output power is verified according to applicable versions of 3GPP TS 34.121 and SAR must be measured according to these maximum output conditions. When Maximum Power Reduction (MPR) is not implemented according to Cubic Metric (CM) requirements for Release 6 HSPA, the following procedures do not apply.

For Release 5 HSDPA Data Devices:

Sub-test	β_c	β_d	β_d (SF)	β_c / β_d	β_{hs}	CM/dB
1	2/15	15/15	64	2/15	4/15	0.0
2	12/15	15/15	64	12/15	24/25	1.0
3	15/15	8/15	64	15/8	30/15	1.5
4	15/15	4/15	64	15/4	30/15	1.5

For Release 6 HSPA Data Devices

Sub-test	β_c	β_d	β_d (SF)	β_c / β_d	β_{hs}	β_{ec}	β_{ed}	β_{ed} (SF)	β_{ed} (codes)	CM (dB)	MPR (dB)	AG Index	E-TFCI
1	11/15	15/15	64	11/15	22/15	209/225	1039/225	4	1	1.5	1.5	20	75
2	6/15	15/15	64	6/15	12/15	12/15	12/15	4	1	1.5	1.5	12	67
3	15/15	9/15	64	15/9	30/15	30/15	$\beta_{ed1}:47/15$ $\beta_{ed2}:47/15$	4	2	1.5	1.5	15	92
4	2/15	15/15	64	2/15	4/15	4/15	56/75	4	1	1.5	1.5	17	71
5	15/15	15/15	64	15/15	24/15	30/15	134/15	4	1	1.5	1.5	21	81

Rel.8 DC-HSDPA (Cat 24)

SAR test exclusion for Rel.8 DC-HSDPA must satisfy the SAR test exclusion requirements of Rel.5 HSDPA. SAR test exclusion for DC-HSDPA devices is determined by power measurements according to the H-Set 12, Fixed Reference Channel (FRC) configuration in Table C.8.1.12 of 3GPP TS 34.121-1. A primary and a secondary serving HS-DSCH Cell are required to perform the power measurement and for the results to qualify for SAR test exclusion.

9.4 SAR Measurement for LTE

SAR tests for LTE are performed with a base station simulator, Rohde & Schwarz CMW500. Closed loop power control was used so the UE transmits with maximum output power during SAR testing. All powers were measured with the CMW 500.

It is performed for conducted power and SAR based on the KDB941225 D05.

SAR is evaluated separately according to the following procedures for the different test positions in each exposure condition – head, body, body-worn accessories and other use conditions. The procedures in the following subsections are applied separately to test each LTE frequency band.

1) QPSK with 1 RB allocation

Start with the largest channel bandwidth and measure SAR for QPSK with 1 RB allocation, using the RB offset and required test channel combination with the highest maximum output power among RB offsets at the upper edge, middle and lower edge of each required test channel. When the reported SAR is ≤ 0.8 W/kg, testing of the remaining RB offset configurations and required test channels is not required for 1 RB allocation; otherwise, SAR is required for the remaining required test channels and only for the RB offset configuration with the highest output power for that channel. When the reported SAR of a required test channel is > 1.45 W/kg, SAR is required for all three RB offset configurations for that required test channel.

2) QPSK with 50% RB allocation

The procedures required for 1 RB allocation in 1) are applied to measure the SAR for QPSK with 50% RB allocation.

3) QPSK with 100% RB allocation

For QPSK with 100% RB allocation, SAR is not required when the highest maximum output power for 100 % RB allocation is less than the highest maximum output power in 50% and 1 RB allocations and the highest reported SAR for 1 RB and 50% RB allocation in 1) and 2) are ≤ 0.8 W/kg. Otherwise, SAR is measured for the highest output power channel; and if the reported SAR is > 1.45 W/kg, the remaining required test channels must also be tested.

TDD test:

TDD testing is performed using guidance from FCC KDB 941225 D05 v02r05 and the SAR test guidance provided in April 2013 TCB works hop notes. TDD is tested at the highest duty factor using UL-DL configuration 0 with special subframe configuration 6 and applying the FDD LTE procedures in KDB 941225 D05 v02r05. SAR testing is performed using the extended cyclic prefix listed in 3GPP TS 36.211.

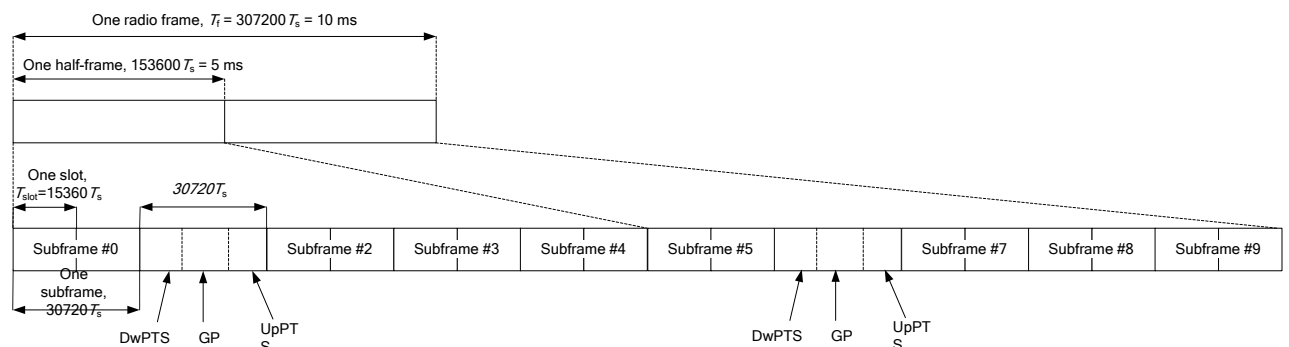

Figure 9.2: Frame structure type 2 (for 5 ms switch-point periodicity)

Table 9.1: Configuration of special subframe (lengths of DwPTS/GP/UpPTS)

Special subframe configuration	Normal cyclic prefix in downlink			Extended cyclic prefix in downlink		
	DwPTS	UpPTS		DwPTS	UpPTS	
		Normal cyclic prefix in uplink	Extended cyclic prefix in uplink		Normal cyclic prefix in uplink	Extended cyclic prefix in uplink
0	$6592 \cdot T_s$	$2192 \cdot T_s$	$2560 \cdot T_s$	$7680 \cdot T_s$	$2192 \cdot T_s$	$2560 \cdot T_s$
1	$19760 \cdot T_s$			$20480 \cdot T_s$		
2	$21952 \cdot T_s$			$23040 \cdot T_s$		
3	$24144 \cdot T_s$			$25600 \cdot T_s$		
4	$26336 \cdot T_s$	$4384 \cdot T_s$	$5120 \cdot T_s$	$7680 \cdot T_s$	$4384 \cdot T_s$	$5120 \cdot T_s$
5	$6592 \cdot T_s$			$20480 \cdot T_s$		
6	$19760 \cdot T_s$			$23040 \cdot T_s$		
7	$21952 \cdot T_s$			$12800 \cdot T_s$		
8	$24144 \cdot T_s$			-		
9	$13168 \cdot T_s$	-	-	-	-	-

Table 9.2: Uplink-downlink configurations

Uplink-downlink configuration	Downlink-to-Uplink Switch-point periodicity	Subframe number									
		0	1	2	3	4	5	6	7	8	9
0	5 ms	D	S	U	U	U	D	S	U	U	U
1	5 ms	D	S	U	U	D	D	S	U	U	D
2	5 ms	D	S	U	D	D	D	S	U	D	D
3	10 ms	D	S	U	U	U	D	D	D	D	D
4	10 ms	D	S	U	U	D	D	D	D	D	D
5	10 ms	D	S	U	D	D	D	D	D	D	D
6	5 ms	D	S	U	U	U	D	S	U	U	D

Duty factor is calculated by:

$$\begin{aligned}
 \text{Duty factor} &= \text{uplink frame} \cdot 6 + \text{UpPTS} \cdot 2 / \text{one frame length} \\
 &= (30720 \cdot T_s \cdot 6 + 5120 \cdot T_s \cdot 2) / 307200 \cdot T_s \\
 &= 0.633
 \end{aligned}$$

According to the KDB 447498 D01, SAR should be evaluated at more than 3 frequencies for devices supporting transmit bands wider than 100MHz. Oct.2014 FCC-TCB conference notes (Dec. 2014 rev.) specifies the 5 test channels to use for 3GPP band 41 SAR evaluation.

9.5 Bluetooth & Wi-Fi Measurement Procedures for SAR

Normal network operating configurations are not suitable for measuring the SAR of 802.11 transmitters in general. Unpredictable fluctuations in network traffic and antenna diversity conditions can introduce undesirable variations in SAR results. The SAR for these devices should be measured using chipset based test mode software to ensure that the results are consistent and reliable.

Chipset based test mode software is hardware dependent and generally varies among manufacturers. The device operating parameters established in a test mode for SAR measurements must be identical to those programmed in production units, including output power levels, amplifier gain settings and other RF performance tuning parameters. The test frequencies should correspond to actual channel frequencies defined for domestic use. SAR for devices with switched diversity should be measured with only one antenna transmitting at a time during each SAR measurement, according to a fixed modulation and data rate. The same data pattern should be used for all measurements.

9.6 Power Drift

To control the output power stability during the SAR test, DASY4 system calculates the power drift by measuring the E-field at the same location at the beginning and at the end of the measurement for each test position. These drift values can be found in section 14 labeled as: (Power Drift [dB]). This ensures that the power drift during one measurement is within 5%.

10 Area Scan Based 1-g SAR

10.1 Requirement of KDB

According to the KDB447498 D01 v05, when the implementation is based the specific polynomial fit algorithm as presented at the 29th Bioelectromagnetics Society meeting (2007) and the estimated 1-gSAR is ≤ 1.2 W/kg, a zoom scan measurement is not required provided it is also not needed for any other purpose; for example, if the peak SAR location required for simultaneous transmission SAR test exclusion can be determined accurately by the SAR system or manually to discriminate between distinctive peaks and scattered noisy SAR distributions from area scans.

There must not be any warning or alert messages due to various measurement concerns identified by the SAR system; for example, noise in measurements, peaks too close to scan boundary, peaks are too sharp, spatial resolution and uncertainty issues etc. The SAR system verification must also demonstrate that the area scan estimated 1-g SAR is within 3% of the zoom scan 1-g SAR (See Annex B). When all the SAR results for each exposure condition in a frequency band and wireless mode are based on estimated 1-g SAR, the 1-g SAR for the highest SAR configuration must be determined by a zoom scan.

10.2 Fast SAR Algorithms

The approach is based on the area scan measurement applying a frequency dependent attenuation parameter. This attenuation parameter was empirically determined by analyzing a large number of phones. The MOTOROLA FAST SAR was developed and validated by the MOTOROLA Research Group in Ft. Lauderdale.

In the initial study, an approximation algorithm based on Linear fit was developed. The accuracy of the algorithm has been demonstrated across a broad frequency range (136-2450 MHz) and for both 1- and 10-g averaged SAR using a sample of 264 SAR measurements from 55 wireless handsets. For the sample size studied, the root-mean-squared errors of the algorithm are 1.2% and 5.8% for 1- and 10-g averaged SAR, respectively. The paper describing the algorithm in detail is expected to be published in August 2004 within the Special Issue of Transactions on MTT.

In the second step, the same research group optimized the fitting algorithm to an Polynomial fit whereby the frequency validity was extended to cover the range 30-6000MHz. Details of this study can be found in the BEMS 2007 Proceedings.

Both algorithms are implemented in DASY software.

11 Conducted Output Power

For Main antenna, there are two sets of tune-up power, Normal power and Low power (Hotspot on)

Normal power	Low Power-Hotspot on
Power Level A	Power Level B

11.1 GSM Measurement result

During the process of testing, the EUT was controlled via Agilent Digital Radio Communication tester (E5515C) to ensure the maximum power transmission and proper modulation. This result contains conducted output power for the EUT. In all cases, the measured peak output power should be greater and within 5% than EMI measurement.

Table 11.1-1: The conducted power measurement results for GSM, GPRS and EGPRS-Level A

GSM 850 Speech (GMSK)	Measured Power (dBm)			Tune up	calculation	Averaged Power (dBm)		
	251	190	128			251	190	128
1 Txslot	31.13	31.12	31.43	32.50	/	/	/	/
GSM 850 GPRS (GMSK)	Measured Power (dBm)				calculation	Averaged Power (dBm)		
	251	190	128			251	190	128
1 Txslot	31.16	31.10	31.40	32.50	-9.03	22.13	22.07	22.37
2 Txslots	28.86	28.78	28.70	30.00	-6.02	22.84	22.76	22.68
3 Txslots	27.16	27.14	27.01	28.50	-4.26	22.90	22.88	22.75
4 Txslots	25.83	25.88	25.76	27.00	-3.01	22.82	22.87	22.75
GSM 850 EGPRS (GMSK)	Measured Power (dBm)				calculation	Averaged Power (dBm)		
	251	190	128			251	190	128
1 Txslot	31.11	31.06	31.37	32.50	-9.03	22.08	22.03	22.34
2 Txslots	28.82	28.76	28.68	30.00	-6.02	22.80	22.74	22.66
3 Txslots	27.14	27.16	27.03	28.50	-4.26	22.88	22.90	22.77
4 Txslots	25.88	25.90	25.76	27.00	-3.01	22.87	22.89	22.75
GSM 850 EGPRS (8PSK)	Measured Power (dBm)				calculation	Averaged Power (dBm)		
	251	190	128			251	190	128
1 Txslot	24.76	24.99	24.85	26.70	-9.03	15.73	15.96	15.82
2 Txslots	23.11	23.21	24.11	25.00	-6.02	17.09	17.19	18.09
3 Txslots	21.24	21.47	21.15	23.10	-4.26	16.98	17.21	16.89
4 Txslots	19.72	19.79	20.57	21.70	-3.01	16.71	16.78	17.56
PCS1900 Speech (GMSK)	Measured Power (dBm)			Tune up	calculation	Averaged Power (dBm)		
	810	661	512			810	661	512
1 Txslot	30.19	29.76	29.71	31.00	/	/	/	/
PCS1900 GPRS (GMSK)	Measured Power (dBm)				calculation	Averaged Power (dBm)		
	810	661	512			810	661	512
1 Txslot	30.65	30.13	29.99	31.00	-9.03	21.62	21.10	20.96
2 Txslots	27.15	26.47	26.29	28.00	-6.02	21.13	20.45	20.27
3 Txslots	25.73	25.00	24.72	26.20	-4.26	21.47	20.74	20.46

4 Txslots	24.61	23.80	23.61	25.00	-3.01	21.60	20.79	20.60
PCS1900 EGPRS (GMSK)	Measured Power (dBm)				calculation	Averaged Power (dBm)		
	810	661	512			810	661	512
1 Txslot	30.48	29.98	29.98	31.00	-9.03	21.45	20.95	20.95
2 Txslots	27.14	26.45	26.28	28.00	-6.02	21.12	20.43	20.26
3 Txslots	25.71	24.97	24.71	26.20	-4.26	21.45	20.71	20.45
4 Txslots	24.42	23.77	23.59	25.00	-3.01	21.41	20.76	20.58
PCS1900 EGPRS (8PSK)	Measured Power (dBm)				calculation	Averaged Power (dBm)		
	810	661	512			810	661	512
1 Txslot	25.05	24.80	24.35	26.30	-9.03	16.02	15.77	15.32
2 Txslots	23.33	22.86	22.66	23.50	-6.02	17.31	16.84	16.64
3 Txslots	21.87	21.43	21.01	22.00	-4.26	17.61	17.17	16.75
4 Txslots	20.28	19.82	19.68	20.50	-3.01	17.27	16.81	16.67

NOTES:

1) Division Factors

To average the power, the division factor is as follows:

1TX-slot = 1 transmit time slot out of 8 time slots=> conducted power divided by (8/1) => -9.03dB

2TX-slots = 2 transmit time slots out of 8 time slots=> conducted power divided by (8/2) => -6.02dB

3TX-slots = 3 transmit time slots out of 8 time slots=> conducted power divided by (8/3) => -4.26dB

4TX-slots = 4 transmit time slots out of 8 time slots=> conducted power divided by (8/4) => -3.01dB

According to the conducted power as above, the body measurements are performed with 3Txslots for GSM850 and 1Txslots for GSM1900.

Power-Level B

PCS1900 Speech (GMSK)	Measured Power (dBm)			Tune up	calculation	Averaged Power (dBm)		
	810	661	512			810	661	512
1 Txslot	27.63	27.24	26.61	28.50	/	/	/	/
PCS1900 GPRS (GMSK)	Measured Power (dBm)				calculation	Averaged Power (dBm)		
	810	661	512			810	661	512
1 Txslot	27.63	27.11	26.62	28.50	-9.03	18.60	18.08	17.59
2 Txslots	24.74	23.90	23.68	25.50	-6.02	18.72	17.88	17.66
3 Txslots	23.25	22.34	22.20	24.20	-4.26	18.99	18.08	17.94
4 Txslots	21.66	20.96	20.62	22.50	-3.01	18.65	17.95	17.61
PCS1900 EGPRS (GMSK)	Measured Power (dBm)				calculation	Averaged Power (dBm)		
	810	661	512			810	661	512
1 Txslot	27.65	27.28	26.63	28.50	-9.03	18.62	18.25	17.60
2 Txslots	24.76	23.90	23.69	25.50	-6.02	18.74	17.88	17.67
3 Txslots	23.15	22.43	22.20	24.20	-4.26	18.89	18.17	17.94
4 Txslots	21.65	20.97	20.63	22.50	-3.01	18.64	17.96	17.62
PCS1900 EGPRS (8PSK)	Measured Power (dBm)				calculation	Averaged Power (dBm)		
	810	661	512			810	661	512

1 Txslot	25.04	24.58	24.50	26.30	-9.03	16.01	15.55	15.47
2 Txslots	22.94	21.96	21.75	23.50	-6.02	16.92	15.94	15.73
3 Txslots	20.70	20.38	20.10	22.00	-4.26	16.44	16.12	15.84
4 Txslots	19.35	18.87	18.69	20.50	-3.01	16.34	15.86	15.68

NOTES:

1) Division Factors

To average the power, the division factor is as follows:

1TX-slot = 1 transmit time slot out of 8 time slots=> conducted power divided by (8/1) => -9.03dB

2TX-slots = 2 transmit time slots out of 8 time slots=> conducted power divided by (8/2) => -6.02dB

3TX-slots = 3 transmit time slots out of 8 time slots=> conducted power divided by (8/3) => -4.26dB

4TX-slots = 4 transmit time slots out of 8 time slots=> conducted power divided by (8/4) => -3.01dB

According to the conducted power as above, the body measurements are performed with 3Txslots for GSM1900.

11.2 WCDMA Measurement result

Table 11.2-1: The conducted Power for WCDMA-Level A

Item	band	FDDV result			
	ARFCN	4233 (846.6MHz)	4182 (836.4MHz)	4132 (826.4MHz)	Tune up
WCDMA	\	22.15	22.13	22.06	22.50
HSUPA	1	21.10	20.86	20.87	22.00
	2	20.10	19.87	19.84	21.00
	3	20.02	19.71	19.68	21.00
	4	20.44	20.15	20.08	20.50
	5	21.16	21.07	21.15	22.50
HSPA+(16QAM)		20.65	20.56	20.55	21.00
DC-HSDPA	1	21.15	21.13	21.12	22.00
	2	21.14	21.11	21.05	22.00
	3	20.70	20.71	20.69	21.50
	4	20.68	20.75	20.73	21.50
Item	band	FDDIV result			
	ARFCN	1513 (1752.6MHz)	1412 (1732.4MHz)	1312 (1712.4MHz)	Tune up
WCDMA	\	22.58	22.62	22.66	23.00
HSUPA	1	21.15	21.29	21.37	22.50
	2	20.56	20.69	20.72	21.00
	3	20.61	20.47	20.68	21.50
	4	21.12	21.26	21.22	21.50
	5	21.57	21.88	21.80	22.50
HSPA+(16QAM)		21.21	21.30	21.37	21.50
DC-HSDPA	1	21.72	21.81	21.74	22.50
	2	21.71	21.79	21.73	22.50

	3	21.19	21.15	21.18	22.00
	4	21.17	21.16	21.19	22.00
Item	band	FDDII result			
	ARFCN	9538 (1907.6MHz)	9400 (1880MHz)	9262 (1852.4MHz)	Tune up
WCDMA	\	20.58	20.66	20.63	21.50
HSUPA	1	19.13	19.35	19.02	21.50
	2	18.59	18.58	18.54	19.50
	3	18.66	18.59	18.52	20.50
	4	19.12	19.33	19.17	19.50
	5	19.81	19.87	19.82	20.50
HSPA+(16QAM)		19.21	19.28	19.26	19.50
DC-HSDPA	1	19.91	19.84	19.74	21.00
	2	19.89	19.86	19.73	21.00
	3	19.44	19.44	19.36	20.50
	4	19.45	19.43	19.37	20.50

Table 11.2-2: The conducted Power for WCDMA-Level B

Item	band	FDDIV result			
	ARFCN	1513 (1752.6MHz)	1412(1732.4MHz)	1312 (1712.4MHz)	Tune up
WCDMA	\	20.65	20.86	20.83	21.00
HSUPA	1	19.36	19.66	19.40	20.50
	2	18.69	18.64	18.41	19.00
	3	18.31	18.57	18.25	19.50
	4	19.12	19.35	19.27	19.50
	5	19.24	19.38	19.33	20.50
HSPA+(16QAM)		19.33	19.46	19.45	19.50
DC-HSDPA	1	19.69	19.88	19.87	20.50
	2	19.72	19.86	19.88	20.50
	3	19.24	19.39	19.35	20.00
	4	19.20	19.35	19.35	20.00
Item	band	FDDII result			
	ARFCN	9538 (1907.6MHz)	9400 (1880MHz)	9262 (1852.4MHz)	Tune up
WCDMA	\	16.82	16.83	16.91	17.50
HSUPA	1	15.91	15.81	16.14	17.00
	2	14.70	14.67	14.61	15.00
	3	14.86	14.71	14.81	16.00
	4	15.76	15.57	15.67	16.00
	5	15.70	15.55	15.60	16.00
HSPA+(16QAM)		15.66	15.63	15.67	16.00
DC-HSDPA	1	16.13	16.10	16.06	17.00

	2	16.16	16.09	16.16	17.00
	3	15.69	15.60	15.69	16.50
	4	15.76	15.66	15.67	16.50

11.3 LTE Measurement result

Table 11.3-1: Maximum Power Reduction (MPR) for LTE

Modulation	Channel bandwidth / Transmission bandwidth configuration [RB]						MPR (dB)
	1.4	3	5	10	15	20	
	MHz	MHz	MHz	MHz	MHz	MHz	
QPSK	> 5	> 4	> 8	> 12	> 16	> 18	1
16 QAM	≤ 5	≤ 4	≤ 8	≤ 12	≤ 16	≤ 18	1
16 QAM	> 5	> 4	> 8	> 12	> 16	> 18	2

Table 11.3-2: The tune up for LTE – Level A

Band	Tune up
LTE Band 2	21.5
LTE Band 4	23
LTE Band 5	23
LTE Band 7	21.7
LTE Band 28	23

Table 11.3-3: The tune up for LTE – Level B

Band	Tune up
LTE Band 2	17.5
LTE Band 4	21
LTE Band 7	18.5

LTEB2-Level A				
BANDWIDTH	Number of RBs	Frequency	QPSK	16QAM
1.4MHz	1RB-High (5)	1909.3 (19193)	20.37	19.31
		1880 (18900)	20.35	19.28
		1850.7 (18607)	20.64	19.90
	1RB-Middle (3)	1909.3 (19193)	20.55	19.31
		1880 (18900)	20.38	19.42
		1850.7 (18607)	20.68	19.26
	1RB-Low (0)	1909.3 (19193)	20.50	19.39
		1880 (18900)	20.43	19.16
		1850.7 (18607)	20.57	19.92
	3RB-High (3)	1909.3 (19193)	20.31	19.60
		1880 (18900)	20.37	19.13
		1850.7 (18607)	20.71	19.37
	3RB-Middle (1)	1909.3 (19193)	20.41	19.61
		1880 (18900)	20.47	19.07
		1850.7 (18607)	20.67	19.68
	3RB-Low (0)	1909.3 (19193)	20.40	19.63
		1880 (18900)	20.42	19.02
		1850.7 (18607)	20.60	19.55
6RB (0)	1909.3 (19193)	19.45	18.45	
	1880 (18900)	19.52	18.07	
	1850.7 (18607)	19.58	18.37	
3MHz	1RB-High (14)	1908.5 (19185)	20.44	19.49
		1880 (18900)	20.44	19.49
		1851.5 (18615)	20.66	19.96
	1RB-Middle (7)	1908.5 (19185)	20.62	19.69
		1880 (18900)	20.30	19.57
		1851.5 (18615)	20.69	19.04
	1RB-Low (0)	1908.5 (19185)	20.56	19.44
		1880 (18900)	20.47	19.45
		1851.5 (18615)	20.56	19.94
	8RB-High (7)	1908.5 (19185)	19.30	18.29
		1880 (18900)	19.30	18.33
		1851.5 (18615)	19.66	18.78
	8RB-Middle (4)	1908.5 (19185)	19.37	18.36
		1880 (18900)	19.39	18.42
		1851.5 (18615)	19.60	18.65
8RB-Low (0)	1908.5 (19185)	19.37	18.37	
	1880 (18900)	19.32	18.39	
	1851.5 (18615)	19.52	18.78	



	15RB (0)	1908.5 (19185)	19.35	18.24	
		1880 (18900)	19.33	18.52	
		1851.5 (18615)	19.63	18.66	
5MHz	1RB-High (24)	1907.5 (19175)	20.23	18.91	
		1880 (18900)	20.29	18.74	
		1852.5 (18625)	20.32	19.40	
	1RB-Middle (12)	1907.5 (19175)	20.27	19.41	
		1880 (18900)	20.45	18.68	
		1852.5 (18625)	20.59	18.94	
	1RB-Low (0)	1907.5 (19175)	20.13	18.82	
		1880 (18900)	20.27	18.73	
		1852.5 (18625)	20.35	18.96	
	12RB-High (13)	1907.5 (19175)	19.50	18.21	
		1880 (18900)	19.27	18.33	
		1852.5 (18625)	19.50	18.51	
	12RB-Middle (6)	1907.5 (19175)	19.46	18.44	
		1880 (18900)	19.31	18.37	
		1852.5 (18625)	19.50	18.41	
	12RB-Low (0)	1907.5 (19175)	19.32	18.32	
		1880 (18900)	19.27	18.32	
		1852.5 (18625)	19.49	18.50	
	25RB (0)	1907.5 (19175)	19.28	18.36	
		1880 (18900)	19.30	18.38	
		1852.5 (18625)	19.61	18.65	
	10MHz	1RB-High (49)	1905 (19150)	20.41	19.18
			1880 (18900)	20.58	19.41
			1855 (18650)	20.37	19.74
1RB-Middle (24)		1905 (19150)	20.37	19.54	
		1880 (18900)	20.46	19.52	
		1855 (18650)	20.46	18.89	
1RB-Low (0)		1905 (19150)	20.48	19.35	
		1880 (18900)	20.42	19.19	
		1855 (18650)	20.50	19.30	
25RB-High (25)		1905 (19150)	19.33	18.71	
		1880 (18900)	19.30	18.35	
		1855 (18650)	19.46	18.53	
25RB-Middle (12)		1905 (19150)	19.15	18.26	
		1880 (18900)	19.25	18.31	
		1855 (18650)	19.35	18.43	
25RB-Low (0)		1905 (19150)	19.12	18.15	
		1880 (18900)	19.25	18.21	
		1855 (18650)	19.49	18.57	



	50RB (0)	1905 (19150)	19.22	18.20	
		1880 (18900)	19.32	18.34	
		1855 (18650)	19.49	18.48	
15MHz	1RB-High (74)	1902.5 (19125)	20.27	19.35	
		1880 (18900)	20.34	19.65	
		1857.5 (18675)	20.13	19.88	
	1RB-Middle (37)	1902.5 (19125)	20.31	19.24	
		1880 (18900)	20.01	19.49	
		1857.5 (18675)	20.11	19.84	
	1RB-Low (0)	1902.5 (19125)	20.32	19.44	
		1880 (18900)	20.09	18.90	
		1857.5 (18675)	20.39	20.12	
	36RB-High (38)	1902.5 (19125)	19.20	18.22	
		1880 (18900)	19.26	18.30	
		1857.5 (18675)	19.24	18.34	
	36RB-Middle (19)	1902.5 (19125)	19.14	18.18	
		1880 (18900)	19.25	18.29	
		1857.5 (18675)	19.23	18.22	
	36RB-Low (0)	1902.5 (19125)	19.28	18.21	
		1880 (18900)	19.22	18.23	
		1857.5 (18675)	19.25	18.20	
	75RB (0)	1902.5 (19125)	19.29	18.24	
		1880 (18900)	19.24	18.24	
		1857.5 (18675)	19.23	18.34	
	20MHz	1RB-High (99)	1900 (19100)	20.42	19.71
			1880 (18900)	20.45	19.87
			1860 (18700)	20.10	19.43
1RB-Middle (50)		1900 (19100)	20.65	19.43	
		1880 (18900)	20.29	19.06	
		1860 (18700)	20.33	19.46	
1RB-Low (0)		1900 (19100)	20.56	19.29	
		1880 (18900)	20.12	19.23	
		1860 (18700)	20.23	19.03	
50RB-High (50)		1900 (19100)	19.23	18.19	
		1880 (18900)	19.35	18.40	
		1860 (18700)	19.36	18.48	
50RB-Middle (25)		1900 (19100)	19.37	18.42	
		1880 (18900)	19.35	18.31	
		1860 (18700)	19.41	18.46	
50RB-Low (0)		1900 (19100)	19.32	18.39	
		1880 (18900)	19.29	18.18	
		1860 (18700)	19.42	18.45	



	100RB (0)	1900 (19100)	19.25	18.31
		1880 (18900)	19.31	18.30
		1860 (18700)	19.35	18.39

LTEB4-Level A				
BANDWIDTH	Number of RBs	Frequency	QPSK	16QAM
1.4MHz	1RB-High (5)	1754.3 (20393)	22.63	21.97
		1732.5 (20175)	22.38	21.59
		1710.7 (19957)	22.54	21.44
	1RB-Middle (3)	1754.3 (20393)	22.59	21.95
		1732.5 (20175)	22.63	21.61
		1710.7 (19957)	22.67	21.51
	1RB-Low (0)	1754.3 (20393)	22.36	21.05
		1732.5 (20175)	22.55	21.59
		1710.7 (19957)	22.57	21.34
	3RB-High (3)	1754.3 (20393)	22.62	20.95
		1732.5 (20175)	22.63	21.88
		1710.7 (19957)	22.67	21.35
	3RB-Middle (1)	1754.3 (20393)	22.79	21.58
		1732.5 (20175)	22.70	21.97
		1710.7 (19957)	22.59	21.57
	3RB-Low (0)	1754.3 (20393)	22.60	21.56
		1732.5 (20175)	22.54	21.80
		1710.7 (19957)	22.55	21.57
	6RB (0)	1754.3 (20393)	21.65	20.53
		1732.5 (20175)	21.54	20.63
		1710.7 (19957)	21.68	20.75
3MHz	1RB-High (14)	1753.5 (20385)	22.41	21.68
		1732.5 (20175)	22.66	21.82
		1711.5 (19965)	22.60	21.30
	1RB-Middle (7)	1753.5 (20385)	22.55	21.48
		1732.5 (20175)	22.75	21.94
		1711.5 (19965)	22.70	21.48
	1RB-Low (0)	1753.5 (20385)	22.42	21.56
		1732.5 (20175)	22.85	21.65
		1711.5 (19965)	22.66	21.28
8RB-High (7)	1753.5 (20385)	21.59	20.40	
	1732.5 (20175)	21.72	20.81	
	1711.5 (19965)	21.57	20.64	

	8RB-Middle (4)	1753.5 (20385)	21.49	20.30	
		1732.5 (20175)	21.68	20.72	
		1711.5 (19965)	21.58	20.83	
	8RB-Low (0)	1753.5 (20385)	21.47	20.29	
		1732.5 (20175)	21.58	20.80	
		1711.5 (19965)	21.59	20.69	
	15RB (0)	1753.5 (20385)	21.54	20.38	
		1732.5 (20175)	21.58	20.53	
		1711.5 (19965)	21.54	20.57	
5MHz	1RB-High (24)	1752.5 (20375)	22.63	21.33	
		1732.5 (20175)	22.79	21.09	
		1712.5 (19975)	22.17	21.22	
	1RB-Middle (12)	1752.5 (20375)	22.52	21.14	
		1732.5 (20175)	22.99	21.02	
		1712.5 (19975)	22.27	21.01	
	1RB-Low (0)	1752.5 (20375)	22.67	21.16	
		1732.5 (20175)	22.90	20.93	
		1712.5 (19975)	22.37	21.07	
	12RB-High (13)	1752.5 (20375)	21.72	20.48	
		1732.5 (20175)	21.71	20.63	
		1712.5 (19975)	21.47	20.30	
	12RB-Middle (6)	1752.5 (20375)	21.51	20.39	
		1732.5 (20175)	21.60	20.43	
		1712.5 (19975)	21.59	20.43	
	12RB-Low (0)	1752.5 (20375)	21.51	20.28	
		1732.5 (20175)	21.61	20.44	
		1712.5 (19975)	21.55	20.51	
	25RB (0)	1752.5 (20375)	21.61	20.40	
		1732.5 (20175)	21.63	20.57	
		1712.5 (19975)	21.59	20.58	
	10MHz	1RB-High (49)	1750 (20350)	22.81	21.77
			1732.5 (20175)	22.54	21.55
			1715 (20000)	22.41	21.81
		1RB-Middle (24)	1750 (20350)	22.74	21.74
			1732.5 (20175)	22.94	21.83
			1715 (20000)	22.56	21.90
1RB-Low (0)		1750 (20350)	22.62	21.34	
		1732.5 (20175)	22.66	21.53	
		1715 (20000)	22.55	21.93	
25RB-High (25)		1750 (20350)	21.53	20.79	
		1732.5 (20175)	21.63	20.53	
		1715 (20000)	21.45	20.61	



	25RB-Middle (12)	1750 (20350)	21.45	20.68	
		1732.5 (20175)	21.50	20.56	
		1715 (20000)	21.46	20.69	
	25RB-Low (0)	1750 (20350)	21.45	20.51	
		1732.5 (20175)	21.54	20.64	
		1715 (20000)	21.54	20.79	
	50RB (0)	1750 (20350)	21.57	20.48	
		1732.5 (20175)	21.53	20.50	
		1715 (20000)	21.52	20.57	
15MHz	1RB-High (74)	1747.5 (20325)	22.72	21.72	
		1732.5 (20175)	22.35	21.85	
		1717.5 (20025)	22.22	21.99	
	1RB-Middle (37)	1747.5 (20325)	22.75	21.68	
		1732.5 (20175)	22.45	21.78	
		1717.5 (20025)	22.23	22.00	
	1RB-Low (0)	1747.5 (20325)	22.81	21.43	
		1732.5 (20175)	22.28	21.82	
		1717.5 (20025)	22.45	22.00	
	36RB-High (38)	1747.5 (20325)	21.58	20.50	
		1732.5 (20175)	21.55	20.65	
		1717.5 (20025)	21.49	20.33	
	36RB-Middle (19)	1747.5 (20325)	21.42	20.44	
		1732.5 (20175)	21.51	20.51	
		1717.5 (20025)	21.42	20.29	
	36RB-Low (0)	1747.5 (20325)	21.49	20.48	
		1732.5 (20175)	21.44	20.47	
		1717.5 (20025)	21.59	20.25	
	75RB (0)	1747.5 (20325)	21.52	20.44	
		1732.5 (20175)	21.57	20.46	
		1717.5 (20025)	21.52	20.36	
	20MHz	1RB-High (99)	1745 (20300)	22.83	21.66
			1732.5 (20175)	22.43	21.59
			1720 (20050)	22.37	21.33
		1RB-Middle (50)	1745 (20300)	22.68	21.59
			1732.5 (20175)	22.91	21.52
			1720 (20050)	22.65	21.08
1RB-Low (0)		1745 (20300)	22.69	21.66	
		1732.5 (20175)	22.75	21.55	
		1720 (20050)	22.40	21.11	
50RB-High (50)		1745 (20300)	21.62	20.64	
		1732.5 (20175)	21.65	20.42	
		1720 (20050)	21.62	20.60	

	50RB-Middle (25)	1745 (20300)	21.55	20.52
		1732.5 (20175)	21.76	20.56
		1720 (20050)	21.65	20.68
	50RB-Low (0)	1745 (20300)	21.60	20.61
		1732.5 (20175)	21.69	20.54
		1720 (20050)	21.62	20.48
	100RB (0)	1745 (20300)	21.72	20.72
		1732.5 (20175)	21.67	20.60
		1720 (20050)	21.72	20.70

LTEB5-LvelA				
BANDWIDTH	Number of RBs	Frequency	QPSK	16QAM
1.4MHz	1RB-High (5)	848.3 (20643)	21.51	20.66
		836.5 (20525)	21.67	20.64
		824.7 (20407)	21.36	20.75
	1RB-Middle (3)	848.3 (20643)	21.73	20.63
		836.5 (20525)	21.79	20.46
		824.7 (20407)	21.51	20.96
	1RB-Low (0)	848.3 (20643)	21.60	20.64
		836.5 (20525)	21.57	20.33
		824.7 (20407)	21.25	20.60
	3RB-High (3)	848.3 (20643)	21.58	20.77
		836.5 (20525)	21.63	20.48
		824.7 (20407)	21.44	20.44
	3RB-Middle (1)	848.3 (20643)	21.71	20.88
		836.5 (20525)	21.73	20.76
		824.7 (20407)	21.70	20.46
	3RB-Low (0)	848.3 (20643)	21.59	20.87
		836.5 (20525)	21.78	20.59
		824.7 (20407)	21.63	20.43
	6RB (0)	848.3 (20643)	20.65	19.79
		836.5 (20525)	20.69	19.71
		824.7 (20407)	20.55	19.29
3MHz	1RB-High (14)	847.5 (20635)	21.43	20.66
		836.5 (20525)	21.60	20.63
		825.5 (20415)	21.73	20.98
	1RB-Middle (7)	847.5 (20635)	21.71	20.62
		836.5 (20525)	21.76	20.77
		825.5 (20415)	21.48	20.31
	1RB-Low (0)	847.5 (20635)	21.81	20.65
		836.5 (20525)	21.58	20.57

	8RB-High (7)	825.5 (20415)	21.72	20.01
		847.5 (20635)	20.45	19.47
		836.5 (20525)	20.59	19.74
	8RB-Middle (4)	825.5 (20415)	20.51	19.54
		847.5 (20635)	20.57	19.58
		836.5 (20525)	20.54	19.65
	8RB-Low (0)	825.5 (20415)	20.44	19.65
		847.5 (20635)	20.59	19.55
		836.5 (20525)	20.60	19.78
	15RB (0)	825.5 (20415)	20.36	19.69
		847.5 (20635)	20.55	19.27
		836.5 (20525)	20.61	19.60
5MHz	1RB-High (24)	825.5 (20415)	20.48	19.56
		846.5 (20625)	21.29	20.48
		836.5 (20525)	21.40	20.03
	1RB-Middle (12)	826.5 (20425)	21.50	20.00
		846.5 (20625)	21.85	20.45
		836.5 (20525)	21.61	20.26
	1RB-Low (0)	826.5 (20425)	21.95	20.09
		846.5 (20625)	21.23	20.21
		836.5 (20525)	21.39	20.14
	12RB-High (13)	826.5 (20425)	21.68	20.00
		846.5 (20625)	20.37	19.41
		836.5 (20525)	20.55	19.52
	12RB-Middle (6)	826.5 (20425)	20.48	19.47
		846.5 (20625)	20.52	19.56
		836.5 (20525)	20.61	19.55
	12RB-Low (0)	826.5 (20425)	20.53	19.48
		846.5 (20625)	20.52	19.55
		836.5 (20525)	20.59	19.48
25RB (0)	826.5 (20425)	20.41	19.31	
	846.5 (20625)	20.42	19.47	
	836.5 (20525)	20.61	19.55	
10MHz	1RB-High (49)	826.5 (20425)	20.47	19.58
		844 (20600)	21.63	20.36
		836.5 (20525)	21.84	20.73
	1RB-Middle (24)	829 (20450)	21.78	20.67
		844 (20600)	22.00	20.35
		836.5 (20525)	21.77	20.87
	1RB-Low (0)	829 (20450)	21.82	20.82
		844 (20600)	21.77	20.96
		836.5 (20525)	21.75	20.66



	25RB-High (25)	829 (20450)	21.58	20.56
		844 (20600)	20.73	19.72
		836.5 (20525)	20.75	19.81
	25RB-Middle (12)	829 (20450)	20.75	19.72
		844 (20600)	20.70	19.78
		836.5 (20525)	20.69	19.75
	25RB-Low (0)	829 (20450)	20.71	19.71
		844 (20600)	20.77	19.85
		836.5 (20525)	20.55	19.61
	50RB (0)	829 (20450)	20.59	19.57
		844 (20600)	20.69	19.75
		836.5 (20525)	20.66	19.66
		829 (20450)	20.62	19.59

LTEB7-LevelA				
BANDWIDTH	Number of RBs	Frequency	QPSK	16QAM
5MHz	1RB-High (24)	2567.5 (21425)	21.26	20.20
		2535 (21100)	21.58	19.99
		2502.5 (20775)	21.30	20.00
	1RB-Middle (12)	2567.5 (21425)	21.47	20.13
		2535 (21100)	21.66	20.19
		2502.5 (20775)	21.12	20.05
	1RB-Low (0)	2567.5 (21425)	21.26	20.13
		2535 (21100)	21.66	19.82
		2502.5 (20775)	21.16	19.91
	12RB-High (13)	2567.5 (21425)	20.33	19.22
		2535 (21100)	20.58	19.38
		2502.5 (20775)	20.50	19.46
	12RB-Middle (6)	2567.5 (21425)	20.41	19.31
		2535 (21100)	20.59	19.46
		2502.5 (20775)	20.54	19.32
	12RB-Low (0)	2567.5 (21425)	20.52	19.42
		2535 (21100)	20.48	19.46
		2502.5 (20775)	20.41	19.22
	25RB (0)	2567.5 (21425)	20.33	19.25
		2535 (21100)	20.55	19.59
		2502.5 (20775)	20.59	19.40
10MHz	1RB-High (49)	2565 (21400)	21.35	20.44
		2535 (21100)	21.68	20.56
		2505 (20800)	21.46	20.09
	1RB-Middle (24)	2565 (21400)	21.46	20.61



		2535 (21100)	21.66	20.53	
		2505 (20800)	21.56	20.12	
		2565 (21400)	21.37	20.44	
	1RB-Low (0)	2535 (21100)	21.63	20.28	
		2505 (20800)	21.48	20.11	
		2565 (21400)	20.43	19.54	
	25RB-High (25)	2535 (21100)	20.59	19.60	
		2505 (20800)	20.65	19.70	
		2565 (21400)	20.50	19.55	
	25RB-Middle (12)	2535 (21100)	20.57	19.51	
		2505 (20800)	20.50	19.64	
		2565 (21400)	20.43	19.42	
	25RB-Low (0)	2535 (21100)	20.48	19.39	
		2505 (20800)	20.52	19.48	
		2565 (21400)	20.36	19.34	
50RB (0)	2535 (21100)	20.59	19.57		
	2505 (20800)	20.64	19.48		
	2562.5 (21375)	21.27	20.44		
15MHz	1RB-High (74)	2535 (21100)	21.51	20.39	
		2507.5 (20825)	21.23	21.05	
		2562.5 (21375)	21.67	20.74	
	1RB-Middle (37)	2535 (21100)	21.54	20.39	
		2507.5 (20825)	21.18	20.90	
		2562.5 (21375)	21.55	20.61	
	1RB-Low (0)	2535 (21100)	21.32	20.17	
		2507.5 (20825)	21.11	20.45	
		2562.5 (21375)	20.27	19.45	
	36RB-High (38)	2535 (21100)	20.51	19.51	
		2507.5 (20825)	20.46	19.39	
		2562.5 (21375)	20.29	19.40	
	36RB-Middle (19)	2535 (21100)	20.42	19.46	
		2507.5 (20825)	20.45	19.40	
		2562.5 (21375)	20.22	19.35	
	36RB-Low (0)	2535 (21100)	20.33	19.38	
		2507.5 (20825)	20.47	19.20	
		2562.5 (21375)	20.35	19.41	
	75RB (0)	2535 (21100)	20.44	19.48	
		2507.5 (20825)	20.49	19.47	
		2560 (21350)	21.11	20.23	
	20MHz	1RB-High (99)	2535 (21100)	21.15	20.29
			2510 (20850)	20.95	20.25
			2560 (21350)	21.46	20.32
		1RB-Middle (50)	2560 (21350)	21.46	20.32



		2535 (21100)	21.14	20.26
		2510 (20850)	21.37	20.21
		2560 (21350)	21.37	20.40
	1RB-Low (0)	2535 (21100)	20.91	20.21
		2510 (20850)	20.86	19.71
		2560 (21350)	20.24	19.25
	50RB-High (50)	2535 (21100)	20.32	19.44
		2510 (20850)	20.33	19.45
		2560 (21350)	20.32	19.42
	50RB-Middle (25)	2535 (21100)	20.29	19.33
		2510 (20850)	20.33	19.40
		2560 (21350)	20.29	19.42
	50RB-Low (0)	2535 (21100)	20.17	19.29
		2510 (20850)	20.41	19.32
		2560 (21350)	20.22	19.25
100RB (0)	2535 (21100)	20.34	19.48	
	2510 (20850)	20.40	19.30	

LTEB28-LevelA				
BANDWIDTH	Number of RBs	Frequency	QPSK	16QAM
3MHz	1RB-High (14)	746.5 (27645)	21.63	20.79
		719.5 (27375)	21.85	20.83
		704.5 (27225)	21.83	21.02
	1RB-Middle (7)	746.5 (27645)	21.97	20.97
		719.5 (27375)	22.08	21.13
		704.5 (27225)	21.81	20.43
	1RB-Low (0)	746.5 (27645)	22.07	21.06
		719.5 (27375)	22.03	21.23
		704.5 (27225)	22.07	20.83
	8RB-High (7)	746.5 (27645)	20.73	19.89
		719.5 (27375)	20.83	19.55
		704.5 (27225)	20.79	19.88
	8RB-Middle (4)	746.5 (27645)	20.76	19.94
		719.5 (27375)	20.92	19.55
		704.5 (27225)	20.79	19.86
	8RB-Low (0)	746.5 (27645)	20.84	19.79
		719.5 (27375)	20.83	19.59
		704.5 (27225)	20.76	19.76
	15RB (0)	746.5 (27645)	20.80	19.71
		719.5 (27375)	20.86	19.88
		704.5 (27225)	20.73	19.58

5MHz	1RB-High (24)	745.5 (27635)	21.68	20.26	
		720.5 (27385)	21.40	20.50	
		705.5 (27235)	21.60	20.23	
	1RB-Middle (12)	745.5 (27635)	22.01	20.35	
		720.5 (27385)	21.63	20.87	
		705.5 (27235)	21.76	20.38	
	1RB-Low (0)	745.5 (27635)	22.16	20.23	
		720.5 (27385)	21.67	20.67	
		705.5 (27235)	21.59	20.51	
	12RB-High (13)	745.5 (27635)	20.74	19.82	
		720.5 (27385)	20.63	19.71	
		705.5 (27235)	20.76	19.61	
	12RB-Middle (6)	745.5 (27635)	20.72	19.80	
		720.5 (27385)	20.71	19.60	
		705.5 (27235)	20.58	19.53	
	12RB-Low (0)	745.5 (27635)	20.80	19.99	
		720.5 (27385)	20.82	19.79	
		705.5 (27235)	20.76	19.79	
	25RB (0)	745.5 (27635)	20.73	19.85	
		720.5 (27385)	20.77	19.79	
		705.5 (27235)	20.67	19.62	
	10MHz	1RB-High (49)	743 (27610)	21.55	20.56
			723 (27410)	21.55	20.82
			708 (27260)	21.75	20.81
1RB-Middle (24)		743 (27610)	22.37	21.63	
		723 (27410)	21.90	21.20	
		708 (27260)	22.12	21.02	
1RB-Low (0)		743 (27610)	22.00	20.86	
		723 (27410)	21.78	20.74	
		708 (27260)	21.65	21.20	
25RB-High (25)		743 (27610)	20.75	19.86	
		723 (27410)	20.81	19.82	
		708 (27260)	20.73	19.89	
25RB-Middle (12)		743 (27610)	21.00	19.92	
		723 (27410)	20.77	19.77	
		708 (27260)	20.65	19.72	
25RB-Low (0)		743 (27610)	20.87	20.05	
		723 (27410)	20.84	19.69	
		708 (27260)	20.72	19.77	
50RB (0)		743 (27610)	20.81	19.80	
		723 (27410)	20.77	19.67	
		708 (27260)	20.69	19.85	

15MHz	1RB-High (74)	740.5 (27585)	21.67	20.89
		725.5 (27435)	21.57	21.26
		710.5 (27285)	21.69	20.82
	1RB-Middle (37)	740.5 (27585)	21.70	21.06
		725.5 (27435)	21.54	21.30
		710.5 (27285)	21.67	20.67
	1RB-Low (0)	740.5 (27585)	21.62	20.87
		725.5 (27435)	21.74	21.35
		710.5 (27285)	21.94	20.90
	36RB-High (38)	740.5 (27585)	20.73	19.79
		725.5 (27435)	20.71	19.54
		710.5 (27285)	20.71	19.72
	36RB-Middle (19)	740.5 (27585)	20.76	19.83
		725.5 (27435)	20.74	19.69
		710.5 (27285)	20.62	19.64
	36RB-Low (0)	740.5 (27585)	20.71	19.88
		725.5 (27435)	20.74	19.66
		710.5 (27285)	20.70	19.62
75RB (0)	740.5 (27585)	20.72	19.81	
	725.5 (27435)	20.63	19.70	
	710.5 (27285)	20.66	19.69	
20MHz	1RB-High (99)	738 (27560)	21.74	20.72
		728 (27460)	21.53	20.63
		713 (27310)	21.51	20.50
	1RB-Middle (50)	738 (27560)	22.00	20.85
		728 (27460)	21.64	20.50
		713 (27310)	21.66	20.50
	1RB-Low (0)	738 (27560)	21.51	20.52
		728 (27460)	21.66	20.69
		713 (27310)	21.50	20.50
	50RB-High (50)	738 (27560)	20.65	19.53
		728 (27460)	20.54	19.55
		713 (27310)	20.64	19.64
	50RB-Middle (25)	738 (27560)	20.68	19.91
		728 (27460)	20.65	19.65
		713 (27310)	20.56	19.60
	50RB-Low (0)	738 (27560)	20.82	19.86
		728 (27460)	20.72	19.74
		713 (27310)	20.57	19.72
100RB (0)	738 (27560)	20.69	19.69	
	728 (27460)	20.50	19.55	
	713 (27310)	20.69	19.73	

LTEB2-Level B					
BANDWIDTH	Number of RBs	Frequency	QPSK	16QAM	
1.4MHz	1RB-High (5)	1909.3 (19193)	16.81	16.86	
		1880 (18900)	16.86	16.74	
		1850.7 (18607)	17.10	17.04	
	1RB-Middle (3)	1909.3 (19193)	17.04	16.82	
		1880 (18900)	17.09	16.76	
		1850.7 (18607)	17.13	17.16	
	1RB-Low (0)	1909.3 (19193)	16.82	16.47	
		1880 (18900)	16.86	16.70	
		1850.7 (18607)	16.90	16.79	
	3RB-High (3)	1909.3 (19193)	16.85	16.76	
		1880 (18900)	16.92	17.00	
		1850.7 (18607)	16.99	17.01	
	3RB-Middle (1)	1909.3 (19193)	16.76	16.67	
		1880 (18900)	16.87	17.07	
		1850.7 (18607)	16.93	16.94	
	3RB-Low (0)	1909.3 (19193)	16.76	16.82	
		1880 (18900)	16.95	17.02	
		1850.7 (18607)	16.97	17.05	
	6RB (0)	1909.3 (19193)	16.84	16.61	
		1880 (18900)	16.84	17.08	
		1850.7 (18607)	17.03	17.15	
	3MHz	1RB-High (14)	1908.5 (19185)	16.76	16.75
			1880 (18900)	16.87	17.05
			1851.5 (18615)	17.10	17.41
1RB-Middle (7)		1908.5 (19185)	17.09	16.74	
		1880 (18900)	16.92	17.06	
		1851.5 (18615)	16.95	16.99	
1RB-Low (0)		1908.5 (19185)	16.90	16.93	
		1880 (18900)	16.92	17.14	
		1851.5 (18615)	16.86	16.45	
8RB-High (7)		1908.5 (19185)	16.77	16.53	
		1880 (18900)	16.88	16.81	
		1851.5 (18615)	16.97	16.99	
8RB-Middle (4)		1908.5 (19185)	16.90	16.68	
		1880 (18900)	16.89	16.83	
		1851.5 (18615)	16.95	16.98	
8RB-Low (0)		1908.5 (19185)	16.91	16.60	
		1880 (18900)	16.85	16.85	
		1851.5 (18615)	16.95	17.07	
15RB (0)		1908.5 (19185)	16.79	16.79	

		1880 (18900)	16.86	16.79	
		1851.5 (18615)	17.00	17.08	
5MHz	1RB-High (24)	1907.5 (19175)	16.55	16.35	
		1880 (18900)	16.85	16.48	
		1852.5 (18625)	16.96	16.43	
	1RB-Middle (12)	1907.5 (19175)	17.27	16.69	
		1880 (18900)	16.62	16.37	
		1852.5 (18625)	16.91	16.46	
	1RB-Low (0)	1907.5 (19175)	16.78	16.24	
		1880 (18900)	16.95	16.50	
		1852.5 (18625)	16.82	16.53	
	12RB-High (13)	1907.5 (19175)	16.70	16.74	
		1880 (18900)	16.83	16.62	
		1852.5 (18625)	16.93	17.05	
	12RB-Middle (6)	1907.5 (19175)	16.92	16.92	
		1880 (18900)	16.87	16.83	
		1852.5 (18625)	16.88	16.95	
	12RB-Low (0)	1907.5 (19175)	16.85	16.99	
		1880 (18900)	16.90	16.78	
		1852.5 (18625)	16.94	16.85	
	25RB (0)	1907.5 (19175)	16.76	16.95	
		1880 (18900)	16.82	16.72	
		1852.5 (18625)	16.99	16.98	
	10MHz	1RB-High (49)	1905 (19150)	16.82	16.77
			1880 (18900)	16.72	16.98
			1855 (18650)	17.17	16.58
1RB-Middle (24)		1905 (19150)	17.08	16.91	
		1880 (18900)	16.86	17.09	
		1855 (18650)	17.04	16.45	
1RB-Low (0)		1905 (19150)	17.01	16.73	
		1880 (18900)	16.96	16.97	
		1855 (18650)	16.99	16.41	
25RB-High (25)		1905 (19150)	16.72	16.95	
		1880 (18900)	16.95	17.06	
		1855 (18650)	16.95	17.12	
25RB-Middle (12)		1905 (19150)	16.79	16.89	
		1880 (18900)	16.95	17.04	
		1855 (18650)	16.88	16.93	
25RB-Low (0)		1905 (19150)	16.77	16.73	
		1880 (18900)	16.92	16.97	
		1855 (18650)	16.95	16.89	
50RB (0)	1905 (19150)	16.67	16.67		

		1880 (18900)	16.86	16.86
		1855 (18650)	17.00	16.99
15MHz	1RB-High (74)	1902.5 (19125)	16.58	16.08
		1880 (18900)	16.64	17.04
		1857.5 (18675)	17.13	17.19
	1RB-Middle (37)	1902.5 (19125)	16.88	16.11
		1880 (18900)	17.22	17.44
		1857.5 (18675)	17.03	17.27
	1RB-Low (0)	1902.5 (19125)	16.46	17.02
		1880 (18900)	16.78	17.33
		1857.5 (18675)	17.12	16.81
	36RB-High (38)	1902.5 (19125)	16.68	16.60
		1880 (18900)	16.83	16.82
		1857.5 (18675)	16.90	16.98
	36RB-Middle (19)	1902.5 (19125)	16.73	16.77
		1880 (18900)	16.84	16.78
		1857.5 (18675)	16.81	16.90
	36RB-Low (0)	1902.5 (19125)	16.64	16.71
		1880 (18900)	16.74	16.57
		1857.5 (18675)	16.80	16.81
	75RB (0)	1902.5 (19125)	16.58	16.60
		1880 (18900)	16.71	16.79
		1857.5 (18675)	16.91	16.98
20MHz	1RB-High (99)	1900 (19100)	16.70	16.43
		1880 (18900)	16.93	16.68
		1860 (18700)	16.89	16.85
	1RB-Middle (50)	1900 (19100)	16.95	16.67
		1880 (18900)	17.19	17.09
		1860 (18700)	16.80	16.40
	1RB-Low (0)	1900 (19100)	16.63	16.44
		1880 (18900)	17.06	16.89
		1860 (18700)	16.55	16.64
	50RB-High (50)	1900 (19100)	16.84	16.61
		1880 (18900)	16.90	16.75
		1860 (18700)	16.83	16.86
	50RB-Middle (25)	1900 (19100)	16.98	16.97
		1880 (18900)	16.99	17.04
		1860 (18700)	16.87	16.79
50RB-Low (0)	1900 (19100)	16.89	16.74	
	1880 (18900)	16.92	16.94	
	1860 (18700)	16.77	16.81	
	100RB (0)	1900 (19100)	16.87	16.89



		1880 (18900)	16.86	16.86
		1860 (18700)	16.95	16.93

LTEB4-Level B				
BANDWIDTH	Number of RBs	Frequency	QPSK	16QAM
1.4MHz	1RB-High (5)	1754.3 (20393)	20.54	20.64
		1732.5 (20175)	20.46	20.61
		1710.7 (19957)	20.47	20.26
	1RB-Middle (3)	1754.3 (20393)	20.64	20.70
		1732.5 (20175)	20.61	20.58
		1710.7 (19957)	20.54	20.54
	1RB-Low (0)	1754.3 (20393)	20.60	20.58
		1732.5 (20175)	20.48	20.42
		1710.7 (19957)	20.40	20.20
	3RB-High (3)	1754.3 (20393)	20.59	20.68
		1732.5 (20175)	20.64	20.33
		1710.7 (19957)	20.55	20.57
	3RB-Middle (1)	1754.3 (20393)	20.57	20.70
		1732.5 (20175)	20.66	20.37
		1710.7 (19957)	20.61	20.54
	3RB-Low (0)	1754.3 (20393)	20.60	20.92
		1732.5 (20175)	20.60	20.51
		1710.7 (19957)	20.67	20.56
	6RB (0)	1754.3 (20393)	20.56	20.60
		1732.5 (20175)	20.52	20.61
		1710.7 (19957)	20.56	20.34
3MHz	1RB-High (14)	1753.5 (20385)	20.63	20.62
		1732.5 (20175)	20.71	20.57
		1711.5 (19965)	20.50	20.08
	1RB-Middle (7)	1753.5 (20385)	20.52	20.48
		1732.5 (20175)	20.78	20.45
		1711.5 (19965)	20.53	20.10
	1RB-Low (0)	1753.5 (20385)	20.43	20.59
		1732.5 (20175)	20.72	20.54
		1711.5 (19965)	20.63	20.97
	8RB-High (7)	1753.5 (20385)	20.56	20.43
		1732.5 (20175)	20.63	20.70
		1711.5 (19965)	20.51	20.56
	8RB-Middle (4)	1753.5 (20385)	20.62	20.42

		1732.5 (20175)	20.57	20.54	
		1711.5 (19965)	20.56	20.61	
		1753.5 (20385)	20.51	20.42	
	8RB-Low (0)	1732.5 (20175)	20.56	20.62	
		1711.5 (19965)	20.58	20.83	
		1753.5 (20385)	20.59	20.49	
	15RB (0)	1732.5 (20175)	20.55	20.74	
		1711.5 (19965)	20.53	20.72	
		1753.5 (20385)	20.59	20.49	
5MHz	1RB-High (24)	1752.5 (20375)	20.62	20.47	
		1732.5 (20175)	20.65	19.92	
		1712.5 (19975)	20.22	19.96	
	1RB-Middle (12)	1752.5 (20375)	20.67	20.44	
		1732.5 (20175)	20.65	19.82	
		1712.5 (19975)	20.25	19.77	
	1RB-Low (0)	1752.5 (20375)	20.42	20.25	
		1732.5 (20175)	20.48	20.21	
		1712.5 (19975)	20.31	19.91	
	12RB-High (13)	1752.5 (20375)	20.67	20.69	
		1732.5 (20175)	20.49	20.69	
		1712.5 (19975)	20.48	20.40	
	12RB-Middle (6)	1752.5 (20375)	20.54	20.76	
		1732.5 (20175)	20.47	20.53	
		1712.5 (19975)	20.45	20.45	
	12RB-Low (0)	1752.5 (20375)	20.57	20.72	
		1732.5 (20175)	20.44	20.52	
		1712.5 (19975)	20.49	20.48	
	25RB (0)	1752.5 (20375)	20.69	20.64	
		1732.5 (20175)	20.43	20.64	
		1712.5 (19975)	20.54	20.72	
	10MHz	1RB-High (49)	1750 (20350)	20.76	20.77
			1732.5 (20175)	20.18	20.11
			1715 (20000)	20.47	20.80
1RB-Middle (24)		1750 (20350)	20.49	20.73	
		1732.5 (20175)	20.82	20.63	
		1715 (20000)	20.72	20.97	
1RB-Low (0)		1750 (20350)	20.56	20.31	
		1732.5 (20175)	20.69	20.21	
		1715 (20000)	20.43	20.26	
25RB-High (25)		1750 (20350)	20.68	20.70	
		1732.5 (20175)	20.42	20.36	
		1715 (20000)	20.57	20.71	
25RB-Middle (12)	1750 (20350)	20.52	20.62		

		1732.5 (20175)	20.54	20.34	
		1715 (20000)	20.59	20.65	
		1750 (20350)	20.42	20.44	
	25RB-Low (0)	1732.5 (20175)	20.44	20.45	
		1715 (20000)	20.47	20.52	
		1750 (20350)	20.58	20.54	
	50RB (0)	1732.5 (20175)	20.45	20.46	
		1715 (20000)	20.56	20.67	
		1750 (20350)	20.58	20.54	
15MHz	1RB-High (74)	1747.5 (20325)	20.43	20.29	
		1732.5 (20175)	20.39	20.56	
		1717.5 (20025)	20.78	20.88	
	1RB-Middle (37)	1747.5 (20325)	20.25	20.18	
		1732.5 (20175)	20.36	21.31	
		1717.5 (20025)	20.90	20.52	
	1RB-Low (0)	1747.5 (20325)	20.42	20.12	
		1732.5 (20175)	20.31	20.56	
		1717.5 (20025)	20.70	20.60	
	36RB-High (38)	1747.5 (20325)	20.46	20.59	
		1732.5 (20175)	20.49	20.44	
		1717.5 (20025)	20.47	20.48	
	36RB-Middle (19)	1747.5 (20325)	20.41	20.61	
		1732.5 (20175)	20.50	20.35	
		1717.5 (20025)	20.56	20.56	
	36RB-Low (0)	1747.5 (20325)	20.53	20.64	
		1732.5 (20175)	20.36	20.43	
		1717.5 (20025)	20.54	20.48	
	75RB (0)	1747.5 (20325)	20.44	20.46	
		1732.5 (20175)	20.37	20.37	
		1717.5 (20025)	20.48	20.46	
	20MHz	1RB-High (99)	1745 (20300)	20.51	20.29
			1732.5 (20175)	20.04	20.05
			1720 (20050)	20.00	19.85
		1RB-Middle (50)	1745 (20300)	20.55	20.21
			1732.5 (20175)	20.46	20.19
			1720 (20050)	20.35	19.73
1RB-Low (0)		1745 (20300)	20.45	20.33	
		1732.5 (20175)	20.22	20.00	
		1720 (20050)	20.02	19.73	
50RB-High (50)		1745 (20300)	20.32	20.40	
		1732.5 (20175)	20.25	20.16	
		1720 (20050)	20.22	20.39	
50RB-Middle (25)	1745 (20300)	20.29	20.23		

	50RB-Low (0)	1732.5 (20175)	20.24	20.31	
		1720 (20050)	20.31	20.41	
		1745 (20300)	20.31	20.38	
	100RB (0)	1732.5 (20175)	20.21	20.35	
		1720 (20050)	20.29	20.34	
		1745 (20300)	20.34	20.35	
			1732.5 (20175)	20.17	20.21
			1720 (20050)	20.34	20.41

LTEB7-Level B					
BANDWIDTH	Number of RBs	Frequency	QPSK	16QAM	
5MHz	1RB-High (24)	2567.5 (21425)	17.83	17.36	
		2535 (21100)	17.55	17.53	
		2502.5 (20775)	17.29	16.95	
	1RB-Middle (12)	2567.5 (21425)	17.80	17.21	
		2535 (21100)	17.83	17.00	
		2502.5 (20775)	17.39	16.96	
	1RB-Low (0)	2567.5 (21425)	18.11	17.21	
		2535 (21100)	17.52	16.97	
		2502.5 (20775)	17.34	16.91	
	12RB-High (13)	2567.5 (21425)	17.74	17.90	
		2535 (21100)	17.69	17.46	
		2502.5 (20775)	17.29	17.38	
	12RB-Middle (6)	2567.5 (21425)	17.77	17.76	
		2535 (21100)	17.64	17.50	
		2502.5 (20775)	17.25	17.29	
	12RB-Low (0)	2567.5 (21425)	17.92	17.77	
		2535 (21100)	17.59	17.47	
		2502.5 (20775)	17.25	17.33	
	25RB (0)	2567.5 (21425)	17.91	18.05	
		2535 (21100)	17.69	17.86	
		2502.5 (20775)	17.28	17.40	
	10MHz	1RB-High (49)	2565 (21400)	17.80	17.85
			2535 (21100)	17.93	17.72
			2505 (20800)	17.60	17.81
1RB-Middle (24)		2565 (21400)	17.82	18.01	
		2535 (21100)	18.07	17.82	
		2505 (20800)	17.37	17.00	
1RB-Low (0)	2565 (21400)	17.47	17.79		
	2535 (21100)	17.75	17.42		



	25RB-High (25)	2505 (20800)	17.27	16.69
		2565 (21400)	17.83	17.99
		2535 (21100)	17.72	17.69
	25RB-Middle (12)	2505 (20800)	17.55	17.58
		2565 (21400)	17.90	18.05
		2535 (21100)	17.73	17.60
	25RB-Low (0)	2505 (20800)	17.37	17.49
		2565 (21400)	17.82	17.91
		2535 (21100)	17.65	17.60
	50RB (0)	2505 (20800)	17.28	17.40
		2565 (21400)	17.84	17.90
		2535 (21100)	17.71	17.77
15MHz	1RB-High (74)	2505 (20800)	17.40	17.33
		2562.5 (21375)	17.65	17.53
		2535 (21100)	17.67	18.11
	1RB-Middle (37)	2507.5 (20825)	17.71	17.54
		2562.5 (21375)	17.71	17.80
		2535 (21100)	17.60	18.11
	1RB-Low (0)	2507.5 (20825)	17.69	17.33
		2562.5 (21375)	17.75	17.55
		2535 (21100)	17.49	18.12
	36RB-High (38)	2507.5 (20825)	17.53	17.44
		2562.5 (21375)	17.94	18.15
		2535 (21100)	17.77	17.84
	36RB-Middle (19)	2507.5 (20825)	17.54	17.73
		2562.5 (21375)	17.83	17.95
		2535 (21100)	17.71	17.75
	36RB-Low (0)	2507.5 (20825)	17.37	17.40
		2562.5 (21375)	17.78	18.02
		2535 (21100)	17.61	17.65
75RB (0)	2507.5 (20825)	17.28	17.17	
	2562.5 (21375)	17.84	17.94	
	2535 (21100)	17.68	17.76	
20MHz	1RB-High (99)	2507.5 (20825)	17.40	17.47
		2560 (21350)	17.84	17.94
		2535 (21100)	17.68	17.76
	1RB-Middle (50)	2560 (21350)	17.84	17.94
		2535 (21100)	17.68	17.76
		2510 (20850)	17.08	17.11
	1RB-Low (0)	2560 (21350)	17.59	17.57
		2535 (21100)	17.69	17.55
		2510 (20850)	17.50	17.71
		2560 (21350)	17.23	17.16
		2535 (21100)	17.49	17.24



	50RB-High (50)	2510 (20850)	16.76	16.92
		2560 (21350)	17.66	17.78
		2535 (21100)	17.58	17.46
		2510 (20850)	17.18	17.17
	50RB-Middle (25)	2560 (21350)	17.76	17.91
		2535 (21100)	17.56	17.54
		2510 (20850)	17.27	17.26
	50RB-Low (0)	2560 (21350)	17.74	17.80
		2535 (21100)	17.48	17.38
		2510 (20850)	17.08	17.10
	100RB (0)	2560 (21350)	17.66	17.77
		2535 (21100)	17.47	17.46
2510 (20850)		17.12	17.12	

11.4 Wi-Fi and BT Measurement result

The maximum output power of BT is 8.05dBm.

The maximum tune up of BT is 9.9dBm.

WIFI Conducted power:

2.4G									
802.11b	Channel\data rate	1Mbps	2Mbps	5.5Mbps	11Mbps				
WLAN2450	11(2462MHz)	15.19	/	/	/				
	6(2437(MHz)	14.35	/	/	/				
	1(2412MHz)	15.46	15.28	15.27	15.30				
	Tune up	15.50	15.50	15.50	15.50				
802.11g	Channel\data rate	6Mbps	9Mbps	12Mbps	18Mbps	24Mbps	36Mbps	48Mbps	54Mbps
WLAN2450	11(2462MHz)	13.25	/	/	/	/	/	/	/
	6(2437(MHz)	12.47	/	/	/	/	/	/	/
	1(2412MHz)	13.45	13.42	13.44	13.41	13.45	13.38	13.35	13.35
	Tune up	13.50	13.50	13.50	13.50	13.50	13.50	13.50	13.50
802.11n-20MHz	Channel\data rate	MCS0	MCS1	MCS2	MCS3	MCS4	MCS5	MCS6	MCS7
WLAN2450	11(2462MHz)	12.30	/	/	/	/	/	/	/
	6(2437(MHz)	11.57	/	/	/	/	/	/	/
	1(2412MHz)	12.56	12.53	12.51	12.54	12.53	12.44	12.42	12.41
	Tune up	12.60	12.60	12.60	12.60	12.60	12.60	12.60	12.60

12 Simultaneous TX SAR Considerations

12.1 Introduction

The following procedures adopted from “FCC SAR Considerations for Cell Phones with Multiple Transmitters” are applicable to handsets with built-in unlicensed transmitters such as 802.11 a/b/g and Bluetooth devices which may simultaneously transmit with the licensed transmitter. For this device, the BT and Wi-Fi can transmit simultaneous with other transmitters.

12.2 Transmit Antenna Separation Distances

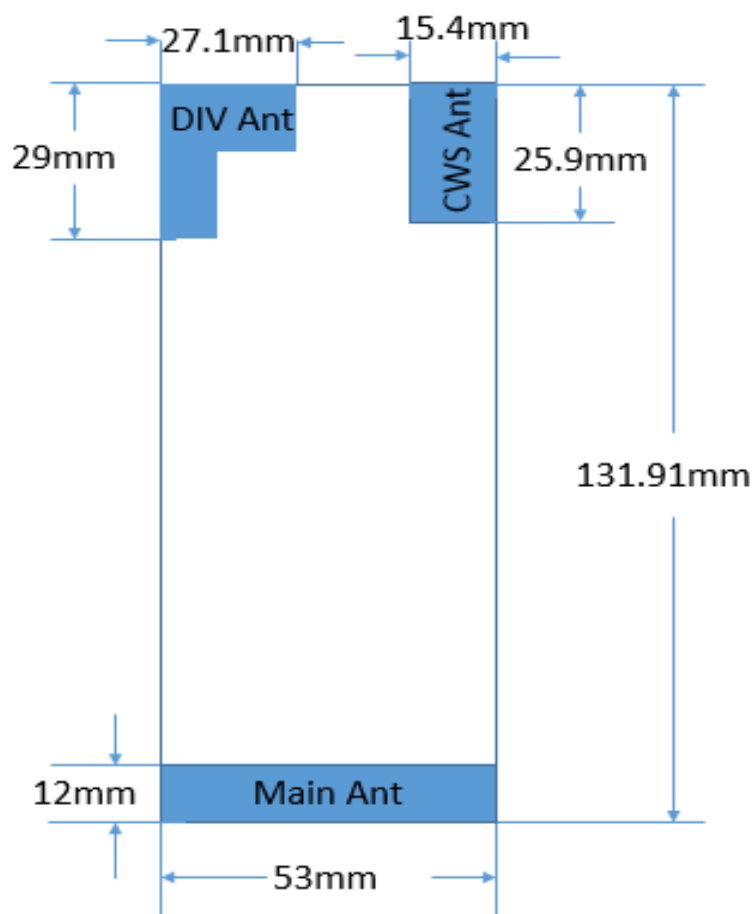

Picture 12.1 Antenna Locations

12.3 SAR Measurement Positions

According to the KDB941225 D06 Hot Spot SAR v01, the edges with less than 2.5 cm distance to the antennas need to be tested for SAR.

SAR measurement positions						
Mode	Front	Rear	Left edge	Right edge	Top edge	Bottom edge
Main antenna	Yes	Yes	Yes	Yes	No	Yes
WLAN 2.4G	Yes	Yes	Yes	Yes	Yes	No

12.4 Standalone SAR Test Exclusion Considerations

Standalone 1-g head or body SAR evaluation by measurement or numerical simulation is not required when the corresponding SAR Exclusion Threshold condition, listed below, is satisfied. The 1-g SAR test exclusion threshold for 100 MHz to 6 GHz at test separation distances ≤ 50 mm are determined by:

$[(\text{max. power of channel, including tune-up tolerance, mW}) / (\text{min. test separation distance, mm})] \cdot [\sqrt{f(\text{GHz})}] \leq 3.0$ for 1-g SAR, where

- $f(\text{GHz})$ is the RF channel transmit frequency in GHz
- Power and distance are rounded to the nearest mW and mm before calculation
- The result is rounded to one decimal place for comparison

Table 12.1: Standalone SAR test exclusion considerations

Band/Mode	F(GHz)	Position	SAR test exclusion threshold(mW)	RF output power		SAR test exclusion
				dBm	mW	
Bluetooth	2.441	Head	9.60	9.9	9.80	No
		Body	19.20	9.9	9.80	Yes
2.4GHz WLAN	2.45	Head	9.58	15.5	35.5	No
		Body	19.17	15.5	35.5	No

13 Evaluation of Simultaneous

Table 13.1: The sum of reported SAR values for main antenna and WiFi2.4G

	Position	Main antenna	WiFi	Sum
Highest reported SAR value for Head	Right head, Cheek	1.20	0.17	1.37
Highest reported SAR value for Hotspot	Bottom 10mm	1.31	0.00	1.31
Highest reported SAR value for Hotspot	Rear 10mm	1.25	0.07	1.32
Highest reported SAR value for Body	Rear 15mm	1.06	0.07	1.13

[1] – the wifi value with 10mm is used to evaluate the sum value with 15mm

Table 13.3: The sum of reported SAR values for main antenna and BT

	Position	Main antenna	BT	Sum
Maximum reported SAR value for Head	Right head, Cheek	1.20	<0.01	1.20
Maximum reported SAR value for Hotspot	Bottom 10mm	1.31	<0.01	1.31
Highest reported SAR value for Body	Rear 15mm	1.06	<0.01	1.06

* - Maximum possible output power declared by manufacturer

Conclusion:

According to the above tables, the sum of reported SAR values is <1.6W/kg. So the simultaneous transmission SAR with volume scans is not required.

14 SAR Test Result

It is determined by user manual for the distance between the EUT and the phantom bottom. The distance is 10 mm or 15mm and just applied to the condition of body worn accessory.

It is performed for all SAR measurements with area scan based 1-g SAR estimation (Fast SAR). A zoom scan measurement is added when the estimated 1-gSAR is the highest measured SAR in each exposure configuration, wireless mode and frequency band combination or more than 1.2W/kg.

The calculated SAR is obtained by the following formula:

$$\text{Reported SAR} = \text{Measured SAR} \times 10^{(P_{\text{Target}} - P_{\text{Measured}})/10}$$

Where P_{Target} is the power of manufacturing upper limit;

P_{Measured} is the measured power in chapter 11.

Table 14.1: Duty Cycle

Mode	Duty Cycle
Speech for GSM850	1:8.3
Speech for GSM1900	1:8.3
GPRS&EGPRS for GSM850- Normal Power	1:2.67
GPRS&EGPRS for GSM1900-Normal Power	1:8.3
GPRS&EGPRS for GSM1900-Low Power	1:2.67
WCDMA<E FDD	1:1

14.1 SAR results for Fast SAR

Table 14.1-1: SAR Values (GSM 850 MHz Band - Head)

Ambient Temperature: 22.9°C						Liquid Temperature: 22.5°C					
Frequency		Side	Test Position	Figure No.	Conducted Power (dBm)	Max. tune-up Power (dBm)	Measured SAR(10g) (W/kg)	Reported SAR(10g) (W/kg)	Measured SAR(1g) (W/kg)	Reported SAR(1g) (W/kg)	Power Drift (dB)
Ch.	MHz										
251	848.8	Left	Cheek	/	31.13	32.5	0.287	0.39	0.385	0.53	-0.03
190	836.6	Left	Cheek	Fig.1	31.12	32.5	0.291	0.40	0.391	0.54	-0.06
128	824.2	Left	Cheek	/	31.43	32.5	0.262	0.34	0.353	0.45	0.01
190	836.6	Left	Tilt	/	31.12	32.5	0.188	0.26	0.245	0.34	0.19
190	836.6	Right	Cheek	/	31.12	32.5	0.293	0.40	0.366	0.50	-0.06
190	836.6	Right	Tilt	/	31.12	32.5	0.2	0.27	0.263	0.36	0.15

Table 14.1-2: SAR Values (GSM 850 MHz Band - Body)

Ambient Temperature: 22.9°C						Liquid Temperature: 22.5°C					
Frequency		Mode (number of timeslots)	Test Position	Figure No.	Conducted Power (dBm)	Max. tune-up Power (dBm)	Measured SAR(10g) (W/kg)	Reported SAR(10g) (W/kg)	Measured SAR(1g) (W/kg)	Reported SAR(1g) (W/kg)	Power Drift (dB)
Ch.	MHz										
190	836.6	Front	GPRS(3)	/	27.14	28.5	0.34	0.47	0.467	0.64	0.02
251	848.8	Rear	GPRS(3)	/	27.16	28.5	0.40	0.54	0.545	0.74	0.06
190	836.6	Rear	GPRS(3)	Fig.2	27.14	28.5	0.41	0.56	0.552	0.75	0.08
128	824.2	Rear	GPRS(3)	/	27.01	28.5	0.31	0.44	0.435	0.61	0.01
190	836.6	Left	GPRS(3)	/	27.14	28.5	0.16	0.22	0.229	0.31	-0.09
190	836.6	Right	GPRS(3)	/	27.14	28.5	0.14	0.18	0.196	0.27	-0.09
190	836.6	Bottom	GPRS(3)	/	27.14	28.5	0.02	0.03	0.038	0.05	-0.17
190	836.6	Rear	EGPRS(3)	/	27.16	28.5	0.41	0.55	0.548	0.75	-0.13

Note: The distance between the EUT and the phantom bottom is 10mm.

Table 14.1-3: SAR Values (GSM 1900 MHz Band - Head)

Ambient Temperature: 22.9°C						Liquid Temperature: 22.5°C					
Frequency		Side	Test Position	Figure No.	Conducted Power (dBm)	Max. tune-up Power (dBm)	Measured SAR(10g) (W/kg)	Reported SAR(10g) (W/kg)	Measured SAR(1g) (W/kg)	Reported SAR(1g) (W/kg)	Power Drift (dB)
Ch.	MHz										
661	1880	Left	Cheek	/	29.76	31	0.34	0.45	0.522	0.69	-0.13
661	1880	Left	Tilt	/	29.76	31	0.222	0.30	0.357	0.47	-0.03
810	1909.8	Right	Cheek	Fig.3	30.19	31	0.435	0.52	0.699	0.84	0.18
661	1880	Right	Cheek	/	29.76	31	0.376	0.50	0.613	0.82	0.07
512	1850.2	Right	Cheek	/	29.71	31	0.369	0.50	0.589	0.79	-0.05
661	1880	Right	Tilt	/	29.76	31	0.165	0.22	0.251	0.33	-0.19

Table 14.1-4: SAR Values (GSM 1900 MHz Band - Body)

Frequency		Mode (number of timeslots)	Test Position	Figure No.	Conducted Power (dBm)	Max. tune-up Power (dBm)	Measured SAR(10g) (W/kg)	Reported SAR(10g) (W/kg)	Measured SAR(1g) (W/kg)	Reported SAR(1g) (W/kg)	Power Drift (dB)
Ch.	MHz										
810	1909.8	Front	GPRS(3)	/	23.25	24.2	0.34	0.42	0.555	0.69	0.06
810	1909.8	Rear	GPRS(3)	/	23.25	24.2	0.495	0.62	0.894	1.11	-0.08
661	1880	Rear	GPRS(3)	/	22.34	24.2	0.376	0.41	0.668	1.03	0.06
512	1850.2	Rear	GPRS(3)	/	22.20	24.2	0.274	0.30	0.571	0.90	-0.15
810	1909.8	Left	GPRS(3)	/	23.25	24.2	0.042	0.05	0.07	0.09	-0.14
810	1909.8	Right	GPRS(3)	/	23.25	24.2	0.027	0.03	0.046	0.06	-0.05
810	1909.8	Bottom	GPRS(3)	Fig.4	23.25	24.2	0.565	0.70	1.05	1.31	-0.09
661	1880	Bottom	GPRS(3)	/	22.34	24.2	0.394	0.60	0.723	1.11	-0.05
512	1850.2	Bottom	GPRS(3)	/	22.20	24.2	0.431	0.68	0.794	1.26	-0.14
810	1909.8	Bottom	EGPRS(3)	/	23.15	24.2	0.558	0.71	0.997	1.27	0.09
810	1909.8	Bottom	GPRS(3)	H	23.25	24.2	0.458	0.57	0.827	1.03	0.06

Note1: The distance between the EUT and the phantom bottom is 10mm

Table 14.1-5: SAR Values (GSM 1900 MHz Band - Body)

Frequency		Mode (number of timeslots)	Test Position	Figure No.	Conducted Power (dBm)	Max. tune-up Power (dBm)	Measured SAR(10g) (W/kg)	Reported SAR(10g) (W/kg)	Measured SAR(1g) (W/kg)	Reported SAR(1g) (W/kg)	Power Drift (dB)
Ch.	MHz										
661	1880	Front	GPRS(1)	/	30.13	31	0.245	0.30	0.395	0.48	-0.18
810	1909.8	Rear	GPRS(1)	/	30.65	31	0.312	0.34	0.57	0.62	-0.07
661	1880	Rear	GPRS(1)	Fig.5	30.13	31	0.36	0.44	0.65	0.79	-0.09
512	1850.2	Rear	GPRS(1)	/	29.99	31	0.281	0.35	0.51	0.64	0.19

Note1: The distance between the EUT and the phantom bottom is 15mm

Table 14.1-6: SAR Values (WCDMA 1900 MHz Band - Head)

Frequency		Side	Test Position	Figure No.	Conducted Power (dBm)	Max. tune-up Power (dBm)	Measured SAR(10g) (W/kg)	Reported SAR(10g) (W/kg)	Measured SAR(1g) (W/kg)	Reported SAR(1g) (W/kg)	Power Drift (dB)
Ch.	MHz										
9400	1880	Left	Cheek	/	20.66	21.5	0.376	0.46	0.59	0.72	-0.14
9400	1880	Left	Tilt	/	20.66	21.5	0.256	0.31	0.41	0.50	-0.15
9538	1907.6	Right	Cheek	/	20.58	21.5	0.431	0.53	0.701	0.87	-0.13
9400	1880	Right	Cheek	/	20.66	21.5	0.465	0.56	0.75	0.91	0.19
9262	1852.4	Right	Cheek	Fig.6	20.63	21.5	0.474	0.58	0.765	0.93	0.474
9400	1880	Right	Tilt	/	20.66	21.5	0.194	0.24	0.306	0.37	-0.07

Table 14.1-7: SAR Values (WCDMA 1900 MHz Band - Body)

Frequency		Test Position	Figure No.	Conduct ed Power (dBm)	Max. tune-up Power (dBm)	Ambient Temperature: 22.9 °C		Liquid Temperature: 22.5 °C		Power Drift (dB)
Ch.	MHz					Measured SAR(10g) (W/kg)	Reported SAR(10g) (W/kg)	Measured SAR(1g) (W/kg)	Reported SAR(1g) (W/kg)	
9400	1880	Front	/	16.83	17.5	0.234	0.27	0.38	0.44	0.03
9538	1907.6	Rear	/	16.82	17.5	0.307	0.36	0.568	0.66	-0.03
9400	1880	Rear	/	16.83	17.5	0.38	0.44	0.701	0.82	-0.19
9262	1852.4	Rear	/	16.91	17.5	0.471	0.54	0.716	0.82	0
9400	1880	Left	/	16.83	17.5	0.037	0.04	0.061	0.07	0.06
9400	1880	Right	/	16.83	17.5	0.043	0.05	0.072	0.08	-0.13
9538	1907.6	Bottom	/	16.82	17.5	0.343	0.40	0.632	0.74	0.19
9538	1880	Bottom	/	16.83	17.5	0.425	0.50	0.78	0.91	-0.18
9262	1852.4	Bottom	Fig.7	16.91	17.5	0.43	0.49	0.797	0.91	-0.09

Note: The distance between the EUT and the phantom bottom is 10mm

Table 14.1-8: SAR Values (WCDMA 1900 MHz Band - Body)

Frequency		Test Position	Figure No.	Conduct ed Power (dBm)	Max. tune-up Power (dBm)	Ambient Temperature: 22.9 °C		Liquid Temperature: 22.5 °C		Power Drift (dB)
Ch.	MHz					Measured SAR(10g) (W/kg)	Reported SAR(10g) (W/kg)	Measured SAR(1g) (W/kg)	Reported SAR(1g) (W/kg)	
9400	1880	Front	/	20.66	21.5	0.317	0.38	0.504	0.61	-0.19
9538	1907.6	Rear	/	20.58	21.5	0.389	0.48	0.681	0.84	-0.13
9400	1880	Rear	/	20.66	21.5	0.47	0.57	0.828	1.00	-0.06
9262	1852.4	Rear	Fig.8	20.63	21.5	0.484	0.59	0.865	1.06	0.17

Note: The distance between the EUT and the phantom bottom is 15mm

Table 14.1-9: SAR Values (WCDMA 1700 MHz Band - Head)

Frequency		Side	Test Position	Figure No.	Conducte d Power (dBm)	Max. tune-up Power (dBm)	Ambient Temperature: 22.9 °C		Liquid Temperature: 22.5 °C		Powe r Drift (dB)
Ch.	MHz						Measure d SAR(10g) (W/kg)	Reported SAR(10g) (W/kg)	Measure d SAR(1g) (W/kg)	Reporte d SAR(1g) (W/kg)	
1412	1732.4	Left	Cheek	/	22.62	23	0.400	0.44	0.559	0.61	0.08
1412	1732.4	Left	Tilt	/	22.62	23	0.326	0.36	0.469	0.51	0.12
1513	1752.6	Right	Cheek	/	22.58	23	0.729	0.80	1.08	1.19	0.08
1412	1732.4	Right	Cheek	Fig.9	22.62	23	0.700	0.76	1.09	1.19	-0.09
1312	1712.4	Right	Cheek	/	22.66	23	0.723	0.78	1.04	1.12	0.04
1412	1732.4	Right	Tilt	/	22.62	23	0.335	0.37	0.476	0.52	0.16

Table 14.1-10: SAR Values (WCDMA 1700 MHz Band - Body)

Frequency		Test Position	Figure No.	Conducted Power (dBm)	Max. tune-up Power (dBm)	Measured SAR(10g) (W/kg)	Reported SAR(10g) (W/kg)	Measured SAR(1g) (W/kg)	Reported SAR(1g) (W/kg)	Power Drift (dB)
Ch.	MHz									
Ambient Temperature: 22.9°C Liquid Temperature: 22.5°C										
1412	1732.5	Front	/	20.86	21	0.402	0.42	0.67	0.69	0.04
1513	1752.6	Rear	Fig.10	20.65	21	0.507	0.55	0.984	1.07	-0.18
1412	1732.5	Rear	/	20.86	21	0.44	0.45	0.865	0.89	0.1
1312	1712.4	Rear	/	20.83	21	0.401	0.42	0.775	0.81	-0.01
1412	1732.5	Left	/	20.86	21	0.04	0.04	0.07	0.07	-0.17
1412	1732.5	Right	/	20.86	21	0.344	0.36	0.599	0.62	-0.18
1412	1732.5	Bottom	/	20.86	21	0.28	0.29	0.529	0.55	-0.17

Note: The distance between the EUT and the phantom bottom is 10mm

Table 14.1-11: SAR Values (WCDMA 1700 MHz Band - Body)

Frequency		Test Position	Figure No.	Conducted Power (dBm)	Max. tune-up Power (dBm)	Measured SAR(10g) (W/kg)	Reported SAR(10g) (W/kg)	Measured SAR(1g) (W/kg)	Reported SAR(1g) (W/kg)	Power Drift (dB)
Ch.	MHz									
Ambient Temperature: 22.9°C Liquid Temperature: 22.5°C										
1412	1732.5	Front	/	22.62	23	0.37	0.40	0.592	0.65	-0.01
1513	1752.6	Rear	/	22.58	23	0.428	0.47	0.486	0.54	0.00
1412	1732.5	Rear	/	22.62	23	0.364	0.40	0.67	0.73	0.08
1312	1712.4	Rear	Fig.11	22.66	23	0.386	0.42	0.689	0.75	-0.01

Note: The distance between the EUT and the phantom bottom is 15mm

Table 14.1-12: SAR Values (WCDMA 850 MHz Band - Head)

Frequency		Side	Test Position	Figure No.	Conducted Power (dBm)	Max. tune-up Power (dBm)	Measured SAR(10g) (W/kg)	Reported SAR(10g) (W/kg)	Measured SAR(1g) (W/kg)	Reported SAR(1g) (W/kg)	Power Drift (dB)
Ch.	MHz										
Ambient Temperature: 22.9°C Liquid Temperature: 22.5°C											
4233	846.6	Left	Cheek	/	22.15	22.5	0.582	0.63	0.763	0.83	-0.1
4183	836.6	Left	Cheek	Fig.12	22.13	22.5	0.617	0.67	0.831	0.90	0.02
4132	826.4	Left	Cheek	/	22.06	22.5	0.546	0.60	0.723	0.80	0.08
4183	836.6	Left	Tilt	/	22.13	22.5	0.366	0.40	0.484	0.53	0.12
4233	846.6	Right	Cheek	/	22.15	22.5	0.545	0.59	0.7	0.76	0.07
4183	836.6	Right	Cheek	/	22.13	22.5	0.578	0.63	0.762	0.83	-0.07
4132	826.4	Right	Cheek	/	22.06	22.5	0.511	0.57	0.663	0.73	-0.03
4183	836.6	Right	Tilt	/	22.13	22.5	0.379	0.41	0.486	0.53	0.06

Table 14.1-13: SAR Values (WCDMA 850 MHz Band - Body)

Frequency		Test Position	Figure No.	Conducted Power (dBm)	Max. tune-up Power (dBm)	Ambient Temperature: 22.9°C		Liquid Temperature: 22.5°C		Power Drift (dB)
Ch.	MHz					Measured SAR(10g) (W/kg)	Reported SAR(10g) (W/kg)	Measured SAR(1g) (W/kg)	Reported SAR(1g) (W/kg)	
4233	846.6	Front	/	22.15	22.5	0.728	0.79	1.00	1.08	0.09
4183	836.6	Front	/	22.13	22.5	0.641	0.70	0.871	0.95	0.06
4132	826.4	Front	/	22.06	22.5	0.62	0.69	0.842	0.93	0.14
4233	846.6	Rear	Fig.13	22.15	22.5	0.837	0.91	1.15	1.25	-0.15
4183	836.6	Rear	/	22.13	22.5	0.737	0.80	1.00	1.09	0.04
4132	826.4	Rear	/	22.06	22.5	0.713	0.79	0.967	1.07	-0.06
4183	836.6	Left	/	22.13	22.5	0.52	0.57	0.73	0.79	0.18
4183	836.6	Right	/	22.13	22.5	0.438	0.48	0.618	0.67	0.08
4183	836.6	Bottom	/	22.13	22.5	0.033	0.04	0.056	0.06	0.19
4233	846.6	Rear	H	22.15	22.5	0.817	0.89	1.03	1.12	0.05

Note: The distance between the EUT and the phantom bottom is 10mm.

Table 14.1-14: SAR Values (LTE Band2 - Head)

Frequency		Mode	Side	Test Position	Figure No.	Ambient Temperature: 22.9°C		Liquid Temperature: 22.5°C		Measured SAR(1g) (W/kg)	Reported SAR(1g) (W/kg)	Power Drift (dB)
Ch.	MHz					Conducted Power (dBm)	Max. tune-up Power (dBm)	Measured SAR(10g) (W/kg)	Reported SAR(10g) (W/kg)			
19100	1900	1RB-Mid	Left	Cheek	/	20.65	21.5	0.405	0.49	0.635	0.77	-0.11
19100	1900	1RB-Mid	Left	Tilt	/	20.65	21.5	0.24	0.29	0.38	0.46	-0.12
19100	1900	1RB-Mid	Right	Cheek	Fig.14	20.65	21.5	0.479	0.58	0.777	0.94	0.05
18900	1880	1RB-High	Right	Cheek	/	20.45	21.5	0.389	0.49	0.597	0.76	0.09
18700	1860	1RB-Mid	Right	Cheek	/	20.33	21.5	0.295	0.39	0.474	0.62	0.12
19100	1900	1RB-Mid	Right	Tilt	/	20.65	21.5	0.195	0.24	0.305	0.37	-0.06
18700	1860	50RB-Low	Left	Cheek	/	19.42	20.5	0.304	0.39	0.472	0.61	0.15
18700	1860	50RB-Low	Left	Tilt	/	19.42	20.5	0.201	0.26	0.316	0.41	-0.02
19100	1900	50RB-Mid	Right	Cheek	/	19.37	20.5	0.357	0.46	0.574	0.75	-0.16
18900	1880	50RB-Mid	Right	Cheek	/	19.35	20.5	0.335	0.44	0.54	0.70	0.12
18700	1860	50RB-Low	Right	Cheek	/	19.42	20.5	0.402	0.52	0.648	0.83	0.09
18700	1860	50RB-Low	Right	Tilt	/	19.42	20.5	0.147	0.19	0.223	0.29	0.18
18700	1860	100RB	Right	Cheek	/	19.35	20.5	0.331	0.43	0.536	0.70	-0.07

Note1: The LTE mode is QPSK_20MHz.

Table 14.1-15: SAR Values (LTE Band2 - Body)

Frequency		Mode	Test Position	Figure No.	Conducted Power (dBm)	Max. tune-up Power (dBm)	Measured SAR(10g) (W/kg)	Reported SAR(10g)(W/kg)	Measured SAR(1g) (W/kg)	Reported SAR(1g) (W/kg)	Power Drift (dB)
Ch.	MHz										
18900	1880	1RB-Mid	Front	/	17.19	17.5	0.278	0.30	0.442	0.47	0.02
19100	1900	1RB-Mid	Rear	/	16.95	17.5	0.48	0.54	0.875	0.99	0.06
18900	1880	1RB-Mid	Rear	/	17.19	17.5	0.507	0.54	0.925	0.99	0.15
18700	1860	1RB-High	Rear	/	16.89	17.5	0.473	0.54	0.863	0.99	0.11
18900	1880	1RB-Mid	Left	/	17.19	17.5	0.066	0.07	0.106	0.11	0.06
18900	1880	1RB-Mid	Right	/	17.19	17.5	0.152	0.16	0.242	0.26	-0.12
19100	1900	1RB-Mid	Bottom	/	16.95	17.5	0.549	0.62	0.998	1.13	0.17
18900	1880	1RB-Mid	Bottom	Fig15	17.19	17.5	0.583	0.63	1.07	1.15	0.07
18700	1860	1RB-High	Bottom	/	16.89	17.5	0.537	0.62	0.984	1.13	0.08
18900	1880	50RB-Mid	Front	/	16.99	17.5	0.283	0.32	0.45	0.51	-0.02
19100	1900	50RB-Mid	Rear	/	16.98	17.5	0.498	0.56	0.91	1.02	0.17
18900	1880	50RB-Mid	Rear	/	16.99	17.5	0.503	0.57	0.914	1.03	0.05
18700	1860	50RB-Mid	Rear	/	16.87	17.5	0.489	0.57	0.889	1.03	0.08
18900	1880	50RB-Mid	Left	/	16.99	17.5	0.051	0.06	0.082	0.09	0.11
18900	1880	50RB-Mid	Right	/	16.99	17.5	0.149	0.17	0.237	0.27	-0.04
19100	1900	50RB-Mid	Bottom	/	16.98	17.5	0.544	0.61	0.97	1.09	0.05
18900	1880	50RB-Mid	Bottom	/	16.99	17.5	0.549	0.62	0.998	1.12	-0.16
18700	1860	50RB-Mid	Bottom	/	16.87	17.5	0.442	0.51	0.947	1.10	-0.03
18700	1860	100RB	Rear	/	16.95	17.5	0.478	0.54	0.869	0.99	0.08
18700	1860	100RB	Bottom	/	16.95	17.5	0.546	0.62	0.996	1.13	0.11

Note1: The distance between the EUT and the phantom bottom is 10mm

Note2: The LTE mode is QPSK_20MHz.

Table 14.1-16: SAR Values (LTE Band2 - Body)

Frequency		Mode	Test Position	Figure No.	Conducted Power (dBm)	Max. tune-up Power (dBm)	Measured SAR(10g) (W/kg)	Reported SAR(10g)(W/kg)	Measured SAR(1g) (W/kg)	Reported SAR(1g) (W/kg)	Power Drift (dB)
Ch.	MHz										
19100	1900	1RB-Mid	Front	/	20.65	21.5	0.339	0.41	0.555	0.67	-0.03
19100	1900	1RB-Mid	Rear	Fig.16	20.65	21.5	0.467	0.57	0.837	1.02	0.03
18900	1880	1RB-High	Rear	/	20.45	21.5	0.442	0.56	0.794	1.01	-0.06
18700	1860	1RB-Mid	Rear	/	20.33	21.5	0.429	0.56	0.772	1.01	0.05
18700	1860	50RB-Low	Front	/	19.42	20.5	0.281	0.36	0.455	0.58	-0.15
19100	1900	50RB-Mid	Rear	/	19.37	20.5	0.434	0.56	0.783	1.02	0
18900	1880	50RB-Mid	Rear	/	19.35	20.5	0.426	0.56	0.776	1.01	-0.11
18700	1860	50RB-Low	Rear	/	19.42	20.5	0.442	0.57	0.799	1.02	0.17
18700	1860	100RB	Rear	/	19.35	20.5	0.419	0.55	0.768	1.00	0.14

Note1: The distance between the EUT and the phantom bottom is 15mm

Note2: The LTE mode is QPSK_20MHz.

Table 14.1-17: SAR Values (LTE Band4 - Head)

Ambient Temperature: 22.9 °C Liquid Temperature: 22.5°C												
Frequency		Mode	Side	Test Position	Figure No.	Conducted Power (dBm)	Max. tune-up Power (dBm)	Measured SAR(10g) (W/kg)	Reported SAR(10g)(W/kg)	Measured SAR(1g) (W/kg)	Reported SAR(1g) (W/kg)	Power Drift (dB)
Ch.	MHz											
20175	1732.5	1RB-Mid	Left	Cheek	/	22.91	23	0.463	0.47	0.719	0.73	0.13
20175	1732.5	1RB-Mid	Left	Tilt	/	22.91	23	0.361	0.37	0.574	0.59	-0.02
20300	1745	1RB-High	Right	Cheek	/	22.83	23	0.666	0.69	1.01	1.05	-0.09
20175	1732.5	1RB-Mid	Right	Cheek	Fig.17	22.91	23	0.682	0.70	1.08	1.10	-0.03
20050	1720	1RB-Mid	Right	Cheek	/	22.65	23	0.639	0.69	0.989	1.07	0.16
20175	1732.5	1RB-Mid	Right	Tilt	/	22.91	23	0.359	0.37	0.563	0.57	-0.17
20175	1732.5	50RB-Mid	Left	Cheek	/	21.76	22	0.438	0.46	0.684	0.72	-0.03
20175	1732.5	50RB-Mid	Left	Tilt	/	21.76	22	0.341	0.36	0.542	0.57	-0.18
20300	1745	50RB-High	Right	Cheek	/	21.62	22	0.584	0.64	0.946	1.03	-0.07
20175	1732.5	50RB-Mid	Right	Cheek	/	21.76	22	0.62	0.66	0.986	1.04	-0.03
20050	1720	50RB-Mid	Right	Cheek	/	21.65	22	0.601	0.65	0.957	1.04	-0.08
20175	1732.5	50RB-Mid	Right	Tilt	/	21.76	22	0.339	0.36	0.533	0.56	-0.15
20300	1745	100RB	Right	Cheek	/	21.72	22	0.609	0.65	0.962	1.03	-0.05

Note1: The LTE mode is QPSK_20MHz.

Table 14.1-18: SAR Values (LTE Band4 - Body)

Ambient Temperature: 22.9 °C Liquid Temperature: 22.5°C											
Frequency		Mode	Test Position	Figure No.	Conducted Power (dBm)	Max. tune-up Power (dBm)	Measured SAR(10g) (W/kg)	Reported SAR(10g)(W/kg)	Measured SAR(1g) (W/kg)	Reported SAR(1g) (W/kg)	Power Drift (dB)
Ch.	MHz										
20300	1745	1RB-Mid	Front	/	20.55	21	0.471	0.52	0.768	0.85	0.08
20175	1732.5	1RB-Mid	Front	/	20.46	21	0.458	0.52	0.746	0.85	-0.05
20050	1720	1RB-Mid	Front	/	20.35	21	0.446	0.52	0.725	0.84	0.1
20300	1745	1RB-Mid	Rear	/	20.55	21	0.539	0.60	1.03	1.14	-0.03
20175	1732.5	1RB-Mid	Rear	/	20.46	21	0.521	0.59	0.995	1.13	-0.16
20050	1720	1RB-Mid	Rear	/	20.35	21	0.507	0.59	0.973	1.13	-0.01
20300	1745	1RB-Mid	Left	/	20.55	21	0.15	0.17	0.25	0.28	-0.09
20300	1745	1RB-Mid	Right	/	20.55	21	0.321	0.36	0.537	0.60	-0.06
20300	1745	1RB-Mid	Bottom	/	20.55	21	0.429	0.48	0.807	0.90	0.13

20175	1732.5	1RB-Mid	Bottom	/	20.46	21	0.418	0.47	0.782	0.89	0.18
20050	1720	1RB-Mid	Bottom	/	20.35	21	0.403	0.47	0.763	0.89	-0.09
20300	1745	50RB-High	Front	/	20.32	21	0.49	0.57	0.797	0.93	0.11
20175	1732.5	50RB-High	Front	/	20.25	21	0.469	0.56	0.771	0.92	0.06
20050	1720	50RB-Mid	Front	/	20.31	21	0.483	0.57	0.79	0.93	0.13
20300	1745	50RB-High	Rear	Fig.18	20.32	21	0.548	0.64	1.04	1.22	-0.11
20175	1732.5	50RB-High	Rear	/	20.25	21	0.521	0.62	0.988	1.17	0.08
20050	1720	50RB-Mid	Rear	/	20.31	21	0.534	0.63	1.01	1.18	0
20300	1745	50RB-High	Left	/	20.32	21	0.069	0.08	0.109	0.13	-0.07
20300	1745	50RB-High	Right	/	20.32	21	0.374	0.44	0.629	0.74	0.06
20300	1745	50RB-High	Bottom	/	20.32	21	0.48	0.56	0.91	1.06	0.1
20175	1732.5	50RB-High	Bottom	/	20.25	21	0.456	0.54	0.879	1.04	0.08
20050	1720	50RB-Mid	Bottom	/	20.31	21	0.469	0.55	0.895	1.05	0.13
20300	1745	100RB	Front	/	20.34	21	0.438	0.51	0.721	0.84	0
20300	1745	100RB	Rear	/	20.34	21	0.497	0.58	0.968	1.13	-0.07
20300	1745	100RB	Bottom	/	20.34	21	0.389	0.45	0.757	0.88	0.19
20300	1745	50RB-High	Rear	H	20.32	21	0.531	0.621	0.983	1.15	0.17

Note1: The distance between the EUT and the phantom bottom is 10mm.

Note2: The LTE mode is QPSK_20MHz.

Table 14.1-19: SAR Values (LTE Band4 - Body)

Frequency		Ambient Temperature: 22.9 °C Liquid Temperature: 22.5°C										
Ch.	MHz	Mode	Test Position	Figure No.	Conducted Power (dBm)	Max. tune-up Power (dBm)	Measured SAR(10g) (W/kg)	Reported SAR(10g)(W/kg)	Measured SAR(1g) (W/kg)	Reported SAR(1g) (W/kg)	Power Drift (dB)	
20175	1732.5	1RB-Middle	Front	/	22.91	23	0.49	0.50	0.761	0.78	-0.05	
20300	1745	1RB-High	Rear	/	22.83	23	0.439	0.46	0.772	0.80	-0.18	
20175	1732.5	1RB-Middle	Rear	Fig.19	22.91	23	0.452	0.46	0.792	0.81	-0.19	
20050	1720	1RB-Middle	Rear	/	22.65	23	0.418	0.45	0.739	0.80	-0.14	
20300	1745	50RB-High	Front	/	21.62	22	0.368	0.40	0.625	0.68	0.02	
20175	1732.5	50RB-Middle	Front	/	21.76	22	0.423	0.45	0.662	0.70	-0.11	
20050	1720	50RB-Middle	Front	/	21.65	22	0.408	0.44	0.639	0.69	-0.13	
20300	1745	50RB-High	Rear	/	21.62	22	0.383	0.42	0.687	0.75	0.04	
20175	1732.5	50RB-Middle	Rear	/	21.76	22	0.414	0.44	0.729	0.77	-0.16	
20050	1720	50RB-Middle	Rear	/	21.65	22	0.398	0.43	0.705	0.77	-0.15	
20300	1745	100RB	Front	/	21.72	22	0.388	0.41	0.645	0.69	0.1	
20300	1745	100RB	Rear	/	21.72	22	0.405	0.43	0.704	0.75	0.14	

Table 14.1-20: SAR Values (LTE Band5 - Head)

Frequency		Mode	Side	Test Position	Figure No.	Conducted Power (dBm)	Max. tune-up Power (dBm)	Measured SAR(10g) (W/kg)	Reported SAR(10g)(W/kg)	Measured SAR(1g) (W/kg)	Reported SAR(1g) (W/kg)	Power Drift (dB)
Ch.	MHz											
Ambient Temperature: 22.9°C Liquid Temperature: 22.5°C												
20600	844	1RB-Mid	Left	Cheek	Fig.20	22.00	23	0.482	0.61	0.651	0.82	0.18
20525	836.5	1RB-High	Left	Cheek	/	21.84	23	0.443	0.58	0.599	0.78	0.06
20450	829	1RB-Mid	Left	Cheek	/	21.82	23	0.439	0.58	0.592	0.78	0.01
20600	844	1RB-Mid	Left	Tilt	/	22.00	23	0.3	0.38	0.406	0.51	0.09
20600	844	1RB-Mid	Right	Cheek	/	22.00	23	0.462	0.58	0.624	0.79	-0.1
20600	844	1RB-Mid	Right	Tilt	/	22.00	23	0.337	0.42	0.449	0.57	0.19
20600	844	25RB-Low	Left	Cheek	/	20.77	22	0.364	0.48	0.496	0.66	0.01
20600	844	25RB-Low	Left	Tilt	/	20.77	22	0.239	0.32	0.326	0.43	-0.19
20600	844	25RB-Low	Right	Cheek	/	20.77	22	0.331	0.44	0.45	0.60	0.19
20600	844	25RB-Low	Right	Tilt	/	20.77	22	0.24	0.32	0.319	0.42	-0.1
20600	844	50RB	Left	Cheek	/	20.69	22	0.346	0.47	0.476	0.64	0.14

Note1: The LTE mode is QPSK_10MHz.

Table 14.1-21: SAR Values (LTE Band5 - Body)

Frequency		Mode	Test Position	Figure No.	Conducted Power (dBm)	Max. tune-up Power (dBm)	Measured SAR(10g) (W/kg)	Reported SAR(10g) (W/kg)	Measured SAR(1g) (W/kg)	Reported SAR(1g) (W/kg)	Power Drift (dB)
Ch.	MHz										
Ambient Temperature: 22.9°C Liquid Temperature: 22.5°C											
20600	844	1RB-Mid	Front	/	22.00	23	0.457	0.58	0.623	0.78	-0.15
20600	844	1RB-Mid	Rear	Fig.21	22.00	23	0.578	0.73	0.783	0.99	0.04
20525	836.5	1RB-High	Rear	/	21.84	23	0.532	0.69	0.72	0.94	0.01
20450	829	1RB-Mid	Rear	/	21.82	23	0.526	0.69	0.713	0.94	0.09
20600	844	1RB-Mid	Left	/	22.00	23	0.226	0.28	0.324	0.41	-0.1
20600	844	1RB-Mid	Right	/	22.00	23	0.219	0.28	0.315	0.40	-0.09
20600	844	1RB-Mid	Bottom	/	22.00	23	<0.01	<0.01	<0.01	<0.01	-0.03
20600	844	25RB-Low	Front	/	20.77	22	0.355	0.47	0.479	0.64	0.13
20600	844	25RB-Low	Rear	/	20.77	22	0.416	0.55	0.562	0.75	-0.14
20600	844	25RB-Low	Left	/	20.77	22	0.155	0.21	0.218	0.29	0.08
20600	844	25RB-Low	Right	/	20.77	22	0.163	0.22	0.229	0.30	-0.16
20600	844	25RB-Low	Bottom	/	20.77	22	<0.01	<0.01	<0.01	<0.01	0.02
20600	844	50RB	Rear	/	20.69	22	0.366	0.49	0.522	0.71	0.08

Note1: The distance between the EUT and the phantom bottom is 10mm.

Note2: The LTE mode is QPSK_10MHz.

Table 14.1-22: SAR Values (LTE Band7 - Head)

Ambient Temperature: 22.9 °C Liquid Temperature: 22.5 °C												
Frequency		Mode	Side	Test Position	Figure No.	Conducted Power (dBm)	tune-up Power (dBm)	Measured SAR(10g) (W/kg)	Reported SAR(10g)(W/kg)	Measured SAR(1g) (W/kg)	Reported SAR(1g) (W/kg)	Power Drift (dB)
Ch.	MHz											
21350	2560	1RB-Mid	Left	Cheek	/	21.46	21.7	0.519	0.55	0.983	1.04	0.18
21100	2535	1RB-High	Left	Cheek	/	21.15	21.7	0.409	0.46	0.774	0.88	0.17
20850	2510	1RB-Mid	Left	Cheek	/	21.26	21.7	0.448	0.50	0.848	0.94	0.00
21350	2560	1RB-Mid	Left	Tilt	/	21.46	21.7	0.455	0.48	0.909	0.96	-0.18
21100	2535	1RB-High	Left	Tilt	/	21.15	21.7	0.358	0.41	0.716	0.81	-0.18
20850	2510	1RB-Mid	Left	Tilt	/	21.26	21.7	0.393	0.44	0.784	0.87	-0.05
21350	2560	1RB-Mid	Right	Cheek	/	21.46	21.7	0.59	0.62	1.06	1.12	0.00
21100	2535	1RB-High	Right	Cheek	/	21.15	21.7	0.48	0.54	0.922	1.05	0.13
20850	2510	1RB-Mid	Right	Cheek	Fig.22	21.37	21.7	0.59	0.64	1.11	1.20	0.09
21350	2560	1RB-Mid	Right	Tilt	/	21.46	21.7	0.42	0.44	0.821	0.87	-0.07
21100	2535	1RB-High	Right	Tilt	/	21.15	21.7	0.331	0.38	0.647	0.73	0.18
20850	2510	1RB-Mid	Right	Tilt	/	21.26	21.7	0.362	0.40	0.709	0.79	-0.15
20850	2510	50RB-Low	Left	Cheek	/	20.41	20.7	0.377	0.40	0.705	0.75	-0.08
20850	2510	50RB-Low	Left	Tilt	/	20.41	20.7	0.383	0.41	0.735	0.79	-0.1
21350	2560	50RB-Mid	Right	Cheek	/	20.32	20.7	0.463	0.50	0.893	0.97	0.17
21100	2535	50RB-High	Right	Cheek	/	20.32	20.7	0.472	0.51	0.908	0.99	-0.09
20850	2510	50RB-Low	Right	Cheek	/	20.41	20.7	0.495	0.53	0.954	1.02	0.13
20850	2510	50RB-Low	Right	Tilt	/	20.41	20.7	0.324	0.35	0.622	0.66	-0.15
20850	2510	100RB	Left	Cheek	/	20.40	20.7	0.335	0.36	0.667	0.72	-0.13
20850	2510	100RB	Left	Tilt	/	20.40	20.7	0.315	0.34	0.604	0.65	-0.17
20850	2510	100RB	Right	Cheek	/	20.40	20.7	0.389	0.42	0.728	0.78	0.03
20850	2510	100RB	Right	Tilt	/	20.40	20.7	0.31	0.33	0.595	0.64	0.17

Note1: The LTE mode is QPSK_20MHz.

Table 14.1-23: SAR Values (LTE Band7 - Body)

Frequency		Mode	Test Position	Figure No.	Conduct ed Power (dBm)	tune-up Power (dBm)	Measured SAR(10g) (W/kg)	Reported SAR(10g) (W/kg)	Measured SAR(1g) (W/kg)	Reported SAR(1g) (W/kg)	Power Drift (dB)
Ch.	MHz										
Ambient Temperature: 22.9°C Liquid Temperature: 22.5°C											
21100	2335	1RB-Mid	Front	Fig.23	17.69	18.5	0.303	0.37	0.608	0.73	0.07
21100	2335	1RB-Mid	Rear	/	17.69	18.5	0.198	0.24	0.373	0.45	0.19
21100	2335	1RB-Mid	Left	/	17.69	18.5	0.067	0.08	0.117	0.14	0.00
21100	2335	1RB-Mid	Right	/	17.69	18.5	0.165	0.20	0.309	0.37	-0.15
21100	2335	1RB-Mid	Bottom	/	17.69	18.5	0.121	0.15	0.247	0.30	0.05
21350	2560	50RB-Mid	Front	/	17.76	18.5	0.228	0.27	0.443	0.53	0.07
21350	2560	50RB-Mid	Rear	/	17.76	18.5	0.145	0.17	0.273	0.32	0.05
21350	2560	50RB-Mid	Left	/	17.76	18.5	0.041	0.05	0.073	0.09	0.04
21350	2560	50RB-Mid	Right	/	17.76	18.5	0.122	0.14	0.239	0.28	-0.09
21350	2560	50RB-Mid	Bottom	/	17.76	18.5	0.093	0.11	0.189	0.22	0.05

Note1: The distance between the EUT and the phantom bottom is 10mm

Note2: The LTE mode is QPSK_20MHz.

Table 14.1-24: SAR Values (LTE Band7 - Body)

Frequency		Mode	Test Position	Figure No.	Conduct ed Power (dBm)	tune-up Power (dBm)	Measured SAR(10g) (W/kg)	Reported SAR(10g) (W/kg)	Measured SAR(1g) (W/kg)	Reported SAR(1g) (W/kg)	Power Drift (dB)
Ch.	MHz										
Ambient Temperature: 22.9°C Liquid Temperature: 22.5°C											
21350	2560	1RB-Mid	Front	Fig.24	21.46	21.7	0.299	0.32	0.575	0.61	0.05
21100	2535	1RB-High	Front	/	21.15	21.7	0.235	0.27	0.453	0.51	0.06
20850	2510	1RB-Mid	Front	/	21.37	21.7	0.258	0.28	0.496	0.54	-0.04
21350	2560	1RB-Mid	Rear	/	21.46	21.7	0.217	0.23	0.405	0.43	-0.09
21350	2560	50RB-Mid	Front	/	20.32	20.7	0.169	0.18	0.327	0.36	0.16
21100	2535	50RB-High	Front	/	20.32	20.7	0.174	0.19	0.337	0.37	0.08
20850	2510	50RB-Low	Front	/	20.41	20.7	0.217	0.23	0.419	0.45	0.13
20850	2510	50RB-Low	Rear	/	20.41	20.7	0.158	0.17	0.292	0.31	-0.12
20850	2510	100RB	Front	/	20.40	20.7	0.221	0.24	0.424	0.45	0.08

Note1: The distance between the EUT and the phantom bottom is 15mm

Note2: The LTE mode is QPSK_20MHz.

Table 14.1-25: SAR Values (LTE Band28 - Head)

Ambient Temperature: 22.9°C Liquid Temperature: 22.5°C												
Frequency		Mode	Side	Test Position	Figure No.	Conducted Power (dBm)	tune-up Power (dBm)	Measured SAR(10g) (W/kg)	Reported SAR(10g) (W/kg)	Measured SAR(1g) (W/kg)	Reported SAR(1g) (W/kg)	Power Drift (dB)
Ch.	MHz											
27560	738	1RB-Middle	Left	Cheek	/	22.00	23	0.227	0.29	0.3	0.38	0
27560	738	1RB-Middle	Left	Tilt	/	22.00	23	0.195	0.25	0.262	0.33	-0.06
27560	738	1RB-Middle	Right	Cheek	Fig.25	22.00	23	0.27	0.34	0.364	0.45	-0.16
27560	738	1RB-Middle	Right	Tilt	/	22.00	23	0.241	0.30	0.316	0.40	-0.11
27560	738	50RB-Low	Left	Cheek	/	20.82	22	0.163	0.21	0.224	0.29	-0.05
27560	738	50RB-Low	Left	Tilt	/	20.82	22	0.084	0.11	0.11	0.14	-0.05
27560	738	50RB-Low	Right	Cheek	/	20.82	22	0.214	0.28	0.285	0.37	0.02
27560	738	50RB-Low	Right	Tilt	/	20.82	22	0.168	0.22	0.219	0.29	-0.01

Table 14.1-26: SAR Values (LTE Band28 - Body)

Ambient Temperature: 22.9°C Liquid Temperature: 22.5°C												
Frequency		Mode	Test Position	Figure No.	Conducted Power (dBm)	Max. tune-up Power (dBm)	Measured SAR(10g) (W/kg)	Reported SAR(10g) (W/kg)	Measured SAR(1g) (W/kg)	Reported SAR(1g) (W/kg)	Power Drift (dB)	
Ch.	MHz											
27560	738	1RB-Middle	Front	Fig.26	22.00	23	0.233	0.29	0.316	0.40	0.09	
27560	738	1RB-Middle	Rear	/	22.00	23	0.219	0.28	0.297	0.37	0.11	
27560	738	1RB-Middle	Left	/	22.00	23	0.179	0.23	0.248	0.31	-0.18	
27560	738	1RB-Middle	Right	/	22.00	23	0.162	0.20	0.225	0.28	-0.08	
27560	738	1RB-Middle	Bottom	/	22.00	23	0.017	0.02	0.031	0.04	-0.04	
27560	738	50RB-Low	Front	/	20.82	22	0.188	0.25	0.253	0.33	-0.12	
27560	738	50RB-Low	Rear	/	20.82	22	0.195	0.26	0.267	0.35	0.19	
27560	738	50RB-Low	Left	/	20.82	22	0.142	0.19	0.2	0.26	-0.16	
27560	738	50RB-Low	Right	/	20.82	22	0.132	0.17	0.185	0.24	-0.02	
27560	738	50RB-Low	Bottom	/	20.82	22	0.015	0.02	0.032	0.04	-0.02	

Note1: The distance between the EUT and the phantom bottom is 10mm.

Note2: The LTE mode is QPSK_20MHz.

14.2 SAR results for Standard procedure

There is zoom scan measurement to be added for the highest measured SAR in each exposure configuration/band.

Table 14.2-1: SAR Values (GSM 850 MHz Band - Head)

Frequency		Side	Test Position	Figure No.	Conducted Power (dBm)	Max. tune-up Power (dBm)	Measured SAR(10g) (W/kg)	Reported SAR(10g) (W/kg)	Measured SAR(1g) (W/kg)	Reported SAR(1g) (W/kg)	Power Drift (dB)
Ch.	MHz										
190	836.6	Left	Cheek	Fig.1	31.12	32.5	0.291	0.40	0.391	0.54	-0.06

Table 14.2-2: SAR Values (GSM 850 MHz Band - Body)

Frequency		Mode (number of timeslots)	Test Position	Figure No.	Conducted Power (dBm)	Max. tune-up Power (dBm)	Measured SAR(10g) (W/kg)	Reported SAR(10g) (W/kg)	Measured SAR(1g) (W/kg)	Reported SAR(1g) (W/kg)	Power Drift (dB)
Ch.	MHz										
190	836.6	Rear	GPRS(3)	Fig.2	27.14	28.5	0.41	0.56	0.552	0.75	0.08

Note: The distance between the EUT and the phantom bottom is 10mm.

Table 14.2-3: SAR Values (GSM 1900 MHz Band - Head)

Frequency		Side	Test Position	Figure No.	Conducted Power (dBm)	Max. tune-up Power (dBm)	Measured SAR(10g) (W/kg)	Reported SAR(10g) (W/kg)	Measured SAR(1g) (W/kg)	Reported SAR(1g) (W/kg)	Power Drift (dB)
Ch.	MHz										
810	1909.8	Right	Cheek	Fig.3	30.19	31	0.435	0.52	0.699	0.84	0.18

Table 14.2-4: SAR Values (GSM 1900 MHz Band - Body)

Frequency		Mode (number of timeslots)	Test Position	Figure No.	Conducted Power (dBm)	Max. tune-up Power (dBm)	Measured SAR(10g) (W/kg)	Reported SAR(10g) (W/kg)	Measured SAR(1g) (W/kg)	Reported SAR(1g) (W/kg)	Power Drift (dB)
Ch.	MHz										
810	1909.8	Bottom	GPRS(3)	Fig.4	23.25	24.2	0.565	0.70	1.05	1.31	-0.09

Note1: The distance between the EUT and the phantom bottom is 10mm

Table 14.2-5: SAR Values (GSM 1900 MHz Band - Body)

Frequency		Mode (number of timeslots)	Test Position	Figure No.	Conducted Power (dBm)	Max. tune-up Power (dBm)	Measured SAR(10g) (W/kg)	Reported SAR(10g) (W/kg)	Measured SAR(1g) (W/kg)	Reported SAR(1g) (W/kg)	Power Drift (dB)
Ch.	MHz										
661	1880	Rear	GPRS(1)	Fig.5	30.13	31	0.36	0.44	0.65	0.79	-0.09

Note1: The distance between the EUT and the phantom bottom is 15mm

Table 14.2-6: SAR Values (WCDMA 1900 MHz Band - Head)

Frequency		Side	Test Position	Figure No.	Conducted Power (dBm)	Max. tune-up Power (dBm)	Measured SAR(10g) (W/kg)	Reported SAR(10g) (W/kg)	Measured SAR(1g) (W/kg)	Reported SAR(1g) (W/kg)	Power Drift (dB)	
Ch.	MHz											
		Ambient Temperature: 22.9 °C					Liquid Temperature: 22.5 °C					
9262	1852.4	Right	Cheek	Fig.6	20.63	21.5	0.474	0.58	0.765	0.93	0.474	

Table 14.2-7: SAR Values (WCDMA 1900 MHz Band - Body)

Frequency		Test Position	Figure No.	Conduct ed Power (dBm)	Max. tune-up Power (dBm)	Measured SAR(10g) (W/kg)	Reported SAR(10g) (W/kg)	Measured SAR(1g) (W/kg)	Reported SAR(1g) (W/kg)	Power Drift (dB)	
Ch.	MHz										
		Ambient Temperature: 22.9 °C					Liquid Temperature: 22.5 °C				
9262	1852.4	Bottom	Fig7	16.91	17.5	0.43	0.49	0.797	0.91	-0.09	

Note: The distance between the EUT and the phantom bottom is 10mm

Table 14.2-8: SAR Values (WCDMA 1900 MHz Band - Body)

Frequency		Test Position	Figure No.	Conduct ed Power (dBm)	Max. tune-up Power (dBm)	Measured SAR(10g) (W/kg)	Reported SAR(10g) (W/kg)	Measured SAR(1g) (W/kg)	Reported SAR(1g) (W/kg)	Power Drift (dB)	
Ch.	MHz										
		Ambient Temperature: 22.9 °C					Liquid Temperature: 22.5 °C				
9262	1852.4	Rear	Fig8	20.63	21.5	0.484	0.59	0.865	1.06	0.17	

Note: The distance between the EUT and the phantom bottom is 15mm

Table 14.2-9: SAR Values (WCDMA 1700 MHz Band - Head)

Frequency		Side	Test Position	Figure No.	Conducte d Power (dBm)	Max. tune-up Power (dBm)	Measure d SAR(10g) (W/kg)	Reported SAR(10g) (W/kg)	Measure d SAR(1g) (W/kg)	Reporte d SAR(1g) (W/kg)	Powe r Drift (dB)	
Ch.	MHz											
		Ambient Temperature: 22.9 °C					Liquid Temperature: 22.5 °C					
1412	1732.4	Right	Cheek	Fig.9	22.62	23	0.700	0.76	1.09	1.19	-0.09	

Table 14.2-10: SAR Values (WCDMA 1700 MHz Band - Body)

Frequency		Test Position	Figure No.	Conduc ted Power (dBm)	Max. tune-up Power (dBm)	Measured SAR(10g) (W/kg)	Reported SAR(10g) (W/kg)	Measured SAR(1g) (W/kg)	Reported SAR(1g) (W/kg)	Power Drift (dB)	
Ch.	MHz										
		Ambient Temperature: 22.9 °C					Liquid Temperature: 22.5 °C				
1513	1752.6	Rear	Fig.10	20.65	21	0.507	0.55	0.984	1.07	-0.18	

Note: The distance between the EUT and the phantom bottom is 10mm

Table 14.2-11: SAR Values (WCDMA 1700 MHz Band - Body)

Frequency		Test Position	Figure No.	Conducted Power (dBm)	Max. tune-up Power (dBm)	Measured SAR(10g) (W/kg)	Reported SAR(10g) (W/kg)	Measured SAR(1g) (W/kg)	Reported SAR(1g) (W/kg)	Power Drift (dB)	
Ch.	MHz										
		Ambient Temperature: 22.9 °C				Liquid Temperature: 22.5 °C					
1312	1712.4	Rear	Fig.11	22.66	23	0.386	0.42	0.689	0.75	-0.01	

Note: The distance between the EUT and the phantom bottom is 15mm

Table 14.2-12: SAR Values (WCDMA 850 MHz Band - Head)

Frequency		Side	Test Position	Figure No.	Conducted Power (dBm)	Max. tune-up Power (dBm)	Measured SAR(10g) (W/kg)	Reported SAR(10g) (W/kg)	Measured SAR(1g) (W/kg)	Reported SAR(1g) (W/kg)	Power Drift (dB)
Ch.	MHz										
		Ambient Temperature: 22.9 °C				Liquid Temperature: 22.5 °C					
4183	836.6	Left	Cheek	Fig.12	22.13	22.5	0.617	0.67	0.831	0.90	0.02

Table 14.2-13: SAR Values (WCDMA 850 MHz Band - Body)

Frequency		Test Position	Figure No.	Conducted Power (dBm)	Max. tune-up Power (dBm)	Measured SAR(10g) (W/kg)	Reported SAR(10g) (W/kg)	Measured SAR(1g) (W/kg)	Reported SAR(1g) (W/kg)	Power Drift (dB)	
Ch.	MHz										
		Ambient Temperature: 22.9 °C				Liquid Temperature: 22.5 °C					
4233	846.6	Rear	Fig.13	22.15	22.5	0.837	0.91	1.15	1.25	-0.15	

Note: The distance between the EUT and the phantom bottom is 10mm.

Table 14.2-14: SAR Values (LTE Band2 - Head)

Frequency		Mode	Side	Test Position	Figure No.	Conducted Power (dBm)	Max. tune-up Power (dBm)	Measured SAR(10g) (W/kg)	Reported SAR(10g) (W/kg)	Measured SAR(1g) (W/kg)	Reported SAR(1g) (W/kg)	Power Drift (dB)
Ch.	MHz											
		Ambient Temperature: 22.9 °C				Liquid Temperature: 22.5 °C						
19100	1900	1RB-Mid	Right	Cheek	Fig.14	20.65	21.5	0.479	0.58	0.777	0.94	0.05

Note1: The LTE mode is QPSK_20MHz.