



# FCC RF Test Report

**APPLICANT** : HMD Global Oy  
**EQUIPMENT** : Mobile Phone  
**BRAND NAME** : NOKIA  
**MODEL NAME** : TA-1285  
**FCC ID** : 2AJOTTA-1285  
**STANDARD** : 47 CFR Part 2, 22(H), 24(E), 27(L), 27(H), 27(M), 27(F)  
**CLASSIFICATION** : PCS Licensed Transmitter Held to Ear (PCE)

The product was received on Jul. 03, 2020 and completely tested on Aug. 28, 2020. We, Sporton International (Kunshan) Inc., would like to declare that the tested sample has been evaluated in accordance with the procedures given in ANSI C63.26-2015 and shown compliance with the applicable technical standards.

The test results in this report apply exclusively to the tested model / sample. Without written approval of Sporton International (Kunshan) Inc., the test report shall not be reproduced except in full.

Jason Jia

Reviewed by: Jason Jia / Supervisor

James Huang

Approved by: James Huang / Manager



**Sporton International (Kunshan) Inc.**

No. 1098, Pengxi North Road, Kunshan Economic Development Zone Jiangsu Province 215300  
People's Republic of China



TABLE OF CONTENTS

REVISION HISTORY... 3
SUMMARY OF TEST RESULT ... 4
1 GENERAL DESCRIPTION ... 6
1.1 Applicant ... 6
1.2 Manufacturer ... 6
1.3 Product Feature of Equipment Under Test ... 6
1.4 Product Specification of Equipment Under Test ... 7
1.5 Modification of EUT ... 7
1.6 Maximum ERP/EIRP Power, Frequency Tolerance, and Emission Designator ... 8
1.7 Testing Location ... 10
1.8 Test Software ... 10
1.9 Applicable Standards ... 10
2 TEST CONFIGURATION OF EQUIPMENT UNDER TEST ... 11
2.1 Test Mode ... 11
2.2 Connection Diagram of Test System ... 15
2.3 Support Unit used in test configuration and system ... 15
2.4 Measurement Results Explanation Example ... 15
2.5 Frequency List of Low/Middle/High Channels ... 16
3 CONDUCTED TEST ITEMS ... 19
3.1 Measuring Instruments ... 19
3.2 Test Setup ... 19
3.3 Test Result of Conducted Test ... 19
3.4 Conducted Output Power and ERP/EIRP ... 20
3.5 Peak-to-Average Ratio ... 21
3.6 Occupied Bandwidth ... 22
3.7 Conducted Band Edge ... 23
3.8 Conducted Spurious Emission ... 25
3.9 Frequency Stability ... 26
4 RADIATED TEST ITEMS ... 27
4.1 Measuring Instruments ... 27
4.2 Test Setup ... 27
4.3 Test Result of Radiated Test ... 27
4.4 Radiated Spurious Emission ... 28
5 LIST OF MEASURING EQUIPMENT ... 30
6 UNCERTAINTY OF EVALUATION ... 31
APPENDIX A. TEST RESULTS OF CONDUCTED TEST
APPENDIX B. TEST RESULTS OF RADIATED TEST
APPENDIX C. TEST SETUP PHOTOGRAPHS



### REVISION HISTORY

REPORT NO.	VERSION	DESCRIPTION	ISSUED DATE
FG070302-01B	Rev. 01	Initial issue of report	Sep. 07, 2020



## SUMMARY OF TEST RESULT

Report Section	FCC Rule	Description	Limit	Result	Remark
3.4	§2.1046	Conducted Output Power	Reporting Only	PASS	-
	§22.913(a)(5)	Effective Radiated Power (Band 5)	ERP < 7 Watt	PASS	-
	§27.50(b)(10) §27.50(c)(10)	Effective Radiated Power (Band 12) (Band 13) (Band 17)	ERP < 3 Watt	PASS	-
	§24.232(c) §27.50(h)(2)	Equivalent Isotropic Radiated Power (Band 2) (Band 7)	EIRP < 2Watt	PASS	-
	§27.50(d)(4)	Equivalent Isotropic Radiated Power (Band 4) (Band 66)	EIRP < 1Watt	PASS	-
3.5	§24.232(d)	Peak-to-Average Ratio	<13 dB	PASS	-
3.6	§2.1049	Occupied Bandwidth	Reporting Only	PASS	-
3.7	§2.1051 §22.917(a) §24.238(a) §27.53(c)(2)(4) §27.53(g) §27.53(h)	Conducted Band Edge Measurement (Band 2) (Band 4) (Band 5) (Band 12) (Band 13) (Band 17) (Band 66)	< 43+10log <sub>10</sub> (P[Watts])	PASS	-
	§27.53(m)(4)	Conducted Band Edge Measurement (Band 7)	§27.53(m)(4)		
3.8	§2.1051 §22.917(a) §24.238(a) §27.53(c)(2) §27.53(g) §27.53(h)	Conducted Spurious Emission (Band 2) (Band 4) (Band 5) (Band 12) (Band 13) (Band 17) (Band 66)	< 43+10log <sub>10</sub> (P[Watts])	PASS	-
	§2.1051 §27.53(m)(4)	Conducted Spurious Emission (Band 7)	< 55+10log <sub>10</sub> (P[Watts])		
3.9	§2.1055 §22.355	Frequency Stability Temperature & Voltage	< 2.5 ppm for Part 22	PASS	-
	§2.1055 §24.235 §27.54		Within Authorized Band		



4.4	§2.1053 §22.917(a) §24.238(a) §27.53(c)(2) §27.53(f) §27.53(g) §27.53(h)	Radiated Spurious Emission (Band 2) (Band 4) (Band 5) (Band 12) (Band 13) (Band 17) (Band 66)	$< 43+10\log_{10}(P[\text{Watts}])$	PASS	Under limit 18.05 dB at 7580.000 MHz
	§2.1053 §27.53(m)(4)	Radiated Spurious Emission (Band 7)	$< 55+10\log_{10}(P[\text{Watts}])$		

**Declaration of Conformity:**

The test results with all measurement uncertainty excluded are presented in accordance with the regulation limits or requirements declared by manufacturers.

**Comments and Explanations:**

The declared of product specification for EUT presented in the report are provided by the manufacturer, and the manufacturer takes all the responsibilities for the accuracy of product specification.



# 1 General Description

## 1.1 Applicant

HMD Global Oy  
Bertel Jungin aukio 9, 02600 Espoo, Finland

## 1.2 Manufacturer

HMD Global Oy  
Bertel Jungin aukio 9, 02600 Espoo, Finland

## 1.3 Product Feature of Equipment Under Test

Product Feature	
Equipment	Mobile Phone
Brand Name	NOKIA
Model Name	TA-1285
FCC ID	2AJOTTA-1285
EUT supports Radios application	GSM/WCDMA/LTE WLAN 2.4GHz 802.11b/g/n HT20/HT40 Bluetooth BR/EDR/LE FM Receiver and GNSS
IMEI Code	Conducted: 353183110006720 Radiation: 353183110022545
HW Version	MB_V3
SW Version	0-00WW-A01
EUT Stage	Identical Prototype

Note: There are two types of EUT, the differences is that please refer to the product equality declaration which is submitted separately. According to the difference, we choose the sample1 perform full test.



### 1.4 Product Specification of Equipment Under Test

Standards-related Product Specification	
<b>Tx Frequency</b>	LTE Band 2 : 1850.7 MHz ~ 1909.3 MHz LTE Band 4 : 1710.7 MHz ~ 1754.3 MHz LTE Band 5 : 824.7 MHz ~ 848.3 MHz LTE Band 7 : 2502.5 MHz ~ 2567.5 MHz LTE Band 12 : 699.7 MHz ~ 715.3 MHz LTE Band 13 : 779.5 MHz ~ 784.5 MHz LTE Band 17 : 706.5 MHz ~ 713.5 MHz LTE Band 66 : 1710.7 MHz ~ 1779.3 MHz
<b>Rx Frequency</b>	LTE Band 2 : 1930.7 MHz ~ 1989.3 MHz LTE Band 4 : 2110.7 MHz ~ 2154.3 MHz LTE Band 5 : 869.7 MHz ~ 893.3 MHz LTE Band 7 : 2622.5MHz ~ 2687.5 MHz LTE Band 12 : 729.7 MHz ~ 745.3 MHz LTE Band 13 : 748.5 MHz ~ 753.5 MHz LTE Band 17 : 736.5 MHz ~ 743.5 MHz LTE Band 66 : 2110.7 MHz~ 2179.3 MHz
<b>Bandwidth</b>	LTE Band 2 : 1.4MHz / 3MHz / 5MHz / 10MHz / 15MHz / 20MHz LTE Band 4 : 1.4MHz / 3MHz / 5MHz / 10MHz / 15MHz / 20MHz LTE Band 5 : 1.4MHz / 3MHz / 5MHz / 10MHz LTE Band 7 : 5MHz/ 10MHz / 15MHz / 20MHz LTE Band 12 : 1.4MHz / 3MHz / 5MHz / 10MHz LTE Band 13 : 5MHz / 10MHz LTE Band 17 : 5MHz / 10MHz LTE Band 66 : 1.4MHz / 3MHz / 5MHz / 10MHz / 15MHz / 20MHz
<b>Maximum Output Power to Antenna</b>	LTE Band 2 : 23.45 dBm LTE Band 4 : 22.98 dBm LTE Band 5 : 23.41 dBm LTE Band 7 : 22.63 dBm LTE Band 12 : 23.38 dBm LTE Band 13 : 23.40 dBm LTE Band 17 : 23.30 dBm LTE Band 66 : 22.80 dBm
<b>Antenna Gain</b>	LTE Band 2 : -6.0 dBi LTE Band 4 : -6.0 dBi LTE Band 5 : -7.0 dBi LTE Band 7 : -6.0 dBi LTE Band 12 : -7.0 dBi LTE Band 13 : -7.5 dBi LTE Band 17 : -8.0 dBi LTE Band 66 : -6.0 dBi
<b>Type of Modulation</b>	QPSK / 16QAM

### 1.5 Modification of EUT

No modifications are made to the EUT during all test items.



### 1.6 Maximum ERP/EIRP Power, Frequency Tolerance, and Emission Designator

LTE Band 2		QPSK			16QAM		
BW (MHz)	Frequency Range (MHz)	Emission Designator (99%OBW)	Frequency Tolerance (ppm)	Maximum EIRP(W)	Emission Designator (99%OBW)	Frequency Tolerance (ppm)	Maximum EIRP(W)
1.4	1850.7 ~ 1909.3	1M10G7D	-	0.0555	1M10W7D	-	0.0442
3	1851.5 ~ 1908.5	2M72G7D	-	0.0542	2M73W7D	-	0.0429
5	1852.5 ~ 1907.5	4M49G7D	-	0.0540	4M50W7D	-	0.0409
10	1855.0 ~ 1905.0	9M07G7D	0.0022	0.0546	9M03W7D	-	0.0420
15	1857.5 ~ 1902.5	13M4G7D	-	0.0542	13M5W7D	-	0.0402
20	1860.0 ~ 1900.0	18M3G7D	-	0.0556	18M3W7D	-	0.0438
LTE Band 4		QPSK			16QAM		
BW (MHz)	Frequency Range (MHz)	Emission Designator (99%OBW)	Frequency Tolerance (ppm)	Maximum EIRP(W)	Emission Designator (99%OBW)	Frequency Tolerance (ppm)	Maximum EIRP(W)
1.4	1710.7 ~ 1754.3	1M10G7D	-	0.0479	1M10W7D	-	0.0404
3	1711.5 ~ 1753.5	2M73G7D	-	0.0472	2M74W7D	-	0.0400
5	1712.5 ~ 1752.5	4M50G7D	-	0.0473	4M50W7D	-	0.0390
10	1715.0 ~ 1750.0	9M03G7D	0.0021	0.0475	9M03W7D	-	0.0393
15	1717.5 ~ 1747.5	13M4G7D	-	0.0469	13M4W7D	-	0.0392
20	1720.0 ~ 1745.0	18M3G7D	-	0.0499	18M5W7D	-	0.0403
LTE Band 5		QPSK			16QAM		
BW (MHz)	Frequency Range (MHz)	Emission Designator (99%OBW)	Frequency Tolerance (ppm)	Maximum ERP(W)	Emission Designator (99%OBW)	Frequency Tolerance (ppm)	Maximum ERP(W)
1.4	824.7 ~ 848.3	1M09G7D	-	0.0261	1M10W7D	-	0.0210
3	825.5 ~ 847.5	2M72G7D	-	0.0211	2M73W7D	-	0.0213
5	826.5 ~ 846.5	4M48G7D	-	0.0265	4M49W7D	-	0.0215
10	829.0 ~ 844.0	9M05G7D	0.0015	0.0267	9M01W7D	-	0.0216
LTE Band 7		QPSK			16QAM		
BW (MHz)	Frequency Range (MHz)	Emission Designator (99%OBW)	Frequency Tolerance (ppm)	Maximum EIRP(W)	Emission Designator (99%OBW)	Frequency Tolerance (ppm)	Maximum EIRP(W)
5	2502.5 ~ 2567.5	4M49G7D	-	0.0455	4M50W7D	-	0.0393
10	2505.0 ~ 2565.0	9M03G7D	0.0009	0.0456	8M99W7D	-	0.0383
15	2507.5 ~ 2562.5	13M5G7D	-	0.0459	13M5W7D	-	0.0394
20	2510.0 ~ 2560.0	18M4G7D	-	0.0460	18M4W7D	-	0.0390





LTE Band 12		QPSK			16QAM		
BW (MHz)	Frequency Range (MHz)	Emission Designator (99%OBW)	Frequency Tolerance (ppm)	Maximum ERP(W)	Emission Designator (99%OBW)	Frequency Tolerance (ppm)	Maximum ERP(W)
1.4	699.7 ~ 715.3	1M09G7D	-	0.0264	1M10W7D	-	0.0215
3	700.5 ~ 714.5	2M73G7D	-	0.0263	2M73W7D	-	0.0213
5	701.5 ~ 713.5	4M52G7D	-	0.0264	4M49W7D	-	0.0204
10	704.0 ~ 711.0	9M03G7D	0.0106	0.0265	9M01W7D	-	0.0203
LTE Band 13		QPSK			16QAM		
BW (MHz)	Frequency Range (MHz)	Emission Designator (99%OBW)	Frequency Tolerance (ppm)	Maximum ERP(W)	Emission Designator (99%OBW)	Frequency Tolerance (ppm)	Maximum ERP(W)
5	779.5 ~ 784.5	4M49G7D	-	0.0237	4M50W7D	-	0.0191
10	782.0	8M95G7D	0.0019	0.0237	8M93W7D	-	0.0179
LTE Band 17		QPSK			16QAM		
BW (MHz)	Frequency Range (MHz)	Emission Designator (99%OBW)	Frequency Tolerance (ppm)	Maximum ERP(W)	Emission Designator (99%OBW)	Frequency Tolerance (ppm)	Maximum ERP(W)
5	706.5 ~ 713.5	4M51G7D	-	0.0203	4M50W7D	-	0.0163
10	709.0 ~ 711.0	9M03G7D	0.0026	0.0207	9M03W7D	-	0.0166
LTE Band 66		QPSK			16QAM		
BW (MHz)	Frequency Range (MHz)	Emission Designator (99%OBW)	Frequency Tolerance (ppm)	Maximum EIRP(W)	Emission Designator (99%OBW)	Frequency Tolerance (ppm)	Maximum EIRP(W)
1.4	1710.7 ~ 1779.3	1M09G7D	-	0.0467	1M10W7D	-	0.0408
3	1711.5 ~ 1778.5	2M73G7D	-	0.0466	2M72W7D	-	0.0397
5	1712.5 ~ 1777.5	4M49G7D	-	0.0467	4M51W7D	-	0.0357
10	1715.0 ~ 1775.0	9M01G7D	0.0034	0.0467	9M03W7D	-	0.0386
15	1717.5 ~ 1772.5	13M5G7D	-	0.0467	13M5W7D	-	0.0389
20	1720.0 ~ 1770.0	18M3G7D	-	0.0479	18M3W7D	-	0.0381



### 1.7 Testing Location

Sporton International (Kunshan) Inc. is accredited to ISO/IEC 17025:2017 by American Association for Laboratory Accreditation with Certificate Number 5145.02.

<b>Test Firm</b>	Sporton International (Kunshan) Inc.		
<b>Test Site Location</b>	No. 1098, Pengxi North Road, Kunshan Economic Development Zone Jiangsu Province 215300 People's Republic of China TEL : +86-512-57900158 FAX : +86-512-57900958		
<b>Test Site No.</b>	<b>Sporton Site No.</b>	<b>FCC Designation No.</b>	<b>FCC Test Firm Registration No.</b>
	03CH05-KS TH01-KS	CN1257	314309

### 1.8 Test Software

Item	Site	Manufacture	Name	Version
1.	03CH05-KS	AUDIX	E3	6.2009-8-24al

### 1.9 Applicable Standards

According to the specifications of the manufacturer, the EUT must comply with the requirements of the following standards:

- ♦ 47 CFR Part 2, 22(H), 24(E), 27(L), 27(H), 27(M), 27(F)
- ♦ ANSI C63.26-2015
- ♦ FCC KDB 971168 D01 Power Meas License Digital Systems v03r01
- ♦ FCC KDB 412172 D01 Determining ERP and EIRP v01r01

**Remark:**

1. All test items were verified and recorded according to the standards and without any deviation during the test.
2. This EUT has also been tested and complied with the requirements of FCC Part 15, Subpart B, recorded in a separate test report.



## 2 Test Configuration of Equipment Under Test

### 2.1 Test Mode

Antenna port conducted and radiated test items listed below are performed according to KDB 971168 D01 Power Meas License Digital Systems v03r01 with maximum output power.

Radiated measurements are performed by rotating the EUT in three different orthogonal test planes to find the maximum emission.

Test Items	Band	Bandwidth (MHz)						Modulation			RB #			Test Channel		
		1.4	3	5	10	15	20	QPSK	16QAM	64QAM	1	Half	Full	L	M	H
Max. Output Power	2	v	v	v	v	v	v	v	v		v	v	v	v	v	v
	4	v	v	v	v	v	v	v	v		v	v	v	v	v	v
	5	v	v	v	v	-	-	v	v		v	v	v	v	v	v
	7	-	-	v	v	v	v	v	v		v	v	v	v	v	v
	12	v	v	v	v	-	-	v	v		v	v	v	v	v	v
	13	-	-	v		-	-	v	v		v	v	v	v	v	v
		-	-		v	-	-	v	v		v	v	v		v	
	17	-	-	v	v	-	-	v	v		v	v	v	v	v	v
66	v	v	v	v	v	v	v	v		v	v	v	v	v	v	
Peak-to-Average Ratio	2					v	v	v		v		v	v	v	v	
	4					v	v	v		v		v	v	v	v	
	5				v	-	-	v	v		v		v	v	v	
	7	-	-			v	v	v		v		v	v	v	v	
	12				v	-	-	v	v		v		v	v	v	
	13	-	-		v	-	-	v	v		v		v	v	v	
	17	-	-		v	-	-	v	v		v		v	v	v	
	66					v	v	v		v		v	v	v	v	



Test Items	Band	Bandwidth (MHz)						Modulation			RB #			Test Channel		
		1.4	3	5	10	15	20	QPSK	16QAM	64QAM	1	Half	Full	L	M	H
26dB and 99% Bandwidth	2	v	v	v	v	v	v	v	v				v	v	v	v
	4	v	v	v	v	v	v	v	v				v	v	v	v
	5	v	v	v	v	-	-	v	v				v	v	v	v
	7	-	-	v	v	v	v	v	v				v	v	v	v
	12	v	v	v	v	-	-	v	v				v	v	v	v
	13	-	-	v		-	-	v	v				v	v	v	v
		-	-		v	-	-	v	v				v		v	
	17	-	-	v	v	-	-	v	v				v	v	v	v
66	v	v	v	v	v	v	v	v				v	v	v	v	
Conducted Band Edge	2	v	v	v	v	v	v	v	v		v		v	v		v
	4	v	v	v	v	v	v	v	v		v		v	v		v
	5	v	v	v	v	-	-	v	v		v		v	v		v
	7	-	-	v	v	v	v	v	v		v		v	v		v
	12	v	v	v	v	-	-	v	v		v		v	v		v
	13	-	-	v		-	-	v	v		v		v	v		v
		-	-		v	-	-	v	v		v		v		v	
	17	-	-	v	v	-	-	v	v		v		v	v		v
66	v	v	v	v	v	v	v	v		v		v	v		v	



Test Items	Band	Bandwidth (MHz)						Modulation			RB #			Test Channel		
		1.4	3	5	10	15	20	QPSK	16QAM	64QAM	1	Half	Full	L	M	H
Conducted Spurious Emission	2	v	v	v	v	v	v	v	v		v			v	v	v
	4	v	v	v	v	v	v	v	v		v			v	v	v
	5	v	v	v	v	-	-	v	v		v			v	v	v
	7	-	-	v	v	v	v	v	v		v			v	v	v
	12	v	v	v	v	-	-	v	v		v			v	v	v
	13	-	-	v		-	-	v	v		v			v	v	v
		-	-		v	-	-	v	v		v				v	
	17	-	-	v	v	-	-	v	v		v			v	v	v
66	v	v	v	v	v	v	v	v		v			v	v	v	
Frequency Stability	2				v			v					v		v	
	4				v			v					v		v	
	5				v	-	-	v					v		v	
	7	-	-		v			v					v		v	
	12				v	-	-	v					v		v	
	13	-	-		v	-	-	v					v		v	
	17	-	-		v	-	-	v					v		v	
	66				v			v					v		v	



Test Items	Band	Bandwidth (MHz)						Modulation			RB #			Test Channel		
		1.4	3	5	10	15	20	QPSK	16QAM	64QAM	1	Half	Full	L	M	H
E.R.P / E.I.R.P	2	v	v	v	v	v	v	v	v		v			v	v	v
	4	v	v	v	v	v	v	v	v		v			v	v	v
	5	v	v	v	v	-	-	v	v		v			v	v	v
	7	-	-	v	v	v	v	v	v		v			v	v	v
	12	v	v	v	v	-	-	v	v		v			v	v	v
	13	-	-	v		-	-	v	v		v			v	v	v
					v			v	v		v				v	
	17	-	-	v	v	-	-	v	v		v			v	v	v
66	v	v	v	v	v	v	v	v		v			v	v	v	
Radiated Spurious Emission	2	Worst Case											v	v	v	
	4	Worst Case											v	v	v	
	5	Worst Case											v	v	v	
	7	Worst Case											v	v	v	
	12	Worst Case											v	v	v	
	13	Worst Case											v	v	v	
	17	Worst Case											v	v	v	
	66	Worst Case											v	v	v	
Note	1. The mark "v " means that this configuration is chosen for testing 2. The mark "- " means that this bandwidth is not supported. 3. The device is investigated from 30MHz to 10 times of fundamental signal for radiated spurious emission test under different RB size/offset and modulations in exploratory test. Subsequently, only the worst case emissions are reported.															

## 2.2 Connection Diagram of Test System

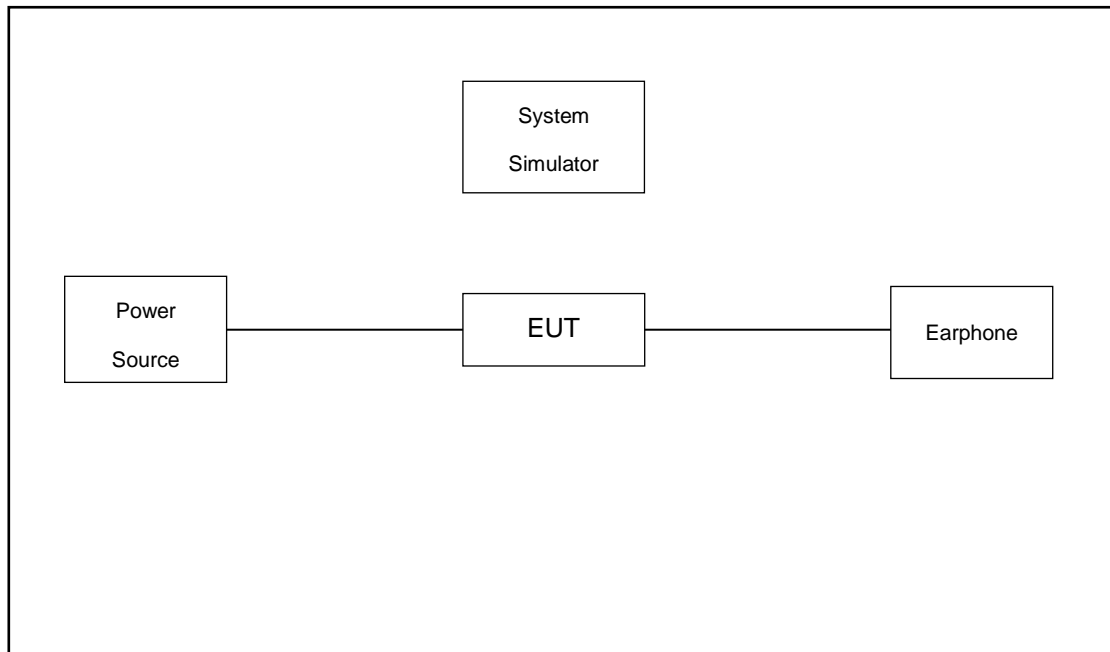

## 2.3 Support Unit used in test configuration and system

Item	Equipment	Trade Name	Model No.	FCC ID	Data Cable	Power Cord
1.	Power Supply	GWINSTEK	PSS-2002	N/A	N/A	Unshielded, 1.8 m
2.	LTE Base Station	Anritsu	MT8820C	N/A	N/A	Unshielded, 1.8 m

## 2.4 Measurement Results Explanation Example

### For all conducted test items:

The offset level is set in the spectrum analyzer to compensate the RF cable loss between EUT conducted output port and spectrum analyzer. With the offset compensation, the spectrum analyzer reading level is exactly the EUT RF output level.

The spectrum analyzer offset is derived from RF cable loss.

*Offset = RF cable loss.*

Following shows an offset computation example with cable loss 5.4 dB.

Example :

$$\begin{aligned}
 \text{Offset(dB)} &= \text{RF cable loss(dB)}. \\
 &= 5.4 \text{ (dB)}
 \end{aligned}$$



### 2.5 Frequency List of Low/Middle/High Channels

LTE Band 2 Channel and Frequency List				
BW [MHz]	Channel/Frequency(MHz)	Lowest	Middle	Highest
20	Channel	18700	18900	19100
	Frequency	1860	1880	1900
15	Channel	18675	18900	19125
	Frequency	1857.5	1880	1902.5
10	Channel	18650	18900	19150
	Frequency	1855	1880	1905
5	Channel	18625	18900	19175
	Frequency	1852.5	1880	1907.5
3	Channel	18615	18900	19185
	Frequency	1851.5	1880	1908.5
1.4	Channel	18607	18900	19193
	Frequency	1850.7	1880	1909.3

LTE Band 4 Channel and Frequency List				
BW [MHz]	Channel/Frequency(MHz)	Lowest	Middle	Highest
20	Channel	20050	20175	20300
	Frequency	1720	1732.5	1745
15	Channel	20025	20175	20325
	Frequency	1717.5	1732.5	1747.5
10	Channel	20000	20175	20350
	Frequency	1715	1732.5	1750
5	Channel	19975	20175	20375
	Frequency	1712.5	1732.5	1752.5
3	Channel	19965	20175	20385
	Frequency	1711.5	1732.5	1753.5
1.4	Channel	19957	20175	20393
	Frequency	1710.7	1732.5	1754.3





LTE Band 5 Channel and Frequency List				
BW [MHz]	Channel/Frequency(MHz)	Lowest	Middle	Highest
10	Channel	20450	20525	20600
	Frequency	829	836.5	844
5	Channel	20425	20525	20625
	Frequency	826.5	836.5	846.5
3	Channel	20415	20525	20635
	Frequency	825.5	836.5	847.5
1.4	Channel	20407	20525	20643
	Frequency	824.7	836.5	848.3

LTE Band 7 Channel and Frequency List				
BW [MHz]	Channel/Frequency(MHz)	Lowest	Middle	Highest
20	Channel	20850	21100	21350
	Frequency	2510	2535	2560
15	Channel	20825	21100	21375
	Frequency	2507.5	2535	2562.5
10	Channel	20800	21100	21400
	Frequency	2505	2535	2565
5	Channel	20775	21100	21425
	Frequency	2502.5	2535	2567.5

LTE Band 12 Channel and Frequency List				
BW [MHz]	Channel/Frequency(MHz)	Lowest	Middle	Highest
10	Channel	23060	23095	23130
	Frequency	704	707.5	711
5	Channel	23035	23095	23155
	Frequency	701.5	707.5	713.5
3	Channel	23025	23095	23165
	Frequency	700.5	707.5	714.5
1.4	Channel	23017	23095	23173
	Frequency	699.7	707.5	715.3



LTE Band 13 Channel and Frequency List				
BW [MHz]	Channel/Frequency(MHz)	Lowest	Middle	Highest
10	Channel	-	23230	-
	Frequency	-	782	-
5	Channel	23205	23230	23255
	Frequency	779.5	782	784.5

LTE Band 17 Channel and Frequency List				
BW [MHz]	Channel/Frequency(MHz)	Lowest	Middle	Highest
10	Channel	23780	23790	23800
	Frequency	709	710	711
5	Channel	23755	23790	23825
	Frequency	706.5	710	713.5

LTE Band 66 Channel and Frequency List				
BW [MHz]	Channel/Frequency(MHz)	Lowest	Middle	Highest
20	Channel	132072	132322	132572
	Frequency	1720	1745	1770
15	Channel	132047	132322	132597
	Frequency	1717.5	1745	1772.5
10	Channel	132022	132322	132622
	Frequency	1715	1745	1775
5	Channel	131997	132322	132647
	Frequency	1712.5	1745	1777.5
3	Channel	131987	132322	132657
	Frequency	1711.5	1745	1778.5
1.4	Channel	131979	132322	132665
	Frequency	1710.7	1745	1779.3

### 3 Conducted Test Items

#### 3.1 Measuring Instruments

See list of measuring instruments of this test report.

#### 3.2 Test Setup

##### 3.2.1 Conducted Output Power



##### 3.2.2 Peak-to-Average Ratio, Occupied Bandwidth ,Conducted Band-Edge and Conducted Spurious Emission



##### 3.2.3 Frequency Stability

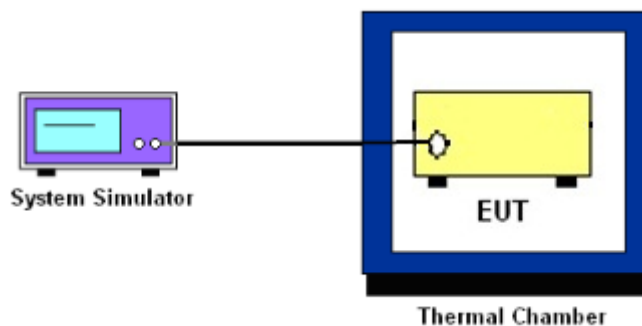

### 3.3 Test Result of Conducted Test

Please refer to Appendix A.



### 3.4 Conducted Output Power and ERP/EIRP

#### 3.4.1 Description of the Conducted Output Power Measurement and ERP/EIRP Measurement

A system simulator was used to establish communication with the EUT. Its parameters were set to force the EUT transmitting at maximum output power. The measured power in the radio frequency on the transmitter output terminals shall be reported.

The ERP of mobile transmitters must not exceed 7 Watts for LTE Band 5.

The ERP of mobile transmitters must not exceed 3 Watts for LTE Band 12, Band 13 and Band 17.

The EIRP of mobile transmitters must not exceed 2 Watts for LTE Band 2 and Band 7.

The EIRP of mobile transmitters must not exceed 1 Watts for LTE Band 4 and Band 66.

According to KDB 412172 D01 Power Approach,

$EIRP = P_T + G_T - L_C$ ,  $ERP = EIRP - 2.15$ , where

$P_T$  = transmitter output power in dBm

$G_T$  = gain of the transmitting antenna in dBi

$L_C$  = signal attenuation in the connecting cable between the transmitter and antenna in dB

#### 3.4.2 Test Procedures

1. The testing follows ANSI C63.26 Section 5.2
2. The transmitter output port was connected to the system simulator.
3. Set EUT at maximum power through the system simulator.
4. Select lowest, middle, and highest channels for each band and different modulation.
5. Measure and record the power level from the system simulator.



## 3.5 Peak-to-Average Ratio

### 3.5.1 Description of the PAR Measurement

Power Complementary Cumulative Distribution Function (CCDF) curves provide a means for characterizing the power peaks of a digitally modulated signal on a statistical basis. A CCDF curve depicts the probability of the peak signal amplitude exceeding the average power level. Most contemporary measurement instrumentation include the capability to produce CCDF curves for an input signal provided that the instrument's resolution bandwidth can be set wide enough to accommodate the entire input signal bandwidth. In measuring transmissions in this band using an average power technique, the peak-to-average ratio (PAR) of the transmission may not exceed 13 dB.

### 3.5.2 Test Procedures

1. The testing follows ANSI C63.26 Section 5.2.3.4 (CCDF).
2. The EUT was connected to spectrum and system simulator via a power divider.
3. Set the CCDF (Complementary Cumulative Distribution Function) option in spectrum analyzer.
4. The highest RF powers were measured and recorded the maximum PAPR level associated with a probability of 0.1 %.
5. Record the deviation as Peak to Average Ratio.



### 3.6 Occupied Bandwidth

#### 3.6.1 Description of Occupied Bandwidth Measurement

The occupied bandwidth is the width of a frequency band such that, below the lower and above the upper frequency limits, the mean powers emitted are each equal to a specified percentage 0.5% of the total mean transmitted power.

The 26 dB emission bandwidth is defined as the frequency range between two points, one above and one below the carrier frequency, at which the spectral density of the emission is attenuated 26 dB below the maximum in-band spectral density of the modulated signal. Spectral density (power per unit bandwidth) is to be measured with a detector of resolution bandwidth equal to approximately 1.0% of the emission bandwidth.

#### 3.6.2 Test Procedures

1. The testing follows ANSI C63.26 Section 5.4
2. The EUT was connected to spectrum analyzer and system simulator via a power divider.
3. The spectrum analyzer center frequency is set to the nominal EUT channel center frequency. The span range for the spectrum analyzer shall be between two and five times the anticipated OBW.
4. The nominal resolution bandwidth (RBW) shall be in the range of 1 to 5 % of the anticipated OBW, and the VBW shall be at least 3 times the RBW.
5. Set the detection mode to peak, and the trace mode to max hold.
6. Determine the reference value: Set the EUT to transmit a modulated signal. Allow the trace to stabilize. Set the spectrum analyzer marker to the highest level of the displayed trace.  
(this is the reference value)
7. Determine the “-26 dB down amplitude” as equal to (Reference Value – X).
8. Place two markers, one at the lowest and the other at the highest frequency of the envelope of the spectral display such that each marker is at or slightly below the “-X dB down amplitude” determined in step 6. If a marker is below this “-X dB down amplitude” value it shall be placed as close as possible to this value. The OBW is the positive frequency difference between the two markers.
9. Use the 99 % power bandwidth function of the spectrum analyzer and report the measured bandwidth.



### 3.7 Conducted Band Edge

#### 3.7.1 Description of Conducted Band Edge Measurement

22.917(a)

For operations in the 824 – 849 MHz band, the FCC limit is  $43 + 10\log_{10}(P[\text{Watts}])$  dB below the transmitter power  $P(\text{Watts})$  in a 100kHz bandwidth. However, in the 1MHz bands immediately outside and adjacent to the licensee's frequency block, a resolution bandwidth of at least one percent of the emission bandwidth of the fundamental emission of the transmitter may be employed.

24.238 (a)

For operations in the 1850-1910 and 1930-1990 MHz band, the FCC limit is  $43 + 10\log_{10}(P[\text{Watts}])$  dB below the transmitter power  $P(\text{Watts})$  in a 1MHz bandwidth. However, in the 1 MHz bands immediately outside and adjacent to the frequency block a resolution bandwidth of at least one percent of the emission bandwidth of the fundamental emission of the transmitter may be employed.

27.53 (c)

For operations in the 776-788 MHz band, the FCC limit is  $43 + 10\log_{10}(P[\text{Watts}])$  dB below the transmitter power  $P(\text{Watts})$  in a 100 kHz bandwidth. However, in the 100 kHz bands immediately outside and adjacent to the frequency block, a resolution bandwidth of at least 30 kHz may be employed. In addition, the power of any unwanted emissions in any 6.25 kHz bandwidth for all frequencies between 763-775 MHz and 793-806 MHz shall be attenuated below the transmitter power,  $P$  (dBW), by at least  $65 + 10 \log_{10} p(\text{watts})$ , dB, for mobile and portable equipment.

27.53 (g)

For operations in the 600MHz band and 698 -746 MHz band, the FCC limit is  $43 + 10\log_{10}(P[\text{Watts}])$  dB below the transmitter power  $P(\text{Watts})$  in a 100 kHz bandwidth. However, in the 100 kilohertz bands immediately outside and adjacent to a licensee's frequency block, a resolution bandwidth of at least 30 kHz may be employed.

27.53 (h)

For operations in the 1710 – 1755 MHz band, the FCC limit is  $43 + 10\log_{10}(P[\text{Watts}])$  dB below the transmitter power  $P(\text{Watts})$  in a 1 MHz bandwidth. However, in the 1MHz bands immediately outside and adjacent to the licensee's frequency block, a resolution bandwidth of at least one percent of the emission bandwidth of the fundamental emission of the transmitter may be employed.



27.53(m)(4)

For mobile digital stations, the attenuation factor shall be not less than  $40 + 10 \log (P)$  dB on all frequencies between the channel edge and 5 megahertz from the channel edge,  $43 + 10 \log (P)$  dB on all frequencies between 5 megahertz and X megahertz from the channel edge, and  $55 + 10 \log (P)$  dB on all frequencies more than X megahertz from the channel edge, where X is the greater of 6 megahertz or the actual emission bandwidth as defined in paragraph (m)(6) of this section. In addition, the attenuation factor shall not be less that  $43 + 10 \log (P)$  dB on all frequencies between 2490.5 MHz and 2496 MHz and  $55 + 10 \log (P)$  dB at or below 2490.5 MHz. Mobile Satellite Service licensees operating on frequencies below 2495 MHz may also submit a documented interference complaint against BRS licensees operating on channel BRS Channel 1 on the same terms and conditions as adjacent channel BRS or EBS licensees.

### 3.7.2 Test Procedures

1. The testing follows ANSI C63.26 section 5.7
2. The EUT was connected to spectrum analyzer and system simulator via a power divider.
3. The band edges of low and high channels for the highest RF powers were measured.
4. Set RBW  $\geq$  1% EBW in the 1MHz band immediately outside and adjacent to the band edge.
5. Beyond the 1 MHz band from the band edge, RBW=1MHz was used.
6. Set spectrum analyzer with RMS detector.
7. The RF fundamental frequency should be excluded against the limit line in the operating frequency band.
8. Checked that all the results comply with the emission limit line.

Example:

The limit line is derived from  $43 + 10\log(P)$ dB below the transmitter power P(Watts)  
=  $P(W) - [43 + 10\log(P)]$  (dB)  
=  $[30 + 10\log(P)]$  (dBm) -  $[43 + 10\log(P)]$  (dB) = -13dBm.

9. For LTE Band 7, the other 40 dB, and 55 dB have additionally applied same calculation above.





### 3.8 Conducted Spurious Emission

#### 3.8.1 Description of Conducted Spurious Emission Measurement

The power of any emission outside of the authorized operating frequency ranges must be lower than the transmitter power (P) by a factor of at least  $43 + 10 \log (P)$  dB.

For Band 7:

The power of any emission outside of the authorized operating frequency ranges must be lower than the transmitter power (P) by a factor of at least  $55 + 10 \log (P)$  dB.

It is measured by means of a calibrated spectrum analyzer and scanned from 30 MHz up to a frequency including its 10<sup>th</sup> harmonic.

#### 3.8.2 Test Procedures

1. The testing follows ANSI C63.26 section 5.7
2. The EUT was connected to spectrum analyzer and system simulator via a power divider.
3. The RF output of EUT was connected to the spectrum analyzer by RF cable and attenuator. The path loss was compensated to the results for each measurement.
4. The middle channel for the highest RF power within the transmitting frequency was measured.
5. The conducted spurious emission for the whole frequency range was taken.
6. Make the measurement with the spectrum analyzer's RBW = 1MHz, VBW = 3MHz.
7. Set spectrum analyzer with RMS detector.
8. Taking the record of maximum spurious emission.
9. The RF fundamental frequency should be excluded against the limit line in the operating frequency band.
10. The limit line is derived from  $43 + 10\log(P)$ dB below the transmitter power P(Watts)  
 $= P(W) - [43 + 10\log(P)]$  (dB)  
 $= [30 + 10\log(P)]$  (dBm) -  $[43 + 10\log(P)]$  (dB)  
 $= -13$ dBm.
11. For Band 7  
The limit line is derived from  $55 + 10\log(P)$ dB below the transmitter power P(Watts)  
 $= P(W) - [55 + 10\log(P)]$  (dB)  
 $= [30 + 10\log(P)]$  (dBm) -  $[55 + 10\log(P)]$  (dB)  
 $= -25$ dBm.



## 3.9 Frequency Stability

### 3.9.1 Description of Frequency Stability Measurement

The frequency stability shall be measured by variation of ambient temperature and variation of primary supply voltage to ensure that the fundamental emission stays within the authorized frequency block. The frequency stability of the transmitter shall be maintained within  $\pm 0.00025\%$  ( $\pm 2.5\text{ppm}$ ) of the center frequency.

### 3.9.2 Test Procedures for Temperature Variation

1. The testing follows ANSI C63.26 section 5.6.4
2. The EUT was set up in the thermal chamber and connected with the system simulator.
3. With power OFF, the temperature was decreased to  $-30^{\circ}\text{C}$  and the EUT was stabilized before testing. Power was applied and the maximum change in frequency was recorded within one minute.
4. With power OFF, the temperature was raised in  $10^{\circ}\text{C}$  step up to  $50^{\circ}\text{C}$ . The EUT was stabilized at each step for at least half an hour. Power was applied and the maximum frequency change was recorded within one minute.

### 3.9.3 Test Procedures for Voltage Variation

1. The testing follows ANSI C63.26 section 5.6.5
2. The EUT was placed in a temperature chamber at  $20\pm 5^{\circ}\text{C}$  and connected with the system simulator.
3. The power supply voltage to the EUT was varied from 85% to 115% of the nominal value for other than hand carried battery equipment.
4. For hand carried, battery powered equipment, reduce the primary ac or dc supply voltage to the battery operating end point, which shall be specified by the manufacturer.
5. The variation in frequency was measured for the worst case.

## 4 Radiated Test Items

### 4.1 Measuring Instruments

See list of measuring instruments of this test report.

### 4.2 Test Setup

#### 4.2.1 For radiated test from 30MHz to 1GHz

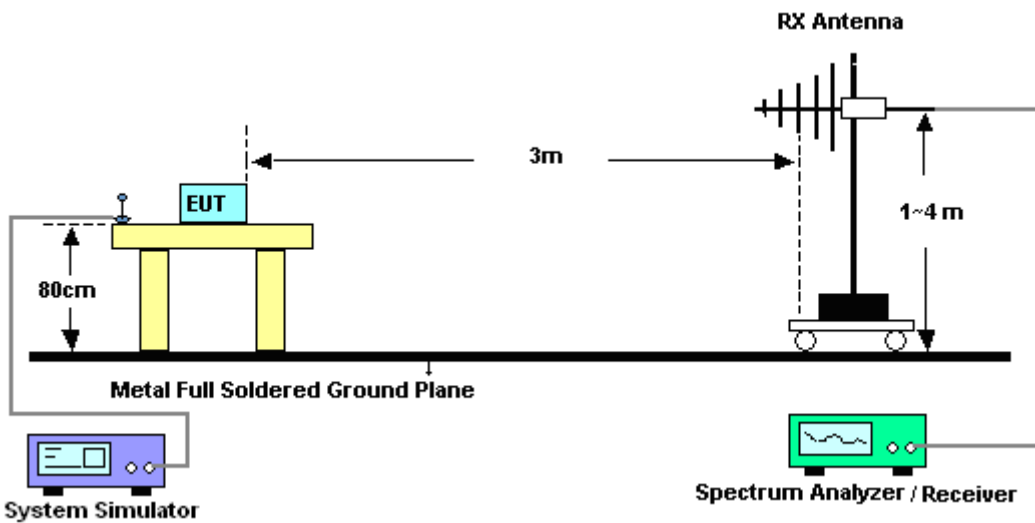

#### 4.2.2 For radiated test above 1GHz

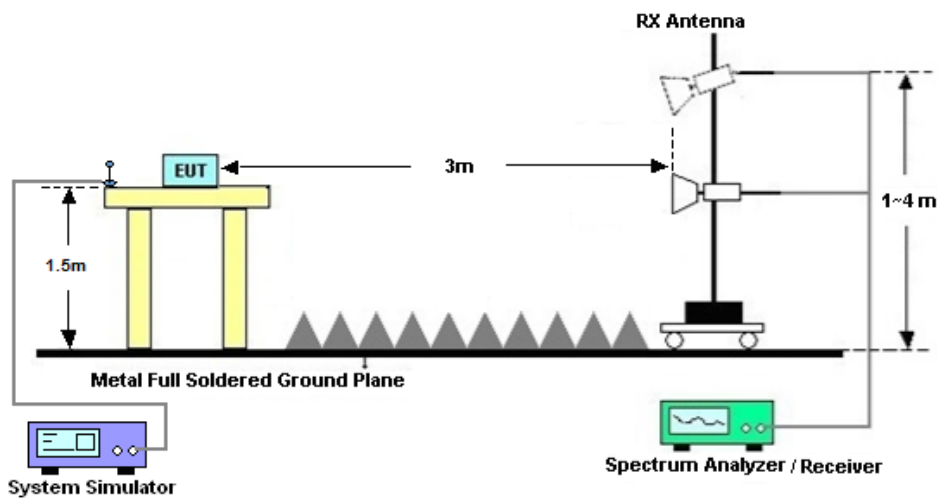

### 4.3 Test Result of Radiated Test

Please refer to Appendix B.



## 4.4 Radiated Spurious Emission

### 4.4.1 Description of Radiated Spurious Emission

The radiated spurious emission was measured by substitution method according to ANSI C63.26. The power of any emission outside of the authorized operating frequency ranges must be attenuated below the transmitter power (P) by a factor of at least  $43 + 10 \log (P)$  dB.

For Band 7

The power of any emission outside of the authorized operating frequency ranges must be attenuated below the transmitter power (P) by a factor of at least  $55 + 10 \log (P)$  dB.

For LTE Band 13

For operations in the 746-758 MHz, 775-788 MHz, and 805-806 MHz bands, emissions in the band 1559-1610 MHz shall be limited to  $-70$  dBW/MHz equivalent isotropically radiated power (EIRP) for wideband signals, and  $-80$  dBW EIRP for discrete emissions of less than 700 Hz bandwidth.

The spectrum is scanned from 30 MHz up to a frequency including its 10th harmonic.



#### 4.4.2 Test Procedures

1. The testing follows ANSI C63.26 Section 5.5
2. The EUT was placed on a turntable with 0.8 meter height for frequency below 1GHz and 1.5 meter height for frequency above 1GHz respectively above ground.
3. The EUT was set 3 meters from the receiving antenna mounted on the antenna tower.
4. The table was rotated 360 degrees to determine the position of the highest spurious emission.
5. The height of the receiving antenna is varied between 1m to 4m to search the maximum spurious emission for both horizontal and vertical polarizations.
6. During the measurement, the system simulator parameters were set to force the EUT transmitting at maximum output power.
7. Make the measurement with the spectrum analyzer's RBW = 1MHz, VBW = 3MHz, taking the record of maximum spurious emission.
8. A horn antenna was substituted in place of the EUT and was driven by a signal generator.
9. Tune the output power of signal generator to the same emission level with EUT maximum spurious emission.
10.  $EIRP \text{ (dBm)} = S.G. \text{ Power} - Tx \text{ Cable Loss} + Tx \text{ Antenna Gain}$
11.  $ERP \text{ (dBm)} = EIRP - 2.15$
12. The RF fundamental frequency should be excluded against the limit line in the operating frequency band.  
The limit line is derived from  $43 + 10\log(P)\text{dB}$  below the transmitter power  $P(\text{Watts})$   
 $= P(\text{W}) - [43 + 10\log(P)] \text{ (dB)}$   
 $= [30 + 10\log(P)] \text{ (dBm)} - [43 + 10\log(P)] \text{ (dB)}$   
 $= -13\text{dBm}.$
13. For Band 7:  
The limit line is derived from  $55 + 10\log(P)\text{dB}$  below the transmitter power  $P(\text{Watts})$



## 5 List of Measuring Equipment

Instrument	Manufacturer	Model No.	Serial No.	Characteristics	Calibration Date	Test Date	Due Date	Remark
Spectrum Analyzer	R&S	FSV40	101040	10Hz~40GHz	Nov. 02, 2019	Jul. 31, 2020~ Aug. 06, 2020	Nov. 01, 2020	Conducted (TH01-KS)
Thermal Chamber	Ten Billion	TTC-B3S	TBN-960502	-40~+150°C	Oct. 28, 2019	Jul. 31, 2020~ Aug. 06, 2020	Oct. 27, 2020	Conducted (TH01-KS)
EXA Spectrum Analyzer	Keysight	N9010A	MY55150244	10Hz-44G,MAX 30dB	Apr. 15, 2020	Aug. 28, 2020	Apr. 14, 2021	Radiation (03CH05-KS)
Bilog Antenna	TeseQ	CBL6111D	49922	30MHz-1GHz	May 30, 2020	Aug. 28, 2020	May 29, 2021	Radiation (03CH05-KS)
Double Ridge Horn Antenna	ETS-Lindgren	3117	00218652	1GHz~18GHz	Apr. 26, 2020	Aug. 28, 2020	Apr. 25, 2021	Radiation (03CH05-KS)
SHF-EHF Horn	Com-power	AH-840	101115	18GHz~40GHz	Nov. 10, 2019	Aug. 28, 2020	Nov. 09, 2020	Radiation (03CH05-KS)
Amplifier	SONOMA	310N	187289	9KHz-1GHz	Apr. 14, 2020	Aug. 28, 2020	Apr. 13, 2021	Radiation (03CH05-KS)
Amplifier	MITEQ	EM18G40G GA	060728	18~40GHz	Jan. 08, 2020	Aug. 28, 2020	Jan. 07, 2021	Radiation (03CH05-KS)
high gain Amplifier	MITEQ	AMF-7D-00 101800-30-1 0P	2012228	1Ghz-18Ghz	Oct. 18, 2019	Aug. 28, 2020	Oct. 17, 2020	Radiation (03CH05-KS)
Amplifier	Keysight	83017A	MY53270316	500MHz~26.5GHz	Oct. 18, 2019	Aug. 28, 2020	Oct. 17, 2020	Radiation (03CH05-KS)
AC Power Source	Chroma	61601	F104090004	N/A	NCR	Aug. 28, 2020	NCR	Radiation (03CH05-KS)
Turn Table	ChamPro	EM 1000-T	060762-T	0~360 degree	NCR	Aug. 28, 2020	NCR	Radiation (03CH05-KS)
Antenna Mast	ChamPro	EM 1000-A	060762-A	1 m~4 m	NCR	Aug. 28, 2020	NCR	Radiation (03CH05-KS)

NCR: No Calibration Required



## 6 Uncertainty of Evaluation

The measurement uncertainties shown below were calculated in accordance with the requirements of ANSI 63.26-2015. All the measurement uncertainty value were shown with a coverage K=2 to indicate 95% level of confidence. The measurement data show herein meets or exceeds the CISPR measurement uncertainty values specified in CISPR 16-4-2 and can be compared directly to specified limit to determine compliance.

### Uncertainty of Radiated Emission Measurement (30 MHz ~ 1000 MHz)

Measuring Uncertainty for a Level of Confidence of 95% (U = 2Uc(y))	2.5dB
---	-------

### Uncertainty of Radiated Emission Measurement (1 GHz ~ 40 GHz)

Measuring Uncertainty for a Level of Confidence of 95% (U = 2Uc(y))	2.1dB
---	-------



### Appendix A. Test Results of Conducted Test

#### Conducted Output Power(Average power)

LTE Band 2

BW [MHz]	Modulation	RB Size	RB Offset	Power Low Ch. / Freq.	Power Middle Ch. / Freq.	Power High Ch. / Freq.
Channel				18700	18900	19100
Frequency (MHz)				1860	1880	1900
20	QPSK	1	0	23.33	23.45	23.21
20	QPSK	1	49	23.35	23.12	23.21
20	QPSK	1	99	23.11	23	23.22
20	QPSK	50	0	22.02	22.03	21.83
20	QPSK	50	24	21.98	21.86	21.67
20	QPSK	50	50	21.92	21.79	21.59
20	QPSK	100	0	21.94	21.95	21.66
20	16QAM	1	0	22.41	22.25	22.32
20	16QAM	1	49	22.38	22.19	22.19
20	16QAM	1	99	22	22.18	22.03
20	16QAM	50	0	21.05	20.74	20.88
20	16QAM	50	24	21.06	20.95	20.86
20	16QAM	50	50	20.96	20.8	20.73
20	16QAM	100	0	20.97	20.82	20.69
Channel				18675	18900	19125
Frequency (MHz)				1857.5	1880	1902.5
15	QPSK	1	0	23.10	23.00	23.11
15	QPSK	1	37	23.18	23.34	23.09
15	QPSK	1	74	22.92	22.98	23.00
15	QPSK	36	0	21.99	21.97	22.00
15	QPSK	36	20	21.96	21.95	21.90
15	QPSK	36	39	22.02	21.98	21.91
15	QPSK	75	0	22.04	21.94	21.94
15	16QAM	1	0	22.05	21.82	22.00
15	16QAM	1	37	22.00	21.91	21.65





15	16QAM	1	74	21.83	21.56	21.67
15	16QAM	36	0	21.02	20.94	20.87
15	16QAM	36	20	20.98	20.95	20.90
15	16QAM	36	39	21.05	20.98	20.83
15	16QAM	75	0	21.06	21.01	20.95
Channel				18650	18900	19150
Frequency (MHz)				1855	1880	1905
10	QPSK	1	0	23.15	22.96	23.21
10	QPSK	1	25	23.37	23.23	23.04
10	QPSK	1	49	23.01	23.12	23.24
10	QPSK	25	0	22.36	22.23	22.13
10	QPSK	25	12	22.23	22.18	22.17
10	QPSK	25	25	22.2	22.24	22.15
10	QPSK	50	0	22.23	22.16	22.08
10	16QAM	1	0	22.23	22.03	21.99
10	16QAM	1	25	22.13	22.09	21.95
10	16QAM	1	49	22.21	21.86	21.86
10	16QAM	25	0	21.12	21.1	21.25
10	16QAM	25	12	21.48	21.18	21.09
10	16QAM	25	25	21.2	21.23	21.01
10	16QAM	50	0	21.26	21.26	21.01
Channel				18625	18900	19175
Frequency (MHz)				1852.5	1880	1907.5
5	QPSK	1	0	23.19	23.27	23.32
5	QPSK	1	12	23.21	23.23	23.11
5	QPSK	1	24	23.03	23.31	22.98
5	QPSK	12	0	22.41	22.17	22.05
5	QPSK	12	7	22.47	22.24	22.05
5	QPSK	12	13	22.43	22.28	22.02
5	QPSK	25	0	22.36	22.2	22.02
5	16QAM	1	0	22.12	21.95	21.8
5	16QAM	1	12	22.01	22.05	21.91
5	16QAM	1	24	22.02	21.96	21.74
5	16QAM	12	0	21.33	21.09	20.98
5	16QAM	12	7	21.23	21.24	20.89
5	16QAM	12	13	21.39	21.29	21.03



5	16QAM	25	0	21.42	21.19	21
Channel				18615	18900	19185
Frequency (MHz)				1851.5	1880	1908.5
3	QPSK	1	0	23.34	23.27	23.1
3	QPSK	1	8	23.21	23.12	23.07
3	QPSK	1	14	23.28	23.25	23.07
3	QPSK	8	0	22.44	22.21	22
3	QPSK	8	4	22.21	22.21	22.05
3	QPSK	8	7	22.44	22.15	22.02
3	QPSK	15	0	22.31	22.15	22
3	16QAM	1	0	22.2	22.02	22
3	16QAM	1	8	22.12	21.91	21.83
3	16QAM	1	14	22.32	21.96	21.99
3	16QAM	8	0	21.34	21.44	21.03
3	16QAM	8	4	21.48	21.36	21.23
3	16QAM	8	7	21.36	21.18	21.22
3	16QAM	15	0	21.3	21.12	21.12
Channel				18607	18900	19193
Frequency (MHz)				1850.7	1880	1909.3
1.4	QPSK	1	0	23.16	23.35	23.2
1.4	QPSK	1	3	23.25	23.31	23.22
1.4	QPSK	1	5	23.27	23.37	23.25
1.4	QPSK	3	0	23.33	23.12	23.22
1.4	QPSK	3	1	23.11	23.4	23.23
1.4	QPSK	3	3	23.44	23.36	23.19
1.4	QPSK	6	0	22.33	22.38	22.31
1.4	16QAM	1	0	22.24	22.11	22.04
1.4	16QAM	1	3	22.25	22.33	22.18
1.4	16QAM	1	5	22.15	22.09	22.12
1.4	16QAM	3	0	22.23	22.42	22.22
1.4	16QAM	3	1	22.26	22.42	22.21
1.4	16QAM	3	3	22.15	22.45	22.17
1.4	16QAM	6	0	21.34	21.43	21.13



LTE Band 4

BW [MHz]	Modulation	RB Size	RB Offset	Power Low Ch. / Freq.	Power Middle Ch. / Freq.	Power High Ch. / Freq.
Channel				20050	20175	20300
Frequency (MHz)				1720	1732.5	1745
20	QPSK	1	0	22.75	22.98	22.77
20	QPSK	1	49	22.75	22.78	22.76
20	QPSK	1	99	22.69	22.81	22.79
20	QPSK	50	0	21.91	22.12	22.11
20	QPSK	50	24	21.84	22.02	22.02
20	QPSK	50	50	21.83	21.94	21.9
20	QPSK	100	0	21.89	22.06	22.01
20	16QAM	1	0	21.69	21.69	22.05
20	16QAM	1	49	21.77	21.79	21.83
20	16QAM	1	99	21.65	21.74	21.82
20	16QAM	50	0	20.95	21.06	21.22
20	16QAM	50	24	20.88	21.04	21.07
20	16QAM	50	50	20.8	20.93	20.94
20	16QAM	100	0	21.01	21.04	21.07
Channel				20025	20175	20325
Frequency (MHz)				1717.5	1732.5	1747.5
15	QPSK	1	0	22.67	22.65	22.61
15	QPSK	1	37	22.69	22.58	22.71
15	QPSK	1	74	22.69	22.71	22.67
15	QPSK	36	0	21.86	22.02	22.07
15	QPSK	36	20	21.75	22.07	21.95
15	QPSK	36	39	21.75	22.05	21.89
15	QPSK	75	0	21.78	22.06	22
15	16QAM	1	0	21.72	21.64	21.93
15	16QAM	1	37	21.64	21.58	21.53
15	16QAM	1	74	21.66	21.75	21.79
15	16QAM	36	0	20.87	21.06	21.1
15	16QAM	36	20	20.78	21.02	20.99
15	16QAM	36	39	20.79	20.97	20.84
15	16QAM	75	0	20.81	21	21.14



Channel				20000	20175	20350
Frequency (MHz)				1715	1732.5	1750
10	QPSK	1	0	22.72	22.69	22.76
10	QPSK	1	25	22.72	22.77	22.73
10	QPSK	1	49	22.62	22.71	22.71
10	QPSK	25	0	21.89	22.08	21.93
10	QPSK	25	12	21.78	22	21.92
10	QPSK	25	25	21.79	21.94	21.92
10	QPSK	50	0	21.8	22.07	21.98
10	16QAM	1	0	21.69	21.8	21.85
10	16QAM	1	25	21.58	21.86	21.77
10	16QAM	1	49	21.55	21.76	21.94
10	16QAM	25	0	20.86	21.13	20.97
10	16QAM	25	12	20.97	20.95	20.96
10	16QAM	25	25	20.83	21.16	21.24
10	16QAM	50	0	20.93	21.02	21.02
Channel				19975	20175	20375
Frequency (MHz)				1712.5	1732.5	1752.5
5	QPSK	1	0	22.51	22.61	22.69
5	QPSK	1	12	22.58	22.61	22.63
5	QPSK	1	24	22.54	22.66	22.75
5	QPSK	12	0	21.9	22.04	21.9
5	QPSK	12	7	21.82	22.04	21.92
5	QPSK	12	13	21.72	21.91	22.1
5	QPSK	25	0	21.77	21.98	21.94
5	16QAM	1	0	21.57	21.91	21.75
5	16QAM	1	12	21.59	21.88	21.86
5	16QAM	1	24	21.55	21.64	21.72
5	16QAM	12	0	20.93	20.81	20.69
5	16QAM	12	7	20.96	21.1	20.83
5	16QAM	12	13	20.86	20.77	20.96
5	16QAM	25	0	20.98	20.94	20.79
Channel				19965	20175	20385
Frequency (MHz)				1711.5	1732.5	1753.5
3	QPSK	1	0	22.69	22.68	22.63
3	QPSK	1	8	22.58	22.7	22.74



3	QPSK	1	14	22.61	22.69	22.74
3	QPSK	8	0	21.78	22.07	22.03
3	QPSK	8	4	21.81	22.09	21.98
3	QPSK	8	7	21.73	21.89	21.94
3	QPSK	15	0	21.84	22	21.96
3	16QAM	1	0	21.95	21.96	21.95
3	16QAM	1	8	21.55	21.63	21.72
3	16QAM	1	14	21.6	21.77	22.02
3	16QAM	8	0	20.85	21.19	21.01
3	16QAM	8	4	20.79	21.09	21.03
3	16QAM	8	7	20.81	21.07	20.72
3	16QAM	15	0	20.68	21.06	20.64
Channel				19957	20175	20393
Frequency (MHz)				1710.7	1732.5	1754.3
1.4	QPSK	1	0	22.71	22.75	22.77
1.4	QPSK	1	3	22.77	22.75	22.75
1.4	QPSK	1	5	22.8	22.77	22.71
1.4	QPSK	3	0	22.69	22.73	22.71
1.4	QPSK	3	1	22.73	22.76	22.7
1.4	QPSK	3	3	22.8	22.71	22.79
1.4	QPSK	6	0	21.77	22.05	21.95
1.4	16QAM	1	0	21.59	21.92	21.79
1.4	16QAM	1	3	21.66	21.85	21.88
1.4	16QAM	1	5	21.61	21.75	21.71
1.4	16QAM	3	0	21.73	22.01	21.86
1.4	16QAM	3	1	21.86	22.02	22.03
1.4	16QAM	3	3	21.79	21.97	22.06
1.4	16QAM	6	0	20.87	20.79	20.56



LTE Band 5

BW [MHz]	Modulation	RB Size	RB Offset	Power Low Ch. / Freq.	Power Middle Ch. / Freq.	Power High Ch. / Freq.
Channel				20450	20525	20600
Frequency (MHz)				829	836.5	844
10	QPSK	1	0	23.34	23.41	23.34
10	QPSK	1	25	23.23	23.32	23.33
10	QPSK	1	49	23.33	23.12	23.3
10	QPSK	25	0	22.45	22.46	22.34
10	QPSK	25	12	22.33	22.32	22.21
10	QPSK	25	25	22.32	22.23	22.34
10	QPSK	50	0	22.33	22.34	22.21
10	16QAM	1	0	22.47	22.32	22.5
10	16QAM	1	25	22.33	22.28	22.42
10	16QAM	1	49	22.41	22.37	22.06
10	16QAM	25	0	21.31	21.14	21.41
10	16QAM	25	12	21.42	21.03	21.45
10	16QAM	25	25	21.43	21.2	21.16
10	16QAM	50	0	21.21	21.11	21.14
Channel				20425	20525	20625
Frequency (MHz)				826.5	836.5	846.5
5	QPSK	1	0	23.39	23.1	23.2
5	QPSK	1	12	23.32	23.3	23.32
5	QPSK	1	24	23.13	23.33	23.21
5	QPSK	12	0	22.45	22.48	22.5
5	QPSK	12	7	22.23	22.21	22.5
5	QPSK	12	13	22.33	22.32	22.44
5	QPSK	25	0	22.21	22.23	22.47
5	16QAM	1	0	22.33	22.41	22.34
5	16QAM	1	12	22.48	22.24	22.29
5	16QAM	1	24	22.33	22.29	22.12
5	16QAM	12	0	21.3	21.2	21.29
5	16QAM	12	7	21.35	21.33	21.31
5	16QAM	12	13	21.37	21.42	21.28
5	16QAM	25	0	21.3	21.33	21.26



Channel				20415	20525	20635
Frequency (MHz)				825.5	836.5	847.5
3	QPSK	1	0	23.22	23.35	23.2
3	QPSK	1	8	23.33	23.22	23.21
3	QPSK	1	14	23.4	23.28	23.2
3	QPSK	8	0	22.4	22.34	22.34
3	QPSK	8	4	22.33	22.34	22.31
3	QPSK	8	7	22.32	22.26	22.32
3	QPSK	15	0	22.34	22.21	22.24
3	16QAM	1	0	22.35	22.33	22.21
3	16QAM	1	8	22.43	22.18	22.37
3	16QAM	1	14	22.26	22.36	22.33
3	16QAM	8	0	21.3	21.24	21.19
3	16QAM	8	4	21.48	21.21	21.28
3	16QAM	8	7	21.34	21.3	21.33
3	16QAM	15	0	21.19	21.08	21.12
Channel				20407	20525	20643
Frequency (MHz)				824.7	836.5	848.3
1.4	QPSK	1	0	23.27	23.17	23.17
1.4	QPSK	1	3	23.31	23.31	23.28
1.4	QPSK	1	5	23.22	23.24	23.11
1.4	QPSK	3	0	23.3	23.31	23.24
1.4	QPSK	3	1	23.22	23.16	23.27
1.4	QPSK	3	3	23.21	23.16	23.18
1.4	QPSK	6	0	22.21	22.13	22.19
1.4	16QAM	1	0	22.31	22.03	22.14
1.4	16QAM	1	3	22.37	22.14	22.09
1.4	16QAM	1	5	22.28	22.2	22.06
1.4	16QAM	3	0	22.2	22.26	22.27
1.4	16QAM	3	1	22.28	22.26	22.2
1.4	16QAM	3	3	22.23	22.2	22.18
1.4	16QAM	6	0	21.38	21.12	21.33



LTE Band 7

BW [MHz]	Modulation	RB Size	RB Offset	Power Low Ch. / Freq.	Power Middle Ch. / Freq.	Power High Ch. / Freq.
Channel				20850	21100	21350
Frequency (MHz)				2510	2535	2560
20	QPSK	1	0	22.54	22.63	22.62
20	QPSK	1	49	22.53	22.6	22.59
20	QPSK	1	99	22.47	22.57	22.6
20	QPSK	50	0	21.76	21.77	21.75
20	QPSK	50	24	21.61	21.54	21.71
20	QPSK	50	50	21.69	21.73	21.69
20	QPSK	100	0	21.72	21.74	21.7
20	16QAM	1	0	21.64	21.91	21.54
20	16QAM	1	49	21.67	21.79	21.62
20	16QAM	1	99	21.62	21.72	21.53
20	16QAM	50	0	20.79	20.98	20.87
20	16QAM	50	24	20.82	20.85	20.84
20	16QAM	50	50	20.79	20.78	20.96
20	16QAM	100	0	20.8	20.95	20.85
Channel				20825	21100	21375
Frequency (MHz)				2507.5	2535	2562.5
15	QPSK	1	0	22.57	22.62	22.61
15	QPSK	1	37	22.61	22.62	22.5
15	QPSK	1	74	22.59	22.52	22.53
15	QPSK	36	0	21.81	21.82	21.85
15	QPSK	36	20	21.79	21.78	21.74
15	QPSK	36	39	21.93	21.9	21.76
15	QPSK	75	0	21.91	21.78	21.77
15	16QAM	1	0	21.93	21.65	21.58
15	16QAM	1	37	21.95	21.93	21.96
15	16QAM	1	74	21.69	21.72	21.68
15	16QAM	36	0	20.79	20.82	20.82
15	16QAM	36	20	20.88	20.84	20.84
15	16QAM	36	39	20.91	20.86	20.85
15	16QAM	75	0	20.82	20.9	20.75





Channel				20800	21100	21400
Frequency (MHz)				2505	2535	2565
10	QPSK	1	0	22.59	22.58	22.42
10	QPSK	1	25	22.55	22.51	22.52
10	QPSK	1	49	22.59	22.56	22.51
10	QPSK	25	0	21.82	21.69	21.61
10	QPSK	25	12	21.82	21.75	21.68
10	QPSK	25	25	21.84	21.84	21.69
10	QPSK	50	0	21.83	21.7	21.64
10	16QAM	1	0	21.83	21.72	21.51
10	16QAM	1	25	21.64	21.6	21.52
10	16QAM	1	49	21.71	21.61	21.57
10	16QAM	25	0	20.9	20.75	20.68
10	16QAM	25	12	20.93	20.74	20.67
10	16QAM	25	25	20.89	20.86	20.81
10	16QAM	50	0	20.8	20.85	20.74
Channel				20775	21100	21425
Frequency (MHz)				2502.5	2535	2567.5
5	QPSK	1	0	22.48	22.52	22.47
5	QPSK	1	12	22.58	22.57	22.51
5	QPSK	1	24	22.47	22.47	22.54
5	QPSK	12	0	21.92	21.82	21.72
5	QPSK	12	7	21.75	21.84	21.7
5	QPSK	12	13	21.77	21.7	21.68
5	QPSK	25	0	21.69	21.7	21.7
5	16QAM	1	0	21.75	21.66	21.49
5	16QAM	1	12	21.93	21.94	21.65
5	16QAM	1	24	21.57	21.64	21.57
5	16QAM	12	0	20.81	20.68	20.79
5	16QAM	12	7	20.75	20.93	20.81
5	16QAM	12	13	20.77	20.78	20.96
5	16QAM	25	0	21	20.96	20.98



LTE Band 12

BW [MHz]	Modulation	RB Size	RB Offset	Power Low Ch. / Freq.	Power Middle Ch. / Freq.	Power High Ch. / Freq.
Channel				23060	23095	23130
Frequency (MHz)				704	707.5	711
10	QPSK	1	0	23.23	23.38	23.22
10	QPSK	1	25	23.21	23.34	23.37
10	QPSK	1	49	23.24	23.25	22.99
10	QPSK	25	0	22.29	22.4	22.39
10	QPSK	25	12	22.32	22.28	22.32
10	QPSK	25	25	22.33	22.28	22.32
10	QPSK	50	0	22.32	22.36	22.35
10	16QAM	1	0	22.1	21.76	22.22
10	16QAM	1	25	22.01	22.16	22.16
10	16QAM	1	49	22.03	21.97	21.85
10	16QAM	25	0	21.18	21.33	21.35
10	16QAM	25	12	21.5	21.29	21.27
10	16QAM	25	25	21.23	21.22	21.18
10	16QAM	50	0	21.29	21.32	21.42
Channel				23035	23095	23155
Frequency (MHz)				701.5	707.5	713.5
5	QPSK	1	0	23.21	23.21	23.37
5	QPSK	1	12	23.26	23.21	23.12
5	QPSK	1	24	22.9	23.33	23.25
5	QPSK	12	0	22.22	22.45	22.29
5	QPSK	12	7	22.29	22.45	22.35
5	QPSK	12	13	22.2	22.39	22.19
5	QPSK	25	0	22.2	22.33	22.15
5	16QAM	1	0	22.21	22.14	22.2
5	16QAM	1	12	22.2	22.24	22.1
5	16QAM	1	24	22	22.02	21.96
5	16QAM	12	0	21.3	21.33	21.35
5	16QAM	12	7	21.3	21.41	21.29
5	16QAM	12	13	21.18	21.37	21.18
5	16QAM	25	0	21.29	21.31	21.33



Channel				23025	23095	23165
Frequency (MHz)				700.5	707.5	714.5
3	QPSK	1	0	23.23	23.35	23.27
3	QPSK	1	8	23.18	23.21	23.34
3	QPSK	1	14	22.93	23.23	23.21
3	QPSK	8	0	22.34	22.46	22.32
3	QPSK	8	4	22.46	22.5	22.29
3	QPSK	8	7	22.47	22.48	22.27
3	QPSK	15	0	22.38	22.12	22.4
3	16QAM	1	0	22.34	22.33	22.43
3	16QAM	1	8	22.14	22.35	21.95
3	16QAM	1	14	22.05	22.28	22.13
3	16QAM	8	0	21.37	21.34	21.45
3	16QAM	8	4	21.31	21.33	21.4
3	16QAM	8	7	21.23	21.23	21.38
3	16QAM	15	0	21.2	21.22	21.35
Channel				23017	23095	23173
Frequency (MHz)				699.7	707.5	715.3
1.4	QPSK	1	0	23.18	23.32	23.32
1.4	QPSK	1	3	23.24	23.33	23.23
1.4	QPSK	1	5	23.2	23.21	23.36
1.4	QPSK	3	0	23.2	23.22	23.23
1.4	QPSK	3	1	23.24	23.21	23.26
1.4	QPSK	3	3	23.25	23.34	23.37
1.4	QPSK	6	0	22.4	22.47	22.31
1.4	16QAM	1	0	22.34	22.2	22.04
1.4	16QAM	1	3	22.21	22.43	22.35
1.4	16QAM	1	5	22.44	22.32	22.35
1.4	16QAM	3	0	22.27	22.47	22.27
1.4	16QAM	3	1	22.42	22.21	22.26
1.4	16QAM	3	3	22.32	22.12	22.35
1.4	16QAM	6	0	21.42	21.35	21.41



LTE Band 13

BW [MHz]	Modulation	RB Size	RB Offset	Power Low Ch. / Freq.	Power Middle Ch. / Freq.	Power High Ch. / Freq.
Channel				23230		
Frequency (MHz)				782		
10	QPSK	1	0		23.4	
10	QPSK	1	25		23.21	
10	QPSK	1	49		22.94	
10	QPSK	25	0		22.21	
10	QPSK	25	12		22.2	
10	QPSK	25	25		22.2	
10	QPSK	50	0		22.26	
10	16QAM	1	0		22	
10	16QAM	1	25		22.18	
10	16QAM	1	49		21.92	
10	16QAM	25	0		21.23	
10	16QAM	25	12		21.14	
10	16QAM	25	25		21.45	
10	16QAM	50	0		21.14	
Channel					23205	
Frequency (MHz)				779.5	782	784.5
5	QPSK	1	0	23.22	23.21	23.1
5	QPSK	1	12	23.21	23.21	23.22
5	QPSK	1	24	23.1	23.39	23.13
5	QPSK	12	0	22.19	22.23	22.15
5	QPSK	12	7	22.25	22.03	22.19
5	QPSK	12	13	22.2	22.26	22.17
5	QPSK	25	0	22.24	22.29	22.13
5	16QAM	1	0	22.47	22.34	22.02
5	16QAM	1	12	22.23	22.16	22.03
5	16QAM	1	24	22.06	22.19	22.04
5	16QAM	12	0	21.17	21.31	21.28
5	16QAM	12	7	21.19	21.3	21.15
5	16QAM	12	13	21.19	21.19	21.21
5	16QAM	25	0	21.05	21.2	21.4



LTE Band 17

BW [MHz]	Modulation	RB Size	RB Offset	Power Low Ch. / Freq.	Power Middle Ch. / Freq.	Power High Ch. / Freq.
Channel				23780	23790	23800
Frequency (MHz)				709	710	711
10	QPSK	1	0	23.29	23.3	23.28
10	QPSK	1	25	23.21	23.22	23.21
10	QPSK	1	49	23.21	23.25	23.29
10	QPSK	25	0	22.34	22.42	22.37
10	QPSK	25	12	22.41	22.38	22.39
10	QPSK	25	25	22.37	22.36	22.31
10	QPSK	50	0	22.21	22.37	22.33
10	16QAM	1	0	22.33	22.21	22.36
10	16QAM	1	25	22.28	22.22	22.27
10	16QAM	1	49	22.21	22.03	21.96
10	16QAM	25	0	21.45	21.23	21.46
10	16QAM	25	12	21.37	21.35	21.26
10	16QAM	25	25	21.32	21.23	21.37
10	16QAM	50	0	21.38	21.42	21.4
Channel				23755	23790	23825
Frequency (MHz)				706.5	710	713.5
5	QPSK	1	0	23.02	23.07	23.21
5	QPSK	1	12	23.21	23.22	23.21
5	QPSK	1	24	23.21	23.03	23.18
5	QPSK	12	0	22.41	22.32	22.34
5	QPSK	12	7	22.21	22.34	22.3
5	QPSK	12	13	22.44	22.32	22.13
5	QPSK	25	0	22.39	22.34	22.21
5	16QAM	1	0	22.26	22.17	22.21
5	16QAM	1	12	22.2	21.98	21.96
5	16QAM	1	24	22.17	22.14	21.99
5	16QAM	12	0	21.2	21.22	21.21
5	16QAM	12	7	21.4	21.23	21.27
5	16QAM	12	13	21.23	21.33	21.21
5	16QAM	25	0	21.23	21.49	21.08



LTE Band 66

BW [MHz]	Modulation	RB Size	RB Offset	Power Low Ch. / Freq.	Power Middle Ch. / Freq.	Power High Ch. / Freq.
Channel				132072	132322	132572
Frequency (MHz)				1720	1745	1770
20	QPSK	1	0	22.42	22.8	22.62
20	QPSK	1	49	22.67	22.68	22.58
20	QPSK	1	99	22.58	22.61	22.62
20	QPSK	50	0	21.68	22.17	21.72
20	QPSK	50	24	21.68	22.14	22.08
20	QPSK	50	50	21.71	22.04	22.01
20	QPSK	100	0	21.67	22.08	21.77
20	16QAM	1	0	21.34	21.7	21.69
20	16QAM	1	49	21.44	21.81	21.74
20	16QAM	1	99	21.36	21.67	21.35
20	16QAM	50	0	20.7	21.11	20.83
20	16QAM	50	24	20.82	21.12	20.7
20	16QAM	50	50	20.81	21.02	20.69
20	16QAM	100	0	20.75	21.06	20.75
Channel				132047	132322	132597
Frequency (MHz)				1717.5	1745	1772.5
15	QPSK	1	0	22.57	22.62	22.65
15	QPSK	1	37	22.69	22.65	22.64
15	QPSK	1	74	22.62	22.64	22.57
15	QPSK	36	0	21.59	21.99	21.67
15	QPSK	36	20	21.67	21.99	21.62
15	QPSK	36	39	21.68	21.96	21.6
15	QPSK	75	0	21.61	22	21.64
15	16QAM	1	0	21.46	21.76	21.54
15	16QAM	1	37	21.9	21.9	21.43
15	16QAM	1	74	21.5	21.63	21.43
15	16QAM	36	0	20.6	20.99	20.68
15	16QAM	36	20	20.53	21.01	20.73
15	16QAM	36	39	20.6	20.99	20.62
15	16QAM	75	0	20.63	21.03	20.66
Channel				132022	132322	132622
Frequency (MHz)				1715	1745	1775
10	QPSK	1	0	22.57	22.59	22.58



10	QPSK	1	25	22.62	22.67	22.67
10	QPSK	1	49	22.61	22.69	22.66
10	QPSK	25	0	21.57	21.67	21.87
10	QPSK	25	12	21.69	21.76	21.75
10	QPSK	25	25	21.75	22.07	21.68
10	QPSK	50	0	21.64	22.12	21.68
10	16QAM	1	0	21.46	21.58	21.57
10	16QAM	1	25	21.51	21.87	21.58
10	16QAM	1	49	21.47	21.86	21.48
10	16QAM	25	0	20.68	21.15	20.89
10	16QAM	25	12	20.73	21.15	20.89
10	16QAM	25	25	20.74	21.09	20.83
10	16QAM	50	0	20.83	21.14	20.65
Channel				131997	132322	132647
Frequency (MHz)				1712.5	1745	1777.5
5	QPSK	1	0	22.32	22.66	22.49
5	QPSK	1	12	22.6	22.59	22.61
5	QPSK	1	24	22.46	22.69	22.63
5	QPSK	12	0	21.59	21.95	21.75
5	QPSK	12	7	21.6	21.94	21.69
5	QPSK	12	13	21.63	21.94	21.68
5	QPSK	25	0	21.53	21.62	21.73
5	16QAM	1	0	21.09	21.51	21.46
5	16QAM	1	12	21.36	21.53	21.52
5	16QAM	1	24	21.4	21.5	21.41
5	16QAM	12	0	20.59	21.02	20.93
5	16QAM	12	7	20.58	21.02	20.63
5	16QAM	12	13	20.59	21.06	20.62
5	16QAM	25	0	20.66	21.07	20.6
Channel				131987	132322	132657
Frequency (MHz)				1711.5	1745	1778.5
3	QPSK	1	0	22.43	22.66	22.42
3	QPSK	1	8	22.38	22.68	22.31
3	QPSK	1	14	22.36	22.61	22.44
3	QPSK	8	0	21.69	22.1	21.76
3	QPSK	8	4	21.61	22.09	21.79
3	QPSK	8	7	21.67	22.11	21.69
3	QPSK	15	0	21.6	22.1	21.7



3	16QAM	1	0	21.54	21.99	21.61
3	16QAM	1	8	21.49	21.87	21.49
3	16QAM	1	14	21.5	21.82	21.54
3	16QAM	8	0	20.63	20.89	20.54
3	16QAM	8	4	20.57	20.85	20.56
3	16QAM	8	7	20.6	20.86	20.49
3	16QAM	15	0	20.24	20.74	20.46
Channel				131979	132322	132665
Frequency (MHz)				1710.7	1745	1779.3
1.4	QPSK	1	0	22.54	22.65	22.61
1.4	QPSK	1	3	22.68	22.69	22.64
1.4	QPSK	1	5	22.61	22.68	22.67
1.4	QPSK	3	0	22.67	22.69	22.67
1.4	QPSK	3	1	22.61	22.63	22.61
1.4	QPSK	3	3	22.55	22.66	22.61
1.4	QPSK	6	0	21.54	22.01	21.69
1.4	16QAM	1	0	21.63	21.93	21.61
1.4	16QAM	1	3	21.7	21.9	21.73
1.4	16QAM	1	5	21.45	21.9	21.61
1.4	16QAM	3	0	21.67	22.09	21.83
1.4	16QAM	3	1	21.61	22.11	21.76
1.4	16QAM	3	3	21.64	22.08	21.8
1.4	16QAM	6	0	20.37	20.86	20.56





**ERP/EIRP**

LTE Band 2 (GT - LC = -6.0 dB) QPSK									
Bandwidth	1.4M			3M			5M		
Channel	18607	18900	19193	18615	18900	19185	18625	18900	19175
	(Low)	(Mid)	(High)	(Low)	(Mid)	(High)	(Low)	(Mid)	(High)
Frequency	1850.7	1880	1909.3	1851.5	1880	1908.5	1852.5	1880	1907.5
(MHz)									
Conducted Power (dBm)	23.44	23.36	23.19	23.34	23.27	23.10	23.19	23.27	23.32
Conducted Power (Watts)	0.2208	0.2168	0.2084	0.2158	0.2123	0.2042	0.2084	0.2123	0.2148
EIRP(dBm)	17.44	17.36	17.19	17.34	17.27	17.10	17.19	17.27	17.32
EIRP(Watts)	0.0555	0.0545	0.0524	0.0542	0.0533	0.0513	0.0524	0.0533	0.0540

LTE Band 2 (GT - LC = -6.0 dB) QPSK									
Bandwidth	10M			15M			20M		
Channel	18650	18900	19150	18675	18900	19125	18650	18900	19100
	(Low)	(Mid)	(High)	(Low)	(Mid)	(High)	(Low)	(Mid)	(High)
Frequency	1855	1880	1905	1857.5	1880	1902.5	1860	1880	1900
(MHz)									
Conducted Power (dBm)	23.37	23.23	23.04	23.18	23.34	23.09	23.33	23.45	23.21
Conducted Power (Watts)	0.2173	0.2104	0.2014	0.2078	0.2156	0.2036	0.2153	0.2213	0.2094
EIRP(dBm)	17.37	17.23	17.04	17.18	17.34	17.09	17.33	17.45	17.21
EIRP(Watts)	0.0546	0.0528	0.0506	0.0522	0.0542	0.0511	0.0541	0.0556	0.0526



LTE Band 2 (GT - LC = -6.0 dB) 16QAM									
Bandwidth	1.4M			3M			5M		
Channel	18607	18900	19193	18615	18900	19185	18625	18900	19175
	(Low)	(Mid)	(High)	(Low)	(Mid)	(High)	(Low)	(Mid)	(High)
Frequency (MHz)	1850.7	1880	1909.3	1851.5	1880	1908.5	1852.5	1880	1907.5
Conducted Power (dBm)	22.15	22.45	22.17	22.32	21.96	21.99	22.12	21.95	21.80
Conducted Power (Watts)	0.1641	0.1758	0.1648	0.1706	0.1570	0.1581	0.1629	0.1567	0.1514
EIRP(dBm)	16.15	16.45	16.17	16.32	15.96	15.99	16.12	15.95	15.80
EIRP(Watts)	0.0412	0.0442	0.0414	0.0429	0.0394	0.0397	0.0409	0.0394	0.0380

LTE Band 2 (GT - LC = -6.0 dB) 16QAM									
Bandwidth	10M			15M			20M		
Channel	18650	18900	19150	18675	18900	19125	18650	18900	19100
	(Low)	(Mid)	(High)	(Low)	(Mid)	(High)	(Low)	(Mid)	(High)
Frequency (MHz)	1855	1880	1905	1857.5	1880	1902.5	1860	1880	1900
Conducted Power (dBm)	22.23	22.03	21.99	22.05	21.82	22.00	22.41	22.25	22.32
Conducted Power (Watts)	0.1671	0.1596	0.1581	0.1602	0.1519	0.1584	0.1742	0.1679	0.1706
EIRP(dBm)	16.23	16.03	15.99	16.05	15.82	16.00	16.41	16.25	16.32
EIRP(Watts)	0.0420	0.0401	0.0397	0.0402	0.0382	0.0398	0.0438	0.0422	0.0429



LTE Band 4 (GT - LC = -6.0 dB) QPSK									
Bandwidth	1.4M			3M			5M		
Channel	19957	20175	20393	19965	20175	20385	19975	20175	20375
	(Low)	(Mid)	(High)	(Low)	(Mid)	(High)	(Low)	(Mid)	(High)
Frequency (MHz)	1710.7	1732.5	1754.3	1711.5	1732.5	1753.5	1712.5	1732.5	1752.5
Conducted Power (dBm)	22.80	22.77	22.71	22.58	22.70	22.74	22.54	22.66	22.75
Conducted Power (Watts)	0.1905	0.1892	0.1866	0.1811	0.1862	0.1879	0.1795	0.1845	0.1884
EIRP(dBm)	16.80	16.77	16.71	16.58	16.70	16.74	16.54	16.66	16.75
EIRP(Watts)	0.0479	0.0475	0.0469	0.0455	0.0468	0.0472	0.0451	0.0463	0.0473

LTE Band 4 (GT - LC = -6.0 dB) QPSK									
Bandwidth	10M			15M			20M		
Channel	20000	20175	20350	20025	20175	20325	20050	20175	20300
	(Low)	(Mid)	(High)	(Low)	(Mid)	(High)	(Low)	(Mid)	(High)
Frequency (MHz)	1715	1732.5	1750	1717.5	1732.5	1747.5	1720	1732.5	1745
Conducted Power (dBm)	22.72	22.77	22.73	22.69	22.58	22.71	22.75	22.98	22.77
Conducted Power (Watts)	0.1871	0.1892	0.1875	0.1858	0.1811	0.1866	0.1884	0.1986	0.1892
EIRP(dBm)	16.72	16.77	16.73	16.69	16.58	16.71	16.75	16.98	16.77
EIRP(Watts)	0.0470	0.0475	0.0471	0.0467	0.0455	0.0469	0.0473	0.0499	0.0475



LTE Band 4 (GT - LC = -6.0 dB) 16QAM									
Bandwidth	1.4M			3M			5M		
Channel	19957	20175	20393	19965	20175	20385	19975	20175	20375
	(Low)	(Mid)	(High)	(Low)	(Mid)	(High)	(Low)	(Mid)	(High)
Frequency (MHz)	1710.7	1732.5	1754.3	1711.5	1732.5	1753.5	1712.5	1732.5	1752.5
Conducted Power (dBm)	21.79	21.97	22.06	21.60	21.77	22.02	21.57	21.91	21.75
Conducted Power (Watts)	0.1510	0.1574	0.1607	0.1445	0.1503	0.1592	0.1435	0.1552	0.1496
EIRP(dBm)	15.79	15.97	16.06	15.60	15.77	16.02	15.57	15.91	15.75
EIRP(Watts)	0.0379	0.0395	0.0404	0.0363	0.0378	0.0400	0.0361	0.0390	0.0376

LTE Band 4 (GT - LC = -6.0 dB) 16QAM									
Bandwidth	10M			15M			20M		
Channel	20000	20175	20350	20025	20175	20325	20050	20175	20300
	(Low)	(Mid)	(High)	(Low)	(Mid)	(High)	(Low)	(Mid)	(High)
Frequency (MHz)	1715	1732.5	1750	1717.5	1732.5	1747.5	1720	1732.5	1745
Conducted Power (dBm)	21.55	21.76	21.94	21.72	21.64	21.93	21.69	21.69	22.05
Conducted Power (Watts)	0.1429	0.1500	0.1563	0.1486	0.1459	0.1560	0.1476	0.1476	0.1603
EIRP(dBm)	15.55	15.76	15.94	15.72	15.64	15.93	15.69	15.69	16.05
EIRP(Watts)	0.0359	0.0377	0.0393	0.0373	0.0366	0.0392	0.0371	0.0371	0.0403



LTE Band 5 (GT - LC = -7.0 dB) QPSK									
Bandwidth	1.4M			3M			5M		
Channel	20407	20525	20643	20415	20525	20635	20425	20525	20625
	(Low)	(Mid)	(High)	(Low)	(Mid)	(High)	(Low)	(Mid)	(High)
Frequency (MHz)	824.7	836.5	848.3	825.5	836.5	847.5	826.5	836.5	846.5
Conducted Power (dBm)	23.31	23.31	23.28	22.40	22.34	22.34	23.39	23.10	23.20
Conducted Power (Watts)	0.2143	0.2143	0.2128	0.1738	0.1714	0.1714	0.2183	0.2042	0.2089
ERP(dBm)	14.16	14.16	14.13	13.25	13.19	13.19	14.24	13.95	14.05
ERP(Watts)	0.0261	0.0261	0.0259	0.0211	0.0208	0.0208	0.0265	0.0248	0.0254

LTE Band 5 (GT - LC = -7.0 dB) QPSK			
Bandwidth	10M		
Channel	20450	20525	20600
	(Low)	(Mid)	(High)
Frequency (MHz)	829	836.5	844
Conducted Power (dBm)	23.34	23.41	23.34
Conducted Power (Watts)	0.2158	0.2193	0.2158
ERP(dBm)	14.19	14.26	14.19
ERP(Watts)	0.0262	0.0267	0.0262



LTE Band 5 (GT - LC = -7.0 dB) 16QAM									
Bandwidth	1.4M			3M			5M		
Channel	20407	20525	20643	20415	20525	20635	20425	20525	20625
	(Low)	(Mid)	(High)	(Low)	(Mid)	(High)	(Low)	(Mid)	(High)
Frequency (MHz)	824.7	836.5	848.3	825.5	836.5	847.5	826.5	836.5	846.5
Conducted Power (dBm)	22.37	22.14	22.09	22.43	22.18	22.37	22.48	22.24	22.29
Conducted Power (Watts)	0.1726	0.1637	0.1618	0.1750	0.1652	0.1726	0.1770	0.1675	0.1694
ERP(dBm)	13.22	12.99	12.94	13.28	13.03	13.22	13.33	13.09	13.14
ERP(Watts)	0.0210	0.0199	0.0197	0.0213	0.0201	0.0210	0.0215	0.0204	0.0206

LTE Band 5 (GT - LC = -7.0 dB) 16QAM			
Bandwidth	10M		
Channel	20450	20525	20600
	(Low)	(Mid)	(High)
Frequency (MHz)	829	836.5	844
Conducted Power (dBm)	22.47	22.32	22.50
Conducted Power (Watts)	0.1766	0.1706	0.1778
ERP(dBm)	13.32	13.17	13.35
ERP(Watts)	0.0215	0.0207	0.0216



LTE Band 7 (GT - LC = -6.0 dB) QPSK			
Bandwidth	5M		
Channel	20775	21100	21425
	(Low)	(Mid)	(High)
Frequency	2502.5	2535	2567.5
(MHz)			
Conducted Power (dBm)	22.58	22.57	22.51
Conducted Power (Watts)	0.1811	0.1807	0.1782
EIRP(dBm)	16.58	16.57	16.51
EIRP(Watts)	0.0455	0.0454	0.0448

LTE Band 7 (GT - LC = -6.0 dB) QPSK									
Bandwidth	10M			15M			20M		
Channel	20800	21100	21400	20825	21100	21375	20850	21100	21350
	(Low)	(Mid)	(High)	(Low)	(Mid)	(High)	(Low)	(Mid)	(High)
Frequency	2505	2535	2565	2507.5	2535	2562.5	2510	2535	2560
(MHz)									
Conducted Power (dBm)	22.59	22.58	22.42	22.57	22.62	22.61	22.54	22.63	22.62
Conducted Power (Watts)	0.1816	0.1811	0.1746	0.1807	0.1828	0.1824	0.1795	0.1832	0.1828
EIRP(dBm)	16.59	16.58	16.42	16.57	16.62	16.61	16.54	16.63	16.62
EIRP(Watts)	0.0456	0.0455	0.0439	0.0454	0.0459	0.0458	0.0451	0.0460	0.0459



LTE Band 7 (GT - LC = -6.0 dB) 16QAM			
Bandwidth	5M		
Channel	20775	21100	21425
	(Low)	(Mid)	(High)
Frequency	2502.5	2535	2567.5
(MHz)			
Conducted Power (dBm)	21.93	21.94	21.65
Conducted Power (Watts)	0.1560	0.1563	0.1462
EIRP(dBm)	15.93	15.94	15.65
EIRP(Watts)	0.0392	0.0393	0.0367

LTE Band 7 (GT - LC = -6.0 dB) 16QAM									
Bandwidth	10M			15M			20M		
Channel	20800	21100	21400	20825	21100	21375	20850	21100	21350
	(Low)	(Mid)	(High)	(Low)	(Mid)	(High)	(Low)	(Mid)	(High)
Frequency	2505	2535	2565	2507.5	2535	2562.5	2510	2535	2560
(MHz)									
Conducted Power (dBm)	21.83	21.72	21.51	21.95	21.93	21.96	21.64	21.91	21.54
Conducted Power (Watts)	0.1524	0.1486	0.1416	0.1567	0.1560	0.1570	0.1459	0.1552	0.1426
EIRP(dBm)	15.83	15.72	15.51	15.95	15.93	15.96	15.64	15.91	15.54
EIRP(Watts)	0.0383	0.0373	0.0356	0.0394	0.0392	0.0394	0.0366	0.0390	0.0358





LTE Band 12 (GT - LC = -7.0 dB) QPSK									
Bandwidth	1.4M			3M			5M		
Channel	23017	23095	23173	23025	23095	23165	23035	23095	23155
	(Low)	(Mid)	(High)	(Low)	(Mid)	(High)	(Low)	(Mid)	(High)
Frequency (MHz)	699.7	707.5	715.3	700.5	707.5	714.5	701.5	707.5	713.5
Conducted Power (dBm)	23.25	23.34	23.37	23.23	23.35	23.27	23.21	23.21	23.37
Conducted Power (Watts)	0.2113	0.2158	0.2173	0.2104	0.2163	0.2123	0.2094	0.2094	0.2173
ERP(dBm)	14.10	14.19	14.22	14.08	14.20	14.12	14.06	14.06	14.22
ERP(Watts)	0.0257	0.0262	0.0264	0.0256	0.0263	0.0258	0.0255	0.0255	0.0264

LTE Band 12 (GT - LC = -7.0 dB) QPSK			
Bandwidth	10M		
Channel	23060	23095	23130
	(Low)	(Mid)	(High)
Frequency (MHz)	704	707.5	711
Conducted Power (dBm)	23.23	23.38	23.22
Conducted Power (Watts)	0.2104	0.2178	0.2099
ERP(dBm)	14.08	14.23	14.07
ERP(Watts)	0.0256	0.0265	0.0255



LTE Band 12 (GT - LC = -7.0 dB) 16QAM									
Bandwidth	1.4M			3M			5M		
Channel	23017	23095	23173	23025	23095	23165	23035	23095	23155
	(Low)	(Mid)	(High)	(Low)	(Mid)	(High)	(Low)	(Mid)	(High)
Frequency (MHz)	699.7	707.5	715.3	700.5	707.5	714.5	701.5	707.5	713.5
Conducted Power (dBm)	22.27	22.47	22.27	22.34	22.33	22.43	22.20	22.24	22.10
Conducted Power (Watts)	0.1687	0.1766	0.1687	0.1714	0.1710	0.1750	0.1660	0.1675	0.1622
ERP(dBm)	13.12	13.32	13.12	13.19	13.18	13.28	13.05	13.09	12.95
ERP(Watts)	0.0205	0.0215	0.0205	0.0208	0.0208	0.0213	0.0202	0.0204	0.0197

LTE Band 12 (GT - LC = -7.0 dB) 16QAM			
Bandwidth	10M		
Channel	23060	23095	23130
	(Low)	(Mid)	(High)
Frequency (MHz)	704	707.5	711
Conducted Power (dBm)	22.10	21.76	22.22
Conducted Power (Watts)	0.1622	0.1500	0.1667
ERP(dBm)	12.95	12.61	13.07
ERP(Watts)	0.0197	0.0182	0.0203



LTE Band 13 (GT - LC = -7.5 dB) QPSK						
Bandwidth	5M			10M		
Channel	23205	23230	23255	23230		
	(Low)	(Mid)	(High)	-	(Mid)	-
Frequency	779.5	782	784.5	-	782	-
(MHz)						
Conducted Power (dBm)	23.10	23.39	23.13	-	23.40	-
Conducted Power (Watts)	0.2042	0.2183	0.2056	-	0.2188	-
ERP(dBm)	13.45	13.74	13.48	-	13.75	-
ERP(Watts)	0.0221	0.0237	0.0223	-	0.0237	-

LTE Band 13 (GT - LC = -7.5 dB) 16QAM						
Bandwidth	5M			10M		
Channel	23205	23230	23255	23230		
	(Low)	(Mid)	(High)	-	(Mid)	-
Frequency	779.5	782	784.5	-	782	-
(MHz)						
Conducted Power (dBm)	22.47	22.34	22.02	-	22.18	-
Conducted Power (Watts)	0.1766	0.1714	0.1592	-	0.1652	-
ERP(dBm)	12.82	12.69	12.37	-	12.53	-
ERP(Watts)	0.0191	0.0186	0.0173	-	0.0179	-



LTE Band 17 (GT - LC = -8.0 dB) QPSK						
Bandwidth	5M			10M		
Channel	23755	23790	23825	23780	23790	23800
	(Low)	(Mid)	(High)	(Low)	(Mid)	(High)
Frequency	706.5	710	713.5	709	710	711
(MHz)						
Conducted Power (dBm)	23.21	23.22	23.21	23.29	23.30	23.28
Conducted Power (Watts)	0.2094	0.2099	0.2094	0.2133	0.2138	0.2128
ERP(dBm)	13.06	13.07	13.06	13.14	13.15	13.13
ERP(Watts)	0.0202	0.0203	0.0202	0.0206	0.0207	0.0206

LTE Band 17 (GT - LC = -8.0 dB) 16QAM						
Bandwidth	5M			10M		
Channel	23755	23790	23825	23780	23790	23800
	(Low)	(Mid)	(High)	(Low)	(Mid)	(High)
Frequency	706.5	710	713.5	709	710	711
(MHz)						
Conducted Power (dBm)	22.26	22.17	22.21	22.33	22.21	22.36
Conducted Power (Watts)	0.1683	0.1648	0.1663	0.1710	0.1663	0.1722
ERP(dBm)	12.11	12.02	12.06	12.18	12.06	12.21
ERP(Watts)	0.0163	0.0159	0.0161	0.0165	0.0161	0.0166



LTE Band 66 (GT - LC = -6.0 dB) QPSK									
Bandwidth	1.4M			3M			5M		
Channel	131979	132322	132665	131987	132322	132657	131997	132322	132647
	(Low)	(Mid)	(High)	(Low)	(Mid)	(High)	(Low)	(Mid)	(High)
Frequency (MHz)	1710.7	1745	1779.3	1711.5	1745	1778.5	1712.5	1745	1777.5
Conducted Power (dBm)	22.68	22.69	22.64	22.38	22.68	22.31	22.46	22.69	22.63
Conducted Power (Watts)	0.1854	0.1858	0.1837	0.1730	0.1854	0.1702	0.1762	0.1858	0.1832
EIRP(dBm)	16.68	16.69	16.64	16.38	16.68	16.31	16.46	16.69	16.63
EIRP(Watts)	0.0466	0.0467	0.0461	0.0435	0.0466	0.0428	0.0443	0.0467	0.0460

LTE Band 66 (GT - LC = -6.0 dB) QPSK									
Bandwidth	10M			15M			20M		
Channel	132022	132322	132622	132047	132322	132597	132072	132322	132572
	(Low)	(Mid)	(High)	(Low)	(Mid)	(High)	(Low)	(Mid)	(Mid)
Frequency (MHz)	1715	1745	1775	1717.5	1745	1772.5	1720	1745	1770
Conducted Power (dBm)	22.61	22.69	22.66	22.69	22.65	22.64	22.42	22.80	22.62
Conducted Power (Watts)	0.1824	0.1858	0.1845	0.1858	0.1841	0.1837	0.1746	0.1905	0.1828
EIRP(dBm)	16.61	16.69	16.66	16.69	16.65	16.64	16.42	16.80	16.62
EIRP(Watts)	0.0458	0.0467	0.0463	0.0467	0.0462	0.0461	0.0439	0.0479	0.0459



LTE Band 66 (GT - LC = -6.0 dB) 16QAM									
Bandwidth	1.4M			3M			5M		
Channel	131979	132322	132665	131987	132322	132657	131997	132322	132647
	(Low)	(Mid)	(High)	(Low)	(Mid)	(High)	(Low)	(Mid)	(High)
Frequency (MHz)	1710.7	1745	1779.3	1711.5	1745	1778.5	1712.5	1745	1777.5
Conducted Power (dBm)	21.61	22.11	21.76	21.54	21.99	21.61	21.36	21.53	21.52
Conducted Power (Watts)	0.1449	0.1626	0.1500	0.1426	0.1581	0.1449	0.1368	0.1422	0.1419
EIRP(dBm)	15.61	16.11	15.76	15.54	15.99	15.61	15.36	15.53	15.52
EIRP(Watts)	0.0364	0.0408	0.0377	0.0358	0.0397	0.0364	0.0344	0.0357	0.0356

LTE Band 66 (GT - LC = -6.0 dB) 16QAM									
Bandwidth	10M			15M			20M		
Channel	132022	132322	132622	132047	132322	132597	132072	132322	132572
	(Low)	(Mid)	(High)	(Low)	(Mid)	(High)	(Low)	(Mid)	(Mid)
Frequency (MHz)	1715	1745	1775	1717.5	1745	1772.5	1720	1745	1770
Conducted Power (dBm)	21.51	21.87	21.58	21.90	21.90	21.43	21.44	21.81	21.74
Conducted Power (Watts)	0.1416	0.1538	0.1439	0.1549	0.1549	0.1390	0.1393	0.1517	0.1493
EIRP(dBm)	15.51	15.87	15.58	15.90	15.90	15.43	15.44	15.81	15.74
EIRP(Watts)	0.0356	0.0386	0.0361	0.0389	0.0389	0.0349	0.0350	0.0381	0.0375



## LTE Band 2

### Peak-to-Average Ratio

Mode	LTE Band 2 / 20MHz				
Mod.	QPSK		16QAM		Limit: 13dB
RB Size	1RB	Full RB	1RB	Full RB	Result
Lowest CH	4.64	4.43	4.46	5.42	<b>PASS</b>
Middle CH	4.29	4.90	4.99	5.97	
Highest CH	3.86	4.72	5.04	5.83	



LTE Band 2 / 20MHz / QPSK

Lowest Channel / 1RB

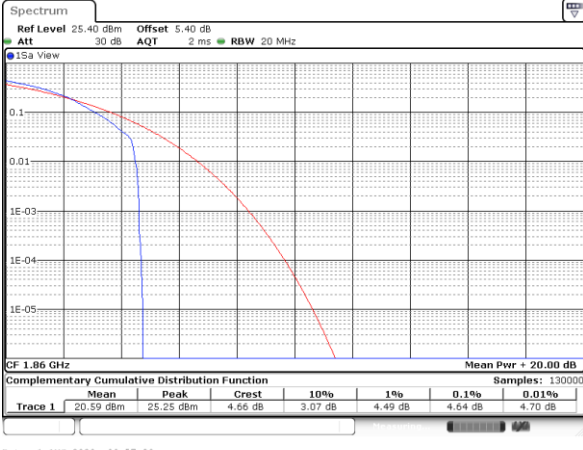

Date: 1.AUG.2020 00:57:30

Lowest Channel / Full RB

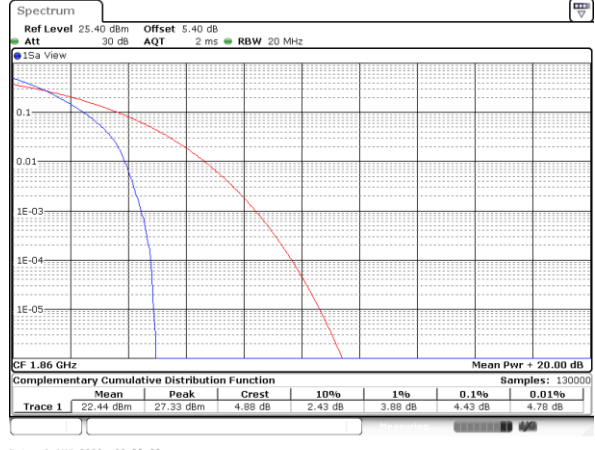

Date: 1.AUG.2020 00:55:33

Middle Channel / 1RB

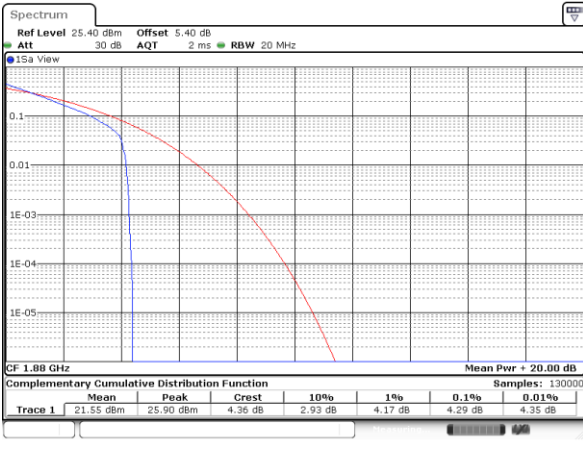

Date: 1.AUG.2020 01:00:52

Middle Channel / Full RB

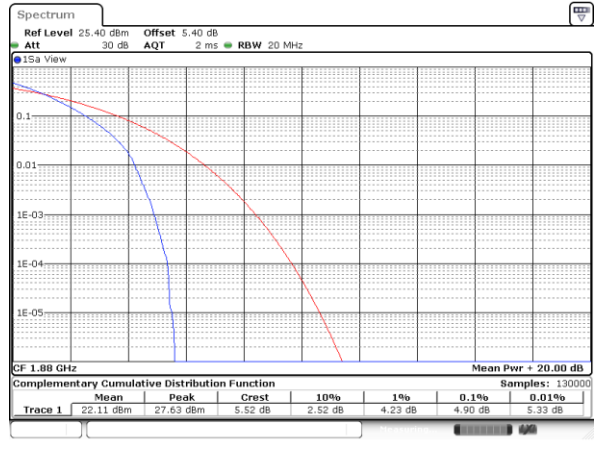

Date: 1.AUG.2020 01:00:25

Highest Channel / 1RB

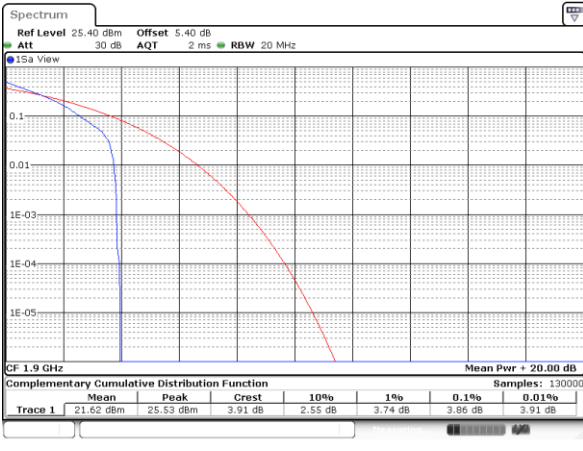

Date: 1.AUG.2020 01:02:50

Highest Channel / Full RB

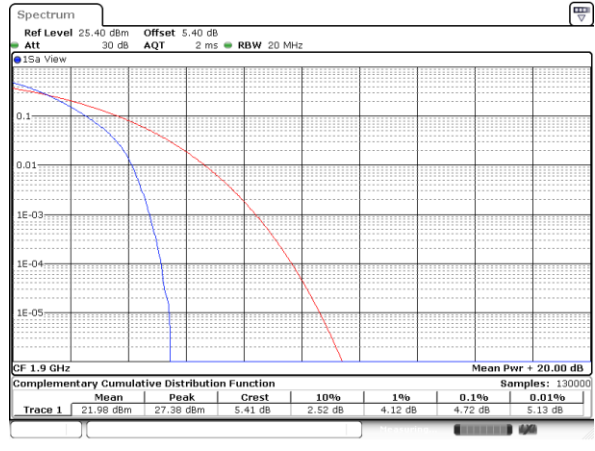

Date: 1.AUG.2020 01:03:30





LTE Band 2 / 20MHz / 16QAM

Lowest Channel / 1RB

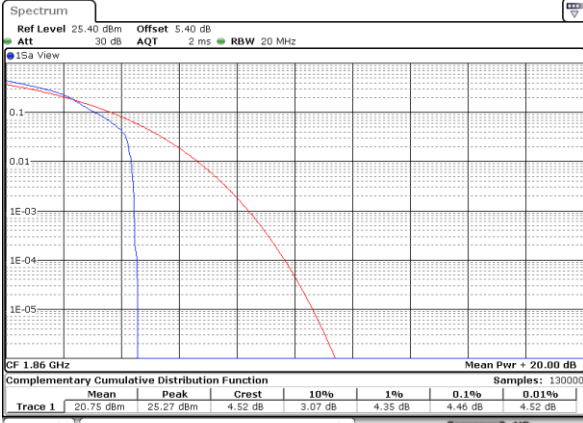

Date: 1.AUG.2020 00:57:19

Lowest Channel / Full RB

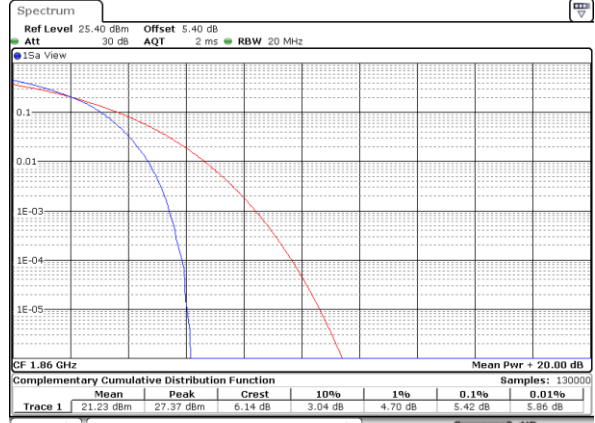

Date: 1.AUG.2020 00:55:57

Middle Channel / 1RB

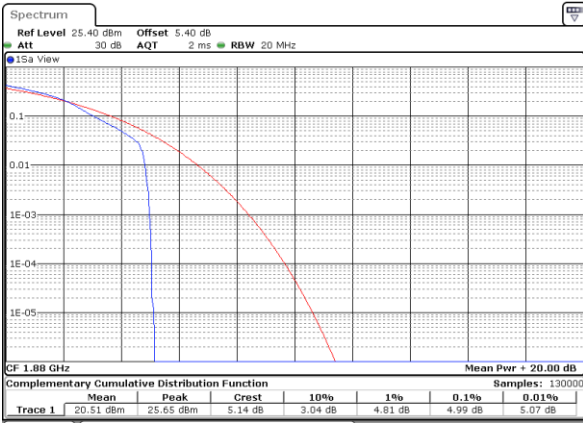

Date: 1.AUG.2020 01:01:06

Middle Channel / Full RB

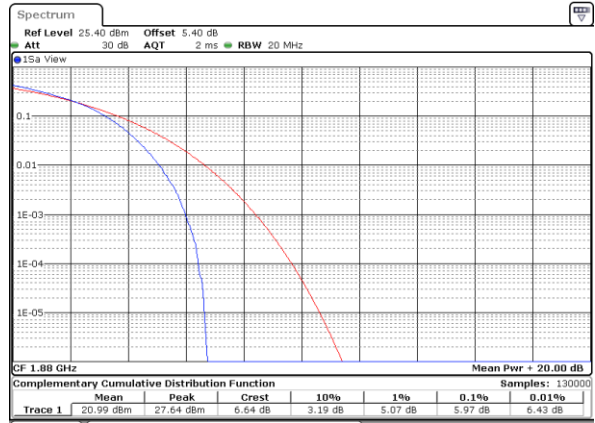

Date: 1.AUG.2020 01:00:11

Highest Channel / 1RB

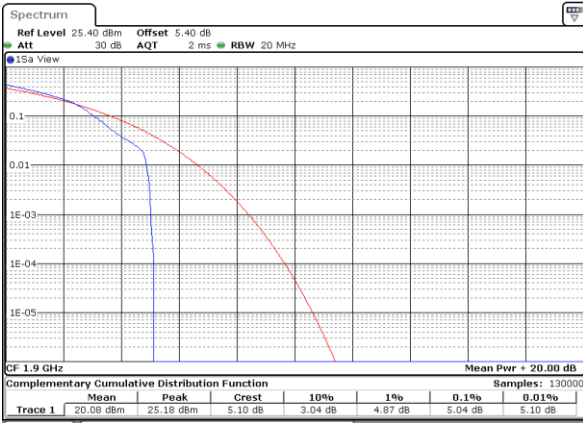

Date: 1.AUG.2020 01:02:36

Highest Channel / Full RB

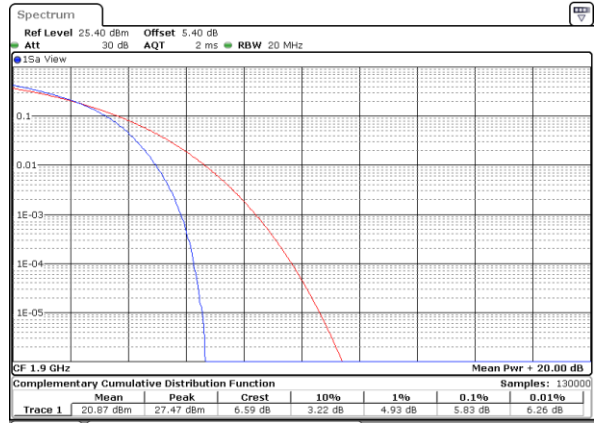

Date: 1.AUG.2020 01:00:52



**26dB Bandwidth**

Mode	LTE Band 2 : 26dB BW(MHz)											
	1.4MHz		3MHz		5MHz		10MHz		15MHz		20MHz	
BW	QPSK	16QAM	QPSK	16QAM	QPSK	16QAM	QPSK	16QAM	QPSK	16QAM	QPSK	16QAM
Lowest CH	1.25	1.30	3.00	3.01	4.98	4.90	9.87	9.95	14.33	14.39	20.30	20.14
Middle CH	1.31	1.25	2.98	2.96	4.87	4.86	9.89	9.75	14.33	14.48	20.26	20.22
Highest CH	1.26	1.29	3.05	2.97	4.88	4.82	9.81	9.69	14.12	14.45	20.26	20.14



LTE Band 2

Lowest Channel / 1.4MHz / QPSK

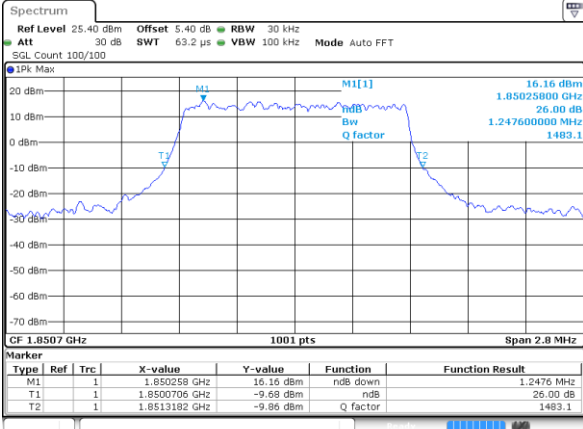

Date: 31 JUL 2020 23:16:42

Lowest Channel / 1.4MHz / 16QAM

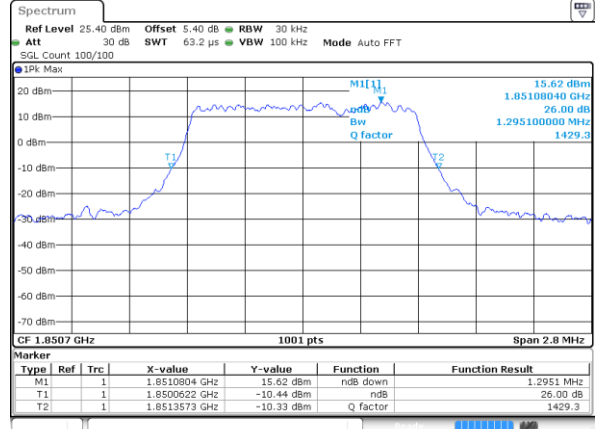

Date: 31 JUL 2020 23:16:52

Middle Channel / 1.4MHz / QPSK

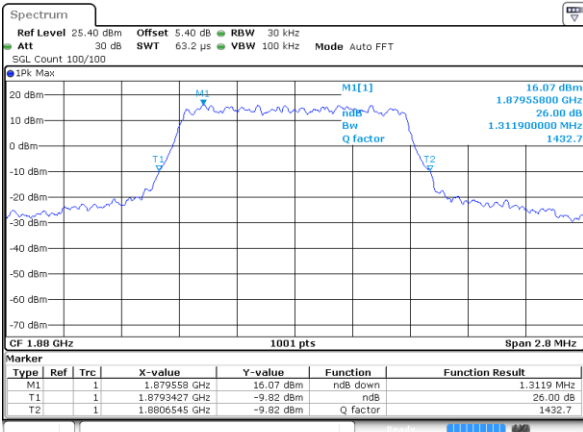

Date: 31 JUL 2020 23:23:44

Middle Channel / 1.4MHz / 16QAM

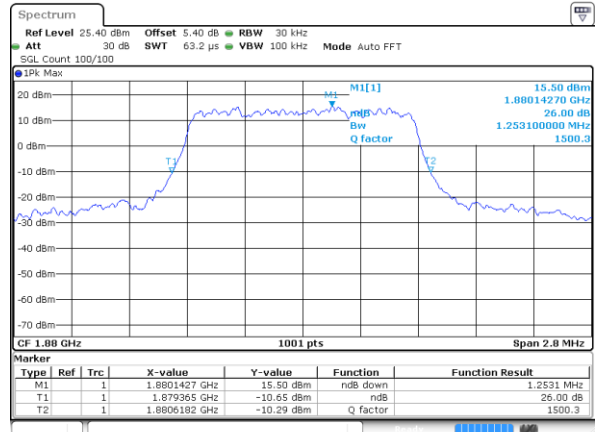

Date: 31 JUL 2020 23:23:54

Highest Channel / 1.4MHz / QPSK

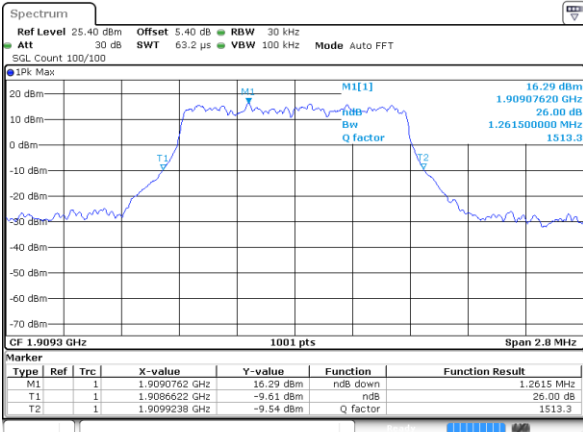

Date: 31 JUL 2020 23:26:12

Highest Channel / 1.4MHz / 16QAM

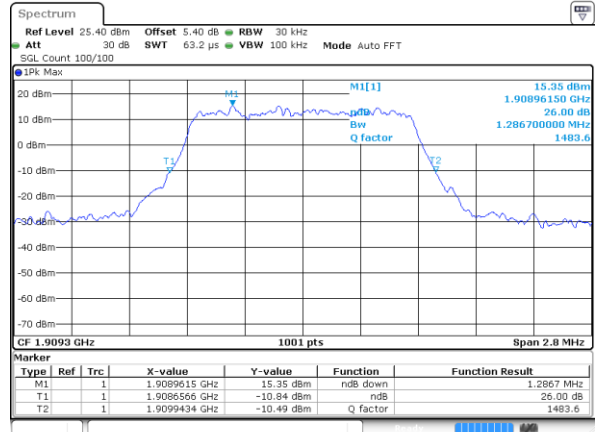

Date: 31 JUL 2020 23:26:22



LTE Band 2

Lowest Channel / 3MHz / QPSK

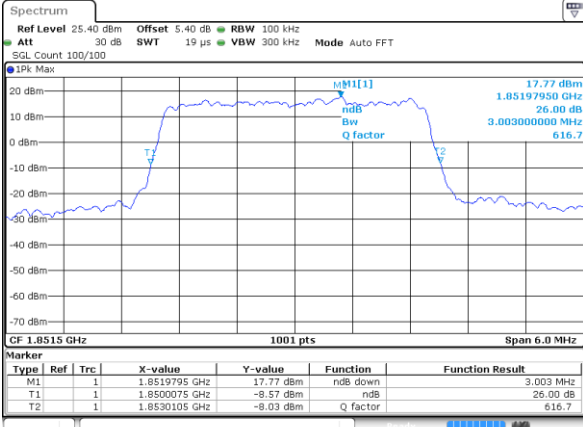

Date: 31 JUL 2020 23:33:15

Lowest Channel / 3MHz / 16QAM

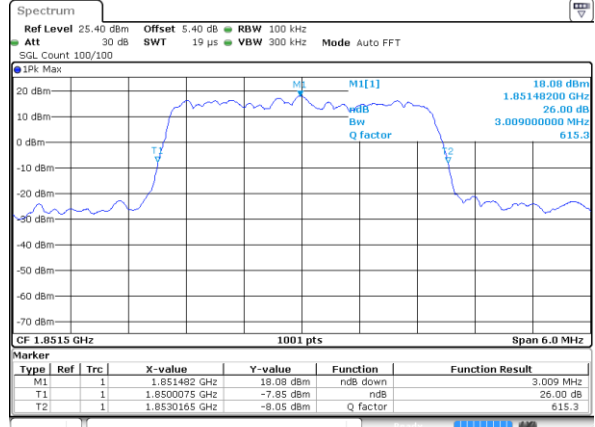

Date: 31 JUL 2020 23:33:25

Middle Channel / 3MHz / QPSK

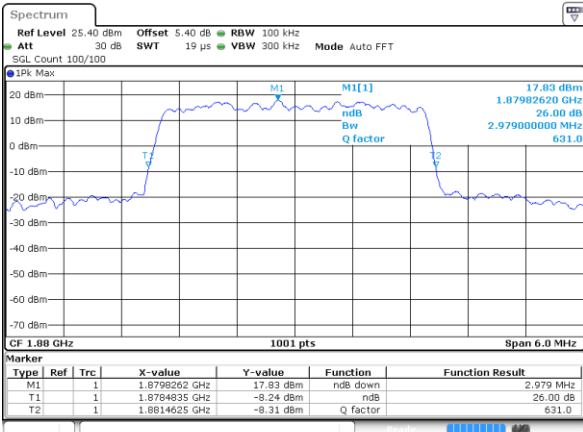

Date: 31 JUL 2020 23:40:18

Middle Channel / 3MHz / 16QAM

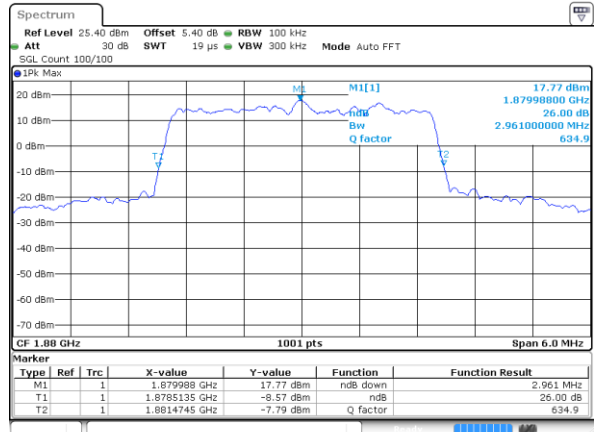

Date: 31 JUL 2020 23:40:28

Highest Channel / 3MHz / QPSK

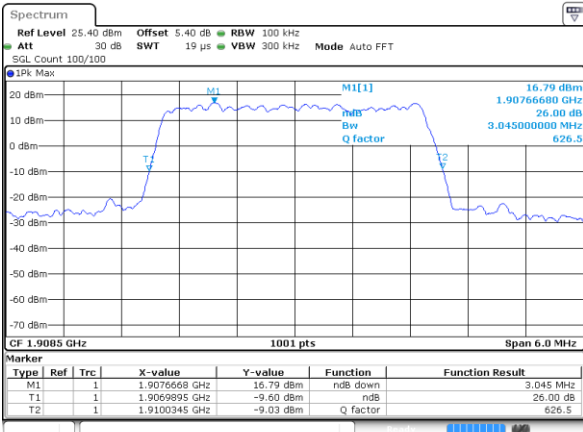

Date: 31 JUL 2020 23:42:46

Highest Channel / 3MHz / 16QAM

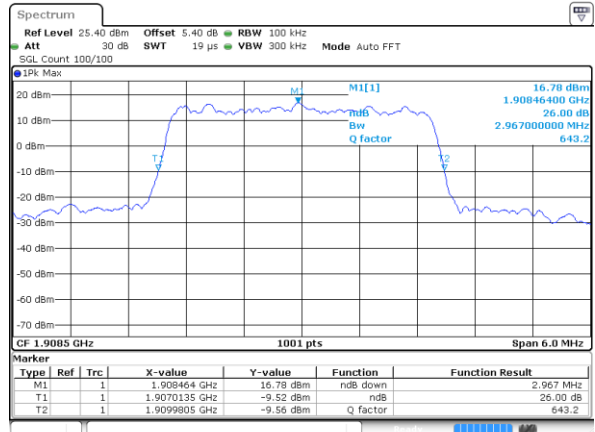

Date: 31 JUL 2020 23:42:56



LTE Band 2

Lowest Channel / 5MHz / QPSK

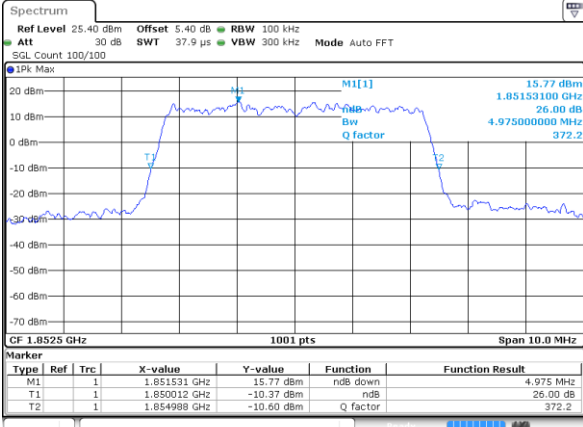

Date: 31 JUL 2020 23:50:00

Lowest Channel / 5MHz / 16QAM

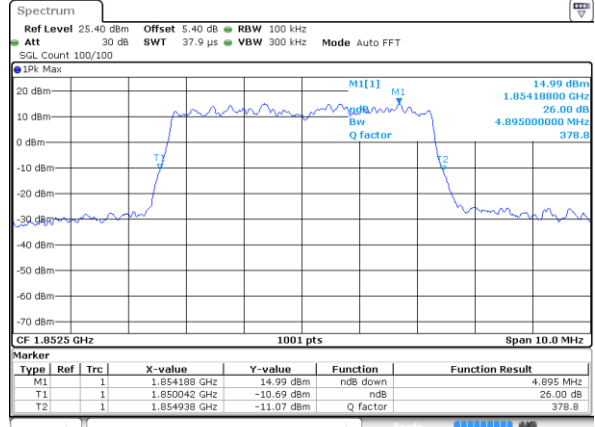

Date: 31 JUL 2020 23:50:11

Middle Channel / 5MHz / QPSK

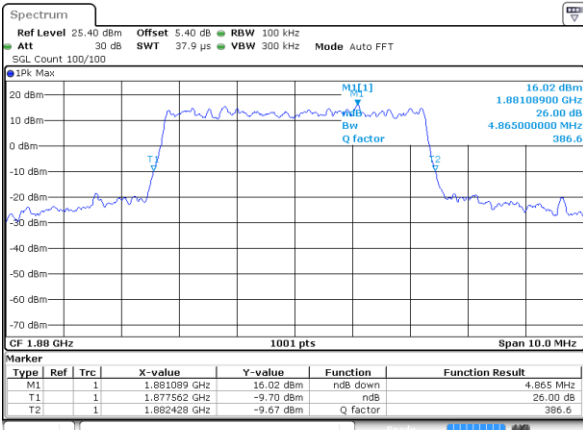

Date: 31 JUL 2020 23:57:04

Middle Channel / 5MHz / 16QAM

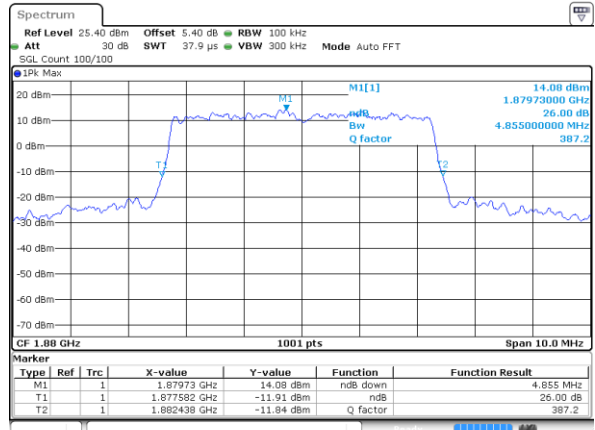

Date: 31 JUL 2020 23:57:13

Highest Channel / 5MHz / QPSK

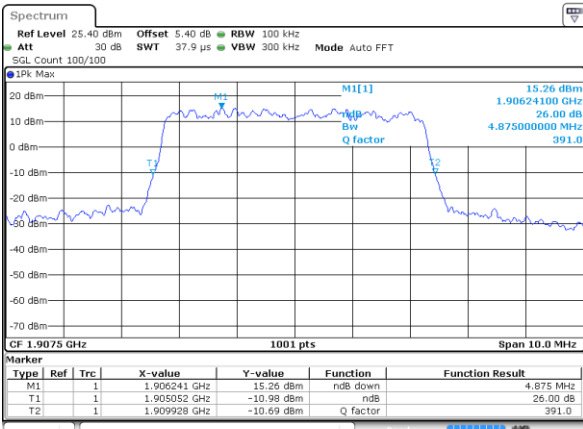

Date: 31 JUL 2020 23:59:31

Highest Channel / 5MHz / 16QAM

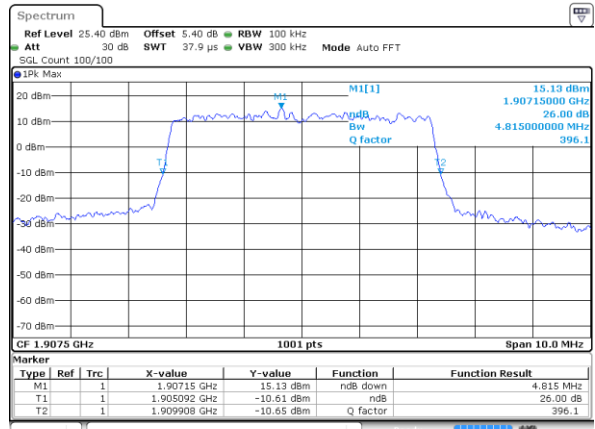

Date: 31 JUL 2020 23:59:41



LTE Band 2

Lowest Channel / 10MHz / QPSK

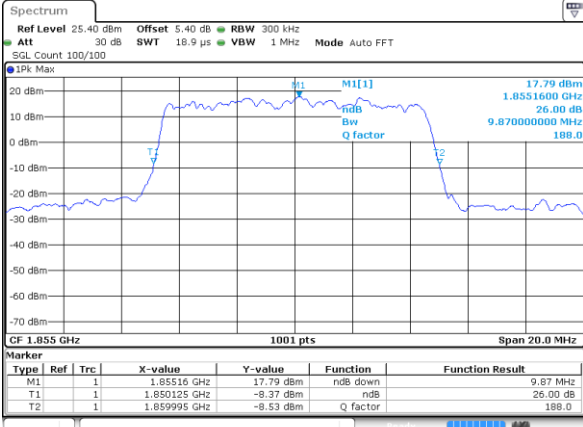

Date: 1 AUG 2020 00:06:34

Lowest Channel / 10MHz / 16QAM

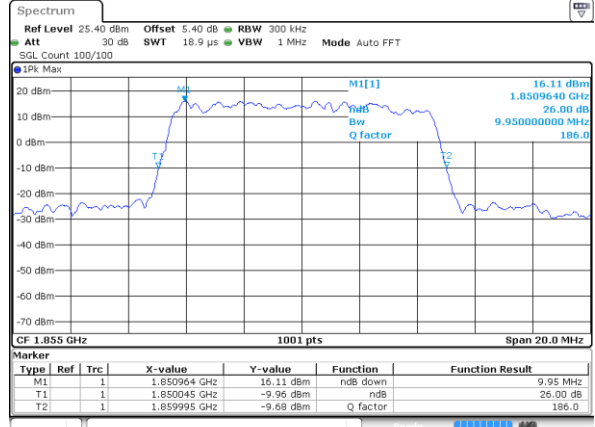

Date: 1 AUG 2020 00:06:44

Middle Channel / 10MHz / QPSK

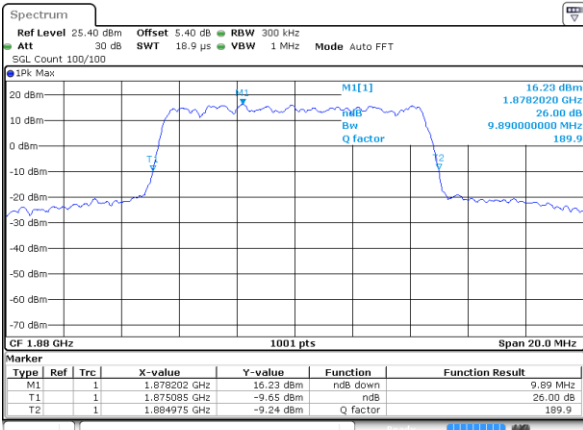

Date: 1 AUG 2020 00:13:37

Middle Channel / 10MHz / 16QAM

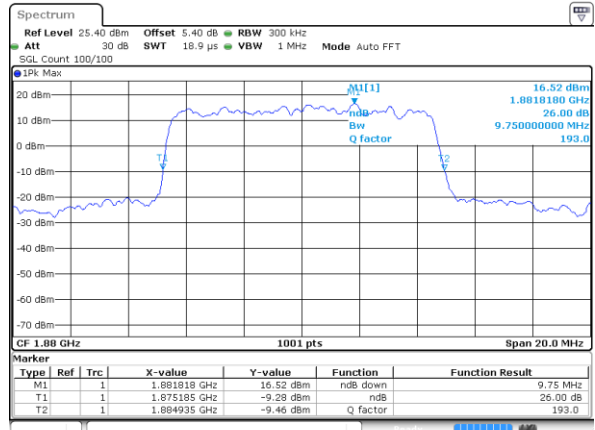

Date: 1 AUG 2020 00:13:47

Highest Channel / 10MHz / QPSK

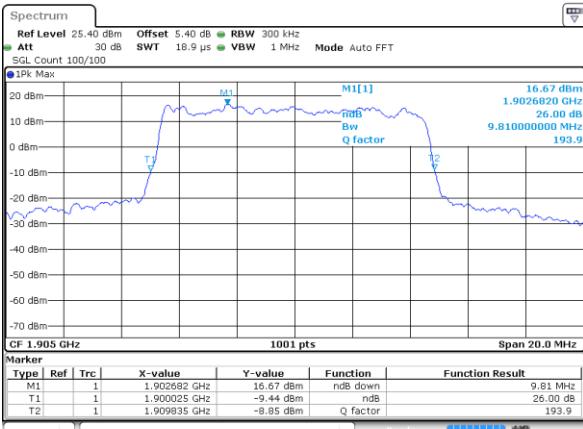

Date: 1 AUG 2020 00:16:05

Highest Channel / 10MHz / 16QAM

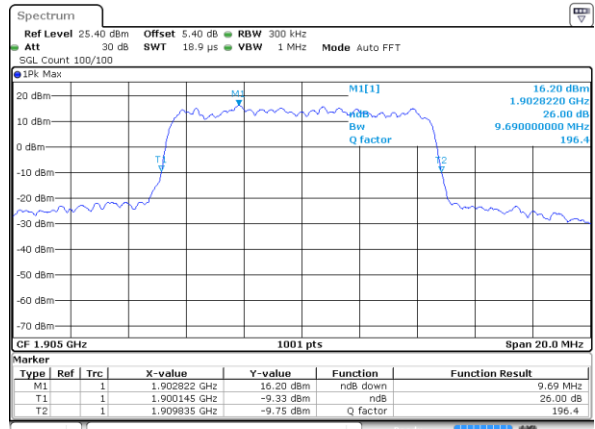

Date: 1 AUG 2020 00:16:15



LTE Band 2

Lowest Channel / 15MHz / QPSK

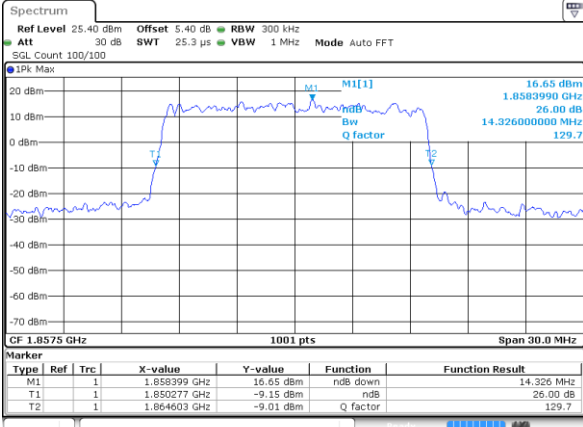

Date: 1 AUG 2020 00:23:08

Lowest Channel / 15MHz / 16QAM

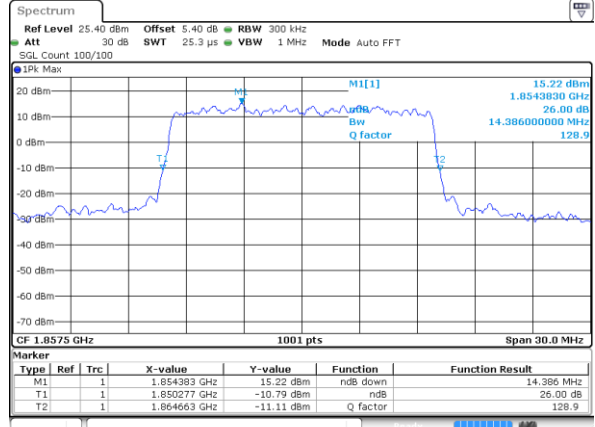

Date: 1 AUG 2020 00:23:18

Middle Channel / 15MHz / QPSK

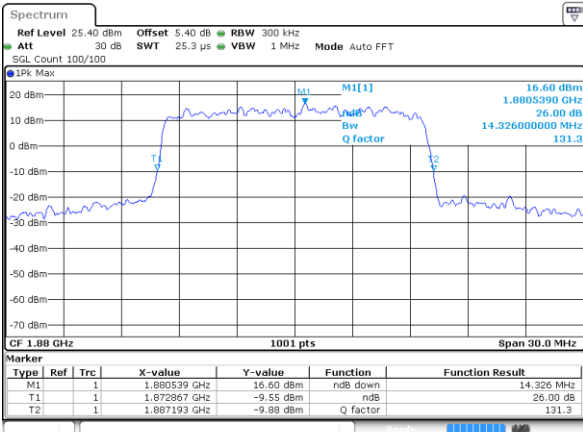

Date: 1 AUG 2020 00:30:11

Middle Channel / 15MHz / 16QAM

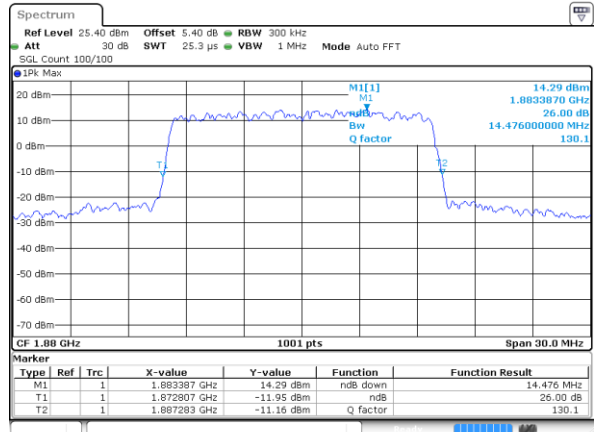

Date: 1 AUG 2020 00:30:21

Highest Channel / 15MHz / QPSK

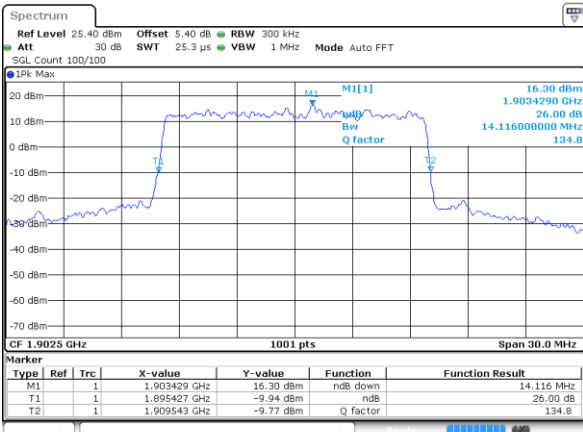

Date: 1 AUG 2020 00:32:39

Highest Channel / 15MHz / 16QAM

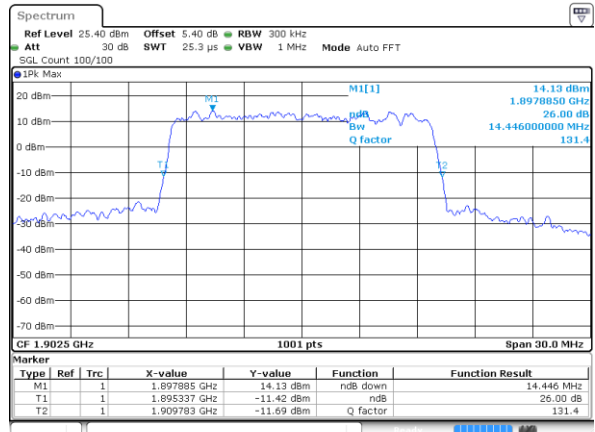

Date: 1 AUG 2020 00:32:49



LTE Band 2

Lowest Channel / 20MHz / QPSK

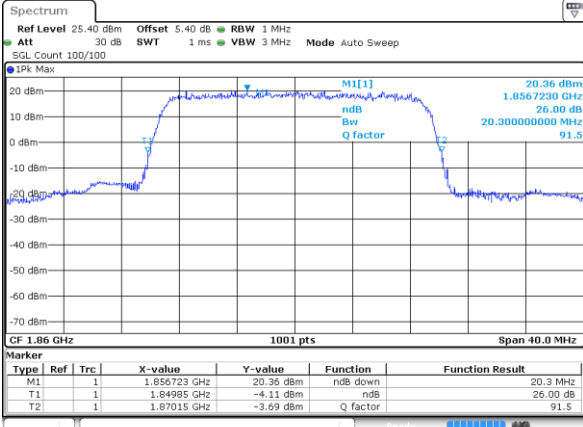

Date: 1 AUG 2020 00:39:42

Lowest Channel / 20MHz / 16QAM

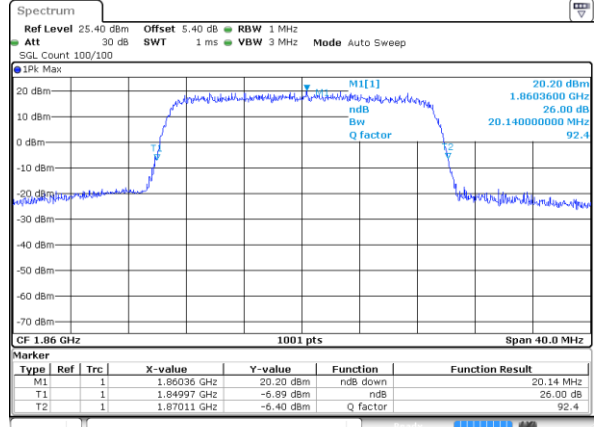

Date: 1 AUG 2020 00:39:52

Middle Channel / 20MHz / QPSK

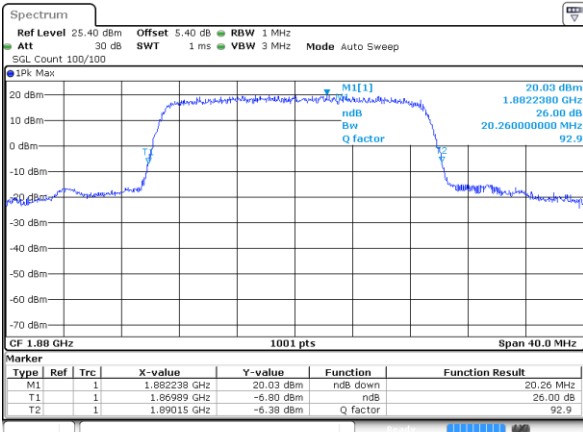

Date: 1 AUG 2020 00:46:45

Middle Channel / 20MHz / 16QAM

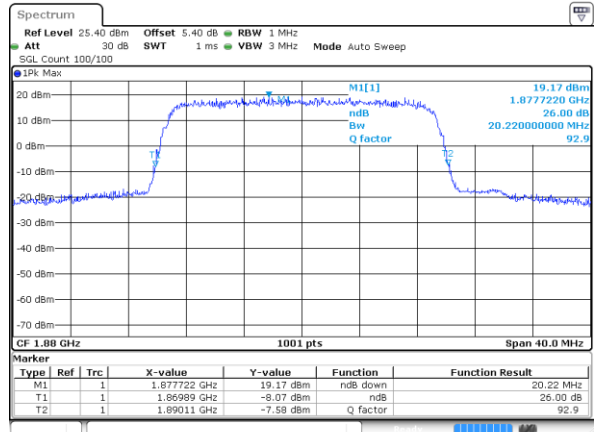

Date: 1 AUG 2020 00:46:55

Highest Channel / 20MHz / QPSK

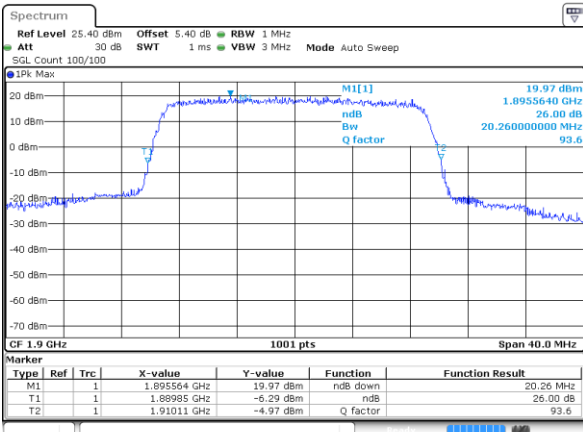

Date: 1 AUG 2020 00:49:13

Highest Channel / 20MHz / 16QAM

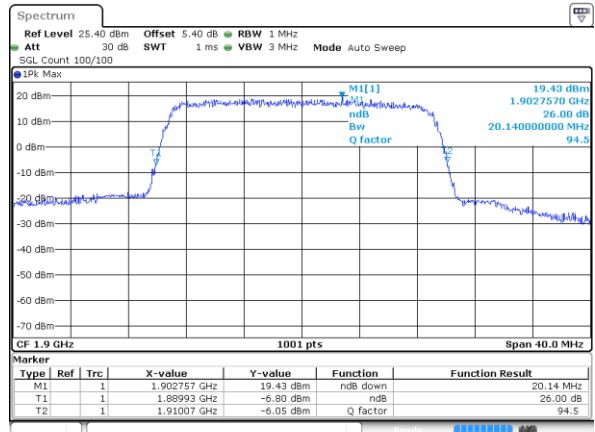

Date: 1 AUG 2020 00:49:23





### Occupied Bandwidth

Mode	LTE Band 2 : 99%OBW(MHz)											
	1.4MHz		3MHz		5MHz		10MHz		15MHz		20MHz	
BW	QPSK	16QAM	QPSK	16QAM	QPSK	16QAM	QPSK	16QAM	QPSK	16QAM	QPSK	16QAM
Lowest CH	1.09	1.10	2.71	2.72	4.48	4.46	9.01	8.95	13.34	13.34	18.30	18.34
Middle CH	1.10	1.09	2.72	2.71	4.49	4.50	9.07	9.03	13.43	13.40	18.30	18.30
Highest CH	1.09	1.09	2.71	2.73	4.49	4.49	9.05	9.01	13.25	13.46	18.30	18.26



LTE Band 2

Lowest Channel / 1.4MHz / QPSK

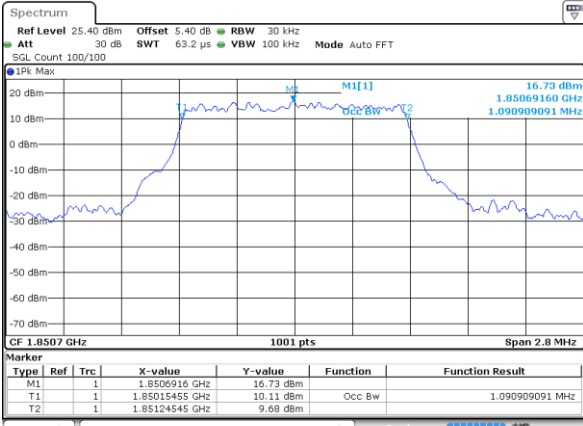

Date: 31 JUL 2020 23:16:22

Lowest Channel / 1.4MHz / 16QAM

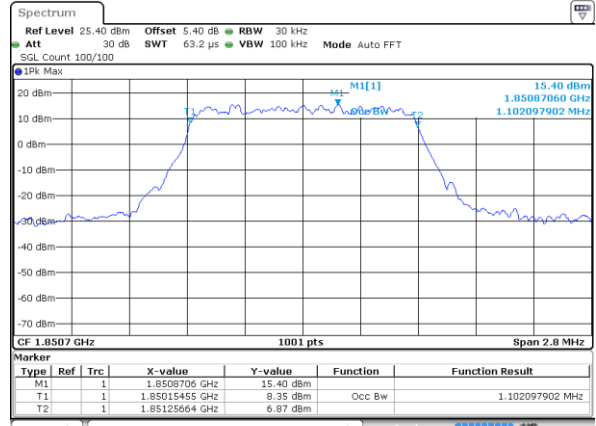

Date: 31 JUL 2020 23:16:32

Middle Channel / 1.4MHz / QPSK

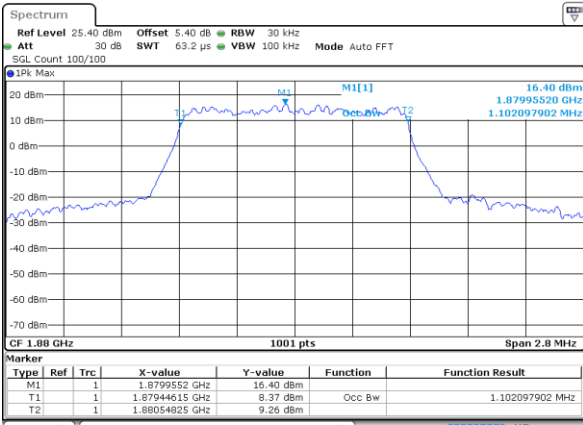

Date: 31 JUL 2020 23:23:24

Middle Channel / 1.4MHz / 16QAM

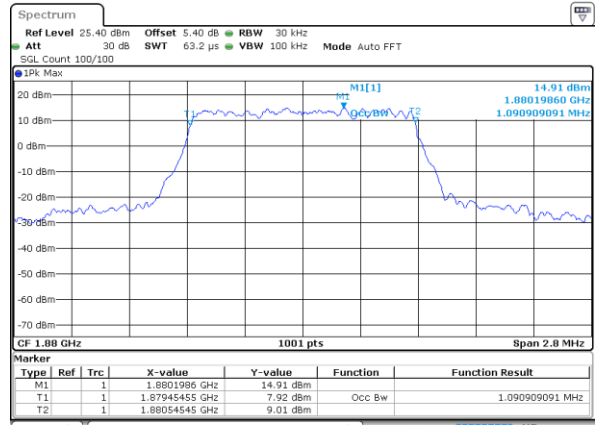

Date: 31 JUL 2020 23:23:35

Highest Channel / 1.4MHz / QPSK

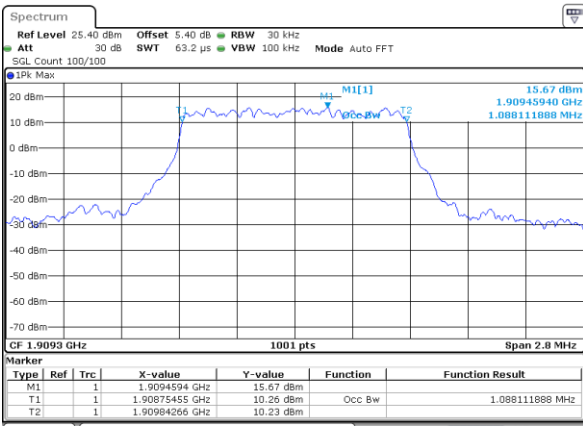

Date: 31 JUL 2020 23:25:52

Highest Channel / 1.4MHz / 16QAM

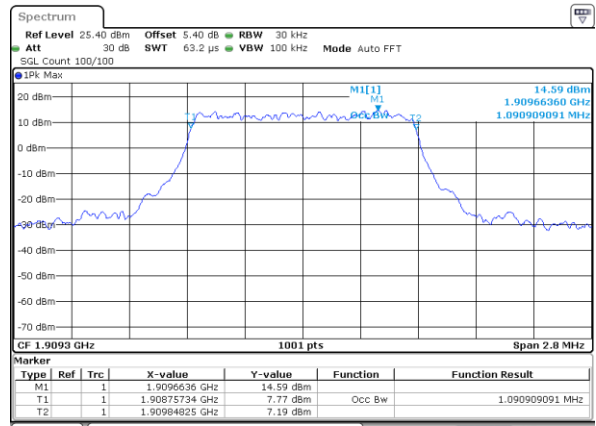

Date: 31 JUL 2020 23:26:02



LTE Band 2

Lowest Channel / 3MHz / QPSK

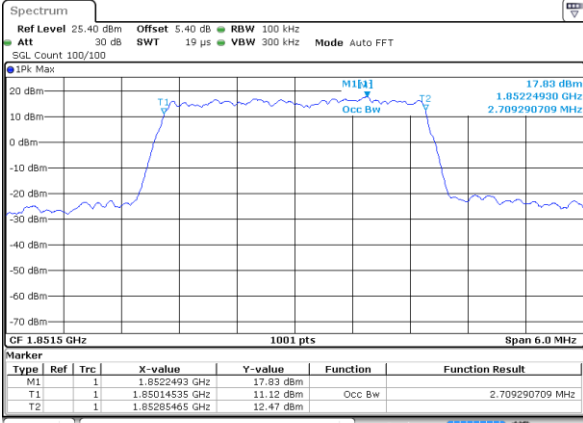

Date: 31 JUL 2020 23:32:55

Lowest Channel / 3MHz / 16QAM

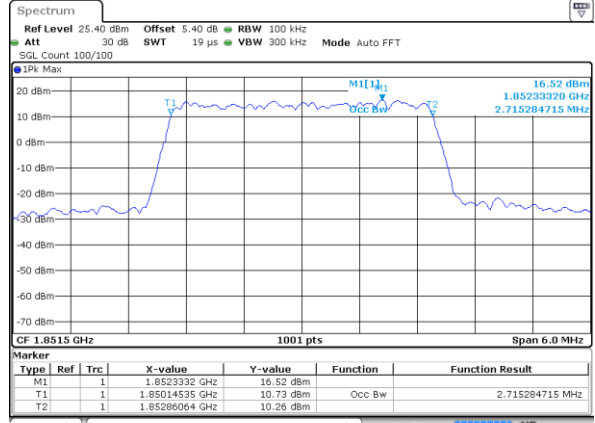

Date: 31 JUL 2020 23:33:05

Middle Channel / 3MHz / QPSK

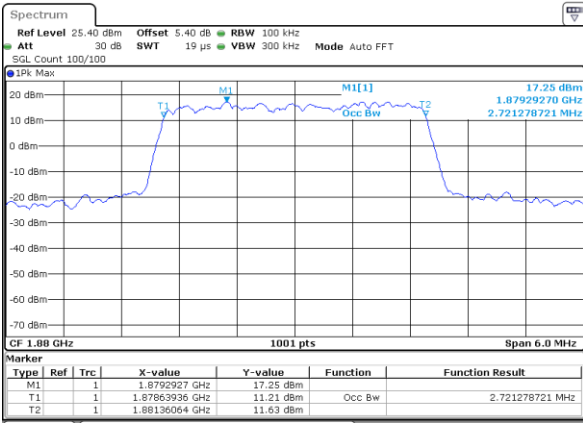

Date: 31 JUL 2020 23:39:58

Middle Channel / 3MHz / 16QAM

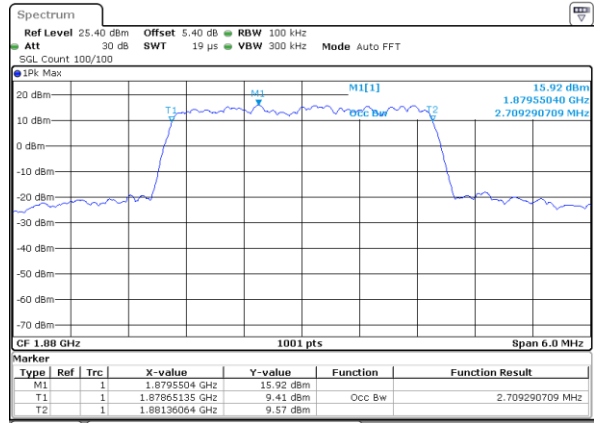

Date: 31 JUL 2020 23:40:08

Highest Channel / 3MHz / QPSK

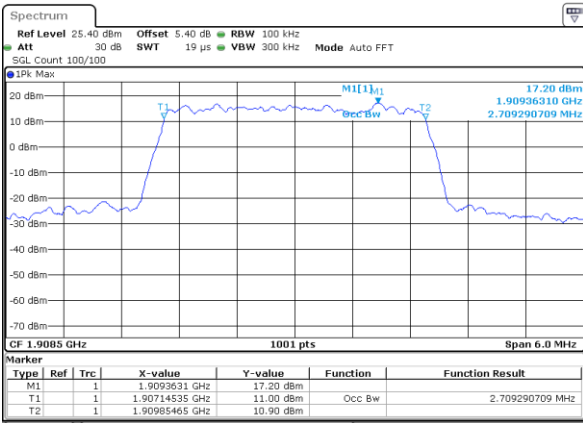

Date: 31 JUL 2020 23:42:26

Highest Channel / 3MHz / 16QAM

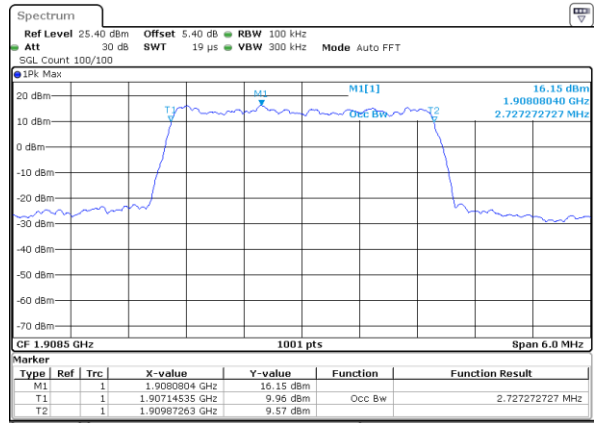

Date: 31 JUL 2020 23:42:36



LTE Band 2

Lowest Channel / 5MHz / QPSK

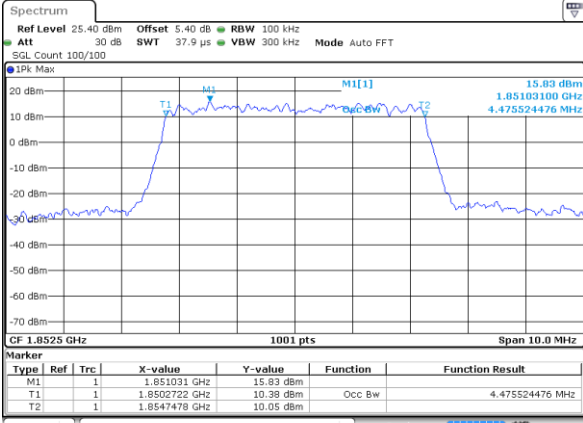

Date: 31 JUL 2020 23:49:34

Lowest Channel / 5MHz / 16QAM

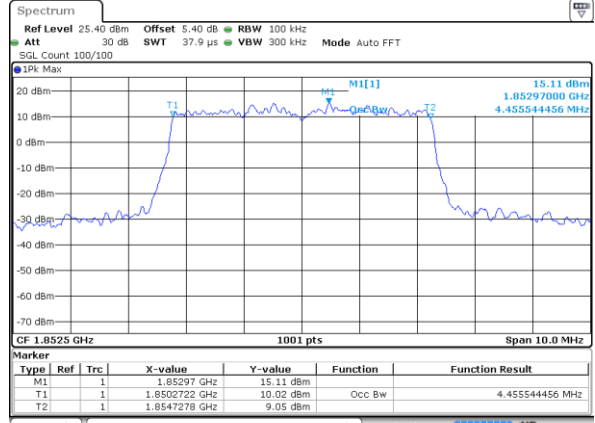

Date: 31 JUL 2020 23:49:47

Middle Channel / 5MHz / QPSK

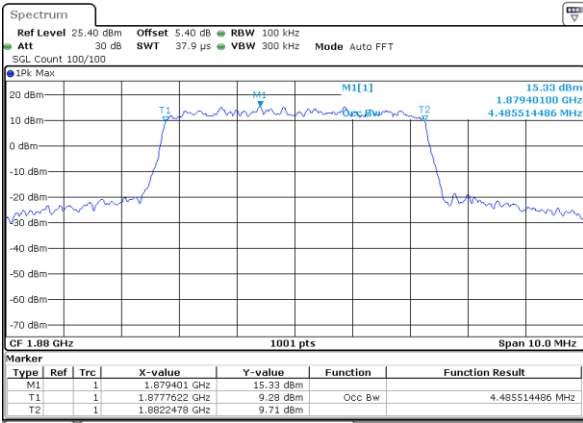

Date: 31 JUL 2020 23:56:44

Middle Channel / 5MHz / 16QAM

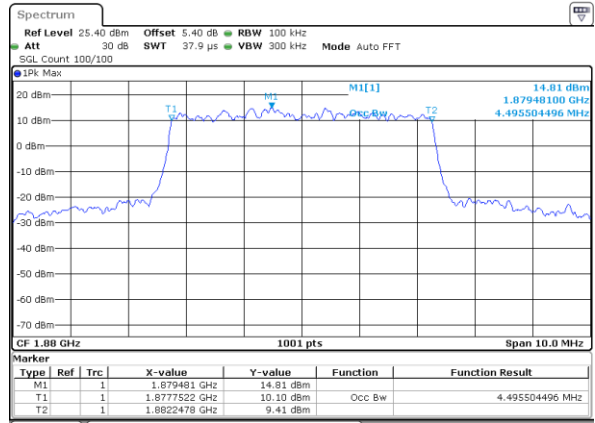

Date: 31 JUL 2020 23:56:54

Highest Channel / 5MHz / QPSK

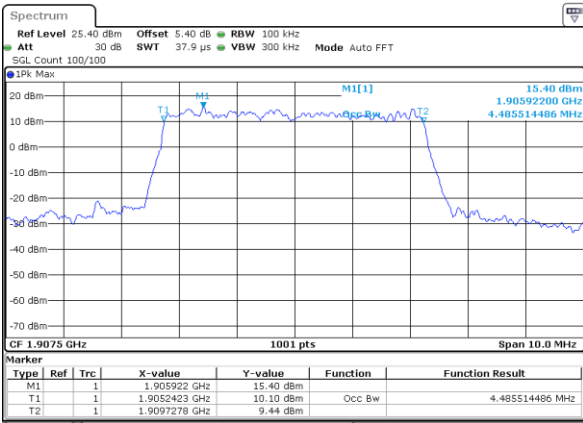

Date: 31 JUL 2020 23:59:11

Highest Channel / 5MHz / 16QAM

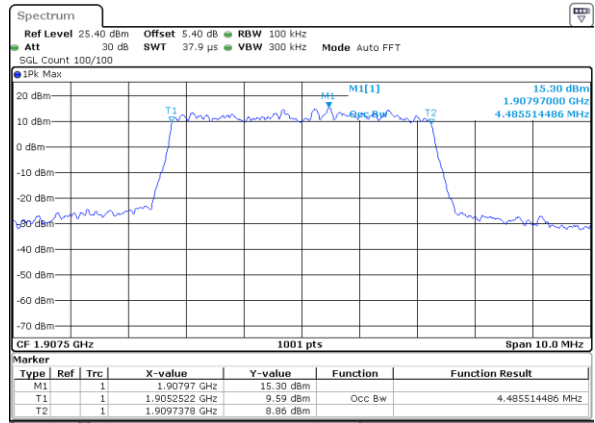

Date: 31 JUL 2020 23:59:21



LTE Band 2

Lowest Channel / 10MHz / QPSK

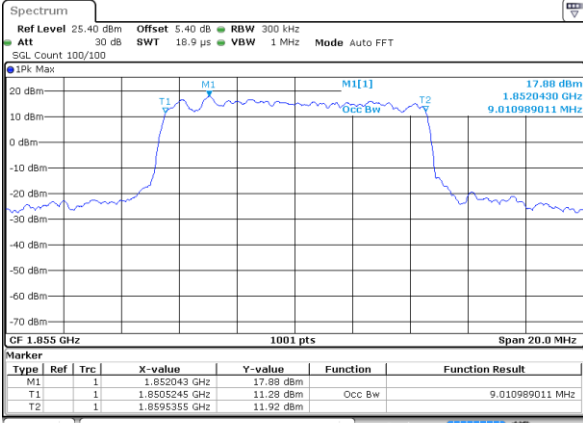

Date: 1 AUG 2020 00:06:14

Lowest Channel / 10MHz / 16QAM

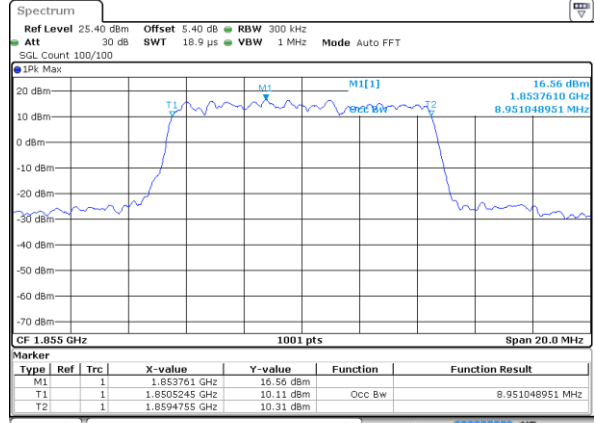

Date: 1 AUG 2020 00:06:24

Middle Channel / 10MHz / QPSK

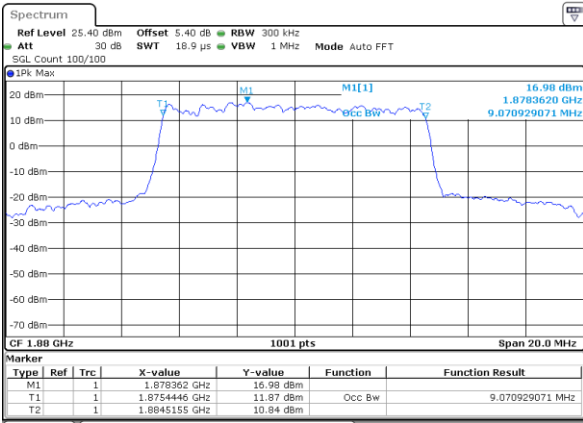

Date: 1 AUG 2020 00:13:17

Middle Channel / 10MHz / 16QAM

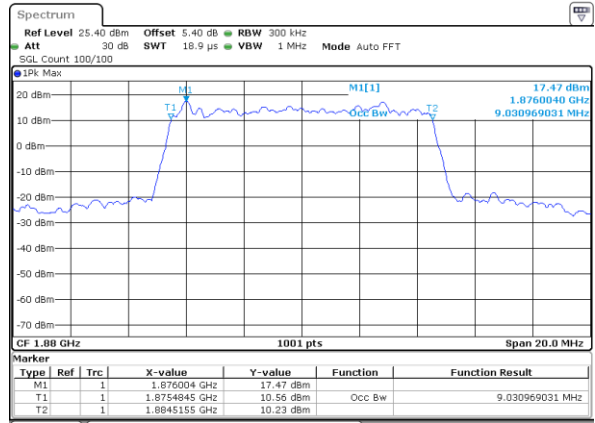

Date: 1 AUG 2020 00:13:27

Highest Channel / 10MHz / QPSK

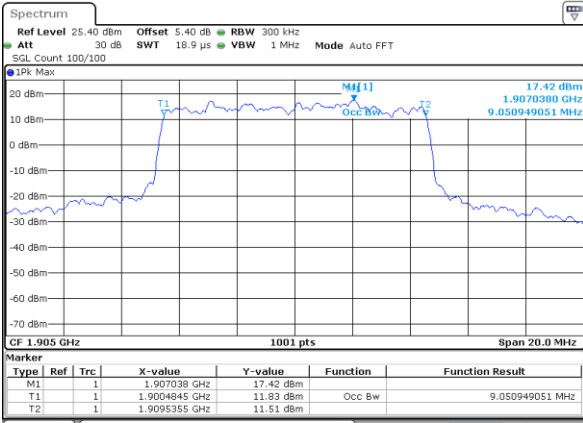

Date: 1 AUG 2020 00:15:45

Highest Channel / 10MHz / 16QAM

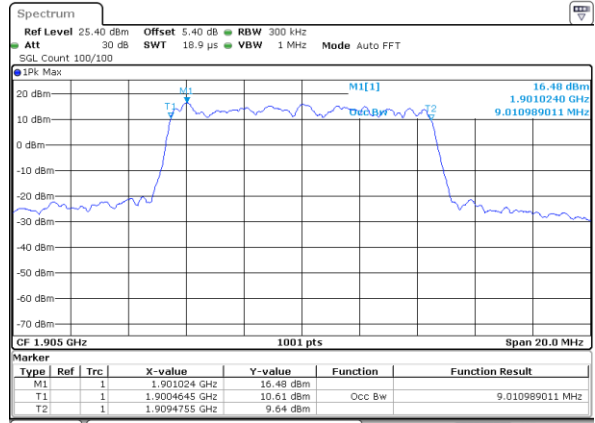

Date: 1 AUG 2020 00:15:55



LTE Band 2

Lowest Channel / 15MHz / QPSK

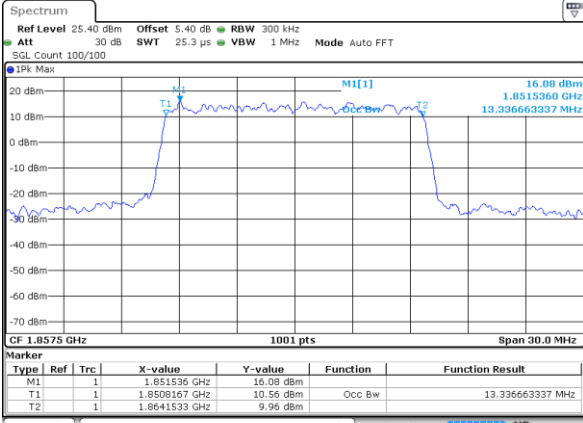

Date: 1 AUG 2020 00:22:48

Lowest Channel / 15MHz / 16QAM

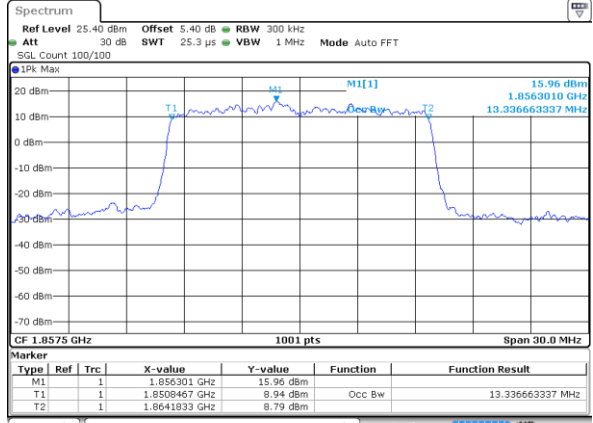

Date: 1 AUG 2020 00:22:58

Middle Channel / 15MHz / QPSK

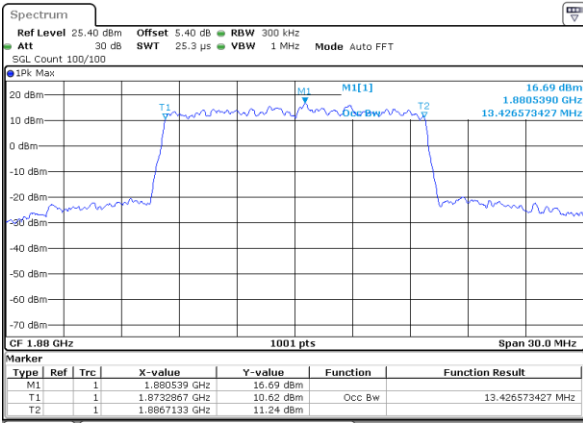

Date: 1 AUG 2020 00:29:51

Middle Channel / 15MHz / 16QAM

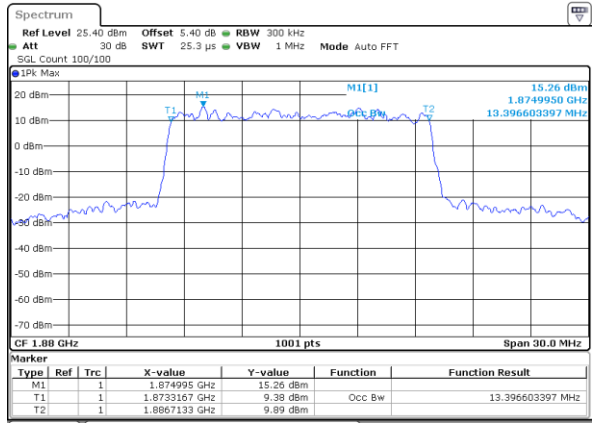

Date: 1 AUG 2020 00:30:01

Highest Channel / 15MHz / QPSK

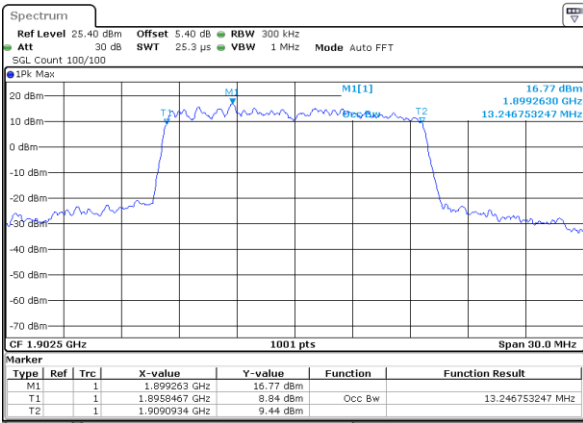

Date: 1 AUG 2020 00:32:19

Highest Channel / 15MHz / 16QAM

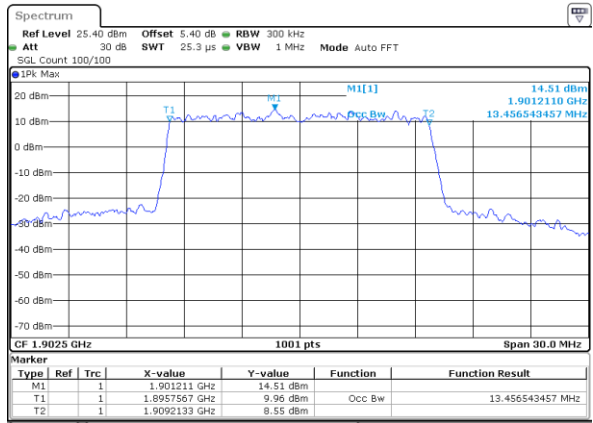

Date: 1 AUG 2020 00:32:29



LTE Band 2

Lowest Channel / 20MHz / QPSK

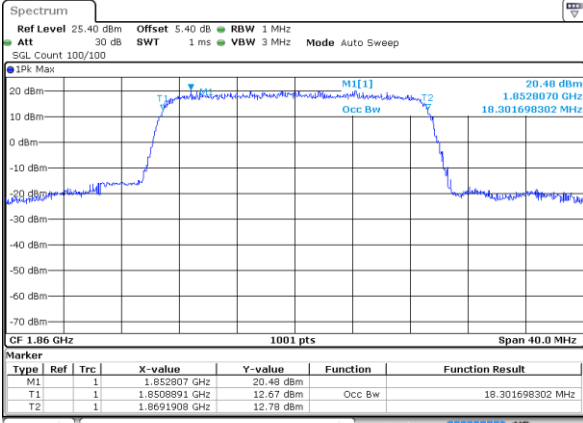

Date: 1 AUG 2020 00:39:22

Lowest Channel / 20MHz / 16QAM

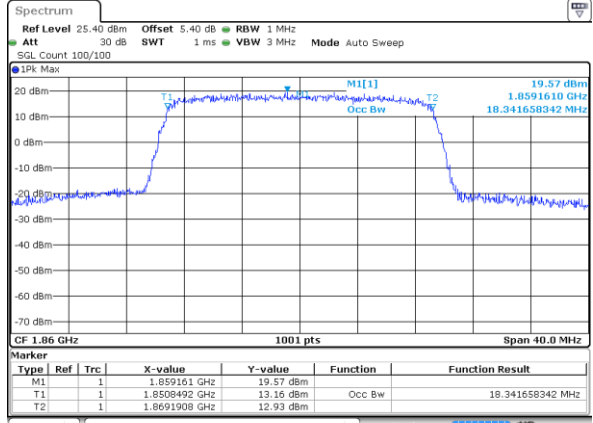

Date: 1 AUG 2020 00:39:32

Middle Channel / 20MHz / QPSK

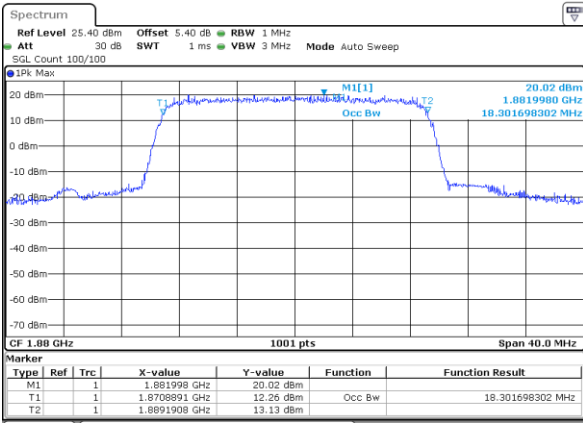

Date: 1 AUG 2020 00:46:25

Middle Channel / 20MHz / 16QAM

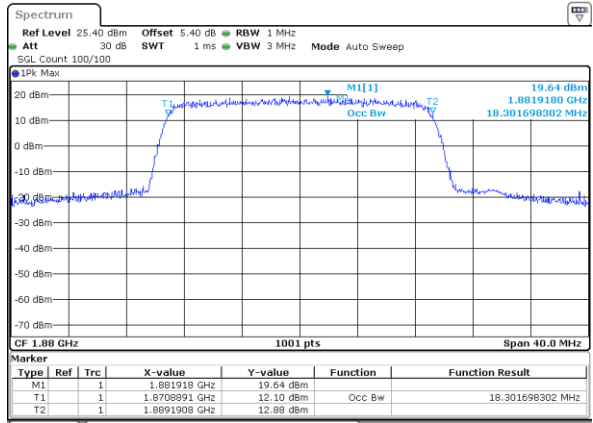

Date: 1 AUG 2020 00:46:35

Highest Channel / 20MHz / QPSK

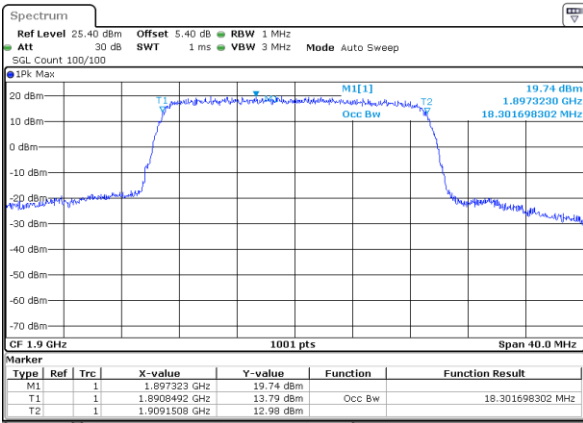

Date: 1 AUG 2020 00:48:53

Highest Channel / 20MHz / 16QAM

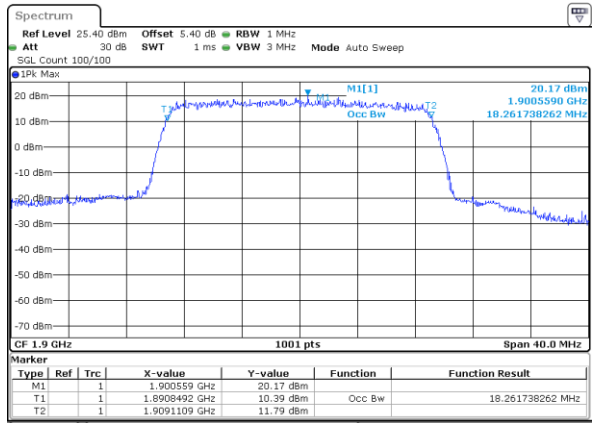

Date: 1 AUG 2020 00:49:03



# Conducted Band Edge

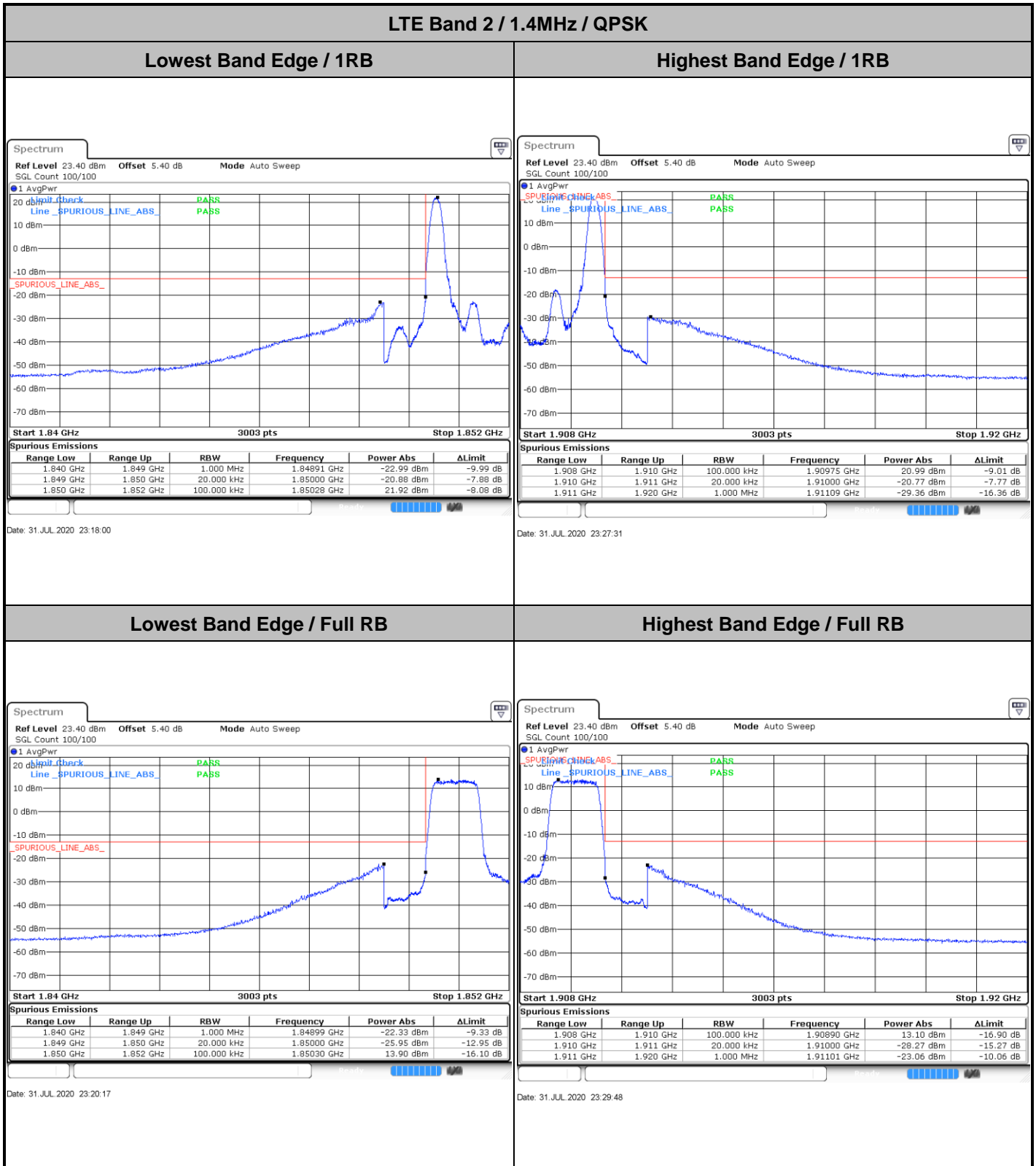





LTE Band 2 / 1.4MHz / 16QAM

Lowest Band Edge / 1 RB

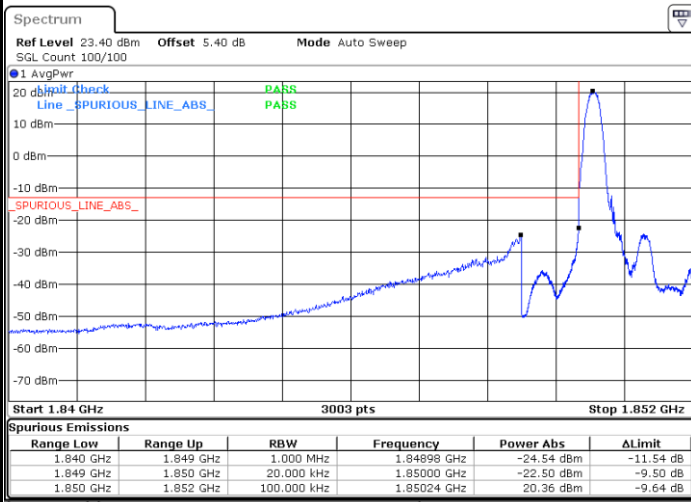

Date: 31.JUL.2020 23:19:09

Highest Band Edge / 1 RB

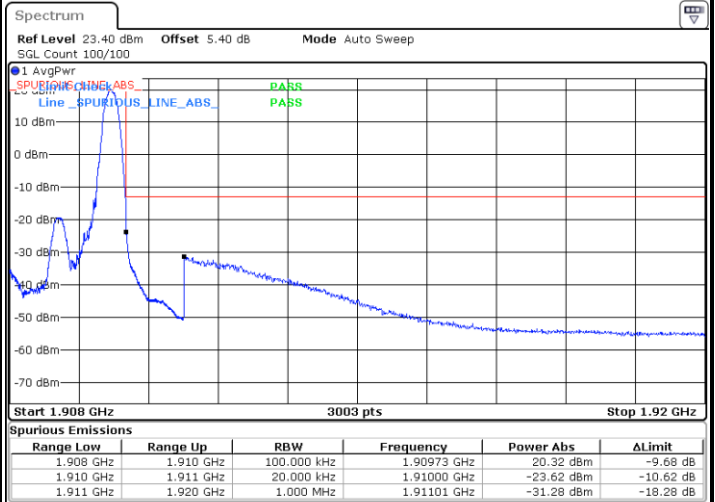

Date: 31.JUL.2020 23:28:39

Lowest Band Edge / Full RB

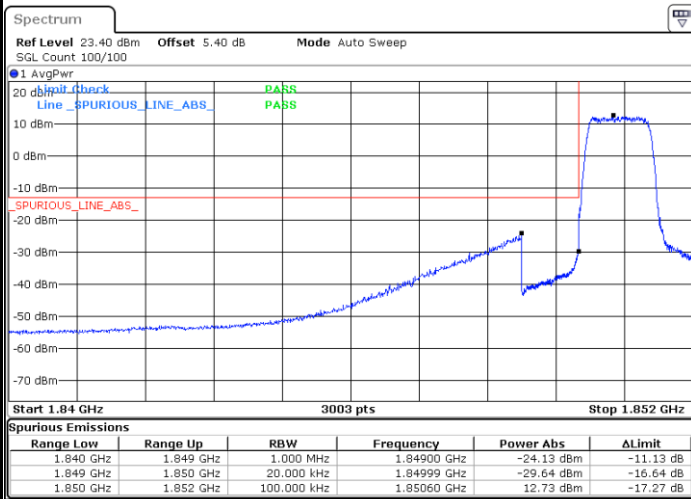

Date: 31.JUL.2020 23:21:26

Highest Band Edge / Full RB



Date: 31.JUL.2020 23:30:57



LTE Band 2 / 3MHz / QPSK

Lowest Band Edge / 1RB

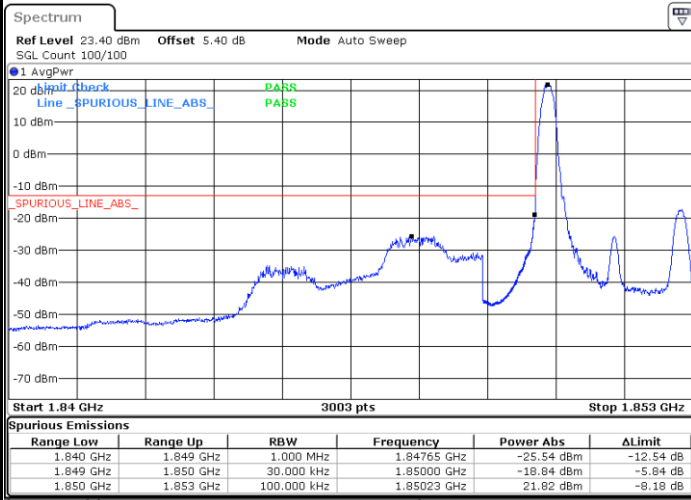

Date: 31.JUL.2020 23:34:34

Highest Band Edge / 1 RB

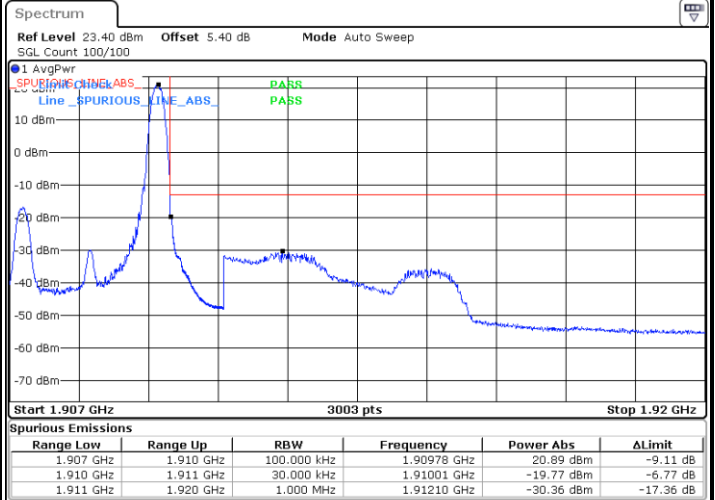

Date: 31.JUL.2020 23:44:05

Lowest Band Edge / Full RB

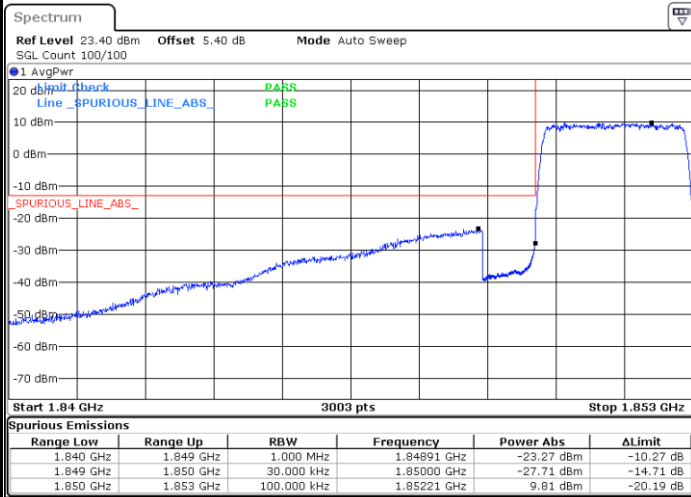

Date: 31.JUL.2020 23:36:51

Highest Band Edge / Full RB



Date: 31.JUL.2020 23:46:24



LTE Band 2 / 3MHz / 16QAM

Lowest Band Edge / 1 RB

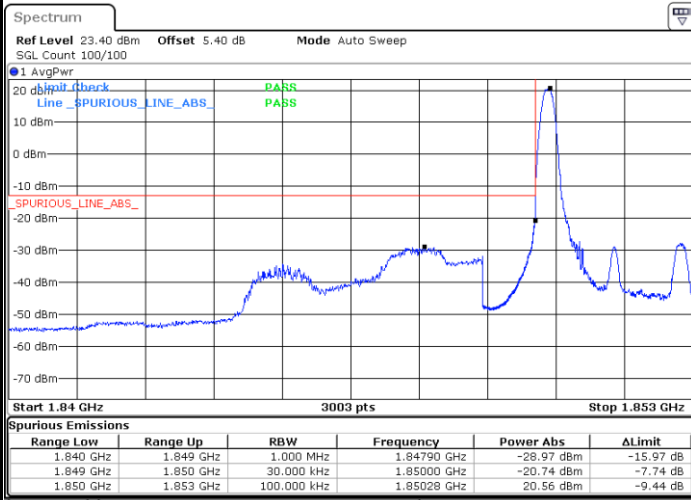

Date: 31.JUL.2020 23:35:42

Highest Band Edge / 1 RB

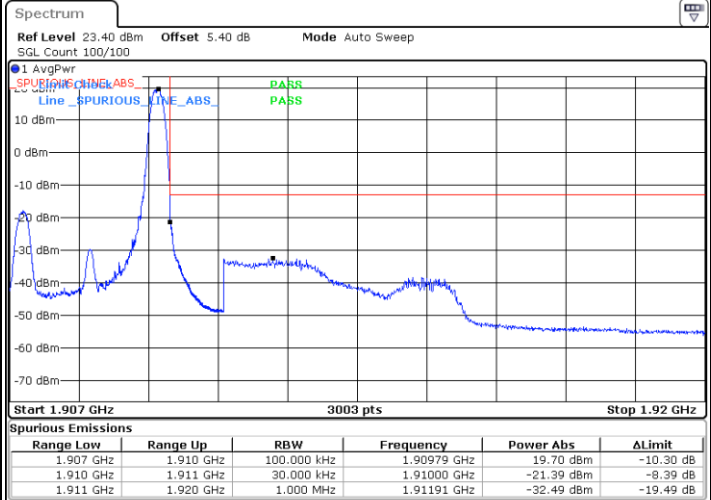

Date: 31.JUL.2020 23:45:13

Lowest Band Edge / Full RB

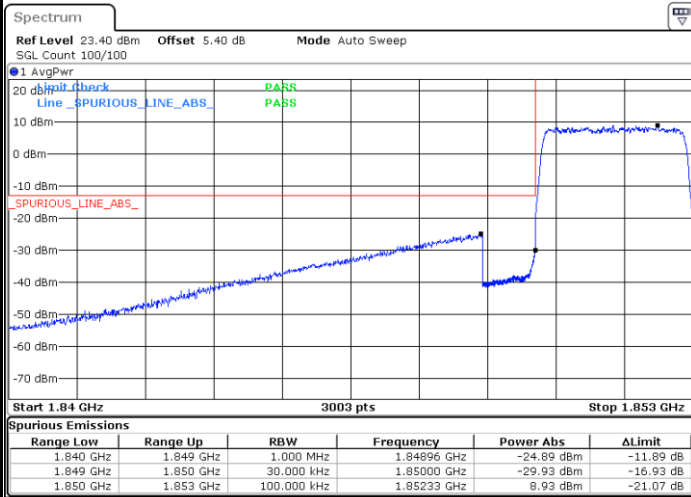

Date: 31.JUL.2020 23:38:00

Highest Band Edge / Full RB

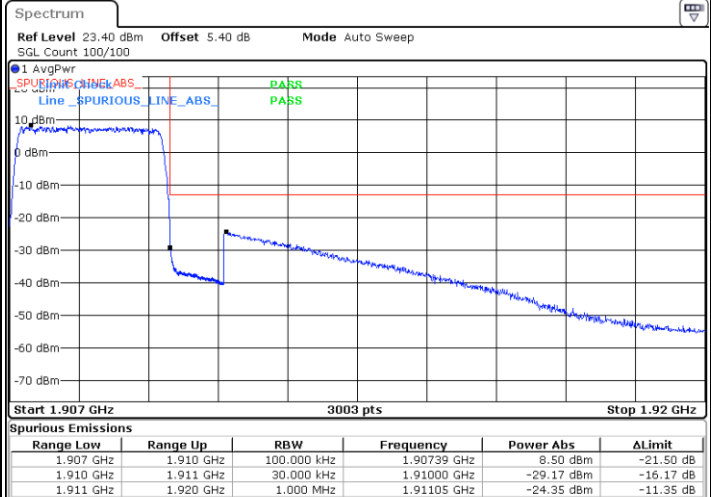

Date: 31.JUL.2020 23:47:33