

20	Liquid conductivity (meas.)	A	2.06	N	1	0.64	0.43	1.32	0.89	43
21	Liquid permittivity (target)	B	5.0	R	$\sqrt{3}$	0.6	0.49	1.7	1.4	∞
22	Liquid permittivity (meas.)	A	1.6	N	1	0.6	0.49	1.0	0.8	521
Combined standard uncertainty		$u_c = \sqrt{\sum_{i=1}^{22} c_i^2 u_i^2}$						10.4	10.3	257
Expanded uncertainty (confidence interval of 95 %)		$u_e = 2u_c$						20.8	20.6	

16.4 Measurement Uncertainty for Fast SAR Tests (3~6GHz)

No.	Error Description	Type	Uncertainty value	Probably Distribution	Div.	(Ci) 1g	(Ci) 10g	Std. Unc. (1g)	Std. Unc. (10g)	Degree of freedom
Measurement system										
1	Probe calibration	B	6.55	N	1	1	1	6.55	6.55	∞
2	Isotropy	B	4.7	R	$\sqrt{3}$	0.7	0.7	1.9	1.9	∞
3	Boundary effect	B	2.0	R	$\sqrt{3}$	1	1	1.2	1.2	∞
4	Linearity	B	4.7	R	$\sqrt{3}$	1	1	2.7	2.7	∞
5	Detection limit	B	1.0	R	$\sqrt{3}$	1	1	0.6	0.6	∞
6	Readout electronics	B	0.3	R	$\sqrt{3}$	1	1	0.3	0.3	∞
7	Response time	B	0.8	R	$\sqrt{3}$	1	1	0.5	0.5	∞
8	Integration time	B	2.6	R	$\sqrt{3}$	1	1	1.5	1.5	∞
9	RF ambient conditions-noise	B	0	R	$\sqrt{3}$	1	1	0	0	∞
10	RFambient conditions-reflection	B	0	R	$\sqrt{3}$	1	1	0	0	∞
11	Probe positioned mech. Restrictions	B	0.8	R	$\sqrt{3}$	1	1	0.5	0.5	∞
12	Probe positioning with respect to phantom shell	B	6.7	R	$\sqrt{3}$	1	1	3.9	3.9	∞
13	Post-processing	B	1.0	R	$\sqrt{3}$	1	1	0.6	0.6	∞
14	Fast SAR z-Approximation	B	14.0	R	$\sqrt{3}$	1	1	8.1	8.1	∞
Test sample related										
15	Test sample positioning	A	3.3	N	1	1	1	3.3	3.3	71
16	Device holder uncertainty	A	3.4	N	1	1	1	3.4	3.4	5

17	Drift of output power	B	5.0	R	$\sqrt{3}$	1	1	2.9	2.9	∞
Phantom and set-up										
18	Phantom uncertainty	B	4.0	R	$\sqrt{3}$	1	1	2.3	2.3	∞
19	Liquid conductivity (target)	B	5.0	R	$\sqrt{3}$	0.64	0.43	1.8	1.2	∞
20	Liquid conductivity (meas.)	A	2.06	N	1	0.64	0.43	1.32	0.89	43
21	Liquid permittivity (target)	B	5.0	R	$\sqrt{3}$	0.6	0.49	1.7	1.4	∞
22	Liquid permittivity (meas.)	A	1.6	N	1	0.6	0.49	1.0	0.8	521
Combined standard uncertainty		$u_c = \sqrt{\sum_{i=1}^{22} c_i^2 u_i^2}$						13.5	13.4	257
Expanded uncertainty (confidence interval of 95 %)		$u_e = 2u_c$						27.0	26.8	

17 MAIN TEST INSTRUMENTS

Table 17.1: List of Main Instruments

No.	Name	Type	Serial Number	Calibration Date	Valid Period
01	Network analyzer	E5071C	MY46110673	February 10, 2020	One year
02	Power meter	NRP2	106277	September 4, 2019	One year
03	Power sensor	NRP8S	104291		
04	Signal Generator	E4438C	MY49071430	February 25, 2020	One Year
05	Amplifier	60S1G4	0331848	No Calibration Requested	
06	BTS	CMW500	166370	June 27, 2019	One year
07	E-field Probe	SPEAG EX3DV4	3617	January 30, 2020	One year
08	DAE	SPEAG DAE4	777	January 8, 2020	One year
09	Dipole Validation Kit	SPEAG D750V3	1017	July 18,2019	One year
10	Dipole Validation Kit	SPEAG D835V2	4d069	July 18,2019	One year
11	Dipole Validation Kit	SPEAG D1750V2	1003	July 16,2019	One year
12	Dipole Validation Kit	SPEAG D1900V2	5d101	July 17,2019	One year
13	Dipole Validation Kit	SPEAG D2450V2	853	July 17,2019	One year
14	Dipole Validation Kit	SPEAG D2450V2	1012	July 17,2019	One year

END OF REPORT BODY

ANNEX A Graph Results

GSM850_CH190 Right Cheek 2TX

Date: 6/21/2020

Electronics: DAE4 Sn777

Medium: head 835 MHz

Medium parameters used: $f = 836.6$; $\sigma = 0.886$ mho/m; $\epsilon_r = 41.45$; $\rho = 1000$ kg/m³

Ambient Temperature: 22.5°C, Liquid Temperature: 22.3°C

Communication System: GSM850 836.6 Duty Cycle: 1:4

Probe: EX3DV4 – SN3617 ConvF(9.66,9.66,9.66)

Area Scan (71x121x1): Interpolated grid: dx=1.000 mm, dy=1.000 mm

Maximum value of SAR (interpolated) = 0.251 W/kg

Zoom Scan (7x7x7)/Cube 0: Measurement grid: dx=5mm, dy=5mm, dz=5mm

Reference Value = 3.479 V/m; Power Drift = -0.04 dB

Peak SAR (extrapolated) = 0.288 W/kg

SAR(1 g) = 0.211 W/kg; SAR(10 g) = 0.162 W/kg

Maximum value of SAR (measured) = 0.240 W/kg

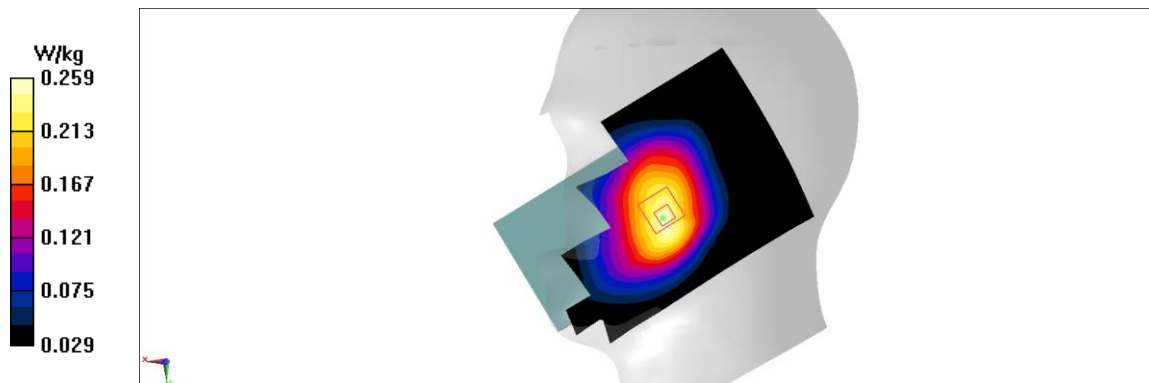

Fig A.1

GSM850_CH251 Rear GPRS 10mm 2TX

Date: 6/21/2020

Electronics: DAE4 Sn777

Medium: body 835 MHz

Medium parameters used: $f = 848.8$; $\sigma = 0.987$ mho/m; $\epsilon_r = 54.73$; $\rho = 1000$ kg/m³

Ambient Temperature: 22.5°C, Liquid Temperature: 22.3°C

Communication System: GSM850 848.8 Duty Cycle: 1:4

Probe: EX3DV4 – SN3617 ConvF(9.66,9.66,9.66)

Area Scan (71x121x1): Interpolated grid: dx=1.000 mm, dy=1.000 mm

Maximum value of SAR (interpolated) = 0.512 W/kg

Zoom Scan (7x7x7)/Cube 0: Measurement grid: dx=5mm, dy=5mm, dz=5mm

Reference Value = 21.45 V/m; Power Drift = 0 dB

Peak SAR (extrapolated) = 0.623 W/kg

SAR(1 g) = 0.332 W/kg; SAR(10 g) = 0.193 W/kg

Maximum value of SAR (measured) = 0.500 W/kg

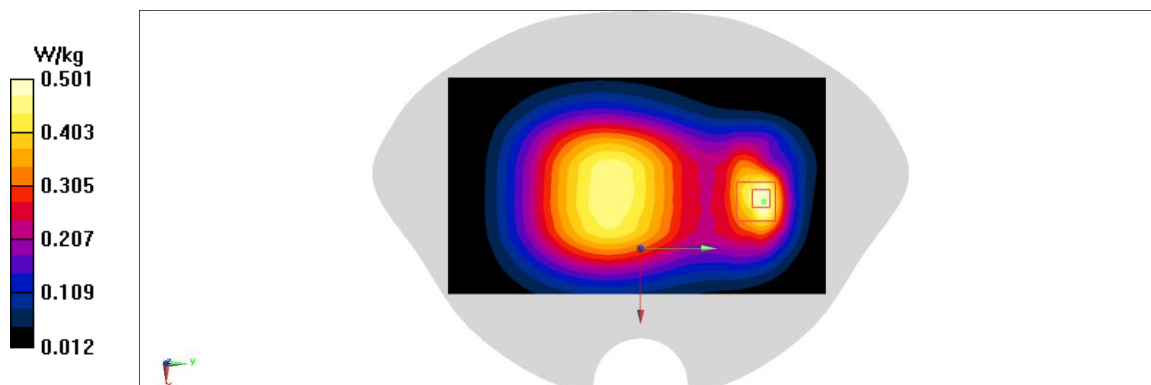

Fig A.2

PCS1900_CH661 Left Tilt 2TX

Date: 6/23/2020

Electronics: DAE4 Sn777

Medium: head 1900 MHz

Medium parameters used: $f = 1880$; $\sigma = 1.363$ mho/m; $\epsilon_r = 39.35$; $\rho = 1000$ kg/m³

Ambient Temperature: 22.5°C, Liquid Temperature: 22.3°C

Communication System: PCS1900 1880 Duty Cycle: 1:4

Probe: EX3DV4 – SN3617 ConvF(8.14,8.14,8.14)

Area Scan (71x121x1): Interpolated grid: dx=1.000 mm, dy=1.000 mm

Maximum value of SAR (interpolated) = 0.222 W/kg

Zoom Scan (7x7x7)/Cube 0: Measurement grid: dx=5mm, dy=5mm, dz=5mm

Reference Value = 6.061 V/m; Power Drift = -0.02 dB

Peak SAR (extrapolated) = 0.227 W/kg

SAR(1 g) = 0.147 W/kg; SAR(10 g) = 0.091 W/kg

Maximum value of SAR (measured) = 0.231 W/kg

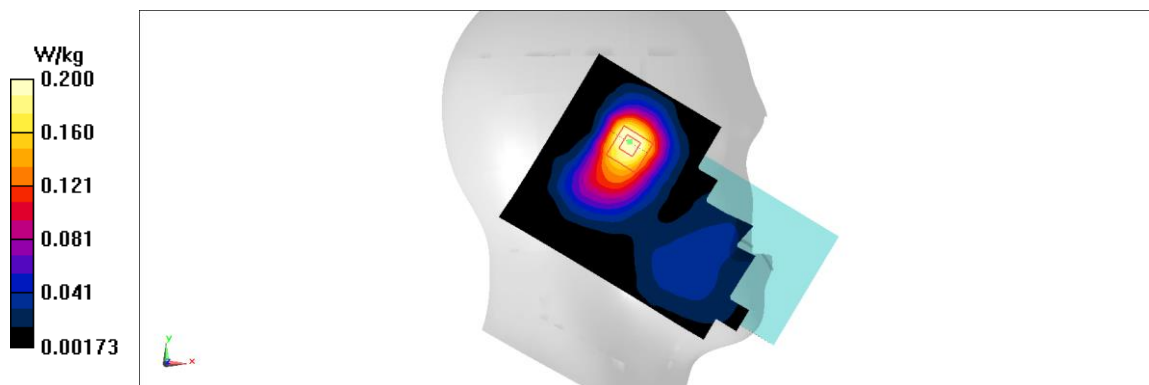
**Fig A.3**

PCS1900_CH512 Bottom Edge GPRS 10mm 1TX

Date: 6/23/2020

Electronics: DAE4 Sn777

Medium: body 1900 MHz

Medium parameters used: $f = 1850.2$; $\sigma = 1.477$ mho/m; $\epsilon_r = 53.27$; $\rho = 1000$ kg/m³

Ambient Temperature: 22.5°C, Liquid Temperature: 22.3°C

Communication System: PCS1900 1850.2 Duty Cycle: 1:8.3

Probe: EX3DV4 – SN3617 ConvF(8.14,8.14,8.14)

Area Scan (71x121x1): Interpolated grid: dx=1.000 mm, dy=1.000 mm

Maximum value of SAR (interpolated) = 1.51 W/kg

Zoom Scan (7x7x7)/Cube 0: Measurement grid: dx=5mm, dy=5mm, dz=5mm

Reference Value = 25.85 V/m; Power Drift = 0.07 dB

Peak SAR (extrapolated) = 1.77 W/kg

SAR(1 g) = 0.942 W/kg; SAR(10 g) = 0.48 W/kg

Maximum value of SAR (measured) = 1.44 W/kg

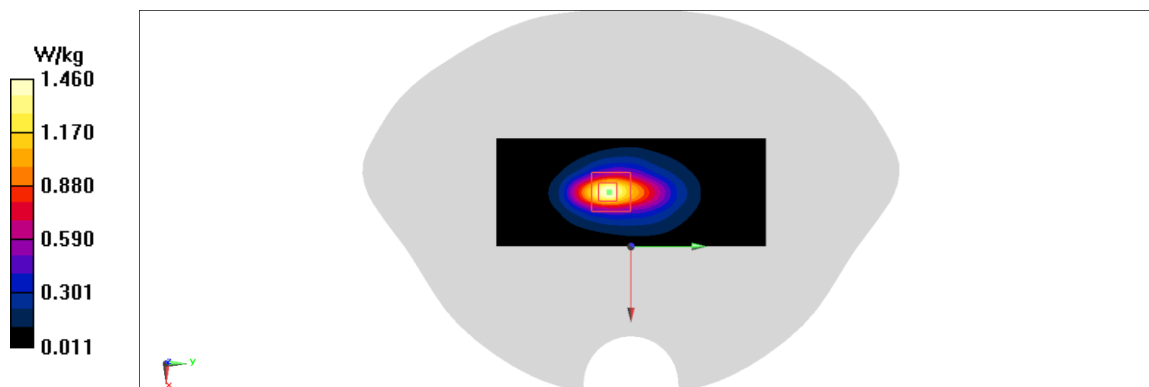

Fig A.4

WCDMA1900-BII_CH9400 Left Tilt

Date: 6/23/2020

Electronics: DAE4 Sn777

Medium: head 1900 MHz

Medium parameters used: $f = 1880$; $\sigma = 1.363$ mho/m; $\epsilon_r = 39.35$; $\rho = 1000$ kg/m³

Ambient Temperature: 22.5°C, Liquid Temperature: 22.3°C

Communication System: WCDMA1900-BII 1880 Duty Cycle: 1:1

Probe: EX3DV4 – SN3617 ConvF(8.14,8.14,8.14)

Area Scan (71x121x1): Interpolated grid: dx=1.000 mm, dy=1.000 mm

Maximum value of SAR (interpolated) = 0.299 W/kg

Zoom Scan (7x7x7)/Cube 0: Measurement grid: dx=5mm, dy=5mm, dz=5mm

Reference Value = 7.01 V/m; Power Drift = -0.07 dB

Peak SAR (extrapolated) = 0.302 W/kg

SAR(1 g) = 0.196 W/kg; SAR(10 g) = 0.12 W/kg

Maximum value of SAR (measured) = 0.312W/kg

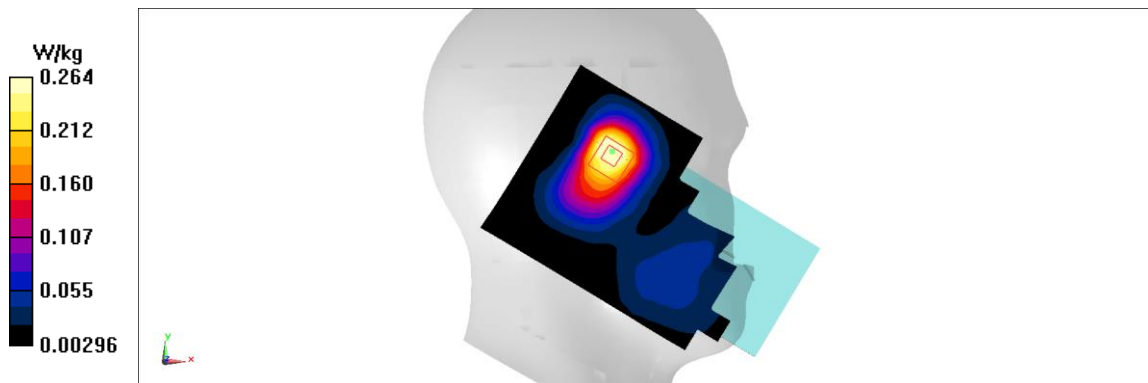

Fig A.5

WCDMA1900-BII_CH9262 Front 10mm

Date: 6/23/2020

Electronics: DAE4 Sn777

Medium: body 1900 MHz

Medium parameters used: $f = 1852.4$; $\sigma = 1.479$ mho/m; $\epsilon_r = 53.27$; $\rho = 1000$ kg/m³

Ambient Temperature: 22.5°C, Liquid Temperature: 22.3°C

Communication System: WCDMA1900-BII 1852.4 Duty Cycle: 1:1

Probe: EX3DV4 – SN3617 ConvF(8.14,8.14,8.14)

Area Scan (71x121x1): Interpolated grid: dx=1.000 mm, dy=1.000 mm

Maximum value of SAR (interpolated) = 1.62 W/kg

Zoom Scan (7x7x7)/Cube 0: Measurement grid: dx=5mm, dy=5mm, dz=5mm

Reference Value = 13.03 V/m; Power Drift = -0.06 dB

Peak SAR (extrapolated) = 1.9 W/kg

SAR(1 g) = 0.999 W/kg; SAR(10 g) = 0.519 W/kg

Maximum value of SAR (measured) = 1.45 W/kg

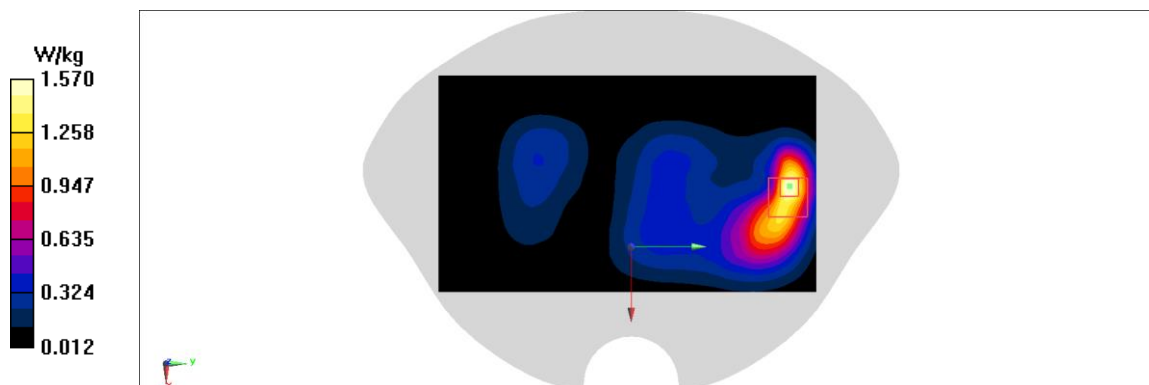

Fig A.6

WCDMA1700-BIV_CH1513 Right Cheek

Date: 6/22/2020

Electronics: DAE4 Sn777

Medium: head 1750 MHz

Medium parameters used: $f = 1752.6$; $\sigma = 1.377$ mho/m; $\epsilon_r = 39.44$; $\rho = 1000$ kg/m³

Ambient Temperature: 22.5°C, Liquid Temperature: 22.3°C

Communication System: WCDMA1700-BIV 1752.6 Duty Cycle: 1:1

Probe: EX3DV4 – SN3617 ConvF(8.41,8.41,8.41)

Area Scan (71x121x1): Interpolated grid: dx=1.000 mm, dy=1.000 mm

Maximum value of SAR (interpolated) = 0.247 W/kg

Zoom Scan (7x7x7)/Cube 0: Measurement grid: dx=5mm, dy=5mm, dz=5mm

Reference Value = 1.915 V/m; Power Drift = -0.06 dB

Peak SAR (extrapolated) = 0.267 W/kg

SAR(1 g) = 0.176 W/kg; SAR(10 g) = 0.111 W/kg

Maximum value of SAR (measured) = 0.259 W/kg

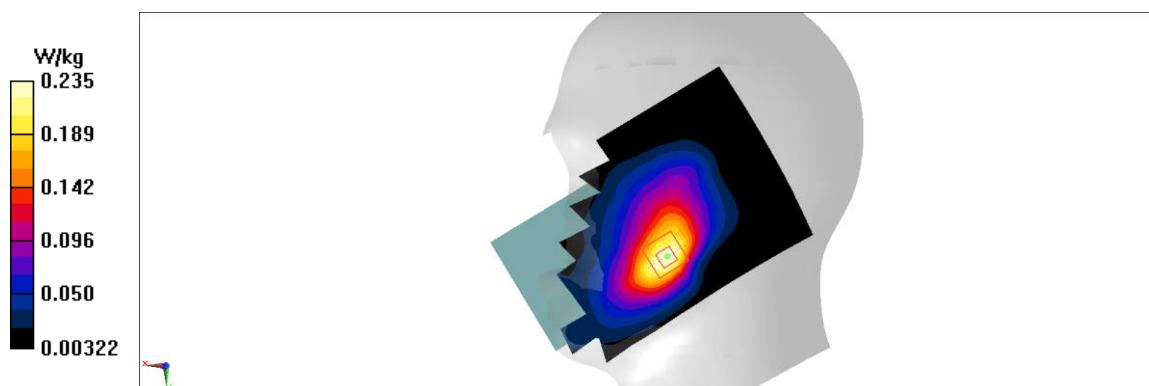

Fig A.7

WCDMA1700-BIV_CH1412 Front 10mm

Date: 6/22/2020

Electronics: DAE4 Sn777

Medium: body 1750 MHz

Medium parameters used: $f = 1732.5$; $\sigma = 1.449$ mho/m; $\epsilon_r = 54.06$; $\rho = 1000$ kg/m³

Ambient Temperature: 22.5°C, Liquid Temperature: 22.3°C

Communication System: WCDMA1700-BIV 1732.5 Duty Cycle: 1:1

Probe: EX3DV4 – SN3617 ConvF(8.41,8.41,8.41)

Area Scan (71x121x1): Interpolated grid: dx=1.000 mm, dy=1.000 mm

Maximum value of SAR (interpolated) = 1.3 W/kg

Zoom Scan (7x7x7)/Cube 0: Measurement grid: dx=5mm, dy=5mm, dz=5mm

Reference Value = 25.29 V/m; Power Drift = -0.07 dB

Peak SAR (extrapolated) = 1.46 W/kg

SAR(1 g) = 1.17 W/kg; SAR(10 g) = 0.6 W/kg

Maximum value of SAR (measured) = 1.10 W/kg

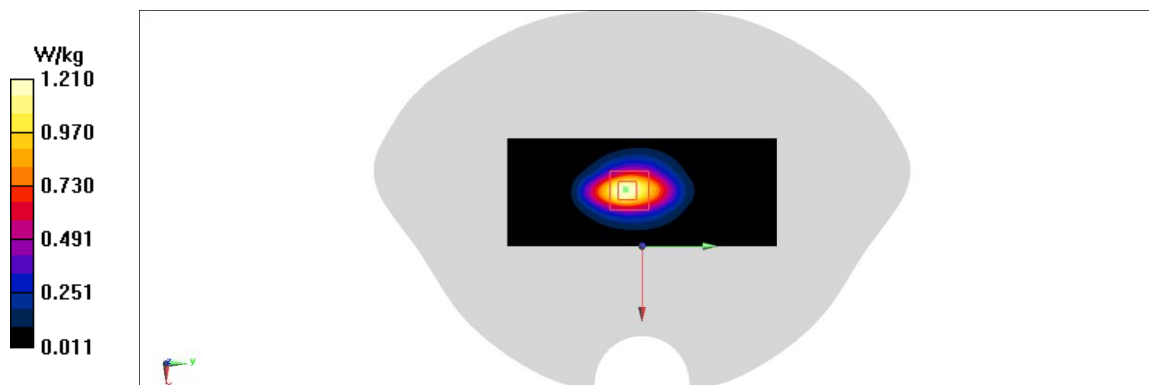
**Fig A.8**

WCDMA850-BV_CH4183 Left Cheek

Date: 6/21/2020

Electronics: DAE4 Sn777

Medium: head 835 MHz

Medium parameters used: $f = 836.6$; $\sigma = 0.886$ mho/m; $\epsilon_r = 41.45$; $\rho = 1000$ kg/m³

Ambient Temperature: 22.5°C, Liquid Temperature: 22.3°C

Communication System: WCDMA850-BV 836.6 Duty Cycle: 1:1

Probe: EX3DV4 – SN3617 ConvF(9.66,9.66,9.66)

Area Scan (71x121x1): Interpolated grid: dx=1.000 mm, dy=1.000 mm

Maximum value of SAR (interpolated) = 0.218 W/kg

Zoom Scan (7x7x7)/Cube 0: Measurement grid: dx=5mm, dy=5mm, dz=5mm

Reference Value = 4.469 V/m; Power Drift = 0.05 dB

Peak SAR (extrapolated) = 0.245 W/kg

SAR(1 g) = 0.163 W/kg; SAR(10 g) = 0.128 W/kg

Maximum value of SAR (measured) = 0.229 W/kg

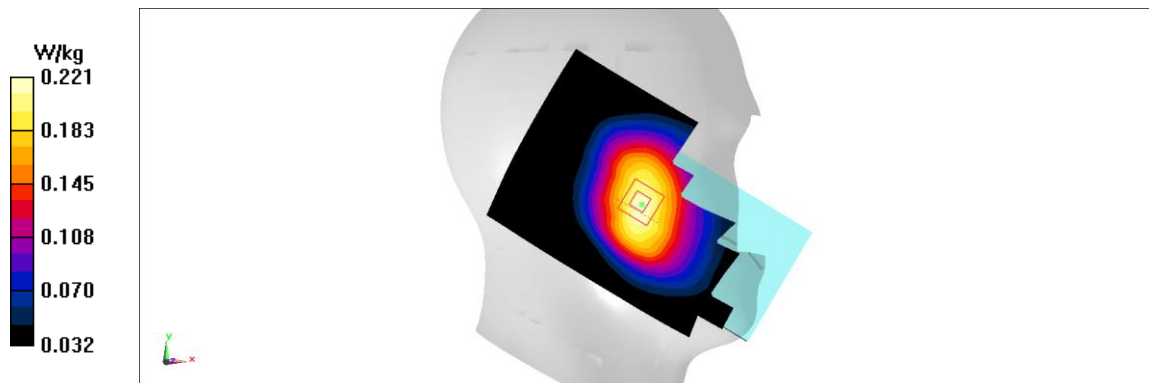

Fig A.9

WCDMA850-BV_CH4183 Rear 10mm

Date: 6/21/2020

Electronics: DAE4 Sn777

Medium: body 835 MHz

Medium parameters used: $f = 836.6$; $\sigma = 0.976$ mho/m; $\epsilon_r = 54.75$; $\rho = 1000$ kg/m³

Ambient Temperature: 22.5°C, Liquid Temperature: 22.3°C

Communication System: WCDMA850-BV 836.6 Duty Cycle: 1:1

Probe: EX3DV4 – SN3617 ConvF(9.66,9.66,9.66)

Area Scan (71x121x1): Interpolated grid: dx=1.000 mm, dy=1.000 mm

Maximum value of SAR (interpolated) = 0.347 W/kg

Zoom Scan (7x7x7)/Cube 0: Measurement grid: dx=5mm, dy=5mm, dz=5mm

Reference Value = 17.71 V/m; Power Drift = -0.02 dB

Peak SAR (extrapolated) = 0.424 W/kg

SAR(1 g) = 0.227 W/kg; SAR(10 g) = 0.13 W/kg

Maximum value of SAR (measured) = 0.359 W/kg

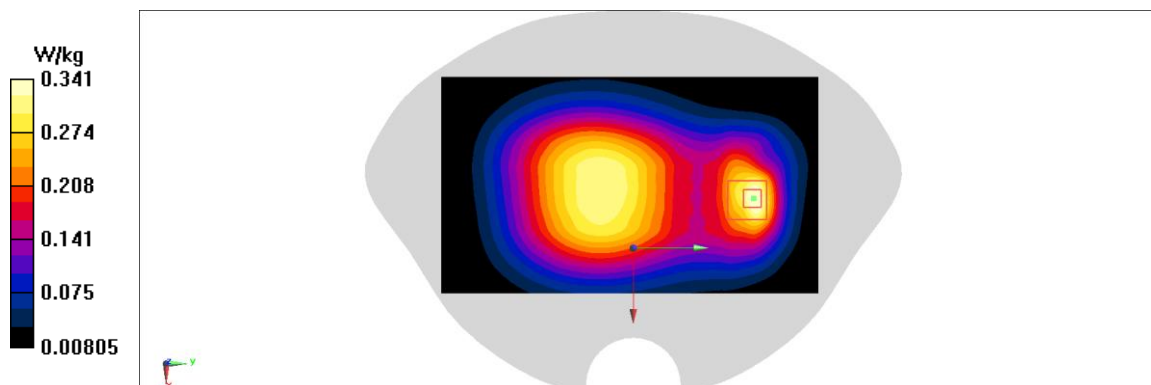

Fig A.10

LTE1900-FDD2_CH18900 Left Tilt 1RB-Middle

Date: 6/23/2020

Electronics: DAE4 Sn777

Medium: head 1900 MHz

Medium parameters used: $f = 1880$ MHz; $\sigma = 1.363$ mho/m; $\epsilon_r = 39.35$; $\rho = 1000$ kg/m³

Ambient Temperature: 22.5°C, Liquid Temperature: 22.3°C

Communication System: LTE1900-FDD2 1880 MHz Duty Cycle: 1:1

Probe: EX3DV4 – SN3617 ConvF(8.14,8.14,8.14)

Area Scan (71x121x1): Interpolated grid: dx=1.000 mm, dy=1.000 mm

Maximum value of SAR (interpolated) = 0.368 W/kg

Zoom Scan (7x7x7)/Cube 0: Measurement grid: dx=5mm, dy=5mm, dz=5mm

Reference Value = 6.369 V/m; Power Drift = -0.05 dB

Peak SAR (extrapolated) = 0.361 W/kg

SAR(1 g) = 0.238 W/kg; SAR(10 g) = 0.147 W/kg

Maximum value of SAR (measured) = 0.380 W/kg

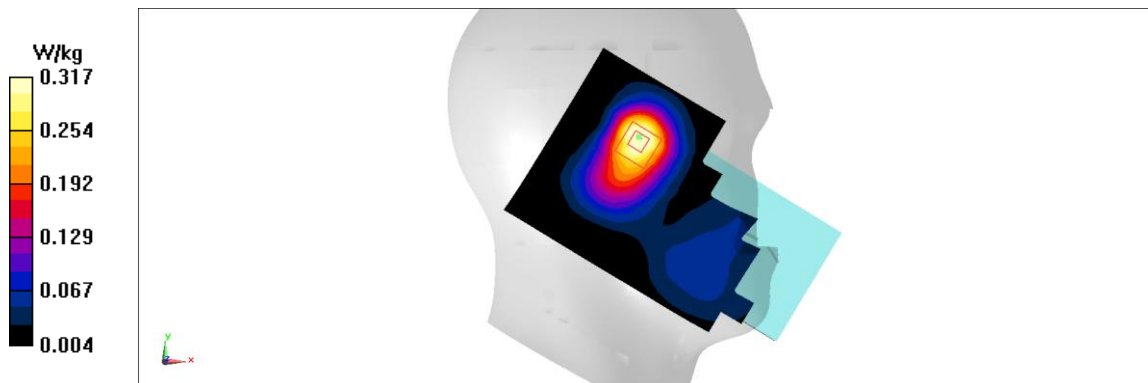

Fig A.11

LTE1900-FDD2_CH19100 1RB-Middle Bottom Edge 10mm

Date: 6/23/2020

Electronics: DAE4 Sn777

Medium: body 1900 MHz

Medium parameters used: $f = 1900$ MHz; $\sigma = 1.525$ mho/m; $\epsilon_r = 53.21$; $\rho = 1000$ kg/m³

Ambient Temperature: 22.5°C, Liquid Temperature: 22.3°C

Communication System: LTE1900-FDD2 1900 MHz Duty Cycle: 1:1

Probe: EX3DV4 – SN3617 ConvF(8.14,8.14,8.14)

Area Scan (71x121x1): Interpolated grid: dx=1.000 mm, dy=1.000 mm

Maximum value of SAR (interpolated) = 1.6 W/kg

Zoom Scan (7x7x7)/Cube 0: Measurement grid: dx=5mm, dy=5mm, dz=5mm

Reference Value = 33.13 V/m; Power Drift = -0.14 dB

Peak SAR (extrapolated) = 2.02 W/kg

SAR(1 g) = 1.06 W/kg; SAR(10 g) = 0.539 W/kg

Maximum value of SAR (measured) = 1.39 W/kg

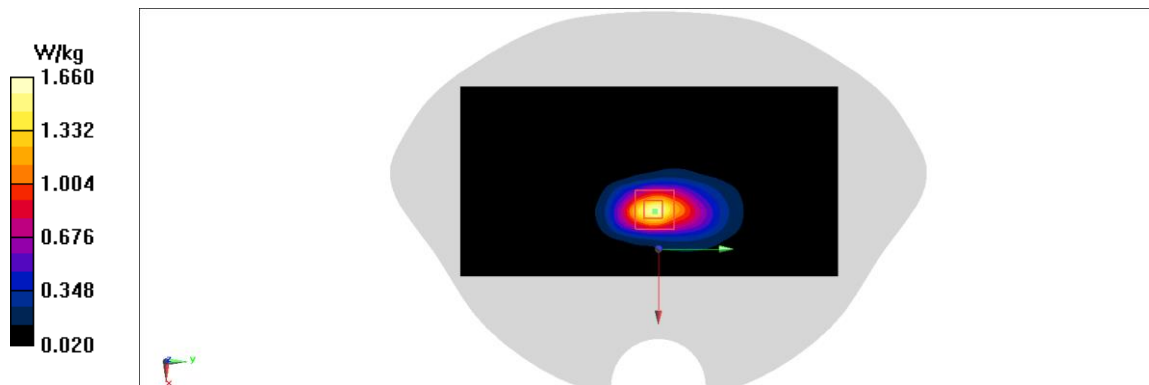

Fig A.12

LTE850-FDD5_CH20450 Right Cheek 1RB-Middle

Date: 6/21/2020

Electronics: DAE4 Sn777

Medium: head 835 MHz

Medium parameters used: $f = 829$ MHz; $\sigma = 0.878$ mho/m; $\epsilon_r = 41.46$; $\rho = 1000$ kg/m³

Ambient Temperature: 22.5°C, Liquid Temperature: 22.3°C

Communication System: LTE850-FDD5 829 MHz Duty Cycle: 1:1

Probe: EX3DV4 – SN3617 ConvF(9.66,9.66,9.66)

Area Scan (71x121x1): Interpolated grid: dx=1.000 mm, dy=1.000 mm

Maximum value of SAR (interpolated) = 0.193 W/kg

Zoom Scan (7x7x7)/Cube 0: Measurement grid: dx=5mm, dy=5mm, dz=5mm

Reference Value = 4.046 V/m; Power Drift = 0 dB

Peak SAR (extrapolated) = 0.212 W/kg

SAR(1 g) = 0.161 W/kg; SAR(10 g) = 0.125 W/kg

Maximum value of SAR (measured) = 0.214 W/kg

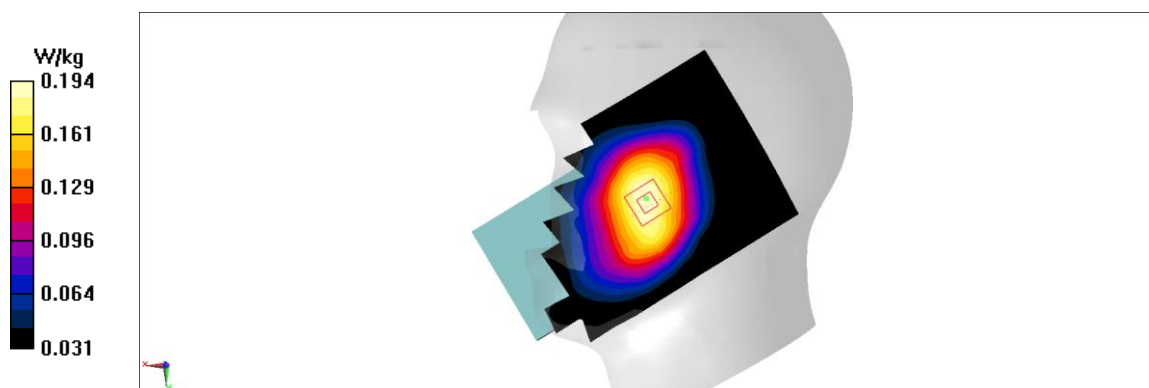

Fig A.13

LTE850-FDD5_CH20450 1RB-Middle Rear 10mm

Date: 6/21/2020

Electronics: DAE4 Sn777

Medium: body 835 MHz

Medium parameters used: $f = 829$ MHz; $\sigma = 0.968$ mho/m; $\epsilon_r = 54.76$; $\rho = 1000$ kg/m³

Ambient Temperature: 22.5°C, Liquid Temperature: 22.3°C

Communication System: LTE850-FDD5 829 MHz Duty Cycle: 1:1

Probe: EX3DV4 – SN3617 ConvF(9.66,9.66,9.66)

Area Scan (71x121x1): Interpolated grid: dx=1.000 mm, dy=1.000 mm

Maximum value of SAR (interpolated) = 0.35 W/kg

Zoom Scan (7x7x7)/Cube 0: Measurement grid: dx=5mm, dy=5mm, dz=5mm

Reference Value = 18.66 V/m; Power Drift = 0.03 dB

Peak SAR (extrapolated) = 0.463 W/kg

SAR(1 g) = 0.242 W/kg; SAR(10 g) = 0.143 W/kg

Maximum value of SAR (measured) = 0.371 W/kg

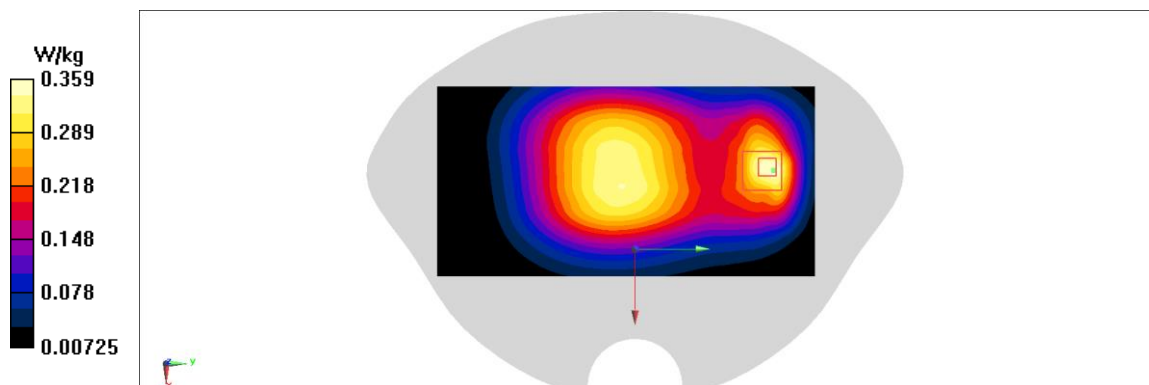

Fig A.14

LTE2500-FDD7_CH21350 Right Cheek 1RB-Middle

Date: 6/25/2020

Electronics: DAE4 Sn777

Medium: head 2600 MHz

Medium parameters used: $f = 2560$ MHz; $\sigma = 1.918$ mho/m; $\epsilon_r = 38.51$; $\rho = 1000$ kg/m³

Ambient Temperature: 22.5°C, Liquid Temperature: 22.3°C

Communication System: LTE2500-FDD7 2560 MHz Duty Cycle: 1:1

Probe: EX3DV4 – SN3617 ConvF(7.52,7.52,7.52)

Area Scan (71x121x1): Interpolated grid: dx=1.000 mm, dy=1.000 mm

Maximum value of SAR (interpolated) = 0.233 W/kg

Zoom Scan (7x7x7)/Cube 0: Measurement grid: dx=5mm, dy=5mm, dz=5mm

Reference Value = 2.258 V/m; Power Drift = 0.03 dB

Peak SAR (extrapolated) = 0.27 W/kg

SAR(1 g) = 0.149 W/kg; SAR(10 g) = 0.076 W/kg

Maximum value of SAR (measured) = 0.250 W/kg

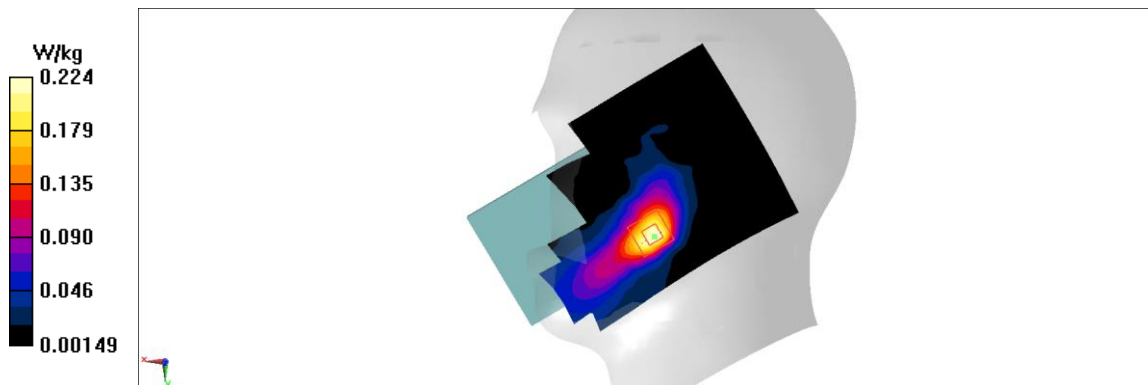

Fig A.15

LTE2500-FDD7_CH21350 1RB-Middle Rear 10mm

Date: 6/25/2020

Electronics: DAE4 Sn777

Medium: body 2600 MHz

Medium parameters used: $f = 2560$ MHz; $\sigma = 2.11$ mho/m; $\epsilon_r = 52.98$; $\rho = 1000$ kg/m³

Ambient Temperature: 22.5°C, Liquid Temperature: 22.3°C

Communication System: LTE2500-FDD7 2560 MHz Duty Cycle: 1:1

Probe: EX3DV4 – SN3617 ConvF(7.65,7.65,7.65)

Area Scan (71x121x1): Interpolated grid: dx=1.000 mm, dy=1.000 mm

Maximum value of SAR (interpolated) = 1.07 W/kg

Zoom Scan (7x7x7)/Cube 0: Measurement grid: dx=5mm, dy=5mm, dz=5mm

Reference Value = 3.483 V/m; Power Drift = -0.02 dB

Peak SAR (extrapolated) = 1.38 W/kg

SAR(1 g) = 0.67 W/kg; SAR(10 g) = 0.287 W/kg

Maximum value of SAR (measured) = 1.11 W/kg

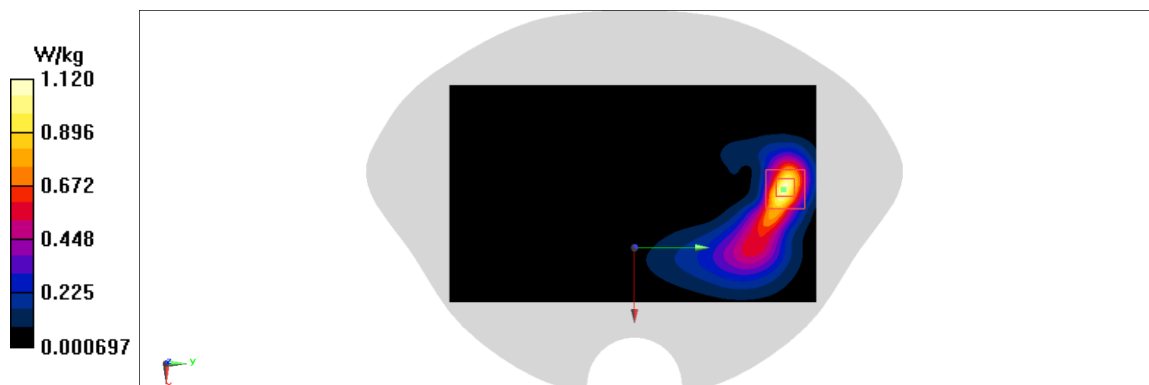

Fig A.16

LTE700-FDD12_CH23060 Right Cheek 1RB-Middle

Date: 6/20/2020

Electronics: DAE4 Sn777

Medium: head 750 MHz

Medium parameters used: $f = 704$ MHz; $\sigma = 0.853$ mho/m; $\epsilon_r = 42.13$; $\rho = 1000$ kg/m³

Ambient Temperature: 22.5°C, Liquid Temperature: 22.3°C

Communication System: LTE700-FDD12 704 MHz Duty Cycle: 1:1

Probe: EX3DV4 – SN3617 ConvF(10.07,10.07,10.07)

Area Scan (71x121x1): Interpolated grid: dx=1.000 mm, dy=1.000 mm

Maximum value of SAR (interpolated) = 0.166 W/kg

Zoom Scan (7x7x7)/Cube 0: Measurement grid: dx=5mm, dy=5mm, dz=5mm

Reference Value = 3.974 V/m; Power Drift = 0.07 dB

Peak SAR (extrapolated) = 0.183 W/kg

SAR(1 g) = 0.168 W/kg; SAR(10 g) = 0.13 W/kg

Maximum value of SAR (measured) = 1.25 W/kg

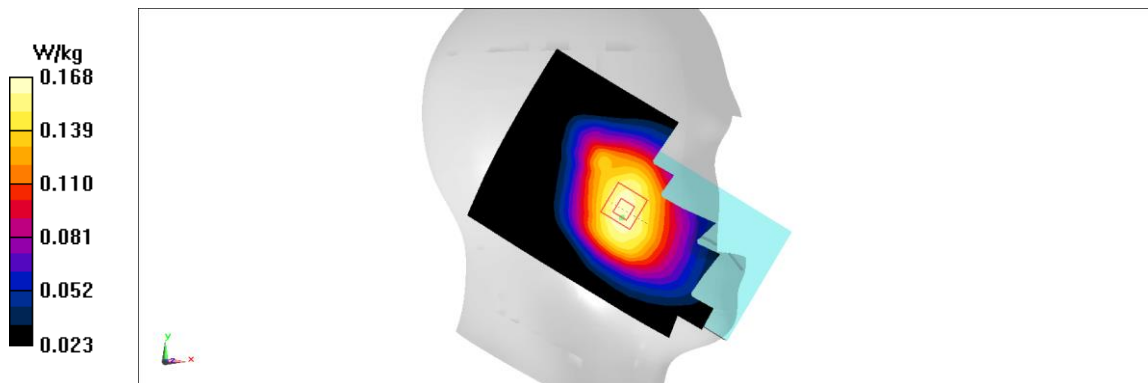

Fig A.17

LTE700-FDD12_CH23060 1RB-Middle Rear 10mm

Date: 6/20/2020

Electronics: DAE4 Sn777

Medium: body 750 MHz

Medium parameters used: $f = 704$ MHz; $\sigma = 0.917$ mho/m; $\epsilon_r = 55.09$; $\rho = 1000$ kg/m³

Ambient Temperature: 22.5°C, Liquid Temperature: 22.3°C

Communication System: LTE700-FDD12 704 MHz Duty Cycle: 1:1

Probe: EX3DV4 – SN3617 ConvF(10.07,10.07,10.07)

Area Scan (71x121x1): Interpolated grid: dx=1.000 mm, dy=1.000 mm

Maximum value of SAR (interpolated) = 0.346 W/kg

Zoom Scan (7x7x7)/Cube 0: Measurement grid: dx=5mm, dy=5mm, dz=5mm

Reference Value = 18.61 V/m; Power Drift = 0.08 dB

Peak SAR (extrapolated) = 0.392 W/kg

SAR(1 g) = 0.281 W/kg; SAR(10 g) = 0.214 W/kg

Maximum value of SAR (measured) = 0.391 W/kg

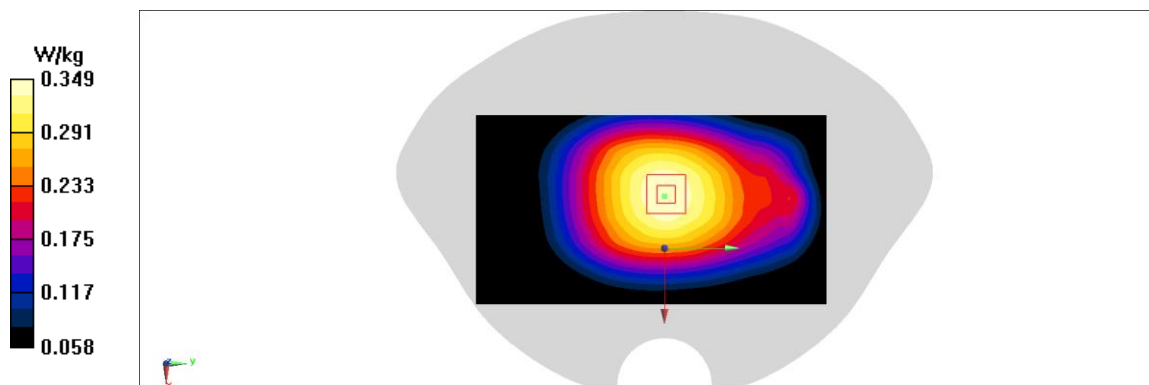

Fig A.18

LTE1700-FDD66_CH132072 Right Cheek 1RB-Middle

Date: 6/22/2020

Electronics: DAE4 Sn777

Medium: head 1750 MHz

Medium parameters used: $f = 728$ MHz; $\sigma = 0.403$ mho/m; $\epsilon_r = 40.67$; $\rho = 1000$ kg/m³

Ambient Temperature: 22.5°C, Liquid Temperature: 22.3°C

Communication System: LTE1700-FDD66 728 MHz Duty Cycle: 1:1

Probe: EX3DV4 – SN3617 ConvF(8.41,8.41,8.41)

Area Scan (71x121x1): Interpolated grid: dx=1.000 mm, dy=1.000 mm

Maximum value of SAR (interpolated) = 0.278 W/kg

Zoom Scan (7x7x7)/Cube 0: Measurement grid: dx=5mm, dy=5mm, dz=5mm

Reference Value = 2.627 V/m; Power Drift = -0.07 dB

Peak SAR (extrapolated) = 0.315 W/kg

SAR(1 g) = 0.205 W/kg; SAR(10 g) = 0.131 W/kg

Maximum value of SAR (measured) = 0.294 W/kg

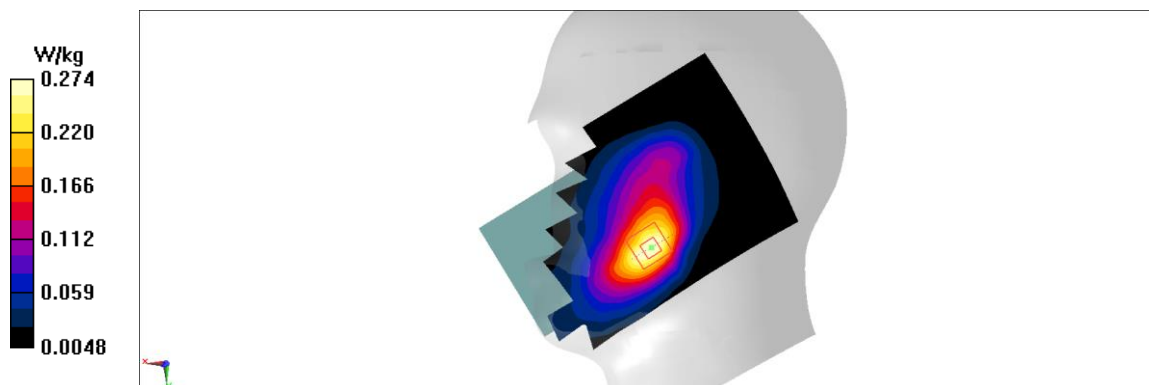

Fig A.19

LTE1700-FDD66_CH132072 1RB-Middle Front 10mm

Date: 6/22/2020

Electronics: DAE4 Sn777

Medium: body 1750 MHz

Medium parameters used: $f = 728$ MHz; $\sigma = 0.495$ mho/m; $\epsilon_r = 55.27$; $\rho = 1000$ kg/m³

Ambient Temperature: 22.5°C, Liquid Temperature: 22.3°C

Communication System: LTE1700-FDD66 728 MHz Duty Cycle: 1:1

Probe: EX3DV4 – SN3617 ConvF(8.41,8.41,8.41)

Area Scan (71x121x1): Interpolated grid: dx=1.000 mm, dy=1.000 mm

Maximum value of SAR (interpolated) = 1.63 W/kg

Zoom Scan (7x7x7)/Cube 0: Measurement grid: dx=5mm, dy=5mm, dz=5mm

Reference Value = 8.954 V/m; Power Drift = 0.07 dB

Peak SAR (extrapolated) = 2.14 W/kg

SAR(1 g) = 1.13 W/kg; SAR(10 g) = 0.6 W/kg

Maximum value of SAR (measured) = 1.45 W/kg

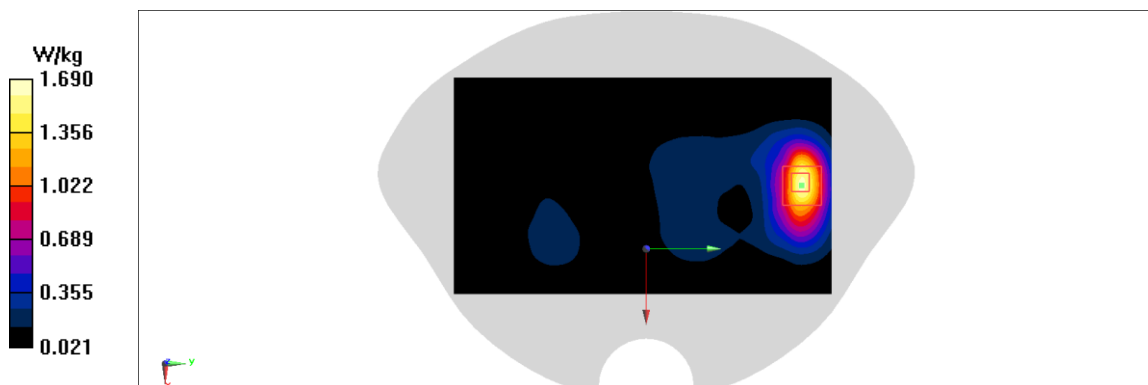
**Fig A.20**

WLAN2450_CH6 Left Tilt

Date: 6/24/2020

Electronics: DAE4 Sn777

Medium: head 2450 MHz

Medium parameters used: $f = 2437$; $\sigma = 1.788$ mho/m; $\epsilon_r = 38.6$; $\rho = 1000$ kg/m³

Ambient Temperature: 22.5°C, Liquid Temperature: 22.3°C

Communication System: WLAN2450 2437 Duty Cycle: 1:1

Probe: EX3DV4 – SN3617 ConvF(7.65,7.65,7.65)

Area Scan (71x121x1): Interpolated grid: dx=1.000 mm, dy=1.000 mm

Maximum value of SAR (interpolated) = 1.15 W/kg

Zoom Scan (7x7x7)/Cube 0: Measurement grid: dx=5mm, dy=5mm, dz=5mm

Reference Value = 8.668 V/m; Power Drift = 0.04 dB

Peak SAR (extrapolated) = 1.36 W/kg

SAR(1 g) = 0.658 W/kg; SAR(10 g) = 0.323 W/kg

Maximum value of SAR (measured) = 1.00 W/kg

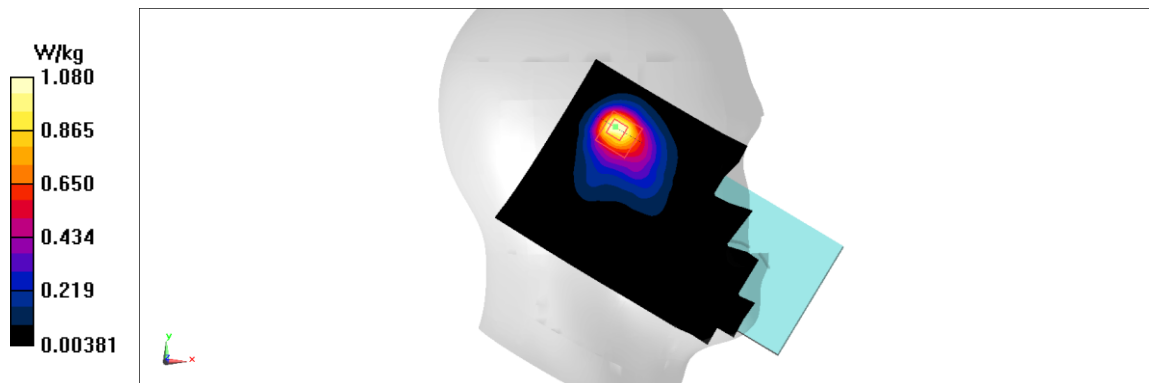

Fig A.21

WLAN2450_CH6 Rear 10mm

Date: 6/24/2020

Electronics: DAE4 Sn777

Medium: body 2450 MHz

Medium parameters used: $f = 2437$; $\sigma = 1.929$ mho/m; $\epsilon_r = 53.32$; $\rho = 1000$ kg/m³

Ambient Temperature: 22.5°C, Liquid Temperature: 22.3°C

Communication System: WLAN2450 2437 Duty Cycle: 1:1

Probe: EX3DV4 – SN3617 ConvF(7.65,7.65,7.65)

Area Scan (71x121x1): Interpolated grid: dx=1.000 mm, dy=1.000 mm

Maximum value of SAR (interpolated) = 0.291 W/kg

Zoom Scan (7x7x7)/Cube 0: Measurement grid: dx=5mm, dy=5mm, dz=5mm

Reference Value = 5.774 V/m; Power Drift = -0.12 dB

Peak SAR (extrapolated) = 0.34 W/kg

SAR(1 g) = 0.167 W/kg; SAR(10 g) = 0.087 W/kg

Maximum value of SAR (measured) = 0.310 W/kg

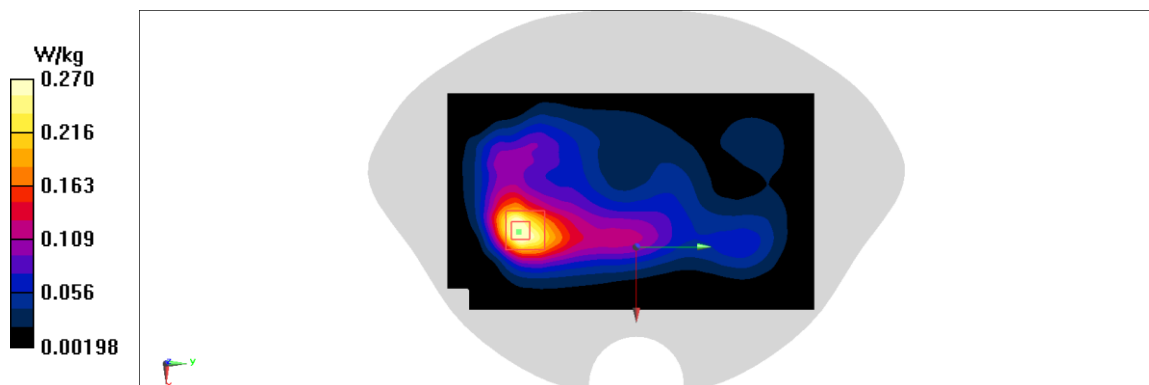

Fig A.22

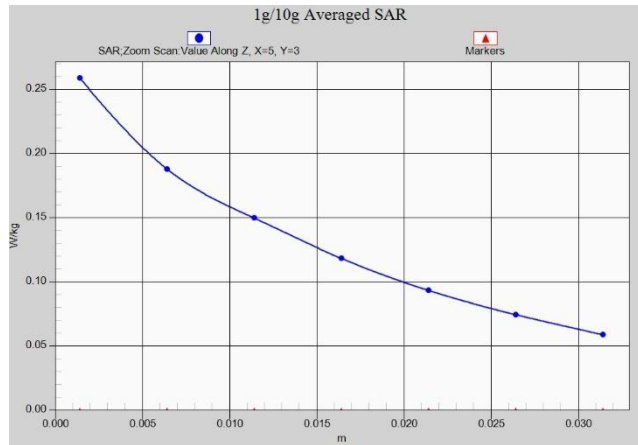

Fig. 1-1 Z-Scan at power reference point (WCDMA850)

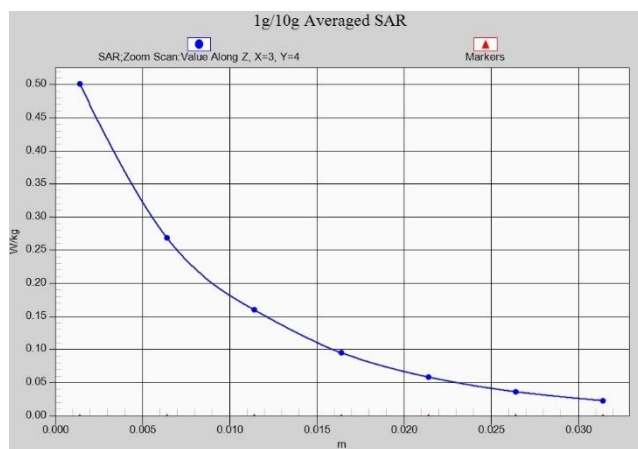

Fig. 1-2 Z-Scan at power reference point (WCDMA850)

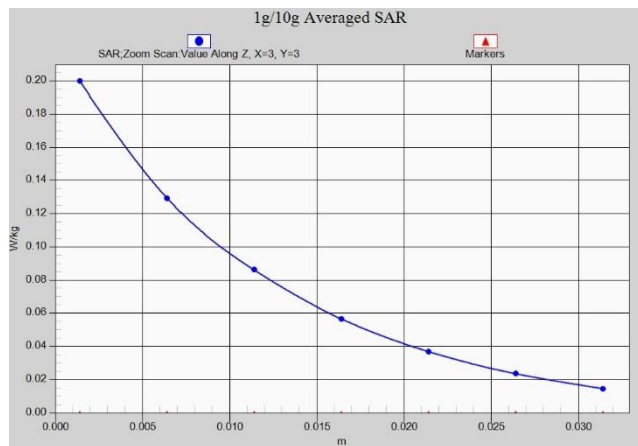

Fig. 1-3 Z-Scan at power reference point (WCDMA1900)

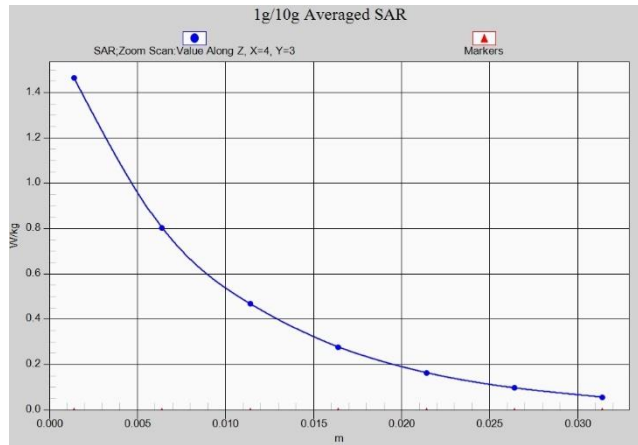

Fig. 1-4 Z-Scan at power reference point (WCDMA1900)

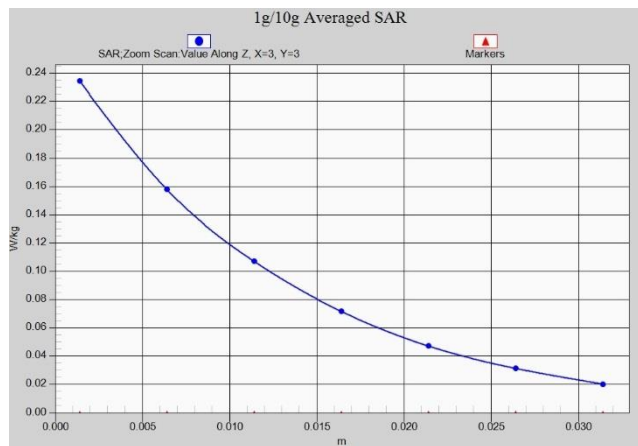

Fig. 1-5 Z-Scan at power reference point (WCDMA1700)

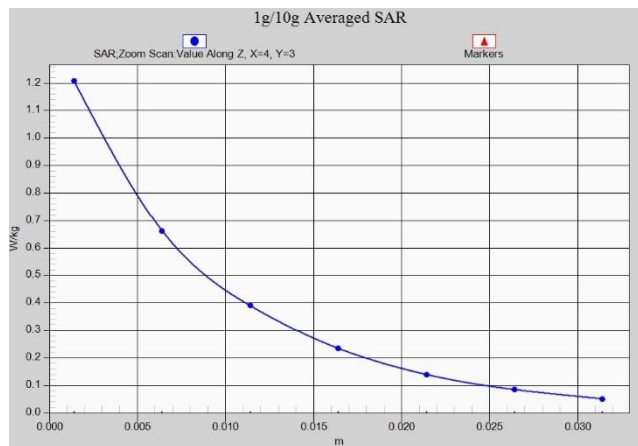

Fig. 1-6 Z-Scan at power reference point (WCDMA1700)

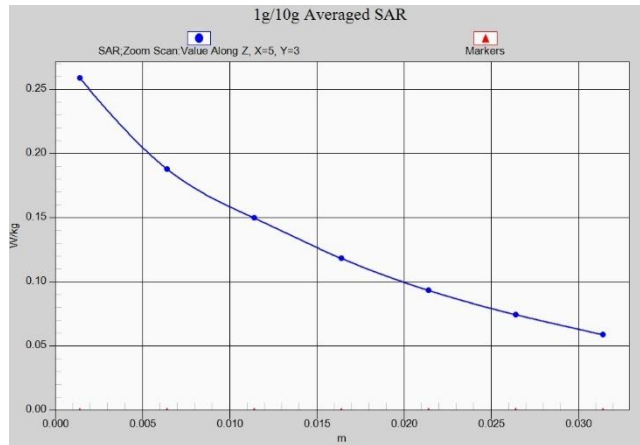

Fig. 1-7 Z-Scan at power reference point (GSM850)

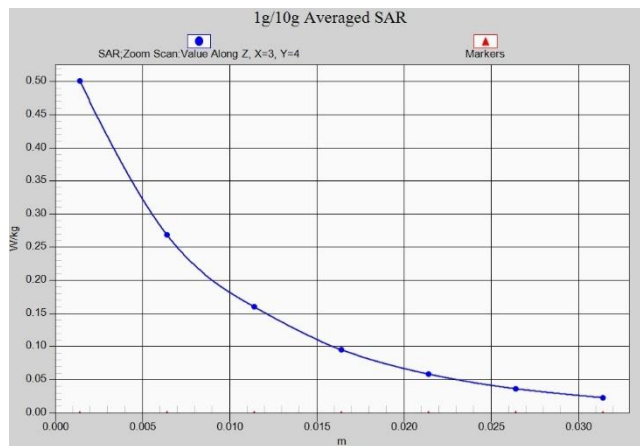

Fig. 1-8 Z-Scan at power reference point (GSM850)

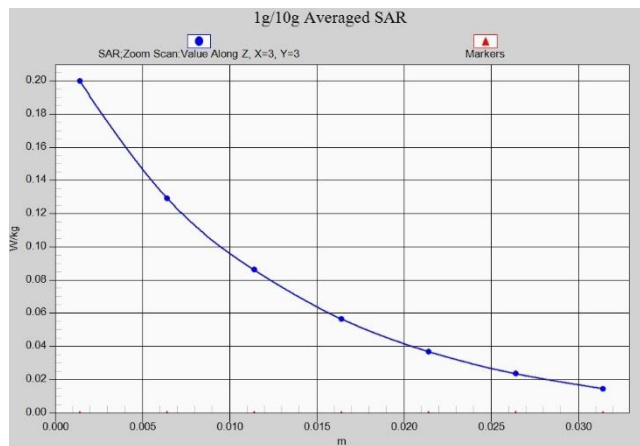

Fig. 1-9 Z-Scan at power reference point (GSM1900)

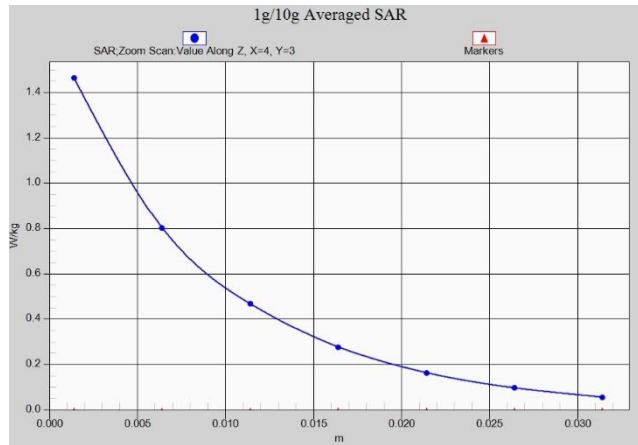

Fig. 1-10 Z-Scan at power reference point (GSM1900)

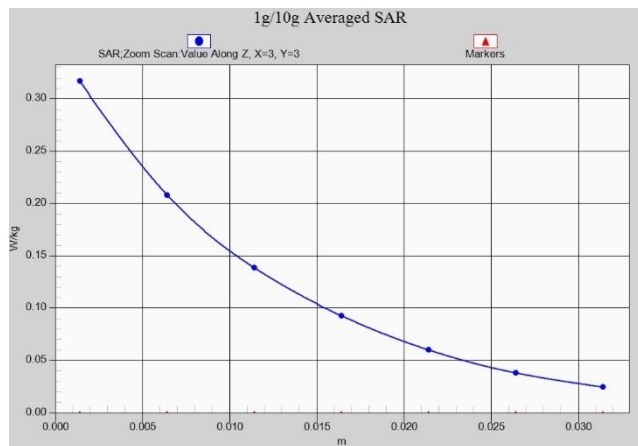

Fig. 1-11 Z-Scan at power reference point (LTE Band2)

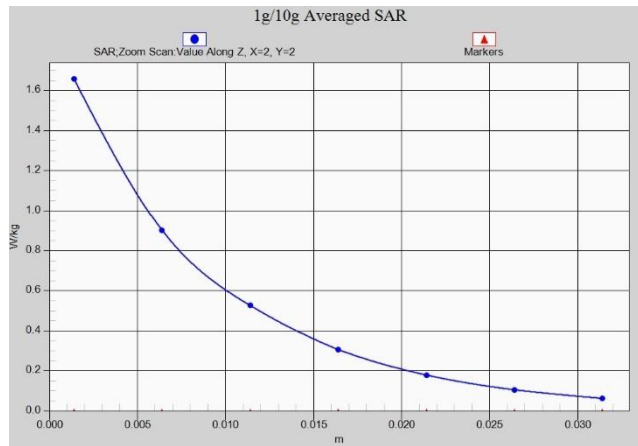

Fig. 1-12 Z-Scan at power reference point (LTE Band2)

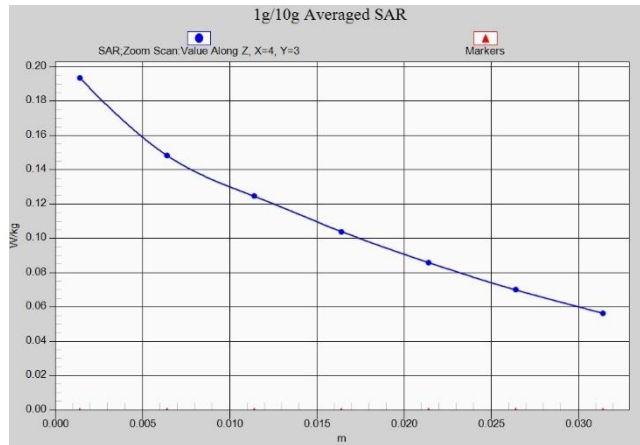

Fig. 1-13 Z-Scan at power reference point (LTE Band5)

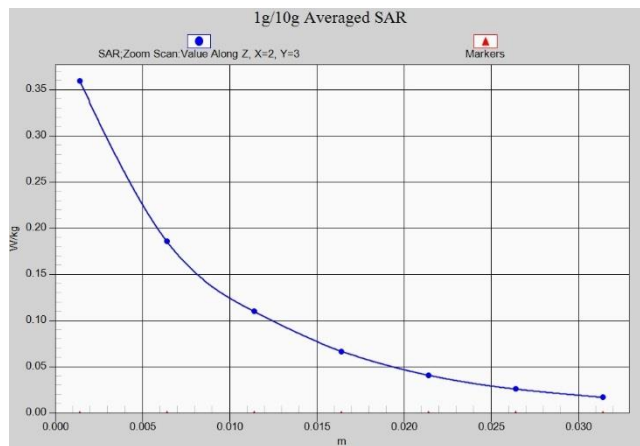

Fig. 1-14 Z-Scan at power reference point (LTE Band5)

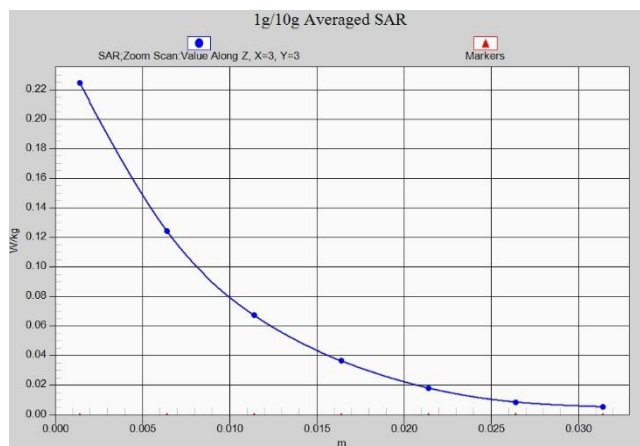

Fig. 1-15 Z-Scan at power reference point (LTE Band7)

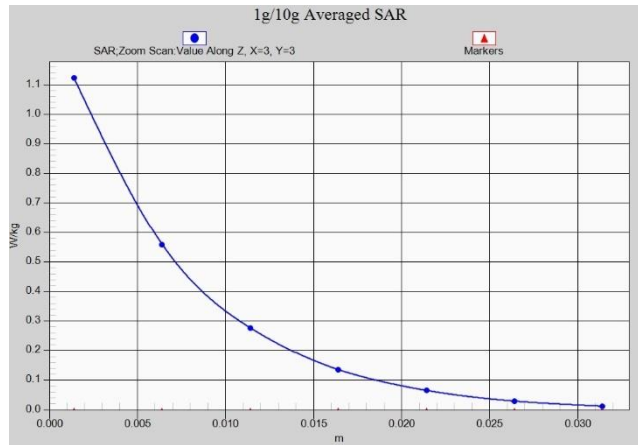

Fig. 1-16 Z-Scan at power reference point (LTE Band7)



Fig. 1-17 Z-Scan at power reference point (LTE Band12)

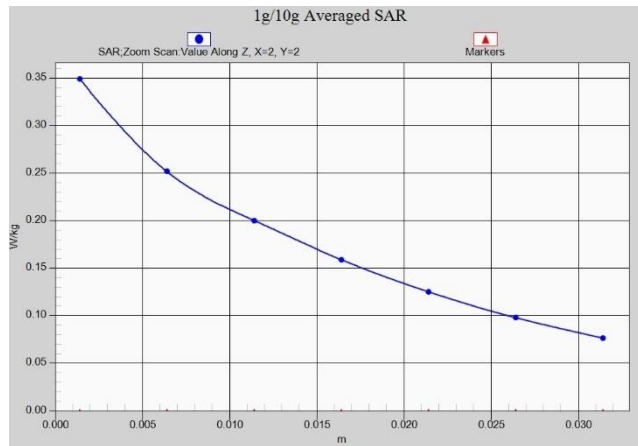

Fig. 1-18 Z-Scan at power reference point (LTE Band12)

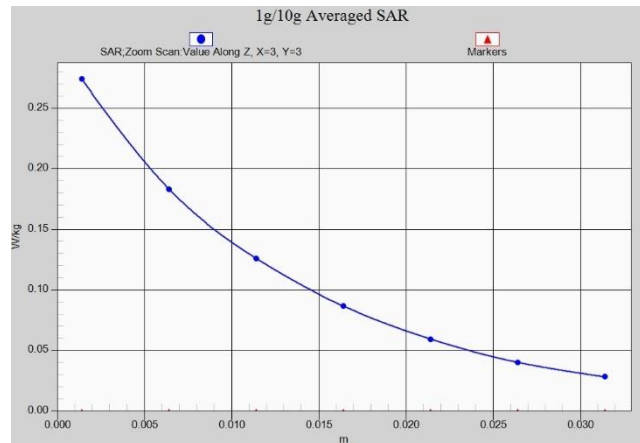

Fig. 1-19 Z-Scan at power reference point (LTE Band66)

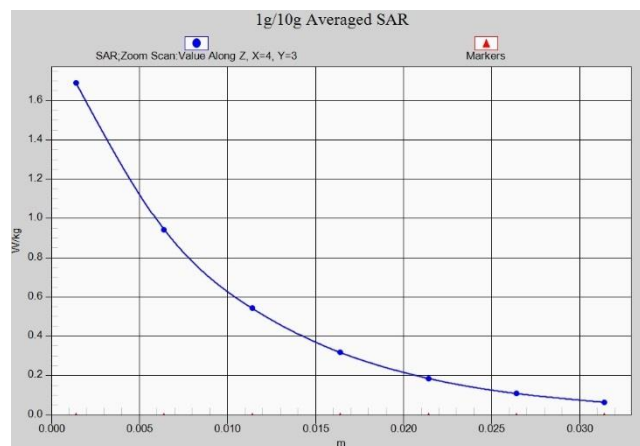

Fig. 1-20 Z-Scan at power reference point (LTE Band66)

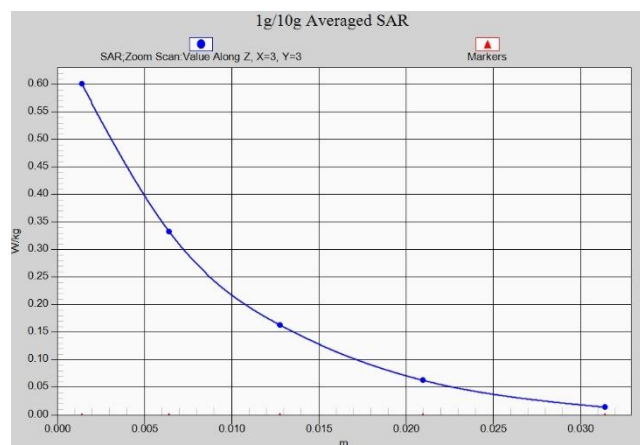

Fig. 1-21 Z-Scan at power reference point (2450 MHz)

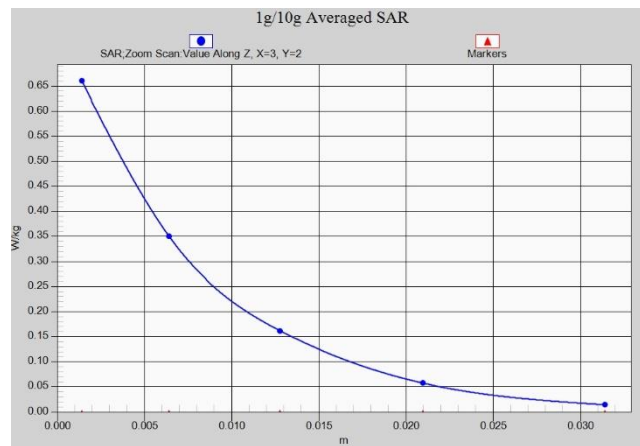

Fig. 1-22 Z-Scan at power reference point (2450 MHz)

ANNEX B System Verification Results

750 MHz

Date: 6/20/2020

Electronics: DAE4 Sn777

Medium: Head 750 MHz

Medium parameters used: $f = 750 \text{ MHz}$; $\sigma = 0.898 \text{ mho/m}$; $\epsilon_r = 41.7$; $\rho = 1000 \text{ kg/m}^3$

Ambient Temperature: 22.5°C Liquid Temperature: 22.3°C

Communication System: CW Frequency: 750 MHz Duty Cycle: 1:1

Probe: EX3DV4 – SN3617 ConvF(10.07,10.07,10.07)

System Validation /Area Scan (81x191x1): Interpolated grid: $dx=1.000 \text{ mm}$, $dy=1.000 \text{ mm}$

Reference Value = 60.78 V/m ; Power Drift = 0.03

Fast SAR: SAR(1 g) = 2.11 W/kg ; SAR(10 g) = 1.42 W/kg

Maximum value of SAR (interpolated) = 2.78 W/kg

System Validation /Zoom Scan (7x7x7)/Cube 0: Measurement grid: $dx=5\text{mm}$, $dy=5\text{mm}$, $dz=5\text{mm}$

Reference Value = 60.78 V/m ; Power Drift = 0.03 dB

Peak SAR (extrapolated) = 3.16 W/kg

SAR(1 g) = 2.14 W/kg ; SAR(10 g) = 1.38 W/kg

Maximum value of SAR (measured) = 2.83 W/kg

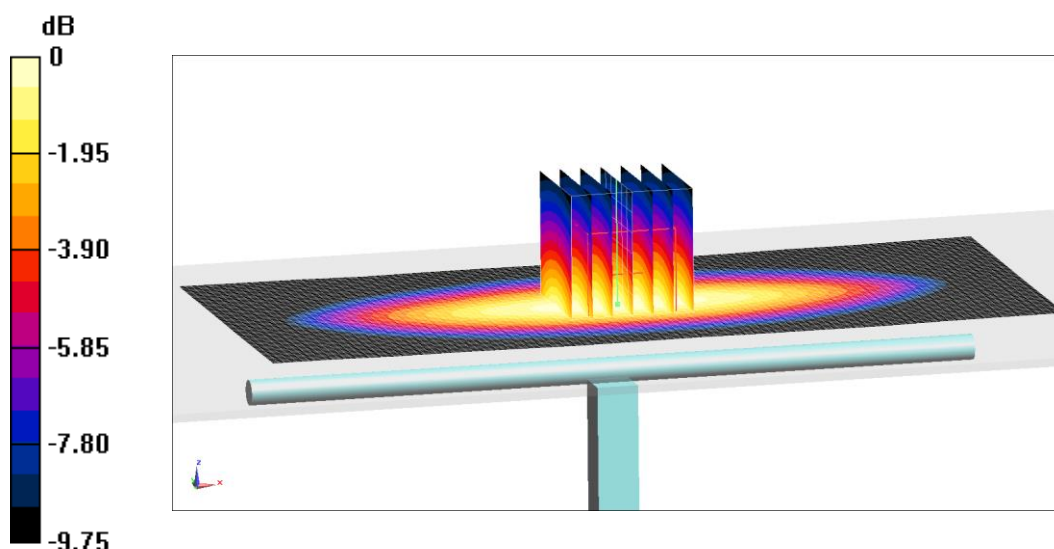

0 dB = $2.83 \text{ W/kg} = 4.52 \text{ dB W/kg}$

Fig.B.1 validation 750 MHz 250mW

835 MHz

Date: 6/21/2020

Electronics: DAE4 Sn777

Medium: Head 835 MHz

Medium parameters used: $f = 835 \text{ MHz}$; $\sigma = 0.901 \text{ mho/m}$; $\epsilon_r = 41.6$; $\rho = 1000 \text{ kg/m}^3$

Ambient Temperature: 22.5°C Liquid Temperature: 22.3°C

Communication System: CW Frequency: 835 MHz Duty Cycle: 1:1

Probe: EX3DV4 – SN3617 ConvF(9.66,9.66,9.66)

System Validation /Area Scan (81x191x1): Interpolated grid: $dx=1.000 \text{ mm}$, $dy=1.000 \text{ mm}$

Reference Value = 63.88 V/m; Power Drift = 0.04

Fast SAR: SAR(1 g) = 2.42 W/kg; SAR(10 g) = 1.56 W/kg

Maximum value of SAR (interpolated) = 3.16 W/kg

System Validation /Zoom Scan (7x7x7)/Cube 0: Measurement grid: $dx=5\text{mm}$, $dy=5\text{mm}$, $dz=5\text{mm}$

Reference Value =63.88 V/m; Power Drift = 0.04 dB

Peak SAR (extrapolated) = 3.62 W/kg

SAR(1 g) = 2.45 W/kg; SAR(10 g) = 1.57 W/kg

Maximum value of SAR (measured) = 3.26 W/kg

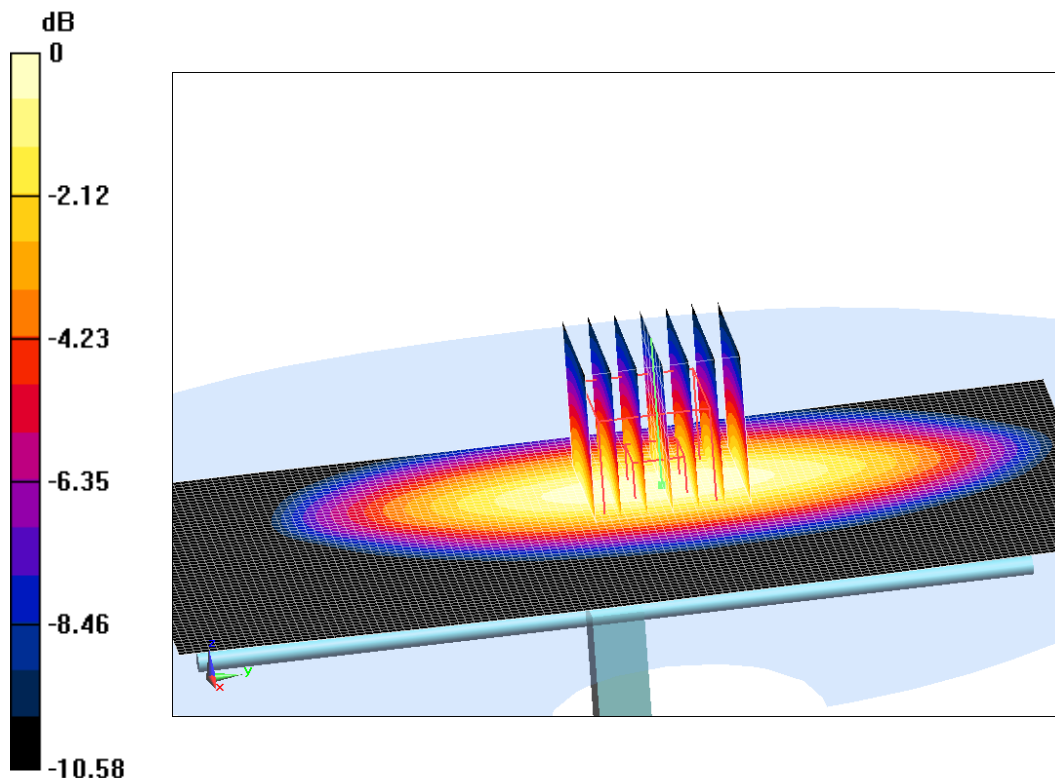

0 dB = 3.26 W/kg = 5.13 dB W/kg

Fig.B.2 validation 835 MHz 250mW

1750 MHz

Date: 6/22/2020

Electronics: DAE4 Sn777

Medium: Head 1750 MHz

Medium parameters used: $f = 1750$ MHz; $\sigma = 1.38$ mho/m; $\epsilon_r = 40.68$; $\rho = 1000$ kg/m³

Ambient Temperature: 22.5°C Liquid Temperature: 22.3°C

Communication System: CW Frequency: 1750 MHz Duty Cycle: 1:1

Probe: EX3DV4 – SN3617 ConvF(8.41,8.41,8.41)

System Validation /Area Scan (81x191x1): Interpolated grid: dx=1.000 mm, dy=1.000 mm

Reference Value = 104.5 V/m; Power Drift = 0.06

Fast SAR: SAR(1 g) = 9.03 W/kg; SAR(10 g) = 4.83 W/kg

Maximum value of SAR (interpolated) = 14.31 W/kg

System Validation /Zoom Scan (7x7x7)/Cube 0: Measurement grid: dx=5mm, dy=5mm, dz=5mm

Reference Value = 104.5 V/m; Power Drift = 0.06 dB

Peak SAR (extrapolated) = 16.53 W/kg

SAR(1 g) = 9.01 W/kg; SAR(10 g) = 4.85 W/kg

Maximum value of SAR (measured) = 13.9 W/kg

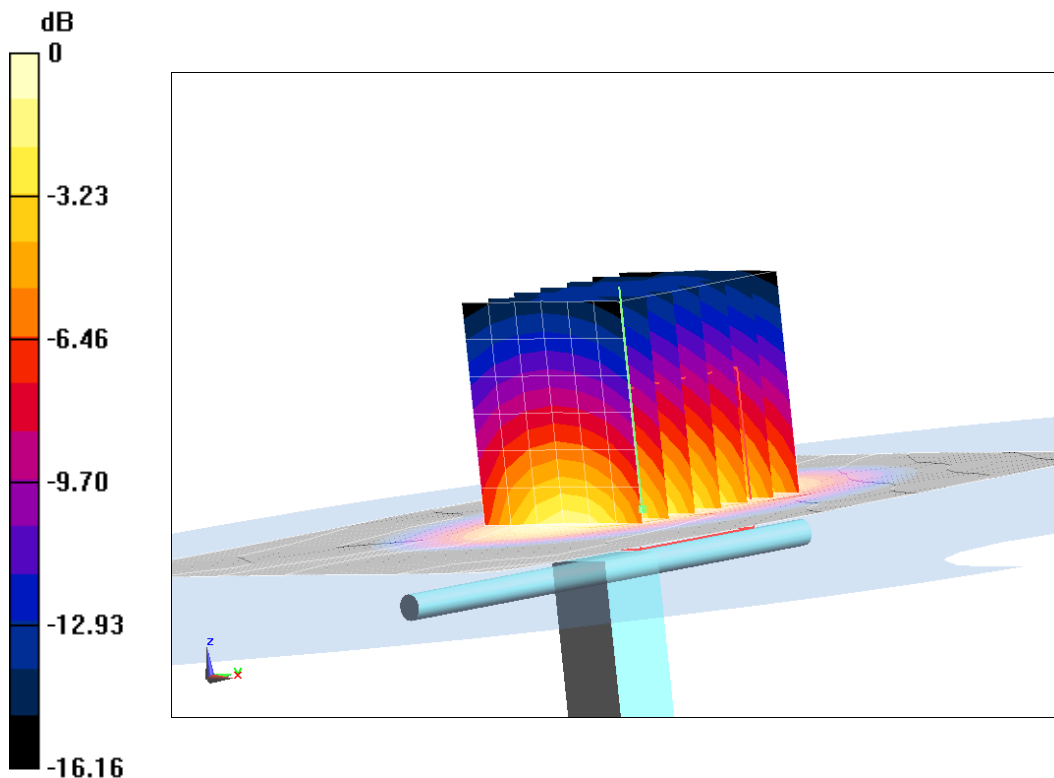

0 dB = 13.9 W/kg = 11.43 dB W/kg

Fig.B.3 validation 1750 MHz 250mW

1900 MHz

Date: 6/23/2020

Electronics: DAE4 Sn777

Medium: Head 1900 MHz

Medium parameters used: $f = 1900$ MHz; $\sigma = 1.39$ mho/m; $\epsilon_r = 39.55$; $\rho = 1000$ kg/m³

Ambient Temperature: 22.5°C Liquid Temperature: 22.3°C

Communication System: CW Frequency: 1900 MHz Duty Cycle: 1:1

Probe: EX3DV4 – SN3617 ConvF(8.14,8.14,8.14)

System Validation /Area Scan (81x191x1): Interpolated grid: dx=1.000 mm, dy=1.000 mm

Reference Value = 107.26 V/m; Power Drift = 0.02

Fast SAR: SAR(1 g) = 9.96 W/kg; SAR(10 g) = 5.2 W/kg

Maximum value of SAR (interpolated) = 15.34 W/kg

System Validation /Zoom Scan (7x7x7)/Cube 0: Measurement grid: dx=5mm, dy=5mm, dz=5mm

Reference Value = 107.26 V/m; Power Drift = 0.02 dB

Peak SAR (extrapolated) = 17.52 W/kg

SAR(1 g) = 10.07 W/kg; SAR(10 g) = 5.15 W/kg

Maximum value of SAR (measured) = 14.81 W/kg

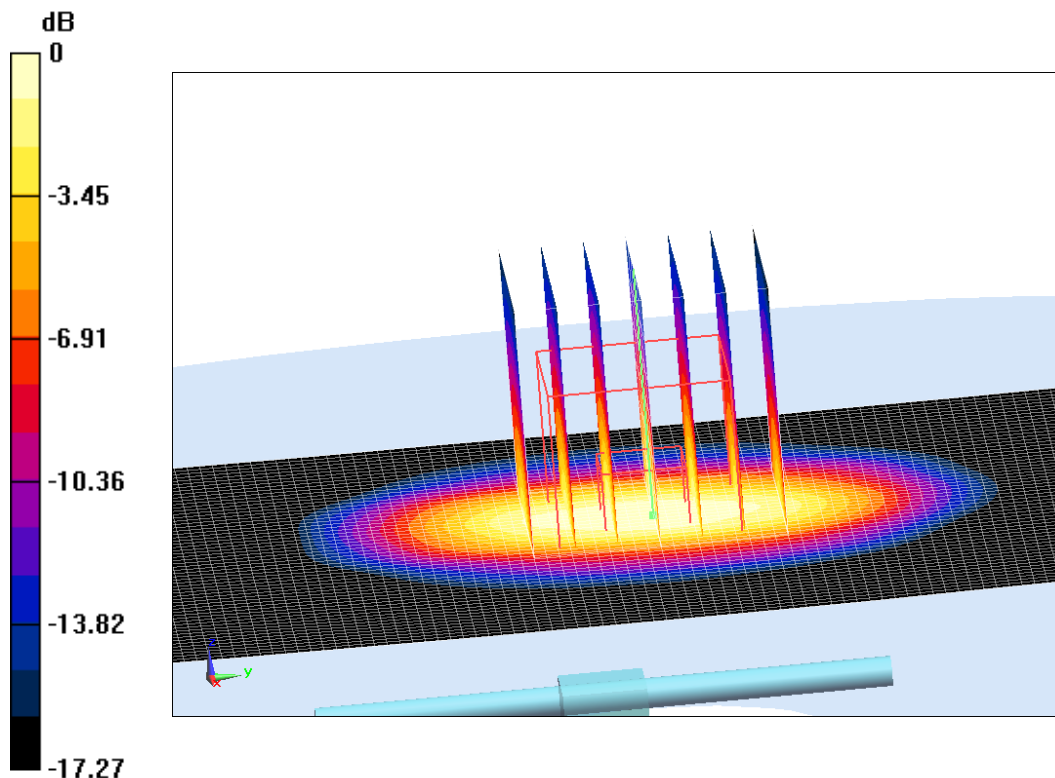

0 dB = 14.81 W/kg = 11.71 dB W/kg

Fig.B.4 validation 1900 MHz 250mW

2450 MHz

Date: 6/24/2020

Electronics: DAE4 Sn777

Medium: Head 2450 MHz

Medium parameters used: $f = 2450$ MHz; $\sigma = 1.784$ mho/m; $\epsilon_r = 39.05$; $\rho = 1000$ kg/m³

Ambient Temperature: 22.5°C Liquid Temperature: 22.3°C

Communication System: CW Frequency: 2450 MHz Duty Cycle: 1:1

Probe: EX3DV4 – SN3617 ConvF(7.65,7.65,7.65)

System Validation /Area Scan (81x191x1): Interpolated grid: dx=1.000 mm, dy=1.000 mm

Reference Value = 116.72 V/m; Power Drift = -0.08

Fast SAR: SAR(1 g) = 12.8 W/kg; SAR(10 g) = 5.97 W/kg

Maximum value of SAR (interpolated) = 21.99 W/kg

System Validation /Zoom Scan (7x7x7)/Cube 0: Measurement grid: dx=5mm, dy=5mm, dz=5mm

Reference Value = 116.72 V/m; Power Drift = -0.08 dB

Peak SAR (extrapolated) = 25.53 W/kg

SAR(1 g) = 13.14 W/kg; SAR(10 g) = 6.16 W/kg

Maximum value of SAR (measured) = 21.92 W/kg

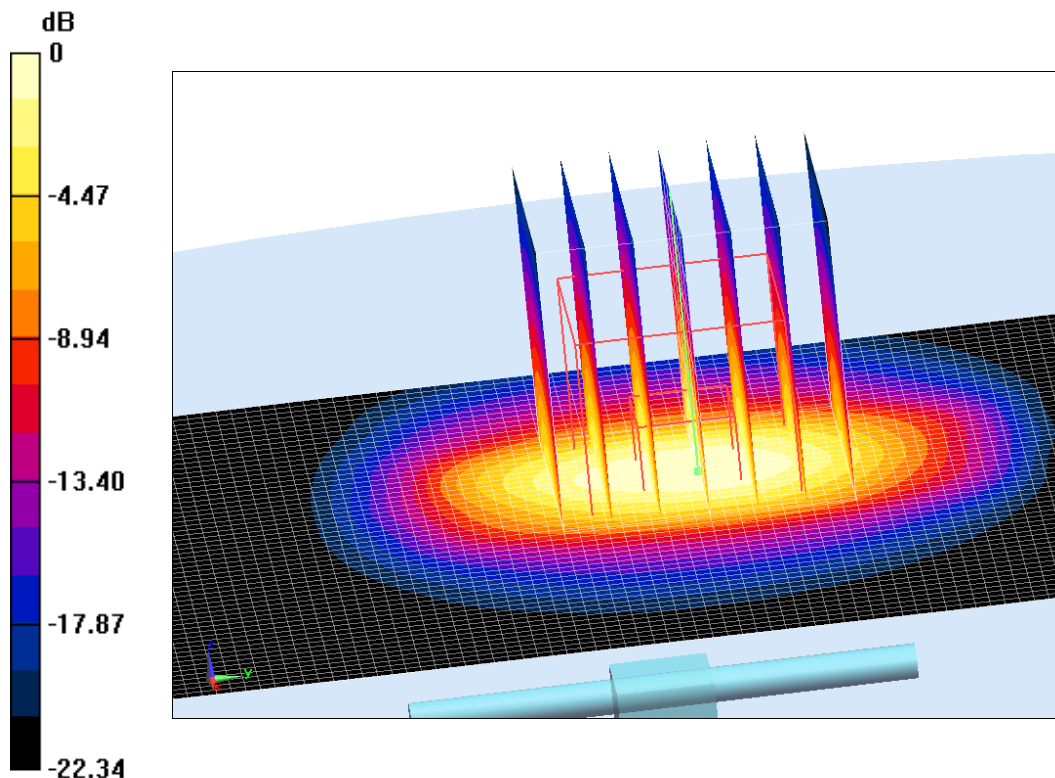

0 dB = 21.92 W/kg = 13.41 dB W/kg

Fig.B.5 validation 2450 MHz 250mW

2600 MHz

Date: 6/25/2020

Electronics: DAE4 Sn777

Medium: Head 2600 MHz

Medium parameters used: $f = 2600$ MHz; $\sigma = 1.966$ mho/m; $\epsilon_r = 39.57$; $\rho = 1000$ kg/m³

Ambient Temperature: 22.5°C Liquid Temperature: 22.3°C

Communication System: CW Frequency: 2600 MHz Duty Cycle: 1:1

Probe: EX3DV4 – SN3617 ConvF(7.52,7.52,7.52)

System Validation /Area Scan (81x191x1): Interpolated grid: dx=1.000 mm, dy=1.000 mm

Reference Value = 118.31 V/m; Power Drift = -0.05

Fast SAR: SAR(1 g) = 13.82 W/kg; SAR(10 g) = 6.2 W/kg

Maximum value of SAR (interpolated) = 25.14 W/kg

System Validation /Zoom Scan (7x7x7)/Cube 0: Measurement grid: dx=5mm, dy=5mm, dz=5mm

Reference Value = 118.31 V/m; Power Drift = -0.05 dB

Peak SAR (extrapolated) = 28.68 W/kg

SAR(1 g) = 14.17 W/kg; SAR(10 g) = 6.31 W/kg

Maximum value of SAR (measured) = 23.74 W/kg

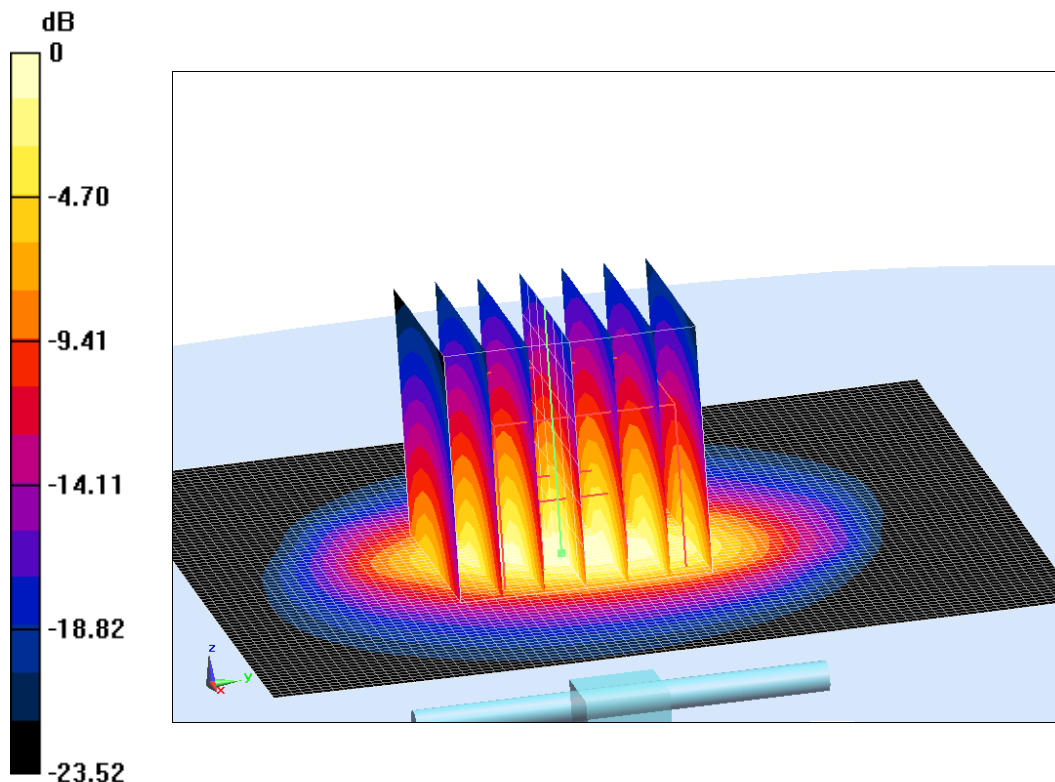

0 dB = 23.74 W/kg = 13.75 dB W/kg

Fig.B.6 validation 2600 MHz 250mW



The SAR system verification must be required that the area scan estimated 1-g SAR is within 3% of the zoom scan 1-g SAR.

Table B.1 Comparison between area scan and zoom scan for system verification

Date	Band	Position	Area scan (1g)	Zoom scan (1g)	Drift (%)
2020-6-15	750	Head	2.11	2.14	-1.40
2020-6-16	835	Head	2.42	2.45	-1.22
2020-6-17	1750	Head	9.03	9.01	0.22
2020-6-18	1900	Head	9.96	10.07	-1.09
2020-6-19	2450	Head	12.8	13.14	-2.59
2020-6-20	2600	Head	13.82	14.17	-2.47

ANNEX C SAR Measurement Setup

C.1 Measurement Set-up

The Dasy4 or DASY5 system for performing compliance tests is illustrated above graphically. This system consists of the following items:

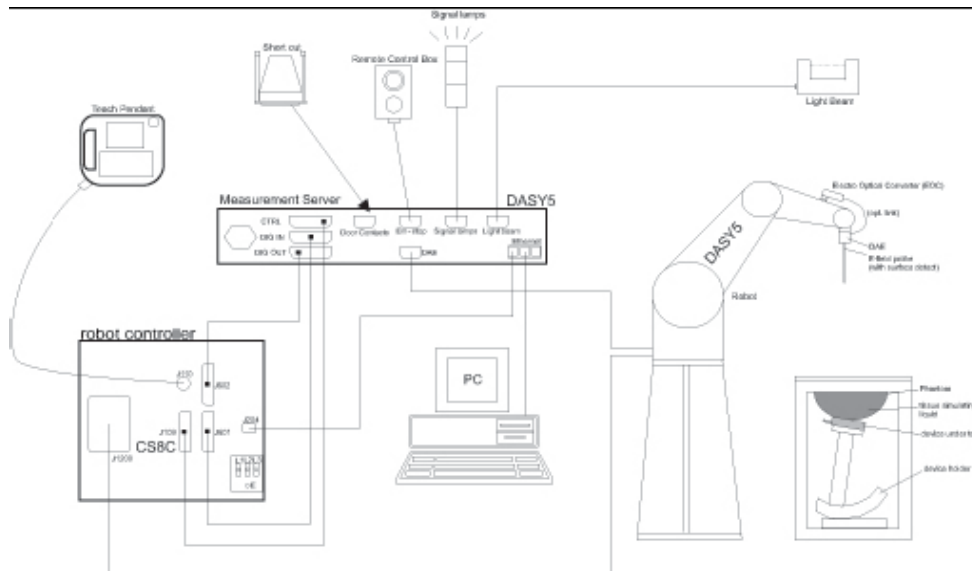

Picture C.1 SAR Lab Test Measurement Set-up

- A standard high precision 6-axis robot (StäubliTX=RX family) with controller, teach pendant and software. An arm extension for accommodating the data acquisition electronics (DAE).
- An isotropic field probe optimized and calibrated for the targeted measurement.
- A data acquisition electronics (DAE) which performs the signal amplification, signal multiplexing, AD-conversion, offset measurements, mechanical surface detection, collision detection, etc. The unit is battery powered with standard or rechargeable batteries. The signal is optically transmitted to the EOC.
- The Electro-optical converter (EOC) performs the conversion from optical to electrical signals for the digital communication to the DAE. To use optical surface detection, a special version of the EOC is required. The EOC signal is transmitted to the measurement server.
- The function of the measurement server is to perform the time critical tasks such as signal filtering, control of the robot operation and fast movement interrupts.
- The Light Beam used is for probe alignment. This improves the (absolute) accuracy of the probe positioning.
- A computer running WinXP and the DASY4 or DASY5 software.
- Remote control and teach pendant as well as additional circuitry for robot safety such as warning lamps, etc.
- The phantom, the device holder and other accessories according to the targeted measurement.

C.2 Dasy4 or DASY5 E-field Probe System

The SAR measurements were conducted with the dosimetric probe designed in the classical triangular configuration and optimized for dosimetric evaluation. The probe is constructed using the thick film technique; with printed resistive lines on ceramic substrates. The probe is equipped with an optical multifiber line ending at the front of the probe tip. It is connected to the EOC box on the robot arm and provides an automatic detection of the phantom surface. Half of the fibers are connected to a pulsed infrared transmitter, the other half to a synchronized receiver. As the probe approaches the surface, the reflection from the surface produces a coupling from the transmitting to the receiving fibers. This reflection increases first during the approach, reaches maximum and then decreases. If the probe is flatly touching the surface, the coupling is zero. The distance of the coupling maximum to the surface is independent of the surface reflectivity and largely independent of the surface to probe angle. The DASY4 or DASY5 software reads the reflection during a software approach and looks for the maximum using 2nd ord curve fitting. The approach is stopped at reaching the maximum.

Probe Specifications:

Model:	ES3DV3, EX3DV4
Frequency	10MHz — 6.0GHz(EX3DV4)
Range:	10MHz — 4GHz(ES3DV3)
Calibration:	In head and body simulating tissue at Frequencies from 835 up to 5800MHz
Linearity:	± 0.2 dB(30 MHz to 6 GHz) for EX3DV4 ± 0.2 dB(30 MHz to 4 GHz) for ES3DV3
DynamicRange:	10 mW/kg — 100W/kg
Probe Length:	330 mm
Probe Tip	
Length:	20 mm
Body Diameter:	12 mm
Tip Diameter:	2.5 mm (3.9 mm for ES3DV3)
Tip-Center:	1 mm (2.0mm for ES3DV3)
Application:	SAR Dosimetry Testing Compliance tests of mobile phones Dosimetry in strong gradient fields



Picture C.2 Near-field Probe



Picture C.3 E-field Probe

C.3 E-field Probe Calibration

Each E-Probe/Probe Amplifier combination has unique calibration parameters. A TEM cell calibration procedure is conducted to determine the proper amplifier settings to enter in the probe parameters. The amplifier settings are determined for a given frequency by subjecting the probe to a known E-field density (1 mW/cm^2) using an RF Signal generator, TEM cell, and RF Power Meter.

The free space E-field from amplified probe outputs is determined in a test chamber. This calibration can be performed in a TEM cell if the frequency is below 1 GHz and in a waveguide or

other methodologies above 1 GHz for free space. For the free space calibration, the probe is placed in the volumetric center of the cavity and at the proper orientation with the field. The probe is then rotated 360 degrees until the three channels show the maximum reading. The power density readings equates to 1 mW/cm².

E-field temperature correlation calibration is performed in a flat phantom filled with the appropriate simulated brain tissue. The E-field in the medium correlates with the temperature rise in the dielectric medium. For temperature correlation calibration a RF transparent thermistor-based temperature probe is used in conjunction with the E-field probe.

$$SAR = C \frac{\Delta T}{\Delta t}$$

Where:

Δt = Exposure time (30 seconds),

C = Heat capacity of tissue (brain or muscle),

ΔT = Temperature increase due to RF exposure.

$$SAR = \frac{|E|^2 \cdot \sigma}{\rho}$$

Where:

σ = Simulated tissue conductivity,

ρ = Tissue density (kg/m³).

C.4 Other Test Equipment

C.4.1 Data Acquisition Electronics(DAE)

The data acquisition electronics consist of a highly sensitive electrometer-grade preamplifier with auto-zeroing, a channel and gain-switching multiplexer, a fast 16 bit AD-converter and a command decoder with a control logic unit. Transmission to the measurement server is accomplished through an optical downlink for data and status information, as well as an optical uplink for commands and the clock.

The mechanical probe mounting device includes two different sensor systems for frontal and sideways probe contacts. They are used for mechanical surface detection and probe collision detection.

The input impedance of the DAE is 200 MOhm; the inputs are symmetrical and floating. Common mode rejection is above 80 dB.



PictureC.4: DAE

C.4.2 Robot

The SPEAG DASY system uses the high precision robots (DASY4: RX90XL; DASY5: RX160L) type from Stäubli SA (France). For the 6-axis controller system, the robot controller version from Stäubli is used. The Stäubli robot series have many features that are important for our application:

- High precision (repeatability 0.02mm)
- High reliability (industrial design)
- Low maintenance costs (virtually maintenance free due to direct drive gears; no belt drives)
- Jerk-free straight movements (brushless synchron motors; no stepper motors)
- Low ELF interference (motor control fields shielded via the closed metallic construction shields)



Picture C.5 DASY 4



Picture C.6 DASY 5

C.4.3 Measurement Server

The Measurement server is based on a PC/104 CPU board with CPU (dasy4: 166 MHz, Intel Pentium; DASY5: 400 MHz, Intel Celeron), chipdisk (DASY4: 32 MB; DASY5: 128MB), RAM (DASY4: 64 MB, DASY5: 128MB). The necessary circuits for communication with the DAE electronic box, as well as the 16 bit AD converter system for optical detection and digital I/O interface are contained on the DASY I/O board, which is directly connected to the PC/104 bus of the CPU board.

The measurement server performs all real-time data evaluation of field measurements and surface detection, controls robot movements and handles safety operation. The PC operating system cannot interfere with these time critical processes. All connections are supervised by a watchdog, and disconnection of any of the cables to the measurement server will automatically disarm the robot and disable all program-controlled robot movements. Furthermore, the measurement server is equipped with an expansion port which is reserved for future applications. Please note that this expansion port does not have a standardized pinout, and therefore only devices provided by SPEAG can be connected. Devices from any other supplier could seriously damage the measurement server.



Picture C.7 Server for DASY 4



Picture C.8 Server for DASY 5

C.4.4 Device Holder for Phantom

The SAR in the phantom is approximately inversely proportional to the square of the distance between the source and the liquid surface. For a source at 5mm distance, a positioning uncertainty of $\pm 0.5\text{mm}$ would produce a SAR uncertainty of $\pm 20\%$. Accurate device positioning is therefore crucial for accurate and repeatable measurements. The positions in which the devices must be measured are defined by the standards.

The DASY device holder is designed to cope with the different positions given in the standard. It has two scales for device rotation (with respect to the body axis) and device inclination (with respect to the line between the ear reference points). The rotation centers for both scales are the ear reference point (ERP). Thus the device needs no repositioning when changing the angles.

The DASY device holder is constructed of low-loss POM material having the following dielectric parameters: relative permittivity $\epsilon = 3$ and loss tangent $\delta = 0.02$. The amount of dielectric material has been reduced in the closest vicinity of the device, since measurements have suggested that the influence of the clamp on the test results could thus be lowered.

<Laptop Extension Kit>

The extension is lightweight and made of POM, acrylic glass and foam. It fits easily on the upper part of the Mounting Device in place of the phone positioner. The extension is fully compatible with the Twin-SAM and ELI phantoms.



Picture C.9-1: Device Holder

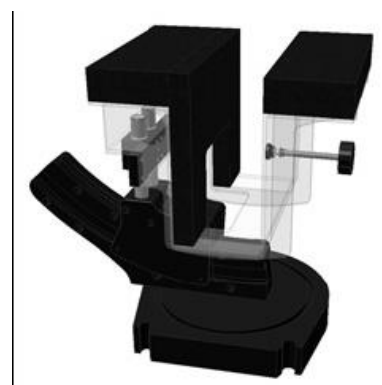

Picture C.9-2: Laptop Extension Kit

C.4.5 Phantom

The SAM Twin Phantom V4.0 is constructed of a fiberglass shell integrated in a table. The shape of the shell is based on data from an anatomical study designed to represent the 90th percentile of the population. The phantom enables the dissymmetric evaluation

of SAR for both left and right handed handset usage, as well as body-worn usage using the flat phantom region. Reference markings on the Phantom allow the complete setup of all predefined phantom positions and measurement grids by manually teaching three points in the robot. The shell phantom has a 2mm shell thickness (except the ear region where shell thickness increases to 6 mm).

Shell Thickness: 2 ± 0.2 mm

Filling Volume: Approx. 25 liters

Dimensions: 810 x 1000 x 500 mm (H x L x W)

Available: Special



Picture C.10: SAM Twin Phantom

ANNEX D Position of the wireless device in relation to the phantom

D.1 General considerations

This standard specifies two handset test positions against the head phantom – the “cheek” position and the “tilt” position.

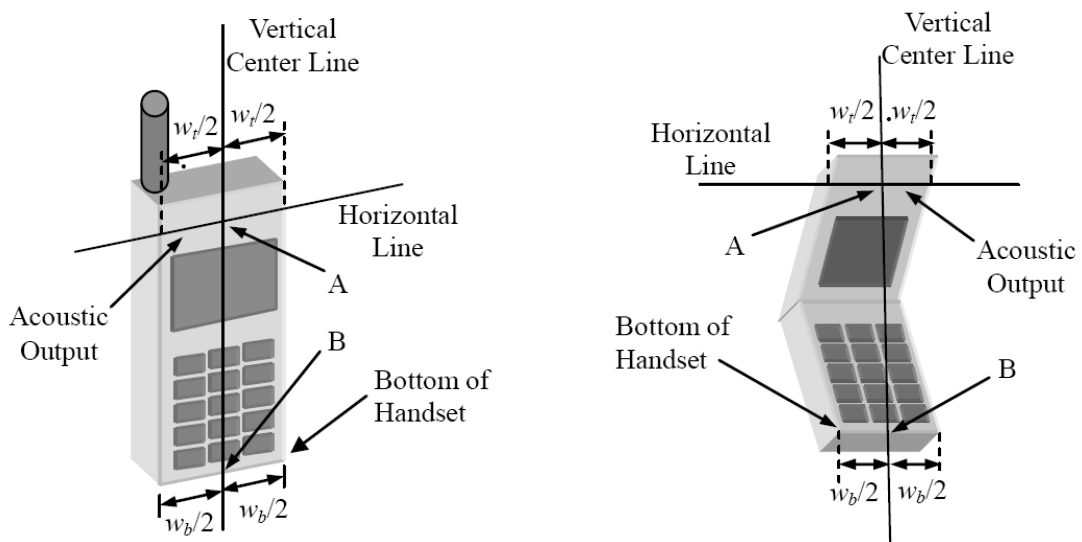

- w_t Width of the handset at the level of the acoustic
- w_b Width of the bottom of the handset
- A Midpoint of the width w_t of the handset at the level of the acoustic output
- B Midpoint of the width w_b of the bottom of the handset

Picture D.1-a Typical “fixed” case handset Picture D.1-b Typical “clam-shell” case handset

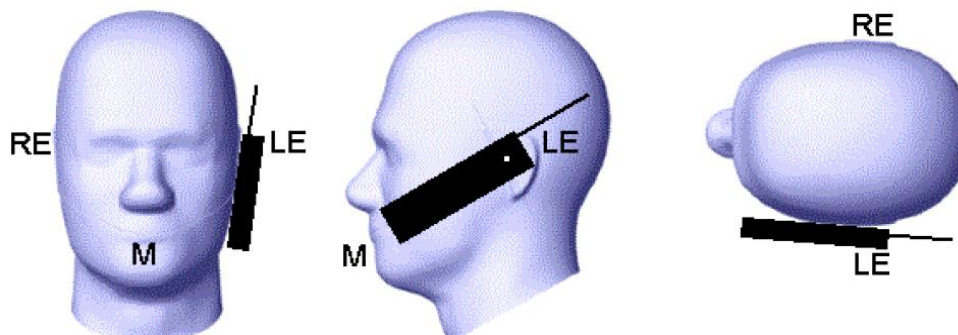

Picture D.2 Cheek position of the wireless device on the left side of SAM

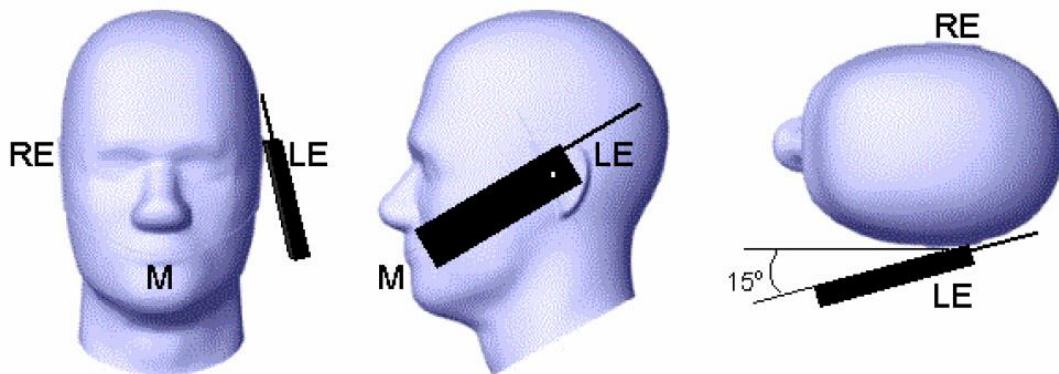

Picture D.3 Tilt position of the wireless device on the left side of SAM

D.2 Body-worn device

A typical example of a body-worn device is a mobile phone, wireless enabled PDA or other battery operated wireless device with the ability to transmit while mounted on a person's body using a carry accessory approved by the wireless device manufacturer.

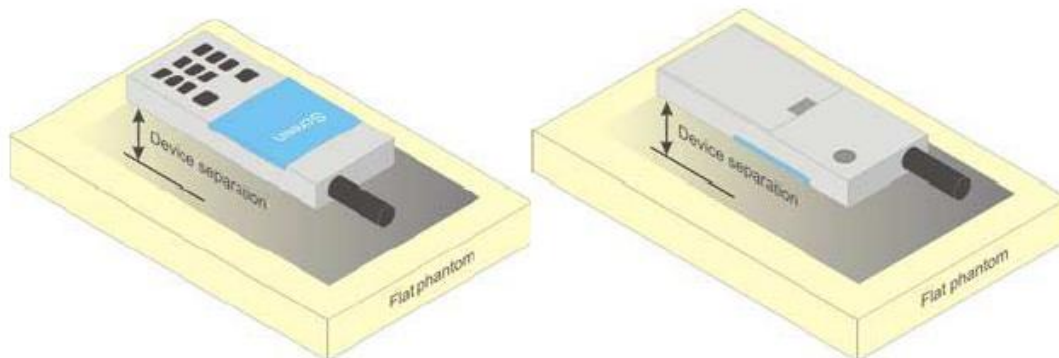

Picture D.4 Test positions for body-worn devices

D.3 Desktop device

A typical example of a desktop device is a wireless enabled desktop computer placed on a table or desk when used.

The DUT shall be positioned at the distance and in the orientation to the phantom that corresponds to the intended use as specified by the manufacturer in the user instructions. For devices that employ an external antenna with variable positions, tests shall be performed for all antenna positions specified. Picture 8.5 show positions for desktop device SAR tests. If the intended use is not specified, the device shall be tested directly against the flat phantom.

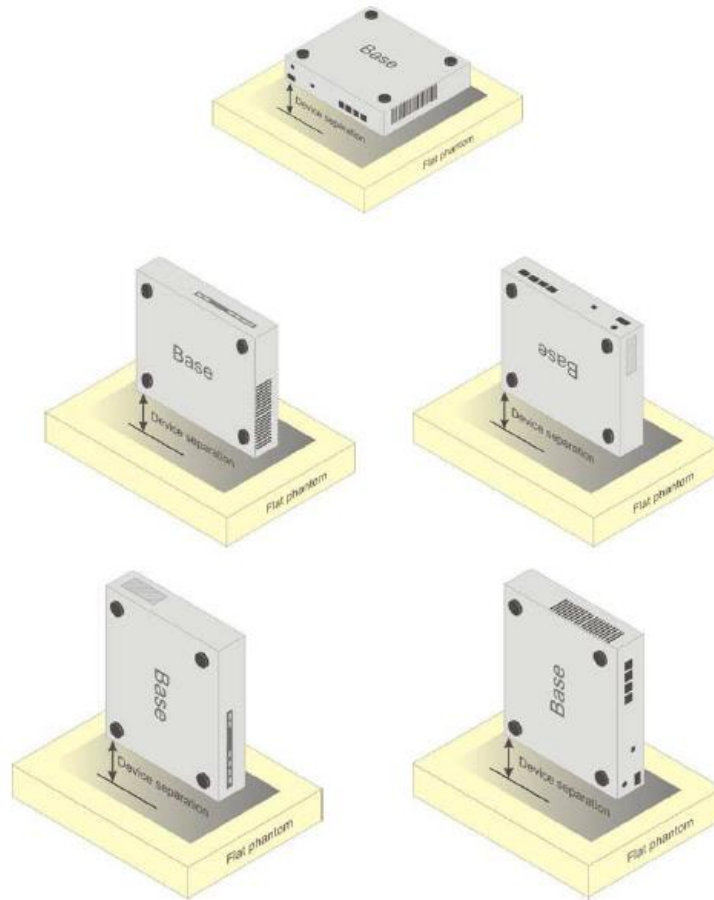

Picture D.5 Test positions for desktop devices

D.4 DUT Setup Photos



Picture D.6

ANNEX E Equivalent Media Recipes

The liquid used for the frequency range of 800-3000 MHz consisted of water, sugar, salt, preventol, glycol monobutyl and Cellulose. The liquid has been previously proven to be suited for worst-case. The Table E.1 shows the detail solution. It's satisfying the latest tissue dielectric parameters requirements proposed by the IEEE 1528 and IEC 62209.

TableE.1: Composition of the Tissue Equivalent Matter

Frequency (MHz)	835Head	835Body	1900 Head	1900 Body	2450 Head	2450 Body	5800 Head	5800 Body
Ingredients (% by weight)								
Water	41.45	52.5	55.242	69.91	58.79	72.60	65.53	65.53
Sugar	56.0	45.0	\	\	\	\	\	\
Salt	1.45	1.4	0.306	0.13	0.06	0.18	\	\
Preventol	0.1	0.1	\	\	\	\	\	\
Cellulose	1.0	1.0	\	\	\	\	\	\
Glycol Monobutyl	\	\	44.452	29.96	41.15	27.22	\	\
Diethylenglycol monohexylether	\	\	\	\	\	\	17.24	17.24
Triton X-100	\	\	\	\	\	\	17.24	17.24
Dielectric Parameters Target Value	$\epsilon=41.5$ $\sigma=0.90$	$\epsilon=55.2$ $\sigma=0.97$	$\epsilon=40.0$ $\sigma=1.40$	$\epsilon=53.3$ $\sigma=1.52$	$\epsilon=39.2$ $\sigma=1.80$	$\epsilon=52.7$ $\sigma=1.95$	$\epsilon=35.3$ $\sigma=5.27$	$\epsilon=48.2$ $\sigma=6.00$

Note: There are a little adjustment respectively for 750, 1750, 2600, 5200, 5300 and 5600 based on the recipe of closest frequency in table E.1.

ANNEX F System Validation

The SAR system must be validated against its performance specifications before it is deployed. When SAR probes, system components or software are changed, upgraded or recalibrated, these must be validated with the SAR system(s) that operates with such components.

Table F.1: System Validation for 7307

Probe SN.	Liquid name	Validation date	Frequency point	Status (OK or Not)
7307	Head 750MHz	June 14,2019	750 MHz	OK
7307	Head 850MHz	June 14,2019	835 MHz	OK
7307	Head 900MHz	June 14,2019	900 MHz	OK
7307	Head 1750MHz	June 14,2019	1750 MHz	OK
7307	Head 1810MHz	June 14,2019	1810 MHz	OK
7307	Head 1900MHz	June 15,2019	1900 MHz	OK
7307	Head 2000MHz	June 15,2019	2000 MHz	OK
7307	Head 2100MHz	June 15,2019	2100 MHz	OK
7307	Head 2300MHz	June 15,2019	2300 MHz	OK
7307	Head 2450MHz	June 15,2019	2450 MHz	OK
7307	Head 2600MHz	June 16,2019	2600 MHz	OK
7307	Head 3500MHz	June 16,2019	3500 MHz	OK
7307	Head 3700MHz	June 16,2019	3700 MHz	OK
7307	Head 5200MHz	June 16,2019	5250 MHz	OK
7307	Head 5500MHz	June 16,2019	5600 MHz	OK
7307	Head 5800MHz	June 16,2019	5800 MHz	OK
7307	Body 750MHz	June 16,2019	750 MHz	OK
7307	Body 850MHz	June 13,2019	835 MHz	OK
7307	Body 900MHz	June 13,2019	900 MHz	OK
7307	Body 1750MHz	June 13,2019	1750 MHz	OK
7307	Body 1810MHz	June 13,2019	1810 MHz	OK
7307	Body 1900MHz	June 13,2019	1900 MHz	OK
7307	Body 2000MHz	June 17,2019	2000 MHz	OK
7307	Body 2100MHz	June 17,2019	2100 MHz	OK
7307	Body 2300MHz	June 17,2019	2300 MHz	OK
7307	Body 2450MHz	June 17,2019	2450 MHz	OK
7307	Body 2600MHz	June 17,2019	2600 MHz	OK
7307	Body 3500MHz	June 12,2019	3500 MHz	OK
7307	Body 3700MHz	June 12,2019	3700 MHz	OK
7307	Body 5200MHz	June 12,2019	5250 MHz	OK
7307	Body 5500MHz	June 12,2019	5600 MHz	OK
7307	Body 5800MHz	June 12,2019	5800 MHz	OK



No.I20Z60930-SEM03

ANNEX G Probe Calibration Certificate

Probe 3617 Calibration Certificate

**Calibration Laboratory of
Schmid & Partner
Engineering AG**
Zeughausstrasse 43, 8004 Zurich, Switzerland



S Schweizerischer Kalibrierdienst
C Service suisse d'étalonnage
S Servizio svizzero di taratura
S Swiss Calibration Service

Accredited by the Swiss Accreditation Service (SAS)
The Swiss Accreditation Service is one of the signatories to the EA
Multilateral Agreement for the recognition of calibration certificates

Accreditation No.: **SCS 0108**

Client **CTTL (Auden)**

Certificate No: **EX3-3617_Jan20/2**

CALIBRATION CERTIFICATE (Replacement of No: EX3-3617_Jan20)

Object **EX3DV4 - SN:3617**

Calibration procedure(s) **QA CAL-01.v9, QA CAL-12.v9, QA CAL-14.v5, QA CAL-23.v5,
QA CAL-25.v7
Calibration procedure for dosimetric E-field probes**

Calibration date: **January 30, 2020**

This calibration certificate documents the traceability to national standards, which realize the physical units of measurements (SI).
The measurements and the uncertainties with confidence probability are given on the following pages and are part of the certificate.

All calibrations have been conducted in the closed laboratory facility: environment temperature (22 ± 3)°C and humidity < 70%.

Calibration Equipment used (M&TE critical for calibration)

Primary Standards	ID	Cal Date (Certificate No.)	Scheduled Calibration
Power meter NRP	SN: 104778	03-Apr-19 (No. 217-02892/02893)	Apr-20
Power sensor NRP-Z91	SN: 103244	03-Apr-19 (No. 217-02892)	Apr-20
Power sensor NRP-Z91	SN: 103245	03-Apr-19 (No. 217-02893)	Apr-20
Reference 20 dB Attenuator	SN: S5277 (20x)	04-Apr-19 (No. 217-02894)	Apr-20
DAE4	SN: 660	27-Dec-19 (No. DAE4-660_Dec19)	Dec-20
Reference Probe ES3DV2	SN: 3013	31-Dec-19 (No. ES3-3013_Dec19)	Dec-20
Secondary Standards	ID	Check Date (in house)	Scheduled Check
Power meter E4419B	SN: GB41293874	06-Apr-16 (in house check Jun-18)	In house check: Jun-20
Power sensor E4412A	SN: MY41498087	06-Apr-16 (in house check Jun-18)	In house check: Jun-20
Power sensor E4412A	SN: 000110210	06-Apr-16 (in house check Jun-18)	In house check: Jun-20
RF generator HP 8648C	SN: US3642U01700	04-Aug-99 (in house check Jun-18)	In house check: Jun-20
Network Analyzer E8358A	SN: US41080477	31-Mar-14 (in house check Oct-19)	In house check: Oct-20

	Name	Function	Signature
Calibrated by:	Claudio Leubler	Laboratory Technician	
Approved by:	Katja Pokovic	Technical Manager	

Issued: April 7, 2020

This calibration certificate shall not be reproduced except in full without written approval of the laboratory.

**Calibration Laboratory of
Schmid & Partner
Engineering AG**
Zeughausstrasse 43, 8004 Zurich, Switzerland



S Schweizerischer Kalibrierdienst
C Service suisse d'étalonnage
S Servizio svizzero di taratura
Swiss Calibration Service

Accredited by the Swiss Accreditation Service (SAS)
The Swiss Accreditation Service is one of the signatories to the EA
Multilateral Agreement for the recognition of calibration certificates

Accreditation No.: **SCS 0108**

Glossary:

TSL	tissue simulating liquid
NORM _{x,y,z}	sensitivity in free space
ConvF	sensitivity in TSL / NORM _{x,y,z}
DCP	diode compression point
CF	crest factor (1/duty_cycle) of the RF signal
A, B, C, D	modulation dependent linearization parameters
Polarization φ	φ rotation around probe axis
Polarization ϑ	ϑ rotation around an axis that is in the plane normal to probe axis (at measurement center), i.e., $\vartheta = 0$ is normal to probe axis
Connector Angle	information used in DASY system to align probe sensor X to the robot coordinate system

Calibration is Performed According to the Following Standards:

- IEEE Std 1528-2013, "IEEE Recommended Practice for Determining the Peak Spatial-Averaged Specific Absorption Rate (SAR) in the Human Head from Wireless Communications Devices: Measurement Techniques", June 2013
- IEC 62209-1, "Measurement procedure for the assessment of Specific Absorption Rate (SAR) from hand-held and body-mounted devices used next to the ear (frequency range of 300 MHz to 6 GHz)", July 2016
- IEC 62209-2, "Procedure to determine the Specific Absorption Rate (SAR) for wireless communication devices used in close proximity to the human body (frequency range of 30 MHz to 6 GHz)", March 2010
- KDB 865664, "SAR Measurement Requirements for 100 MHz to 6 GHz"

Methods Applied and Interpretation of Parameters:

- NORM_{x,y,z}**: Assessed for E-field polarization $\vartheta = 0$ ($f \leq 900$ MHz in TEM-cell; $f > 1800$ MHz: R22 waveguide). NORM_{x,y,z} are only intermediate values, i.e., the uncertainties of NORM_{x,y,z} does not affect the E^2 -field uncertainty inside TSL (see below *ConvF*).
- NORM(f)_{x,y,z} = NORM_{x,y,z} * frequency_response** (see Frequency Response Chart). This linearization is implemented in DASY4 software versions later than 4.2. The uncertainty of the frequency response is included in the stated uncertainty of *ConvF*.
- DCP_{x,y,z}**: DCP are numerical linearization parameters assessed based on the data of power sweep with CW signal (no uncertainty required). DCP does not depend on frequency nor media.
- PAR**: PAR is the Peak to Average Ratio that is not calibrated but determined based on the signal characteristics
- A_{x,y,z}; B_{x,y,z}; C_{x,y,z}; D_{x,y,z}; VR_{x,y,z}**: A, B, C, D are numerical linearization parameters assessed based on the data of power sweep for specific modulation signal. The parameters do not depend on frequency nor media. VR is the maximum calibration range expressed in RMS voltage across the diode.
- ConvF and Boundary Effect Parameters**: Assessed in flat phantom using E-field (or Temperature Transfer Standard for $f \leq 800$ MHz) and inside waveguide using analytical field distributions based on power measurements for $f > 800$ MHz. The same setups are used for assessment of the parameters applied for boundary compensation (alpha, depth) of which typical uncertainty values are given. These parameters are used in DASY4 software to improve probe accuracy close to the boundary. The sensitivity in TSL corresponds to NORM_{x,y,z} * ConvF whereby the uncertainty corresponds to that given for ConvF. A frequency dependent ConvF is used in DASY version 4.4 and higher which allows extending the validity from ± 50 MHz to ± 100 MHz.
- Spherical isotropy (3D deviation from isotropy)**: in a field of low gradients realized using a flat phantom exposed by a patch antenna.
- Sensor Offset**: The sensor offset corresponds to the offset of virtual measurement center from the probe tip (on probe axis). No tolerance required.
- Connector Angle**: The angle is assessed using the information gained by determining the NORM_x (no uncertainty required).

EX3DV4 – SN:3617

January 30, 2020

DASY/EASY - Parameters of Probe: EX3DV4 - SN:3617

Basic Calibration Parameters

	Sensor X	Sensor Y	Sensor Z	Unc (k=2)
Norm ($\mu\text{V}/(\text{V}/\text{m})^2$) ^A	0.35	0.21	0.32	± 10.1 %
DCP (mV) ^B	104.3	93.8	97.1	

Calibration Results for Modulation Response

UID	Communication System Name		A dB	B dB/μV	C	D dB	VR mV	Max dev.	Max Unc ^E (k=2)
0	CW	X	0.00	0.00	1.00	0.00	130.5	± 3.5 %	± 4.7 %
		Y	0.00	0.00	1.00		137.4		
		Z	0.00	0.00	1.00		129.2		
10352-AAA	Pulse Waveform (200Hz, 10%)	X	5.74	74.31	15.16	10.00	60.0	± 2.6 %	± 9.6 %
		Y	20.00	84.63	18.23		60.0		
		Z	20.00	90.64	20.98		60.0		
10353-AAA	Pulse Waveform (200Hz, 20%)	X	11.18	82.57	16.62	6.99	80.0	± 1.6 %	± 9.6 %
		Y	11.60	81.13	15.97		80.0		
		Z	20.00	91.54	20.06		80.0		
10354-AAA	Pulse Waveform (200Hz, 40%)	X	20.00	88.75	16.93	3.98	95.0	± 1.0 %	± 9.6 %
		Y	1.22	64.13	8.17		95.0		
		Z	20.00	94.77	20.04		95.0		
10355-AAA	Pulse Waveform (200Hz, 60%)	X	20.00	90.94	16.71	2.22	120.0	± 1.3 %	± 9.6 %
		Y	0.41	60.00	4.32		120.0		
		Z	20.00	99.77	20.92		120.0		
10387-AAA	QPSK Waveform, 1 MHz	X	0.73	63.23	9.65	0.00	150.0	± 4.1 %	± 9.6 %
		Y	0.47	60.00	5.82		150.0		
		Z	0.73	63.00	9.63		150.0		
10388-AAA	QPSK Waveform, 10 MHz	X	2.46	70.66	17.17	0.00	150.0	± 1.7 %	± 9.6 %
		Y	2.10	68.37	15.67		150.0		
		Z	2.45	70.34	17.05		150.0		
10396-AAA	64-QAM Waveform, 100 kHz	X	3.34	72.82	19.20	3.01	150.0	± 1.6 %	± 9.6 %
		Y	3.57	72.45	19.52		150.0		
		Z	3.45	73.00	19.94		150.0		
10399-AAA	64-QAM Waveform, 40 MHz	X	3.61	68.21	16.41	0.00	150.0	± 3.8 %	± 9.6 %
		Y	3.40	67.13	15.82		150.0		
		Z	3.62	68.06	16.39		150.0		
10414-AAA	WLAN CCDF, 64-QAM, 40MHz	X	4.88	66.26	15.89	0.00	150.0	± 6.6 %	± 9.6 %
		Y	4.57	64.95	15.35		150.0		
		Z	4.92	66.18	15.92		150.0		

Note: For details on UID parameters see Appendix

The reported uncertainty of measurement is stated as the standard uncertainty of measurement multiplied by the coverage factor k=2, which for a normal distribution corresponds to a coverage probability of approximately 95%.

^A The uncertainties of Norm X,Y,Z do not affect the E²-field uncertainty inside TSL (see Pages 5 and 6).

^B Numerical linearization parameter: uncertainty not required.

^E Uncertainty is determined using the max. deviation from linear response applying rectangular distribution and is expressed for the square of the field value.



EX3DV4- SN:3617

January 30, 2020

DASY/EASY - Parameters of Probe: EX3DV4 - SN:3617**Sensor Model Parameters**

	C1 fF	C2 fF	α V ⁻¹	T1 ms.V ⁻²	T2 ms.V ⁻¹	T3 ms	T4 V ⁻²	T5 V ⁻¹	T6
X	41.2	299.64	34.06	12.13	0.82	5.00	1.88	0.20	1.00
Y	42.0	334.64	39.96	9.91	1.46	5.06	0.00	0.82	1.01
Z	42.8	318.14	35.45	11.95	0.73	5.04	1.02	0.40	1.01

Other Probe Parameters

Sensor Arrangement	Triangular
Connector Angle (°)	13
Mechanical Surface Detection Mode	enabled
Optical Surface Detection Mode	disabled
Probe Overall Length	337 mm
Probe Body Diameter	10 mm
Tip Length	9 mm
Tip Diameter	2.5 mm
Probe Tip to Sensor X Calibration Point	1 mm
Probe Tip to Sensor Y Calibration Point	1 mm
Probe Tip to Sensor Z Calibration Point	1 mm
Recommended Measurement Distance from Surface	1.4 mm