



FCC RF Test Report

APPLICANT : HMD Global Oy
EQUIPMENT : Smart Phone
BRAND NAME : NOKIA
MODEL NAME : TA-1243, TA-1251
FCC ID : 2AJOTTA-1243
STANDARD : 47 CFR Part 2, 27(M), 27(N)
CLASSIFICATION : PCS Licensed Transmitter Held to Ear (PCE)

The product was received on May 12, 2020 and completely tested on Jul. 20, 2020. We, Sporton International (Kunshan) Inc., would like to declare that the tested sample has been evaluated in accordance with the procedures given in ANSI C63.26-2015 and shown compliance with the applicable technical standards.

The test results in this report apply exclusively to the tested model / sample. Without written approval of Sporton International (Kunshan) Inc., the test report shall not be reproduced except in full.

Jason Jia

Reviewed by: Jason Jia / Supervisor

James Huang

Approved by: James Huang / Manager



Sporton International (Kunshan) Inc.

**No. 1098, Pengxi North Road, Kunshan Economic Development Zone Jiangsu Province 215300
People's Republic of China**



TABLE OF CONTENTS

REVISION HISTORY... 3
SUMMARY OF TEST RESULT ... 4
1 GENERAL DESCRIPTION ... 5
1.1 Applicant ... 5
1.2 Manufacturer ... 5
1.3 Product Feature of Equipment Under Test ... 5
1.4 Product Specification of Equipment Under Test ... 6
1.5 Modification of EUT ... 6
1.6 Maximum ERP/EIRP, Frequency Tolerance, and Emission Designator ... 7
1.7 Testing Location ... 10
1.8 Test Software ... 10
1.9 Applicable Standards ... 10
2 TEST CONFIGURATION OF EQUIPMENT UNDER TEST ... 11
2.1 Test Mode ... 11
2.2 Connection Diagram of Test System ... 14
2.3 Support Unit used in test configuration and system ... 14
2.4 Measurement Results Explanation Example ... 14
2.5 Frequency List of Low/Middle/High Channels ... 15
3 CONDUCTED TEST ITEMS ... 20
3.1 Measuring Instruments ... 20
3.2 Test Setup ... 20
3.3 Test Result of Conducted Test ... 20
3.4 Conducted Output Power and ERP/EIRP ... 21
3.5 Peak-to-Average Ratio ... 22
3.6 Occupied Bandwidth ... 23
3.7 Conducted Band Edge ... 24
3.8 Conducted Spurious Emission ... 26
3.9 Frequency Stability ... 27
4 RADIATED TEST ITEMS ... 28
4.1 Measuring Instruments ... 28
4.2 Test Setup ... 28
4.3 Test Result of Radiated Test ... 28
4.4 Radiated Spurious Emission ... 29
5 LIST OF MEASURING EQUIPMENT ... 30
6 UNCERTAINTY OF EVALUATION ... 31
APPENDIX A. TEST RESULTS OF CONDUCTED TEST
APPENDIX B. TEST RESULTS OF RADIATED TEST
APPENDIX C. TEST SETUP PHOTOGRAPHS



REVISION HISTORY

REPORT NO.	VERSION	DESCRIPTION	ISSUED DATE
FG051228C	Rev. 01	Initial issue of report	Aug. 24, 2020



SUMMARY OF TEST RESULT

Report Section	FCC Rule	Description	Limit	Result	Remark
3.4	§2.1046	Conducted Output Power	Reporting Only	PASS	-
	§27.50(c)(10)	Effective Radiated Power (Band 71)	ERP < 3 Watt	PASS	-
	§27.50(h)(2)	Equivalent Isotropic Radiated Power (Band 7) (Band 38) (Band 41)	EIRP < 2Watt	PASS	-
3.5	N/A	Peak-to-Average Ratio	<13 dB	PASS	-
3.6	§2.1049	Occupied Bandwidth	Reporting Only	PASS	-
3.7	§2.1051 §27.53(g)	Conducted Band Edge Measurement (Band 71)	< 43+10log ₁₀ (P[Watts])	PASS	-
	§27.53(m)(4)	Conducted Band Edge Measurement (Band 7) (Band 38) (Band 41)	§27.53(m)(4)		
3.8	§2.1051 §27.53(g)	Conducted Spurious Emission (Band 71)	< 43+10log ₁₀ (P[Watts])	PASS	-
	§2.1051 §27.53(m)(4)	Conducted Spurious Emission (Band 7) (Band 38) (Band 41)	< 55+10log ₁₀ (P[Watts])		
3.9	§2.1055 §27.54	Frequency Stability Temperature & Voltage	Within Authorized Band	PASS	-
4.4	§2.1053 §27.53(g)	Radiated Spurious Emission (Band 71)	< 43+10log ₁₀ (P[Watts])	PASS	Under limit 37.01 dB at 7580.000 MHz
	§2.1053 §27.53(m)(4)	Radiated Spurious Emission (Band 7) (Band 38) (Band 41)	< 55+10log ₁₀ (P[Watts])		

Declaration of Conformity:

The test results with all measurement uncertainty excluded are presented in accordance with the regulation limits or requirements declared by manufacturers.

Comments and Explanations:

The declared of product specification for EUT presented in the report are provided by the manufacturer, and the manufacturer takes all the responsibilities for the accuracy of product specification.



1 General Description

1.1 Applicant

HMD Global Oy
Bertel Jungin aukio 9, 02600 Espoo, Finland

1.2 Manufacturer

HMD Global Oy
Bertel Jungin aukio 9, 02600 Espoo, Finland

1.3 Product Feature of Equipment Under Test

Product Feature	
Equipment	Smart Phone
Brand Name	NOKIA
Model Name	TA-1243, TA-1251
FCC ID	2AJOTTA-1243
EUT supports Radios application	GSM/WCDMA/LTE/5G NR/NFC WLAN 2.4GHz 802.11b/g/n HT20 WLAN 5GHz 802.11a/n HT20/HT40 WLAN 5GHz 802.11ac VHT20/VHT40/VHT80 Bluetooth BR/EDR/LE FM Receiver and GNSS
IMEI Code	Conducted: N/A Radiation: 353137110023127/353137110023135
HW Version	HW03
SW Version	00WW_0_180
EUT Stage	Identical Prototype

Note: There are two types of EUT, the difference is that dual SIM card mobile phone (Model Name: TA-1243) and single SIM card mobile phone (Model Name: TA-1251), the others are the same. According to the difference, we choose dual SIM card mobile phone to perform full test.



1.4 Product Specification of Equipment Under Test

Standards-related Product Specification	
Tx Frequency	LTE Band 7 : 2502.5 MHz ~ 2567.5 MHz LTE Band 38 : 2572.5MHz ~ 2617.5MHz LTE Band 41 : 2498.5 MHz ~ 2687.5 MHz LTE Band 71: 665.5 MHz ~ 695.5MHz
Rx Frequency	LTE Band 7 : 2622.5MHz ~ 2687.5 MHz LTE Band 38 : 2572.5MHz ~ 2617.5MHz LTE Band 41 : 2498.5 MHz ~ 2687.5 MHz LTE Band 71: 619.5 MHz ~ 649.5MHz
Bandwidth	LTE Band 7 : 5MHz/ 10MHz / 15MHz / 20MHz LTE Band 38 : 5MHz / 10MHz / 15MHz / 20MHz LTE Band 41 : 5MHz / 10MHz / 15MHz / 20MHz LTE Band 71 : 5MHz / 10MHz / 15MHz / 20MHz
Maximum Output Power to Antenna	LTE Band 7 : 23.39 dBm LTE Band 7C_CA : 23.30 dBm LTE Band 38 : 22.96 dBm LTE Band 38C_CA : 22.76 dBm LTE Band 41 : 24.85 dBm LTE Band 41C_CA : 23.22 dBm LTE Band 71 : 23.28 dBm
Antenna Gain	LTE Band 7 : -0.3 dBi LTE Band 38 : -0.3 dBi LTE Band 41 : -0.3 dBi LTE Band 71 : -3.3 dBi
Type of Modulation	QPSK / 16QAM / 64QAM

Remark:

1. The maximum ERP/EIRP and Conducted is calculated from max output power and max antenna gain.
2. LTE band 41 supports HPUE for single carrier mode.

1.5 Modification of EUT

No modifications are made to the EUT during all test items.



1.6 Maximum ERP/EIRP, Frequency Tolerance, and Emission Designator

LTE Band 7		QPSK			16QAM		
BW (MHz)	Frequency Range (MHz)	Emission Designator (99%OBW)	Frequency Tolerance (ppm)	Maximum EIRP(W)	Emission Designator (99%OBW)	Frequency Tolerance (ppm)	Maximum EIRP(W)
5	2502.5 ~ 2567.5	4M51G7D	-	0.2009	4M50W7D	-	0.1730
10	2505.0 ~ 2565.0	9M01G7D	0.0032	0.1982	9M01W7D	-	0.1750
15	2507.5 ~ 2562.5	13M5G7D	-	0.2032	13M5W7D	-	0.1722
20	2510.0 ~ 2560.0	18M5G7D	-	0.2037	18M5W7D	-	0.1746
LTE Band 7		64QAM					
BW (MHz)	Frequency Range (MHz)	Emission Designator (99%OBW)	Frequency Tolerance (ppm)		Maximum EIRP(W)		
5	2502.5 ~ 2567.5	4M50W7D	-		0.1349		
10	2505.0 ~ 2565.0	9M03W7D	-		0.1371		
15	2507.5 ~ 2562.5	13M4W7D	-		0.1318		
20	2510.0 ~ 2560.0	18M3W7D	-		0.1346		
LTE Band 38		QPSK			16QAM		
BW (MHz)	Frequency Range (MHz)	Emission Designator (99%OBW)	Frequency Tolerance (ppm)	Maximum EIRP(W)	Emission Designator (99%OBW)	Frequency Tolerance (ppm)	Maximum EIRP(W)
5	2572.5 ~ 2617.5	4M52G7D	-	0.2812	4M50W7D	-	0.2421
10	2575.0 ~ 2615.0	9M05G7D	0.0016	0.2825	9M05W7D	-	0.2410
15	2577.5 ~ 2612.5	13M5G7D	-	0.2761	13M5W7D	-	0.2366
20	2580.0 ~ 2610.0	18M5G7D	-	0.2851	18M4W7D	-	0.2410
LTE Band 38		64QAM					
BW (MHz)	Frequency Range (MHz)	Emission Designator (99%OBW)	Frequency Tolerance (ppm)		Maximum EIRP(W)		
5	2572.5 ~ 2617.5	4M49W7D	-		0.1875		
10	2575.0 ~ 2615.0	9M05W7D	-		0.1941		
15	2577.5 ~ 2612.5	13M5W7D	-		0.1837		
20	2580.0 ~ 2610.0	18M3W7D	-		0.1858		



LTE Band 41		QPSK			16QAM		
BW (MHz)	Frequency Range (MHz)	Emission Designator (99%OBW)	Frequency Tolerance (ppm)	Maximum EIRP(W)	Emission Designator (99%OBW)	Frequency Tolerance (ppm)	Maximum EIRP(W)
5	2498.5 ~ 2687.5	4M52G7D	-	0.2812	4M50W7D	-	0.2421
10	2501.0 ~ 2685.0	9M05G7D	0.0016	0.2825	9M05W7D	-	0.2410
15	2503.5 ~ 2682.5	13M5G7D	-	0.2761	13M5W7D	-	0.2366
20	2506.0 ~ 2680.0	18M5G7D	-	0.2851	18M4W7D	-	0.2410
LTE Band 41		64QAM					
BW (MHz)	Frequency Range (MHz)	Emission Designator (99%OBW)	Frequency Tolerance (ppm)		Maximum EIRP(W)		
5	2498.5 ~ 2687.5	4M49W7D	-		0.1875		
10	2501.0 ~ 2685.0	9M05W7D	-		0.1941		
15	2503.5 ~ 2682.5	13M5W7D	-		0.1837		
20	2506.0 ~ 2680.0	18M3W7D	-		0.1858		
LTE Band 71		QPSK			16QAM		
BW (MHz)	Frequency Range (MHz)	Emission Designator (99%OBW)	Frequency Tolerance (ppm)	Maximum ERP(W)	Emission Designator (99%OBW)	Frequency Tolerance (ppm)	Maximum ERP(W)
5	665.5 ~ 695.5	4M51G7D	-	0.0603	4M50W7D	-	0.0511
10	668.0 ~ 693.0	9M05G7D	0.0042	0.0605	9M05W7D	-	0.0508
15	670.5 ~ 690.5	13M5G7D	-	0.0604	13M5W7D	-	0.0515
20	673.0 ~ 688.0	17M9G7D	-	0.0607	17M9W7D	-	0.0520
LTE Band 71		64QAM					
BW (MHz)	Frequency Range (MHz)	Emission Designator (99%OBW)	Frequency Tolerance (ppm)		Maximum ERP(W)		
5	665.5 ~ 695.5	4M50W7D	-		0.0404		
10	668.0 ~ 693.0	9M03W7D	-		0.0406		
15	670.5 ~ 690.5	13M5W7D	-		0.0394		
20	673.0 ~ 688.0	17M9W7D	-		0.0399		



LTE Band 7 CA	QPSK			16QAM		
BW (MHz)	Emission Designator (99%OBW)	Frequency Tolerance (ppm)	Maximum EIRP(W)	Emission Designator (99%OBW)	Frequency Tolerance (ppm)	Maximum EIRP(W)
20MHz+20MHz	37M6G7D	-	0.1995	37M6W7D	-	0.1641
LTE Band 7 CA	64QAM					
BW (MHz)	Emission Designator (99%OBW)		Frequency Tolerance (ppm)		Maximum EIRP(W)	
20MHz+20MHz	37M5W7D		-		0.1337	
LTE Band 38 CA	QPSK			16QAM		
BW (MHz)	Emission Designator (99%OBW)	Frequency Tolerance (ppm)	Maximum EIRP(W)	Emission Designator (99%OBW)	Frequency Tolerance (ppm)	Maximum EIRP(W)
20MHz+20MHz	37M7G7D	-	0.1954	37M7W7D	-	0.1782
LTE Band 38 CA	64QAM					
BW (MHz)	Emission Designator (99%OBW)		Frequency Tolerance (ppm)		Maximum EIRP(W)	
20MHz+20MHz	37M5W7D		-		0.1403	
LTE Band 41 CA	QPSK			16QAM		
BW (MHz)	Emission Designator (99%OBW)	Frequency Tolerance (ppm)	Maximum EIRP(W)	Emission Designator (99%OBW)	Frequency Tolerance (ppm)	Maximum EIRP(W)
20MHz+20MHz	37M7G7D	-	0.1959	37M7W7D	-	0.1770
LTE Band 41 CA	64QAM					
BW (MHz)	Emission Designator (99%OBW)		Frequency Tolerance (ppm)		Maximum EIRP(W)	
20MHz+20MHz	37M5W7D		-		0.1406	

Note:

1. LTE Band 41 overlaps the entire frequency range of LTE Band 38. Therefore, the test results provided in this report covers Band 41 as well as Band 38.
2. The maximum EIRP for CA band is calculated from max output power of 20M+20M and max antenna gain, only the maximum EIRP is shown on the report.



1.7 Testing Location

Sporton International (Kunshan) Inc. is accredited to ISO/IEC 17025:2017 by American Association for Laboratory Accreditation with Certificate Number 5145.02.

Test Firm	Sporton International (Kunshan) Inc.		
Test Site Location	No. 1098, Pengxi North Road, Kunshan Economic Development Zone Jiangsu Province 215300 People's Republic of China TEL : +86-512-57900158 FAX : +86-512-57900958		
Test Site No.	Sporton Site No.	FCC Designation No.	FCC Test Firm Registration No.
	03CH02-KS TH01-KS	CN1257	314309

1.8 Test Software

Item	Site	Manufacture	Name	Version
1.	03CH02-KS	AUDIX	E3	6.2009-8-24a

1.9 Applicable Standards

According to the specifications of the manufacturer, the EUT must comply with the requirements of the following standards:

- 47 CFR Part 2, 27(M), 27(N)
- ANSI C63.26-2015
- FCC KDB 971168 D01 Power Meas License Digital Systems v03r01
- FCC KDB 412172 D01 Determining ERP and EIRP v01r01

Remark: All test items were verified and recorded according to the standards and without any deviation during the test.



2 Test Configuration of Equipment Under Test

2.1 Test Mode

Antenna port conducted and radiated test items listed below are performed according to KDB 971168 D01 Power Meas License Digital Systems v03r01 with maximum output power.

Radiated measurements are performed by rotating the EUT in three different orthogonal test planes to find the maximum emission.

Test Items	Band	Bandwidth (MHz)						Modulation			RB #			Test Channel		
		1.4	3	5	10	15	20	QPSK	16QAM	64QAM	1	Half	Full	L	M	H
Max. Output Power	7	-	-	v	v	v	v	v	v	v	v	v	v	v	v	v
	38	-	-	v	v	v	v	v	v	v	v	v	v	v	v	v
	41	-	-	v	v	v	v	v	v	v	v	v	v	v	v	v
	71	-	-	v	v	v	v	v	v	v	v	v	v	v	v	v
Peak-to-Average Ratio	7	-	-				v	v	v	v	v		v	v	v	v
	41	-	-				v	v	v	v	v		v	v	v	v
	71	-	-				v	v	v	v	v		v	v	v	v
26dB and 99% Bandwidth	7	-	-	v	v	v	v	v	v	v			v	v	v	v
	41	-	-	v	v	v	v	v	v	v			v	v	v	v
	71	-	-	v	v	v	v	v	v	v			v	v	v	v
Conducted Band Edge	7	-	-	v	v	v	v	v	v	v	v		v	v		v
	41	-	-	v	v	v	v	v	v	v	v		v	v		v
	71	-	-	v	v	v	v	v	v	v	v		v	v		v
Conducted Spurious Emission	7	-	-	v	v	v	v	v	v	v	v			v	v	v
	41	-	-	v	v	v	v	v	v	v	v			v	v	v
	71	-	-	v	v	v	v	v	v	v	v			v	v	v



Test Items	Band	Bandwidth (MHz)						Modulation			RB #			Test Channel		
		1.4	3	5	10	15	20	QPSK	16QAM	64QAM	1	Half	Full	L	M	H
Frequency Stability	7	-	-		v			v					v		v	
	41	-	-		v			v					v		v	
	71	-	-		v			v					v		v	
E.R.P / E.I.R.P	7	-	-	v	v	v	v	v	v	v	v			v	v	v
	41	-	-	v	v	v	v	v	v	v	v			v	v	v
	71	-	-	v	v	v	v	v	v	v	v			v	v	v
Radiated Spurious Emission	7	Worst Case												v		
	41	Worst Case												v		
	71	Worst Case												v		
Note	<ol style="list-style-type: none"> The mark "v" means that this configuration is chosen for testing The mark "-" means that this bandwidth is not supported. The device is investigated from 30MHz to 10 times of fundamental signal for radiated spurious emission test under different RB size/offset and modulations in exploratory test. Subsequently, only the worst case emissions are reported. LTE Band 41 overlaps the entire frequency range of LTE Band 38. Therefore, the test results provided in this report covers Band 41 as well as Band 38. 															



Test Items	Band	Bandwidth (MHz)										Modulation			RB #			Test Channel		
		20+20	20+15	15+20	20+10	10+20	20+5	5+20	15+15	15+10	10+15	QPSK	16QAM	64QAM	1	Half	Full	L	M	H
Max. Output Power	7C_CA	v	v	v	v	v	-	-	v	v	-	v	v	v	v	v	v	v	v	v
	38C_CA	v	-	-	-	-	-	-	v	-	-	v	v	v	v	v	v	v	v	v
	41C_CA	v	v	v	v	v	v	v	v	v	v	v	v	v	v	v	v	v	v	v
26dB and 99% Bandwidth	7C_CA	v	v	v	v	v	-	-	v	v	-	v	v	v			v	v	v	v
	41C_CA	v	v	v	v	v	v	v	v	v	v	v	v	v			v	v	v	v
Conducted Band Edge	7C_CA	v	v	v	v	v	-	-	v	v	-	v	v	v	v		v	v		v
	41C_CA	v	v	v	v	v	v	v	v	v	v	v	v	v	v		v	v		v
Conducted Spurious Emission	7C_CA	v	v	v	v	v	-	-	v	v	-	v	v	v	v			v	v	v
	41C_CA	v	v	v	v	v	v	v	v	v	v	v	v	v	v			v	v	v
E.I.R.P.	7C_CA	v	v	v	v	v	-	-	v	v	-	v	v	v	v			v	v	v
	41C_CA	v	v	v	v	v	v	v	v	v	v	v	v	v	v			v	v	v
Radiated Spurious Emission	7C_CA	Worst Case																	v	
	41C_CA	Worst Case																	v	
Note	<ol style="list-style-type: none"> The mark "v" means that this configuration is chosen for testing The mark "-" means that this bandwidth is not supported. The device is investigated from 30MHz to 10 times of fundamental signal for radiated spurious emission test under different RB size/offset and modulations in exploratory test. Subsequently, only the worst case emissions are reported. LTE Band 41_CA overlaps the entire frequency range of LTE Band 38_CA. Therefore, the test results provided in this report covers Band 41_CA as well as Band 38_CA. 																			

2.2 Connection Diagram of Test System

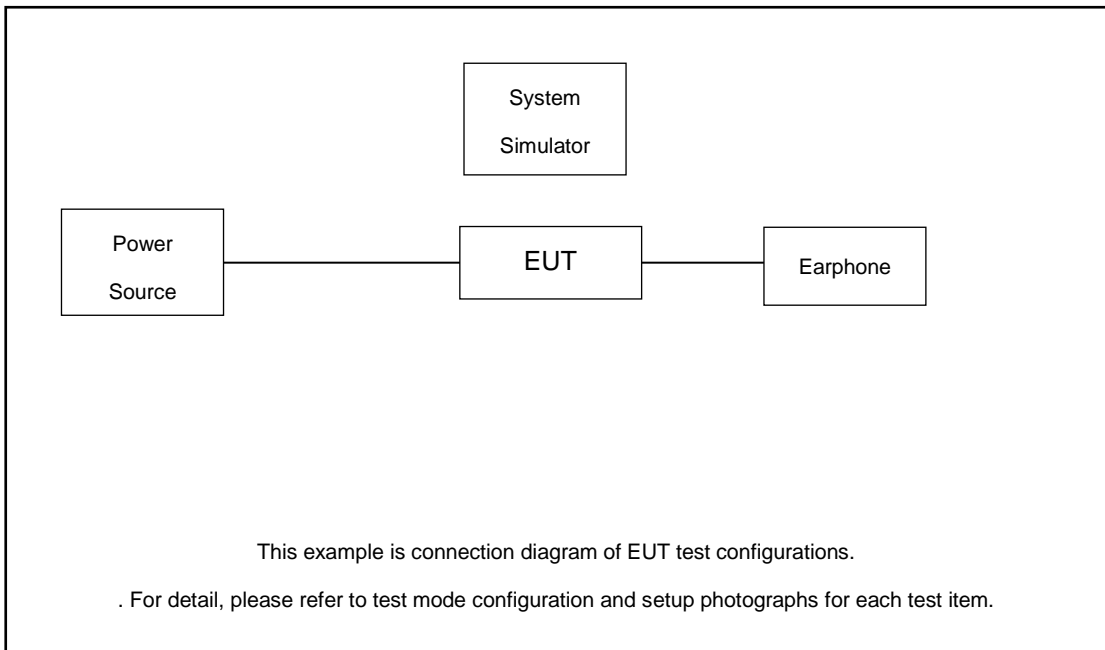

2.3 Support Unit used in test configuration and system

Item	Equipment	Trade Name	Model No.	FCC ID	Data Cable	Power Cord
1.	LTE Base Station	Anritsu	MT8820C	N/A	N/A	Unshielded, 1.8 m
2.	LTE Base Station	Anritsu	MT8821C	N/A	N/A	Unshielded, 1.8 m
3.	DC Power Supply	GWINSTEK	GPS-3030D	N/A	N/A	Unshielded, 1.8 m

2.4 Measurement Results Explanation Example

For all conducted test items:

The offset level is set in the spectrum analyzer to compensate the RF cable loss between EUT conducted output port and spectrum analyzer. With the offset compensation, the spectrum analyzer reading level is exactly the EUT RF output level.

The spectrum analyzer offset is derived from RF cable loss.

Offset = RF cable loss.

Following shows an offset computation example with cable loss 5.8 dB.

Example :

$$\begin{aligned} \text{Offset(dB)} &= \text{RF cable loss(dB)}. \\ &= 5.8 \text{ (dB)} \end{aligned}$$



2.5 Frequency List of Low/Middle/High Channels

LTE Band 7 Channel and Frequency List				
BW [MHz]	Channel/Frequency(MHz)	Lowest	Middle	Highest
20	Channel	20850	21100	21350
	Frequency	2510	2535	2560
15	Channel	20825	21100	21375
	Frequency	2507.5	2535	2562.5
10	Channel	20800	21100	21400
	Frequency	2505	2535	2565
5	Channel	20775	21100	21425
	Frequency	2502.5	2535	2567.5

LTE Band 38 Channel and Frequency List				
BW [MHz]	Channel/Frequency(MHz)	Lowest	Middle	Highest
20	Channel	37850	38000	38150
	Frequency	2580	2595	2610
15	Channel	37825	38000	38175
	Frequency	2577.5	2595	2612.5
10	Channel	37800	38000	38200
	Frequency	2575	2595	2615
5	Channel	37775	38000	38225
	Frequency	2572.5	2595	2617.5

LTE Band 41 Channel and Frequency List				
BW [MHz]	Channel/Frequency(MHz)	Lowest	Middle	Highest
20	Channel	39750	40620	41490
	Frequency	2506	2593	2680
15	Channel	39725	40620	41515
	Frequency	2503.5	2593	2682.5
10	Channel	39700	40620	41540
	Frequency	2501	2593	2685
5	Channel	39675	40620	41565
	Frequency	2498.5	2593	2687.5



LTE Band 71 Channel and Frequency List				
BW [MHz]	Channel/Frequency(MHz)	Lowest	Middle	Highest
20	Channel	133222	133322	133372
	Frequency	673.0	680.5	688.0
15	Channel	133197	133297	133397
	Frequency	670.5	680.5	690.5
10	Channel	133172	133272	133422
	Frequency	668.0	678.0	693.0
5	Channel	133147	133247	133447
	Frequency	665.5	675.5	695.5



LTE Band 7C_CA Channel and Frequency List					
BW [MHz]	Channel/Frequency(MHz)		Lowest	Middle	Highest
20 + 20	PCC	Channel	20850	21001	21152
		Frequency	2510.0	2525.1	2540.2
	SCC	Channel	21048	21199	21350
		Frequency	2529.8	2544.9	2560.0
20 + 15	PCC	Channel	20850	21026	21201
		Frequency	2510.0	2527.6	2545.1
	SCC	Channel	21021	21197	21372
		Frequency	2527.1	2544.7	2562.2
15 + 20	PCC	Channel	20828	21003	21179
		Frequency	2507.8	2525.3	2542.9
	SCC	Channel	20999	21174	21350
		Frequency	2524.9	2542.4	2560.0
20 + 10	PCC	Channel	20850	21051	21251
		Frequency	2510.0	2530.1	2550.1
	SCC	Channel	20994	21195	21395
		Frequency	2524.4	2544.5	2564.5
10 + 20	PCC	Channel	20805	21006	21206
		Frequency	2505.5	2525.6	2545.6
	SCC	Channel	20949	21150	21350
		Frequency	2519.9	2540.0	2560.0
15 + 15	PCC	Channel	20825	21025	21225
		Frequency	2507.5	2527.5	2547.5
	SCC	Channel	20975	21175	21375
		Frequency	2522.5	2542.5	2562.5
15 + 10	PCC	Channel	20825	21051	21277
		Frequency	2507.5	2530.1	2552.7
	SCC	Channel	20945	21171	21397
		Frequency	2519.5	2542.1	2564.7



LTE Band 38C_CA Channel and Frequency List					
BW [MHz]	Channel/Frequency(MHz)		Lowest	Middle	Highest
20 + 20	PCC	Channel	37850	37901	37952
		Frequency	2580.0	2585.1	2590.2
	SCC	Channel	38048	38099	38150
		Frequency	2599.8	2604.9	2610.0
15+ 15	PCC	Channel	37825	37925	38025
		Frequency	2577.5	2587.5	2597.5
	SCC	Channel	37975	38075	38175
		Frequency	2592.5	2602.5	2612.5

LTE Band 41C_CA Channel and Frequency List					
BW [MHz]	Channel/Frequency(MHz)		Lowest	Middle	Highest
20 + 20	PCC	Channel	39750	40521	41292
		Frequency	2506.0	2583.1	2660.2
	SCC	Channel	39948	40719	41490
		Frequency	2525.8	2602.9	2680.0
20 + 15	PCC	Channel	39750	40546	41341
		Frequency	2506.0	2585.6	2665.1
	SCC	Channel	39921	40717	41512
		Frequency	2523.1	2602.7	2682.2
15 + 20	PCC	Channel	39728	40523	41319
		Frequency	2503.8	2593.3	2662.9
	SCC	Channel	39899	40694	41490
		Frequency	2520.9	2600.4	2680.0
20 + 10	PCC	Channel	39750	40571	41391
		Frequency	2506.0	2588.1	2670.1
	SCC	Channel	39894	40715	41535
		Frequency	2520.4	2602.5	2684.5
10 + 20	PCC	Channel	39705	40526	41346
		Frequency	2501.5	2583.6	2665.6
	SCC	Channel	39849	40670	41490
		Frequency	2515.9	2598.0	2680.0



LTE Band 41C_CA Channel and Frequency List					
20 + 5	PCC	Channel	39750	40595	41440
		Frequency	2506.0	2590.5	2675.0
	SCC	Channel	39867	40712	41557
		Frequency	2517.7	2602.2	2686.7
5 + 20	PCC	Channel	39683	40528	41373
		Frequency	2499.3	2583.8	2668.3
	SCC	Channel	39800	40645	41490
		Frequency	2511.0	2595.5	2680.0
15 + 15	PCC	Channel	39725	40545	41365
		Frequency	2503.5	2585.5	2667.5
	SCC	Channel	39875	40695	41515
		Frequency	2518.5	2600.5	2682.5
10 + 15	PCC	Channel	39703	40549	41395
		Frequency	2501.3	2585.9	2670.5
	SCC	Channel	39823	40669	41515
		Frequency	2513.3	2597.9	2682.5
15 + 10	PCC	Channel	39725	40571	41417
		Frequency	2503.5	2588.1	2672.7
	SCC	Channel	39845	40691	41537
		Frequency	2515.5	2600.1	2684.7

3 Conducted Test Items

3.1 Measuring Instruments

See list of measuring instruments of this test report.

3.2 Test Setup

3.2.1 Conducted Output Power



3.2.2 Peak-to-Average Ratio, Occupied Bandwidth ,Conducted Band-Edge and Conducted Spurious Emission

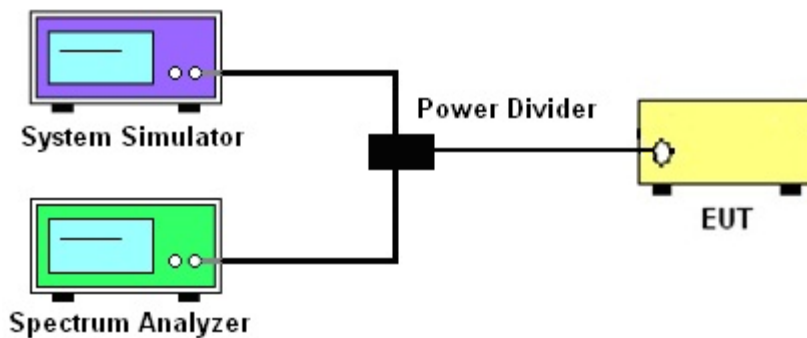

3.2.3 Frequency Stability

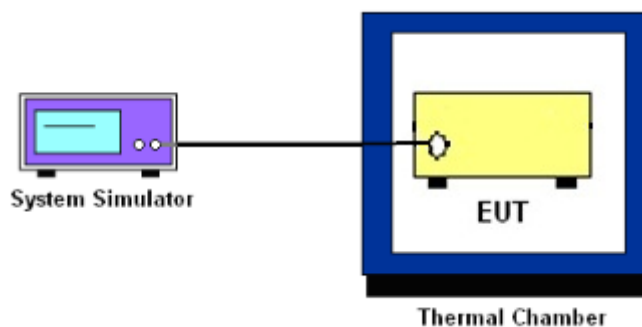

3.3 Test Result of Conducted Test

Please refer to Appendix A.



3.4 Conducted Output Power and ERP/EIRP

3.4.1 Description of the Conducted Output Power Measurement and ERP/EIRP Measurement

A system simulator was used to establish communication with the EUT. Its parameters were set to force the EUT transmitting at maximum output power. The measured power in the radio frequency on the transmitter output terminals shall be reported.

The ERP of mobile transmitters must not exceed 3 Watts for LTE Band 71.

The EIRP of mobile transmitters must not exceed 2 Watts for LTE Band 7 and Band 38 and Band 41.

According to KDB 412172 D01 Power Approach,

$EIRP = P_T + G_T - L_C$, $ERP = EIRP - 2.15$, where

P_T = transmitter output power in dBm

G_T = gain of the transmitting antenna in dBi

L_C = signal attenuation in the connecting cable between the transmitter and antenna in dB

3.4.2 Test Procedures

1. The testing follows ANSI C63.26 Section 5.2
2. The transmitter output port was connected to the system simulator.
3. Set EUT at maximum power through the system simulator.
4. Select lowest, middle, and highest channels for each band and different modulation.
5. Measure and record the power level from the system simulator.



3.5 Peak-to-Average Ratio

3.5.1 Description of the PAR Measurement

Power Complementary Cumulative Distribution Function (CCDF) curves provide a means for characterizing the power peaks of a digitally modulated signal on a statistical basis. A CCDF curve depicts the probability of the peak signal amplitude exceeding the average power level. Most contemporary measurement instrumentation include the capability to produce CCDF curves for an input signal provided that the instrument's resolution bandwidth can be set wide enough to accommodate the entire input signal bandwidth. In measuring transmissions in this band using an average power technique, the peak-to-average ratio (PAR) of the transmission may not exceed 13 dB.

3.5.2 Test Procedures

1. The testing follows ANSI C63.26 Section 5.2.3.4 (CCDF).
2. The EUT was connected to spectrum and system simulator via a power divider.
3. Set the CCDF (Complementary Cumulative Distribution Function) option in spectrum analyzer.
4. The highest RF powers were measured and recorded the maximum PAPR level associated with a probability of 0.1 %.
5. Record the deviation as Peak to Average Ratio.



3.6 Occupied Bandwidth

3.6.1 Description of Occupied Bandwidth Measurement

The occupied bandwidth is the width of a frequency band such that, below the lower and above the upper frequency limits, the mean powers emitted are each equal to a specified percentage 0.5% of the total mean transmitted power.

The 26 dB emission bandwidth is defined as the frequency range between two points, one above and one below the carrier frequency, at which the spectral density of the emission is attenuated 26 dB below the maximum in-band spectral density of the modulated signal. Spectral density (power per unit bandwidth) is to be measured with a detector of resolution bandwidth equal to approximately 1.0% of the emission bandwidth.

3.6.2 Test Procedures

1. The testing follows ANSI C63.26 Section 5.4
2. The EUT was connected to spectrum analyzer and system simulator via a power divider.
3. The spectrum analyzer center frequency is set to the nominal EUT channel center frequency. The span range for the spectrum analyzer shall be between two and five times the anticipated OBW.
4. The nominal resolution bandwidth (RBW) shall be in the range of 1 to 5 % of the anticipated OBW, and the VBW shall be at least 3 times the RBW.
5. Set the detection mode to peak, and the trace mode to max hold.
6. Determine the reference value: Set the EUT to transmit a modulated signal. Allow the trace to stabilize. Set the spectrum analyzer marker to the highest level of the displayed trace.
(this is the reference value)
7. Determine the “-26 dB down amplitude” as equal to (Reference Value – X).
8. Place two markers, one at the lowest and the other at the highest frequency of the envelope of the spectral display such that each marker is at or slightly below the “-X dB down amplitude” determined in step 6. If a marker is below this “-X dB down amplitude” value it shall be placed as close as possible to this value. The OBW is the positive frequency difference between the two markers.
9. Use the 99 % power bandwidth function of the spectrum analyzer and report the measured bandwidth.



3.7 Conducted Band Edge

3.7.1 Description of Conducted Band Edge Measurement

27.53 (g)

For operations in the 600MHz band and 698 -746 MHz band, the FCC limit is $43 + 10\log_{10}(P[\text{Watts}])$ dB below the transmitter power $P(\text{Watts})$ in a 100 kHz bandwidth. However, in the 100 kilohertz bands immediately outside and adjacent to a licensee's frequency block, a resolution bandwidth of at least 30 kHz may be employed.

27.53(m)(4)

For mobile digital stations, the attenuation factor shall be not less than $40 + 10 \log (P)$ dB on all frequencies between the channel edge and 5 megahertz from the channel edge, $43 + 10 \log (P)$ dB on all frequencies between 5 megahertz and X megahertz from the channel edge, and $55 + 10 \log (P)$ dB on all frequencies more than X megahertz from the channel edge, where X is the greater of 6 megahertz or the actual emission bandwidth as defined in paragraph (m)(6) of this section. In addition, the attenuation factor shall not be less that $43 + 10 \log (P)$ dB on all frequencies between 2490.5 MHz and 2496 MHz and $55 + 10 \log (P)$ dB at or below 2490.5 MHz. Mobile Satellite Service licensees operating on frequencies below 2495 MHz may also submit a documented interference complaint against BRS licensees operating on channel BRS Channel 1 on the same terms and conditions as adjacent channel BRS or EBS licensees.



3.7.2 Test Procedures

1. The testing follows ANSI C63.26 section 5.7
2. The EUT was connected to spectrum analyzer and system simulator via a power divider.
3. The band edges of low and high channels for the highest RF powers were measured.
4. Set RBW \geq 1% EBW in the 1MHz band immediately outside and adjacent to the band edge.
5. Beyond the 1 MHz band from the band edge, RBW=1MHz was used.
6. Set spectrum analyzer with RMS detector.
7. Offset has included the duty factor for LTE Band 38/41. Duty factor = $10 \log (1/x)$, where x is the measured duty cycle.
8. The RF fundamental frequency should be excluded against the limit line in the operating frequency band.
9. Checked that all the results comply with the emission limit line.

Example:

The limit line is derived from $43 + 10\log(P)$ dB below the transmitter power P(Watts)

$$= P(W) - [43 + 10\log(P)] \text{ (dB)}$$

$$= [30 + 10\log(P)] \text{ (dBm)} - [43 + 10\log(P)] \text{ (dB)} = -13\text{dBm}.$$

10. For LTE Band 7, 38, 41, the other 40 dB, and 55 dB have additionally applied same calculation above.



3.8 Conducted Spurious Emission

3.8.1 Description of Conducted Spurious Emission Measurement

The power of any emission outside of the authorized operating frequency ranges must be lower than the transmitter power (P) by a factor of at least $43 + 10 \log (P)$ dB.

For Band 7,38,41:

The power of any emission outside of the authorized operating frequency ranges must be lower than the transmitter power (P) by a factor of at least $55 + 10 \log (P)$ dB.

It is measured by means of a calibrated spectrum analyzer and scanned from 30 MHz up to a frequency including its 10th harmonic.

3.8.2 Test Procedures

1. The testing follows ANSI C63.26 section 5.7
2. The EUT was connected to spectrum analyzer and system simulator via a power divider.
3. The RF output of EUT was connected to the spectrum analyzer by RF cable and attenuator. The path loss was compensated to the results for each measurement.
4. The middle channel for the highest RF power within the transmitting frequency was measured.
5. The conducted spurious emission for the whole frequency range was taken.
6. Make the measurement with the spectrum analyzer's RBW = 1MHz, VBW = 3MHz.
7. Set spectrum analyzer with RMS detector.
8. Offset has included the duty factor for LTE Band 38/41. Duty factor = $10 \log (1/x)$, where x is the measured duty cycle
9. Taking the record of maximum spurious emission.
10. The RF fundamental frequency should be excluded against the limit line in the operating frequency band.
11. The limit line is derived from $43 + 10 \log (P)$ dB below the transmitter power P(Watts)
= $P(W) - [43 + 10 \log (P)]$ (dB)
= $[30 + 10 \log (P)]$ (dBm) - $[43 + 10 \log (P)]$ (dB)
= -13dBm.
12. For Band 7, 38, 41
The limit line is derived from $55 + 10 \log (P)$ dB below the transmitter power P(Watts)
= $P(W) - [55 + 10 \log (P)]$ (dB)
= $[30 + 10 \log (P)]$ (dBm) - $[55 + 10 \log (P)]$ (dB)
= -25dBm.



3.9 Frequency Stability

3.9.1 Description of Frequency Stability Measurement

The frequency stability shall be measured by variation of ambient temperature and variation of primary supply voltage to ensure that the fundamental emission stays within the authorized frequency block. The frequency stability of the transmitter shall be maintained within $\pm 0.00025\%$ ($\pm 2.5\text{ppm}$) of the center frequency.

3.9.2 Test Procedures for Temperature Variation

1. The testing follows ANSI C63.26 section 5.6.4
2. The EUT was set up in the thermal chamber and connected with the system simulator.
3. With power OFF, the temperature was decreased to -30°C and the EUT was stabilized before testing. Power was applied and the maximum change in frequency was recorded within one minute.
4. With power OFF, the temperature was raised in 10°C step up to 50°C . The EUT was stabilized at each step for at least half an hour. Power was applied and the maximum frequency change was recorded within one minute.

3.9.3 Test Procedures for Voltage Variation

1. The testing follows ANSI C63.26 section 5.6.5
2. The EUT was placed in a temperature chamber at $20\pm 5^{\circ}\text{C}$ and connected with the system simulator.
3. The power supply voltage to the EUT was varied from 85% to 115% of the nominal value for other than hand carried battery equipment.
4. For hand carried, battery powered equipment, reduce the primary ac or dc supply voltage to the battery operating end point, which shall be specified by the manufacturer.
5. The variation in frequency was measured for the worst case.

4 Radiated Test Items

4.1 Measuring Instruments

See list of measuring instruments of this test report.

4.2 Test Setup

4.2.1 For radiated test from 30MHz to 1GHz



4.2.2 For radiated test above 1GHz

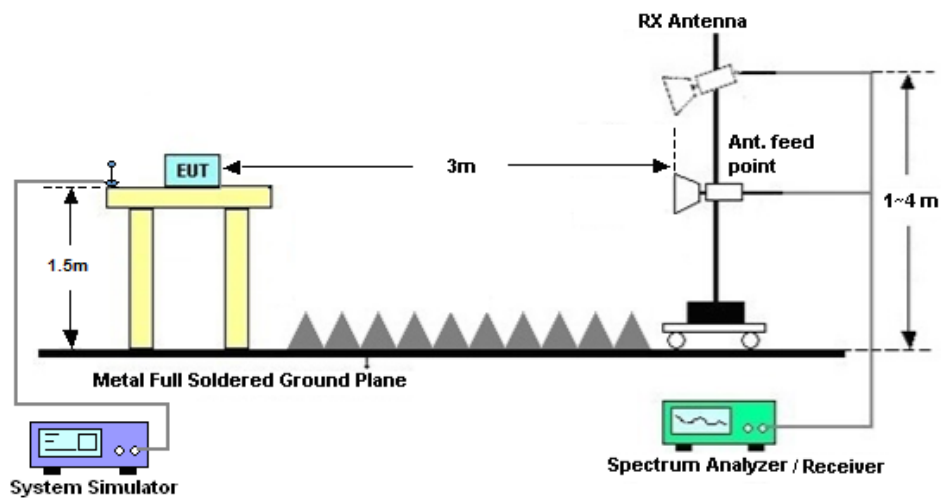

4.3 Test Result of Radiated Test

Please refer to Appendix B.



4.4 Radiated Spurious Emission

4.4.1 Description of Radiated Spurious Emission

The radiated spurious emission was measured by substitution method according to ANSI C63.26. The power of any emission outside of the authorized operating frequency ranges must be attenuated below the transmitter power (P) by a factor of at least $43 + 10 \log (P)$ dB.

For Band 7, 38, 41

The power of any emission outside of the authorized operating frequency ranges must be attenuated below the transmitter power (P) by a factor of at least $55 + 10 \log (P)$ dB.

The spectrum is scanned from 30 MHz up to a frequency including its 10th harmonic.

4.4.2 Test Procedures

1. The testing follows ANSI C63.26 Section 5.5
2. The EUT was placed on a turntable with 0.8 meter height for frequency below 1GHz and 1.5 meter height for frequency above 1GHz respectively above ground.
3. The EUT was set 3 meters from the receiving antenna mounted on the antenna tower.
4. The table was rotated 360 degrees to determine the position of the highest spurious emission.
5. The height of the receiving antenna is varied between 1m to 4m to search the maximum spurious emission for both horizontal and vertical polarizations.
6. During the measurement, the system simulator parameters were set to force the EUT transmitting at maximum output power.
7. Make the measurement with the spectrum analyzer's RBW = 1MHz, VBW = 3MHz, taking the record of maximum spurious emission.
8. A horn antenna was substituted in place of the EUT and was driven by a signal generator.
9. Tune the output power of signal generator to the same emission level with EUT maximum spurious emission.
10. $EIRP (dBm) = S.G. Power - Tx Cable Loss + Tx Antenna Gain$
11. $ERP (dBm) = EIRP - 2.15$
12. The RF fundamental frequency should be excluded against the limit line in the operating frequency band.

The limit line is derived from $43 + 10\log(P)$ dB below the transmitter power P(Watts)
 $= P(W) - [43 + 10\log(P)] (dB)$
 $= [30 + 10\log(P)] (dBm) - [43 + 10\log(P)] (dB)$
 $= -13dBm.$

13. For Band 7, 38, 41:

The limit line is derived from $55 + 10\log(P)$ dB below the transmitter power P(Watts)



5 List of Measuring Equipment

Instrument	Manufacturer	Model No.	Serial No.	Characteristics	Calibration Date	Test Date	Due Date	Remark
Spectrum Analyzer	R&S	FSV40	101040	10Hz~40GHz	Nov. 02, 2019	Jun. 07, 2020 ~Jul. 03, 2020	Nov. 01, 2020	Conducted (TH01-KS)
Thermal Chamber	Ten Billion	TTC-B3S	TBN-960502	-40~+150°C	Oct. 28, 2019	Jun. 07, 2020 ~Jul. 03, 2020	Oct. 27, 2020	Conducted (TH01-KS)
EMI Test Receiver	R&S	ESR7	101403	9kHz~7GHz;Max 30dBm	Oct. 18, 2019	Jul. 20, 2020	Oct. 17, 2020	Radiation (03CH02-KS)
EXA Spectrum Analyzer	Keysight	N9010A	MY55370528	10Hz-44G,MAX 30dB	Oct. 18, 2019	Jul. 20, 2020	Oct. 17, 2020	Radiation (03CH02-KS)
Bilog Antenna	TeseQ	CBL6111D	44483	30MHz-1GHz	Dec. 30, 2019	Jul. 20, 2020	Dec. 29, 2020	Radiation (03CH02-KS)
Double Ridge Horn Antenna	ETS-Lindgren	3117	75957	1GHz~18GHz	Nov. 10, 2019	Jul. 20, 2020	Nov. 09, 2020	Radiation (03CH02-KS)
high gain Amplifier	MITEQ	AMF-7D-00 101800-30-1 0P	2025788	100MHz-18GHz	Jan. 02, 2020	Jul. 20, 2020	Jan. 01, 2021	Radiation (03CH02-KS)
SHF-EHF Horn	Com-power	AH-840	101115	18GHz~40GHz	Nov. 10, 2019	Jul. 20, 2020	Nov. 09, 2020	Radiation (03CH02-KS)
Amplifier	SONOMA	310N	187289	9KHz-1GHz	Jan. 02, 2020	Jul. 20, 2020	Jan. 01, 2021	Radiation (03CH02-KS)
Amplifier	Keysight	83017A	MY53270316	500MHz~26.5GHz	Oct. 18, 2019	Jul. 20, 2020	Oct. 17, 2020	Radiation (03CH02-KS)
Amplifier	MITEQ	EM18G40G GA	060728	18~40GHz	Jan. 08, 2020	Jul. 20, 2020	Jan. 07, 2021	Radiation (03CH02-KS)
AC Power Source	Chroma	61601	61601000247 3	N/A	NCR	Jul. 20, 2020	NCR	Radiation (03CH02-KS)
Turn Table	MF	MF7802	N/A	0~360 degree	NCR	Jul. 20, 2020	NCR	Radiation (03CH02-KS)
Antenna Mast	MF	MF7802	N/A	1 m~4 m	NCR	Jul. 20, 2020	NCR	Radiation (03CH02-KS)

NCR: No Calibration Required.



6 Uncertainty of Evaluation

The measurement uncertainties shown below were calculated in accordance with the requirements of ANSI 63.26-2015. All the measurement uncertainty value were shown with a coverage K=2 to indicate 95% level of confidence. The measurement data show herein meets or exceeds the CISPR measurement uncertainty values specified in CISPR 16-4-2 and can be compared directly to specified limit to determine compliance.

Uncertainty of Radiated Emission Measurement (30 MHz ~ 1000 MHz)

Measuring Uncertainty for a Level of Confidence of 95% (U = 2Uc(y))	2.5dB
---	-------

Uncertainty of Radiated Emission Measurement (1 GHz ~ 18 GHz)

Measuring Uncertainty for a Level of Confidence of 95% (U = 2Uc(y))	2.1 dB
---	--------

Uncertainty of Radiated Emission Measurement (18 GHz ~ 40 GHz)

Measuring Uncertainty for a Level of Confidence of 95% (U = 2Uc(y))	2.1 dB
---	--------



Appendix A. Test Results of Conducted Test

Conducted Output Power(Average power)

LTE Band 7						
BW [MHz]	Modulation	RB Size	RB Offset	Power Low Ch. / Freq.	Power Middle Ch. / Freq.	Power High Ch. / Freq.
Channel				20850	21100	21350
Frequency (MHz)				2510	2535	2560
20	QPSK	1	0	23.16	23.39	23.20
20	QPSK	1	49	23.09	23.25	23.16
20	QPSK	1	99	23.25	23.10	22.96
20	QPSK	50	0	22.25	22.43	22.28
20	QPSK	50	24	22.42	22.37	22.23
20	QPSK	50	50	22.39	22.38	22.24
20	QPSK	100	0	22.37	22.38	22.22
20	16QAM	1	0	22.58	22.67	22.60
20	16QAM	1	49	22.72	22.53	22.41
20	16QAM	1	99	22.65	22.46	22.33
20	16QAM	50	0	21.29	21.35	21.30
20	16QAM	50	24	21.44	21.28	21.23
20	16QAM	50	50	21.45	21.34	21.24
20	16QAM	100	0	21.30	21.37	21.14
20	64QAM	1	0	21.41	21.51	21.34
20	64QAM	1	49	21.51	21.59	21.31
20	64QAM	1	99	21.25	21.35	21.18
20	64QAM	50	0	20.35	20.40	20.36
20	64QAM	50	24	20.43	20.40	20.39
20	64QAM	50	50	20.39	20.37	20.29
20	64QAM	100	0	20.41	20.27	20.21



Channel				20825	21100	21375
Frequency (MHz)				2507.5	2535	2562.5
15	QPSK	1	0	23.28	23.38	23.19
15	QPSK	1	37	23.26	23.27	23.07
15	QPSK	1	74	23.20	23.28	22.99
15	QPSK	36	0	22.43	22.35	22.29
15	QPSK	36	20	22.35	22.33	22.22
15	QPSK	36	39	22.40	22.39	22.18
15	QPSK	75	0	22.39	22.32	22.20
15	16QAM	1	0	22.45	22.61	22.49
15	16QAM	1	37	22.39	22.66	22.33
15	16QAM	1	74	22.61	22.57	22.36
15	16QAM	36	0	21.39	21.39	21.27
15	16QAM	36	20	21.37	21.41	21.22
15	16QAM	36	39	21.38	21.43	21.27
15	16QAM	75	0	21.34	21.39	21.28
15	64QAM	1	0	21.36	21.50	21.45
15	64QAM	1	37	21.49	21.31	21.35
15	64QAM	1	74	21.28	21.50	21.20
15	64QAM	36	0	20.44	20.48	20.25
15	64QAM	36	20	20.49	20.40	20.30
15	64QAM	36	39	20.44	20.42	20.23
15	64QAM	75	0	20.36	20.32	20.20



Channel				20800	21100	21400
Frequency (MHz)				2505	2535	2565
10	QPSK	1	0	23.27	23.18	23.13
10	QPSK	1	25	23.18	23.15	23.06
10	QPSK	1	49	23.16	23.16	22.99
10	QPSK	25	0	22.35	22.40	22.20
10	QPSK	25	12	22.43	22.30	22.29
10	QPSK	25	25	22.39	22.33	22.13
10	QPSK	50	0	22.48	22.33	22.14
10	16QAM	1	0	22.73	22.73	22.55
10	16QAM	1	25	22.56	22.55	22.37
10	16QAM	1	49	22.60	22.61	22.41
10	16QAM	25	0	21.36	21.31	21.24
10	16QAM	25	12	21.41	21.43	21.18
10	16QAM	25	25	21.38	21.44	21.20
10	16QAM	50	0	21.42	21.30	21.12
10	64QAM	1	0	21.54	21.48	21.55
10	64QAM	1	25	21.67	21.59	21.43
10	64QAM	1	49	21.52	21.66	21.33
10	64QAM	25	0	20.40	20.39	20.17
10	64QAM	25	12	20.49	20.43	20.30
10	64QAM	25	25	20.44	20.44	20.23
10	64QAM	50	0	20.38	20.29	20.21



Channel				20775	21100	21425
Frequency (MHz)				2502.5	2535	2567.5
5	QPSK	1	0	23.28	23.27	23.16
5	QPSK	1	12	23.31	23.29	23.15
5	QPSK	1	24	23.28	23.33	23.15
5	QPSK	12	0	22.43	22.34	22.24
5	QPSK	12	7	22.35	22.31	22.24
5	QPSK	12	13	22.42	22.40	22.26
5	QPSK	25	0	22.36	22.33	22.19
5	16QAM	1	0	22.61	22.68	22.46
5	16QAM	1	12	22.49	22.61	22.45
5	16QAM	1	24	22.60	22.63	22.42
5	16QAM	12	0	21.37	21.38	21.28
5	16QAM	12	7	21.38	21.35	21.27
5	16QAM	12	13	21.46	21.44	21.23
5	16QAM	25	0	21.39	21.35	21.28
5	64QAM	1	0	21.49	21.56	21.50
5	64QAM	1	12	21.38	21.53	21.36
5	64QAM	1	24	21.60	21.55	21.41
5	64QAM	12	0	20.44	20.48	20.32
5	64QAM	12	7	20.47	20.42	20.29
5	64QAM	12	13	20.42	20.53	20.26
5	64QAM	25	0	20.39	20.43	20.31



LTE Band 38						
BW [MHz]	Modulation	RB Size	RB Offset	Power Low Ch. / Freq.	Power Middle Ch. / Freq.	Power High Ch. / Freq.
Channel				37850	38000	38150
Frequency (MHz)				2580	2595	2610
20	QPSK	1	0	22.93	22.96	22.95
20	QPSK	1	49	22.79	22.85	22.88
20	QPSK	1	99	22.78	22.77	22.78
20	QPSK	50	0	21.92	22.03	21.97
20	QPSK	50	24	21.97	21.93	22.02
20	QPSK	50	50	21.89	21.97	21.98
20	QPSK	100	0	21.99	22.03	22.02
20	16QAM	1	0	22.04	22.07	22.07
20	16QAM	1	49	21.84	21.92	21.92
20	16QAM	1	99	21.84	21.90	21.79
20	16QAM	50	0	20.98	21.02	21.03
20	16QAM	50	24	20.99	20.98	21.05
20	16QAM	50	50	20.93	20.95	21.00
20	16QAM	100	0	21.02	20.97	21.06
20	64QAM	1	0	20.63	20.59	20.61
20	64QAM	1	49	20.52	20.53	20.58
20	64QAM	1	99	20.42	20.48	20.45
20	64QAM	50	0	19.98	20.07	20.03
20	64QAM	50	24	20.05	19.98	20.08
20	64QAM	50	50	19.93	19.99	19.97
20	64QAM	100	0	19.99	19.95	20.05



Channel				37825	38000	38175
Frequency (MHz)				2577.5	2595	2612.5
15	QPSK	1	0	22.86	22.86	22.88
15	QPSK	1	37	22.80	22.89	22.85
15	QPSK	1	74	22.75	22.73	22.76
15	QPSK	36	0	21.91	21.97	21.95
15	QPSK	36	20	21.97	21.92	21.91
15	QPSK	36	39	21.92	21.95	21.95
15	QPSK	75	0	21.96	21.93	21.92
15	16QAM	1	0	22.02	22.01	22.01
15	16QAM	1	37	21.71	21.76	21.82
15	16QAM	1	74	21.88	21.91	21.87
15	16QAM	36	0	20.89	20.91	20.97
15	16QAM	36	20	20.93	20.88	20.87
15	16QAM	36	39	20.88	20.90	20.95
15	16QAM	75	0	21.03	20.93	20.95
15	64QAM	1	0	20.62	20.57	20.56
15	64QAM	1	37	20.53	20.52	20.56
15	64QAM	1	74	20.40	20.49	20.45
15	64QAM	36	0	19.95	19.95	20.04
15	64QAM	36	20	19.97	19.96	19.94
15	64QAM	36	39	19.95	19.96	19.97
15	64QAM	75	0	20.04	19.95	19.99



Channel				37800	38000	38200
Frequency (MHz)				2575	2595	2615
10	QPSK	1	0	22.85	22.83	22.83
10	QPSK	1	25	22.80	22.84	22.87
10	QPSK	1	49	22.73	22.75	22.80
10	QPSK	25	0	22.02	21.95	21.97
10	QPSK	25	12	21.96	21.91	21.88
10	QPSK	25	25	21.92	21.97	21.93
10	QPSK	50	0	21.95	21.93	21.88
10	16QAM	1	0	22.07	22.08	22.05
10	16QAM	1	25	21.97	21.99	21.97
10	16QAM	1	49	21.93	21.92	21.95
10	16QAM	25	0	20.95	20.91	20.96
10	16QAM	25	12	21.02	20.97	20.88
10	16QAM	25	25	20.92	20.92	20.86
10	16QAM	50	0	21.00	20.93	20.94
10	64QAM	1	0	20.81	20.51	20.77
10	64QAM	1	25	20.77	20.58	20.50
10	64QAM	1	49	20.47	20.48	20.43
10	64QAM	25	0	20.08	20.00	20.01
10	64QAM	25	12	20.07	20.03	19.95
10	64QAM	25	25	20.02	20.05	19.92
10	64QAM	50	0	20.01	19.94	19.90



Channel				37775	38000	38225
Frequency (MHz)				2572.5	2595	2617.5
5	QPSK	1	0	22.93	22.86	22.90
5	QPSK	1	12	22.81	22.87	22.85
5	QPSK	1	24	22.82	22.86	22.80
5	QPSK	12	0	22.02	21.91	22.00
5	QPSK	12	7	21.96	21.91	22.01
5	QPSK	12	13	21.94	21.97	21.99
5	QPSK	25	0	21.98	21.93	21.96
5	16QAM	1	0	22.08	22.01	22.07
5	16QAM	1	12	22.08	22.02	22.00
5	16QAM	1	24	22.03	22.07	22.01
5	16QAM	12	0	20.99	20.91	20.96
5	16QAM	12	7	20.95	20.90	21.00
5	16QAM	12	13	20.88	20.93	20.92
5	16QAM	25	0	21.01	20.96	21.02
5	64QAM	1	0	20.71	20.58	20.64
5	64QAM	1	12	20.62	20.62	20.59
5	64QAM	1	24	20.60	20.61	20.58
5	64QAM	12	0	20.05	20.00	20.05
5	64QAM	12	7	20.03	19.98	20.05
5	64QAM	12	13	19.99	20.01	20.02
5	64QAM	25	0	20.01	19.96	20.05



LTE Band 41						
BW [MHz]	Modulation	RB Size	RB Offset	Power Low Ch. / Freq.	Power Middle Ch. / Freq.	Power High Ch. / Freq.
Channel				39750	40620	41490
Frequency (MHz)				2506	2593	2680
20	QPSK	1	0	24.65	24.63	24.85
20	QPSK	1	49	24.64	24.55	24.63
20	QPSK	1	99	24.64	24.57	24.63
20	QPSK	50	0	23.86	23.80	24.02
20	QPSK	50	24	23.98	23.77	23.89
20	QPSK	50	50	23.95	23.84	23.87
20	QPSK	100	0	23.96	23.78	24.01
20	16QAM	1	0	24.03	24.12	24.03
20	16QAM	1	49	24.06	23.95	23.92
20	16QAM	1	99	23.98	24.00	23.92
20	16QAM	50	0	22.92	22.89	22.84
20	16QAM	50	24	23.05	22.95	22.83
20	16QAM	50	50	22.98	22.93	22.87
20	16QAM	100	0	23.01	22.94	22.81
20	64QAM	1	0	22.90	22.99	22.91
20	64QAM	1	49	22.84	22.82	22.77
20	64QAM	1	99	22.93	22.84	22.76
20	64QAM	50	0	21.83	21.81	21.76
20	64QAM	50	24	21.96	21.88	21.75
20	64QAM	50	50	21.94	21.86	21.81
20	64QAM	100	0	22.02	21.96	21.85



Channel				39725	40620	41515
Frequency (MHz)				2503.5	2593	2682.5
15	QPSK	1	0	24.69	24.70	24.61
15	QPSK	1	37	24.69	24.66	24.55
15	QPSK	1	74	24.71	24.71	24.67
15	QPSK	36	0	23.84	23.82	23.76
15	QPSK	36	20	23.94	23.90	23.75
15	QPSK	36	39	23.92	23.85	23.80
15	QPSK	75	0	23.96	23.88	23.75
15	16QAM	1	0	24.00	23.96	23.92
15	16QAM	1	37	23.97	23.93	23.92
15	16QAM	1	74	24.04	24.01	23.97
15	16QAM	36	0	22.83	22.80	22.77
15	16QAM	36	20	22.90	22.85	22.72
15	16QAM	36	39	22.85	22.83	22.82
15	16QAM	75	0	22.97	22.90	22.77
15	64QAM	1	0	22.94	22.86	22.80
15	64QAM	1	37	22.87	22.80	22.81
15	64QAM	1	74	22.88	22.88	22.84
15	64QAM	36	0	21.86	21.83	21.78
15	64QAM	36	20	21.96	21.88	21.75
15	64QAM	36	39	21.94	21.87	21.81
15	64QAM	75	0	21.98	21.88	21.76



Channel				39700	40620	41540
Frequency (MHz)				2501	2593	2685
10	QPSK	1	0	24.75	24.70	24.63
10	QPSK	1	25	24.75	24.72	24.69
10	QPSK	1	49	24.81	24.68	24.64
10	QPSK	25	0	23.95	23.82	23.78
10	QPSK	25	12	23.95	23.94	23.80
10	QPSK	25	25	23.92	23.89	23.85
10	QPSK	50	0	23.95	23.92	23.76
10	16QAM	1	0	24.12	24.08	24.04
10	16QAM	1	25	24.11	24.08	24.03
10	16QAM	1	49	24.05	24.05	24.02
10	16QAM	25	0	22.97	22.84	22.78
10	16QAM	25	12	22.99	22.95	22.86
10	16QAM	25	25	22.92	22.89	22.86
10	16QAM	50	0	22.99	22.95	22.84
10	64QAM	1	0	23.18	23.09	23.04
10	64QAM	1	25	23.07	23.10	23.08
10	64QAM	1	49	23.12	23.07	23.04
10	64QAM	25	0	21.92	21.81	21.80
10	64QAM	25	12	21.94	21.93	21.80
10	64QAM	25	25	21.92	21.90	21.83
10	64QAM	50	0	21.94	21.89	21.77



Channel				39675	40620	41565
Frequency (MHz)				2498.5	2593	2687.5
5	QPSK	1	0	24.79	24.66	24.70
5	QPSK	1	12	24.69	24.72	24.64
5	QPSK	1	24	24.76	24.68	24.65
5	QPSK	12	0	23.95	23.86	23.87
5	QPSK	12	7	23.99	23.96	23.89
5	QPSK	12	13	23.95	23.90	23.84
5	QPSK	25	0	23.93	23.88	23.81
5	16QAM	1	0	24.14	24.06	24.04
5	16QAM	1	12	24.08	24.09	24.02
5	16QAM	1	24	24.10	24.05	24.00
5	16QAM	12	0	22.99	22.89	22.91
5	16QAM	12	7	23.03	23.00	22.91
5	16QAM	12	13	22.97	22.92	22.88
5	16QAM	25	0	23.01	22.98	22.87
5	64QAM	1	0	23.02	22.93	22.94
5	64QAM	1	12	23.03	22.97	22.92
5	64QAM	1	24	23.01	22.99	22.92
5	64QAM	12	0	21.93	21.83	21.86
5	64QAM	12	7	21.97	21.94	21.86
5	64QAM	12	13	21.93	21.86	21.83
5	64QAM	25	0	21.94	21.90	21.81



LTE Band 71						
BW [MHz]	Modulation	RB Size	RB Offset	Power Low Ch. / Freq.	Power Middle Ch. / Freq.	Power High Ch. / Freq.
Channel				133222	133322	133372
Frequency (MHz)				673	683	688
20	QPSK	1	0	23.16	23.28	23.25
20	QPSK	1	49	23.05	22.98	22.96
20	QPSK	1	99	22.89	22.86	22.87
20	QPSK	50	0	22.26	22.27	22.26
20	QPSK	50	24	22.26	22.06	22.16
20	QPSK	50	50	22.14	22.06	22.09
20	QPSK	100	0	22.15	22.16	22.15
20	16QAM	1	0	22.50	22.61	22.52
20	16QAM	1	49	22.49	22.44	22.35
20	16QAM	1	99	22.30	22.15	22.23
20	16QAM	50	0	21.19	21.16	21.19
20	16QAM	50	24	21.20	21.17	21.11
20	16QAM	50	50	21.21	21.08	21.14
20	16QAM	100	0	21.22	21.13	21.18
20	64QAM	1	0	21.46	21.24	21.30
20	64QAM	1	49	21.12	21.19	21.17
20	64QAM	1	99	21.10	21.06	21.02
20	64QAM	50	0	20.23	20.24	20.18
20	64QAM	50	24	20.30	20.16	20.13
20	64QAM	50	50	20.15	20.11	20.00
20	64QAM	100	0	20.24	20.15	20.22



Channel				133197	133297	133397
Frequency (MHz)				670.5	680.5	690.5
15	QPSK	1	0	23.26	23.17	23.07
15	QPSK	1	37	23.04	23.07	22.92
15	QPSK	1	74	22.98	22.98	22.90
15	QPSK	36	0	22.25	22.15	22.14
15	QPSK	36	20	22.21	22.07	22.10
15	QPSK	36	39	22.17	22.04	22.00
15	QPSK	75	0	22.17	22.14	22.15
15	16QAM	1	0	22.56	22.40	22.37
15	16QAM	1	37	22.48	22.57	22.26
15	16QAM	1	74	22.36	22.23	22.27
15	16QAM	36	0	21.24	21.24	21.11
15	16QAM	36	20	21.17	21.08	21.13
15	16QAM	36	39	21.11	21.16	21.01
15	16QAM	75	0	21.25	21.11	21.08
15	64QAM	1	0	21.36	21.42	21.21
15	64QAM	1	37	21.41	21.28	21.10
15	64QAM	1	74	21.33	21.10	21.03
15	64QAM	36	0	20.19	20.20	20.17
15	64QAM	36	20	20.32	20.17	20.20
15	64QAM	36	39	20.23	20.22	20.13
15	64QAM	75	0	20.27	20.16	20.13



Channel				133172	133272	133422
Frequency (MHz)				668	678	693
10	QPSK	1	0	23.17	23.05	23.27
10	QPSK	1	25	22.91	23.04	22.93
10	QPSK	1	49	22.94	22.93	22.88
10	QPSK	25	0	22.29	22.21	22.06
10	QPSK	25	12	22.16	22.19	22.13
10	QPSK	25	25	22.12	22.16	22.11
10	QPSK	50	0	22.22	22.15	22.15
10	16QAM	1	0	22.48	22.51	22.51
10	16QAM	1	25	22.34	22.43	22.36
10	16QAM	1	49	22.42	22.40	22.30
10	16QAM	25	0	21.16	21.24	21.04
10	16QAM	25	12	21.22	21.22	21.13
10	16QAM	25	25	21.15	21.20	21.13
10	16QAM	50	0	21.25	21.28	21.15
10	64QAM	1	0	21.53	21.38	21.23
10	64QAM	1	25	21.36	21.45	21.48
10	64QAM	1	49	21.22	21.31	21.21
10	64QAM	25	0	20.34	20.21	20.15
10	64QAM	25	12	20.29	20.23	20.18
10	64QAM	25	25	20.26	20.27	20.18
10	64QAM	50	0	20.20	20.24	20.16



Channel				133147	133247	133447
Frequency (MHz)				665.5	675.5	695.5
5	QPSK	1	0	23.22	23.04	23.06
5	QPSK	1	12	23.25	23.03	22.99
5	QPSK	1	24	23.02	23.06	22.85
5	QPSK	12	0	22.30	22.23	22.06
5	QPSK	12	7	22.22	22.16	22.08
5	QPSK	12	13	22.19	22.15	22.04
5	QPSK	25	0	22.29	22.17	22.03
5	16QAM	1	0	22.48	22.53	22.48
5	16QAM	1	12	22.35	22.37	22.38
5	16QAM	1	24	22.36	22.36	22.24
5	16QAM	12	0	21.36	21.26	21.07
5	16QAM	12	7	21.25	21.26	21.15
5	16QAM	12	13	21.23	21.21	20.98
5	16QAM	25	0	21.22	21.24	21.05
5	64QAM	1	0	21.51	21.47	21.37
5	64QAM	1	12	21.35	21.30	21.26
5	64QAM	1	24	21.45	21.26	21.15
5	64QAM	12	0	20.39	20.22	20.19
5	64QAM	12	7	20.32	20.33	20.17
5	64QAM	12	13	20.25	20.24	20.04
5	64QAM	25	0	20.30	20.26	20.05



CA Power

CA_7C							
Combination 20MHz+20MHz (100RB+100RB)							
PCC Channel	SCC Channel	Modulation	PCC		SCC		Measured Power (dBm)
			RB Size	RB offset	RB Size	RB offset	
20850	21048	QPSK	1	0	0	0	23.07
21001	21199	QPSK	1	0	0	0	23.14
21152	21350	QPSK	1	0	0	0	23.30
20850	21048	16QAM	1	0	0	0	22.45
21001	21199	16QAM	1	0	0	0	22.32
21152	21350	16QAM	1	0	0	0	22.33
20850	21048	64QAM	1	0	0	0	21.23
21001	21199	64QAM	1	0	0	0	21.56
21152	21350	64QAM	1	0	0	0	21.44



CA_38C							
Combination 20MHz+20MHz (100RB+100RB)							
PCC Channel	SCC Channel	Modulation	PCC		SCC		Measured Power (dBm)
			RB Size	RB offset	RB Size	RB offset	
37850	38048	QPSK	1	0	0	0	22.76
37901	38099	QPSK	1	0	0	0	22.49
37952	38150	QPSK	1	0	0	0	22.60
37850	38048	16QAM	1	0	0	0	21.91
37901	38099	16QAM	1	0	0	0	21.92
37952	38150	16QAM	1	0	0	0	21.95
37850	38048	64QAM	1	0	0	0	21.01
37901	38099	64QAM	1	0	0	0	21.03
37952	38150	64QAM	1	0	0	0	21.00



CA_41C							
Combination 20MHz+20MHz (100RB+100RB)							
PCC Channel	SCC Channel	Modulation	PCC		SCC		Measured Power (dBm)
			RB Size	RB offset	RB Size	RB offset	
39750	39948	QPSK	1	0	0	0	23.14
40521	40719	QPSK	1	0	0	0	23.02
41292	41490	QPSK	1	0	0	0	23.22
39750	39948	16QAM	1	0	0	0	22.78
40521	40719	16QAM	1	0	0	0	22.78
41292	41490	16QAM	1	0	0	0	22.73
39750	39948	64QAM	1	0	0	0	21.78
40521	40719	64QAM	1	0	0	0	21.77
41292	41490	64QAM	1	0	0	0	21.49



ERP/EIRP

LTE Band 7 (GT - LC = -0.30 dB) QPSK			
Bandwidth	5M		
Channel	20775	21100	21425
	(Low)	(Mid)	(High)
Frequency	2502.5	2535	2567.5
(MHz)			
Conducted Power (dBm)	23.28	23.33	23.15
Conducted Power (Watts)	0.2128	0.2153	0.2065
EIRP(dBm)	22.98	23.03	22.85
EIRP(Watts)	0.1986	0.2009	0.1928

LTE Band 7 (GT - LC = -0.30 dB) QPSK									
Bandwidth	10M			15M			20M		
Channel	20800	21100	21400	20825	21100	21375	20850	21100	21350
	(Low)	(Mid)	(High)	(Low)	(Mid)	(High)	(Low)	(Mid)	(High)
Frequency	2505	2535	2565	2507.5	2535	2562.5	2510	2535	2560
(MHz)									
Conducted Power (dBm)	23.27	23.18	23.13	23.28	23.38	23.19	23.16	23.39	23.20
Conducted Power (Watts)	0.2123	0.2080	0.2056	0.2128	0.2178	0.2084	0.2070	0.2183	0.2089
EIRP(dBm)	22.97	22.88	22.83	22.98	23.08	22.89	22.86	23.09	22.90
EIRP(Watts)	0.1982	0.1941	0.1919	0.1986	0.2032	0.1945	0.1932	0.2037	0.1950



LTE Band 7 (GT - LC = -0.30 dB) 16QAM			
Bandwidth	5M		
Channel	20775	21100	21425
	(Low)	(Mid)	(High)
Frequency	2502.5	2535	2567.5
(MHz)			
Conducted Power (dBm)	22.61	22.68	22.46
Conducted Power (Watts)	0.1824	0.1854	0.1762
EIRP(dBm)	22.31	22.38	22.16
EIRP(Watts)	0.1702	0.1730	0.1644

LTE Band 7 (GT - LC = -0.30 dB) 16QAM									
Bandwidth	10M			15M			20M		
Channel	20800	21100	21400	20825	21100	21375	20850	21100	21350
	(Low)	(Mid)	(High)	(Low)	(Mid)	(High)	(Low)	(Mid)	(High)
Frequency	2505	2535	2565	2507.5	2535	2562.5	2510	2535	2560
(MHz)									
Conducted Power (dBm)	22.73	22.73	22.55	22.39	22.66	22.33	22.72	22.53	22.41
Conducted Power (Watts)	0.1875	0.1875	0.1799	0.1734	0.1845	0.1710	0.1871	0.1791	0.1742
EIRP(dBm)	22.43	22.43	22.25	22.09	22.36	22.03	22.42	22.23	22.11
EIRP(Watts)	0.1750	0.1750	0.1679	0.1618	0.1722	0.1596	0.1746	0.1671	0.1626



LTE Band 7 (GT - LC = -0.30 dB) 64QAM			
Bandwidth	5M		
Channel	20775	21100	21425
	(Low)	(Mid)	(High)
Frequency	2502.5	2535	2567.5
(MHz)			
Conducted Power (dBm)	21.60	21.55	21.41
Conducted Power (Watts)	0.1445	0.1429	0.1384
EIRP(dBm)	21.30	21.25	21.11
EIRP(Watts)	0.1349	0.1334	0.1291

LTE Band 7 (GT - LC = -0.30 dB) 64QAM									
Bandwidth	10M			15M			20M		
Channel	20800	21100	21400	20825	21100	21375	20850	21100	21350
	(Low)	(Mid)	(High)	(Low)	(Mid)	(High)	(Low)	(Mid)	(High)
Frequency	2505	2535	2565	2507.5	2535	2562.5	2510	2535	2560
(MHz)									
Conducted Power (dBm)	21.67	21.59	21.43	21.36	21.50	21.45	21.51	21.59	21.31
Conducted Power (Watts)	0.1469	0.1442	0.1390	0.1368	0.1413	0.1396	0.1416	0.1442	0.1352
EIRP(dBm)	21.37	21.29	21.13	21.06	21.20	21.15	21.21	21.29	21.01
EIRP(Watts)	0.1371	0.1346	0.1297	0.1276	0.1318	0.1303	0.1321	0.1346	0.1262



LTE Band 41 (G _T - L _C = -0.30 dB) QPSK									
Bandwidth	5M			10M			15M		
Channel	39675	40620	41565	39700	40620	41540	39725	40620	41515
	(Low)	(Mid)	(High)	(Low)	(Mid)	(High)	(Low)	(Mid)	(High)
Frequency (MHz)	2498.5	2593	2687.5	2501	2593	2685	2503.5	2593	2682.5
Conducted Power (dBm)	24.79	24.66	24.70	24.81	24.68	24.64	24.71	24.71	24.67
Conducted Power (Watts)	0.3013	0.2924	0.2951	0.3027	0.2938	0.2911	0.2958	0.2958	0.2931
EIRP(dBm)	24.49	24.36	24.40	24.51	24.38	24.34	24.41	24.41	24.37
EIRP(Watts)	0.2812	0.2729	0.2754	0.2825	0.2742	0.2716	0.2761	0.2761	0.2735

LTE Band 41 (G _T - L _C = -0.30 dB) QPSK			
Bandwidth	20M		
Channel	39750	40620	41490
	(Low)	(Mid)	(High)
Frequency (MHz)	2506	2593	2680
Conducted Power (dBm)	24.65	24.63	24.85
Conducted Power (Watts)	0.2917	0.2904	0.3055
EIRP(dBm)	24.35	24.33	24.55
EIRP(Watts)	0.2723	0.2710	0.2851



LTE Band 41 (G _T - L _C = -0.30 dB) 16QAM									
Bandwidth	5M			10M			15M		
Channel	39675	40620	41565	39700	40620	41540	39725	40620	41515
	(Low)	(Mid)	(High)	(Low)	(Mid)	(High)	(Low)	(Mid)	(High)
Frequency	2498.5	2593	2687.5	2501	2593	2685	2503.5	2593	2682.5
(MHz)									
Conducted Power (dBm)	24.14	24.06	24.04	24.12	24.08	24.04	24.04	24.01	23.97
Conducted Power (Watts)	0.2594	0.2547	0.2535	0.2582	0.2559	0.2535	0.2535	0.2518	0.2495
EIRP(dBm)	23.84	23.76	23.74	23.82	23.78	23.74	23.74	23.71	23.67
EIRP(Watts)	0.2421	0.2377	0.2366	0.2410	0.2388	0.2366	0.2366	0.2350	0.2328

LTE Band 41 (G _T - L _C = -0.30 dB) 16QAM			
Bandwidth	20M		
Channel	39750	40620	41490
	(Low)	(Mid)	(High)
Frequency	2506	2593	2680
(MHz)			
Conducted Power (dBm)	24.03	24.12	24.03
Conducted Power (Watts)	0.2529	0.2582	0.2529
EIRP(dBm)	23.73	23.82	23.73
EIRP(Watts)	0.2360	0.2410	0.2360



LTE Band 41 (G _T - L _C = -0.30 dB) 64QAM									
Bandwidth	5M			10M			15M		
Channel	39675	40620	41565	39700	40620	41540	39725	40620	41515
	(Low)	(Mid)	(High)	(Low)	(Mid)	(High)	(Low)	(Mid)	(High)
Frequency (MHz)	2498.5	2593	2687.5	2501	2593	2685	2503.5	2593	2682.5
Conducted Power (dBm)	23.03	22.97	22.92	23.18	23.09	23.04	22.94	22.86	22.80
Conducted Power (Watts)	0.2009	0.1982	0.1959	0.2080	0.2037	0.2014	0.1968	0.1932	0.1905
EIRP(dBm)	22.73	22.67	22.62	22.88	22.79	22.74	22.64	22.56	22.50
EIRP(Watts)	0.1875	0.1849	0.1828	0.1941	0.1901	0.1879	0.1837	0.1803	0.1778

LTE Band 41 (G _T - L _C = -0.30 dB) 64QAM			
Bandwidth	20M		
Channel	39750	40620	41490
	(Low)	(Mid)	(High)
Frequency (MHz)	2506	2593	2680
Conducted Power (dBm)	22.90	22.99	22.91
Conducted Power (Watts)	0.1950	0.1991	0.1954
EIRP(dBm)	22.60	22.69	22.61
EIRP(Watts)	0.1820	0.1858	0.1824



LTE Band 71 (GT - LC = -3.30 dB) QPSK									
Bandwidth	5M			10M			15M		
Channel	133147	133297	133447	133172	133297	133422	133197	133297	133397
	(Low)	(Mid)	(High)	(Low)	(Mid)	(High)	(Low)	(Mid)	(High)
Frequency (MHz)	665.5	680.5	695.5	668	680.5	693	670.5	680.5	690.5
Conducted Power (dBm)	23.25	23.03	22.99	23.17	23.05	23.27	23.26	23.17	23.07
Conducted Power (Watts)	0.2113	0.2009	0.1991	0.2075	0.2018	0.2123	0.2118	0.2075	0.2028
ERP(dBm)	17.80	17.58	17.54	17.72	17.60	17.82	17.81	17.72	17.62
ERP(Watts)	0.0603	0.0573	0.0568	0.0592	0.0575	0.0605	0.0604	0.0592	0.0578

LTE Band 71 (GT - LC = -3.30 dB) QPSK			
Bandwidth	20M		
Channel	133222	133297	133372
	(Low)	(Mid)	(High)
Frequency (MHz)	673	680.5	688
Conducted Power (dBm)	23.16	23.28	23.25
Conducted Power (Watts)	0.2070	0.2128	0.2113
ERP(dBm)	17.71	17.83	17.80
ERP(Watts)	0.0590	0.0607	0.0603



LTE Band 71 (GT - LC = -3.30 dB) 16QAM									
Bandwidth	5M			10M			15M		
Channel	133147	133297	133447	133172	133297	133422	133197	133297	133397
	(Low)	(Mid)	(High)	(Low)	(Mid)	(High)	(Low)	(Mid)	(High)
Frequency (MHz)	665.5	680.5	695.5	668	680.5	693	670.5	680.5	690.5
Conducted Power (dBm)	22.48	22.53	22.48	22.48	22.51	22.51	22.48	22.57	22.26
Conducted Power (Watts)	0.1770	0.1791	0.1770	0.1770	0.1782	0.1782	0.1770	0.1807	0.1683
ERP(dBm)	17.03	17.08	17.03	17.03	17.06	17.06	17.03	17.12	16.81
ERP(Watts)	0.0505	0.0511	0.0505	0.0505	0.0508	0.0508	0.0505	0.0515	0.0480

LTE Band 71 (GT - LC = -3.30 dB) 16QAM			
Bandwidth	20M		
Channel	133222	133297	133372
	(Low)	(Mid)	(High)
Frequency (MHz)	673	680.5	688
Conducted Power (dBm)	22.50	22.61	22.52
Conducted Power (Watts)	0.1778	0.1824	0.1786
ERP(dBm)	17.05	17.16	17.07
ERP(Watts)	0.0507	0.0520	0.0509



LTE Band 71 (GT - LC = -3.30 dB) 64QAM									
Bandwidth	5M			10M			15M		
Channel	133147	133297	133447	133172	133297	133422	133197	133297	133397
	(Low)	(Mid)	(High)	(Low)	(Mid)	(High)	(Low)	(Mid)	(High)
Frequency (MHz)	665.5	680.5	695.5	668	680.5	693	670.5	680.5	690.5
Conducted Power (dBm)	21.51	21.47	21.37	21.53	21.38	21.23	21.41	21.28	21.10
Conducted Power (Watts)	0.1416	0.1403	0.1371	0.1422	0.1374	0.1327	0.1384	0.1343	0.1288
ERP(dBm)	16.06	16.02	15.92	16.08	15.93	15.78	15.96	15.83	15.65
ERP(Watts)	0.0404	0.0400	0.0391	0.0406	0.0392	0.0378	0.0394	0.0383	0.0367

LTE Band 71 (GT - LC = -3.30 dB) 64QAM			
Bandwidth	20M		
Channel	133222	133297	133372
	(Low)	(Mid)	(High)
Frequency (MHz)	673	680.5	688
Conducted Power (dBm)	21.46	21.24	21.30
Conducted Power (Watts)	0.1400	0.1330	0.1349
ERP(dBm)	16.01	15.79	15.85
ERP(Watts)	0.0399	0.0379	0.0385



CA EIRP

LTE Band 7 CA (GT - LC = -0.30 dB) QPSK			
Bandwidth	20M + 20M		
Channel PCC	20850	21001	21152
	(Low)	(Mid)	(High)
Channel SCC	21048	21199	21350
	(Low)	(Mid)	(High)
Conducted Power (dBm)	23.07	23.14	23.3
Conducted Power (Watts)	0.2028	0.2061	0.2138
EIRP(dBm)	22.77	22.84	23.00
EIRP(Watts)	0.1892	0.1923	0.1995

LTE Band 7 CA (GT - LC = -0.30 dB) 16QAM			
Bandwidth	20M + 20M		
Channel PCC	20850	21001	21152
	(Low)	(Mid)	(High)
Channel SCC	21048	21199	21350
	(Low)	(Mid)	(High)
Conducted Power (dBm)	22.45	22.32	22.33
Conducted Power (Watts)	0.1758	0.1706	0.1710
EIRP(dBm)	22.15	22.02	22.03
EIRP(Watts)	0.1641	0.1592	0.1596

LTE Band 7 CA (GT - LC = -0.30 dB) 64QAM			
Bandwidth	20M + 20M		
Channel PCC	20850	21001	21152
	(Low)	(Mid)	(High)
Channel SCC	21048	21199	21350
	(Low)	(Mid)	(High)
Conducted Power (dBm)	21.23	21.56	21.44
Conducted Power (Watts)	0.1327	0.1432	0.1393
EIRP(dBm)	20.93	21.26	21.14
EIRP(Watts)	0.1239	0.1337	0.1300



LTE Band 41 CA (GT - LC = -0.30 dB) QPSK			
Bandwidth	20M+20M		
Channel PCC	39750	40521	41292
	(Low)	(Mid)	(High)
Channel SCC	39948	40719	41490
	(Low)	(Mid)	(High)
Conducted Power (dBm)	23.14	23.02	23.22
Conducted Power (Watts)	0.2061	0.2004	0.2099
EIRP(dBm)	22.84	22.72	22.92
EIRP(Watts)	0.1923	0.1871	0.1959

LTE Band 41 CA (GT - LC = -0.30 dB) 16QAM			
Bandwidth	20M+20M		
Channel PCC	39750	40521	41292
	(Low)	(Mid)	(High)
Channel SCC	39948	40719	41490
	(Low)	(Mid)	(High)
Conducted Power (dBm)	22.78	22.78	22.73
Conducted Power (Watts)	0.1897	0.1897	0.1875
EIRP(dBm)	22.48	22.48	22.43
EIRP(Watts)	0.1770	0.1770	0.1750

LTE Band 41 CA (GT - LC = -0.30 dB) 64QAM			
Bandwidth	20M+20M		
Channel PCC	39750	40521	41292
	(Low)	(Mid)	(High)
Channel SCC	39948	40719	41490
	(Low)	(Mid)	(High)
Conducted Power (dBm)	21.78	21.77	21.49
Conducted Power (Watts)	0.1507	0.1503	0.1409
EIRP(dBm)	21.48	21.47	21.19
EIRP(Watts)	0.1406	0.1403	0.1315



LTE Band 7

Peak-to-Average Ratio

Mode	LTE Band 7 / 20MHz				
Mod.	QPSK		16QAM		Limit: 13dB
RB Size	1RB	Full RB	1RB	Full RB	Result
Lowest CH	3.65	4.49	4.26	5.59	PASS
Middle CH	3.42	4.43	4.46	5.57	
Highest CH	3.54	4.49	4.35	5.62	
Mode	LTE Band 7 / 20MHz				
Mod.	64QAM				Limit: 13dB
RB Size	1RB	Full RB			Result
Lowest CH	6.55	6.43	-	-	PASS
Middle CH	6.20	6.46	-	-	
Highest CH	6.26	6.43	-	-	



LTE Band 7 / 20MHz / QPSK

Lowest Channel / 1RB

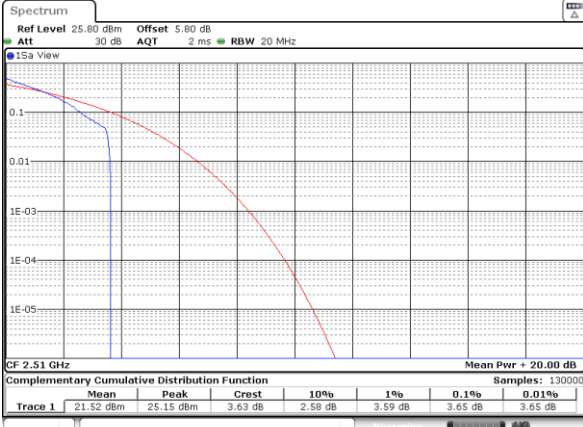

Date: 7, JUN, 2020 10:40:08

Lowest Channel / Full RB

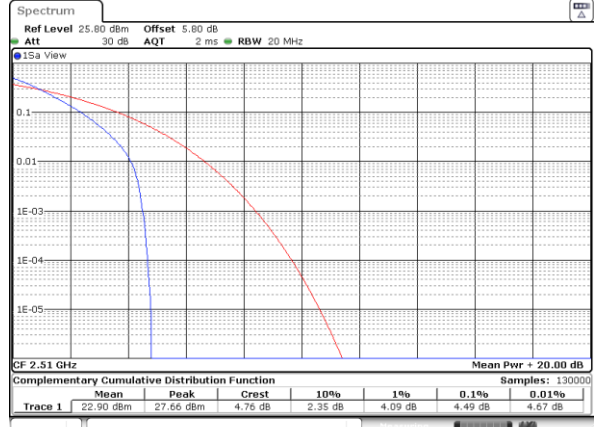

Date: 7, JUN, 2020 10:40:19

Middle Channel / 1RB

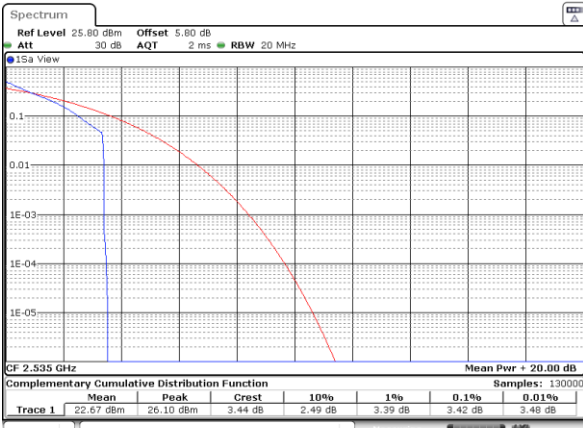

Date: 7, JUN, 2020 10:41:05

Middle Channel / Full RB

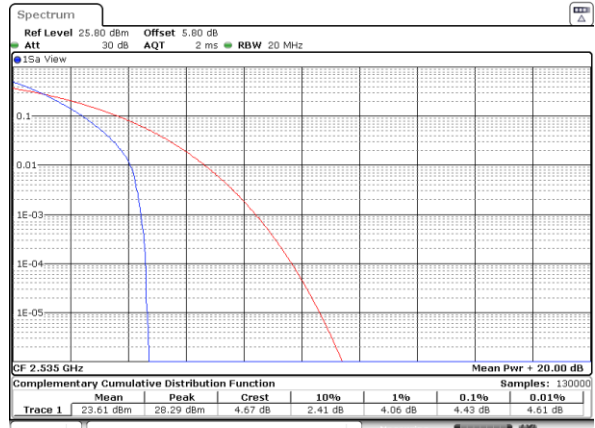

Date: 7, JUN, 2020 10:40:56

Highest Channel / 1RB

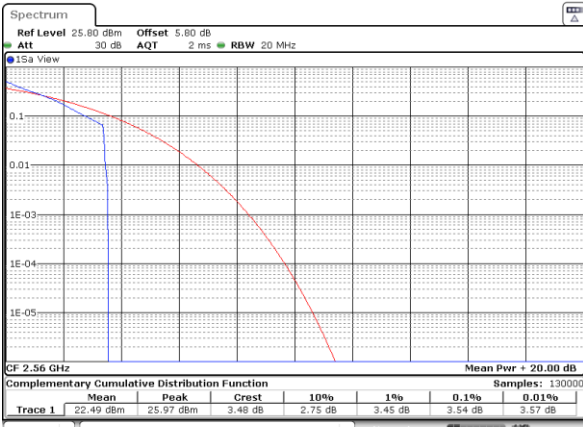

Date: 7, JUN, 2020 10:42:23

Highest Channel / Full RB

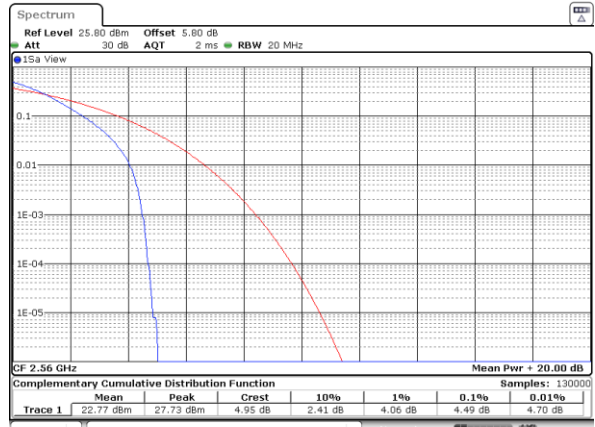

Date: 7, JUN, 2020 10:42:34



LTE Band 7 / 20MHz / 16QAM

Lowest Channel / 1RB

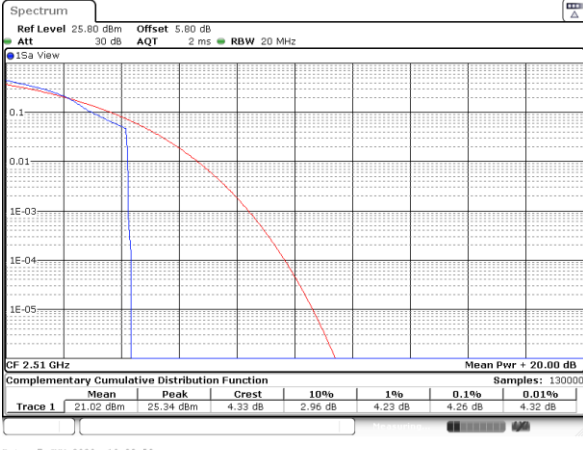

Date: 7, JUN, 2020 10:39:53

Lowest Channel / Full RB

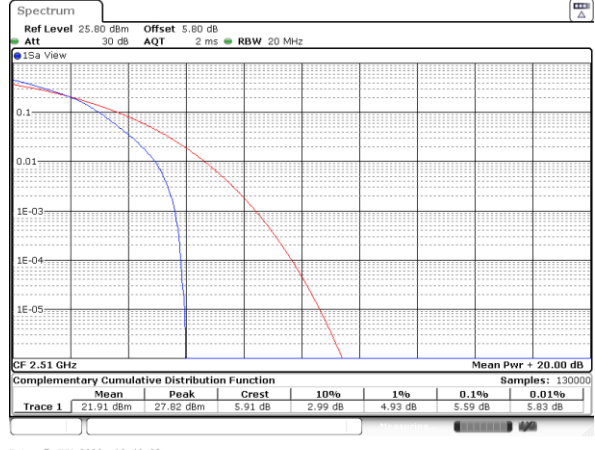

Date: 7, JUN, 2020 10:40:29

Middle Channel / 1RB

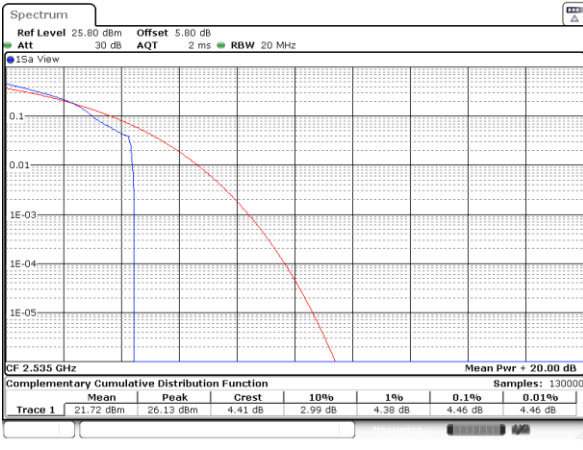

Date: 7, JUN, 2020 10:41:15

Middle Channel / Full RB

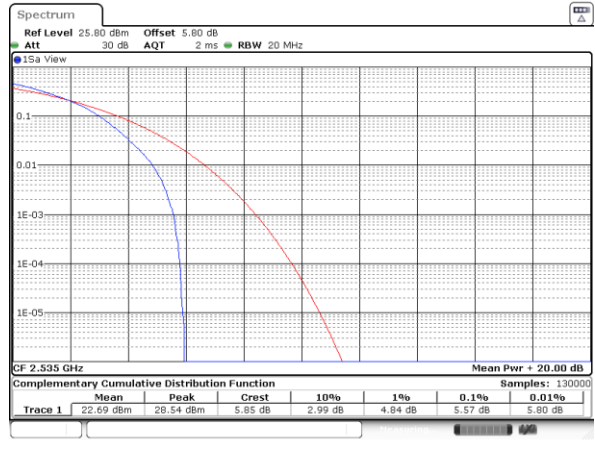

Date: 7, JUN, 2020 10:40:40

Highest Channel / 1RB

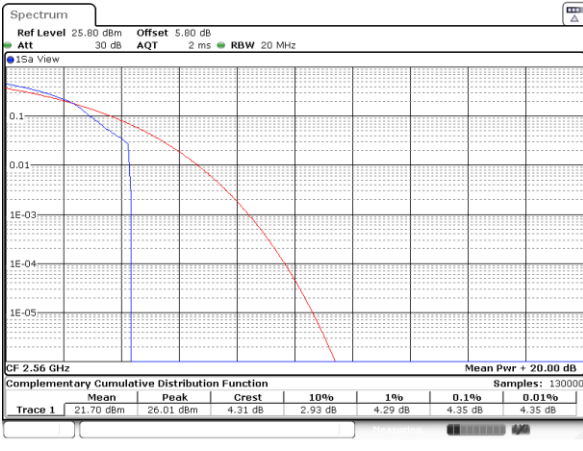

Date: 7, JUN, 2020 10:42:11

Highest Channel / Full RB

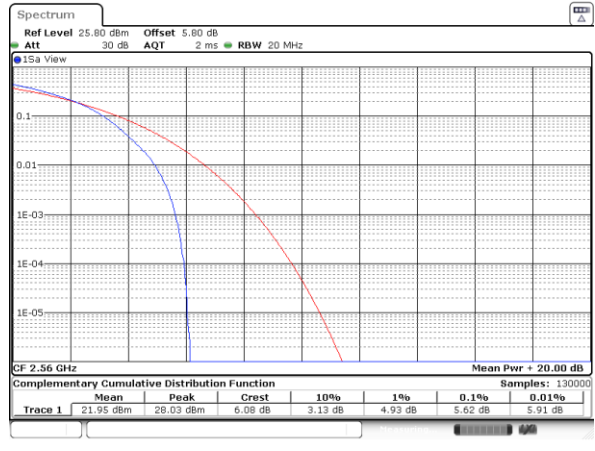

Date: 7, JUN, 2020 10:42:43



LTE Band 7 / 20MHz / 64QAM

Lowest Channel / 1RB

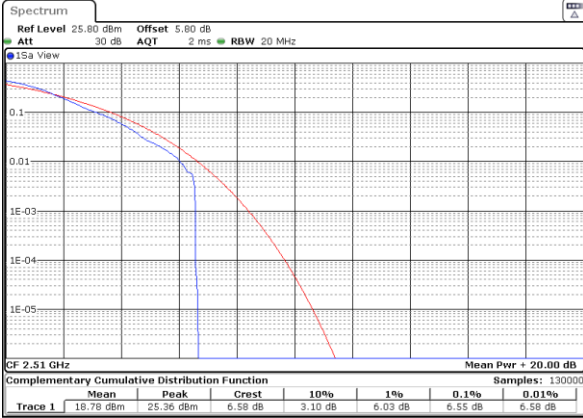

Date: 7, JUN, 2020 11:07:29

Lowest Channel / Full RB

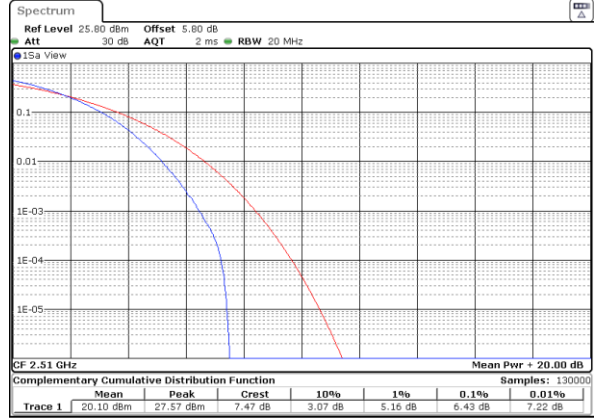

Date: 7, JUN, 2020 11:07:38

Middle Channel / 1RB

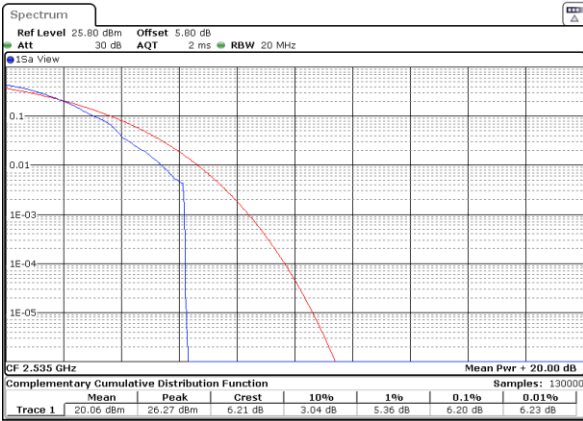

Date: 7, JUN, 2020 11:07:56

Middle Channel / Full RB

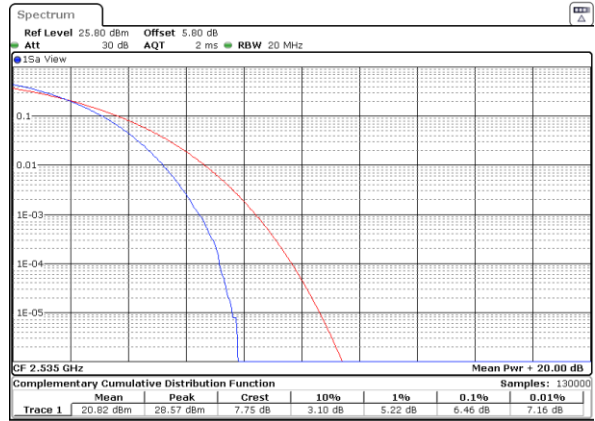

Date: 7, JUN, 2020 11:07:47

Highest Channel / 1RB

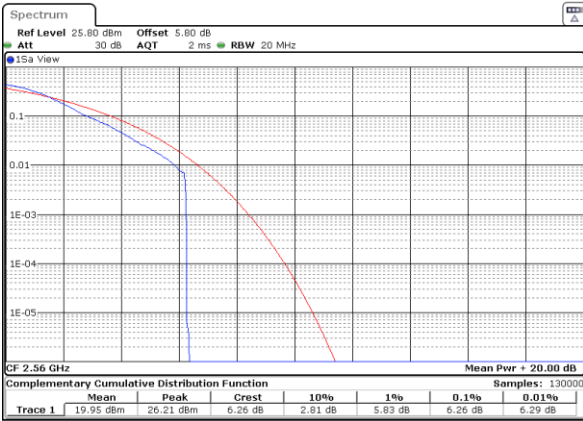

Date: 7, JUN, 2020 11:08:04

Highest Channel / Full RB

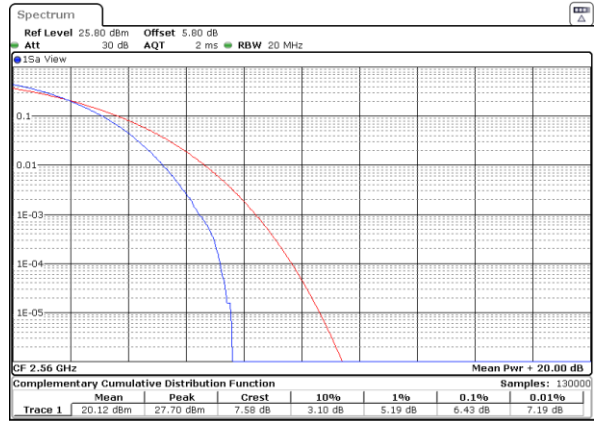

Date: 7, JUN, 2020 11:08:13



26dB Bandwidth

Mode	LTE Band 7 : 26dB BW(MHz)											
BW	1.4MHz		3MHz		5MHz		10MHz		15MHz		20MHz	
Mod.	QPSK	16QAM	QPSK	16QAM	QPSK	16QAM	QPSK	16QAM	QPSK	16QAM	QPSK	16QAM
Lowest CH	-	-	-	-	4.98	4.93	9.79	9.77	14.18	14.54	20.18	20.06
Middle CH	-	-	-	-	4.88	4.78	9.75	9.69	14.45	14.48	20.14	20.06
Highest CH	-	-	-	-	4.91	4.91	9.75	9.71	14.18	14.51	20.10	20.34
Mode	LTE Band 7 : 26dB BW(MHz)											
BW	1.4MHz		3MHz		5MHz		10MHz		15MHz		20MHz	
Mod.	64QAM		64QAM		64QAM		64QAM		64QAM		64QAM	
Lowest CH	-	-	-	-	4.88	-	9.77	-	14.60	-	20.06	-
Middle CH	-	-	-	-	4.91	-	9.69	-	14.30	-	20.02	-
Highest CH	-	-	-	-	4.85	-	9.67	-	14.30	-	20.10	-



LTE Band 7

Lowest Channel / 5MHz / QPSK

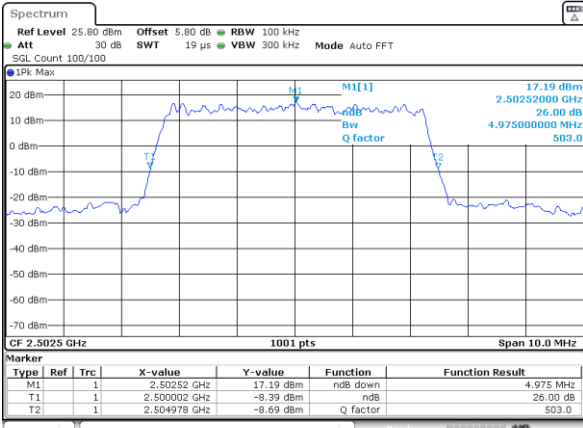

Date: 7, JUN, 2020 09:28:48

Lowest Channel / 5MHz / 16QAM

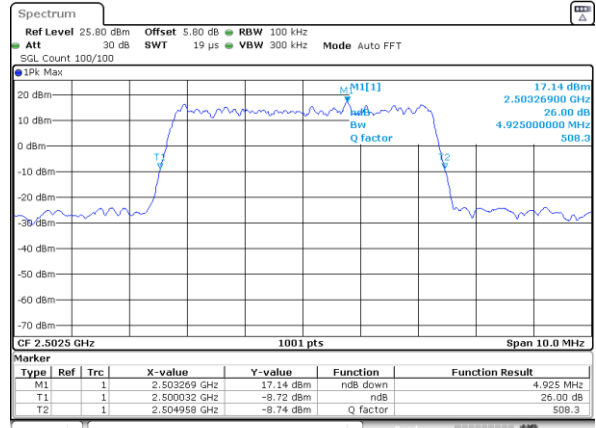

Date: 7, JUN, 2020 09:29:08

Middle Channel / 5MHz / QPSK

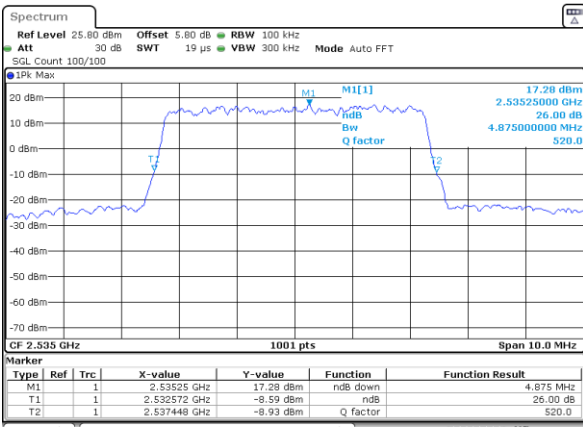

Date: 7, JUN, 2020 09:29:47

Middle Channel / 5MHz / 16QAM

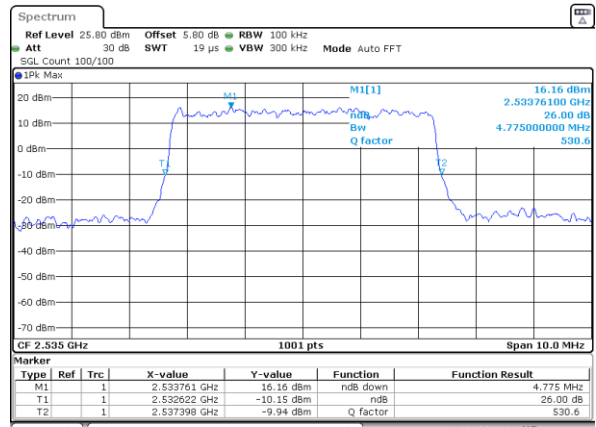

Date: 7, JUN, 2020 09:29:27

Highest Channel / 5MHz / QPSK

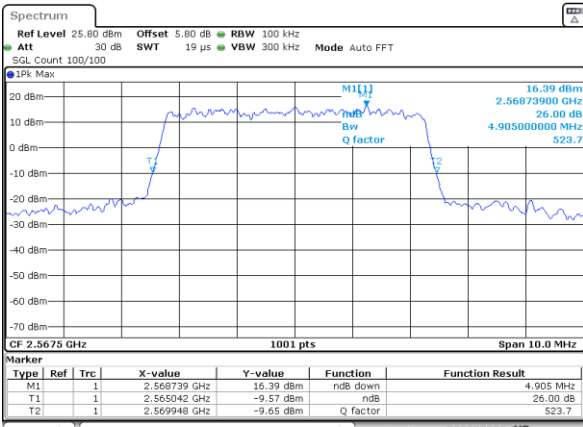

Date: 7, JUN, 2020 09:30:07

Highest Channel / 5MHz / 16QAM

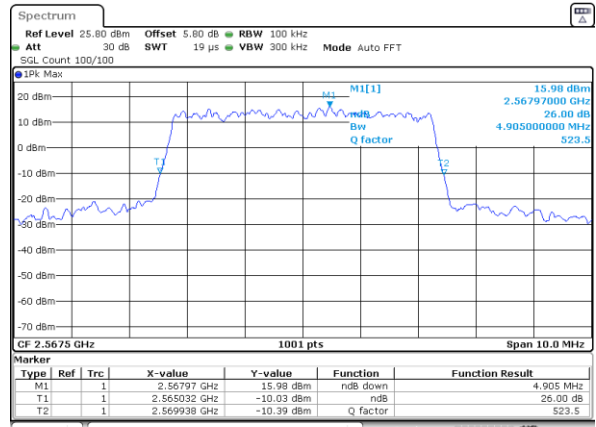

Date: 7, JUN, 2020 09:30:26



LTE Band 7

Lowest Channel / 10MHz / QPSK

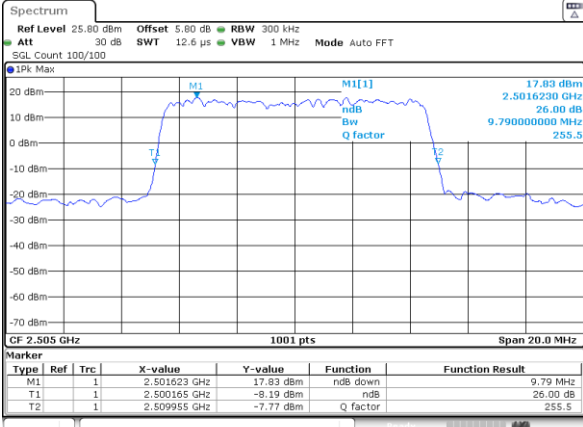

Date: 7, JUN, 2020 09:45:21

Lowest Channel / 10MHz / 16QAM

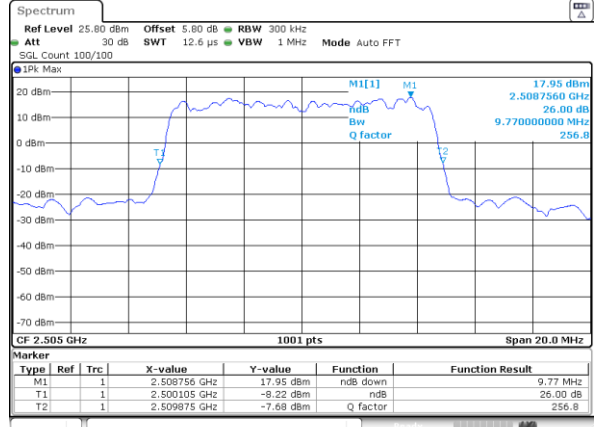

Date: 7, JUN, 2020 09:45:41

Middle Channel / 10MHz / QPSK

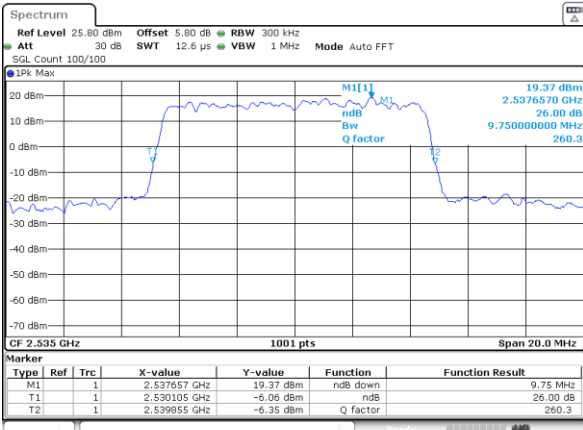

Date: 7, JUN, 2020 09:46:21

Middle Channel / 10MHz / 16QAM

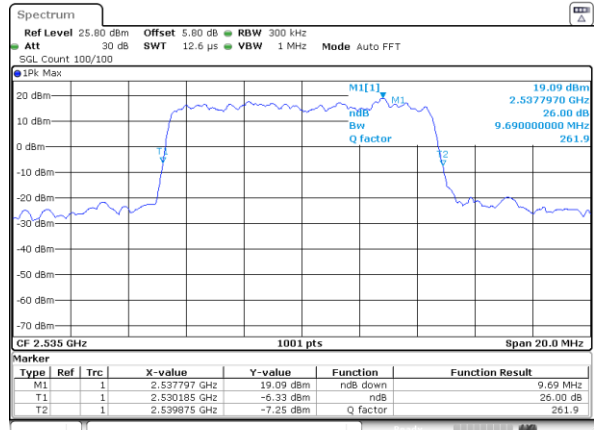

Date: 7, JUN, 2020 09:46:01

Highest Channel / 10MHz / QPSK

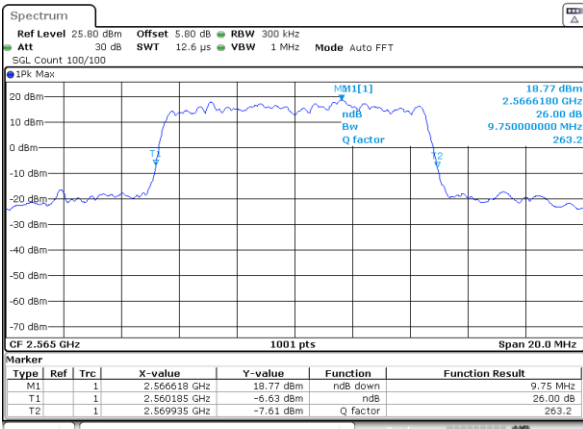

Date: 7, JUN, 2020 09:46:41

Highest Channel / 10MHz / 16QAM

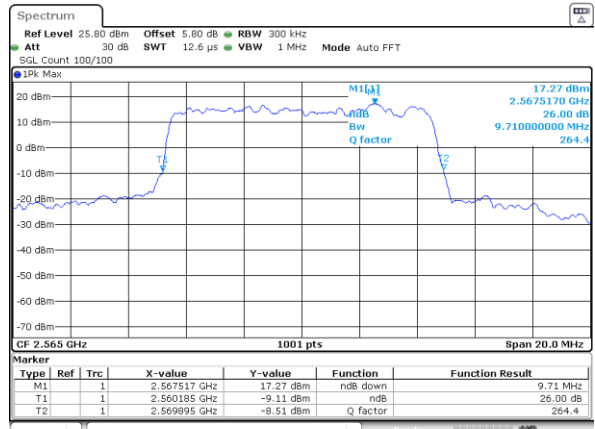

Date: 7, JUN, 2020 09:47:00



LTE Band 7

Lowest Channel / 15MHz / QPSK

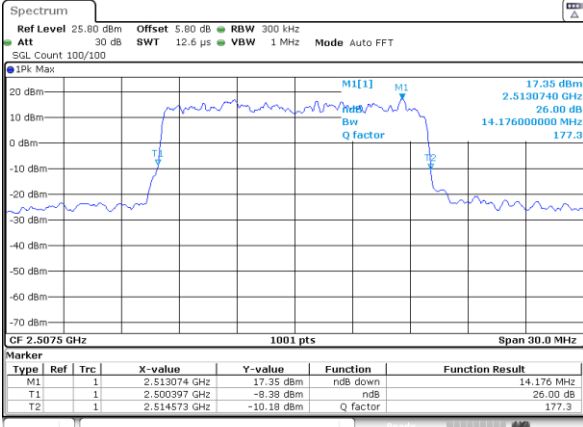

Date: 7, JUN, 2020 10:02:13

Lowest Channel / 15MHz / 16QAM

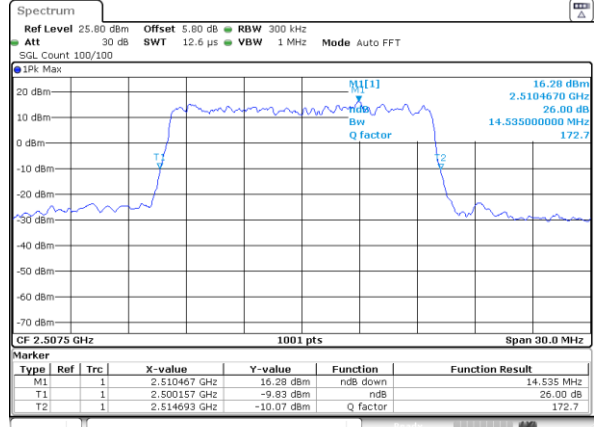

Date: 7, JUN, 2020 10:01:53

Middle Channel / 15MHz / QPSK

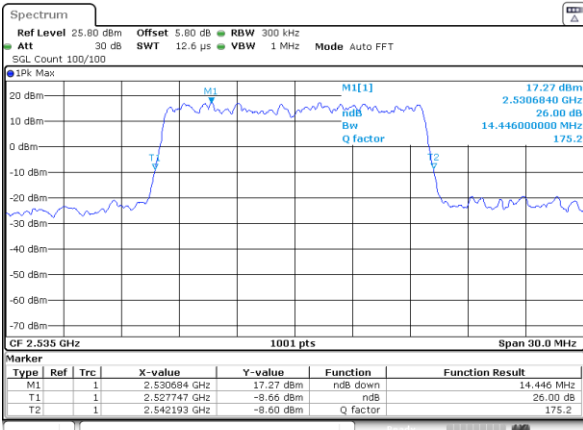

Date: 7, JUN, 2020 10:02:32

Middle Channel / 15MHz / 16QAM

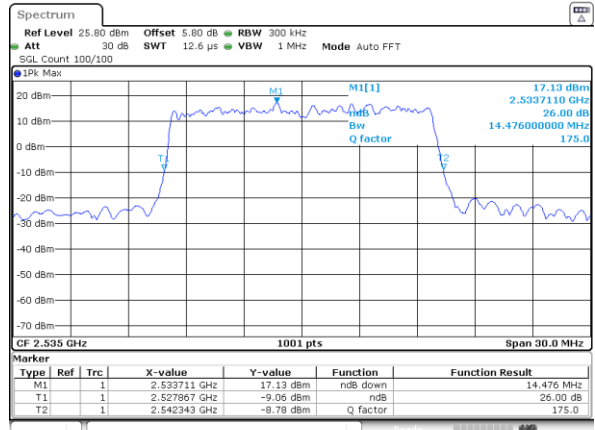

Date: 7, JUN, 2020 10:02:52

Highest Channel / 15MHz / QPSK

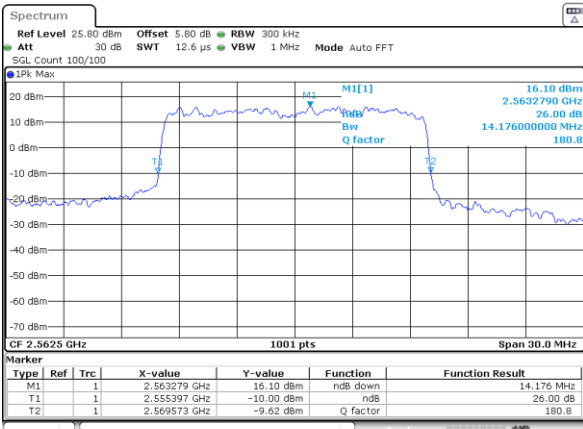

Date: 7, JUN, 2020 10:03:32

Highest Channel / 15MHz / 16QAM

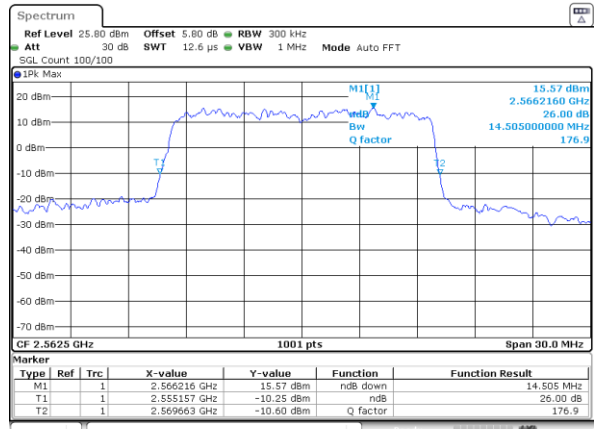

Date: 7, JUN, 2020 10:03:12



LTE Band 7

Lowest Channel / 20MHz / QPSK

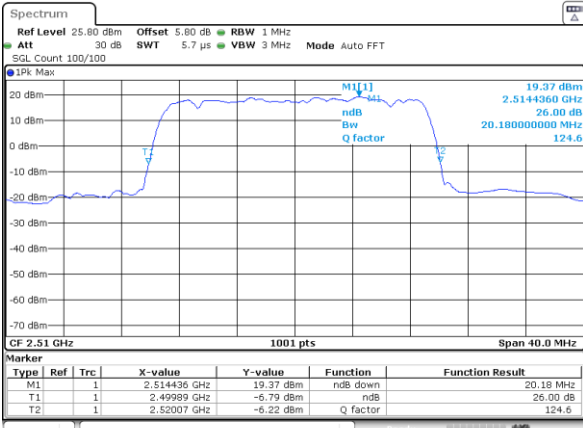

Date: 7, JUN, 2020 10:18:44

Lowest Channel / 20MHz / 16QAM

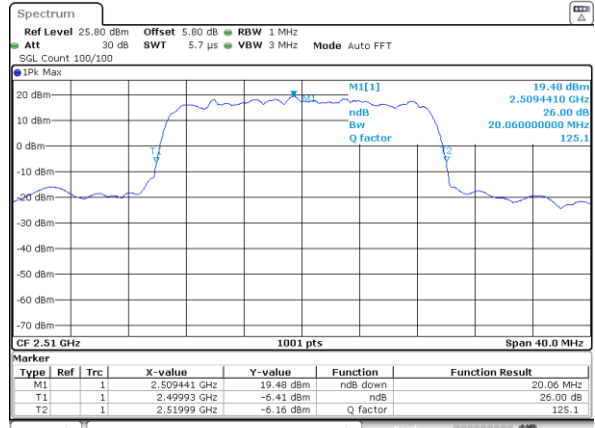

Date: 7, JUN, 2020 10:18:25

Middle Channel / 20MHz / QPSK

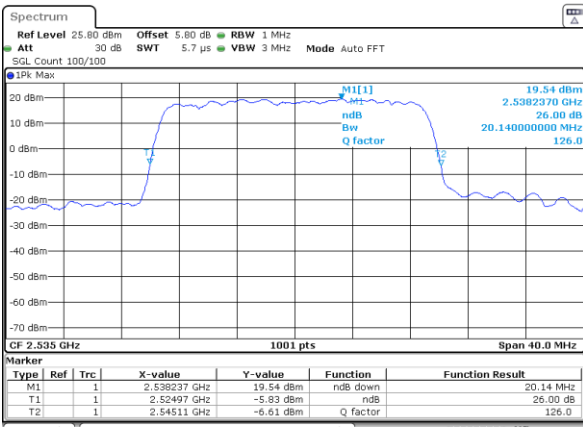

Date: 7, JUN, 2020 10:19:04

Middle Channel / 20MHz / 16QAM

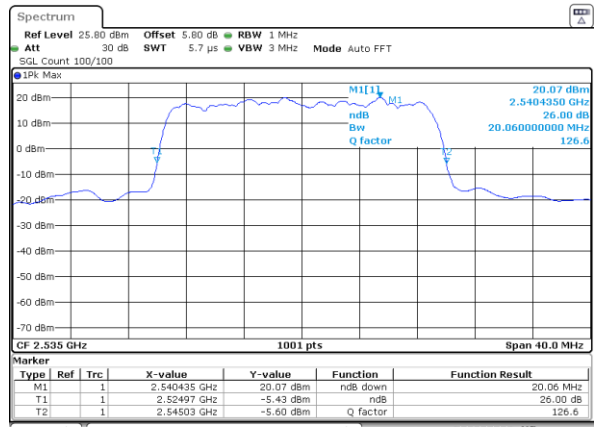

Date: 7, JUN, 2020 10:19:24

Highest Channel / 20MHz / QPSK

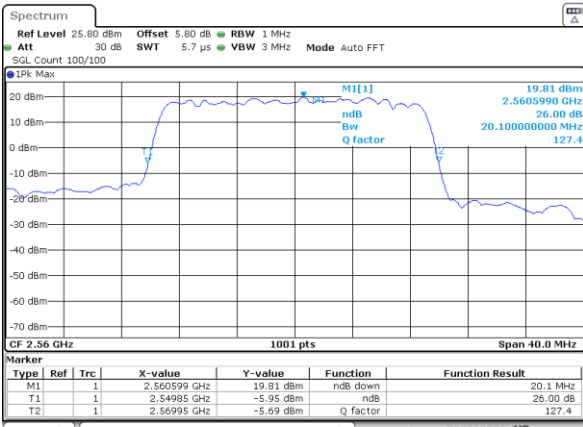

Date: 7, JUN, 2020 10:20:03

Highest Channel / 20MHz / 16QAM

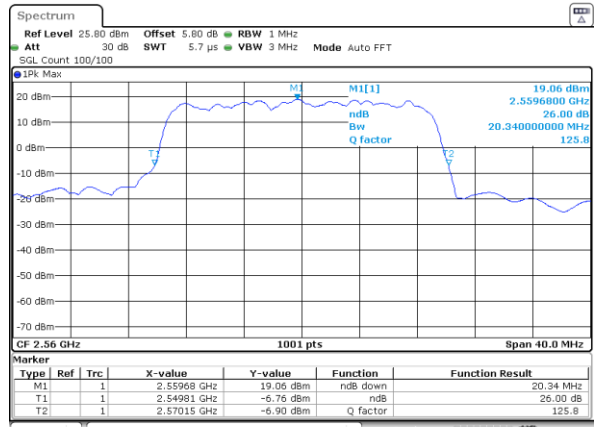

Date: 7, JUN, 2020 10:19:44



LTE Band 7

Lowest Channel / 5MHz / 64QAM

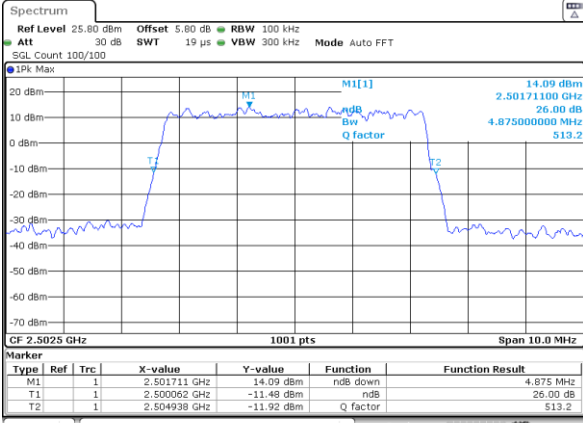

Date: 7, JUN, 2020 10:43:45

Lowest Channel / 10MHz / 64QAM

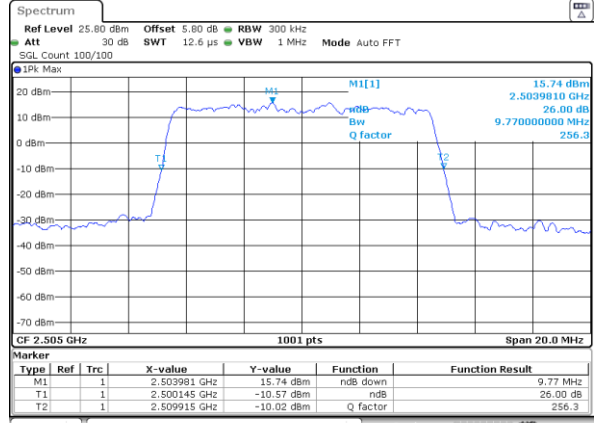

Date: 7, JUN, 2020 10:49:44

Middle Channel / 5MHz / 64QAM

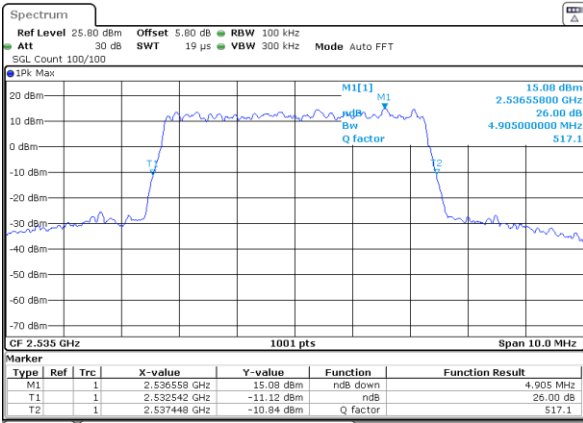

Date: 7, JUN, 2020 10:43:55

Middle Channel / 10MHz / 64QAM

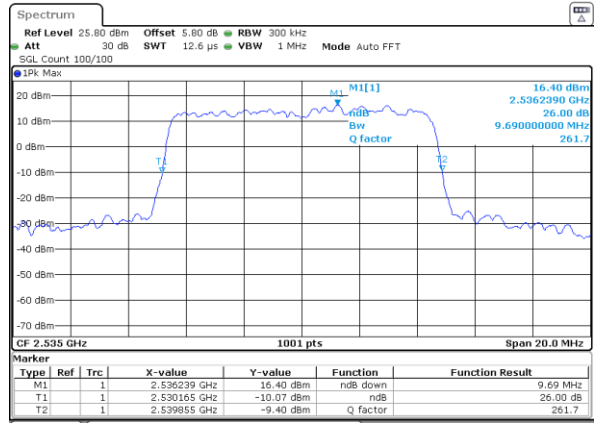

Date: 7, JUN, 2020 10:49:54

Highest Channel / 5MHz / 64QAM

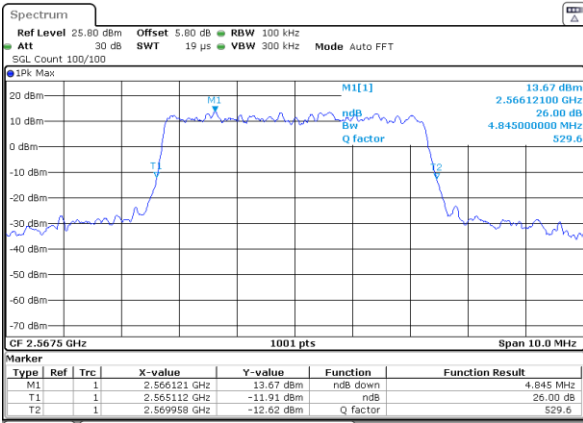

Date: 7, JUN, 2020 10:44:05

Highest Channel / 10MHz / 64QAM

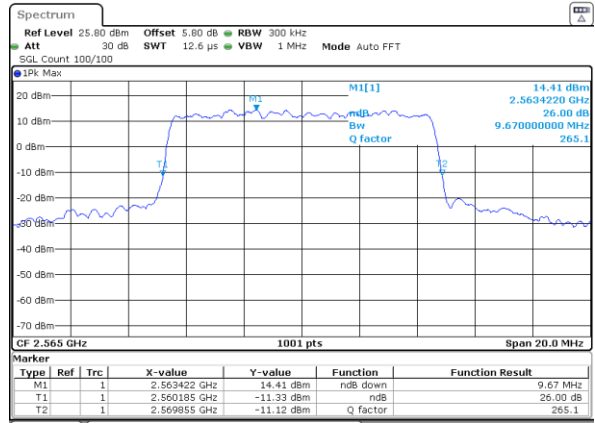

Date: 7, JUN, 2020 10:50:04



LTE Band 7

Lowest Channel / 15MHz / 64QAM

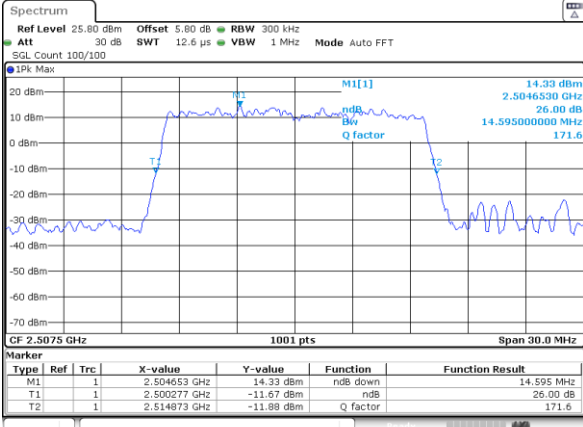

Date: 7, JUN, 2020 10:55:43

Lowest Channel / 20MHz / 64QAM

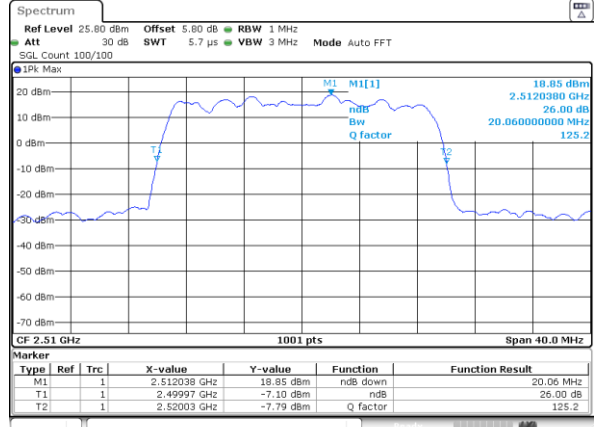

Date: 7, JUN, 2020 11:01:41

Middle Channel / 15MHz / 64QAM

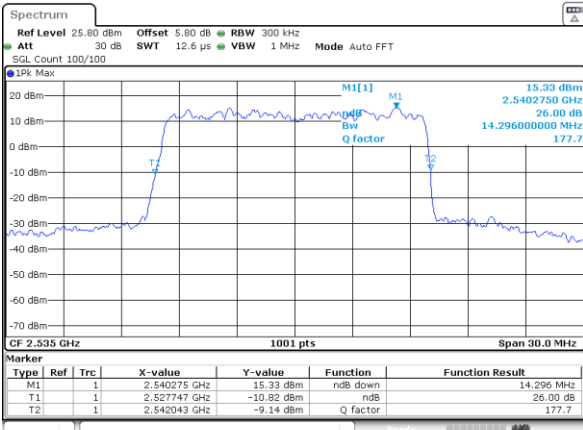

Date: 7, JUN, 2020 10:55:53

Middle Channel / 20MHz / 64QAM

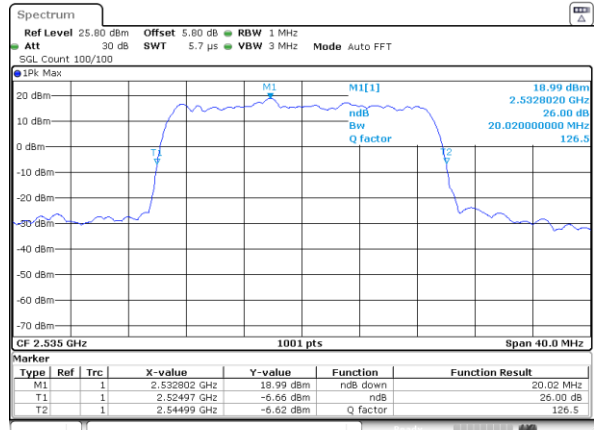

Date: 7, JUN, 2020 11:01:51

Highest Channel / 15MHz / 64QAM

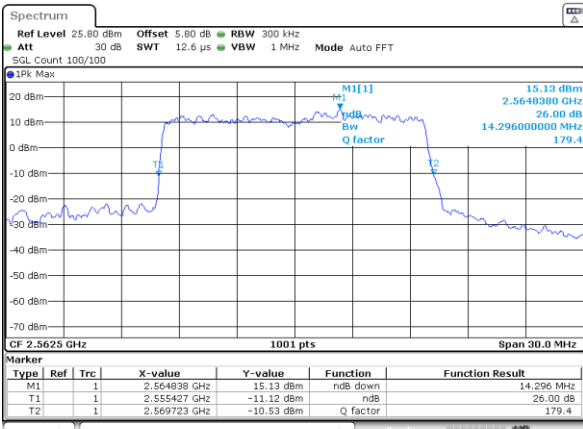

Date: 7, JUN, 2020 10:56:02

Highest Channel / 20MHz / 64QAM

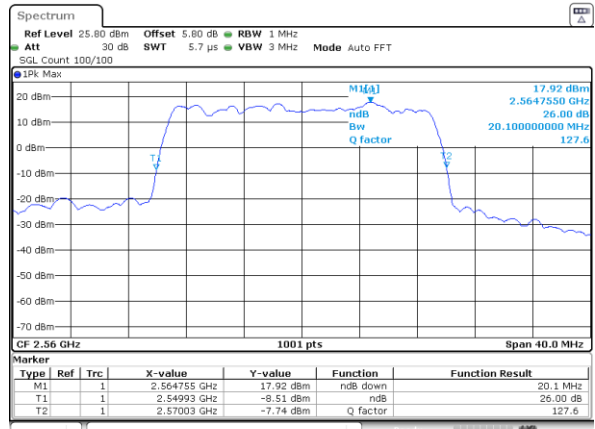

Date: 7, JUN, 2020 11:02:01



Occupied Bandwidth

Mode	LTE Band 7 : 99%OBW(MHz)											
BW	1.4MHz		3MHz		5MHz		10MHz		15MHz		20MHz	
Mod.	QPSK	16QAM	QPSK	16QAM	QPSK	16QAM	QPSK	16QAM	QPSK	16QAM	QPSK	16QAM
Lowest CH	-	-	-	-	4.51	4.47	9.01	8.99	13.40	13.43	18.26	18.18
Middle CH	-	-	-	-	4.48	4.48	9.01	9.01	13.40	13.46	18.46	18.46
Highest CH	-	-	-	-	4.50	4.50	9.01	8.93	13.49	13.49	18.46	18.26
Mode	LTE Band 7 : 99%OBW(MHz)											
BW	1.4MHz		3MHz		5MHz		10MHz		15MHz		20MHz	
Mod.	64QAM		64QAM		64QAM		64QAM		64QAM		64QAM	
Lowest CH	-	-	-	-	4.50	-	9.01	-	13.43	-	18.14	-
Middle CH	-	-	-	-	4.48	-	9.01	-	13.43	-	18.34	-
Highest CH	-	-	-	-	4.48	-	9.03	-	13.40	-	18.30	-



LTE Band 7

Lowest Channel / 5MHz / QPSK

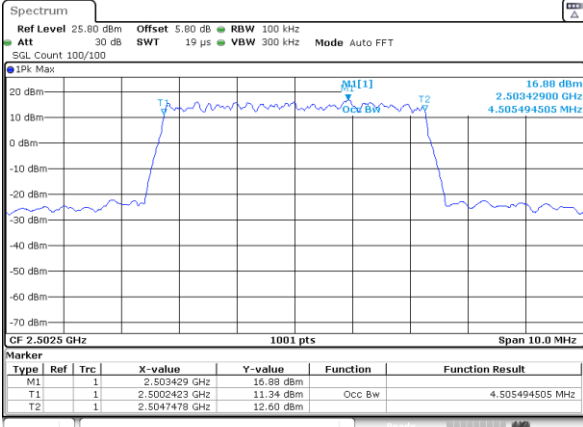

Date: 7 JUN 2020 09:28:38

Lowest Channel / 5MHz / 16QAM

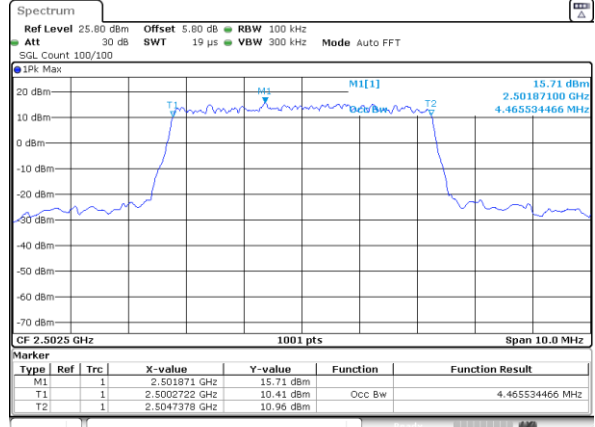

Date: 7 JUN 2020 09:28:58

Middle Channel / 5MHz / QPSK

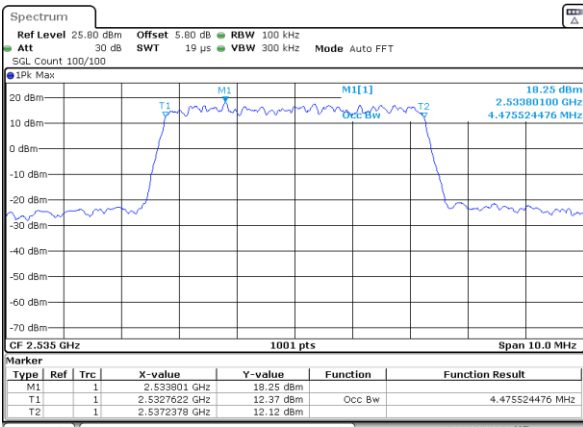

Date: 7 JUN 2020 09:29:37

Middle Channel / 5MHz / 16QAM

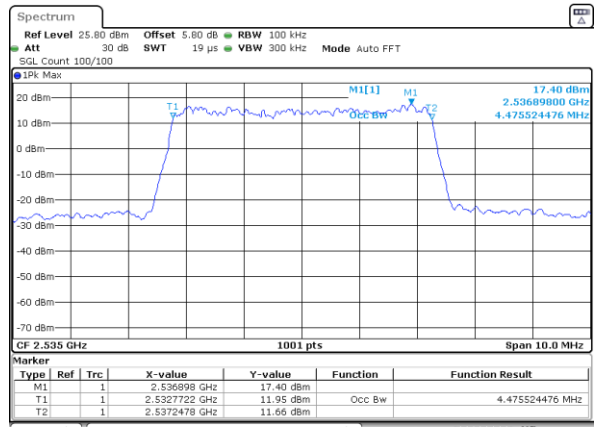

Date: 7 JUN 2020 09:29:58

Highest Channel / 5MHz / QPSK

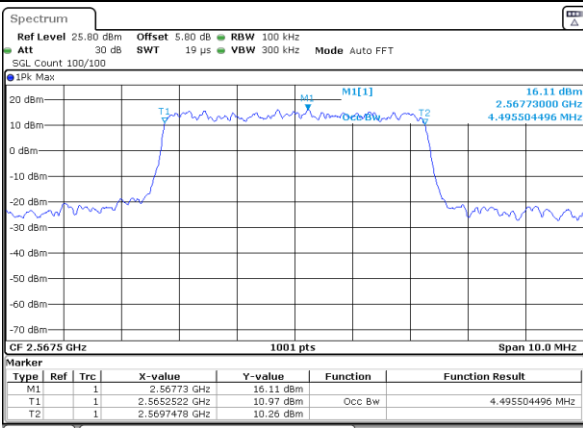

Date: 7 JUN 2020 09:29:57

Highest Channel / 5MHz / 16QAM

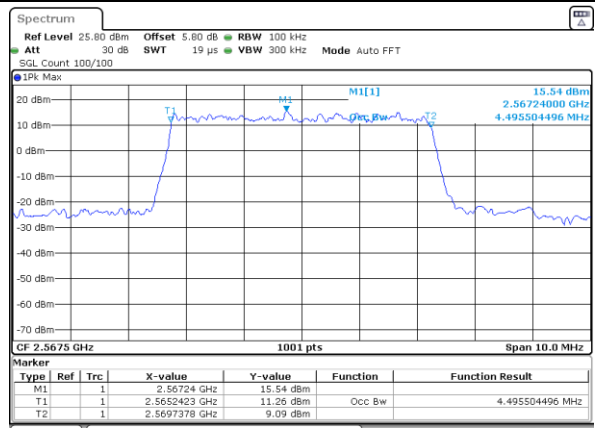

Date: 7 JUN 2020 09:30:17



LTE Band 7

Lowest Channel / 10MHz / QPSK

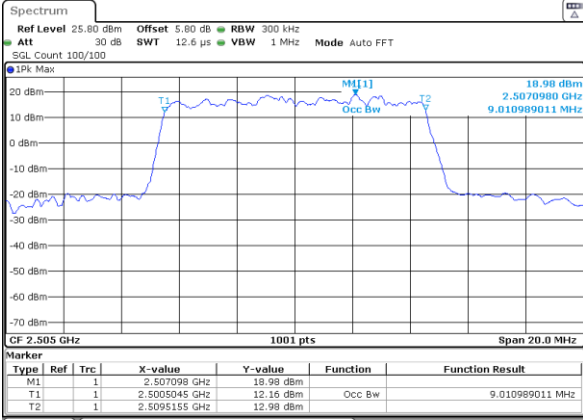

Date: 7 JUN 2020 09:45:12

Lowest Channel / 10MHz / 16QAM

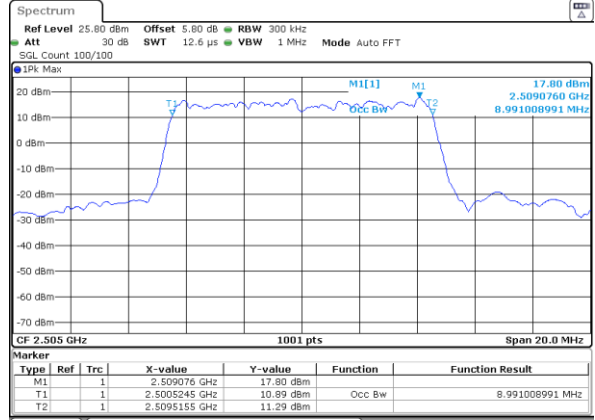

Date: 7 JUN 2020 09:45:31

Middle Channel / 10MHz / QPSK

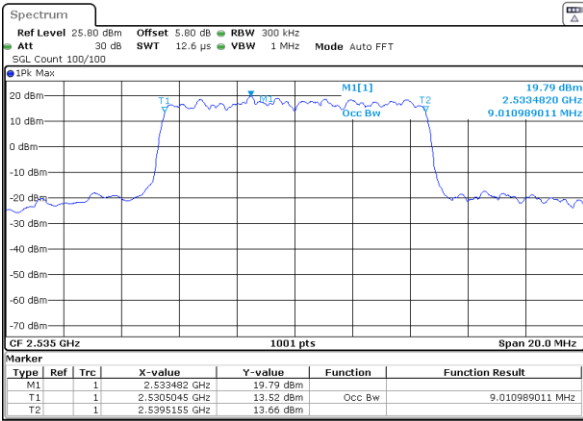

Date: 7 JUN 2020 09:46:11

Middle Channel / 10MHz / 16QAM

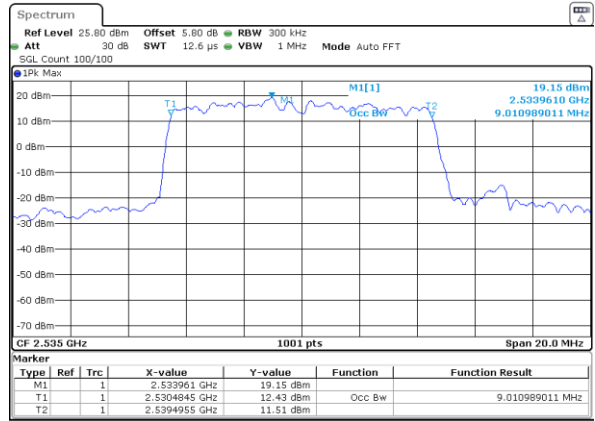

Date: 7 JUN 2020 09:45:51

Highest Channel / 10MHz / QPSK

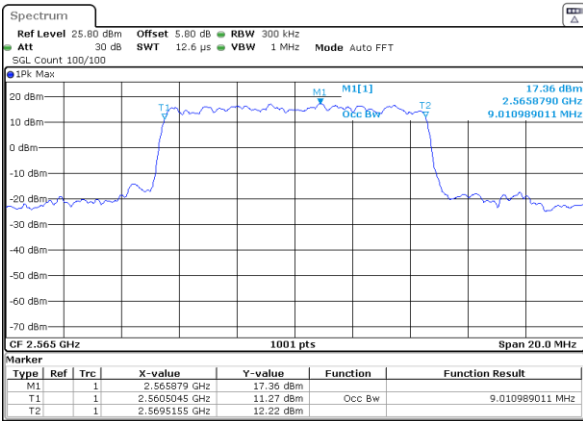

Date: 7 JUN 2020 09:46:31

Highest Channel / 10MHz / 16QAM

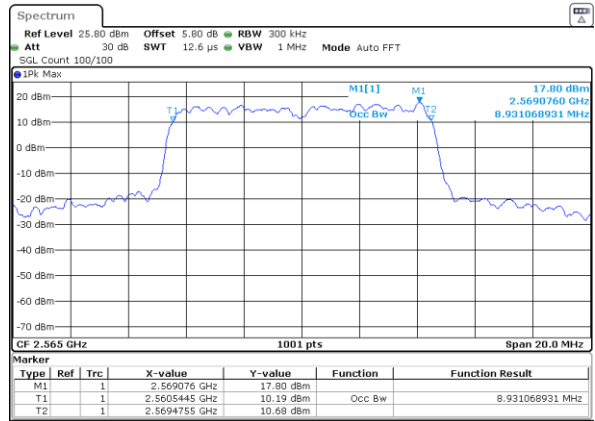

Date: 7 JUN 2020 09:46:51



LTE Band 7

Lowest Channel / 15MHz / QPSK

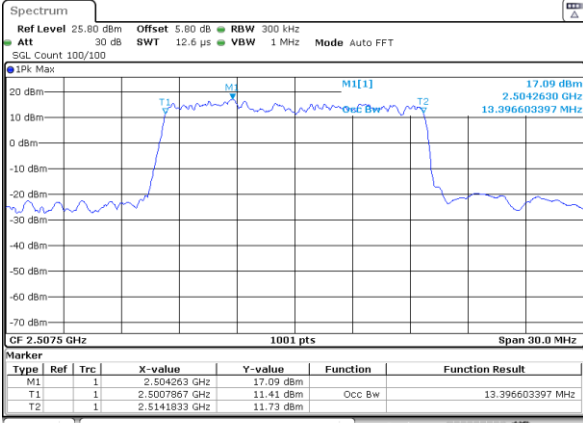

Date: 7 JUN 2020 10:02:03

Lowest Channel / 15MHz / 16QAM

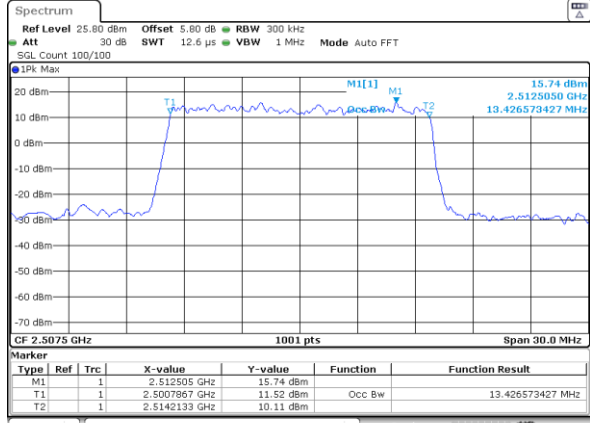

Date: 7 JUN 2020 10:01:43

Middle Channel / 15MHz / QPSK

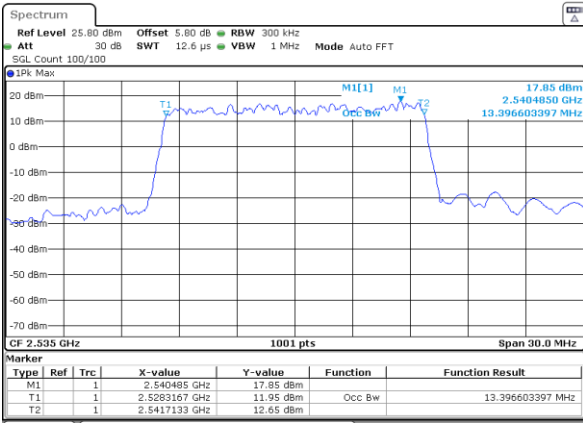

Date: 7 JUN 2020 10:02:22

Middle Channel / 15MHz / 16QAM

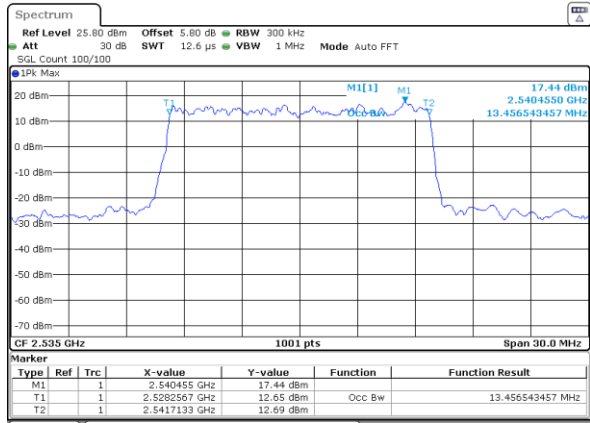

Date: 7 JUN 2020 10:02:42

Highest Channel / 15MHz / QPSK

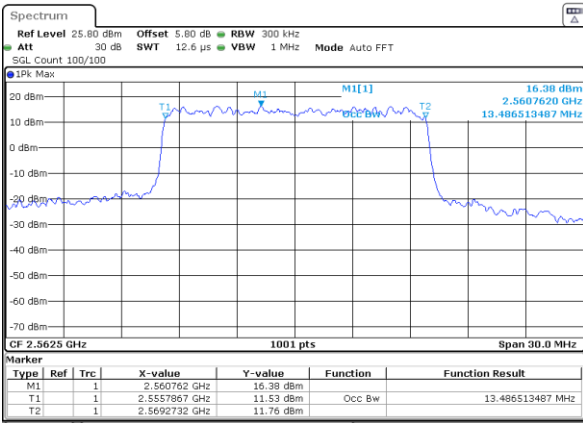

Date: 7 JUN 2020 10:03:22

Highest Channel / 15MHz / 16QAM

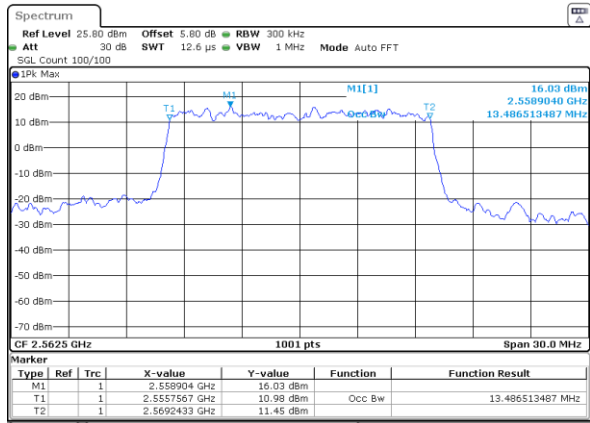

Date: 7 JUN 2020 10:03:02



LTE Band 7

Lowest Channel / 20MHz / QPSK

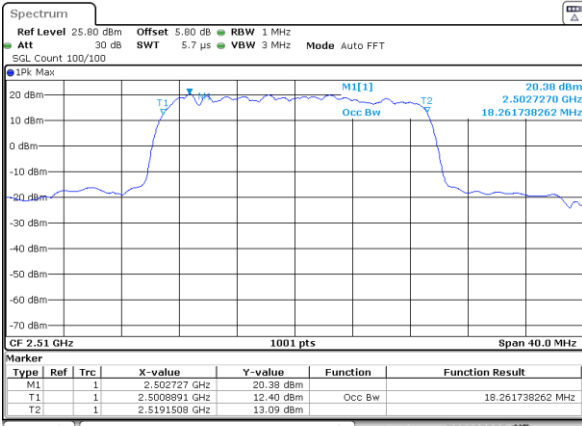

Date: 7 JUN 2020 10:18:35

Lowest Channel / 20MHz / 16QAM

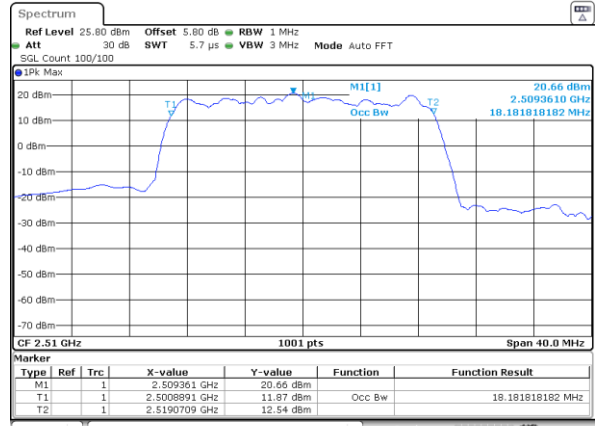

Date: 7 JUN 2020 10:18:15

Middle Channel / 20MHz / QPSK

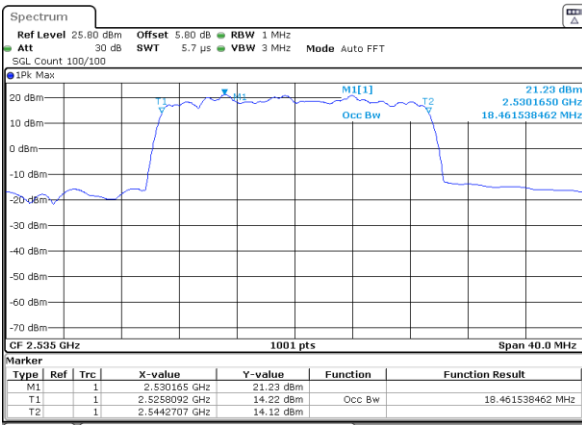

Date: 7 JUN 2020 10:18:54

Middle Channel / 20MHz / 16QAM

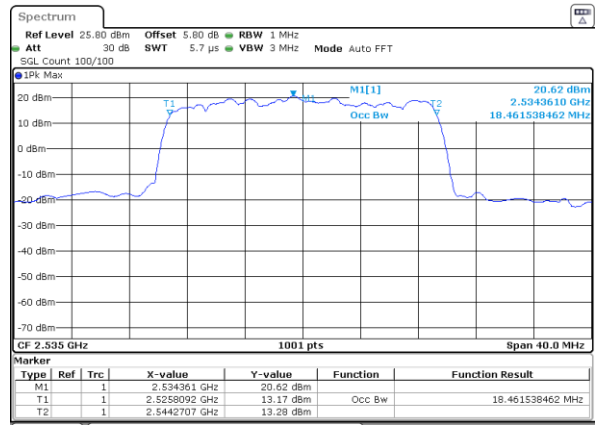

Date: 7 JUN 2020 10:19:14

Highest Channel / 20MHz / QPSK

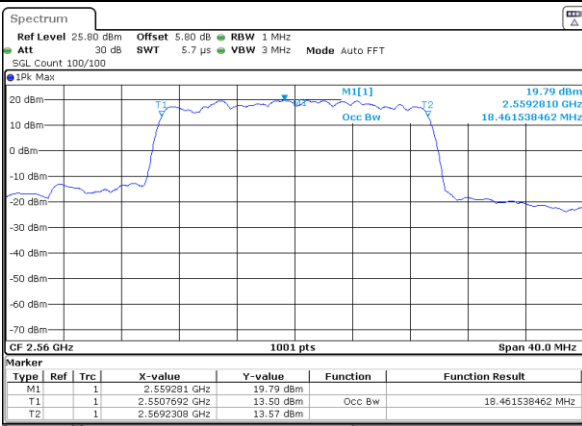

Date: 7 JUN 2020 10:19:54

Highest Channel / 20MHz / 16QAM

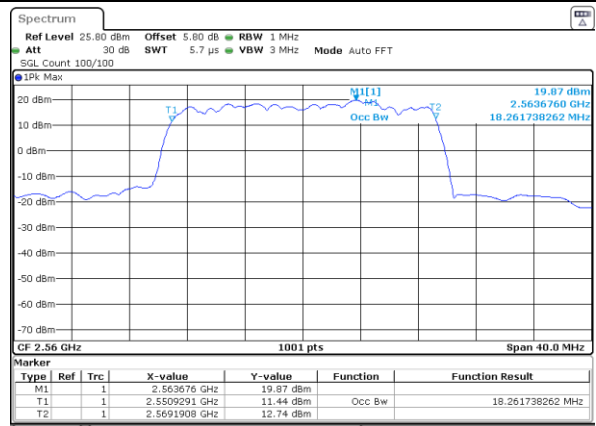

Date: 7 JUN 2020 10:19:34



LTE Band 7

Lowest Channel / 5MHz / 64QAM

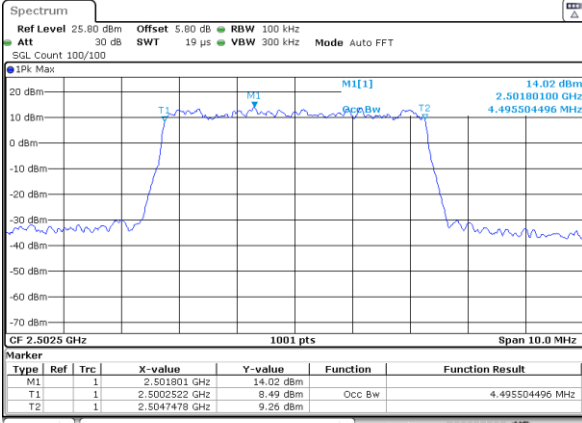

Date: 7, JUN, 2020 10:43:15

Lowest Channel / 10MHz / 64QAM

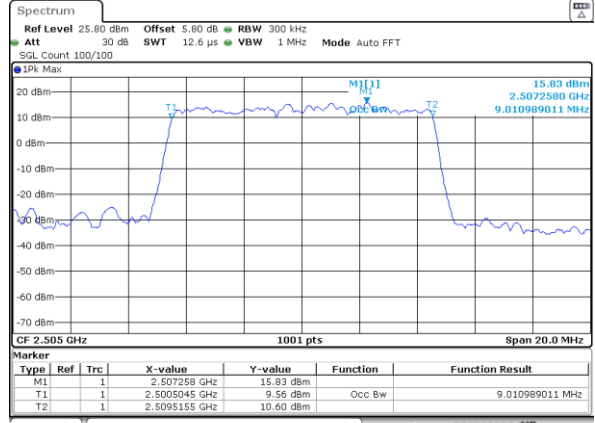

Date: 7, JUN, 2020 10:49:15

Middle Channel / 5MHz / 64QAM

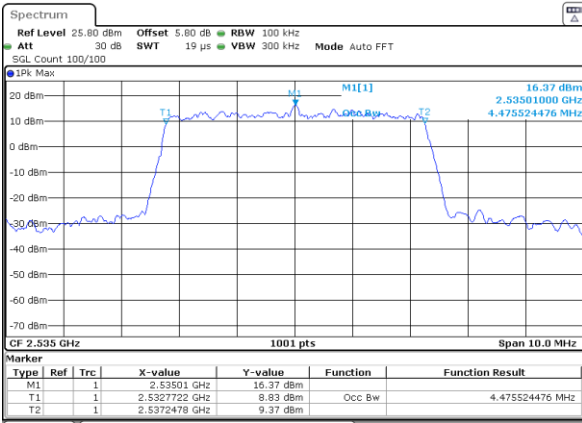

Date: 7, JUN, 2020 10:43:25

Middle Channel / 10MHz / 64QAM

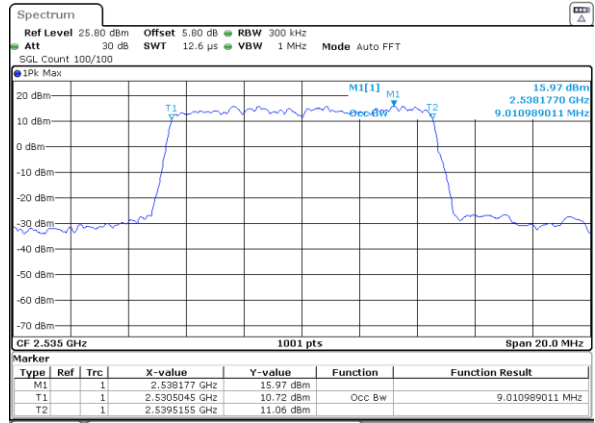

Date: 7, JUN, 2020 10:49:24

Highest Channel / 5MHz / 64QAM

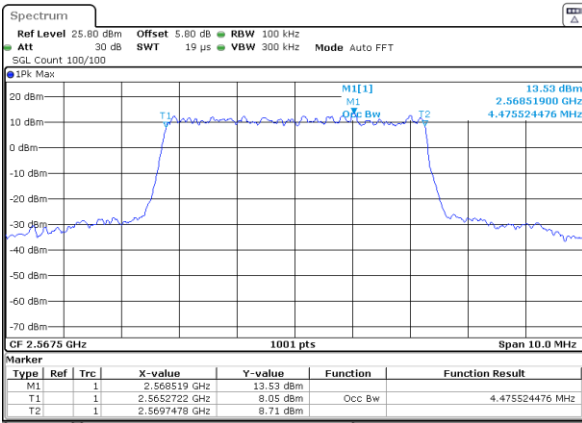

Date: 7, JUN, 2020 10:43:35

Highest Channel / 10MHz / 64QAM

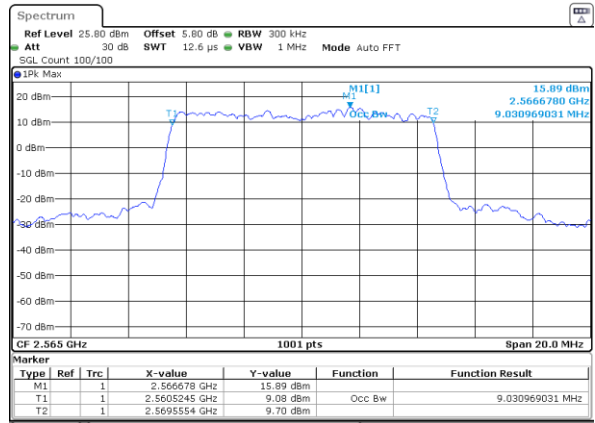

Date: 7, JUN, 2020 10:49:34



LTE Band 7

Lowest Channel / 15MHz / 64QAM

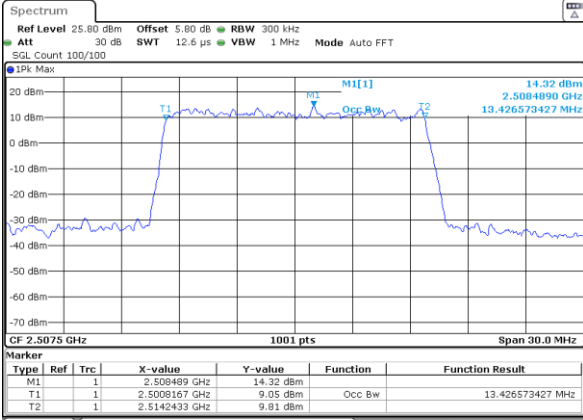

Date: 7 JUN 2020 10:55:13

Lowest Channel / 20MHz / 64QAM

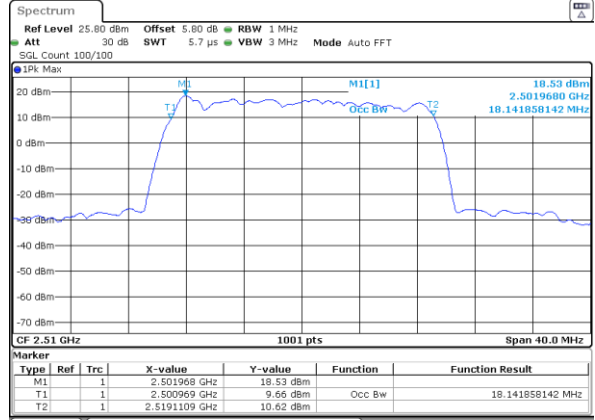

Date: 7 JUN 2020 11:01:12

Middle Channel / 15MHz / 64QAM

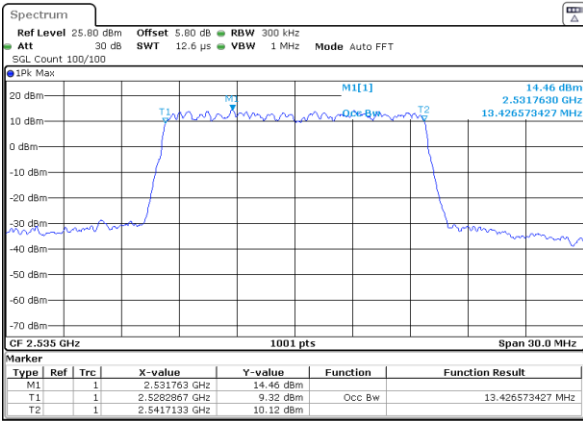

Date: 7 JUN 2020 10:55:23

Middle Channel / 20MHz / 64QAM

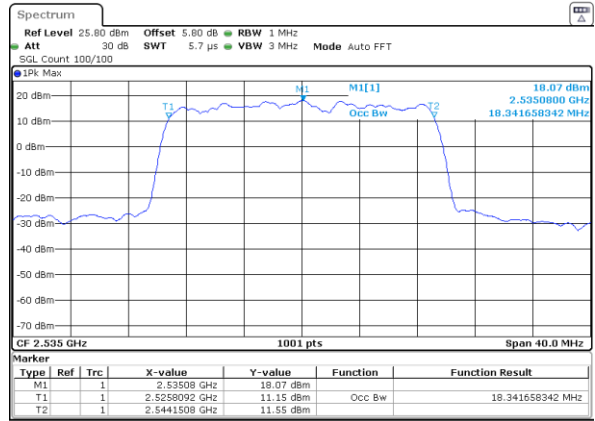

Date: 7 JUN 2020 11:01:22

Highest Channel / 15MHz / 64QAM

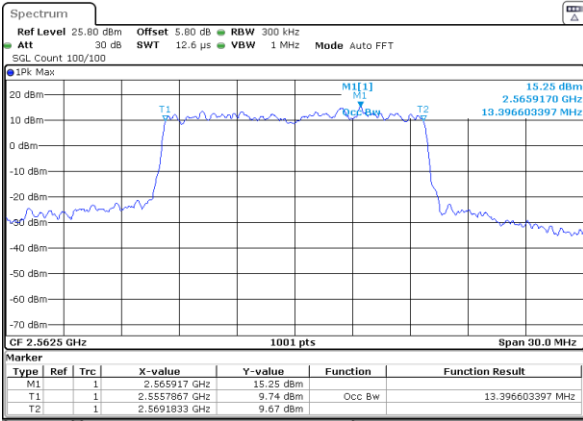

Date: 7 JUN 2020 10:55:33

Highest Channel / 20MHz / 64QAM

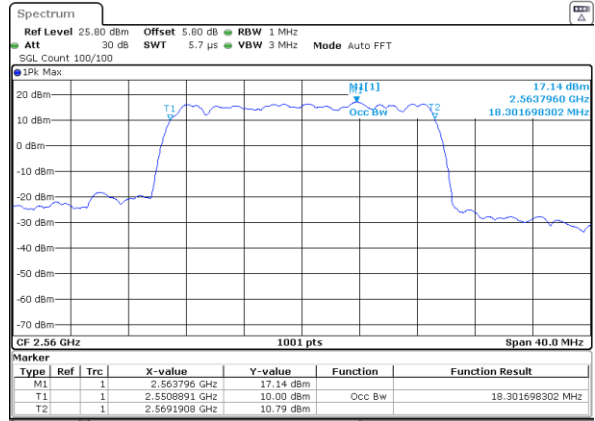

Date: 7 JUN 2020 11:01:32



Conducted Band Edge

LTE Band 7 / 5MHz / QPSK

Lowest Band Edge / 1 RB

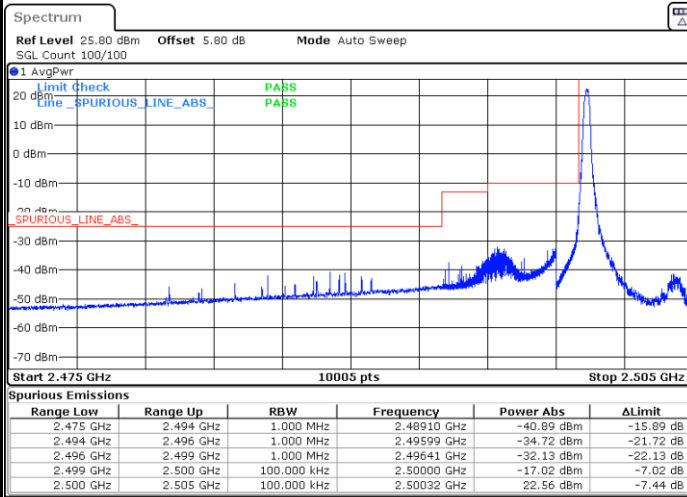

Highest Band Edge / 1 RB

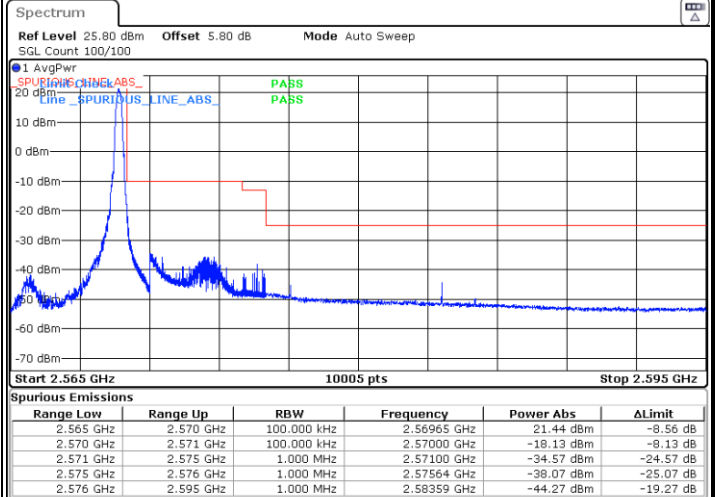

Lowest Band Edge / Full RB

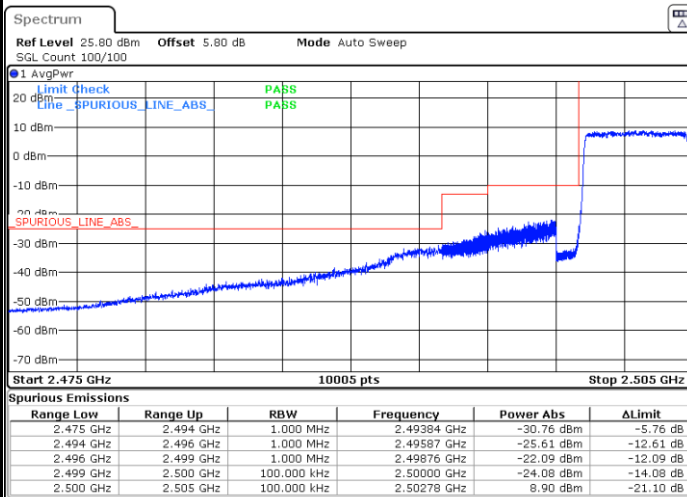

Highest Band Edge / Full RB

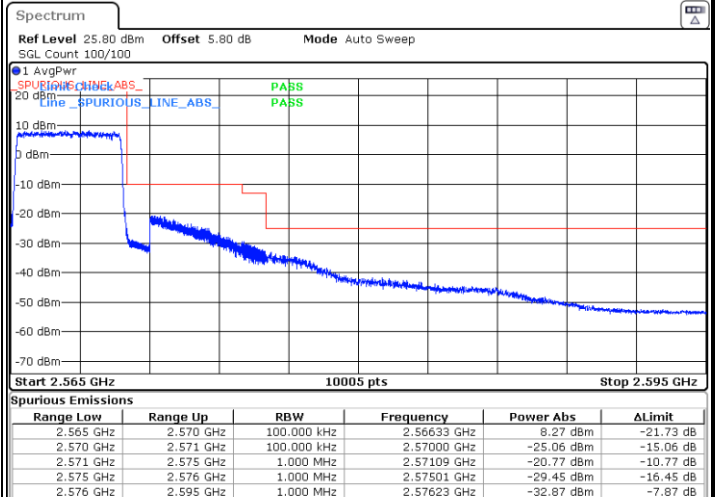



LTE Band 7 / 5MHz / 16QAM

Lowest Band Edge / 1 RB

Highest Band Edge / 1 RB

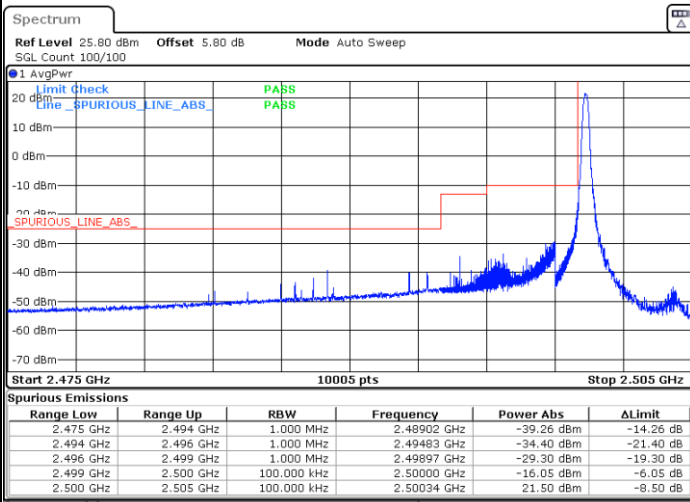

Date: 7 JUN 2020 09:32:44

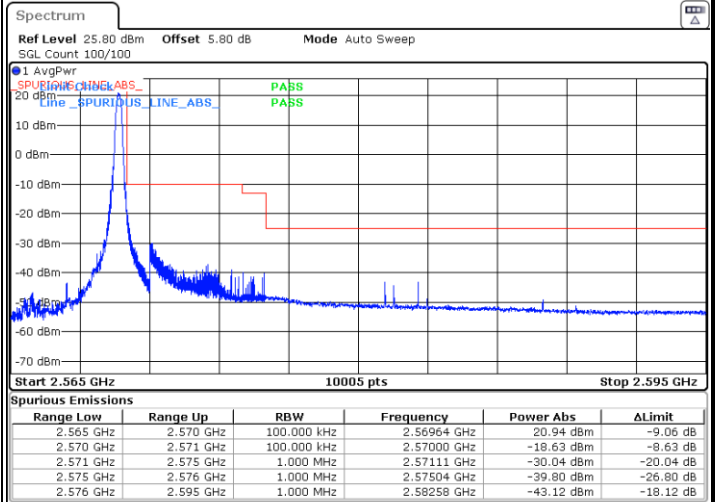

Date: 7 JUN 2020 09:38:27

Lowest Band Edge / Full RB

Highest Band Edge / Full RB

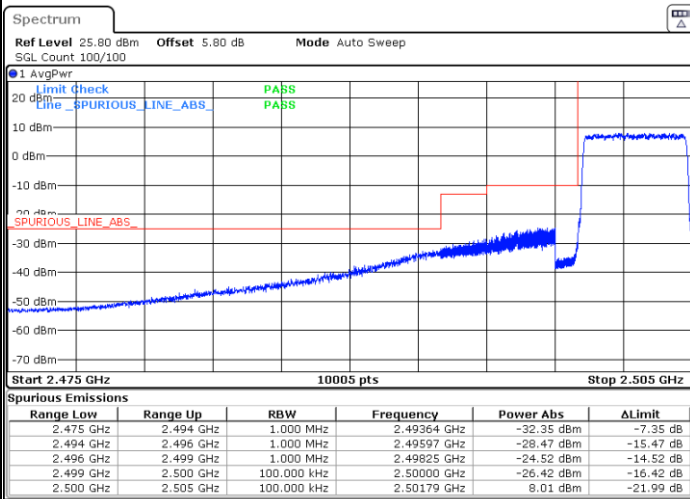

Date: 7 JUN 2020 09:33:53

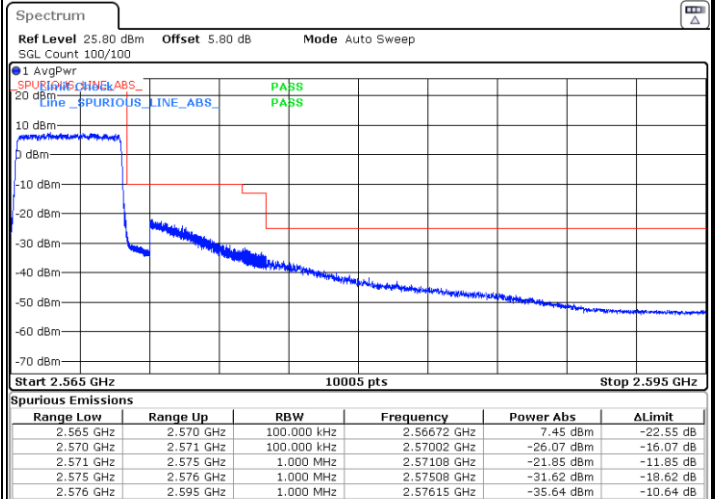

Date: 7 JUN 2020 09:37:19



LTE Band 7 / 5MHz / 64QAM

Lowest Band Edge / 1RB

Highest Band Edge / 1 RB

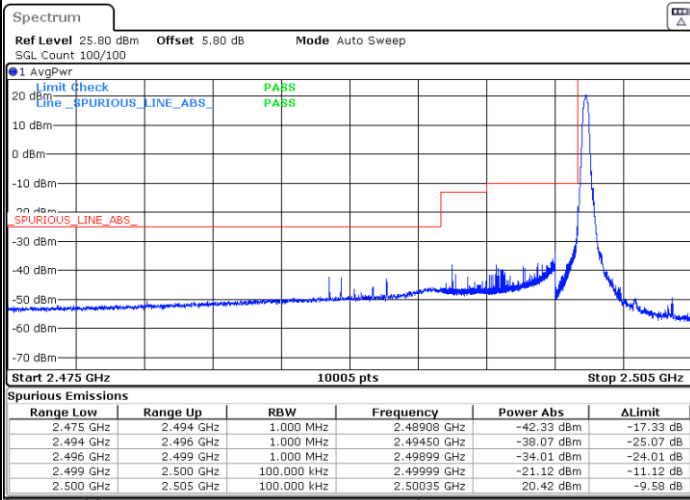

Date: 7.JUN.2020 11:11:59

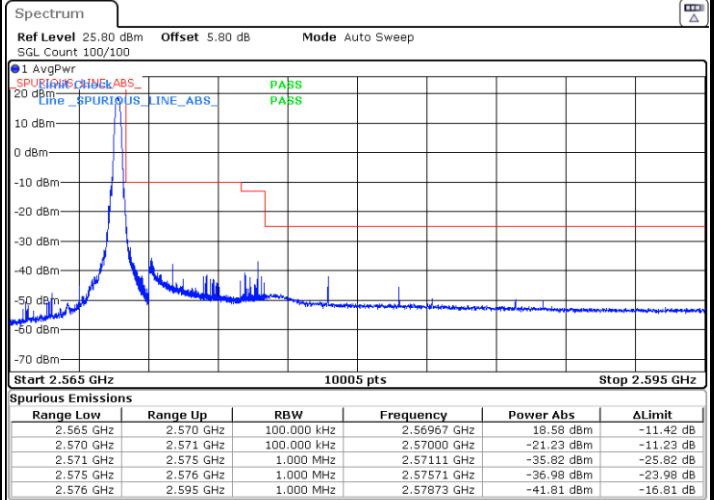

Date: 7.JUN.2020 10:47:57

Lowest Band Edge / Full RB

Highest Band Edge / Full RB

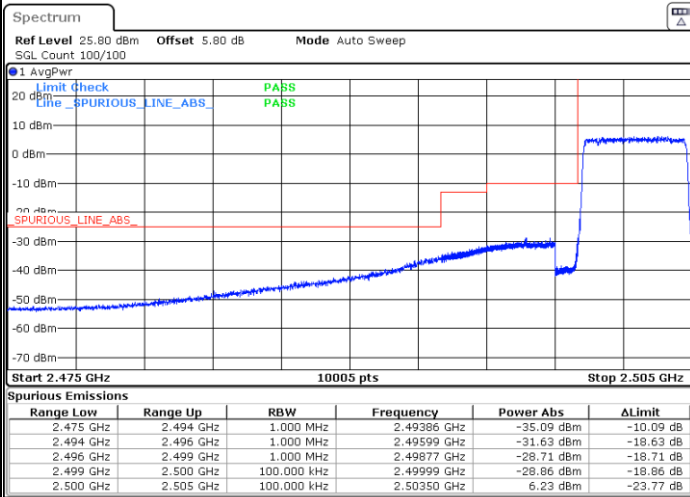

Date: 7.JUN.2020 11:12:18

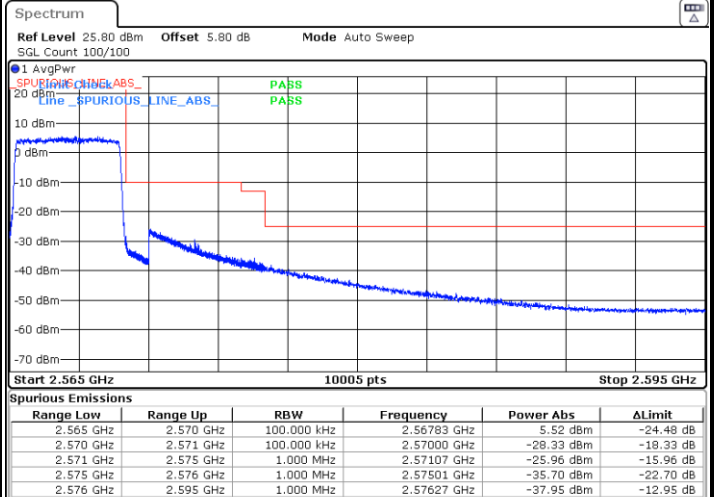

Date: 7.JUN.2020 10:49:05