



RF TEST REPORT

Applicant HMD Global Oy
FCC ID 2AJOTTA-1223
Product mobile phone
Brand Nokia
Model TA-1223
Report No. R2001A0040-R6
Issue Date March 13, 2020

TA Technology (Shanghai) Co., Ltd. tested the above equipment in accordance with the requirements in **FCC CFR47 Part 15C (2019)**. The test results show that the equipment tested is capable of demonstrating compliance with the requirements as documented in this report.

Performed by: Peng Tao

Approved by: Kai Xu

TA Technology (Shanghai) Co., Ltd.

No.145, Jintang Rd, Tangzhen Industry Park, Pudong Shanghai, China

TEL: +86-021-50791141/2/3

FAX: +86-021-50791141/2/3-8000

TABLE OF CONTENT

| | | |
|-------------|----------------------------------------------------------|----|
| 1 | Test Laboratory | 4 |
| 1.1 | Notes of the Test Report | 4 |
| 1.2. | Test facility | 4 |
| 1.3 | Testing Location | 4 |
| 2 | General Description of Equipment under Test | 5 |
| 2.1 | Applicant and Manufacturer Information..... | 5 |
| 2.2 | General information..... | 5 |
| 3 | Applied Standards | 7 |
| 4 | Information about the FHSS characteristics | 8 |
| 4.1 | Frequency Hopping System Requirement..... | 8 |
| 4.2 | Pseudorandom Frequency Hopping Sequence..... | 9 |
| 4.3 | Equal Hopping Frequency Use | 10 |
| 4.4 | System Receiver Input Bandwidth | 10 |
| 4.5 | Test Configuration | 11 |
| 5 | Test Case Results | 12 |
| 5.1 | Peak Power Output –Conducted..... | 12 |
| 5.2 | Occupied Bandwidth (20dB)..... | 14 |
| 5.3 | Frequency Separation | 18 |
| 5.4 | Time of Occupancy (Dwell Time)..... | 22 |
| 5.5 | Band Edge Compliance | 26 |
| 5.6 | Number of hopping Frequency..... | 29 |
| 5.7 | Spurious RF Conducted Emissions..... | 31 |
| 5.8 | Unwanted Emission | 35 |
| 5.9 | Conducted Emission | 53 |
| 6 | Main Test Instruments | 56 |

Summary of Measurement Results

| Number | Test Case | Clause in FCC rules | Verdict |
|----------------------------------------------------------------------------------------------------------------------------------------------------------------------------------------------------------------------------------------------------------------------------------------------|---------------------------------|-------------------------|---------|
| 1 | Frequency Hopping System | 15.247 (g), (h) | PASS |
| 2 | Peak Power Output -Conducted | 15.247(b)(1) | PASS |
| 3 | Occupied Bandwidth (20dB) | 15.247(a)(1) | PASS |
| 4 | Frequency Separation | 15.247(a)(1) | PASS |
| 5 | Time of Occupancy (Dwell Time) | 15.247(a)(1)(iii) | PASS |
| 6 | Band Edge Compliance | 15.247(d) | PASS |
| 7 | Number of Hopping Frequency | 15.247(a)(1)(iii) | PASS |
| 8 | Spurious RF Conducted Emissions | 15.247(d) | PASS |
| 9 | Unwanted Emissions | 15.247(d),15.205,15.209 | PASS |
| 10 | Conducted Emissions | 15.207 | PASS |
| Date of Testing: January 16, 2020 ~ February 28, 2020 | | | |
| <p>Note: All indications of Pass/Fail in this report are opinions expressed by TA Technology (Shanghai) Co., Ltd. based on interpretations and/or observations of test results. Measurement Uncertainties were not taken into account and are published for informational purposes only.</p> | | | |

1 Test Laboratory

1.1 Notes of the Test Report

This report shall not be reproduced in full or partial, without the written approval of **TA technology (shanghai) co., Ltd.** The results documented in this report apply only to the tested sample, under the conditions and modes of operation as described herein .Measurement Uncertainties were not taken into account and are published for informational purposes only. This report is written to support regulatory compliance of the applicable standards stated above.

1.2. Test facility

FCC (Designation number: CN1179, Test Firm Registration Number: 446626)

TA Technology (Shanghai) Co., Ltd. has been listed on the US Federal Communications Commission list of test facilities recognized to perform electromagnetic emissions measurements.

A2LA (Certificate Number: 3857.01)

TA Technology (Shanghai) Co., Ltd. has been listed by American Association for Laboratory Accreditation to perform electromagnetic emission measurement.

1.3 Testing Location

Company: TA Technology (Shanghai) Co., Ltd.
Address: No.145, Jintang Rd, Tangzhen Industry Park, Pudong Shanghai, China
City: Shanghai
Post code: 201201
Country: P. R. China
Contact: Xu Kai
Telephone: +86-021-50791141/2/3
Fax: +86-021-50791141/2/3-8000
Website: <http://www.ta-shanghai.com>
E-mail: xukai@ta-shanghai.com

2 General Description of Equipment under Test

2.1 Applicant and Manufacturer Information

| | |
|-----------------------------|--------------------------------------------|
| Applicant | HMD Global Oy |
| Applicant address | Bertel Jungin aukio 9,02600 ESPOO. FINLAND |
| Manufacturer | HMD Global Oy |
| Manufacturer address | Bertel Jungin aukio 9,02600 ESPOO. FINLAND |

2.2 General information

| EUT Description | | | |
|----------------------------------|-------------------------------------------------------------------------------------|-------------------------|-------|
| Model | TA-1223 | | |
| SN: | IMEI 1: 355795100011986 IMEI 2: 355795100014758 | | |
| Hardware Version | LLDM528 | | |
| Software Version | LLDB7749 | | |
| Power Supply | Battery/AC adapter | | |
| Antenna Type | Internal Antenna | | |
| Antenna Connector | A permanently attached antenna (meet with the standard FCC Part 15.203 requirement) | | |
| Antenna Gain | -1dBi | | |
| Test Mode(s) | Basic Rate | Enhanced Data Rate(EDR) | |
| Modulation Type | Frequency Hopping Spread Spectrum (FHSS) | | |
| | GFSK | $\pi/4$ DQPSK | 8DPSK |
| Packet Type (Maximum Payload) | DH5 | 2DH5 | 3DH5 |
| Max. Conducted Power | 10.82 dBm | | |
| Operating Frequency Range(s) | 2402-2480 MHz | | |
| EUT Accessory | | | |
| Adapter 1 | Manufacturer: SHENZHEN TIANYIN ELECTRONICS CO.,LTD. Model: CH-21E | | |
| Adapter 2 | Manufacturer: Jiangsu Chenyang Electron Co., Ltd. Model: AD-10WE | | |
| Adapter 3 | Manufacturer: SHENZHEN TIANYIN ELECTRONICS CO.,LTD. Model: CH-21U | | |
| Adapter 4 | Manufacturer: SHENZHEN TIANYIN ELECTRONICS CO.,LTD. Model: CH-21N | | |
| Adapter 5 | Manufacturer: SHENZHEN TIANYIN ELECTRONICS CO.,LTD. Model: CH-21X | | |
| Adapter 6 | Manufacturer: SHENZHEN TIANYIN ELECTRONICS CO.,LTD. | | |



| | |
|-------------------------------------------------------------------------------------------------------------------------------------------------------------------------------------------------------------------------------------------------------------------------------------------------------------------------------------------------------------------|-------------------------------------------------------------------------------|
| | Model: CH-21A |
| Adapter 7 | Manufacturer: DONGGUAN AOHAI POWER TECHNOLOGY CO.,LTD. Model: AD-10WR |
| Adapter 8 | Manufacturer: SHENZHEN TIANYIN ELECTRONICS CO.,LTD. Model: CH-21B |
| Battery 1 | Manufacturer: Jiade Energy Technology (Zhuhai) Co., Ltd. Model: LC-620U |
| Battery 2 | Manufacturer: Veken Model: LC-620U |
| Earphone 1 | Manufacturer: Huizhou New Leader Industry Co., Ltd. Model: NLD-EM300M-03SF |
| Earphone 2 | Manufacturer: Xiaolin Electronics Model: XL-5178 |
| USB Cable 1 | Manufacturer: Xiamen Li Qi Electronics Co., Ltd. Model: LQ03500090 |
| USB Cable 2 | Manufacturer: Saibao (Jiangxi) Industrial Co. , Ltd. Model: SLQ-A125A |
| <p>Note: 1. The EUT is sent from the applicant to TA and the information of the EUT is declared by the applicant.</p> <p>2. There is more than one Adapter, Battery, Earphone and USB Cable, each one should be applied throughout the compliance test respectively, and however, only the worst case (Adapter 1, Battery 1) will be recorded in this report.</p> | |

3 Applied Standards

According to the specifications of the manufacturer, it must comply with the requirements of the following standards:

Test standards:

FCC CFR47 Part 15C (2019) Radio Frequency Devices

ANSI C63.10 (2013)

Reference standard:

KDB 558074 D01 15.247 Meas Guidance v05r02

4 Information about the FHSS characteristics

4.1 Frequency Hopping System Requirement

Standard requirement:

(g) Frequency hopping spread spectrum systems are not required to employ all available hopping channels during each transmission. However, the system, consisting of both the transmitter and the receiver, must be designed to comply with all of the regulations in this section should the transmitter be presented with a continuous data (or information) stream. In addition, a system employing short transmission bursts must comply with the definition of a frequency hopping system and must distribute its transmissions over the minimum number of hopping channels specified in this section.

(h) The incorporation of intelligence within a frequency hopping spread spectrum system that permits the system to recognize other users within the spectrum band so that it individually and independently chooses and adapts its hop sets to avoid hopping on occupied channels is permitted. The coordination of frequency hopping systems in any other manner for the express purpose of avoiding the simultaneous occupancy of individual hopping frequencies by multiple transmitters is not permitted.

Compliance for section 15.247(g):

According to Bluetooth Core Specification, the Bluetooth system transmits the packets with the pseudorandom hopping frequency with a continuous data and short burst transmission from the Bluetooth system is also transmitted under the frequency hopping system with the pseudorandom hopping frequency system.

Compliance for section 15.247(h):

According to Bluetooth Core Specification, the Bluetooth system incorporates with an adaptive system to detect other user within the spectrum band so that it individually and independently to avoid hopping on the occupied channels.

According to Bluetooth Core Specification, the Bluetooth system is designed not have the ability to coordinate with other FHSS System in an effort to avoid the simultaneous occupancy of individual hopping frequencies by multiple transmitter.

4.2 Pseudorandom Frequency Hopping Sequence

Frequency Hopping Systems. A spread spectrum system in which the carrier is modulated with the coded information in a conventional manner causing a conventional spreading of the RF energy about the frequency carrier. The frequency of the carrier is not fixed but changes at fixed intervals under the direction of a coded sequence. The wide RF bandwidth needed by such a system is not required by spreading of the RF energy about the carrier but rather to accommodate the range of frequencies to which the carrier frequency can hop. The test of a frequency hopping system is that the near term distribution of hops appears random, the long term distribution appears evenly distributed over the hop set, and sequential hops are randomly distributed in both direction and magnitude of change in the hop set.

Adaptive Frequency Hopping (AFH) was introduced in the Bluetooth specification to provide an effective way for a Bluetooth radio to counteract normal interference. AFH identifies "bad" channels, where either other wireless devices are interfering with the Bluetooth signal or the Bluetooth signal is interfering with another device. The AFH-enabled Bluetooth device will then communicate with other devices within its pioneer to share details of any identified bad channels. The devices will then switch to alternative available "good" channels, away from the areas of interference, thus having no impact on the bandwidth used.

The selection scheme chooses a segment of 32 hop frequencies spanning about 64 MHz and visits these hops in a pseudo-random order. Next, a different 32-hop segment is chosen, etc. In the page, master page response, slave page response, page scan, inquiry, inquiry response and inquiry scan hopping sequences, the same 32-hop segment is used all the time (the segment is selected by the address; different devices will have different paging segments).

When the basic channel hopping sequence is selected, the output constitutes a pseudo-random sequence that slides through the 79 hops. The principle is depicted in the figure below.

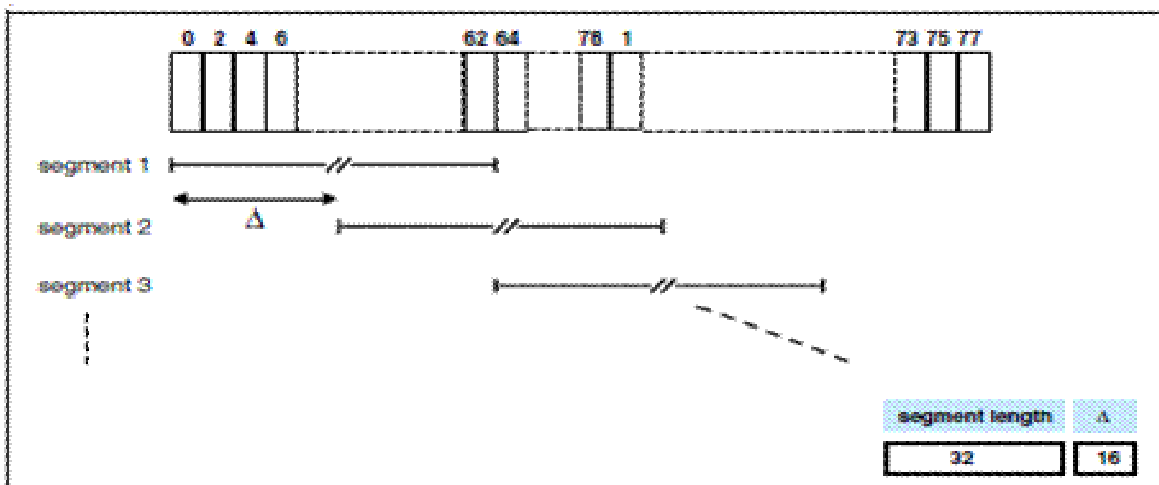

Hop selection scheme in CONNECTION state.

Pseudorandom Frequency Hopping Sequence Table as below:

Channel: 08, 24, 40, 56, 40, 56, 72, 09, 01, 09, 33, 41, 33, 41, 65, 73, 53, 69, 06, 22, 04, 20, 36, 52, 38, 46, 70, 78, 68, 76, 21, 29, 10, 26, 42, 58, 44, 60, 76, 13, 03, 11, 35, 43, 37, 45, 69, 77, 55, 71, 08, 24, 08, 24, 40, 56, 40, 48, 72, 01, 72, 01, 25, 33, 12, 28, 44, 60, 42, 58, 74, 11, 05, 13, 37, 45, etc.

Each frequency used equally on the average by each transmitter.



The system receiver have input bandwidths that match the hopping channel bandwidths of their corresponding transmitters and shift frequencies in synchronization with the transmitted signals.

4.3 Equal Hopping Frequency Use

All Bluetooth units participating in the Pico net are time and hop-synchronized to the channel. Each new transmission event begins on the next channel in the hopping sequence after the final channel used in the previous transmission event.

4.4 System Receiver Input Bandwidth

Each channel bandwidth is 1MHz. The system receivers have input bandwidths that match the hopping channel bandwidths of their corresponding transmitters and shift frequencies in synchronization with the transmitted signals.

4.5 Test Configuration

The EUT has been associated with peripherals and configuration operated in a manner tended to maximize its emission characteristics in a typical application.

The radiated emission was measured in the following position: EUT stand-up position (Z axis), lie-down position (X, Y axis). The worst emission was found in lie-down position (X axis) and the worst case was recorded.

| Test Cases | Test Modes |
|---------------------------------|---------------|
| Peak Power Output -Conducted | DH5/2DH5/3DH5 |
| Occupied Bandwidth (20dB) | DH5/2DH5/3DH5 |
| Frequency Separation | DH5/2DH5/3DH5 |
| Time of Occupancy (Dwell Time) | DH5/2DH5/3DH5 |
| Band Edge Compliance | DH5/2DH5/3DH5 |
| Number of Hopping Frequency | DH5/2DH5/3DH5 |
| Spurious RF Conducted Emissions | DH5/2DH5/3DH5 |
| Unwanted Emission | DH5/2DH5/3DH5 |
| Conducted Emission | DH5/2DH5/3DH5 |

5 Test Case Results

5.1 Peak Power Output –Conducted

Ambient condition

| Temperature | Relative humidity | Pressure |
|-------------|-------------------|----------|
| 23°C ~25°C | 45%~50% | 101.5kPa |

Methods of Measurement

During the process of the testing, The EUT was connected to the spectrum analyzer and Bluetooth test set via a power splitter with a known loss. The EUT is controlled by the Bluetooth test set to ensure max power transmission with proper modulation. The peak detector is used. RBW is set to 2 MHz; VBW is set to 6 MHz. These measurements have been tested at following channels: 0, 39, and 78.

Test Setup

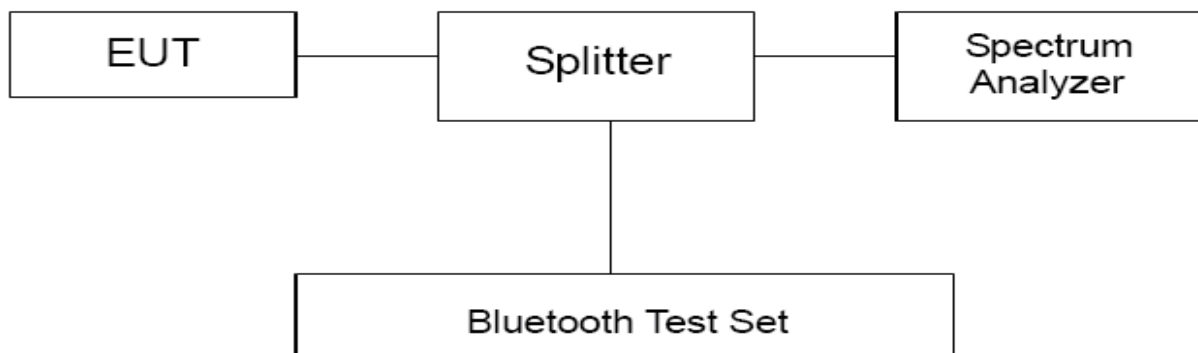

Limits

Rule Part 15.247 (b) (1) specifies that " For frequency hopping systems operating in the 2400–2483.5 MHz band employing at least 75 non-overlapping hopping channels, and all frequency hopping systems in the 5725–5850 MHz band: 1 watt. For all other frequency hopping systems in the 2400–2483.5 MHz band: 0.125 watts."

| | |
|-------------------|-----------------|
| Peak Output Power | ≤ 125mW (21dBm) |
|-------------------|-----------------|

Measurement Uncertainty

The assessed measurement uncertainty to ensure 95% confidence level for the normal distribution is with the coverage factor $k = 2$, $U=0.44$ dB.

**Test Results**

| Channel | Frequency (MHz) | Peak Output Power (dBm) | | | Limit (dBm) | Conclusion |
|---------|-----------------|-------------------------|-------|-------|-------------|------------|
| | | DH5 | 2DH5 | 3DH5 | | |
| 0 | 2402 | 10.02 | 9.42 | 9.46 | 21 | PASS |
| 39 | 2441 | 10.82 | 10.28 | 10.29 | 21 | PASS |
| 78 | 2480 | 9.76 | 9.33 | 9.34 | 21 | PASS |

Note: The measured power density (dBm) has the offset with cable loss already.

Note: For AFH mode using 20 hopping channels, the maximum output power limit is 21dBm.

5.2 Occupied Bandwidth (20dB)

Ambient condition

| Temperature | Relative humidity | Pressure |
|-------------|-------------------|----------|
| 23°C ~25°C | 45%~50% | 101.5kPa |

Method of Measurement

The EUT was connected to the spectrum analyzer and Bluetooth test set via a power splitter with a known loss. The occupied bandwidth is measured using spectrum analyzer. RBW is set to 30kHz and VBW is set to 100kHz on spectrum analyzer. -20dB occupied bandwidths are recorded.

Test Setup

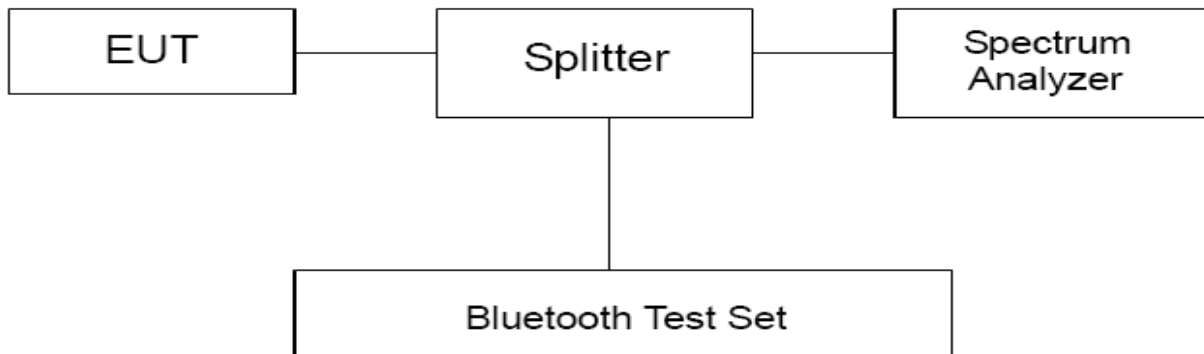

Limits

No specific occupied bandwidth requirements in part 15.247(a) (1).

Measurement Uncertainty

The assessed measurement uncertainty to ensure 95% confidence level for the normal distribution is with the coverage factor $k = 2$, $U=936$ Hz.

Test Results

| Mode | | Channel | Frequency (MHz) | 99% bandwidth(kHz) | 20dB Bandwidth(kHz) |
|------|------|---------|-----------------|--------------------|---------------------|
| BT | DH5 | 0 | 2402 | 862.65 | 955.5 |
| | | 39 | 2441 | 862.84 | 857.4 |
| | | 78 | 2480 | 860.99 | 958.2 |
| | 2DH5 | 0 | 2402 | 1175.1 | 1292 |
| | | 39 | 2441 | 1177.3 | 1309 |
| | | 78 | 2480 | 1187.5 | 1316 |
| | 3DH5 | 0 | 2402 | 1182.8 | 1305 |
| | | 39 | 2441 | 1189.7 | 1310 |
| | | 78 | 2480 | 1204.5 | 1311 |

BT DH5 CH0, Carrier frequency (MHz): 2402



BT 2DH5 CH0, Carrier frequency (MHz): 2402



BT DH5 CH39, Carrier frequency (MHz): 2441



BT 2DH5 CH39, Carrier frequency (MHz): 2441

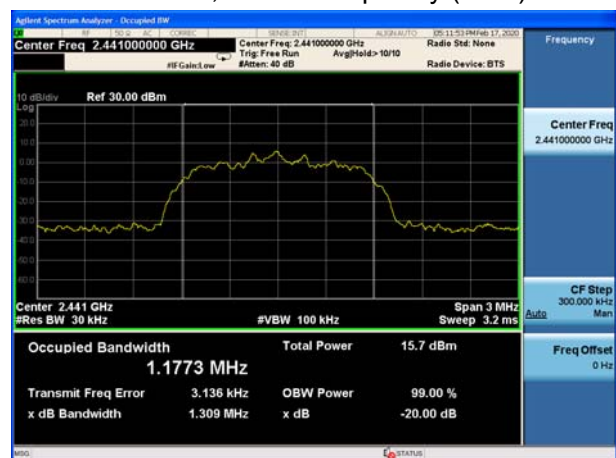

BT DH5 CH78, Carrier frequency (MHz): 2480

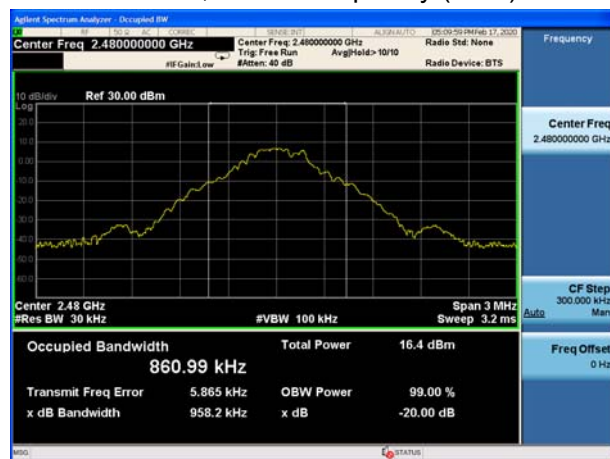

BT 2DH5 CH78, Carrier frequency (MHz): 2480

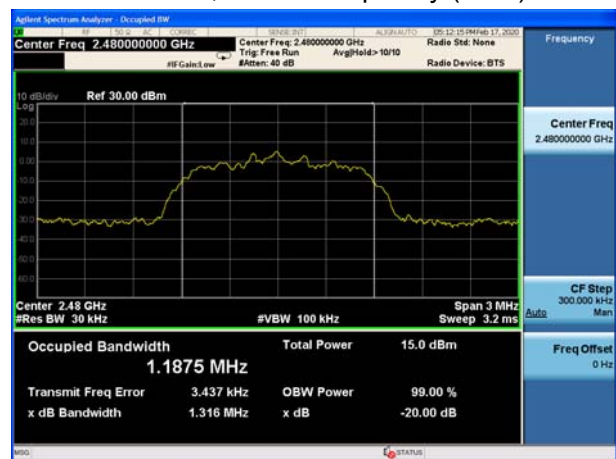

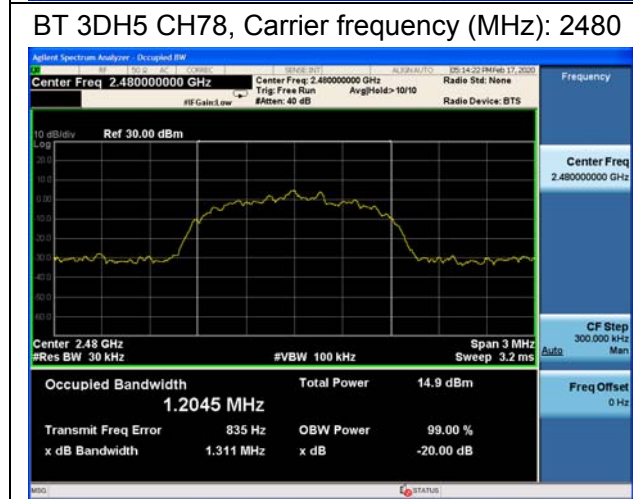
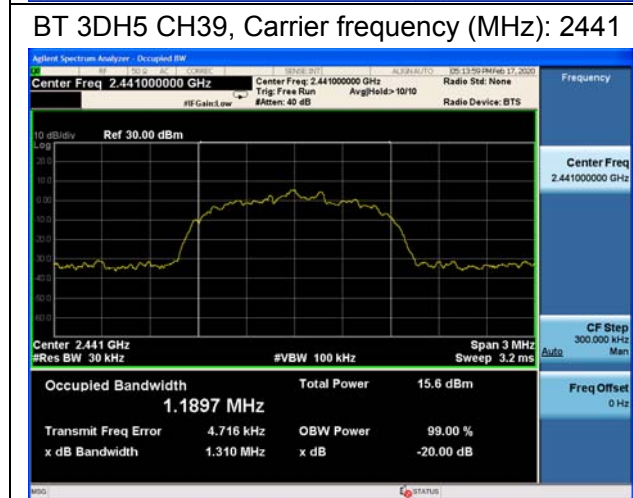
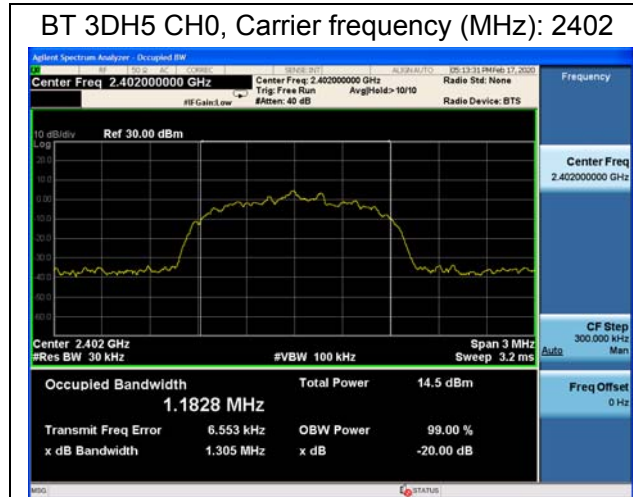

5.3 Frequency Separation

Ambient condition

| Temperature | Relative humidity | Pressure |
|-------------|-------------------|----------|
| 23°C ~25°C | 45%~50% | 101.5kPa |

Method of Measurement

The EUT was connected to the spectrum analyzer and Bluetooth test set via a power splitter with a known loss. RBW is set to 30 kHz and VBW is set to 100 kHz on spectrum analyzer. Set EUT on Hopping on mode.

Test setup

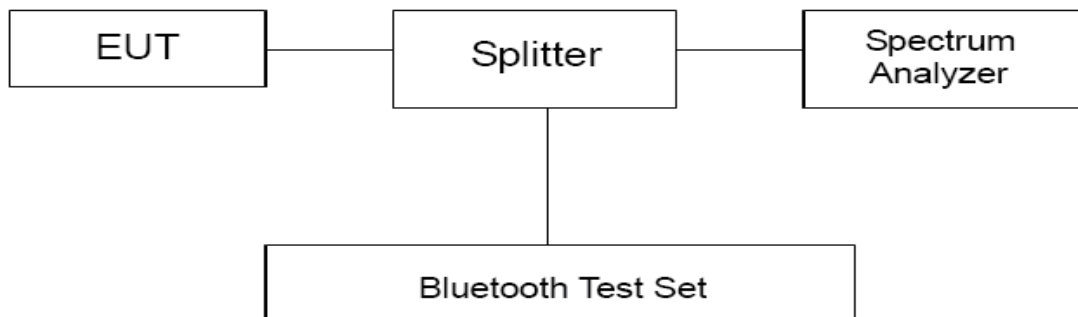

Limits

Rule Part 15.247(a)(1) specifies that “Frequency hopping systems shall have hopping channel carrier frequencies separated by a minimum of 25 kHz or the 20 dB bandwidth of the hopping channel, whichever is greater. Alternatively, frequency hopping systems operating in the 2400–2483.5 MHz band may have hopping channel carrier frequencies that are separated by 25 kHz or two-thirds of the 20 dB bandwidth of the hopping channel, whichever is greater, provided the systems operate with an output power no greater than 125 mW. ”

Note: The value of two-thirds of 20 dB bandwidth is always greater than 25 kHz.

Measurement Uncertainty

The assessed measurement uncertainty to ensure 95% confidence level for the normal distribution is with the coverage factor $k = 2$, $U=936$ Hz.

Test Results:

| Packet type | Carrier frequency (MHz) | Carrier frequency separation(kHz) | 20dB Bandwidth(kHz) | Limit (kHz) | Conclusion |
|---------------------------------------------------|-------------------------|-----------------------------------|---------------------|-------------|------------|
| DH5 | 2402 | 999 | 955.5 | 637.00 | PASS |
| | 2441 | 999 | 857.4 | 571.60 | PASS |
| | 2480 | 999 | 958.2 | 638.80 | PASS |
| 2DH5 | 2402 | 999 | 1292 | 861.33 | PASS |
| | 2441 | 999 | 1309 | 872.67 | PASS |
| | 2480 | 999 | 1316 | 877.33 | PASS |
| 3DH5 | 2402 | 999 | 1305 | 870.00 | PASS |
| | 2441 | 999 | 1310 | 873.33 | PASS |
| | 2480 | 999 | 1311 | 874.00 | PASS |
| Note: The limit is two-thirds of 20 dB bandwidth. | | | | | |

BT DH5 CH0, Carrier frequency (MHz): 2402



BT 2DH5 CH0, Carrier frequency (MHz): 2402



BT DH5 CH39, Carrier frequency (MHz): 2441



BT 2DH5 CH39, Carrier frequency (MHz): 2441



BT DH5 CH78, Carrier frequency (MHz): 2480



BT 2DH5 CH78, Carrier frequency (MHz): 2480





BT 3DH5 CH0, Carrier frequency (MHz): 2402



BT 3DH5 CH39, Carrier frequency (MHz): 2441



BT 3DH5 CH78, Carrier frequency (MHz): 2480



5.4 Time of Occupancy (Dwell Time)

Ambient condition

| Temperature | Relative humidity | Pressure |
|-------------|-------------------|----------|
| 23°C ~25°C | 45%~50% | 101.5kPa |

Methods of Measurement

The EUT was connected to the spectrum analyzer and Bluetooth test set via a power splitter with a known loss. RBW is set to 1MHz and VBW is set to 1MHz on spectrum analyzer. The dwell time is calculated by:

Dwell time = time slot length * hop rate * 0.4s with:

In normal mode, The selected EUT Packet type uses a slot type of DH5 packet and a hopping rate of 1600(ch*hop/s) for all channels. So the final hopping rate for all channel is 1600/5=320(ch*hop/s)

In AFH mode, The selected EUT Packet type uses a slot type of DH5 packet and a hopping rate of 800(ch*hop/s) for all channels. So the final hopping rate for all channel is 800/5=160(ch*hop/s)

Test Setup

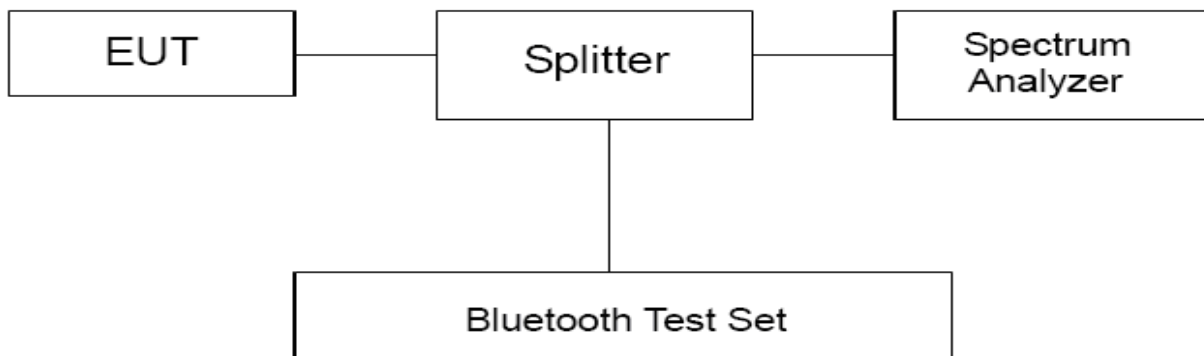

Limits

Rule Part15.247(a) specifies that " Frequency hopping systems in the 2400–2483.5 MHz band shall use at least 15 channels. The average time of occupancy on any channel shall not be greater than 0.4 seconds within a period of 0.4 seconds multiplied by the number of hopping channels employed."

| | |
|------------|---------|
| Dwell time | ≤ 400ms |
|------------|---------|

Measurement Uncertainty

The assessed measurement uncertainty to ensure 95% confidence level for the normal distribution is with the coverage factor $k = 2$.

| Requirements | Uncertainty | | | | | |
|--------------|-------------|------------|------|------------|------|------------|
| Dwell Time | DH5 | $U=0.70ms$ | 2DH5 | $U=0.70ms$ | 3DH5 | $U=0.70ms$ |

Test Results:

In normal mode:

| Packet type | Channel | hop rate (1/s) | Time slot length(ms) | Dwell time (ms) | Limit (ms) | Conclusion |
|-------------|---------|----------------|----------------------|-----------------|------------|------------|
| DH5 | 0 | 320 | 2.89 | 369.92 | 400 | PASS |
| | 39 | 320 | 2.89 | 369.92 | 400 | PASS |
| | 78 | 320 | 2.89 | 369.92 | 400 | PASS |
| 2DH5 | 0 | 320 | 2.88 | 368.64 | 400 | PASS |
| | 39 | 320 | 2.88 | 368.64 | 400 | PASS |
| | 78 | 320 | 2.88 | 368.64 | 400 | PASS |
| 3DH5 | 0 | 320 | 2.89 | 369.92 | 400 | PASS |
| | 39 | 320 | 2.88 | 368.64 | 400 | PASS |
| | 78 | 320 | 2.89 | 369.92 | 400 | PASS |

Note: Dwell time = time slot length * hop rate * 0.4s

In AFH mode:

| Packet type | Channel | hop rate (1/s) | Time slot length(ms) | Dwell time (ms) | Limit (ms) | Conclusion |
|-------------|---------|----------------|----------------------|-----------------|------------|------------|
| DH5 | 0 | 160 | 2.89 | 184.96 | 400 | PASS |
| | 39 | 160 | 2.89 | 184.96 | 400 | PASS |
| | 78 | 160 | 2.89 | 184.96 | 400 | PASS |
| 2DH5 | 0 | 160 | 2.88 | 184.32 | 400 | PASS |
| | 39 | 160 | 2.88 | 184.32 | 400 | PASS |
| | 78 | 160 | 2.88 | 184.32 | 400 | PASS |
| 3DH5 | 0 | 160 | 2.89 | 184.96 | 400 | PASS |
| | 39 | 160 | 2.88 | 184.32 | 400 | PASS |
| | 78 | 160 | 2.89 | 184.96 | 400 | PASS |

Note: Dwell time = time slot length * hop rate * 0.4s

BT DH5 CH0, Carrier frequency (MHz): 2402

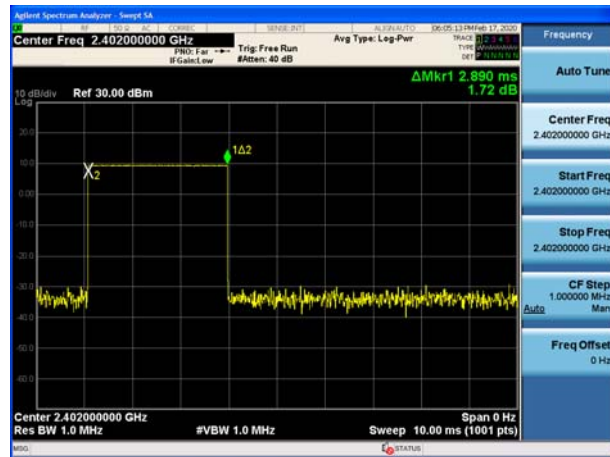

BT 2DH5 CH0, Carrier frequency (MHz): 2402

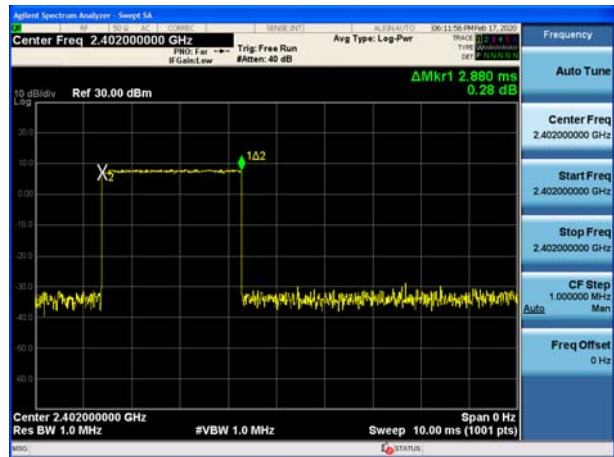

BT DH5 CH39, Carrier frequency (MHz): 2441

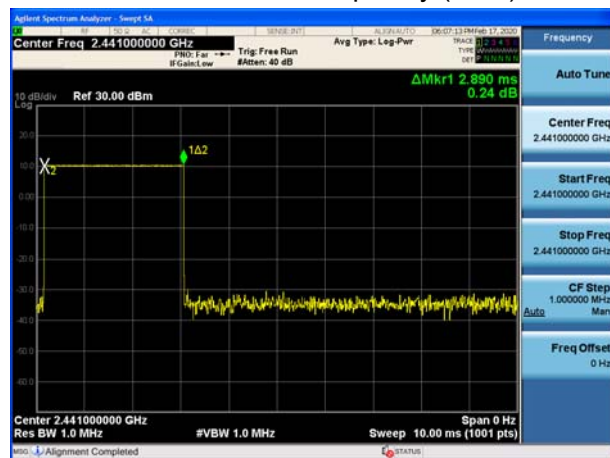

BT 2DH5 CH39, Carrier frequency (MHz): 2441

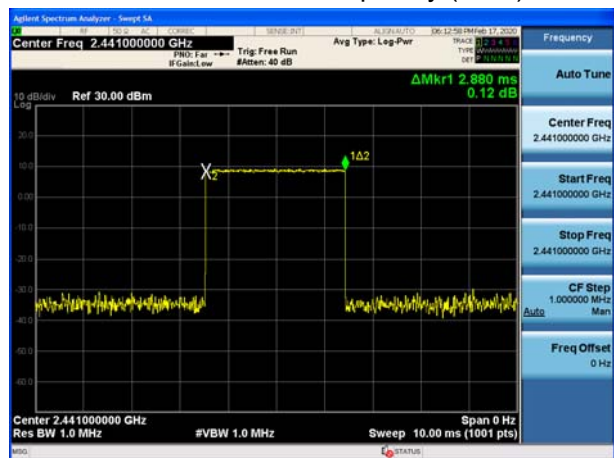

BT DH5 CH78, Carrier frequency (MHz): 2480

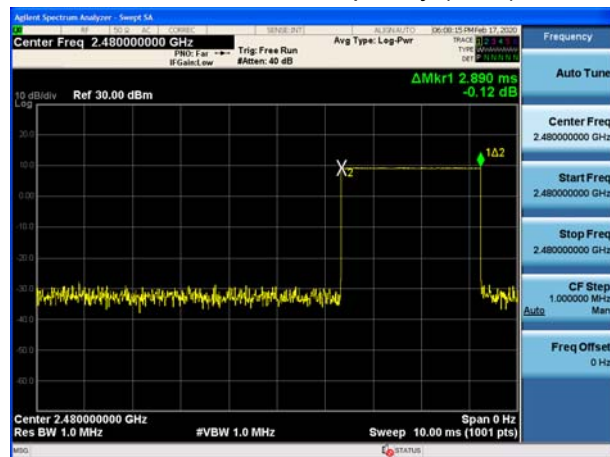

BT 2DH5 CH78, Carrier frequency (MHz): 2480

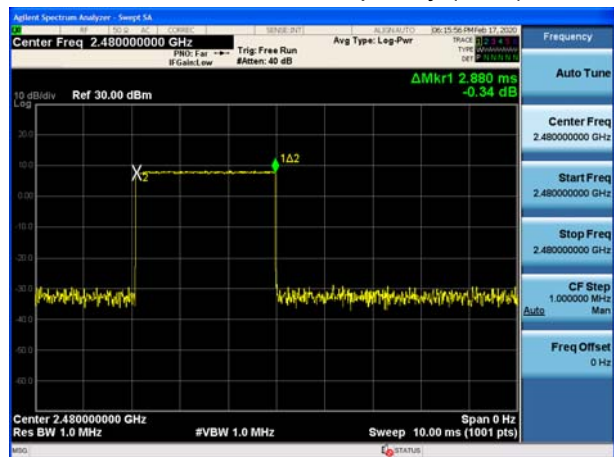



BT 3DH5 CH0, Carrier frequency (MHz): 2402

BT 3DH5 CH39, Carrier frequency (MHz): 2441

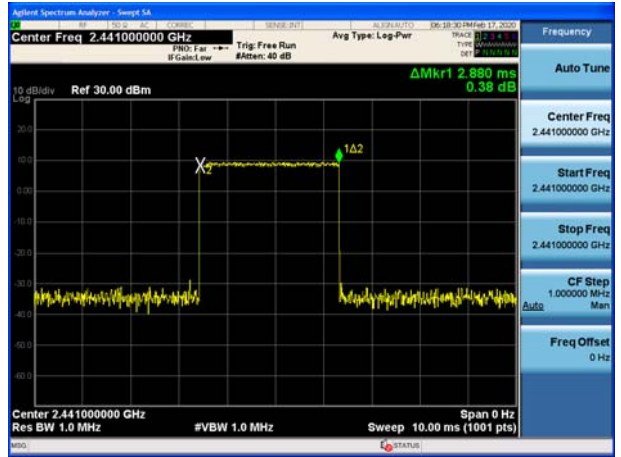
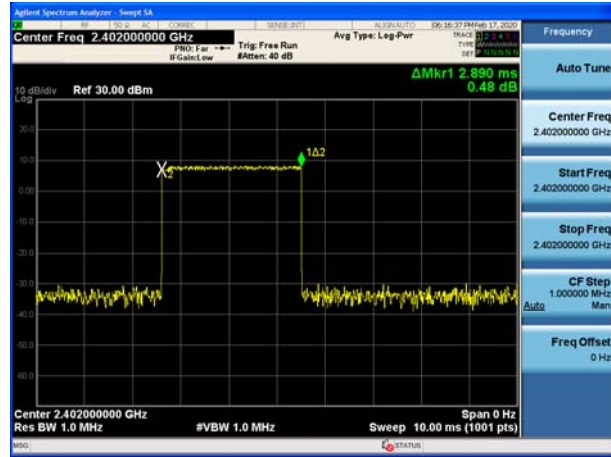

BT 3DH5 CH78, Carrier frequency (MHz): 2480

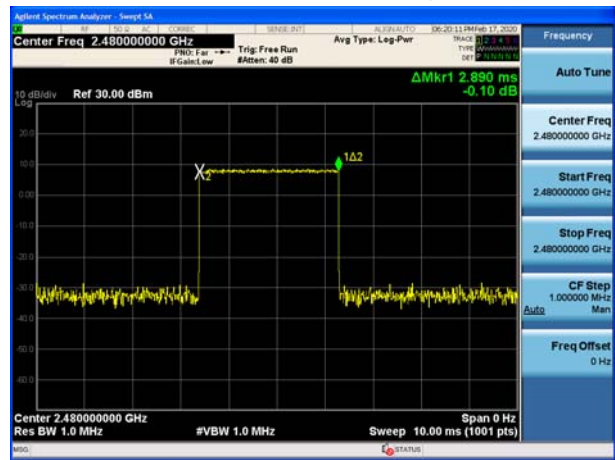

5.5 Band Edge Compliance

Ambient condition

| Temperature | Relative humidity | Pressure |
|-------------|-------------------|----------|
| 23°C ~25°C | 45%~50% | 101.5kPa |

Method of Measurement

The EUT was connected to the spectrum analyzer and Bluetooth test set via a power splitter with a known loss. The lowest and highest channels were measured. The peak detector is used. RBW is set to 100 kHz and VBW is set to 300 kHz on spectrum analyzer. EUT test for Hopping On mode and Hopping Off mode.

Test Setup

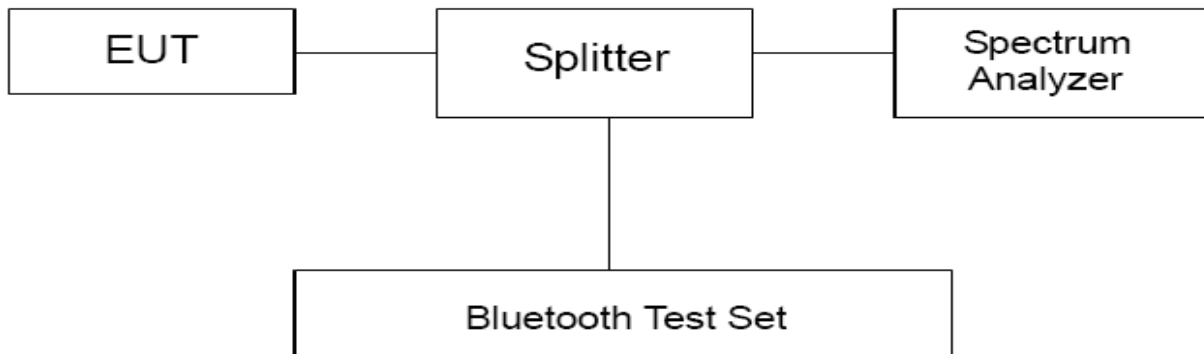

Limits

Rule Part 15.247(d) specifies that “In any 100 kHz bandwidth outside the frequency band in which the spread spectrum or digitally modulated intentional radiator is operating, the radio frequency power that is produced by the intentional radiator shall be at least 20 dB below that in the 100 kHz bandwidth within the band that contains the highest level of the desired power, based on either an RF conducted or a radiated measurement, provided the transmitter demonstrates compliance with the peak conducted power limits.”

Measurement Uncertainty

The assessed measurement uncertainty to ensure 95% confidence level for the normal distribution is with the coverage factor $k = 1.96$.

| Frequency | Uncertainty |
|-----------|-------------|
| 2GHz-3GHz | 1.407 dB |

Test Results
Hopping On

BT DH5 CH0, Carrier frequency (MHz): 2402

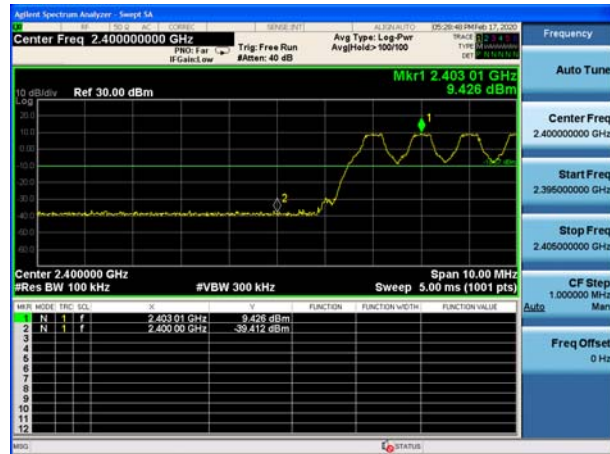

BT DH5 CH78, Carrier frequency (MHz): 2480

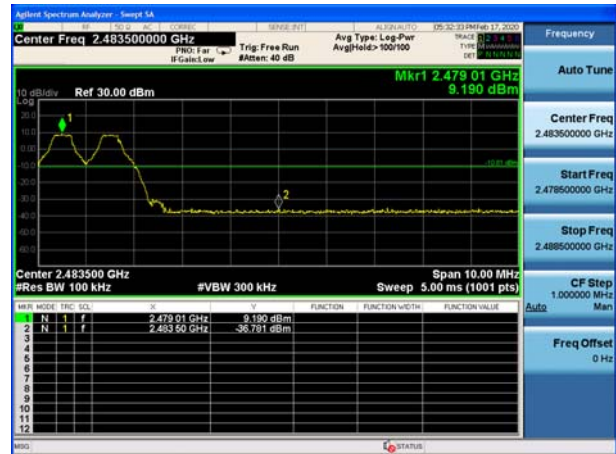

BT 2DH5 CH0, Carrier frequency (MHz): 2402

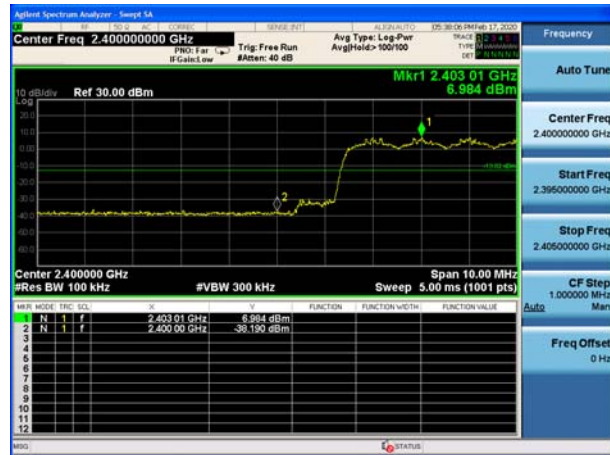

BT 2DH5 CH78, Carrier frequency (MHz): 2480



BT 3DH5 CH0, Carrier frequency (MHz): 2402

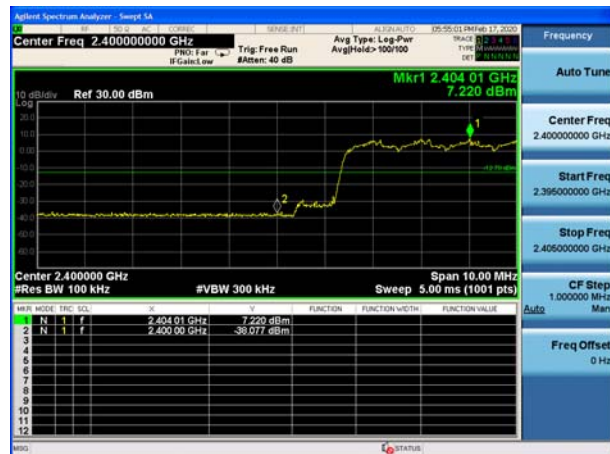

BT 3DH5 CH78, Carrier frequency (MHz): 2480



Hopping Off

BT DH5 CH0, Carrier frequency (MHz): 2402

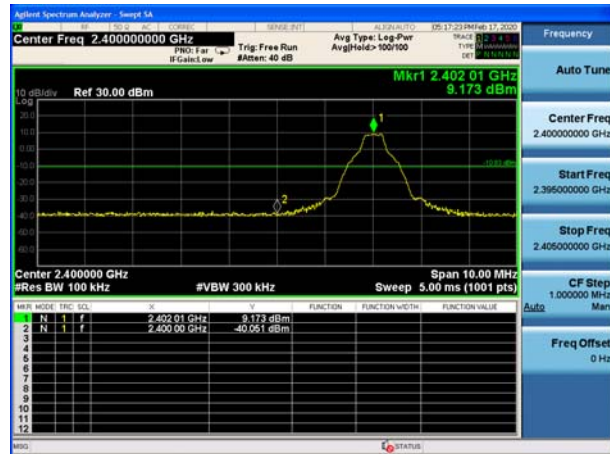

BT DH5 CH78, Carrier frequency (MHz): 2480

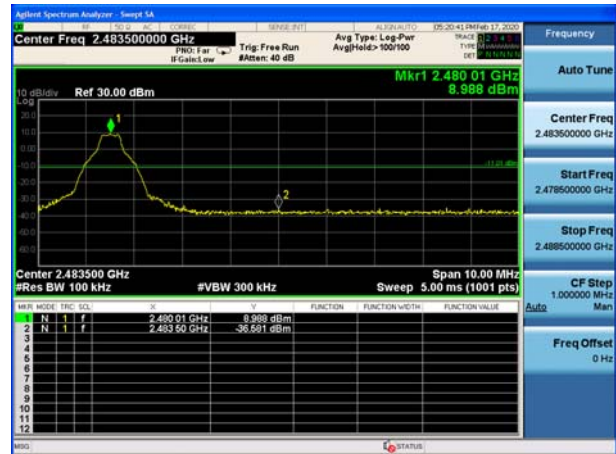

BT 2DH5 CH0, Carrier frequency (MHz): 2402

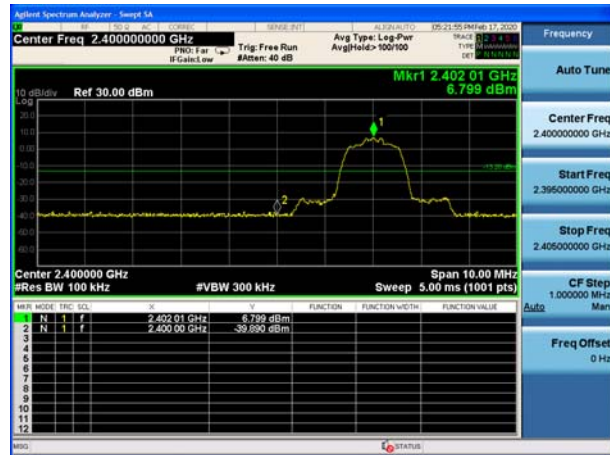

BT 2DH5 CH78, Carrier frequency (MHz): 2480

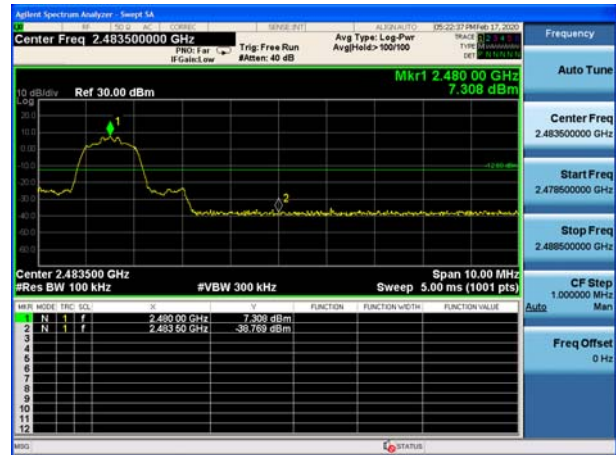

BT 3DH5 CH0, Carrier frequency (MHz): 2402

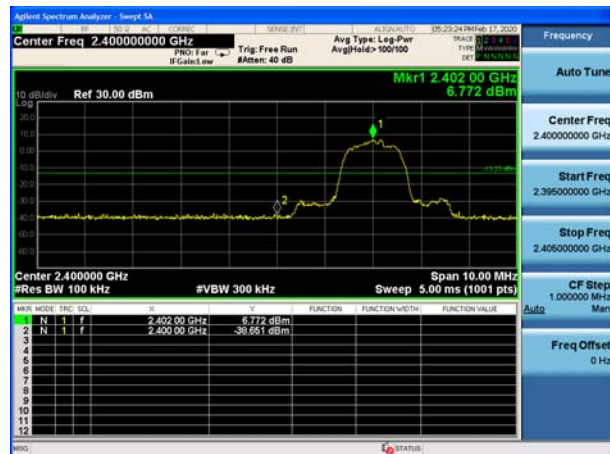

BT 3DH5 CH78, Carrier frequency (MHz): 2480



5.6 Number of hopping Frequency

Ambient condition

| Temperature | Relative humidity | Pressure |
|-------------|-------------------|----------|
| 23°C ~25°C | 45%~50% | 101.5kPa |

Method of Measurement

The EUT was connected to the spectrum analyzer and Bluetooth test set via a power splitter with a known loss. RBW is set to 100kHz and VBW is set to 300kHz on spectrum analyzer. Set EUT on Hopping on mode.

Test setup

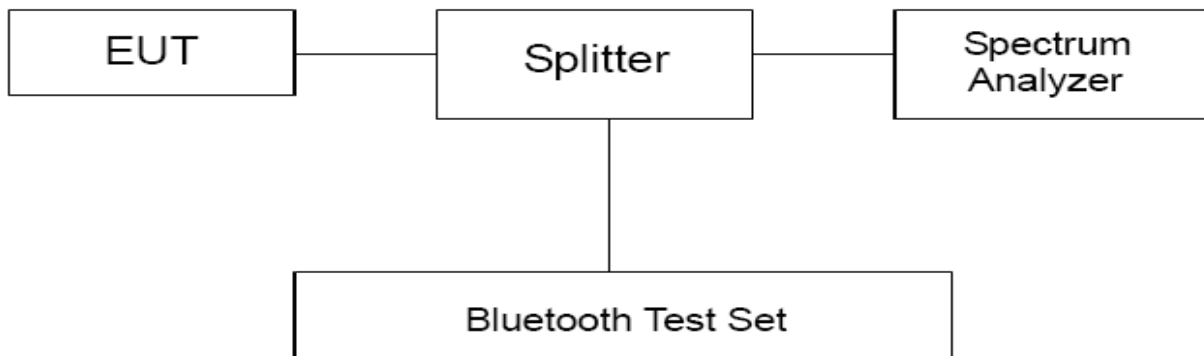

Limits

Rule Part 15.247(a) (1) (iii) specifies that” Frequency hopping systems in the 2400–2483.5 MHz band shall use at least 15 channels.”

| | |
|--------|---------------|
| Limits | ≥ 75 channels |
|--------|---------------|

Test Results:

| Mode | | Number of hopping channels | conclusion |
|------|------|----------------------------|------------|
| BT | DH5 | 79 | PASS |
| | 2DH5 | 79 | PASS |
| | 3DH5 | 79 | PASS |

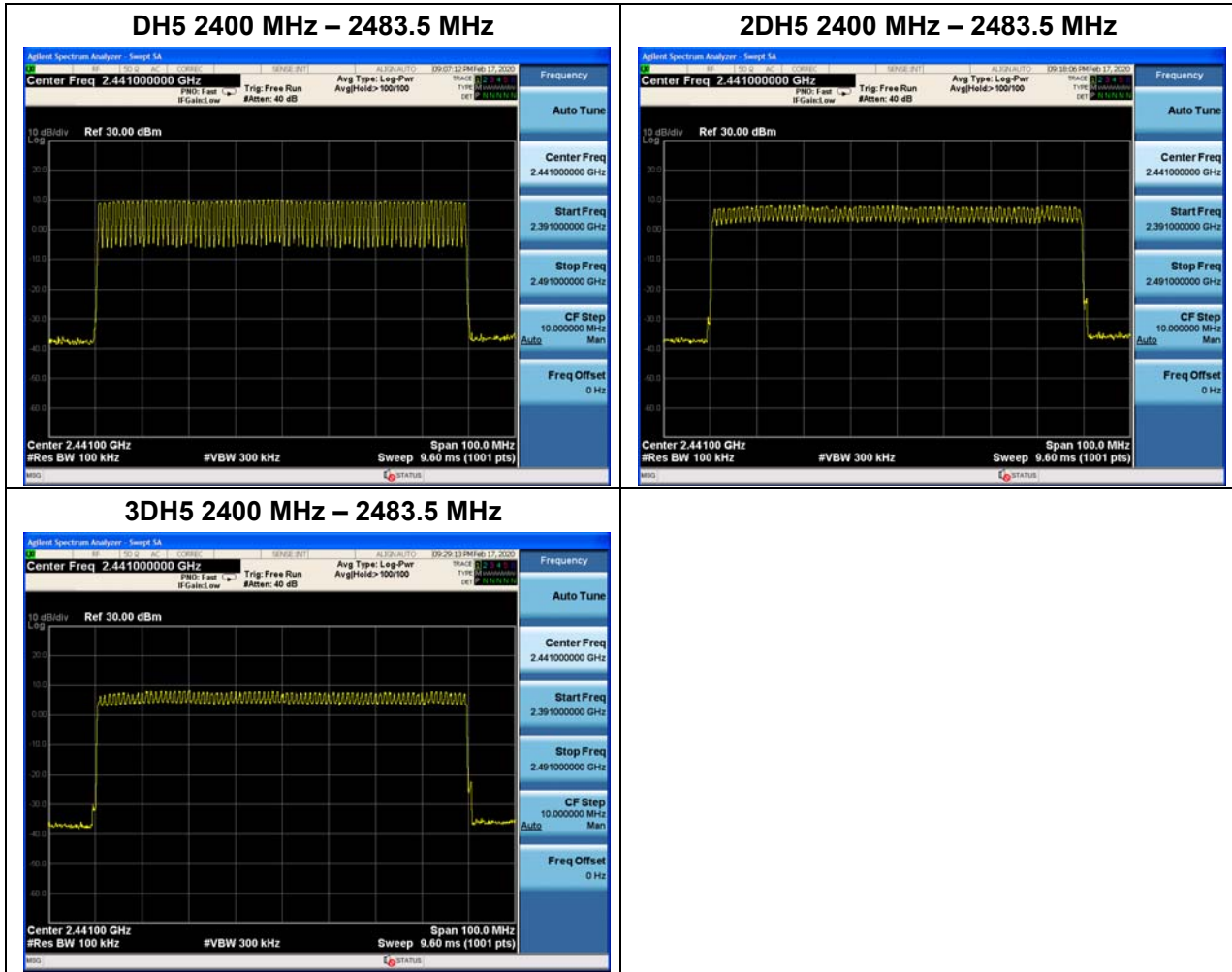

5.7 Spurious RF Conducted Emissions

Ambient condition

| Temperature | Relative humidity | Pressure |
|-------------|-------------------|----------|
| 23°C ~25°C | 45%~50% | 101.5kPa |

Method of Measurement

The EUT was connected to the spectrum analyzer and Bluetooth test set via a power splitter with a known loss. The spectrum analyzer scans from 30MHz to the 10th harmonic of the carrier. The peak detector is used. Set RBW 100kHz and VBW 300 kHz, Sweep is set to ATUO.

The test is in transmitting mode.

Test setup

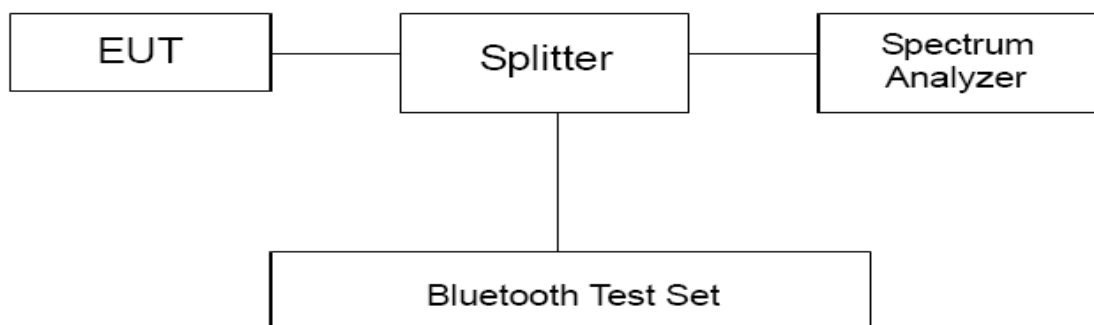

Limits

Rule Part 15.247(d) specifies that “In any 100 kHz bandwidth outside the frequency band in which the spread spectrum intentional radiator is operating, the radio frequency power that is produced by the intentional radiator shall be at least 20 dB below that in the 100 kHz bandwidth within the band that contains the highest level of the desired power.”

| Mode | Carrier frequency (MHz) | Reference value (dBm) | Limit |
|------|-------------------------|-----------------------|--------|
| DH5 | 2402 | 8.86 | -11.14 |
| | 2441 | 9.46 | -10.54 |
| | 2480 | 8.56 | -11.44 |
| 2DH5 | 2402 | 6.19 | -13.81 |
| | 2441 | 6.76 | -13.24 |
| | 2480 | 6.48 | -13.52 |
| 3DH5 | 2402 | 5.66 | -14.34 |
| | 2441 | 5.61 | -14.39 |
| | 2480 | 6.77 | -13.23 |

**Measurement Uncertainty**

The assessed measurement uncertainty to ensure 95% confidence level for the normal distribution is with the coverage factor $k = 1.96$.

| Frequency | Uncertainty |
|-------------|-------------|
| 100kHz-2GHz | 0.684 dB |
| 2GHz-26GHz | 1.407 dB |

Test Results:

The signal beyond the limit is carrier.

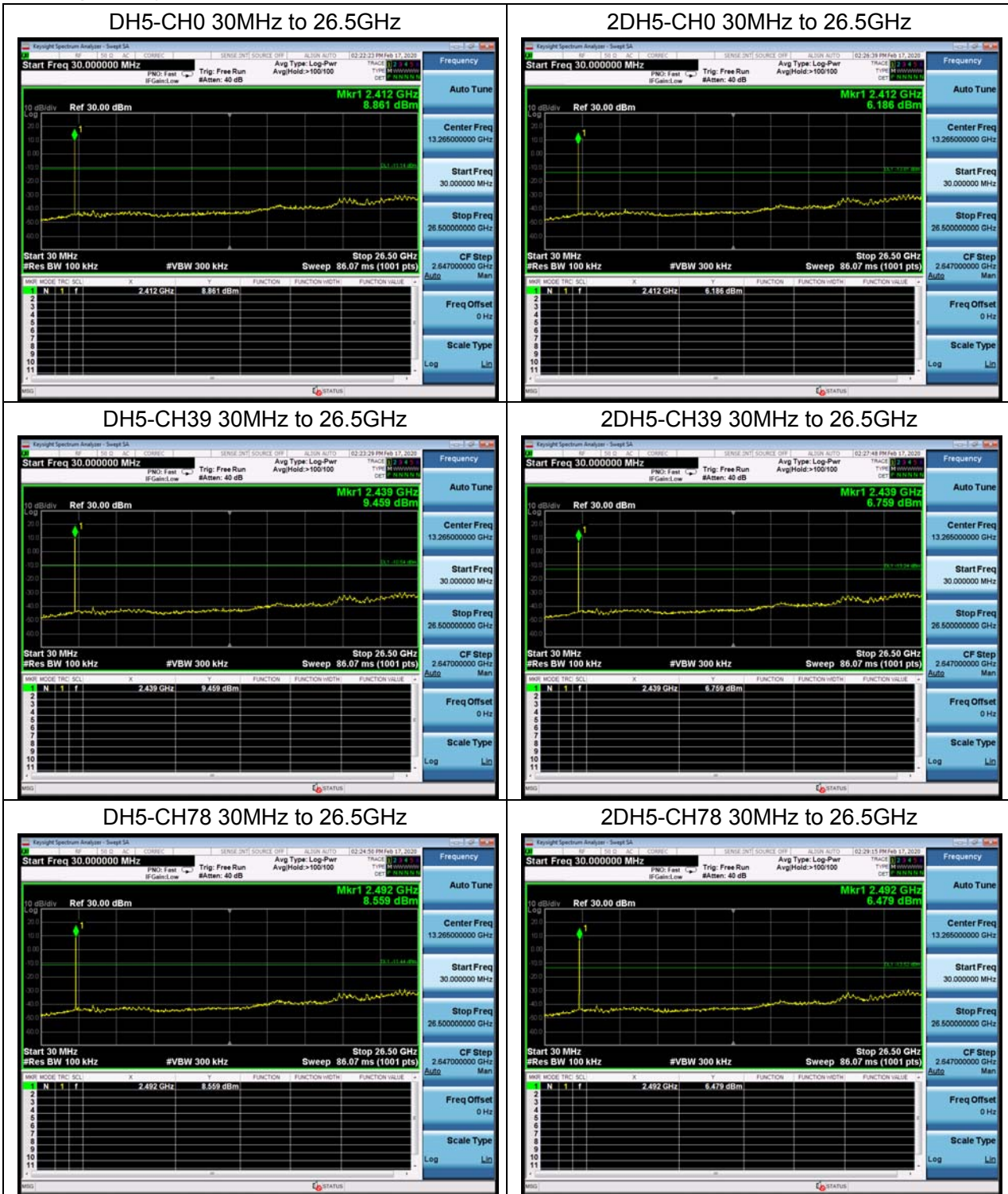



3DH5-CH0 30MHz to 26.5GHz

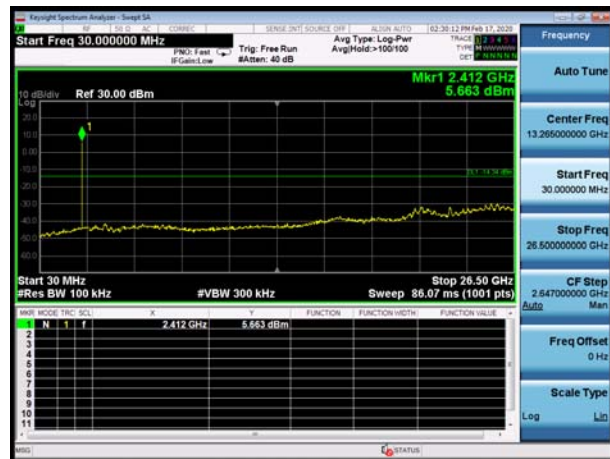

3DH5-CH39 30MHz to 26.5GHz

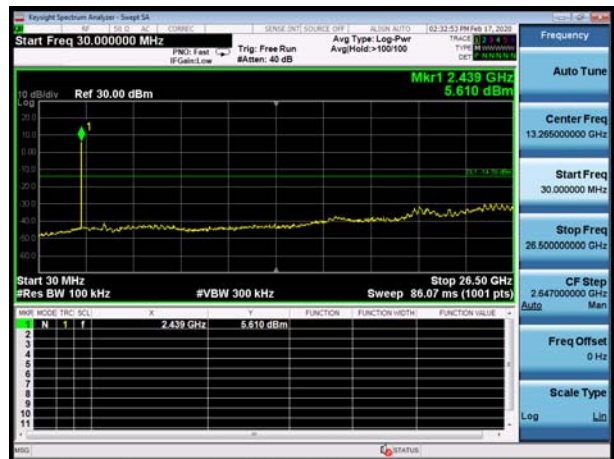

3DH5-CH78 30MHz to 26.5GHz

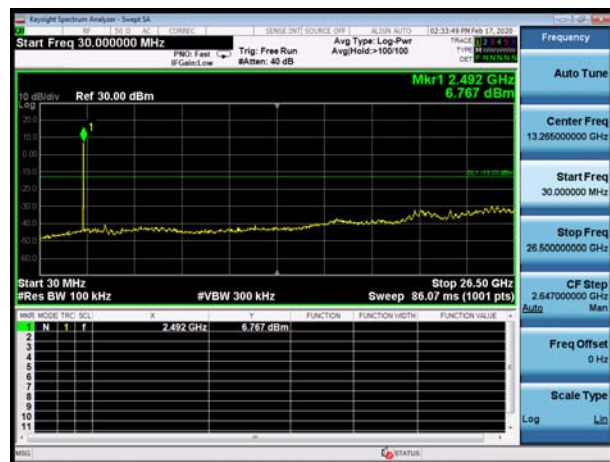

5.8 Unwanted Emission

Ambient condition

| Temperature | Relative humidity | Pressure |
|-------------|-------------------|----------|
| 23°C ~25°C | 45%~50% | 101.5kPa |

Method of Measurement

The test set-up was made in accordance to the general provisions of ANSI C63.10-2013. The Equipment Under Test (EUT) was set up on a non-conductive table in the semi-anechoic chamber. The test was performed at the distance of 3 m between the EUT and the receiving antenna. The radiated emissions measurements were made in a typical installation configuration. Sweep the whole frequency band through the range from 9 kHz to the 10th harmonic of the carrier, and the emissions less than 20 dB below the permissible value are reported.

During the test, below 30MHz, the center of the loop shall be 1 meters; above 30MHz, the height of receive antenna shall be moved from 1 to 4 meters, and the antenna shall be performed under horizontal and vertical polarization. The turntable shall be rotated from 0 to 360 degrees for detecting the maximum of radiated spurious signal level. The measurements shall be repeated with orthogonal polarization of the test antenna. The data of cable loss and antenna factor has been calibrated in full testing frequency range before the testing.

Set the spectrum analyzer in the following:

Below 1GHz (detector: Peak and Quasi-Peak)

RBW=100kHz / VBW=300kHz / Sweep=AUTO

Above 1GHz(detector: Peak):

(a) PEAK: RBW=1MHz VBW=3MHz/ Sweep=AUTO

(b) AVERAGE: RBW=1MHz / VBW=3MHz / Sweep=AUTO

The dwell time per channel of the hopping signal is less than 100 ms, then the reading obtained with the 10 Hz VBW may be further adjusted by a “duty cycle correction factor”, derived from $20\log(\text{dwell time}/100 \text{ ms})$, in an effort to demonstrate compliance with the 15.209 limit.

If the emission is pulsed, modify the unit for continuous operation; use the settings shown above, then correct the reading by subtracting the peak- average correction factor, derived form the appropriate duty cycle calculation.

This setting method can refer to **KDB 558074 D01**.

This mode was measured in the following mode: EUT with cradle and EUT without cradle. The worst emission was found in EUT with cradle mode and the worst case was recorded.

The test is in transmitting mode.

Test setup
9KHz ~ 30MHz

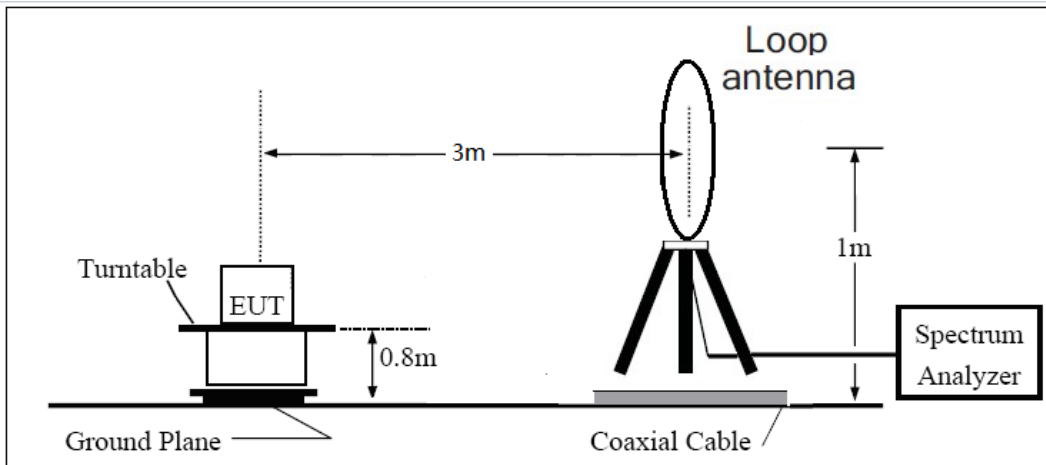

30MHz ~ 1GHz

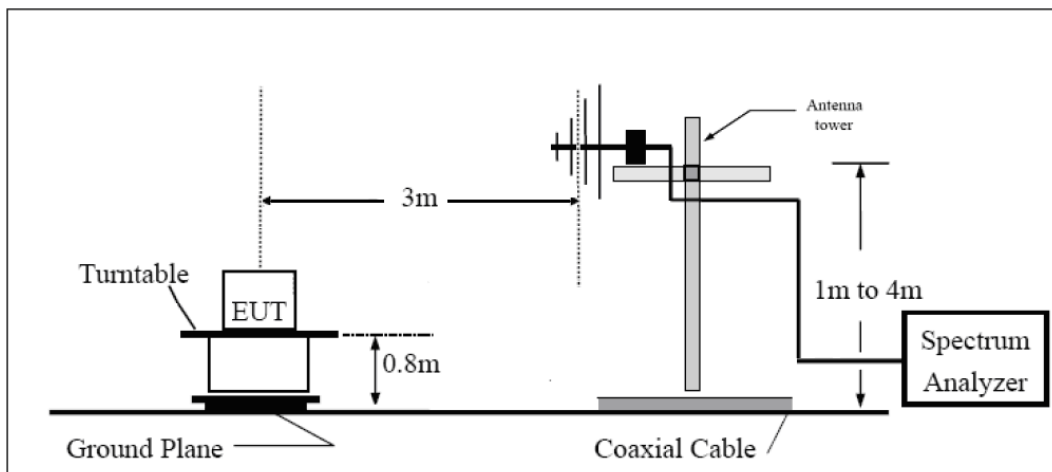

Above 1GHz

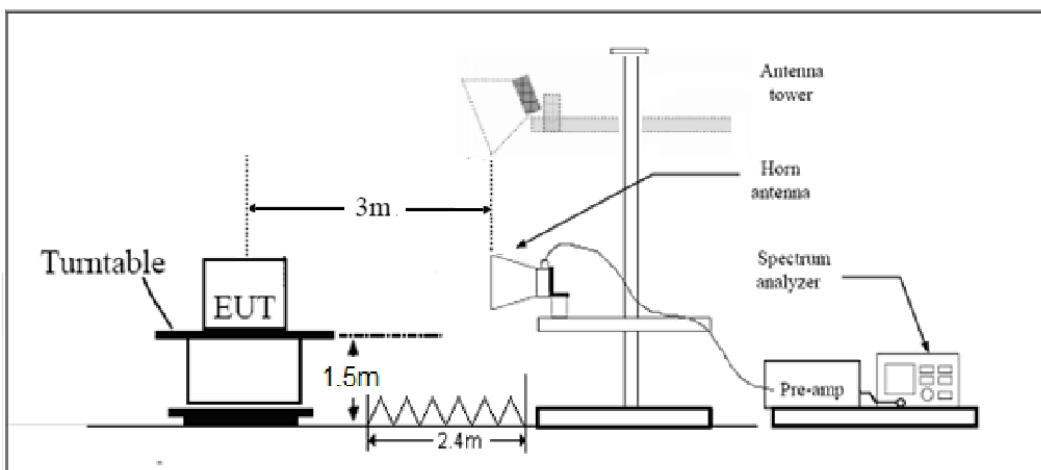

Limits

Rule Part 15.247(d) specifies that “In addition, radiated emissions which fall in the restricted bands, as defined in § 15.205(a), must also comply with the radiated emission limits specified in § 15.209(a) (see § 15.205(c)).”

Limit in restricted band

| Frequency of emission (MHz) | Field strength(uV/m) | Field strength(dBuV/m) |
|-----------------------------|----------------------|------------------------|
| 0.009–0.490 | 2400/F(kHz) | / |
| 0.490–1.705 | 24000/F(kHz) | / |
| 1.705–30.0 | 30 | / |
| 30-88 | 100 | 40 |
| 88-216 | 150 | 43.5 |
| 216-960 | 200 | 46 |
| Above960 | 500 | 54 |

§15.35(b)

There is also a limit on the radio frequency emissions, as measured using instrumentation with a peak detector function, corresponding to 20 dB above the maximum permitted average limit.

Peak Limit=74dBuV/m

Average Limit=54dBuV/m

Spurious Radiated Emissions are permitted in any of the frequency bands listed below:

| MHz | MHz | MHz | GHz |
|----------------------------|-----------------------|-----------------|------------------|
| 0.090 - 0.110 | 16.42 - 16.423 | 399.9 - 410 | 4.5 - 5.15 |
| ¹ 0.495 - 0.505 | 16.69475 - 16.69525 | 608 - 614 | 5.35 - 5.46 |
| 2.1735 - 2.1905 | 16.80425 - 16.80475 | 960 - 1240 | 7.25 - 7.75 |
| 4.125 - 4.128 | 25.5 - 25.67 | 1300 - 1427 | 8.025 - 8.5 |
| 4.17725 - 4.17775 | 37.5 - 38.25 | 1435 - 1626.5 | 9.0 - 9.2 |
| 4.20725 - 4.20775 | 73 - 74.6 | 1645.5 - 1646.5 | 9.3 - 9.5 |
| 6.215 - 6.218 | 74.8 - 75.2 | 1660 - 1710 | 10.6 - 12.7 |
| 6.26775 - 6.26825 | 108 - 121.94 | 1718.8 - 1722.2 | 13.25 - 13.4 |
| 6.31175 - 6.31225 | 123 - 138 | 2200 - 2300 | 14.47 - 14.5 |
| 8.291 - 8.294 | 149.9 - 150.05 | 2310 - 2390 | 15.35 - 16.2 |
| 8.362 - 8.366 | 156.52475 - 156.52525 | 2483.5 - 2500 | 17.7 - 21.4 |
| 8.37625 - 8.38675 | 156.7 - 156.9 | 2690 - 2900 | 22.01 - 23.12 |
| 8.41425 - 8.41475 | 162.0125 - 167.17 | 3260 - 3267 | 23.6 - 24.0 |
| 12.29 - 12.293 | 167.72 - 173.2 | 3332 - 3339 | 31.2 - 31.8 |
| 12.51975 - 12.52025 | 240 - 285 | 3345.8 - 3358 | 36.43 - 36.5 |
| 12.57675 - 12.57725 | 322 - 335.4 | 3600 - 4400 | (²) |
| 13.36 - 13.41 | | | |

**Measurement Uncertainty**

The assessed measurement uncertainty to ensure 95% confidence level for the normal distribution is with the coverage factor $k = 1.96$.

| Frequency | Uncertainty |
|--------------|-------------|
| 9KHz-30MHz | 3.55 dB |
| 30MHz-200MHz | 4.02 dB |
| 200MHz-1GHz | 3.28 dB |
| 1-18GHz | 3.70 dB |
| 18-26.5GHz | 5.78 dB |

Test Results:

The signal beyond the limit is carrier.

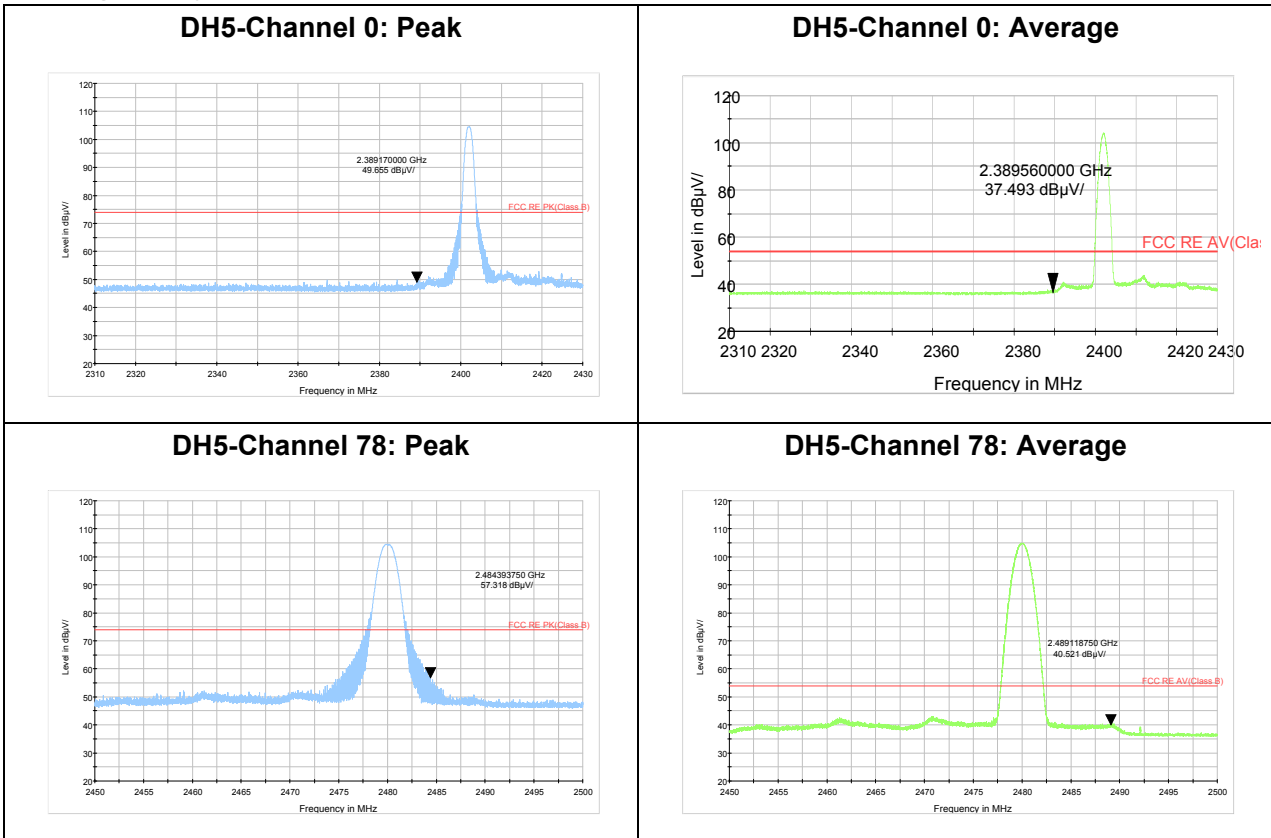

The bandage was performed in all EDR mode(2DH5 and 3DH5), 3DH5 was selected as the worse condition. The test data of the worst-case condition was recorded in this report.

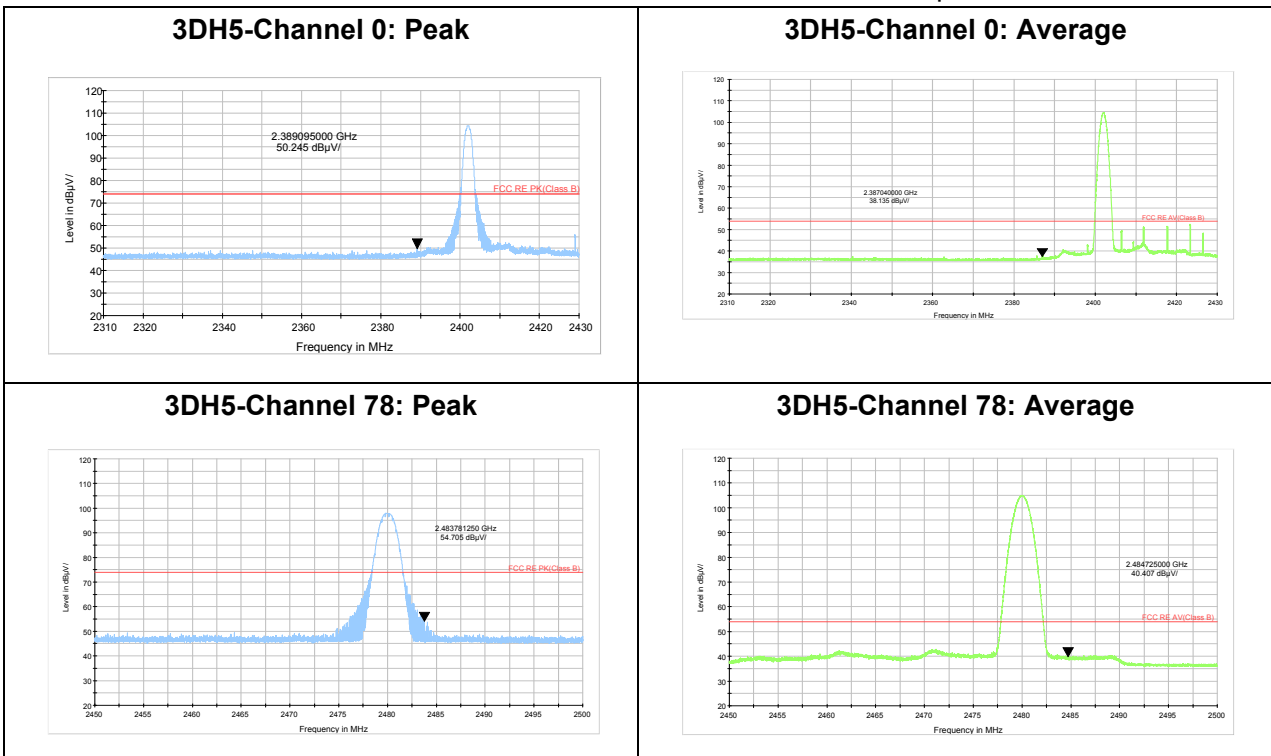

Result of RE

Test result

Sweep the whole frequency band through the range from 9kHz to the 10th harmonic of the carrier, the Emissions in the frequency band 9kHz-30MHz and 18GHz -26.5GHz are more than 20dB below the limit are not reported.

The following graphs display the maximum values of horizontal and vertical by software. For above 1GHz, Blue trace uses the peak detection, Green trace uses the average detection.

During the test, the Radiates Emission from 30MHz to 1GHz was performed in all modes with all channels, BT 3DH5-Channel 39 are selected as the worst condition. The test data of the worst-case condition was recorded in this report.

Continuous TX mode:

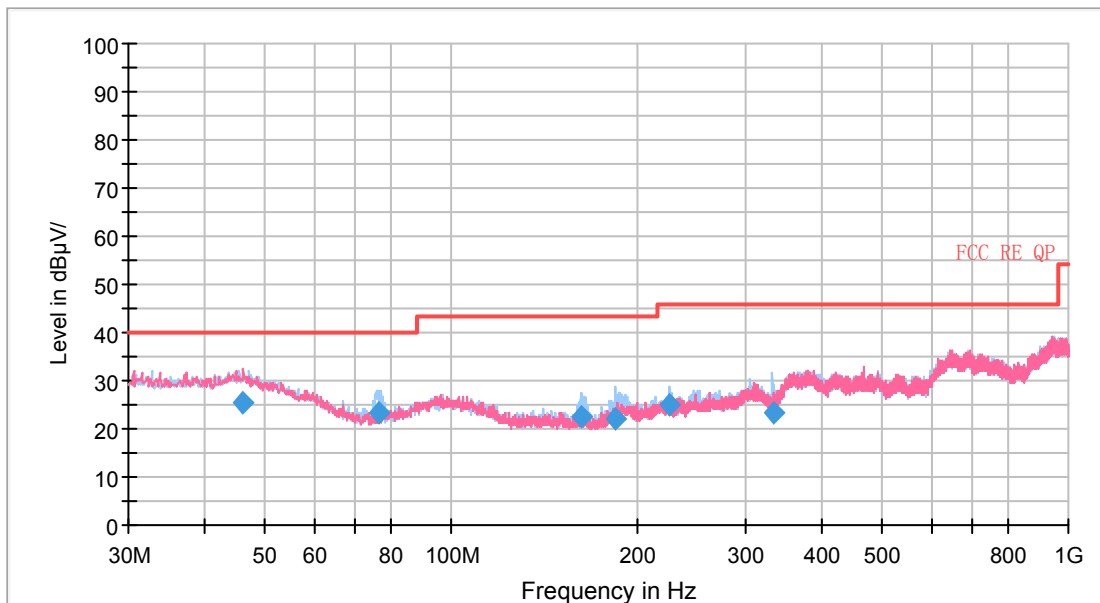

Radiates Emission from 30MHz to 1GHz

| Frequency (MHz) | Quasi-Peak (dBuV/m) | Height (cm) | Polarization | Azimuth (deg) | Correct Factor (dB) | Margin (dB) | Limit (dBuV/m) |
|-----------------|---------------------|-------------|--------------|---------------|---------------------|-------------|----------------|
| 45.889988 | 25.40 | 198.0 | V | 320.0 | 3.0 | 14.60 | 40.00 |
| 76.244813 | 23.53 | 225.0 | H | 179.0 | -6.5 | 16.47 | 40.00 |
| 162.689460 | 22.57 | 184.0 | H | 148.0 | -6.9 | 20.93 | 43.50 |
| 184.854160 | 22.04 | 123.0 | H | 148.0 | -5.8 | 21.46 | 43.50 |
| 225.535000 | 24.83 | 125.0 | H | 285.0 | -4.9 | 21.17 | 46.00 |
| 332.602500 | 23.17 | 100.0 | H | 49.0 | -2.8 | 22.83 | 46.00 |

Remark: 1. Correction Factor = Antenna factor+ Insertion loss(cable loss+amplifier gain)

2. Margin = Limit – Quasi-Peak

DH5-Channel 0

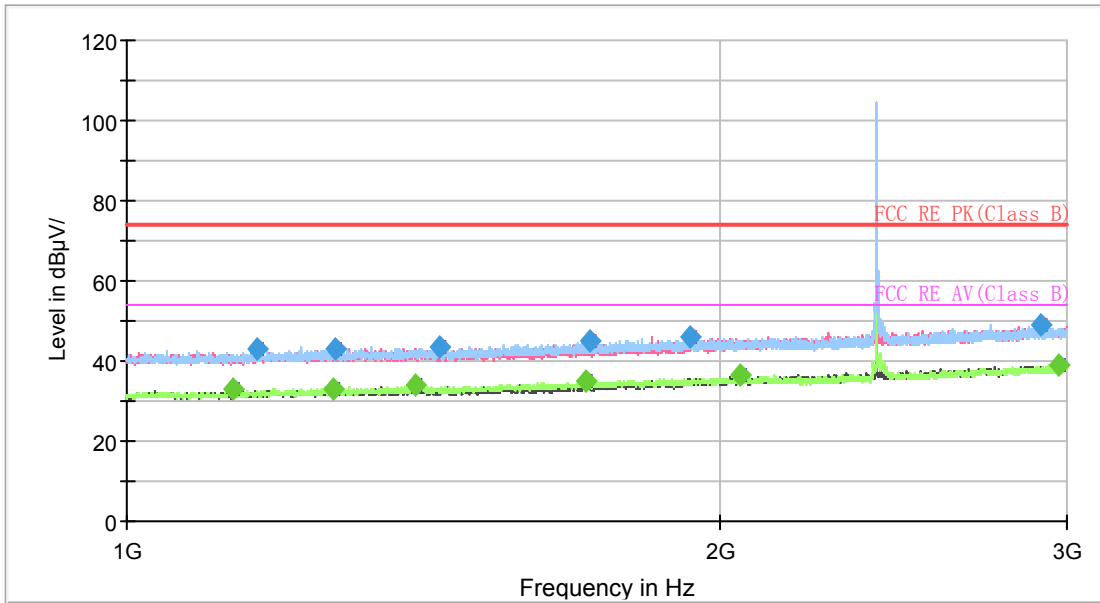

Note: The signal beyond the limit is carrier.
Radiates Emission from 1GHz to 3GHz

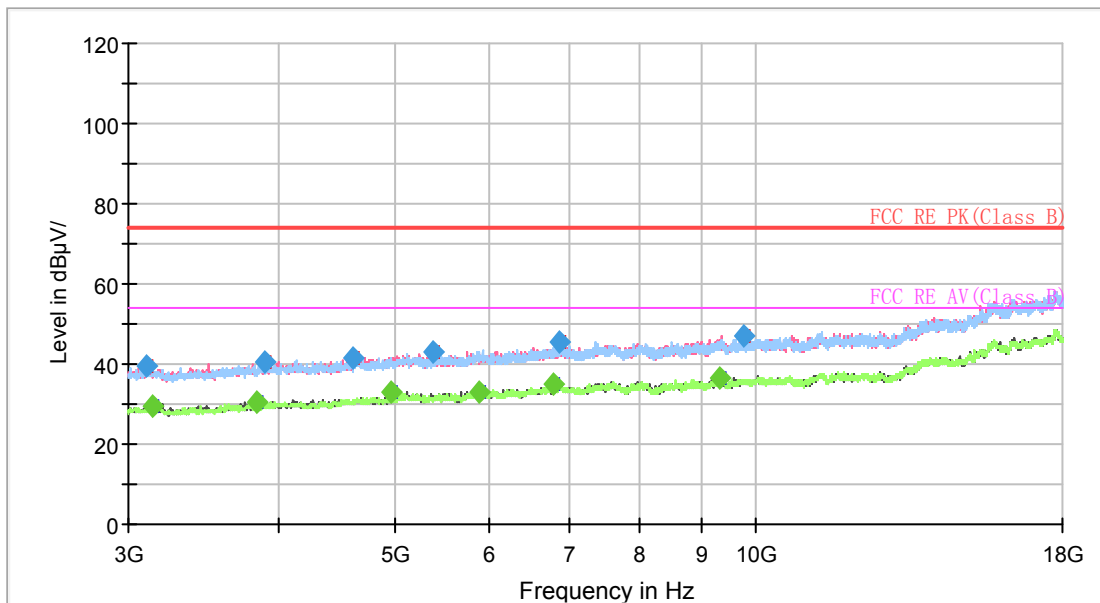

Radiates Emission from 3GHz to 18GHz

| Frequency (MHz) | Peak (dBuV/m) | Average (dBuV/m) | Limit (dBuV/m) | Margin (dB) | Height (cm) | Polarization | Azimuth (deg) | Correct Factor (dB) |
|-----------------|---------------|------------------|----------------|-------------|-------------|--------------|---------------|---------------------|
| 1131.750000 | --- | 32.78 | 54.00 | 21.22 | 200.0 | V | 345.0 | -0.5 |
| 1163.250000 | 42.88 | --- | 74.00 | 31.12 | 100.0 | V | 95.0 | 0.0 |
| 1272.250000 | --- | 32.79 | 54.00 | 21.21 | 200.0 | V | 194.0 | 0.4 |
| 1274.500000 | 42.82 | --- | 74.00 | 31.18 | 200.0 | H | 255.0 | 0.4 |
| 1400.500000 | --- | 33.79 | 54.00 | 20.21 | 200.0 | H | 64.0 | 1.0 |
| 1440.250000 | 43.70 | --- | 74.00 | 30.30 | 200.0 | V | 297.0 | 1.1 |
| 1710.250000 | --- | 34.82 | 54.00 | 19.18 | 100.0 | H | 358.0 | 2.5 |
| 1719.250000 | 44.76 | --- | 74.00 | 29.24 | 100.0 | H | 235.0 | 2.5 |
| 1931.000000 | 45.89 | --- | 74.00 | 28.11 | 100.0 | H | 214.0 | 3.5 |
| 2046.000000 | --- | 36.31 | 54.00 | 17.69 | 100.0 | H | 178.0 | 4.0 |
| 2909.750000 | 48.95 | --- | 74.00 | 25.05 | 100.0 | V | 0.0 | 7.5 |
| 2972.750000 | --- | 38.93 | 54.00 | 15.07 | 200.0 | H | 0.0 | 7.9 |

Remark: 1. Correction Factor = Antenna factor+ Insertion loss (cable loss + amplifier gain)

DH5-Channel 39

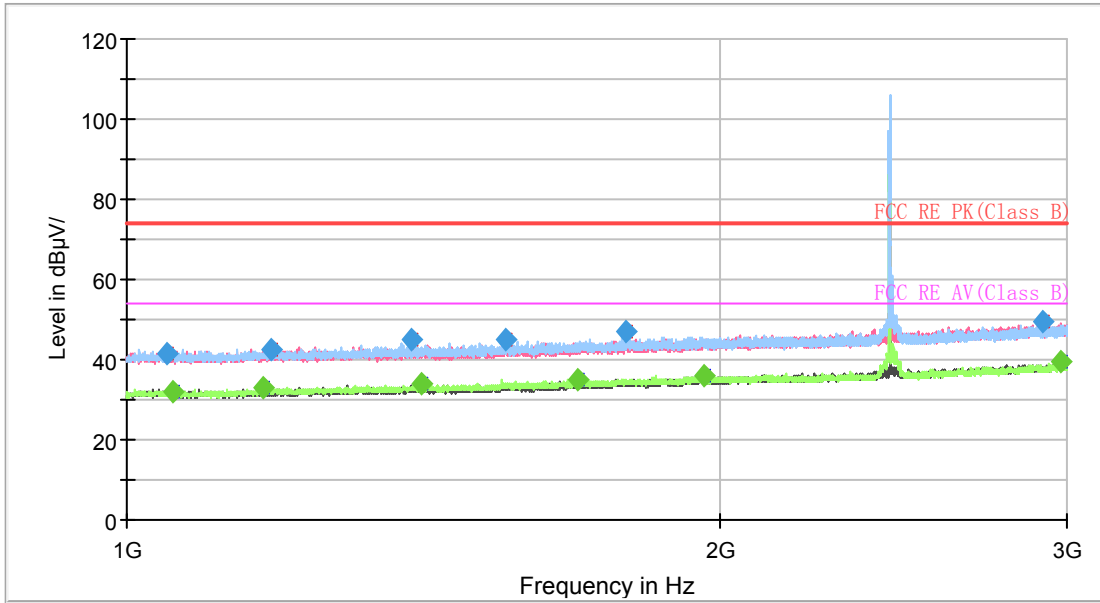

Note: The signal beyond the limit is carrier.
Radiates Emission from 1GHz to 3GHz

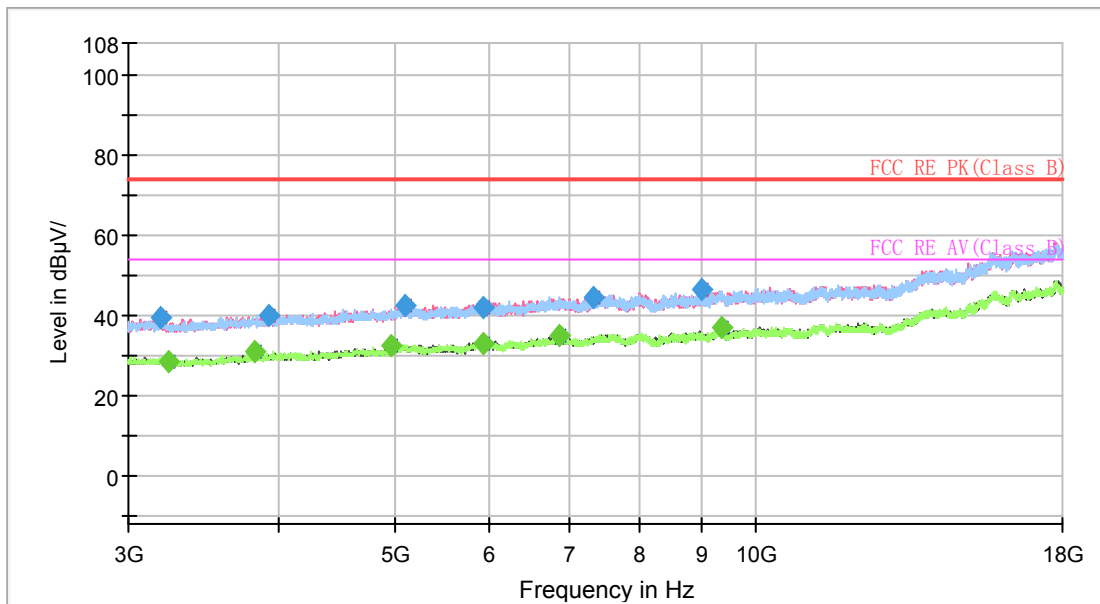

Radiates Emission from 3GHz to 18GHz

| Frequency (MHz) | Peak (dBuV/m) | Average (dBuV/m) | Limit (dBuV/m) | Margin (dB) | Height (cm) | Polarization | Azimuth (deg) | Correct Factor (dB) |
|-----------------|---------------|------------------|----------------|-------------|-------------|--------------|---------------|---------------------|
| 1048.750000 | 41.51 | --- | 74.00 | 32.49 | 200.0 | V | 302.0 | -1.0 |
| 1054.500000 | --- | 31.94 | 54.00 | 22.06 | 200.0 | H | 33.0 | -0.9 |
| 1173.750000 | --- | 33.03 | 54.00 | 20.97 | 100.0 | V | 337.0 | 0.0 |
| 1182.750000 | 42.66 | --- | 74.00 | 31.34 | 100.0 | H | 320.0 | 0.1 |
| 1394.750000 | 44.81 | --- | 74.00 | 29.19 | 100.0 | V | 157.0 | 0.9 |
| 1409.500000 | --- | 34.14 | 54.00 | 19.86 | 200.0 | H | 81.0 | 1.1 |
| 1557.750000 | 45.03 | --- | 74.00 | 28.97 | 200.0 | H | 115.0 | 1.9 |
| 1695.250000 | --- | 35.12 | 54.00 | 18.88 | 100.0 | H | 157.0 | 2.4 |
| 1791.500000 | 47.05 | --- | 74.00 | 26.95 | 100.0 | H | 198.0 | 2.9 |
| 1962.500000 | --- | 36.11 | 54.00 | 17.89 | 100.0 | H | 244.0 | 3.8 |
| 2920.000000 | 49.56 | --- | 74.00 | 24.44 | 100.0 | V | 146.0 | 7.5 |
| 2982.250000 | --- | 39.31 | 54.00 | 14.69 | 200.0 | H | 126.0 | 8.0 |

Remark: 1. Correction Factor = Antenna factor+ Insertion loss (cable loss + amplifier gain)

DH5-Channel 78

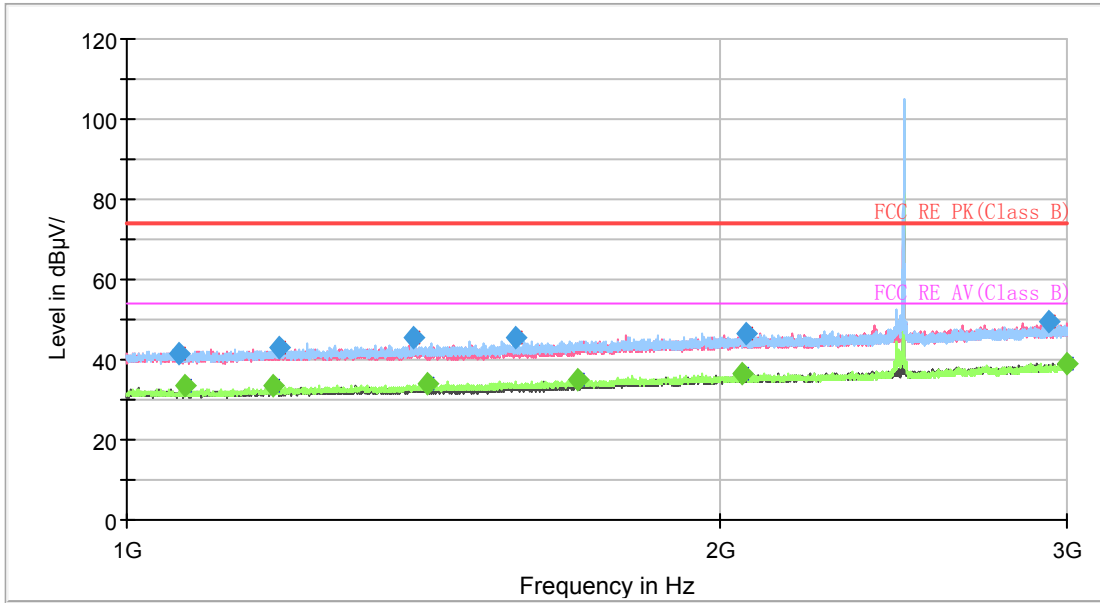

Note: The signal beyond the limit is carrier.
Radiates Emission from 1GHz to 3GHz

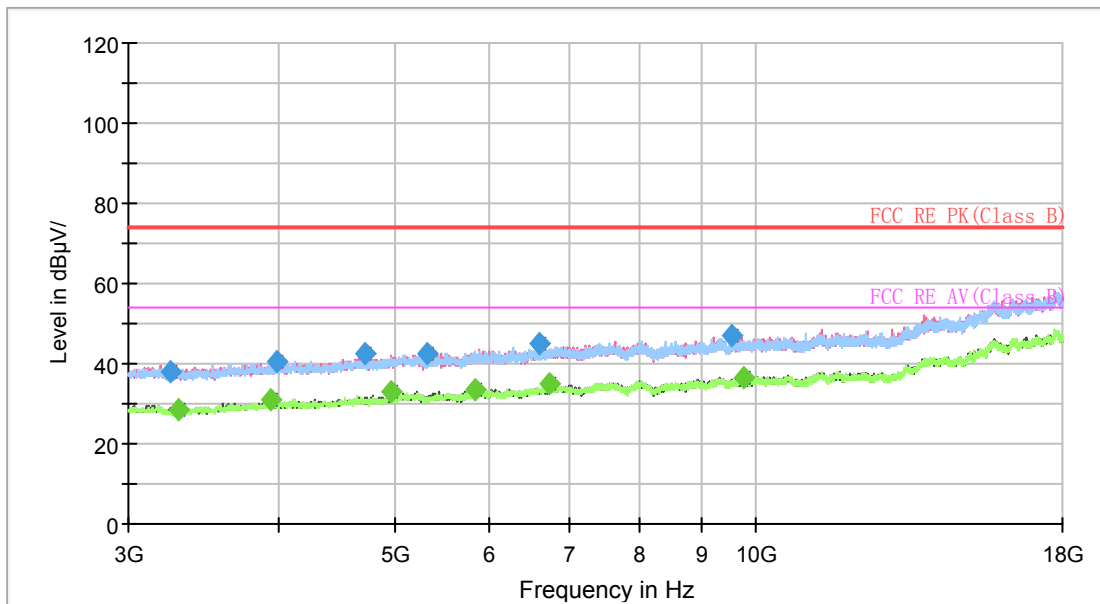

Radiates Emission from 3GHz to 18GHz

| Frequency (MHz) | Peak (dBuV/m) | Average (dBuV/m) | Limit (dBuV/m) | Margin (dB) | Height (cm) | Polarization | Azimuth (deg) | Correct Factor (dB) |
|-----------------|---------------|------------------|----------------|-------------|-------------|--------------|---------------|---------------------|
| 1062.250000 | 41.33 | --- | 74.00 | 32.67 | 100.0 | H | 239.0 | -0.9 |
| 1071.500000 | --- | 33.26 | 54.00 | 20.74 | 200.0 | H | 85.0 | -1.0 |
| 1185.250000 | --- | 33.29 | 54.00 | 20.71 | 100.0 | V | 40.0 | 0.1 |
| 1194.250000 | 43.01 | --- | 74.00 | 30.99 | 200.0 | V | 179.0 | 0.1 |
| 1398.500000 | 45.37 | --- | 74.00 | 28.63 | 100.0 | V | 172.0 | 1.0 |
| 1421.000000 | --- | 33.86 | 54.00 | 20.14 | 200.0 | H | 27.0 | 1.0 |
| 1577.000000 | 45.28 | --- | 74.00 | 28.72 | 200.0 | H | 6.0 | 1.8 |
| 1692.250000 | --- | 34.89 | 54.00 | 19.11 | 100.0 | H | 343.0 | 2.3 |
| 2053.500000 | --- | 36.44 | 54.00 | 17.56 | 200.0 | H | 20.0 | 4.0 |
| 2063.750000 | 46.32 | --- | 74.00 | 27.68 | 100.0 | H | 117.0 | 4.0 |
| 2937.750000 | 49.29 | --- | 74.00 | 24.71 | 200.0 | V | 253.0 | 7.7 |
| 2999.250000 | --- | 39.01 | 54.00 | 14.99 | 200.0 | V | 225.0 | 8.1 |

Remark: 1. Correction Factor = Antenna factor+ Insertion loss (cable loss + amplifier gain)



The Radiates Emission was performed in all EDR mode(2DH5 and 3DH5), 3DH5 was selected as the worse condition. The test data of the worst-case condition was recorded in this report.

3DH5-Channel 0

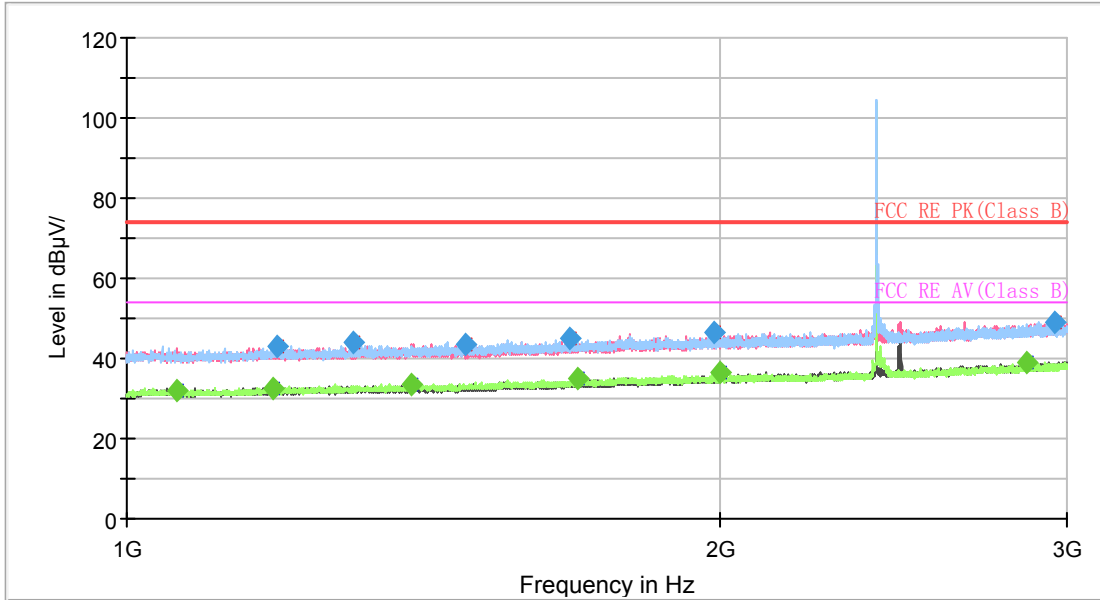

Note: The signal beyond the limit is carrier.
Radiates Emission from 1GHz to 3GHz

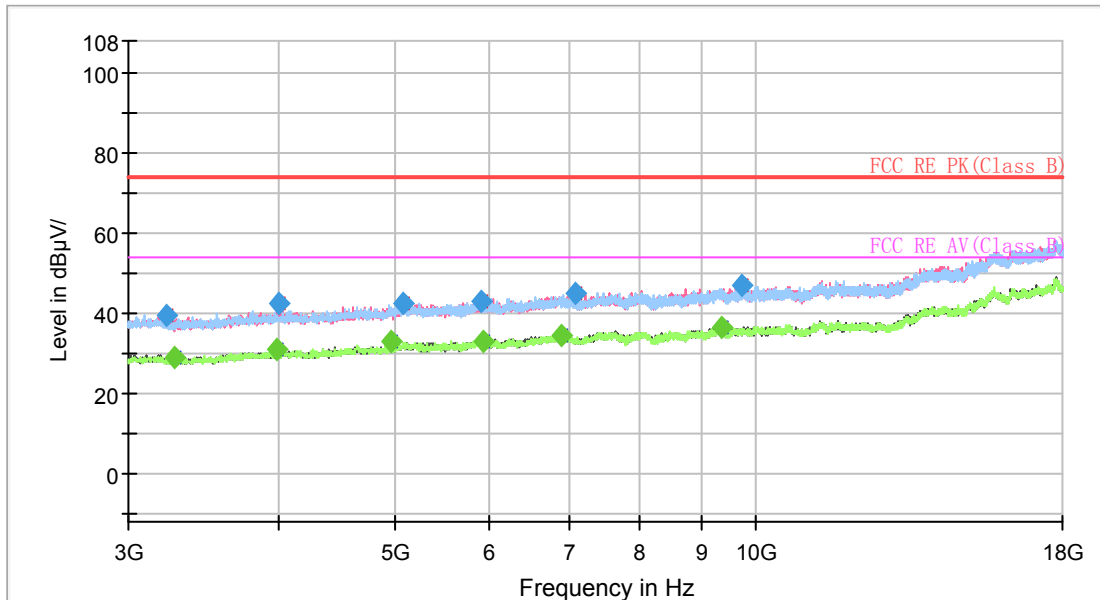

Radiates Emission from 3GHz to 18GHz

| Frequency (MHz) | Peak (dBuV/m) | Average (dBuV/m) | Limit (dBuV/m) | Margin (dB) | Height (cm) | Polarization | Azimuth (deg) | Correct Factor (dB) |
|-----------------|---------------|------------------|----------------|-------------|-------------|--------------|---------------|---------------------|
| 1059.750000 | --- | 31.97 | 54.00 | 22.03 | 200.0 | H | 62.0 | -0.9 |
| 1186.250000 | --- | 32.70 | 54.00 | 21.30 | 100.0 | V | 166.0 | 0.1 |
| 1193.250000 | 42.92 | --- | 74.00 | 31.08 | 100.0 | H | 299.0 | 0.1 |
| 1303.500000 | 43.91 | --- | 74.00 | 30.09 | 100.0 | V | 53.0 | 0.5 |
| 1394.000000 | --- | 33.72 | 54.00 | 20.28 | 200.0 | H | 87.0 | 0.9 |
| 1484.500000 | 43.41 | --- | 74.00 | 30.59 | 200.0 | V | 277.0 | 1.4 |
| 1677.250000 | 44.77 | --- | 74.00 | 29.23 | 200.0 | V | 267.0 | 2.2 |
| 1693.250000 | --- | 34.89 | 54.00 | 19.11 | 100.0 | H | 296.0 | 2.4 |
| 1987.500000 | 46.34 | --- | 74.00 | 27.66 | 100.0 | V | 170.0 | 3.7 |
| 1998.250000 | --- | 36.43 | 54.00 | 17.57 | 100.0 | H | 147.0 | 3.9 |
| 2860.000000 | --- | 39.05 | 54.00 | 14.95 | 100.0 | V | 24.0 | 7.5 |
| 2960.250000 | 49.06 | --- | 74.00 | 24.94 | 100.0 | V | 60.0 | 7.9 |

Remark: 1. Correction Factor = Antenna factor+ Insertion loss (cable loss + amplifier gain)



3DH5-Channel 39

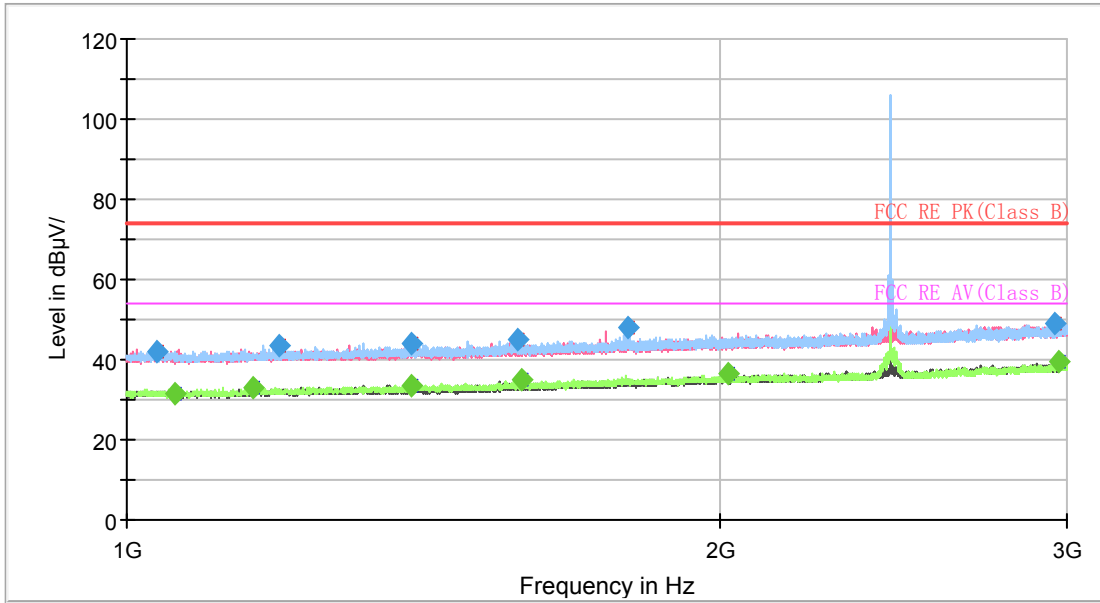

Note: The signal beyond the limit is carrier.
Radiates Emission from 1GHz to 3GHz

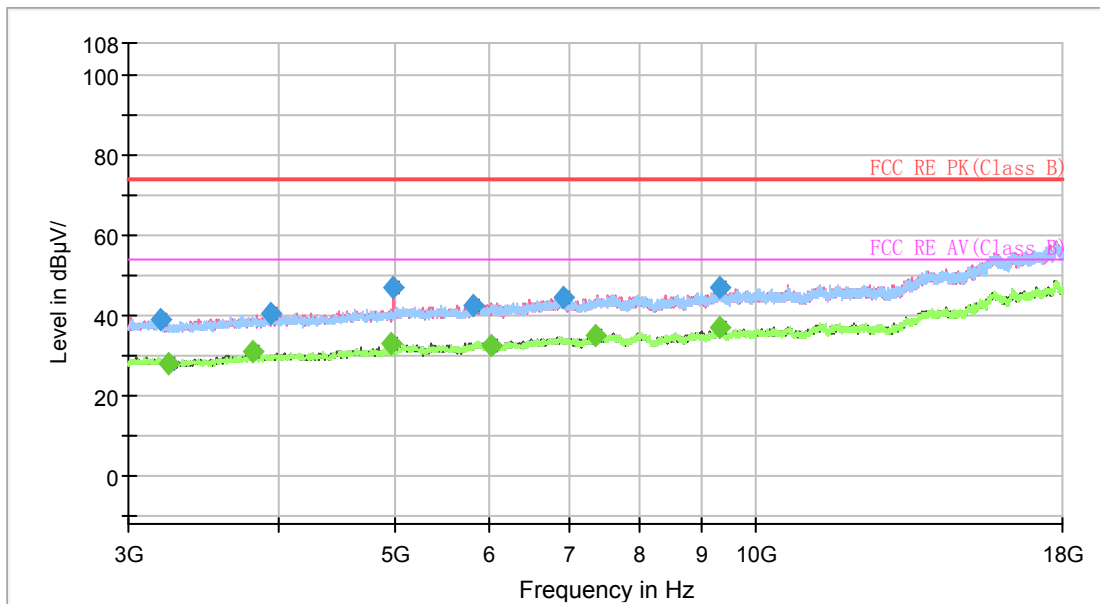

Radiates Emission from 3GHz to 18GHz

| Frequency (MHz) | Peak (dBuV/m) | Average (dBuV/m) | Limit (dBuV/m) | Margin (dB) | Height (cm) | Polarization | Azimuth (deg) | Correct Factor (dB) |
|-----------------|---------------|------------------|----------------|-------------|-------------|--------------|---------------|---------------------|
| 1035.000000 | 42.25 | --- | 74.00 | 31.75 | 200.0 | V | 341.0 | -1.0 |
| 1057.000000 | --- | 31.43 | 54.00 | 22.57 | 200.0 | V | 131.0 | -0.9 |
| 1158.250000 | --- | 33.06 | 54.00 | 20.94 | 200.0 | H | 313.0 | 0.0 |
| 1194.500000 | 43.74 | --- | 74.00 | 30.26 | 200.0 | V | 169.0 | 0.1 |
| 1394.500000 | --- | 33.61 | 54.00 | 20.39 | 100.0 | H | 0.0 | 0.9 |
| 1395.000000 | 44.12 | --- | 74.00 | 29.88 | 200.0 | V | 190.0 | 0.9 |
| 1580.000000 | 44.90 | --- | 74.00 | 29.10 | 200.0 | H | 0.0 | 1.8 |
| 1587.500000 | --- | 34.91 | 54.00 | 19.09 | 100.0 | H | 175.0 | 1.9 |
| 1795.500000 | 48.17 | --- | 74.00 | 25.83 | 100.0 | H | 157.0 | 2.9 |
| 2017.750000 | --- | 36.40 | 54.00 | 17.60 | 200.0 | H | 76.0 | 4.0 |
| 2957.500000 | 48.75 | --- | 74.00 | 25.25 | 200.0 | H | 213.0 | 7.8 |
| 2974.250000 | --- | 39.33 | 54.00 | 14.68 | 100.0 | H | 249.0 | 7.9 |

Remark: 1. Correction Factor = Antenna factor+ Insertion loss (cable loss + amplifier gain)



3DH5-Channel 78

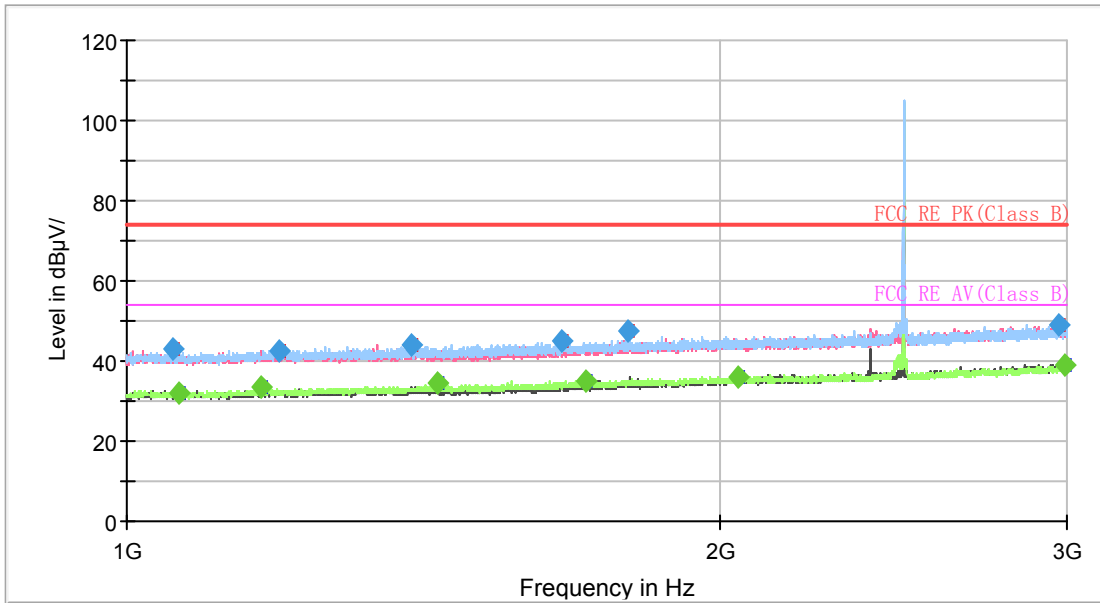

Note: The signal beyond the limit is carrier.
Radiates Emission from 1GHz to 3GHz

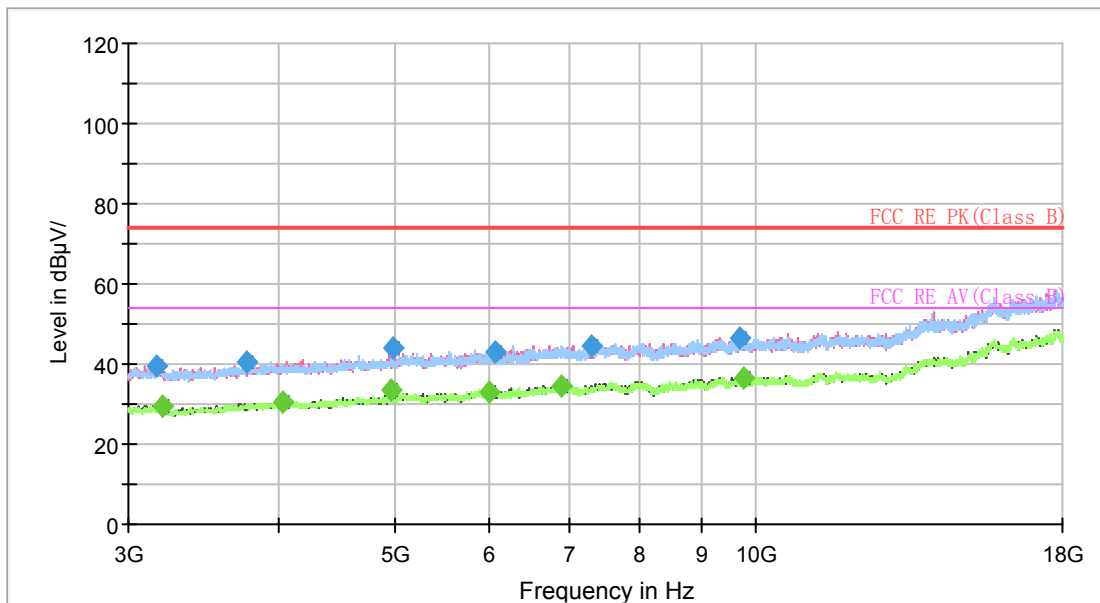

Radiates Emission from 3GHz to 18GHz

| Frequency (MHz) | Peak (dBuV/m) | Average (dBuV/m) | Limit (dBuV/m) | Margin (dB) | Height (cm) | Polarization | Azimuth (deg) | Correct Factor (dB) |
|-----------------|---------------|------------------|----------------|-------------|-------------|--------------|---------------|---------------------|
| 1056.250000 | 42.97 | --- | 74.00 | 31.03 | 100.0 | H | 302.0 | -0.9 |
| 1064.000000 | --- | 31.91 | 54.00 | 22.09 | 200.0 | V | 153.0 | -1.0 |
| 1170.000000 | --- | 33.33 | 54.00 | 20.67 | 100.0 | H | 349.0 | 0.0 |
| 1194.750000 | 42.42 | --- | 74.00 | 31.58 | 100.0 | H | 222.0 | 0.1 |
| 1395.000000 | 43.92 | --- | 74.00 | 30.08 | 200.0 | V | 95.0 | 0.9 |
| 1436.250000 | --- | 34.27 | 54.00 | 19.73 | 100.0 | H | 58.0 | 1.1 |
| 1661.000000 | 45.06 | --- | 74.00 | 28.94 | 200.0 | H | 8.0 | 2.2 |
| 1710.250000 | --- | 34.97 | 54.00 | 19.03 | 200.0 | H | 1.0 | 2.5 |
| 1794.250000 | 47.41 | --- | 74.00 | 26.59 | 200.0 | V | 180.0 | 2.9 |
| 2043.000000 | --- | 36.24 | 54.00 | 17.76 | 200.0 | H | 353.0 | 4.0 |
| 2973.250000 | 49.21 | --- | 74.00 | 24.79 | 200.0 | V | 286.0 | 7.9 |
| 2993.000000 | --- | 38.98 | 54.00 | 15.02 | 200.0 | V | 286.0 | 8.0 |

Remark: 1. Correction Factor = Antenna factor+ Insertion loss (cable loss + amplifier gain)

5.9 Conducted Emission

Ambient condition

| Temperature | Relative humidity | Pressure |
|-------------|-------------------|----------|
| 23°C ~25°C | 45%~50% | 101.5kPa |

Methods of Measurement

The EUT is placed on a non-metallic table of 80cm height above the horizontal metal reference ground plane. During the test, the EUT was operating in its typical mode. The test method is according to ANSI C63.10-2013. Connect the AC power line of the EUT to the L.I.S.N. Use EMI receiver to detect the average and Quasi-peak value. RBW is set to 9 kHz, VBW is set to 30kHz. The measurement result should include both L line and N line.

The test is in transmitting mode.

Test Setup

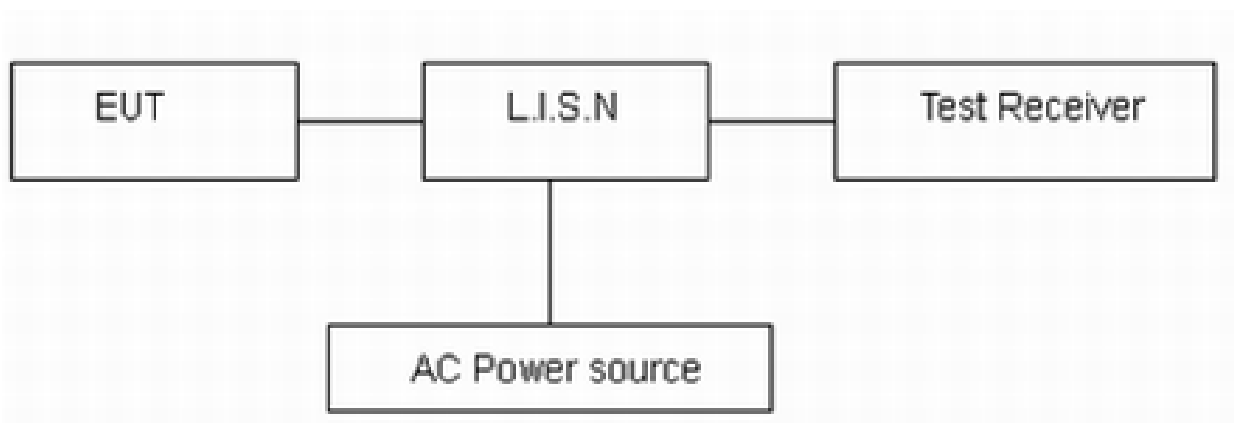

Note: AC Power source is used to 120V/60Hz.

Limits

| Frequency (MHz) | Conducted Limits(dBμV) | |
|-----------------|------------------------|------------|
| | Quasi-peak | Average |
| 0.15 - 0.5 | 66 to 56 * | 56 to 46 * |
| 0.5 - 5 | 56 | 46 |
| 5 - 30 | 60 | 50 |

*: Decreases with the logarithm of the frequency.

Measurement Uncertainty

The assessed measurement uncertainty to ensure 95% confidence level for the normal distribution is with the coverage factor $k = 1.96$, $U=2.69$ dB.

Test Results:

Following plots, Blue trace uses the peak detection, Green trace uses the average detection. During the test, the Conducted Emission was performed in all modes with all channels, BT 3DH5-Channel 39 , are selected as the worst condition. The test data of the worst-case condition was recorded in this report.

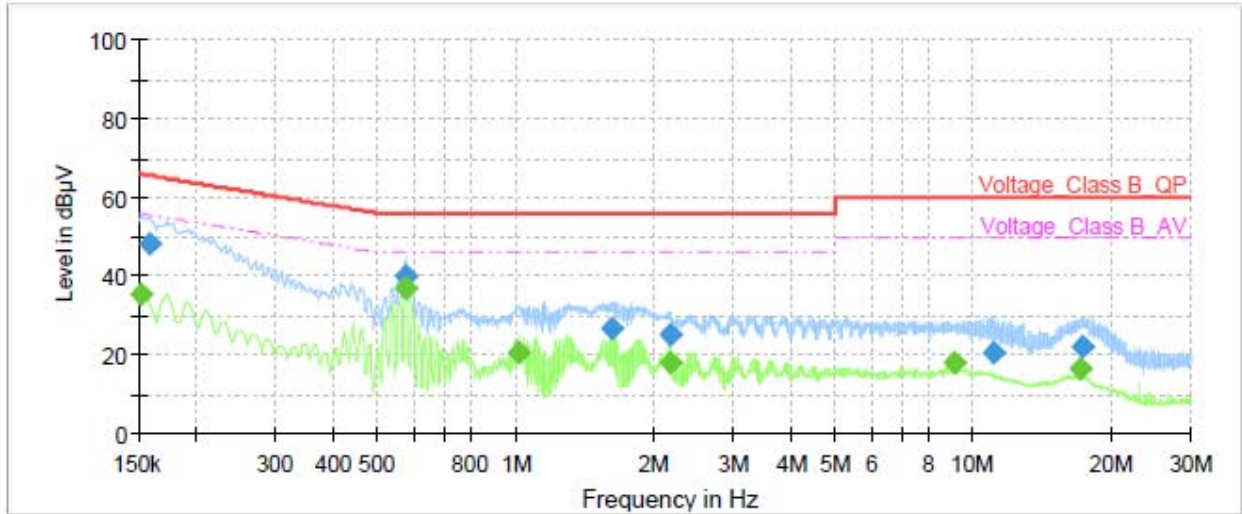

| Frequency (MHz) | QuasiPeak (dBµV) | Average (dBµV) | Limit (dBµV) | Margin (dB) | Meas. Time (ms) | Bandwidth (kHz) | Line | Filter | Corr. (dB) |
|-----------------|------------------|----------------|--------------|-------------|-----------------|-----------------|------|--------|------------|
| 0.15 | --- | 35.62 | 55.88 | 20.26 | 1000.0 | 9.000 | L1 | ON | 19 |
| 0.16 | 48.04 | --- | 65.52 | 17.48 | 1000.0 | 9.000 | L1 | ON | 19 |
| 0.57 | 40.05 | --- | 56.00 | 15.95 | 1000.0 | 9.000 | L1 | ON | 19 |
| 0.58 | --- | 37.14 | 46.00 | 8.86 | 1000.0 | 9.000 | L1 | ON | 19 |
| 1.02 | --- | 20.66 | 46.00 | 25.34 | 1000.0 | 9.000 | L1 | ON | 19 |
| 1.63 | 26.58 | --- | 56.00 | 29.42 | 1000.0 | 9.000 | L1 | ON | 19 |
| 2.17 | --- | 17.85 | 46.00 | 28.15 | 1000.0 | 9.000 | L1 | ON | 19 |
| 2.18 | 25.34 | --- | 56.00 | 30.66 | 1000.0 | 9.000 | L1 | ON | 19 |
| 9.11 | --- | 17.89 | 50.00 | 32.11 | 1000.0 | 9.000 | L1 | ON | 19 |
| 11.06 | 20.28 | --- | 60.00 | 39.72 | 1000.0 | 9.000 | L1 | ON | 19 |
| 17.19 | --- | 16.35 | 50.00 | 33.65 | 1000.0 | 9.000 | L1 | ON | 20 |
| 17.33 | 22.12 | --- | 60.00 | 37.88 | 1000.0 | 9.000 | L1 | ON | 20 |

Remark: Correct factor=cable loss + LISN factor

L line

Conducted Emission from 150 KHz to 30 MHz

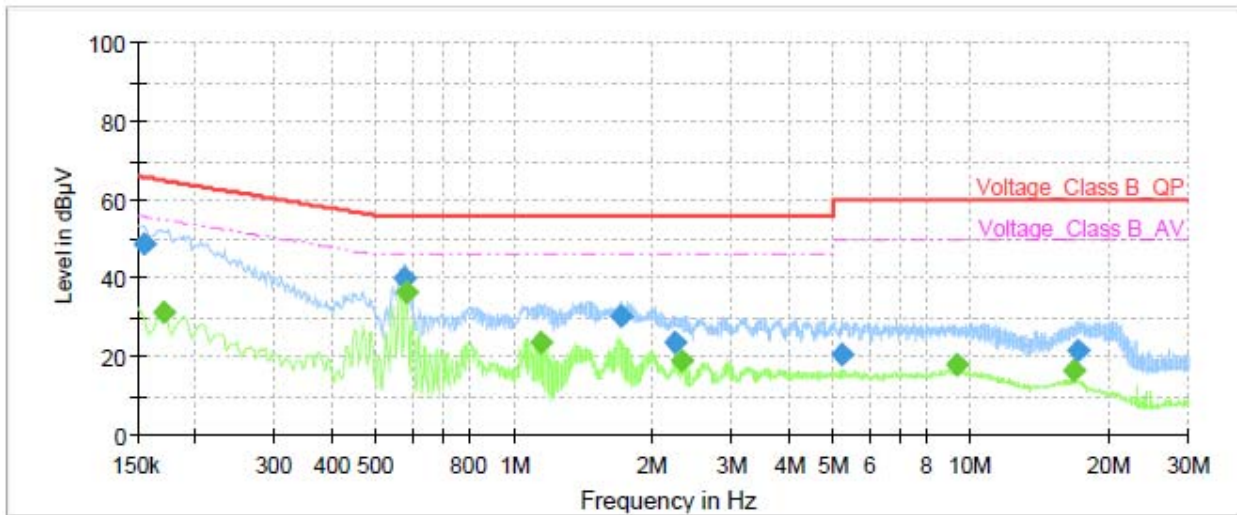

| Frequency (MHz) | QuasiPeak (dBµV) | Average (dBµV) | Limit (dBµV) | Margin (dB) | Meas. Time (ms) | Bandwidth (kHz) | Line | Filter | Corr. (dB) |
|-----------------|------------------|----------------|--------------|-------------|-----------------|-----------------|------|--------|------------|
| 0.15 | 48.87 | --- | 65.75 | 16.88 | 1000.0 | 9.000 | N | ON | 19 |
| 0.17 | --- | 31.21 | 54.95 | 23.74 | 1000.0 | 9.000 | N | ON | 19 |
| 0.58 | 39.82 | --- | 56.00 | 16.18 | 1000.0 | 9.000 | N | ON | 19 |
| 0.58 | --- | 36.55 | 46.00 | 9.45 | 1000.0 | 9.000 | N | ON | 19 |
| 1.14 | --- | 23.77 | 46.00 | 22.23 | 1000.0 | 9.000 | N | ON | 19 |
| 1.71 | 30.07 | --- | 56.00 | 25.93 | 1000.0 | 9.000 | N | ON | 19 |
| 2.24 | 23.76 | --- | 56.00 | 32.24 | 1000.0 | 9.000 | N | ON | 19 |
| 2.32 | --- | 19.13 | 46.00 | 26.87 | 1000.0 | 9.000 | N | ON | 19 |
| 5.25 | 20.47 | --- | 60.00 | 39.53 | 1000.0 | 9.000 | N | ON | 19 |
| 9.27 | --- | 18.06 | 50.00 | 31.94 | 1000.0 | 9.000 | N | ON | 19 |
| 16.85 | --- | 16.16 | 50.00 | 33.84 | 1000.0 | 9.000 | N | ON | 19 |
| 17.14 | 21.44 | --- | 60.00 | 38.56 | 1000.0 | 9.000 | N | ON | 20 |

Remark: Correct factor=cable loss + LISN factor

N line

Conducted Emission from 150 KHz to 30 MHz

6 Main Test Instruments

| Name | Manufacturer | Type | Serial Number | Calibration Date | Expiration Date |
|--------------------------------------|--------------|--------------|---------------|------------------|-----------------|
| BT Base Station Simulator | R&S | CBT | 100271 | 2019-05-19 | 2020-05-18 |
| Signal Analyzer | R&S | FSV30 | 100815 | 2019-12-15 | 2020-12-14 |
| EMI Test Receiver | R&S | ESCI | 100948 | 2019-05-19 | 2020-05-18 |
| Loop Antenna | Schwarzbeck | FMZB1519 | 1519-047 | 2017-09-26 | 2020-09-25 |
| TRILOG Broadband Antenna | Schwarzbeck | VULB 9163 | 9163-201 | 2017-11-18 | 2020-11-17 |
| Double Ridged Waveguide Horn Antenna | R&S | HF907 | 100126 | 2018-07-07 | 2020-07-06 |
| Standard Gain Horn | ETS-Lindgren | 3160-09 | 00102643 | 2018-06-20 | 2020-06-19 |
| EMI Test Receiver | R&S | ESR | 101667 | 2019-05-19 | 2020-05-18 |
| LISN | R&S | ENV216 | 101171 | 2018-12-15 | 2021-12-14 |
| Spectrum Analyzer | Agilent | N9010A | MY47191109 | 2019-05-19 | 2020-05-18 |
| RF Cable | Agilent | SMA 15cm | 0001 | 2019-12-13 | 2020-06-12 |
| Power Splitter | Hua Xiang | SHX-GF2-2-13 | 10120101 | / | / |
| Software | R&S | EMC32 | 9.26.0 | / | / |

*****END OF REPORT *****