



# SAR TEST REPORT

No. I19Z61671-SEM01

For

**HMD Global Oy**

**Multi-band GSM/WCDMA/LTE phone with Bluetooth, WLAN**

**Model name: TA-1214**

With

**Hardware Version: 99621\_1\_11**

**Software Version: 000T\_0\_130**

**FCC ID: 2AJOTTA-1214**

**Issued Date: 2019-10-18**

**Note:**

The test results in this test report relate only to the devices specified in this report. This report shall not be reproduced except in full without the written approval of CTTL.

The report must not be used by the client to claim product certification, approval, or endorsement by NVLAP, NIST, or any agency of the U.S. Government.

**Test Laboratory:**

CTTL, Telecommunication Technology Labs, CAICT

No. 51, Xueyuan Road, Haidian District, Beijing, P. R. China 100191.

Tel:+86(0)10-62304633-2512, Fax:+86(0)10-62304633-2504

Email: [ctl\\_terminals@caict.ac.cn](mailto:ctl_terminals@caict.ac.cn), website: [www.caict.ac.cn](http://www.caict.ac.cn)



No.I19Z61671-SEM01

## **REPORT HISTORY**

<b>Report Number</b>	<b>Revision</b>	<b>Issue Date</b>	<b>Description</b>
I19Z61671-SEM01	Rev.0	2019-10-18	Initial creation of test report

## TABLE OF CONTENT

<b>1 TEST LABORATORY</b> .....	<b>5</b>
1.1 TESTING LOCATION .....	5
1.2 TESTING ENVIRONMENT.....	5
1.3 PROJECT DATA .....	5
1.4 SIGNATURE.....	5
<b>2 STATEMENT OF COMPLIANCE</b> .....	<b>6</b>
<b>3 CLIENT INFORMATION</b> .....	<b>7</b>
3.1 APPLICANT INFORMATION .....	7
3.2 MANUFACTURER INFORMATION .....	7
<b>4 EQUIPMENT UNDER TEST (EUT) AND ANCILLARY EQUIPMENT (AE)</b> .....	<b>8</b>
4.1 ABOUT EUT .....	8
4.2 INTERNAL IDENTIFICATION OF EUT USED DURING THE TEST .....	8
4.3 INTERNAL IDENTIFICATION OF AE USED DURING THE TEST .....	8
<b>5 TEST METHODOLOGY</b> .....	<b>9</b>
5.1 APPLICABLE LIMIT REGULATIONS .....	9
5.2 APPLICABLE MEASUREMENT STANDARDS.....	9
<b>6 SPECIFIC ABSORPTION RATE (SAR)</b> .....	<b>10</b>
6.1 INTRODUCTION.....	10
6.2 SAR DEFINITION.....	10
<b>7 TISSUE SIMULATING LIQUIDS</b> .....	<b>11</b>
7.1 TARGETS FOR TISSUE SIMULATING LIQUID .....	11
7.2 DIELECTRIC PERFORMANCE .....	11
<b>8 SYSTEM VERIFICATION</b> .....	<b>18</b>
8.1 SYSTEM SETUP.....	18
8.2 SYSTEM VERIFICATION.....	19
<b>9 MEASUREMENT PROCEDURES</b> .....	<b>20</b>
9.1 TESTS TO BE PERFORMED .....	20
9.2 GENERAL MEASUREMENT PROCEDURE.....	22
9.3 WCDMA MEASUREMENT PROCEDURES FOR SAR .....	23
9.4 SAR MEASUREMENT FOR LTE.....	24
9.5 BLUETOOTH & WI-FI MEASUREMENT PROCEDURES FOR SAR .....	24
9.6 POWER DRIFT.....	25
<b>10 AREA SCAN BASED 1-G SAR</b> .....	<b>25</b>
10.1 REQUIREMENT OF KDB.....	25
10.2 FAST SAR ALGORITHMS .....	25



<b>11 CONDUCTED OUTPUT POWER.....</b>	<b>26</b>
11.1 GSM MEASUREMENT RESULT .....	26
11.2 WCDMA MEASUREMENT RESULT.....	28
11.3 LTE MEASUREMENT RESULT .....	30
11.4 WI-FI AND BT MEASUREMENT RESULT .....	51
<b>12 SIMULTANEOUS TX SAR CONSIDERATIONS.....</b>	<b>52</b>
12.1 INTRODUCTION.....	52
12.2 TRANSMIT ANTENNA SEPARATION DISTANCES .....	52
12.3 SAR MEASUREMENT POSITIONS .....	53
12.4 STANDALONE SAR TEST EXCLUSION CONSIDERATIONS .....	53
<b>13 EVALUATION OF SIMULTANEOUS.....</b>	<b>54</b>
<b>14 SAR TEST RESULT .....</b>	<b>55</b>
14.1 SAR RESULTS FOR FAST SAR.....	56
14.2 SAR RESULTS FOR STANDARD PROCEDURE .....	66
14.3 WLAN EVALUATION FOR 2.4G .....	71
<b>15 SAR MEASUREMENT VARIABILITY.....</b>	<b>74</b>
<b>16 MEASUREMENT UNCERTAINTY .....</b>	<b>76</b>
16.1 MEASUREMENT UNCERTAINTY FOR NORMAL SAR TESTS (300MHZ~3GHZ) .....	76
16.2 MEASUREMENT UNCERTAINTY FOR NORMAL SAR TESTS (3~6GHZ) .....	77
16.3 MEASUREMENT UNCERTAINTY FOR FAST SAR TESTS (300MHZ~3GHZ) .....	78
16.4 MEASUREMENT UNCERTAINTY FOR FAST SAR TESTS (3~6GHZ).....	79
<b>17 MAIN TEST INSTRUMENTS.....</b>	<b>80</b>
<b>ANNEX A GRAPH RESULTS.....</b>	<b>81</b>
<b>ANNEX B SYSTEM VERIFICATION RESULTS .....</b>	<b>111</b>
<b>ANNEX C SAR MEASUREMENT SETUP .....</b>	<b>124</b>
<b>ANNEX D POSITION OF THE WIRELESS DEVICE IN RELATION TO THE PHANTOM .....</b>	<b>130</b>
<b>ANNEX E EQUIVALENT MEDIA RECIPES.....</b>	<b>133</b>
<b>ANNEX F SYSTEM VALIDATION .....</b>	<b>134</b>
<b>ANNEX G PROBE CALIBRATION CERTIFICATE.....</b>	<b>135</b>
<b>ANNEX H DIPOLE CALIBRATION CERTIFICATE .....</b>	<b>154</b>
<b>ANNEX I SENSOR TRIGGERING DATA SUMMARY.....</b>	<b>202</b>
<b>ANNEX J ACCREDITATION CERTIFICATE.....</b>	<b>206</b>

## 1 Test Laboratory

### 1.1 Testing Location

Company Name:	CTTL(Shouxiang)
Address:	No. 51 Shouxiang Science Building, Xueyuan Road, Haidian District, Beijing, P. R. China100191

### 1.2 Testing Environment

Temperature:	18°C~25°C,
Relative humidity:	30%~ 70%
Ground system resistance:	< 0.5 $\Omega$
Ambient noise & Reflection:	< 0.012 W/kg

### 1.3 Project Data

Project Leader:	Qi Dianyuan
Test Engineer:	Lin Xiaojun
Testing Start Date:	October 9, 2019
Testing End Date:	October 12, 2019

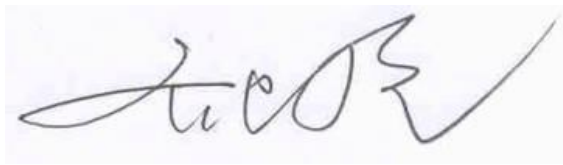
### 1.4 Signature



---

Lin Xiaojun

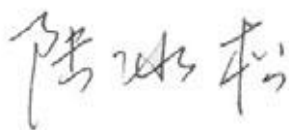
(Prepared this test report)



---

Qi Dianyuan

(Reviewed this test report)



---

Lu Bingsong

Deputy Director of the laboratory

(Approved this test report)

## 2 Statement of Compliance

The maximum results of SAR found during testing for HMD Global Oy Multi-band GSM/WCDMA/LTE phone with Bluetooth, WLAN TA-1214 are as follows:

**Table 2.1: Highest Reported SAR (1g)**

Exposure Configuration	Technology Band	Highest Reported SAR 1g(W/kg)	Equipment Class
Head (Separation Distance 0mm)	GSM 850	0.29	PCE
	PCS 1900	0.19	
	UMTS FDD 2	0.31	
	UMTS FDD 4	0.39	
	UMTS FDD 5	0.24	
	LTE Band 2	0.27	
	LTE Band 5	0.24	
	LTE Band 7	0.25	
	LTE Band 12	0.04	
	LTE Band 66	0.29	
	WLAN 2.4 GHz	0.87	DTS
Hotspot (Separation Distance 10mm)	GSM 850	0.49	PCE
	PCS 1900	1.07	
	UMTS FDD 2	0.95	
	UMTS FDD 4	1.30	
	UMTS FDD 5	0.30	
	LTE Band 2	1.24	
	LTE Band 5	0.37	
	LTE Band 7	1.14	
	LTE Band 12	0.09	
	LTE Band 66	1.19	
	WLAN 2.4 GHz	0.29	DTS

The SAR values found for the Mobile Phone are below the maximum recommended levels of 1.6 W/kg as averaged over any 1g tissue according to the ANSI C95.1-1992.

For body operation, this device has been tested and meets FCC RF exposure guidelines when used with any accessory that contains no metal and which provides a minimum separation distance of 10 mm for hotspot and 15mm for body worn between this device and the body of the user. Use of other accessories may not ensure compliance with FCC RF exposure guidelines.

The EUT battery must be fully charged and checked periodically during the test to ascertain uniform power output.

The measurement together with the test system set-up is described in annex C of this test report. A detailed description of the equipment under test can be found in chapter 4 of this test report. The highest reported SAR value is obtained at the case of **(Table 2.1)**, and the values are: **1.30 W/kg(1g)**.

**Table 2.2: The sum of reported SAR values for main antenna and WiFi**

	Position	Main antenna	WiFi	Sum
<b>Highest reported SAR value for Head</b>	Left hand, Touch cheek	0.31	0.87	<b>1.18</b>
<b>Highest reported SAR value for Body</b>	Rear 10mm	1.14	0.29	<b>1.43</b>

**Table 2.3: The sum of reported SAR values for main antenna and BT**

	Position	Main antenna	BT	Sum
<b>Maximum reported SAR value for Head</b>	Right hand, Touch cheek	0.39	0.23 <sup>[1]</sup>	<b>0.62</b>
<b>Maximum reported SAR value for Body</b>	Bottom 17mm	1.30	/	<b>1.30</b>

[1] - Estimated SAR for Bluetooth (see the table 13.3)

According to the above tables, the highest sum of reported SAR values is **1.43 W/kg (1g)**. The detail for simultaneous transmission consideration is described in chapter 13.

### 3 Client Information

#### 3.1 Applicant Information

Company Name:	HMD Global Oy
Address/Post:	Bertel Jungin aukio 9,02600 Espoo, Finland
Contact Person:	Rosario Casillo
Contact Email:	Rosario.Casillo@hmdglobal.com
Telephone:	NA

#### 3.2 Manufacturer Information

Company Name:	HMD Global Oy
Address/Post:	Bertel Jungin aukio 9,02600 Espoo, Finland
Contact Person:	Rosario Casillo
Contact Email:	Rosario.Casillo@hmdglobal.com
Telephone:	NA

## 4 Equipment Under Test (EUT) and Ancillary Equipment (AE)

### 4.1 About EUT

Description:	Multi-band GSM/WCDMA/LTE phone with Bluetooth, WLAN
Model name:	TA-1214
Operating mode(s):	GSM 850/900/1800/1900, UMTS FDD 1/2/4/5/8, BT, Wi-Fi LTE Band 1/2/3/4/5/7/8/12/17/28/66
Tested Tx Frequency:	824 – 849 MHz (GSM 850)
	1850 – 1910 MHz (GSM 1900)
	824–849 MHz (WCDMA 850 Band V)
	1710 – 1755 MHz (WCDMA 1700 Band IV)
	1850–1910 MHz (WCDMA1900 Band II)
	1850 – 1910 MHz (LTE Band 2)
	824 – 849 MHz (LTE Band 5)
	2502.5 – 2567.5 MHz (LTE Band 7)
	699 – 716 MHz (LTE Band 12)
	1710.7 – 1779.3 MHz (LTE Band 66)
2412 – 2462 MHz (Wi-Fi 2.4G)	
GPRS/EGPRS Multislot Class:	12
GPRS capability Class:	B
Test device Production information:	Production unit
Device type:	Portable device
Antenna type:	Integrated antenna
Hotspot mode:	Support

### 4.2 Internal Identification of EUT used during the test

EUT ID*	IMEI	HW	SW Version
EUT1	354219100003738	99621_1_11	000T_0_130
EUT2	354219100005089	99621_1_11	000T_0_130
EUT3	354219100005014	99621_1_11	000T_0_130
EUT4	354219100003498	99621_1_11	000T_0_130
EUT5	354217100001561	99621_1_11	000T_0_130
EUT6	354219100003472	99621_1_11	000T_0_130

\*EUT ID: is used to identify the test sample in the lab internally.

**Note:** It is performed to test SAR with the EUT1~3 and conducted power with the EUT4~6.

### 4.3 Internal Identification of AE used during the test

AE ID*	Description	Model	SN	Manufacturer
AE1	Battery	WT240	/	Jiade Energy Technology (Zhuhai) Co., Ltd
AE2	Headset	HS-34		New Leader Industry Co.,Ltd

\*AE ID: is used to identify the test sample in the lab internally.



## 5 TEST METHODOLOGY

### 5.1 Applicable Limit Regulations

**ANSI C95.1–1992:** IEEE Standard for Safety Levels with Respect to Human Exposure to Radio Frequency Electromagnetic Fields, 3 kHz to 300 GHz.

It specifies the maximum exposure limit of **1.6 W/kg** as averaged over any 1 gram of tissue for portable devices being used within 20 cm of the user in the uncontrolled environment.

### 5.2 Applicable Measurement Standards

**IEEE 1528–2013:** Recommended Practice for Determining the Peak Spatial-Average Specific Absorption Rate (SAR) in the Human Head from Wireless Communications Devices: Measurement Techniques.

**KDB447498 D01: General RF Exposure Guidance v06:** Mobile and Portable Devices RF Exposure Procedures and Equipment Authorization Policies.

**KDB648474 D04 Handset SAR v01r03:** SAR Evaluation Considerations for Wireless Handsets.

**KDB941225 D01 SAR test for 3G devices v03r01:** SAR Measurement Procedures for 3G Devices

**KDB941225 D05 SAR for LTE Devices v02r05:** SAR Evaluation Considerations for LTE Devices

**KDB941225 D06 Hotspot Mode SAR v02r01:** SAR Evaluation Procedures for Portable Devices with Wireless Router Capabilities

**KDB248227 D01 802.11 Wi-Fi SAR v02r02:** SAR GUIDANCE FOR IEEE 802.11 (Wi-Fi) TRANSMITTERS

**KDB865664 D01 SAR measurement 100 MHz to 6 GHz v01r04:** SAR Measurement Requirements for 100 MHz to 6 GHz.

**KDB865664 D02 RF Exposure Reporting v01r02:** RF Exposure Compliance Reporting and Documentation Considerations

## 6 Specific Absorption Rate (SAR)

### 6.1 Introduction

SAR is related to the rate at which energy is absorbed per unit mass in an object exposed to a radio field. The SAR distribution in a biological body is complicated and is usually carried out by experimental techniques or numerical modeling. The standard recommends limits for two tiers of groups, occupational/controlled and general population/uncontrolled, based on a person's awareness and ability to exercise control over his or her exposure. In general, occupational/controlled exposure limits are higher than the limits for general population/uncontrolled.

### 6.2 SAR Definition

The SAR definition is the time derivative (rate) of the incremental energy ( $dW$ ) absorbed by (dissipated in) an incremental mass ( $dm$ ) contained in a volume element ( $dv$ ) of a given density ( $\rho$ ). The equation description is as below:

$$SAR = \frac{d}{dt} \left( \frac{dW}{dm} \right) = \frac{d}{dt} \left( \frac{dW}{\rho dv} \right)$$

SAR is expressed in units of Watts per kilogram (W/kg)

SAR measurement can be either related to the temperature elevation in tissue by

$$SAR = c \left( \frac{\delta T}{\delta t} \right)$$

Where:  $C$  is the specific heat capacity,  $\delta T$  is the temperature rise and  $\delta t$  is the exposure duration, or related to the electrical field in the tissue by

$$SAR = \frac{\sigma |E|^2}{\rho}$$

Where:  $\sigma$  is the conductivity of the tissue,  $\rho$  is the mass density of tissue and  $E$  is the RMS electrical field strength.

However for evaluating SAR of low power transmitter, electrical field measurement is typically applied.

## 7 Tissue Simulating Liquids

### 7.1 Targets for tissue simulating liquid

**Table 7.1: Targets for tissue simulating liquid**

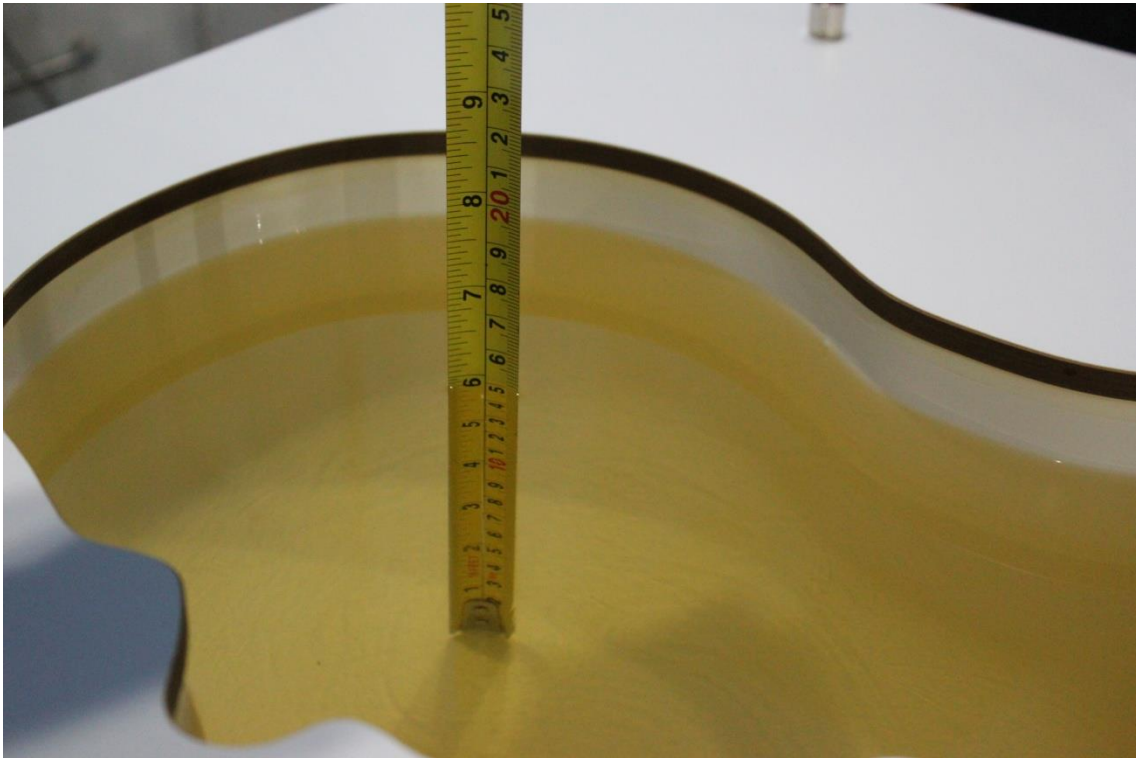
Frequency(MHz)	Liquid Type	Conductivity( $\sigma$ )	$\pm 5\%$ Range	Permittivity( $\epsilon$ )	$\pm 5\%$ Range
750	Head	0.89	0.85~0.93	41.94	39.8~44.0
750	Body	0.96	0.91~1.01	55.5	52.7~58.3
835	Head	0.90	0.86~0.95	41.5	39.4~43.6
835	Body	0.97	0.92~1.02	55.2	52.4~58.0
1750	Head	1.37	1.30~1.44	40.08	38.1~42.1
1750	Body	1.49	1.42~1.56	53.4	50.7~56.1
1900	Head	1.40	1.33~1.47	40.0	38.0~42.0
1900	Body	1.52	1.44~1.60	53.3	50.6~56.0
2450	Head	1.80	1.71~1.89	39.2	37.2~41.2
2450	Body	1.95	1.85~2.05	52.7	50.1~55.3
2600	Head	1.96	1.86~2.06	39.01	37.1~41.0
2600	Body	2.16	2.05~2.27	52.5	49.9~55.1

### 7.2 Dielectric Performance

**Table 7.2: Dielectric Performance of Tissue Simulating Liquid**

Measurement Date (yyyy-mm-dd)	Type	Frequency	Permittivity $\epsilon$	Drift (%)	Conductivity $\sigma$ (S/m)	Drift (%)
2019-10-9	Head	750 MHz	41.35	-1.41	0.888	-0.22
	Body	750 MHz	55.95	0.81	0.955	-0.52
2019-10-9	Head	835 MHz	41.1	-0.96	0.892	-0.89
	Body	835 MHz	54.29	-1.65	0.977	0.72
2019-10-10	Head	1750 MHz	40.82	1.85	1.377	0.51
	Body	1750 MHz	52.58	-1.54	1.485	-0.34
2019-10-11	Head	1900 MHz	39.99	-0.02	1.428	2.00
	Body	1900 MHz	53.11	-0.36	1.51	-0.66
2019-10-12	Head	2450 MHz	38.99	-0.54	1.78	-1.11
	Body	2450 MHz	53.49	1.50	1.957	0.36
2019-10-12	Head	2600 MHz	39.06	0.13	1.925	-1.79
	Body	2600 MHz	52.63	0.25	2.179	0.88

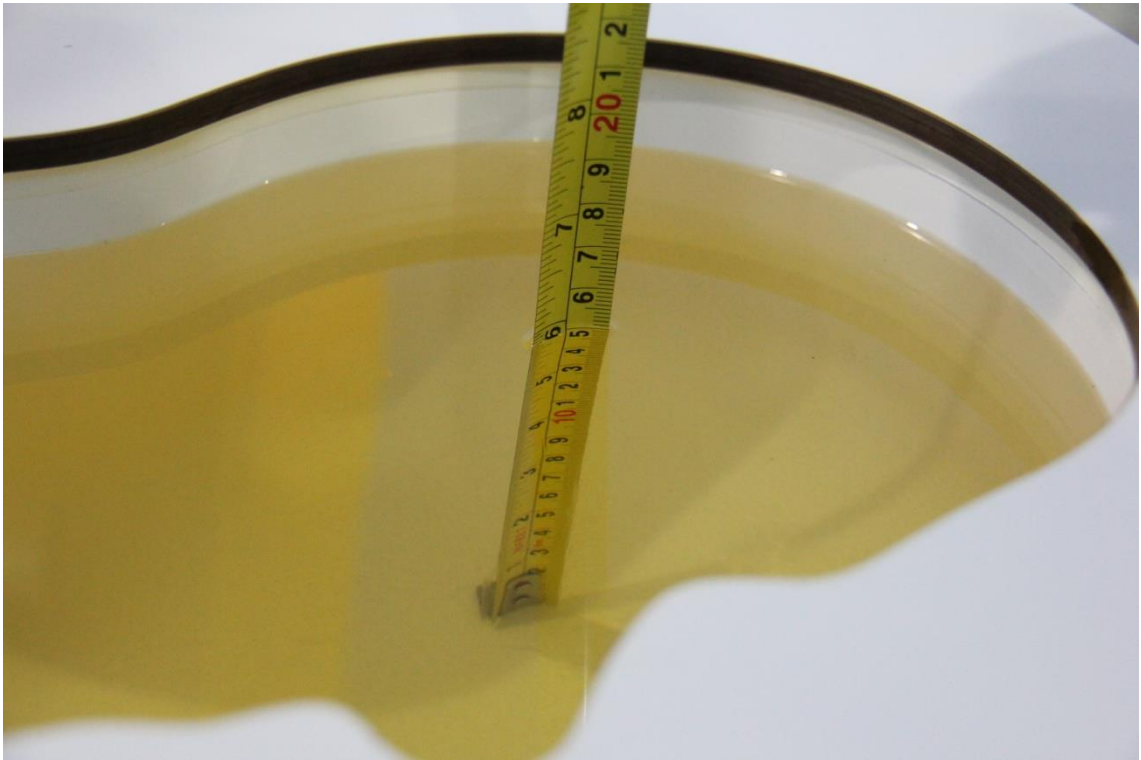
Note: The liquid temperature is 22.0°C



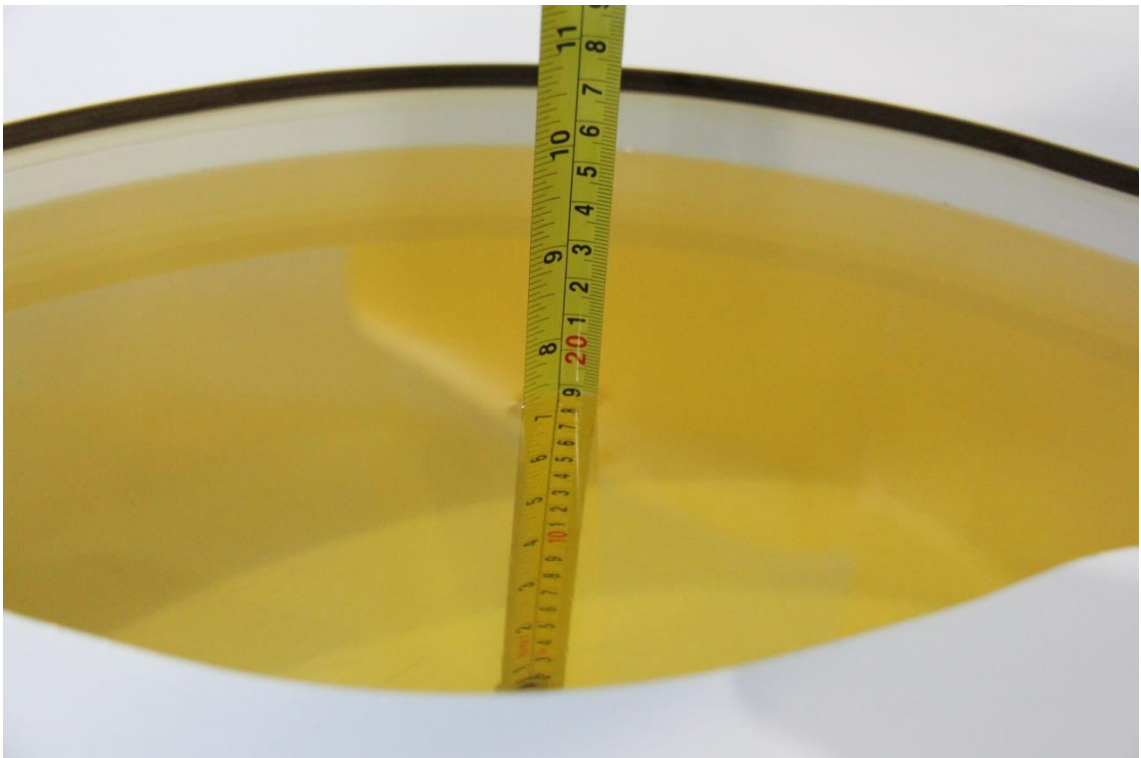
Picture 7-1 Liquid depth in the Head Phantom (750MHz)



Picture 7-2 Liquid depth in the Flat Phantom (750MHz)

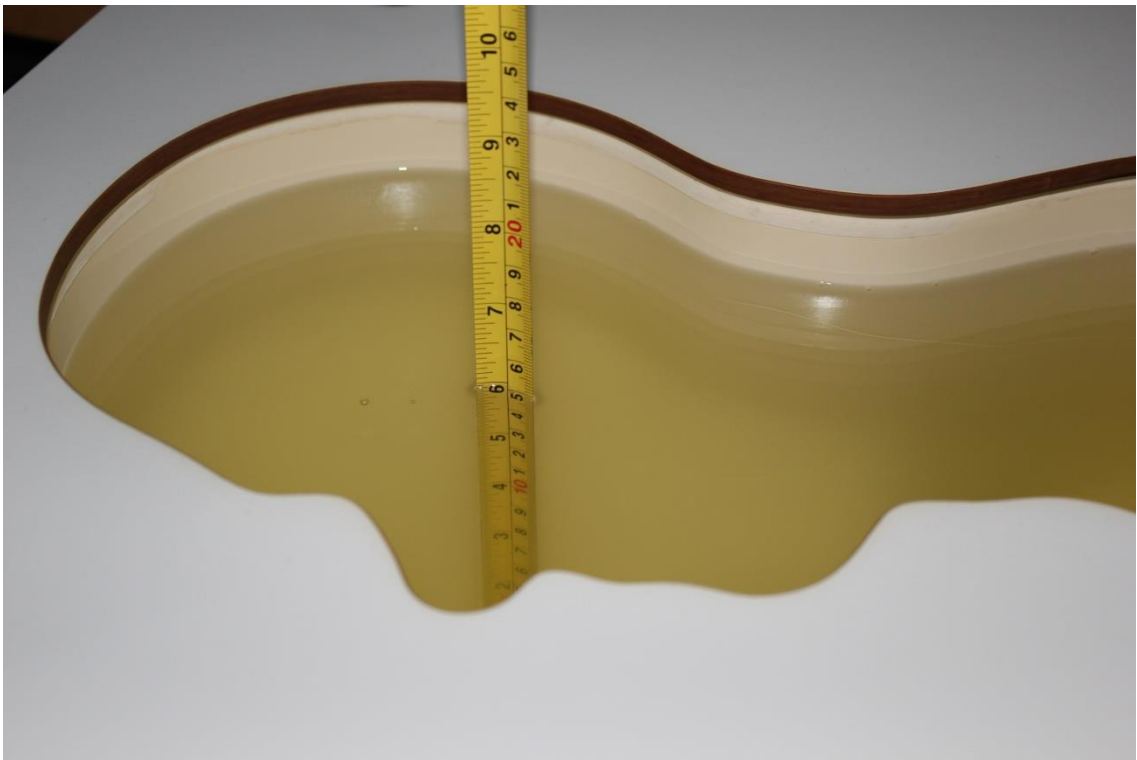


**Picture 7-3 Liquid depth in the Head Phantom (835 MHz)**

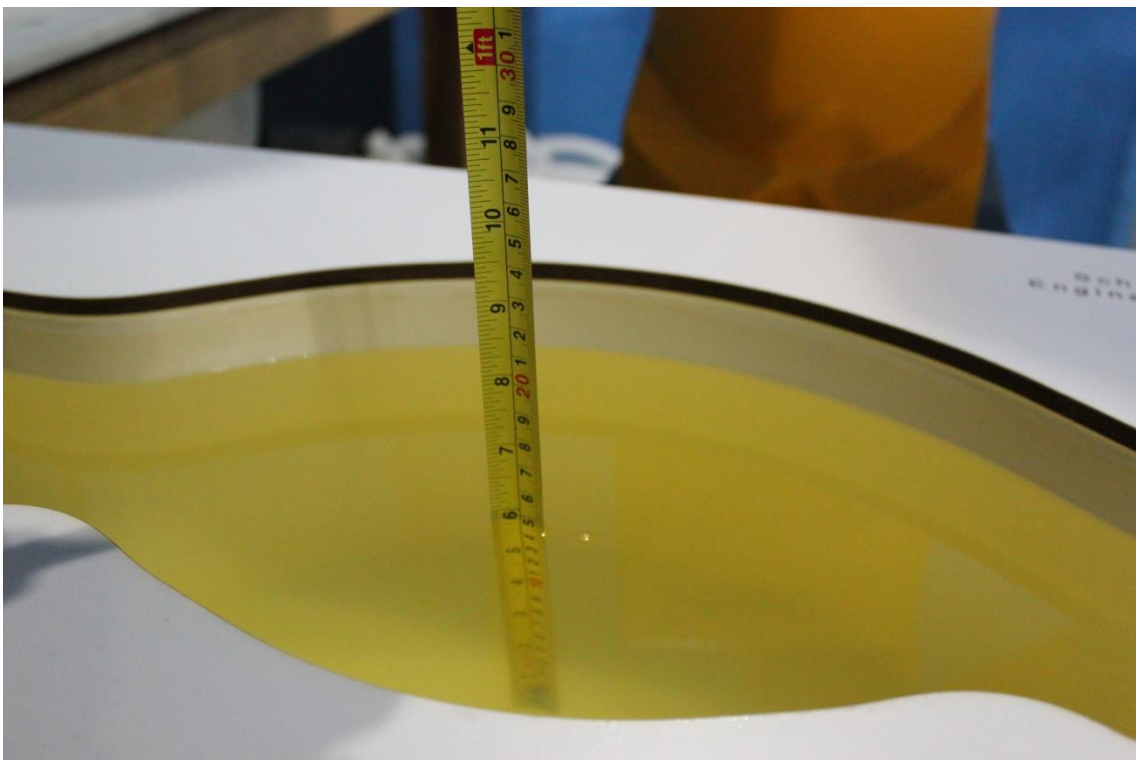


**Picture 7-4 Liquid depth in the Flat Phantom (835 MHz)**

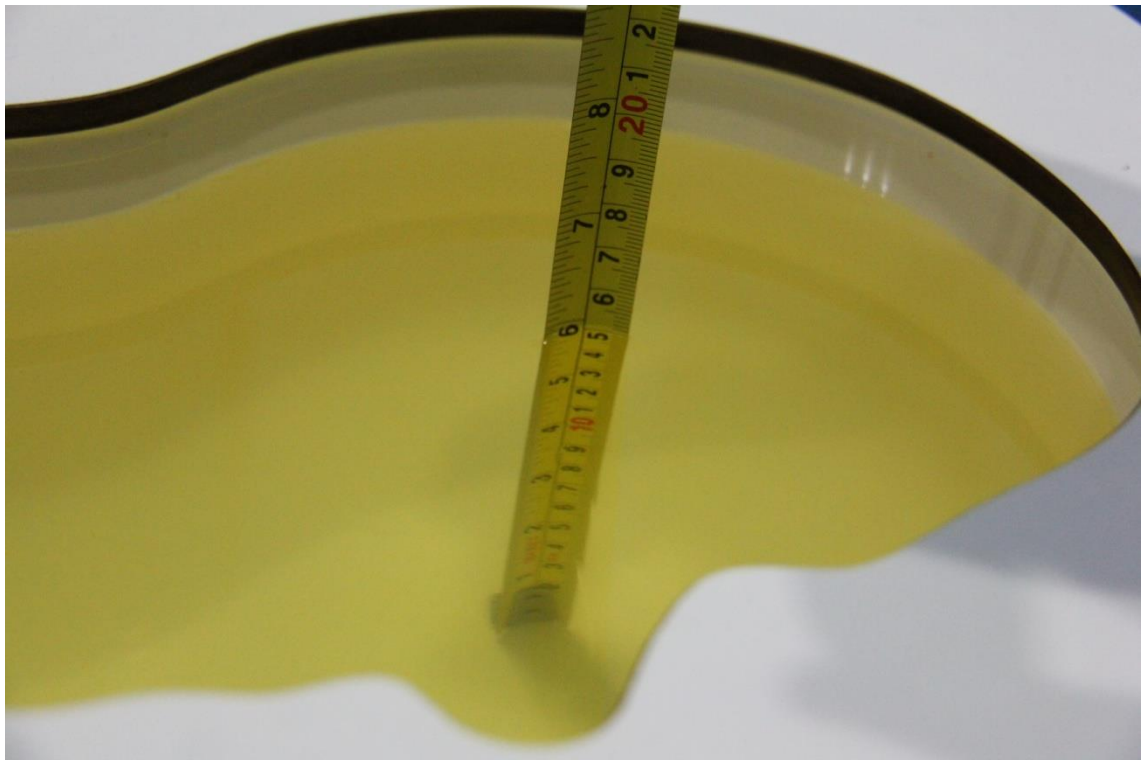




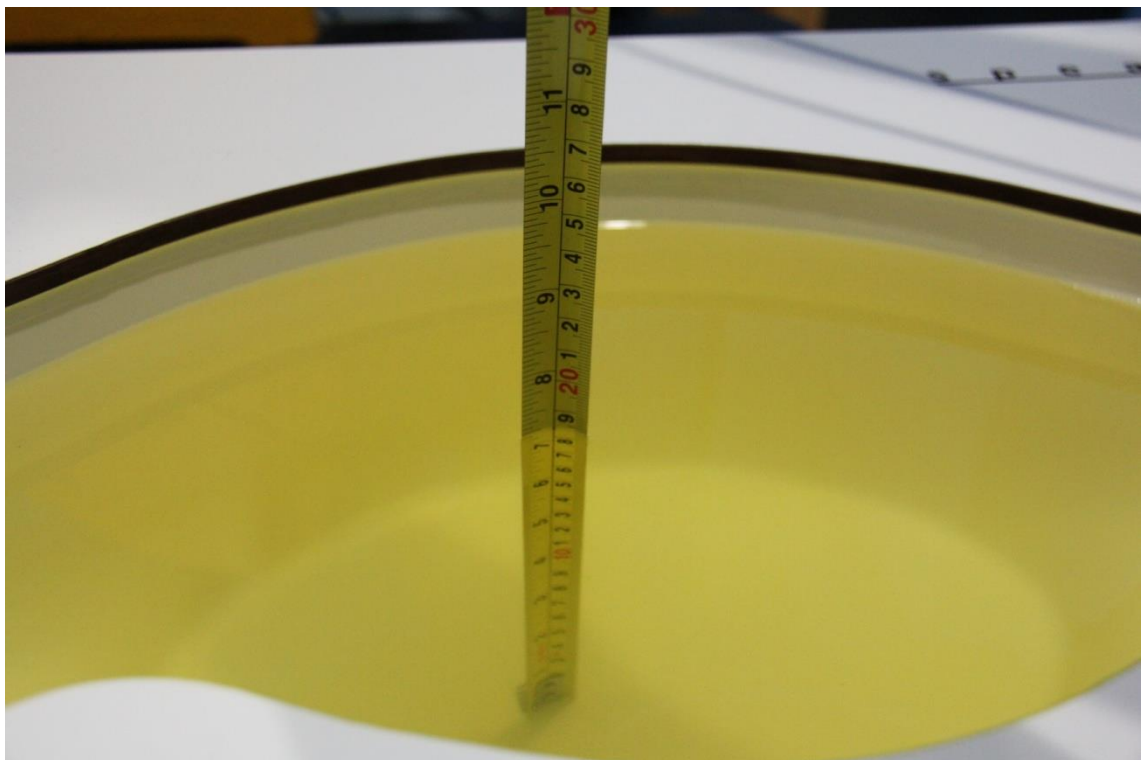
Picture 7-5 Liquid depth in the Head Phantom (1750 MHz)



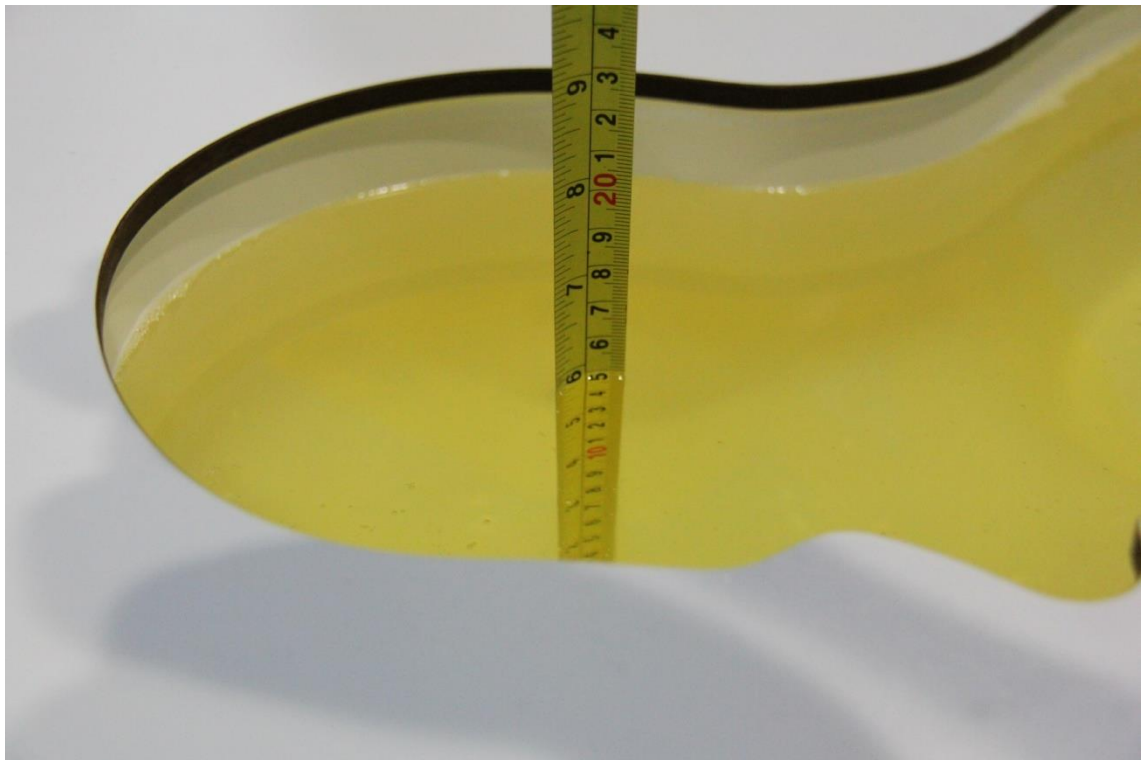
Picture 7-6 Liquid depth in the Flat Phantom (1750MHz)



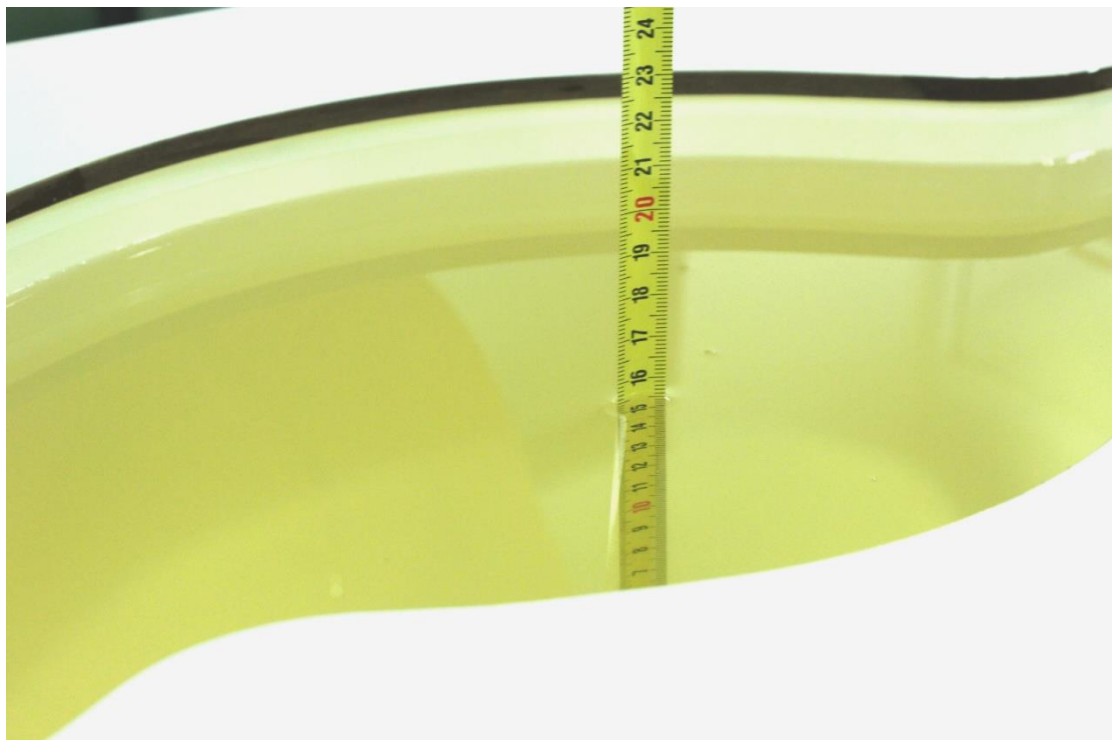
Picture 7-7 Liquid depth in the Head Phantom (1900 MHz)



Picture 7-8 Liquid depth in the Flat Phantom (1900MHz)

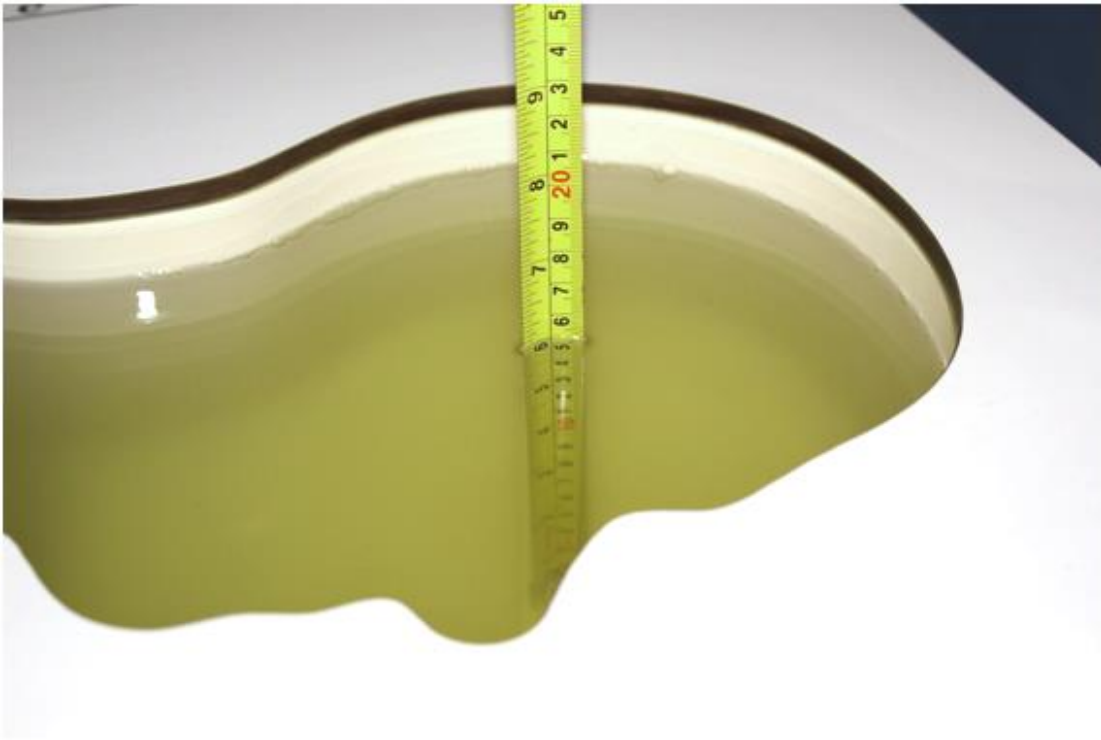


**Picture 7-9 Liquid depth in the Head Phantom (2450MHz)**

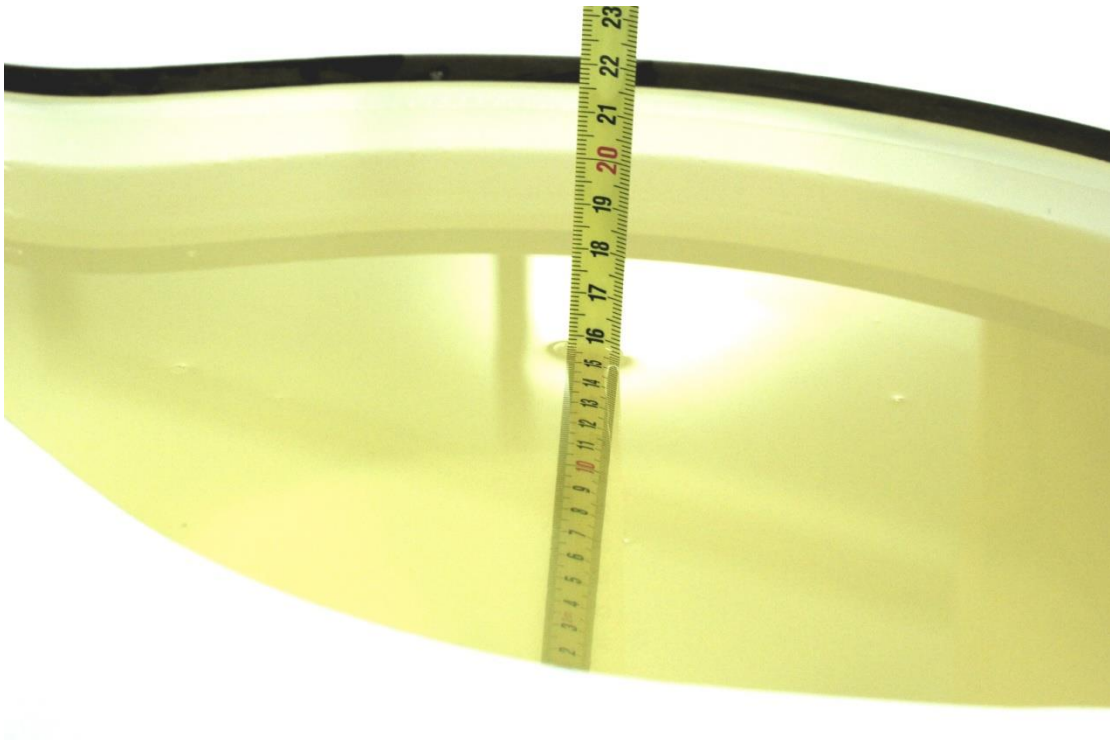


**Picture 7-10 Liquid depth in the Flat Phantom (2450MHz)**





**Picture 7-11 Liquid depth in the Head Phantom (2600 MHz)**

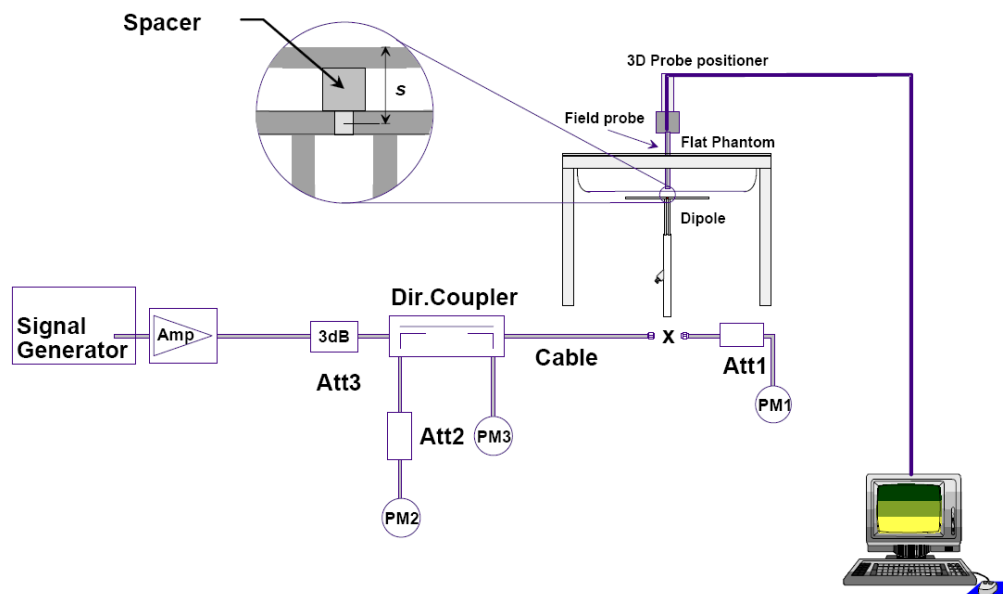


**Picture 7-12 Liquid depth in the Flat Phantom (2600MHz)**

## 8 System verification

### 8.1 System Setup

In the simplified setup for system evaluation, the DUT is replaced by a calibrated dipole and the power source is replaced by a continuous wave that comes from a signal generator. The calibrated dipole must be placed beneath the flat phantom section of the SAM twin phantom with the correct distance holder. The distance holder should touch the phantom surface with a light pressure at the reference marking and be oriented parallel to the long side of the phantom. The equipment setup is shown below:



Picture 8.1 System Setup for System Evaluation



Picture 8.2 Photo of Dipole Setup

## 8.2 System Verification

SAR system verification is required to confirm measurement accuracy, according to the tissue dielectric media, probe calibration points and other system operating parameters required for measuring the SAR of a test device. The system verification must be performed for each frequency band and within the valid range of each probe calibration point required for testing the device.

The system verification results are required that the area scan estimated 1-g SAR is within 3% of the zoom scan 1-g SAR. The details are presented in annex B.

**Table 8.1: System Verification of Head**

Measurement Date (yyyy-mm-dd)	Frequency	Target value (W/kg)		Measured value(W/kg)		Deviation	
		10 g Average	1 g Average	10 g Average	1 g Average	10 g Average	1 g Average
2019-10-9	750 MHz	5.57	8.57	5.68	8.6	1.97%	0.35%
2019-10-9	835 MHz	6.29	9.70	6.32	9.6	0.48%	-1.03%
2019-10-10	1750 MHz	19.3	36.6	19.32	36.68	0.10%	0.22%
2019-10-11	1900 MHz	20.8	39.7	21.12	39.68	1.54%	-0.05%
2019-10-12	2450 MHz	24.2	51.6	24.48	50.72	1.16%	-1.71%
2019-10-12	2600 MHz	25.1	55.8	25	54.72	-0.40%	-1.94%

**Table 8.2: System Verification of Body**

Measurement Date (yyyy-mm-dd)	Frequency	Target value (W/kg)		Measured value (W/kg)		Deviation	
		10 g Average	1 g Average	10 g Average	1 g Average	10 g Average	1 g Average
2019-10-9	750 MHz	5.63	8.55	5.52	8.44	-1.95%	-1.29%
2019-10-9	835 MHz	6.32	9.68	6.4	9.84	1.27%	1.65%
2019-10-10	1750 MHz	19.5	36.8	19.44	37.44	-0.31%	1.74%
2019-10-11	1900 MHz	20.9	39.7	20.8	40	-0.48%	0.76%
2019-10-12	2450 MHz	24.5	52.3	24.4	51.4	-0.41%	-1.72%
2019-10-12	2600 MHz	24.8	55	24.56	54.84	-0.97%	-0.29%

## 9 Measurement Procedures

### 9.1 Tests to be performed

In order to determine the highest value of the peak spatial-average SAR of a handset, all device positions, configurations and operational modes shall be tested for each frequency band according to steps 1 to 3 below. A flowchart of the test process is shown in picture 9.1.

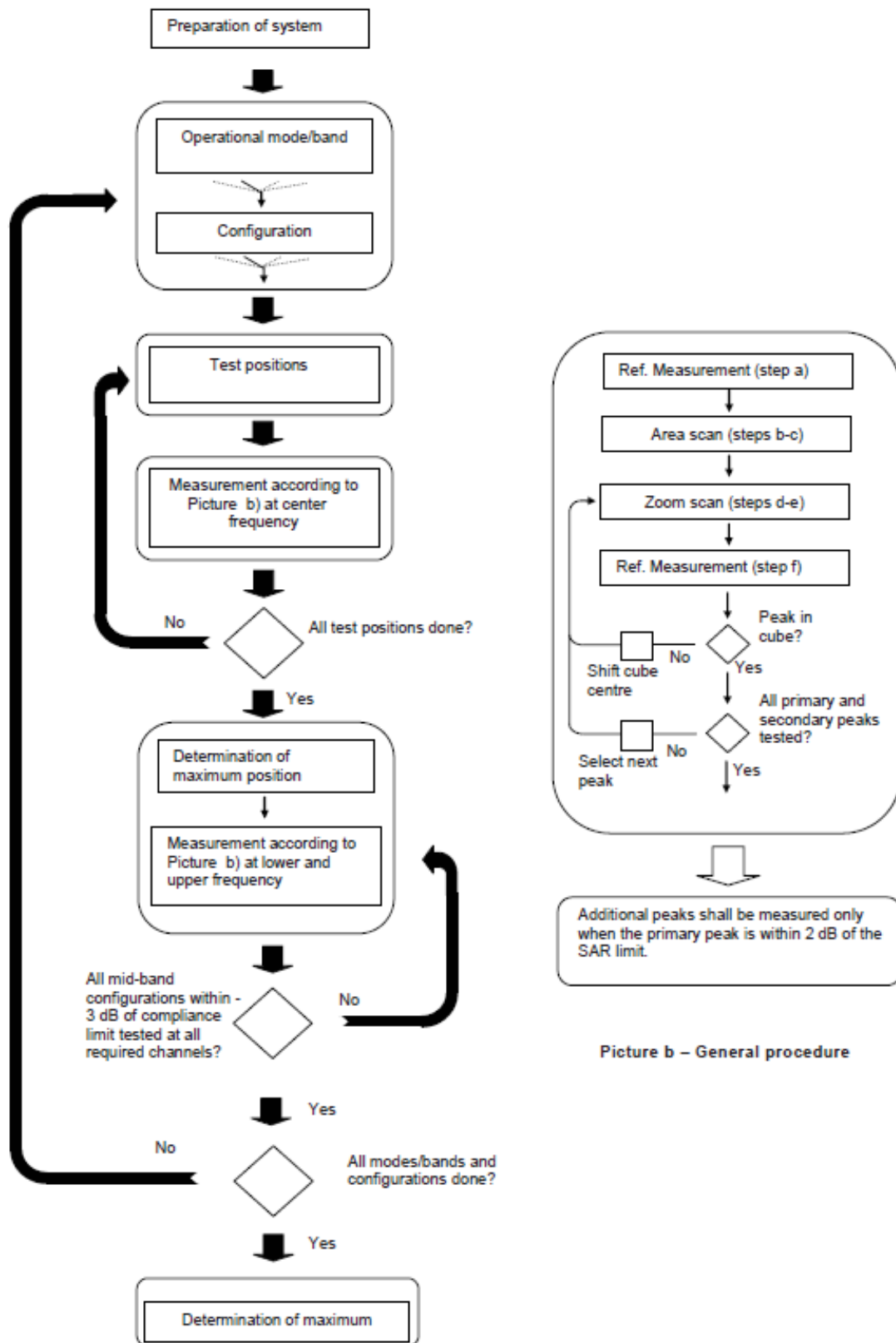
**Step 1:** The tests described in 9.2 shall be performed at the channel that is closest to the centre of the transmit frequency band ( $f_c$ ) for:

- a) all device positions (cheek and tilt, for both left and right sides of the SAM phantom, as described in annex D),
- b) all configurations for each device position in a), e.g., antenna extended and retracted, and
- c) all operational modes, e.g., analogue and digital, for each device position in a) and configuration in b) in each frequency band.

If more than three frequencies need to be tested according to 11.1 (i.e.,  $N_c > 3$ ), then all frequencies, configurations and modes shall be tested for all of the above test conditions.

**Step 2:** For the condition providing highest peak spatial-average SAR determined in Step 1, perform all tests described in 9.2 at all other test frequencies, i.e., lowest and highest frequencies. In addition, for all other conditions (device position, configuration and operational mode) where the peak spatial-average SAR value determined in Step 1 is within 3 dB of the applicable SAR limit, it is recommended that all other test frequencies shall be tested as well.

**Step 3:** Examine all data to determine the highest value of the peak spatial-average SAR found in Steps 1 to 2.



Picture a – Tests to be performed

Picture b – General procedure

Picture 9.1 Block diagram of the tests to be performed

## 9.2 General Measurement Procedure

The area and zoom scan resolutions specified in the table below must be applied to the SAR measurements and fully documented in SAR reports to qualify for TCB approval. Probe boundary effect error compensation is required for measurements with the probe tip closer than half a probe tip diameter to the phantom surface. Both the probe tip diameter and sensor offset distance must satisfy measurement protocols; to ensure probe boundary effect errors are minimized and the higher fields closest to the phantom surface can be correctly measured and extrapolated to the phantom surface for computing 1-g SAR. Tolerances of the post-processing algorithms must be verified by the test laboratory for the scan resolutions used in the SAR measurements, according to the reference distribution functions specified in IEEE Std 1528-2003. The results should be documented as part of the system validation records and may be requested to support test results when all the measurement parameters in the following table are not satisfied.

		$\leq 3$ GHz	$> 3$ GHz
Maximum distance from closest measurement point (geometric center of probe sensors) to phantom surface		$5 \pm 1$ mm	$\frac{1}{2} \cdot \delta \cdot \ln(2) \pm 0.5$ mm
Maximum probe angle from probe axis to phantom surface normal at the measurement location		$30^\circ \pm 1^\circ$	$20^\circ \pm 1^\circ$
Maximum area scan spatial resolution: $\Delta x_{Area}$ , $\Delta y_{Area}$		$\leq 2$ GHz: $\leq 15$ mm 2 – 3 GHz: $\leq 12$ mm	3 – 4 GHz: $\leq 12$ mm 4 – 6 GHz: $\leq 10$ mm
		When the x or y dimension of the test device, in the measurement plane orientation, is smaller than the above, the measurement resolution must be $\leq$ the corresponding x or y dimension of the test device with at least one measurement point on the test device.	
Maximum zoom scan spatial resolution: $\Delta x_{Zoom}$ , $\Delta y_{Zoom}$		$\leq 2$ GHz: $\leq 8$ mm 2 – 3 GHz: $\leq 5$ mm*	3 – 4 GHz: $\leq 5$ mm* 4 – 6 GHz: $\leq 4$ mm*
Maximum zoom scan spatial resolution, normal to phantom surface	uniform grid: $\Delta z_{Zoom}(n)$	$\leq 5$ mm	3 – 4 GHz: $\leq 4$ mm 4 – 5 GHz: $\leq 3$ mm 5 – 6 GHz: $\leq 2$ mm
	graded grid	$\Delta z_{Zoom}(1)$ : between 1 <sup>st</sup> two points closest to phantom surface	$\leq 4$ mm
		$\Delta z_{Zoom}(n>1)$ : between subsequent points	$\leq 1.5 \cdot \Delta z_{Zoom}(n-1)$
Minimum zoom scan volume	x, y, z	$\geq 30$ mm	3 – 4 GHz: $\geq 28$ mm 4 – 5 GHz: $\geq 25$ mm 5 – 6 GHz: $\geq 22$ mm
Note: $\delta$ is the penetration depth of a plane-wave at normal incidence to the tissue medium; see draft standard IEEE P1528-2011 for details. * When zoom scan is required and the <i>reported</i> SAR from the area scan based 1-g SAR estimation procedures of KDB 447498 is $\leq 1.4$ W/kg, $\leq 8$ mm, $\leq 7$ mm and $\leq 5$ mm zoom scan resolution may be applied, respectively, for 2 GHz to 3 GHz, 3 GHz to 4 GHz and 4 GHz to 6 GHz.			

### 9.3 WCDMA Measurement Procedures for SAR

The following procedures are applicable to WCDMA handsets operating under 3GPP Release99, Release 5 and Release 6. The default test configuration is to measure SAR with an established radio link between the DUT and a communication test set using a 12.2kbps RMC (reference measurement channel) configured in Test Loop Mode 1. SAR is selectively confirmed for other physical channel configurations (DPCCH & DPDCH<sub>n</sub>), HSDPA and HSPA (HSUPA/HSDPA) modes according to output power, exposure conditions and device operating capabilities. Both uplink and downlink should be configured with the same RMC or AMR, when required. SAR for Release 5 HSDPA and Release 6 HSPA are measured using the applicable FRC (fixed reference channel) and E-DCH reference channel configurations. Maximum output power is verified according to applicable versions of 3GPP TS 34.121 and SAR must be measured according to these maximum output conditions. When Maximum Power Reduction (MPR) is not implemented according to Cubic Metric (CM) requirements for Release 6 HSPA, the following procedures do not apply.

#### For Release 5 HSDPA Data Devices:

Sub-test	$\beta_c$	$\beta_d$	$\beta_d$ (SF)	$\beta_c/\beta_d$	$\beta_{hs}$	CM/dB
1	2/15	15/15	64	2/15	4/15	0.0
2	12/15	15/15	64	12/15	24/25	1.0
3	15/15	8/15	64	15/8	30/15	1.5
4	15/15	4/15	64	15/4	30/15	1.5

#### For Release 6 HSPA Data Devices

Sub-test	$\beta_c$	$\beta_d$	$\beta_d$ (SF)	$\beta_c/\beta_d$	$\beta_{hs}$	$\beta_{ec}$	$\beta_{ed}$	$\beta_{ed}$ (SF)	$\beta_{ed}$ (codes)	CM (dB)	MPR (dB)	AG Index	E-TFCI
1	11/15	15/15	64	11/15	22/15	209/225	1039/225	4	1	1.5	1.5	20	75
2	6/15	15/15	64	6/15	12/15	12/15	12/15	4	1	1.5	1.5	12	67
3	15/15	9/15	64	15/9	30/15	30/15	$\beta_{ed1}:47/15$ $\beta_{ed2}:47/15$	4	2	1.5	1.5	15	92
4	2/15	15/15	64	2/15	4/15	4/15	56/75	4	1	1.5	1.5	17	71
5	15/15	15/15	64	15/15	24/15	30/15	134/15	4	1	1.5	1.5	21	81

#### Rel.8 DC-HSDPA (Cat 24)

SAR test exclusion for Rel.8 DC-HSDPA must satisfy the SAR test exclusion requirements of Rel.5 HSDPA. SAR test exclusion for DC-HSDPA devices is determined by power measurements according to the H-Set 12, Fixed Reference Channel (FRC) configuration in Table C.8.1.12 of 3GPP TS 34.121-1. A primary and a secondary serving HS-DSCH Cell are required to perform the power measurement and for the results to qualify for SAR test exclusion.



## 9.4 SAR Measurement for LTE

SAR tests for LTE are performed with a base station simulator, Rohde & Schwarz CMW500. Closed loop power control was used so the UE transmits with maximum output power during SAR testing. All powers were measured with the CMW 500.

It is performed for conducted power and SAR based on the KDB941225 D05.

SAR is evaluated separately according to the following procedures for the different test positions in each exposure condition – head, body, body-worn accessories and other use conditions. The procedures in the following subsections are applied separately to test each LTE frequency band.

### 1) QPSK with 1 RB allocation

Start with the largest channel bandwidth and measure SAR for QPSK with 1 RB allocation, using the RB offset and required test channel combination with the highest maximum output power among RB offsets at the upper edge, middle and lower edge of each required test channel. When the reported SAR is  $\leq 0.8$  W/kg, testing of the remaining RB offset configurations and required test channels is not required for 1 RB allocation; otherwise, SAR is required for the remaining required test channels and only for the RB offset configuration with the highest output power for that channel. When the reported SAR of a required test channel is  $> 1.45$  W/kg, SAR is required for all three RB offset configurations for that required test channel.

### 2) QPSK with 50% RB allocation

The procedures required for 1 RB allocation in 1) are applied to measure the SAR for QPSK with 50% RB allocation.

### 3) QPSK with 100% RB allocation

For QPSK with 100% RB allocation, SAR is not required when the highest maximum output power for 100 % RB allocation is less than the highest maximum output power in 50% and 1 RB allocations and the highest reported SAR for 1 RB and 50% RB allocation in 1) and 2) are  $\leq 0.8$  W/kg. Otherwise, SAR is measured for the highest output power channel; and if the reported SAR is  $> 1.45$  W/kg, the remaining required test channels must also be tested.

## 9.5 Bluetooth & Wi-Fi Measurement Procedures for SAR

Normal network operating configurations are not suitable for measuring the SAR of 802.11 transmitters in general. Unpredictable fluctuations in network traffic and antenna diversity conditions can introduce undesirable variations in SAR results. The SAR for these devices should be measured using chipset based test mode software to ensure that the results are consistent and reliable.

Chipset based test mode software is hardware dependent and generally varies among manufacturers. The device operating parameters established in a test mode for SAR measurements must be identical to those programmed in production units, including output power levels, amplifier gain settings and other RF performance tuning parameters. The test frequencies should correspond to actual channel frequencies defined for domestic use. SAR for devices with switched diversity should be measured with only one antenna transmitting at a time during each SAR measurement, according to a fixed modulation and data rate. The same data pattern should be used for all measurements.



## 9.6 Power Drift

To control the output power stability during the SAR test, DASY4 system calculates the power drift by measuring the E-field at the same location at the beginning and at the end of the measurement for each test position. These drift values can be found in section 14 labeled as: (Power Drift [dB]). This ensures that the power drift during one measurement is within 5%.

## 10 Area Scan Based 1-g SAR

### 10.1 Requirement of KDB

According to the KDB447498 D01 v05, when the implementation is based on the specific polynomial fit algorithm as presented at the 29th Bioelectromagnetics Society meeting (2007) and the estimated 1-g SAR is  $\leq 1.2$  W/kg, a zoom scan measurement is not required provided it is also not needed for any other purpose; for example, if the peak SAR location required for simultaneous transmission SAR test exclusion can be determined accurately by the SAR system or manually to discriminate between distinctive peaks and scattered noisy SAR distributions from area scans.

There must not be any warning or alert messages due to various measurement concerns identified by the SAR system; for example, noise in measurements, peaks too close to scan boundary, peaks are too sharp, spatial resolution and uncertainty issues etc. The SAR system verification must also demonstrate that the area scan estimated 1-g SAR is within 3% of the zoom scan 1-g SAR (See Annex B). When all the SAR results for each exposure condition in a frequency band and wireless mode are based on estimated 1-g SAR, the 1-g SAR for the highest SAR configuration must be determined by a zoom scan.

### 10.2 Fast SAR Algorithms

The approach is based on the area scan measurement applying a frequency dependent attenuation parameter. This attenuation parameter was empirically determined by analyzing a large number of phones. The MOTOROLA FAST SAR was developed and validated by the MOTOROLA Research Group in Ft. Lauderdale.

In the initial study, an approximation algorithm based on Linear fit was developed. The accuracy of the algorithm has been demonstrated across a broad frequency range (136-2450 MHz) and for both 1- and 10-g averaged SAR using a sample of 264 SAR measurements from 55 wireless handsets. For the sample size studied, the root-mean-squared errors of the algorithm are 1.2% and 5.8% for 1- and 10-g averaged SAR, respectively. The paper describing the algorithm in detail is expected to be published in August 2004 within the Special Issue of Transactions on MTT.

In the second step, the same research group optimized the fitting algorithm to an Polynomial fit whereby the frequency validity was extended to cover the range 30-6000 MHz. Details of this study can be found in the BEMS 2007 Proceedings.

Both algorithms are implemented in DASY software.

## 11 Conducted Output Power

For Main antenna, there are two sets of tune-up power, Normal power and Low power, used for different use cases for PCS1900/WCDMA1700/ WCDMA1900 and LTE Band2/7/66. Normal power status is applied for head test and body worn test of above bands. Low power status is applied for sensor test of above bands. For other bands, Normal power status is applied for both head and body test.

### 11.1 GSM Measurement result

During the process of testing, the EUT was controlled via Agilent Digital Radio Communication tester (E5515C) to ensure the maximum power transmission and proper modulation. This result contains conducted output power for the EUT. In all cases, the measured peak output power should be greater and within 5% than EMI measurement.

#### Normal Power

**Table 11.1-1: The conducted power measurement results for GSM, GPRS and EGPRS**

GSM 850 Speech (GMSK)	Measured Power (dBm)			Tune up	calculation	Averaged Power (dBm)		
	251	190	128			251	190	128
1 Txslot	33.78	33.49	33.36	35.00	/	/	/	/
GSM 850 GPRS (GMSK)	Measured Power (dBm)				calculation	Averaged Power (dBm)		
	251	190	128			251	190	128
1 Txslot	33.78	33.46	33.35	35.00	-9.03	24.75	24.43	24.32
<b>2 Txslots</b>	<b>32.74</b>	<b>32.43</b>	<b>32.32</b>	<b>33.00</b>	<b>-6.02</b>	<b>26.72</b>	<b>26.41</b>	<b>26.30</b>
3Txslots	30.82	30.51	30.40	31.00	-4.26	26.56	26.25	26.14
4 Txslots	28.73	28.48	28.33	29.00	-3.01	25.72	25.47	25.32
GSM 850 EGPRS (GMSK)	Measured Power (dBm)				calculation	Averaged Power (dBm)		
	251	190	128			251	190	128
1 Txslot	33.67	33.46	33.31	35.00	-9.03	24.64	24.43	24.28
<b>2 Txslots</b>	<b>32.68</b>	<b>32.44</b>	<b>32.28</b>	<b>33.00</b>	<b>-6.02</b>	<b>26.66</b>	<b>26.42</b>	<b>26.26</b>
3Txslots	30.77	30.52	30.34	31.00	-4.26	26.51	26.26	26.08
4 Txslots	28.72	28.41	28.25	29.00	-3.01	25.71	25.40	25.24
GSM 850 EGPRS (8PSK)	Measured Power (dBm)				calculation	Averaged Power (dBm)		
	251	190	128			251	190	128
1 Txslot	27.40	27.44	27.56	29.00	-9.03	18.37	18.41	18.53
2 Txslots	26.40	26.47	26.62	28.00	-6.02	20.38	20.45	20.60
3Txslots	24.36	24.40	24.57	26.00	-4.26	20.10	20.14	20.31
4 Txslots	23.39	23.44	23.60	25.00	-3.01	20.38	20.43	20.59
PCS1900 Speech (GMSK)	Measured Power (dBm)			Tune up	calculation	Averaged Power (dBm)		
	810	661	512			810	661	512
1 Txslot	30.49	30.59	30.74	32.00	/	/	/	/
PCS1900 GPRS (GMSK)	Measured Power (dBm)				calculation	Averaged Power (dBm)		
	810	661	512			810	661	512

1 Txslot	30.42	30.58	30.70	32.00	-9.03	21.39	21.55	21.67
<b>2 Txslots</b>	<b>29.50</b>	<b>29.58</b>	<b>29.67</b>	<b>30.00</b>	<b>-6.02</b>	<b>23.48</b>	<b>23.56</b>	<b>23.65</b>
3Txslots	27.54	27.55	27.56	28.00	-4.26	23.28	23.29	23.30
4 Txslots	25.63	25.53	25.57	27.00	-3.01	22.62	22.52	22.56
PCS1900	Measured Power (dBm)				calculation	Averaged Power (dBm)		
EGPRS (GMSK)	810	661	512			810	661	512
1 Txslot	30.41	30.56	30.70	32.00	-9.03	21.38	21.53	21.67
<b>2 Txslots</b>	<b>29.49</b>	<b>29.59</b>	<b>29.68</b>	<b>30.00</b>	<b>-6.02</b>	<b>23.47</b>	<b>23.57</b>	<b>23.66</b>
3Txslots	27.53	27.52	27.56	28.00	-4.26	23.27	23.26	23.30
4 Txslots	25.62	25.57	25.57	27.00	-3.01	22.61	22.56	22.56
PCS1900	Measured Power (dBm)				calculation	Averaged Power (dBm)		
EGPRS (8PSK)	810	661	512			810	661	512
1 Txslot	26.78	26.85	26.95	27.50	-9.03	17.75	17.82	17.92
2 Txslots	25.75	25.87	25.90	26.50	-6.02	19.73	19.85	19.88
3Txslots	23.65	23.71	23.69	24.00	-4.26	19.39	19.45	19.43
4 Txslots	22.56	22.54	22.60	23.00	-3.01	19.55	19.53	19.59

## NOTES:

## 1) Division Factors

To average the power, the division factor is as follows:

1TX-slot = 1 transmit time slot out of 8 time slots=> conducted power divided by (8/1) => -9.03dB

2TX-slots = 2 transmit time slots out of 8 time slots=> conducted power divided by (8/2) => -6.02dB

3TX-slots = 3 transmit time slots out of 8 time slots=> conducted power divided by (8/3) => -4.26dB

4TX-slots = 4 transmit time slots out of 8 time slots=> conducted power divided by (8/4) => -3.01dB

**According to the conducted power as above, the body measurements are performed with 2Txslots for GSM850 and GSM1900.**

**Low Power**

PCS1900	Measured Power (dBm)				calculation	Averaged Power (dBm)		
GPRS (GMSK)	810	661	512			810	661	512
1 Txslot	30.03	30.32	30.36	32.00	-9.03	21.00	21.29	21.33
2 Txslots	26.73	26.97	26.89	28.00	-6.02	20.71	20.95	20.87
3Txslots	24.22	24.39	24.28	26.00	-4.26	19.96	20.13	20.02
<b>4 Txslots</b>	<b>24.20</b>	<b>24.38</b>	<b>24.37</b>	<b>25.00</b>	<b>-3.01</b>	<b>21.19</b>	<b>21.37</b>	<b>21.36</b>
PCS1900	Measured Power (dBm)				calculation	Averaged Power (dBm)		
EGPRS (GMSK)	810	661	512			810	661	512
1 Txslot	30.03	30.40	30.27	32.00	-9.03	21.00	21.37	21.24
2 Txslots	26.74	26.97	26.89	28.00	-6.02	20.72	20.95	20.87
3Txslots	24.23	24.40	24.28	26.00	-4.26	19.97	20.14	20.02
<b>4 Txslots</b>	<b>24.21</b>	<b>24.39</b>	<b>24.27</b>	<b>25.00</b>	<b>-3.01</b>	<b>21.20</b>	<b>21.38</b>	<b>21.26</b>
PCS1900	Measured Power (dBm)				calculation	Averaged Power (dBm)		
EGPRS (8PSK)	810	661	512			810	661	512
1 Txslot	26.18	26.33	26.56	27.50	-9.03	17.15	17.30	17.53

2 Txslots	23.17	23.05	23.23	24.50	-6.02	17.15	17.03	17.21
3Txslots	20.60	20.56	20.85	22.00	-4.26	16.34	16.30	16.59
4 Txslots	20.54	20.55	20.72	21.00	-3.01	17.53	17.54	17.71

NOTES:

1) Division Factors

To average the power, the division factor is as follows:

1TX-slot = 1 transmit time slot out of 8 time slots=> conducted power divided by (8/1) => -9.03dB

2TX-slots = 2 transmit time slots out of 8 time slots=> conducted power divided by (8/2) => -6.02dB

3TX-slots = 3 transmit time slots out of 8 time slots=> conducted power divided by (8/3) => -4.26dB

4TX-slots = 4 transmit time slots out of 8 time slots=> conducted power divided by (8/4) => -3.01dB

**According to the conducted power as above, the body measurements are performed with 4Txslots for GSM1900.**

## 11.2 WCDMA Measurement result

Normal power

**Table 11.2-1: The conducted Power for WCDMA**

Item	band	FDDV result			
	ARFCN	4233 (846.6MHz)	4182 (836.4MHz)	4132 (826.4MHz)	Tune up
WCDMA	\	24.40	24.37	24.39	25.00
HSUPA	1	21.34	21.33	21.31	22.50
	2	21.36	21.31	21.30	22.50
	3	22.32	22.29	22.27	23.00
	4	20.86	20.80	20.82	22.00
	5	22.31	22.28	22.30	23.50
HSPA+(16QAM)		22.37	22.33	22.46	23.50
DC-HSDPA	1	23.33	23.32	23.29	23.50
	2	23.22	23.17	23.19	23.50
	3	22.78	22.78	22.81	23.50
	4	22.78	22.77	22.76	23.50
Item	band	FDDIV result			
	ARFCN	1513 (1752.6MHz)	1412 (1732.4MHz)	1312 (1712.4MHz)	
WCDMA	\	23.48	23.51	23.55	25.00
HSUPA	1	20.35	20.34	20.43	23.00
	2	20.45	20.43	20.55	23.00
	3	21.46	21.40	21.52	23.50
	4	19.94	19.91	19.98	22.00
	5	21.4	21.41	21.51	23.50
HSPA+(16QAM)		22.05	22.03	22.07	23.50
DC-HSDPA	1	22.44	22.42	22.59	23.50

	<b>2</b>	22.34	22.39	22.42	23.50
	<b>3</b>	21.93	21.97	22.05	23.50
	<b>4</b>	21.92	21.96	22.06	23.50
<b>Item</b>	<b>band</b>	<b>FDDII result</b>			
	<b>ARFCN</b>	<b>9538 (1907.6MHz)</b>	<b>9400 (1880MHz)</b>	<b>9262 (1852.4MHz)</b>	<b>Tune up</b>
<b>WCDMA</b>	<b>\</b>	24.50	24.50	24.56	25.00
<b>HSUPA</b>	<b>1</b>	21.31	21.35	21.30	22.00
	<b>2</b>	21.36	21.37	21.34	22.00
	<b>3</b>	22.35	22.33	22.34	23.00
	<b>4</b>	20.84	20.83	20.81	21.50
	<b>5</b>	22.32	22.31	22.28	23.00
<b>HSPA+(16QAM)</b>		22.45	22.52	22.60	23.00
<b>DC-HSDPA</b>	<b>1</b>	23.37	23.38	23.34	23.00
	<b>2</b>	23.31	23.29	23.36	23.00
	<b>3</b>	22.87	22.90	22.86	23.00
	<b>4</b>	22.83	22.87	22.85	23.00

**Low power**
**Table 11.2-2: The conducted Power for WCDMA**

<b>Item</b>	<b>band</b>	<b>FDDIV result</b>			
	<b>ARFCN</b>	<b>1513 (1752.6MHz)</b>	<b>1412(1732.4MHz)</b>	<b>1312 (1712.4MHz)</b>	<b>Tune up</b>
<b>WCDMA</b>	<b>\</b>	17.83	17.87	17.81	22.00
<b>HSUPA</b>	<b>1</b>	14.89	14.91	14.93	20.00
	<b>2</b>	14.9	14.88	14.89	20.00
	<b>3</b>	15.9	15.83	15.82	20.50
	<b>4</b>	14.39	14.35	14.37	19.00
	<b>5</b>	15.89	15.81	15.79	20.50
<b>HSPA+(16QAM)</b>		16.36	16.44	16.30	20.50
<b>DC-HSDPA</b>	<b>1</b>	15.91	15.93	15.99	20.50
	<b>2</b>	15.84	15.78	15.93	20.50
	<b>3</b>	15.44	15.39	15.43	20.50
	<b>4</b>	15.39	15.41	15.44	20.50
<b>Item</b>	<b>band</b>	<b>FDDII result</b>			
	<b>ARFCN</b>	<b>9538 (1907.6MHz)</b>	<b>9400 (1880MHz)</b>	<b>9262 (1852.4MHz)</b>	<b>Tune up</b>
<b>WCDMA</b>	<b>\</b>	21.06	21.07	21.03	19.00
<b>HSUPA</b>	<b>1</b>	18.11	18.13	18.15	16.00
	<b>2</b>	18.05	18.01	18.02	16.00
	<b>3</b>	19.04	19.07	19.01	17.00
	<b>4</b>	17.51	17.52	17.48	15.50
	<b>5</b>	18.91	18.93	18.98	17.00
<b>HSPA+(16QAM)</b>		19.65	19.63	19.59	17.00
<b>DC-HSDPA</b>	<b>1</b>	19.17	19.14	19.13	17.00

<b>2</b>	19.15	19.10	19.04	17.00
<b>3</b>	18.67	18.62	18.58	17.00
<b>4</b>	18.68	18.61	18.59	17.00

### 11.3 LTE Measurement result

**Table 13.3-1: Maximum Power Reduction (MPR) for LTE**

Modulation	Channel bandwidth / Transmission bandwidth configuration [RB]						MPR (dB)
	1.4 MHz	3 MHz	5 MHz	10 MHz	15 MHz	20 MHz	
QPSK	> 5	> 4	> 8	> 12	> 16	> 18	1
16 QAM	≤ 5	≤ 4	≤ 8	≤ 12	≤ 16	≤ 18	1
16 QAM	> 5	> 4	> 8	> 12	> 16	> 18	2

**Table 13.3-2: The tune up for LTE – Normal Power**

Band	Tune up
LTE Band 2	25
LTE Band 5	25
LTE Band 7	25
LTE Band 12	25
LTE Band 66	25

**Table 13.3-3: The tune up for LTE – Low Power**

Band	Tune up
LTE Band 2	23
LTE Band 7	22
LTE Band 66	20

## Normal power

Table 11.3-4: The conducted Power for LTE

Band 2						
Bandwidth (MHz)	RB allocation RB offset (Start RB)	Frequency (MHz)	QPSK	16QAM	64QAM	
			Actual output power (dBm)	Actual output power (dBm)	Actual output power (dBm)	
1.4 MHz	1RB High (5)	1909.3	24.56	23.60	22.78	
		1880	24.50	23.58	22.76	
		1850.7	24.58	23.55	22.84	
	1RB Middle (3)	1909.3	24.51	23.54	22.91	
		1880	24.48	23.54	22.84	
		1850.7	24.53	23.53	22.92	
	1RB Low (0)	1909.3	24.05	22.98	22.23	
		1880	24.02	22.95	22.21	
		1850.7	24.08	22.98	22.31	
	3RB High (3)	1909.3	24.59	23.52	22.91	
		1880	24.57	23.47	22.89	
		1850.7	24.52	23.55	22.95	
	3RB Middle (1)	1909.3	24.41	23.16	22.58	
		1880	24.37	23.13	22.56	
		1850.7	24.43	23.18	22.63	
	3RB Low (0)	1909.3	24.19	22.92	22.36	
		1880	24.13	22.91	22.32	
		1850.7	24.17	22.97	22.38	
	6RB (0)	1909.3	23.51	22.27	21.58	
		1880	23.44	22.22	21.54	
		1850.7	23.49	22.27	21.62	
	3 MHz	1RB High (14)	1908.5	24.51	23.59	22.95
			1880	24.57	23.59	22.93
			1851.5	24.53	23.59	22.91
		1RB Middle (7)	1908.5	24.41	23.32	22.76
			1880	24.38	23.29	22.73
			1851.5	24.44	23.38	22.85
1RB Low (0)		1908.5	24.04	22.96	22.29	
		1880	24.02	22.93	22.27	
		1851.5	24.09	23.03	22.36	
8RB High (7)		1908.5	23.51	22.50	21.93	
		1880	23.53	22.47	21.86	
		1851.5	23.51	22.50	21.92	
8RB Middle (4)		1908.5	23.53	22.34	21.76	
		1880	23.48	22.26	21.69	
		1851.5	23.52	22.32	21.75	
8RB Low (0)		1908.5	23.14	21.96	21.36	
		1880	23.09	21.90	21.31	
		1851.5	23.15	21.96	21.35	
15RB		1908.5	23.46	22.20	21.61	

	(0)	1880	23.38	22.15	21.55
		1851.5	23.44	22.21	21.62
5 MHz	1RB High (24)	1907.5	24.55	23.53	22.81
		1880	24.50	23.51	22.78
		1852.5	24.58	23.60	22.84
	1RB Middle (12)	1907.5	24.33	23.27	22.75
		1880	24.33	23.33	22.74
		1852.5	24.43	23.40	22.82
	1RB Low (0)	1907.5	23.90	22.86	22.18
		1880	23.85	22.86	22.16
		1852.5	23.93	22.92	22.22
	12RB High (13)	1907.5	23.54	22.51	21.91
		1880	23.47	22.46	21.86
		1852.5	23.56	22.55	21.96
	12RB Middle (6)	1907.5	23.44	22.23	21.68
		1880	23.36	22.18	21.63
		1852.5	23.43	22.23	21.69
	12RB Low (0)	1907.5	23.08	21.87	21.31
		1880	23.01	21.79	21.25
		1852.5	23.07	21.85	21.32
	25RB (0)	1907.5	23.44	22.26	21.65
		1880	23.37	22.18	21.56
		1852.5	23.41	22.26	21.62
10 MHz	1RB High (49)	1905	24.58	23.55	22.83
		1880	24.51	23.52	22.81
		1855	24.55	23.55	22.84
	1RB Middle (24)	1905	24.12	23.05	22.45
		1880	24.10	23.07	22.48
		1855	24.18	23.16	22.58
	1RB Low (0)	1905	23.97	22.88	22.24
		1880	23.95	22.89	22.22
		1855	24.03	22.99	22.33
	25RB High (25)	1905	23.51	22.54	21.92
		1880	23.58	22.49	21.91
		1855	23.55	22.57	21.98
	25RB Middle (12)	1905	23.41	22.23	21.65
		1880	23.37	22.22	21.61
		1855	23.43	22.27	21.66
	25RB Low (0)	1905	23.15	21.96	21.35
		1880	23.06	21.85	21.27
		1855	23.09	21.94	21.35
	50RB (0)	1905	23.42	22.22	21.63
		1880	23.36	22.18	21.62
		1855	23.44	22.25	21.69
15 MHz	1RB High (74)	1902.5	24.45	23.43	22.74
		1880	24.40	23.41	22.73
		1857.5	24.44	23.43	22.70
	1RB	1902.5	24.28	23.23	22.71



	Middle (37)	1880	24.21	23.22	22.68	
		1857.5	24.30	23.28	22.77	
	1RB Low (0)	1902.5	23.84	22.83	22.17	
		1880	23.81	22.78	22.14	
	36RB High (38)	1857.5	23.94	22.98	22.35	
		1902.5	23.54	22.44	21.90	
		1880	23.51	22.43	21.89	
	36RB Middle (19)	1857.5	23.57	22.49	21.95	
		1902.5	23.34	22.16	21.58	
		1880	23.34	22.15	21.60	
	36RB Low (0)	1857.5	23.40	22.21	21.67	
		1902.5	23.08	21.87	21.32	
		1880	23.01	21.81	21.27	
	75RB (0)	1857.5	23.07	21.89	21.35	
		1902.5	23.32	22.15	21.58	
		1880	23.31	22.16	21.56	
	20 MHz	1RB High (99)	1857.5	23.38	22.21	21.63
			1900	24.24	23.27	22.61
1880			24.15	23.22	22.54	
1RB Middle (50)		1860	24.24	23.25	22.57	
		1900	24.49	23.49	22.94	
		1880	24.47	23.50	22.93	
1RB Low (0)		1860	24.56	23.54	22.95	
		1900	23.70	22.75	22.09	
		1880	23.64	22.60	22.00	
50RB High (50)		1860	23.76	22.78	22.17	
		1900	23.52	22.33	21.75	
		1880	23.54	22.39	21.82	
50RB Middle (25)		1860	23.55	22.38	21.85	
		1900	23.36	22.17	21.63	
		1880	23.31	22.16	21.61	
50RB Low (0)		1860	23.40	22.23	21.69	
		1900	23.06	21.88	21.31	
		1880	22.94	21.78	21.25	
100RB (0)		1860	23.02	21.86	21.35	
		1900	23.27	22.12	21.54	
		1880	23.26	22.12	21.58	
			1860	23.28	22.13	21.61

Band 5						
Bandwidth (MHz)	RB allocation	Frequency (MHz)	QPSK	16QAM	64QAM	
	RB offset (Start RB)		Actual output power (dBm)	Actual output power (dBm)	Actual output power (dBm)	
1.4 MHz	1RB High (5)	848.3	24.35	23.46	22.84	
		836.5	24.35	23.50	22.78	
		824.7	24.39	23.45	22.82	
	1RB Middle (3)	848.3	24.32	23.42	22.81	
		836.5	24.31	23.44	22.86	
		824.7	24.37	23.43	22.88	
	1RB Low (0)	848.3	23.71	22.85	22.18	
		836.5	23.71	22.85	22.21	
		824.7	23.75	22.82	22.20	
	3RB High (3)	848.3	24.43	23.39	22.88	
		836.5	24.42	23.36	22.86	
		824.7	24.46	23.38	22.89	
	3RB Middle (1)	848.3	24.07	23.00	22.52	
		836.5	24.09	23.03	22.52	
		824.7	24.11	22.98	22.52	
	3RB Low (0)	848.3	23.80	22.81	22.26	
		836.5	23.85	22.80	22.27	
		824.7	23.88	22.80	22.29	
	6RB (0)	848.3	23.19	22.15	21.51	
		836.5	23.16	22.11	21.46	
		824.7	23.20	22.16	21.54	
	3 MHz	1RB High (14)	847.5	24.38	23.50	22.85
			836.5	24.36	23.45	22.84
			825.5	24.40	23.51	22.86
		1RB Middle (7)	847.5	24.03	23.14	22.62
			836.5	24.14	23.21	22.61
			825.5	24.11	23.18	22.65
1RB Low (0)		847.5	23.71	22.81	22.16	
		836.5	23.74	22.83	22.25	
		825.5	23.77	22.82	22.21	
8RB High (7)		847.5	23.41	22.37	21.78	
		836.5	23.38	22.35	21.81	
		825.5	23.42	22.40	21.84	
8RB Middle (4)		847.5	23.19	22.18	21.61	
		836.5	23.19	22.20	21.62	
		825.5	23.22	22.19	21.68	
8RB Low (0)		847.5	22.81	21.78	21.18	
		836.5	22.84	21.83	21.25	
		825.5	22.86	21.82	21.30	
15RB (0)		847.5	23.14	22.08	21.47	
		836.5	23.15	22.10	21.49	
		825.5	23.16	22.12	21.54	
5 MHz		1RB	846.5	24.28	23.43	22.76

	High (24)	836.5	24.24	23.36	22.66	
		826.5	24.27	23.45	22.73	
	1RB Middle (12)	846.5	24.10	23.23	22.63	
		836.5	24.09	23.24	22.62	
		826.5	24.11	23.22	22.64	
	1RB Low (0)	846.5	23.57	22.74	22.04	
		836.5	23.63	22.77	22.11	
		826.5	23.66	22.76	22.05	
	12RB High (13)	846.5	23.41	22.36	21.81	
		836.5	23.44	22.36	21.78	
		826.5	23.46	22.43	21.89	
	12RB Middle (6)	846.5	23.14	22.09	21.52	
		836.5	23.15	22.11	21.53	
		826.5	23.16	22.11	21.58	
	12RB Low (0)	846.5	22.78	21.75	21.15	
		836.5	22.80	21.78	21.18	
		826.5	22.76	21.73	21.19	
	25RB (0)	846.5	23.13	22.11	21.46	
		836.5	23.13	22.13	21.48	
		826.5	23.15	22.14	21.52	
	10 MHz	1RB High (49)	844.0	24.37	23.50	22.79
			836.5	24.33	23.48	22.74
			829.0	24.35	23.50	22.80
		1RB Middle (24)	844.0	23.79	22.90	22.33
836.5			23.85	22.95	22.38	
829.0			23.84	22.98	22.45	
1RB Low (0)		844.0	23.66	22.77	22.08	
		836.5	23.71	22.87	22.19	
		829.0	23.75	22.78	22.14	
25RB High (25)		844.0	23.44	22.40	21.76	
		836.5	23.47	22.44	21.81	
		829.0	23.51	22.51	21.86	
25RB Middle (12)		844.0	23.16	22.13	21.48	
		836.5	23.15	22.13	21.49	
		829.0	23.17	22.16	21.56	
25RB Low (0)		844.0	22.84	21.83	21.17	
		836.5	22.84	21.84	21.17	
		829.0	22.82	21.82	21.21	
50RB (0)		844.0	23.15	22.13	21.49	
		836.5	23.17	22.15	21.53	
		829.0	23.20	22.17	21.58	

Band 7						
Bandwidth (MHz)	RB allocation	Frequency (MHz)	QPSK	16QAM	64QAM	
	RB offset (Start RB)		Actual output power (dBm)	Actual output power (dBm)	Actual output power (dBm)	
5 MHz	1RB High (24)	2567.5	23.78	22.99	22.33	
		2535	23.73	22.99	22.28	
		2502.5	23.75	22.94	22.29	
	1RB Middle (12)	2567.5	23.59	22.85	22.28	
		2535	23.58	22.77	22.17	
		2502.5	23.55	22.76	22.18	
	1RB Low (0)	2567.5	23.10	22.33	21.74	
		2535	23.09	22.33	21.66	
		2502.5	23.09	22.27	21.65	
	12RB High (13)	2567.5	22.94	22.04	21.42	
		2535	22.91	22.00	21.35	
		2502.5	22.95	22.00	21.47	
	12RB Middle (6)	2567.5	22.67	21.76	21.21	
		2535	22.64	21.70	21.09	
		2502.5	22.64	21.70	21.19	
	12RB Low (0)	2567.5	22.32	21.40	20.86	
		2535	22.26	21.33	20.72	
		2502.5	22.28	21.32	20.80	
	25RB (0)	2567.5	22.67	21.74	21.17	
		2535	22.63	21.72	21.06	
		2502.5	22.65	21.70	21.15	
	10 MHz	1RB High (49)	2565	23.94	23.01	21.46
			2535	23.93	23.02	22.45
			2505	23.94	23.09	22.46
1RB Middle (24)		2565	23.38	22.60	22.09	
		2535	23.38	22.60	22.04	
		2505	23.41	22.50	22.01	
1RB Low (0)		2565	23.27	22.50	21.92	
		2535	23.27	22.46	21.84	
		2505	23.25	22.40	21.82	
25RB High (25)		2565	23.04	22.10	21.46	
		2535	23.05	22.02	21.41	
		2505	23.09	22.01	21.42	
25RB Middle (12)		2565	22.69	21.79	21.22	
		2535	22.69	21.74	21.13	
		2505	22.74	21.76	21.21	
25RB Low (0)		2565	22.42	21.50	20.96	
		2535	22.40	21.45	20.78	
		2505	22.37	21.39	20.77	
50RB (0)		2565	22.71	21.78	21.22	
		2535	22.75	21.81	21.05	
		2505	22.73	21.76	21.17	
15 MHz		1RB	2562.5	23.88	23.10	22.44

	High (74)	2535	23.87	23.06	22.33	
		2507.5	23.86	23.08	22.41	
	1RB Middle (37)	2562.5	23.68	22.87	22.34	
		2535	23.64	22.83	22.23	
	1RB Low (0)	2507.5	23.66	22.78	22.18	
		2562.5	23.22	22.44	21.82	
		2535	23.19	22.39	21.67	
	36RB High (38)	2507.5	23.15	22.27	21.69	
		2562.5	23.07	22.02	21.45	
		2535	23.06	22.07	21.43	
	36RB Middle (19)	2507.5	23.08	22.01	21.47	
		2562.5	22.74	21.81	21.23	
		2535	22.74	21.77	21.15	
	36RB Low (0)	2507.5	22.74	21.74	21.19	
		2562.5	22.40	21.45	20.89	
		2535	22.37	21.42	20.73	
	75RB (0)	2507.5	22.35	21.35	20.78	
		2562.5	22.73	21.79	21.17	
		2535	22.72	21.76	21.04	
	20 MHz	1RB High (99)	2507.5	22.75	21.77	21.14
			2560	23.72	22.91	22.29
			2535	23.66	22.86	22.11
		1RB Middle (50)	2510	23.71	22.92	22.25
			2560	23.88	23.02	22.47
2535			23.89	23.06	22.47	
1RB Low (0)		2510	23.88	23.03	22.41	
		2560	23.01	22.27	21.58	
		2535	23.02	22.21	21.56	
50RB High (50)		2510	22.99	22.23	21.48	
		2560	22.99	22.04	21.49	
		2535	23.09	22.08	21.41	
50RB Middle (25)		2510	23.10	22.05	21.46	
		2560	22.79	21.85	21.31	
		2535	22.77	21.80	21.21	
50RB Low (0)		2510	22.77	21.80	21.27	
		2560	22.38	21.45	20.92	
		2535	22.34	21.38	20.82	
100RB (0)		2510	22.32	21.33	20.84	
		2560	22.69	21.79	21.27	
		2535	22.72	21.76	21.19	
			2510	22.73	21.76	21.26

Band 12						
Bandwidth (MHz)	RB allocation RB offset (Start RB)	Frequency (MHz)	QPSK	16QAM	64QAM	
			Actual output power (dBm)	Actual output power (dBm)	Actual output power (dBm)	
1.4 MHz	1RB High (5)	715.3	24.36	23.42	22.75	
		707.5	24.42	23.49	22.80	
		699.7	24.39	23.50	22.80	
	1RB Middle (3)	715.3	24.33	23.38	22.79	
		707.5	24.34	23.42	22.81	
		699.7	24.35	23.42	22.80	
	1RB Low (0)	715.3	23.70	22.79	22.09	
		707.5	23.73	22.84	22.14	
		699.7	23.70	22.81	22.11	
	3RB High (3)	715.3	24.47	23.36	22.75	
		707.5	24.49	23.41	22.81	
		699.7	24.48	23.40	22.79	
	3RB Middle (1)	715.3	24.10	23.00	22.43	
		707.5	24.06	23.02	22.42	
		699.7	24.07	23.01	22.41	
	3RB Low (0)	715.3	23.87	22.80	22.17	
		707.5	23.85	22.83	22.18	
		699.7	23.83	22.82	22.17	
	6RB (0)	715.3	23.19	22.16	21.40	
		707.5	23.21	22.18	21.42	
		699.7	23.14	22.16	21.39	
	3 MHz	1RB High (14)	714.5	24.49	23.51	22.75
			707.5	24.50	23.58	22.83
			700.5	24.47	23.60	22.82
		1RB Middle (7)	714.5	24.14	23.21	22.49
			707.5	24.14	23.19	22.52
			700.5	24.12	23.22	22.53
1RB Low (0)		714.5	23.84	22.92	22.14	
		707.5	23.82	22.90	22.16	
		700.5	23.78	22.88	22.12	
8RB High (7)		714.5	23.46	22.46	21.75	
		707.5	23.49	22.52	21.77	
		700.5	23.46	22.47	21.73	
8RB Middle (4)		714.5	23.25	22.25	21.50	
		707.5	23.27	22.29	21.54	
		700.5	23.25	22.27	21.51	
8RB Low (0)		714.5	22.89	21.90	21.15	
		707.5	22.89	21.92	21.17	
		700.5	22.86	21.88	21.13	
15RB (0)		714.5	23.20	22.16	21.40	
		707.5	23.25	22.22	21.45	
		700.5	23.20	22.17	21.42	
5 MHz		1RB High (24)	713.5	24.40	23.44	22.60
			707.5	24.38	23.48	22.62

	1RB Middle (12)	701.5	24.39	23.52	22.65
		713.5	24.13	23.32	22.54
		707.5	24.11	23.16	22.50
		701.5	24.13	23.28	22.51
	1RB Low (0)	713.5	23.72	22.82	22.00
		707.5	23.74	22.87	22.01
		701.5	23.70	22.79	21.97
	12RB High (13)	713.5	23.55	22.50	21.73
		707.5	23.54	22.52	21.77
		701.5	23.53	22.51	21.74
	12RB Middle (6)	713.5	23.24	22.19	21.44
		707.5	23.24	22.21	21.45
		701.5	23.21	22.19	21.42
	12RB Low (0)	713.5	22.92	21.88	21.11
		707.5	22.88	21.87	21.09
		701.5	22.89	21.86	21.10
	25RB (0)	713.5	23.25	22.26	21.42
		707.5	23.28	22.27	21.44
701.5		23.23	22.21	21.41	
10 MHz	1RB High (49)	711	24.49	23.53	22.65
		707.5	24.47	23.57	22.72
		704	24.47	23.54	22.68
	1RB Middle (24)	711	24.00	23.10	22.32
		707.5	23.94	23.04	22.30
		704	23.97	23.09	22.33
	1RB Low (0)	711	23.77	22.87	22.00
		707.5	23.77	22.89	22.03
		704	23.76	22.86	22.00
	25RB High (25)	711	23.58	22.58	21.77
		707.5	23.57	22.57	21.71
		704	23.60	22.51	21.78
	25RB Middle (12)	711	23.30	22.28	21.43
		707.5	23.29	22.27	21.44
		704	23.28	22.29	21.47
	25RB Low (0)	711	22.97	21.97	21.12
		707.5	22.91	21.90	21.07
		704	22.95	21.93	21.12
	50RB (0)	711	23.29	22.28	21.44
		707.5	23.28	22.26	21.44
		704	23.33	22.30	21.49

Band 66					
Bandwidth (MHz)	RB allocation	Frequency (MHz)	QPSK	16QAM	64QAM
	RB offset (Start RB)		Actual output power (dBm)	Actual output power (dBm)	Actual output power (dBm)
1.4 MHz	1RB High (5)	1779.3	23.62	22.50	21.91
		1745	23.67	22.64	22.05
		1710.7	23.66	23.09	22.50
	1RB Middle (3)	1779.3	23.51	22.68	22.09
		1745	23.59	22.81	22.22
		1710.7	23.64	23.30	22.71
	1RB Low (0)	1779.3	23.59	22.52	21.93
		1745	23.58	22.64	22.05
		1710.7	23.66	23.09	22.50
	3RB High (3)	1779.3	23.63	22.78	22.19
		1745	23.57	22.64	22.05
		1710.7	23.82	23.02	22.43
	3RB Middle (1)	1779.3	23.75	22.80	22.21
		1745	23.65	22.67	22.08
		1710.7	23.86	23.01	22.42
	3RB Low (0)	1779.3	23.68	22.70	22.11
		1745	23.63	22.64	22.05
		1710.7	23.80	22.99	22.40
	6RB (0)	1779.3	22.70	21.83	21.24
		1745	22.66	21.81	21.22
		1710.7	22.80	21.75	21.16
3 MHz	1RB High (14)	1778.5	23.76	22.46	21.62
		1745	23.63	22.89	22.05
		1711.5	23.92	22.69	21.85
	1RB Middle (7)	1778.5	23.59	22.53	21.69
		1745	23.67	23.05	22.21
		1711.5	23.86	22.89	22.05
	1RB Low (0)	1778.5	23.62	22.43	21.59
		1745	23.37	22.90	22.06
		1711.5	23.73	22.79	21.95
	8RB High (7)	1778.5	23.86	21.68	20.84
		1745	23.75	21.68	20.84
		1711.5	23.49	21.80	20.96
	8RB Middle (4)	1778.5	22.64	21.77	20.93
		1745	22.60	21.73	20.89
		1711.5	22.74	21.88	21.04
	8RB Low (0)	1778.5	22.61	21.74	20.90
		1745	22.60	21.70	20.86
		1711.5	22.78	21.83	20.99
15RB (0)	1778.5	22.58	21.62	20.78	
	1745	22.59	21.64	20.80	



		1711.5	22.71	21.75	20.91
5 MHz	1RB High (24)	1777.5	23.52	22.66	21.66
		1745	23.57	23.00	22.00
		1712.5	23.62	22.79	21.79
	1RB Middle (12)	1777.5	23.80	22.90	21.90
		1745	23.85	23.27	22.27
		1712.5	23.89	22.99	21.99
	1RB Low (0)	1777.5	23.55	22.68	21.68
		1745	23.62	23.00	22.00
		1712.5	23.66	22.78	21.78
	12RB High (13)	1777.5	22.60	21.69	20.69
		1745	22.63	21.71	20.71
		1712.5	22.78	21.84	20.84
	12RB Middle (6)	1777.5	22.70	21.77	20.77
		1745	22.68	21.81	20.81
		1712.5	22.85	21.88	20.88
	12RB Low (0)	1777.5	22.67	21.74	20.74
		1745	22.63	21.75	20.75
		1712.5	22.77	21.82	20.82
	25RB (0)	1777.5	22.63	21.67	20.67
		1745	22.63	21.72	20.72
		1712.5	22.74	21.77	20.77
10 MHz	1RB High (49)	1775	23.60	22.42	21.60
		1745	23.64	22.88	22.06
		1715	23.70	22.68	21.86
	1RB Middle (24)	1775	23.74	22.60	21.78
		1745	23.75	23.02	22.20
		1715	23.83	22.85	22.03
	1RB Low (0)	1775	23.61	22.41	21.59
		1745	23.68	22.85	22.03
		1715	23.66	22.73	21.91
	25RB High (25)	1775	22.57	21.65	20.83
		1745	22.65	21.64	20.82
		1715	22.82	21.89	21.07
	25RB Middle (12)	1775	22.65	21.69	20.87
		1745	22.66	21.66	20.84
		1715	22.79	21.90	21.08
	25RB Low (0)	1775	22.67	21.69	20.87
		1745	22.68	21.72	20.90
		1715	22.75	21.85	21.03
	50RB (0)	1775	22.62	21.67	20.85
		1745	22.65	21.64	20.82
		1715	22.82	21.85	21.03
15 MHz	1RB High (74)	1772.5	23.53	22.37	21.57
		1745	23.60	22.81	22.01
		1717.5	23.65	22.99	22.19
	1RB Middle	1772.5	23.71	22.50	21.70
		1745	23.73	22.93	22.13

	(37)	1717.5	23.78	23.14	22.34	
	1RB Low (0)	1772.5	23.54	22.39	21.59	
		1745	23.61	22.84	22.04	
		1717.5	23.70	23.06	22.26	
	36RB High (38)	1772.5	22.72	21.63	20.83	
		1745	22.69	21.68	20.88	
		1717.5	22.83	21.78	20.98	
	36RB Middle (19)	1772.5	22.78	21.69	20.89	
		1745	22.75	21.73	20.93	
		1717.5	22.83	21.74	20.94	
	36RB Low (0)	1772.5	22.77	21.71	20.91	
		1745	22.77	21.76	20.96	
		1717.5	22.81	21.72	20.92	
	75RB (0)	1772.5	22.76	21.71	20.91	
		1745	22.73	21.70	20.90	
		1717.5	22.81	21.77	20.97	
	<b>20 MHz</b>	1RB High (99)	1770	23.28	22.63	21.12
			1745	23.29	22.66	21.15
			1720	23.38	22.88	21.37
		1RB Middle (50)	1770	23.87	23.06	21.55
			1745	23.78	23.06	21.55
			1720	23.85	23.35	21.84
		1RB Low (0)	1770	23.29	22.66	21.15
			1745	23.33	22.66	21.15
			1720	23.42	22.95	21.44
		50RB High (50)	1770	22.87	21.53	20.02
			1745	22.52	21.54	20.03
1720			22.71	21.79	20.28	
50RB Middle (25)		1770	22.64	21.67	20.16	
		1745	22.65	21.61	20.10	
		1720	22.77	21.78	20.27	
50RB Low (0)		1770	22.61	21.65	20.14	
		1745	22.67	21.62	20.11	
		1720	22.70	21.74	20.23	
100RB (0)		1770	22.68	21.61	20.10	
		1745	22.64	21.61	20.10	
		1720	22.65	21.71	20.20	

## Low power

Table 11.3-5: The conducted Power for LTE

Band 2						
Bandwidth (MHz)	RB allocation	Frequency (MHz)	QPSK	16QAM	64QAM	
	RB offset (Start RB)		Actual output power (dBm)	Actual output power (dBm)	Actual output power (dBm)	
1.4 MHz	1RB High (5)	1909.3	21.51	20.64	20.08	
		1880	21.54	20.69	20.13	
		1850.7	21.58	20.97	20.41	
	1RB Middle (3)	1909.3	21.72	20.80	20.24	
		1880	21.73	20.81	20.25	
		1850.7	21.75	20.82	20.26	
	1RB Low (0)	1909.3	21.49	20.63	20.07	
		1880	21.57	20.69	20.13	
		1850.7	21.60	20.97	20.41	
	3RB High (3)	1909.3	21.70	20.91	20.35	
		1880	21.64	20.70	20.14	
		1850.7	21.64	20.92	20.36	
	3RB Middle (1)	1909.3	21.73	20.89	20.33	
		1880	21.66	20.77	20.21	
		1850.7	21.73	20.94	20.38	
	3RB Low (0)	1909.3	21.67	20.87	20.31	
		1880	21.62	20.69	20.13	
		1850.7	21.69	20.91	20.35	
	6RB (0)	1909.3	20.62	19.86	19.30	
		1880	20.59	19.76	19.20	
		1850.7	20.64	19.57	19.01	
	3 MHz	1RB High (14)	1908.5	21.55	20.63	20.07
			1880	21.53	20.53	19.97
			1851.5	21.62	20.92	20.36
		1RB Middle (7)	1908.5	21.71	20.84	20.28
			1880	21.68	20.68	20.12
			1851.5	21.78	20.98	20.42
1RB Low (0)		1908.5	21.56	20.64	20.08	
		1880	21.49	20.56	20.00	
		1851.5	21.63	20.69	20.13	
8RB High (7)		1908.5	20.60	19.72	19.16	
		1880	20.57	19.73	19.17	
		1851.5	20.59	19.72	19.16	
8RB Middle (4)		1908.5	20.65	19.75	19.19	
		1880	20.63	19.77	19.21	
		1851.5	20.66	19.80	19.24	
8RB Low (0)		1908.5	20.65	19.71	19.15	
		1880	20.64	19.72	19.16	
		1851.5	20.64	19.74	19.18	
15RB (0)		1908.5	20.63	19.66	19.10	
		1880	20.60	19.70	19.14	

5 MHz	1RB High (24)	1851.5	20.65	19.67	19.11
		1907.5	21.51	20.68	20.12
		1880	21.51	20.70	20.14
	1RB Middle (12)	1852.5	21.50	20.94	20.38
		1907.5	21.82	20.93	20.37
		1880	21.82	20.97	20.41
	1RB Low (0)	1852.5	21.79	20.93	20.37
		1907.5	21.51	20.61	20.05
		1880	21.54	20.66	20.10
	12RB High (13)	1852.5	21.50	20.92	20.36
		1907.5	20.60	19.66	19.10
		1880	20.60	19.67	19.11
	12RB Middle (6)	1852.5	20.66	19.76	19.20
		1907.5	20.67	19.78	19.22
		1880	20.64	19.74	19.18
	12RB Low (0)	1852.5	20.73	19.82	19.26
		1907.5	20.66	19.72	19.16
		1880	20.59	19.70	19.14
	25RB (0)	1852.5	20.61	19.77	19.21
		1907.5	20.62	19.64	19.08
		1880	20.61	19.64	19.08
10 MHz	1RB High (49)	1852.5	20.63	19.75	19.19
		1907.5	21.54	20.68	20.12
		1880	21.52	20.53	19.97
	1RB Middle (24)	1855	21.61	20.99	20.43
		1905	21.64	20.72	20.16
		1880	21.63	20.57	20.01
	1RB Low (0)	1855	21.70	20.93	20.37
		1905	21.53	20.61	20.05
		1880	21.52	20.52	19.96
	25RB High (25)	1855	21.64	20.90	20.34
		1905	20.57	19.72	19.16
		1880	20.63	19.71	19.15
	25RB Middle (12)	1855	20.73	19.77	19.21
		1905	20.61	19.79	19.23
		1880	20.62	19.70	19.14
	25RB Low (0)	1855	20.69	19.72	19.16
		1905	20.67	19.83	19.27
		1880	20.70	19.74	19.18
	50RB (0)	1855	20.67	19.72	19.16
		1905	20.66	19.70	19.14
		1880	20.72	19.71	19.15
15 MHz	1RB High (74)	1855	20.71	19.77	19.21
		1902.5	21.46	20.97	20.41
		1880	21.36	20.45	19.89
	1RB Middle (37)	1857.5	21.49	20.90	20.34
		1902.5	21.59	20.96	20.40
		1880	21.53	20.54	19.98

	1RB Low (0)	1857.5	21.61	20.91	20.35
		1902.5	21.50	20.93	20.37
		1880	21.45	20.42	19.86
		1857.5	21.51	20.92	20.36
	36RB High (38)	1902.5	20.57	19.57	19.01
		1880	20.60	19.58	19.02
		1857.5	20.62	19.68	19.12
	36RB Middle (19)	1902.5	20.62	19.60	19.04
		1880	20.64	19.61	19.05
		1857.5	20.65	19.71	19.15
	36RB Low (0)	1902.5	20.63	19.60	19.04
		1880	20.68	19.66	19.10
		1857.5	20.63	19.64	19.08
	75RB (0)	1902.5	20.60	19.60	19.04
		1880	20.67	19.67	19.11
1857.5		20.63	19.65	19.09	
20 MHz	1RB High (99)	1900	21.29	20.85	19.96
		1880	21.28	20.83	19.94
		1860	21.27	20.74	19.85
	1RB Middle (50)	1900	21.71	20.94	20.05
		1880	21.71	20.94	20.05
		1860	21.76	20.96	20.07
	1RB Low (0)	1900	21.25	20.84	19.95
		1880	21.27	20.78	19.89
		1860	21.27	20.80	19.91
	50RB High (50)	1900	20.46	19.57	18.68
		1880	20.63	19.68	18.79
		1860	20.61	19.65	18.76
	50RB Middle (25)	1900	20.63	19.69	18.80
		1880	20.64	19.66	18.77
		1860	20.65	19.60	18.71
	50RB Low (0)	1900	20.62	19.68	18.79
		1880	20.61	19.73	18.84
		1860	20.58	19.58	18.69
	100RB (0)	1900	20.56	19.66	18.77
		1880	20.61	19.73	18.84
		1860	20.65	19.66	18.77

Band 7						
Bandwidth (MHz)	RB allocation	Frequency (MHz)	QPSK	16QAM	64QAM	
	RB offset (Start RB)		Actual output power (dBm)	Actual output power (dBm)	Actual output power (dBm)	
5 MHz	1RB High (24)	2567.5	20.58	19.72	19.24	
		2535	20.72	19.83	19.34	
		2502.5	20.47	20.01	19.52	
	1RB Middle (12)	2567.5	20.82	19.84	19.46	
		2535	20.94	20.05	19.59	
		2502.5	20.70	20.26	19.74	
	1RB Low (0)	2567.5	20.60	19.75	19.23	
		2535	20.67	19.81	19.33	
		2502.5	20.47	20.00	19.50	
	12RB High (13)	2567.5	19.62	18.76	18.20	
		2535	19.72	18.81	18.29	
		2502.5	19.62	18.80	18.24	
	12RB Middle (6)	2567.5	19.68	18.82	18.27	
		2535	19.77	18.84	18.32	
		2502.5	19.64	18.81	18.26	
	12RB Low (0)	2567.5	19.68	18.79	18.23	
		2535	19.69	18.79	18.27	
		2502.5	19.60	18.76	18.22	
	25RB (0)	2567.5	19.63	18.71	18.14	
		2535	19.78	18.73	18.24	
		2502.5	19.64	18.72	18.20	
	10 MHz	1RB High (49)	2565	20.56	19.70	19.24
			2535	20.68	19.65	19.16
			2505	20.62	19.97	19.47
1RB Middle (24)		2565	20.67	19.76	19.32	
		2535	20.82	19.81	19.28	
		2505	20.69	20.05	19.55	
1RB Low (0)		2565	20.48	19.69	19.18	
		2535	20.64	19.66	19.16	
		2505	20.57	19.91	19.41	
25RB High (25)		2565	19.64	18.78	18.22	
		2535	19.73	18.76	18.22	
		2505	19.63	18.74	18.21	
25RB Middle (12)		2565	19.73	18.88	18.31	
		2535	19.80	18.81	18.28	
		2505	19.66	18.73	18.17	
25RB Low (0)		2565	19.63	18.80	18.22	
		2535	19.70	18.77	18.21	
		2505	19.56	18.65	18.09	
50RB (0)		2565	19.67	18.76	18.20	
		2535	19.70	18.70	18.18	
		2505	19.60	18.67	18.12	
15 MHz		1RB	2562.5	20.51	20.13	19.01

	High (74)	2535	20.54	19.54	19.48	
		2507.5	20.56	20.00	19.56	
	1RB Middle (37)	2562.5	20.68	20.15	19.14	
		2535	20.67	19.70	19.56	
	1RB Low (0)	2507.5	20.57	19.92	19.51	
		2562.5	20.56	20.08	19.05	
		2535	20.55	19.57	19.47	
	36RB High (38)	2507.5	20.44	19.87	19.45	
		2562.5	19.64	18.63	18.08	
		2535	19.70	18.69	18.26	
	36RB Middle (19)	2507.5	19.64	18.73	18.09	
		2562.5	19.64	18.65	18.10	
		2535	19.74	18.75	18.28	
	36RB Low (0)	2507.5	19.64	18.71	18.07	
		2562.5	19.62	18.62	18.10	
		2535	19.70	18.68	18.24	
	75RB (0)	2507.5	19.57	18.64	18.00	
		2562.5	19.60	18.65	18.07	
		2535	19.71	18.71	18.21	
	20 MHz	1RB High (99)	2507.5	19.59	18.67	18.05
			2560	20.32	19.91	19.06
			2535	20.37	19.79	19.21
		1RB Middle (50)	2510	20.38	19.89	19.23
			2560	20.75	20.34	19.47
2535			20.85	20.26	19.58	
1RB Low (0)		2510	20.70	20.24	19.54	
		2560	20.38	19.98	19.14	
		2535	20.33	19.79	19.16	
50RB High (50)		2510	20.23	19.79	19.03	
		2560	19.70	18.68	17.87	
		2535	19.72	18.72	18.01	
50RB Middle (25)		2510	19.73	18.79	18.05	
		2560	19.69	18.72	17.94	
		2535	19.71	18.70	18.01	
50RB Low (0)		2510	19.63	18.69	17.97	
		2560	19.68	18.76	17.96	
		2535	19.67	18.65	17.97	
100RB (0)		2510	19.55	18.60	17.87	
		2560	19.70	18.72	17.95	
		2535	19.70	18.71	18.00	
			2510	19.71	18.70	17.95



Band 66						
Bandwidth (MHz)	RB allocation	Frequency (MHz)	QPSK	16QAM	64QAM	
	RB offset (Start RB)		Actual output power (dBm)	Actual output power (dBm)	Actual output power (dBm)	
1.4 MHz	1RB High (5)	1779.3	18.70	17.88	16.98	
		1745	18.71	18.06	17.16	
		1710.7	18.66	17.78	16.88	
	1RB Middle (3)	1779.3	18.84	18.11	17.21	
		1745	18.86	18.20	17.30	
		1710.7	18.85	17.97	17.07	
	1RB Low (0)	1779.3	18.73	17.92	17.02	
		1745	18.69	18.06	17.16	
		1710.7	18.65	17.76	16.86	
	3RB High (3)	1779.3	18.79	17.85	16.95	
		1745	18.76	17.92	17.02	
		1710.7	18.84	17.98	17.08	
	3RB Middle (1)	1779.3	18.87	17.91	17.01	
		1745	18.84	18.01	17.11	
		1710.7	18.86	18.06	17.16	
	3RB Low (0)	1779.3	18.79	17.86	16.96	
		1745	18.78	17.96	17.06	
		1710.7	18.79	17.98	17.08	
	6RB (0)	1779.3	17.76	16.94	16.04	
		1745	17.76	16.66	16.03	
		1710.7	17.75	16.93	16.03	
	3 MHz	1RB High (14)	1778.5	18.68	17.70	16.79
			1745	18.73	18.07	17.16
			1711.5	18.64	17.74	16.83
1RB Middle (7)		1778.5	18.78	17.86	16.95	
		1745	18.87	18.25	17.34	
		1711.5	18.83	17.95	17.04	
1RB Low (0)		1778.5	18.63	17.73	16.82	
		1745	18.70	18.04	17.13	
		1711.5	18.69	17.80	16.89	
8RB High (7)		1778.5	17.68	16.81	16.03	
		1745	17.67	16.77	15.99	
		1711.5	17.69	16.74	15.96	
8RB Middle (4)		1778.5	17.73	16.85	16.07	
		1745	17.73	16.83	16.05	
		1711.5	17.73	16.78	16.00	
8RB Low (0)		1778.5	17.72	16.87	16.09	
		1745	17.70	16.79	16.01	
		1711.5	17.70	16.75	15.97	
15RB (0)		1778.5	17.69	16.78	16.00	
		1745	17.69	16.70	15.92	

		1711.5	17.73	16.70	15.92
5 MHz	1RB High (24)	1777.5	18.66	17.82	16.78
		1745	18.66	18.11	17.07
		1712.5	18.65	17.74	16.70
		1777.5	18.93	18.10	17.06
	1RB Middle (12)	1745	18.88	18.36	17.32
		1712.5	18.97	18.07	17.03
		1777.5	18.67	17.84	16.80
	1RB Low (0)	1745	18.61	18.06	17.02
		1712.5	18.66	17.75	16.71
		1777.5	17.66	16.70	15.66
	12RB High (13)	1745	17.66	16.73	15.69
		1712.5	17.69	16.72	15.68
		1777.5	17.77	16.83	15.79
	12RB Middle (6)	1745	17.73	16.83	15.79
		1712.5	17.78	16.78	15.74
		1777.5	17.71	16.79	15.75
	12RB Low (0)	1745	17.70	16.79	15.75
		1712.5	17.68	16.71	15.67
		1777.5	17.70	16.70	15.66
	25RB (0)	1745	17.68	16.73	15.69
		1712.5	17.70	16.65	15.61
1775		18.63	17.71	16.79	
10 MHz	1RB High (49)	1745	18.70	18.01	17.09
		1715	18.69	17.83	16.91
		1775	18.79	17.81	16.89
	1RB Middle (24)	1745	18.80	18.13	17.21
		1715	18.76	17.89	16.97
		1775	18.64	17.70	16.78
	1RB Low (0)	1745	18.70	18.06	17.14
		1715	18.66	17.76	16.84
		1775	17.72	16.72	15.80
	25RB High (25)	1745	17.66	16.69	15.77
		1715	17.75	16.84	15.92
		1775	17.75	16.77	15.85
	25RB Middle (12)	1745	17.75	16.79	15.87
		1715	17.72	16.85	15.93
		1775	17.78	16.83	15.91
	25RB Low (0)	1745	17.71	16.76	15.84
		1715	17.73	16.78	15.86
		1775	17.72	16.72	15.80
	50RB (0)	1745	17.72	16.73	15.81
		1715	17.74	16.76	15.84
		1772.5	18.53	17.60	16.69
15 MHz	1RB High (74)	1745	18.70	18.10	17.19
		1717.5	18.62	18.18	17.27
		1772.5	18.71	17.75	16.84
	1RB Middle	1745	18.77	18.13	17.22



	(37)	1717.5	18.75	18.23	17.32	
	1RB Low (0)	1772.5	18.56	17.58	16.67	
		1745	18.60	17.99	17.08	
		1717.5	18.61	18.11	17.20	
	36RB High (38)	1772.5	17.65	16.64	15.73	
		1745	17.72	16.69	15.78	
		1717.5	17.77	16.73	15.82	
	36RB Middle (19)	1772.5	17.75	16.76	15.85	
		1745	17.73	16.76	15.85	
		1717.5	17.75	16.71	15.80	
	36RB Low (0)	1772.5	17.78	16.73	15.82	
		1745	17.77	16.75	15.84	
		1717.5	17.72	16.66	15.75	
	75RB (0)	1772.5	17.67	16.71	15.80	
		1745	17.69	16.69	15.78	
		1717.5	17.73	16.69	15.78	
	<b>20 MHz</b>	1RB High (99)	1770	18.40	17.96	16.98
			1745	18.42	18.01	17.03
			1720	18.46	17.93	16.95
		1RB Middle (50)	1770	18.86	18.38	17.40
			1745	18.85	18.37	17.39
1720			18.85	18.29	17.31	
1RB Low (0)		1770	18.41	17.89	16.91	
		1745	18.40	17.93	16.95	
		1720	18.41	17.87	16.89	
50RB High (50)		1770	17.96	16.60	15.62	
		1745	17.63	16.69	15.71	
		1720	17.76	16.79	15.81	
50RB Middle (25)		1770	17.73	16.75	15.77	
		1745	17.74	16.73	15.75	
		1720	17.76	16.70	15.72	
50RB Low (0)		1770	17.75	16.78	15.80	
		1745	17.78	16.80	15.82	
		1720	17.69	16.66	15.68	
100RB (0)		1770	17.79	16.73	15.75	
		1745	17.75	16.74	15.76	
		1720	17.76	16.73	15.75	

### 11.4 Wi-Fi and BT Measurement result

The maximum output power of BT is 6.39dBm.

The maximum tune up of BT is 7.5dBm.

The average conducted power for Wi-Fi is as following:

802.11b (dBm)

Channel\data rate	1Mbps	2Mbps	5.5Mbps	11Mbps
1	17.83	/	/	/
6	17.73	/	/	/
11	17.86	17.77	17.85	17.80
<b>Tune up</b>	<b>18.00</b>	<b>18.00</b>	<b>18.00</b>	<b>18.00</b>

802.11g (dBm)

Channel\data rate	6Mbps	9Mbps	12Mbps	18Mbps	24Mbps	36Mbps	48Mbps	54Mbps
1	/	/	/	/	/	/	/	15.42
6	/	/	/	/	/	/	/	15.24
11	15.43	15.38	15.37	15.30	15.31	15.12	15.57	15.58
<b>Tune up</b>	<b>16.00</b>	<b>16.00</b>	<b>16.00</b>	<b>16.00</b>	<b>16.00</b>	<b>16.00</b>	<b>16.00</b>	<b>16.00</b>

802.11n (dBm) - HT20 (2.4G)

Channel\data rate	MCS0	MCS1	MCS2	MCS3	MCS4	MCS5	MCS6	MCS7
1	13.31	/	/	/	/	/	/	/
6	13.14	/	/	/	/	/	/	/
11	13.39	13.31	13.24	13.22	13.21	13.35	13.36	13.35
<b>Tune up</b>	<b>13.50</b>	<b>13.50</b>	<b>13.50</b>	<b>13.50</b>	<b>13.50</b>	<b>13.50</b>	<b>13.50</b>	<b>13.50</b>

802.11n (dBm) – HT40 (2.4G)

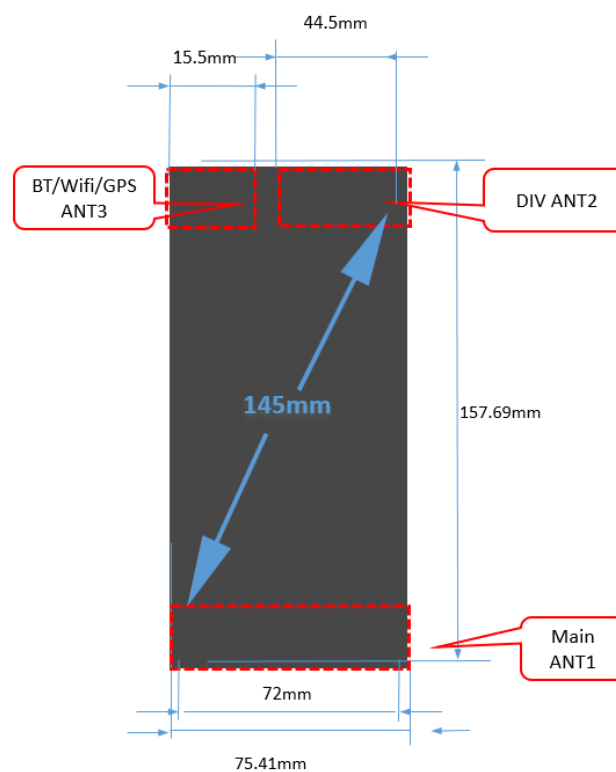
Channel\data rate	MCS0	MCS1	MCS2	MCS3	MCS4	MCS5	MCS6	MCS7
1	/	/	/	/	/	/	/	12.92
6	14.02	14.05	14.04	14.03	14.03	14.26	14.27	14.29
11	/	/	/	/	/	/	/	13.82
<b>Tune up</b>	<b>14.50</b>	<b>14.50</b>	<b>14.50</b>	<b>14.50</b>	<b>14.50</b>	<b>14.50</b>	<b>14.50</b>	<b>14.50</b>

## 12 Simultaneous TX SAR Considerations

### 12.1 Introduction

The following procedures adopted from “FCC SAR Considerations for Cell Phones with Multiple Transmitters” are applicable to handsets with built-in unlicensed transmitters such as 802.11 a/b/g and Bluetooth devices which may simultaneously transmit with the licensed transmitter. For this device, the BT and Wi-Fi can transmit simultaneous with other transmitters.

### 12.2 Transmit Antenna Separation Distances



Ant	Mode	Band
Ant1	Main	GSM 850,900, 1800, 1900 WCDMA : 1, 2, 4, 5, 8 LTE : 1, 2, 3, 4, 5, 7, 8, 12/17, 28, 66,TX,RX
Ant2	DIV	GSM 850,900, 1800 WCDMA : 1, 2, 4, 5, 8 LTE : 1, 2, 3, 4, 5, 7, 8, 12/17, 28, 66 RX
Ant3	WCN	GPS/BT/WIFI(2.4G)

Picture 12.1 Antenna Locations

### 12.3 SAR Measurement Positions

According to the KDB941225 D06 Hot Spot SAR v01, the edges with less than 2.5 cm distance to the antennas need to be tested for SAR.

SAR measurement positions						
Mode	Front	Rear	Left edge	Right edge	Top edge	Bottom edge
Main antenna	Yes	Yes	Yes	Yes	No	Yes
WLAN	Yes	Yes	No	Yes	Yes	No

### 12.4 Standalone SAR Test Exclusion Considerations

Standalone 1-g head or body SAR evaluation by measurement or numerical simulation is not required when the corresponding SAR Exclusion Threshold condition, listed below, is satisfied. The 1-g SAR test exclusion threshold for 100 MHz to 6 GHz at test separation distances  $\leq 50$  mm are determined by:

$[(\text{max. power of channel, including tune-up tolerance, mW}) / (\text{min. test separation distance, mm})] \cdot [\sqrt{f(\text{GHz})}] \leq 3.0$  for 1-g SAR, where

- $f(\text{GHz})$  is the RF channel transmit frequency in GHz
- Power and distance are rounded to the nearest mW and mm before calculation
- The result is rounded to one decimal place for comparison

**Table 12.1: Standalone SAR test exclusion considerations**

Band/Mode	F(GHz)	Position	SAR test exclusion threshold(mW)	RF output power		SAR test exclusion
				dBm	mW	
Bluetooth	2.441	Head	9.60	7.5	5.62	Yes
		Body	19.20	7.5	5.62	Yes
2.4GHz WLAN	2.45	Head	9.58	18	63.10	No
		Body	19.17	18	63.10	No

### 13 Evaluation of Simultaneous

**Table 13.1: The sum of reported SAR values for main antenna and WiFi**

	Position	Main antenna	WiFi	Sum
Highest reported SAR value for Head	Left hand, Touch cheek	0.31	0.87	<b>1.18</b>
Highest reported SAR value for Body	Rear 10mm	1.14	0.29	<b>1.43</b>

**Table 13.2: The sum of reported SAR values for main antenna and BT**

	Position	Main antenna	BT	Sum
Maximum reported SAR value for Head	Right hand, Touch cheek	0.39	0.23 <sup>[1]</sup>	<b>0.62</b>
Maximum reported SAR value for Body	Bottom 17mm	1.30	/	<b>1.30</b>

[1] - Estimated SAR for Bluetooth (see the table 13.3)

**Table 13.3: Estimated SAR for Bluetooth**

Mode/Band	F (GHz)	Position	Distance (mm)	Upper limit of power *		Estimated <sub>1g</sub> (W/kg)
				dBm	mW	
Bluetooth	2.441	Head	5	7.5	5.6	0.23
Bluetooth	2.441	Body	10	7.5	5.6	0.11

\* - Maximum possible output power declared by manufacturer

When standalone SAR test exclusion applies to an antenna that transmits simultaneously with other antennas, the standalone SAR must be estimated according to following to determine simultaneous transmission SAR test exclusion:

(max. power of channel, including tune-up tolerance, mW)/(min. test separation distance,mm)·[√f(GHz)/x] W/kg for test separation distances ≤ 50 mm;  
where x = 7.5 for 1-g SAR.

When the minimum test separation distance is < 5 mm, a distance of 5 mm is applied to determine SAR test exclusion

#### Conclusion:

According to the above tables, the sum of reported SAR values is < 1.6W/kg. So the simultaneous transmission SAR with volume scans is not required.



## 14 SAR Test Result

It is determined by user manual for the distance between the EUT and the phantom bottom. The distance is 10 mm or 15mm and just applied to the condition of body worn accessory.

It is performed for all SAR measurements with area scan based 1-g SAR estimation (Fast SAR). A zoom scan measurement is added when the estimated 1-gSAR is the highest measured SAR in each exposure configuration, wireless mode and frequency band combination or more than 1.2W/kg.

The calculated SAR is obtained by the following formula:

$$\text{Reported SAR} = \text{Measured SAR} \times 10^{(P_{\text{Target}} - P_{\text{Measured}})/10}$$

Where  $P_{\text{Target}}$  is the power of manufacturing upper limit;

$P_{\text{Measured}}$  is the measured power in chapter 11.

**Table 14.1: Duty Cycle**

<b>Mode</b>	<b>Duty Cycle</b>
Speech for GSM850/1900	1:4
GPRS&EGPRS for GSM850/1900- Normal Power	1:4
GPRS&EGPRS for GSM1900-Low Power	1:2
WCDMA&LTE FDD	1:1

### 14.1 SAR results for Fast SAR

**Table 14.1-1: SAR Values (GSM 850 MHz Band - Head)**

Frequency		Side	Test Position	Figure No.	Conducted Power (dBm)	Max. tune-up Power (dBm)	Measured SAR(10g) (W/kg)	Reported SAR(10g) (W/kg)	Measured SAR(1g) (W/kg)	Reported SAR(1g) (W/kg)	Power Drift (dB)
Ch.	MHz										
Ambient Temperature: 22.9 °C      Liquid Temperature: 22.5 °C											
251	848.8	Left	Touch	Fig.1	32.74	33.00	0.207	<b>0.22</b>	0.277	<b>0.29</b>	-0.08
190	836.6	Left	Touch	/	32.43	33.00	0.180	<b>0.21</b>	0.231	<b>0.26</b>	0.06
128	824.2	Left	Touch	/	32.32	33.00	0.145	<b>0.17</b>	0.193	<b>0.23</b>	-0.13
190	836.6	Left	Tilt	/	32.43	33.00	0.111	<b>0.13</b>	0.139	<b>0.16</b>	0.10
190	836.6	Right	Touch	/	32.43	33.00	0.170	<b>0.19</b>	0.220	<b>0.25</b>	-0.03
190	836.6	Right	Tilt	/	32.43	33.00	0.095	<b>0.11</b>	0.119	<b>0.14</b>	-0.01

Note: the head SAR of GSM850 is tested with GPRS (2Txslots) mode because of VoIP.

**Table 14.1-2: SAR Values (GSM 850 MHz Band - Body)**

Frequency		Mode (number of timeslots)	Test Position	Figure No.	Conducted Power (dBm)	Max. tune-up Power (dBm)	Measured SAR(10g) (W/kg)	Reported SAR(10g) (W/kg)	Measured SAR(1g) (W/kg)	Reported SAR(1g) (W/kg)	Power Drift (dB)
Ch.	MHz										
Ambient Temperature: 22.9 °C      Liquid Temperature: 22.5 °C											
190	836.6	GPRS (2)	Front	/	32.43	33.00	0.149	<b>0.17</b>	0.195	<b>0.22</b>	0.08
251	848.8	GPRS (2)	Rear	Fig.2	32.74	33.00	0.359	<b>0.38</b>	0.465	<b>0.49</b>	0.08
190	836.6	GPRS (2)	Rear	/	32.43	33.00	0.291	<b>0.33</b>	0.387	<b>0.44</b>	0.08
128	824.2	GPRS (2)	Rear	/	32.32	33.00	0.200	<b>0.23</b>	0.262	<b>0.31</b>	0.05
190	836.6	GPRS (2)	Left	/	32.43	33.00	0.126	<b>0.14</b>	0.189	<b>0.22</b>	-0.03
190	836.6	GPRS (2)	Right	/	32.43	33.00	0.082	<b>0.09</b>	0.121	<b>0.14</b>	0.02
190	836.6	GPRS (2)	Bottom	/	32.43	33.00	0.034	<b>0.04</b>	0.055	<b>0.06</b>	-0.02
251	848.8	EGPRS (2)	Rear	/	32.68	33.00	0.318	<b>0.34</b>	0.433	<b>0.47</b>	0.13

Note: The distance between the EUT and the phantom bottom is 10mm.

**Table 14.1-3: SAR Values (GSM 1900 MHz Band - Head)**

Frequency		Side	Test Position	Figure No.	Conducted Power (dBm)	Max. tune-up Power (dBm)	Measured SAR(10g) (W/kg)	Reported SAR(10g) (W/kg)	Measured SAR(1g) (W/kg)	Reported SAR(1g) (W/kg)	Power Drift (dB)
Ch.	MHz										
Ambient Temperature: 22.9 °C      Liquid Temperature: 22.5 °C											
661	1880	Left	Touch	/	29.58	30.00	0.103	<b>0.11</b>	0.166	<b>0.18</b>	0.11
661	1880	Left	Tilt	/	29.58	30.00	0.098	<b>0.11</b>	0.162	<b>0.18</b>	0.08
810	1909.8	Right	Touch	/	29.50	30.00	0.091	<b>0.10</b>	0.149	<b>0.17</b>	0.10
661	1880	Right	Touch	Fig.3	29.58	30.00	0.110	<b>0.12</b>	0.175	<b>0.19</b>	0.12
512	1850.2	Right	Touch	/	29.67	30.00	0.100	<b>0.11</b>	0.159	<b>0.17</b>	0.00
661	1880	Right	Tilt	/	29.58	30.00	0.076	<b>0.08</b>	0.119	<b>0.13</b>	0.11

Note: the head SAR of GSM1900 is tested with GPRS (2Txslots) mode because of VoIP.

**Table 14.1-4: SAR Values (GSM 1900 MHz Band - Body)**

Frequency		Mode (number of timeslots)	Test Position	Figure No.	Conducted Power (dBm)	Max. tune-up Power (dBm)	Measured SAR(10g) (W/kg)	Reported SAR(10g) (W/kg)	Measured SAR(1g) (W/kg)	Reported SAR(1g) (W/kg)	Power Drift (dB)
Ch.	MHz										
Ambient Temperature: 22.9 °C      Liquid Temperature: 22.5 °C											
661	1880	GPRS (4)	Front	/	24.38	25.00	0.149	<b>0.17</b>	0.252	<b>0.29</b>	-0.04
661	1880	GPRS (4)	Rear	/	24.38	25.00	0.191	<b>0.22</b>	0.371	<b>0.43</b>	0.09
810	1909.8	GPRS (4)	Bottom	/	24.20	25.00	0.257	<b>0.31</b>	0.510	<b>0.61</b>	-0.09
661	1880	GPRS (4)	Bottom	/	24.38	25.00	0.360	<b>0.42</b>	0.709	<b>0.82</b>	0.13
512	1850.2	GPRS (4)	Bottom	Fig.4	24.37	25.00	0.472	<b>0.55</b>	0.923	<b>1.07</b>	-0.09
661	1880	GPRS (2)	Front	Note2	29.58	30.00	0.200	<b>0.22</b>	0.313	<b>0.34</b>	-0.13
661	1880	GPRS (2)	Rear	Note3	29.58	30.00	0.128	<b>0.14</b>	0.208	<b>0.23</b>	0.05
661	1880	GPRS (2)	Left	/	29.58	30.00	0.072	<b>0.08</b>	0.115	<b>0.13</b>	0.04
661	1880	GPRS (2)	Right	/	29.58	30.00	0.069	<b>0.08</b>	0.110	<b>0.12</b>	-0.13
661	1880	GPRS (2)	Bottom	Note3	29.58	30.00	0.215	<b>0.24</b>	0.363	<b>0.40</b>	-0.05
512	1850.2	EGPRS (4)	Bottom	/	24.27	25.00	0.429	<b>0.51</b>	0.816	<b>0.97</b>	0.02

Note1: The distance between the EUT and the phantom bottom is 10mm

Note2: The distance between the EUT and the phantom bottom is 11mm by sensor (See detail in annex I).

Note3: The distance between the EUT and the phantom bottom is 17mm by sensor (See detail in annex I).

**Table 14.1-5: SAR Values (WCDMA 1900 MHz Band - Head)**

Frequency		Side	Test Position	Figure No.	Conducted Power (dBm)	Max. tune-up Power (dBm)	Measured SAR(10g) (W/kg)	Reported SAR(10g) (W/kg)	Measured SAR(1g) (W/kg)	Reported SAR(1g) (W/kg)	Power Drift (dB)
Ch.	MHz										
Ambient Temperature: 22.9 °C      Liquid Temperature: 22.5 °C											
9938	1907.6	Left	Touch	Fig.5	24.50	25.00	0.174	<b>0.20</b>	0.280	<b>0.31</b>	0.08
9800	1880	Left	Touch	/	24.50	25.00	0.168	<b>0.19</b>	0.270	<b>0.30</b>	-0.03
9662	1852.4	Left	Touch	/	24.56	25.00	0.130	<b>0.14</b>	0.198	<b>0.22</b>	-0.01
9800	1880	Left	Tilt	/	24.50	25.00	0.154	<b>0.17</b>	0.261	<b>0.29</b>	-0.03
9800	1880	Right	Touch	/	24.50	25.00	0.165	<b>0.19</b>	0.266	<b>0.30</b>	-0.05
9800	1880	Right	Tilt	/	24.50	25.00	0.125	<b>0.14</b>	0.203	<b>0.23</b>	-0.04

**Table 14.1-6: SAR Values (WCDMA 1900 MHz Band - Body)**

Frequency		Test Position	Figure No.	Conducted Power (dBm)	Max. tune-up Power (dBm)	Measured SAR(10g) (W/kg)	Reported SAR(10g) (W/kg)	Measured SAR(1g) (W/kg)	Reported SAR(1g) (W/kg)	Power Drift (dB)
Ch.	MHz									
Ambient Temperature: 22.9 °C      Liquid Temperature: 22.5 °C										
9800	1880	Front	/	21.07	22.00	0.160	<b>0.20</b>	0.258	<b>0.32</b>	0.06
9800	1880	Rear	/	21.07	22.00	0.214	<b>0.27</b>	0.383	<b>0.47</b>	0.11
9938	1907.6	Bottom	/	21.06	22.00	0.288	<b>0.36</b>	0.568	<b>0.71</b>	0.08
9800	1880	Bottom	/	21.07	22.00	0.337	<b>0.42</b>	0.660	<b>0.82</b>	-0.02
9662	1852.4	Bottom	Fig.6	21.03	22.00	0.388	<b>0.49</b>	0.756	<b>0.95</b>	-0.09
9800	1880	Front	Note2	24.50	25.00	0.314	<b>0.35</b>	0.540	<b>0.61</b>	0.10
9800	1880	Rear	Note3	24.50	25.00	0.190	<b>0.21</b>	0.330	<b>0.37</b>	0.00
9800	1880	Left	/	24.50	25.00	0.130	<b>0.15</b>	0.221	<b>0.25</b>	-0.10
9800	1880	Right	/	24.50	25.00	0.108	<b>0.12</b>	0.182	<b>0.20</b>	-0.06
9800	1880	Bottom	Note3	24.50	25.00	0.322	<b>0.36</b>	0.591	<b>0.66</b>	0.00

Note1: The distance between the EUT and the phantom bottom is 10mm

Note2: The distance between the EUT and the phantom bottom is 11mm by sensor (See detail in annex I).

Note3: The distance between the EUT and the phantom bottom is 17mm by sensor (See detail in annex I).

**Table 14.1-7: SAR Values (WCDMA 1700 MHz Band - Head)**

Frequency		Side	Test Position	Figure No.	Conducted Power (dBm)	Max. tune-up Power (dBm)	Measured SAR(10g) (W/kg)	Reported SAR(10g) (W/kg)	Measured SAR(1g) (W/kg)	Reported SAR(1g) (W/kg)	Power Drift (dB)
Ch.	MHz										
Ambient Temperature: 22.9 °C      Liquid Temperature: 22.5 °C											
1412	1732.4	Left	Touch	/	23.19	25.00	0.125	<b>0.19</b>	0.181	<b>0.27</b>	0.12
1412	1732.4	Left	Tilt	/	23.19	25.00	0.084	<b>0.13</b>	0.130	<b>0.20</b>	0.03
1513	1752.6	Right	Touch	Fig.7	23.21	25.00	0.168	<b>0.25</b>	0.256	<b>0.39</b>	0.01
1412	1732.4	Right	Touch	/	23.19	25.00	0.151	<b>0.23</b>	0.231	<b>0.35</b>	-0.12
1312	1712.4	Right	Touch	/	23.33	25.00	0.159	<b>0.23</b>	0.236	<b>0.35</b>	-0.11
1412	1732.4	Right	Tilt	/	23.19	25.00	0.090	<b>0.14</b>	0.135	<b>0.20</b>	0.00

**Table 14.1-8: SAR Values (WCDMA 1700 MHz Band - Body)**

Ambient Temperature: 22.9 °C						Liquid Temperature: 22.5 °C				
Frequency		Test Position	Figure No.	Conducted Power (dBm)	Max. tune-up Power (dBm)	Measured SAR(10g) (W/kg)	Reported SAR(10g) (W/kg)	Measured SAR(1g) (W/kg)	Reported SAR(1g) (W/kg)	Power Drift (dB)
Ch.	MHz									
1412	1732.5	Front	/	17.87	19.00	0.156	<b>0.20</b>	0.280	<b>0.36</b>	-0.05
1513	1752.6	Rear	/	17.83	19.00	0.280	<b>0.37</b>	0.518	<b>0.68</b>	0.12
1412	1732.5	Rear	/	17.87	19.00	0.343	<b>0.44</b>	0.639	<b>0.83</b>	0.10
1312	1712.4	Rear	/	17.81	19.00	0.379	<b>0.50</b>	0.710	<b>0.93</b>	-0.06
1513	1752.6	Bottom	/	17.83	19.00	0.363	<b>0.48</b>	0.679	<b>0.89</b>	0.02
1412	1732.5	Bottom	/	17.87	19.00	0.375	<b>0.49</b>	0.709	<b>0.92</b>	-0.10
1312	1712.4	Bottom	/	17.81	19.00	0.430	<b>0.57</b>	0.812	<b>1.07</b>	-0.02
1412	1732.5	Front	Note2	23.19	25.00	0.239	<b>0.36</b>	0.386	<b>0.59</b>	-0.08
1412	1732.5	Rear	Note3	23.19	25.00	0.276	<b>0.42</b>	0.444	<b>0.67</b>	0.11
1412	1732.5	Left	/	23.19	25.00	0.030	<b>0.05</b>	0.044	<b>0.07</b>	-0.10
1412	1732.5	Right	/	23.19	25.00	0.061	<b>0.09</b>	0.091	<b>0.14</b>	0.08
1513	1752.6	Bottom	Note3	23.21	25.00	0.440	<b>0.66</b>	0.744	<b>1.12</b>	0.12
1412	1732.5	Bottom	Note3	23.19	25.00	0.369	<b>0.56</b>	0.602	<b>0.91</b>	0.11
1312	1712.4	Bottom	Note3 Fig.8	23.33	25.00	0.518	<b>0.76</b>	0.882	<b>1.30</b>	-0.03
1312	1712.4	Bottom	Headset	23.33	25.00	0.501	<b>0.74</b>	0.853	<b>1.25</b>	0.09

Note1: The distance between the EUT and the phantom bottom is 10mm

Note2: The distance between the EUT and the phantom bottom is 11mm by sensor (See detail in annex I).

Note3: The distance between the EUT and the phantom bottom is 17mm by sensor (See detail in annex I).

**Table 14.1-9: SAR Values (WCDMA 850 MHz Band - Head)**

Ambient Temperature: 22.9 °C						Liquid Temperature: 22.5 °C					
Frequency		Side	Test Position	Figure No.	Conducted Power (dBm)	Max. tune-up Power (dBm)	Measured SAR(10g) (W/kg)	Reported SAR(10g) (W/kg)	Measured SAR(1g) (W/kg)	Reported SAR(1g) (W/kg)	Power Drift (dB)
Ch.	MHz										
4233	846.6	Left	Touch	Fig.9	24.40	25.00	0.158	<b>0.18</b>	0.210	<b>0.24</b>	-0.12
4182	836.4	Left	Touch	/	24.37	25.00	0.153	<b>0.18</b>	0.203	<b>0.23</b>	0.04
4132	826.4	Left	Touch	/	24.39	25.00	0.144	<b>0.17</b>	0.191	<b>0.22</b>	0.11
4182	836.4	Left	Tilt	/	24.37	25.00	0.093	<b>0.11</b>	0.121	<b>0.14</b>	-0.13
4182	836.4	Right	Touch	/	24.37	25.00	0.130	<b>0.15</b>	0.174	<b>0.20</b>	0.10
4182	836.4	Right	Tilt	/	24.37	25.00	0.082	<b>0.09</b>	0.104	<b>0.12</b>	0.12

**Table 14.1-10: SAR Values (WCDMA 850 MHz Band - Body)**

Ambient Temperature: 22.9 °C						Liquid Temperature: 22.5°C				
Frequency		Test Position	Figure No.	Conducted Power (dBm)	Max. tune-up Power (dBm)	Measured SAR(10g) (W/kg)	Reported SAR(10g) (W/kg)	Measured SAR(1g) (W/kg)	Reported SAR(1g) (W/kg)	Power Drift (dB)
Ch.	MHz									
4182	836.4	Front	/	24.37	25.00	0.114	<b>0.13</b>	0.147	<b>0.17</b>	0.13
4233	846.6	Rear	/	24.40	25.00	0.188	<b>0.22</b>	0.243	<b>0.28</b>	0.04
4182	836.4	Rear	/	24.37	25.00	0.194	<b>0.22</b>	0.249	<b>0.29</b>	-0.09
4132	826.4	Rear	Fig.10	24.39	25.00	0.202	<b>0.23</b>	0.261	<b>0.30</b>	-0.12
4182	836.4	Left	/	24.37	25.00	0.104	<b>0.12</b>	0.153	<b>0.18</b>	-0.02
4182	836.4	Right	/	24.37	25.00	0.100	<b>0.12</b>	0.146	<b>0.17</b>	0.10
4182	836.4	Bottom	/	24.37	25.00	0.028	<b>0.03</b>	0.046	<b>0.05</b>	0.06

Note: The distance between the EUT and the phantom bottom is 10mm.

**Table 14.1-11: SAR Values (LTE Band2 - Head)**

Ambient Temperature: 22.9 °C						Liquid Temperature: 22.5°C						
Frequency		Mode	Side	Test Position	Figure No.	Conducted Power (dBm)	Max. tune-up Power (dBm)	Measured SAR(10g) (W/kg)	Reported SAR(10g) (W/kg)	Measured SAR(1g) (W/kg)	Reported SAR(1g) (W/kg)	Power Drift (dB)
Ch.	MHz											
18700	1860	1RB_Mid	Left	Touch	Fig.11	24.56	25.00	0.154	<b>0.17</b>	0.247	<b>0.27</b>	-0.01
18700	1860	1RB_Mid	Left	Tilt	/	24.56	25.00	0.109	<b>0.12</b>	0.189	<b>0.21</b>	-0.04
18700	1860	1RB_Mid	Right	Touch	/	24.56	25.00	0.089	<b>0.10</b>	0.149	<b>0.16</b>	0.06
18700	1860	1RB_Mid	Right	Tilt	/	24.56	25.00	0.109	<b>0.12</b>	0.181	<b>0.20</b>	0.08
18700	1860	50RB_High	Left	Touch	/	23.55	24.00	0.123	<b>0.14</b>	0.197	<b>0.22</b>	-0.10
18700	1860	50RB_High	Left	Tilt	/	23.55	24.00	0.088	<b>0.10</b>	0.151	<b>0.17</b>	0.06
18700	1860	50RB_High	Right	Touch	/	23.55	24.00	0.074	<b>0.08</b>	0.125	<b>0.14</b>	0.01
18700	1860	50RB_High	Right	Tilt	/	23.55	24.00	0.088	<b>0.10</b>	0.145	<b>0.16</b>	0.11

Note1: The LTE mode is QPSK\_20MHz.

**Table 14.1-12: SAR Values (LTE Band2 - Body)**

Frequency		Mode	Test Position	Figure No.	Conduct ed Power (dBm)	Max. tune-up Power (dBm)	Measured SAR(10g) (W/kg)	Reported SAR(10g) (W/kg)	Measured SAR(1g) (W/kg)	Reported SAR(1g) (W/kg)	Power Drift (dB)
Ch.	MHz										
Ambient Temperature: 22.9 °C      Liquid Temperature: 22.5 °C											
18700	1860	1RB_Mid	Front	/	21.76	23.00	0.151	<b>0.20</b>	0.260	<b>0.35</b>	-0.02
18700	1860	1RB_Mid	Rear	/	21.76	23.00	0.252	<b>0.34</b>	0.468	<b>0.62</b>	-0.11
19100	1900	1RB_Mid	Bottom	/	21.71	23.00	0.364	<b>0.49</b>	0.728	<b>0.98</b>	0.12
18900	1880	1RB_Mid	Bottom	/	21.71	23.00	0.395	<b>0.53</b>	0.796	<b>1.07</b>	-0.13
18700	1860	1RB_Mid	Bottom	Fig.12	21.76	23.00	0.480	<b>0.64</b>	0.934	<b>1.24</b>	0.00
18700	1860	1RB_Mid	Front	Note2	24.56	25.00	0.232	<b>0.26</b>	0.371	<b>0.41</b>	0.05
18700	1860	1RB_Mid	Rear	Note3	24.56	25.00	0.190	<b>0.21</b>	0.315	<b>0.35</b>	0.13
18700	1860	1RB_Mid	Left	/	24.56	25.00	0.081	<b>0.09</b>	0.127	<b>0.14</b>	-0.10
18700	1860	1RB_Mid	Right	/	24.56	25.00	0.110	<b>0.12</b>	0.183	<b>0.20</b>	-0.09
18700	1860	1RB_Mid	Bottom	Note3	24.56	25.00	0.291	<b>0.32</b>	0.507	<b>0.56</b>	0.04
18700	1860	50RB_Mid	Front	/	20.65	22.00	0.148	<b>0.20</b>	0.247	<b>0.34</b>	-0.02
18700	1860	50RB_Mid	Rear	/	20.65	22.00	0.219	<b>0.30</b>	0.409	<b>0.56</b>	-0.12
19100	1900	50RB_Mid	Bottom	/	20.63	22.00	0.310	<b>0.43</b>	0.620	<b>0.85</b>	0.09
18900	1880	50RB_Mid	Bottom	/	20.64	22.00	0.338	<b>0.46</b>	0.678	<b>0.93</b>	-0.06
18700	1860	50RB_Mid	Bottom	/	20.65	22.00	0.372	<b>0.51</b>	0.744	<b>1.01</b>	0.00
18700	1860	50RB_High	Front	Note2	23.55	24.00	0.193	<b>0.21</b>	0.307	<b>0.34</b>	0.10
18700	1860	50RB_High	Rear	Note3	23.55	24.00	0.184	<b>0.20</b>	0.303	<b>0.34</b>	-0.01
18700	1860	50RB_High	Left	/	23.55	24.00	0.058	<b>0.06</b>	0.092	<b>0.10</b>	0.06
18700	1860	50RB_High	Right	/	23.55	24.00	0.092	<b>0.10</b>	0.151	<b>0.17</b>	-0.11
18700	1860	50RB_High	Bottom	Note3	23.55	24.00	0.248	<b>0.28</b>	0.434	<b>0.48</b>	0.01
18700	1860	100RB	Bottom	/	20.65	22.00	0.393	<b>0.54</b>	0.789	<b>1.08</b>	-0.08
18700	1860	1RB_Mid	Bottom	Headset	21.76	23.00	0.437	<b>0.58</b>	0.911	<b>1.21</b>	0.03

Note1: The distance between the EUT and the phantom bottom is 10mm

Note2: The distance between the EUT and the phantom bottom is 11mm by sensor (See detail in annex I).

Note3: The distance between the EUT and the phantom bottom is 17mm by sensor (See detail in annex I).



**Table 14.1-13: SAR Values (LTE Band5 - Head)**

Ambient Temperature: 22.9°C						Liquid Temperature: 22.5°C						
Frequency		Mode	Side	Test Position	Figure No.	Conducted Power (dBm)	Max. tune-up Power (dBm)	Measured SAR(10g) (W/kg)	Reported SAR(10g) (W/kg)	Measured SAR(1g) (W/kg)	Reported SAR(1g) (W/kg)	Power Drift (dB)
Ch.	MHz											
20600	844	1RB_High	Left	Touch	Fig.13	24.37	25.00	0.157	<b>0.18</b>	0.207	<b>0.24</b>	0.04
20600	844	1RB_High	Left	Tilt	/	24.37	25.00	0.087	<b>0.10</b>	0.113	<b>0.13</b>	-0.10
20600	844	1RB_High	Right	Touch	/	24.37	25.00	0.144	<b>0.17</b>	0.191	<b>0.22</b>	-0.03
20600	844	1RB_High	Right	Tilt	/	24.37	25.00	0.080	<b>0.09</b>	0.100	<b>0.12</b>	-0.11
20450	829	25RB_High	Left	Touch	/	23.51	24.00	0.121	<b>0.14</b>	0.158	<b>0.18</b>	-0.02
20450	829	25RB_High	Left	Tilt	/	23.51	24.00	0.076	<b>0.09</b>	0.098	<b>0.11</b>	-0.05
20450	829	25RB_High	Right	Touch	/	23.51	24.00	0.118	<b>0.13</b>	0.156	<b>0.17</b>	-0.09
20450	829	25RB_High	Right	Tilt	/	23.51	24.00	0.066	<b>0.07</b>	0.084	<b>0.09</b>	-0.11

Note1: The LTE mode is QPSK\_10MHz.

**Table 14.1-14: SAR Values (LTE Band5 - Body)**

Ambient Temperature: 22.9°C						Liquid Temperature: 22.5°C					
Frequency		Mode	Test Position	Figure No.	Conducted Power (dBm)	Max. tune-up Power (dBm)	Measured SAR(10g) (W/kg)	Reported SAR(10g) (W/kg)	Measured SAR(1g) (W/kg)	Reported SAR(1g) (W/kg)	Power Drift (dB)
Ch.	MHz										
20600	844	1RB_High	Front	/	24.37	25.00	0.164	<b>0.19</b>	0.215	<b>0.25</b>	0.09
20600	844	1RB_High	Rear	Fig.14	24.37	25.00	0.244	<b>0.28</b>	0.320	<b>0.37</b>	-0.07
20600	844	1RB_High	Left	/	24.37	25.00	0.164	<b>0.19</b>	0.245	<b>0.28</b>	-0.11
20600	844	1RB_High	Right	/	24.37	25.00	0.115	<b>0.13</b>	0.167	<b>0.19</b>	-0.01
20600	844	1RB_High	Bottom	/	24.37	25.00	0.047	<b>0.05</b>	0.084	<b>0.10</b>	0.04
20450	829	25RB_High	Front	/	23.51	24.00	0.112	<b>0.13</b>	0.167	<b>0.19</b>	0.05
20450	829	25RB_High	Rear	/	23.51	24.00	0.144	<b>0.16</b>	0.236	<b>0.26</b>	0.12
20450	829	25RB_High	Left	/	23.51	24.00	0.060	<b>0.07</b>	0.088	<b>0.10</b>	0.04
20450	829	25RB_High	Right	/	23.51	24.00	0.084	<b>0.09</b>	0.124	<b>0.14</b>	0.00
20450	829	25RB_High	Bottom	/	23.51	24.00	0.037	<b>0.04</b>	0.065	<b>0.07</b>	-0.05

Note1: The distance between the EUT and the phantom bottom is 10mm.

Note2: The LTE mode is QPSK\_10MHz.

**Table 14.1-15: SAR Values (LTE Band7 - Head)**

Ambient Temperature: 22.9 °C						Liquid Temperature: 22.5 °C						
Frequency		Mode	Side	Test Position	Figure No.	Conducted Power (dBm)	Max. tune-up Power (dBm)	Measured SAR(10g) (W/kg)	Reported SAR(10g) (W/kg)	Measured SAR(1g) (W/kg)	Reported SAR(1g) (W/kg)	Power Drift (dB)
Ch.	MHz											
21100	2535	1RB_Mid	Left	Touch	/	23.89	25.00	0.051	<b>0.07</b>	0.091	<b>0.12</b>	-0.04
21100	2535	1RB_Mid	Left	Tilt	/	23.89	25.00	0.042	<b>0.05</b>	0.081	<b>0.10</b>	0.07
21100	2535	1RB_Mid	Right	Touch	Fig.15	23.89	25.00	0.100	<b>0.13</b>	0.192	<b>0.25</b>	-0.05
21100	2535	1RB_Mid	Right	Tilt	/	23.89	25.00	0.038	<b>0.05</b>	0.068	<b>0.09</b>	-0.12
20850	2510	50RB_High	Left	Touch	/	23.10	24.00	0.031	<b>0.04</b>	0.054	<b>0.07</b>	-0.01
20850	2510	50RB_High	Left	Tilt	/	23.10	24.00	0.038	<b>0.05</b>	0.071	<b>0.09</b>	-0.01
20850	2510	50RB_High	Right	Touch	/	23.10	24.00	0.067	<b>0.08</b>	0.128	<b>0.16</b>	0.13
20850	2510	50RB_High	Right	Tilt	/	23.10	24.00	0.028	<b>0.03</b>	0.050	<b>0.06</b>	0.04

Note1: The LTE mode is QPSK\_20MHz.

**Table 14.1-16: SAR Values (LTE Band7 - Body)**

Ambient Temperature: 22.9 °C						Liquid Temperature: 22.5 °C					
Frequency		Mode	Test Position	Figure No.	Conducted Power (dBm)	Max. tune-up Power (dBm)	Measured SAR(10g) (W/kg)	Reported SAR(10g) (W/kg)	Measured SAR(1g) (W/kg)	Reported SAR(1g) (W/kg)	Power Drift (dB)
Ch.	MHz										
21100	2535	1RB_Mid	Front	/	20.85	22.00	0.110	<b>0.14</b>	0.210	<b>0.27</b>	-0.12
21325	2560	1RB_Mid	Rear	Fig.16	20.75	22.00	0.388	<b>0.52</b>	0.855	<b>1.14</b>	-0.08
21100	2535	1RB_Mid	Rear	/	20.85	22.00	0.345	<b>0.45</b>	0.767	<b>1.00</b>	0.03
20825	2510	1RB_Mid	Rear	/	20.70	22.00	0.315	<b>0.42</b>	0.703	<b>0.95</b>	-0.09
21100	2535	1RB_Mid	Bottom	/	20.85	22.00	0.246	<b>0.32</b>	0.536	<b>0.70</b>	0.03
21100	2535	1RB_Mid	Front	Note2	23.89	25.00	0.181	<b>0.23</b>	0.362	<b>0.47</b>	0.06
21100	2535	1RB_Mid	Rear	Note3	23.89	25.00	0.300	<b>0.39</b>	0.588	<b>0.76</b>	-0.07
21100	2535	1RB_Mid	Left	/	23.89	25.00	0.063	<b>0.08</b>	0.104	<b>0.13</b>	-0.12
21100	2535	1RB_Mid	Right	/	23.89	25.00	0.147	<b>0.19</b>	0.250	<b>0.32</b>	0.06
21100	2535	1RB_Mid	Bottom	Note3	23.89	25.00	0.256	<b>0.33</b>	0.509	<b>0.66</b>	0.08
20825	2510	50RB_High	Front	/	19.73	21.00	0.079	<b>0.11</b>	0.148	<b>0.20</b>	0.03
20825	2510	50RB_High	Rear	/	19.73	21.00	0.244	<b>0.33</b>	0.495	<b>0.66</b>	-0.06
20825	2510	50RB_High	Bottom	/	19.73	21.00	0.177	<b>0.24</b>	0.386	<b>0.52</b>	-0.07
20850	2510	50RB_High	Front	Note2	23.10	24.00	0.147	<b>0.18</b>	0.278	<b>0.34</b>	0.01
20850	2510	50RB_High	Rear	Note3	23.10	24.00	0.185	<b>0.23</b>	0.358	<b>0.44</b>	-0.11
20850	2510	50RB_High	Left	/	23.10	24.00	0.046	<b>0.06</b>	0.083	<b>0.10</b>	-0.04
20850	2510	50RB_High	Right	/	23.10	24.00	0.082	<b>0.10</b>	0.142	<b>0.17</b>	-0.03
20850	2510	50RB_High	Bottom	Note3	23.10	24.00	0.227	<b>0.28</b>	0.484	<b>0.60</b>	-0.10
20850	2510	100RB	Bottom	/	19.71	21.00	0.237	<b>0.32</b>	0.481	<b>0.65</b>	0.02

Note1: The distance between the EUT and the phantom bottom is 10mm

Note2: The distance between the EUT and the phantom bottom is 11mm by sensor (See detail in annex I).

Note3: The distance between the EUT and the phantom bottom is 17mm by sensor (See detail in annex I).

**Table 14.1-17: SAR Values (LTE Band12 - Head)**

Ambient Temperature: 22.9 °C						Liquid Temperature: 22.5°C						
Frequency		Mode	Side	Test Position	Figure No.	Conduct ed Power (dBm)	Max. tune-up Power (dBm)	Measured SAR(10g) (W/kg)	Reported SAR(10g) (W/kg)	Measured SAR(1g) (W/kg)	Reported SAR(1g) (W/kg)	Power Drift (dB)
Ch.	MHz											
23130	711	1RB_High	Left	Touch	/	24.49	25.00	0.017	<b>0.02</b>	0.029	<b>0.03</b>	0.02
23130	711	1RB_High	Left	Tilt	/	24.49	25.00	0.022	<b>0.02</b>	0.026	<b>0.03</b>	0.07
23130	711	1RB_High	Right	Touch	Fig.17	24.49	25.00	0.028	<b>0.03</b>	0.034	<b>0.04</b>	-0.05
23130	711	1RB_High	Right	Tilt	/	24.49	25.00	0.021	<b>0.02</b>	0.025	<b>0.03</b>	-0.10
23060	704	25RB_High	Left	Touch	/	23.60	24.00	0.022	<b>0.02</b>	0.027	<b>0.03</b>	0.05
23060	704	25RB_High	Left	Tilt	/	23.60	24.00	0.013	<b>0.01</b>	0.015	<b>0.02</b>	0.13
23060	704	25RB_High	Right	Touch	/	23.60	24.00	0.019	<b>0.02</b>	0.023	<b>0.03</b>	-0.05
23060	704	25RB_High	Right	Tilt	/	23.60	24.00	0.013	<b>0.01</b>	0.015	<b>0.02</b>	-0.12

Note1: The LTE mode is QPSK\_10MHz.

**Table 14.1-18: SAR Values (LTE Band12 - Body)**

Ambient Temperature: 22.9 °C						Liquid Temperature: 22.5°C						
Frequency		Mode	Test Position	Figure No.	Conducted Power (dBm)	Max. tune-up Power (dBm)	Measured SAR(10g) (W/kg)	Reported SAR(10g) (W/kg)	Measured SAR(1g) (W/kg)	Reported SAR(1g) (W/kg)	Power Drift (dB)	
Ch.	MHz											
23130	711	1RB_High	Front	/	24.49	25.00	0.043	<b>0.05</b>	0.055	<b>0.06</b>	-0.12	
23130	711	1RB_High	Rear	Fig.18	24.49	25.00	0.062	<b>0.07</b>	0.079	<b>0.09</b>	0.09	
23130	711	1RB_High	Left	/	24.49	25.00	0.043	<b>0.05</b>	0.060	<b>0.07</b>	0.07	
23130	711	1RB_High	Right	/	24.49	25.00	0.034	<b>0.04</b>	0.048	<b>0.05</b>	-0.01	
23130	711	1RB_High	Bottom	/	24.49	25.00	0.016	<b>0.02</b>	0.020	<b>0.02</b>	0.11	
23060	704	25RB_High	Front	/	23.60	24.00	0.028	<b>0.03</b>	0.035	<b>0.04</b>	0.12	
23060	704	25RB_High	Rear	/	23.60	24.00	0.050	<b>0.05</b>	0.063	<b>0.07</b>	0.07	
23060	704	25RB_High	Left	/	23.60	24.00	0.027	<b>0.03</b>	0.038	<b>0.04</b>	0.04	
23060	704	25RB_High	Right	/	23.60	24.00	0.019	<b>0.02</b>	0.027	<b>0.03</b>	-0.02	
23060	704	25RB_High	Bottom	/	23.60	24.00	0.013	<b>0.01</b>	0.017	<b>0.02</b>	0.09	

Note1: The distance between the EUT and the phantom bottom is 10mm.

Note2: The LTE mode is QPSK\_10MHz.

**Table 14.1-19: SAR Values (LTE Band66 - Head)**

Frequency		Mode	Side	Test Position	Figure No.	Conducted Power (dBm)	Max. tune-up Power (dBm)	Measured SAR(10g) (W/kg)	Reported SAR(10g) (W/kg)	Measured SAR(1g) (W/kg)	Reported SAR(1g) (W/kg)	Power Drift (dB)
Ch.	MHz											
132572	1770	1RB_Mid	Left	Touch	/	23.87	25.00	0.119	<b>0.15</b>	0.169	<b>0.22</b>	0.12
132572	1770	1RB_Mid	Left	Tilt	/	23.87	25.00	0.085	<b>0.11</b>	0.129	<b>0.17</b>	-0.03
132572	1770	1RB_Mid	Right	Touch	Fig.19	23.87	25.00	0.147	<b>0.19</b>	0.223	<b>0.29</b>	0.13
132572	1770	1RB_Mid	Right	Tilt	/	23.87	25.00	0.085	<b>0.11</b>	0.125	<b>0.16</b>	-0.10
132572	1770	50RB_High	Left	Touch	/	22.87	25.00	0.089	<b>0.15</b>	0.126	<b>0.21</b>	0.10
132572	1770	50RB_High	Left	Tilt	/	22.87	25.00	0.072	<b>0.12</b>	0.112	<b>0.18</b>	-0.06
132572	1770	50RB_High	Right	Touch	/	22.87	25.00	0.112	<b>0.18</b>	0.168	<b>0.27</b>	-0.04
132572	1770	50RB_High	Right	Tilt	/	22.87	25.00	0.069	<b>0.11</b>	0.102	<b>0.17</b>	-0.08

Note1: The LTE mode is QPSK\_10MHz.

**Table 14.1-20: SAR Values (LTE Band66 - Body)**

Frequency		Mode	Test Position	Figure No.	Conducted Power (dBm)	Max. tune-up Power (dBm)	Measured SAR(10g) (W/kg)	Reported SAR(10g) (W/kg)	Measured SAR(1g) (W/kg)	Reported SAR(1g) (W/kg)	Power Drift (dB)
Ch.	MHz										
132572	1770	1RB_Mid	Front	/	18.86	20.00	0.151	<b>0.20</b>	0.275	<b>0.36</b>	0.06
132572	1770	1RB_Mid	Rear	/	18.86	20.00	0.330	<b>0.43</b>	0.624	<b>0.81</b>	0.12
132322	1745	1RB_Mid	Rear	/	18.85	20.00	0.372	<b>0.48</b>	0.712	<b>0.93</b>	-0.02
132072	1720	1RB_Mid	Rear	/	18.85	20.00	0.450	<b>0.59</b>	0.862	<b>1.12</b>	0.05
132572	1770	1RB_Mid	Bottom	/	18.86	20.00	0.424	<b>0.55</b>	0.831	<b>1.08</b>	-0.12
132322	1745	1RB_Mid	Bottom	Fig.20	18.85	20.00	0.477	<b>0.62</b>	0.915	<b>1.19</b>	-0.06
132072	1720	1RB_Mid	Bottom	/	18.85	20.00	0.405	<b>0.53</b>	0.770	<b>1.00</b>	-0.03
132572	1770	1RB_Mid	Front	Note2	23.87	25.00	0.251	<b>0.33</b>	0.429	<b>0.56</b>	0.05
132572	1770	1RB_Mid	Rear	Note3	23.87	25.00	0.199	<b>0.26</b>	0.322	<b>0.42</b>	0.12
132572	1770	1RB_Mid	Left	/	23.87	25.00	0.048	<b>0.06</b>	0.074	<b>0.10</b>	-0.06
132572	1770	1RB_Mid	Right	/	23.87	25.00	0.086	<b>0.11</b>	0.131	<b>0.17</b>	0.03
132572	1770	1RB_Mid	Bottom	Note3	23.87	25.00	0.306	<b>0.40</b>	0.498	<b>0.65</b>	-0.05
132572	1770	50RB_High	Front	/	17.96	19.00	0.118	<b>0.15</b>	0.215	<b>0.27</b>	-0.11
132572	1770	50RB_High	Rear	/	17.96	19.00	0.251	<b>0.32</b>	0.480	<b>0.61</b>	0.01
132572	1770	50RB_High	Bottom	/	17.96	19.00	0.330	<b>0.42</b>	0.625	<b>0.79</b>	-0.02
132572	1770	50RB_High	Front	Note2	22.87	25.00	0.192	<b>0.31</b>	0.327	<b>0.53</b>	0.11
132572	1770	50RB_High	Rear	Note3	22.87	25.00	0.148	<b>0.24</b>	0.240	<b>0.39</b>	-0.09
132572	1770	50RB_High	Left	/	22.87	25.00	0.032	<b>0.05</b>	0.049	<b>0.08</b>	-0.05
132572	1770	50RB_High	Right	/	22.87	25.00	0.068	<b>0.11</b>	0.105	<b>0.17</b>	-0.13
132572	1770	50RB_High	Bottom	Note3	22.87	25.00	0.186	<b>0.30</b>	0.300	<b>0.49</b>	0.08
132572	1770	100RB	Rear	/	17.79	19.00	0.250	<b>0.33</b>	0.488	<b>0.65</b>	0.11

132572	1770	100RB	Bottom	/	17.79	19.00	0.334	<b>0.44</b>	0.642	<b>0.85</b>	-0.09
--------	------	-------	--------	---	-------	-------	-------	-------------	-------	-------------	-------

Note1: The distance between the EUT and the phantom bottom is 10mm

Note2: The distance between the EUT and the phantom bottom is 11mm by sensor (See detail in annex I).

Note3: The distance between the EUT and the phantom bottom is 17mm by sensor (See detail in annex I).

### 14.2 SAR results for Standard procedure

There is zoom scan measurement to be added for the highest measured SAR in each exposure configuration/band.

**Table 14.2-1: SAR Values (GSM 850 MHz Band - Head)**

Ambient Temperature: 22.9 °C						Liquid Temperature: 22.5 °C					
Frequency		Side	Test Position	Figure No.	Conducted Power (dBm)	Max. tune-up Power (dBm)	Measured SAR(10g) (W/kg)	Reported SAR(10g) (W/kg)	Measured SAR(1g) (W/kg)	Reported SAR(1g) (W/kg)	Power Drift (dB)
Ch.	MHz										
251	848.8	Left	Touch	Fig.1	32.74	33.00	0.207	<b>0.22</b>	0.277	<b>0.29</b>	-0.08

Note: the head SAR of GSM850 is tested with GPRS (2Txslots) mode because of VoIP.

**Table 14.2-2: SAR Values (GSM 850 MHz Band - Body)**

Ambient Temperature: 22.9 °C						Liquid Temperature: 22.5 °C					
Frequency		Mode (number of timeslots)	Test Position	Figure No.	Conducted Power (dBm)	Max. tune-up Power (dBm)	Measured SAR(10g) (W/kg)	Reported SAR(10g) (W/kg)	Measured SAR(1g) (W/kg)	Reported SAR(1g) (W/kg)	Power Drift (dB)
Ch.	MHz										
251	848.8	GPRS (2)	Rear	Fig.2	32.74	33.00	0.359	<b>0.38</b>	0.465	<b>0.49</b>	0.08

Note: The distance between the EUT and the phantom bottom is 10mm.

**Table 14.2-3: SAR Values (GSM 1900 MHz Band - Head)**

Ambient Temperature: 22.9 °C						Liquid Temperature: 22.5 °C					
Frequency		Side	Test Position	Figure No.	Conducted Power (dBm)	Max. tune-up Power (dBm)	Measured SAR(10g) (W/kg)	Reported SAR(10g) (W/kg)	Measured SAR(1g) (W/kg)	Reported SAR(1g) (W/kg)	Power Drift (dB)
Ch.	MHz										
661	1880	Right	Touch	Fig.3	29.58	30.00	0.110	<b>0.12</b>	0.175	<b>0.19</b>	0.12

Note: the head SAR of GSM1900 is tested with GPRS (2Txslots) mode because of VoIP.

**Table 14.2-4: SAR Values (GSM 1900 MHz Band - Body)**

Ambient Temperature: 22.9 °C						Liquid Temperature: 22.5 °C					
Frequency		Mode (number of timeslots)	Test Position	Figure No.	Conducted Power (dBm)	Max. tune-up Power (dBm)	Measured SAR(10g) (W/kg)	Reported SAR(10g) (W/kg)	Measured SAR(1g) (W/kg)	Reported SAR(1g) (W/kg)	Power Drift (dB)
Ch.	MHz										
512	1850.2	GPRS (4)	Bottom	Fig.4	24.37	25.00	0.472	<b>0.55</b>	0.923	<b>1.07</b>	-0.09

Note1: The distance between the EUT and the phantom bottom is 10mm

**Table 14.2-5: SAR Values (WCDMA 1900 MHz Band - Head)**

Frequency		Side	Test Position	Figure No.	Ambient Temperature: 22.9 °C		Liquid Temperature: 22.5 °C				Power Drift (dB)
Ch.	MHz				Conducted Power (dBm)	Max. tune-up Power (dBm)	Measured SAR(10g) (W/kg)	Reported SAR(10g) (W/kg)	Measured SAR(1g) (W/kg)	Reported SAR(1g) (W/kg)	
9938	1907.6	Left	Touch	Fig.5	24.50	25.00	0.174	<b>0.20</b>	0.280	<b>0.31</b>	0.08

**Table 14.2-6: SAR Values (WCDMA 1900 MHz Band - Body)**

Frequency		Test Position	Figure No.	Ambient Temperature: 22.9 °C		Liquid Temperature: 22.5 °C				Power Drift (dB)
Ch.	MHz			Conducted Power (dBm)	Max. tune-up Power (dBm)	Measured SAR(10g) (W/kg)	Reported SAR(10g) (W/kg)	Measured SAR(1g) (W/kg)	Reported SAR(1g) (W/kg)	
9662	1852.4	Bottom	Fig.6	21.03	22.00	0.388	<b>0.49</b>	0.756	<b>0.95</b>	-0.09

Note1: The distance between the EUT and the phantom bottom is 10mm

**Table 14.2-7: SAR Values (WCDMA 1700 MHz Band - Head)**

Frequency		Side	Test Position	Figure No.	Ambient Temperature: 22.9 °C		Liquid Temperature: 22.5 °C				Power Drift (dB)
Ch.	MHz				Conducted Power (dBm)	Max. tune-up Power (dBm)	Measured SAR(10g) (W/kg)	Reported SAR(10g) (W/kg)	Measured SAR(1g) (W/kg)	Reported SAR(1g) (W/kg)	
1513	1752.6	Right	Touch	Fig.7	23.21	25.00	0.168	<b>0.25</b>	0.256	<b>0.39</b>	0.01

**Table 14.2-8: SAR Values (WCDMA 1700 MHz Band - Body)**

Frequency		Test Position	Figure No.	Ambient Temperature: 22.9 °C		Liquid Temperature: 22.5 °C				Power Drift (dB)
Ch.	MHz			Conducted Power (dBm)	Max. tune-up Power (dBm)	Measured SAR(10g) (W/kg)	Reported SAR(10g) (W/kg)	Measured SAR(1g) (W/kg)	Reported SAR(1g) (W/kg)	
1312	1712.4	Bottom	Note3 Fig.8	23.33	25.00	0.518	<b>0.76</b>	0.882	<b>1.30</b>	-0.03

Note3: The distance between the EUT and the phantom bottom is 17mm by sensor (See detail in annex I).

**Table 14.2-9: SAR Values (WCDMA 850 MHz Band - Head)**

Frequency		Side	Test Position	Figure No.	Ambient Temperature: 22.9 °C		Liquid Temperature: 22.5 °C				Power Drift (dB)
Ch.	MHz				Conducted Power (dBm)	Max. tune-up Power (dBm)	Measured SAR(10g) (W/kg)	Reported SAR(10g) (W/kg)	Measured SAR(1g) (W/kg)	Reported SAR(1g) (W/kg)	
4233	846.6	Left	Touch	Fig.9	24.40	25.00	0.158	<b>0.18</b>	0.210	<b>0.24</b>	-0.12

**Table 14.2-10: SAR Values (WCDMA 850 MHz Band - Body)**

Ambient Temperature: 22.9°C						Liquid Temperature: 22.5°C				
Frequency		Test Position	Figure No.	Conducted Power (dBm)	Max. tune-up Power (dBm)	Measured SAR(10g) (W/kg)	Reported SAR(10g) (W/kg)	Measured SAR(1g) (W/kg)	Reported SAR(1g) (W/kg)	Power Drift (dB)
Ch.	MHz									
4132	826.4	Rear	Fig.10	24.39	25.00	0.202	<b>0.23</b>	0.261	<b>0.30</b>	-0.12

Note: The distance between the EUT and the phantom bottom is 10mm.

**Table 14.2-11: SAR Values (LTE Band2 - Head)**

Ambient Temperature: 22.9°C						Liquid Temperature: 22.5°C						
Frequency		Mode	Side	Test Position	Figure No.	Conducted Power (dBm)	Max. tune-up Power (dBm)	Measured SAR(10g) (W/kg)	Reported SAR(10g) (W/kg)	Measured SAR(1g) (W/kg)	Reported SAR(1g) (W/kg)	Power Drift (dB)
Ch.	MHz											
18700	1860	1RB_Mid	Left	Touch	Fig.11	24.56	25.00	0.154	<b>0.17</b>	0.247	<b>0.27</b>	-0.01

Note1: The LTE mode is QPSK\_20MHz.

**Table 14.2-12: SAR Values (LTE Band2 - Body)**

Ambient Temperature: 22.9°C						Liquid Temperature: 22.5°C					
Frequency		Mode	Test Position	Figure No.	Conducted Power (dBm)	Max. tune-up Power (dBm)	Measured SAR(10g) (W/kg)	Reported SAR(10g) (W/kg)	Measured SAR(1g) (W/kg)	Reported SAR(1g) (W/kg)	Power Drift (dB)
Ch.	MHz										
18700	1860	1RB_Mid	Bottom	Fig.12	21.76	23.00	0.480	<b>0.64</b>	0.934	<b>1.24</b>	0.00

Note1: The distance between the EUT and the phantom bottom is 10mm

**Table 14.2-13: SAR Values (LTE Band5 - Head)**

Ambient Temperature: 22.9°C						Liquid Temperature: 22.5°C						
Frequency		Mode	Side	Test Position	Figure No.	Conducted Power (dBm)	Max. tune-up Power (dBm)	Measured SAR(10g) (W/kg)	Reported SAR(10g) (W/kg)	Measured SAR(1g) (W/kg)	Reported SAR(1g) (W/kg)	Power Drift (dB)
Ch.	MHz											
20600	844	1RB_High	Left	Touch	Fig.13	24.37	25.00	0.157	<b>0.18</b>	0.207	<b>0.24</b>	0.04

Note1: The LTE mode is QPSK\_10MHz.



**Table 14.2-14: SAR Values (LTE Band5 - Body)**

Ambient Temperature: 22.9 °C						Liquid Temperature: 22.5 °C					
Frequency		Mode	Test Position	Figure No.	Conducted Power (dBm)	Max. tune-up Power (dBm)	Measured SAR(10g) (W/kg)	Reported SAR(10g) (W/kg)	Measured SAR(1g) (W/kg)	Reported SAR(1g) (W/kg)	Power Drift (dB)
Ch.	MHz										
20600	844	1RB_High	Rear	Fig.14	24.37	25.00	0.244	<b>0.28</b>	0.320	<b>0.37</b>	-0.07

Note1: The distance between the EUT and the phantom bottom is 10mm.

Note2: The LTE mode is QPSK\_10MHz.

**Table 14.2-15: SAR Values (LTE Band7 - Head)**

Ambient Temperature: 22.9 °C						Liquid Temperature: 22.5 °C						
Frequency		Mode	Side	Test Position	Figure No.	Conducted Power (dBm)	Max. tune-up Power (dBm)	Measured SAR(10g) (W/kg)	Reported SAR(10g) (W/kg)	Measured SAR(1g) (W/kg)	Reported SAR(1g) (W/kg)	Power Drift (dB)
Ch.	MHz											
21100	2535	1RB_Mid	Right	Touch	Fig.15	23.89	25.00	0.100	<b>0.13</b>	0.192	<b>0.25</b>	-0.05

Note1: The LTE mode is QPSK\_20MHz.

**Table 14.2-16: SAR Values (LTE Band7 - Body)**

Ambient Temperature: 22.9 °C						Liquid Temperature: 22.5 °C					
Frequency		Mode	Test Position	Figure No.	Conducted Power (dBm)	Max. tune-up Power (dBm)	Measured SAR(10g) (W/kg)	Reported SAR(10g) (W/kg)	Measured SAR(1g) (W/kg)	Reported SAR(1g) (W/kg)	Power Drift (dB)
Ch.	MHz										
21325	2560	1RB_Mid	Rear	Fig.16	20.75	22.00	0.388	<b>0.52</b>	0.855	<b>1.14</b>	-0.08

Note1: The distance between the EUT and the phantom bottom is 10mm

**Table 14.2-17: SAR Values (LTE Band12 - Head)**

Ambient Temperature: 22.9 °C						Liquid Temperature: 22.5 °C						
Frequency		Mode	Side	Test Position	Figure No.	Conducted Power (dBm)	Max. tune-up Power (dBm)	Measured SAR(10g) (W/kg)	Reported SAR(10g) (W/kg)	Measured SAR(1g) (W/kg)	Reported SAR(1g) (W/kg)	Power Drift (dB)
Ch.	MHz											
23130	711	1RB_High	Right	Touch	Fig.17	24.49	25.00	0.028	<b>0.03</b>	0.034	<b>0.04</b>	-0.05

Note1: The LTE mode is QPSK\_10MHz.

**Table 14.2-18: SAR Values (LTE Band12 - Body)**

Ambient Temperature: 22.9 °C						Liquid Temperature: 22.5°C					
Frequency		Mode	Test Position	Figure No.	Conducted Power (dBm)	Max. tune-up Power (dBm)	Measured SAR(10g) (W/kg)	Reported SAR(10g) (W/kg)	Measured SAR(1g) (W/kg)	Reported SAR(1g) (W/kg)	Power Drift (dB)
Ch.	MHz										
23130	711	1RB_High	Rear	Fig.18	24.49	25.00	0.062	<b>0.07</b>	0.079	<b>0.09</b>	0.09

Note1: The distance between the EUT and the phantom bottom is 10mm.

Note2: The LTE mode is QPSK\_10MHz.

**Table 14.2-19: SAR Values (LTE Band66 - Head)**

Ambient Temperature: 22.9 °C						Liquid Temperature: 22.5°C						
Frequency		Mode	Side	Test Position	Figure No.	Conducted Power (dBm)	Max. tune-up Power (dBm)	Measured SAR(10g) (W/kg)	Reported SAR(10g) (W/kg)	Measured SAR(1g) (W/kg)	Reported SAR(1g) (W/kg)	Power Drift (dB)
Ch.	MHz											
132572	1770	1RB_Mid	Right	Touch	Fig.19	23.87	25.00	0.147	<b>0.19</b>	0.223	<b>0.29</b>	0.13

Note1: The LTE mode is QPSK\_10MHz.

**Table 14.2-20: SAR Values (LTE Band66 - Body)**

Ambient Temperature: 22.9 °C						Liquid Temperature: 22.5°C					
Frequency		Mode	Test Position	Figure No.	Conducted Power (dBm)	Max. tune-up Power (dBm)	Measured SAR(10g) (W/kg)	Reported SAR(10g) (W/kg)	Measured SAR(1g) (W/kg)	Reported SAR(1g) (W/kg)	Power Drift (dB)
Ch.	MHz										
132322	1745	1RB_Mid	Bottom	Fig.20	18.85	20.00	0.477	<b>0.62</b>	0.915	<b>1.19</b>	-0.06

Note1: The distance between the EUT and the phantom bottom is 10mm

### 14.3 WLAN Evaluation for 2.4G

According to the KDB248227 D01, SAR is measured for 2.4GHz 802.11b DSSS using the initial test position procedure.

#### Head Evaluation

**Table 14.3-1: SAR Values (WLAN - Head)– 802.11b (Fast SAR)**

Ambient Temperature: 22.9 °C						Liquid Temperature: 22.5 °C					
Frequency		Side	Test Position	Figure No.	Conducted Power (dBm)	Max. tune-up Power (dBm)	Measured SAR(10g) (W/kg)	Reported SAR(10g) (W/kg)	Measured SAR(1g) (W/kg)	Reported SAR(1g)(W/kg)	Power Drift (dB)
MHz	Ch.										
2412	1	Left	Touch	/	17.86	18.00	0.355	<b>0.37</b>	0.654	<b>0.68</b>	-0.07
2412	1	Left	Tilt	/	17.86	18.00	0.264	<b>0.27</b>	0.523	<b>0.54</b>	0.01
2412	1	Right	Touch	/	17.86	18.00	0.162	<b>0.17</b>	0.267	<b>0.28</b>	-0.13
2412	1	Right	Tilt	/	17.86	18.00	0.139	<b>0.14</b>	0.261	<b>0.27</b>	-0.01

As shown above table, the initial test position for head is “Left Touch”. So the head SAR of WLAN is presented as below:

**Table 14.3-2: SAR Values (WLAN - Head)– 802.11b (Full SAR)**

Ambient Temperature: 22.9 °C						Liquid Temperature: 22.5 °C					
Frequency		Side	Test Position	Figure No.	Conducted Power (dBm)	Max. tune-up Power (dBm)	Measured SAR(10g) (W/kg)	Reported SAR(10g) (W/kg)	Measured SAR(1g) (W/kg)	Reported SAR(1g)(W/kg)	Power Drift (dB)
MHz	Ch.										
2462	11	Left	Touch	Fig.21	17.83	18.00	0.420	<b>0.44</b>	0.835	<b>0.87</b>	0.02
2412	1	Left	Touch	/	17.86	18.00	0.343	<b>0.35</b>	0.650	<b>0.67</b>	-0.07
2412	1	Left	Tilt	/	17.86	18.00	0.255	<b>0.26</b>	0.557	<b>0.58</b>	0.01

Note1: When the reported SAR of the initial test position is > 0.4 W/kg, SAR is repeated for the 802.11 transmission mode configuration tested in the initial test position using subsequent highest estimated 1-g SAR conditions determined by area scans, on the highest maximum output power channel, until the reported SAR is  $\leq$  0.8 W/kg.

Note2: For all positions/configurations tested using the initial test position and subsequent test positions, when the reported SAR is > 0.8 W/kg, SAR is measured for these test positions/configurations on the subsequent next highest measured output power channel until the reported SAR is  $\leq$  1.2 W/kg or all required channels are tested.

According to the KDB248227 D01, The reported SAR must be scaled to 100% transmission duty factor to determine compliance at the maximum tune-up tolerance limit. The scaled reported SAR is presented as below.

**Table 14.3-3: SAR Values (WLAN - Head) – 802.11b (Scaled Reported SAR)**

Ambient Temperature: 22.9 °C						Liquid Temperature: 22.5 °C	
Frequency		Side	Test Position	Actual duty factor	maximum duty factor	Reported SAR (1g)(W/kg)	Scaled reported SAR (1g)(W/kg)
MHz	Ch.						
2462	11	Left	Touch	100%	100%	<b>0.87</b>	<b>0.87</b>

SAR is not required for OFDM because the 802.11b adjusted SAR  $\leq$  1.2 W/kg.

**Body Evaluation**
**Table 14.3-4: SAR Values (WLAN - Body)– 802.11b (Fast SAR)**

Frequency		Test Position	Figure No.	Conducted Power (dBm)	Max. tune-up Power (dBm)	Ambient Temperature: 22.9°C		Liquid Temperature: 22.5°C		Power Drift (dB)
MHz	Ch.					Measured SAR(10g) (W/kg)	Reported SAR(10g) (W/kg)	Measured SAR(1g) (W/kg)	Reported SAR(1g) (W/kg)	
2412	1	Front	/	17.86	18.00	0.085	<b>0.09</b>	0.153	<b>0.16</b>	-0.05
2412	1	Rear	/	17.86	18.00	0.144	<b>0.15</b>	0.277	<b>0.29</b>	0.18
2412	1	Right	/	17.86	18.00	0.127	<b>0.13</b>	0.262	<b>0.27</b>	-0.05
2412	1	Top	/	17.86	18.00	0.066	<b>0.07</b>	0.140	<b>0.14</b>	0.08

As shown above table, the initial test position for body is “Rear”. So the body SAR of WLAN is presented as below:

**Table 14.3-5: SAR Values (WLAN - Body)– 802.11b (Full SAR)**

Frequency		Test Position	Figure No.	Conducted Power (dBm)	Max. tune-up Power (dBm)	Ambient Temperature: 22.9°C		Liquid Temperature: 22.5°C		Power Drift (dB)
MHz	Ch.					Measured SAR(10g) (W/kg)	Reported SAR(10g) (W/kg)	Measured SAR(1g) (W/kg)	Reported SAR(1g) (W/kg)	
2412	1	Rear	Fig.22	17.86	18.00	0.145	<b>0.15</b>	0.283	<b>0.29</b>	0.18

Note1: When the reported SAR of the initial test position is > 0.4 W/kg, SAR is repeated for the 802.11 transmission mode configuration tested in the initial test position using subsequent highest estimated 1-g SAR conditions determined by area scans, on the highest maximum output power channel, until the reported SAR is  $\leq$  0.8 W/kg.

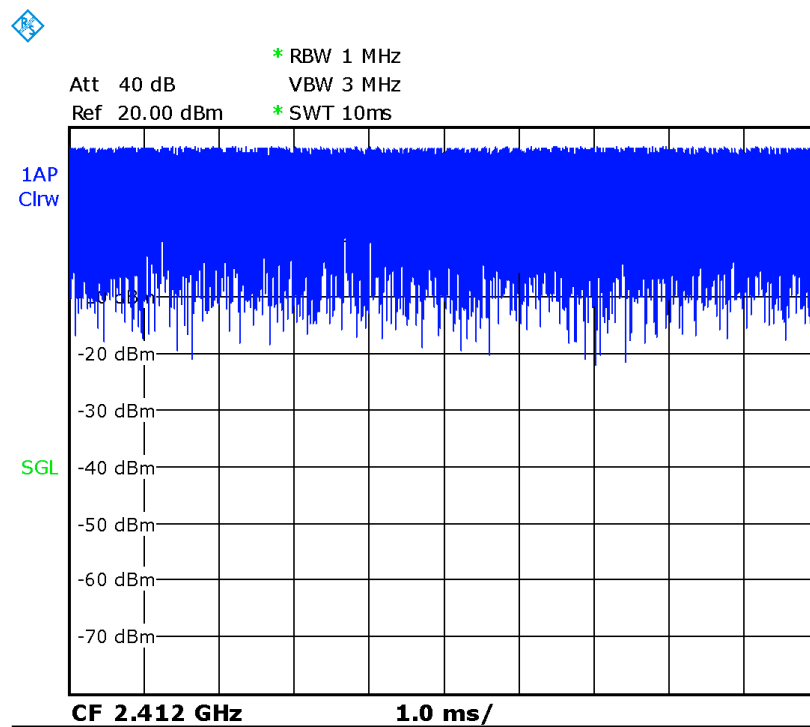
Note2: For all positions/configurations tested using the initial test position and subsequent test positions, when the reported SAR is > 0.8 W/kg, SAR is measured for these test positions/configurations on the subsequent next highest measured output power channel until the reported SAR is  $\leq$  1.2 W/kg or all required channels are tested.

According to the KDB248227 D01, The reported SAR must be scaled to 100% transmission duty factor to determine compliance at the maximum tune-up tolerance limit. The scaled reported SAR is presented as below.

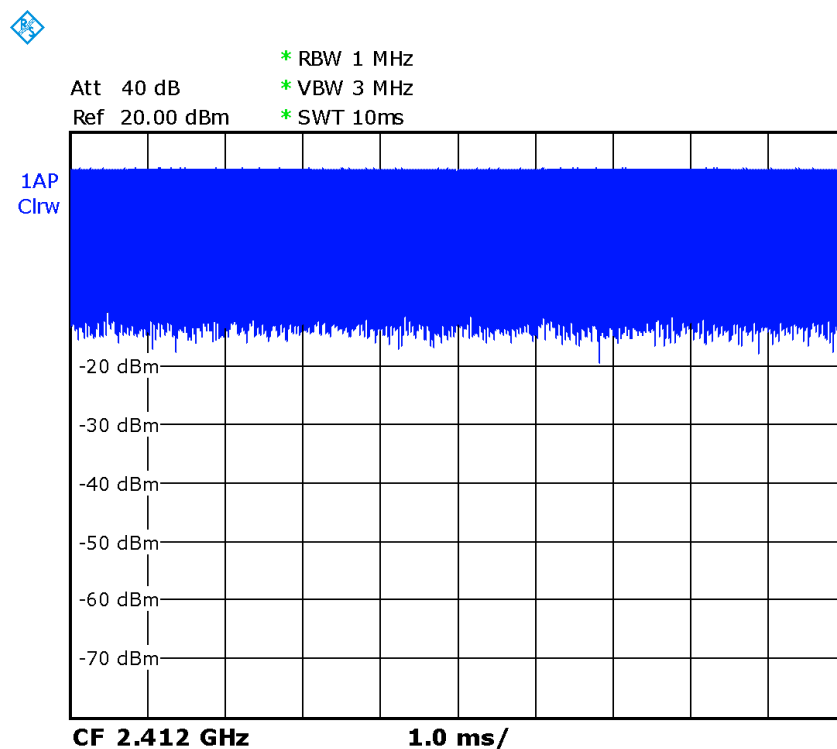
**Table 14.3-6: SAR Values (WLAN - Body) – 802.11b (Scaled Reported SAR)**

Frequency		Test Position	Ambient Temperature: 22.9°C		Liquid Temperature: 22.5°C	
MHz	Ch.		Actual duty factor	maximum duty factor	Reported SAR (1g)(W/kg)	Scaled reported SAR (1g)(W/kg)
2462	11	Rear	100%	100%	<b>0.29</b>	<b>0.29</b>

SAR is not required for OFDM because the 802.11b adjusted SAR  $\leq$  1.2 W/kg.



Picture 14.1 Duty factor plot for Head



Picture 14.2 Duty factor plot for Body

## 15 SAR Measurement Variability

SAR measurement variability must be assessed for each frequency band, which is determined by the SAR probe calibration point and tissue-equivalent medium used for the device measurements. When both head and body tissue-equivalent media are required for SAR measurements in a frequency band, the variability measurement procedures should be applied to the tissue medium with the highest measured SAR, using the highest measured SAR configuration for that tissue-equivalent medium.

The following procedures are applied to determine if repeated measurements are required.

- 1) Repeated measurement is not required when the original highest measured SAR is  $< 0.80$  W/kg; steps 2) through 4) do not apply.
- 2) When the original highest measured SAR is  $\geq 0.80$  W/kg, repeat that measurement once.
- 3) Perform a second repeated measurement only if the ratio of largest to smallest SAR for the original and first repeated measurements is  $> 1.20$  or when the original or repeated measurement is  $\geq 1.45$  W/kg ( $\sim 10\%$  from the 1-g SAR limit).
- 4) Perform a third repeated measurement only if the original, first or second repeated measurement is  $\geq 1.5$  W/kg and the ratio of largest to smallest SAR for the original, first and second repeated measurements is  $> 1.20$ .

**Table 15.1: SAR Measurement Variability for Body GSM1900 (1g)**

Frequency		Test Position	Spacing (mm)	Original SAR (W/kg)	First Repeated SAR (W/kg)	The Ratio	Second Repeated SAR (W/kg)
Ch.	MHz						
512	1825.2	Bottom	10	0.923	0.904	1.02	/

**Table 15.2: SAR Measurement Variability for Body WCDMA1700 (1g)**

Frequency		Test Position	Spacing (mm)	Original SAR (W/kg)	First Repeated SAR (W/kg)	The Ratio	Second Repeated SAR (W/kg)
Ch.	MHz						
1312	1712.4	Bottom	18	0.882	0.851	1.04	/

**Table 15.3: SAR Measurement Variability for Body LTE B2 (1g)**

Frequency		Test Position	Spacing (mm)	Original SAR (W/kg)	First Repeated SAR (W/kg)	The Ratio	Second Repeated SAR (W/kg)
Ch.	MHz						
18700	1860	Bottom	10	0.934	0.905	1.03	/

**Table 15.4: SAR Measurement Variability for Body LTE B7 (1g)**

Frequency		Test Position	Spacing (mm)	Original SAR (W/kg)	First Repeated SAR (W/kg)	The Ratio	Second Repeated SAR (W/kg)
Ch.	MHz						
21325	2560	Rear	10	0.855	0.808	1.06	/

**Table 15.5: SAR Measurement Variability for Body LTE B66 (1g)**

Frequency		Test Position	Spacing (mm)	Original SAR (W/kg)	First Repeated SAR (W/kg)	The Ratio	Second Repeated SAR (W/kg)
Ch.	MHz						
132322	1745	Bottom	10	0.915	0.872	1.05	/

## 16 Measurement Uncertainty

### 16.1 Measurement Uncertainty for Normal SAR Tests (300MHz~3GHz)

No.	Error Description	Type	Uncertainty value	Probably Distribution	Div.	(Ci) 1g	(Ci) 10g	Std. Unc. (1g)	Std. Unc. (10g)	Degree of freedom
<b>Measurement system</b>										
1	Probe calibration	B	6.0	N	1	1	1	6.0	6.0	$\infty$
2	Isotropy	B	4.7	R	$\sqrt{3}$	0.7	0.7	1.9	1.9	$\infty$
3	Boundary effect	B	1.0	R	$\sqrt{3}$	1	1	0.6	0.6	$\infty$
4	Linearity	B	4.7	R	$\sqrt{3}$	1	1	2.7	2.7	$\infty$
5	Detection limit	B	1.0	N	1	1	1	0.6	0.6	$\infty$
6	Readout electronics	B	0.3	R	$\sqrt{3}$	1	1	0.3	0.3	$\infty$
7	Response time	B	0.8	R	$\sqrt{3}$	1	1	0.5	0.5	$\infty$
8	Integration time	B	2.6	R	$\sqrt{3}$	1	1	1.5	1.5	$\infty$
9	RF ambient conditions-noise	B	0	R	$\sqrt{3}$	1	1	0	0	$\infty$
10	RFambient conditions-reflection	B	0	R	$\sqrt{3}$	1	1	0	0	$\infty$
11	Probe positioned mech. restrictions	B	0.4	R	$\sqrt{3}$	1	1	0.2	0.2	$\infty$
12	Probe positioning with respect to phantom shell	B	2.9	R	$\sqrt{3}$	1	1	1.7	1.7	$\infty$
13	Post-processing	B	1.0	R	$\sqrt{3}$	1	1	0.6	0.6	$\infty$
<b>Test sample related</b>										
14	Test sample positioning	A	3.3	N	1	1	1	3.3	3.3	71
15	Device holder uncertainty	A	3.4	N	1	1	1	3.4	3.4	5
16	Drift of output power	B	5.0	R	$\sqrt{3}$	1	1	2.9	2.9	$\infty$
<b>Phantom and set-up</b>										
17	Phantom uncertainty	B	4.0	R	$\sqrt{3}$	1	1	2.3	2.3	$\infty$
18	Liquid conductivity (target)	B	5.0	R	$\sqrt{3}$	0.64	0.43	1.8	1.2	$\infty$
19	Liquid conductivity (meas.)	A	2.06	N	1	0.64	0.43	1.32	0.89	43
20	Liquid permittivity (target)	B	5.0	R	$\sqrt{3}$	0.6	0.49	1.7	1.4	$\infty$
21	Liquid permittivity (meas.)	A	1.6	N	1	0.6	0.49	1.0	0.8	521



Combined standard uncertainty	$u_c = \sqrt{\sum_{i=1}^{21} c_i^2 u_i^2}$							9.55	9.43	257
Expanded uncertainty (confidence interval of 95 %)	$u_e = 2u_c$							19.1	18.9	

**16.2 Measurement Uncertainty for Normal SAR Tests (3~6GHz)**

No.	Error Description	Type	Uncertainty value	Probably Distribution	Div.	(Ci) 1g	(Ci) 10g	Std. Unc. (1g)	Std. Unc. (10g)	Degree of freedom
<b>Measurement system</b>										
1	Probe calibration	B	6.55	N	1	1	1	6.55	6.55	$\infty$
2	Isotropy	B	4.7	R	$\sqrt{3}$	0.7	0.7	1.9	1.9	$\infty$
3	Boundary effect	B	2.0	R	$\sqrt{3}$	1	1	1.2	1.2	$\infty$
4	Linearity	B	4.7	R	$\sqrt{3}$	1	1	2.7	2.7	$\infty$
5	Detection limit	B	1.0	R	$\sqrt{3}$	1	1	0.6	0.6	$\infty$
6	Readout electronics	B	0.3	R	$\sqrt{3}$	1	1	0.3	0.3	$\infty$
7	Response time	B	0.8	R	$\sqrt{3}$	1	1	0.5	0.5	$\infty$
8	Integration time	B	2.6	R	$\sqrt{3}$	1	1	1.5	1.5	$\infty$
9	RF ambient conditions-noise	B	0	R	$\sqrt{3}$	1	1	0	0	$\infty$
10	RFambient conditions-reflection	B	0	R	$\sqrt{3}$	1	1	0	0	$\infty$
11	Probe positioned mech. restrictions	B	0.8	R	$\sqrt{3}$	1	1	0.5	0.5	$\infty$
12	Probe positioning with respect to phantom shell	B	6.7	R	$\sqrt{3}$	1	1	3.9	3.9	$\infty$
13	Post-processing	B	4.0	R	$\sqrt{3}$	1	1	2.3	2.3	$\infty$
<b>Test sample related</b>										
14	Test sample positioning	A	3.3	N	1	1	1	3.3	3.3	71
15	Device holder uncertainty	A	3.4	N	1	1	1	3.4	3.4	5
16	Drift of output power	B	5.0	R	$\sqrt{3}$	1	1	2.9	2.9	$\infty$
<b>Phantom and set-up</b>										
17	Phantom uncertainty	B	4.0	R	$\sqrt{3}$	1	1	2.3	2.3	$\infty$
18	Liquid conductivity (target)	B	5.0	R	$\sqrt{3}$	0.64	0.43	1.8	1.2	$\infty$
19	Liquid conductivity (meas.)	A	2.06	N	1	0.64	0.43	1.32	0.89	43
20	Liquid permittivity	B	5.0	R	$\sqrt{3}$	0.6	0.49	1.7	1.4	$\infty$

	(target)									
21	Liquid permittivity (meas.)	A	1.6	N	1	0.6	0.49	1.0	0.8	521
Combined standard uncertainty		$u_c = \sqrt{\sum_{i=1}^{21} c_i^2 u_i^2}$						10.7	10.6	257
Expanded uncertainty (confidence interval of 95 %)		$u_e = 2u_c$						21.4	21.1	

### 16.3 Measurement Uncertainty for Fast SAR Tests (300MHz~3GHz)

No.	Error Description	Type	Uncertainty value	Probably Distribution	Div.	(Ci) 1g	(Ci) 10g	Std. Unc. (1g)	Std. Unc. (10g)	Degree of freedom
<b>Measurement system</b>										
1	Probe calibration	B	6.0	N	1	1	1	6.0	6.0	$\infty$
2	Isotropy	B	4.7	R	$\sqrt{3}$	0.7	0.7	1.9	1.9	$\infty$
3	Boundary effect	B	1.0	R	$\sqrt{3}$	1	1	0.6	0.6	$\infty$
4	Linearity	B	4.7	R	$\sqrt{3}$	1	1	2.7	2.7	$\infty$
5	Detection limit	B	1.0	R	$\sqrt{3}$	1	1	0.6	0.6	$\infty$
6	Readout electronics	B	0.3	R	$\sqrt{3}$	1	1	0.3	0.3	$\infty$
7	Response time	B	0.8	R	$\sqrt{3}$	1	1	0.5	0.5	$\infty$
8	Integration time	B	2.6	R	$\sqrt{3}$	1	1	1.5	1.5	$\infty$
9	RF ambient conditions-noise	B	0	R	$\sqrt{3}$	1	1	0	0	$\infty$
10	RFambient conditions-reflection	B	0	R	$\sqrt{3}$	1	1	0	0	$\infty$
11	Probe positioned mech. Restrictions	B	0.4	R	$\sqrt{3}$	1	1	0.2	0.2	$\infty$
12	Probe positioning with respect to phantom shell	B	2.9	R	$\sqrt{3}$	1	1	1.7	1.7	$\infty$
13	Post-processing	B	1.0	R	$\sqrt{3}$	1	1	0.6	0.6	$\infty$
14	Fast SAR z-Approximation	B	7.0	R	$\sqrt{3}$	1	1	4.0	4.0	$\infty$
<b>Test sample related</b>										
15	Test sample positioning	A	3.3	N	1	1	1	3.3	3.3	71
16	Device holder uncertainty	A	3.4	N	1	1	1	3.4	3.4	5
17	Drift of output power	B	5.0	R	$\sqrt{3}$	1	1	2.9	2.9	$\infty$
<b>Phantom and set-up</b>										
18	Phantom uncertainty	B	4.0	R	$\sqrt{3}$	1	1	2.3	2.3	$\infty$

19	Liquid conductivity (target)	B	5.0	R	$\sqrt{3}$	0.64	0.43	1.8	1.2	$\infty$
20	Liquid conductivity (meas.)	A	2.06	N	1	0.64	0.43	1.32	0.89	43
21	Liquid permittivity (target)	B	5.0	R	$\sqrt{3}$	0.6	0.49	1.7	1.4	$\infty$
22	Liquid permittivity (meas.)	A	1.6	N	1	0.6	0.49	1.0	0.8	521
Combined standard uncertainty		$u_c = \sqrt{\sum_{i=1}^{22} c_i^2 u_i^2}$						10.4	10.3	257
Expanded uncertainty (confidence interval of 95 %)		$u_e = 2u_c$						20.8	20.6	

#### 16.4 Measurement Uncertainty for Fast SAR Tests (3~6GHz)

No.	Error Description	Type	Uncertainty value	Probably Distribution	Div.	(Ci) 1g	(Ci) 10g	Std. Unc. (1g)	Std. Unc. (10g)	Degree of freedom
<b>Measurement system</b>										
1	Probe calibration	B	6.55	N	1	1	1	6.55	6.55	$\infty$
2	Isotropy	B	4.7	R	$\sqrt{3}$	0.7	0.7	1.9	1.9	$\infty$
3	Boundary effect	B	2.0	R	$\sqrt{3}$	1	1	1.2	1.2	$\infty$
4	Linearity	B	4.7	R	$\sqrt{3}$	1	1	2.7	2.7	$\infty$
5	Detection limit	B	1.0	R	$\sqrt{3}$	1	1	0.6	0.6	$\infty$
6	Readout electronics	B	0.3	R	$\sqrt{3}$	1	1	0.3	0.3	$\infty$
7	Response time	B	0.8	R	$\sqrt{3}$	1	1	0.5	0.5	$\infty$
8	Integration time	B	2.6	R	$\sqrt{3}$	1	1	1.5	1.5	$\infty$
9	RF ambient conditions-noise	B	0	R	$\sqrt{3}$	1	1	0	0	$\infty$
10	RF ambient conditions-reflection	B	0	R	$\sqrt{3}$	1	1	0	0	$\infty$
11	Probe positioned mech. Restrictions	B	0.8	R	$\sqrt{3}$	1	1	0.5	0.5	$\infty$
12	Probe positioning with respect to phantom shell	B	6.7	R	$\sqrt{3}$	1	1	3.9	3.9	$\infty$
13	Post-processing	B	1.0	R	$\sqrt{3}$	1	1	0.6	0.6	$\infty$
14	Fast SAR z-Approximation	B	14.0	R	$\sqrt{3}$	1	1	8.1	8.1	$\infty$
<b>Test sample related</b>										
15	Test sample positioning	A	3.3	N	1	1	1	3.3	3.3	71

16	Device holder uncertainty	A	3.4	N	1	1	1	3.4	3.4	5
17	Drift of output power	B	5.0	R	$\sqrt{3}$	1	1	2.9	2.9	$\infty$
<b>Phantom and set-up</b>										
18	Phantom uncertainty	B	4.0	R	$\sqrt{3}$	1	1	2.3	2.3	$\infty$
19	Liquid conductivity (target)	B	5.0	R	$\sqrt{3}$	0.64	0.43	1.8	1.2	$\infty$
20	Liquid conductivity (meas.)	A	2.06	N	1	0.64	0.43	1.32	0.89	43
21	Liquid permittivity (target)	B	5.0	R	$\sqrt{3}$	0.6	0.49	1.7	1.4	$\infty$
22	Liquid permittivity (meas.)	A	1.6	N	1	0.6	0.49	1.0	0.8	521
Combined standard uncertainty		$u_c = \sqrt{\sum_{i=1}^{22} c_i^2 u_i^2}$						13.5	13.4	257
Expanded uncertainty (confidence interval of 95 %)		$u_e = 2u_c$						27.0	26.8	

## 17 MAIN TEST INSTRUMENTS

**Table 17.1: List of Main Instruments**

No.	Name	Type	Serial Number	Calibration Date	Valid Period
01	Network analyzer	E5071C	MY46110673	January 24, 2019	One year
02	Power meter	NRVD	102083	October 24, 2018	One year
03	Power sensor	NRV-Z5	100542		
04	Signal Generator	E4438C	MY49070393	January 4, 2019	One Year
05	Amplifier	60S1G4	0331848	No Calibration Requested	
06	BTS	E5515C	MY50263375	January 17, 2019	One year
07	BTS	CMW500	159890	January 3, 2019	One year
08	E-field Probe	SPEAG EX3DV4	3617	January 31, 2019	One year
09	DAE	SPEAG DAE4	771	January 11, 2019	One year
10	Dipole Validation Kit	SPEAG D750V3	1017	July 23, 2018	One year
11	Dipole Validation Kit	SPEAG D835V2	4d069	July 23, 2018	One year
12	Dipole Validation Kit	SPEAG D1750V2	1003	July 20, 2018	One year
13	Dipole Validation Kit	SPEAG D1900V2	5d101	July 24, 2018	One year
14	Dipole Validation Kit	SPEAG D2450V2	853	July 24, 2018	One year
15	Dipole Validation Kit	SPEAG D2600V2	1012	July 26, 2018	One year

\*\*\*END OF REPORT BODY\*\*\*

## ANNEX A Graph Results

### GSM850\_CH251 Left Cheek

Date: 10/9/2019

Electronics: DAE4 Sn771

Medium: head 835 MHz

Medium parameters used:  $f = 848.8$ ;  $\sigma = 0.905$  mho/m;  $\epsilon_r = 41.08$ ;  $\rho = 1000$  kg/m<sup>3</sup>

Ambient Temperature: 22.5°C, Liquid Temperature: 22.3°C

Communication System: GSM850 848.8 Duty Cycle: 1:4

Probe: EX3DV4 – SN3617 ConvF(9.75,9.75,9.75)

**Area Scan (71x121x1):** Interpolated grid: dx=1.000 mm, dy=1.000 mm

Maximum value of SAR (interpolated) = 0.324 W/kg

**Zoom Scan (7x7x7)/Cube 0:** Measurement grid: dx=5mm, dy=5mm, dz=5mm

Reference Value = 4.095 V/m; Power Drift = -0.08 dB

Peak SAR (extrapolated) = 0.353 W/kg

**SAR(1 g) = 0.277 W/kg; SAR(10 g) = 0.207 W/kg**

Maximum value of SAR (measured) = 0.318 W/kg

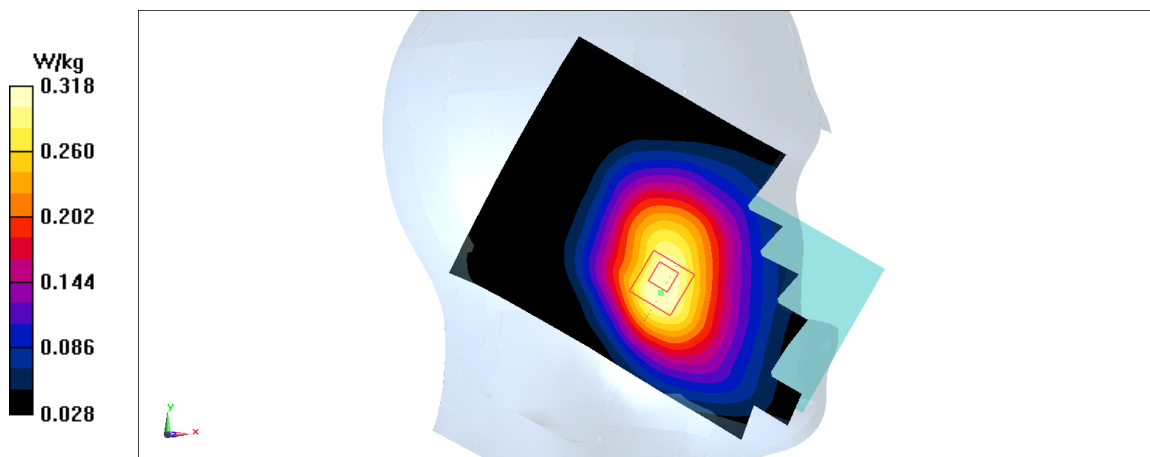


Fig A.1

**GSM850\_CH251 Rear**

Date: 10/9/2019

Electronics: DAE4 Sn771

Medium: body 835 MHz

Medium parameters used:  $f = 848.8$ ;  $\sigma = 0.99$  mho/m;  $\epsilon_r = 54.27$ ;  $\rho = 1000$  kg/m<sup>3</sup>

Ambient Temperature: 22.5°C, Liquid Temperature: 22.3°C

Communication System: GSM850 848.8 Duty Cycle: 1:4

Probe: EX3DV4 – SN3617 ConvF(9.61,9.61,9.61)

**Area Scan (71x121x1):** Interpolated grid: dx=1.000 mm, dy=1.000 mm

Maximum value of SAR (interpolated) = 0.537 W/kg

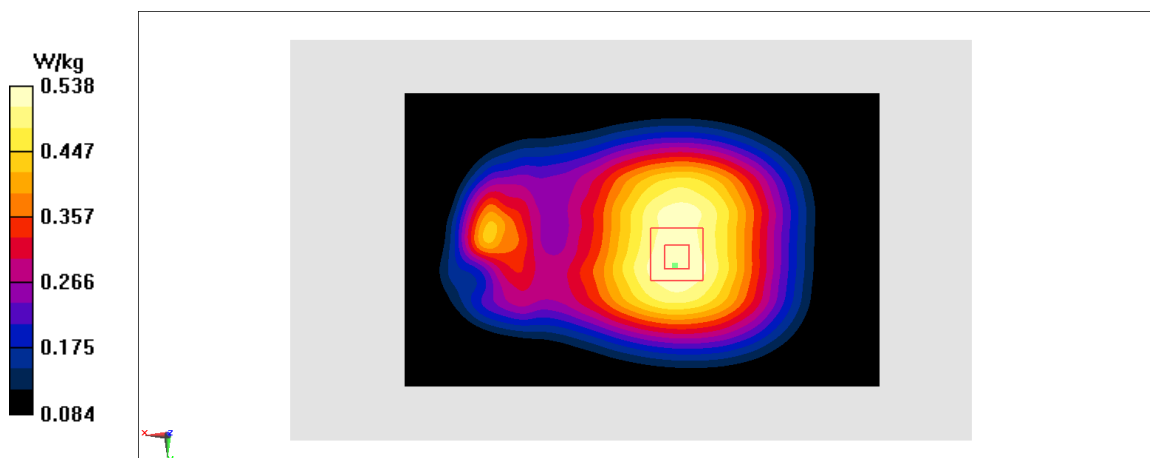
**Zoom Scan (7x7x7)/Cube 0:** Measurement grid: dx=5mm, dy=5mm, dz=5mm

Reference Value = 20.73 V/m; Power Drift = 0.08 dB

Peak SAR (extrapolated) = 0.602 W/kg

**SAR(1 g) = 0.465 W/kg; SAR(10 g) = 0.359 W/kg**

Maximum value of SAR (measured) = 0.538 W/kg

**Fig A.2**

**PCS1900\_CH661 Right Cheek**

Date: 10/11/2019

Electronics: DAE4 Sn771

Medium: head 1900 MHz

Medium parameters used:  $f = 1880$ ;  $\sigma = 1.409$  mho/m;  $\epsilon_r = 40.01$ ;  $\rho = 1000$  kg/m<sup>3</sup>

Ambient Temperature: 22.5°C, Liquid Temperature: 22.3°C

Communication System: PCS1900 1880 Duty Cycle: 1:4

Probe: EX3DV4 – SN3617 ConvF(8.14,8.14,8.14)

**Area Scan (71x121x1):** Interpolated grid: dx=1.000 mm, dy=1.000 mm

Maximum value of SAR (interpolated) = 0.234 W/kg

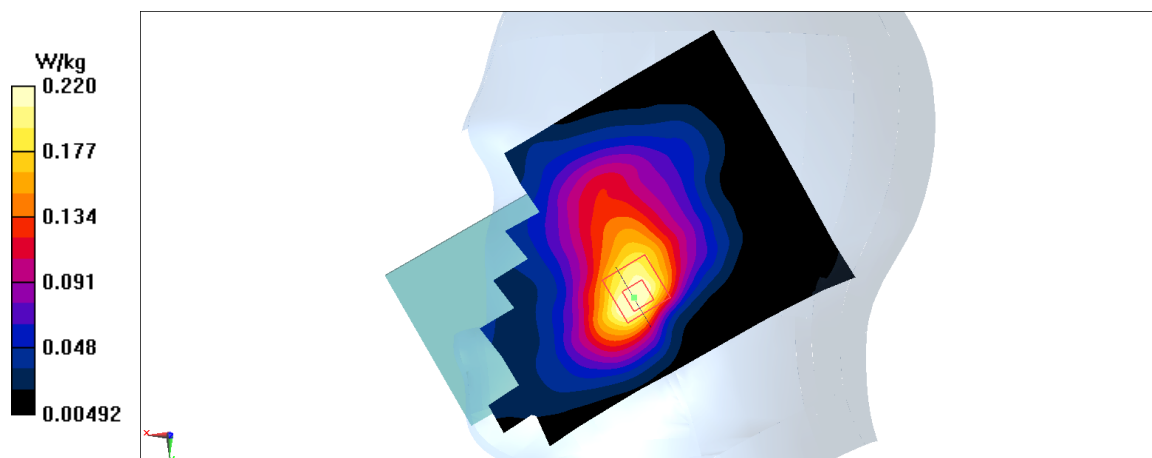
**Zoom Scan (7x7x7)/Cube 0:** Measurement grid: dx=5mm, dy=5mm, dz=5mm

Reference Value = 3.332 V/m; Power Drift = 0.12 dB

Peak SAR (extrapolated) = 0.261 W/kg

**SAR(1 g) = 0.175 W/kg; SAR(10 g) = 0.11 W/kg**

Maximum value of SAR (measured) = 0.22 W/kg

**Fig A.3**

**PCS1900\_CH512 Bottom**

Date: 10/11/2019

Electronics: DAE4 Sn771

Medium: body 1900 MHz

Medium parameters used:  $f = 1825.2$ ;  $\sigma = 1.439$  mho/m;  $\epsilon_r = 53.2$ ;  $\rho = 1000$  kg/m<sup>3</sup>

Ambient Temperature: 22.5°C, Liquid Temperature: 22.3°C

Communication System: PCS1900 1825.2 Duty Cycle: 1:2

Probe: EX3DV4 – SN3617 ConvF(7.78,7.78,7.78)

**Area Scan (71x121x1):** Interpolated grid: dx=1.000 mm, dy=1.000 mm

Maximum value of SAR (interpolated) = 1.41 W/kg

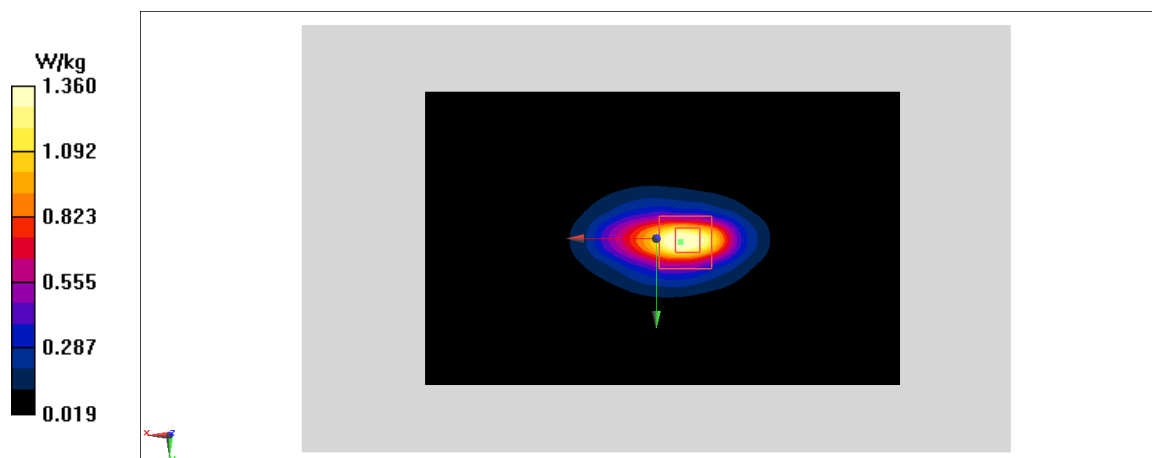
**Zoom Scan (7x7x7)/Cube 0:** Measurement grid: dx=5mm, dy=5mm, dz=5mm

Reference Value = 22.68 V/m; Power Drift = -0.09 dB

Peak SAR (extrapolated) = 1.66 W/kg

**SAR(1 g) = 0.923 W/kg; SAR(10 g) = 0.472 W/kg**

Maximum value of SAR (measured) = 1.36 W/kg

**Fig A.4**



**WCDMA1900-BII\_CH9538 Left Cheek**

Date: 10/11/2019

Electronics: DAE4 Sn771

Medium: head 1900 MHz

Medium parameters used:  $f = 1907.6$ ;  $\sigma = 1.436$  mho/m;  $\epsilon_r = 39.98$ ;  $\rho = 1000$  kg/m<sup>3</sup>

Ambient Temperature: 22.5°C, Liquid Temperature: 22.3°C

Communication System: WCDMA1900-BII 1907.6 Duty Cycle: 1:1

Probe: EX3DV4 – SN3617 ConvF(8.14,8.14,8.14)

**Area Scan (71x121x1):** Interpolated grid: dx=1.000 mm, dy=1.000 mm

Maximum value of SAR (interpolated) = 0.382 W/kg

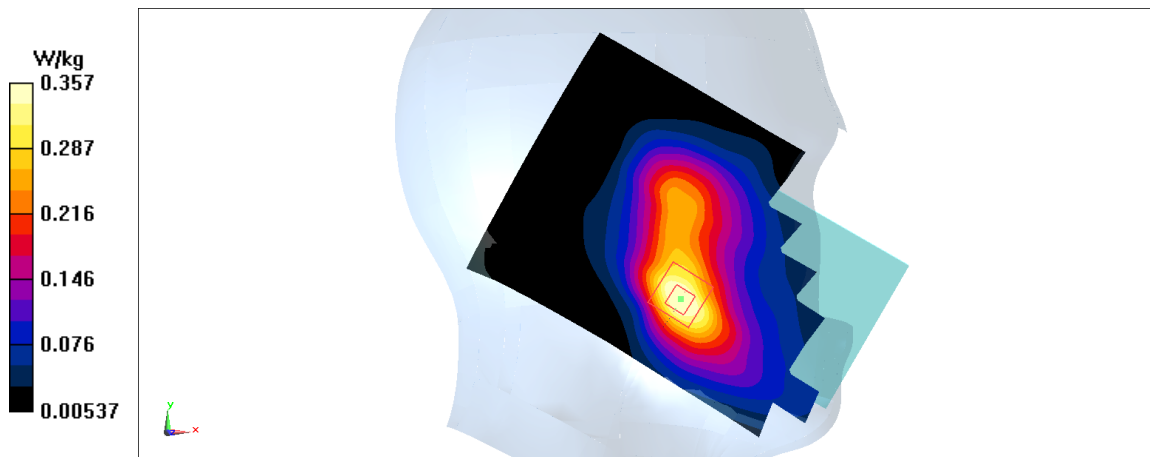
**Zoom Scan (7x7x7)/Cube 0:** Measurement grid: dx=5mm, dy=5mm, dz=5mm

Reference Value = 3.18 V/m; Power Drift = 0.08 dB

Peak SAR (extrapolated) = 0.438 W/kg

**SAR(1 g) = 0.28 W/kg; SAR(10 g) = 0.174 W/kg**

Maximum value of SAR (measured) = 0.357 W/kg

**Fig A.5**

**WCDMA1900-BII\_CH9262 Bottom**

Date: 10/11/2019

Electronics: DAE4 Sn771

Medium: body 1900 MHz

Medium parameters used:  $f = 1852.4$ ;  $\sigma = 1.464$  mho/m;  $\epsilon_r = 53.17$ ;  $\rho = 1000$  kg/m<sup>3</sup>

Ambient Temperature: 22.5°C, Liquid Temperature: 22.3°C

Communication System: WCDMA1900-BII 1852.4 Duty Cycle: 1:1

Probe: EX3DV4 – SN3617 ConvF(7.78,7.78,7.78)

**Area Scan (71x121x1):** Interpolated grid: dx=1.000 mm, dy=1.000 mm

Maximum value of SAR (interpolated) = 1.2 W/kg

**Zoom Scan (7x7x7)/Cube 0:** Measurement grid: dx=5mm, dy=5mm, dz=5mm

Reference Value = 10.07 V/m; Power Drift = -0.09 dB

Peak SAR (extrapolated) = 1.38 W/kg

**SAR(1 g) = 0.756 W/kg; SAR(10 g) = 0.388 W/kg**

Maximum value of SAR (measured) = 1.15 W/kg

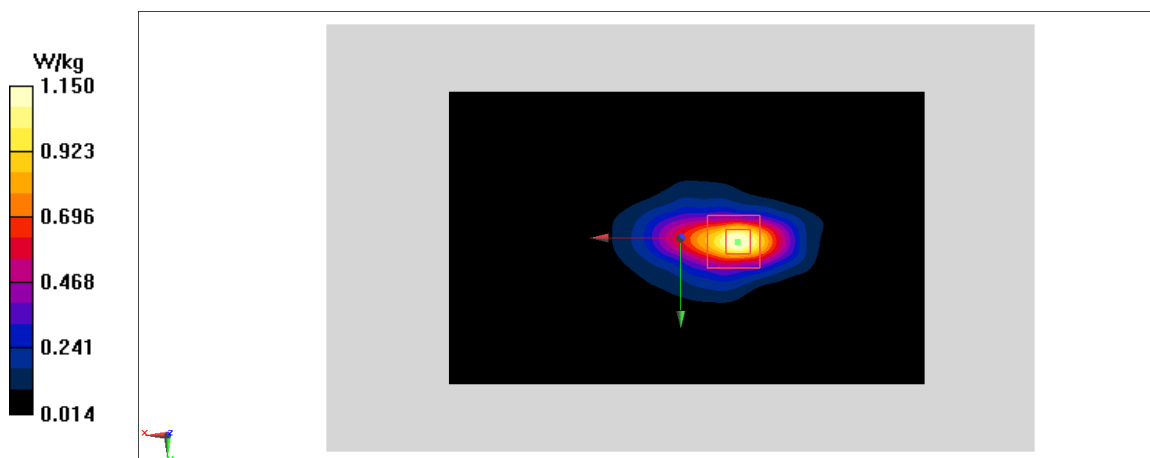


Fig A.6

**WCDMA1700-BIV\_CH1513 Right Cheek**

Date: 10/10/2019

Electronics: DAE4 Sn771

Medium: head 1750 MHz

Medium parameters used:  $f = 1752.6$ ;  $\sigma = 1.38$  mho/m;  $\epsilon_r = 40.82$ ;  $\rho = 1000$  kg/m<sup>3</sup>

Ambient Temperature: 22.5°C, Liquid Temperature: 22.3°C

Communication System: WCDMA1700-BIV 1752.6 Duty Cycle: 1:1

Probe: EX3DV4 – SN3617 ConvF(8.38,8.38,8.38)

**Area Scan (71x121x1):** Interpolated grid: dx=1.000 mm, dy=1.000 mm

Maximum value of SAR (interpolated) = 0.363 W/kg

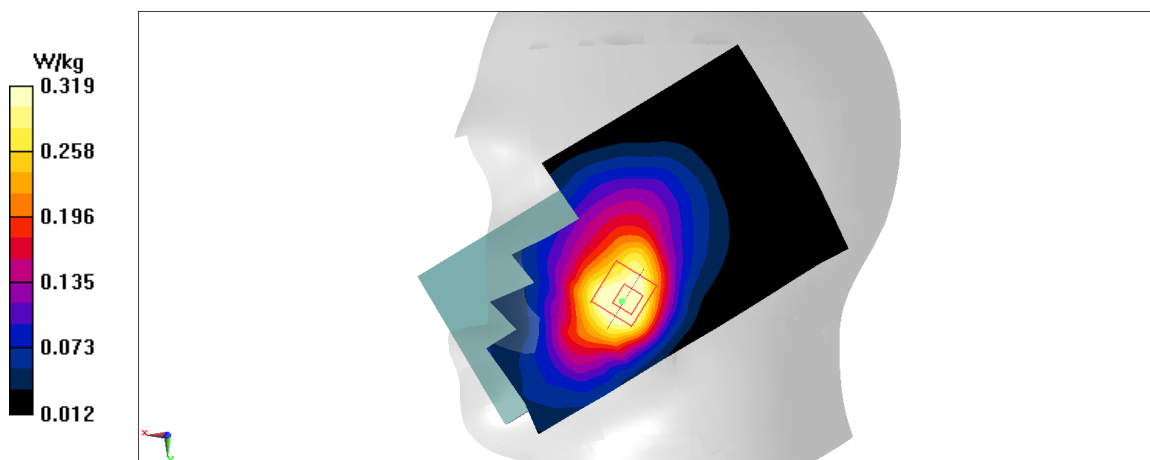
**Zoom Scan (7x7x7)/Cube 0:** Measurement grid: dx=5mm, dy=5mm, dz=5mm

Reference Value = 2.947 V/m; Power Drift = 0.01 dB

Peak SAR (extrapolated) = 0.379 W/kg

**SAR(1 g) = 0.256 W/kg; SAR(10 g) = 0.168 W/kg**

Maximum value of SAR (measured) = 0.319 W/kg

**Fig A.7**

**WCDMA1700-BIV\_CH1312 Bottom**

Date: 10/10/2019

Electronics: DAE4 Sn771

Medium: body 1750 MHz

Medium parameters used:  $f = 1712.4$ ;  $\sigma = 1.449$  mho/m;  $\epsilon_r = 52.63$ ;  $\rho = 1000$  kg/m<sup>3</sup>

Ambient Temperature: 22.5°C, Liquid Temperature: 22.3°C

Communication System: WCDMA1700-BIV 1712.4 Duty Cycle: 1:1

Probe: EX3DV4 – SN3617 ConvF(8.03,8.03,8.03)

**Area Scan (71x121x1):** Interpolated grid: dx=1.000 mm, dy=1.000 mm

Maximum value of SAR (interpolated) = 1.28 W/kg

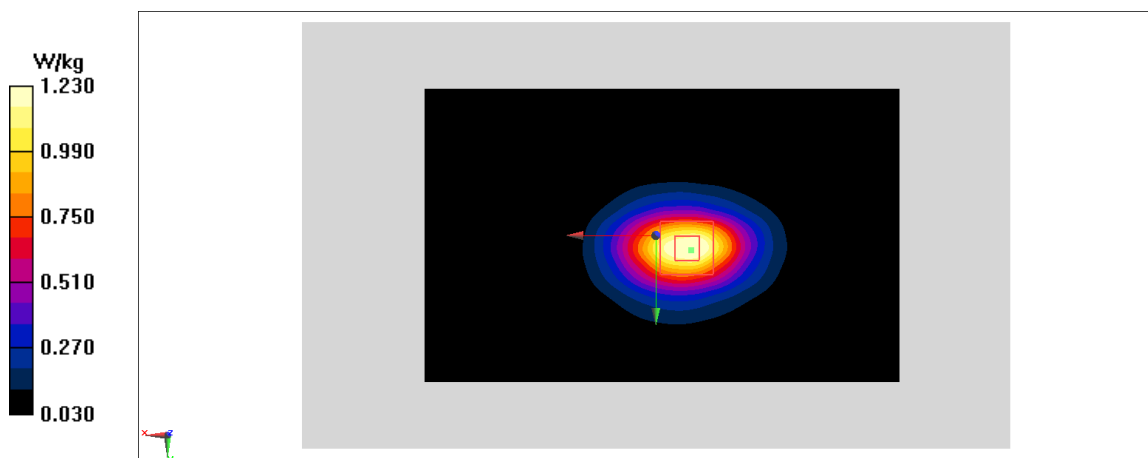
**Zoom Scan (7x7x7)/Cube 0:** Measurement grid: dx=5mm, dy=5mm, dz=5mm

Reference Value = 21.65 V/m; Power Drift = -0.03 dB

Peak SAR (extrapolated) = 1.46 W/kg

**SAR(1 g) = 0.882 W/kg; SAR(10 g) = 0.518 W/kg**

Maximum value of SAR (measured) = 1.23 W/kg

**Fig A.8**

**WCDMA850-BV\_CH4233 Left Cheek**

Date: 10/9/2019

Electronics: DAE4 Sn771

Medium: head 835 MHz

Medium parameters used:  $f = 846.6$ ;  $\sigma = 0.903$  mho/m;  $\epsilon_r = 41.09$ ;  $\rho = 1000$  kg/m<sup>3</sup>

Ambient Temperature: 22.5°C, Liquid Temperature: 22.3°C

Communication System: WCDMA850-BV 846.6 Duty Cycle: 1:1

Probe: EX3DV4 – SN3617 ConvF(9.75,9.75,9.75)

**Area Scan (71x121x1):** Interpolated grid: dx=1.000 mm, dy=1.000 mm

Maximum value of SAR (interpolated) = 0.248 W/kg

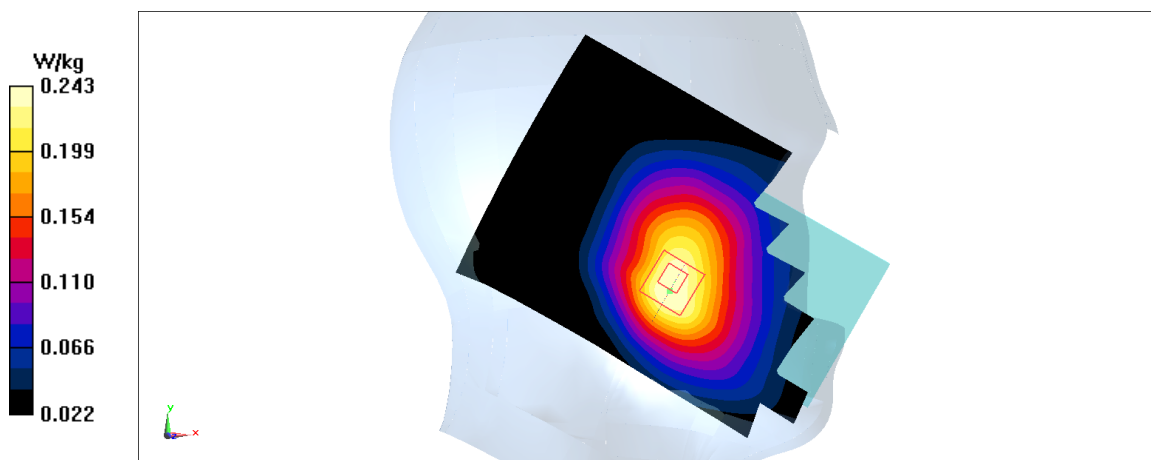
**Zoom Scan (7x7x7)/Cube 0:** Measurement grid: dx=5mm, dy=5mm, dz=5mm

Reference Value = 2.819 V/m; Power Drift = -0.12 dB

Peak SAR (extrapolated) = 0.271 W/kg

**SAR(1 g) = 0.21 W/kg; SAR(10 g) = 0.158 W/kg**

Maximum value of SAR (measured) = 0.243 W/kg

**Fig A.9**

**WCDMA850-BV\_CH4132 Rear**

Date: 10/9/2019

Electronics: DAE4 Sn771

Medium: body 835 MHz

Medium parameters used:  $f = 826.4$ ;  $\sigma = 0.968$  mho/m;  $\epsilon_r = 54.3$ ;  $\rho = 1000$  kg/m<sup>3</sup>

Ambient Temperature: 22.5°C, Liquid Temperature: 22.3°C

Communication System: WCDMA850-BV 826.4 Duty Cycle: 1:1

Probe: EX3DV4 – SN3617 ConvF(9.61,9.61,9.61)

**Area Scan (71x121x1):** Interpolated grid: dx=1.000 mm, dy=1.000 mm

Maximum value of SAR (interpolated) = 0.303 W/kg

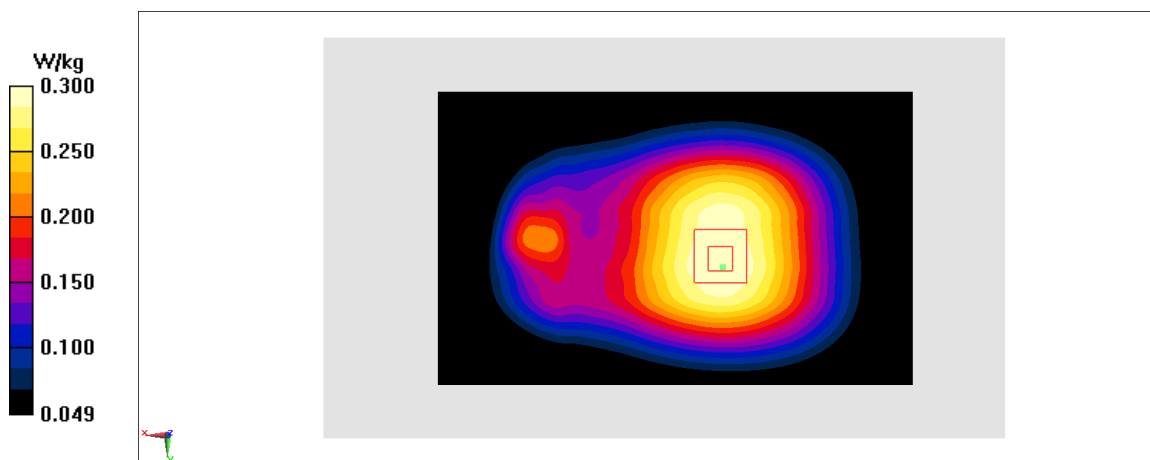
**Zoom Scan (7x7x7)/Cube 0:** Measurement grid: dx=5mm, dy=5mm, dz=5mm

Reference Value = 15.41 V/m; Power Drift = -0.12 dB

Peak SAR (extrapolated) = 0.332 W/kg

**SAR(1 g) = 0.261 W/kg; SAR(10 g) = 0.202 W/kg**

Maximum value of SAR (measured) = 0.3 W/kg

**Fig A.10**

**LTE1900-FDD2\_CH18700 Left Cheek**

Date: 10/11/2019

Electronics: DAE4 Sn771

Medium: head 1900 MHz

Medium parameters used:  $f = 1860$  MHz;  $\sigma = 1.39$  mho/m;  $\epsilon_r = 40.04$ ;  $\rho = 1000$  kg/m<sup>3</sup>

Ambient Temperature: 22.5°C, Liquid Temperature: 22.3°C

Communication System: LTE1900-FDD2 1860 MHz Duty Cycle: 1:1

Probe: EX3DV4 – SN3617 ConvF(8.14,8.14,8.14)

**Area Scan (71x121x1):** Interpolated grid: dx=1.000 mm, dy=1.000 mm

Maximum value of SAR (interpolated) = 0.336 W/kg

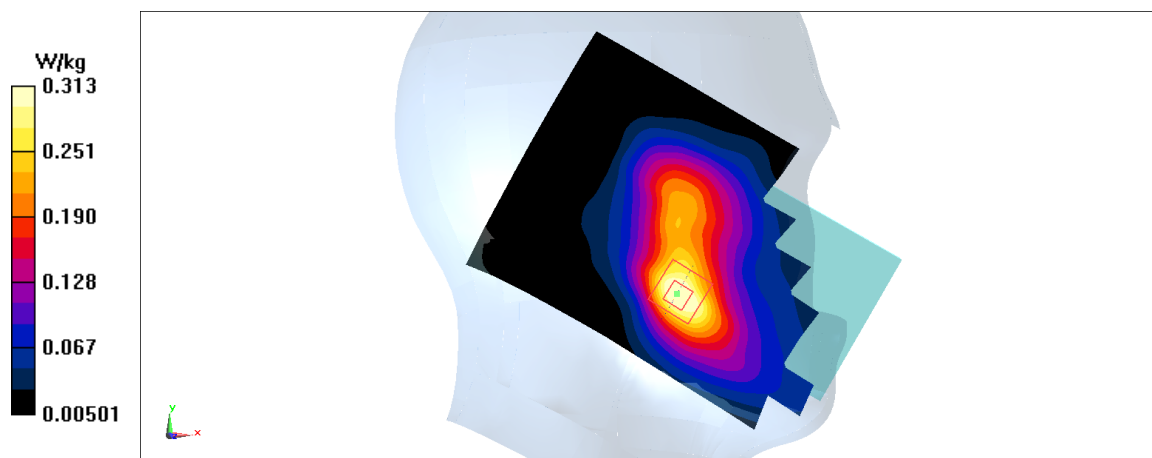
**Zoom Scan (7x7x7)/Cube 0:** Measurement grid: dx=5mm, dy=5mm, dz=5mm

Reference Value = 2.491 V/m; Power Drift = -0.01 dB

Peak SAR (extrapolated) = 0.381 W/kg

**SAR(1 g) = 0.247 W/kg; SAR(10 g) = 0.154 W/kg**

Maximum value of SAR (measured) = 0.313 W/kg

**Fig A.11**



**LTE1900-FDD2\_CH18700 Bottom**

Date: 10/11/2019

Electronics: DAE4 Sn771

Medium: body 1900 MHz

Medium parameters used:  $f = 1860$  MHz;  $\sigma = 1.472$  mho/m;  $\epsilon_r = 53.16$ ;  $\rho = 1000$  kg/m<sup>3</sup>

Ambient Temperature: 22.5°C, Liquid Temperature: 22.3°C

Communication System: LTE1900-FDD2 1860 MHz Duty Cycle: 1:1

Probe: EX3DV4 – SN3617 ConvF(7.78,7.78,7.78)

**Area Scan (71x121x1):** Interpolated grid: dx=1.000 mm, dy=1.000 mm

Maximum value of SAR (interpolated) = 1.32 W/kg

**Zoom Scan (7x7x7)/Cube 0:** Measurement grid: dx=5mm, dy=5mm, dz=5mm

Reference Value = 18.35 V/m; Power Drift = 0 dB

Peak SAR (extrapolated) = 1.69 W/kg

**SAR(1 g) = 0.934 W/kg; SAR(10 g) = 0.48 W/kg**

Maximum value of SAR (measured) = 1.41 W/kg

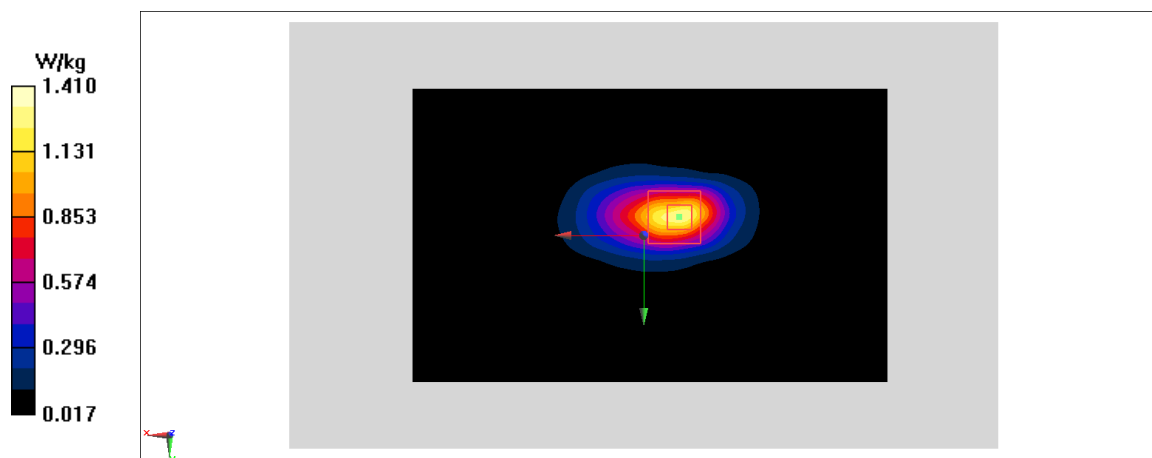


Fig A.12

**LTE850-FDD5\_CH20600 Left Cheek**

Date: 10/9/2019

Electronics: DAE4 Sn771

Medium: head 835 MHz

Medium parameters used:  $f = 844$  MHz;  $\sigma = 0.901$  mho/m;  $\epsilon_r = 41.09$ ;  $\rho = 1000$  kg/m<sup>3</sup>

Ambient Temperature: 22.5°C, Liquid Temperature: 22.3°C

Communication System: LTE850-FDD5 844 MHz Duty Cycle: 1:1

Probe: EX3DV4 – SN3617 ConvF(9.75,9.75,9.75)

**Area Scan (71x121x1):** Interpolated grid: dx=1.000 mm, dy=1.000 mm

Maximum value of SAR (interpolated) = 0.241 W/kg

**Zoom Scan (7x7x7)/Cube 0:** Measurement grid: dx=5mm, dy=5mm, dz=5mm

Reference Value = 3.307 V/m; Power Drift = 0.04 dB

Peak SAR (extrapolated) = 0.264 W/kg

**SAR(1 g) = 0.207 W/kg; SAR(10 g) = 0.157 W/kg**

Maximum value of SAR (measured) = 0.238 W/kg

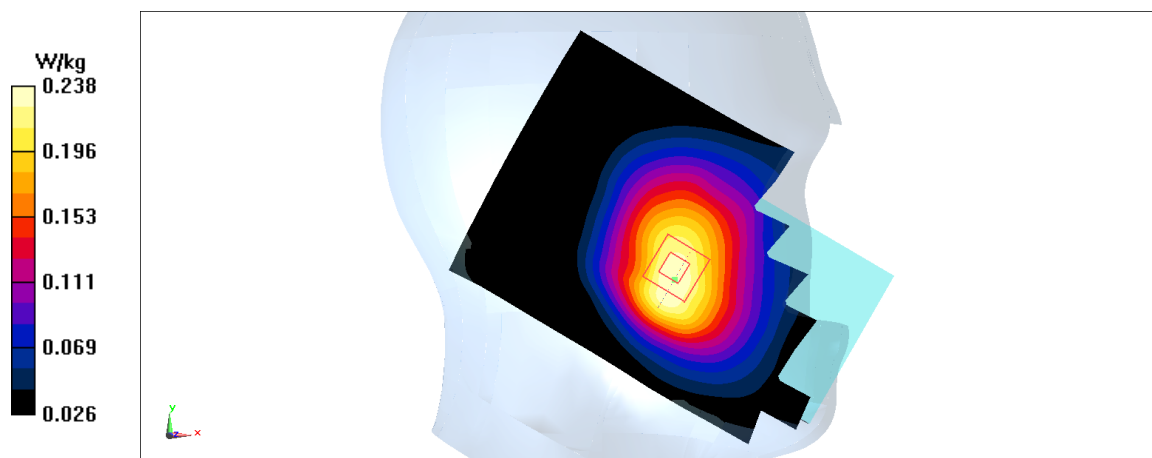


Fig A.13

**LTE850-FDD5\_CH20600 Rear**

Date: 10/9/2019

Electronics: DAE4 Sn771

Medium: body 835 MHz

Medium parameters used:  $f = 844$  MHz;  $\sigma = 0.986$  mho/m;  $\epsilon_r = 54.28$ ;  $\rho = 1000$  kg/m<sup>3</sup>

Ambient Temperature: 22.5°C, Liquid Temperature: 22.3°C

Communication System: LTE850-FDD5 844 MHz Duty Cycle: 1:1

Probe: EX3DV4 – SN3617 ConvF(9.61,9.61,9.61)

**Area Scan (71x121x1):** Interpolated grid: dx=1.000 mm, dy=1.000 mm

Maximum value of SAR (interpolated) = 0.374 W/kg

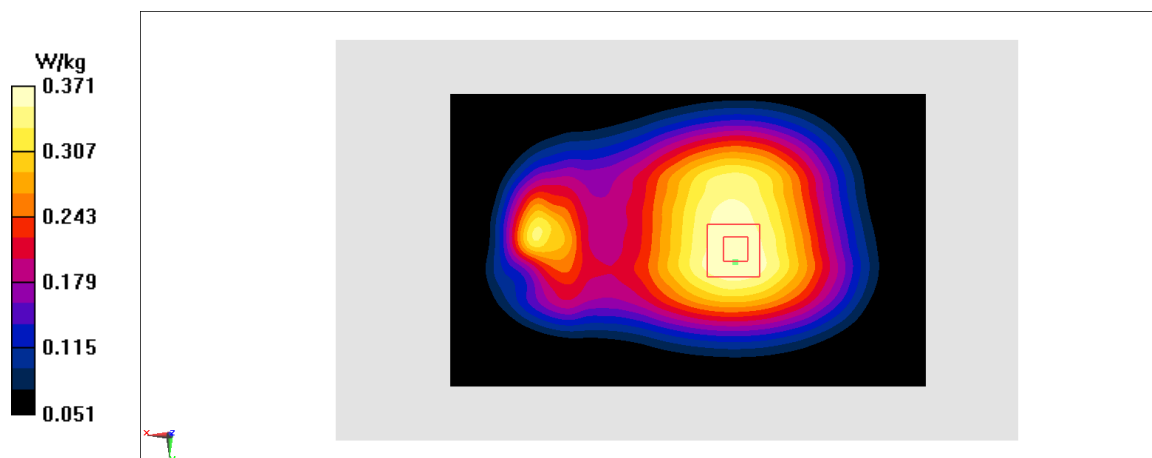
**Zoom Scan (7x7x7)/Cube 0:** Measurement grid: dx=5mm, dy=5mm, dz=5mm

Reference Value = 16.9 V/m; Power Drift = -0.07 dB

Peak SAR (extrapolated) = 0.413 W/kg

**SAR(1 g) = 0.32 W/kg; SAR(10 g) = 0.244 W/kg**

Maximum value of SAR (measured) = 0.371 W/kg

**Fig A.14**

**LTE2500-FDD7\_CH21100 Right Cheek**

Date: 10/12/2019

Electronics: DAE4 Sn771

Medium: head 2600 MHz

Medium parameters used:  $f = 2535$  MHz;  $\sigma = 1.863$  mho/m;  $\epsilon_r = 39.14$ ;  $\rho = 1000$  kg/m<sup>3</sup>

Ambient Temperature: 22.5°C, Liquid Temperature: 22.3°C

Communication System: LTE2500-FDD7 2535 MHz Duty Cycle: 1:1

Probe: EX3DV4 – SN3617 ConvF(7.19,7.19,7.19)

**Area Scan (71x121x1):** Interpolated grid: dx=1.000 mm, dy=1.000 mm

Maximum value of SAR (interpolated) = 0.302 W/kg

**Zoom Scan (7x7x7)/Cube 0:** Measurement grid: dx=5mm, dy=5mm, dz=5mm

Reference Value = 2.285 V/m; Power Drift = -0.05 dB

Peak SAR (extrapolated) = 0.366 W/kg

**SAR(1 g) = 0.192 W/kg; SAR(10 g) = 0.1 W/kg**

Maximum value of SAR (measured) = 0.277 W/kg

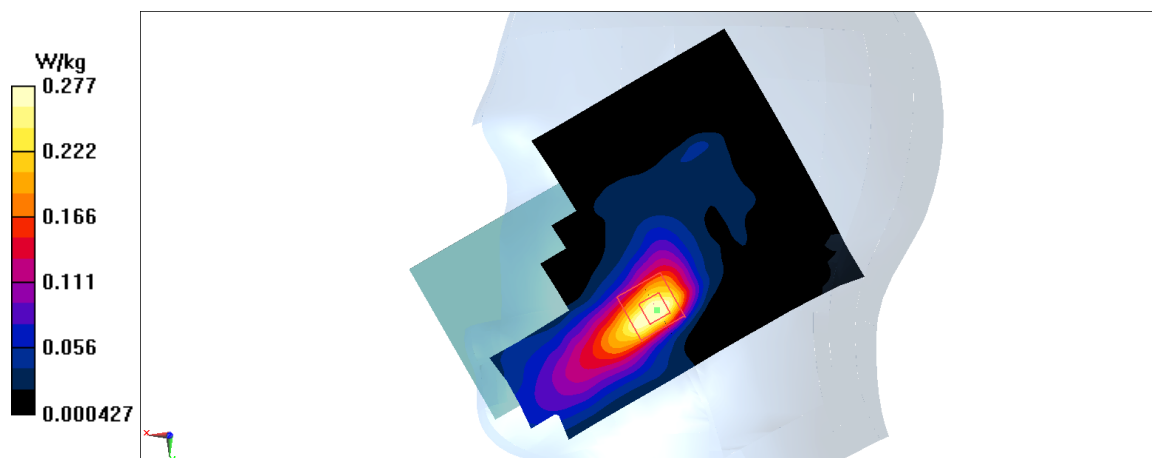


Fig A.15

**LTE2500-FDD7\_CH21325 Rear**

Date: 10/12/2019

Electronics: DAE4 Sn771

Medium: body 2600 MHz

Medium parameters used:  $f = 2557.5$  MHz;  $\sigma = 2.139$  mho/m;  $\epsilon_r = 52.68$ ;  $\rho = 1000$  kg/m<sup>3</sup>

Ambient Temperature: 22.5°C, Liquid Temperature: 22.3°C

Communication System: LTE2500-FDD7 2557.5 MHz Duty Cycle: 1:1

Probe: EX3DV4 – SN3617 ConvF(7.49,7.49,7.49)

**Area Scan (71x121x1):** Interpolated grid: dx=1.000 mm, dy=1.000 mm

Maximum value of SAR (interpolated) = 1.39 W/kg

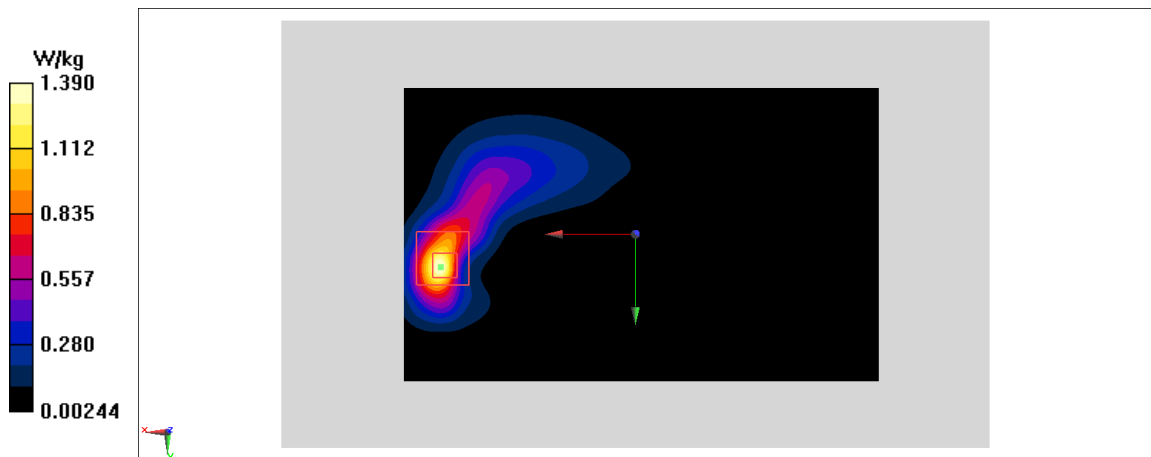
**Zoom Scan (7x7x7)/Cube 0:** Measurement grid: dx=5mm, dy=5mm, dz=5mm

Reference Value = 7.468 V/m; Power Drift = -0.08 dB

Peak SAR (extrapolated) = 1.73 W/kg

**SAR(1 g) = 0.855 W/kg; SAR(10 g) = 0.388 W/kg**

Maximum value of SAR (measured) = 1.39 W/kg



**Fig A.16**

**LTE700-FDD12\_CH23130 Right Cheek**

Date: 10/9/2019

Electronics: DAE4 Sn771

Medium: head 750 MHz

Medium parameters used:  $f = 711 \text{ MHz}$ ;  $\sigma = 0.851 \text{ mho/m}$ ;  $\epsilon_r = 41.4$ ;  $\rho = 1000 \text{ kg/m}^3$ 

Ambient Temperature: 22.5°C, Liquid Temperature: 22.3°C

Communication System: LTE700-FDD12 711 MHz Duty Cycle: 1:1

Probe: EX3DV4 – SN3617 ConvF(10.03,10.03,10.03)

**Area Scan (71x121x1):** Interpolated grid:  $dx=1.000 \text{ mm}$ ,  $dy=1.000 \text{ mm}$ 

Maximum value of SAR (interpolated) = 0.0385 W/kg

**Zoom Scan (7x7x7)/Cube 0:** Measurement grid:  $dx=5\text{mm}$ ,  $dy=5\text{mm}$ ,  $dz=5\text{mm}$ 

Reference Value = 1.701 V/m; Power Drift = -0.05 dB

Peak SAR (extrapolated) = 0.041 W/kg

**SAR(1 g) = 0.034 W/kg; SAR(10 g) = 0.028 W/kg**

Maximum value of SAR (measured) = 0.0381 W/kg

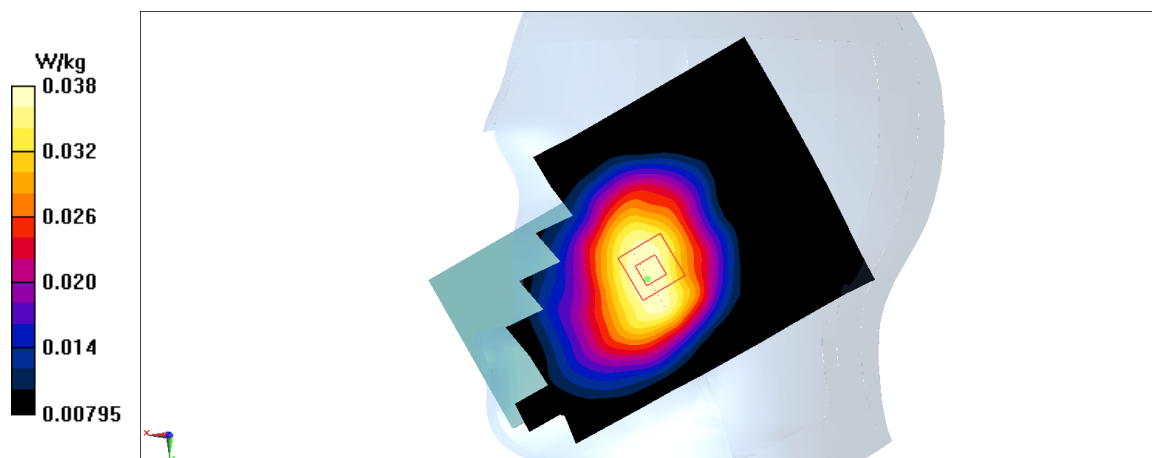


Fig A.17

**LTE700-FDD12\_CH23130 Rear**

Date: 10/9/2019

Electronics: DAE4 Sn771

Medium: body 750 MHz

Medium parameters used:  $f = 711$  MHz;  $\sigma = 0.918$  mho/m;  $\epsilon_r = 56$ ;  $\rho = 1000$  kg/m<sup>3</sup>

Ambient Temperature: 22.5°C, Liquid Temperature: 22.3°C

Communication System: LTE700-FDD12 711 MHz Duty Cycle: 1:1

Probe: EX3DV4 – SN3617 ConvF(9.85,9.85,9.85)

**Area Scan (71x121x1):** Interpolated grid: dx=1.000 mm, dy=1.000 mm

Maximum value of SAR (interpolated) = 0.0881 W/kg

**Zoom Scan (7x7x7)/Cube 0:** Measurement grid: dx=5mm, dy=5mm, dz=5mm

Reference Value = 9.636 V/m; Power Drift = 0.09 dB

Peak SAR (extrapolated) = 0.097 W/kg

**SAR(1 g) = 0.079 W/kg; SAR(10 g) = 0.062 W/kg**

Maximum value of SAR (measured) = 0.0887 W/kg

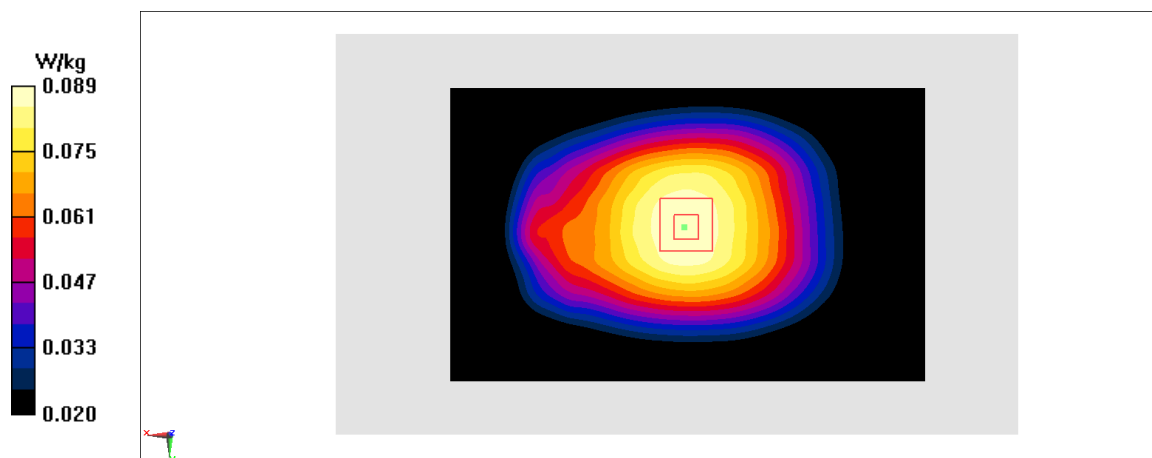


Fig A.18



**LTE1700-FDD66\_CH132572 Right Cheek**

Date: 10/10/2019

Electronics: DAE4 Sn771

Medium: head 1750 MHz

Medium parameters used:  $f = 713$  MHz;  $\sigma = 0.392$  mho/m;  $\epsilon_r = 42.06$ ;  $\rho = 1000$  kg/m<sup>3</sup>

Ambient Temperature: 22.5°C, Liquid Temperature: 22.3°C

Communication System: LTE1700-FDD66 713 MHz Duty Cycle: 1:1

Probe: EX3DV4 – SN3617 ConvF(8.38,8.38,8.38)

**Area Scan (71x121x1):** Interpolated grid: dx=1.000 mm, dy=1.000 mm

Maximum value of SAR (interpolated) = 0.312 W/kg

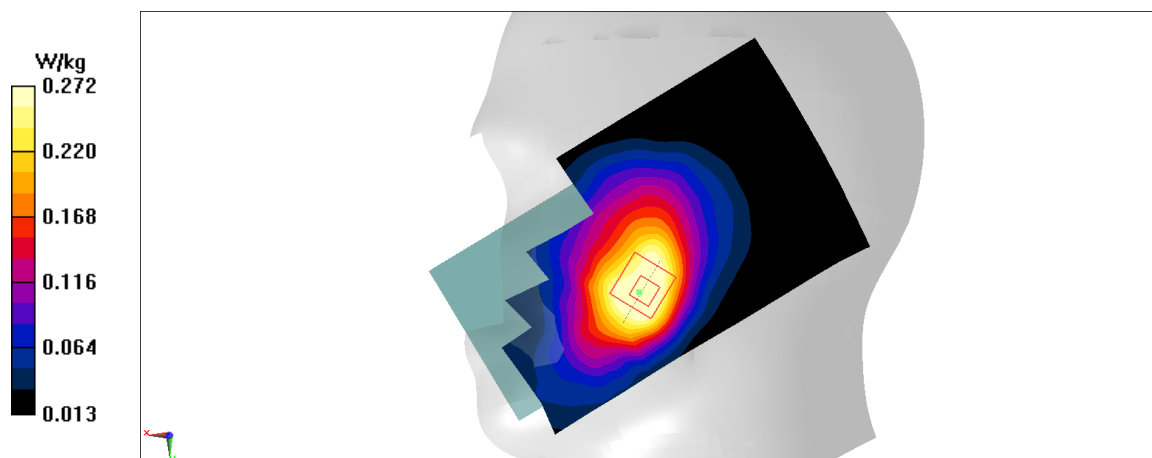
**Zoom Scan (7x7x7)/Cube 0:** Measurement grid: dx=5mm, dy=5mm, dz=5mm

Reference Value = 2.906 V/m; Power Drift = 0.13 dB

Peak SAR (extrapolated) = 0.321 W/kg

**SAR(1 g) = 0.223 W/kg; SAR(10 g) = 0.147 W/kg**

Maximum value of SAR (measured) = 0.272 W/kg

**Fig A.19**

**LTE1700-FDD66\_CH132322 Bottom**

Date: 10/10/2019

Electronics: DAE4 Sn771

Medium: body 1750 MHz

Medium parameters used:  $f = 713 \text{ MHz}$ ;  $\sigma = 0.5 \text{ mho/m}$ ;  $\epsilon_r = 53.82$ ;  $\rho = 1000 \text{ kg/m}^3$

Ambient Temperature:  $22.5^\circ\text{C}$ , Liquid Temperature:  $22.3^\circ\text{C}$

Communication System: LTE1700-FDD66 713 MHz Duty Cycle: 1:1

Probe: EX3DV4 – SN3617 ConvF(8.03,8.03,8.03)

**Area Scan (71x121x1):** Interpolated grid:  $dx=1.000 \text{ mm}$ ,  $dy=1.000 \text{ mm}$

Maximum value of SAR (interpolated) =  $1.44 \text{ W/kg}$

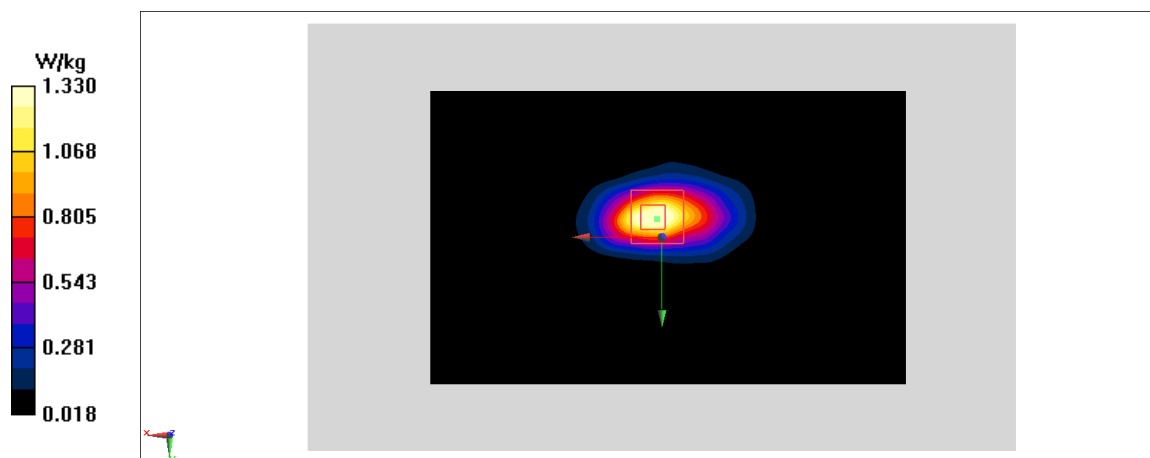
**Zoom Scan (7x7x7)/Cube 0:** Measurement grid:  $dx=5\text{mm}$ ,  $dy=5\text{mm}$ ,  $dz=5\text{mm}$

Reference Value =  $20.36 \text{ V/m}$ ; Power Drift =  $-0.06 \text{ dB}$

Peak SAR (extrapolated) =  $1.69 \text{ W/kg}$

**SAR(1 g) =  $0.915 \text{ W/kg}$ ; SAR(10 g) =  $0.477 \text{ W/kg}$**

Maximum value of SAR (measured) =  $1.33 \text{ W/kg}$



**Fig A.20**

**WLAN2450\_CH11 Left Cheek**

Date: 10/12/2019

Electronics: DAE4 Sn771

Medium: head 2450 MHz

Medium parameters used:  $f = 2462$ ;  $\sigma = 1.791$  mho/m;  $\epsilon_r = 38.98$ ;  $\rho = 1000$  kg/m<sup>3</sup>

Ambient Temperature: 22.5°C, Liquid Temperature: 22.3°C

Communication System: WLAN2450 2462 Duty Cycle: 1:1

Probe: EX3DV4 – SN3617 ConvF(7.62,7.62,7.62)

**Area Scan (71x121x1):** Interpolated grid: dx=1.000 mm, dy=1.000 mm

Maximum value of SAR (interpolated) = 1.3 W/kg

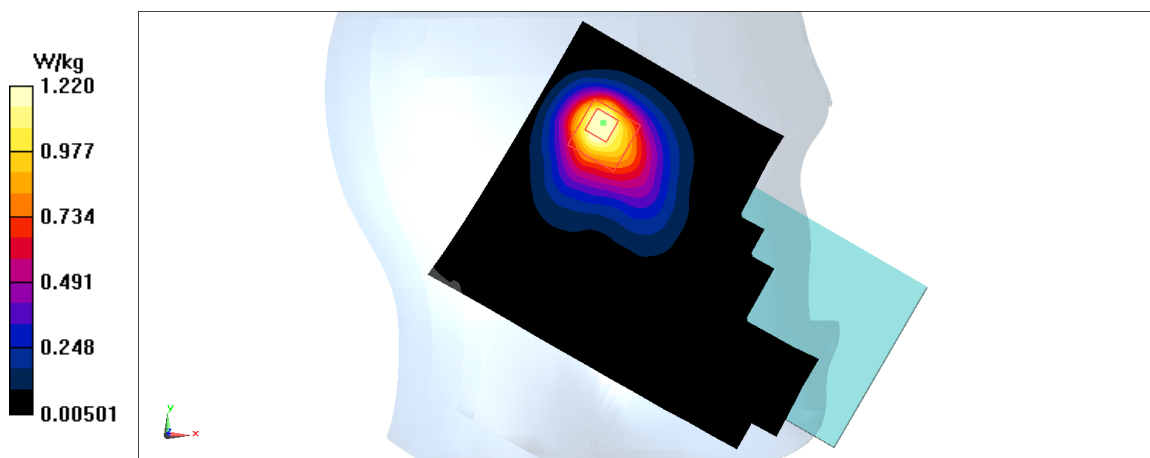
**Zoom Scan (7x7x7)/Cube 0:** Measurement grid: dx=5mm, dy=5mm, dz=5mm

Reference Value = 11.03 V/m; Power Drift = 0.02 dB

Peak SAR (extrapolated) = 1.72 W/kg

**SAR(1 g) = 0.835 W/kg; SAR(10 g) = 0.42 W/kg**

Maximum value of SAR (measured) = 1.22 W/kg



**Fig A.21**

**WLAN2450\_CH1 Rear**

Date: 10/12/2019

Electronics: DAE4 Sn771

Medium: body 2450 MHz

Medium parameters used:  $f = 2412$ ;  $\sigma = 1.921$  mho/m;  $\epsilon_r = 53.54$ ;  $\rho = 1000$  kg/m<sup>3</sup>

Ambient Temperature: 22.5°C, Liquid Temperature: 22.3°C

Communication System: WLAN2450 2412 Duty Cycle: 1:1

Probe: EX3DV4 – SN3617 ConvF(7.79,7.79,7.79)

**Area Scan (71x121x1):** Interpolated grid: dx=1.000 mm, dy=1.000 mm

Maximum value of SAR (interpolated) = 0.403 W/kg

**Zoom Scan (7x7x7)/Cube 0:** Measurement grid: dx=5mm, dy=5mm, dz=5mm

Reference Value = 5.599 V/m; Power Drift = 0.18 dB

Peak SAR (extrapolated) = 0.558 W/kg

**SAR(1 g) = 0.283 W/kg; SAR(10 g) = 0.145 W/kg**

Maximum value of SAR (measured) = 0.416 W/kg

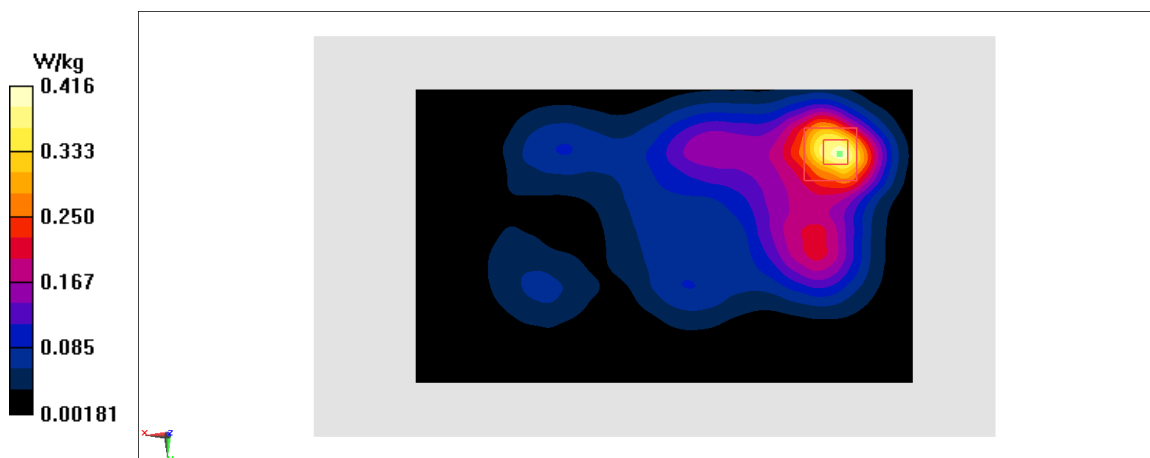
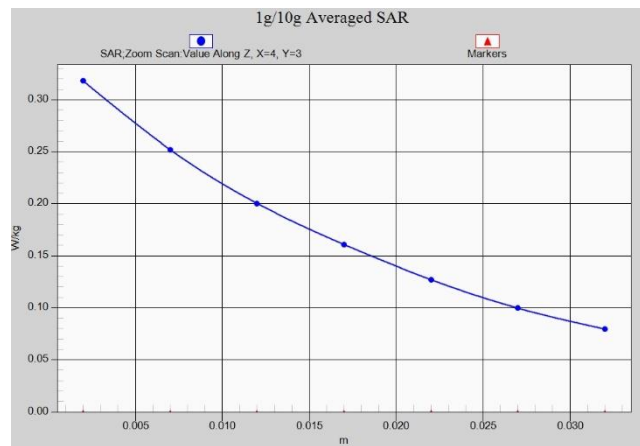
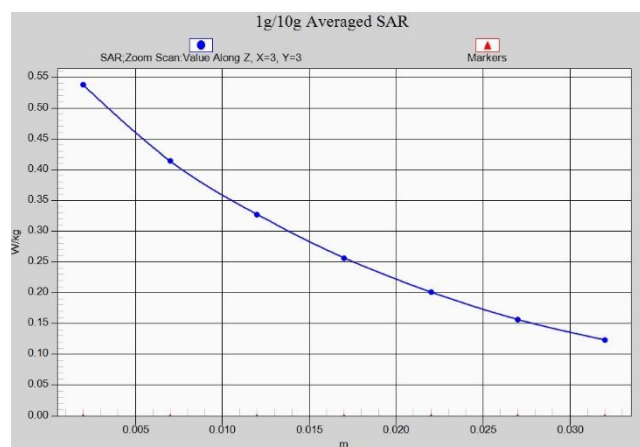


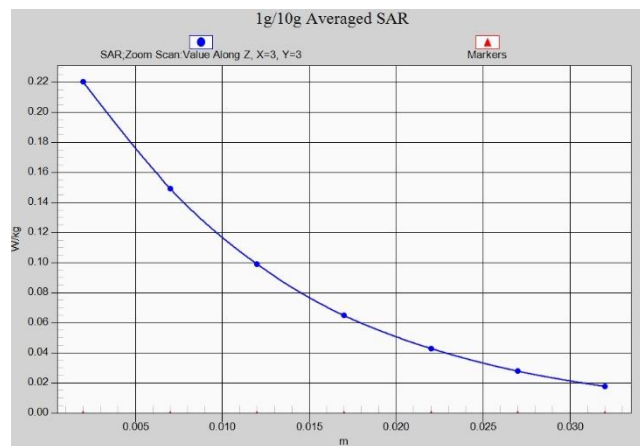
Fig A.22



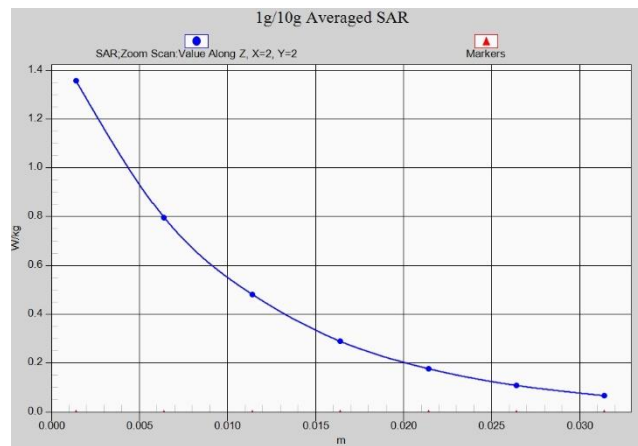
**Fig. 1-1 Z-Scan at power reference point (GSM850)**



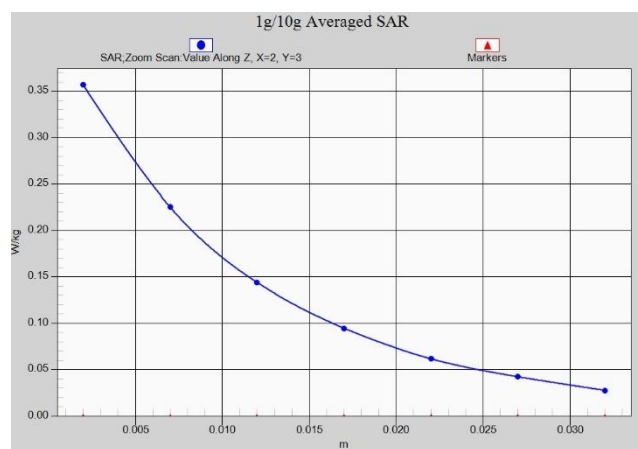
**Fig. 1-2 Z-Scan at power reference point (GSM850)**



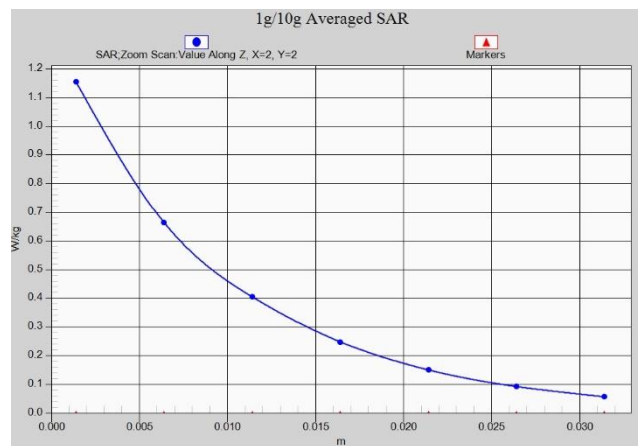
**Fig. 1-3 Z-Scan at power reference point (PCS1900)**



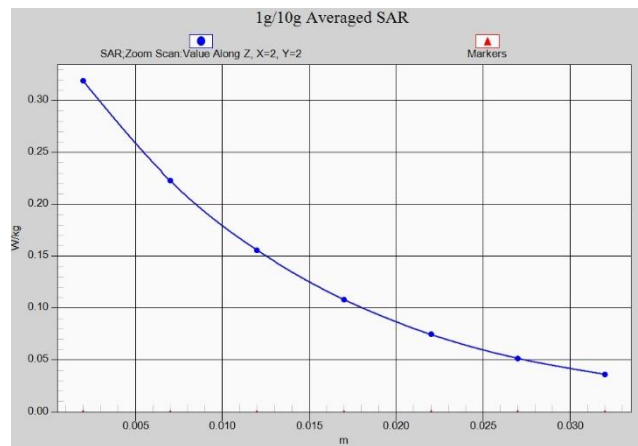
**Fig. 1-4 Z-Scan at power reference point (PCS1900)**



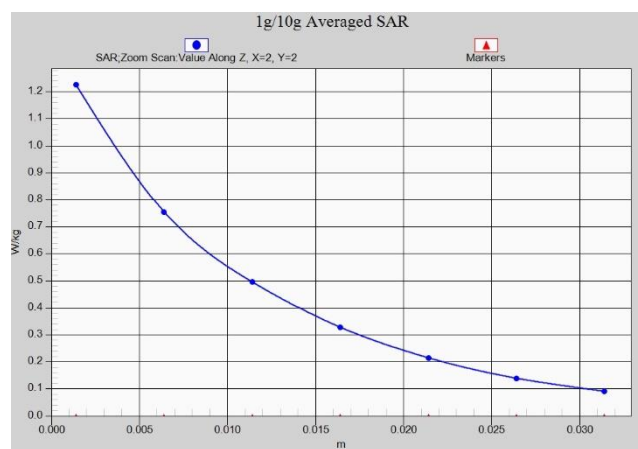
**Fig. 1-5 Z-Scan at power reference point (WCDMA1900)**



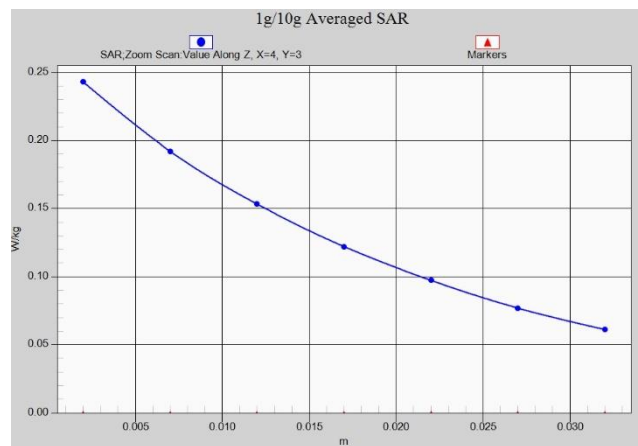
**Fig. 1-6 Z-Scan at power reference point (WCDMA1900)**



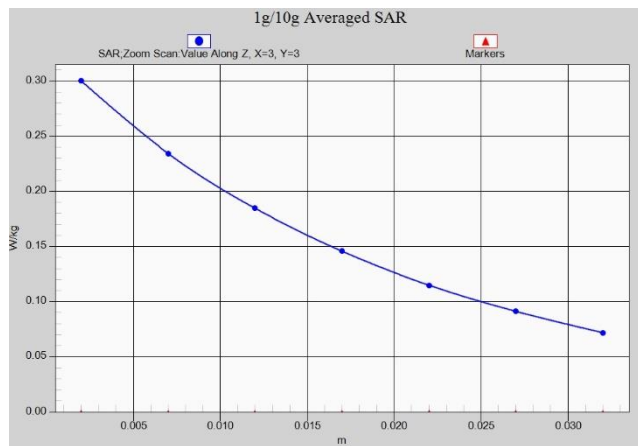
**Fig. 1-7 Z-Scan at power reference point (WCDMA1700)**



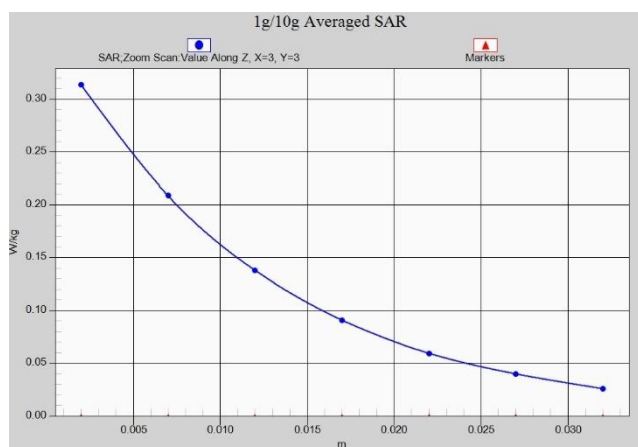
**Fig. 1-8 Z-Scan at power reference point (WCDMA1700)**



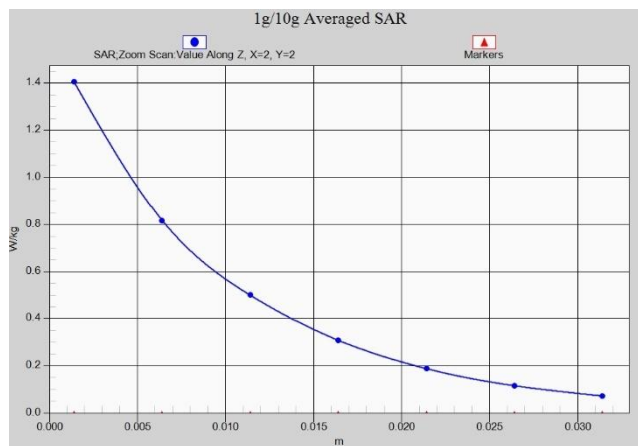
**Fig. 1-9 Z-Scan at power reference point (WCDMA850)**



**Fig. 1-10 Z-Scan at power reference point (WCDMA850)**

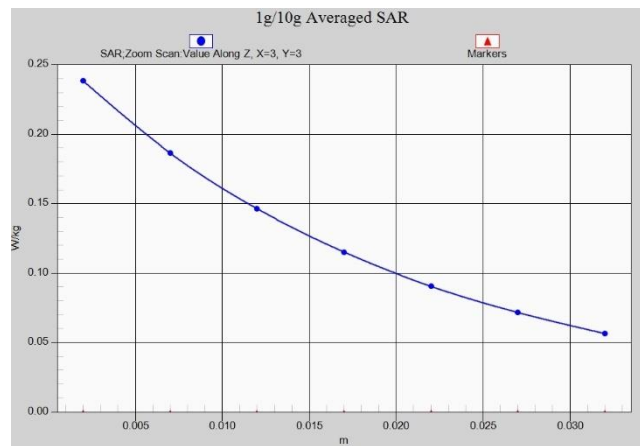


**Fig. 1-11 Z-Scan at power reference point (LTE Band2)**

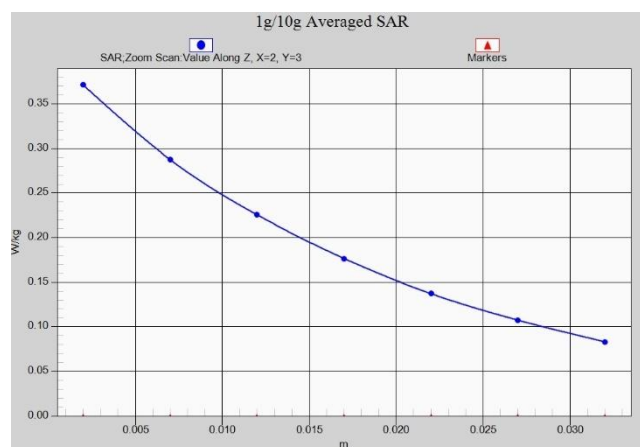


**Fig. 1-12 Z-Scan at power reference point (LTE Band2)**

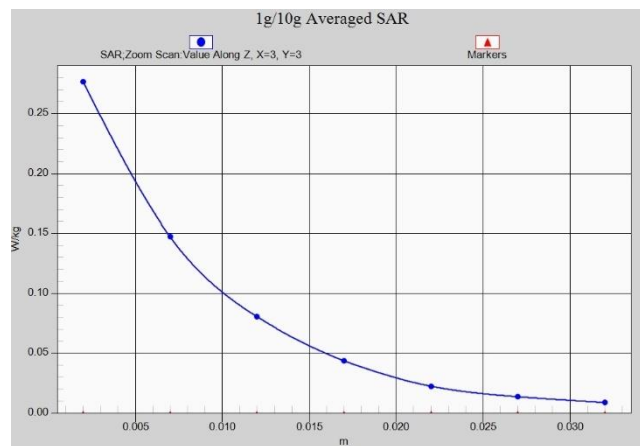




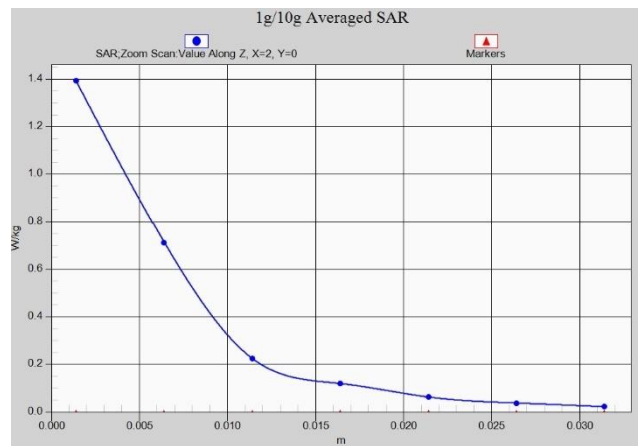
**Fig. 1-13 Z-Scan at power reference point (LTE Band5)**



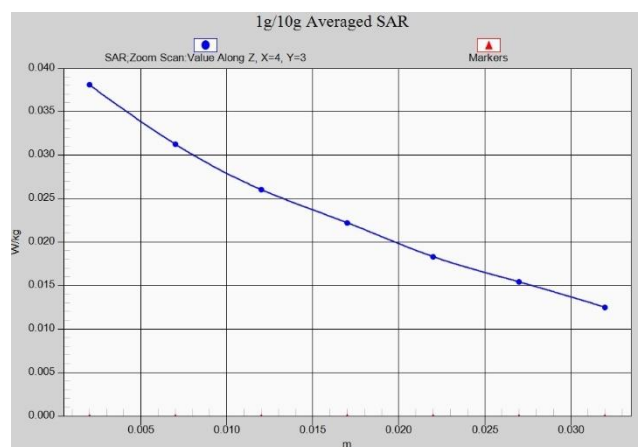
**Fig. 1-14 Z-Scan at power reference point (LTE Band5)**



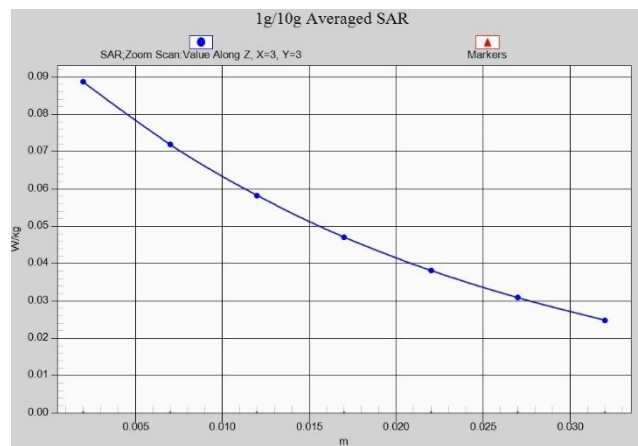
**Fig. 1-15 Z-Scan at power reference point (LTE Band7)**



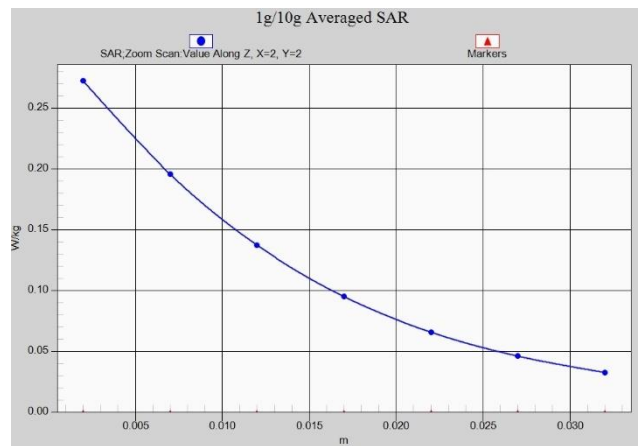
**Fig. 1-16 Z-Scan at power reference point (LTE Band7)**



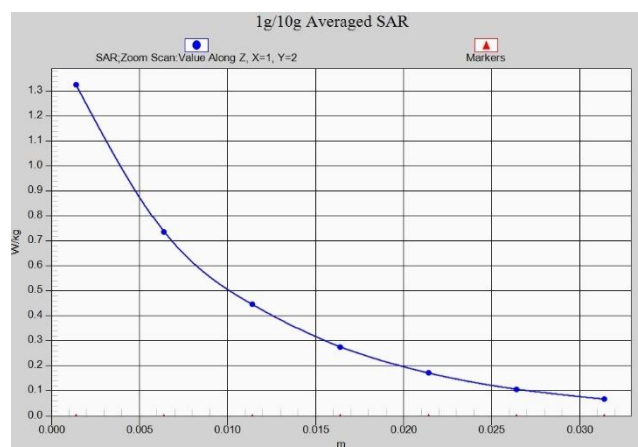
**Fig. 1-17 Z-Scan at power reference point (LTE Band12)**



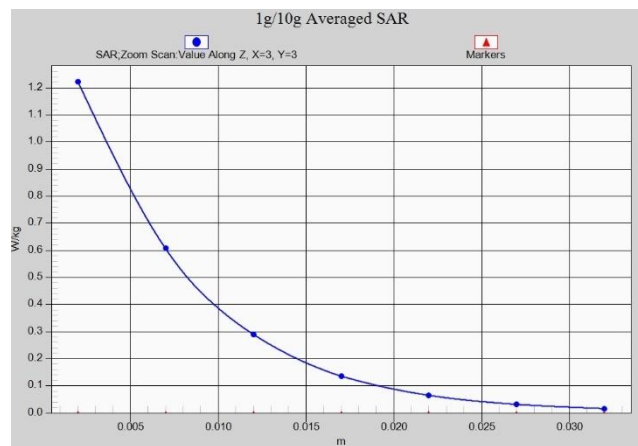
**Fig. 1-18 Z-Scan at power reference point (LTE Band12)**



**Fig. 1-19 Z-Scan at power reference point (LTE Band66)**



**Fig. 1-20 Z-Scan at power reference point (LTE Band66)**



**Fig. 1-21 Z-Scan at power reference point (2450 MHz)**

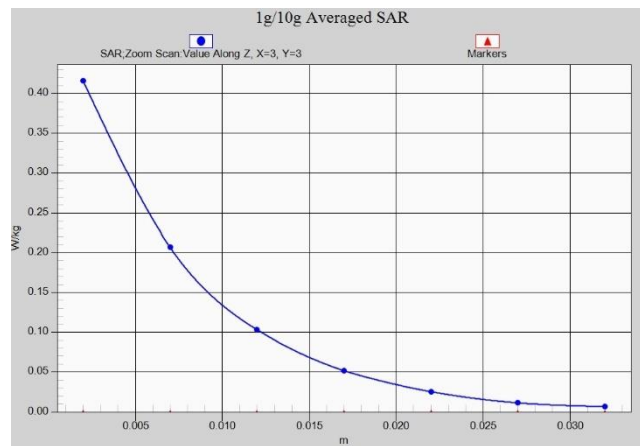


Fig. 1-22 Z-Scan at power reference point (2450 MHz)

## ANNEX B System Verification Results

### 750 MHz

Date: 10/9/2019

Electronics: DAE4 Sn771

Medium: Head 750 MHz

Medium parameters used:  $f = 750 \text{ MHz}$ ;  $\sigma = 0.888 \text{ mho/m}$ ;  $\epsilon_r = 41.35$ ;  $\rho = 1000 \text{ kg/m}^3$

Ambient Temperature:  $22.5^\circ\text{C}$  Liquid Temperature:  $22.3^\circ\text{C}$

Communication System: CW Frequency: 750 MHz Duty Cycle: 1:1

Probe: EX3DV4 – SN3617 ConvF(10.03,10.03,10.03)

**System Validation /Area Scan (81x191x1):** Interpolated grid:  $dx=1.000 \text{ mm}$ ,  $dy=1.000 \text{ mm}$

Reference Value =  $60.74 \text{ V/m}$ ; Power Drift =  $-0.08$

**Fast SAR: SAR(1 g) =  $2.14 \text{ W/kg}$ ; SAR(10 g) =  $1.38 \text{ W/kg}$**

Maximum value of SAR (interpolated) =  $2.82 \text{ W/kg}$

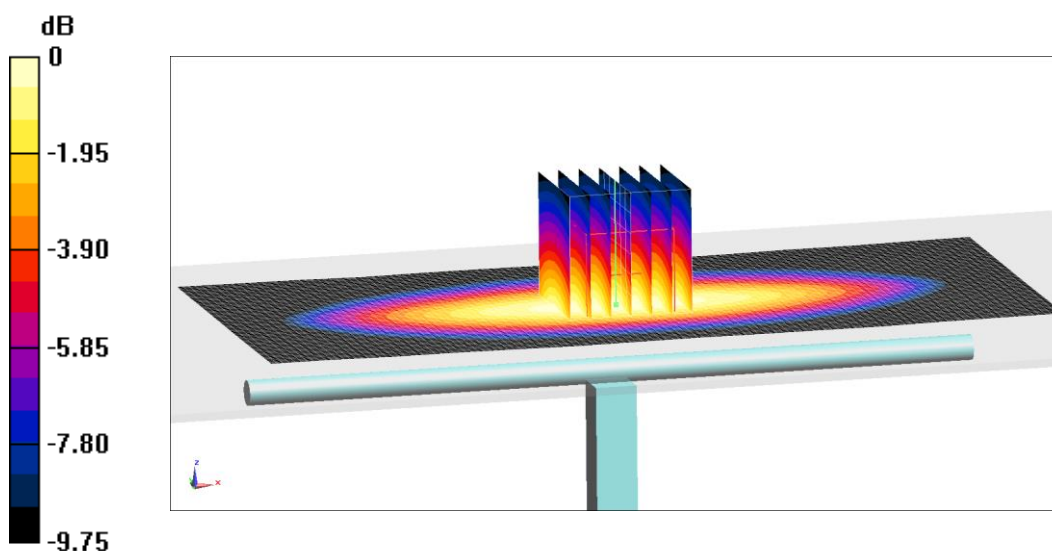
**System Validation /Zoom Scan (7x7x7)/Cube 0:** Measurement grid:  $dx=5\text{mm}$ ,  $dy=5\text{mm}$ ,  $dz=5\text{mm}$

Reference Value =  $60.74 \text{ V/m}$ ; Power Drift =  $-0.08 \text{ dB}$

Peak SAR (extrapolated) =  $3.2 \text{ W/kg}$

**SAR(1 g) =  $2.15 \text{ W/kg}$ ; SAR(10 g) =  $1.42 \text{ W/kg}$**

Maximum value of SAR (measured) =  $2.83 \text{ W/kg}$



0 dB =  $2.83 \text{ W/kg}$  =  $4.52 \text{ dB W/kg}$

**Fig.B.1 validation 750 MHz 250mW**

## 750 MHz

Date: 10/9/2019

Electronics: DAE4 Sn771

Medium: Body 750 MHz

Medium parameters used:  $f = 750 \text{ MHz}$ ;  $\sigma = 0.955 \text{ mho/m}$ ;  $\epsilon_r = 55.95$ ;  $\rho = 1000 \text{ kg/m}^3$

Ambient Temperature: 22.5°C Liquid Temperature: 22.3°C

Communication System: CW Frequency: 750 MHz Duty Cycle: 1:1

Probe: EX3DV4 – SN3617 ConvF(9.85,9.85,9.85)

**System Validation /Area Scan (81x191x1):** Interpolated grid:  $dx=1.000 \text{ mm}$ ,  $dy=1.000 \text{ mm}$

Reference Value = 55.81 V/m; Power Drift = 0.05

**Fast SAR: SAR(1 g) = 2.11 W/kg; SAR(10 g) = 1.38 W/kg**

Maximum value of SAR (interpolated) = 3.05 W/kg

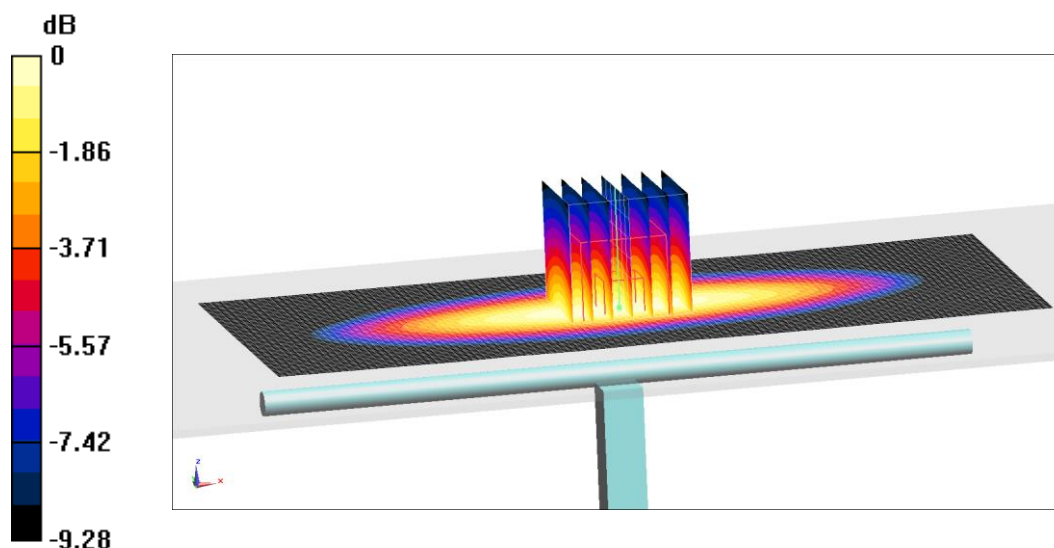
**System Validation /Zoom Scan (7x7x7)/Cube 0:** Measurement grid:  $dx=5\text{mm}$ ,  $dy=5\text{mm}$ ,  $dz=5\text{mm}$

Reference Value = 55.81 V/m; Power Drift = 0.05 dB

Peak SAR (extrapolated) = 3.18 W/kg

**SAR(1 g) = 2.11 W/kg; SAR(10 g) = 1.38 W/kg**

Maximum value of SAR (measured) = 2.81 W/kg



0 dB = 2.81 W/kg = 4.49 dB W/kg

**Fig.B.2 validation 750 MHz 250mW**

## 835 MHz

Date: 10/9/2019

Electronics: DAE4 Sn771

Medium: Head 835 MHz

Medium parameters used:  $f = 835 \text{ MHz}$ ;  $\sigma = 0.892 \text{ mho/m}$ ;  $\epsilon_r = 41.1$ ;  $\rho = 1000 \text{ kg/m}^3$

Ambient Temperature: 22.5°C Liquid Temperature: 22.3°C

Communication System: CW Frequency: 835 MHz Duty Cycle: 1:1

Probe: EX3DV4 – SN3617 ConvF(9.75,9.75,9.75)

**System Validation /Area Scan (81x191x1):** Interpolated grid:  $dx=1.000 \text{ mm}$ ,  $dy=1.000 \text{ mm}$

Reference Value = 62.29 V/m; Power Drift = 0.06

**Fast SAR: SAR(1 g) = 2.4 W/kg; SAR(10 g) = 1.54 W/kg**

Maximum value of SAR (interpolated) = 3.11 W/kg

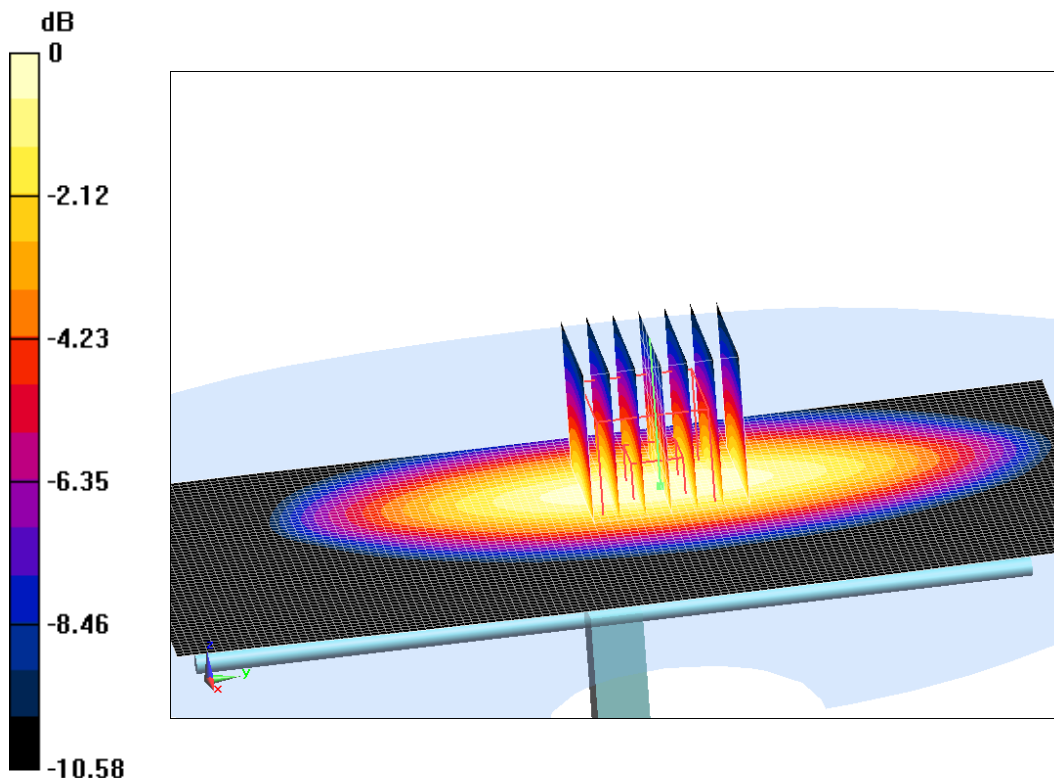
**System Validation /Zoom Scan (7x7x7)/Cube 0:** Measurement grid:  $dx=5\text{mm}$ ,  $dy=5\text{mm}$ ,  $dz=5\text{mm}$

Reference Value = 62.29 V/m; Power Drift = 0.06 dB

Peak SAR (extrapolated) = 3.54 W/kg

**SAR(1 g) = 2.4 W/kg; SAR(10 g) = 1.58 W/kg**

Maximum value of SAR (measured) = 3.28 W/kg



0 dB = 3.28 W/kg = 5.16 dB W/kg

**Fig.B.3 validation 835 MHz 250mW**

## 835 MHz

Date: 10/9/2019

Electronics: DAE4 Sn771

Medium: Body 835 MHz

Medium parameters used:  $f = 835 \text{ MHz}$ ;  $\sigma = 0.977 \text{ mho/m}$ ;  $\epsilon_r = 54.29$ ;  $\rho = 1000 \text{ kg/m}^3$

Ambient Temperature: 22.5°C Liquid Temperature: 22.3°C

Communication System: CW Frequency: 835 MHz Duty Cycle: 1:1

Probe: EX3DV4 – SN3617 ConvF(9.61,9.61,9.61)

**System Validation /Area Scan (81x191x1):** Interpolated grid:  $dx=1.000 \text{ mm}$ ,  $dy=1.000 \text{ mm}$

Reference Value = 57.4 V/m; Power Drift = -0.04

**Fast SAR: SAR(1 g) = 2.4 W/kg; SAR(10 g) = 1.58 W/kg**

Maximum value of SAR (interpolated) = 3.35 W/kg

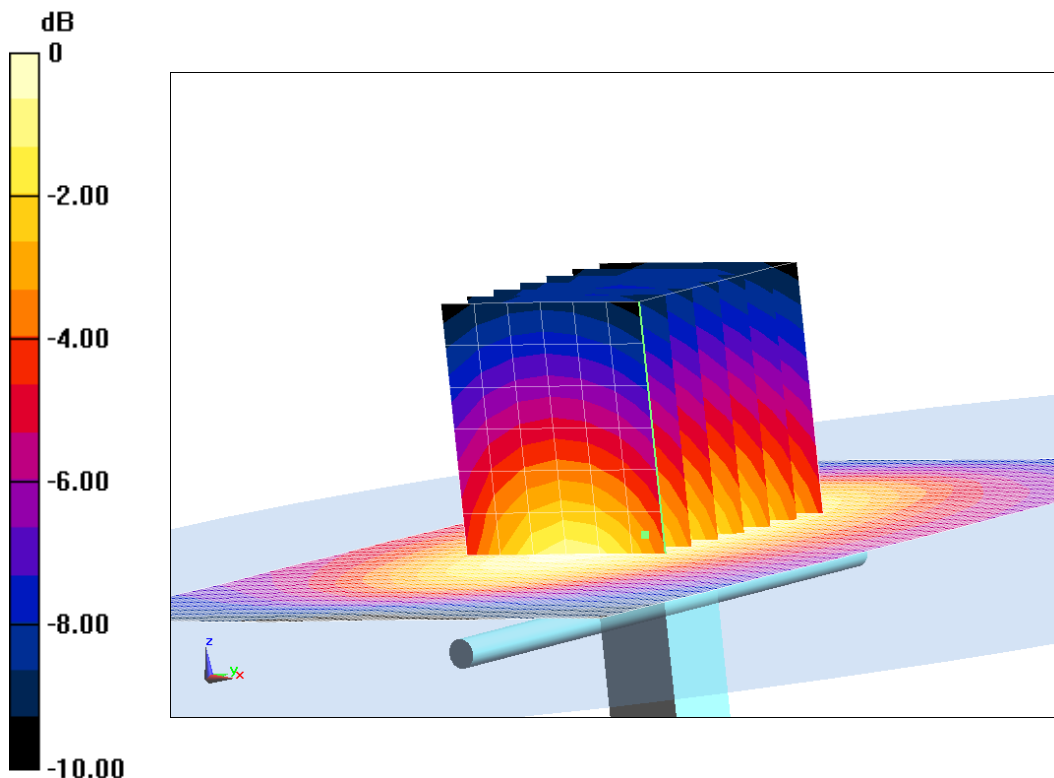
**System Validation /Zoom Scan (7x7x7)/Cube 0:** Measurement grid:  $dx=5\text{mm}$ ,  $dy=5\text{mm}$ ,  $dz=5\text{mm}$

Reference Value = 57.4 V/m; Power Drift = -0.04 dB

Peak SAR (extrapolated) = 3.65 W/kg

**SAR(1 g) = 2.46 W/kg; SAR(10 g) = 1.6 W/kg**

Maximum value of SAR (measured) = 3.26 W/kg



0 dB = 3.26 W/kg = 5.13 dB W/kg

**Fig.B.4 validation 835 MHz 250mW**



## 1750 MHz

Date: 10/10/2019

Electronics: DAE4 Sn771

Medium: Head 1750 MHz

Medium parameters used:  $f = 1750$  MHz;  $\sigma = 1.377$  mho/m;  $\epsilon_r = 40.82$ ;  $\rho = 1000$  kg/m<sup>3</sup>

Ambient Temperature: 22.5°C Liquid Temperature: 22.3°C

Communication System: CW Frequency: 1750 MHz Duty Cycle: 1:1

Probe: EX3DV4 – SN3617 ConvF(8.38,8.38,8.38)

**System Validation /Area Scan (81x191x1):** Interpolated grid: dx=1.000 mm, dy=1.000 mm

Reference Value = 107.9 V/m; Power Drift = -0.03

**Fast SAR: SAR(1 g) = 9.33 W/kg; SAR(10 g) = 4.73 W/kg**

Maximum value of SAR (interpolated) = 14.19 W/kg

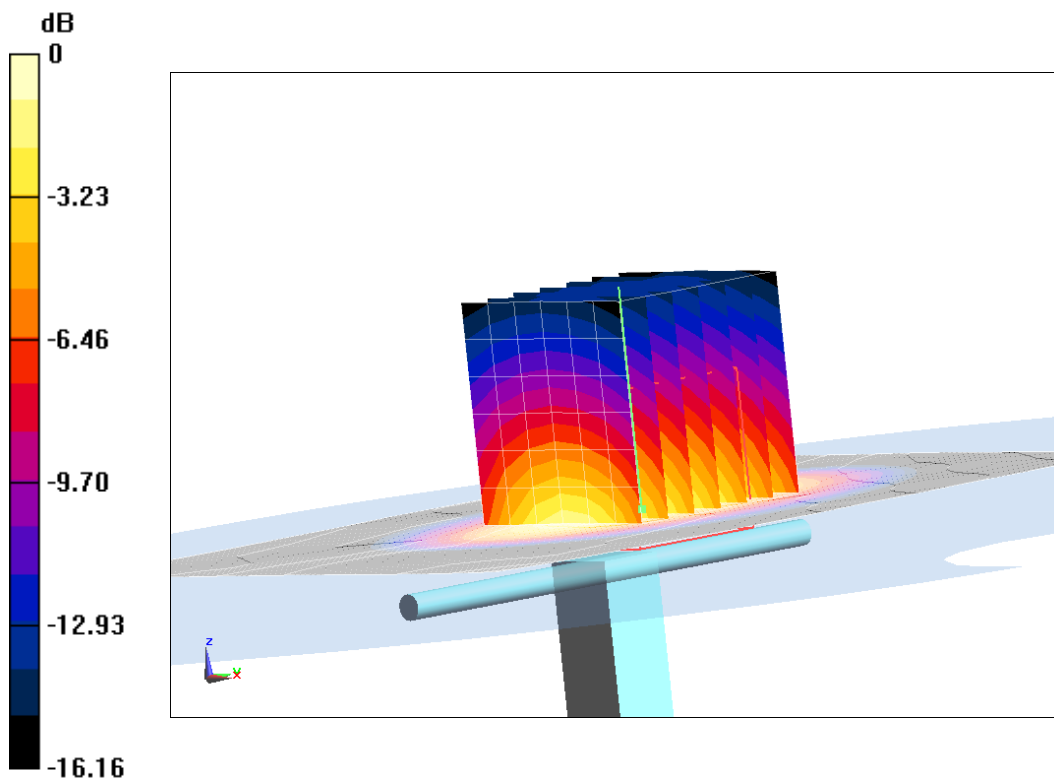
**System Validation /Zoom Scan (7x7x7)/Cube 0:** Measurement grid: dx=5mm, dy=5mm, dz=5mm

Reference Value = 107.9 V/m; Power Drift = -0.03 dB

Peak SAR (extrapolated) = 16.59 W/kg

**SAR(1 g) = 9.17 W/kg; SAR(10 g) = 4.83 W/kg**

Maximum value of SAR (measured) = 14.09 W/kg



0 dB = 14.09 W/kg = 11.49 dB W/kg

**Fig.B.5 validation 1750 MHz 250mW**

## 1750 MHz

Date: 10/10/2019

Electronics: DAE4 Sn771

Medium: Body 1750 MHz

Medium parameters used:  $f = 1750 \text{ MHz}$ ;  $\sigma = 1.485 \text{ mho/m}$ ;  $\epsilon_r = 52.58$ ;  $\rho = 1000 \text{ kg/m}^3$

Ambient Temperature: 22.5°C Liquid Temperature: 22.3°C

Communication System: CW Frequency: 1750 MHz Duty Cycle: 1:1

Probe: EX3DV4 – SN3617 ConvF(8.03,8.03,8.03)

**System Validation /Area Scan (81x191x1):** Interpolated grid:  $dx=1.000 \text{ mm}$ ,  $dy=1.000 \text{ mm}$

Reference Value = 101.79 V/m; Power Drift = -0.07

**Fast SAR: SAR(1 g) = 9.16 W/kg; SAR(10 g) = 4.84 W/kg**

Maximum value of SAR (interpolated) = 13.42 W/kg

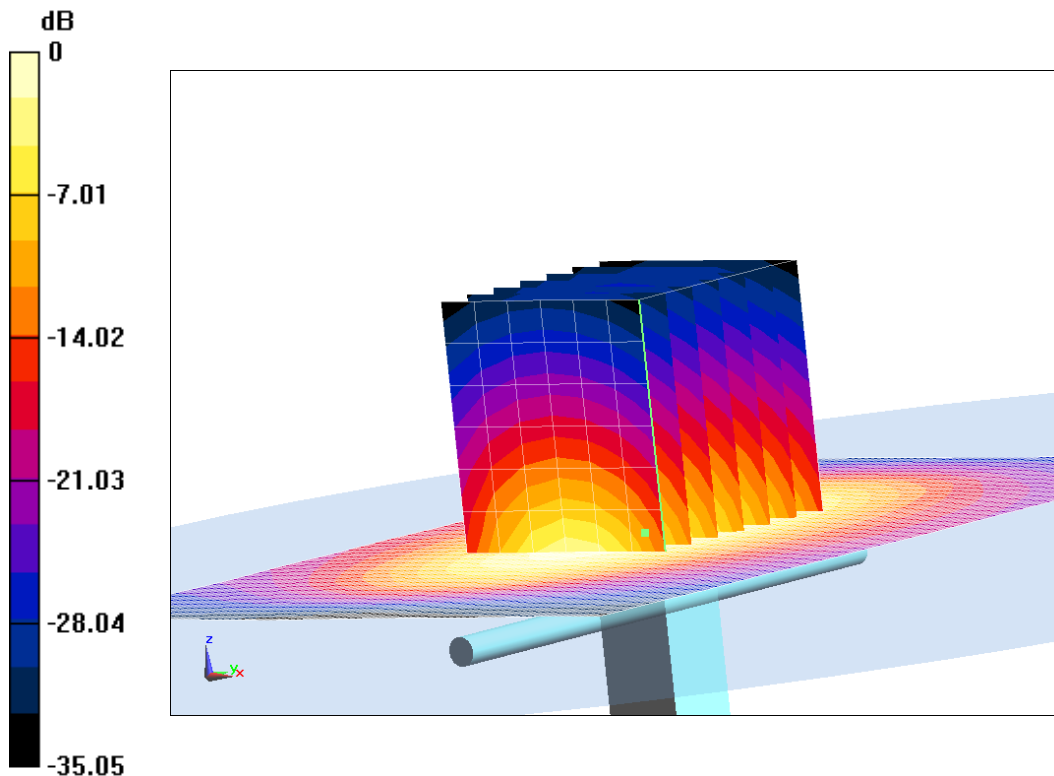
**System Validation /Zoom Scan (7x7x7)/Cube 0:** Measurement grid:  $dx=5\text{mm}$ ,  $dy=5\text{mm}$ ,  $dz=5\text{mm}$

Reference Value = 101.79 V/m; Power Drift = -0.07 dB

Peak SAR (extrapolated) = 15.82 W/kg

**SAR(1 g) = 9.36 W/kg; SAR(10 g) = 4.86 W/kg**

Maximum value of SAR (measured) = 13.78 W/kg



0 dB = 13.78 W/kg = 11.39 dB W/kg

**Fig.B.6 validation 1750 MHz 250mW**

## 1900 MHz

Date: 10/11/2019

Electronics: DAE4 Sn771

Medium: Head 1900 MHz

Medium parameters used:  $f = 1900$  MHz;  $\sigma = 1.428$  mho/m;  $\epsilon_r = 39.99$ ;  $\rho = 1000$  kg/m<sup>3</sup>

Ambient Temperature: 22.5°C Liquid Temperature: 22.3°C

Communication System: CW Frequency: 1900 MHz Duty Cycle: 1:1

Probe: EX3DV4 – SN3617 ConvF(8.14,8.14,8.14)

**System Validation /Area Scan (81x191x1):** Interpolated grid: dx=1.000 mm, dy=1.000 mm

Reference Value = 109.25 V/m; Power Drift = -0.02

**Fast SAR: SAR(1 g) = 9.9 W/kg; SAR(10 g) = 5.14 W/kg**

Maximum value of SAR (interpolated) = 14.98 W/kg

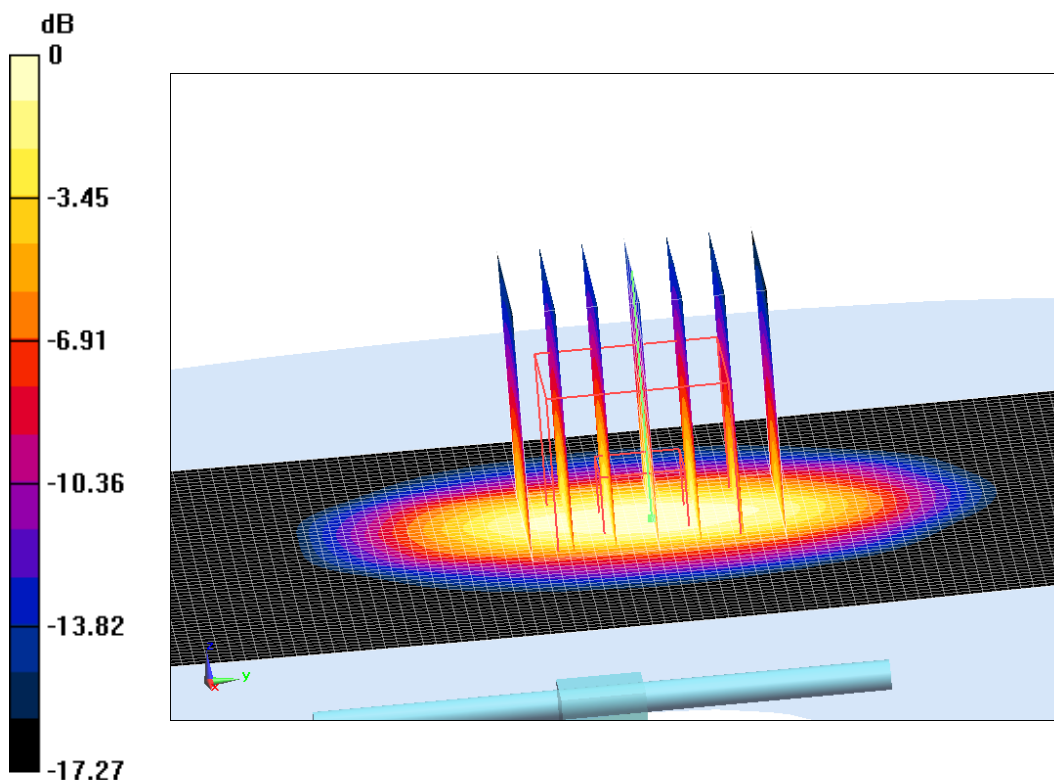
**System Validation /Zoom Scan (7x7x7)/Cube 0:** Measurement grid: dx=5mm, dy=5mm, dz=5mm

Reference Value = 109.25 V/m; Power Drift = -0.02 dB

Peak SAR (extrapolated) = 17.82 W/kg

**SAR(1 g) = 9.92 W/kg; SAR(10 g) = 5.28 W/kg**

Maximum value of SAR (measured) = 14.78 W/kg



0 dB = 14.78 W/kg = 11.7 dB W/kg

**Fig.B.7 validation 1900 MHz 250mW**

## 1900 MHz

Date: 10/11/2019

Electronics: DAE4 Sn771

Medium: Body 1900 MHz

Medium parameters used:  $f = 1900$  MHz;  $\sigma = 1.51$  mho/m;  $\epsilon_r = 53.11$ ;  $\rho = 1000$  kg/m<sup>3</sup>

Ambient Temperature: 22.5°C Liquid Temperature: 22.3°C

Communication System: CW Frequency: 1900 MHz Duty Cycle: 1:1

Probe: EX3DV4 – SN3617 ConvF(7.78,7.78,7.78)

**System Validation /Area Scan (81x191x1):** Interpolated grid: dx=1.000 mm, dy=1.000 mm

Reference Value = 102.96 V/m; Power Drift = 0.01

**Fast SAR: SAR(1 g) = 9.93 W/kg; SAR(10 g) = 5.25 W/kg**

Maximum value of SAR (interpolated) = 16.82 W/kg

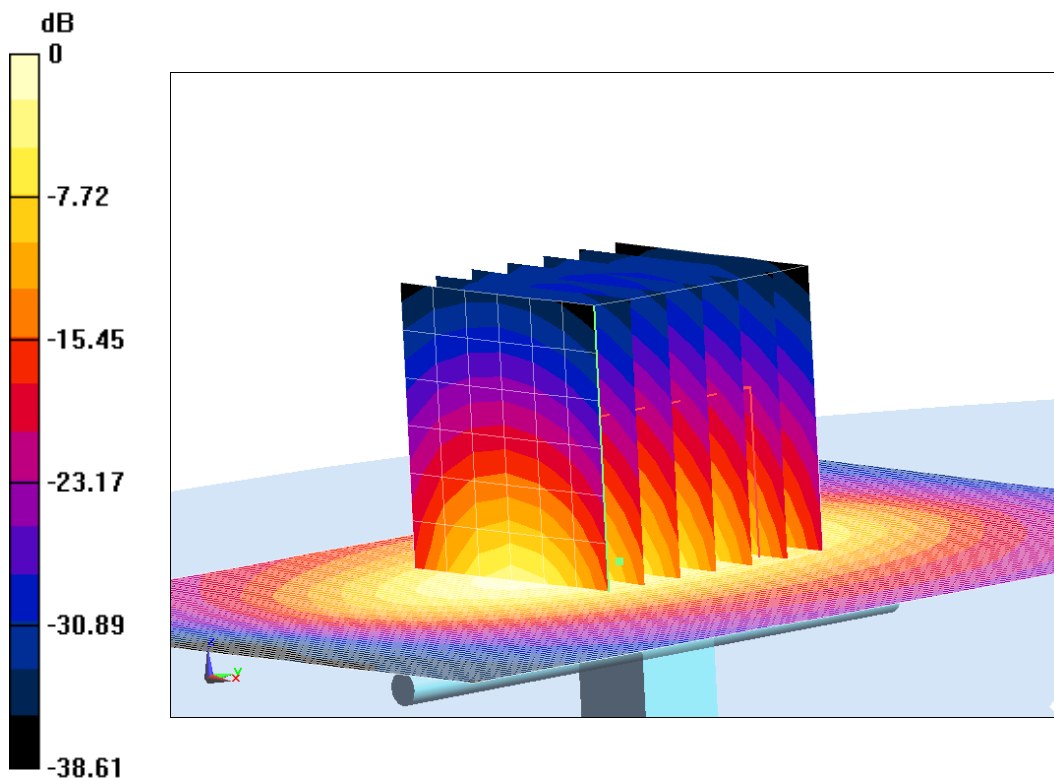
**System Validation /Zoom Scan (7x7x7)/Cube 0:** Measurement grid: dx=5mm, dy=5mm, dz=5mm

Reference Value = 102.96 V/m; Power Drift = 0.01 dB

Peak SAR (extrapolated) = 17.33 W/kg

**SAR(1 g) = 10 W/kg; SAR(10 g) = 5.2 W/kg**

Maximum value of SAR (measured) = 14.58 W/kg



0 dB = 14.58 W/kg = 11.64 dB W/kg

**Fig.B.8 validation 1900 MHz 250mW**

## 2450 MHz

Date: 10/12/2019

Electronics: DAE4 Sn771

Medium: Head 2450 MHz

Medium parameters used:  $f = 2450$  MHz;  $\sigma = 1.78$  mho/m;  $\epsilon_r = 38.99$ ;  $\rho = 1000$  kg/m<sup>3</sup>

Ambient Temperature: 22.5°C Liquid Temperature: 22.3°C

Communication System: CW Frequency: 2450 MHz Duty Cycle: 1:1

Probe: EX3DV4 – SN3617 ConvF(7.62,7.62,7.62)

**System Validation /Area Scan (81x191x1):** Interpolated grid: dx=1.000 mm, dy=1.000 mm

Reference Value = 115.5 V/m; Power Drift = 0.04

**Fast SAR: SAR(1 g) = 12.73 W/kg; SAR(10 g) = 5.98 W/kg**

Maximum value of SAR (interpolated) = 21.56 W/kg

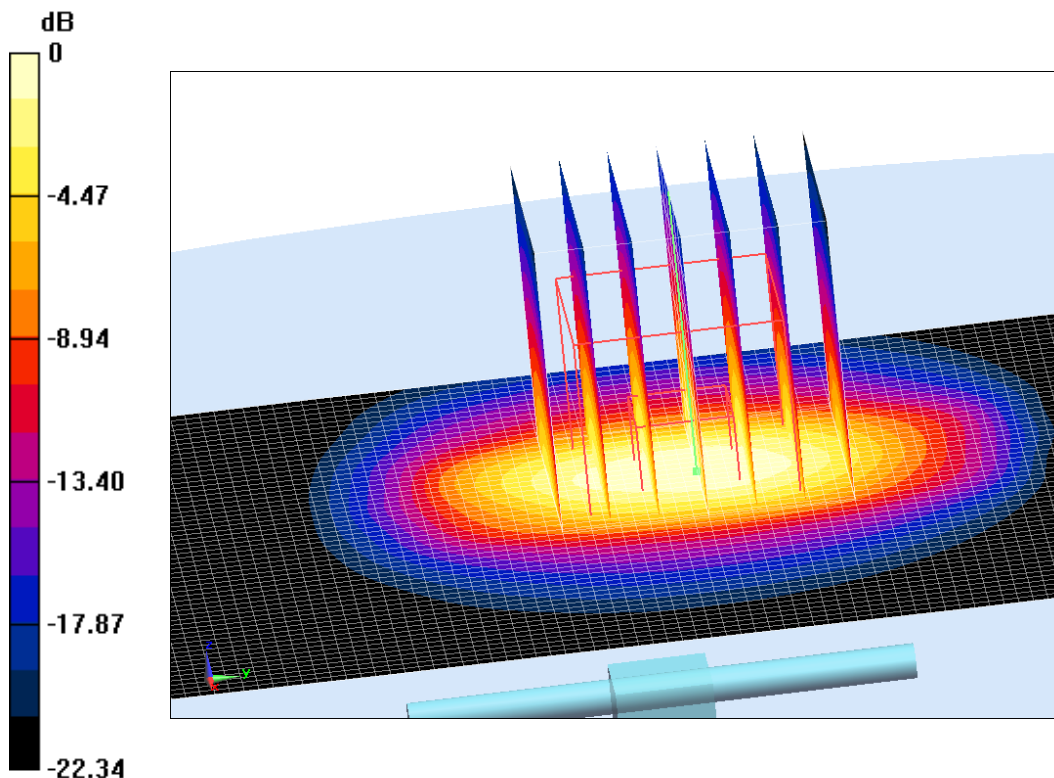
**System Validation /Zoom Scan (7x7x7)/Cube 0:** Measurement grid: dx=5mm, dy=5mm, dz=5mm

Reference Value = 115.5 V/m; Power Drift = 0.04 dB

Peak SAR (extrapolated) = 25.82 W/kg

**SAR(1 g) = 12.68 W/kg; SAR(10 g) = 6.12 W/kg**

Maximum value of SAR (measured) = 21.47 W/kg



0 dB = 21.47 W/kg = 13.32 dB W/kg

**Fig.B.9 validation 2450 MHz 250mW**

## 2450 MHz

Date: 10/12/2019

Electronics: DAE4 Sn771

Medium: Body 2450 MHz

Medium parameters used:  $f = 2450$  MHz;  $\sigma = 1.957$  mho/m;  $\epsilon_r = 53.49$ ;  $\rho = 1000$  kg/m<sup>3</sup>

Ambient Temperature: 22.5°C Liquid Temperature: 22.3°C

Communication System: CW Frequency: 2450 MHz Duty Cycle: 1:1

Probe: EX3DV4 – SN3617 ConvF(7.79,7.79,7.79)

**System Validation /Area Scan (81x191x1):** Interpolated grid: dx=1.000 mm, dy=1.000 mm

Reference Value = 108.84 V/m; Power Drift = 0.05

**Fast SAR: SAR(1 g) = 13.2 W/kg; SAR(10 g) = 6.24 W/kg**

Maximum value of SAR (interpolated) = 20.82 W/kg

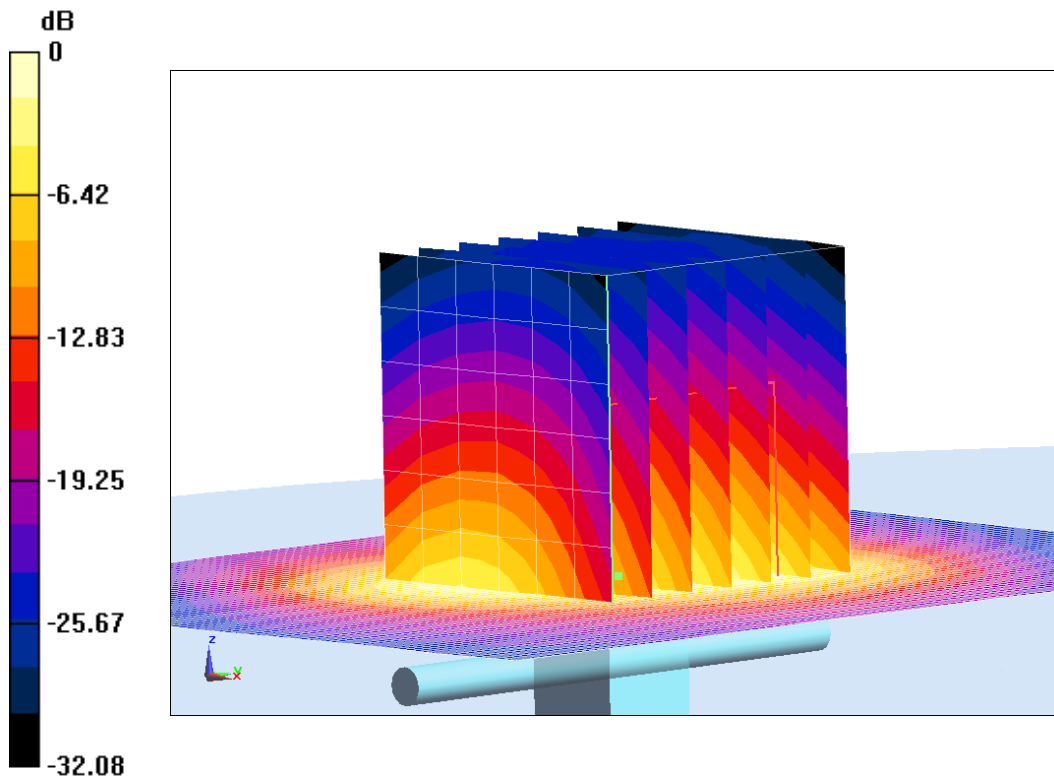
**System Validation /Zoom Scan (7x7x7)/Cube 0:** Measurement grid: dx=5mm, dy=5mm, dz=5mm

Reference Value = 108.84 V/m; Power Drift = 0.05 dB

Peak SAR (extrapolated) = 26.6 W/kg

**SAR(1 g) = 12.85 W/kg; SAR(10 g) = 6.1 W/kg**

Maximum value of SAR (measured) = 21.47 W/kg



0 dB = 21.47 W/kg = 13.32 dB W/kg

**Fig.B.10 validation 2450 MHz 250mW**

## 2600 MHz

Date: 10/12/2019

Electronics: DAE4 Sn771

Medium: Head 2600 MHz

Medium parameters used:  $f = 2600$  MHz;  $\sigma = 1.925$  mho/m;  $\epsilon_r = 39.06$ ;  $\rho = 1000$  kg/m<sup>3</sup>

Ambient Temperature: 22.5°C Liquid Temperature: 22.3°C

Communication System: CW Frequency: 2600 MHz Duty Cycle: 1:1

Probe: EX3DV4 – SN3617 ConvF(7.19,7.19,7.19)

**System Validation /Area Scan (81x191x1):** Interpolated grid: dx=1.000 mm, dy=1.000 mm

Reference Value = 117.26 V/m; Power Drift = 0.05

**Fast SAR: SAR(1 g) = 14.08 W/kg; SAR(10 g) = 6.31 W/kg**

Maximum value of SAR (interpolated) = 24.99 W/kg

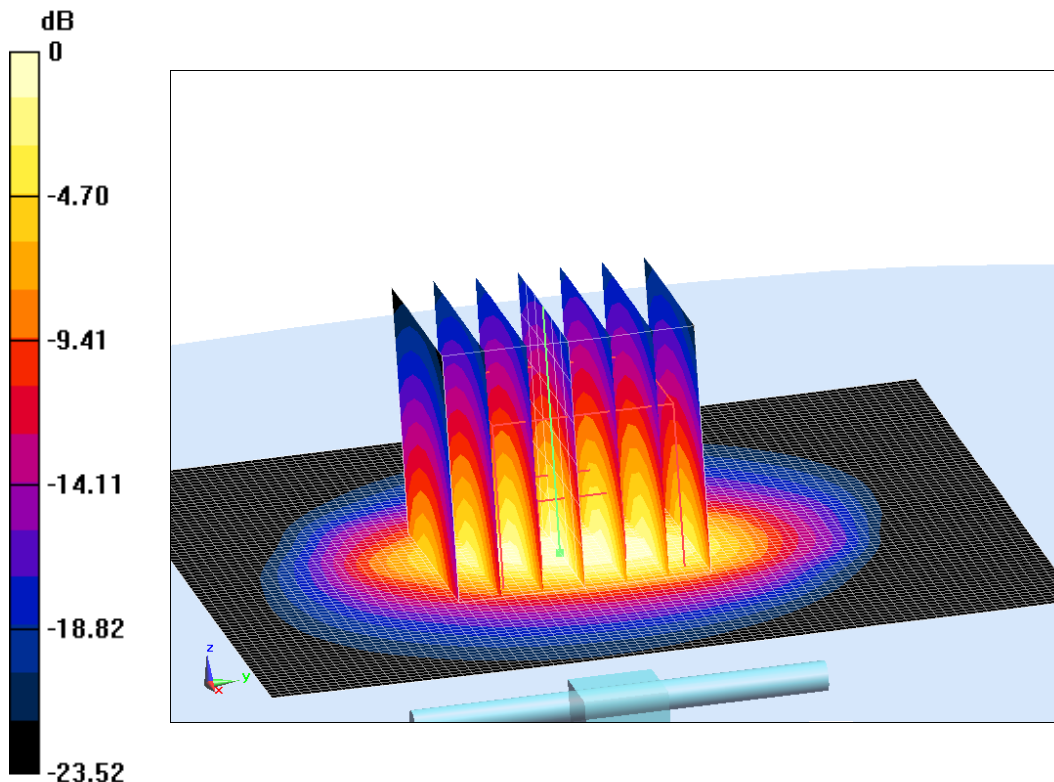
**System Validation /Zoom Scan (7x7x7)/Cube 0:** Measurement grid: dx=5mm, dy=5mm, dz=5mm

Reference Value = 117.26 V/m; Power Drift = 0.05 dB

Peak SAR (extrapolated) = 28.68 W/kg

**SAR(1 g) = 13.68 W/kg; SAR(10 g) = 6.25 W/kg**

Maximum value of SAR (measured) = 24.47 W/kg



0 dB = 24.47 W/kg = 13.89 dB W/kg

**Fig.B.11 validation 2600 MHz 250mW**



## 2600 MHz

Date: 10/12/2019

Electronics: DAE4 Sn771

Medium: Body 2600 MHz

Medium parameters used:  $f = 2600$  MHz;  $\sigma = 2.179$  mho/m;  $\epsilon_r = 52.63$ ;  $\rho = 1000$  kg/m<sup>3</sup>

Ambient Temperature: 22.5°C Liquid Temperature: 22.3°C

Communication System: CW Frequency: 2600 MHz Duty Cycle: 1:1

Probe: EX3DV4 – SN3617 ConvF(7.49,7.49,7.49)

**System Validation /Area Scan (81x191x1):** Interpolated grid: dx=1.000 mm, dy=1.000 mm

Reference Value = 109.96 V/m; Power Drift = 0.05

**Fast SAR: SAR(1 g) = 13.52 W/kg; SAR(10 g) = 6.25 W/kg**

Maximum value of SAR (interpolated) = 23.32 W/kg

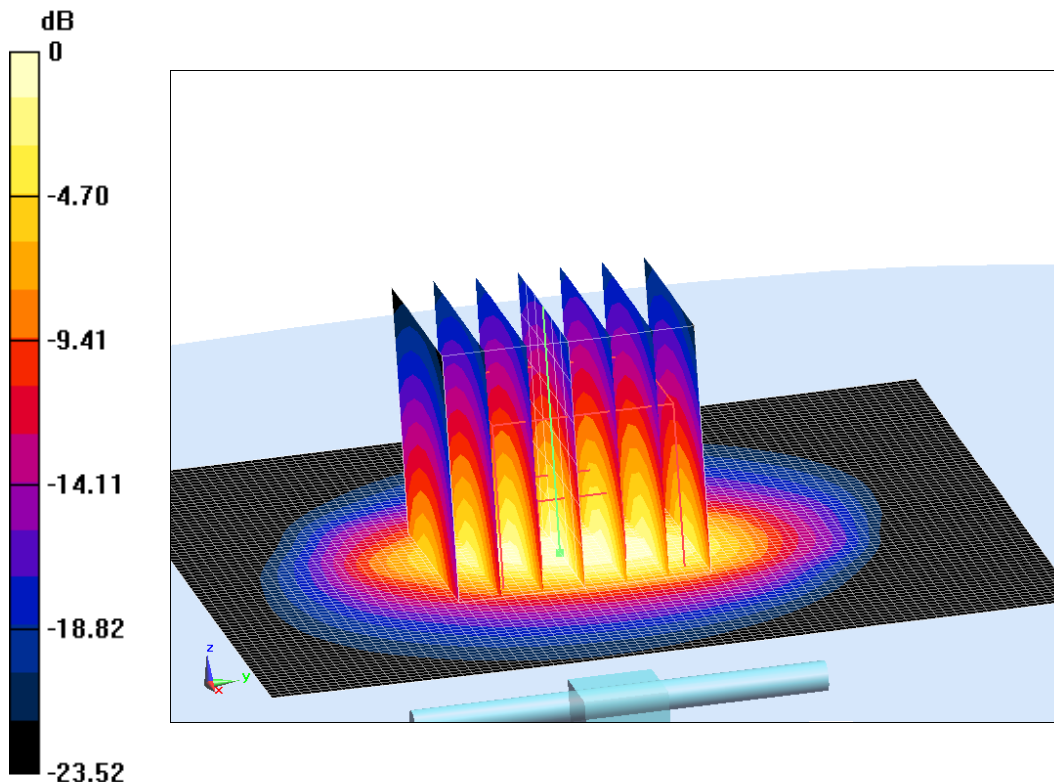
**System Validation /Zoom Scan (7x7x7)/Cube 0:** Measurement grid: dx=5mm, dy=5mm, dz=5mm

Reference Value = 109.96 V/m; Power Drift = 0.05 dB

Peak SAR (extrapolated) = 28.76 W/kg

**SAR(1 g) = 13.71 W/kg; SAR(10 g) = 6.14 W/kg**

Maximum value of SAR (measured) = 23.58 W/kg



0 dB = 23.58 W/kg = 13.73 dB W/kg

**Fig.B.12 validation 2600 MHz 250mW**



The SAR system verification must be required that the area scan estimated 1-g SAR is within 3% of the zoom scan 1-g SAR.

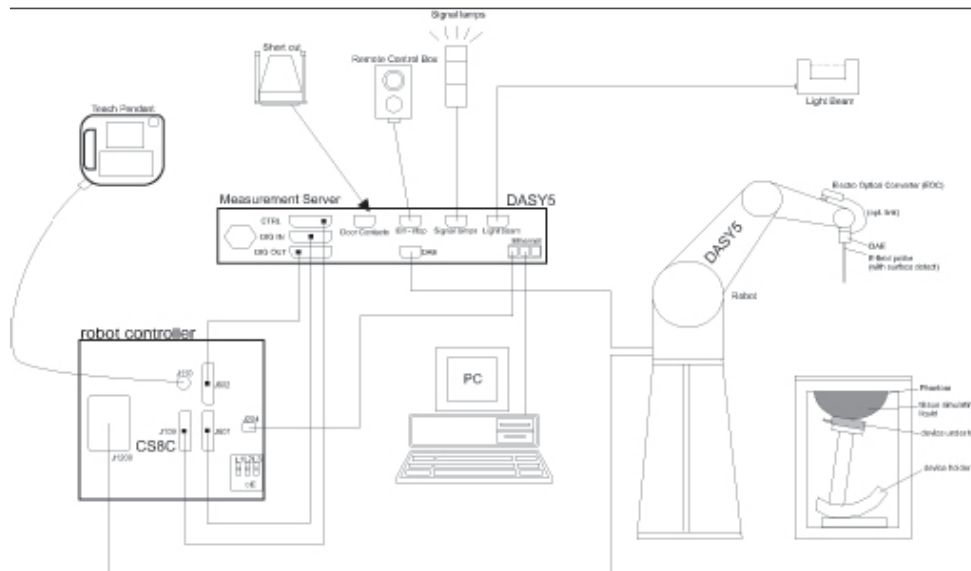
**Table B.1 Comparison between area scan and zoom scan for system verification**

Date	Band	Position	Area scan (1g)	Zoom scan (1g)	Drift (%)
2019-7-1	750	Head	2.14	2.15	-0.47
	750	Body	2.11	2.11	0.00
2019-7-2	835	Head	2.4	2.4	0.00
	835	Body	2.4	2.46	-2.44
2019-7-3	1750	Head	9.33	9.17	1.74
	1750	Body	9.16	9.36	-2.14
2019-7-4	1900	Head	9.9	9.92	-0.20
	1900	Body	9.93	10	-0.70
2019-7-5	2300	Head	12.73	12.68	0.39
	2300	Body	13.2	12.85	2.72
2019-7-5	2450	Head	14.08	13.68	2.92
	2450	Body	13.52	13.71	-1.39

## ANNEX C SAR Measurement Setup

### C.1 Measurement Set-up

The Dasy4 or DASY5 system for performing compliance tests is illustrated above graphically. This system consists of the following items:



Picture C.1 SAR Lab Test Measurement Set-up

- A standard high precision 6-axis robot (Stäubli TX=RX family) with controller, teach pendant and software. An arm extension for accommodating the data acquisition electronics (DAE).
- An isotropic field probe optimized and calibrated for the targeted measurement.
- A data acquisition electronics (DAE) which performs the signal amplification, signal multiplexing, AD-conversion, offset measurements, mechanical surface detection, collision detection, etc. The unit is battery powered with standard or rechargeable batteries. The signal is optically transmitted to the EOC.
- The Electro-optical converter (EOC) performs the conversion from optical to electrical signals for the digital communication to the DAE. To use optical surface detection, a special version of the EOC is required. The EOC signal is transmitted to the measurement server.
- The function of the measurement server is to perform the time critical tasks such as signal filtering, control of the robot operation and fast movement interrupts.
- The Light Beam used is for probe alignment. This improves the (absolute) accuracy of the probe positioning.
- A computer running WinXP and the DASY4 or DASY5 software.
- Remote control and teach pendant as well as additional circuitry for robot safety such as
- warning lamps, etc.
- The phantom, the device holder and other accessories according to the targeted measurement.

## C.2 Dasy4 or DASY5 E-field Probe System

The SAR measurements were conducted with the dosimetric probe designed in the classical triangular configuration and optimized for dosimetric evaluation. The probe is constructed using the thick film technique; with printed resistive lines on ceramic substrates. The probe is equipped with an optical multifiber line ending at the front of the probe tip. It is connected to the EOC box on the robot arm and provides an automatic detection of the phantom surface. Half of the fibers are connected to a pulsed infrared transmitter, the other half to a synchronized receiver. As the probe approaches the surface, the reflection from the surface produces a coupling from the transmitting to the receiving fibers. This reflection increases first during the approach, reaches maximum and then decreases. If the probe is flatly touching the surface, the coupling is zero. The distance of the coupling maximum to the surface is independent of the surface reflectivity and largely independent of the surface to probe angle. The DASY4 or DASY5 software reads the reflection during a software approach and looks for the maximum using 2<sup>nd</sup> order curve fitting. The approach is stopped at reaching the maximum.

### Probe Specifications:

<b>Model:</b>	<b>ES3DV3, EX3DV4</b>
<b>Frequency</b>	<b>10MHz — 6.0GHz(EX3DV4)</b>
<b>Range:</b>	<b>10MHz — 4GHz(ES3DV3)</b>
<b>Calibration:</b>	<b>In head and body simulating tissue at Frequencies from 835 up to 5800MHz</b>
<b>Linearity:</b>	<b>± 0.2 dB(30 MHz to 6 GHz) for EX3DV4 ± 0.2 dB(30 MHz to 4 GHz) for ES3DV3</b>
<b>DynamicRange:</b>	<b>10 mW/kg — 100W/kg</b>
<b>Probe Length:</b>	<b>330 mm</b>
<b>Probe Tip</b>	
<b>Length:</b>	<b>20 mm</b>
<b>Body Diameter:</b>	<b>12 mm</b>
<b>Tip Diameter:</b>	<b>2.5 mm (3.9 mm for ES3DV3)</b>
<b>Tip-Center:</b>	<b>1 mm (2.0mm for ES3DV3)</b>
<b>Application:</b>	<b>SAR Dosimetry Testing Compliance tests of mobile phones Dosimetry in strong gradient fields</b>



Picture C.2 Near-field Probe



Picture C.3 E-field Probe

## C.3 E-field Probe Calibration

Each E-Probe/Probe Amplifier combination has unique calibration parameters. A TEM cell calibration procedure is conducted to determine the proper amplifier settings to enter in the probe parameters. The amplifier settings are determined for a given frequency by subjecting the probe to a known E-field density (1 mW/cm<sup>2</sup>) using an RF Signal generator, TEM cell, and RF Power Meter.

The free space E-field from amplified probe outputs is determined in a test chamber. This calibration can be performed in a TEM cell if the frequency is below 1 GHz and in a waveguide or

other methodologies above 1 GHz for free space. For the free space calibration, the probe is placed in the volumetric center of the cavity and at the proper orientation with the field. The probe is then rotated 360 degrees until the three channels show the maximum reading. The power density readings equates to 1 mW/cm<sup>2</sup>.

E-field temperature correlation calibration is performed in a flat phantom filled with the appropriate simulated brain tissue. The E-field in the medium correlates with the temperature rise in the dielectric medium. For temperature correlation calibration a RF transparent thermistor-based temperature probe is used in conjunction with the E-field probe.

$$SAR = C \frac{\Delta T}{\Delta t}$$

Where:

$\Delta t$  = Exposure time (30 seconds),

C = Heat capacity of tissue (brain or muscle),

$\Delta T$  = Temperature increase due to RF exposure.

$$SAR = \frac{|E|^2 \cdot \sigma}{\rho}$$

Where:

$\sigma$  = Simulated tissue conductivity,

$\rho$  = Tissue density (kg/m<sup>3</sup>).

## C.4 Other Test Equipment

### C.4.1 Data Acquisition Electronics(DAE)

The data acquisition electronics consist of a highly sensitive electrometer-grade preamplifier with auto-zeroing, a channel and gain-switching multiplexer, a fast 16 bit AD-converter and a command decoder with a control logic unit. Transmission to the measurement server is accomplished through an optical downlink for data and status information, as well as an optical uplink for commands and the clock.

The mechanical probe mounting device includes two different sensor systems for frontal and sideways probe contacts. They are used for mechanical surface detection and probe collision detection.

The input impedance of the DAE is 200 MOhm; the inputs are symmetrical and floating. Common mode rejection is above 80 dB.



**PictureC.4: DAE**

### C.4.2 Robot

The SPEAG DASY system uses the high precision robots (DASY4: RX90XL; DASY5: RX160L) type from Stäubli SA (France). For the 6-axis controller system, the robot controller version from Stäubli is used. The Stäubli robot series have many features that are important for our application:

- High precision (repeatability 0.02mm)
- High reliability (industrial design)
- Low maintenance costs (virtually maintenance free due to direct drive gears; no belt drives)
- Jerk-free straight movements (brushless synchron motors; no stepper motors)
- Low ELF interference (motor control fields shielded via the closed metallic construction shields)



Picture C.5DASY 4



Picture C.6DASY 5

### C.4.3 Measurement Server

The Measurement server is based on a PC/104 CPU board with CPU (dasy4: 166 MHz, Intel Pentium; DASY5: 400 MHz, Intel Celeron), chipdisk (DASY4: 32 MB; DASY5: 128MB), RAM (DASY4: 64 MB, DASY5: 128MB). The necessary circuits for communication with the DAE electronic box, as well as the 16 bit AD converter system for optical detection and digital I/O interface are contained on the DASY I/O board, which is directly connected to the PC/104 bus of the CPU board.

The measurement server performs all real-time data evaluation of field measurements and surface detection, controls robot movements and handles safety operation. The PC operating system cannot interfere with these time critical processes. All connections are supervised by a watchdog, and disconnection of any of the cables to the measurement server will automatically disarm the robot and disable all program-controlled robot movements. Furthermore, the measurement server is equipped with an expansion port which is reserved for future applications. Please note that this expansion port does not have a standardized pinout, and therefore only devices provided by SPEAG can be connected. Devices from any other supplier could seriously damage the measurement server.



Picture C.7 Server for DASY 4



Picture C.8 Server for DASY 5

#### C.4.4 Device Holder for Phantom

The SAR in the phantom is approximately inversely proportional to the square of the distance between the source and the liquid surface. For a source at 5mm distance, a positioning uncertainty of  $\pm 0.5\text{mm}$  would produce a SAR uncertainty of  $\pm 20\%$ . Accurate device positioning is therefore crucial for accurate and repeatable measurements. The positions in which the devices must be measured are defined by the standards.

The DASY device holder is designed to cope with the different positions given in the standard. It has two scales for device rotation (with respect to the body axis) and device inclination (with respect to the line between the ear reference points). The rotation centers for both scales are the ear reference point (ERP). Thus the device needs no repositioning when changing the angles.

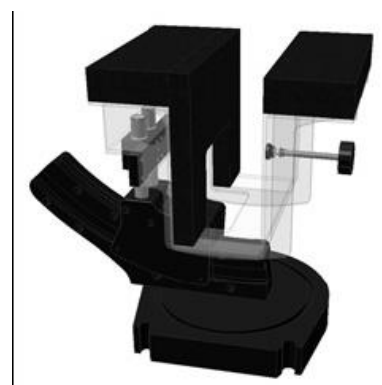
The DASY device holder is constructed of low-loss POM material having the following dielectric parameters: relative permittivity  $\epsilon = 3$  and loss tangent  $\delta = 0.02$ . The amount of dielectric material has been reduced in the closest vicinity of the device, since measurements have suggested that the influence of the clamp on the test results could thus be lowered.

<Laptop Extension Kit>

The extension is lightweight and made of POM, acrylic glass and foam. It fits easily on the upper part of the Mounting Device in place of the phone positioner. The extension is fully compatible with the Twin-SAM and ELI phantoms.



Picture C.9-1: Device Holder



Picture C.9-2: Laptop Extension Kit

#### C.4.5 Phantom

The SAM Twin Phantom V4.0 is constructed of a fiberglass shell integrated in a table. The shape of the shell is based on data from an anatomical study designed to represent the 90<sup>th</sup> percentile of the population. The phantom enables the dissymmetric evaluation

of SAR for both left and right handed handset usage, as well as body-worn usage using the flat phantom region. Reference markings on the Phantom allow the complete setup of all predefined phantom positions and measurement grids by manually teaching three points in the robot. The shell phantom has a 2mm shell thickness (except the ear region where shell thickness increases to 6 mm).

Shell Thickness:  $2 \pm 0.2$  mm

Filling Volume: Approx. 25 liters

Dimensions: 810 x 1000 x 500 mm (H x L x W)

Available: Special



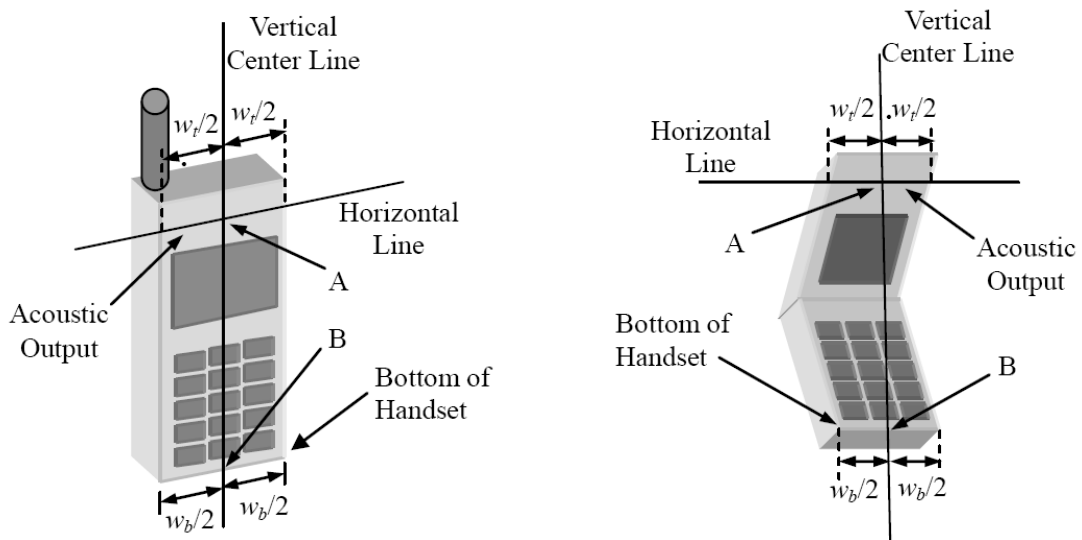
**Picture C.10: SAM Twin Phantom**



## ANNEX D Position of the wireless device in relation to the phantom

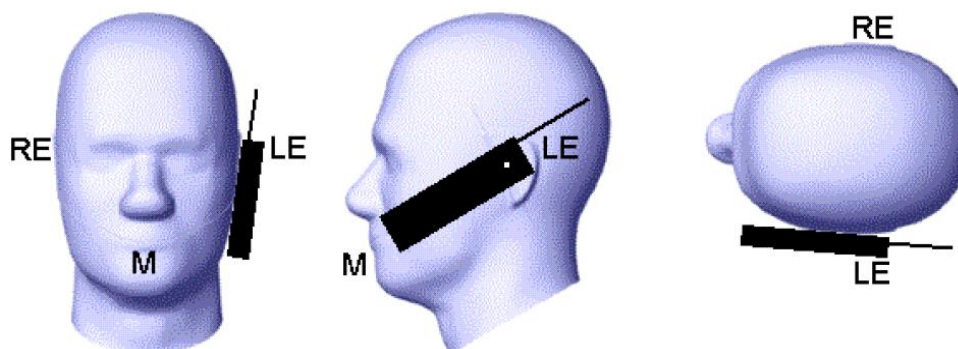
### D.1 General considerations

This standard specifies two handset test positions against the head phantom – the “cheek” position and the “tilt” position.



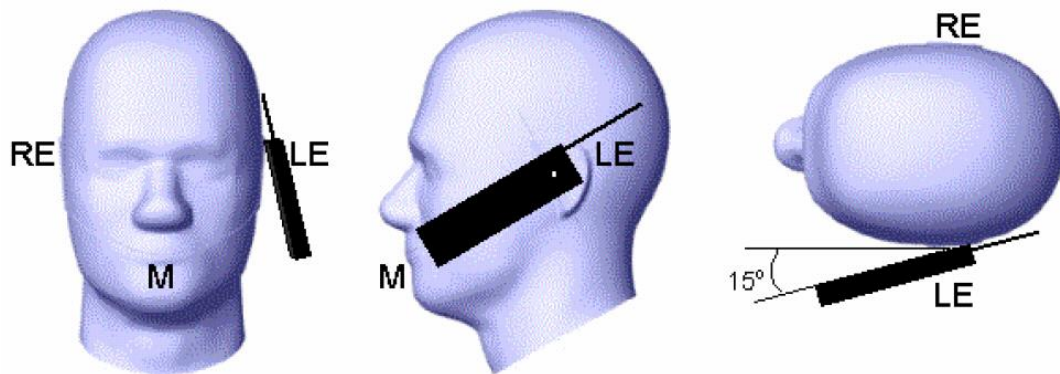
- $w_t$  Width of the handset at the level of the acoustic
- $w_b$  Width of the bottom of the handset
- A Midpoint of the width  $w_t$  of the handset at the level of the acoustic output
- B Midpoint of the width  $w_b$  of the bottom of the handset

Picture D.1-a Typical “fixed” case handset      Picture D.1-b Typical “clam-shell” case handset



Picture D.2 Cheek position of the wireless device on the left side of SAM

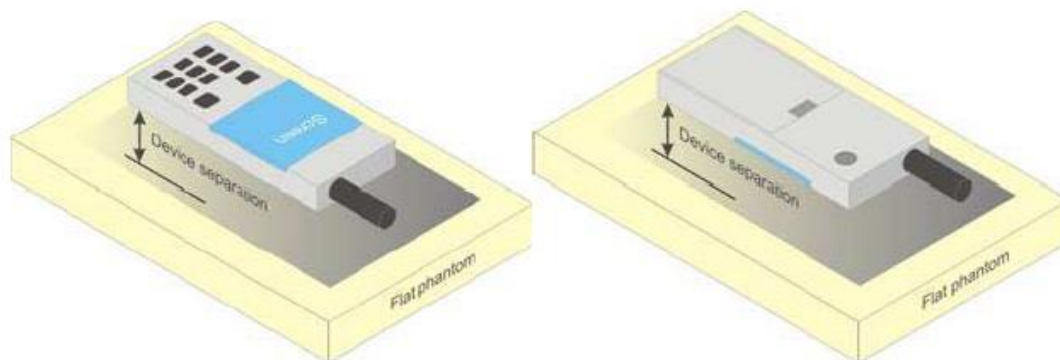




Picture D.3 Tilt position of the wireless device on the left side of SAM

## D.2 Body-worn device

A typical example of a body-worn device is a mobile phone, wireless enabled PDA or other battery operated wireless device with the ability to transmit while mounted on a person's body using a carry accessory approved by the wireless device manufacturer.

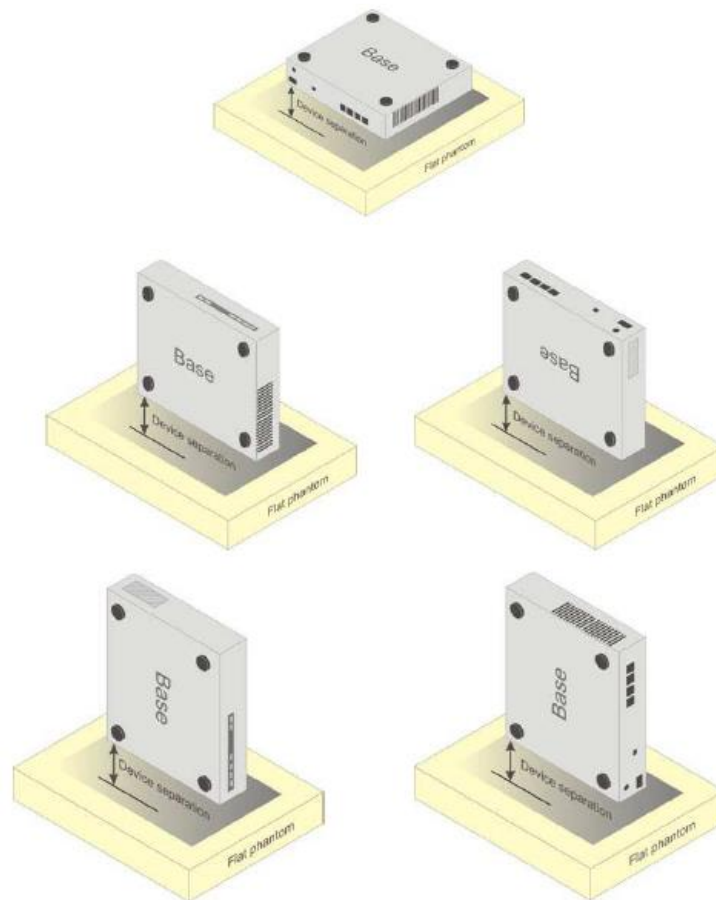


Picture D.4 Test positions for body-worn devices

## D.3 Desktop device

A typical example of a desktop device is a wireless enabled desktop computer placed on a table or desk when used.

The DUT shall be positioned at the distance and in the orientation to the phantom that corresponds to the intended use as specified by the manufacturer in the user instructions. For devices that employ an external antenna with variable positions, tests shall be performed for all antenna positions specified. Picture 8.5 show positions for desktop device SAR tests. If the intended use is not specified, the device shall be tested directly against the flat phantom.



Picture D.5 Test positions for desktop devices

#### D.4 DUT Setup Photos



Picture D.6

## ANNEX E Equivalent Media Recipes

The liquid used for the frequency range of 800-3000 MHz consisted of water, sugar, salt, preventol, glycol monobutyl and Cellulose. The liquid has been previously proven to be suited for worst-case. The Table E.1 shows the detail solution. It's satisfying the latest tissue dielectric parameters requirements proposed by the IEEE 1528 and IEC 62209.

**TableE.1: Composition of the Tissue Equivalent Matter**

Frequency (MHz)	835Head	835Body	1900 Head	1900 Body	2450 Head	2450 Body	5800 Head	5800 Body
Ingredients (% by weight)								
Water	41.45	52.5	55.242	69.91	58.79	72.60	65.53	65.53
Sugar	56.0	45.0	\	\	\	\	\	\
Salt	1.45	1.4	0.306	0.13	0.06	0.18	\	\
Preventol	0.1	0.1	\	\	\	\	\	\
Cellulose	1.0	1.0	\	\	\	\	\	\
Glycol Monobutyl	\	\	44.452	29.96	41.15	27.22	\	\
Diethylenglycol monohexylether	\	\	\	\	\	\	17.24	17.24
Triton X-100	\	\	\	\	\	\	17.24	17.24
Dielectric Parameters Target Value	$\epsilon=41.5$ $\sigma=0.90$	$\epsilon=55.2$ $\sigma=0.97$	$\epsilon=40.0$ $\sigma=1.40$	$\epsilon=53.3$ $\sigma=1.52$	$\epsilon=39.2$ $\sigma=1.80$	$\epsilon=52.7$ $\sigma=1.95$	$\epsilon=35.3$ $\sigma=5.27$	$\epsilon=48.2$ $\sigma=6.00$

**Note: There are a little adjustment respectively for 750, 1750, 2600, 5200, 5300 and 5600 based on the recipe of closest frequency in table E.1.**

## ANNEX F System Validation

The SAR system must be validated against its performance specifications before it is deployed. When SAR probes, system components or software are changed, upgraded or recalibrated, these must be validated with the SAR system(s) that operates with such components.

**Table F.1: System Validation for 3617**

Probe SN.	Liquid name	Validation date	Frequency point	Status (OK or Not)
3617	Head 750MHz	Feb.14,2019	750 MHz	OK
3617	Head 850MHz	Feb.14,2019	835 MHz	OK
3617	Head 900MHz	Feb.14,2019	900 MHz	OK
3617	Head 1750MHz	Feb.14,2019	1750 MHz	OK
3617	Head 1810MHz	Feb.14,2019	1810 MHz	OK
3617	Head 1900MHz	Feb.15,2019	1900 MHz	OK
3617	Head 2000MHz	Feb.15,2019	2000 MHz	OK
3617	Head 2100MHz	Feb.15,2019	2100 MHz	OK
3617	Head 2300MHz	Feb.15,2019	2300 MHz	OK
3617	Head 2450MHz	Feb.15,2019	2450 MHz	OK
3617	Head 2600MHz	Feb.16,2019	2600 MHz	OK
3617	Head 3500MHz	Feb.16,2019	3500 MHz	OK
3617	Head 3700MHz	Feb.16,2019	3700 MHz	OK
3617	Head 5200MHz	Feb.16,2019	5250 MHz	OK
3617	Head 5500MHz	Feb.16,2019	5600 MHz	OK
3617	Head 5800MHz	Feb.16,2019	5800 MHz	OK
3617	Body 750MHz	Feb.16,2019	750 MHz	OK
3617	Body 850MHz	Feb.13,2019	835 MHz	OK
3617	Body 900MHz	Feb.13,2019	900 MHz	OK
3617	Body 1750MHz	Feb.13,2019	1750 MHz	OK
3617	Body 1810MHz	Feb.13,2019	1810 MHz	OK
3617	Body 1900MHz	Feb.13,2019	1900 MHz	OK
3617	Body 2000MHz	Feb.17,2019	2000 MHz	OK
3617	Body 2100MHz	Feb.17,2019	2100 MHz	OK
3617	Body 2300MHz	Feb.17,2019	2300 MHz	OK
3617	Body 2450MHz	Feb.17,2019	2450 MHz	OK
3617	Body 2600MHz	Feb.17,2019	2600 MHz	OK
3617	Body 3500MHz	Feb.12,2019	3500 MHz	OK
3617	Body 3700MHz	Feb.12,2019	3700 MHz	OK
3617	Body 5200MHz	Feb.12,2019	5250 MHz	OK
3617	Body 5500MHz	Feb.12,2019	5600 MHz	OK
3617	Body 5800MHz	Feb.12,2019	5800 MHz	OK



No.I19Z61671-SEM01

# ANNEX G Probe Calibration Certificate

## Probe 3617 Calibration Certificate

**Calibration Laboratory of  
Schmid & Partner  
Engineering AG**  
Zeughausstrasse 43, 8004 Zurich, Switzerland



**S** Schweizerischer Kalibrierdienst  
**C** Service suisse d'étalonnage  
**S** Servizio svizzero di taratura  
**S** Swiss Calibration Service

Accredited by the Swiss Accreditation Service (SAS)  
The Swiss Accreditation Service is one of the signatories to the EA  
Multilateral Agreement for the recognition of calibration certificates

Accreditation No.: **SCS 0108**

Client **CTTL (Auden)**

Certificate No: **EX3-3617\_Jan19**

### CALIBRATION CERTIFICATE

Object **EX3DV4 - SN:3617**

Calibration procedure(s) **QA CAL-01.v9, QA CAL-12.v9, QA CAL-14.v5, QA CAL-23.v5,  
QA CAL-25.v7  
Calibration procedure for dosimetric E-field probes**

Calibration date: **January 31, 2019**

This calibration certificate documents the traceability to national standards, which realize the physical units of measurements (SI).  
The measurements and the uncertainties with confidence probability are given on the following pages and are part of the certificate.

All calibrations have been conducted in the closed laboratory facility: environment temperature (22 ± 3)°C and humidity < 70%.

Calibration Equipment used (M&TE critical for calibration)

Primary Standards	ID	Cal Date (Certificate No.)	Scheduled Calibration
Power meter NRP	SN: 104778	04-Apr-18 (No. 217-02672/02673)	Apr-19
Power sensor NRP-Z91	SN: 103244	04-Apr-18 (No. 217-02672)	Apr-19
Power sensor NRP-Z91	SN: 103245	04-Apr-18 (No. 217-02673)	Apr-19
Reference 20 dB Attenuator	SN: S5277 (20x)	04-Apr-18 (No. 217-02682)	Apr-19
DAE4	SN: 660	19-Dec-18 (No. DAE4-660_Dec18)	Dec-19
Reference Probe ES3DV2	SN: 3013	31-Dec-18 (No. ES3-3013_Dec18)	Dec-19
Secondary Standards	ID	Check Date (in house)	Scheduled Check
Power meter E4419B	SN: GB41293874	06-Apr-16 (in house check Jun-18)	In house check: Jun-20
Power sensor E4412A	SN: MY41498087	06-Apr-16 (in house check Jun-18)	In house check: Jun-20
Power sensor E4412A	SN: 000110210	06-Apr-16 (in house check Jun-18)	In house check: Jun-20
RF generator HP 8648C	SN: US3642U01700	04-Aug-99 (in house check Jun-18)	In house check: Jun-20
Network Analyzer E8358A	SN: US41080477	31-Mar-14 (in house check Oct-18)	In house check: Oct-19

	Name	Function	Signature
Calibrated by:	Jeton Kastrati	Laboratory Technician	
Approved by:	Katja Pokovic	Technical Manager	

Issued: February 2, 2019

This calibration certificate shall not be reproduced except in full without written approval of the laboratory.