



FCC RF Test Report

APPLICANT : HMD Global Oy
EQUIPMENT : 4G feature phone
BRAND NAME : Nokia
MODEL NAME : TA-1155
FCC ID : 2AJOTTA-1155
STANDARD : 47 CFR Part 2, 22(H), 27(M)
CLASSIFICATION : Licensed Non-Broadcast Transmitter Held to Ear (TNE)

The product was received on Oct. 31, 2019 and completely tested on Nov. 26, 2019. We, Sporton International (Kunshan) Inc., would like to declare that the tested sample has been evaluated in accordance with the procedures given in ANSI C63.26-2015 and shown compliance with the applicable technical standards.

The test results in this report apply exclusively to the tested model / sample. Without written approval of Sporton International (Kunshan) Inc., the test report shall not be reproduced except in full.

Jason Jia

Reviewed by: Jason Jia / Supervisor

James Huang

Approved by: James Huang / Manager



Sporton International (Kunshan) Inc.

**No. 1098, Pengxi North Road, Kunshan Economic Development Zone Jiangsu Province 215300
People's Republic of China**



TABLE OF CONTENTS

REVISION HISTORY 3
SUMMARY OF TEST RESULT 4
1 GENERAL DESCRIPTION 5
1.1 Applicant 5
1.2 Manufacturer 5
1.3 Product Feature of Equipment Under Test 5
1.4 Product Specification of Equipment Under Test 6
1.5 Modification of EUT 6
1.6 Maximum ERP/EIRP Power, Frequency Tolerance, and Emission Designator 7
1.7 Testing Location 8
1.8 Test Software 8
1.9 Applicable Standards 8
2 TEST CONFIGURATION OF EQUIPMENT UNDER TEST 9
2.1 Test Mode 9
2.2 Connection Diagram of Test System 11
2.3 Support Unit used in test configuration and system 11
2.4 Measurement Results Explanation Example 11
2.5 Frequency List of Low/Middle/High Channels 12
3 CONDUCTED TEST ITEMS 13
3.1 Measuring Instruments 13
3.2 Test Setup 13
3.3 Test Result of Conducted Test 13
3.4 Conducted Output Power and ERP/EIRP 14
3.5 Peak-to-Average Ratio 15
3.6 Occupied Bandwidth 16
3.7 Conducted Band Edge 17
3.8 Conducted Spurious Emission 19
3.9 Frequency Stability 20
4 RADIATED TEST ITEMS 21
4.1 Measuring Instruments 21
4.2 Test Setup 21
4.3 Test Result of Radiated Test 21
4.4 Radiated Spurious Emission 22
5 LIST OF MEASURING EQUIPMENT 23
6 UNCERTAINTY OF EVALUATION 24
APPENDIX A. TEST RESULTS OF CONDUCTED TEST
APPENDIX B. TEST RESULTS OF RADIATED TEST
APPENDIX C. TEST SETUP PHOTOGRAPHS



REVISION HISTORY

REPORT NO.	VERSION	DESCRIPTION	ISSUED DATE
FG903108B	Rev. 01	Initial issue of report	Nov. 29, 2019



SUMMARY OF TEST RESULT

Report Section	FCC Rule	Description	Limit	Result	Remark
3.4	§2.1046	Conducted Output Power	Reporting Only	PASS	-
	§22.913(a)(5)	Effective Radiated Power (Band 5)	ERP < 7 Watt	PASS	-
	§27.50(h)(2)	Equivalent Isotropic Radiated Power (Band 7) (Band 38)	EIRP < 2Watt	PASS	-
3.5	N/A	Peak-to-Average Ratio	<13 dB	PASS	-
3.6	§2.1049	Occupied Bandwidth	Reporting Only	PASS	-
3.7	§2.1051 §22.917(a)	Conducted Band Edge Measurement (Band 5)	< 43+10log ₁₀ (P[Watts])	PASS	-
	§27.53(m)(4)	Conducted Band Edge Measurement (Band 7) (Band 38)	§27.53(m)(4)		
3.8	§2.1051 §22.917(a)	Conducted Spurious Emission (Band 5)	< 43+10log ₁₀ (P[Watts])	PASS	-
	§2.1051 §27.53(m)(4)	Conducted Spurious Emission (Band 7) (Band 38)	< 55+10log ₁₀ (P[Watts])		
3.9	§2.1055 §22.355	Frequency Stability Temperature & Voltage	< 2.5 ppm for Part 22H	PASS	-
	§2.1055 §27.54		Within Authorized Band		
4.4	§2.1053 §22.917(a)	Radiated Spurious Emission (Band 5)	< 43+10log ₁₀ (P[Watts])	PASS	Under limit 18.70 dB at 7760.000 MHz
	§2.1053 §27.53(m)(4)	Radiated Spurious Emission (Band 7) (Band 38)	< 55+10log ₁₀ (P[Watts])		

Declaration of Conformity:

The test results with all measurement uncertainty excluded are presented in accordance with the regulation limits or requirements declared by manufacturers.

Comments and Explanations:

The declared of product specification for EUT presented in the report are provided by the manufacturer, and the manufacturer takes all the responsibilities for the accuracy of product specification.



1 General Description

1.1 Applicant

HMD Global Oy
Bertel Jungin aukio 9, 02600 Espoo, Finland

1.2 Manufacturer

HMD Global Oy
Bertel Jungin aukio 9, 02600 Espoo, Finland

1.3 Product Feature of Equipment Under Test

Product Feature	
Equipment	4G feature phone
Brand Name	Nokia
Model Name	TA-1155
FCC ID	2AJOTTA-1155
EUT supports Radios application	GSM / LTE Cat 1bis / FM Receiver Bluetooth BR / EDR
IMEI Code	Radiation :357686100000475 / 357686100015473 Conudcted :N/A
HW Version	HW0301
SW Version	14.01.17.05
EUT Stage	Identical Prototype



1.4 Product Specification of Equipment Under Test

Standards-related Product Specification	
Tx Frequency	LTE Band 5 : 824.7 MHz ~ 848.3 MHz LTE Band 7 : 2502.5 MHz ~ 2567.5 MHz LTE Band 38 : 2572.5MHz ~ 2617.5MHz
Rx Frequency	LTE Band 5 : 869.7 MHz ~ 893.3 MHz LTE Band 7 : 2622.5MHz ~ 2687.5 MHz LTE Band 38 : 2572.5MHz ~ 2617.5MHz
Bandwidth	LTE Band 5 : 1.4MHz / 3MHz / 5MHz / 10MHz LTE Band 7 : 5MHz/ 10MHz / 15MHz / 20MHz LTE Band 38 : 5MHz / 10MHz / 15MHz / 20MHz
Maximum Output Power to Antenna	LTE Band 5 : 23.39 dBm LTE Band 7 : 23.46 dBm LTE Band 38 : 23.82 dBm
Antenna Gain	LTE Band 5 : -2.83 dBi LTE Band 7 : -4.48 dBi LTE Band 38 : -4.33 dBi
Type of Modulation	QPSK / 16QAM

1.5 Modification of EUT

No modifications are made to the EUT during all test items.



1.6 Maximum ERP/EIRP Power, Frequency Tolerance, and Emission Designator

LTE Band 5		QPSK			16QAM		
BW (MHz)	Frequency Range (MHz)	Emission Designator (99%OBW)	Frequency Tolerance (ppm)	Maximum ERP(W)	Emission Designator (99%OBW)	Frequency Tolerance (ppm)	Maximum ERP(W)
1.4	824.7 ~ 848.3	1M10G7D	-	0.0627	1M11W7D	-	0.0538
3	825.5 ~ 847.5	2M73G7D	-	0.0665	2M72W7D	-	0.0566
5	826.5 ~ 846.5	4M49G7D	-	0.0625	4M48W7D	-	0.0568
10	829.0 ~ 844.0	9M01G7D	0.0040	0.0693	8M97W7D	-	0.0621
LTE Band 7		QPSK			16QAM		
BW (MHz)	Frequency Range (MHz)	Emission Designator (99%OBW)	Frequency Tolerance (ppm)	Maximum EIRP(W)	Emission Designator (99%OBW)	Frequency Tolerance (ppm)	Maximum EIRP(W)
5	2502.5 ~ 2567.5	4M47G7D	-	0.0731	4M48W7D	-	0.0590
10	2505.0 ~ 2565.0	9M01G7D	0.0043	0.0743	9M01W7D	-	0.0631
15	2507.5 ~ 2562.5	13M5G7D	-	0.0767	9M98W7D	-	0.0635
20	2510.0 ~ 2560.0	18M3G7D	-	0.0791	11M4W7D	-	0.0662
LTE Band 38		QPSK			16QAM		
BW (MHz)	Frequency Range (MHz)	Emission Designator (99%OBW)	Frequency Tolerance (ppm)	Maximum EIRP(W)	Emission Designator (99%OBW)	Frequency Tolerance (ppm)	Maximum EIRP(W)
5	2572.5 ~ 2617.5	4M47G7D	-	0.0824	4M50W7D	-	0.0658
10	2575.0 ~ 2615.0	9M01G7D	0.0041	0.0851	8M99W7D	-	0.0678
15	2577.5 ~ 2612.5	13M4G7D	-	0.0815	9M95W7D	-	0.0659
20	2580.0 ~ 2610.0	18M3G7D	-	0.0889	10M7W7D	-	0.0724



1.7 Testing Location

Sporton International (Kunshan) Inc. is accredited to ISO/IEC 17025:2017 by American Association for Laboratory Accreditation with Certificate Number 5145.02.

Test Firm	Sporton International (Kunshan) Inc.		
Test Site Location	No. 1098, Pengxi North Road, Kunshan Economic Development Zone Jiangsu Province 215300 People's Republic of China TEL : +86-512-57900158 FAX : +86-512-57900958		
Test Site No.	Sporton Site No.	FCC Designation No.	FCC Test Firm Registration No.
	TH01-KS 03CH04-KS	CN1257	314309

1.8 Test Software

Item	Site	Manufacture	Name	Version
1.	03CH04-KS	AUDIX	E3	6.2009-8-24a

1.9 Applicable Standards

According to the specifications of the manufacturer, the EUT must comply with the requirements of the following standards:

- ♦ 47 CFR Part 2, 22(H), 27(M)
- ♦ ANSI C63.26-2015
- ♦ FCC KDB 971168 D01 Power Meas License Digital Systems v03r01
- ♦ FCC KDB 412172 D01 Determining ERP and EIRP v01r01

Remark:

1. All test items were verified and recorded according to the standards and without any deviation during the test.
2. This EUT has also been tested and complied with the requirements of FCC Part 15, Subpart B, recorded in a separate test report.



2 Test Configuration of Equipment Under Test

2.1 Test Mode

Antenna port conducted and radiated test items listed below are performed according to KDB 971168 D01 Power Meas License Digital Systems v03r01 with maximum output power.

Radiated measurements are performed by rotating the EUT in three different orthogonal test planes to find the maximum emission.

Test Items	Band	Bandwidth (MHz)						Modulation			RB #			Test Channel		
		1.4	3	5	10	15	20	QPSK	16QAM	64QAM	1	Half	Full	L	M	H
Max. Output Power	5	v	v	v	v	-	-	v	v		v	v	v	v	v	v
	7	-	-	v	v	v	v	v	v		v	v	v	v	v	v
	38	-	-	v	v	v	v	v	v		v	v	v	v	v	v
Peak-to-Average Ratio	5				v	-	-	v	v		v		v	v	v	v
	7	-	-				v	v	v		v		v	v	v	v
	38	-	-				v	v	v		v		v	v	v	v
26dB and 99% Bandwidth	5	v	v	v	v	-	-	v	v				v	v	v	v
	7	-	-	v	v	v	v	v	v				v	v	v	v
	38	-	-	v	v	v	v	v	v				v	v	v	v
Conducted Band Edge	5	v	v	v	v	-	-	v	v		v		v	v		v
	7	-	-	v	v	v	v	v	v		v		v	v		v
	38	-	-	v	v	v	v	v	v		v		v	v		v
Conducted Spurious Emission	5	v	v	v	v	-	-	v	v		v			v	v	v
	7	-	-	v	v	v	v	v	v		v			v	v	v
	38	-	-	v	v	v	v	v	v		v			v	v	v
Frequency Stability	5				v	-	-	v					v		v	
	7	-	-		v			v					v		v	
	38	-	-		v			v					v		v	



Test Items	Band	Bandwidth (MHz)						Modulation			RB #			Test Channel		
		1.4	3	5	10	15	20	QPSK	16QAM	64QAM	1	Half	Full	L	M	H
E.R.P / E.I.R.P	5	v	v	v	v	-	-	v	v		v			v	v	v
	7	-	-	v	v	v	v	v	v		v			v	v	v
	38	-	-	v	v	v	v	v	v		v			v	v	v
Radiated Spurious Emission	5	Worst Case												v		
	7	Worst Case												v		
	38	Worst Case												v		
Note	1. The mark "v" means that this configuration is chosen for testing 2. The mark "-" means that this bandwidth is not supported. 3. The device is investigated from 30MHz to 10 times of fundamental signal for radiated spurious emission test under different RB size/offset and modulations in exploratory test. Subsequently, only the worst case emissions are reported.															

2.2 Connection Diagram of Test System

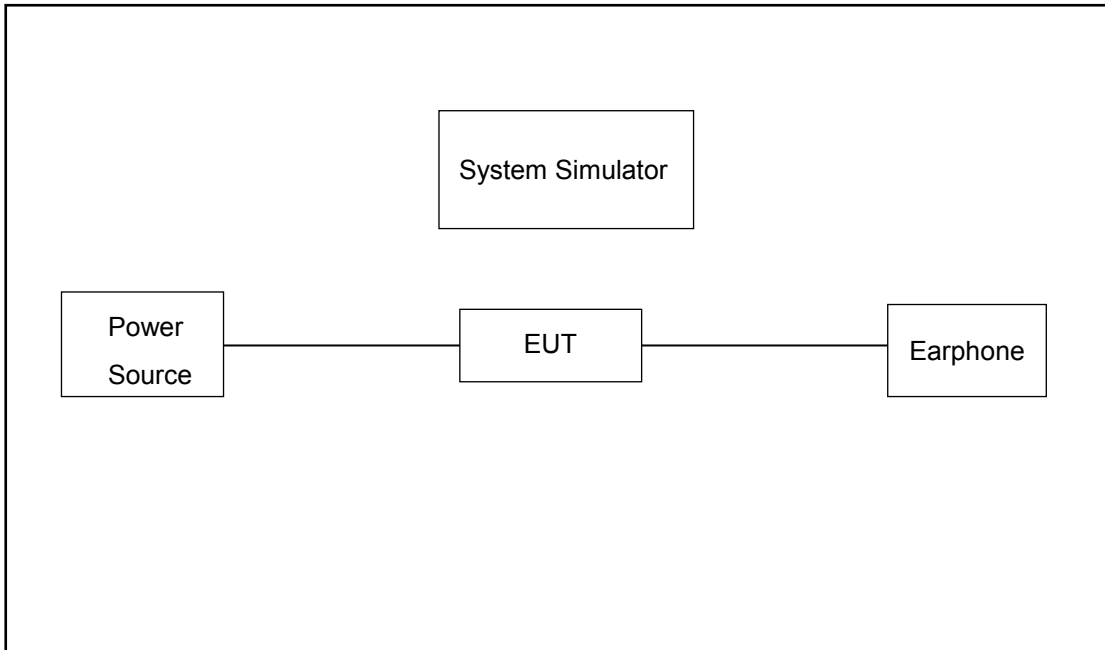

2.3 Support Unit used in test configuration and system

Item	Equipment	Trade Name	Model No.	FCC ID	Data Cable	Power Cord
1.	System Simulator	Anritsu	MT8820C	N/A	N/A	Unshielded, 1.8 m
2.	DC Power Supply	GW INSTEK	GPS-3030D	N/A	N/A	Unshielded, 1.8 m

2.4 Measurement Results Explanation Example

For all conducted test items:

The offset level is set in the spectrum analyzer to compensate the RF cable loss between EUT conducted output port and spectrum analyzer. With the offset compensation, the spectrum analyzer reading level is exactly the EUT RF output level.

The spectrum analyzer offset is derived from RF cable loss.

Offset = RF cable loss.

Following shows an offset computation example with cable loss 4.6 dB.

Example :

$$\begin{aligned}
 \text{Offset(dB)} &= \text{RF cable loss(dB)}. \\
 &= 4.6 \text{ (dB)}
 \end{aligned}$$



2.5 Frequency List of Low/Middle/High Channels

LTE Band 5 Channel and Frequency List				
BW [MHz]	Channel/Frequency(MHz)	Lowest	Middle	Highest
10	Channel	20450	20525	20600
	Frequency	829	836.5	844
5	Channel	20425	20525	20625
	Frequency	826.5	836.5	846.5
3	Channel	20415	20525	20635
	Frequency	825.5	836.5	847.5
1.4	Channel	20407	20525	20643
	Frequency	824.7	836.5	848.3

LTE Band 7 Channel and Frequency List				
BW [MHz]	Channel/Frequency(MHz)	Lowest	Middle	Highest
20	Channel	20850	21100	21350
	Frequency	2510	2535	2560
15	Channel	20825	21100	21375
	Frequency	2507.5	2535	2562.5
10	Channel	20800	21100	21400
	Frequency	2505	2535	2565
5	Channel	20775	21100	21425
	Frequency	2502.5	2535	2567.5

LTE Band 38 Channel and Frequency List				
BW [MHz]	Channel/Frequency(MHz)	Lowest	Middle	Highest
20	Channel	37850	38000	38150
	Frequency	2580	2595	2610
15	Channel	37825	38000	38175
	Frequency	2577.5	2595	2612.5
10	Channel	37800	38000	38200
	Frequency	2575	2595	2615
5	Channel	37775	38000	38225
	Frequency	2572.5	2595	2617.5

3 Conducted Test Items

3.1 Measuring Instruments

See list of measuring instruments of this test report.

3.2 Test Setup

3.2.1 Conducted Output Power

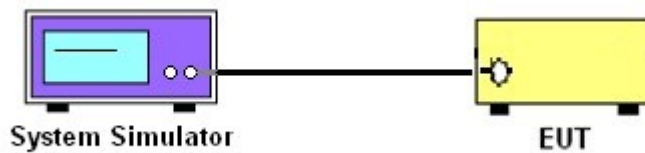

3.2.2 Peak-to-Average Ratio, Occupied Bandwidth ,Conducted Band-Edge and Conducted Spurious Emission



3.2.3 Frequency Stability

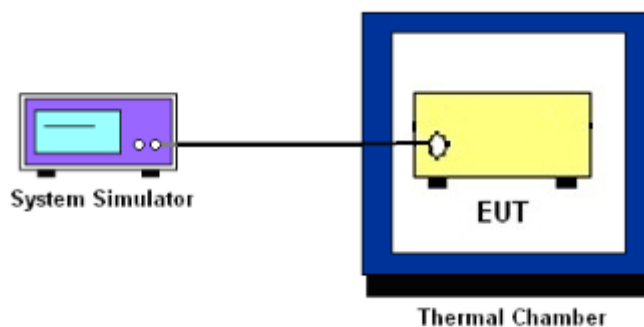

3.3 Test Result of Conducted Test

Please refer to Appendix A.



3.4 Conducted Output Power and ERP/EIRP

3.4.1 Description of the Conducted Output Power Measurement and ERP/EIRP Measurement

A system simulator was used to establish communication with the EUT. Its parameters were set to force the EUT transmitting at maximum output power. The measured power in the radio frequency on the transmitter output terminals shall be reported.

The ERP of mobile transmitters must not exceed 7 Watts for LTE Band 5.

The EIRP of mobile transmitters must not exceed 2 Watts for LTE Band 7 and Band 38.

According to KDB 412172 D01 Power Approach,

$EIRP = P_T + G_T - L_C$, $ERP = EIRP - 2.15$, where

P_T = transmitter output power in dBm

G_T = gain of the transmitting antenna in dBi

L_C = signal attenuation in the connecting cable between the transmitter and antenna in dB

3.4.2 Test Procedures

1. The testing follows ANSI C63.26 Section 5.2
2. The transmitter output port was connected to the system simulator.
3. Set EUT at maximum power through the system simulator.
4. Select lowest, middle, and highest channels for each band and different modulation.
5. Measure and record the power level from the system simulator.



3.5 Peak-to-Average Ratio

3.5.1 Description of the PAR Measurement

Power Complementary Cumulative Distribution Function (CCDF) curves provide a means for characterizing the power peaks of a digitally modulated signal on a statistical basis. A CCDF curve depicts the probability of the peak signal amplitude exceeding the average power level. Most contemporary measurement instrumentation include the capability to produce CCDF curves for an input signal provided that the instrument's resolution bandwidth can be set wide enough to accommodate the entire input signal bandwidth. In measuring transmissions in this band using an average power technique, the peak-to-average ratio (PAR) of the transmission may not exceed 13 dB.

3.5.2 Test Procedures

1. The testing follows ANSI C63.26 Section 5.2.3.4 (CCDF).
2. The EUT was connected to spectrum and system simulator via a power divider.
3. Set the CCDF (Complementary Cumulative Distribution Function) option in spectrum analyzer.
4. The highest RF powers were measured and recorded the maximum PAPR level associated with a probability of 0.1 %.
5. Record the deviation as Peak to Average Ratio.



3.6 Occupied Bandwidth

3.6.1 Description of Occupied Bandwidth Measurement

The occupied bandwidth is the width of a frequency band such that, below the lower and above the upper frequency limits, the mean powers emitted are each equal to a specified percentage 0.5% of the total mean transmitted power.

The 26 dB emission bandwidth is defined as the frequency range between two points, one above and one below the carrier frequency, at which the spectral density of the emission is attenuated 26 dB below the maximum in-band spectral density of the modulated signal. Spectral density (power per unit bandwidth) is to be measured with a detector of resolution bandwidth equal to approximately 1.0% of the emission bandwidth.

3.6.2 Test Procedures

1. The testing follows ANSI C63.26 Section 5.4
2. The EUT was connected to spectrum analyzer and system simulator via a power divider.
3. The spectrum analyzer center frequency is set to the nominal EUT channel center frequency. The span range for the spectrum analyzer shall be between two and five times the anticipated OBW.
4. The nominal resolution bandwidth (RBW) shall be in the range of 1 to 5 % of the anticipated OBW, and the VBW shall be at least 3 times the RBW.
5. Set the detection mode to peak, and the trace mode to max hold.
6. Determine the reference value: Set the EUT to transmit a modulated signal. Allow the trace to stabilize. Set the spectrum analyzer marker to the highest level of the displayed trace.
(this is the reference value)
7. Determine the “-26 dB down amplitude” as equal to (Reference Value – X).
8. Place two markers, one at the lowest and the other at the highest frequency of the envelope of the spectral display such that each marker is at or slightly below the “-X dB down amplitude” determined in step 6. If a marker is below this “-X dB down amplitude” value it shall be placed as close as possible to this value. The OBW is the positive frequency difference between the two markers.
9. Use the 99 % power bandwidth function of the spectrum analyzer and report the measured bandwidth.



3.7 Conducted Band Edge

3.7.1 Description of Conducted Band Edge Measurement

22.917(a)

For operations in the 824 – 849 MHz band, the FCC limit is $43 + 10\log_{10}(P[\text{Watts}])$ dB below the transmitter power $P(\text{Watts})$ in a 100kHz bandwidth. However, in the 1MHz bands immediately outside and adjacent to the licensee's frequency block, a resolution bandwidth of at least one percent of the emission bandwidth of the fundamental emission of the transmitter may be employed.

27.53(m)(4)

For mobile digital stations, the attenuation factor shall be not less than $40 + 10 \log (P)$ dB on all frequencies between the channel edge and 5 megahertz from the channel edge, $43 + 10 \log (P)$ dB on all frequencies between 5 megahertz and X megahertz from the channel edge, and $55 + 10 \log (P)$ dB on all frequencies more than X megahertz from the channel edge, where X is the greater of 6 megahertz or the actual emission bandwidth as defined in paragraph (m)(6) of this section. In addition, the attenuation factor shall not be less that $43 + 10 \log (P)$ dB on all frequencies between 2490.5 MHz and 2496 MHz and $55 + 10 \log (P)$ dB at or below 2490.5 MHz. Mobile Satellite Service licensees operating on frequencies below 2495 MHz may also submit a documented interference complaint against BRS licensees operating on channel BRS Channel 1 on the same terms and conditions as adjacent channel BRS or EBS licensees.



3.7.2 Test Procedures

1. The testing follows ANSI C63.26 section 5.7
2. The EUT was connected to spectrum analyzer and system simulator via a power divider.
3. The band edges of low and high channels for the highest RF powers were measured.
4. Set RBW \geq 1% EBW in the 1MHz band immediately outside and adjacent to the band edge.
5. Beyond the 1 MHz band from the band edge, RBW=1MHz was used.
6. Set spectrum analyzer with RMS detector.
7. The RF fundamental frequency should be excluded against the limit line in the operating frequency band.
8. Checked that all the results comply with the emission limit line.

Example:

The limit line is derived from $43 + 10\log(P)$ dB below the transmitter power P(Watts)

$$= P(W) - [43 + 10\log(P)] \text{ (dB)}$$

$$= [30 + 10\log(P)] \text{ (dBm)} - [43 + 10\log(P)] \text{ (dB)} = -13\text{dBm}.$$

9. For LTE Band 7, 38, the other 40 dB, and 55 dB have additionally applied same calculation above.



3.8 Conducted Spurious Emission

3.8.1 Description of Conducted Spurious Emission Measurement

The power of any emission outside of the authorized operating frequency ranges must be lower than the transmitter power (P) by a factor of at least $43 + 10 \log (P)$ dB.

For Band 7,38:

The power of any emission outside of the authorized operating frequency ranges must be lower than the transmitter power (P) by a factor of at least $55 + 10 \log (P)$ dB.

It is measured by means of a calibrated spectrum analyzer and scanned from 30 MHz up to a frequency including its 10th harmonic.

3.8.2 Test Procedures

1. The testing follows ANSI C63.26 section 5.7
2. The EUT was connected to spectrum analyzer and system simulator via a power divider.
3. The RF output of EUT was connected to the spectrum analyzer by RF cable and attenuator. The path loss was compensated to the results for each measurement.
4. The middle channel for the highest RF power within the transmitting frequency was measured.
5. The conducted spurious emission for the whole frequency range was taken.
6. Make the measurement with the spectrum analyzer's RBW = 1MHz, VBW = 3MHz.
7. Set spectrum analyzer with RMS detector.
8. Taking the record of maximum spurious emission.
9. The RF fundamental frequency should be excluded against the limit line in the operating frequency band.
10. The limit line is derived from $43 + 10\log(P)$ dB below the transmitter power P(Watts)
 $= P(W) - [43 + 10\log(P)]$ (dB)
 $= [30 + 10\log(P)]$ (dBm) - $[43 + 10\log(P)]$ (dB)
 $= -13$ dBm.
11. For Band 7, 38
The limit line is derived from $55 + 10\log(P)$ dB below the transmitter power P(Watts)
 $= P(W) - [55 + 10\log(P)]$ (dB)
 $= [30 + 10\log(P)]$ (dBm) - $[55 + 10\log(P)]$ (dB)
 $= -25$ dBm.



3.9 Frequency Stability

3.9.1 Description of Frequency Stability Measurement

The frequency stability shall be measured by variation of ambient temperature and variation of primary supply voltage to ensure that the fundamental emission stays within the authorized frequency block. The frequency stability of the transmitter shall be maintained within $\pm 0.00025\%$ ($\pm 2.5\text{ppm}$) of the center frequency.

3.9.2 Test Procedures for Temperature Variation

1. The testing follows ANSI C63.26 section 5.6.4
2. The EUT was set up in the thermal chamber and connected with the system simulator.
3. With power OFF, the temperature was decreased to -30°C and the EUT was stabilized before testing. Power was applied and the maximum change in frequency was recorded within one minute.
4. With power OFF, the temperature was raised in 10°C step up to 50°C . The EUT was stabilized at each step for at least half an hour. Power was applied and the maximum frequency change was recorded within one minute.

3.9.3 Test Procedures for Voltage Variation

1. The testing follows ANSI C63.26 section 5.6.5
2. The EUT was placed in a temperature chamber at $20\pm 5^{\circ}\text{C}$ and connected with the system simulator.
3. The power supply voltage to the EUT was varied from 85% to 115% of the nominal value for other than hand carried battery equipment.
4. For hand carried, battery powered equipment, reduce the primary ac or dc supply voltage to the battery operating end point, which shall be specified by the manufacturer.
5. The variation in frequency was measured for the worst case.

4 Radiated Test Items

4.1 Measuring Instruments

See list of measuring instruments of this test report.

4.2 Test Setup

4.2.1 For radiated test from 30MHz to 1GHz

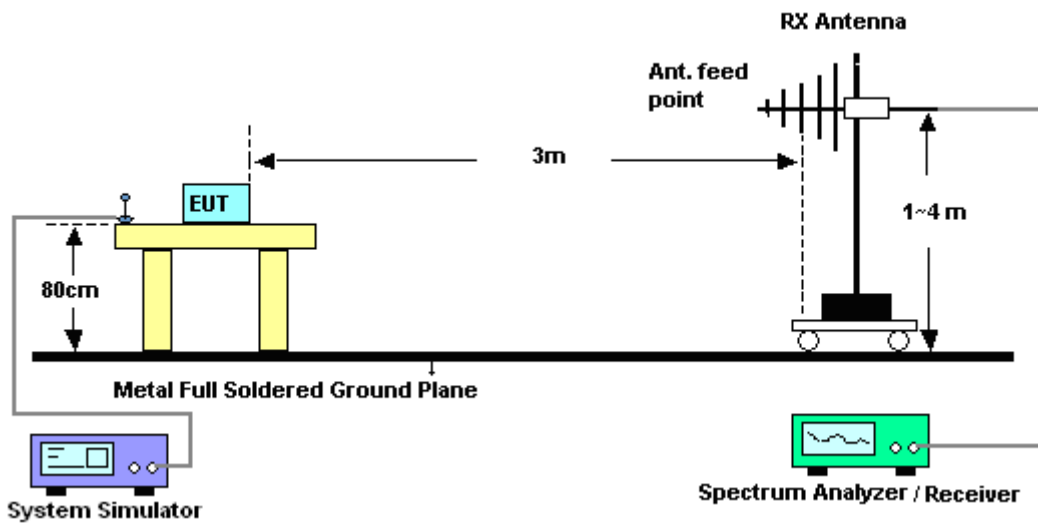

4.2.2 For radiated test above 1GHz

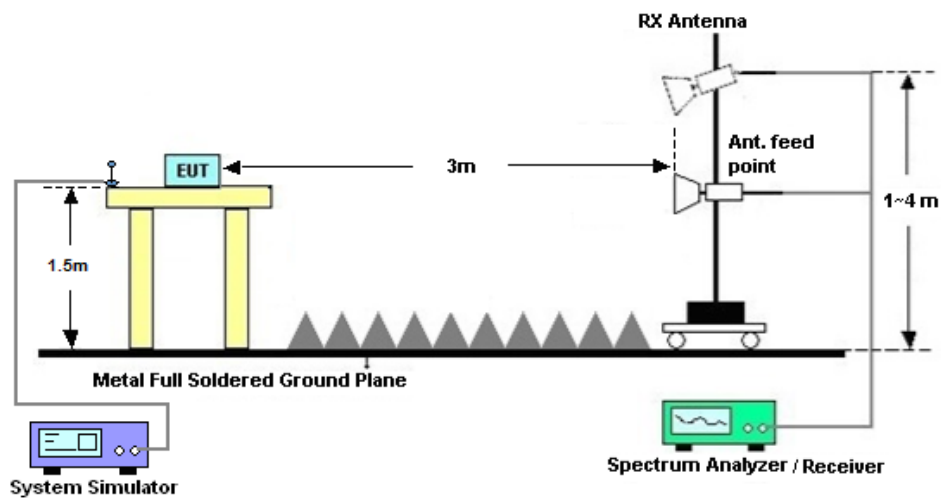

4.3 Test Result of Radiated Test

Please refer to Appendix B.



4.4 Radiated Spurious Emission

4.4.1 Description of Radiated Spurious Emission

The radiated spurious emission was measured by substitution method according to ANSI C63.26. The power of any emission outside of the authorized operating frequency ranges must be attenuated below the transmitter power (P) by a factor of at least $43 + 10 \log (P)$ dB.

For Band 7, 38

The power of any emission outside of the authorized operating frequency ranges must be attenuated below the transmitter power (P) by a factor of at least $55 + 10 \log (P)$ dB.

The spectrum is scanned from 30 MHz up to a frequency including its 10th harmonic.

4.4.2 Test Procedures

1. The testing follows ANSI C63.26 Section 5.5
2. The EUT was placed on a turntable with 0.8 meter height for frequency below 1GHz and 1.5 meter height for frequency above 1GHz respectively above ground.
3. The EUT was set 3 meters from the receiving antenna mounted on the antenna tower.
4. The table was rotated 360 degrees to determine the position of the highest spurious emission.
5. The height of the receiving antenna is varied between 1m to 4m to search the maximum spurious emission for both horizontal and vertical polarizations.
6. During the measurement, the system simulator parameters were set to force the EUT transmitting at maximum output power.
7. Make the measurement with the spectrum analyzer's RBW = 1MHz, VBW = 3MHz, taking the record of maximum spurious emission.
8. A horn antenna was substituted in place of the EUT and was driven by a signal generator.
9. Tune the output power of signal generator to the same emission level with EUT maximum spurious emission.
10. $EIRP (dBm) = S.G. Power - Tx Cable Loss + Tx Antenna Gain$
11. $ERP (dBm) = EIRP - 2.15$
12. The RF fundamental frequency should be excluded against the limit line in the operating frequency band.

The limit line is derived from $43 + 10\log(P)$ dB below the transmitter power P(Watts)
 $= P(W) - [43 + 10\log(P)] (dB)$
 $= [30 + 10\log(P)] (dBm) - [43 + 10\log(P)] (dB)$
 $= -13dBm.$

13. For Band 7, 38:

The limit line is derived from $55 + 10\log(P)$ dB below the transmitter power P(Watts)



5 List of Measuring Equipment

Instrument	Manufacturer	Model No.	Serial No.	Characteristics	Calibration Date	Test Date	Due Date	Remark
Spectrum Analyzer	R&S	FSV40	101040	10Hz~40GHz	Aug. 07, 2019	Nov. 13, 2019~ Nov. 26, 2019	Aug. 06, 2020	Conducted (TH01-KS)
Temperature & humidity chamber	Hongzhan	LP-150U	H2014011440	-40~+150°C 20%~95%RH	Jul. 04, 2019	Nov. 13, 2019~ Nov. 26, 2019	Jul. 03, 2020	Conducted (TH01-KS)
EXA Spectrum Analyzer	Keysight	N9010A	MY55150244	10Hz-44G,MAX 30dB	Apr. 16, 2019	Nov. 16, 2019	Apr. 15, 2020	Radiation (03CH04-KS)
Bilog Antenna	TeseQ	CBL6111D	44483	30MHz-1GHz	Dec. 28, 2018	Nov. 16, 2019	Dec. 27, 2019	Radiation (03CH04-KS)
Horn Antenna	Schwarzbeck	BBHA9120D	1648	1GHz~18GHz	Jan. 27, 2019	Nov. 16, 2019	Jan. 26, 2020	Radiation (03CH04-KS)
SHF-EHF Horn	Com-power	AH-840	101070	18GHz~40GHz	Jan. 05, 2019	Nov. 16, 2019	Jan. 04, 2020	Radiation (03CH04-KS)
Amplifier	SONOMA	310N	187289	9KHz-1GHz	Aug. 06, 2019	Nov. 16, 2019	Aug. 05, 2020	Radiation (03CH04-KS)
Amplifier	MITEQ	TTA1840-35 -HG	2014749	18~40GHz	Jan. 14, 2019	Nov. 16, 2019	Jan. 13, 2020	Radiation (03CH04-KS)
high gain Amplifier	MITEQ	AMF-7D-00 101800-30-1 0P	2025788	1Ghz-18Ghz	Aug. 16, 2019	Nov. 16, 2019	Aug. 15, 2020	Radiation (03CH04-KS)
Amplifier	Keysight	83017A	MY57280106	500MHz~26.5GHz	Apr. 15, 2019	Nov. 16, 2019	Apr. 14, 2020	Radiation (03CH04-KS)
AC Power Source	Chroma	61601	F104090004	N/A	NCR	Nov. 16, 2019	NCR	Radiation (03CH04-KS)
Turn Table	ChamPro	EM 1000-T	060762-T	0~360 degree	NCR	Nov. 16, 2019	NCR	Radiation (03CH04-KS)
Antenna Mast	ChamPro	EM 1000-A	060762-A	1 m~4 m	NCR	Nov. 16, 2019	NCR	Radiation (03CH04-KS)

NCR: No Calibration Required



6 Uncertainty of Evaluation

The measurement uncertainties shown below were calculated in accordance with the requirements of ANSI 63.26-2015. All the measurement uncertainty value were shown with a coverage K=2 to indicate 95% level of confidence. The measurement data show herein meets or exceeds the CISPR measurement uncertainty values specified in CISPR 16-4-2 and can be compared directly to specified limit to determine compliance.

Uncertainty of Radiated Emission Measurement (30 MHz ~ 1000 MHz)

Measuring Uncertainty for a Level of Confidence of 95% (U = 2Uc(y))	3.3dB
---	-------

Uncertainty of Radiated Emission Measurement (1 GHz ~ 18 GHz)

Measuring Uncertainty for a Level of Confidence of 95% (U = 2Uc(y))	2.8dB
---	-------

Uncertainty of Radiated Emission Measurement (18 GHz ~ 40 GHz)

Measuring Uncertainty for a Level of Confidence of 95% (U = 2Uc(y))	2.8dB
---	-------



Appendix A. Test Results of Conducted Test

Conducted Output Power(Average power)

LTE Band 5 Maximum Average Power [dBm]						
BW [MHz]	RB Size	RB Offset	Mod	Lowest	Middle	Highest
10	1	0	QPSK	23.33	22.95	22.90
10	1	25		22.57	22.90	22.97
10	1	49		22.48	23.39	22.29
10	25	0		22.57	22.57	22.86
10	25	12		22.34	22.78	22.71
10	25	25		22.43	23.20	22.84
10	50	0		21.70	22.01	21.84
10	1	0	16-QAM	22.65	22.19	22.31
10	1	25		21.92	22.25	22.21
10	1	49		21.89	23.01	21.81
10	25	0		21.64	21.66	21.85
10	25	12		21.41	21.77	21.74
10	25	25		21.49	22.21	21.88
10	50	0		20.78	21.02	20.98
5	1	0	QPSK	22.78	22.46	22.64
5	1	12		22.45	22.54	22.47
5	1	24		22.26	22.94	22.14
5	12	0		22.62	22.54	22.63
5	12	7		22.45	22.58	22.47
5	12	13		22.43	22.82	22.65
5	25	0		21.60	21.69	21.60
5	1	0	16-QAM	22.12	21.76	22.14
5	1	12		21.84	21.91	21.83
5	1	24		21.63	22.52	21.79
5	12	0		21.72	21.59	21.73
5	12	7		21.53	21.64	21.56
5	12	13		21.51	21.89	21.75
5	25	0		20.67	20.76	20.68



LTE Band 5 Maximum Average Power [dBm]						
BW [MHz]	RB Size	RB Offset	Mod	Lowest	Middle	Highest
3	1	0	QPSK	23.12	22.75	22.67
3	1	8		23.06	23.21	22.81
3	1	14		22.45	22.16	21.92
3	8	0		22.77	22.50	22.71
3	8	4		22.83	22.62	22.46
3	8	7		22.83	23.18	22.72
3	15	0		21.74	21.75	21.47
3	1	0	16-QAM	22.43	22.15	22.08
3	1	8		22.39	22.51	22.13
3	1	14		21.81	22.19	21.55
3	8	0		21.92	22.02	21.93
3	8	4		21.95	21.91	21.66
3	8	7		21.97	22.28	21.95
3	15	0		20.84	20.84	20.67
1.4	1	0	QPSK	22.82	22.63	22.27
1.4	1	3		22.95	22.82	22.27
1.4	1	5		22.69	22.58	21.96
1.4	3	0		22.86	22.56	22.26
1.4	3	1		22.83	22.68	22.31
1.4	3	3		22.81	22.70	22.23
1.4	6	0		21.82	21.58	21.16
1.4	1	0	16-QAM	22.16	21.91	21.59
1.4	1	3		22.29	22.16	21.62
1.4	1	5		22.03	21.89	21.29
1.4	3	0		21.95	21.59	21.36
1.4	3	1		21.92	21.72	21.42
1.4	3	3		21.91	21.77	21.35
1.4	6	0		20.95	20.70	20.32



LTE Band 7 Maximum Average Power [dBm]						
BW [MHz]	RB Size	RB Offset	Mod	Lowest	Middle	Highest
20	1	0	QPSK	23.46	23.27	23.25
20	1	49		23.20	23.12	23.26
20	1	99		23.00	23.03	23.05
20	50	0		23.10	23.04	23.00
20	50	24		23.11	23.08	23.02
20	50	50		23.44	23.35	23.40
20	100	0		22.20	22.03	22.01
20	1	0	16-QAM	22.62	22.54	22.54
20	1	49		22.47	22.49	22.55
20	1	99		22.68	22.18	22.48
20	50	0		22.46	22.24	22.30
20	50	24		22.20	22.22	22.25
20	50	50		22.24	22.42	22.49
20	54	0		21.11	21.30	21.50
15	1	0	QPSK	22.78	23.01	22.96
15	1	37		22.93	22.92	23.07
15	1	74		23.04	23.04	23.22
15	36	0		23.09	23.02	22.99
15	36	20		23.08	23.05	23.10
15	36	39		23.19	23.28	23.33
15	75	0		22.19	22.08	22.19
15	1	0	16-QAM	22.02	22.24	22.21
15	1	37		22.21	22.22	22.36
15	1	74		22.34	22.40	22.51
15	36	0		22.14	22.09	22.06
15	36	20		22.13	22.13	22.27
15	36	39		22.29	22.40	22.46
15	54	0		21.30	21.25	21.36



LTE Band 7 Maximum Average Power [dBm]						
BW [MHz]	RB Size	RB Offset	Mod	Lowest	Middle	Highest
10	1	0	QPSK	22.86	23.04	22.98
10	1	25		22.77	22.98	22.99
10	1	49		22.92	23.06	23.05
10	25	0		22.84	22.92	22.82
10	25	12		22.81	22.95	22.97
10	25	25		22.95	23.17	23.19
10	50	0		21.87	22.06	22.13
10	1	0	16-QAM	22.15	22.36	22.35
10	1	25		22.10	22.33	22.35
10	1	49		22.30	22.47	22.48
10	25	0		21.83	22.00	21.90
10	25	12		21.79	22.02	22.09
10	25	25		22.03	22.27	22.24
10	50	0		20.93	21.16	21.24
5	1	0	QPSK	22.59	22.82	22.88
5	1	12		22.61	22.71	22.64
5	1	24		22.71	22.81	22.84
5	12	0		22.68	22.76	22.86
5	12	7		22.75	22.86	22.76
5	12	13		22.71	22.80	23.12
5	25	0		21.83	21.87	21.85
5	1	0	16-QAM	21.91	22.11	22.14
5	1	12		21.94	22.06	21.95
5	1	24		22.06	22.15	22.19
5	12	0		21.73	21.81	21.96
5	12	7		22.14	21.91	21.87
5	12	13		21.87	21.85	22.17
5	25	0		20.89	20.91	20.94



LTE Band 38 Maximum Average Power [dBm]						
BW [MHz]	RB Size	RB Offset	Mod	Lowest	Middle	Highest
20	1	0	QPSK	23.82	23.61	23.52
20	1	49		23.52	23.32	23.35
20	1	99		23.76	23.75	23.69
20	50	0		23.27	23.20	22.98
20	50	24		23.25	23.15	23.05
20	50	50		23.47	23.46	23.40
20	100	0		22.24	22.10	22.11
20	1	0	16-QAM	22.91	22.72	22.65
20	1	49		22.63	22.44	22.50
20	1	99		22.88	22.93	22.88
20	50	0		22.33	22.18	22.02
20	50	24		22.32	22.14	22.07
20	50	50		22.50	22.49	22.45
20	54	0		21.50	21.41	21.62
15	1	0	QPSK	23.44	23.26	23.26
15	1	37		23.26	23.19	23.24
15	1	74		23.35	23.25	23.43
15	36	0		23.14	23.16	23.25
15	36	20		23.17	23.17	23.19
15	36	39		23.12	23.08	23.31
15	75	0		22.41	22.31	22.36
15	1	0	16-QAM	22.52	22.44	22.34
15	1	37		22.37	22.30	22.34
15	1	74		22.46	22.39	22.51
15	36	0		22.12	22.19	22.14
15	36	20		22.15	22.22	22.11
15	36	39		22.15	22.14	22.47
15	54	0		21.30	21.22	21.37



LTE Band 38 Maximum Average Power [dBm]						
BW [MHz]	RB Size	RB Offset	Mod	Lowest	Middle	Highest
10	1	0	QPSK	23.63	23.49	23.43
10	1	25		23.33	23.25	23.29
10	1	49		23.42	23.43	23.50
10	25	0		23.21	23.19	23.22
10	25	12		23.18	23.17	23.16
10	25	25		23.23	23.10	23.14
10	50	0		22.37	22.20	22.30
10	1	0	16-QAM	22.64	22.60	22.54
10	1	25		22.43	22.41	22.37
10	1	49		22.53	22.61	22.58
10	25	0		22.23	22.29	22.19
10	25	12		22.22	22.27	22.15
10	25	25		22.29	22.21	22.14
10	50	0		21.41	21.34	21.32
5	1	0	QPSK	23.49	23.17	23.33
5	1	12		23.23	23.00	23.23
5	1	24		23.36	23.00	23.44
5	12	0		23.25	23.34	23.27
5	12	7		23.36	23.25	23.21
5	12	13		23.39	23.15	23.33
5	25	0		22.35	22.18	22.27
5	1	0	16-QAM	22.51	22.29	22.45
5	1	12		22.34	22.10	22.24
5	1	24		22.50	22.45	22.50
5	12	0		22.24	22.25	22.26
5	12	7		22.35	22.22	22.23
5	12	13		22.37	22.11	22.38
5	25	0		21.39	21.25	21.39



ERP/EIRP

LTE Band 5 (GT - LC = -2.83 dB) QPSK									
Bandwidth	1.4M			3M			5M		
Channel	20407	20525	20643	20415	20525	20635	20425	20525	20625
	(Low)	(Mid)	(High)	(Low)	(Mid)	(High)	(Low)	(Mid)	(High)
Frequency	824.7	836.5	848.3	825.5	836.5	847.5	826.5	836.5	846.5
(MHz)									
Conducted Power (dBm)	22.95	22.82	22.27	23.06	23.21	22.81	22.26	22.94	22.14
Conducted Power (Watts)	0.1972	0.1914	0.1687	0.2023	0.2094	0.1910	0.1683	0.1968	0.1637
ERP(dBm)	17.97	17.84	17.29	18.08	18.23	17.83	17.28	17.96	17.16
ERP(Watts)	0.0627	0.0608	0.0536	0.0643	0.0665	0.0607	0.0535	0.0625	0.0520

LTE Band 5 (GT - LC = -2.83 dB) QPSK			
Bandwidth	10M		
Channel	20450	20525	20600
	(Low)	(Mid)	(High)
Frequency	829	836.5	844
(MHz)			
Conducted Power (dBm)	22.48	23.39	22.29
Conducted Power (Watts)	0.1770	0.2183	0.1694
ERP(dBm)	17.50	18.41	17.31
ERP(Watts)	0.0562	0.0693	0.0538



LTE Band 5 (GT - LC = -2.83 dB) 16QAM									
Bandwidth	1.4M			3M			5M		
Channel	20407	20525	20643	20415	20525	20635	20425	20525	20625
	(Low)	(Mid)	(High)	(Low)	(Mid)	(High)	(Low)	(Mid)	(High)
Frequency (MHz)	824.7	836.5	848.3	825.5	836.5	847.5	826.5	836.5	846.5
Conducted Power (dBm)	22.29	22.16	21.62	22.39	22.51	22.13	21.63	22.52	21.79
Conducted Power (Watts)	0.1694	0.1644	0.1452	0.1734	0.1782	0.1633	0.1455	0.1786	0.1510
ERP(dBm)	17.31	17.18	16.64	17.41	17.53	17.15	16.65	17.54	16.81
ERP(Watts)	0.0538	0.0522	0.0461	0.0551	0.0566	0.0519	0.0462	0.0568	0.0480

LTE Band 5 (GT - LC = -2.83 dB) 16QAM			
Bandwidth	10M		
Channel	20450	20525	20600
	(Low)	(Mid)	(High)
Frequency (MHz)	829	836.5	844
Conducted Power (dBm)	21.89	22.91	21.81
Conducted Power (Watts)	0.1545	0.1954	0.1517
ERP(dBm)	16.91	17.93	16.83
ERP(Watts)	0.0491	0.0621	0.0482



LTE Band 7 (GT - LC = -4.48 dB) QPSK			
Bandwidth	5M		
Channel	20775	21100	21425
	(Low)	(Mid)	(High)
Frequency	2502.5	2535	2567.5
(MHz)			
Conducted Power (dBm)	22.71	22.80	23.12
Conducted Power (Watts)	0.1866	0.1905	0.2051
EIRP(dBm)	18.23	18.32	18.64
EIRP(Watts)	0.0665	0.0679	0.0731

LTE Band 7 (GT - LC = -4.48 dB) QPSK									
Bandwidth	10M			15M			20M		
Channel	20800	21100	21400	20825	21100	21375	20850	21100	21350
	(Low)	(Mid)	(High)	(Low)	(Mid)	(High)	(Low)	(Mid)	(High)
Frequency	2505	2535	2565	2507.5	2535	2562.5	2510	2535	2560
(MHz)									
Conducted Power (dBm)	22.95	23.17	23.19	23.19	23.28	23.33	23.46	23.27	23.25
Conducted Power (Watts)	0.1972	0.2075	0.2084	0.2084	0.2128	0.2153	0.2218	0.2123	0.2113
EIRP(dBm)	18.47	18.69	18.71	18.71	18.80	18.85	18.98	18.79	18.77
EIRP(Watts)	0.0703	0.0740	0.0743	0.0743	0.0759	0.0767	0.0791	0.0757	0.0753



LTE Band 7 (GT - LC = -4.48 dB) 16QAM			
Bandwidth	5M		
Channel	20775	21100	21425
	(Low)	(Mid)	(High)
Frequency	2502.5	2535	2567.5
(MHz)			
Conducted Power (dBm)	22.06	22.15	22.19
Conducted Power (Watts)	0.1607	0.1641	0.1656
EIRP(dBm)	17.58	17.67	17.71
EIRP(Watts)	0.0573	0.0585	0.0590

LTE Band 7 (GT - LC = -4.48 dB) 16QAM									
Bandwidth	10M			15M			20M		
Channel	20800	21100	21400	20825	21100	21375	20850	21100	21350
	(Low)	(Mid)	(High)	(Low)	(Mid)	(High)	(Low)	(Mid)	(High)
Frequency	2505	2535	2565	2507.5	2535	2562.5	2510	2535	2560
(MHz)									
Conducted Power (dBm)	22.30	22.47	22.48	22.34	22.40	22.51	22.24	22.62	22.69
Conducted Power (Watts)	0.1698	0.1766	0.1770	0.1714	0.1738	0.1782	0.1675	0.1828	0.1858
EIRP(dBm)	17.82	17.99	18.00	17.86	17.92	18.03	17.76	18.14	18.21
EIRP(Watts)	0.0605	0.0630	0.0631	0.0611	0.0619	0.0635	0.0597	0.0652	0.0662



LTE Band 38 (GT - LC = -4.33 dB) QPSK			
Bandwidth	5M		
Channel	37775	38000	38225
	(Low)	(Mid)	(High)
Frequency	2572.5	2595	2617.5
(MHz)			
Conducted Power (dBm)	23.49	23.17	23.33
Conducted Power (Watts)	0.2234	0.2075	0.2153
EIRP(dBm)	19.16	18.84	19.00
EIRP(Watts)	0.0824	0.0766	0.0794

LTE Band 38 (GT - LC = -4.33 dB) QPSK									
Bandwidth	10M			15M			20M		
Channel	37800	38000	38200	37825	38000	38175	37850	38000	38150
	(Low)	(Mid)	(High)	(Low)	(Mid)	(High)	(Low)	(Mid)	(Mid)
Frequency	2575	2595	2615	2577.5	2595	2612.5	2580	2595	2610
(MHz)									
Conducted Power (dBm)	23.63	23.49	23.43	23.44	23.26	23.26	23.82	23.61	23.52
Conducted Power (Watts)	0.2307	0.2234	0.2203	0.2208	0.2118	0.2118	0.2410	0.2296	0.2249
EIRP(dBm)	19.30	19.16	19.10	19.11	18.93	18.93	19.49	19.28	19.19
EIRP(Watts)	0.0851	0.0824	0.0813	0.0815	0.0782	0.0782	0.0889	0.0847	0.0830



LTE Band 38 (GT - LC = -4.33 dB) 16QAM			
Bandwidth	5M		
Channel	37775	38000	38225
	(Low)	(Mid)	(High)
Frequency	2572.5	2595	2617.5
(MHz)			
Conducted Power (dBm)	22.51	22.29	22.45
Conducted Power (Watts)	0.1782	0.1694	0.1758
EIRP(dBm)	18.18	17.96	18.12
EIRP(Watts)	0.0658	0.0625	0.0649

LTE Band 38 (GT - LC = -4.33 dB) 16QAM									
Bandwidth	10M			15M			20M		
Channel	37800	38000	38200	37825	38000	38175	37850	38000	38150
	(Low)	(Mid)	(High)	(Low)	(Mid)	(High)	(Low)	(Mid)	(Mid)
Frequency	2575	2595	2615	2577.5	2595	2612.5	2580	2595	2610
(MHz)									
Conducted Power (dBm)	22.64	22.60	22.54	22.52	22.44	22.34	22.88	22.93	22.88
Conducted Power (Watts)	0.1837	0.1820	0.1795	0.1786	0.1754	0.1714	0.1941	0.1963	0.1941
EIRP(dBm)	18.31	18.27	18.21	18.19	18.11	18.01	18.55	18.60	18.55
EIRP(Watts)	0.0678	0.0671	0.0662	0.0659	0.0647	0.0632	0.0716	0.0724	0.0716



LTE Band 5

Peak-to-Average Ratio

Mode	LTE Band 5 / 10MHz				
Mod.	QPSK		16QAM		Limit: 13dB
RB Size	1RB	Full RB	1RB	Full RB	Result
Lowest CH	3.77	5.04	4.72	5.83	PASS
Middle CH	5.33	5.30	6.35	6.12	
Highest CH	4.75	4.81	4.09	5.68	



LTE Band 5 / 10MHz / QPSK

Lowest Channel / 1RB

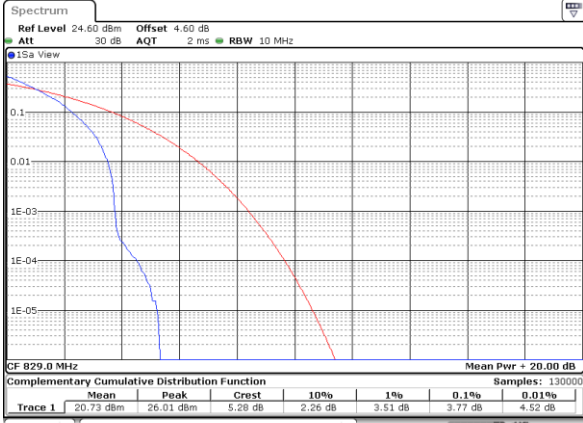

Date: 13 NOV 2019 04:55:28

Lowest Channel / Full RB

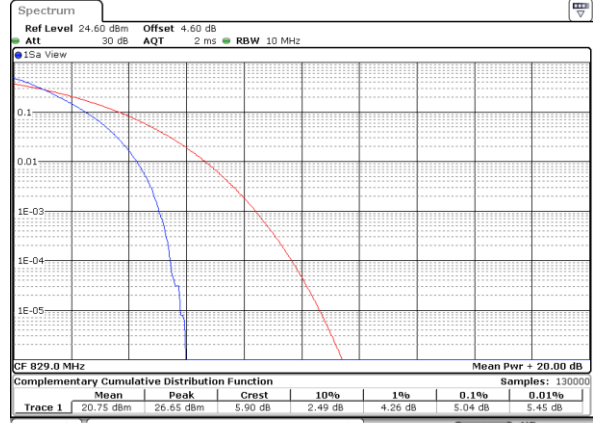

Date: 13 NOV 2019 04:55:44

Middle Channel / 1RB

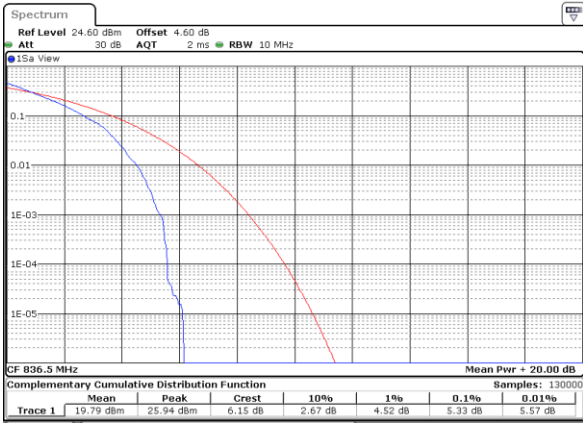

Date: 13 NOV 2019 04:54:13

Middle Channel / Full RB

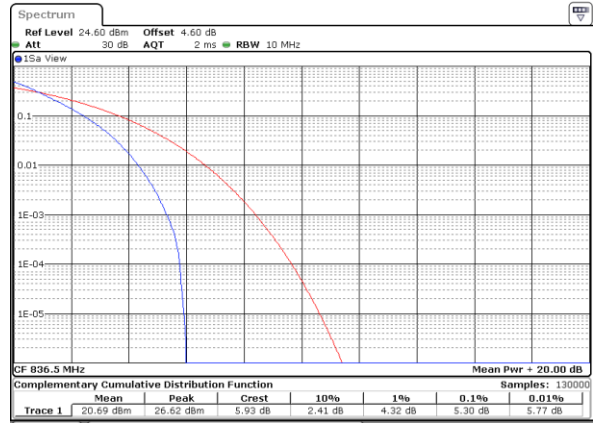

Date: 13 NOV 2019 04:53:42

Highest Channel / 1RB

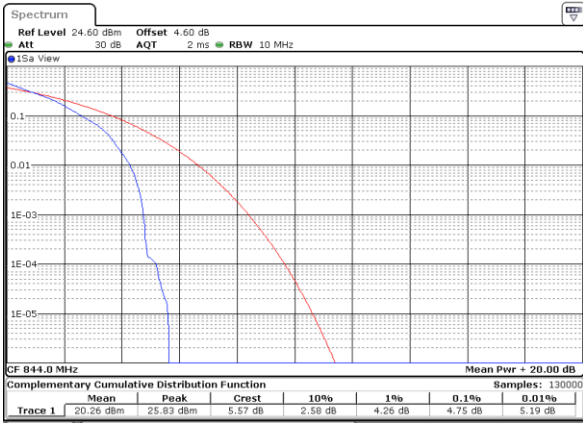

Date: 13 NOV 2019 04:53:20

Highest Channel / Full RB

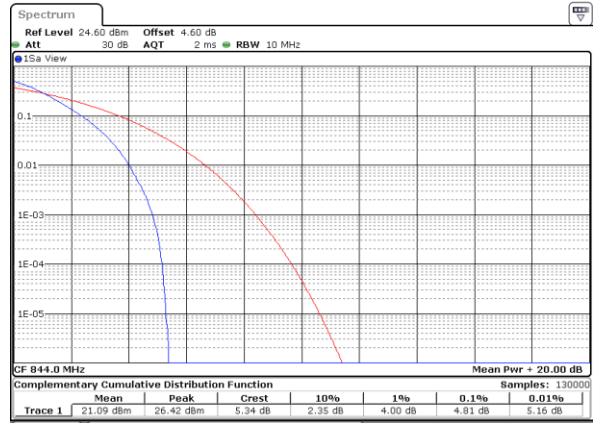

Date: 13 NOV 2019 04:53:32



LTE Band 5 / 10MHz / 16QAM

Lowest Channel / 1RB

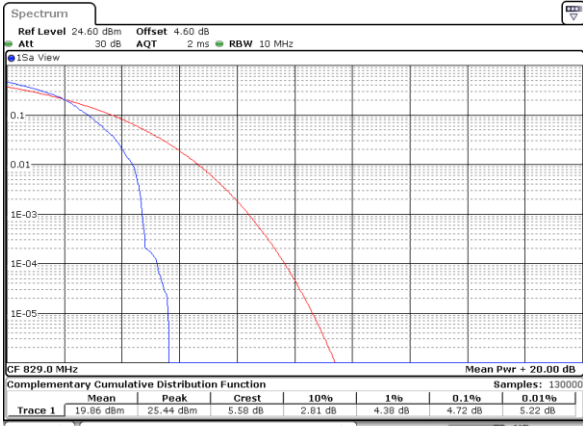

Date: 13 NOV 2019 04:52:09

Lowest Channel / Full RB

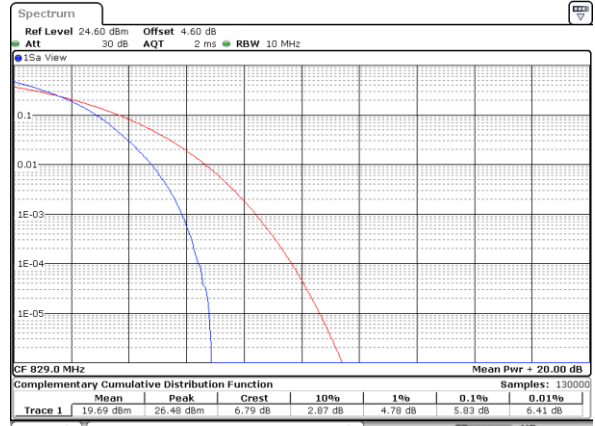

Date: 13 NOV 2019 04:52:19

Middle Channel / 1RB

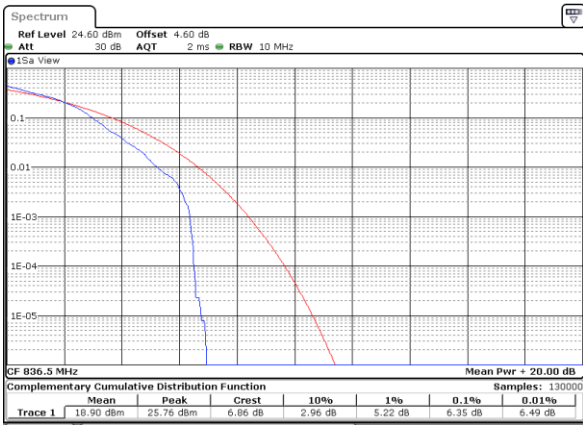

Date: 13 NOV 2019 04:52:29

Middle Channel / Full RB

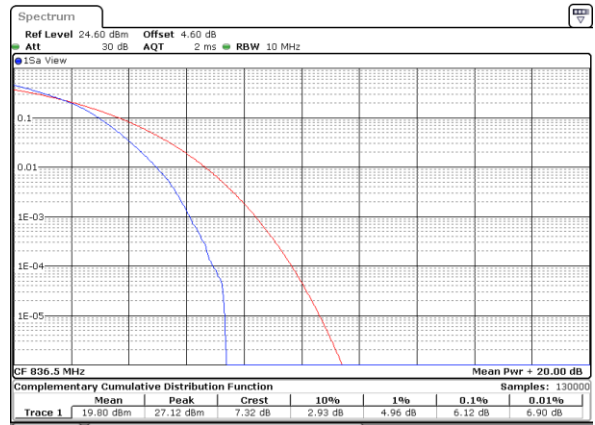

Date: 13 NOV 2019 04:52:38

Highest Channel / 1RB

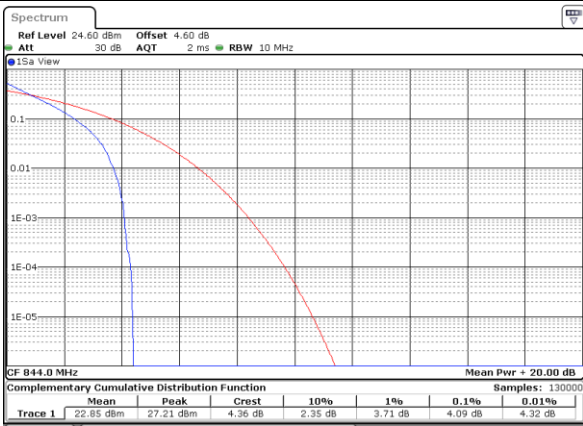

Date: 13 NOV 2019 04:52:58

Highest Channel / Full RB

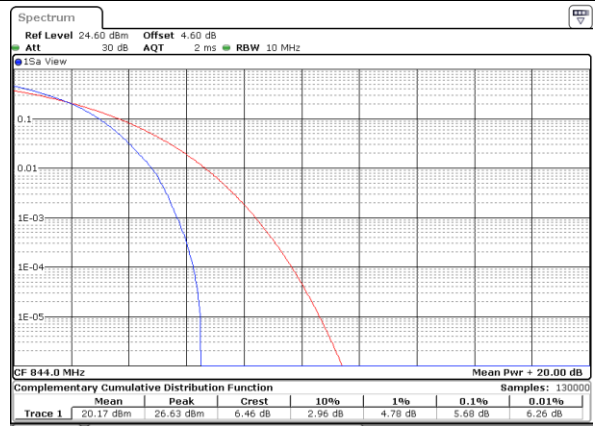

Date: 13 NOV 2019 04:53:08



26dB Bandwidth

Mode	LTE Band 5 : 26dB BW(MHz)											
	1.4MHz		3MHz		5MHz		10MHz		15MHz		20MHz	
BW	QPSK	16QAM	QPSK	16QAM	QPSK	16QAM	QPSK	16QAM	QPSK	16QAM	QPSK	16QAM
Lowest CH	1.387	1.259	2.991	3.273	4.905	4.945	9.69	9.65	-	-	-	-
Middle CH	1.407	1.401	3.225	2.997	5.055	4.885	9.69	9.77	-	-	-	-
Highest CH	1.387	1.368	3.159	3.243	4.875	5.025	9.65	9.79	-	-	-	-



LTE Band 5

Lowest Channel / 1.4MHz / QPSK

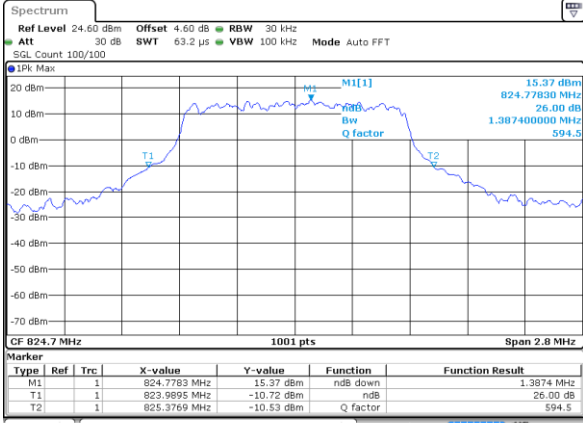

Date: 13 NOV 2019 03:19:33

Lowest Channel / 1.4MHz / 16QAM

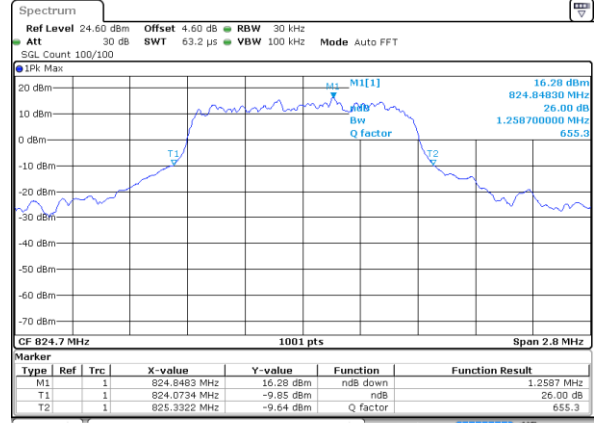

Date: 13 NOV 2019 03:19:23

Middle Channel / 1.4MHz / QPSK

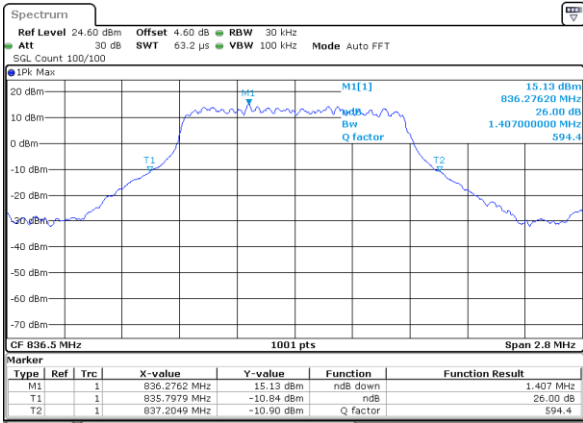

Date: 13 NOV 2019 03:28:23

Middle Channel / 1.4MHz / 16QAM

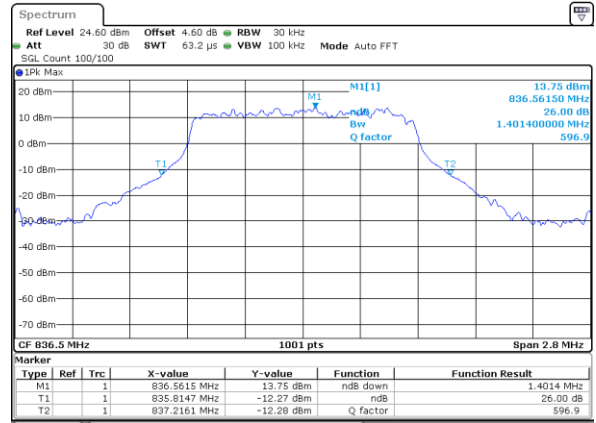

Date: 13 NOV 2019 03:28:33

Highest Channel / 1.4MHz / QPSK

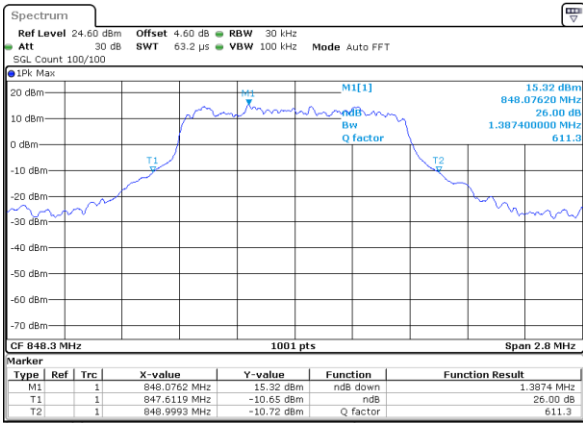

Date: 13 NOV 2019 03:30:52

Highest Channel / 1.4MHz / 16QAM

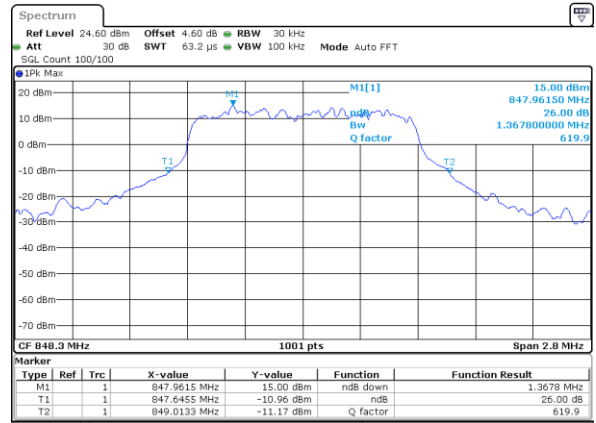

Date: 13 NOV 2019 03:31:02



LTE Band 5

Lowest Channel / 3MHz / QPSK

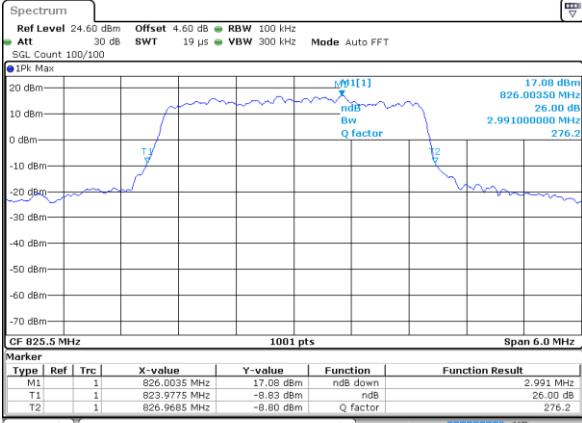

Date: 13 NOV 2019 03:39:51

Lowest Channel / 3MHz / 16QAM

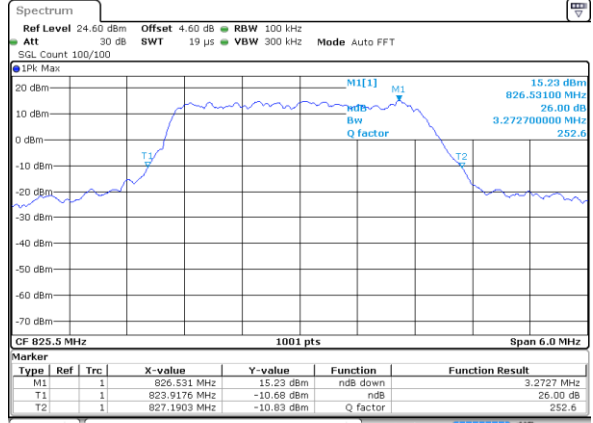

Date: 13 NOV 2019 03:40:01

Middle Channel / 3MHz / QPSK

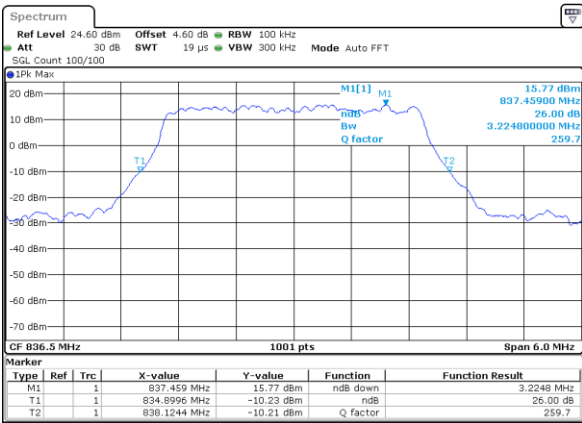

Date: 13 NOV 2019 03:48:50

Middle Channel / 3MHz / 16QAM

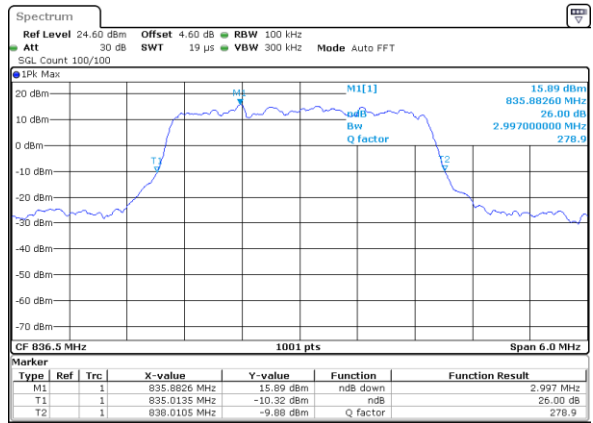

Date: 13 NOV 2019 03:49:00

Highest Channel / 3MHz / QPSK

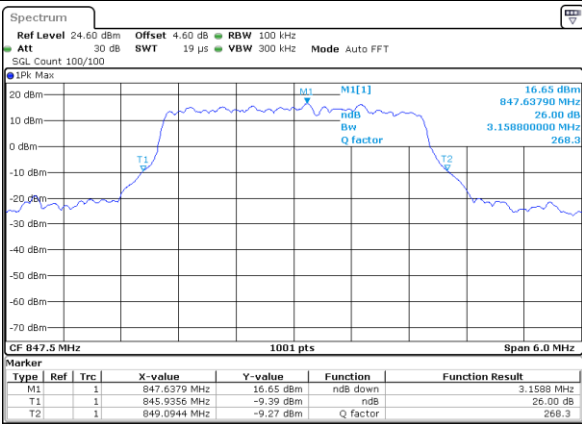

Date: 13 NOV 2019 03:51:19

Highest Channel / 3MHz / 16QAM

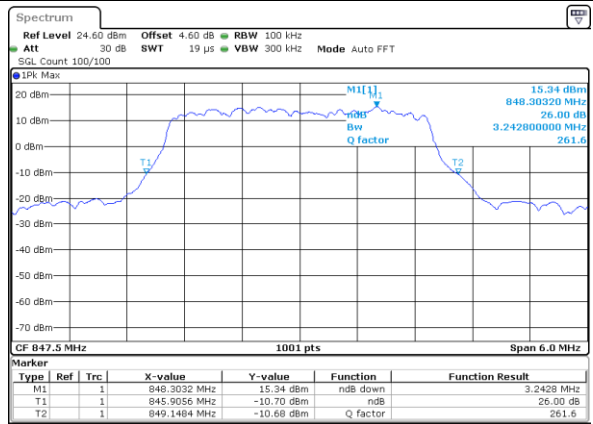

Date: 13 NOV 2019 03:51:29



LTE Band 5

Lowest Channel / 5MHz / QPSK

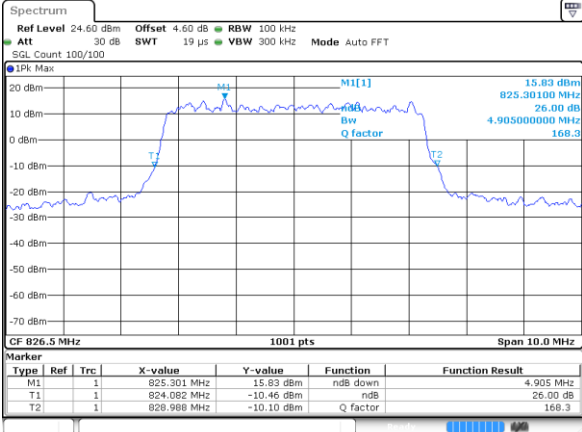

Date: 13 NOV 2019 04:00:18

Lowest Channel / 5MHz / 16QAM

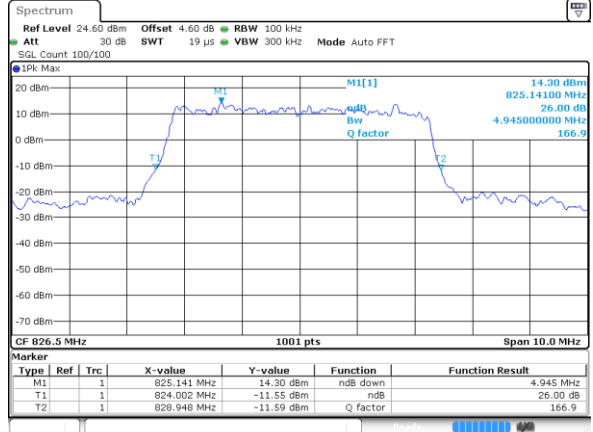

Date: 13 NOV 2019 04:00:28

Middle Channel / 5MHz / QPSK

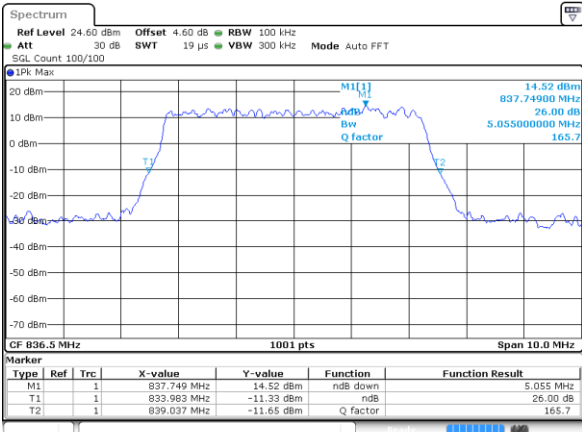

Date: 13 NOV 2019 04:09:18

Middle Channel / 5MHz / 16QAM

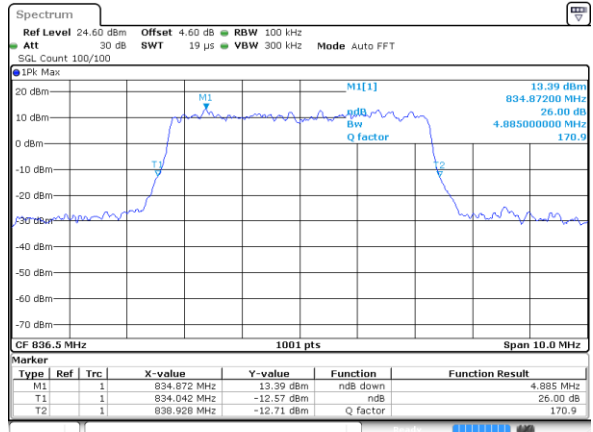

Date: 13 NOV 2019 04:09:28

Highest Channel / 5MHz / QPSK

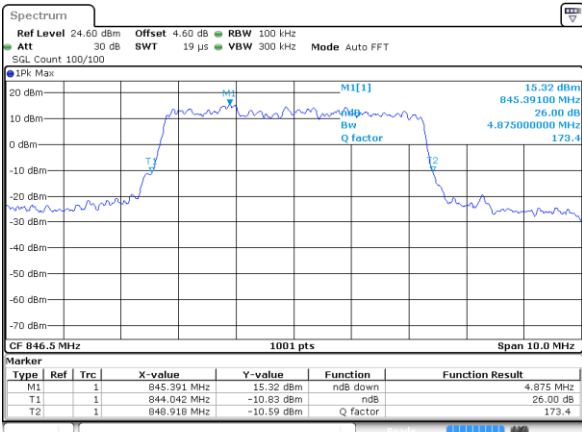

Date: 13 NOV 2019 04:11:47

Highest Channel / 5MHz / 16QAM

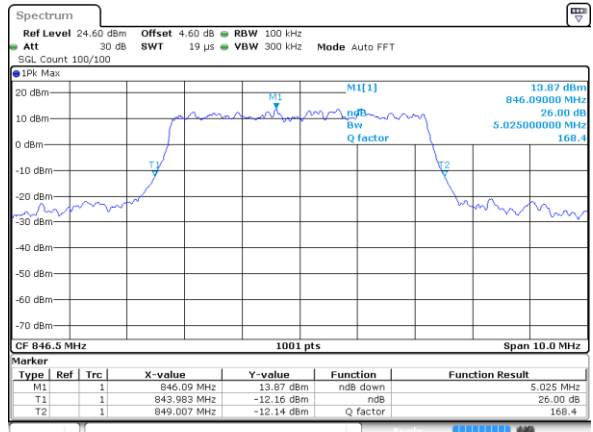

Date: 13 NOV 2019 04:11:57



LTE Band 5

Lowest Channel / 10MHz / QPSK

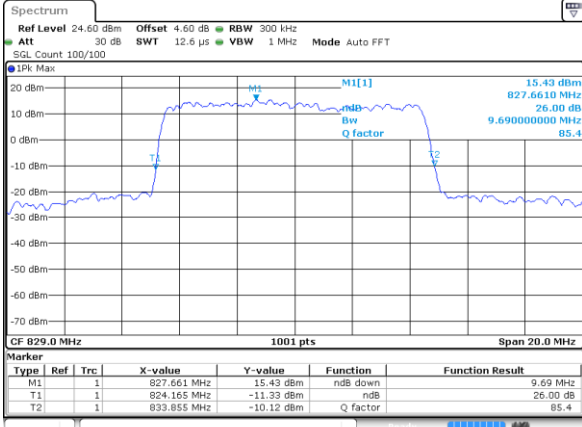

Date: 13 NOV 2019 04:20:48

Lowest Channel / 10MHz / 16QAM

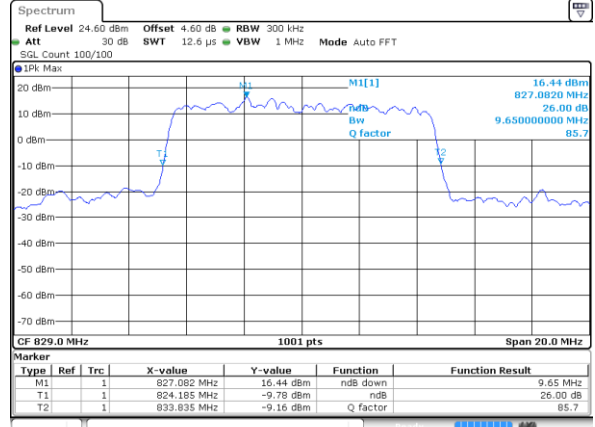

Date: 13 NOV 2019 04:20:56

Middle Channel / 10MHz / QPSK

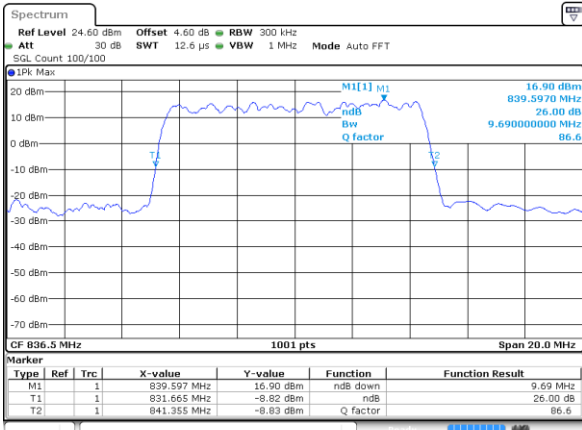

Date: 13 NOV 2019 04:29:48

Middle Channel / 10MHz / 16QAM

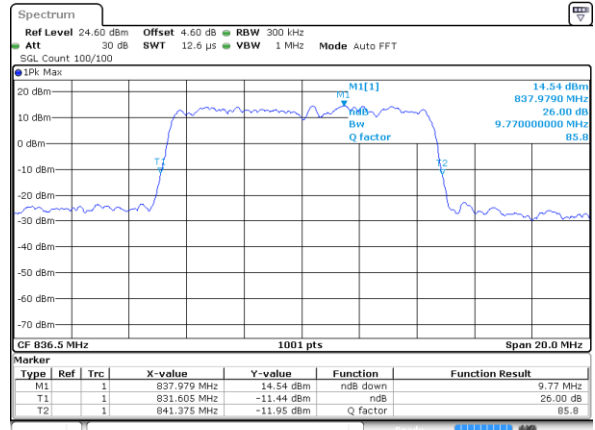

Date: 13 NOV 2019 04:29:56

Highest Channel / 10MHz / QPSK

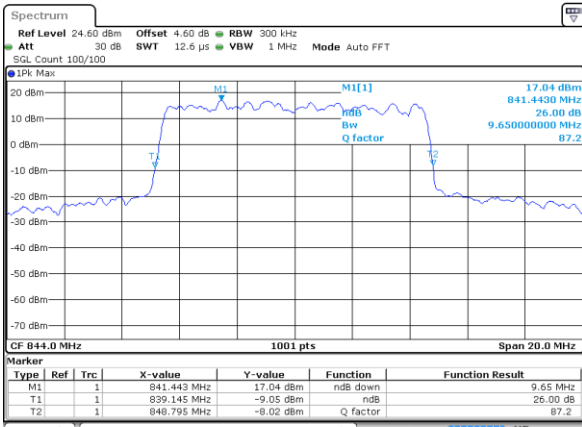

Date: 13 NOV 2019 04:32:16

Highest Channel / 10MHz / 16QAM

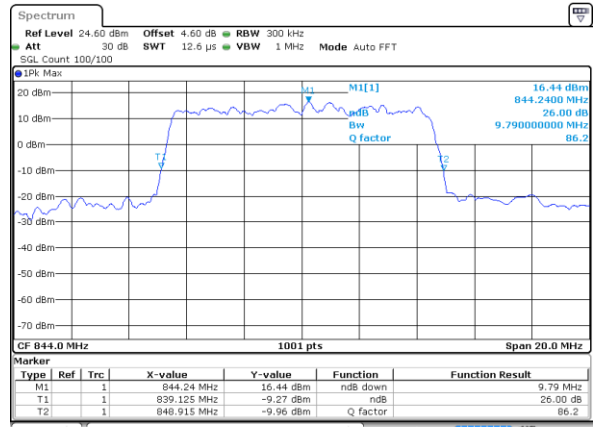

Date: 13 NOV 2019 04:32:26



Occupied Bandwidth

Mode	LTE Band 5 : 99%OBW(MHz)											
	1.4MHz		3MHz		5MHz		10MHz		15MHz		20MHz	
BW												
Mod.	QPSK	16QAM	QPSK	16QAM	QPSK	16QAM	QPSK	16QAM	QPSK	16QAM	QPSK	16QAM
Lowest CH	1.09	1.11	2.70	2.72	4.49	4.46	9.01	8.97	-	-	-	-
Middle CH	1.09	1.09	2.71	2.72	4.49	4.48	8.97	8.97	-	-	-	-
Highest CH	1.10	1.09	2.73	2.70	4.48	4.48	8.97	8.97	-	-	-	-



LTE Band 5

Lowest Channel / 1.4MHz / QPSK

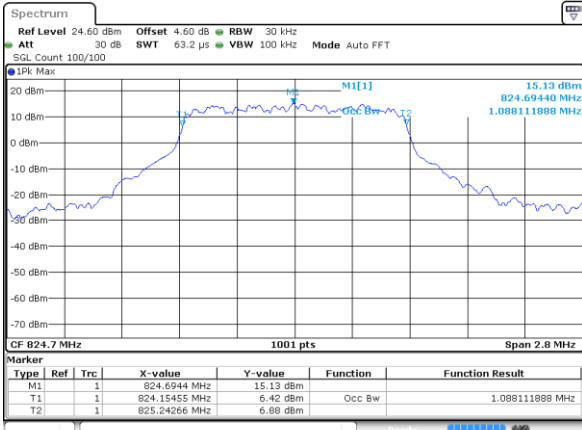

Date: 13 NOV 2019 03:19:03

Lowest Channel / 1.4MHz / 16QAM

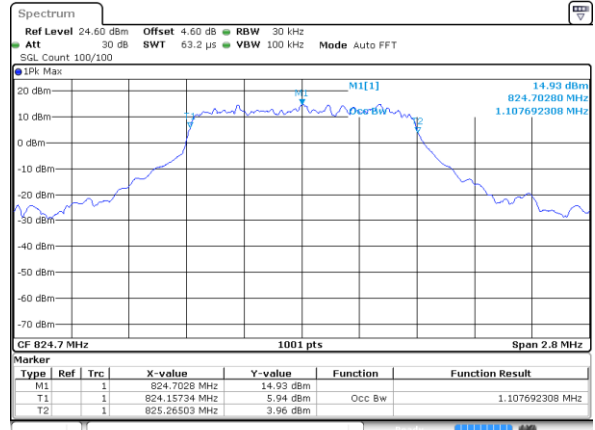

Date: 13 NOV 2019 03:19:13

Middle Channel / 1.4MHz / QPSK

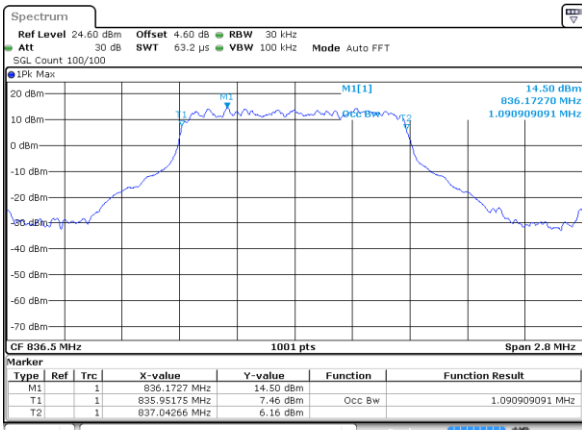

Date: 13 NOV 2019 03:28:03

Middle Channel / 1.4MHz / 16QAM

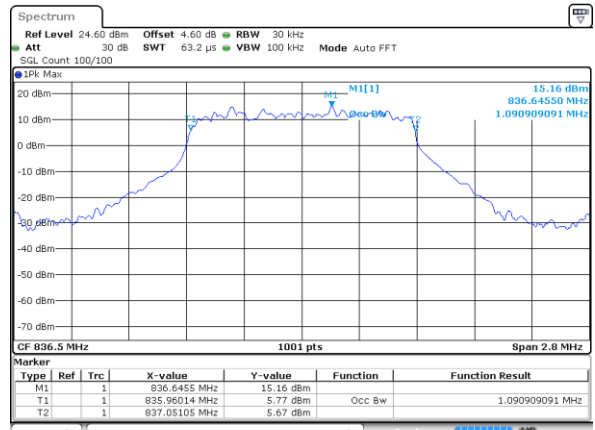

Date: 13 NOV 2019 03:28:13

Highest Channel / 1.4MHz / QPSK

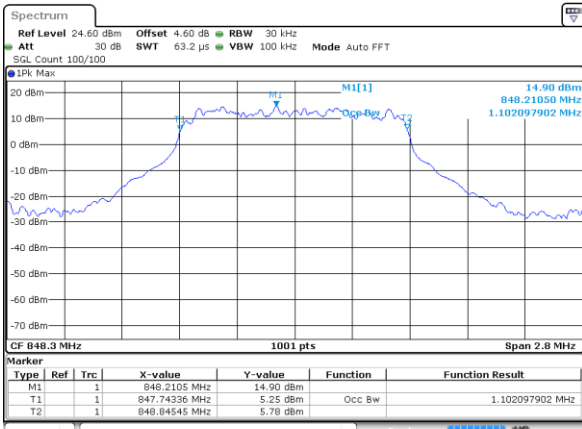

Date: 13 NOV 2019 03:30:32

Highest Channel / 1.4MHz / 16QAM

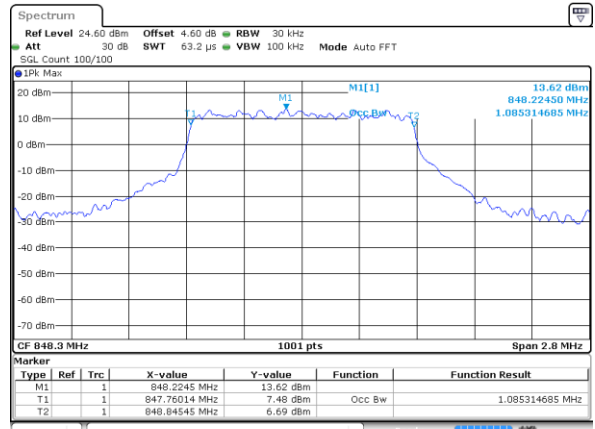

Date: 13 NOV 2019 03:30:42



LTE Band 5

Lowest Channel / 3MHz / QPSK

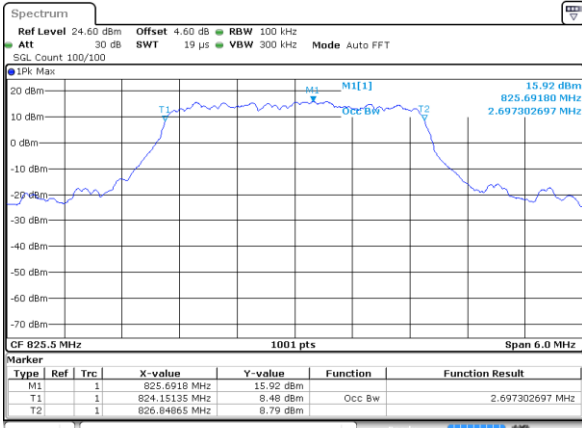

Date: 13 NOV 2019 03:39:31

Lowest Channel / 3MHz / 16QAM

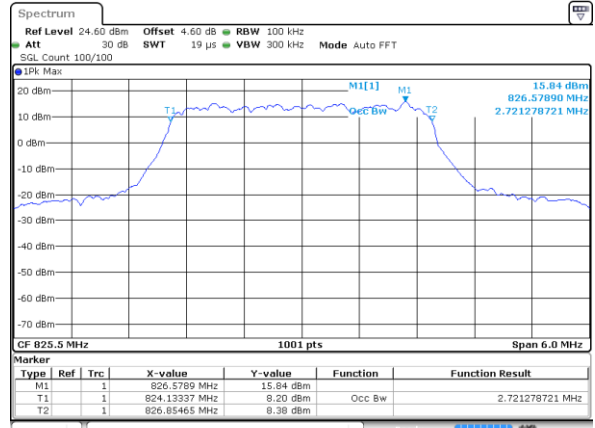

Date: 13 NOV 2019 03:39:41

Middle Channel / 3MHz / QPSK

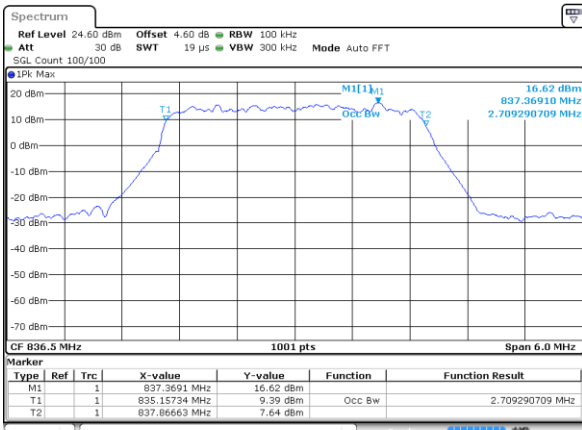

Date: 13 NOV 2019 03:48:30

Middle Channel / 3MHz / 16QAM

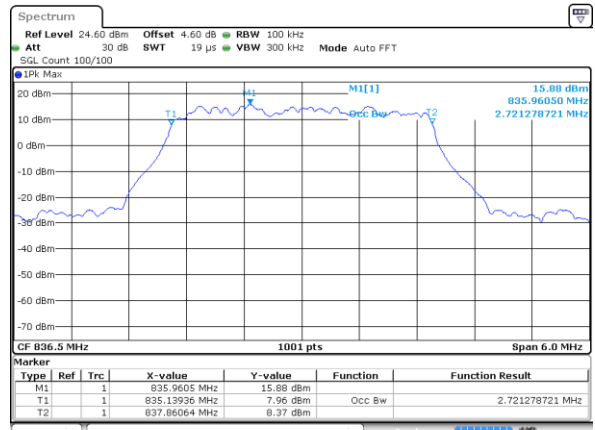

Date: 13 NOV 2019 03:48:40

Highest Channel / 3MHz / QPSK

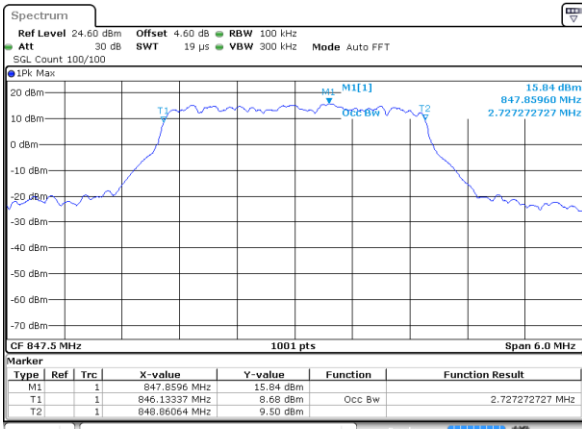

Date: 13 NOV 2019 03:50:59

Highest Channel / 3MHz / 16QAM

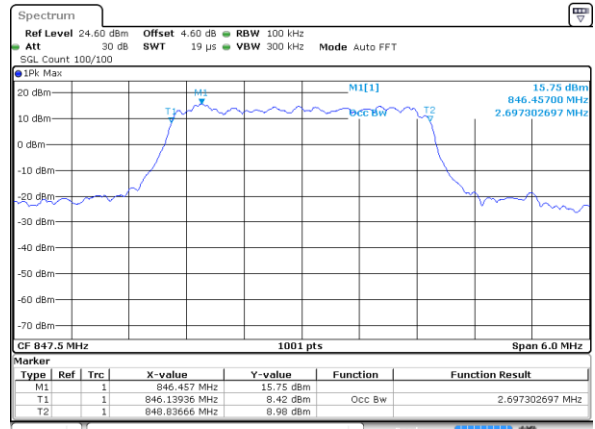

Date: 13 NOV 2019 03:51:09



LTE Band 5

Lowest Channel / 5MHz / QPSK

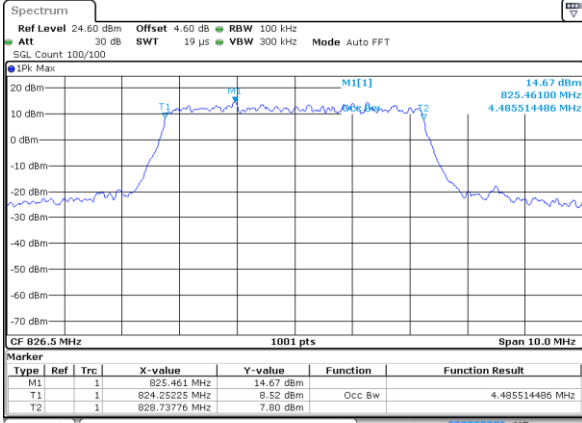

Date: 13 NOV 2019 03:59:58

Lowest Channel / 5MHz / 16QAM

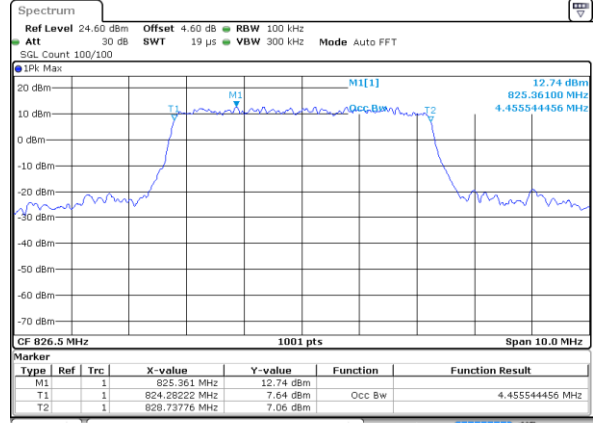

Date: 13 NOV 2019 04:00:08

Middle Channel / 5MHz / QPSK

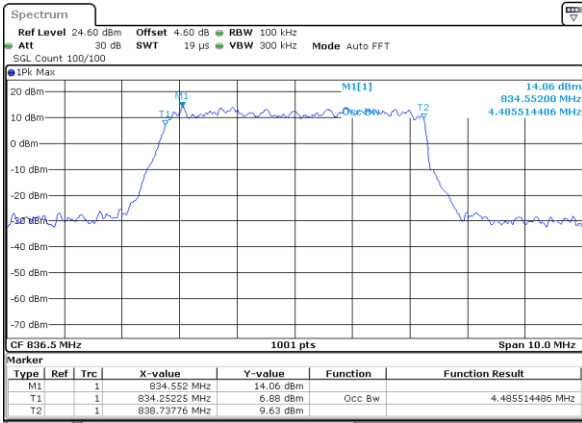

Date: 13 NOV 2019 04:06:57

Middle Channel / 5MHz / 16QAM

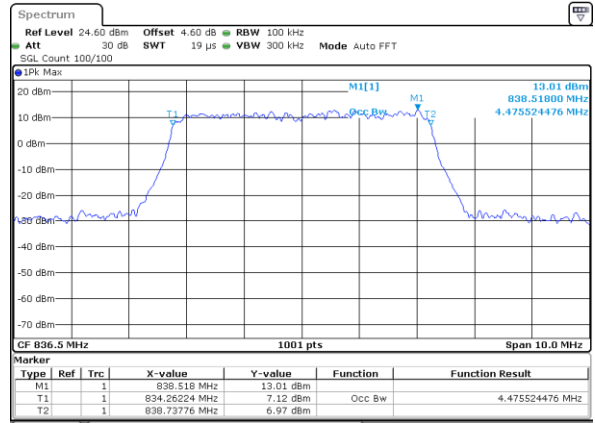

Date: 13 NOV 2019 04:09:08

Highest Channel / 5MHz / QPSK

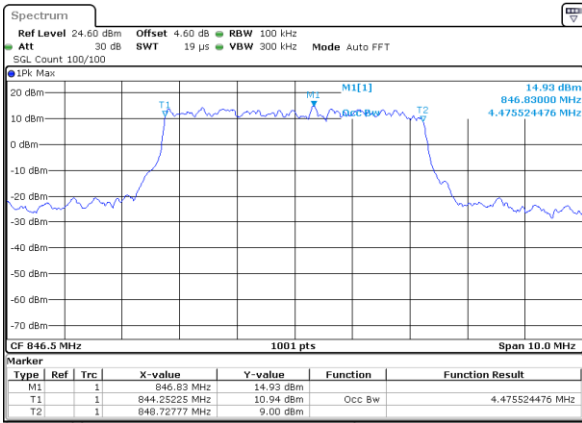

Date: 13 NOV 2019 04:11:27

Highest Channel / 5MHz / 16QAM

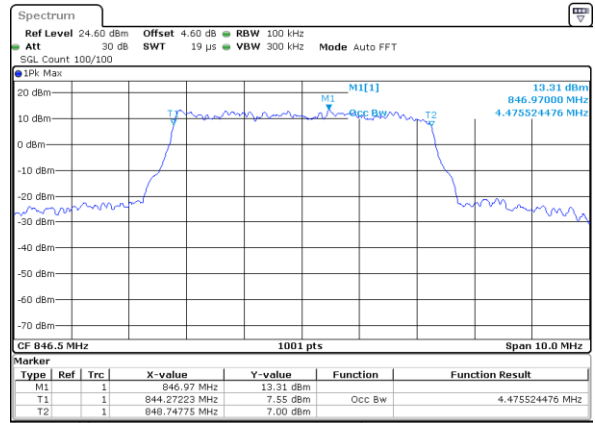

Date: 13 NOV 2019 04:11:37



LTE Band 5

Lowest Channel / 10MHz / QPSK

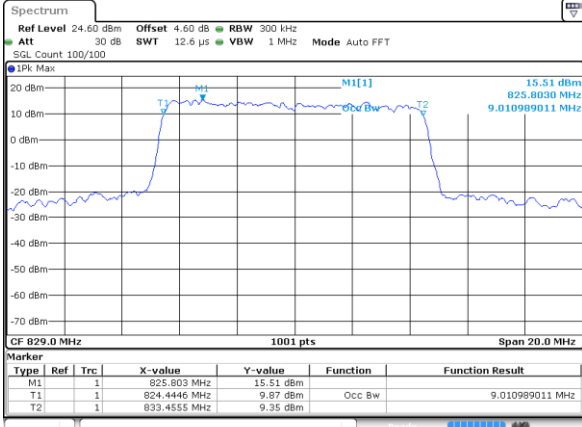

Date: 13 NOV 2019 04:20:28

Lowest Channel / 10MHz / 16QAM

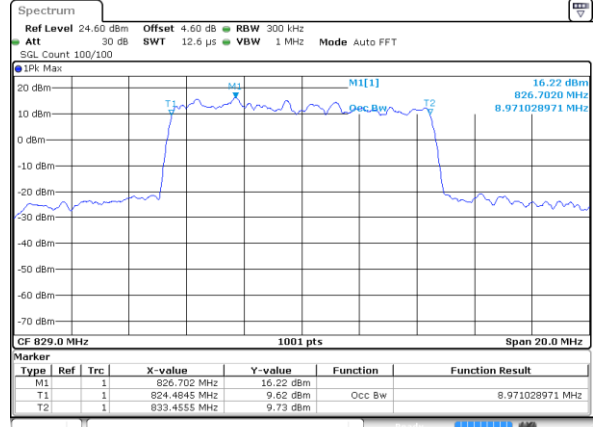

Date: 13 NOV 2019 04:20:36

Middle Channel / 10MHz / QPSK

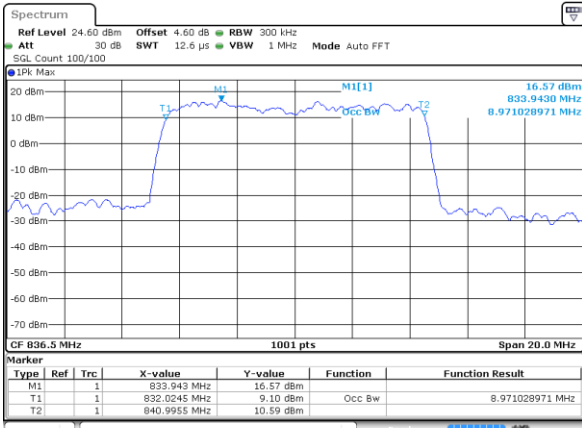

Date: 13 NOV 2019 04:29:28

Middle Channel / 10MHz / 16QAM

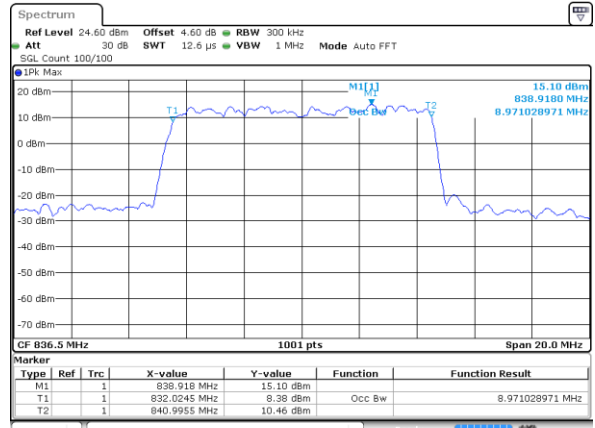

Date: 13 NOV 2019 04:29:36

Highest Channel / 10MHz / QPSK

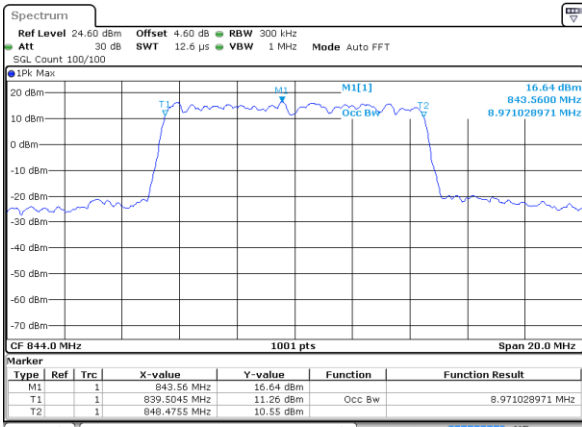

Date: 13 NOV 2019 04:31:55

Highest Channel / 10MHz / 16QAM

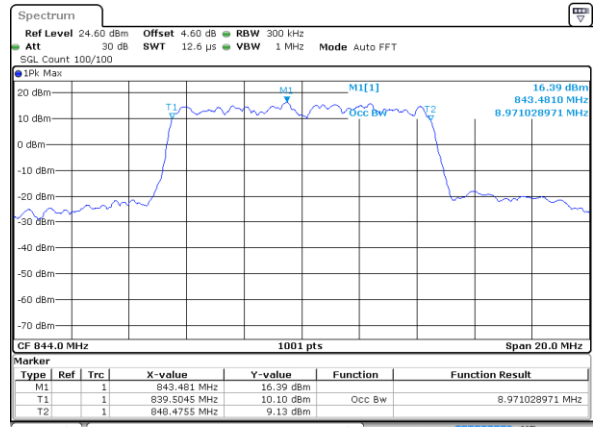

Date: 13 NOV 2019 04:32:06



Conducted Band Edge

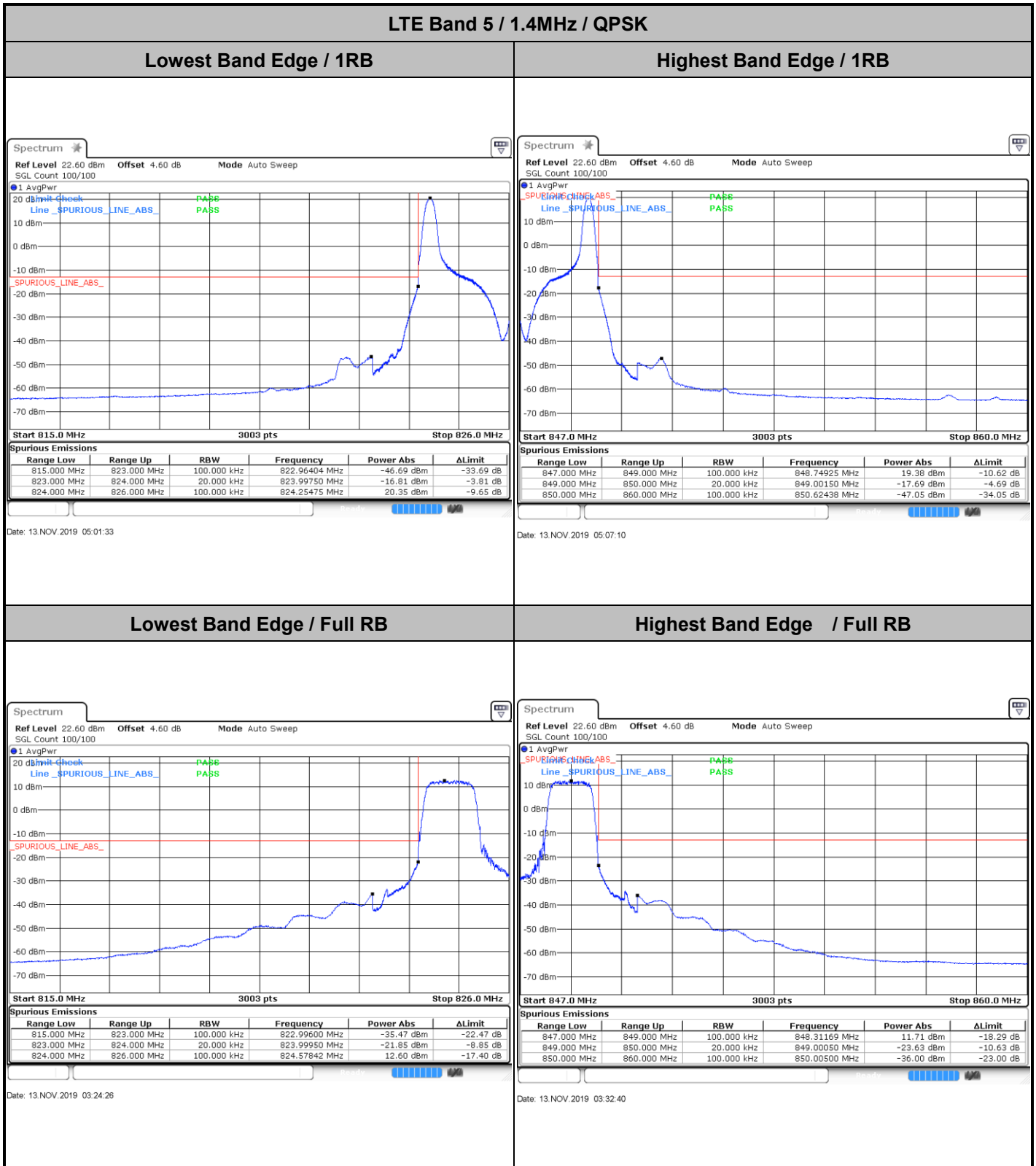



LTE Band 5 / 1.4MHz / 16QAM

Lowest Band Edge / 1 RB

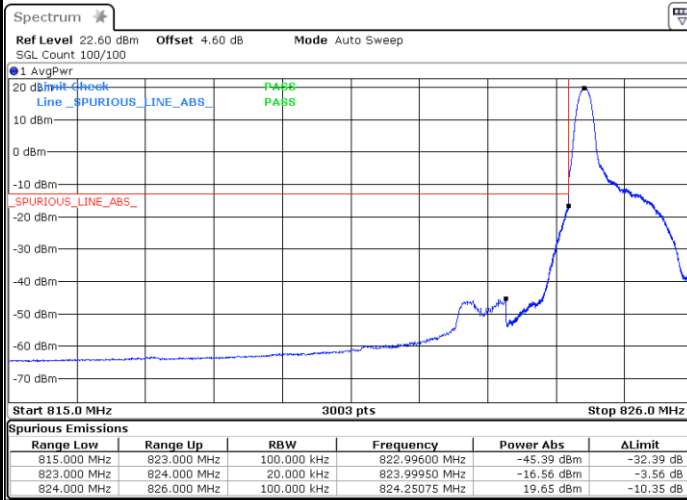

Date: 13 NOV 2019 05:03:17

Highest Band Edge / 1 RB



Date: 13 NOV 2019 05:05:20

Lowest Band Edge / Full RB

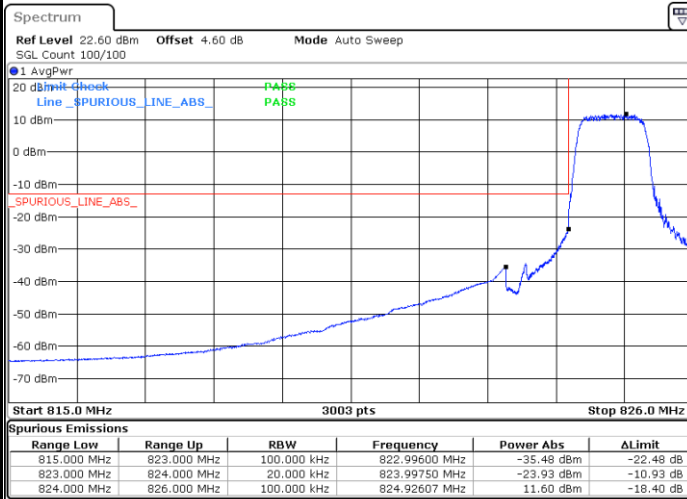

Date: 13 NOV 2019 03:26:04

Highest Band Edge / Full RB



Date: 13 NOV 2019 03:34:18



LTE Band 5 / 3MHz / QPSK

Lowest Band Edge / 1RB

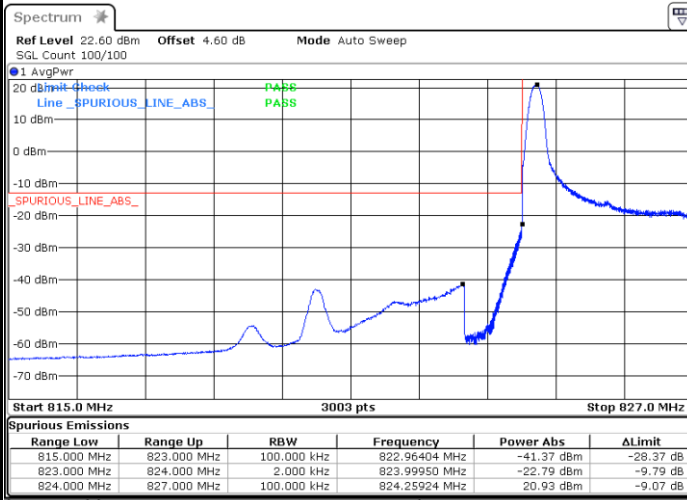

Date: 15.NOV.2019 14:24:18

Highest Band Edge / 1 RB



Date: 13.NOV.2019 05:24:55

Lowest Band Edge / Full RB

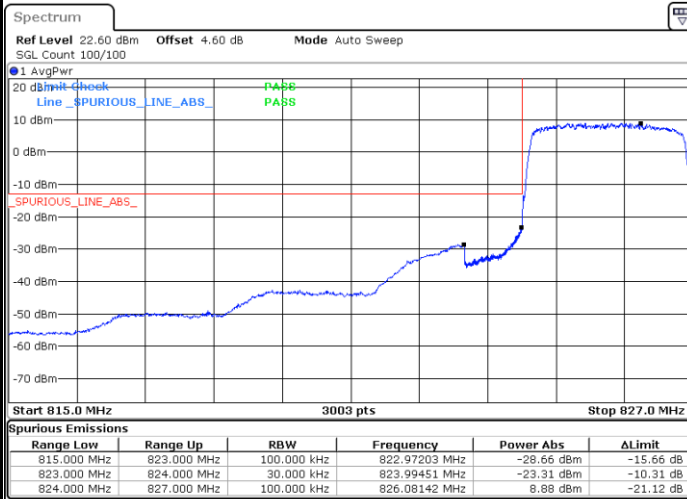

Date: 13.NOV.2019 03:44:54

Highest Band Edge / Full RB



Date: 13.NOV.2019 03:56:22



LTE Band 5 / 3MHz / 16QAM

Lowest Band Edge / 1 RB

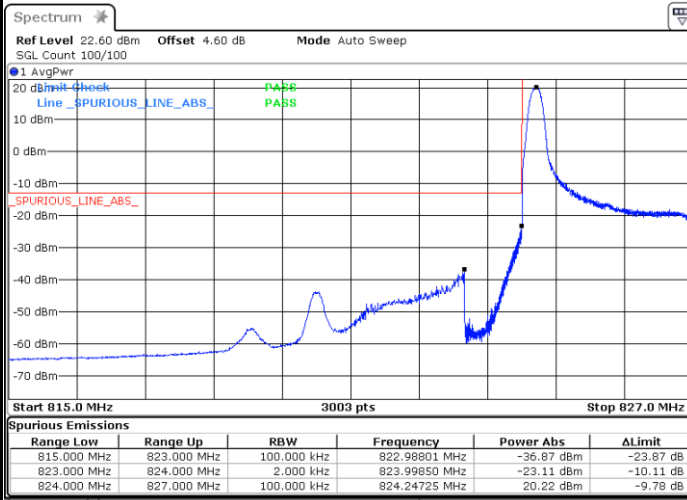

Date: 15.NOV.2019 14:28:08

Highest Band Edge / 1 RB

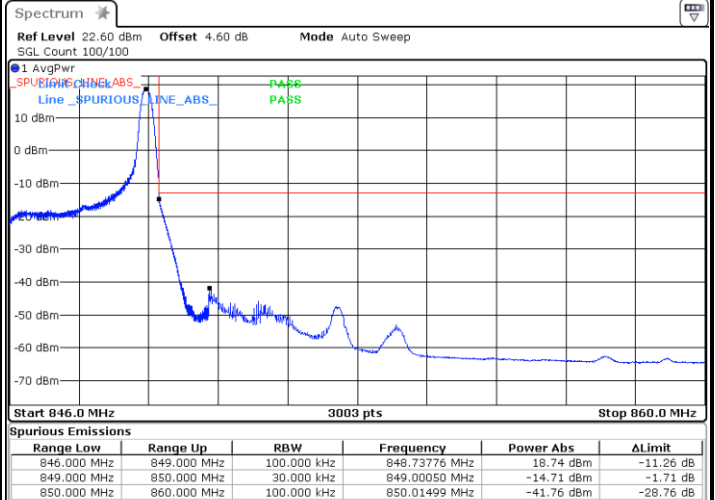

Date: 13.NOV.2019 05:26:49

Lowest Band Edge / Full RB

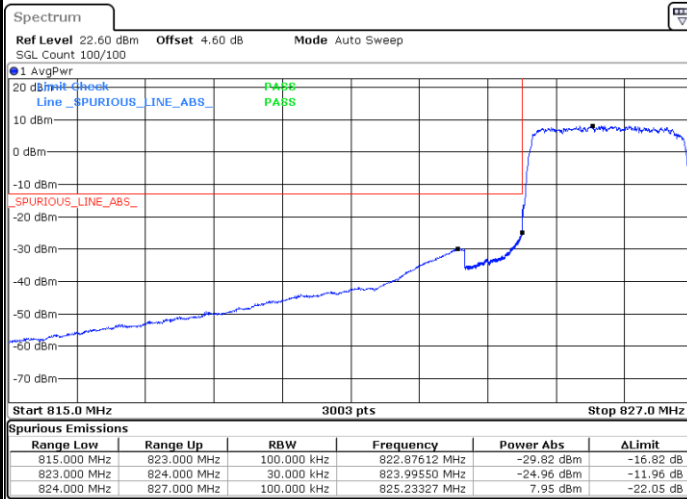

Date: 13.NOV.2019 03:46:31

Highest Band Edge / Full RB

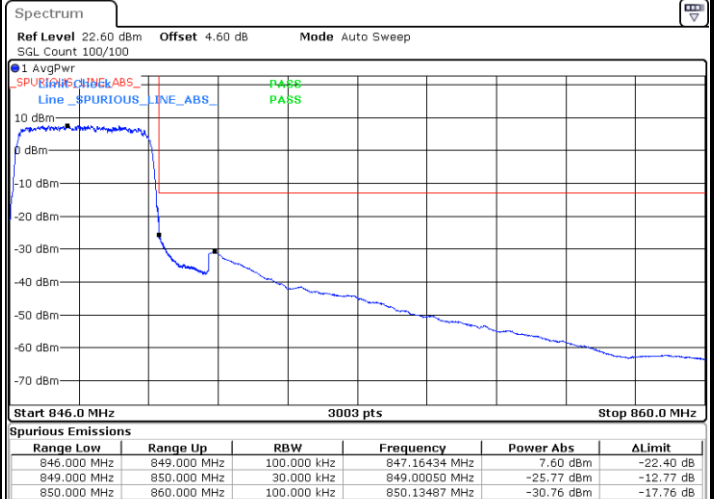

Date: 13.NOV.2019 03:58:00



LTE Band 5 / 5MHz / QPSK

Lowest Band Edge / 1 RB

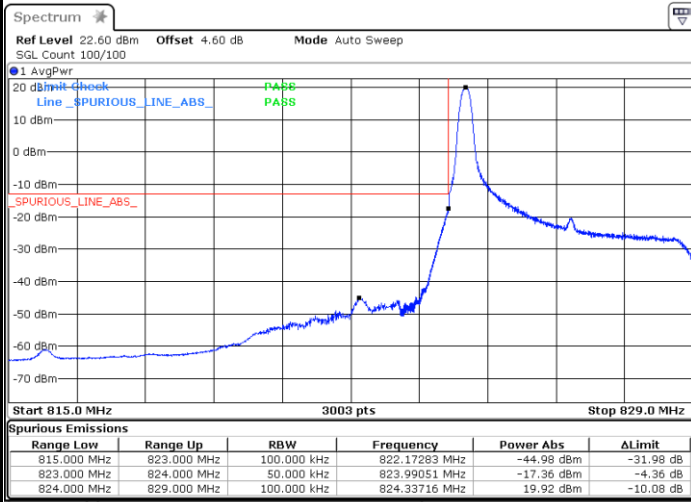

Date: 13 NOV 2019 05:32:21

Highest Band Edge / 1 RB

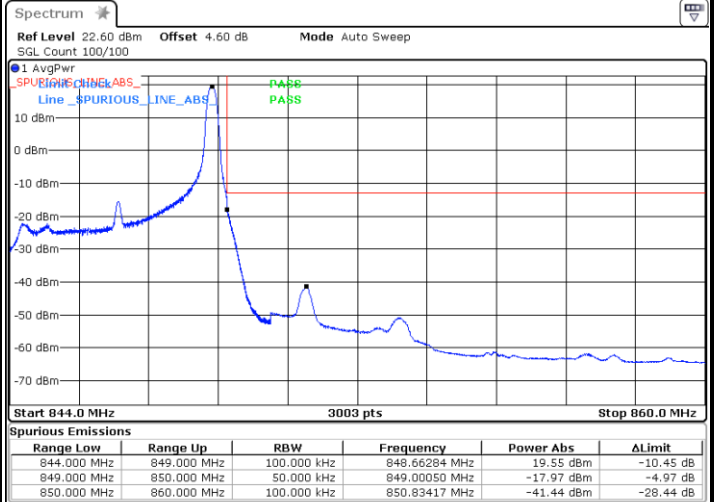

Date: 13 NOV 2019 05:28:20

Lowest Band Edge / Full RB

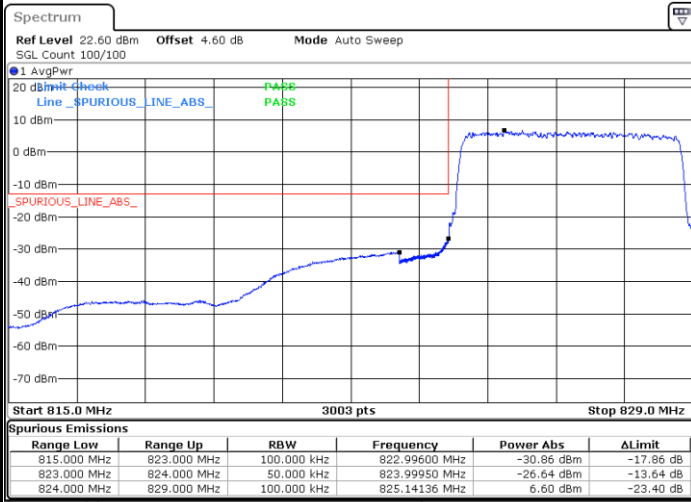

Date: 13 NOV 2019 04:05:21

Highest Band Edge / Full RB

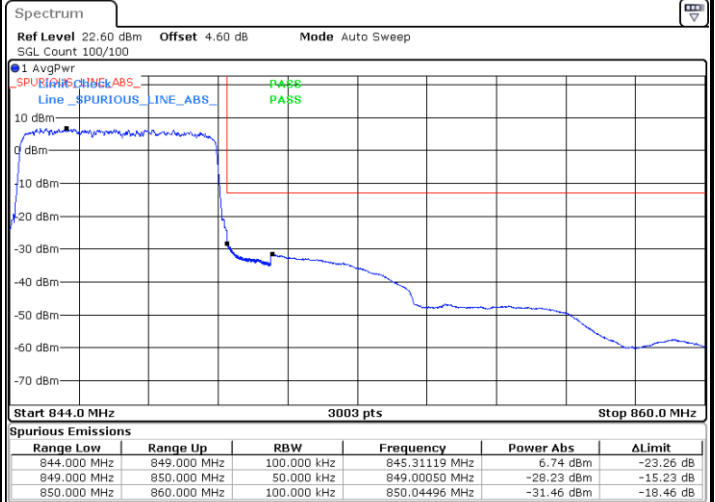

Date: 13 NOV 2019 04:16:50



LTE Band 5 / 5MHz / 16QAM

Lowest Band Edge / 1RB

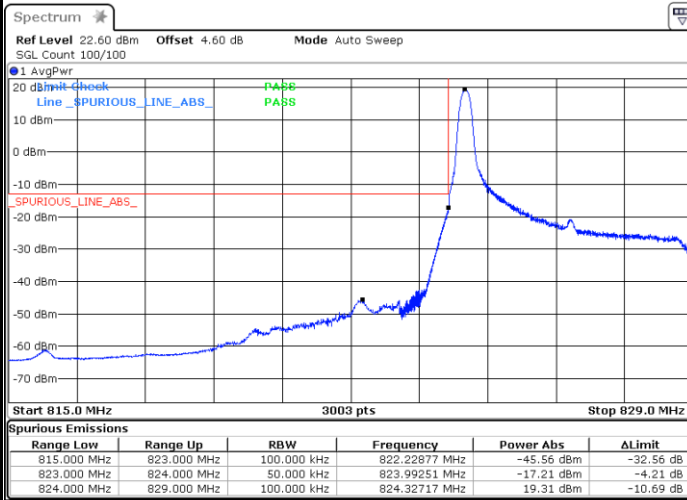

Date: 13 NOV 2019 05:31:26

Highest Band Edge / 1 RB

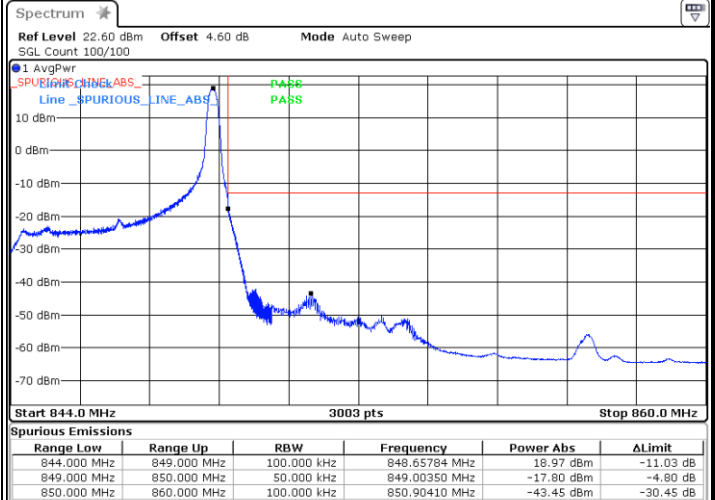

Date: 13 NOV 2019 05:30:22

Lowest Band Edge / Full RB

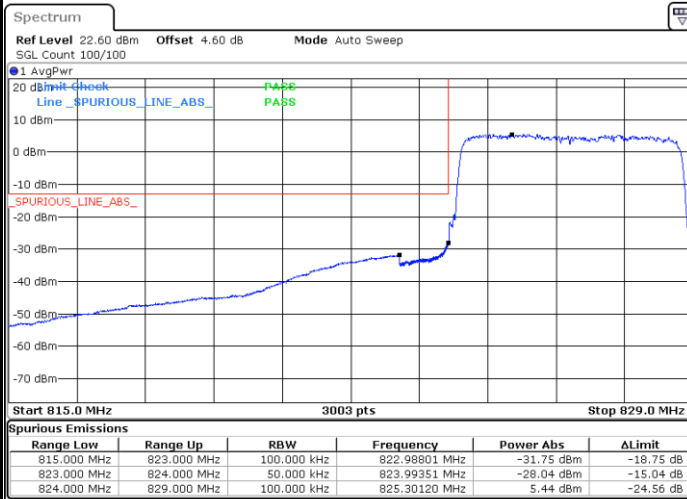

Date: 13 NOV 2019 04:06:59

Highest Band Edge / Full RB



Date: 13 NOV 2019 04:18:27



LTE Band 5 / 10MHz / QPSK

Lowest Band Edge / 1 RB

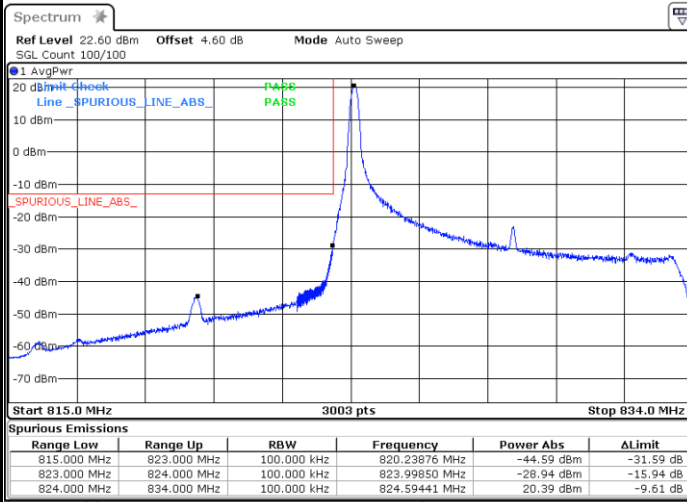

Date: 13 NOV 2019 05:33:15

Highest Band Edge / 1 RB

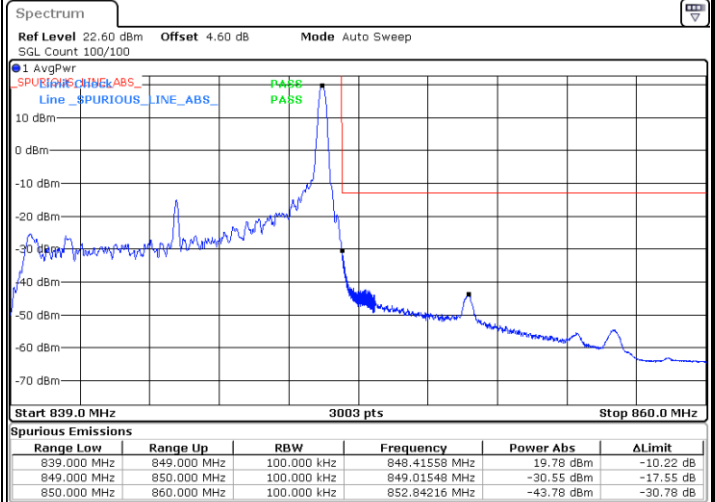

Date: 13 NOV 2019 04:34:04

Lowest Band Edge / Full RB

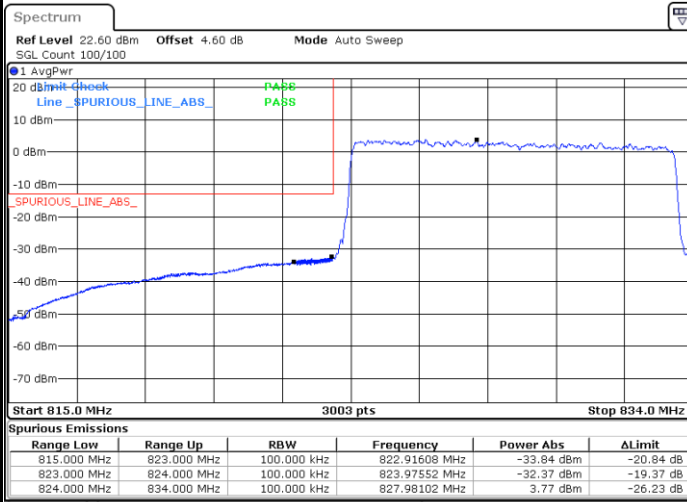

Date: 13 NOV 2019 04:25:49

Highest Band Edge / Full RB

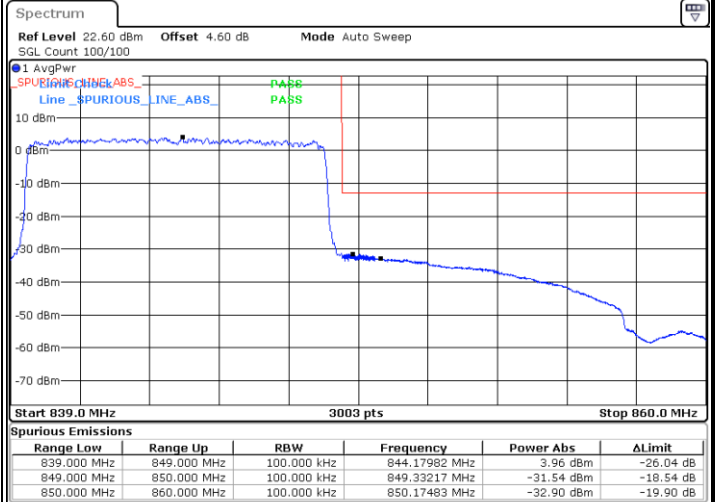

Date: 13 NOV 2019 04:37:19



LTE Band 5 / 10MHz / 16QAM

Lowest Band Edge / 1 RB

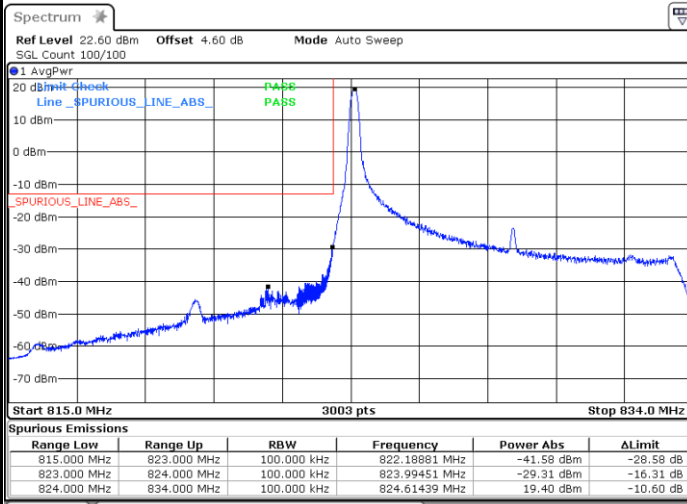

Date: 13 NOV 2019 05:34:01

Highest Band Edge / 1 RB

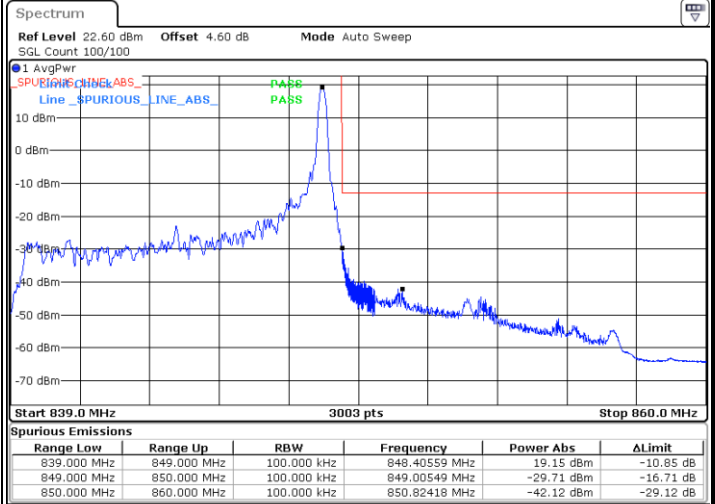

Date: 13 NOV 2019 05:34:51

Lowest Band Edge / Full RB

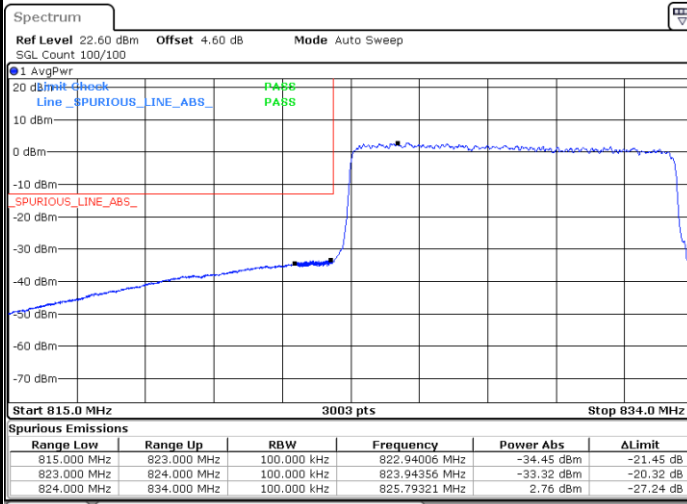

Date: 13 NOV 2019 04:27:27

Highest Band Edge / Full RB

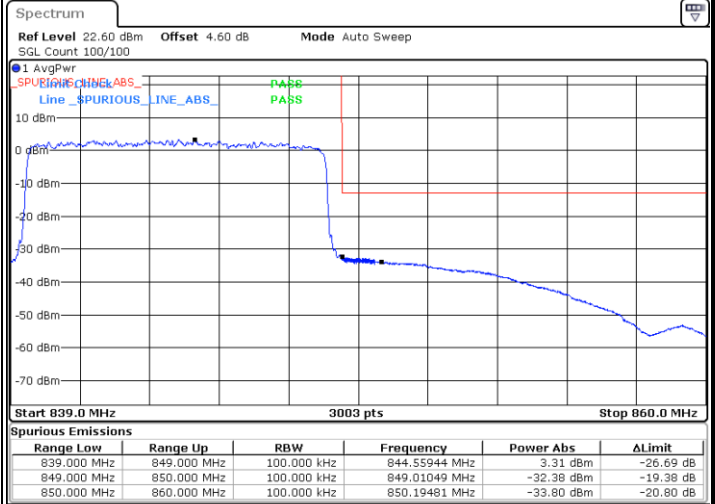

Date: 13 NOV 2019 04:38:56



Conducted Spurious Emission

