



TEST REPORT

No. I18Z62361-IOT10

for

HMD Global OY

Multi-band GSM/WCDMA/LTE phone with Bluetooth, WLAN

GSM 850,900,1800,1900 WCDMA: 1,2,4,5,8

LTE: 1,2,3,4,5,7,8,12/17,28,38,66 mobile phone, Bluetooth 4.2,

WIFI 802.11 b/g/n

FCC ID: 2AJOTTA-1149

with

Hardware Version: 89571_1_12

Software Version: 00XX_1_XXX

Issued Date: 2019-02-14



Note:

The test results in this test report relate only to the devices specified in this report. This report shall not be reproduced except in full without the written approval of CTTL.

The report must not be used by the client to claim product certification, approval, or endorsement by NVLAP, NIST, or any agency of the U.S. Government.

Test Laboratory:

CTTL, Telecommunication Technology Labs, CAICT

No. 52, Huayuan North Road, Haidian District, Beijing, P. R. China 100191.

Tel: +86(0)10-62304633-2512, Fax: +86(0)10-62304633-2504

Email: ctl_terminals@caict.ac.cn, website: www.caict.ac.cn

©Copyright. All rights reserved by CTTL.

REPORT HISTORY

Report Number	Revision	Description	Issue Date
I18Z62361-IOT10	Rev.0	1st edition	2019-01-30
I18Z62361-IOT10	Rev.1	2nd edition	2019-02-14



CONTENTS

1. TEST LABORATORY	4
1.1. TESTING LOCATION	4
1.2. TESTING ENVIRONMENT	4
1.3. PROJECT DATA.....	4
1.4. SIGNATURE.....	4
2. CLIENT INFORMATION	5
2.1. APPLICANT INFORMATION.....	5
2.2. MANUFACTURER INFORMATION	5
3. EQUIPMENT UNDER TEST (EUT) AND ANCILLARY EQUIPMENT (AE)	6
3.1. ABOUT EUT	6
3.2. INTERNAL IDENTIFICATION OF EUT USED DURING THE TEST	6
3.3. INTERNAL IDENTIFICATION OF AE USED DURING THE TEST.....	6
3.4. GENERAL DESCRIPTION	7
3.5. EUT SET-UPS	7
4. REFERENCE DOCUMENTS	8
4.1. DOCUMENTS SUPPLIED BY THE APPLICANT	8
4.2. REGULATIONS AND STANDARDS	8
5. LABORATORY ENVIRONMENT	9
6. SUMMARY OF TEST RESULTS	10
6.1. SUMMARY OF TEST RESULTS	10
6.2. TERMS USED IN THE SUMMARY OF TEST RESULTS	11
6.3. STATEMENTS	11
7. TEST EQUIPMENT UTILIZED	12
ANNEX A: MEASUREMENT RESULTS	13
A.1. ELECTRIC FIELD STRENGTH OF FUNDAMENTAL AND OUTSIDE THE ALLOCATED BANDS	13
A.2. ELECTRIC FIELD RADIATED EMISSIONS (< 30MHz)	15
A.3. ELECTRIC FIELD RADIATED EMISSIONS (≥30MHz)	17
A.4. FREQUENCY TOLERANCE	19
A.5. 20dB BANDWIDTH.....	20
A.6. CONDUCTED EMISSION	22
ANNEX A: ACCREDITATION CERTIFICATE	24

1. Test Laboratory

1.1. Testing Location

CTTL (Huayuan North Road)

Address: No. 52, Huayuan North Road, Haidian District, Beijing,
P. R. China 100191

CTTL(Shouxiang)

Address: No. 51 Shouxiang Science Building, Xueyuan Road,
Haidian District, Beijing, P. R. China 100191

1.2. Testing Environment

Normal Temperature: 15-35°C
Extreme Temperature: -10/+55°C
Relative Humidity: 20-75%

1.3 Project data

Testing Start Date: 2019-01-02
Testing End Date: 2019-01-18

1.4 Signature

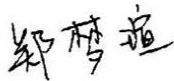

Zheng Mengxuan
(Prepared this test report)



Zhu Liang
(Reviewedthis test report)



Gao Hong
(Approved this test report)



2. Client Information

2.1. Applicant Information

Company Name: HMD Global OY
Address: Bertel Jungin aukio 9,02600 ESPOO,FINLAND
Country: FINLAND
Contact: Rosario Casillo
Tel: \
Email: Rosario.Casillo@hmdglobal.com

2.2 Manufacturer Information

Company Name: HMD Global OY
Address: Bertel Jungin aukio 9,02600 ESPOO,FINLAND
Country: FINLAND
Contact: Rosario Casillo
Tel: \
Email: Rosario.Casillo@hmdglobal.com

3. Equipment Under Test (EUT) and Ancillary Equipment (AE)

3.1. About EUT

Description:	Multi-band GSM/WCDMA/LTE phone with Bluetooth, WLAN GSM 850,900, 1800,1900 WCDMA: 1,2,4,5,8 LTE: 1,2,3,4,5,7,8,12/17,28,38,66 mobile phone, Bluetooth 4.2, WIFI 802.11 b/g/n
FCC ID	2AJOTTA-1149
With NFC Function:	Yes
Frequency:	13.56 MHz
Antenna:	Internal
Operation Voltage:	3.5VDC to 4.4VDC (nominal: 3.9VDC)
Operation Temperature:	-10°C to +55°C

Note1: Photographs of EUT are shown in ANNEX B of this test report. For component list, please refer to documents of the manufacturer.

3.2. Internal Identification of EUT Used during the Test

Mobile phone identification

EUT ID*	IMEI	HW Version	SW Version
EUT3	352900100018964	89571_1_12	00XX_1_XXX
EUT45	352900100018287	89571_1_12	00XX_1_XXX

*EUT ID: is used to identify the test sample in the lab internally.

3.3. Internal Identification of AE Used during the Test

AE ID*

AE1	Battery	/	/
AE2	Battery	/	/
AE3	Charger	/	/
AE5	USB Cable	/	/
AE6	USB Cable	/	/
AE8	PICC Card	/	/
AE9	Charger	/	NO TEST

AE1

Model	WT330
Manufacturer	Jiade Energy Technology(Zhuhai) Co.,Ltd.
Capacitance	3000mAh
Nominal voltage	3.85V

AE2

Model	WT330
-------	-------



Manufacturer	Sunwoda Electronic Co.,Ltd
Capacitance	3000mAh
Nominal voltage	3.85V
AE3	
Model	CH-35U
Manufacturer	Shenzhen Tianyin Electronics Co.,Ltd
Length of cable	/
AE5	
Model	CB-35A
Manufacturer	Leagtech Electronics Co.,Ltd
Length of cable	/
AE6	
Model	CB-35A
Manufacturer	Shenzhen BRL Technology Co.,Ltd.
Length of cable	/
AE8	
Model	PICC Card
Manufacturer	/
Length of cable	/
AE9	
Model	CH-35E
Manufacturer	Shenzhen Tianyin Electronics Co.,Ltd
Length of cable	/

*AE ID: is used to identify the test sample in the lab internally.

3.4. General Description

This is a product supporting Multi-band GSM/WCDMA/LTE phone with Bluetooth, WLAN GSM 850,900,1800,1900, WCDMA:1,2,4,5,8, LTE:1,2,3,4,5,7,8,12/17,28,38,66mobile phone, Bluetooth 4.2, WIFI 802.11 b/g/n.

Manuals and specifications of the EUT were provided to fulfil the test.

Samples undergoing test were selected by the client.

Manufacturer's declaration: NFC work does not depend on other access methods, such as WLAN, GPRS, etc.

3.5. EUT Set-ups

EUT Set-up No.	Combination of EUT and AE	Remarks
Set. NFC01	EUT3 + AE1 + AE3+ AE5 + AE8	--
Set. NFC02	EUT 45	--
Set. NFC03	EUT3 + AE8	--

The Transmit State of NFC: the NFC function is on. The EUT will transmit the NFC data and command continuously during the test.

The Transmit State of without modulation: The EUT will transmit the CW signal at the operating frequency.



4. Reference Documents

4.1. Documents Supplied by the Applicant

EUT feature information is supplied by the applicant or manufacturer, which is the basis of testing.

4.2. Regulations and Standards

The following documents listed in this section are referred for testing.

Reference	Title	Version
CFR 47 Part 2	Part 2 — Frequency Allocations and Radio Treaty Matters; General Rules and Regulations.	2016
CFR 47 Part 15	Part 15 — Radio Frequency Devices. Subpart C — Intentional Radiators. § 15.35 Measurement detector functions and bandwidths. § 15.207 Conducted limits. § 15.209 Radiated emission limits, general requirements. § 15.215 Additional provisions to the general radiated emission limitations. § 15.225 Operation within the band 13.110–14.010 MHz.	2016
ANSI C63.10	American National Standard of Procedures for Compliance Testing of Unlicensed Wireless Devices	2013

5. LABORATORY ENVIRONMENT

Semi-anechoic chamber SAC-1 (23 meters×17meters×10meters) did not exceed following limits along the EMC testing:

Temperature	Min. = 15 °C, Max. = 35 °C
Relative humidity	Min. = 15 %, Max. = 75 %
Shielding effectiveness	0.014MHz - 1MHz, >60dB; 1MHz - 1000MHz, >90dB.
Electrical insulation	> 2 MΩ
Ground system resistance	< 4Ω
Normalised site attenuation (NSA)	< ± 4 dB, 3m/10m distance, from 30 to 1000 MHz
Site voltage standing-wave ratio (S_{VSWR})	Between 0 and 6 dB, from 1GHz to 18GHz
Uniformity of field strength	Between 0 and 6 dB, from 80 to 3000 MHz

Fully-Anechoic Chamber FAC-3 (8.6m×6.1m×3.85m) did not exceed following limits along the testing:

Temperature	Min. = 15 °C, Max. = 25 °C
Relative humidity	Min. = 30 %, Max. = 60 %
Shielding effectiveness	> 110 dB
Electrical insulation	> 2 MΩ
Ground system resistance	< 1 Ω
Site voltage standing-wave ratio (S_{VSWR})	Between 0 and 6 dB, from 1 to 18GHz
Uniformity of field strength	Between 0 and 6 dB, from 80 to 4000 MHz

Conducted Chamber did not exceed following limits along the testing:

Temperature	Min. = 15 °C, Max. = 25 °C
Relative humidity	Min. = 30 %, Max. = 60 %
Shielding effectiveness	> 110 dB
Electrical insulation	> 2 MΩ
Ground system resistance	< 0.5 Ω

Control Room did not exceed following limits along the testing:

Temperature	Min. = 15 °C, Max. = 25 °C
Relative humidity	Min. =30 %, Max. = 60 %
Shielding effectiveness	> 110 dB
Electrical insulation	> 2 MΩ
Ground system resistance	< 0.5 Ω

6. SUMMARY OF TEST RESULTS

6.1. Summary of Test Results

No	Test Cases	Clause in Regulation	Section in This Report	Verdict
1	Electric Field Strength of Fundamental Emissions	CFR 47 § 15.225(a)	A.1	P (Set. NFC03)
2	Electric Field Strength of Outside the Allocated Bands	CFR 47 § 15.225(b) CFR 47 § 15.225(c)		P (Set. NFC03)
3	Electric Field Radiated Emissions	CFR 47 § 15.209	A.2	P (Set. NFC01)
		CFR 47 § 15.225(d)	A.3	P (Set. NFC01)
4	Frequency Tolerance	CFR 47 § 15.225(e)	A.4	P (Set. NFC02)
5	20dB Bandwidth	CFR 47 § 15.215(c)	A.5	P (Set. NFC02)
6	Conducted Emissions	CFR 47 § 15.207	A.6	P (Set. NFC01)
The measurement is carried out according to ANSI C63.10. See ANNEX A for details.				

Test Conditions:

For this report, all the test cases listed above were tested under normal Temperature, Voltage, humidity, and Air Pressure. The specific conditions are as following:

Temperature	T min	-20 °C
	T nom	25 °C
	T max	55 °C
Voltage	V min	3.6 V
	V nom	3.8 V
	V max	4.2 V
Humidity	H nom	44%
Air Pressure	A nom	1010 mbar

6.2. Terms Used in the Summary of Test Results

Terms Used in Condition Column:

T nom	Normal Temperature
T min	Low Temperature
T max	High Temperature
V nom	Normal Voltage
V min	Low Voltage
V max	High voltage
H nom	Norm Humidity
A nom	Norm Air Pressure

Terms Used in Verdict Column:

P	Pass, The EUT complies with the essential requirements in the standard.
NP	Not Perform, The test was not performed by CTTL
NA	Not Applicable, The test was not applicable
F	Fail, The EUT does not comply with the essential requirements in the standard

Abbreviations:

AC	Alternating Current
AFH	Adaptive Frequency Hopping
BW	Band Width
E.I.R.P.	equivalent is tropical radiated power
ISM	Industrial, Scientific and Medical
RF	Radio Frequency
Tx	Transmitter

6.3. Statements

The test cases listed in Section 6.1 of this report for the EUT specified in Section 3 were performed by CTTL according to the reference documents in Section 4.

The EUT meets all applicable requirements of the regulations and standards in Section 4.2.

This report only deals with the NFC function among the features described in section 3.

7. Test Equipment Utilized

NO.	NAME	TYPE	SERIES NUMBER	PRODUCER	CAL. INTERVAL	CAL. DUE DATE
1.	LISN	ESH3-Z5	825562/028	Rohde & Schwarz	1 year	2019-08-22
2.	Test Receiver	ESCI	100766	Rohde & Schwarz	1 year	2019-04-16
3.	Test Receiver	ESU26	100376	Rohde & Schwarz	1 year	2019-11-27
4.	BiLog Antenna	VULB9163	9163-514	Schwarz beck	3 years	2019-02-03
5.	Dual-Ridge Waveguide Horn Antenna	3117	00139065	ETS-Lindgren	3 years	2020-09-21
6.	H-field Antenna	HFH2-Z2	829324/007	R&S	3 years	2019-12-03
7.	Vector Signal Analyser	FSV40	101047	Rohde & Schwarz	1 year	2019-07-27
8.	Spectrum Analyzer	RSA3408A	B010277	Tektronix	1 Year	2019-09-20

ANNEX A: MEASUREMENT RESULTS

A.1. Electric Field Strength of Fundamental and Outside the Allocated bands

A.1.1. Reference

See Clause 6.4 of ANSI C63.10-2013 specifically.

See Clause 4 and Clause 5 of ANSI C63.10-2013 generally.

A.1.2. Measurement Methods

The transmitter carrier output levels (E-Field) from the EUT are measured in a semi-anechoic chamber. The EUT is placed on a non-conductive stand of 80cm high, and at a measurement distance of 3m from the receiving antenna. The center of the receiving loop antenna is 1.0 meter above the ground. The E-field is measured with a shielded loop antenna connected to a measurement receiver. Detected E-field was maximized by rotating the EUT through 360° and adjusting the receiving antenna polarizations. The maximization processes were repeated with the EUT positioned respectively in its three orthogonal axes. The measurements were performed with the peak detector and if required, the quasi-peak detector.

The measurement bandwidth is:

Frequency of Emission (MHz)	RBW/VBW
12.56-14.56	10/30 kHz

The E-field measured at 3m is calculated as:

$$\text{E-field (dB}\mu\text{V/m)} = \text{Rx (dB}\mu\text{V)} + \text{Cable Loss (dB)} + \text{AF@3m (dB/m)}$$

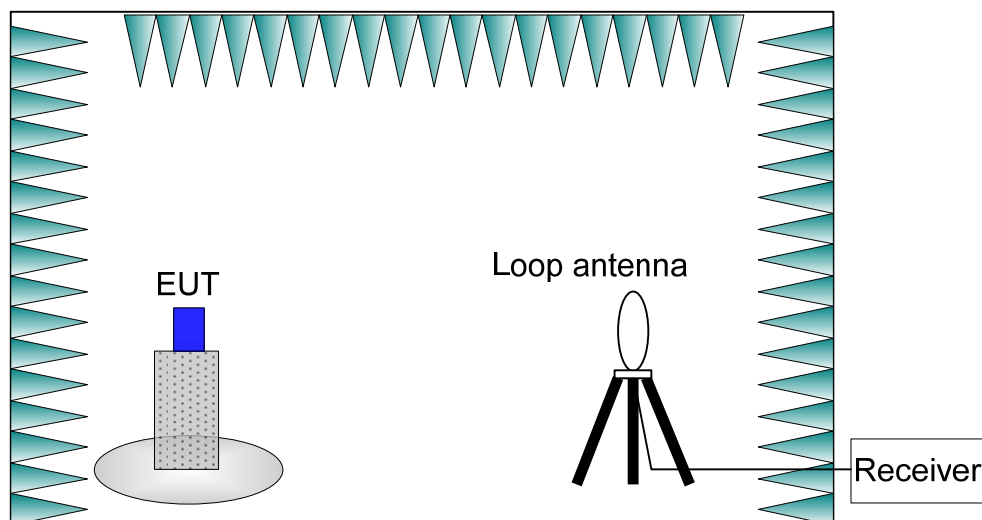

A.1.3. EUT Operating Mode and Test Conditions

The measurement of EUT is carried out under the transmit state of NFC (See 3.5).

The EUT is powered by a travel adapter.

During the measurements, the ambient temperature of the electromagnetic anechoic chamber is

in the range of 15 ~ 25 °C.

A.1.4. Limits

Frequency Range (MHz)	E-field Strength Limit @ 30 m (μV/m)	E-field Strength Limit @ 3 m (dBμV/m)
13.560 ± 0.007	+15,848	124
13.410 to 13.553 13.567 to 13.710	+334	90
13.110 to 13.410 13.710 to 14.010	+106	81

Note: Where the limits have been defined at one distance, and a signal level measured at another, the limits have been extrapolated using the following formula:

$$\text{Extrapolation(dB)} = 40\log_{10}(\text{Measurement Distance}/\text{Specification Distance})$$

A.1.5. Measurement Results

Measurement results of normal conditions see Figure A-1 for different set-ups of EUT. The result displayed take into account applicable antenna factors and cable losses.

Conclusions: Set. NFC03, **PASS**.

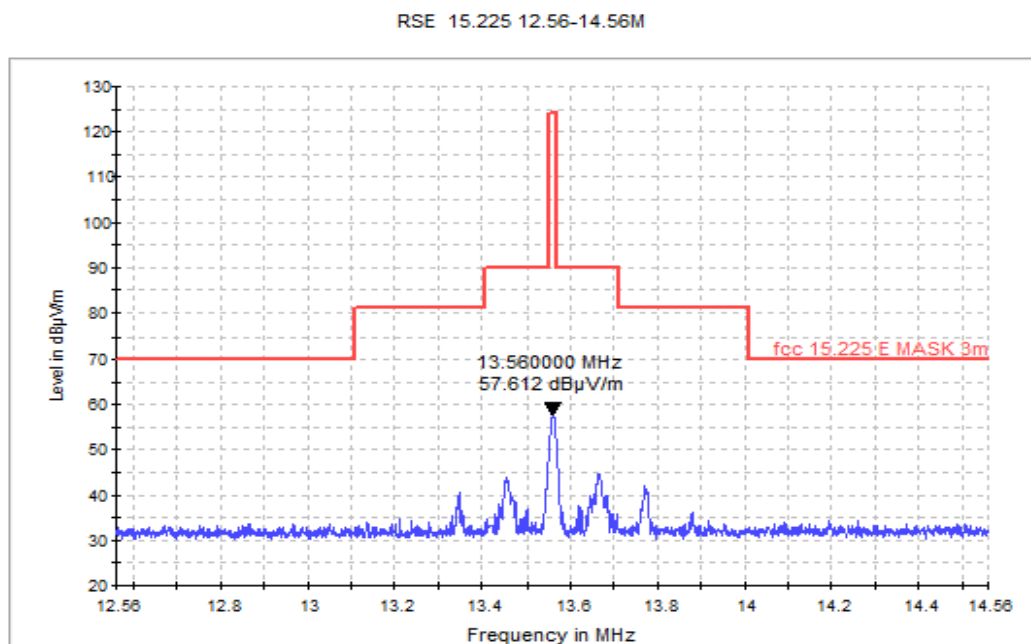

Figure A-1: Set. NFC03

A.1.6. Measurement Uncertainty

Measurement uncertainty: $U = 3.44$ dB, $k=2$.

A.2. Electric Field Radiated Emissions (< 30MHz)

A.2.1. Reference

See Clause 6.4 of ANSI C63.10-2013 specifically.

See Clause 4 and Clause 5 of ANSI C63.10-2013 generally.

A.2.2. Measurement Methods

The transmitter carrier output levels (E-Field) from the EUT are measured in a semi-anechoic chamber. The EUT is placed on a non-conductive stand of 80cm high, and at a measurement distance of 3m from the receiving antenna. The center of the receiving loop antenna is 1.0 meter above the ground. The E-field is measured with a shielded loop antenna connected to a measurement receiver. Detected E-field was maximized by rotating the EUT through 360° and adjusting the receiving antenna polarizations. The maximization processes were repeated with the EUT positioned respectively in its three orthogonal axes. The measurements were performed with the peak detector and if required, the quasi-peak detector.

The measurement bandwidth is:

Frequency of Emission (MHz)	RBW/VBW
0.009-0.15	100/300 Hz
0.15-30	10/30 kHz

The E-field measured at 3m is calculated as:

$$\text{E-field (dB}\mu\text{V/m)} = \text{Rx (dB}\mu\text{V)} + \text{Cable Loss (dB)} + \text{AF@3m (dB/m)}$$

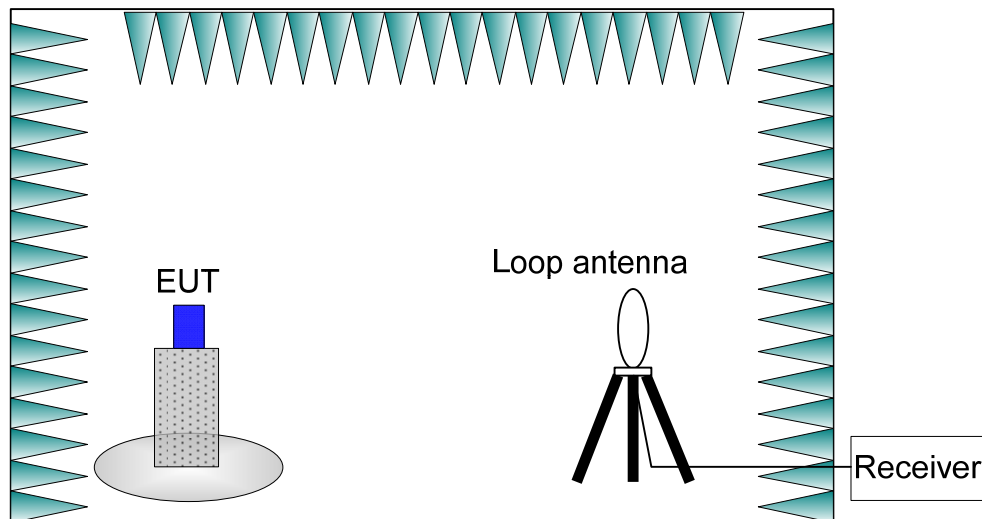

A.2.3. EUT Operating Mode and Test Conditions

The measurement of EUT is carried out under the transmit state of NFC (See 3.5).

The EUT is powered by a travel adapter.

During the measurements, the ambient temperature of the electromagnetic anechoic chamber is in the range of 15 ~ 25 °C.

A.2.4. Limits

Frequency Range (MHz)	E-field Strength Limit @ 30m (mV/m)	E-field Strength Limit @ 3m (dB μ V/m)
0.009-0.490	2400/F(kHz)	129-94
0.490-1.705	24000/F(kHz)	74-63
1.705-30	30	70

Note: Where the limits have been defined at one distance, and a signal level measured at another, the limits have been extrapolated using the following formula:

$$\text{Extrapolation(dB)} = 40\log_{10}(\text{Measurement Distance}/\text{Specification Distance})$$

A.2.5. Measurement Results

Measurement results of normal conditions see Figure A-2 for different set-ups of EUT. The result displayed take into account applicable antenna factors and cable losses.

Conclusions: Set. NFC01, **PASS**.

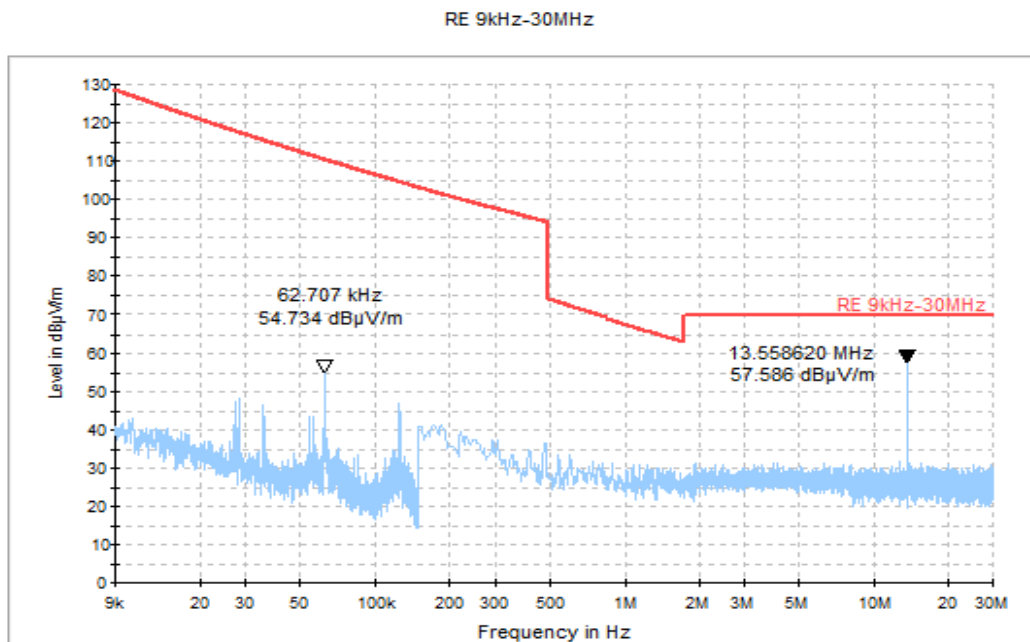

Figure A-2: Set. NFC01

A.2.6. Measurement Uncertainty

Measurement uncertainty: $U = 3.44$ dB, $k=2$.

A.3. Electric Field Radiated Emissions ($\geq 30\text{MHz}$)

A.3.1. Reference

See Clause 6.5 of ANSI C63.10-2013 specifically.

See Clause 4 and Clause 5 of ANSI C63.10-2013 generally.

A.3.2. Measurement Methods

The electric field radiated emissions from the EUT are measured in a semi-anechoic chamber. The EUT is placed on a non-conductive stand of 80cm high, and at a measurement distance of 3/10m from the receiving antenna. The receiving antennas connected to a measurement receiver. In order to search for maximum field strength emitted from the EUT, the receiving antenna can be moved between the height of 1.0 m to 4.0 m. Detected E-field was maximized at each frequency by rotating the EUT through 360° and adjusting the receiving antenna positions for both vertical and horizontal antenna polarizations. The maximization processes were repeated with the EUT positioned respectively in its three orthogonal axes. The measurements were performed with the peak detector and if required, the quasi-peak detector.

The measurement bandwidth is:

Frequency of Emission (MHz)	RBW/VBW
30-1000	120kHz

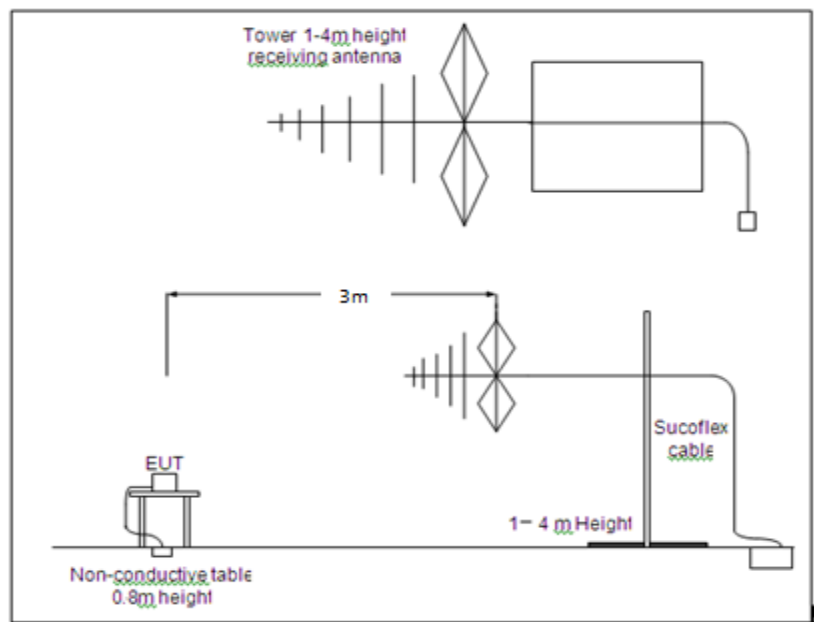

A.3.3. EUT Operating Mode and Test Conditions

The measurement of EUT is carried out under the transmit state of NFC (See 3.5).

EUT1 had been connected to a travel adapter.

During the measurements, the ambient temperature of the electromagnetic anechoic chamber is in the range of 15 ~ 25 °C.

A.3.4. Limits

Frequency Range (MHz)	E-field Strength Limit @ 3m (mV/m)	E-field Strength Limit @ 3m (dB μ V/m)	E-field Strength Limit @ 10m (dB μ V/m)
30-88	100	40	30
88-216	150	43.5	33.5
216-960	200	46	36
960-1000	500	54	44

A.3.5. Measurement Results

Measurement results of normal conditions see Figure A-3 for different set-ups of EUT. The result displayed take into account applicable antenna factors and cable losses.

Conclusions: Set. NFC01, **PASS**.

A.3.6. Measurement Uncertainty

Measurement uncertainty: $U = 5.40$ dB, $k=2$

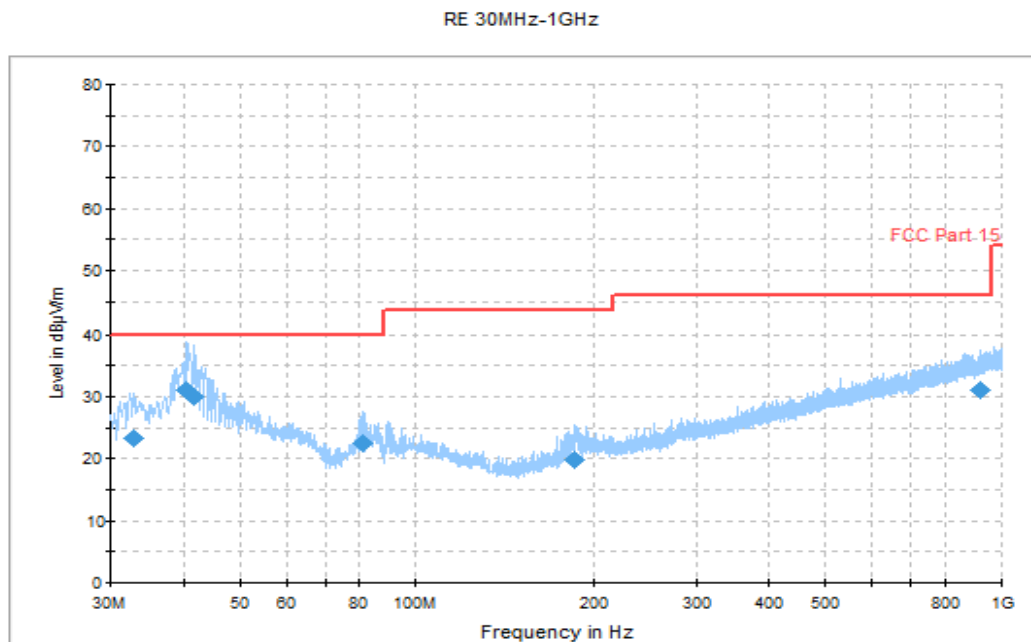

Figure A-3: Set. NFC01

Final Result 1

Frequency (MHz)	QuasiPeak (dB μ V/m)	Height (cm)	Polarization	Azimuth (deg)	Corr. (dB)	Margin (dB)	Limit (dB μ V/m)
33.007000	23.2	125.0	V	-38.0	-0.8	16.8	40.0
40.573000	31.1	100.0	V	93.0	0.8	8.9	40.0
41.834000	29.9	100.0	V	126.0	0.8	10.1	40.0
81.216000	22.5	100.0	V	266.0	-5.4	17.5	40.0
186.26700	19.8	100.0	V	14.0	-2.5	23.7	43.5
916.58000	31.1	118.0	V	-34.0	12.2	14.9	46.0

A.4. Frequency Tolerance

A.4.1. Reference

See Clause 13.6 of ANSI C63.10-2013 specifically.

See Clause 4, Clause 5, and Clause 6 of ANSI C63.10-2013 generally.

A.4.2. Measurement Methods

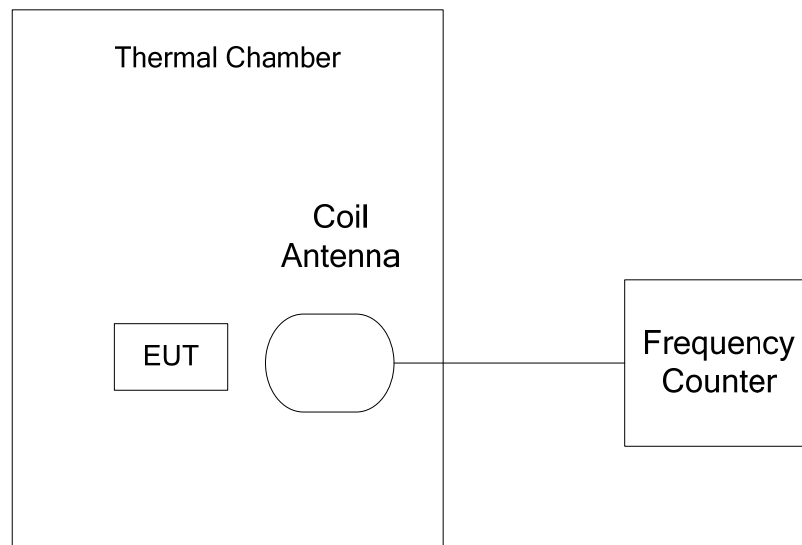

The transmitter output signal was picked up by coil antenna connected to the frequency counter. The center frequency was measured with 30Hz RBW and 1kHz span.

During the test, the EUT was placed in a thermal chamber until thermal balance and lasting appropriate time.

A.4.3. EUT Operating Mode and Test Conditions

The measurement of EUT is carried out under the transmit state of without modulation (See 3.5).

EUT1 had been not connected to a travel adapter.

Operation Temperature: T min, T nom, and T max with V nom.

Operation Voltage: V min and V max with T nom.

A.4.4. Test Layouts

See A.4.2.

A.4.5. Limits

The frequency tolerance of the carrier signal shall be maintained within +/- 0.01% of the operating frequency.

A.4.6. Measurement Results

Measurement results see Table A-1 for different test conditions.

Conclusions: Set. NFC02, **PASS**.

Table A-1: Frequency Stability VS Temperature and Voltage

Temperature	Voltage	Frequency Error (MHz)			
		Startup	2 Min Later	5 Min Later	10 Min Later
T min	V nom	13.5600331	13.5600425	13.5600369	13.5600331
T max	V nom	13.5599881	13.5599738	13.5599713	13.5599750
T nom	V nom	13.5600006	13.5604050	13.5599994	13.5599999
T nom	V min	13.5599919	13.5599938	13.5599931	13.5603900
T nom	V max	13.5599863	13.5599906	13.5599925	13.5599938

Temperature	Voltage	Frequency Error (%)			
		Startup	2 Min Later	5 Min Later	10 Min Later
T min	V nom	0.000	0.000	0.000	0.000
T max	V nom	0.000	0.000	0.000	0.000
T nom	V nom	0.000	0.003	0.000	0.000
T nom	V min	0.000	0.000	0.000	0.003
T nom	V max	0.000	0.000	0.000	0.000

A.4.7. Measurement Uncertainty

Measurement uncertainty: $U = 77$ Hz, $k=2$

A.5. 20dB Bandwidth

A.5.1. Reference

See Clause 13.7 of ANSI C63.10-2013 specifically.

See Clause 4, Clause 5, and Clause 6 of ANSI C63.10-2013 generally.

A.5.2. Measurement Methods

The transmitter output signal was picked up by coil antenna to the spectrum analyzer.

The transmitter output signal was picked up by coil antenna connected to the spectrum analyzer.

The bandwidth of the center frequency was measured with 140Hz RBW, 420Hz VBW and 14kHz span.

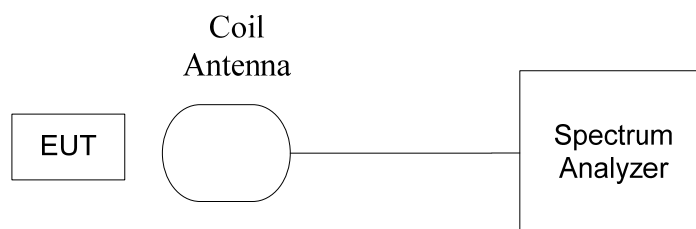

A.5.3. EUT Operating Mode and Test Conditions

The measurement of EUT is carried out under the transmit state of NFC and without modulation (See 3.5).

EUT had been not connected to a travel adapter.

During the measurements, the ambient temperature is in the range of 15 ~ 25 °C.

A.5.4. Test Layouts

See A.5.2.

A.5.5. Limits

The 20dB bandwidth shall be less than 80% of the permitted frequency band. For 13.56 MHz NFC, the permitted frequency band is 14kHz, so the limit is 11.2 kHz.

A.5.6. Measurement Results

Measurement results see Figure A-4.

Conclusions: Set. NFC02, PASS.

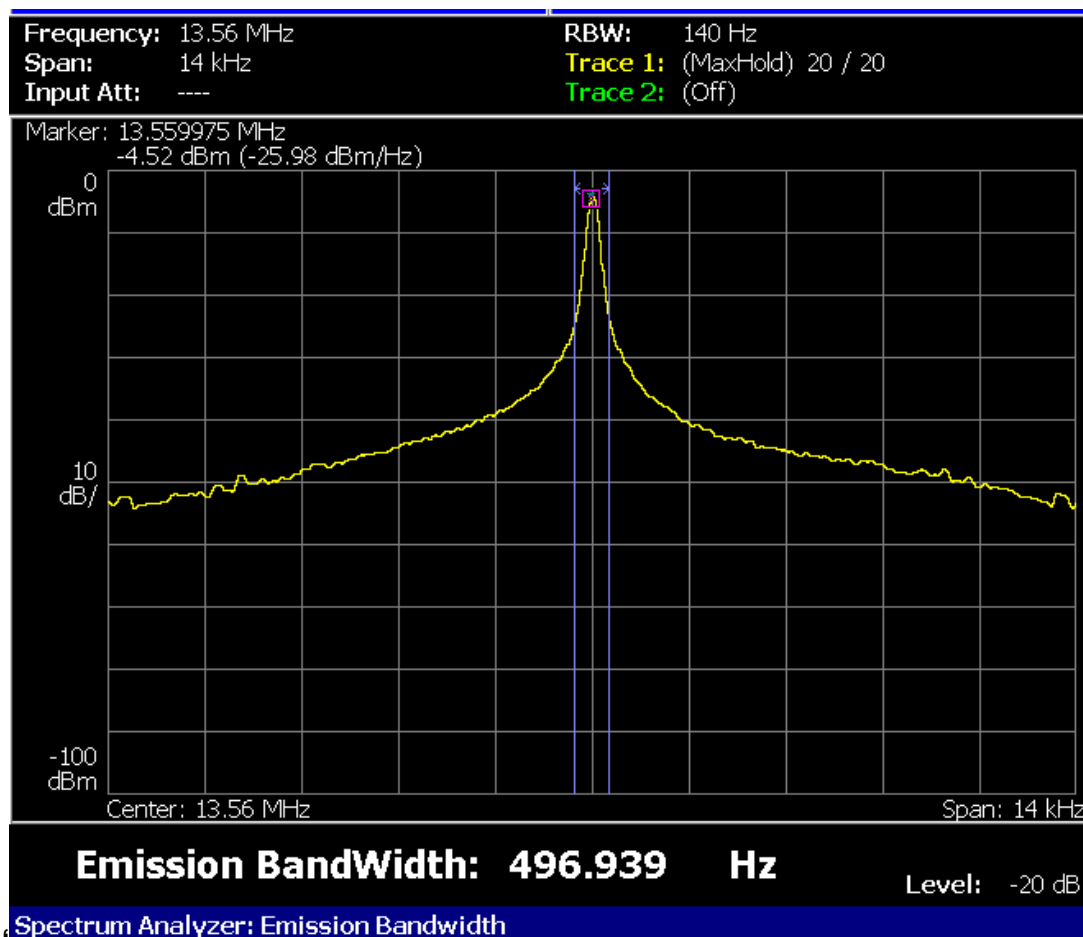

Figure A-4: Test result of EUT45 at test set. NFC02

A.5.7. Measurement Uncertainty

Measurement uncertainty: $U = 77$ Hz, $k=2$

A.6. Conducted emission

A.6.1. Reference

See Clause 6.2 of ANSI C63.10-2013 specifically.

See Clause 4 and Clause 5 of ANSI C63.10-2013 generally.

A.6.2. Measurement Methods

The conducted emissions from the AC port of the EUT are measured in a shielding room. The EUT is connected to a Line Impedance Stabilization Network (LISN). An overview sweep with peak detection was performed. The measurements were performed with a quasi-peak detector and if required, an average detector.

The conducted emission measurements were made with the following detector of the test receiver: Quasi-Peak / Average Detector.

The measurement bandwidth is:

Frequency of Emission (MHz)	RBW/VBW
0.15-30	9kHz

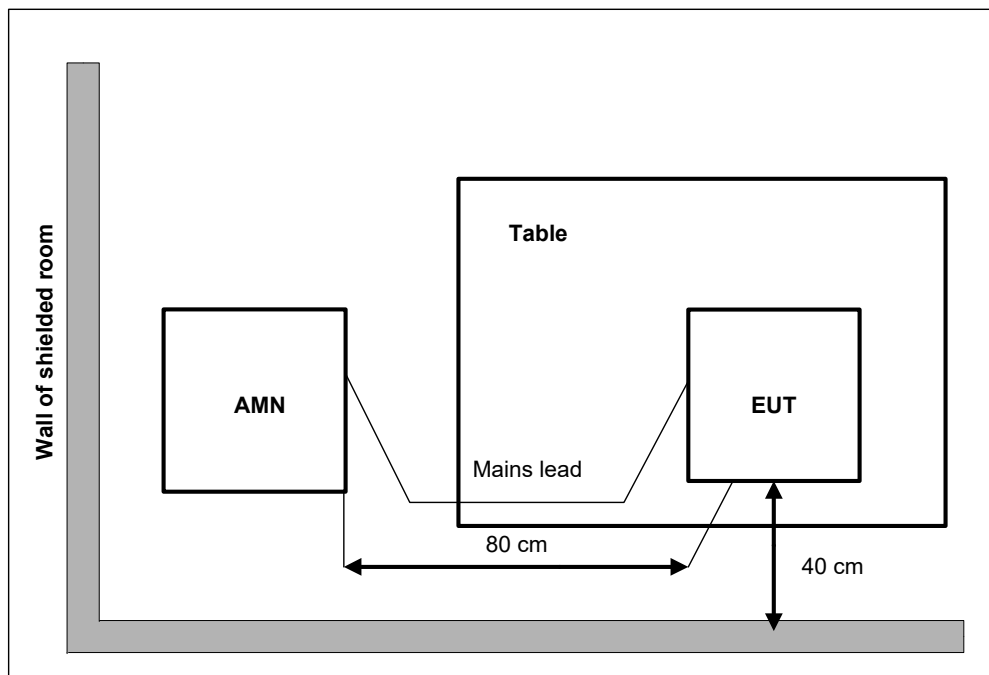

A.6.3. EUT Operating Mode and Test Conditions

The measurement of EUT is carried out under the transmit state of NFC (See 3.5).

The EUT is powered by a travel adapter.

During the measurements, the ambient temperature is in the range of 15 ~ 25 °C.

A.6.4. Limits

Frequency range (MHz)	Quasi-peak Limit (dB μ V)	Average Limit (dB μ V)
0.15 to 0.5	66 to 56	56 to 46
0.5 to 5	56	46
5 to 30	60	50

A.6.5. Measurement Results

Measurement results see Figure A-5.

Conclusions: Set. NFC01, **PASS.**

Note: The measurement result at 13.56MHz is the fundamental emission of NFC signal.

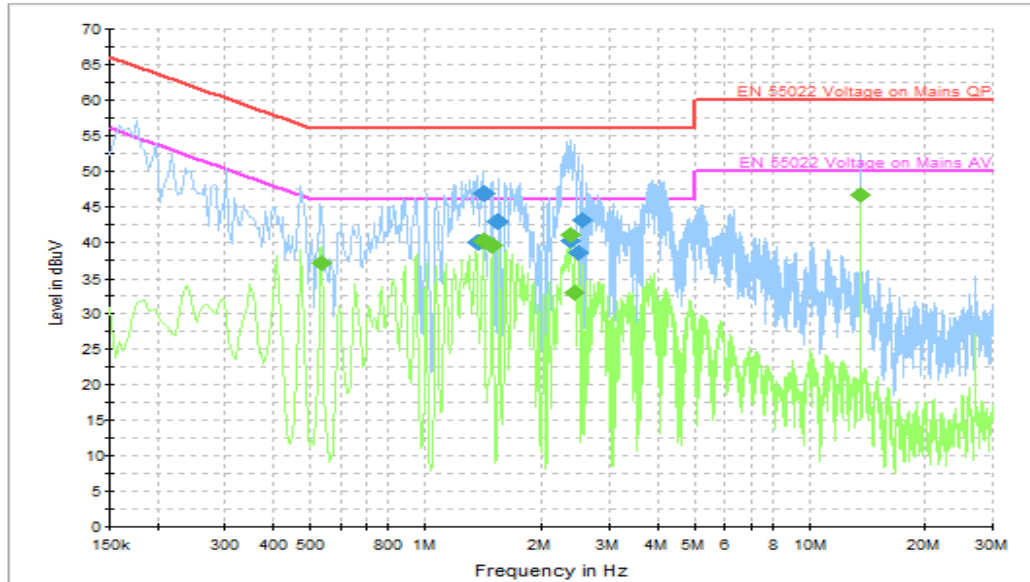

Figure A-5: Test result of EUT1 at test set. NFC01

Final Result 1

Frequency (MHz)	QuasiPeak (dBµV)	Meas. Time (ms)	Bandwidth (kHz)	Line	Corr. (dB)	Margin (dB)	Limit (dBµV)
1.365000	39.9	2000.0	9.000	L1	10.4	16.1	56.0
1.410000	46.9	2000.0	9.000	L1	10.4	9.1	56.0
1.540500	42.9	2000.0	9.000	L1	10.4	13.1	56.0
2.373000	40.1	2000.0	9.000	N	10.4	15.9	56.0
2.485500	38.5	2000.0	9.000	L1	10.4	17.5	56.0
2.544000	43.0	2000.0	9.000	L1	10.4	13.0	56.0

Final Result 2

Frequency (MHz)	Average (dBµV)	Meas. Time (ms)	Bandwidth (kHz)	Line	Corr. (dB)	Margin (dB)	Limit (dBµV)
0.537000	37.1	2000.0	9.000	N	10.4	6.6	46.0
1.414500	40.2	2000.0	9.000	L1	10.4	5.1	46.0
1.477500	39.4	2000.0	9.000	N	10.4	13.0	46.0
2.359500	40.9	2000.0	9.000	L1	11.0	3.3	50.0
2.431500	33.0	2000.0	9.000	N	10.4	6.6	46.0
13.560000	46.7	2000.0	9.000	L1	10.4	5.1	46.0

A.6.6. Measurement Uncertainty

Measurement uncertainty: $U = 3.1$ dB, $k=2$

ANNEX A: Accreditation Certificate

**United States Department of Commerce
National Institute of Standards and Technology**

NVLAP[®]

Certificate of Accreditation to ISO/IEC 17025:2005

NVLAP LAB CODE: 600118-0

Telecommunication Technology Labs, CAICT
Beijing
China

*is accredited by the National Voluntary Laboratory Accreditation Program for specific services,
listed on the Scope of Accreditation, for:*

Electromagnetic Compatibility & Telecommunications

*This laboratory is accredited in accordance with the recognized International Standard ISO/IEC 17025:2005.
This accreditation demonstrates technical competence for a defined scope and the operation of a laboratory quality
management system (refer to joint ISO-ILAC-IAF Communique dated January 2009).*

2018-09-28 through 2019-09-30
Effective Dates



For the National Voluntary Laboratory Accreditation Program

END OF REPORT