



HAC RF TEST REPORT

No. I18Z62361-SEM05

For

HMD Global OY

**Multi-band GSM/WCDMA/LTE phone with Bluetooth, WLAN GSM
850,900,1800,1900 WCDMA : 1,2,4,5,8 LTE : 1,2, 3,4,5,7,8,12/17,28,38,66
mobile phone, Bluetooth 4.2, WIFI 802.11 b/g/n**

Model name: TA-1133

With

Hardware Version: 89571_1_12

Software Version: 00XX_1_XXX

FCC ID: 2AJOTTA-1133

Results Summary: M Category = M4

Issued Date: 2019-01-30



Note:

The test results in this test report relate only to the devices specified in this report. This report shall not be reproduced except in full without the written approval of CTTL.

The report must not be used by the client to claim product certification, approval, or endorsement by NVLAP, NIST, or any agency of the U.S. Government.

Test Laboratory:

CTTL, Telecommunication Technology Labs, CAICT

No. 51, Xueyuan Road, Haidian District, Beijing, P. R. China 100191.

Tel:+86(0)10-62304633-2512, Fax:+86(0)10-62304633-2504



REPORT HISTORY

Report Number	Revision	Issue Date	Description
I18Z62361-SEM05	Rev.0	2019-01-30	Initial creation of test report

TABLE OF CONTENT

1 TEST LABORATORY	5
1.1 TESTING LOCATION	5
1.2 TESTING ENVIRONMENT	5
1.3 PROJECT DATA.....	5
1.4 SIGNATURE.....	5
2 CLIENT INFORMATION	6
2.1 APPLICANT INFORMATION	6
2.2 MANUFACTURER INFORMATION	6
3 EQUIPMENT UNDER TEST (EUT) AND ANCILLARY EQUIPMENT (AE).....	7
3.1 ABOUT EUT	7
3.2 INTERNAL IDENTIFICATION OF EUT USED DURING THE TEST	7
3.3 INTERNAL IDENTIFICATION OF AE USED DURING THE TEST	7
3.4 AIR INTERFACES / BANDS INDICATING OPERATING MODES	7
4 CONDUCTED OUTPUT POWER MEASUREMENT	8
5 REFERENCE DOCUMENTS.....	10
5.1 REFERENCE DOCUMENTS FOR TESTING	10
6 OPERATIONAL CONDITIONS DURING TEST	11
6.1 HAC MEASUREMENT SET-UP	11
6.2 PROBE SPECIFICATION	12
6.3 TEST ARCH PHANTOM & PHONE POSITIONER	13
6.4 ROBOTIC SYSTEM SPECIFICATIONS	13
7 EUT ARRANGEMENT	14
7.1 WD RF EMISSION MEASUREMENTS REFERENCE AND PLANE.....	14
8 SYSTEM VALIDATION	15
8.1 VALIDATION PROCEDURE	15
8.2 VALIDATION RESULT	15
9 EVALUATION OF MIF	16
9.1 INTRODUCTION.....	16
9.2 MIF MEASUREMENT WITH THE AIA.....	17
9.3 TEST EQUIPMENT FOR THE MIF MEASUREMENT.....	17
9.4 TEST SIGNAL VALIDATION.....	17
9.5 DUT MIF RESULTS	18
10 EVALUATION FOR LOW-POWER EXEMPTION	21
10.1 PRODUCT TESTING THRESHOLD	21
10.2 CONDUCTED POWER	21
10.3 CONCLUSION	22



11 RF TEST PROCEDURES.....	23
12 MEASUREMENT RESULTS (E-FIELD).....	24
13 ANSIC 63.19-2011 LIMITS	24
14 MEASUREMENT UNCERTAINTY	25
15 MAIN TEST INSTRUMENTS.....	26
16 CONCLUSION	26
ANNEX A TEST LAYOUT	27
ANNEX B TEST PLOTS	28
ANNEX C SYSTEM VALIDATION RESULT	43
ANNEX D PROBE CALIBRATION CERTIFICATE	46
ANNEX E DIPOLE CALIBRATION CERTIFICATE.....	57

1 Test Laboratory

1.1 Testing Location

CompanyName:	CTTL(Shouxiang)
Address:	No. 51 Shouxiang Science Building, Xueyuan Road, Haidian District, Beijing, P. R. China100191

1.2 Testing Environment

Temperature:	18°C~25°C,
Relative humidity:	30%~ 70%
Ground system resistance:	< 0.5 Ω
Ambient noise is checked and found very low and in compliance with requirement of standards. Reflection of surrounding objects is minimized and in compliance with requirement of standards.	

1.3 Project Data

Project Leader:	Qi Dianyuan
Test Engineer:	Lin Hao
Testing Start Date:	January 17, 2019
Testing End Date:	January 17, 2019

1.4 Signature



Lin Xiaojun
(Prepared this test report)

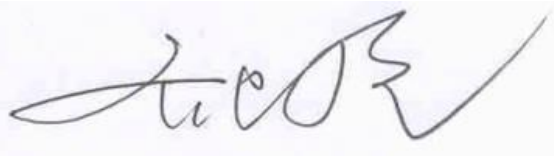

Qi Dianyuan
(Reviewed this test report)

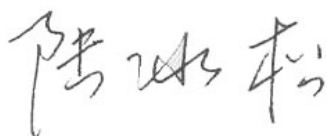

Lu Bingsong
Deputy Director of the laboratory
(Approved this test report)



2 Client Information

2.1 Applicant Information

Company Name:	HMD Global OY
Address /Post:	Bertel Jungin aukio 9, 02600 ESPOO, FINLAND
Contact:	Rosario Casillo
Email:	Rosario.Casillo@hmdglobal.com
Telephone:	\
Fax:	\

2.2 Manufacturer Information

Company Name:	HMD Global OY
Address /Post:	Bertel Jungin aukio 9, 02600 ESPOO, FINLAND
Contact:	Rosario Casillo
Email:	Rosario.Casillo@hmdglobal.com
Telephone:	\
Fax:	\

3 Equipment Under Test (EUT) and Ancillary Equipment (AE)

3.1 About EUT

Description:	Multi-band GSM/WCDMA/LTE phone with Bluetooth, WLAN GSM 850,900,1800,1900 WCDMA : 1,2,4,5,8 LTE : 1,2,3,4,5,7,8,12/17,28,38,66 mobile phone, Bluetooth 4.2, WIFI 802.11 b/g/n
Model name:	TA-1133
Operating mode(s):	GSM850/900/1800/1900, WCDMA850/900/1700/1900/2100, BT, Wi-Fi LTE Band 1,2,3,4, 5,7,8,12/17,28,38,66

3.2 Internal Identification of EUT used during the test

EUT ID*	IMEI	HW Version	SW Version
EUT1	352901100008245 352901100008252	89571_1_12	00XX_1_XXX
EUT2	352900100019020 352900100019038	89571_1_12	00XX_1_XXX
EUT3	352901100008500 352901100008518	89571_1_12	00XX_1_XXX

*EUT ID: is used to identify the test sample in the lab internally.

Note: It is performed to test HAC with the EUT1-2 and conducted power with the EUT3.

3.3 Internal Identification of AE used during the test

AE ID*	Description	Model	SN	Manufacturer
AE1	Battery	WT330	/	Jiade Energy Technology(Zhuhai) Co.,Ltd.
AE2	Battery	WT330	/	Sunwoda Electronic Co.,Ltd

*AE ID: is used to identify the test sample in the lab internally.

3.4 Air Interfaces / Bands Indicating Operating Modes

Air-interface	Band(MHz)	Type	C63.19/tested	Simultaneous Transmissions	OTT
GSM	850	VO	Yes	BT, WLAN	NA
	1900				
GPRS/EDGE	850	DT	NA		
	1900				
WCDMA (UMTS)	850	VO	Yes		
	1700				
	1900	DT	NA		
	HSPA				
LTE TDD	Band 38	V/D	Yes		
LTE FDD	Band 2/5/7/12/66	V/D	Yes		
BT	2450	DT	NA	GSM,WCDMA,LTE	NA
WLAN	2450	V/D	Yes	GSM,WCDMA,LTE	NA

VO: Voice CMRS/PSTN Service Only V/D: Voice CMRS/PSTN and Data Service DT: Digital Transport

* HAC Rating was not based on concurrent voice and data modes, Non current mode was found to represent worst case rating for both M and T rating

Note1 = No Associated T-Coil measurement has been made in accordance with 285076 D02 T-Coil testing for CMRS IP

4 CONDUCTED OUTPUT POWER MEASUREMENT

GSM 850MHz	Conducted Power (dBm)		
	Channel 251(848.8MHz)	Channel 190(836.6MHz)	Channel 128(824.2MHz)
	32.45	32.43	32.32
GSM 1900MHz	Conducted Power(dBm)		
	Channel 810(1909.8MHz)	Channel 661(1880MHz)	Channel 512(1850.2MHz)
	30.15	30.02	30.42
WCDMA 850MHz	Conducted Power (dBm)		
	Channel 4233(846.6MHz)	Channel 4182(836.4MHz)	Channel 4132(826.4MHz)
	24.11	24.05	24.18
WCDMA 1700MHz	Conducted Power (dBm)		
	Channel 1513 (1752.6MHz)	Channel 1412 (1732.4MHz)	Channel 1312 (1712.4MHz)
	24.38	24.42	24.31
WCDMA 1900MHz	Conducted Power (dBm)		
	Channel 9538(1907.6MHz)	Channel 9400(1880MHz)	Channel 9262(1852.4MHz)
	24.40	24.26	24.33
LTE Band2 QPSK	Conducted Power (dBm)		
	Channel 19100(1900MHz)	Channel18900(1880MHz)	Channel 18700(1860MHz)
	24.20	24.43	24.27
LTE Band2 16QAM	Conducted Power (dBm)		
	Channel 19100(1900MHz)	Channel18900(1880MHz)	Channel 18700(1860MHz)
	23.12	23.77	23.33
LTE Band2 64QAM	Conducted Power (dBm)		
	Channel 19100(1900MHz)	Channel18900(1880MHz)	Channel 18700(1860MHz)
	21.65	21.59	21.69
LTE Band5 QPSK	Conducted Power (dBm)		
	Channel 20600(844MHz)	Channel 20525(836.5MHz)	Channel20450(829MHz)
	23.59	23.51	23.53
LTE Band5 16QAM	Conducted Power (dBm)		
	Channel 20600(844MHz)	Channel 20525(836.5MHz)	Channel20450(829MHz)
	22.41	22.71	22.77
LTE Band5 64QAM	Conducted Power (dBm)		
	Channel 20600(844MHz)	Channel 20525(836.5MHz)	Channel20450(829MHz)
	20.89	20.93	21.26
LTE Band7 QPSK	Conducted Power (dBm)		
	Channel 21350(2560MHz)	Channel 21100(2535MHz)	Channel20850(2510MHz)
	24.56	24.04	23.80
LTE Band7 16QAM	Conducted Power (dBm)		
	Channel 21350(2560MHz)	Channel 21100(2535MHz)	Channel20850(2510MHz)
	23.29	23.08	23.20
LTE Band7	Conducted Power (dBm)		



64QAM	Channel 21350(2560MHz)	Channel 21100(2535MHz)	Channel20850(2510MHz)
	21.37	21.58	21.59
LTE Band12 QPSK	Conducted Power (dBm)		
	Channel 23130(711MHz)	Channel 23095(707.5MHz)	Channel23060(704MHz)
	23.43	23.64	23.30
LTE Band12 16QAM	Conducted Power (dBm)		
	Channel 23130(711MHz)	Channel 23095(707.5MHz)	Channel23060(704MHz)
	22.66	22.81	22.28
LTE Band12 64QAM	Conducted Power (dBm)		
	Channel 23130(711MHz)	Channel 23095(707.5MHz)	Channel23060(704MHz)
	20.91	20.98	20.98
LTE Band66 QPSK	Conducted Power (dBm)		
	Channel 132572(1770MHz)	Channel 132322(1745MHz)	Channel 132072(1720MHz)
	23.96	24.42	24.05
LTE Band66 16QAM	Conducted Power (dBm)		
	Channel 132572(1770MHz)	Channel 132322(1745MHz)	Channel 132072(1720MHz)
	23.06	23.08	23.10
LTE Band66 64QAM	Conducted Power (dBm)		
	Channel 132572(1770MHz)	Channel 132322(1745MHz)	Channel 132072(1720MHz)
	21.86	21.97	21.93
LTE Band38 QPSK	Conducted Power (dBm)		
	Channel 38150(2610MHz)	Channel 38000(2595MHz)	Channel 37850(2580MHz)
	24.04	23.86	23.62
LTE Band38 16QAM	Conducted Power (dBm)		
	Channel 38150(2610MHz)	Channel 38000(2595MHz)	Channel 37850(2580MHz)
	22.12	23.31	22.50
LTE Band38 64QAM	Conducted Power (dBm)		
	Channel 38150(2610MHz)	Channel 38000(2595MHz)	Channel 37850(2580MHz)
	20.67	20.58	20.60
2.4GHz 802.11b 1M	Conducted Power (dBm)		
	Channel 11 (2462MHz)	Channel 6 (2437MHz)	Channel 1 (2412MHz)
	16.92	17.03	16.75



5 Reference Documents

5.1 Reference Documents for testing

The following document listed in this section is referred for testing.

Reference	Title	Version
ANSI C63.19-2011	American National Standard for Methods of Measurement of Compatibility between Wireless Communication Devices and Hearing Aids	2011 Edition
FCC 47 CFR §20.19	Hearing Aid Compatible Mobile Headsets	2015 Edition
KDB 285076 D01	Equipment Authorization Guidance for Hearing Aid Compatibility	v05

6 OPERATIONAL CONDITIONS DURING TEST

6.1 HAC MEASUREMENT SET-UP

These measurements are performed using the DASY5 NEO automated dosimetric assessment system. It is made by Schmid & Partner Engineering AG (SPEAG) in Zurich, Switzerland. It consists of high precision robotics system (Stäubli), robot controller, Intel Core2 computer, near-field probe, probe alignment sensor. The robot is a six-axis industrial robot performing precise movements. A cell controller system contains the power supply, robot controller, teach pendant (Joystick), and remote control, is used to drive the robot motors. The PC consists of the HP Intel Core2 1.86 GHz computer with Windows XP system and HAC Measurement Software DASY5 NEO, A/D interface card, monitor, mouse, and keyboard. The Stäubli Robot is connected to the cell controller to allow software manipulation of the robot. A data acquisition electronic (DAE) circuit performs the signal amplification, signal multiplexing, AD-conversion, offset measurements, mechanical surface detection, collision detection, etc. is connected to the Electro-optical coupler (EOC). The EOC performs the conversion from the optical into digital electric signal of the DAE and transfers data to the PC plug-in card.

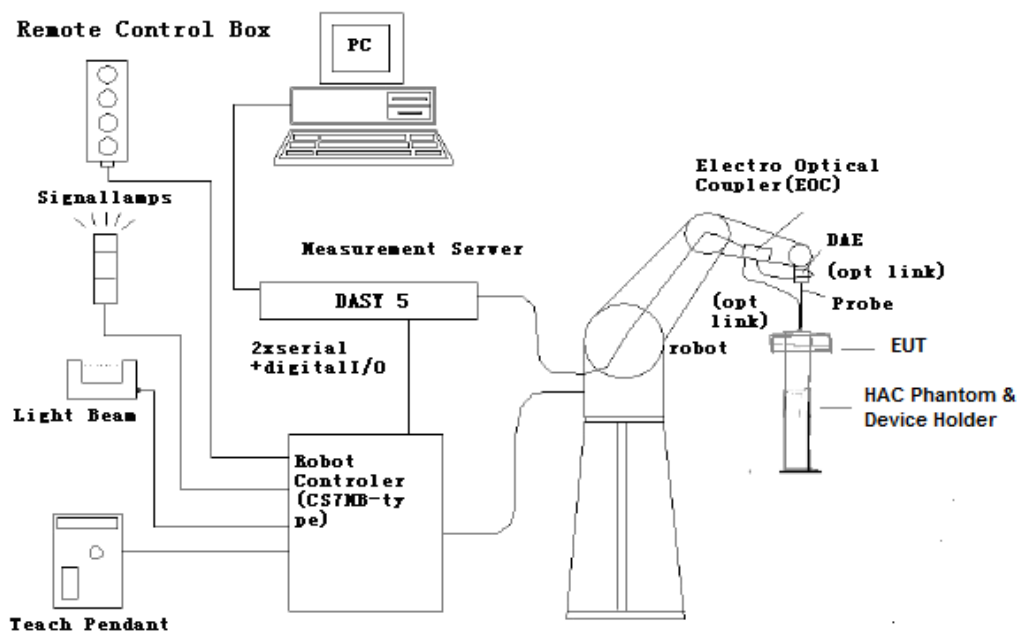

Fig. 1 HAC Test Measurement Set-up

The DAE4 consists of a highly sensitive electrometer-grade preamplifier with auto-zeroing, a channel and gain-switching multiplexer, a fast 16 bit AD-converter and a command decoder and control logic unit. Transmission to the PC-card is accomplished through an optical downlink for data and status information and an optical uplink for commands and clock lines. The mechanical probe mounting device includes two different sensor systems for frontal and sidewise probe contacts. They are also used for mechanical surface detection and probe collision detection. The robot uses its own controller with a built in VME-bus computer.

6.2 Probe Specification

E-Field Probe Description

Construction	One dipole parallel, two dipoles normal to probe axis Built-in shielding against static charges PEEK enclosure material
Calibration	In air from 100 MHz to 3.0 GHz (absolute accuracy $\pm 6.0\%$, k=2)
Frequency	40 MHz to > 6 GHz (can be extended to < 20 MHz) Linearity: ± 0.2 dB (100 MHz to 3 GHz)
Directivity	± 0.2 dB in air (rotation around probe axis) ± 0.4 dB in air (rotation normal to probe axis)
Dynamic Range	2 V/m to > 1000 V/m; Linearity: ± 0.2 dB
Dimensions	Overall length: 330 mm (Tip: 16 mm) Tip diameter: 8 mm (Body: 12 mm) Distance from probe tip to dipole centers: 2.5 mm
Application	General near-field measurements up to 6 GHz Field component measurements Fast automatic scanning in phantoms

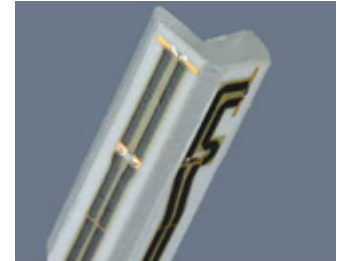

[ER3DV6]

6.3 Test Arch Phantom & Phone Positioner

The Test Arch phantom should be positioned horizontally on a stable surface. Reference markings on the Phantom allow the complete setup of all predefined phantom positions and measurement grids by manually teaching three points in the robot. It enables easy and well defined positioning of the phone and validation dipoles as well as simple teaching of the robot (Dimensions: 370 x 370 x 370 mm).

The Phone Positioner supports accurate and reliable positioning of any phone with effect on near field $< \pm 0.5$ dB.

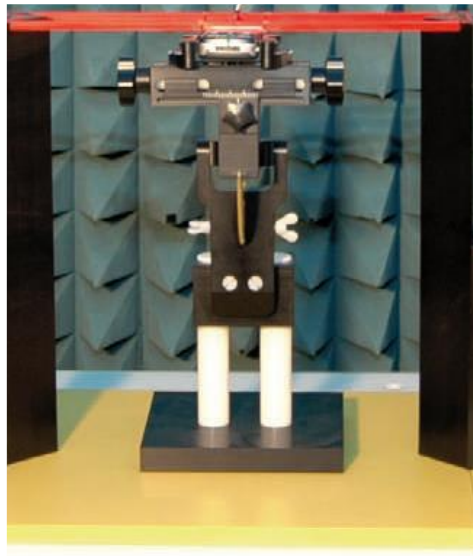

Fig. 2 HAC Phantom & Device Holder

6.4 Robotic System Specifications

Specifications

Positioner: Stäubli Unimation Corp. Robot Model: RX160L

Repeatability: ± 0.02 mm

No. of Axis: 6

Data Acquisition Electronic (DAE) System

Cell Controller

Processor: Intel Core2

Clock Speed: 1.86GHz

Operating System: Windows XP

Data Converter

Features: Signal Amplifier, multiplexer, A/D converter, and control logic

Software: DASY5 software

Connecting Lines: Optical downlink for data and status info.

Optical uplink for commands and clock

7 EUT ARRANGEMENT

7.1 WD RF Emission Measurements Reference and Plane

Figure 4 illustrates the references and reference plane that shall be used in the WD emissions measurement.

- The grid is 5 cm by 5 cm area that is divided into 9 evenly sized blocks or sub-grids.
- The grid is centered on the audio frequency output transducer of the WD (speaker or T-coil).
- The grid is located by reference to a reference plane. This reference plane is the planar area that contains the highest point in the area of the WD that normally rests against the user's ear
- The measurement plane is located parallel to the reference plane and 15 mm from it, out from the phone. The grid is located in the measurement plane.

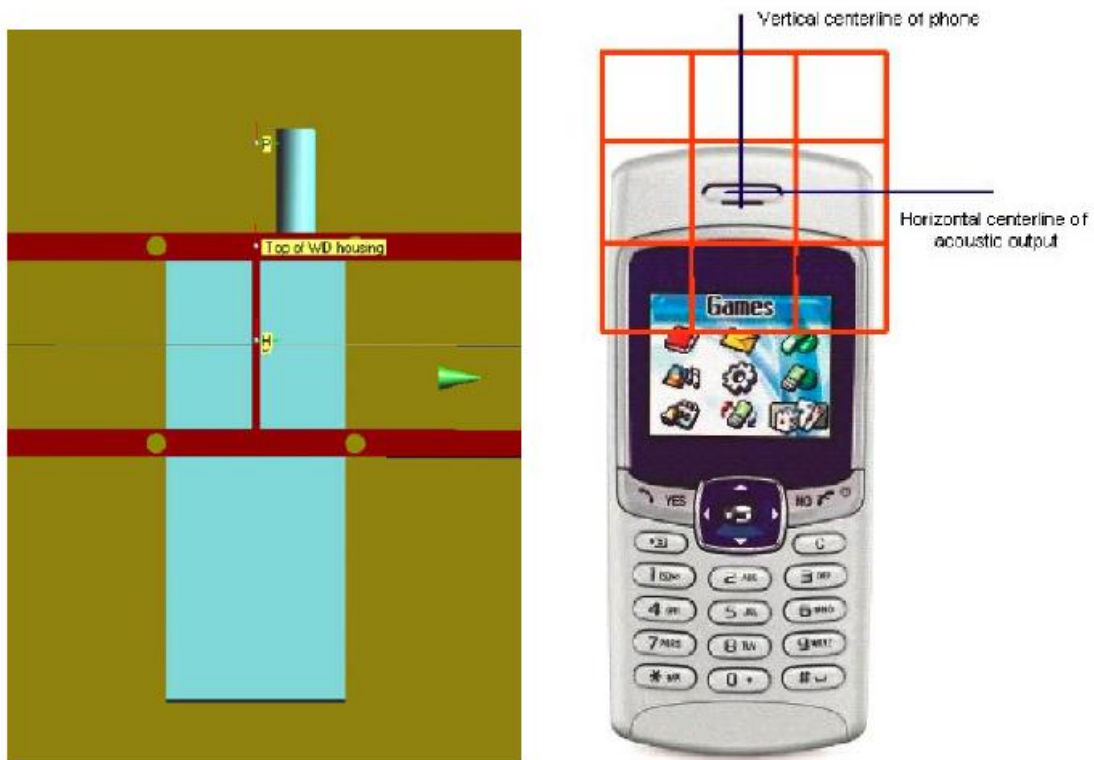

Fig. 3 WD reference and plane for RF emission measurements

8 SYSTEM VALIDATION

8.1 Validation Procedure

Place a dipole antenna meeting the requirements given in ANSI C63.19 in the position normally occupied by the WD. The dipole antenna serves as a known source for an electrical output. Position the E-field probes so that:

- The probes and their cables are parallel to the coaxial feed of the dipole antenna
- The probe cables and the coaxial feed of the dipole antenna approach the measurement area from opposite directions
- The center point of the probe element(s) are 15 mm from the closest surface of the dipole elements.

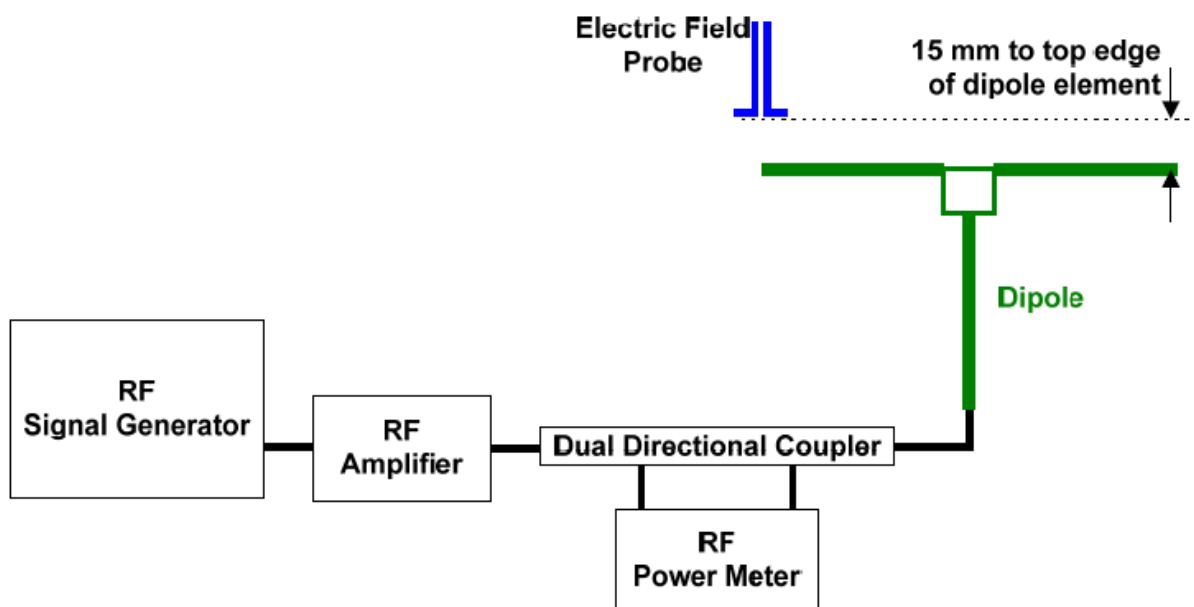

Fig. 4 Dipole Validation Setup

8.2 Validation Result

E-Field Scan						
Mode	Frequency (MHz)	Input Power (mW)	Measured ¹ Value(dBV/m)	Target ² Value(dBV/m)	Deviation ³ (%)	Limit ⁴ (%)
CW	835	100	40.72	40.91	-2.16	± 25
CW	1880	100	39.24	39.01	2.68	± 25
CW	2600	100	38.83	38.72	1.27	± 25

Notes:

1. Please refer to the attachment for detailed measurement data and plot.
2. Target value is provided by SPEAD in the calibration certificate of specific dipoles.
3. Deviation (%) = 100 * (Measured value minus Target value) divided by Target value.
4. ANSI C63.19 requires values within ± 25% are acceptable, of which 12% is deviation and 13% is measurement uncertainty. Values independently validated for the dipole actually used in the measurements should be used, when available.

9 Evaluation of MIF

9.1 Introduction

The MIF (Modulation Interference Factor) is used to classify E-field emission to determine Hearing Aid Compatibility (HAC). It scales the power-averaged signal to the RF audio interference level and is characteristic to a modulation scheme. The HAC standard preferred "indirect" measurement method is based on average field measurement with separate scaling by the MIF. With an Audio Interference Analyzer (AIA) designed by SPEAG specifically for the MIF measurement, these values have been verified by practical measurements on an RF signal modulated with each of the waveforms. The resulting deviations from the simulated values are within the requirements of the HAC standard.

The AIA (Audio Interference Analyzer) is a USB powered electronic sensor to evaluate signals in the frequency range 698MHz - 6 GHz. It contains RMS detector and audio frequency circuits for sampling of the RF envelope.

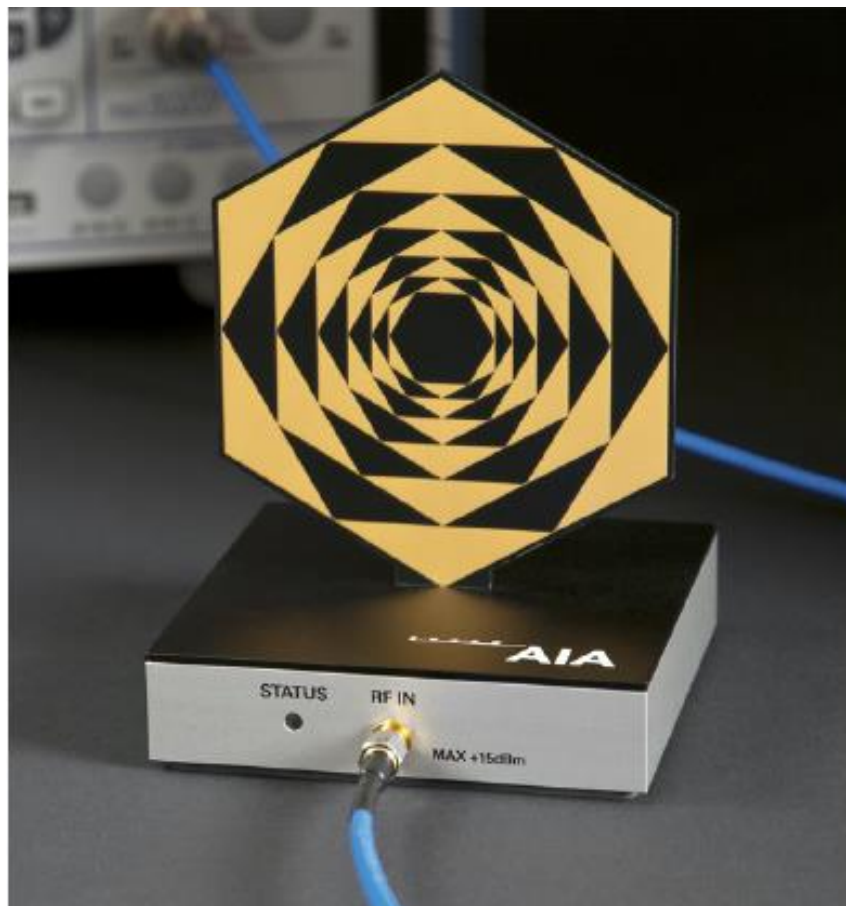

Fig. 5 AIA Front View

9.2 MIF measurement with the AIA

The MIF is measured with the AIA as follows:

1. Connect the AIA via USB to the DASY5 PC and verify the configuration settings.
2. Couple the RF signal to be evaluated to an AIA via cable or antenna.
3. Generate a MIF measurement job for the unknown signal and select the measurement port and timing settings.
4. Document the results via the post processor in a report.

9.3 Test equipment for the MIF measurement

No.	Name	Type	Serial Number	Manufacturer
01	Signal Generator	E4438C	MY49071430	Agilent
02	AIA	SE UMS 170 CB	1029	SPEAG
03	BTS	E5515C	MY50263375	Agilent

9.4 Test signal validation

The signal generator (E4438C) is used to generate a 1GHz signal with different modulation in the below table based on the ANSI C63.19-2011. The measured MIF with AIA are compared with the target values given in ANSI C63.19-2011 table D.3, D.4 and D5.

Pulse modulation	Target MIF	Measured MIF	Deviation
0.5ms pulse, 1000Hz repetition rate	-0.9 dB	-0.9 dB	0 dB
1ms pulse, 100Hz repetition rate	+3.9 dB	+3.7 dB	0.2 dB
0.1ms pulse, 100Hz repetition rate	+10.1 dB	+10.0 dB	0.1 dB
10ms pulse, 10Hz repetition rate	+1.6 dB	+1.7 dB	0.1 dB
Sine-wave modulation	Target MIF	Measured MIF	Deviation
1 kHz, 80% AM	-1.2 dB	-1.3 dB	0.1 dB
1 kHz, 10% AM	-9.1 dB	-9.0 dB	0.1 dB
1 kHz, 1% AM	-19.1 dB	-18.9 dB	0.2 dB
100 Hz, 10% AM	-16.1 dB	-16.0 dB	0.1 dB
10 kHz, 10% AM	-21.5 dB	-21.6 dB	0.1 dB
Transmission protocol	Target MIF	Measured MIF	Deviation
GSM; full-rate version 2; speech codec/handset low	+3.5 dB	+3.47 dB	0.03 dB
WCDMA; speech; speech codec low; AMR 12.2 kb/s	-20.0 dB	-19.8 dB	0.2 dB
CDMA; speech; SO3; RC3; full frame rate; 8kEVRC	-19.0 dB	-19.1 dB	0.1 dB
CDMA; speech; SO3; RC1; 1/8 th frame rate; 8kEVRC	+3.3 dB	+3.44 dB	0.14 dB

9.5 DUT MIF results

Typical MIF levels in ANSI C63.19-2011	
Transmission protocol	Modulation interference factor
GSM; full-rate version 2; speech codec/handset low	+3.5 dB
WCDMA; speech; speech codec low; AMR 12.2 kb/s	-20.0 dB
LTE-FDD (SC-FDMA, 1RB, 20MHz, QPSK)	-15.63 dB
LTE-FDD (SC-FDMA, 1RB, 20MHz, 16QAM)	-9.76 dB
LTE-FDD (SC-FDMA, 1RB, 20MHz, 64QAM)	-9.93 dB
LTE-TDD (SC-FDMA, 1RB, 20MHz, QPSK)	-1.62 dB
LTE-TDD (SC-FDMA, 1RB, 20MHz, 16QAM)	-1.44 dB
LTE-TDD (SC-FDMA, 1RB, 20MHz, 64QAM)	-1.54 dB
CDMA; speech; SO3; RC1; 1/8 th frame rate; 8kEVRC	+3.3 dB

Measured MIF levels		
Band	Channel	Modulation interference factor (dB)
GSM 850	251	3.37
	190	3.48
	128	3.33
GSM 1900	810	3.31
	661	3.38
	512	3.43
WCDMA 850	4233	-22.00
	4182	-21.97
	4132	-22.12
WCDMA 1700	1513	-22.12
	1412	-22.14
	1312	-22.09
WCDMA 1900	9538	-21.98
	9400	-21.86
	9262	-22.07
LTE Band2 QPSK	19100	-14.17
	18900	-14.35
	18700	-14.39
LTE Band5 QPSK	20600	-12.71
	20525	-13.56
	20450	-13.48
LTE Band7 QPSK	21350	-14.06
	21100	-14.32
	20850	-14.23
LTE Band12 QPSK	23130	-12.55
	23095	-12.99
	23060	-13.41



LTE Band66 QPSK	132572	-14.59
	132322	-14.88
	132072	-14.74
LTE Band38 QPSK	38150	-1.74
	38000	-1.59
	37850	-1.65
LTE Band2 16QAM	19100	-10.69
	18900	-10.18
	18700	-10.72
LTE Band5 16QAM	20600	-9.50
	20525	-10.64
	20450	-9.71
LTE Band7 16QAM	21350	-10.08
	21100	-10.08
	20850	-10.74
LTE Band12 16QAM	23130	-9.43
	23095	-9.73
	23060	-10.56
LTE Band66 16QAM	132572	-9.79
	132322	-10.39
	132072	-9.82
LTE Band38 16QAM	38150	-1.52
	38000	-1.53
	37850	-1.51
LTE Band2 64QAM	19100	-10.08
	18900	-9.82
	18700	-10.08
LTE Band5 64QAM	20600	-10.68
	20525	-9.75
	20450	-10.75
LTE Band7 64QAM	21350	-10.38
	21100	-10.44
	20850	-10.17
LTE Band12 64QAM	23130	10.73
	23095	-9.82
	23060	-10.42
LTE Band66 64QAM	132572	-9.43
	132322	-10.46
	132072	-9.74
LTE Band38 64QAM	38150	-1.72
	38000	-1.60
	37850	-1.50



2.4GHz	11	-10.12
802.11b	6	-9.82
1M	1	-10.34

10 Evaluation for low-power exemption

10.1 Product testing threshold

There are two methods for exempting an RF air interface technology from testing. The first method requires evaluation of the MIF for the worst-case operating mode. An RF air interface technology of a device is exempt from testing when its average antenna input power plus its MIF is ≤ 17 dBm for any of its operating modes. The second method does not require determination of the MIF. The RF emissions testing exemption shall be applied to an RF air interface technology in a device whose peak antenna input power, averaged over intervals $\leq 50 \mu s$, is ≤ 23 dBm. An RF air interface technology that is exempted from testing by either method shall be rated as M4.

The first method is used to be exempt from testing for the RF air interface technology in this report.

10.2 Conducted power

Band	Average power (dBm)	MIF (dB)	Sum (dBm)
GSM 850	32.45	3.48	35.93
GSM 1900	30.42	3.43	33.85
WCDMA 850	24.18	-21.97	2.21
WCDMA 1700	24.42	-22.09	2.33
WCDMA 1900	24.40	-21.86	2.54
LTE Band 2 QPSK	24.43	-14.17	10.26
LTE Band 5 QPSK	23.59	-12.71	10.88
LTE Band 7 QPSK	24.56	-14.06	10.5
LTE Band 12 QPSK	23.64	-12.55	11.09
LTE Band 66 QPSK	24.42	-14.59	9.83
LTE Band 38 QPSK	24.04	-1.59	22.45
LTE Band 2 16QAM	23.77	-10.18	13.59
LTE Band 5 16QAM	22.77	-9.50	13.27
LTE Band 7 16QAM	23.29	-10.08	13.21
LTE Band 12 16QAM	22.81	-9.43	13.38
LTE Band 66 16QAM	23.10	-9.79	13.31
LTE Band 38 16QAM	23.31	-1.51	21.8
LTE Band 2 64QAM	21.69	-9.82	11.87
LTE Band 5 64QAM	21.26	-9.75	11.51
LTE Band 7 64QAM	21.59	-10.17	11.42
LTE Band 12 64QAM	20.98	-9.82	11.16
LTE Band 66 64QAM	21.97	-9.43	12.54
LTE Band 38 64QAM	20.60	-1.50	19.1
WiFi-2.4G	17.03	-9.82	7.21



10.3 Conclusion

According to the above table, the sums of average power and MIF for WCDMA, LTE FDD and WiFi are less than 17dBm. So it is measured for GSM, and LTE TDD bands. The WCDMA, LTE FDD and WiFi are exempt from testing and rated as M4.



11 RF TEST PROCEDURES

The evaluation was performed with the following procedure:

- 1) Confirm proper operation of the field probe, probe measurement system and other instrumentation and the positioning system.
- 2) Position the WD in its intended test position. The gauge block can simplify this positioning.
- 3) Configure the WD normal operation for maximum rated RF output power, at the desired channel and other operating parameters (e.g., test mode), as intended for the test.
- 4) The center sub-grid shall be centered on the center of the T-Coil mode axial measurement point or the acoustic output, as appropriate. Locate the field probe at the initial test position in the 50 mm by 50 mm grid, which is contained in the measurement plane. If the field alignment method is used, align the probe for maximum field reception.
- 5) Record the reading.
- 6) Scan the entire 50 mm by 50 mm region in equally spaced increments and record the reading at each measurement point. The distance between measurement points shall be sufficient to assure the identification of the maximum reading.
- 7) Identify the five contiguous sub-grids around the center sub-grid whose maximum reading is the lowest of all available choices. This eliminates the three sub-grids with the maximum readings. Thus, the six areas to be used to determine the WD's highest emissions are identified.
- 8) Identify the maximum field reading within the non-excluded sub-grids identified in Step 7)
- 9) Evaluate the MIF and add to the maximum steady-state rms field-strength reading to obtain the RF audio interference level..
- 10) Compare this RF audio interference level with the categories and record the resulting WD category rating.

12 Measurement Results (E-Field)

Frequency		Measured Value(dBV/m)	Power Drift (dB)	Category
MHz	Channel			
GSM 850				
848.8	251	33.8	0.02	M4 (see Fig B.1)
836.6	190	33.17	-0.03	M4 (see Fig B.2)
824.2	128	31.56	0.09	M4 (see Fig B.3)
GSM 1900				
1909.8	810	23.91	0.01	M4 (see Fig B.4)
1880	661	23.56	-0.10	M4 (see Fig B.5)
1850.2	512	24.17	-0.03	M4 (see Fig B.6)
LTE Band38 QPSK				
2610	38150	18.53	0.17	M4 (see Fig B.7)
2595	38000	18.13	-0.05	M4 (see Fig B.8)
2580	37850	18.09	0.08	M4 (see Fig B.9)
LTE Band38 16-QAM				
2610	38150	17.42	0.03	M4 (see Fig B.10)
2595	38000	17.53	0.09	M4 (see Fig B.11)
2580	37850	17.79	0.06	M4 (see Fig B.12)
LTE Band38 64-QAM				
2610	38150	21.63	-0.04	M4 (see Fig B.13)
2595	38000	21.13	0.02	M4 (see Fig B.14)
2580	37850	21.80	-0.01	M4 (see Fig B.15)

13 ANSIC 63.19-2011 LIMITS

WD RF audio interference level categories in logarithmic units

Emission categories	< 960 MHz	E-field emissions
Category M1	50 to 55	dB (V/m)
Category M2	45 to 50	dB (V/m)
Category M3	40 to 45	dB (V/m)
Category M4	< 40	dB (V/m)
Emission categories	> 960 MHz	E-field emissions
Category M1	40 to 45	dB (V/m)
Category M2	35 to 40	dB (V/m)
Category M3	30 to 35	dB (V/m)
Category M4	< 30	dB (V/m)

14 MEASUREMENT UNCERTAINTY

No.	Error source	Type	Uncertainty Value(%)	Prob. Dist.	k	c _i E	Standard Uncertainty (%) u _i (%)E	Degree of freedom V _{eff} or v _i
Measurement System								
1	Probe Calibration	B	5.	N	1	1	5.1	∞
2	Axial Isotropy	B	4.7	R	$\sqrt{3}$	1	2.7	∞
3	Sensor Displacement	B	16.5	R	$\sqrt{3}$	1	9.5	∞
4	Boundary Effects	B	2.4	R	$\sqrt{3}$	1	1.4	∞
5	Linearity	B	4.7	R	$\sqrt{3}$	1	2.7	∞
6	Scaling to Peak Envelope Power	B	2.0	R	$\sqrt{3}$	1	1.2	∞
7	System Detection Limit	B	1.0	R	$\sqrt{3}$	1	0.6	∞
8	Readout Electronics	B	0.3	N	1	1	0.3	∞
9	Response Time	B	0.8	R	$\sqrt{3}$	1	0.5	∞
10	Integration Time	B	2.6	R	$\sqrt{3}$	1	1.5	∞
11	RF Ambient Conditions	B	3.0	R	$\sqrt{3}$	1	1.7	∞
12	RF Reflections	B	12.0	R	$\sqrt{3}$	1	6.9	∞
13	Probe Positioner	B	1.2	R	$\sqrt{3}$	1	0.7	∞
14	Probe Positioning	A	4.7	R	$\sqrt{3}$	1	2.7	∞
15	Extra. And Interpolation	B	1.0	R	$\sqrt{3}$	1	0.6	∞
Test Sample Related								
16	Device Positioning Vertical	B	4.7	R	$\sqrt{3}$	1	2.7	∞
17	Device Positioning Lateral	B	1.0	R	$\sqrt{3}$	1	0.6	∞
18	Device Holder and Phantom	B	2.4	R	$\sqrt{3}$	1	1.4	∞
19	Power Drift	B	5.0	R	$\sqrt{3}$	1	2.9	∞

20	AIA measurement	B	12	R	$\sqrt{3}$	1	6.9	∞
Phantom and Setup related								
21	Phantom Thickness	B	2.4	R	$\sqrt{3}$	1	1.4	∞
Combined standard uncertainty(%)							16.2	
Expanded uncertainty (confidence interval of 95 %)		$u_e = 2u_c$		N	k=2		32.4	

15 MAIN TEST INSTRUMENTS

Table 1: List of Main Instruments

No.	Name	Type	Serial Number	Calibration Date	Valid Period
01	Signal Generator	E4438C	MY49071430	January 23, 2018	One Year
02	Power meter	NRVD	102196	March 7, 2018	One year
03	Power sensor	NRV-Z5	100596		
04	Amplifier	60S1G4	0331848	No Calibration Requested	
05	E-Field Probe	EF3DV3	4060	June 12, 2018	One year
06	DAE	SPEAG DAE4	1555	August 20, 2018	One year
07	HAC Dipole	CD835V3	1023	August 28, 2018	One year
08	HAC Dipole	CD1880V3	1018	August 28, 2018	One year
09	HAC Dipole	CD2600V3	1017	August 22, 2018	One year
10	BTS	E5515C	MY50263375	January 23, 2018	One year
11	AIA	SE UMS 170 CB	1029	No Calibration Requested	

16 CONCLUSION

The HAC measurement indicates that the EUT complies with the HAC limits of the ANSIC63.19-2011. The total M-rating is **M4**.

END OF REPORT BODY

ANNEX A TEST LAYOUT



Picture A1:HAC RF System Layout

ANNEX B TEST PLOTS

HAC RF E-Field GSM 850 High

Date: 2019-1-17

Electronics: DAE4 Sn1555

Medium: Air

Medium parameters used: $\sigma = 0$ mho/m, $\epsilon_r = 1$; $\rho = 1000$ kg/m³

Ambient Temperature: 22.0°C

Communication System: GSM 850; Frequency: 848.8 MHz; Duty Cycle: 1:8.3

Probe: EF3DV3 - SN4060;ConvF(1, 1, 1)

E Scan - ER3DV6 - 2011: 15 mm from Probe Center to the Device/Hearing Aid Compatibility Test (101x101x1): Interpolated grid: dx=0.5000 mm, dy=0.5000 mm

Device Reference Point: 0, 0, -6.3 mm

Reference Value = 42.10 V/m; Power Drift = 0.02 dB

Applied MIF = 3.37 dB

RF audio interference level = 33.80 dBV/m

Emission category: M4

MIF scaled E-field

Grid 1 M4 33.18 dBV/m	Grid 2 M4 33.64 dBV/m	Grid 3 M4 33.14 dBV/m
Grid 4 M4 33.34 dBV/m	Grid 5 M4 33.8 dBV/m	Grid 6 M4 33.26 dBV/m
Grid 7 M4 33.33 dBV/m	Grid 8 M4 33.59 dBV/m	Grid 9 M4 33.05 dBV/m

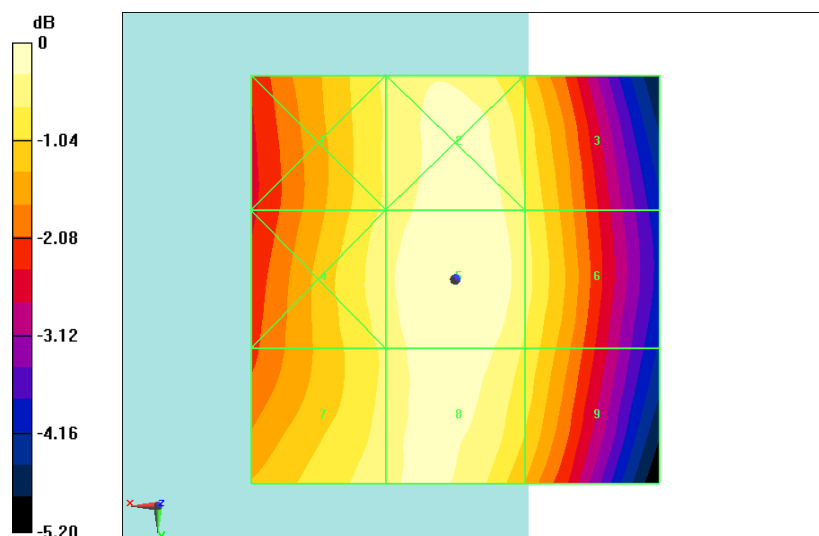

0 dB = 48.96 V/m = 33.80 dBV/m

Fig B.1 HAC RF E-Field GSM 850 High

HAC RF E-Field GSM 850 Middle

Date: 2019-1-17

Electronics: DAE4 Sn1555

Medium: Air

Medium parameters used: $\sigma = 0$ mho/m, $\epsilon_r = 1$; $\rho = 1000$ kg/m³

Ambient Temperature: 22.0°C

Communication System: GSM 850; Frequency: 836.6 MHz; Duty Cycle: 1:8.3

Probe: EF3DV3 - SN4060;ConvF(1, 1, 1)

E Scan - ER3DV6 - 2011: 15 mm from Probe Center to the Device 2/Hearing Aid

Compatibility Test (101x101x1): Interpolated grid: dx=0.5000 mm, dy=0.5000 mm

Device Reference Point: 0, 0, -6.3 mm

Reference Value = 39.08 V/m; Power Drift = -0.03 dB

Applied MIF = 3.48 dB

RF audio interference level = 33.17 dBV/m

Emission category: M4

MIF scaled E-field

Grid 1 M4 32.7 dBV/m	Grid 2 M4 33.07 dBV/m	Grid 3 M4 32.48 dBV/m
Grid 4 M4 32.85 dBV/m	Grid 5 M4 33.17 dBV/m	Grid 6 M4 32.57 dBV/m
Grid 7 M4 32.77 dBV/m	Grid 8 M4 33.01 dBV/m	Grid 9 M4 32.42 dBV/m

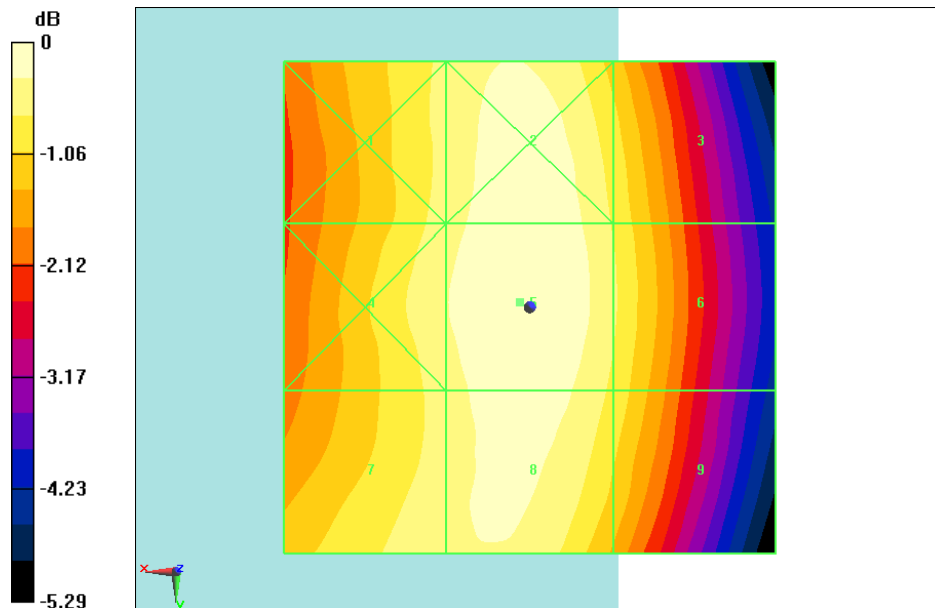

0 dB = 45.81 V/m = 33.22 dBV/m

Fig B.2 HAC RF E-Field GSM 850 Middle

HAC RF E-Field GSM 850 Low

Date: 2019-1-17

Electronics: DAE4 Sn1555

Medium: Air

Medium parameters used: $\sigma = 0$ mho/m, $\epsilon_r = 1$; $\rho = 1000$ kg/m³

Ambient Temperature: 22.0°C

Communication System: GSM 850; Frequency: 824.2 MHz; Duty Cycle: 1:8.3

Probe: EF3DV3 - SN4060;ConvF(1, 1, 1)

E Scan - ER3DV6 - 2011: 15 mm from Probe Center to the Device 3/Hearing Aid

Compatibility Test (101x101x1): Interpolated grid: dx=0.5000 mm, dy=0.5000 mm

Device Reference Point: 0, 0, -6.3 mm

Reference Value = 31.49 V/m; Power Drift = 0.09 dB

Applied MIF = 3.33 dB

RF audio interference level = 31.56 dBV/m

Emission category: M4

MIF scaled E-field

Grid 1 M4 31.11 dBV/m	Grid 2 M4 31.44 dBV/m	Grid 3 M4 30.68 dBV/m
Grid 4 M4 31.26 dBV/m	Grid 5 M4 31.56 dBV/m	Grid 6 M4 30.84 dBV/m
Grid 7 M4 31.24 dBV/m	Grid 8 M4 31.39 dBV/m	Grid 9 M4 30.59 dBV/m

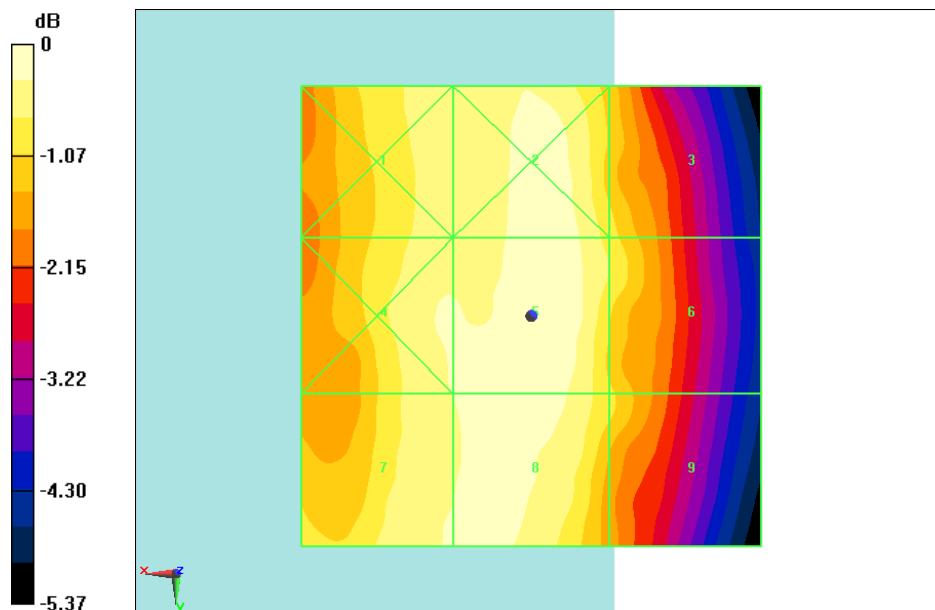

0 dB = 37.83 V/m = 31.56 dBV/m

Fig B.3 HAC RF E-Field GSM 850 Low

HAC RF E-Field GSM 1900 High

Date: 2019-1-17

Electronics: DAE4 Sn1555

Medium: Air

Medium parameters used: $\sigma = 0$ mho/m, $\epsilon_r = 1$; $\rho = 1000$ kg/m³

Ambient Temperature: 22.0°C

Communication System: DCS 1900; Frequency: 1909.8 MHz; Duty Cycle: 1:8.3

Probe: EF3DV3 - SN4060;ConvF(1, 1, 1)

E Scan - ER3DV6 - 2011: 15 mm from Probe Center to the Device/Hearing Aid

Compatibility Test (101x101x1): Interpolated grid: dx=0.5000 mm, dy=0.5000 mm

Device Reference Point: 0, 0, -6.3 mm

Reference Value = 12.28 V/m; Power Drift = 0.01 dB

Applied MIF = 3.31 dB

RF audio interference level = 23.91 dBV/m

Emission category: M4

MIF scaled E-field

Grid 1 M4 20.33 dBV/m	Grid 2 M4 22.62 dBV/m	Grid 3 M4 22.4 dBV/m
Grid 4 M4 22.04 dBV/m	Grid 5 M4 23.91 dBV/m	Grid 6 M4 23.73 dBV/m
Grid 7 M4 22.32 dBV/m	Grid 8 M4 24.06 dBV/m	Grid 9 M4 23.8 dBV/m

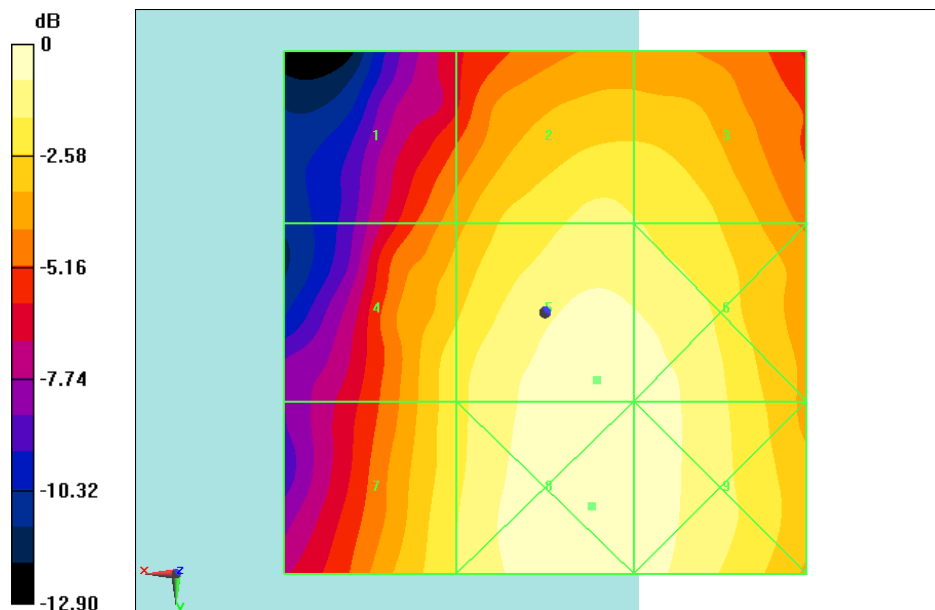

0 dB = 15.95 V/m = 24.06 dBV/m

Fig B.4 HAC RF E-Field GSM 1900 High

HAC RF E-Field GSM 1900 Middle

Date: 2019-1-17

Electronics: DAE4 Sn1555

Medium: Air

Medium parameters used: $\sigma = 0$ mho/m, $\epsilon_r = 1$; $\rho = 1000$ kg/m³

Ambient Temperature: 22.0°C

Communication System: DCS 1900; Frequency: 1880 MHz; Duty Cycle: 1:8.3

Probe: EF3DV3 - SN4060;ConvF(1, 1, 1)

E Scan - ER3DV6 - 2011: 15 mm from Probe Center to the Device 2/Hearing Aid Compatibility Test (101x101x1): Interpolated grid: dx=0.5000 mm, dy=0.5000 mm

Device Reference Point: 0, 0, -6.3 mm

Reference Value = 11.84 V/m; Power Drift = -0.10 dB

Applied MIF = 3.38 dB

RF audio interference level = 23.56 dBV/m

Emission category: M4

MIF scaled E-field

Grid 1 M4 19.83 dBV/m	Grid 2 M4 21.99 dBV/m	Grid 3 M4 21.65 dBV/m
Grid 4 M4 22 dBV/m	Grid 5 M4 23.56 dBV/m	Grid 6 M4 23.36 dBV/m
Grid 7 M4 22.72 dBV/m	Grid 8 M4 24.13 dBV/m	Grid 9 M4 23.79 dBV/m

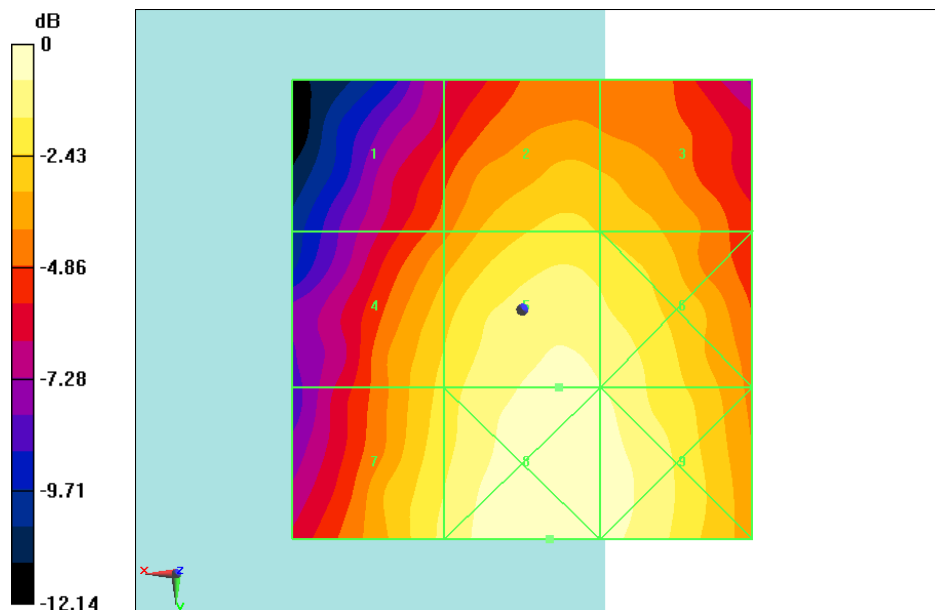

0 dB = 16.09 V/m = 24.13 dBV/m

Fig B.5 HAC RF E-Field GSM 1900 Middle

HAC RF E-Field GSM 1900 Low

Date: 2019-1-17

Electronics: DAE4 Sn1555

Medium: Air

Medium parameters used: $\sigma = 0$ mho/m, $\epsilon_r = 1$; $\rho = 1000$ kg/m³

Ambient Temperature: 22.0°C

Communication System: DCS 1900; Frequency: 1850.2 MHz; Duty Cycle: 1:8.3

Probe: EF3DV3 - SN4060;ConvF(1, 1, 1)

E Scan - ER3DV6 - 2011: 15 mm from Probe Center to the Device 3/Hearing Aid Compatibility Test (101x101x1): Interpolated grid: dx=0.5000 mm, dy=0.5000 mm

Device Reference Point: 0, 0, -6.3 mm

Reference Value = 12.09 V/m; Power Drift = -0.03 dB

Applied MIF = 3.43 dB

RF audio interference level = 24.17 dBV/m

Emission category: M4

MIF scaled E-field

Grid 1 M4 20.2 dBV/m	Grid 2 M4 22.14 dBV/m	Grid 3 M4 21.82 dBV/m
Grid 4 M4 22.98 dBV/m	Grid 5 M4 24.17 dBV/m	Grid 6 M4 23.69 dBV/m
Grid 7 M4 23.93 dBV/m	Grid 8 M4 24.84 dBV/m	Grid 9 M4 24.42 dBV/m

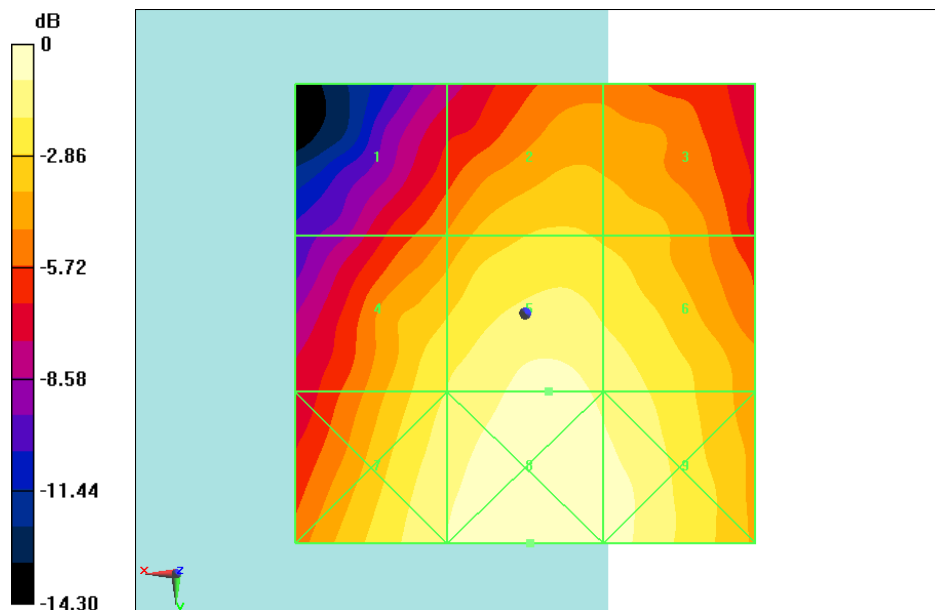

0 dB = 17.45 V/m = 24.84 dBV/m

Fig B.6 HAC RF E-Field GSM 1900 Low

HAC RF E-Field LTE Band38 QPSK CH38150

Date: 2019-1-17

Electronics: DAE4 Sn1555

Medium: Air

Medium parameters used: $\sigma = 0$ mho/m, $\epsilon_r = 1$; $\rho = 1000$ kg/m³

Ambient Temperature: 22.0°C

Communication System: LTE Band38; Frequency: 2610 MHz; Duty Cycle: 1:1.58

Probe: EF3DV3 - SN4060;ConvF(1, 1, 1)

E Scan - ER3DV6 - 2011: 15 mm from Probe Center to the Device/Hearing Aid Compatibility Test (101x101x1): Interpolated grid: dx=0.5000 mm, dy=0.5000 mm

Device Reference Point: 0, 0, -6.3 mm

Reference Value = 11.10 V/m; Power Drift = 0.17 dB

Applied MIF = -1.74 dB

RF audio interference level = 18.53 dBV/m

Emission category: M4

MIF scaled E-field

Grid 1 M4 16.51 dBV/m	Grid 2 M4 18.02 dBV/m	Grid 3 M4 18.03 dBV/m
Grid 4 M4 14.3 dBV/m	Grid 5 M4 18.53 dBV/m	Grid 6 M4 18.54 dBV/m
Grid 7 M4 15.92 dBV/m	Grid 8 M4 18.32 dBV/m	Grid 9 M4 18.37 dBV/m

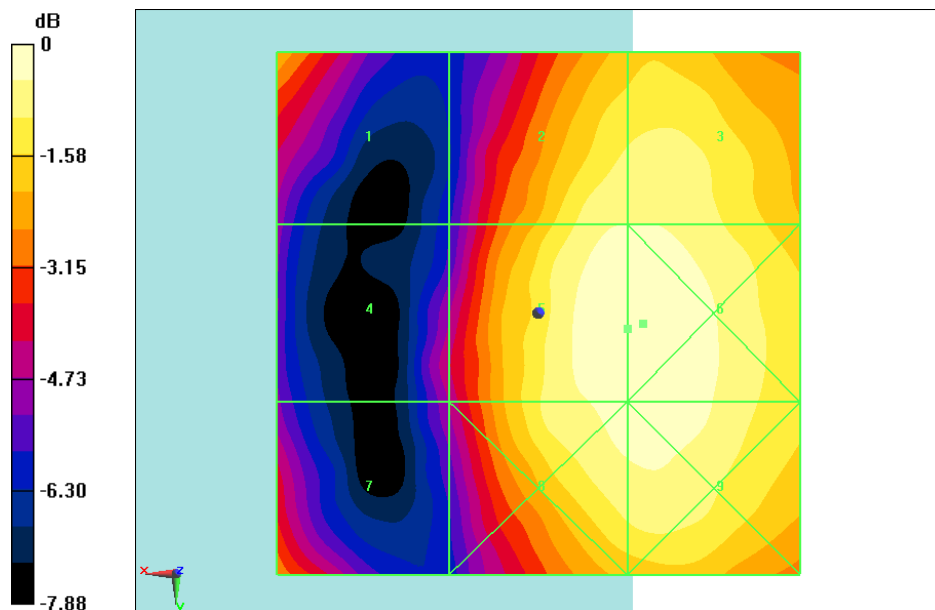

0 dB = 8.455 V/m = 18.54 dBV/m

Fig B.7 HAC RF E-Field LTE Band38 QPSK CH38150

HAC RF E-Field LTE Band38 QPSK CH38000

Date: 2019-1-17

Electronics: DAE4 Sn1555

Medium: Air

Medium parameters used: $\sigma = 0$ mho/m, $\epsilon_r = 1$; $\rho = 1000$ kg/m³

Ambient Temperature: 22.0°C

Communication System: LTE Band38; Frequency: 2595 MHz; Duty Cycle: 1:1.58

Probe: EF3DV3 - SN4060;ConvF(1, 1, 1)

E Scan - ER3DV6 - 2011: 15 mm from Probe Center to the Device 2/Hearing Aid

Compatibility Test (101x101x1): Interpolated grid: dx=0.5000 mm, dy=0.5000 mm

Device Reference Point: 0, 0, -6.3 mm

Reference Value = 10.56 V/m; Power Drift = -0.05 dB

Applied MIF = -1.59 dB

RF audio interference level = 18.13 dBV/m

Emission category: M4

MIF scaled E-field

Grid 1 M4 15.93 dBV/m	Grid 2 M4 17.5 dBV/m	Grid 3 M4 17.54 dBV/m
Grid 4 M4 14.24 dBV/m	Grid 5 M4 18.13 dBV/m	Grid 6 M4 18.06 dBV/m
Grid 7 M4 15.62 dBV/m	Grid 8 M4 17.93 dBV/m	Grid 9 M4 17.86 dBV/m

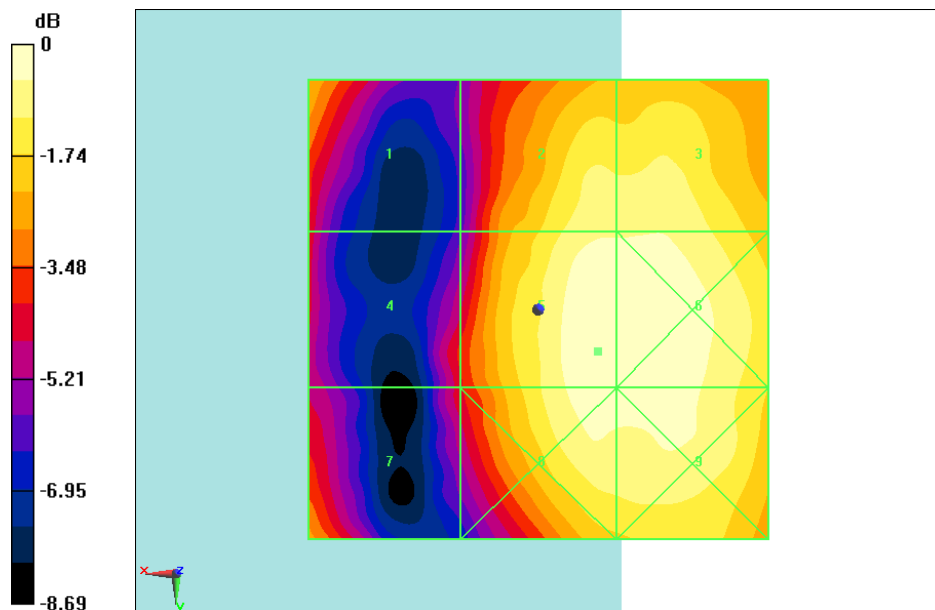

0 dB = 8.061 V/m = 18.13 dBV/m

Fig B.8 HAC RF E-Field LTE Band38 QPSK CH38000

HAC RF E-Field LTE Band38 QPSK CH37850

Date: 2019-1-17

Electronics: DAE4 Sn1555

Medium: Air

Medium parameters used: $\sigma = 0$ mho/m, $\epsilon_r = 1$; $\rho = 1000$ kg/m³

Ambient Temperature: 22.0°C

Communication System: LTE Band38; Frequency: 2580 MHz; Duty Cycle: 1:1.58

Probe: EF3DV3 - SN4060;ConvF(1, 1, 1)

E Scan - ER3DV6 - 2011: 15 mm from Probe Center to the Device 3/Hearing Aid

Compatibility Test (101x101x1): Interpolated grid: dx=0.5000 mm, dy=0.5000 mm

Device Reference Point: 0, 0, -6.3 mm

Reference Value = 10.47 V/m; Power Drift = 0.08 dB

Applied MIF = -1.65 dB

RF audio interference level = 18.09 dBV/m

Emission category: M4

MIF scaled E-field

Grid 1 M4 15.26 dBV/m	Grid 2 M4 17.59 dBV/m	Grid 3 M4 17.57 dBV/m
Grid 4 M4 13.97 dBV/m	Grid 5 M4 18.09 dBV/m	Grid 6 M4 18.1 dBV/m
Grid 7 M4 15.07 dBV/m	Grid 8 M4 17.92 dBV/m	Grid 9 M4 17.94 dBV/m

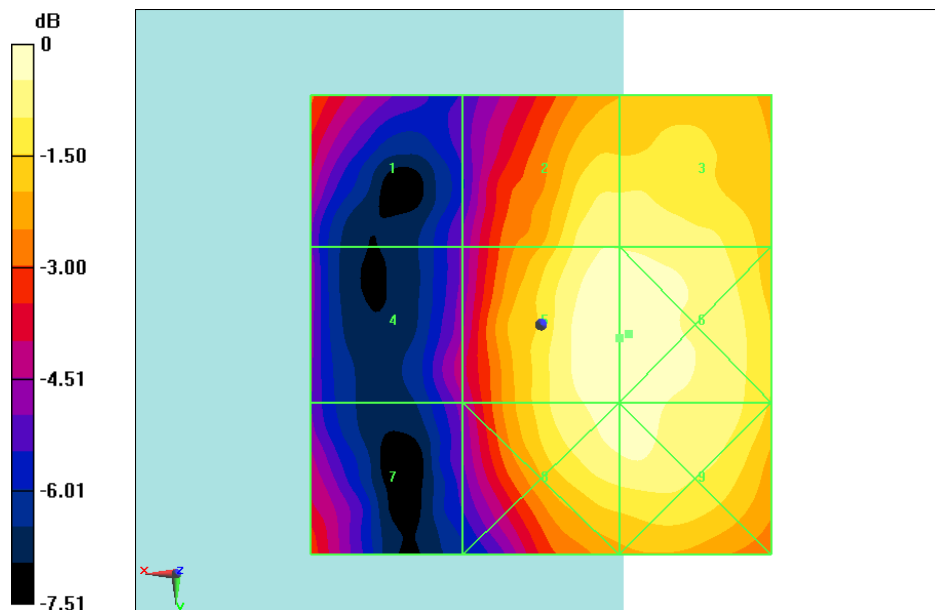

0 dB = 8.032 V/m = 18.10 dBV/m

Fig B.9 HAC RF E-Field LTE Band38 QPSK CH37850

HAC RF E-Field LTE Band38 16QAM CH38150

Date: 2019-1-17

Electronics: DAE4 Sn1555

Medium: Air

Medium parameters used: $\sigma = 0$ mho/m, $\epsilon_r = 1$; $\rho = 1000$ kg/m³

Ambient Temperature: 22.0°C

Communication System: LTE Band38; Frequency: 2610 MHz; Duty Cycle: 1:1.58

Probe: EF3DV3 - SN4060;ConvF(1, 1, 1)

E Scan - ER3DV6 - 2011: 15 mm from Probe Center to the Device/Hearing Aid Compatibility Test (101x101x1): Interpolated grid: dx=0.5000 mm, dy=0.5000 mm

Device Reference Point: 0, 0, -6.3 mm

Reference Value = 9.671 V/m; Power Drift = 0.03 dB

Applied MIF = -1.52 dB

RF audio interference level = 17.42 dBV/m

Emission category: M4

MIF scaled E-field

Grid 1 M4 15.73 dBV/m	Grid 2 M4 16.83 dBV/m	Grid 3 M4 16.85 dBV/m
Grid 4 M4 13.23 dBV/m	Grid 5 M4 17.42 dBV/m	Grid 6 M4 17.45 dBV/m
Grid 7 M4 14.6 dBV/m	Grid 8 M4 17.35 dBV/m	Grid 9 M4 17.4 dBV/m

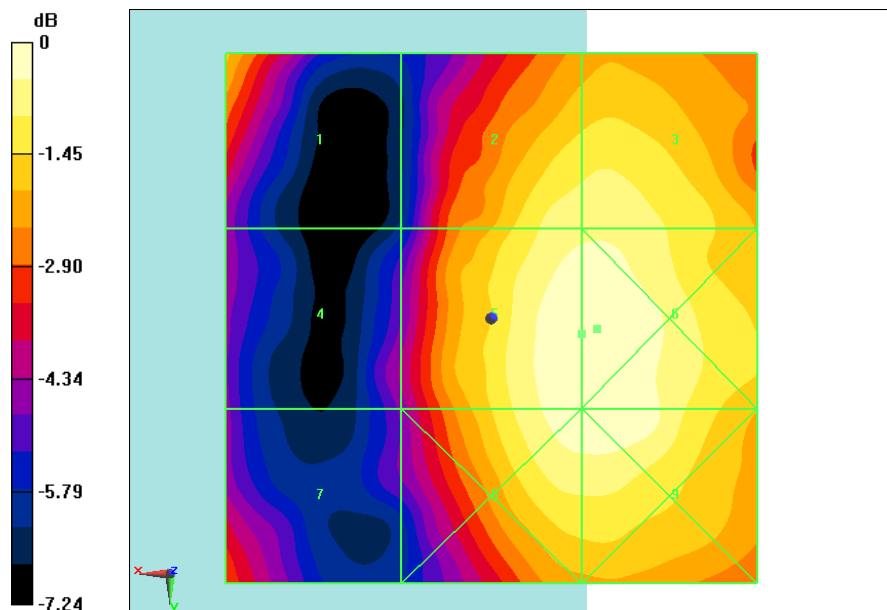

0 dB = 7.460 V/m = 17.45 dBV/m

Fig B.10 HAC RF E-Field LTE Band38 16QAM CH38150

HAC RF E-Field LTE Band38 16QAM CH38000

Date: 2019-1-17

Electronics: DAE4 Sn1555

Medium: Air

Medium parameters used: $\sigma = 0$ mho/m, $\epsilon_r = 1$; $\rho = 1000$ kg/m³

Ambient Temperature: 22.0°C

Communication System: LTE Band38; Frequency: 2595 MHz; Duty Cycle: 1:1.58

Probe: EF3DV3 - SN4060;ConvF(1, 1, 1)

E Scan - ER3DV6 - 2011: 15 mm from Probe Center to the Device 2/Hearing Aid

Compatibility Test (101x101x1): Interpolated grid: dx=0.5000 mm, dy=0.5000 mm

Device Reference Point: 0, 0, -6.3 mm

Reference Value = 10.04 V/m; Power Drift = 0.09 dB

Applied MIF = -1.53 dB

RF audio interference level = 17.53 dBV/m

Emission category: M4

MIF scaled E-field

Grid 1 M4 15.63 dBV/m	Grid 2 M4 17.02 dBV/m	Grid 3 M4 17.36 dBV/m
Grid 4 M4 13.8 dBV/m	Grid 5 M4 17.53 dBV/m	Grid 6 M4 17.75 dBV/m
Grid 7 M4 15.13 dBV/m	Grid 8 M4 17.42 dBV/m	Grid 9 M4 17.55 dBV/m

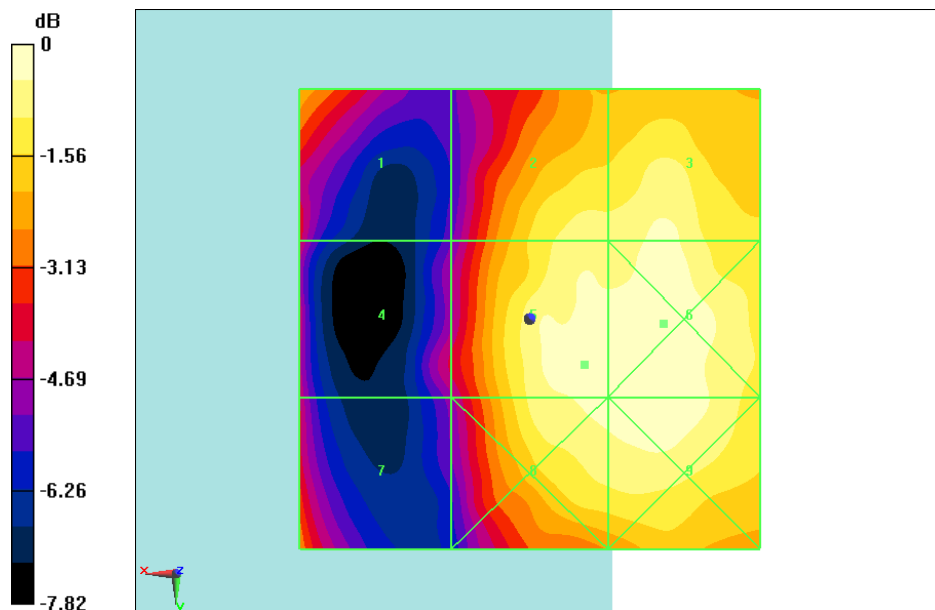

0 dB = 7.714 V/m = 17.75 dBV/m

Fig B.11 HAC RF E-Field LTE Band38 16QAM CH38000

HAC RF E-Field LTE Band38 16QAM CH37850

Date: 2019-1-17

Electronics: DAE4 Sn1555

Medium: Air

Medium parameters used: $\sigma = 0$ mho/m, $\epsilon_r = 1$; $\rho = 1000$ kg/m³

Ambient Temperature: 22.0°C

Communication System: LTE Band38; Frequency: 2580 MHz; Duty Cycle: 1:1.58

Probe: EF3DV3 - SN4060;ConvF(1, 1, 1)

E Scan - ER3DV6 - 2011: 15 mm from Probe Center to the Device 3/Hearing Aid

Compatibility Test (101x101x1): Interpolated grid: dx=0.5000 mm, dy=0.5000 mm

Device Reference Point: 0, 0, -6.3 mm

Reference Value = 10.06 V/m; Power Drift = 0.06 dB

Applied MIF = -1.51 dB

RF audio interference level = 17.79 dBV/m

Emission category: M4

MIF scaled E-field

Grid 1 M4 15.43 dBV/m	Grid 2 M4 17.34 dBV/m	Grid 3 M4 17.39 dBV/m
Grid 4 M4 13.62 dBV/m	Grid 5 M4 17.79 dBV/m	Grid 6 M4 17.76 dBV/m
Grid 7 M4 14.65 dBV/m	Grid 8 M4 17.58 dBV/m	Grid 9 M4 17.57 dBV/m

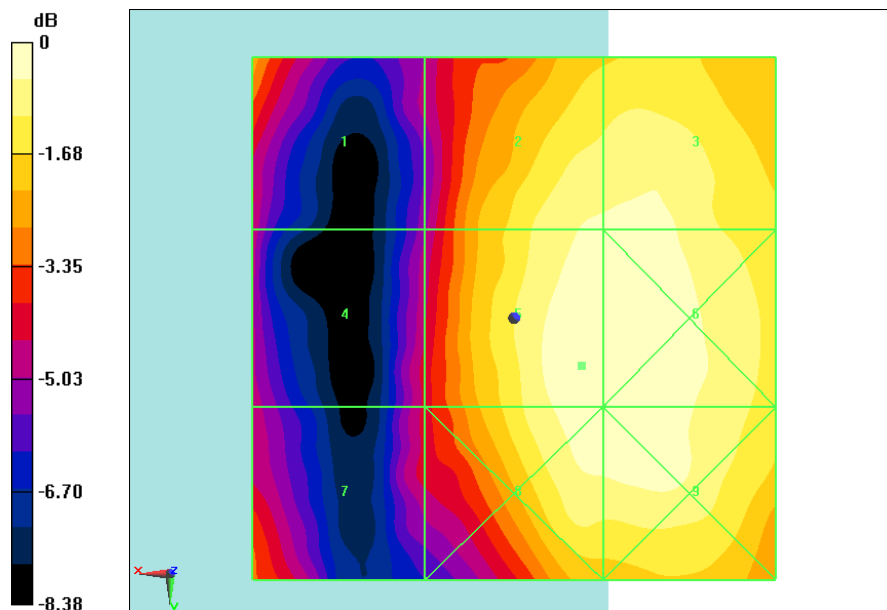

0 dB = 7.753 V/m = 17.79 dBV/m

Fig B.12 HAC RF E-Field LTE Band38 16QAM CH37850

HAC RF E-Field LTE Band38 64QAM CH38150

Date: 2019-1-17

Electronics: DAE4 Sn1555

Medium: Air

Medium parameters used: $\sigma = 0$ mho/m, $\epsilon_r = 1$; $\rho = 1000$ kg/m³

Ambient Temperature: 22.0°C

Communication System: LTE Band38; Frequency: 2610 MHz; Duty Cycle: 1:1.58

Probe: EF3DV3 - SN4060;ConvF(1, 1, 1)

E Scan - ER3DV6 - 2011: 15 mm from Probe Center to the Device/Hearing Aid Compatibility Test (101x101x1): Interpolated grid: dx=0.5000 mm, dy=0.5000 mm

Device Reference Point: 0, 0, -6.3 mm

Reference Value = 13.27 V/m; Power Drift = -0.04 dB

Applied MIF = -1.72 dB

RF audio interference level = 21.63 dBV/m

Emission category: M4

MIF scaled E-field

Grid 1 M4 18.08 dBV/m	Grid 2 M4 22.06 dBV/m	Grid 3 M4 22.03 dBV/m
Grid 4 M4 17.55 dBV/m	Grid 5 M4 21.63 dBV/m	Grid 6 M4 21.59 dBV/m
Grid 7 M4 18.06 dBV/m	Grid 8 M4 18.26 dBV/m	Grid 9 M4 18.92 dBV/m

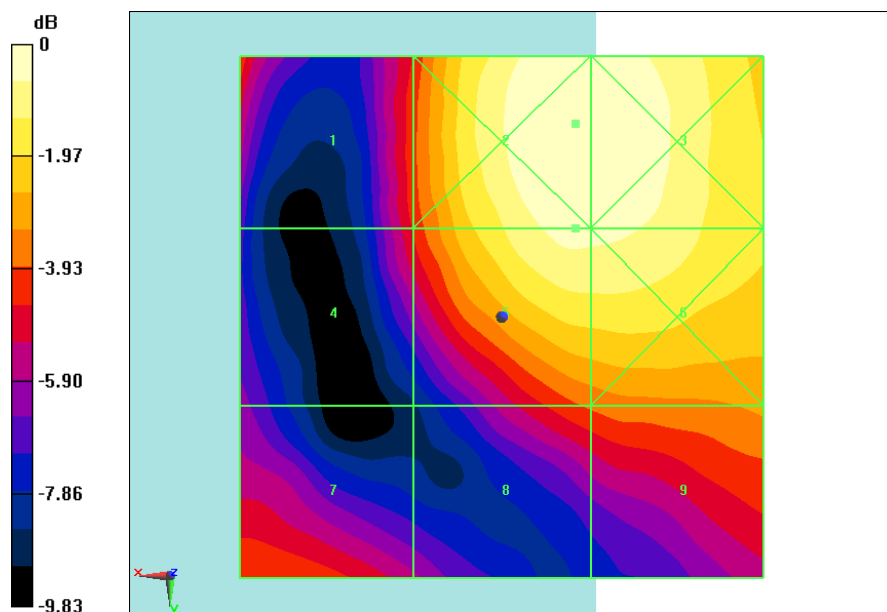

0 dB = 12.67 V/m = 22.06 dBV/m

Fig B.13 HAC RF E-Field LTE Band38 64QAM CH38150

HAC RF E-Field LTE Band38 64QAM CH38000

Date: 2019-1-17

Electronics: DAE4 Sn1555

Medium: Air

Medium parameters used: $\sigma = 0$ mho/m, $\epsilon_r = 1$; $\rho = 1000$ kg/m³

Ambient Temperature: 22.0°C

Communication System: LTE Band38; Frequency: 2595 MHz; Duty Cycle: 1:1.58

Probe: EF3DV3 - SN4060;ConvF(1, 1, 1)

E Scan - ER3DV6 - 2011: 15 mm from Probe Center to the Device 2/Hearing Aid

Compatibility Test (101x101x1): Interpolated grid: dx=0.5000 mm, dy=0.5000 mm

Device Reference Point: 0, 0, -6.3 mm

Reference Value = 12.79 V/m; Power Drift = 0.02 dB

Applied MIF = -1.60 dB

RF audio interference level = 21.13 dBV/m

Emission category: M4

MIF scaled E-field

Grid 1 M4 17.67 dBV/m	Grid 2 M4 21.44 dBV/m	Grid 3 M4 21.44 dBV/m
Grid 4 M4 17.05 dBV/m	Grid 5 M4 21.13 dBV/m	Grid 6 M4 21.13 dBV/m
Grid 7 M4 16.76 dBV/m	Grid 8 M4 18.07 dBV/m	Grid 9 M4 18.23 dBV/m

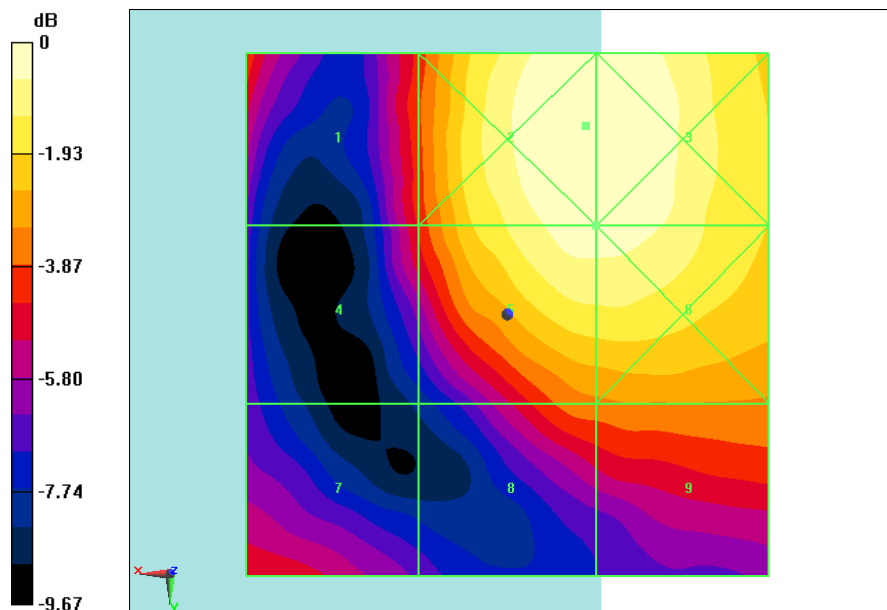

0 dB = 11.81 V/m = 21.44 dBV/m

Fig B.14 HAC RF E-Field LTE Band38 64QAM CH38000

HAC RF E-Field LTE Band38 64QAM CH37850

Date: 2019-1-17

Electronics: DAE4 Sn1555

Medium: Air

Medium parameters used: $\sigma = 0$ mho/m, $\epsilon_r = 1$; $\rho = 1000$ kg/m³

Ambient Temperature: 22.0°C

Communication System: LTE Band38; Frequency: 2580 MHz; Duty Cycle: 1:1.58

Probe: EF3DV3 - SN4060;ConvF(1, 1, 1)

E Scan - ER3DV6 - 2011: 15 mm from Probe Center to the Device 3/Hearing Aid

Compatibility Test (101x101x1): Interpolated grid: dx=0.5000 mm, dy=0.5000 mm

Device Reference Point: 0, 0, -6.3 mm

Reference Value = 14.19 V/m; Power Drift = -0.01 dB

Applied MIF = -1.50 dB

RF audio interference level = 21.80 dBV/m

Emission category: M4

MIF scaled E-field

Grid 1 M4 18.33 dBV/m	Grid 2 M4 22.27 dBV/m	Grid 3 M4 22.24 dBV/m
Grid 4 M4 17.6 dBV/m	Grid 5 M4 21.8 dBV/m	Grid 6 M4 21.79 dBV/m
Grid 7 M4 17.02 dBV/m	Grid 8 M4 18.45 dBV/m	Grid 9 M4 18.68 dBV/m

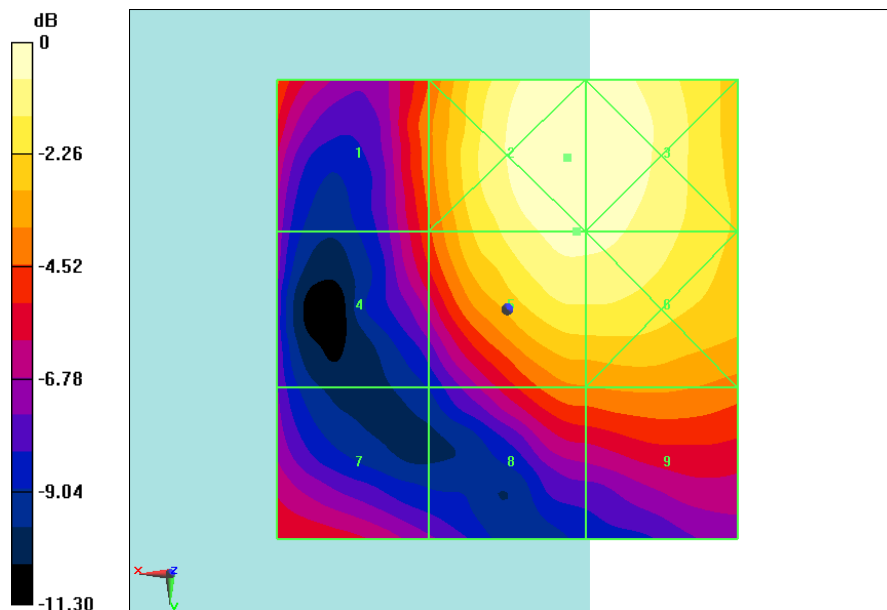

0 dB = 12.99 V/m = 22.27 dBV/m

Fig B.15 HAC RF E-Field LTE Band38 64QAM CH38750

ANNEX C SYSTEM VALIDATION RESULT

E SCAN of Dipole 835 MHz

Date: 2019-1-17

Electronics: DAE4 Sn1555

Medium: Air

Medium parameters used: $\sigma = 0$ mho/m, $\epsilon_r = 1$; $\rho = 1000$ kg/m³

Communication System: CW; Frequency: 835 MHz; Duty Cycle: 1:1

Probe: EF3DV3 - SN4060;ConvF(1, 1, 1)

E Scan - measurement distance from the probe sensor center to CD835 Dipole = 15mm/Hearing Aid Compatibility Test (41x361x1): Interpolated grid: dx=0.5000 mm, dy=0.5000 mm

Device Reference Point: 0, 0, -6.3 mm

Reference Value = 128.6 V/m; Power Drift = -0.03 dB

Applied MIF = 0.00 dB

RF audio interference level = 40.72 dBV/m

Emission category: M3

MIF scaled E-field

Grid 1 M3 40.29 dBV/m	Grid 2 M3 40.72 dBV/m	Grid 3 M3 40.65 dBV/m
Grid 4 M4 35.50 dBV/m	Grid 5 M4 35.84 dBV/m	Grid 6 M4 35.82 dBV/m
Grid 7 M3 40.47 dBV/m	Grid 8 M3 40.85 dBV/m	Grid 9 M3 40.75 dBV/m

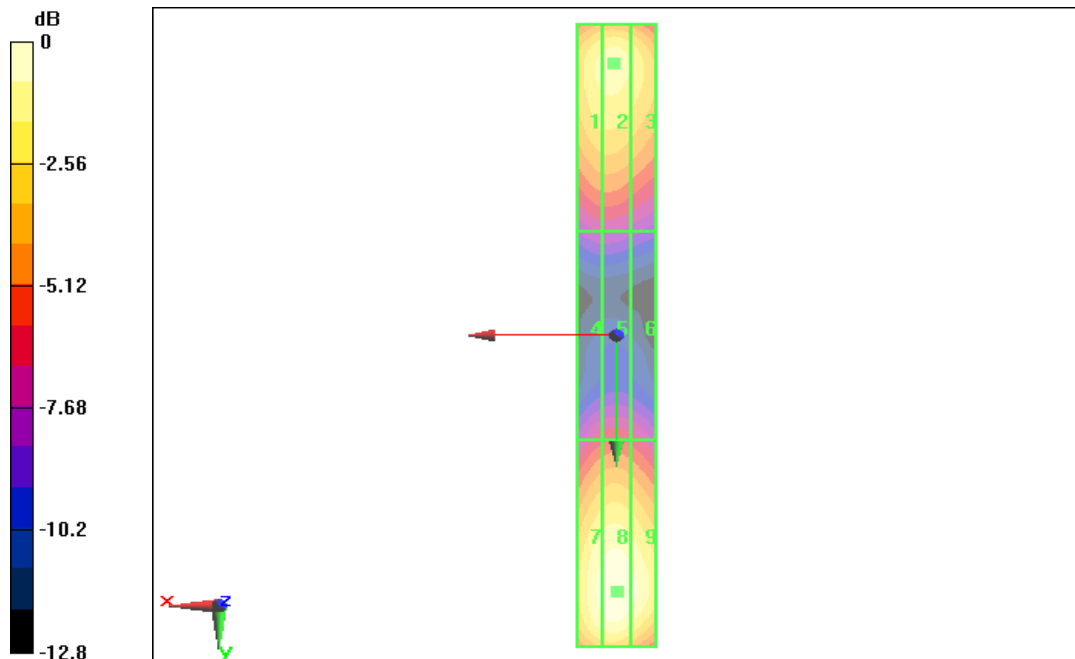

0 dB = 40.72 dBV/m

E SCAN of Dipole 1880 MHz

Date: 2019-1-17

Electronics: DAE4 Sn1555

Medium: Air

Medium parameters used: $\sigma = 0$ mho/m, $\epsilon_r = 1$; $\rho = 1000$ kg/m³

Communication System: CW; Frequency: 1880 MHz; Duty Cycle: 1:1

Probe: EF3DV3 - SN4060;ConvF(1, 1, 1)

E Scan - measurement distance from the probe sensor center to CD1880 Dipole = 15mm/Hearing Aid Compatibility Test (41x181x1): Interpolated grid: dx=0.5000 mm, dy=0.5000 mm

Device Reference Point: 0, 0, -6.3 mm

Reference Value = 157.8 V/m; Power Drift = 0.04 dB

Applied MIF = 0.00 dB

RF audio interference level = 39.24 dBV/m

Emission category: M2

MIF scaled E-field

Grid 1 M2 38.91 dBV/m	Grid 2 M2 39.24 dBV/m	Grid 3 M2 39.12 dBV/m
Grid 4 M2 36.32 dBV/m	Grid 5 M2 36.49 dBV/m	Grid 6 M2 36.45 dBV/m
Grid 7 M2 38.94 dBV/m	Grid 8 M2 39.16 dBV/m	Grid 9 M2 39.07 dBV/m

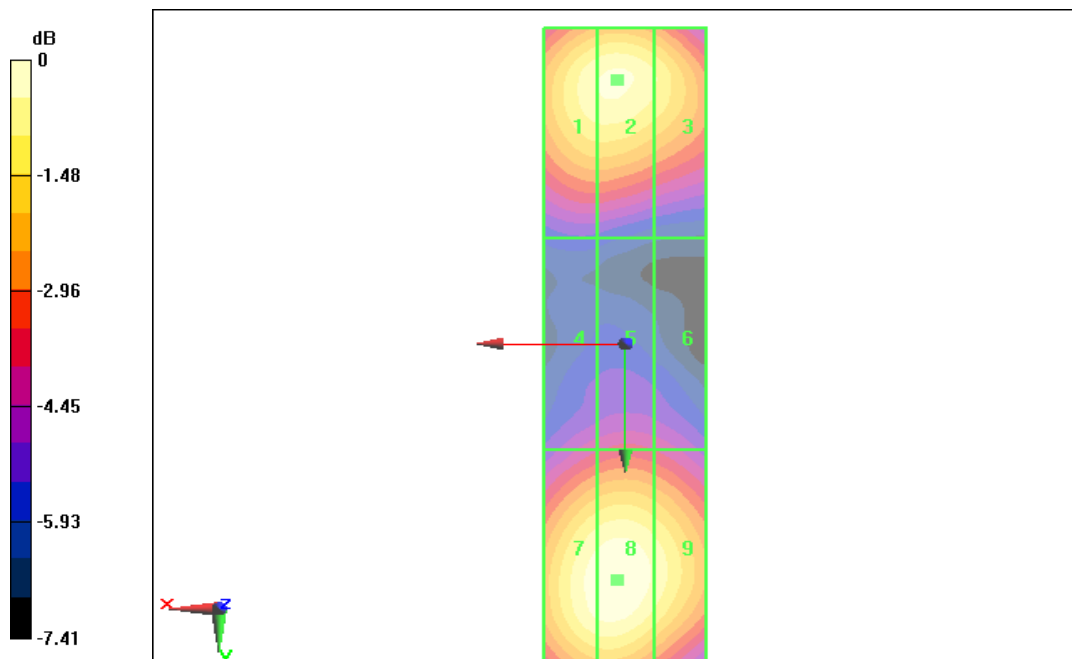

0 dB = 39.24 dBV/m

E SCAN of Dipole 2600 MHz

Date: 2019-1-17

Electronics: DAE4 Sn1555

Medium: Air

Medium parameters used: $\sigma = 0$ mho/m, $\epsilon_r = 1$; $\rho = 1000$ kg/m³

Communication System: CW; Frequency: 2600 MHz; Duty Cycle: 1:1

Probe: EF3DV3 - SN4060;ConvF(1, 1, 1)

E Scan - measurement distance from the probe sensor center to CD2600 Dipole = 15mm/Hearing Aid Compatibility Test (41x181x1): Interpolated grid: dx=0.5000 mm, dy=0.5000 mm

Device Reference Point: 0, 0, -6.3 mm

Reference Value = 67.73 V/m; Power Drift = 0.03 dB

Applied MIF = 0.00 dB

RF audio interference level = 38.83 dBV/m

Emission category: M2

MIF scaled E-field

Grid 1M2 38.47 dBV/m	Grid 2M2 38.71 dBV/m	Grid 3M2 38.62 dBV/m
Grid 4M2 38.02 dBV/m	Grid 5M2 38.22 dBV/m	Grid 6M2 38.18 dBV/m
Grid 7M2 38.60 dBV/m	Grid 8M2 38.83 dBV/m	Grid 9M2 38.74 dBV/m

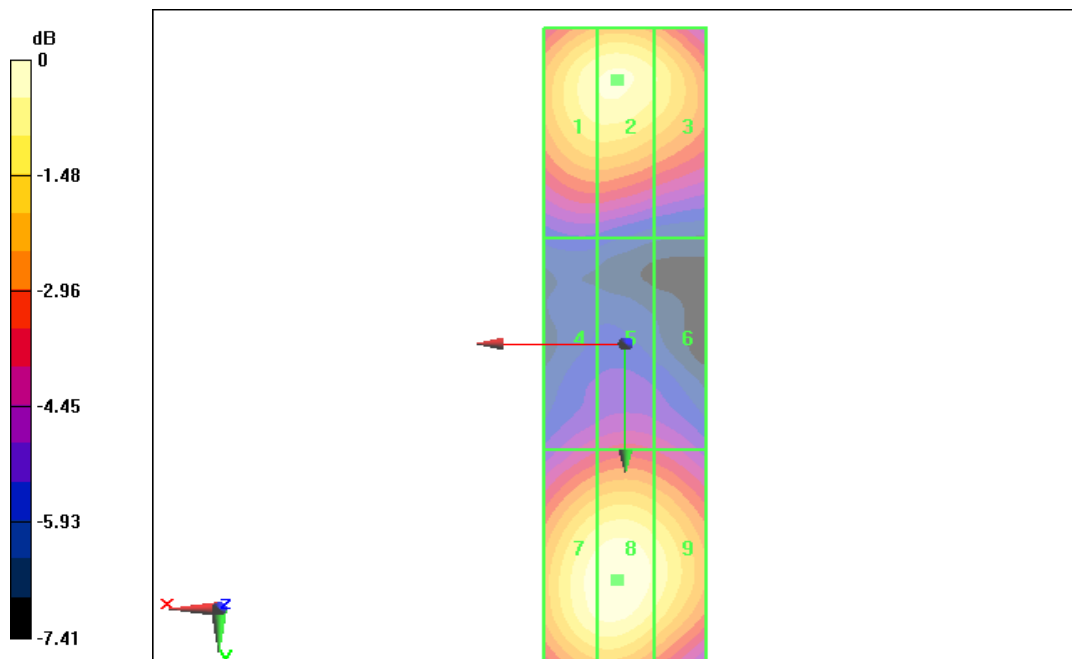

0 dB = 38.83 dBV/m

ANNEX D PROBE CALIBRATION CERTIFICATE

**Calibration Laboratory of
Schmid & Partner
Engineering AG**
Zeughausstrasse 43, 8004 Zurich, Switzerland



S Schweizerischer Kalibrierdienst
S Service suisse d'étalonnage
S Servizio svizzero di taratura
S Swiss Calibration Service

Accredited by the Swiss Accreditation Service (SAS)
The Swiss Accreditation Service is one of the signatories to the EA
Multilateral Agreement for the recognition of calibration certificates

Accreditation No.: **SCS 0108**

Client **CTTL-BJ (Auden)**

Certificate No: **EF3-4060_Jun18**

CALIBRATION CERTIFICATE

Object **EF3DV3 - SN:4060**

Calibration procedure(s) **QA CAL-02.v8, QA CAL-25.v6
Calibration procedure for E-field probes optimized for close near field
evaluations in air**



Calibration date: **June 12, 2018**

This calibration certificate documents the traceability to national standards, which realize the physical units of measurements (SI).
The measurements and the uncertainties with confidence probability are given on the following pages and are part of the certificate.

All calibrations have been conducted in the closed laboratory facility: environment temperature (22 ± 3)°C and humidity < 70%.

Calibration Equipment used (M&TE critical for calibration)

Primary Standards	ID	Cal Date (Certificate No.)	Scheduled Calibration
Power meter NRP	SN: 104778	04-Apr-18 (No. 217-02672/02673)	Apr-19
Power sensor NRP-Z91	SN: 103244	04-Apr-18 (No. 217-02672)	Apr-19
Power sensor NRP-Z91	SN: 103245	04-Apr-18 (No. 217-02673)	Apr-19
Reference 20 dB Attenuator	SN: S5277 (20x)	04-Apr-18 (No. 217-02682)	Apr-19
Reference Probe ER3DV6	SN: 2328	10-Oct-17 (No. ER3-2328_Oct17)	Oct-18
DAE4	SN: 789	2-Aug-17 (No. DAE4-789_Aug17)	Aug-18
Secondary Standards	ID	Check Date (in house)	Scheduled Check
Power meter E4419B	SN: GB41293874	06-Apr-16 (in house check Jun-18)	In house check: Jun-20
Power sensor E4412A	SN: MY41498087	06-Apr-16 (in house check Jun-18)	In house check: Jun-20
Power sensor E4412A	SN: 000110210	06-Apr-16 (in house check Jun-18)	In house check: Jun-20
RF generator HP 8648C	SN: US3642U01700	04-Aug-99 (in house check Jun-18)	In house check: Jun-20
Network Analyzer HP 8753E	SN: US37390585	18-Oct-01 (in house check Oct-17)	In house check: Oct-18

Calibrated by:	Name Michael Weber	Function Laboratory Technician	Signature 
Approved by:	Katja Pokovic	Technical Manager	
			Issued: June 12, 2018

This calibration certificate shall not be reproduced except in full without written approval of the laboratory.

Calibration Laboratory of
Schmid & Partner
Engineering AG
Zeughausstrasse 43, 8004 Zurich, Switzerland



S Schweizerischer Kalibrierdienst
C Service suisse d'étalonnage
S Servizio svizzero di taratura
S Swiss Calibration Service

Accredited by the Swiss Accreditation Service (SAS)
The Swiss Accreditation Service is one of the signatories to the EA
Multilateral Agreement for the recognition of calibration certificates

Accreditation No.: **SCS 0108**

Glossary:

NORM _{x,y,z}	sensitivity in free space
DCP	diode compression point
CF	crest factor (1/duty_cycle) of the RF signal
A, B, C, D	modulation dependent linearization parameters
Polarization ϕ	ϕ rotation around probe axis
Polarization ϑ	ϑ rotation around an axis that is in the plane normal to probe axis (at measurement center), i.e., $\vartheta = 0$ is normal to probe axis
Connector Angle	information used in DASY system to align probe sensor X to the robot coordinate system

Calibration is Performed According to the Following Standards:

- IEEE Std 1309-2005, " IEEE Standard for calibration of electromagnetic field sensors and probes, excluding antennas, from 9 kHz to 40 GHz", December 2005
- CTIA Test Plan for Hearing Aid Compatibility, Rev 3.0, November 2013

Methods Applied and Interpretation of Parameters:

- NORM_{x,y,z}*: Assessed for E-field polarization $\vartheta = 0$ for XY sensors and $\vartheta = 90$ for Z sensor ($f \leq 900$ MHz in TEM-cell; $f > 1800$ MHz: R22 waveguide).
- NORM(f)_{x,y,z}* = *NORM_{x,y,z}* * *frequency_response* (see Frequency Response Chart).
- DCP_{x,y,z}*: DCP are numerical linearization parameters assessed based on the data of power sweep with CW signal (no uncertainty required). DCP does not depend on frequency nor media.
- PAR*: PAR is the Peak to Average Ratio that is not calibrated but determined based on the signal characteristics
- A_{x,y,z}*; *B_{x,y,z}*; *C_{x,y,z}*; *D_{x,y,z}*; *VR_{x,y,z}*: *A, B, C, D* are numerical linearization parameters assessed based on the data of power sweep for specific modulation signal. The parameters do not depend on frequency nor media. *VR* is the maximum calibration range expressed in RMS voltage across the diode.
- Spherical isotropy (3D deviation from isotropy)*: in a locally homogeneous field realized using an open waveguide setup.
- Sensor Offset*: The sensor offset corresponds to the offset of virtual measurement center from the probe tip (on probe axis). No tolerance required.
- Connector Angle*: The angle is assessed using the information gained by determining the *NORM_x* (no uncertainty required).



EF3DV3 – SN:4060

June 12, 2018

Probe EF3DV3

SN:4060

Manufactured: March 13, 2018
Calibrated: June 12, 2018

Calibrated for DASY/EASY Systems
(Note: non-compatible with DASY2 system!)



EF3DV3 – SN:4060

June 12, 2018

DASY/EASY - Parameters of Probe: EF3DV3 - SN:4060

Basic Calibration Parameters

	Sensor X	Sensor Y	Sensor Z	Unc (k=2)
Norm ($\mu\text{V}/(\text{V}/\text{m})^2$)	0.76	0.71	1.33	$\pm 10.1\%$
DCP (mV) ^B	95.7	94.8	94.0	

Modulation Calibration Parameters

UID	Communication System Name		A dB	B dB $\sqrt{\mu\text{V}}$	C	D dB	VR mV	Unc ^E (k=2)
0	CW	X	0.0	0.0	1.0	0.00	178.2	$\pm 2.2\%$
		Y	0.0	0.0	1.0		166.5	
		Z	0.0	0.0	1.0		136.4	

Note: For details on UID parameters see Appendix.

Sensor Model Parameters

	C1 fF	C2 fF	α V ⁻¹	T1 ms.V ⁻²	T2 ms.V ⁻¹	T3 ms	T4 V ⁻²	T5 V ⁻¹	T6
X	37.27	249.6	37.86	6.092	0.115	4.959	0.368	0.148	1.000
Y	36.09	241.8	37.76	8.234	0.000	5.006	0.000	0.039	1.010
Z	34.42	234.1	38.89	6.204	0.000	4.988	0.000	0.063	1.006

The reported uncertainty of measurement is stated as the standard uncertainty of measurement multiplied by the coverage factor k=2, which for a normal distribution corresponds to a coverage probability of approximately 95%.

^B Numerical linearization parameter: uncertainty not required.

^E Uncertainty is determined using the max. deviation from linear response applying rectangular distribution and is expressed for the square of the field value.

EF3DV3 – SN:4060

June 12, 2018

Frequency Response of E-Field (TEM-Cell:ifi110 EXX, Waveguide: R22)

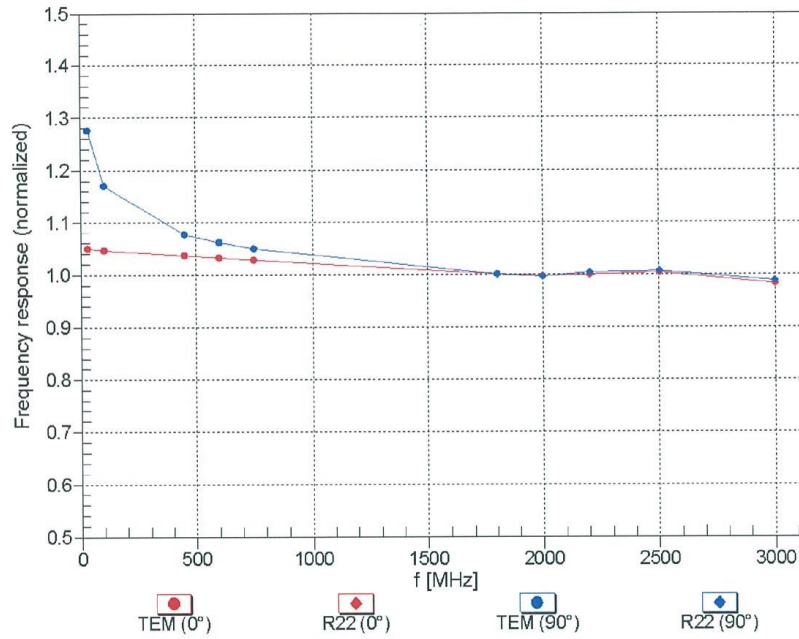

Uncertainty of Frequency Response of E-field: $\pm 6.3\%$ (k=2)

EF3DV3 – SN:4060

June 12, 2018

Receiving Pattern (ϕ), $\vartheta = 0^\circ$

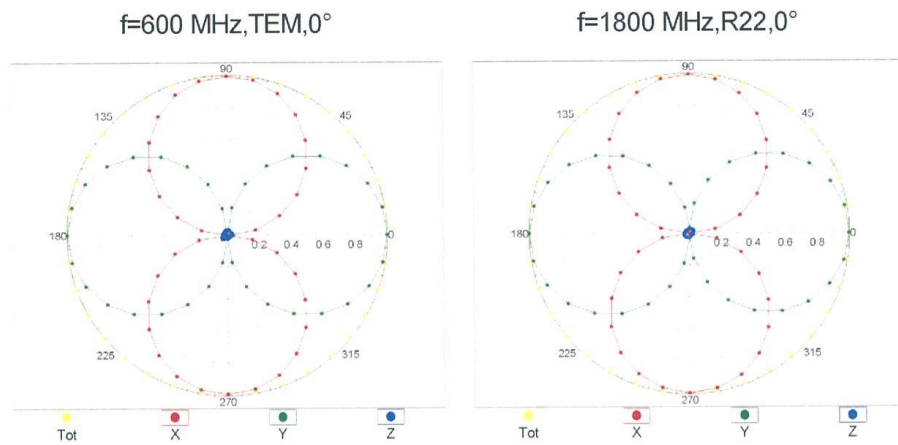

Receiving Pattern (ϕ), $\vartheta = 90^\circ$

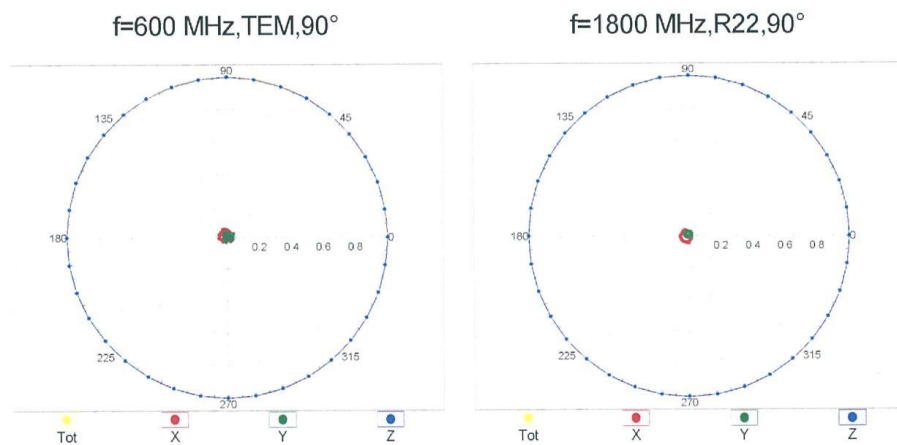

EF3DV3 – SN:4060

June 12, 2018

Receiving Pattern (ϕ), $\vartheta = 0^\circ$

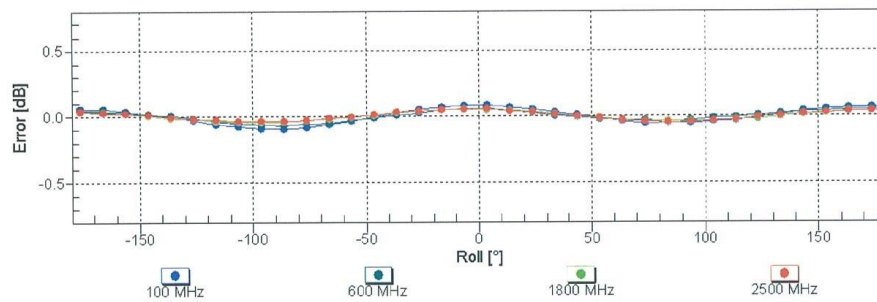

Uncertainty of Axial Isotropy Assessment: $\pm 0.5\%$ ($k=2$)

Receiving Pattern (ϕ), $\vartheta = 90^\circ$

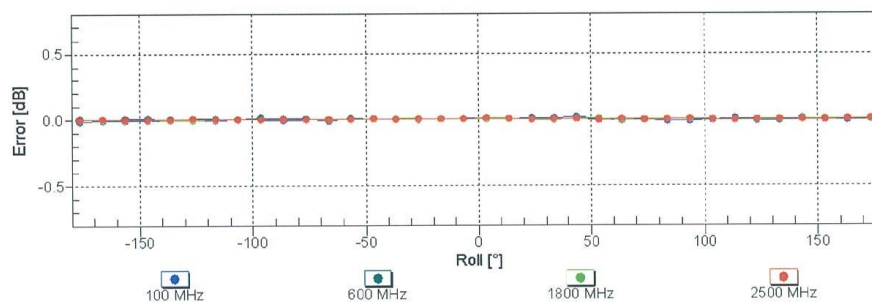

Uncertainty of Axial Isotropy Assessment: $\pm 0.5\%$ ($k=2$)

EF3DV3 – SN:4060

June 12, 2018

Dynamic Range f(E-field) (TEM cell , f = 900 MHz)

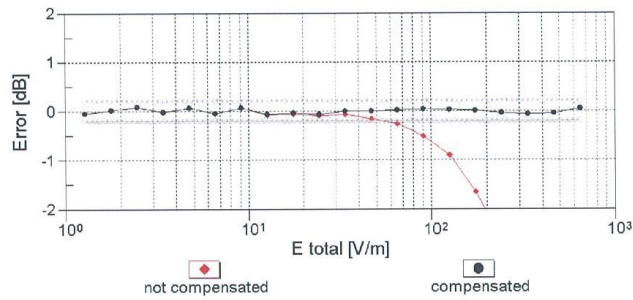
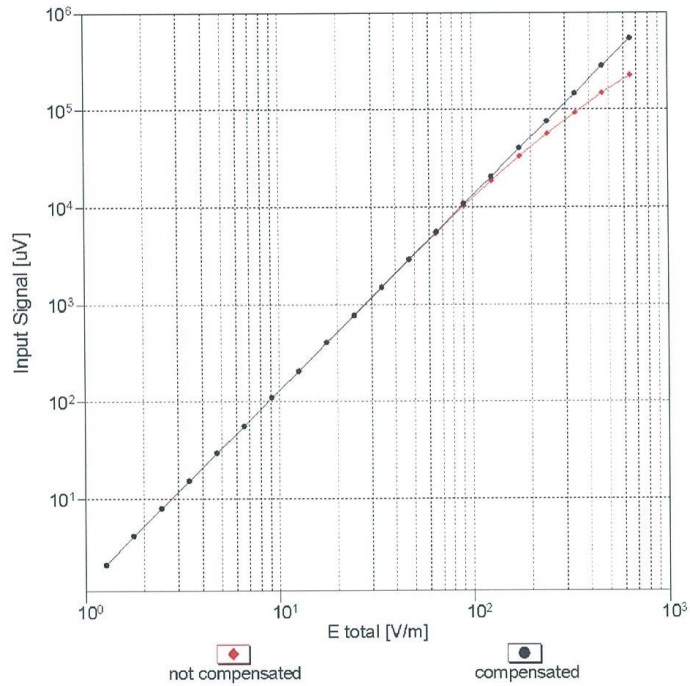

Uncertainty of Linearity Assessment: $\pm 0.6\%$ (k=2)

EF3DV3 – SN:4060

June 12, 2018

Deviation from Isotropy in Air Error (ϕ , θ), $f = 900$ MHz

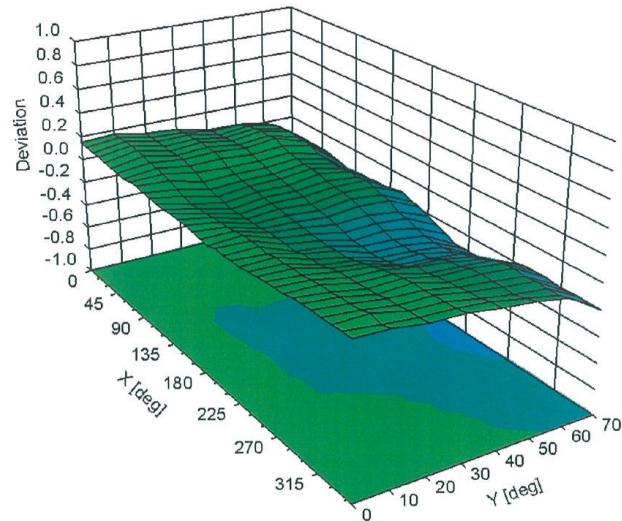

Uncertainty of Spherical Isotropy Assessment: $\pm 2.6\%$ ($k=2$)



EF3DV3 – SN:4060

June 12, 2018

DASY/EASY - Parameters of Probe: EF3DV3 - SN:4060

Other Probe Parameters

Sensor Arrangement	Rectangular
Connector Angle (°)	143.6
Mechanical Surface Detection Mode	enabled
Optical Surface Detection Mode	disabled
Probe Overall Length	335 mm
Probe Body Diameter	12 mm
Tip Length	25 mm
Tip Diameter	4 mm
Probe Tip to Sensor X Calibration Point	2.5 mm
Probe Tip to Sensor Y Calibration Point	2.5 mm
Probe Tip to Sensor Z Calibration Point	2.5 mm

EF3DV3 – SN:4060

June 12, 2018

Appendix (Additional assessments outside the scope of SCS 0108)

Calibration Parameters for 3-4 GHz

	Sensor X	Sensor Y	Sensor Z	Unc (k=2)
Norm ($\mu\text{V}/(\text{V}/\text{m})^2$) ^x	0.79	0.75	1.35	± 10.1 %
DCP (mV) ^b	95.7	94.8	94.0	

Calibration Parameters for 5-6 GHz

	Sensor X	Sensor Y	Sensor Z	Unc (k=2)
Norm ($\mu\text{V}/(\text{V}/\text{m})^2$) ^x	0.86	0.81	1.48	± 10.1 %
DCP (mV) ^b	95.7	94.8	94.0	

The reported uncertainty of measurement is stated as the standard uncertainty of measurement multiplied by the coverage factor k=2, which for a normal distribution corresponds to a coverage probability of approximately 95%.

^b Numerical linearization parameter: uncertainty not required.

^x Calibration procedure for frequencies above 3 GHz is pending accreditation.

ANNEX E DIPOLE CALIBRATION CERTIFICATE

Dipole 835 MHz

Calibration Laboratory of
Schmid & Partner
Engineering AG
Zeughausstrasse 43, 8004 Zurich, Switzerland



S Schweizerischer Kalibrierdienst
C Service suisse d'étalonnage
S Servizio svizzero di taratura
S Swiss Calibration Service

Accredited by the Swiss Accreditation Service (SAS)
The Swiss Accreditation Service is one of the signatories to the EA
Multilateral Agreement for the recognition of calibration certificates

Accreditation No.: SCS 0108

Client **CTTL (Auden)**

Certificate No: **CD835V3-1023_Aug18**

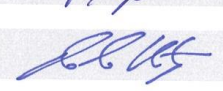
CALIBRATION CERTIFICATE			
Object	CD835V3 - SN: 1023		
Calibration procedure(s)	QA CAL-20.v6 Calibration procedure for dipoles in air		
Calibration date:	August 28, 2018		
This calibration certificate documents the traceability to national standards, which realize the physical units of measurements (SI). The measurements and the uncertainties with confidence probability are given on the following pages and are part of the certificate.			
All calibrations have been conducted in the closed laboratory facility: environment temperature (22 ± 3)°C and humidity < 70%.			
Calibration Equipment used (M&TE critical for calibration)			
Primary Standards	ID #	Cal Date (Certificate No.)	Scheduled Calibration
Power meter NRP	SN: 104778	04-Apr-18 (No. 217-02672/02673)	Apr-19
Power sensor NRP-Z91	SN: 103244	04-Apr-18 (No. 217-02672)	Apr-19
Power sensor NRP-Z91	SN: 103245	04-Apr-18 (No. 217-02673)	Apr-19
Reference 20 dB Attenuator	SN: 5058 (20k)	04-Apr-18 (No. 217-02682)	Apr-19
Type-N mismatch combination	SN: 5047.2 / 06327	04-Apr-18 (No. 217-02683)	Apr-19
Probe EF3DV3	SN: 4013	05-Mar-18 (No. EF3-4013_Mar18)	Mar-19
DAE4	SN: 781	17-Jan-18 (No. DAE4-781_Jan18)	Jan-19
Secondary Standards	ID #	Check Date (in house)	Scheduled Check
Power meter Agilent 4419B	SN: GB42420191	09-Oct-09 (in house check Oct-17)	In house check: Oct-20
Power sensor HP E4412A	SN: US38485102	05-Jan-10 (in house check Oct-17)	In house check: Oct-20
Power sensor HP 8482A	SN: US37295597	09-Oct-09 (in house check Oct-17)	In house check: Oct-20
RF generator R&S SMT-06	SN: 832283/011	27-Aug-12 (in house check Oct-17)	In house check: Oct-20
Network Analyzer Agilent E8358A	SN: US41080477	31-Mar-14 (in house check Oct-17)	In house check: Oct-18
Calibrated by:	Name Leif Klysner	Function Laboratory Technician	Signature 
Approved by:	Name Katja Pokovic	Function Technical Manager	Signature 
This calibration certificate shall not be reproduced except in full without written approval of the laboratory.			Issued: August 28, 2018

**Calibration Laboratory of
Schmid & Partner
Engineering AG**
Zeughausstrasse 43, 8004 Zurich, Switzerland



S Schweizerischer Kalibrierdienst
C Service suisse d'étalonnage
S Servizio svizzero di taratura
Swiss Calibration Service

Accredited by the Swiss Accreditation Service (SAS)
The Swiss Accreditation Service is one of the signatories to the EA
Multilateral Agreement for the recognition of calibration certificates

Accreditation No.: **SCS 0108**

References

- [1] ANSI-C63.19-2011
American National Standard, Methods of Measurement of Compatibility between Wireless Communications Devices and Hearing Aids.

Methods Applied and Interpretation of Parameters:

- **Coordinate System:** y-axis is in the direction of the dipole arms. z-axis is from the basis of the antenna (mounted on the table) towards its feed point between the two dipole arms. x-axis is normal to the other axes. In coincidence with the standards [1], the measurement planes (probe sensor center) are selected to be at a distance of 15 mm above the top metal edge of the dipole arms.
- **Measurement Conditions:** Further details are available from the hardcopies at the end of the certificate. All figures stated in the certificate are valid at the frequency indicated. The forward power to the dipole connector is set with a calibrated power meter connected and monitored with an auxiliary power meter connected to a directional coupler. While the dipole under test is connected, the forward power is adjusted to the same level.
- **Antenna Positioning:** The dipole is mounted on a HAC Test Arch phantom using the matching dipole positioner with the arms horizontal and the feeding cable coming from the floor. The measurements are performed in a shielded room with absorbers around the setup to reduce the reflections. It is verified before the mounting of the dipole under the Test Arch phantom, that its arms are perfectly in a line. It is installed on the HAC dipole positioner with its arms parallel below the dielectric reference wire and able to move elastically in vertical direction without changing its relative position to the top center of the Test Arch phantom. The vertical distance to the probe is adjusted after dipole mounting with a DASY5 Surface Check job. Before the measurement, the distance between phantom surface and probe tip is verified. The proper measurement distance is selected by choosing the matching section of the HAC Test Arch phantom with the proper device reference point (upper surface of the dipole) and the matching grid reference point (tip of the probe) considering the probe sensor offset. The vertical distance to the probe is essential for the accuracy.
- **Feed Point Impedance and Return Loss:** These parameters are measured using a HP 8753E Vector Network Analyzer. The impedance is specified at the SMA connector of the dipole. The influence of reflections was eliminating by applying the averaging function while moving the dipole in the air, at least 70cm away from any obstacles.
- **E-field distribution:** E field is measured in the x-y-plane with an isotropic ER3D-field probe with 100 mW forward power to the antenna feed point. In accordance with [1], the scan area is 20mm wide, its length exceeds the dipole arm length (180 or 90mm). The sensor center is 15 mm (in z) above the metal top of the dipole arms. Two 3D maxima are available near the end of the dipole arms. Assuming the dipole arms are perfectly in one line, the average of these two maxima (in subgrid 2 and subgrid 8) is determined to compensate for any non-parallelity to the measurement plane as well as the sensor displacement. The E-field value stated as calibration value represents the maximum of the interpolated 3D-E-field, in the plane above the dipole surface.

The reported uncertainty of measurement is stated as the standard uncertainty of measurement multiplied by the coverage factor $k=2$, which for a normal distribution corresponds to a coverage probability of approximately 95%.

Measurement Conditions

DASY system configuration, as far as not given on page 1.

DASY Version	DASY5	V52.10.1
Phantom	HAC Test Arch	
Distance Dipole Top - Probe Center	15 mm	
Scan resolution	dx, dy = 5 mm	
Frequency	835 MHz \pm 1 MHz	
Input power drift	< 0.05 dB	

Maximum Field values at 835 MHz

E-field 15 mm above dipole surface	condition	Interpolated maximum
Maximum measured above high end	100 mW input power	111.0 V/m = 40.91 dBV/m
Maximum measured above low end	100 mW input power	109.6 V/m = 40.80 dBV/m
Averaged maximum above arm	100 mW input power	110.3 V/m \pm 12.8 % (k=2)

Appendix (Additional assessments outside the scope of SCS 0108)

Antenna Parameters

Frequency	Return Loss	Impedance
800 MHz	18.1 dB	42.6 Ω - 9.0 j Ω
835 MHz	23.3 dB	53.6 Ω + 6.1 j Ω
880 MHz	15.6 dB	65.0 Ω - 11.8 j Ω
900 MHz	17.7 dB	53.6 Ω - 13.1 j Ω
945 MHz	25.0 dB	46.5 Ω + 4.1 j Ω

3.2 Antenna Design and Handling

The calibration dipole has a symmetric geometry with a built-in two stub matching network, which leads to the enhanced bandwidth.

The dipole is built of standard semirigid coaxial cable. The internal matching line is open ended. The antenna is therefore open for DC signals.

Do not apply force to dipole arms, as they are liable to bend. The soldered connections near the feedpoint may be damaged. After excessive mechanical stress or overheating, check the impedance characteristics to ensure that the internal matching network is not affected.

After long term use with 40W radiated power, only a slight warming of the dipole near the feedpoint can be measured.

Impedance Measurement Plot

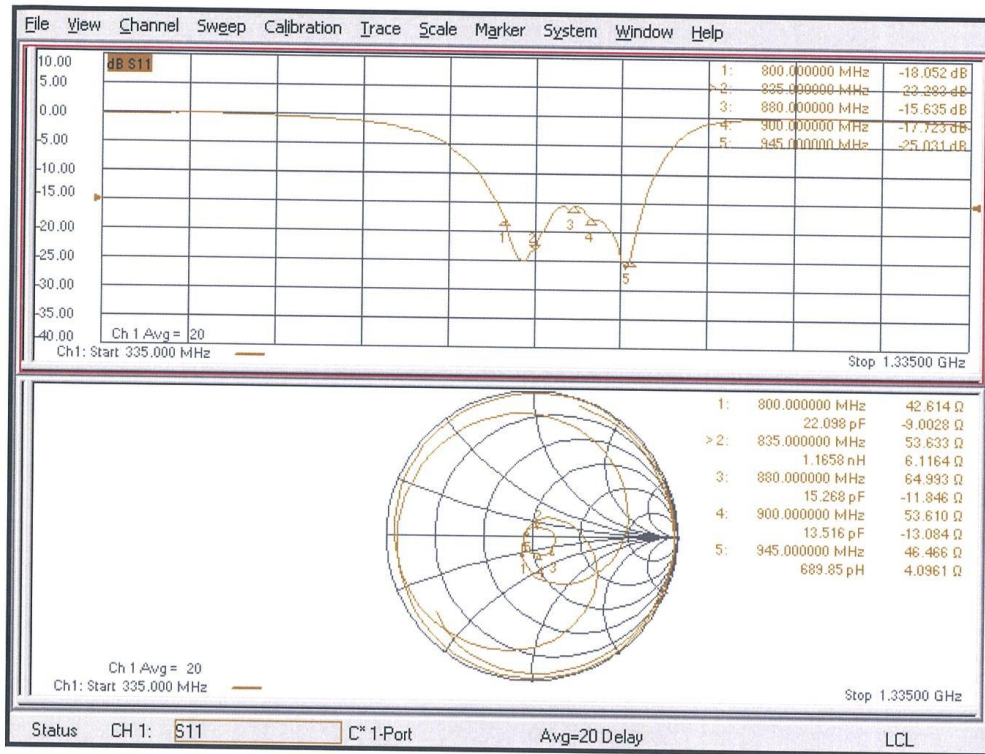

DASY5 E-field Result

Date: 28.08.2018

Test Laboratory: SPEAG Lab2

DUT: HAC-Dipole 835 MHz; Type: CD835V3; Serial: CD835V3 - SN: 1023

Communication System: UID 0 - CW ; Frequency: 835 MHz
 Medium parameters used: $\sigma = 0$ S/m, $\epsilon_r = 1$; $\rho = 0$ kg/m³
 Phantom section: RF Section
 Measurement Standard: DASY5 (IEEE/IEC/ANSI C63.19-2011)

DASY52 Configuration:

- Probe: EF3DV3 - SN4013; ConvF(1, 1, 1) @ 835 MHz; Calibrated: 05.03.2018
- Sensor-Surface: (Fix Surface)
- Electronics: DAE4 Sn781; Calibrated: 17.01.2018
- Phantom: HAC Test Arch with AMCC; Type: SD HAC P01 BA; Serial: 1070
- DASY52 52.10.1(1476); SEMCAD X 14.6.11(7439)

Dipole E-Field measurement @ 835MHz/E-Scan - 835MHz d=15mm/Hearing Aid Compatibility Test (41x361x1):

Interpolated grid: dx=0.5000 mm, dy=0.5000 mm
 Device Reference Point: 0, 0, -6.3 mm
 Reference Value = 132.3 V/m; Power Drift = -0.03 dB
 Applied MIF = 0.00 dB
 RF audio interference level = 40.91 dBV/m
Emission category: M3

MIF scaled E-field

Grid 1 M3 40.37 dBV/m	Grid 2 M3 40.8 dBV/m	Grid 3 M3 40.73 dBV/m
Grid 4 M4 35.58 dBV/m	Grid 5 M4 35.93 dBV/m	Grid 6 M4 35.91 dBV/m
Grid 7 M3 40.56 dBV/m	Grid 8 M3 40.91 dBV/m	Grid 9 M3 40.85 dBV/m

