

FCC SAR Test Report

Report No. : SA190322W004
Applicant : HMD Global Oy
Address : Bertel Jungin aukio 9, 02600 Espoo, Finland
Product : GSM/WCDMA/LTE Mobile Phone
FCC ID : 2AJOTTA-1130
Brand : Nokia
Model No. : TA-1130
Standards : FCC 47 CFR Part 2 (2.1093) / IEEE C95.1:1992 / IEEE 1528:2013
KDB 865664 D01 v01r04 / KDB 865664 D02 v01r02
KDB 248227 D01 v02r02 / KDB 447498 D01 v06
/ KDB 648474 D04 v01r03 / KDB 941225 D01 v03r01
/ KDB 941225 D05 v02r05 / KDB 941225 D06 v02r01
Sample Received Date : Mar. 25, 2019
Date of Testing : Mar. 26, 2019 ~ Mar. 29, 2019

CERTIFICATION: The above equipment have been tested by **BV 7LAYERS COMMUNICATIONS TECHNOLOGY (SHENZHEN) CO. LTD.**, and found compliance with the requirement of the above standards. The test record, data evaluation & Equipment Under Test (EUT) configurations represented herein are true and accurate accounts of the measurements of the sample's SAR characteristics under the conditions specified in this report. It should not be reproduced except in full, without the written approval of our laboratory. The client should not use it to claim product certification, approval, or endorsement by A2LA or any government agencies.

Prepared By :

Xianxiong Qin / Engineer

Approved By :

Luke Lu / Manager



This report is governed by, and incorporates by reference, CPS Conditions of Service as posted at the date of issuance of this report at <http://www.bureauveritas.com/home/about-us/our-business/cps/about-us/terms-conditions/> and is intended for your exclusive use. Any copying or replication of this report to or for any other person or entity, or use of our name or trademark, is permitted only with our prior written permission. This report sets forth our findings solely with respect to the test samples identified herein. The results set forth in this report are not indicative or representative of the quality or characteristics of the lot from which a test sample was taken or any similar or identical product unless specifically and expressly noted. Our report includes all of the tests requested by you and the results thereof based upon the information that you provided to us. Measurement uncertainty is only provided upon request for accredited tests. You have 60 days from date of issuance of this report to notify us of any material error or omission caused by our negligence or if you require measurement uncertainty; provided, however, that such notice shall be in writing and shall specifically address the issue you wish to raise. A failure to raise such issue within the prescribed time shall constitute your unqualified acceptance of the completeness of this report, the tests conducted and the correctness of the report contents.

Table of Contents

Release Control Record	3
1. Summary of Maximum SAR Value	4
2. Description of Equipment Under Test	5
3. SAR Measurement System	6
3.1 Definition of Specific Absorption Rate (SAR)	6
3.2 SPEAG DASY System	6
3.2.1 Robot	7
3.2.2 Probes	8
3.2.3 Data Acquisition Electronics (DAE)	8
3.2.4 Phantoms	9
3.2.5 Device Holder	10
3.2.6 System Validation Dipoles	10
3.2.7 Tissue Simulating Liquids	11
3.3 SAR System Verification	14
3.4 SAR Measurement Procedure	15
3.4.1 Area & Zoom Scan Procedure	15
3.4.2 Volume Scan Procedure	15
3.4.3 Power Drift Monitoring	16
3.4.4 Spatial Peak SAR Evaluation	16
3.4.5 SAR Averaged Methods	16
4. SAR Measurement Evaluation	17
4.1 EUT Configuration and Setting	17
4.2 EUT Testing Position	22
4.2.1 Head Exposure Conditions	22
4.2.2 Body-worn Accessory Exposure Conditions	24
4.2.3 Hotspot Mode Exposure Conditions	25
4.2.4 SAR Test Exclusion Evaluations	26
4.2.5 Simultaneous Transmission Possibilities	26
4.3 Tissue Verification	27
4.4 System Validation	27
4.5 System Verification	28
4.6 Maximum Output Power	29
4.6.1 Maximum Conducted Power	29
4.6.2 Measured Conducted Power Result	31
4.7 SAR Testing Results	39
4.7.1 SAR Test Reduction Considerations	39
4.7.2 SAR Results for Head Exposure Condition	41
4.7.3 SAR Results for Body-worn Exposure Condition (Separation Distance is 1.5 cm Gap)	41
4.7.4 SAR Results for Hotspot Exposure Condition (Separation Distance is 1.0 cm Gap)	42
4.7.5 SAR Measurement Variability	43
4.7.6 Simultaneous Multi-band Transmission Evaluation	43
5. Calibration of Test Equipment	48
6. Measurement Uncertainty	49
7. Information on the Testing Laboratories	51
Appendix A. SAR Plots of System Verification	
Appendix B. SAR Plots of SAR Measurement	
Appendix C. Calibration Certificate for Probe and Dipole	
Appendix D. Photographs of EUT and Setup	

1. Summary of Maximum SAR Value

Equipment Class	Mode	Highest Reported Head SAR _{1g} (W/kg)	Highest Reported Body-worn SAR _{1g} (1.5 cm Gap) (W/kg)	Highest Reported Hotspot SAR _{1g} (1.0 cm Gap) (W/kg)
PCE	GSM850	0.67	0.65	0.61
	GSM1900	0.23	0.19	0.44
	WCDMA V	0.18	0.20	0.47
	LTE 5	0.44	0.65	0.77
	LTE 7	0.29	0.49	0.72
	LTE 28	0.21	0.37	0.43
	LTE 38	0.19	0.28	0.82
DTS	2.4G WLAN	0.84	0.05	0.15
DSS	Bluetooth	N/A	N/A	N/A
Highest Simultaneous Transmission SAR		Head (W/kg)	Body-worn (W/kg)	Hotspot (W/kg)
PCE + DTS		1.44	0.71	0.94
PCE + DSS		N/A	0.73	N/A

Note:

- The SAR limit (**Head & Body: SAR_{1g} 1.6 W/kg**) for general population / uncontrolled exposure is specified in FCC 47 CFR part 2 (2.1093) and ANSI/IEEE C95.1-1992.

FCC SAR Test Report

2. Description of Equipment Under Test

EUT Type	GSM/WCDMA/LTE Mobile Phone
FCC ID	2AJOTTA-1130
Brand Name	Nokia
Model Name	TA-1130
IMEI Code	352886100004692/ 352886100019690
HW Version	HW0201
SW Version	000C_0_310
Tx Frequency Bands (Unit: MHz)	GSM850 : 824.2 ~ 848.8 GSM1900 : 1850.2 ~ 1909.8 WCDMA Band V : 826.4 ~ 846.6 LTE Band 5 : 824.7 ~ 848.3 (1.4M), 825.5 ~ 847.5 (3M), 826.5 ~ 846.5 (5M), 829 ~ 844 (10M) LTE Band 7 : 2502.5 ~ 2567.5 (5M), 2505 ~ 2565 (10M), 2507.5 ~ 2562.5 (15M), 2510 ~ 2560 (20M) LTE Band 28 : 704.5 ~ 746.5(3M), 705.5 ~ 745.5 (5M), 708 ~ 743 (10M), 710.5 ~ 740.5 (15M), 713 ~ 738 (20M) LTE Band 38 : 2572.5 ~ 2617.5 (5M), 2575 ~ 2615 (10M), 2577.5 ~ 2612.5 (15M), 2580 ~ 2610 (20M) WLAN : 2412 ~ 2462 Bluetooth : 2402 ~ 2480
Uplink Modulations	GSM & GPRS : GMSK EDGE : 8PSK WCDMA : QPSK LTE : QPSK, 16QAM 802.11b : DSSS 802.11g/n : OFDM Bluetooth : GFSK, $\pi/4$ -DQPSK, 8-DPSK, LE
Maximum Tune-up Conducted Power (Unit: dBm)	Please refer to section 4.6.1 of this report.
Antenna Type	WLAN: PIFA Antenna WWAN: Fixed Internal Antenna
EUT Stage	Production Unit

Note:

- The above EUT information is declared by manufacturer and for more detailed features description please refers to the manufacturer's specifications or User's Manual.

List of Accessory:

Battery	Brand Name	Lishen
	Model Name	HE365
	Power Rating	3.85Vdc, 2500mAh
	Type	Li-ion
Earphone	Brand Name	Nokia
	Model Name	WH-108
	Manufacturer	OBO
	Signal Line Type	1.5 meter non-shielded cable without ferrite core

3. SAR Measurement System

3.1 Definition of Specific Absorption Rate (SAR)

SAR is related to the rate at which energy is absorbed per unit mass in an object exposed to a radio field. The SAR distribution in a biological body is complicated and is usually carried out by experimental techniques or numerical modeling. The standard recommends limits for two tiers of groups, occupational/controlled and general population/uncontrolled, based on a person's awareness and ability to exercise control over his or her exposure. In general, occupational/controlled exposure limits are higher than the limits for general population/uncontrolled.

The SAR definition is the time derivative (rate) of the incremental energy (dW) absorbed by (dissipated in) an incremental mass (dm) contained in a volume element (dv) of a given density (ρ). The equation description is as below:

$$SAR = \frac{d}{dt} \left(\frac{dW}{dm} \right) = \frac{d}{dt} \left(\frac{dW}{\rho dv} \right)$$

SAR is expressed in units of Watts per kilogram (W/kg)

SAR measurement can be related to the electrical field in the tissue by

$$SAR = \frac{\sigma |E|^2}{\rho}$$

Where: σ is the conductivity of the tissue, ρ is the mass density of the tissue and E is the RMS electrical field strength.

3.2 SPEAG DASY System

DASY system consists of high precision robot, probe alignment sensor, phantom, robot controller, controlled measurement server and near-field probe. The robot includes six axes that can move to the precision position of the DASY5 software defined. The DASY software can define the area that is detected by the probe. The robot is connected to controlled box. Controlled measurement server is connected to the controlled robot box. The DAE includes amplifier, signal multiplexing, AD converter, offset measurement and surface detection. It is connected to the Electro-optical coupler (ECO). The ECO performs the conversion from the optical into digital electric signal of the DAE and transfers data to the PC.

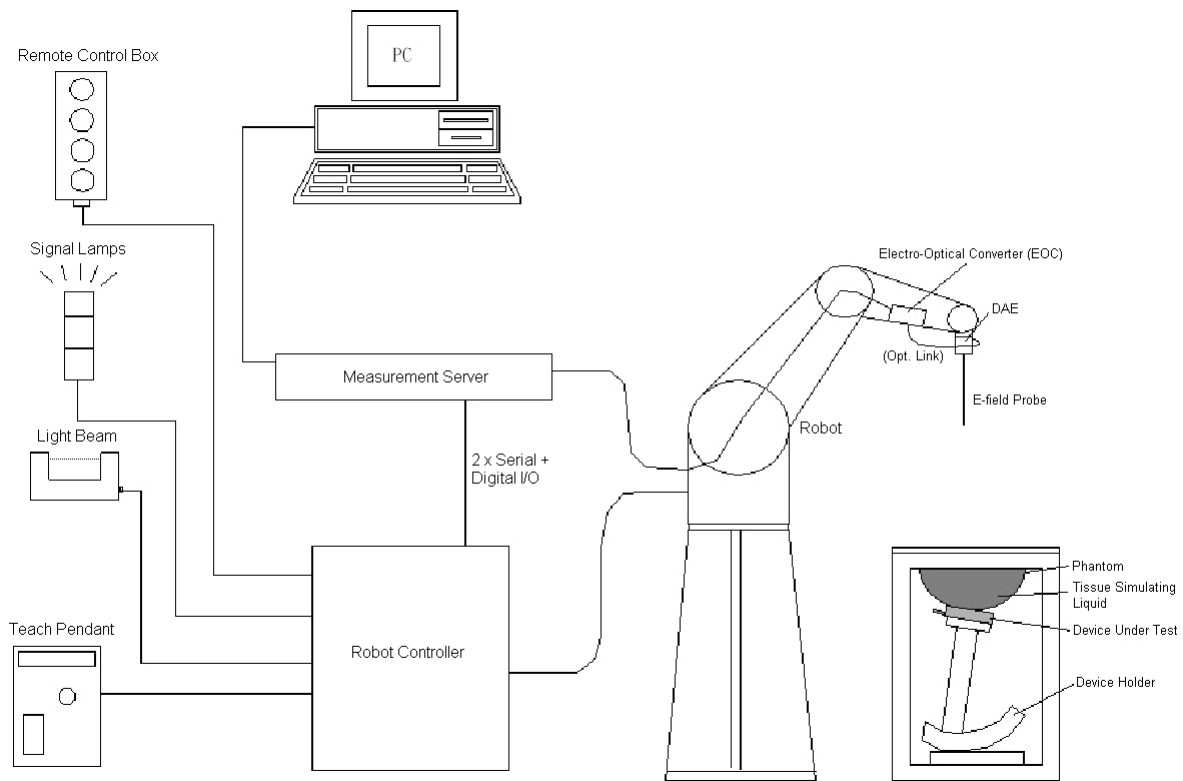

Fig-3.1 DASY System Setup

3.2.1 Robot

The DASY system uses the high precision robots from Stäubli SA (France). For the 6-axis controller system, the robot controller version (DASY5: CS8c) from Stäubli is used. The Stäubli robot series have many features that are important for our application:

- High precision (repeatability ± 0.035 mm)
- High reliability (industrial design)
- Jerk-free straight movements
- Low ELF interference (the closed metallic construction shields against motor control fields)





Fig-3.2 DASY5

FCC SAR Test Report

3.2.2 Probes

The SAR measurement is conducted with the dosimetric probe. The probe is specially designed and calibrated for use in liquid with high permittivity. The dosimetric probe has special calibration in liquid at different frequency.

Model	EX3DV4	
Construction	Symmetrical design with triangular core. Built-in shielding against static charges. PEEK enclosure material (resistant to organic solvents, e.g., DGBE).	
Frequency	10 MHz to 6 GHz Linearity: ± 0.2 dB	
Directivity	± 0.3 dB in HSL (rotation around probe axis) ± 0.5 dB in tissue material (rotation normal to probe axis)	
Dynamic Range	10 μ W/g to 100 mW/g Linearity: ± 0.2 dB (noise: typically < 1 μ W/g)	
Dimensions	Overall length: 337 mm (Tip: 20 mm) Tip diameter: 2.5 mm (Body: 12 mm) Typical distance from probe tip to dipole centers: 1 mm	

Model	ES3DV3	
Construction	Symmetrical design with triangular core. Interleaved sensors. Built-in shielding against static charges. PEEK enclosure material (resistant to organic solvents, e.g., DGBE).	
Frequency	10 MHz to 4 GHz Linearity: ± 0.2 dB	
Directivity	± 0.2 dB in HSL (rotation around probe axis) ± 0.3 dB in tissue material (rotation normal to probe axis)	
Dynamic Range	5 μ W/g to 100 mW/g Linearity: ± 0.2 dB	
Dimensions	Overall length: 337 mm (Tip: 20 mm) Tip diameter: 3.9 mm (Body: 12 mm) Distance from probe tip to dipole centers: 2.0 mm	

3.2.3 Data Acquisition Electronics (DAE)

Model	DAE3, DAE4	
Construction	Signal amplifier, multiplexer, A/D converter and control logic. Serial optical link for communication with DASY embedded system (fully remote controlled). Two step probe touch detector for mechanical surface detection and emergency robot stop.	
Measurement Range	-100 to +300 mV (16 bit resolution and two range settings: 4mV, 400mV)	
Input Offset Voltage	< 5 μ V (with auto zero)	
Input Bias Current	< 50 fA	
Dimensions	60 x 60 x 68 mm	

FCC SAR Test Report

3.2.4 Phantoms

Model	Twin SAM	
Construction	The shell corresponds to the specifications of the Specific Anthropomorphic Mannequin (SAM) phantom defined in IEEE 1528 and IEC 62209-1. It enables the dosimetric evaluation of left and right hand phone usage as well as body mounted usage at the flat phantom region. A cover prevents evaporation of the liquid. Reference markings on the phantom allow the complete setup of all predefined phantom positions and measurement grids by teaching three points with the robot.	
Material	Vinylester, glass fiber reinforced (VE-GF)	
Shell Thickness	2 ± 0.2 mm (6 ± 0.2 mm at ear point)	
Dimensions	Length: 1000 mm Width: 500 mm Height: adjustable feet	
Filling Volume	approx. 25 liters	

Model	ELI	
Construction	Phantom for compliance testing of handheld and body-mounted wireless devices in the frequency range of 30 MHz to 6 GHz. ELI is fully compatible with the IEC 62209-2 standard and all known tissue simulating liquids. ELI has been optimized regarding its performance and can be integrated into our standard phantom tables. A cover prevents evaporation of the liquid. Reference markings on the phantom allow installation of the complete setup, including all predefined phantom positions and measurement grids, by teaching three points. The phantom is compatible with all SPEAG dosimetric probes and dipoles.	
Material	Vinylester, glass fiber reinforced (VE-GF)	
Shell Thickness	2.0 ± 0.2 mm (bottom plate)	
Dimensions	Major axis: 600 mm Minor axis: 400 mm	
Filling Volume	approx. 30 liters	

FCC SAR Test Report

3.2.5 Device Holder

Model	Mounting Device	
Construction	In combination with the Twin SAM Phantom or ELI4, the Mounting Device enables the rotation of the mounted transmitter device in spherical coordinates. Rotation point is the ear opening point. Transmitter devices can be easily and accurately positioned according to IEC, IEEE, FCC or other specifications. The device holder can be locked for positioning at different phantom sections (left head, right head, flat).	
Material	POM	

Model	Laptop Extensions Kit	
Construction	Simple but effective and easy-to-use extension for Mounting Device that facilitates the testing of larger devices according to IEC 62209-2 (e.g., laptops, cameras, etc.). It is lightweight and fits easily on the upper part of the Mounting Device in place of the phone positioner.	
Material	POM, Acrylic glass, Foam	

3.2.6 System Validation Dipoles

Model	D-Serial	
Construction	Symmetrical dipole with 1/4 balun. Enables measurement of feed point impedance with NWA. Matched for use near flat phantoms filled with tissue simulating solutions.	
Frequency	750 MHz to 5800 MHz	
Return Loss	> 20 dB	
Power Capability	> 100 W (f < 1GHz), > 40 W (f > 1GHz)	

3.2.7 Tissue Simulating Liquids

For SAR measurement of the field distribution inside the phantom, the phantom must be filled with homogeneous tissue simulating liquid to a depth of at least 15 cm. For head SAR testing, the liquid height from the ear reference point (ERP) of the phantom to the liquid top surface is larger than 15 cm. For body SAR testing, the liquid height from the center of the flat phantom to the liquid top surface is larger than 15 cm. The nominal dielectric values of the tissue simulating liquids in the phantom and the tolerance of 5% are listed in Table-3.1.

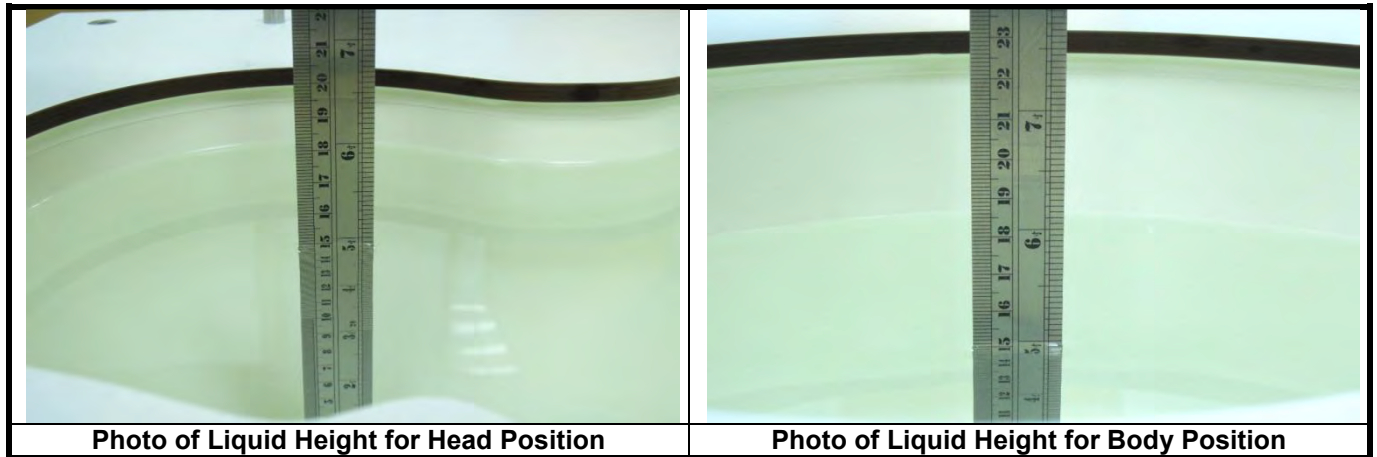

The dielectric properties of the head tissue simulating liquids are defined in IEEE 1528, and KDB 865664 D01 Appendix A. For the body tissue simulating liquids, the dielectric properties are defined in KDB 865664 D01 Appendix A. The dielectric properties of the tissue simulating liquids were verified prior to the SAR evaluation using a dielectric assessment kit and a network analyzer.

Table-3.1 Targets of Tissue Simulating Liquid

Frequency (MHz)	Target Permittivity	Range of $\pm 5\%$	Target Conductivity	Range of $\pm 5\%$
For Head				
750	41.9	39.8 ~ 44.0	0.89	0.85 ~ 0.93
835	41.5	39.4 ~ 43.6	0.90	0.86 ~ 0.95
900	41.5	39.4 ~ 43.6	0.97	0.92 ~ 1.02
1450	40.5	38.5 ~ 42.5	1.20	1.14 ~ 1.26
1640	40.3	38.3 ~ 42.3	1.29	1.23 ~ 1.35
1750	40.1	38.1 ~ 42.1	1.37	1.30 ~ 1.44
1800	40.0	38.0 ~ 42.0	1.40	1.33 ~ 1.47
1900	40.0	38.0 ~ 42.0	1.40	1.33 ~ 1.47
2000	40.0	38.0 ~ 42.0	1.40	1.33 ~ 1.47
2300	39.5	37.5 ~ 41.5	1.67	1.59 ~ 1.75
2450	39.2	37.2 ~ 41.2	1.80	1.71 ~ 1.89
2600	39.0	37.1 ~ 41.0	1.96	1.86 ~ 2.06
3500	37.9	36.0 ~ 39.8	2.91	2.76 ~ 3.06
5200	36.0	34.2 ~ 37.8	4.66	4.43 ~ 4.89
5300	35.9	34.1 ~ 37.7	4.76	4.52 ~ 5.00
5500	35.6	33.8 ~ 37.4	4.96	4.71 ~ 5.21
5600	35.5	33.7 ~ 37.3	5.07	4.82 ~ 5.32
5800	35.3	33.5 ~ 37.1	5.27	5.01 ~ 5.53
For Body				
750	55.5	52.7 ~ 58.3	0.96	0.91 ~ 1.01
835	55.2	52.4 ~ 58.0	0.97	0.92 ~ 1.02
900	55.0	52.3 ~ 57.8	1.05	1.00 ~ 1.10
1450	54.0	51.3 ~ 56.7	1.30	1.24 ~ 1.37
1640	53.8	51.1 ~ 56.5	1.40	1.33 ~ 1.47
1750	53.4	50.7 ~ 56.1	1.49	1.42 ~ 1.56
1800	53.3	50.6 ~ 56.0	1.52	1.44 ~ 1.60
1900	53.3	50.6 ~ 56.0	1.52	1.44 ~ 1.60
2000	53.3	50.6 ~ 56.0	1.52	1.44 ~ 1.60
2300	52.9	50.3 ~ 55.5	1.81	1.72 ~ 1.90
2450	52.7	50.1 ~ 55.3	1.95	1.85 ~ 2.05
2600	52.5	49.9 ~ 55.1	2.16	2.05 ~ 2.27
3500	51.3	48.7 ~ 53.9	3.31	3.14 ~ 3.48
5200	49.0	46.6 ~ 51.5	5.30	5.04 ~ 5.57
5300	48.9	46.5 ~ 51.3	5.42	5.15 ~ 5.69
5500	48.6	46.2 ~ 51.0	5.65	5.37 ~ 5.93
5600	48.5	46.1 ~ 50.9	5.77	5.48 ~ 6.06
5800	48.2	45.8 ~ 50.6	6.00	5.70 ~ 6.30

FCC SAR Test Report

The following table gives the recipes for tissue simulating liquids.

Table-3.2 Recipes of Tissue Simulating Liquid

Tissue Type	Bactericide	DGBE	HEC	NaCl	Sucrose	Triton X-100	Water	Diethylene Glycol Mono-hexylether
H750	0.2	-	0.2	1.5	56.0	-	42.1	-
H835	0.2	-	0.2	1.5	57.0	-	41.1	-
H900	0.2	-	0.2	1.4	58.0	-	40.2	-
H1450	-	43.3	-	0.6	-	-	56.1	-
H1640	-	45.8	-	0.5	-	-	53.7	-
H1750	-	47.0	-	0.4	-	-	52.6	-
H1800	-	44.5	-	0.3	-	-	55.2	-
H1900	-	44.5	-	0.2	-	-	55.3	-
H2000	-	44.5	-	0.1	-	-	55.4	-
H2300	-	44.9	-	0.1	-	-	55.0	-
H2450	-	45.0	-	0.1	-	-	54.9	-
H2600	-	45.1	-	0.1	-	-	54.8	-
H3500	-	28.0	-	0.2	-	20.0	71.8	-
H5G	-	-	-	-	-	17.2	65.5	17.3
B750	0.2	-	0.2	0.8	48.8	-	50.0	-
B835	0.2	-	0.2	0.9	48.5	-	50.2	-
B900	0.2	-	0.2	0.9	48.2	-	50.5	-
B1450	-	34.0	-	0.3	-	-	65.7	-
B1640	-	32.5	-	0.3	-	-	67.2	-
B1750	-	31.0	-	0.2	-	-	68.8	-
B1800	-	29.5	-	0.4	-	-	70.1	-
B1900	-	29.5	-	0.3	-	-	70.2	-
B2000	-	30.0	-	0.2	-	-	69.8	-
B2300	-	31.0	-	0.1	-	-	68.9	-
B2450	-	31.4	-	0.1	-	-	68.5	-
B2600	-	31.8	-	0.1	-	-	68.1	-
B3500	-	28.8	-	0.1	-	-	71.1	-
B5G	-	-	-	-	-	10.7	78.6	10.7

3.3 SAR System Verification

The system check verifies that the system operates within its specifications. It is performed daily or before every SAR measurement. The system check uses normal SAR measurements in the flat section of the phantom with a matched dipole at a specified distance. The system verification setup is shown as below.

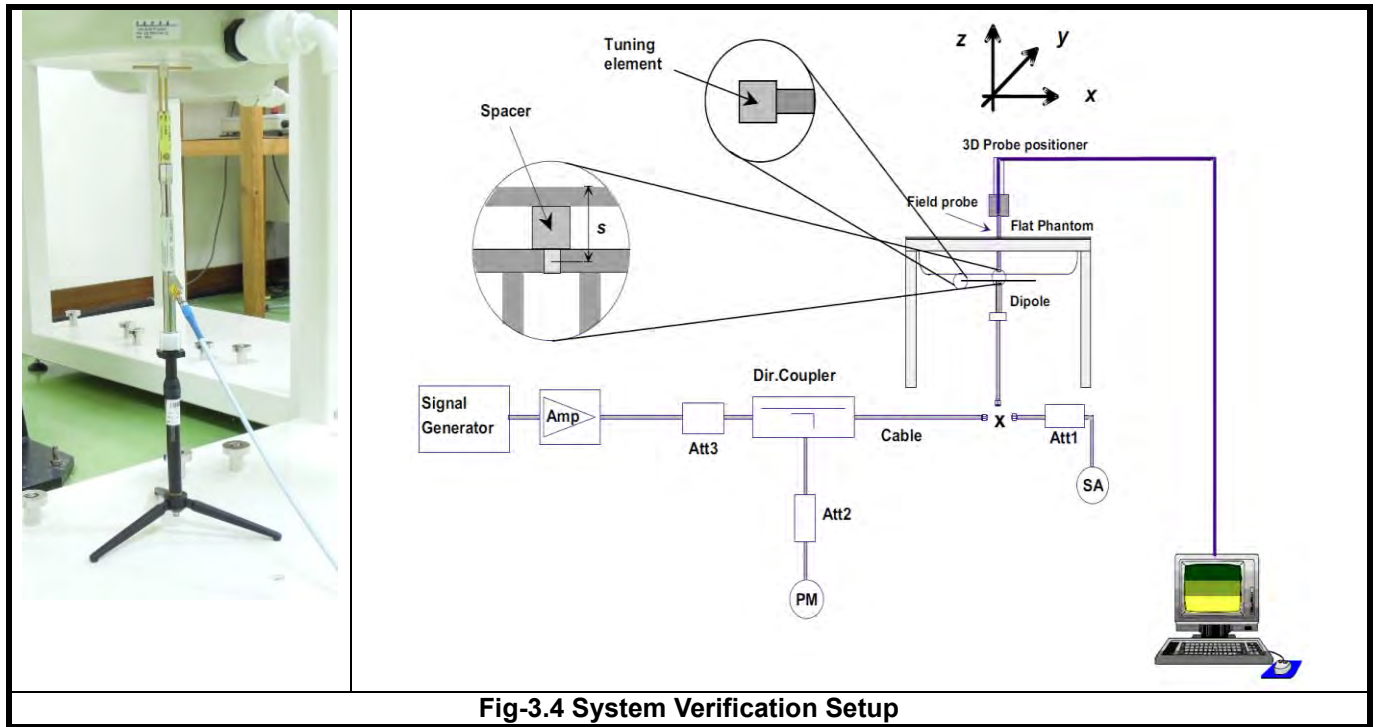

Fig-3.4 System Verification Setup

The validation dipole is placed beneath the flat phantom with the specific spacer in place. The distance spacer is touch the phantom surface with a light pressure at the reference marking and be oriented parallel to the long side of the phantom. The spectrum analyzer measures the forward power at the location of the system check dipole connector. The signal generator is adjusted for the desired forward power (250 mW is used for 700 MHz to 3 GHz, 100 mW is used for 3.5 GHz to 6 GHz) at the dipole connector and the power meter is read at that level. After connecting the cable to the dipole, the signal generator is readjusted for the same reading at power meter.

After system check testing, the SAR result will be normalized to 1W forward input power and compared with the reference SAR value derived from validation dipole certificate report. The deviation of system check should be within 10 %.

3.4 SAR Measurement Procedure

According to the SAR test standard, the recommended procedure for assessing the peak spatial-average SAR value consists of the following steps:

- (a) Power reference measurement
- (b) Area scan
- (c) Zoom scan
- (d) Power drift measurement

The SAR measurement procedures for each of test conditions are as follows:

- (a) Make EUT to transmit maximum output power
- (b) Measure conducted output power through RF cable
- (c) Place the EUT in the specific position of phantom
- (d) Perform SAR testing steps on the DASY system
- (e) Record the SAR value

3.4.1 Area & Zoom Scan Procedure

First Area Scan is used to locate the approximate location(s) of the local peak SAR value(s). The measurement grid within an Area Scan is defined by the grid extent, grid step size and grid offset. Next, in order to determine the EM field distribution in a three-dimensional spatial extension, Zoom Scan is required. The Zoom Scan is performed around the highest E-field value to determine the averaged SAR-distribution over 10 g. According to KDB 865664 D01, the resolution for Area and Zoom scan is specified in the table below.

Items	<= 2 GHz	2-3 GHz	3-4 GHz	4-5 GHz	5-6 GHz
Area Scan ($\Delta x, \Delta y$)	<= 15 mm	<= 12 mm	<= 12 mm	<= 10 mm	<= 10 mm
Zoom Scan ($\Delta x, \Delta y$)	<= 8 mm	<= 5 mm	<= 5 mm	<= 4 mm	<= 4 mm
Zoom Scan (Δz)	<= 5 mm	<= 5 mm	<= 4 mm	<= 3 mm	<= 2 mm
Zoom Scan Volume	>= 30 mm	>= 30 mm	>= 28 mm	>= 25 mm	>= 22 mm

Note:

When zoom scan is required and report SAR is <= 1.4 W/kg, the zoom scan resolution of $\Delta x / \Delta y$ (2-3GHz: <= 8 mm, 3-4GHz: <= 7 mm, 4-6GHz: <= 5 mm) may be applied.

3.4.2 Volume Scan Procedure

The volume scan is used for assess overlapping SAR distributions for antennas transmitting in different frequency bands. It is equivalent to an oversized zoom scan used in standalone measurements. The measurement volume will be used to enclose all the simultaneous transmitting antennas. For antennas transmitting simultaneously in different frequency bands, the volume scan is measured separately in each frequency band. In order to sum correctly to compute the 1g aggregate SAR, the EUT remain in the same test position for all measurements and all volume scan use the same spatial resolution and grid spacing. When all volume scan were completed, the software, SEMCAD postprocessor can combine and subsequently superpose these measurement data to calculating the multiband SAR.

3.4.3 Power Drift Monitoring

All SAR testing is under the EUT install full charged battery and transmit maximum output power. In DASY measurement software, the power reference measurement and power drift measurement procedures are used for monitoring the power drift of EUT during SAR test. Both these procedures measure the field at a specified reference position before and after the SAR testing. The software will calculate the field difference in dB. If the power drift more than 5%, the SAR will be retested.

3.4.4 Spatial Peak SAR Evaluation

The procedure for spatial peak SAR evaluation has been implemented according to the test standard. It can be conducted for 1g and 10g, as well as for user-specific masses. The DASY software includes all numerical procedures necessary to evaluate the spatial peak SAR value.

The base for the evaluation is a "cube" measurement. The measured volume must include the 1g and 10g cubes with the highest averaged SAR values. For that purpose, the center of the measured volume is aligned to the interpolated peak SAR value of a previously performed area scan.

The entire evaluation of the spatial peak values is performed within the post-processing engine (SEMCAD). The system always gives the maximum values for the 1g and 10g cubes. The algorithm to find the cube with highest averaged SAR is divided into the following stages:

- (a) Extraction of the measured data (grid and values) from the Zoom Scan
- (b) Calculation of the SAR value at every measurement point based on all stored data (A/D values and measurement parameters)
- (c) Generation of a high-resolution mesh within the measured volume
- (d) Interpolation of all measured values from the measurement grid to the high-resolution grid
- (e) Extrapolation of the entire 3-D field distribution to the phantom surface over the distance from sensor to surface
- (f) Calculation of the averaged SAR within masses of 1g and 10g

3.4.5 SAR Averaged Methods

In DASY, the interpolation and extrapolation are both based on the modified Quadratic Shepard's method. The interpolation scheme combines a least-square fitted function method and a weighted average method which are the two basic types of computational interpolation and approximation.

Extrapolation routines are used to obtain SAR values between the lowest measurement points and the inner phantom surface. The extrapolation distance is determined by the surface detection distance and the probe sensor offset. The uncertainty increases with the extrapolation distance. To keep the uncertainty within 1% for the 1 g and 10 g cubes, the extrapolation distance should not be larger than 5 mm.

4. SAR Measurement Evaluation

4.1 EUT Configuration and Setting

<Connections between EUT and System Simulator>

For WWAN SAR testing, the EUT was linked and controlled by base station emulator (Agilent E5515C is used for GSM/WCDMA, and Anritsu MT8820C is used for LTE). Communication between the EUT and the emulator was established by air link. The distance between the EUT and the communicating antenna of the emulator is larger than 50 cm and the output power radiated from the emulator antenna is at least 30 dB smaller than the output power of EUT. The EUT was set from the emulator to radiate maximum output power during SAR testing.

<Considerations Related to GSM / GPRS / EDGE for Setup and Testing>

The maximum multi-slot capability supported by this device is as below.

1. This EUT is class B device
2. This EUT supports GPRS multi-slot class 12 (max. uplink: 4, max. downlink: 4, total timeslots: 5)
3. This EUT supports EDGE multi-slot class 12 (max. uplink: 4, max. downlink: 4, total timeslots: 5)

For GSM850 frequency band, the power control level is set to 5 for GSM mode and GPRS (GMSK: CS1), and set to 8 for EDGE (GMSK: MCS1, 8PSK: MCS9). For GSM1900 frequency band, the power control level is set to 0 for GSM mode and GPRS (GMSK: CS1), and set to 2 for EDGE (GMSK: MCS1, 8PSK: MCS9).

SAR test reduction for GPRS and EDGE modes is determined by the source-based time-averaged output power specified for production units, including tune-up tolerance. The data mode with highest specified time-averaged output power should be tested for SAR compliance in the applicable exposure conditions. For modes with the same specified maximum output power and tolerance, the higher number time-slot configuration should be tested.

<Considerations Related to WCDMA for Setup and Testing>

WCDMA Handsets Head SAR

SAR for next to the ear head exposure is measured using a 12.2 kbps RMC with TPC bits configured to all "1's". The 3G SAR test reduction procedure is applied to AMR configurations with 12.2 kbps RMC as the primary mode.

WCDMA Handsets Body-worn SAR

SAR for body-worn configurations is measured using a 12.2 kbps RMC with TPC bits configured to all "1's". The 3G SAR test reduction procedure is applied to other spreading codes and multiple DPDCH_n configurations supported by the handset with 12.2 kbps RMC as the primary mode.

Handsets with Release 5 HSDPA

The 3G SAR test reduction procedure is applied to HSDPA body-worn configurations with 12.2 kbps RMC as the primary mode. Otherwise, SAR is measured for HSDPA using the HSDPA body SAR procedures in the "Release 5 HSDPA Data Devices", for the highest reported SAR body-worn exposure configuration in 12.2 kbps RMC. Handsets with both HSDPA and HSUPA are tested according to Release 6 HSPA test procedures.

Handsets with Release 6 HSUPA

The 3G SAR test reduction procedure is applied to HSPA (HSUPA/HSDPA with RMC) body-worn configurations with 12.2 kbps RMC as the primary mode. Otherwise, SAR is measured for HSPA using the HSPA body SAR procedures in the “Release 6 HSPA Data Devices”, for the highest reported body-worn exposure SAR configuration in 12.2 kbps RMC. When VOIP is applicable for next to the ear head exposure in HSPA, the 3G SAR test reduction procedure is applied to HSPA with 12.2 kbps RMC as the primary mode; otherwise, the same HSPA configuration used for body-worn measurements is tested for next to the ear head exposure.

Release 5 HSDPA Data Devices

The 3G SAR test reduction procedure is applied to body SAR with 12.2 kbps RMC as the primary mode. Otherwise, body SAR for HSDPA is measured using an FRC with H-Set 1 in Sub-test 1 and a 12.2 kbps RMC configured in Test Loop Mode 1, for the highest reported SAR configuration in 12.2 kbps RMC without HSDPA. HSDPA is configured according to the applicable UE category of a test device. The number of HS-DSCH / HS-PDSCHs, HARQ processes, minimum inter-TTI interval, transport block sizes and RV coding sequence are defined by the H-set. To maintain a consistent test configuration and stable transmission conditions, QPSK is used in the H-set for SAR testing. HS-DPCCH should be configured with a CQI feedback cycle of 4 ms and a CQI repetition factor of 2 to maintain a constant rate of active CQI slots. DPCCH and DPDCH gain factors (β_c , β_d), and HS-DPCCH power offset parameters (Δ_{ACK} , Δ_{NACK} , Δ_{CQI}) are set according to values indicated in below. The CQI value is determined by the UE category, transport block size, number of HS-PDSCHs and modulation used in the H-set.

Sub-test	β_c	β_d	β_d (SF)	β_c / β_d	$\beta_{hs}^{(1)}$	CM (dB) ⁽²⁾	MPR
1	2 / 15	15 / 15	64	2 / 15	4 / 15	0.0	0
2	12 / 15 ⁽³⁾	15 / 15 ⁽³⁾	64	12 / 15 ⁽³⁾	24 / 15	1.0	0
3	15 / 15	8 / 15	64	15 / 8	30 / 15	1.5	0.5
4	15 / 15	4 / 15	64	15 / 4	30 / 15	1.5	0.5

Note 1: Δ_{ACK} , Δ_{NACK} and $\Delta_{CQI} = 8 \Leftrightarrow A_{hs} = \beta_{hs} / \beta_c = 30 / 15 \Leftrightarrow \beta_{hs} = 30 / 15 * \beta_c$
Note 2: CM = 1 for $\beta_c / \beta_d = 12 / 15$, $\beta_{hs} / \beta_c = 24 / 15$.
Note 3: For subtest 2 the β_c / β_d ratio of 12 / 15 for the TFC during the measurement period (TF1, TF0) is achieved by setting the signaled gain factors for the reference TFC (TF1, TF1) to $\beta_c = 11 / 15$ and $\beta_d = 15 / 15$.

Release 6 HSUPA Data Devices

The 3G SAR test reduction procedure is applied to body SAR with 12.2 kbps RMC as the primary mode. Otherwise, body SAR for HSPA is measured with E-DCH Sub-test 5, using H-Set 1 and QPSK for FRC and a 12.2 kbps RMC configured in Test Loop Mode 1 and power control algorithm 2, according to the highest reported body SAR configuration in 12.2 kbps RMC without HSPA. When VOIP applies to head exposure, the 3G SAR test reduction procedure is applied with 12.2 kbps RMC as the primary mode. Otherwise, the same HSPA configuration used for body SAR measurements are applied to head exposure testing. Due to inner loop power control requirements in HSPA, a communication test set is required for output power and SAR tests. The 12.2 kbps RMC, FRC H-set 1 and E-DCH configurations for HSPA are configured according to the β values indicated in below.

FCC SAR Test Report

Sub-test	β_c	β_d	β_d (SF)	β_c / β_d	$\beta_{HS}^{(1)}$	β_{ac}	β_{ed}	β_{ed} (SF)	β_{ed} (codes)	CM ⁽²⁾ (dB)	MPR (dB)	AG ⁽⁴⁾ Index	E-TFCI
1	11 / 15 ⁽³⁾	15 / 15 ⁽³⁾	64	11 / 15 ⁽³⁾	22 / 15	209 / 225	1039 / 225	4	1	1.0	0.0	20	75
2	6 / 15	15 / 15	64	6 / 15	12 / 15	12 / 15	94 / 75	4	1	3.0	2.0	12	67
3	15 / 15	9 / 15	64	15 / 9	30 / 15	30 / 15	$\beta_{ed1}: 47/15$ $\beta_{ed2}: 47/15$	4	2	2.0	1.0	15	92
4	2 / 15	15 / 15	64	2 / 15	4 / 15	2 / 15	56 / 75	4	1	3.0	2.0	17	71
5	15 / 15 ⁽⁴⁾	15 / 15 ⁽⁴⁾	64	15 / 15 ⁽⁴⁾	30 / 15	24 / 15	134 / 15	4	1	1.0	0.0	21	81

Note 1: $\Delta_{ACK}, \Delta_{NACK}$ and $\Delta_{COI} = 8 \Leftrightarrow A_{HS} = \beta_{HS} / \beta_c = 30 / 15 \Leftrightarrow \beta_{HS} = 30 / 15 * \beta_c$

Note 2: CM = 1 for $\beta_c / \beta_d = 12 / 15, \beta_{HS} / \beta_c = 24 / 15$. For all other combinations of DPDCH, DPCCH, HS-DPCCH, E-DPDCH and E-DPCCH the MPR is based on the relative CM difference.

Note 3: For subtest 1 the β_c / β_d ratio of 11 / 15 for the TFC during the measurement period (TF1, TF0) is achieved by setting the signaled gain factors for the reference TFC (TF1, TF1) to $\beta_c = 10 / 15$ and $\beta_d = 15 / 15$.

Note 4: For subtest 5 the β_c / β_d ratio of 15 / 15 for the TFC during the measurement period (TF1, TF0) is achieved by setting the signaled gain factors for the reference TFC (TF1, TF1) to $\beta_c = 14 / 15$ and $\beta_d = 15 / 15$.

Note 5: Testing UE using E-DPDCH Physical Layer category 1 Sub-test 3 is not required according to TS 25.306 Table 5.1g.

Note 6: β_{ed} cannot be set directly: it is set by Absolute Grant Value.

<Considerations Related to LTE for Setup and Testing>

This device contains LTE transmitter which follows 3GPP standards, is category 3, supports both QPSK and 16QAM modulations, and supported LTE band and channel bandwidth is listed in below. The output power was tested per 3GPP TS 36.521-1 maximum transmit procedures for both QPSK and 16QAM modulation. The results please refer to section 4.6 of this report.

EUT Supported LTE Band and Channel Bandwidth						
LTE Band	BW 1.4 MHz	BW 3 MHz	BW 5 MHz	BW 10 MHz	BW 15 MHz	BW 20 MHz
5	V	V	V	V		
7			V	V	V	V
28		V	V	V	V	V
38			V	V	V	V

The LTE maximum power reduction (MPR) in accordance with 3GPP TS 36.101 is active all times during LTE operation. The allowed MPR for the maximum output power is specified in below.

Modulation	Channel Bandwidth / RB Configurations						LTE MPR Setting (dB)
	BW 1.4 MHz	BW 3 MHz	BW 5 MHz	BW 10 MHz	BW 15 MHz	BW 20 MHz	
QPSK	> 5	> 4	> 8	> 12	> 16	> 18	1
16QAM	<= 5	<= 4	<= 8	<= 12	<= 16	<= 18	1
16QAM	> 5	> 4	> 8	> 12	> 16	> 18	2

Note: MPR is according to the standard and implemented in the circuit (mandatory).

In addition, the device is compliant with additional maximum power reduction (A-MPR) requirements defined in 3GPP TS 36.101 section 6.2.4 that was disabled for all FCC compliance testing.

FCC SAR Test Report

During LTE SAR testing, the related parameters of operating band, channel bandwidth, uplink channel number, modulation type, and RB was set in base station simulator. When the EUT has registered and communicated to base station simulator, the simulator set to make EUT transmitting the maximum radiated power.

<Considerations Related to WLAN for Setup and Testing>

In general, various vendor specific external test software and chipset based internal test modes are typically used for SAR measurement. These chipset based test mode utilities are generally hardware and manufacturer dependent, and often include substantial flexibility to reconfigure or reprogram a device. A Wi-Fi device must be configured to transmit continuously at the required data rate, channel bandwidth and signal modulation, using the highest transmission duty factor supported by the test mode tools for SAR measurement. The test frequencies established using test mode must correspond to the actual channel frequencies. When 802.11 frame gaps are accounted for in the transmission, a maximum transmission duty factor of 92 - 96% is typically achievable in most test mode configurations. A minimum transmission duty factor of 85% is required to avoid certain hardware and device implementation issues related to wide range SAR scaling. In addition, a periodic transmission duty factor is required for current generation SAR systems to measure SAR correctly. The reported SAR must be scaled to 100% transmission duty factor to determine compliance at the maximum tune-up tolerance limit.

According to KDB 248227 D01, this device has installed WLAN engineering testing software which can provide continuous transmitting RF signal. During WLAN SAR testing, this device was operated to transmit continuously at the maximum transmission duty with specified transmission mode, operating frequency, lowest data rate, and maximum output power.

Initial Test Configuration

An initial test configuration is determined for OFDM transmission modes in 2.4 GHz and 5 GHz bands according to the channel bandwidth, modulation and data rate combination(s) with the highest maximum output power specified for production units in each standalone and aggregated frequency band. When the same maximum power is specified for multiple transmission modes in a frequency band, the largest channel bandwidth, lowest order modulation, lowest data rate and lowest order 802.11a/g/n/ac mode is used for SAR measurement, on the highest measured output power channel in the initial test configuration, for each frequency band.

Subsequent Test Configuration

SAR measurement requirements for the remaining 802.11 transmission mode configurations that have not been tested in the initial test configuration are determined separately for each standalone and aggregated frequency band, in each exposure condition, according to the maximum output power specified for production units. Additional power measurements may be required to determine if SAR measurements are required for subsequent highest output power channels in a subsequent test configuration. When the highest reported SAR for the initial test configuration according to the initial test position or fixed exposure position requirements, is adjusted by the ratio of the subsequent test configuration to initial test configuration specified maximum output power and the adjusted SAR is ≤ 1.2 W/kg, SAR is not required for that subsequent test configuration.

SAR Test Configuration and Channel Selection

When multiple channel bandwidth configurations in a frequency band have the same specified maximum output power, the initial test configuration is using largest channel bandwidth, lowest order modulation, lowest data rate, and lowest order 802.11 mode (i.e., 802.11a is chosen over 802.11n then 802.11ac or 802.11g is chosen over 802.11n). After an initial test configuration is determined, if multiple test channels have the same measured maximum output power, the channel chosen for SAR measurement is determined according to the following.

- 1) The channel closest to mid-band frequency is selected for SAR measurement.
- 2) For channels with equal separation from mid-band frequency; for example, high and low channels or two mid-band channels, the higher frequency (number) channel is selected for SAR measurement.

4.2 EUT Testing Position

This variant report is made for verification. All the worst SAR configurations specified in the original SAR report was repeated and verified to ensure the device remains compliant.

According to KDB 648474 D04, handsets are tested for SAR compliance in head, body-worn accessory and other use configurations described in the following subsections.

4.2.1 Head Exposure Conditions

Head exposure is limited to next to the ear voice mode operations. Head SAR compliance is tested according to the test positions defined in IEEE Std 1528-2013 using the SAM phantom illustrated as below.

1. Define two imaginary lines on the handset
 - (a) The vertical centerline passes through two points on the front side of the handset - the midpoint of the width w_t of the handset at the level of the acoustic output, and the midpoint of the width w_b of the bottom of the handset.
 - (b) The horizontal line is perpendicular to the vertical centerline and passes through the center of the acoustic output. The horizontal line is also tangential to the face of the handset at point A.
 - (c) The two lines intersect at point A. Note that for many handsets, point A coincides with the center of the acoustic output; however, the acoustic output may be located elsewhere on the horizontal line. Also note that the vertical centerline is not necessarily parallel to the front face of the handset, especially for clamshell handsets, handsets with flip covers, and other irregularly shaped handsets.

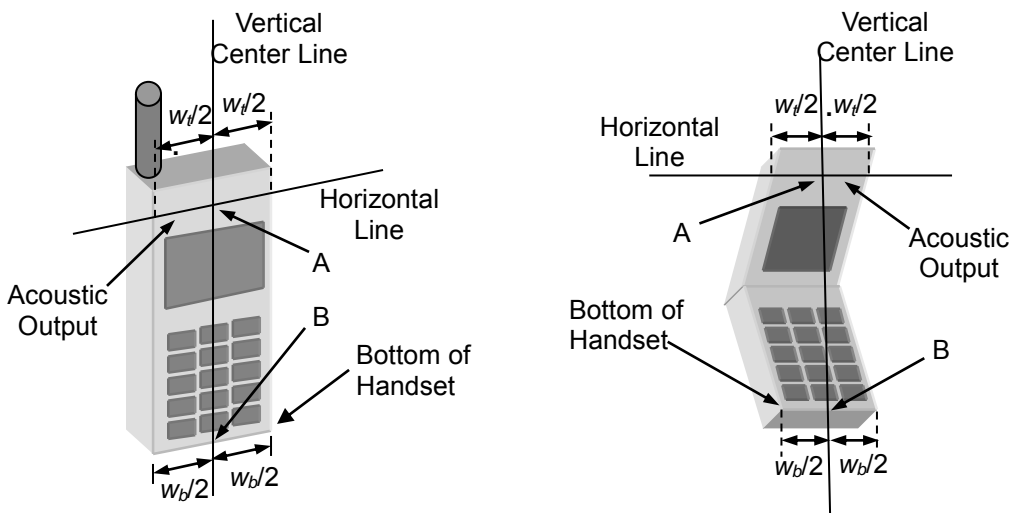

Fig-4.1 Illustration for Handset Vertical and Horizontal Reference Lines

2. Cheek Position

- (a) To position the device with the vertical center line of the body of the device and the horizontal line crossing the center piece in a plane parallel to the sagittal plane of the phantom. While maintaining the device in this plane, align the vertical center line with the reference plane containing the three ear and mouth reference point (M: Mouth, RE: Right Ear, and LE: Left Ear) and align the center of the ear piece with the line RE-LE.
- (b) To move the device towards the phantom with the ear piece aligned with the line LE-RE until the phone touched the ear. While maintaining the device in the reference plane and maintaining the phone contact with the ear, move the bottom of the phone until any point on the front side is in contact with the cheek of the phantom or until contact with the ear is lost (see Fig-4.2).

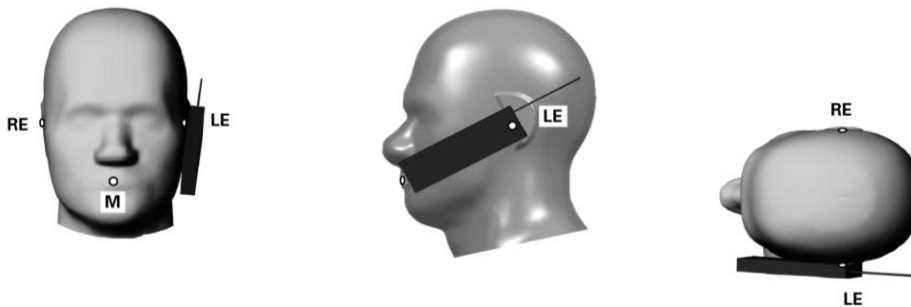

Fig-4.2 Illustration for Cheek Position

3. Tilted Position

- (a) To position the device in the "cheek" position described above.
- (b) While maintaining the device the reference plane described above and pivoting against the ear, moves it outward away from the mouth by an angle of 15 degrees or until contact with the ear is lost (see Fig-4.3).

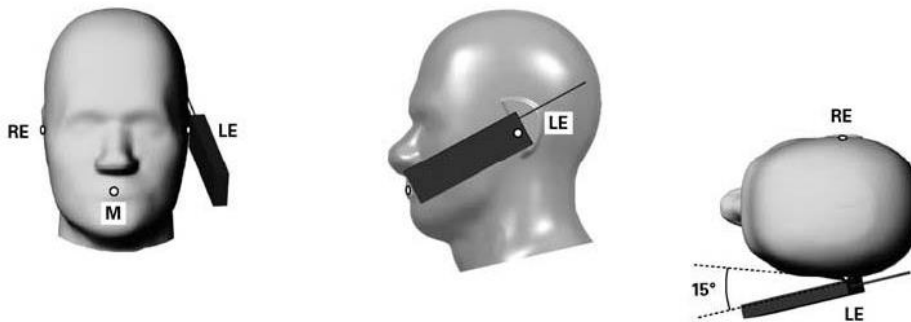

Fig-4.3 Illustration for Tilted Position

4.2.2 Body-worn Accessory Exposure Conditions

Body-worn accessory exposure is typically related to voice mode operations when handsets are carried in body-worn accessories. The body-worn accessory procedures in KDB 447498 D01 are used to test for body-worn accessory SAR compliance, without a headset connected to it. This enables the test results for such configuration to be compatible with that required for hotspot mode when the body-worn accessory test separation distance is greater than or equal to that required for hotspot mode. When the reported SAR for a body-worn accessory, measured without a headset connected to the handset, is > 1.2 W/kg, the highest reported SAR configuration for that wireless mode and frequency band should be repeated for that body-worn accessory with a headset attached to the handset.

Body-worn accessories that do not contain metallic or conductive components may be tested according to worst-case exposure configurations, typically according to the smallest test separation distance required for the group of body-worn accessories with similar operating and exposure characteristics. All body-worn accessories containing metallic components are tested in conjunction with the host device.

Body-worn accessory SAR compliance is based on a single minimum test separation distance for all wireless and operating modes applicable to each body-worn accessory used by the host, and according to the relevant voice and/or data mode transmissions and operations. If a body-worn accessory supports voice only operations in its normal and expected use conditions, testing of data mode for body-worn compliance is not required.

A conservative minimum test separation distance for supporting off-the-shelf body-worn accessories that may be acquired by users of consumer handsets is used to test for body-worn accessory SAR compliance. This distance is determined by the handset manufacturer, according to the requirements of Supplement C 01-01. According to the user manual, will be tested using a conservative minimum test separation distance ≤ 15 mm to support compliance.

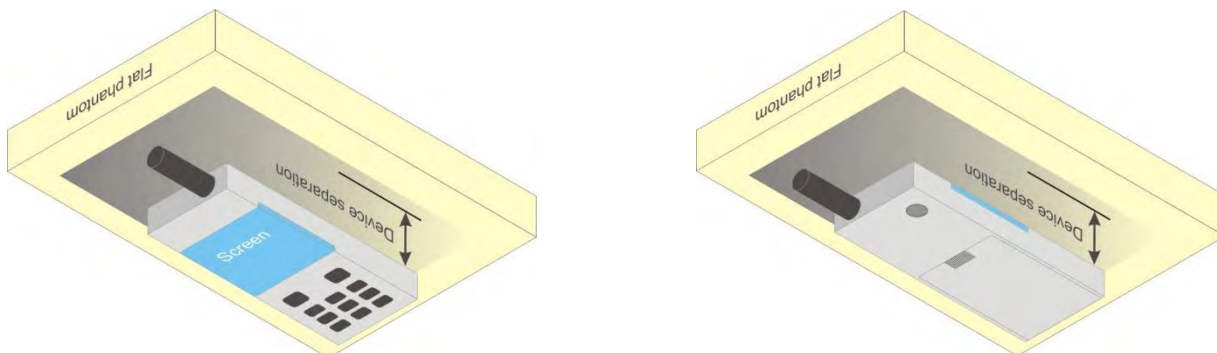
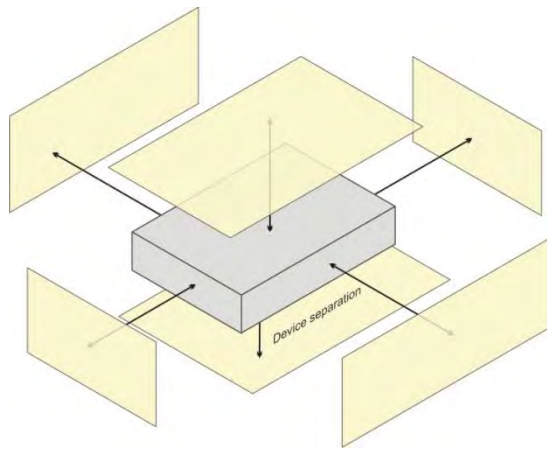

Fig-4.4 Illustration for Body Worn Position

4.2.3 Hotspot Mode Exposure Conditions

For handsets that support hotspot mode operations, with wireless router capabilities and various web browsing functions, the relevant hand and body exposure conditions are tested according to the hotspot SAR procedures in KDB 941225 D06. A test separation distance of 10 mm is required between the phantom and all surfaces and edges with a transmitting antenna located within 25 mm from that surface or edge. When the form factor of a handset is smaller than 9 cm x 5 cm, a test separation distance of 5 mm (instead of 10 mm) is required for testing hotspot mode. When the separation distance required for body-worn accessory testing is larger than or equal to that tested for hotspot mode, in the same wireless mode and for the same surface of the phone, the hotspot mode SAR data may be used to support body-worn accessory SAR compliance for that particular configuration (surface).



Based on the antenna location shown on appendix D of this report, the SAR testing required for hotspot mode is listed as below.

Antenna	Front Face	Rear Face	Left Side	Right Side	Top Side	Bottom Side
WWAN Ant-0	V	V	V	V		V
WLAN / BT	V	V	V	V	V	

FCC SAR Test Report

4.2.4 SAR Test Exclusion Evaluations

According to KDB 447498 D01, the SAR test exclusion condition is based on source-based time-averaged maximum conducted output power, adjusted for tune-up tolerance, and the minimum test separation distance required for the exposure conditions. The SAR exclusion threshold is determined by the following formula.

$$\frac{\text{Max. Tune up Power}_{(mW)}}{\text{Min. Test Separation Distance}_{(mm)}} \times \sqrt{f_{(GHz)}} \leq 3.0 \text{ for SAR-1g, } \leq 7.5 \text{ for SAR-10g}$$

When the minimum test separation distance is < 5 mm, a distance of 5 mm is applied to determine SAR test exclusion.

Mode	Max. Tune-up Power (dBm)	Max. Tune-up Power (mW)	Body-Worn		
			Ant. to Surface (mm)	Calculated Result	Require SAR Testing?
BT (2.48 GHz)	7.5	5.62	15	0.6	No

Note:

- When separation distance <= 50 mm and the calculated result shown in above table is <= 3.0 for SAR-1g exposure condition, or <= 7.5 for SAR-10g exposure condition, the SAR testing exclusion is applied.

4.2.5 Simultaneous Transmission Possibilities

The simultaneous transmission possibilities for this device are listed as below.

Simultaneous TX Combination	Capable Transmit Configurations	Head (Voice / VoIP)	Body-worn (Voice / VoIP)	Hotspot (Data)
1	GSM850 (Voice / Data) + WLAN (Data)	Yes	Yes	Yes
2	GSM1900 (Voice / Data) + WLAN (Data)	Yes	Yes	Yes
3	WCDMA V (Voice / Data) + WLAN (Data)	Yes	Yes	Yes
4	LTE 5 (Data) + WLAN (Data)	Yes	Yes	Yes
5	LTE 7 (Data) + WLAN (Data)	Yes	Yes	Yes
6	LTE 28 (Data) + WLAN (Data)	Yes	Yes	Yes
7	LTE 38 (Data) + WLAN (Data)	Yes	Yes	Yes
8	GSM850 (Voice / Data) + BT (Data)	No	Yes	No
9	GSM1900 (Voice / Data) + BT (Data)	No	Yes	No
10	WCDMA V (Voice / Data) + BT (Data)	No	Yes	No
11	LTE 5 (Data) + BT (Data)	No	Yes	No
12	LTE 7 (Data) + BT (Data)	No	Yes	No
13	LTE 28 (Data) + BT (Data)	No	Yes	No
14	LTE 38 (Data) + BT (Data)	No	Yes	No

Note : The WLAN and Bluetooth cannot transmit simultaneously, so there is no co-location test requirement for WLAN and Bluetooth.

4.3 Tissue Verification

The measuring results for tissue simulating liquid are shown as below.

Test Date	Tissue Type	Frequency (MHz)	Liquid Temp. (°C)	Measured Conductivity (σ)	Measured Permittivity (ε _r)	Target Conductivity (σ)	Target Permittivity (ε _r)	Conductivity Deviation (%)	Permittivity Deviation (%)
Mar. 28, 2019	H750	750	21.9	0.891	40.775	0.89	41.90	0.11	-2.68
Mar. 28, 2019	H835	835	21.9	0.906	41.863	0.90	41.50	0.67	0.87
Mar. 29, 2019	H1900	1900	21.8	1.436	39.743	1.40	40.00	2.57	-0.64
Mar. 27, 2019	H2450	2450	22.1	1.783	40.180	1.80	39.20	-0.94	2.50
Mar. 26, 2019	H2600	2600	22.2	1.989	38.320	1.96	39.00	1.48	-1.74
Mar. 28, 2019	B750	750	21.9	0.967	55.261	0.96	55.50	0.73	-0.43
Mar. 28, 2019	B835	835	21.9	0.992	55.615	0.97	55.20	2.27	0.75
Mar. 29, 2019	B1900	1900	21.8	1.544	52.838	1.52	53.30	1.58	-0.87
Mar. 27, 2019	B2450	2450	22.1	1.902	51.445	1.95	52.70	-2.46	-2.38
Mar. 26, 2019	B2600	2600	22.2	2.096	50.743	2.16	52.50	-2.96	-3.35

Note:

The dielectric properties of the tissue simulating liquid must be measured within 24 hours before the SAR testing and within ±5% of the target values. Liquid temperature during the SAR testing must be within ±2 °C.

4.4 System Validation

The SAR measurement system was validated according to procedures in KDB 865664 D01. The validation status in tabulated summary is as below.

Test Date	Probe S/N	Calibration Point		Measured Conductivity (σ)	Measured Permittivity (ε _r)	Validation for CW			Validation for Modulation		
						Sensitivity Range	Probe Linearity	Probe Isotropy	Modulation Type	Duty Factor	PAR
Mar. 28, 2019	3873	Head	750	0.891	40.775	Pass	Pass	Pass	N/A	N/A	N/A
Mar. 28, 2019	3873	Head	835	0.906	41.863	Pass	Pass	Pass	GMSK	Pass	N/A
Mar. 29, 2019	3873	Head	1900	1.436	39.743	Pass	Pass	Pass	GMSK	Pass	N/A
Mar. 27, 2019	3873	Head	2450	1.783	40.180	Pass	Pass	Pass	OFDM	N/A	Pass
Mar. 26, 2019	3873	Head	2600	1.989	38.320	Pass	Pass	Pass	N/A	N/A	N/A
Mar. 28, 2019	3873	Body	750	0.967	55.261	Pass	Pass	Pass	N/A	N/A	N/A
Mar. 28, 2019	3873	Body	835	0.992	55.615	Pass	Pass	Pass	GMSK	Pass	N/A
Mar. 29, 2019	3873	Body	1900	1.544	52.838	Pass	Pass	Pass	GMSK	Pass	N/A
Mar. 27, 2019	3873	Body	2450	1.902	51.445	Pass	Pass	Pass	OFDM	N/A	Pass
Mar. 26, 2019	3873	Body	2600	2.096	50.743	Pass	Pass	Pass	N/A	N/A	N/A

4.5 System Verification

The measuring result for system verification is tabulated as below.

Test Date	Mode	Frequency (MHz)	1W Target SAR-1g (W/kg)	Measured SAR-1g (W/kg)	Normalized to 1W SAR-1g (W/kg)	Deviation (%)	Dipole S/N	Probe S/N	DAE S/N
Mar. 28, 2019	Head	750	8.51	2.04	8.16	-4.11	1067	3873	1341
Mar. 28, 2019	Head	835	9.51	2.49	9.96	4.73	4d139	3873	1341
Mar. 29, 2019	Head	1900	39.80	10.60	42.40	6.53	5d159	3873	1341
Mar. 27, 2019	Head	2450	53.10	14.10	56.40	6.21	893	3873	1341
Mar. 26, 2019	Head	2600	56.00	13.60	54.40	-2.86	1110	3873	1341
Mar. 28, 2019	Body	750	8.80	2.28	9.12	3.64	1067	3873	1341
Mar. 28, 2019	Body	835	9.70	2.48	9.92	2.27	4d139	3873	1341
Mar. 29, 2019	Body	1900	40.20	10.20	40.80	1.49	5d159	3873	1341
Mar. 27, 2019	Body	2450	51.50	12.60	50.40	-2.14	893	3873	1341
Mar. 26, 2019	Body	2600	54.50	14.40	57.60	5.69	1110	3873	1341

Note:

Comparing to the reference SAR value provided by SPEAG, the validation data should be within its specification of 10 %. The result indicates the system check can meet the variation criterion and the plots can be referred to Appendix A of this report.

4.6 Maximum Output Power

4.6.1 Maximum Conducted Power

The maximum conducted average power (Unit: dBm) including tune-up tolerance is shown as below.

Mode	GSM850 (without Power Reduction)	GSM850 (with Power Reduction)	Power Reduction (dB)
GSM (GMSK, 1Tx-slot)	33.4	31.0	2.4
GPRS (GMSK, 1Tx-slot)	33.4	31.0	2.4
GPRS (GMSK, 2Tx-slot)	31.0	30.0	1.0
GPRS (GMSK, 3Tx-slot)	29.0	28.0	1.0
GPRS (GMSK, 4Tx-slot)	28.0	27.0	1.0
EDGE (8PSK, 1Tx-slot)	28.0	27.5	0.5
EDGE (8PSK, 2Tx-slot)	27.0	27.0	0
EDGE (8PSK, 3Tx-slot)	25.3	25.0	0.3
EDGE (8PSK, 4Tx-slot)	24.3	24.0	0.3

Mode	GSM1900
GSM (GMSK, 1Tx-slot)	31.0
GPRS (GMSK, 1Tx-slot)	31.0
GPRS (GMSK, 2Tx-slot)	27.0
GPRS (GMSK, 3Tx-slot)	26.0
GPRS (GMSK, 4Tx-slot)	24.0
EDGE (8PSK, 1Tx-slot)	26.5
EDGE (8PSK, 2Tx-slot)	25.0
EDGE (8PSK, 3Tx-slot)	23.0
EDGE (8PSK, 4Tx-slot)	22.0

Mode	WCDMA Band V
RMC 12.2K	25.0
HSDPA	23.5
HSUPA	23.5

FCC SAR Test Report

Mode	LTE 7 (without Power Reduction)	LTE 7 (with Power Reduction)	Power Reduction (dB)
QPSK / 16QAM	24.0 / 23.0	21.5 / 21.5	2.5 / 1.5

Mode	LTE 5	LTE 28	LTE 38
QPSK / 16QAM	24.0 / 23.0	24.0 / 23.0	24.0 / 23.0

Mode	2.4G WLAN
802.11b	15.5
802.11g	13.0
802.11n HT20	CH1: 11.0 CH2-11: 13.0

Mode	2.4G Bluetooth
GFSK	7.5
$\pi/4$ -DQPSK	6.2
8DPSK	5.8
LE	7.5

FCC SAR Test Report

4.6.2 Measured Conducted Power Result

The measuring conducted average power (Unit: dBm) is shown as below.

Band Channel Frequency (MHz)	GSM850		
	128	189	251
	824.2	836.4	848.8
EUT without Power Reduction			
Maximum Burst-Averaged Output Power			
GSM (GMSK, 1Tx-slot)	32.37	32.35	32.24
GPRS (GMSK, 1Tx-slot)	32.36	32.34	32.23
GPRS (GMSK, 2Tx-slot)	29.46	29.44	29.33
GPRS (GMSK, 3Tx-slot)	27.56	27.54	27.43
GPRS (GMSK, 4Tx-slot)	26.36	26.34	26.23
EDGE (8PSK, 1Tx-slot)	26.89	26.87	26.76
EDGE (8PSK, 2Tx-slot)	25.98	25.96	25.85
EDGE (8PSK, 3Tx-slot)	24.13	24.11	24.00
EDGE (8PSK, 4Tx-slot)	22.97	22.95	22.84
Maximum Frame-Averaged Output Power			
GSM (GMSK, 1Tx-slot)	23.37	23.35	23.24
GPRS (GMSK, 1Tx-slot)	23.36	23.34	23.23
GPRS (GMSK, 2Tx-slot)	23.46	23.44	23.33
GPRS (GMSK, 3Tx-slot)	23.30	23.28	23.17
GPRS (GMSK, 4Tx-slot)	23.36	23.34	23.23
EDGE (8PSK, 1Tx-slot)	17.89	17.87	17.76
EDGE (8PSK, 2Tx-slot)	19.98	19.96	19.85
EDGE (8PSK, 3Tx-slot)	19.87	19.85	19.74
EDGE (8PSK, 4Tx-slot)	19.97	19.95	19.84
EUT with Power Reduction			
Maximum Burst-Averaged Output Power			
GSM (GMSK, 1Tx-slot)	30.38	30.41	30.27
GPRS (GMSK, 1Tx-slot)	30.37	30.40	30.26
GPRS (GMSK, 2Tx-slot)	29.40	29.43	29.29
GPRS (GMSK, 3Tx-slot)	27.50	27.53	27.39
GPRS (GMSK, 4Tx-slot)	26.30	26.33	26.19
EDGE (8PSK, 1Tx-slot)	27.05	27.08	26.94
EDGE (8PSK, 2Tx-slot)	26.16	26.19	26.05
EDGE (8PSK, 3Tx-slot)	24.19	24.22	24.08
EDGE (8PSK, 4Tx-slot)	23.16	23.19	23.05
Maximum Frame-Averaged Output Power			
GSM (GMSK, 1Tx-slot)	21.38	21.41	21.27
GPRS (GMSK, 1Tx-slot)	21.37	21.40	21.26
GPRS (GMSK, 2Tx-slot)	23.40	23.43	23.29
GPRS (GMSK, 3Tx-slot)	23.24	23.27	23.13
GPRS (GMSK, 4Tx-slot)	23.30	23.33	23.19
EDGE (8PSK, 1Tx-slot)	18.05	18.08	17.94
EDGE (8PSK, 2Tx-slot)	20.16	20.19	20.05
EDGE (8PSK, 3Tx-slot)	19.93	19.96	19.82
EDGE (8PSK, 4Tx-slot)	20.16	20.19	20.05

FCC SAR Test Report

Band	GSM1900		
Channel	512	661	810
Frequency (MHz)	1850.2	1880.0	1909.8
Maximum Burst-Averaged Output Power			
GSM (GMSK, 1Tx-slot)	29.60	29.58	29.64
GPRS (GMSK, 1Tx-slot)	29.56	29.54	29.60
GPRS (GMSK, 2Tx-slot)	26.68	26.66	26.72
GPRS (GMSK, 3Tx-slot)	24.83	24.81	24.87
GPRS (GMSK, 4Tx-slot)	23.65	23.63	23.69
EDGE (8PSK, 1Tx-slot)	25.83	25.81	25.87
EDGE (8PSK, 2Tx-slot)	24.68	24.66	24.72
EDGE (8PSK, 3Tx-slot)	22.66	22.64	22.70
EDGE (8PSK, 4Tx-slot)	21.37	21.35	21.41
Maximum Frame-Averaged Output Power			
GSM (GMSK, 1Tx-slot)	20.60	20.58	20.64
GPRS (GMSK, 1Tx-slot)	20.56	20.54	20.60
GPRS (GMSK, 2Tx-slot)	20.68	20.66	20.72
GPRS (GMSK, 3Tx-slot)	20.57	20.55	20.61
GPRS (GMSK, 4Tx-slot)	20.65	20.63	20.69
EDGE (8PSK, 1Tx-slot)	16.83	16.81	16.87
EDGE (8PSK, 2Tx-slot)	18.68	18.66	18.72
EDGE (8PSK, 3Tx-slot)	18.40	18.38	18.44
EDGE (8PSK, 4Tx-slot)	18.37	18.35	18.41

Note:

- SAR testing was performed on the maximum frame-averaged power mode.
- The frame-averaged power is linearly proportion to the slot number configured and it is linearly scaled the maximum burst-averaged power based on time slots. The calculated method is shown as below:

$$\text{Frame-averaged power} = 10 \times \log (\text{Burst-averaged power mW} \times \text{Slot used} / 8)$$
- The configuration of time-slot for GSM has transmitting signal in one time-slot during one frame (8 time-slots).

Band	WCDMA Band V			3GPP MPR (dB)
Channel	4132	4182	4233	
Frequency (MHz)	826.4	836.4	846.6	
RMC 12.2K	23.99	24.08	24.06	-
HSDPA Subtest-1	22.9	22.99	22.97	0
HSDPA Subtest-2	22.85	22.94	22.92	0
HSDPA Subtest-3	22.38	22.47	22.45	0.5
HSDPA Subtest-4	22.32	22.41	22.39	0.5
HSUPA Subtest-1	22.83	22.92	22.9	0
HSUPA Subtest-2	20.96	21.05	21.03	2
HSUPA Subtest-3	21.9	21.99	21.97	1
HSUPA Subtest-4	21.03	21.12	21.1	2
HSUPA Subtest-5	22.87	22.96	22.94	0

FCC SAR Test Report

LTE Band / BW	RB Size	RB Offset	QPSK			3GPP MPR (dB)	16QAM			3GPP MPR (dB)
			Low CH 20407	Mid CH 20525	High CH 20643		Low CH 20407	Mid CH 20525	High CH 20643	
			824.7 MHz	836.5 MHz	848.3 MHz		824.7 MHz	836.5 MHz	848.3 MHz	
5 / 1.4M	1	0	22.48	22.53	22.55	0	21.58	21.63	21.65	1
	1	2	22.56	22.61	22.63	0	21.63	21.68	21.70	1
	1	5	22.43	22.48	22.50	0	21.53	21.58	21.60	1
	3	0	22.46	22.51	22.53	0	21.57	21.62	21.64	1
	3	1	22.54	22.59	22.61	0	21.62	21.67	21.69	1
	3	3	22.41	22.46	22.48	0	21.52	21.57	21.59	1
	6	0	21.54	21.59	21.61	1	20.52	20.57	20.59	2

LTE Band / BW	RB Size	RB Offset	QPSK			3GPP MPR (dB)	16QAM			3GPP MPR (dB)
			Low CH 20415	Mid CH 20525	High CH 20635		Low CH 20415	Mid CH 20525	High CH 20635	
			825.5 MHz	836.5 MHz	847.5 MHz		825.5 MHz	836.5 MHz	847.5 MHz	
5 / 3M	1	0	22.52	22.57	22.59	0	21.62	21.67	21.69	1
	1	7	22.60	22.65	22.67	0	21.67	21.72	21.74	1
	1	14	22.47	22.52	22.54	0	21.57	21.62	21.64	1
	8	0	21.61	21.66	21.68	1	20.57	20.62	20.64	2
	8	3	21.62	21.67	21.69	1	20.69	20.74	20.76	2
	8	7	21.49	21.54	21.56	1	20.55	20.60	20.62	2
	15	0	21.58	21.63	21.65	1	20.56	20.61	20.63	2

LTE Band / BW	RB Size	RB Offset	QPSK			3GPP MPR (dB)	16QAM			3GPP MPR (dB)
			Low CH 20425	Mid CH 20525	High CH 20625		Low CH 20425	Mid CH 20525	High CH 20625	
			826.5 MHz	836.5 MHz	846.5 MHz		826.5 MHz	836.5 MHz	846.5 MHz	
5 / 5M	1	0	22.58	22.63	22.65	0	21.68	21.73	21.75	1
	1	12	22.66	22.71	22.73	0	21.73	21.78	21.80	1
	1	24	22.53	22.58	22.60	0	21.63	21.68	21.70	1
	12	0	21.67	21.72	21.74	1	20.63	20.68	20.70	2
	12	6	21.68	21.73	21.75	1	20.75	20.80	20.82	2
	12	13	21.55	21.60	21.62	1	20.61	20.66	20.68	2
	25	0	21.64	21.69	21.71	1	20.62	20.67	20.69	2

LTE Band / BW	RB Size	RB Offset	QPSK			3GPP MPR (dB)	16QAM			3GPP MPR (dB)
			Low CH 20450	Mid CH 20525	High CH 20600		Low CH 20450	Mid CH 20525	High CH 20600	
			829.0 MHz	836.5 MHz	844.0 MHz		829.0 MHz	836.5 MHz	844.0 MHz	
5 / 10M	1	0	22.61	22.66	22.68	0	21.71	21.76	21.78	1
	1	24	22.69	22.74	22.76	0	21.76	21.81	21.83	1
	1	49	22.56	22.61	22.63	0	21.66	21.71	21.73	1
	25	0	21.70	21.75	21.77	1	20.66	20.71	20.73	2
	25	12	21.71	21.76	21.78	1	20.78	20.83	20.85	2
	25	25	21.58	21.63	21.65	1	20.64	20.69	20.71	2
	50	0	21.67	21.72	21.74	1	20.65	20.70	20.72	2

FCC SAR Test Report

Band / BW	RB Size	RB Offset	QPSK			3GPP MPR (dB)	16QAM			3GPP MPR (dB)
			Low CH 20775	Mid CH 21100	High CH 21425		Low CH 20775	Mid CH 21100	High CH 21425	
			2502.5 MHz	2535.0 MHz	2567.5 MHz		2502.5 MHz	2535.0 MHz	2567.5 MHz	
EUT without Power Reduction										
7 / 5M	1	0	22.05	22.22	22.30	0	21.30	21.47	21.55	1
	1	12	22.45	22.62	22.70	0	21.36	21.53	21.61	1
	1	24	22.18	22.35	22.43	0	21.24	21.41	21.49	1
	12	0	21.39	21.56	21.64	1	20.36	20.53	20.61	2
	12	6	21.47	21.64	21.72	1	20.43	20.60	20.68	2
	12	13	21.34	21.51	21.59	1	20.34	20.51	20.59	2
	25	0	21.40	21.57	21.65	1	20.36	20.53	20.61	2
EUT with Power Reduction										
7 / 5M	1	0	19.68	20.24	20.32	0	20.08	20.64	20.69	0
	1	12	20.15	20.71	20.69	0	20.45	21.01	21.06	0
	1	24	19.79	20.35	20.40	0	20.05	20.61	20.66	0
	12	0	20.07	20.63	20.68	0	20.10	20.66	20.71	0
	12	6	20.09	20.65	20.70	0	20.09	20.65	20.70	0
	12	13	20.06	20.62	20.67	0	20.06	20.62	20.67	0
	25	0	20.05	20.61	20.66	0	20.03	20.59	20.64	0

Band / BW	RB Size	RB Offset	QPSK			3GPP MPR (dB)	16QAM			3GPP MPR (dB)
			Low CH 20800	Mid CH 21100	High CH 21400		Low CH 20800	Mid CH 21100	High CH 21400	
			2505.0 MHz	2535.0 MHz	2565.0 MHz		2505.0 MHz	2535.0 MHz	2565.0 MHz	
EUT without Power Reduction										
7 / 10M	1	0	22.09	22.26	22.34	0	21.34	21.51	21.59	1
	1	24	22.49	22.66	22.74	0	21.40	21.57	21.65	1
	1	49	22.22	22.39	22.47	0	21.28	21.45	21.53	1
	25	0	21.43	21.60	21.68	1	20.40	20.57	20.65	2
	25	12	21.51	21.68	21.76	1	20.47	20.64	20.72	2
	25	25	21.38	21.55	21.63	1	20.38	20.55	20.63	2
	50	0	21.44	21.61	21.69	1	20.40	20.57	20.65	2
EUT with Power Reduction										
7 / 10M	1	0	19.72	20.28	20.36	0	20.12	20.68	20.73	0
	1	24	20.19	20.75	20.73	0	20.49	21.05	21.10	0
	1	49	19.83	20.39	20.44	0	20.09	20.65	20.70	0
	25	0	20.11	20.67	20.72	0	20.14	20.70	20.75	0
	25	12	20.13	20.69	20.74	0	20.13	20.69	20.74	0
	25	25	20.10	20.66	20.71	0	20.10	20.66	20.71	0
	50	0	20.09	20.65	20.70	0	20.07	20.63	20.68	0

FCC SAR Test Report

Band / BW	RB Size	RB Offset	QPSK			3GPP MPR (dB)	16QAM			3GPP MPR (dB)
			Low CH 20825	Mid CH 21100	High CH 21375		Low CH 20825	Mid CH 21100	High CH 21375	
			2507.5 MHz	2535.0 MHz	2562.5 MHz		2507.5 MHz	2535.0 MHz	2562.5 MHz	
EUT without Power Reduction										
7 / 15M	1	0	22.15	22.32	22.40	0	21.40	21.57	21.65	1
	1	37	22.55	22.72	22.80	0	21.46	21.63	21.71	1
	1	74	22.28	22.45	22.53	0	21.34	21.51	21.59	1
	36	0	21.49	21.66	21.74	1	20.46	20.63	20.71	2
	36	19	21.57	21.74	21.82	1	20.53	20.70	20.78	2
	36	39	21.44	21.61	21.69	1	20.44	20.61	20.69	2
	75	0	21.50	21.67	21.75	1	20.46	20.63	20.71	2
EUT with Power Reduction										
7 / 15M	1	0	19.78	20.34	20.42	0	20.18	20.74	20.79	0
	1	37	20.25	20.81	20.79	0	20.55	21.11	21.16	0
	1	74	19.89	20.45	20.50	0	20.15	20.71	20.76	0
	36	0	20.17	20.73	20.78	0	20.20	20.76	20.81	0
	36	19	20.19	20.75	20.80	0	20.19	20.75	20.80	0
	36	39	20.16	20.72	20.77	0	20.16	20.72	20.77	0
	75	0	20.15	20.71	20.76	0	20.13	20.69	20.74	0

Band / BW	RB Size	RB Offset	QPSK			3GPP MPR (dB)	16QAM			3GPP MPR (dB)
			Low CH 20850	Mid CH 21100	High CH 21350		Low CH 20850	Mid CH 21100	High CH 21350	
			2510.0 MHz	2535.0 MHz	2560.0 MHz		2510.0 MHz	2535.0 MHz	2560.0 MHz	
EUT without Power Reduction										
7 / 20M	1	0	22.18	22.35	22.43	0	21.43	21.60	21.68	1
	1	50	22.58	22.75	22.83	0	21.49	21.66	21.74	1
	1	99	22.31	22.48	22.56	0	21.37	21.54	21.62	1
	50	0	21.52	21.69	21.77	1	20.49	20.66	20.74	2
	50	25	21.60	21.77	21.85	1	20.56	20.73	20.81	2
	50	50	21.47	21.64	21.72	1	20.47	20.64	20.72	2
	100	0	21.53	21.70	21.78	1	20.49	20.66	20.74	2
EUT with Power Reduction										
7 / 20M	1	0	19.81	20.37	20.45	0	20.21	20.77	20.82	0
	1	50	20.28	20.84	20.82	0	20.58	21.14	21.19	0
	1	99	19.92	20.48	20.53	0	20.18	20.74	20.79	0
	50	0	20.20	20.76	20.81	0	20.23	20.79	20.84	0
	50	25	20.22	20.78	20.83	0	20.22	20.78	20.83	0
	50	50	20.19	20.75	20.80	0	20.19	20.75	20.80	0
	100	0	20.18	20.74	20.79	0	20.16	20.72	20.77	0

FCC SAR Test Report

LTE Band / BW	RB Size	RB Offset	QPSK			3GPP MPR (dB)	16QAM			3GPP MPR (dB)
			Low CH 27225	Mid CH 27435	High CH 27645		Low CH 27225	Mid CH 27435	High CH 27645	
			704.5 MHz	719.5 MHz	746.5 MHz		704.5 MHz	719.5 MHz	746.5 MHz	
28 / 3M	1	0	22.34	21.92	22.14	0	21.47	21.40	21.27	1
	1	7	22.69	22.62	22.49	0	21.50	21.35	21.30	1
	1	14	22.49	22.34	22.29	0	21.42	21.35	21.22	1
	8	0	20.56	20.49	20.36	1	20.50	20.35	20.30	2
	8	3	21.77	21.62	21.57	1	20.59	20.52	20.39	2
	8	7	21.75	21.68	21.55	1	20.44	20.29	20.24	2
	15	0	21.62	21.47	21.42	1	20.56	20.49	20.36	2

LTE Band / BW	RB Size	RB Offset	QPSK			3GPP MPR (dB)	16QAM			3GPP MPR (dB)
			Low CH 27235	Mid CH 27435	High CH 27365		Low CH 27235	Mid CH 27435	High CH 27365	
			705.5 MHz	720.5 MHz	745.5 MHz		705.5 MHz	720.5 MHz	745.5 MHz	
28 / 5M	1	0	22.36	21.94	22.16	0	21.49	21.42	21.29	1
	1	12	22.71	22.64	22.51	0	21.52	21.37	21.32	1
	1	24	22.51	22.36	22.31	0	21.44	21.37	21.24	1
	12	0	20.58	20.51	20.38	1	20.52	20.37	20.32	2
	12	6	21.79	21.64	21.59	1	20.61	20.54	20.41	2
	12	13	21.77	21.70	21.57	1	20.46	20.31	20.26	2
	25	0	21.64	21.49	21.44	1	20.58	20.51	20.38	2

LTE Band / BW	RB Size	RB Offset	QPSK			3GPP MPR (dB)	16QAM			3GPP MPR (dB)
			Low CH 27260	Mid CH 27435	High CH 27610		Low CH 27260	Mid CH 27435	High CH 27610	
			708 MHz	723 MHz	743 MHz		708 MHz	723 MHz	743 MHz	
28 / 10M	1	0	22.38	21.96	22.18	0	21.51	21.44	21.31	1
	1	24	22.73	22.66	22.53	0	21.54	21.39	21.34	1
	1	49	22.53	22.38	22.33	0	21.46	21.39	21.26	1
	25	0	20.60	20.53	20.40	1	20.54	20.39	20.34	2
	25	12	21.81	21.66	21.61	1	20.63	20.56	20.43	2
	25	25	21.79	21.72	21.59	1	20.48	20.33	20.28	2
	50	0	21.66	21.51	21.46	1	20.60	20.53	20.40	2

LTE Band / BW	RB Size	RB Offset	QPSK			3GPP MPR (dB)	16QAM			3GPP MPR (dB)
			Low CH 27285	Mid CH 27435	High CH 27585		Low CH 27285	Mid CH 27435	High CH 27585	
			710.5 MHz	725.5 MHz	740.5 MHz		710.5 MHz	725.5 MHz	740.5 MHz	
28 / 15M	1	0	22.40	21.98	22.20	0	21.53	21.46	21.33	1
	1	37	22.75	22.68	22.55	0	21.56	21.41	21.36	1
	1	74	22.55	22.40	22.35	0	21.48	21.41	21.28	1
	36	0	20.62	20.55	20.42	1	20.56	20.41	20.36	2
	36	19	21.83	21.68	21.63	1	20.65	20.58	20.45	2
	36	39	21.81	21.74	21.61	1	20.50	20.35	20.30	2
	75	0	21.68	21.53	21.48	1	20.62	20.55	20.42	2

FCC SAR Test Report

LTE Band / BW	RB Size	RB Offset	QPSK			3GPP MPR (dB)	16QAM			3GPP MPR (dB)
			Low CH 27310	Mid CH 27435	High CH 27560		Low CH 27310	Mid CH 27435	High CH 27560	
			713 MHz	725.5 MHz	738 MHz		713 MHz	725.5 MHz	738 MHz	
28 / 20M	1	0	22.43	22.01	22.23	0	21.56	21.49	21.36	1
	1	50	22.78	22.71	22.58	0	21.59	21.44	21.39	1
	1	99	22.58	22.43	22.38	0	21.51	21.44	21.31	1
	50	0	20.65	20.58	20.45	1	20.59	20.44	20.39	2
	50	25	21.86	21.71	21.66	1	20.68	20.61	20.48	2
	50	50	21.84	21.77	21.64	1	20.53	20.38	20.33	2
	100	0	21.71	21.56	21.51	1	20.65	20.58	20.45	2

LTE Band / BW	RB Size	RB Offset	QPSK			3GPP MPR (dB)	16QAM			3GPP MPR (dB)
			Low CH 37775	Mid CH 38000	High CH 38225		Low CH 37775	Mid CH 38000	High CH 38225	
			2572.5 MHz	2595 MHz	2617.5 MHz		2572.5 MHz	2595 MHz	2617.5 MHz	
38 / 5M	1	0	22.42	22.35	22.39	0	21.43	21.36	21.40	1
	1	12	22.80	22.73	22.77	0	21.79	21.72	21.76	1
	1	24	22.43	22.36	22.40	0	21.42	21.35	21.39	1
	12	0	21.77	21.70	21.74	1	20.69	20.62	20.66	2
	12	6	21.75	21.68	21.72	1	20.78	20.71	20.75	2
	12	13	21.67	21.60	21.64	1	20.64	20.57	20.61	2
	25	0	21.74	21.67	21.71	1	20.74	20.67	20.71	2

LTE Band / BW	RB Size	RB Offset	QPSK			3GPP MPR (dB)	16QAM			3GPP MPR (dB)
			Low CH 37800	Mid CH 38000	High CH 38200		Low CH 37800	Mid CH 38000	High CH 38200	
			2575 MHz	2595 MHz	2615 MHz		2575 MHz	2595 MHz	2615 MHz	
38 / 10M	1	0	22.46	22.39	22.43	0	21.47	21.40	21.44	1
	1	24	22.84	22.77	22.81	0	21.83	21.76	21.80	1
	1	49	22.47	22.40	22.44	0	21.46	21.39	21.43	1
	25	0	21.81	21.74	21.78	1	20.73	20.66	20.70	2
	25	12	21.79	21.72	21.76	1	20.82	20.75	20.79	2
	25	25	21.71	21.64	21.68	1	20.68	20.61	20.65	2
	50	0	21.78	21.71	21.75	1	20.78	20.71	20.75	2

LTE Band / BW	RB Size	RB Offset	QPSK			3GPP MPR (dB)	16QAM			3GPP MPR (dB)
			Low CH 37825	Mid CH 38000	High CH 38175		Low CH 37825	Mid CH 38000	High CH 38175	
			2577.5 MHz	2595 MHz	2612.5 MHz		2577.5 MHz	2595 MHz	2612.5 MHz	
38 / 15M	1	0	22.49	22.42	22.46	0	21.50	21.43	21.47	1
	1	37	22.87	22.80	22.84	0	21.86	21.79	21.83	1
	1	74	22.50	22.43	22.47	0	21.49	21.42	21.46	1
	36	0	21.84	21.77	21.81	1	20.76	20.69	20.73	2
	36	19	21.82	21.75	21.79	1	20.85	20.78	20.82	2
	36	39	21.74	21.67	21.71	1	20.71	20.64	20.68	2
	75	0	21.81	21.74	21.78	1	20.81	20.74	20.78	2

FCC SAR Test Report

LTE Band / BW	RB Size	RB Offset	QPSK			3GPP MPR (dB)	16QAM			3GPP MPR (dB)
			Low CH 37850	Mid CH 38000	High CH 38150		Low CH 37850	Mid CH 38000	High CH 38150	
			2580 MHz	2595 MHz	2610 MHz		2580 MHz	2595 MHz	2610 MHz	
38 / 20M	1	0	22.56	22.49	22.53	0	21.57	21.50	21.54	1
	1	50	22.94	22.87	22.91	0	21.93	21.86	21.90	1
	1	99	22.57	22.50	22.54	0	21.56	21.49	21.53	1
	50	0	21.91	21.84	21.88	1	20.83	20.76	20.80	2
	50	25	21.89	21.82	21.86	1	20.92	20.85	20.89	2
	50	50	21.81	21.74	21.78	1	20.78	20.71	20.75	2
	100	0	21.88	21.81	21.85	1	20.88	20.81	20.85	2

<WLAN 2.4G>

Mode	802.11b		
Channel / Frequency (MHz)	1 (2412)	6 (2437)	11 (2462)
Average Power	14.13	14.80	14.36

<Bluetooth>

Mode	Bluetooth GFSK		
Channel / Frequency (MHz)	0 (2402)	39 (2441)	78 (2480)
Average Power	6.32	6.98	6.26
Mode	Bluetooth LE		
Channel / Frequency (MHz)	0 (2402)	19 (2440)	39 (2480)
Average Power	6.30	7.09	6.28

4.7 SAR Testing Results

4.7.1 SAR Test Reduction Considerations

<KDB 447498 D01, General RF Exposure Guidance>

Testing of other required channels within the operating mode of a frequency band is not required when the reported SAR for the mid-band or highest output power channel is:

- (1) ≤ 0.8 W/kg or 2.0 W/kg, for 1-g or 10-g respectively, when the transmission band is ≤ 100 MHz
- (2) ≤ 0.6 W/kg or 1.5 W/kg, for 1-g or 10-g respectively, when the transmission band is between 100 MHz and 200 MHz
- (3) ≤ 0.4 W/kg or 1.0 W/kg, for 1-g or 10-g respectively, when the transmission band is ≥ 200 MHz

<KDB 941225 D01, 3G SAR Measurement Procedures>

The mode tested for SAR is referred to as the primary mode. The equivalent modes considered for SAR test reduction are denoted as secondary modes. Both primary and secondary modes must be in the same frequency band. When the maximum output power and tune-up tolerance specified for production units in a secondary mode is $\leq 1/4$ dB higher than the primary mode or when the highest reported SAR of the primary mode is scaled by the ratio of specified maximum output power and tune-up tolerance of secondary to primary mode and the adjusted SAR is ≤ 1.2 W/kg, SAR measurement is not required for the secondary mode.

<KDB 941225 D05, SAR Evaluation Considerations for LTE Devices>

- (1) QPSK with 1 RB and 50% RB allocation

Start with the largest channel bandwidth and measure SAR, using the RB offset and required test channel combination with the highest maximum output power among RB offsets at the upper edge, middle and lower edge of each required test channel. When the reported SAR is ≤ 0.8 W/kg, testing of the remaining RB offset configurations and required test channels is not required; otherwise, SAR is required for the remaining required test channels and only for the RB offset configuration with the highest output power for that channel. When the reported SAR of a required test channel is > 1.45 W/kg, SAR is required for all three RB offset configurations for that required test channel.

FCC SAR Test Report

(2) QPSK with 100% RB allocation

SAR is not required when the highest maximum output power for 100% RB allocation is less than the highest maximum output power in 50% and 1 RB allocations and the highest reported SAR for 1 RB and 50% RB allocation are ≤ 0.8 W/kg. Otherwise, SAR is measured for the highest output power channel; and if the reported SAR is > 1.45 W/kg, the remaining required test channels must also be tested.

(3) Higher order modulations

SAR is required only when the highest maximum output power for the configuration in the higher order modulation is $> 1/2$ dB higher than the same configuration in QPSK or when the reported SAR for the QPSK configuration is > 1.45 W/kg.

(4) Other channel bandwidth

SAR is required when the highest maximum output power of the smaller channel bandwidth is $> 1/2$ dB higher than the equivalent channel configurations in the largest channel bandwidth configuration or the reported SAR of a configuration for the largest channel bandwidth is > 1.45 W/kg.

<KDB 248227 D01, SAR Guidance for Wi-Fi Transmitters>

- (1) For handsets operating next to ear, hotspot mode or mini-tablet configurations, the initial test position procedures were applied. The test position with the highest extrapolated peak SAR will be used as the initial test position. When the reported SAR of initial test position is ≤ 0.4 W/kg, SAR testing for remaining test positions is not required. Otherwise, SAR is evaluated at the subsequent highest peak SAR positions until the reported SAR result is ≤ 0.8 W/kg or all test positions are measured.
- (2) For WLAN 2.4 GHz, the highest measured maximum output power channel for DSSS was selected for SAR measurement. When the reported SAR is ≤ 0.8 W/kg, no further SAR testing is required. Otherwise, SAR is evaluated at the next highest measured output power channel. When any reported SAR is > 1.2 W/kg, SAR is required for the third channel. For OFDM modes (802.11g/n), SAR is not required when the highest reported SAR for DSSS is adjusted by the ratio of OFDM to DSSS specified maximum output power and it is ≤ 1.2 W/kg.

FCC SAR Test Report

4.7.2 SAR Results for Head Exposure Condition

Plot No.	Band	Mode	Test Position	Ch.	Max. Tune-up Power (dBm)	Measured Conducted Power (dBm)	Power Drift (dB)	Measured SAR-1g (W/kg)	Scaling Factor	Scaled SAR-1g (W/kg)
1	GSM850	GPRS12	Left Cheek	189	28.0	26.34	-0.02	0.46	1.47	0.67
2	GSM1900	GPRS8	Right Cheek	512	31.0	29.56	0.04	0.162	1.39	0.23
3	WCDMA V	RMC12.2K	Right Cheek	4182	25.0	24.08	-0.08	0.145	1.24	0.18

Plot No.	Band	Mode	Test Position	Ch.	RB#	RB Offset	Max. Tune-up Power (dBm)	Measured Conducted Power (dBm)	Power Drift (dB)	Measured SAR-1g (W/kg)	Scaling Factor	Scaled SAR-1g (W/kg)
4	LTE 5	QPSK10M	Right Cheek	20600	1	24	24.0	22.76	0.08	0.329	1.33	0.44
5	LTE 7	QPSK20M	Left Cheek	21350	1	50	24.0	22.83	0.01	0.225	1.31	0.29
6	LTE 28	QPSK20M	Right Cheek	27310	1	50	24.0	22.78	0.17	0.161	1.32	0.21
7	LTE 38	QPSK20M	Left Cheek	37850	1	50	24.0	22.94	0.09	0.149	1.28	0.19

Plot No.	Band	Mode	Test Position	Ch.	Max. Tune-up Power (dBm)	Measured Conducted Power (dBm)	Power Drift (dB)	Measured SAR-1g (W/kg)	Scaling Factor	Scaled SAR-1g (W/kg)
	802.11b	-	Right Cheek	6	15.5	14.80	0.03	0.702	1.17	0.82
8	802.11b	-	Right Cheek	11	15.5	14.36	0.04	0.649	1.30	0.84

4.7.3 SAR Results for Body-worn Exposure Condition (Separation Distance is 1.5 cm Gap)

Plot No.	Band	Mode	Test Position	Ch.	Max. Tune-up Power (dBm)	Measured Conducted Power (dBm)	Power Drift (dB)	Measured SAR-1g (W/kg)	Scaling Factor	Scaled SAR-1g (W/kg)
9	GSM850	GPRS12	Rear Face	189	28.0	26.34	-0.05	0.446	1.47	0.65
10	GSM1900	GPRS8	Rear Face	512	31.0	29.56	-0.07	0.138	1.39	0.19
11	WCDMA V	RMC12.2K	Rear Face	4182	25.0	24.08	0.01	0.158	1.24	0.20

Plot No.	Band	Mode	Test Position	Ch.	RB#	RB Offset	Max. Tune-up Power (dBm)	Measured Conducted Power (dBm)	Power Drift (dB)	Measured SAR-1g (W/kg)	Scaling Factor	Scaled SAR-1g (W/kg)
12	LTE 5	QPSK10M	Rear Face	20600	1	24	24.0	22.76	0.02	0.485	1.33	0.65
13	LTE 7	QPSK20M	Rear Face	21350	1	50	24.0	22.83	-0.08	0.372	1.31	0.49
14	LTE 28	QPSK20M	Rear Face	27310	1	50	24.0	22.78	0.00	0.278	1.32	0.37
15	LTE 38	QPSK20M	Rear Face	37850	1	50	24.0	22.94	-0.12	0.218	1.28	0.28

Plot No.	Band	Mode	Test Position	Ch.	Max. Tune-up Power (dBm)	Measured Conducted Power (dBm)	Power Drift (dB)	Measured SAR-1g (W/kg)	Scaling Factor	Scaled SAR-1g (W/kg)
16	802.11b	-	Front Face	6	15.5	14.80	-0.19	0.044	1.17	0.05

FCC SAR Test Report

4.7.4 SAR Results for Hotspot Exposure Condition (Separation Distance is 1.0 cm Gap)

Plot No.	Band	Mode	Test Position	Ch.	Max. Tune-up Power (dBm)	Measured Conducted Power (dBm)	Power Drift (dB)	Measured SAR-1g (W/kg)	Scaling Factor	Scaled SAR-1g (W/kg)
17	GSM850	GPRS12	Rear Face	189	27.0	26.33	0.03	0.519	1.17	0.61
18	GSM1900	GPRS8	Rear Face	512	31.0	29.56	0.03	0.316	1.39	0.44
19	WCDMA V	RMC12.2K	Rear Face	4182	25.0	24.08	-0.02	0.379	1.24	0.47

Plot No.	Band	Mode	Test Position	Ch.	RB#	RB Offset	Max. Tune-up Power (dBm)	Measured Conducted Power (dBm)	Power Drift (dB)	Measured SAR-1g (W/kg)	Scaling Factor	Scaled SAR-1g (W/kg)
20	LTE 5	QPSK10M	Rear Face	20600	1	24	24.0	22.76	0.01	0.576	1.33	0.77
21	LTE 7	QPSK20M	Bottom Side	21350	1	50	21.5	20.82	0.00	0.619	1.17	0.72
22	LTE 28	QPSK20M	Rear Face	27310	1	50	24.0	22.78	-0.11	0.327	1.32	0.43
23	LTE 38	QPSK20M	Bottom Side	37850	1	50	24.0	22.94	0.01	0.64	1.28	0.82
	LTE 38	QPSK20M	Bottom Side	38000	1	50	24.0	22.87	0.04	0.558	1.30	0.72
	LTE 38	QPSK20M	Bottom Side	38150	1	50	24.0	22.91	0.10	0.581	1.29	0.75

Plot No.	Band	Mode	Test Position	Ch.	Max. Tune-up Power (dBm)	Measured Conducted Power (dBm)	Power Drift (dB)	Measured SAR-1g (W/kg)	Scaling Factor	Scaled SAR-1g (W/kg)
24	802.11b	-	Front Face	6	15.5	14.80	0.03	0.13	1.17	0.15

FCC SAR Test Report

4.7.5 SAR Measurement Variability

According to KDB 865664 D01, SAR measurement variability was assessed for each frequency band, which is determined by the SAR probe calibration point and tissue-equivalent medium used for the device measurements. When both head and body tissue-equivalent media are required for SAR measurements in a frequency band, the variability measurement procedures should be applied to the tissue medium with the highest measured SAR, using the highest measured SAR configuration for that tissue-equivalent medium. Alternatively, if the highest measured SAR for both head and body tissue-equivalent media are ≤ 1.45 W/kg and the ratio of these highest SAR values, i.e., largest divided by smallest value, is ≤ 1.10 , the highest SAR configuration for either head or body tissue-equivalent medium may be used to perform the repeated measurement. These additional measurements are repeated after the completion of all measurements requiring the same head or body tissue-equivalent medium in a frequency band. The test device should be returned to ambient conditions (normal room temperature) with the battery fully charged before it is re-mounted on the device holder for the repeated measurement(s) to minimize any unexpected variations in the repeated results.

Since all the measured SAR are less than 0.8 W/kg, the repeated measurement is not required.

4.7.6 Simultaneous Multi-band Transmission Evaluation

<Estimated SAR Calculation>

According to KDB 447498 D01, when standalone SAR test exclusion applies to an antenna that transmits simultaneously with other antennas, the standalone SAR was estimated according to following formula to result in substantially conservative SAR values of ≤ 0.4 W/kg to determine simultaneous transmission SAR test exclusion.

$$\text{Estimated SAR} = \frac{\text{Max. Tune up Power}_{(mW)}}{\text{Min. Test Separation Distance}_{(mm)}} \times \frac{\sqrt{f_{(GHz)}}}{7.5}$$

If the minimum test separation distance is < 5 mm, a distance of 5 mm is used for estimated SAR calculation. When the test separation distance is > 50 mm, the 0.4 W/kg is used for SAR-1g.

Mode / Band	Frequency (GHz)	Max. Tune-up Power (dBm)	Test Position	Separation Distance (mm)	Estimated SAR (W/kg)
BT (DSS)	2.48	7.5	Body-worn	15	0.08

Note:

1. The separation distance is determined from the outer housing of the EUT to the user.
2. When standalone SAR testing is not required, an estimated SAR can be applied to determine simultaneous transmission SAR test exclusion.

FCC SAR Test Report

<SAR Summation Analysis>

Simultaneous transmission SAR test exclusion is determined for each operating configuration and exposure condition according to the reported standalone SAR of each applicable simultaneous transmitting antenna. When the sum of SAR_{1g} of all simultaneously transmitting antennas in an operating mode and exposure condition combination is within the SAR limit (SAR_{1g} 1.6 W/kg), the simultaneous transmission SAR is not required. When the sum of SAR_{1g} is greater than the SAR limit (SAR_{1g} 1.6 W/kg), SAR test exclusion is determined by the SPLSR.

No.	Conditions (SAR1 + SAR2)	Exposure Condition	Test Position	Max. SAR1	Max. SAR2	SAR Summation	SPLSR Analysis
1	GSM850 + WLAN (DTS)	Head	Right Cheek	0.60	0.84	1.44	Σ SAR < 1.6, Not required
			Right Tilted	0.32	0.71	1.03	Σ SAR < 1.6, Not required
			Left Cheek	0.67	0.48	1.15	Σ SAR < 1.6, Not required
			Left Tilted	0.32	0.37	0.69	Σ SAR < 1.6, Not required
		Body-Worn	Front Face	0.46	0.05	0.51	Σ SAR < 1.6, Not required
			Rear Face	0.65	0.06	0.71	Σ SAR < 1.6, Not required
		Hotspot	Front Face	0.43	0.15	0.58	Σ SAR < 1.6, Not required
			Rear Face	0.61	0.17	0.78	Σ SAR < 1.6, Not required
			Left Side	0.45	0.14	0.59	Σ SAR < 1.6, Not required
			Right Side	0.44	0.00	0.44	Σ SAR < 1.6, Not required
			Top Side	0.00	0.09	0.09	Σ SAR < 1.6, Not required
			Bottom Side	0.03	0.00	0.03	Σ SAR < 1.6, Not required
2	GSM850 + BT (DSS)	Body-Worn	Front Face	0.46	0.08	0.54	Σ SAR < 1.6, Not required
			Rear Face	0.65	0.08	0.73	Σ SAR < 1.6, Not required

FCC SAR Test Report

No.	Conditions (SAR1 + SAR2)	Exposure Condition	Test Position	Max. SAR1	Max. SAR2	SAR Summation	SPLSR Analysis
3	GSM1900 + WLAN (DTS)	Head	Right Cheek	0.23	0.84	1.07	Σ SAR < 1.6, Not required
			Right Tilted	0.12	0.71	0.83	Σ SAR < 1.6, Not required
			Left Cheek	0.23	0.48	0.71	Σ SAR < 1.6, Not required
			Left Tilted	0.17	0.37	0.54	Σ SAR < 1.6, Not required
		Body-Worn	Front Face	0.18	0.05	0.23	Σ SAR < 1.6, Not required
			Rear Face	0.19	0.06	0.25	Σ SAR < 1.6, Not required
		Hotspot	Front Face	0.14	0.15	0.29	Σ SAR < 1.6, Not required
			Rear Face	0.44	0.17	0.61	Σ SAR < 1.6, Not required
			Left Side	0.21	0.14	0.35	Σ SAR < 1.6, Not required
			Right Side	0.18	0.00	0.18	Σ SAR < 1.6, Not required
			Top Side	0.00	0.09	0.09	Σ SAR < 1.6, Not required
		Bottom Side	0.39	0.00	0.39	Σ SAR < 1.6, Not required	
4	GSM1900 + BT (DSS)	Body-Worn	Front Face	0.18	0.08	0.26	Σ SAR < 1.6, Not required
			Rear Face	0.19	0.08	0.27	Σ SAR < 1.6, Not required

No.	Conditions (SAR1 + SAR2)	Exposure Condition	Test Position	Max. SAR1	Max. SAR2	SAR Summation	SPLSR Analysis
5	WCDMA V + WLAN (DTS)	Head	Right Cheek	0.18	0.84	1.02	Σ SAR < 1.6, Not required
			Right Tilted	0.29	0.71	1.00	Σ SAR < 1.6, Not required
			Left Cheek	0.11	0.48	0.59	Σ SAR < 1.6, Not required
			Left Tilted	0.05	0.37	0.42	Σ SAR < 1.6, Not required
		Body-Worn	Front Face	0.59	0.05	0.64	Σ SAR < 1.6, Not required
			Rear Face	0.20	0.06	0.26	Σ SAR < 1.6, Not required
		Hotspot	Front Face	0.69	0.15	0.84	Σ SAR < 1.6, Not required
			Rear Face	0.47	0.17	0.64	Σ SAR < 1.6, Not required
			Left Side	0.71	0.14	0.85	Σ SAR < 1.6, Not required
			Right Side	0.72	0.00	0.72	Σ SAR < 1.6, Not required
			Top Side	0.00	0.09	0.09	Σ SAR < 1.6, Not required
		Bottom Side	0.04	0.00	0.04	Σ SAR < 1.6, Not required	
6	WCDMA V + BT (DSS)	Body-Worn	Front Face	0.59	0.08	0.67	Σ SAR < 1.6, Not required
			Rear Face	0.20	0.08	0.28	Σ SAR < 1.6, Not required

FCC SAR Test Report

No.	Conditions (SAR1 + SAR2)	Exposure Condition	Test Position	Max. SAR1	Max. SAR2	SAR Summation	SPLSR Analysis
7	LTE Band 5 + WLAN (DTS)	Head	Right Cheek	0.44	0.84	1.28	Σ SAR < 1.6, Not required
			Right Tilted	0.24	0.71	0.95	Σ SAR < 1.6, Not required
			Left Cheek	0.34	0.48	0.82	Σ SAR < 1.6, Not required
			Left Tilted	0.23	0.37	0.60	Σ SAR < 1.6, Not required
		Body-Worn	Front Face	0.44	0.05	0.49	Σ SAR < 1.6, Not required
			Rear Face	0.65	0.06	0.71	Σ SAR < 1.6, Not required
		Hotspot	Front Face	0.52	0.15	0.67	Σ SAR < 1.6, Not required
			Rear Face	0.77	0.17	0.94	Σ SAR < 1.6, Not required
			Left Side	0.52	0.14	0.66	Σ SAR < 1.6, Not required
			Right Side	0.52	0.00	0.52	Σ SAR < 1.6, Not required
			Top Side	0.00	0.09	0.09	Σ SAR < 1.6, Not required
		Bottom Side	0.04	0.00	0.04	Σ SAR < 1.6, Not required	
8	LTE Band 5 + BT (DSS)	Body-Worn	Front Face	0.44	0.08	0.52	Σ SAR < 1.6, Not required
			Rear Face	0.65	0.08	0.73	Σ SAR < 1.6, Not required

No.	Conditions (SAR1 + SAR2)	Exposure Condition	Test Position	Max. SAR1	Max. SAR2	SAR Summation	SPLSR Analysis
9	LTE Band 7 + WLAN (DTS)	Head	Right Cheek	0.12	0.84	0.96	Σ SAR < 1.6, Not required
			Right Tilted	0.11	0.71	0.82	Σ SAR < 1.6, Not required
			Left Cheek	0.29	0.48	0.77	Σ SAR < 1.6, Not required
			Left Tilted	0.06	0.37	0.43	Σ SAR < 1.6, Not required
		Body-Worn	Front Face	0.35	0.05	0.40	Σ SAR < 1.6, Not required
			Rear Face	0.49	0.06	0.55	Σ SAR < 1.6, Not required
		Hotspot	Front Face	0.37	0.15	0.52	Σ SAR < 1.6, Not required
			Rear Face	0.64	0.17	0.81	Σ SAR < 1.6, Not required
			Left Side	0.13	0.14	0.27	Σ SAR < 1.6, Not required
			Right Side	0.09	0.00	0.09	Σ SAR < 1.6, Not required
			Top Side	0.00	0.09	0.09	Σ SAR < 1.6, Not required
		Bottom Side	0.72	0.00	0.72	Σ SAR < 1.6, Not required	
10	LTE Band 7 + BT (DSS)	Body-Worn	Front Face	0.35	0.08	0.43	Σ SAR < 1.6, Not required
			Rear Face	0.49	0.08	0.57	Σ SAR < 1.6, Not required

FCC SAR Test Report

No.	Conditions (SAR1 + SAR2)	Exposure Condition	Test Position	Max. SAR1	Max. SAR2	SAR Summation	SPLSR Analysis
11	LTE Band 28 + WLAN (DTS)	Head	Right Cheek	0.21	0.84	1.05	Σ SAR < 1.6, Not required
			Right Tilted	0.12	0.71	0.83	Σ SAR < 1.6, Not required
			Left Cheek	0.19	0.48	0.67	Σ SAR < 1.6, Not required
			Left Tilted	0.12	0.37	0.49	Σ SAR < 1.6, Not required
		Body-Worn	Front Face	0.23	0.05	0.28	Σ SAR < 1.6, Not required
			Rear Face	0.37	0.06	0.43	Σ SAR < 1.6, Not required
		Hotspot	Front Face	0.30	0.15	0.45	Σ SAR < 1.6, Not required
			Rear Face	0.43	0.17	0.60	Σ SAR < 1.6, Not required
			Left Side	0.32	0.14	0.46	Σ SAR < 1.6, Not required
			Right Side	0.30	0.00	0.30	Σ SAR < 1.6, Not required
			Top Side	0.00	0.09	0.09	Σ SAR < 1.6, Not required
		Bottom Side	0.03	0.00	0.03	Σ SAR < 1.6, Not required	
12	LTE Band 28 + BT (DSS)	Body-Worn	Front Face	0.23	0.08	0.31	Σ SAR < 1.6, Not required
			Rear Face	0.37	0.08	0.45	Σ SAR < 1.6, Not required

No.	Conditions (SAR1 + SAR2)	Exposure Condition	Test Position	Max. SAR1	Max. SAR2	SAR Summation	SPLSR Analysis
13	LTE Band 38 + WLAN (DTS)	Head	Right Cheek	0.09	0.84	0.93	Σ SAR < 1.6, Not required
			Right Tilted	0.10	0.71	0.81	Σ SAR < 1.6, Not required
			Left Cheek	0.19	0.48	0.67	Σ SAR < 1.6, Not required
			Left Tilted	0.08	0.37	0.45	Σ SAR < 1.6, Not required
		Body-Worn	Front Face	0.19	0.05	0.24	Σ SAR < 1.6, Not required
			Rear Face	0.28	0.06	0.34	Σ SAR < 1.6, Not required
		Hotspot	Front Face	0.43	0.15	0.58	Σ SAR < 1.6, Not required
			Rear Face	0.77	0.17	0.94	Σ SAR < 1.6, Not required
			Left Side	0.18	0.14	0.32	Σ SAR < 1.6, Not required
			Right Side	0.10	0.00	0.10	Σ SAR < 1.6, Not required
			Top Side	0.00	0.09	0.09	Σ SAR < 1.6, Not required
		Bottom Side	0.82	0.00	0.82	Σ SAR < 1.6, Not required	
14	LTE Band 38 + BT (DSS)	Body-Worn	Front Face	0.19	0.08	0.27	Σ SAR < 1.6, Not required
			Rear Face	0.28	0.08	0.36	Σ SAR < 1.6, Not required

Note: For simultaneous Transmission analyse, Black color data from original report SA181227W002.

Test Engineer : Xianxiong Qin

5. Calibration of Test Equipment

Equipment	Manufacturer	Model	SN	Cal. Date	Cal. Interval
System Validation Dipole	SPEAG	D750V3	1067	Sep. 05, 2018	1 Year
System Validation Dipole	SPEAG	D835V2	4d139	Sep. 06, 2018	1 Year
System Validation Dipole	SPEAG	D1900V2	5d159	Sep. 11, 2018	1 Year
System Validation Dipole	SPEAG	D2450V2	893	Aug. 31, 2018	1 Year
System Validation Dipole	SPEAG	D2600V2	1110	Aug. 31, 2018	1 Year
Dosimetric E-Field Probe	SPEAG	EX3DV4	3873	Aug. 31, 2018	1 Year
Data Acquisition Electronics	SPEAG	DAE4	1341	Aug. 28, 2018	1 Year
Radio Communication Analyzer	ANRITSU	MT8820C	6201300717	Jul. 09, 2018	1 Year
Wireless Communication Test Set	Agilent	E5515C	MY50260600	Feb. 26, 2019	1 Year
ENA Series Network Analyzer	Agilent	E5071C	MY46214638	Jul. 09, 2018	1 Year
Spectrum Analyzer	KEYSIGHT	N9010A	MY54510355	Jul. 09, 2018	1Year
MXG Analog Signal Generator	KEYSIGHT	N5183A	MY50143024	Mar. 27, 2019	1 Year
Power Meter	Agilent	N1914A	MY52180044	Oct. 10, 2018	2 Years
Power Sensor	Agilent	E9304A H18	MY52050011	Jan. 21, 2019	1 Year
Power Meter	ANRITSU	ML2495A	1506002	Feb. 26, 2019	1 Year
Power Sensor	ANRITSU	MA2411B	1339353	Feb. 26, 2019	1 Year
Temp. & Humi. Recorder	CLOCK	HTC-1	157248	Jul. 11, 2018	1 Year
Electronic Thermometer	YONGFA	YF-160A	120100323	Sep. 14, 2018	1 Year
Coupler	Woken	0110A056020-10	COM27RW1A3	Sep. 14, 2018	1 Year

FCC SAR Test Report

6. Measurement Uncertainty

Source of Uncertainty	Tolerance (± %)	Probability Distribution	Divisor	Ci (1g)	Ci (10g)	Standard Uncertainty (± %, 1g)	Standard Uncertainty (± %, 10g)	Vi
Measurement System								
Probe Calibration	6.0	Normal	1	1	1	6.0	6.0	∞
Axial Isotropy	4.7	Rectangular	√3	0.707	0.707	1.9	1.9	∞
Hemispherical Isotropy	9.6	Rectangular	√3	0.707	0.707	3.9	3.9	∞
Boundary Effect	1.0	Rectangular	√3	1	1	0.6	0.6	∞
Linearity	4.7	Rectangular	√3	1	1	2.7	2.7	∞
System Detection Limits	0.25	Rectangular	√3	1	1	0.14	0.14	∞
Readout Electronics	0.3	Normal	1	1	1	0.3	0.3	∞
Response Time	0.0	Rectangular	√3	1	1	0.0	0.0	∞
Integration Time	1.7	Rectangular	√3	1	1	1.0	1.0	∞
RF Ambient Conditions - Noise	3.0	Rectangular	√3	1	1	1.7	1.7	∞
RF Ambient Conditions - Reflections	3.0	Rectangular	√3	1	1	1.7	1.7	∞
Probe Positioner Mechanical Tolerance	0.4	Rectangular	√3	1	1	0.2	0.2	∞
Probe Positioning with Respect to Phantom Shell	2.9	Rectangular	√3	1	1	1.7	1.7	∞
Extrapolation, interpolation, and integration algorithms for max. SAR evaluation	2.0	Rectangular	√3	1	1	1.2	1.2	∞
Test Sample Related								
Test Sample Positioning	1.5 / 0.7	Normal	1	1	1	1.5	0.7	32
Device Holder Uncertainty	4.2 / 1.8	Normal	1	1	1	4.2	1.8	32
Output Power Variation - SAR Drift Measurement	5.0	Rectangular	√3	1	1	2.9	2.9	∞
Phantom and Tissue Parameters								
Phantom Uncertainty (Shape and Thickness Tolerances)	7.2	Rectangular	√3	1	1	4.2	4.2	∞
Liquid Conductivity - Deviation from Target Values	5.0	Rectangular	√3	0.64	0.43	1.8	1.2	∞
Liquid Conductivity - Measurement Uncertainty	1.0	Normal	1	0.64	0.43	0.6	0.4	25
Liquid Permittivity - Deviation from Target Values	5.0	Rectangular	√3	0.60	0.49	1.7	1.4	∞
Liquid Permittivity - Measurement Uncertainty	0.5	Normal	1	0.60	0.49	0.3	0.2	25
Combined Standard Uncertainty						± 11.2 %	± 10.4 %	
Expanded Uncertainty (K=2)						± 22.4 %	± 20.8 %	

Uncertainty budget for frequency range 300 MHz to 3 GHz

FCC SAR Test Report

Source of Uncertainty	Tolerance (± %)	Probability Distribution	Divisor	Ci (1g)	Ci (10g)	Standard Uncertainty (± %, 1g)	Standard Uncertainty (± %, 10g)	Vi
Measurement System								
Probe Calibration	6.55	Normal	1	1	1	6.55	6.55	∞
Axial Isotropy	4.7	Rectangular	√3	0.707	0.707	1.9	1.9	∞
Hemispherical Isotropy	9.6	Rectangular	√3	0.707	0.707	3.9	3.9	∞
Boundary Effect	2.0	Rectangular	√3	1	1	1.2	1.2	∞
Linearity	4.7	Rectangular	√3	1	1	2.7	2.7	∞
System Detection Limits	0.25	Rectangular	√3	1	1	0.14	0.14	∞
Readout Electronics	0.3	Normal	1	1	1	0.3	0.3	∞
Response Time	0.0	Rectangular	√3	1	1	0.0	0.0	∞
Integration Time	1.7	Rectangular	√3	1	1	1.0	1.0	∞
RF Ambient Conditions - Noise	3.0	Rectangular	√3	1	1	1.7	1.7	∞
RF Ambient Conditions - Reflections	3.0	Rectangular	√3	1	1	1.7	1.7	∞
Probe Positioner Mechanical Tolerance	0.4	Rectangular	√3	1	1	0.2	0.2	∞
Probe Positioning with Respect to Phantom Shell	6.7	Rectangular	√3	1	1	3.9	3.9	∞
Extrapolation, interpolation, and integration algorithms for max. SAR evaluation	4.0	Rectangular	√3	1	1	2.3	2.3	∞
Test Sample Related								
Test Sample Positioning	1.5 / 0.7	Normal	1	1	1	1.5	0.7	32
Device Holder Uncertainty	4.2 / 1.8	Normal	1	1	1	4.2	1.8	32
Output Power Variation - SAR Drift Measurement	5.0	Rectangular	√3	1	1	2.9	2.9	∞
Phantom and Tissue Parameters								
Phantom Uncertainty (Shape and Thickness Tolerances)	7.6	Rectangular	√3	1	1	4.4	4.4	∞
Liquid Conductivity - Deviation from Target Values	5.0	Rectangular	√3	0.64	0.43	1.8	1.2	∞
Liquid Conductivity - Measurement Uncertainty	1.0	Normal	1	0.64	0.43	0.6	0.4	25
Liquid Permittivity - Deviation from Target Values	5.0	Rectangular	√3	0.60	0.49	1.7	1.4	∞
Liquid Permittivity - Measurement Uncertainty	0.5	Normal	1	0.60	0.49	0.3	0.2	25
Combined Standard Uncertainty						± 12.3 %	± 11.5 %	
Expanded Uncertainty (K=2)						± 24.6 %	± 23.0 %	

Uncertainty budget for frequency range 3 GHz to 6 GHz

7. Information on the Testing Laboratories

We, BV 7LAYERS COMMUNICATIONS TECHNOLOGY (SHENZHEN) CO. LTD., were founded in 2015 to provide our best service in EMC, Radio, Telecom and Safety consultation. Our laboratories are accredited and approved according to ISO/IEC 17025.

If you have any comments, please feel free to contact us at the following:

Add: No. B102, Dazu Chuangxin Mansion, North of Beihuan Avenue, North Area, Hi-Tech Industry Park, Nanshan District, Shenzhen, Guangdong, China

Tel: 86-755-8869-6566

Fax: 86-755-8869-6577

Email: customerservice.dg@cn.bureauveritas.com

Web Site: www.bureauveritas.com

The road map of all our labs can be found in our web site also.

---END---



Appendix A. SAR Plots of System Verification

The plots for system verification with largest deviation for each SAR system combination are shown as follows.

System Check_HSL750_190328

DUT: Dipole:750 MHz;Type:D750V3;SN:1067

Communication System: CW; Frequency: 750 MHz;Duty Cycle: 1:1

Medium: HSL750_0328 Medium parameters used: $f = 750$ MHz; $\sigma = 0.891$ S/m; $\epsilon_r = 40.775$; $\rho = 1000$ kg/m³

Ambient Temperature : 22.9°C; Liquid Temperature : 21.9°C

DASY5 Configuration:

- Probe: EX3DV4 - SN3873; ConvF(10.15, 10.15, 10.15); Calibrated: 2018/08/31;
- Sensor-Surface: 1.4mm (Mechanical Surface Detection)
- Electronics: DAE4 Sn1341; Calibrated: 2018/08/28
- Phantom: Left Phantom with CRP v5.0; Type: QD000P40CD; Serial: TP:1722
- Measurement SW: DASY52, Version 52.8 (8); SEMCAD X Version 14.6.10 (7331)

Pin=250mW/Area Scan (71x131x1): Interpolated grid: dx=1.500 mm, dy=1.500 mm
Maximum value of SAR (interpolated) = 2.66 W/kg

Pin=250mW/Zoom Scan (5x5x7)/Cube 0: Measurement grid: dx=8mm, dy=8mm, dz=5mm
Reference Value = 54.47 V/m; Power Drift = 0.01 dB
Peak SAR (extrapolated) = 3.04 W/kg
SAR(1 g) = 2.04 W/kg; SAR(10 g) = 1.35 W/kg
Maximum value of SAR (measured) = 2.72 W/kg

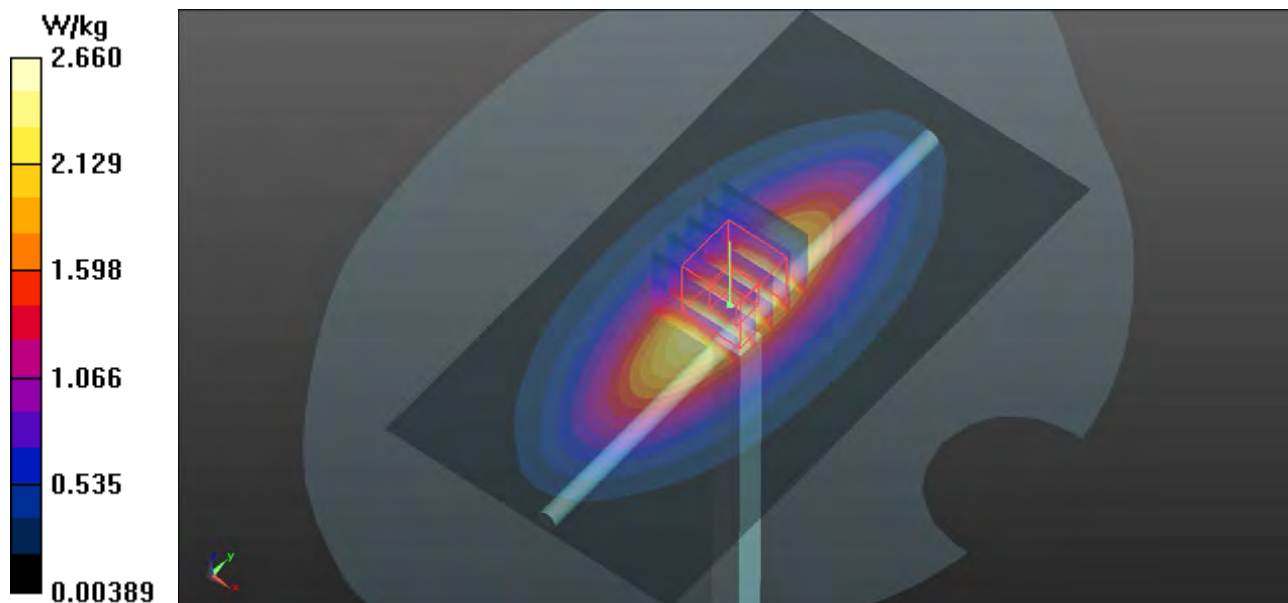

System Check_HSL835_190328

DUT: Dipole:835 MHz;Type:D835V2; SN:4d139

Communication System: CW; Frequency: 835 MHz;Duty Cycle: 1:1

Medium: HSL835_0328 Medium parameters used: $f = 835 \text{ MHz}$; $\sigma = 0.906 \text{ S/m}$; $\epsilon_r = 41.863$; $\rho = 1000 \text{ kg/m}^3$

Ambient Temperature : 22.9°C; Liquid Temperature : 21.9°C

DASY5 Configuration:

- Probe: EX3DV4 - SN3873; ConvF(9.69, 9.69, 9.69); Calibrated: 2018/08/31;
- Sensor-Surface: 1.4mm (Mechanical Surface Detection)
- Electronics: DAE4 Sn1341; Calibrated: 2018/08/28
- Phantom: Left Phantom with CRP v5.0; Type: QD000P40CD; Serial: TP:1722
- Measurement SW: DASY52, Version 52.8 (8); SEMCAD X Version 14.6.10 (7331)

Pin=250mW/Area Scan (71x121x1): Interpolated grid: $dx=1.500 \text{ mm}$, $dy=1.500 \text{ mm}$
Maximum value of SAR (interpolated) = 3.26 W/kg

Pin=250mW/Zoom Scan (5x5x7)/Cube 0: Measurement grid: $dx=8\text{mm}$, $dy=8\text{mm}$, $dz=5\text{mm}$
Reference Value = 59.55 V/m; Power Drift = 0.05 dB
Peak SAR (extrapolated) = 3.75 W/kg
SAR(1 g) = 2.49 W/kg; SAR(10 g) = 1.62 W/kg
Maximum value of SAR (measured) = 3.34 W/kg

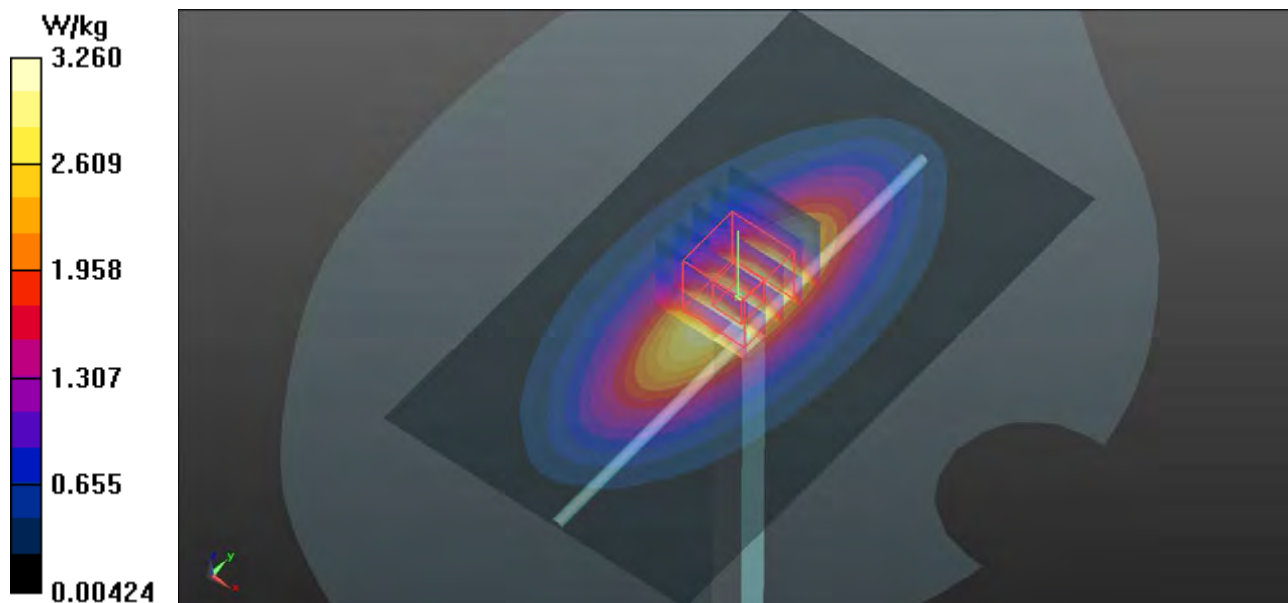

System Check_HSL1900_190329

DUT: Dipole:1900MHz;Type:D1900V2; SN:5d159

Communication System: CW; Frequency: 1900 MHz;Duty Cycle: 1:1

Medium: HSL1900_0329 Medium parameters used: $f = 1900$ MHz; $\sigma = 1.436$ S/m; $\epsilon_r = 39.743$; $\rho = 1000$ kg/m³

Ambient Temperature : 22.8°C; Liquid Temperature : 21.8°C

DASY5 Configuration:

- Probe: EX3DV4 - SN3873; ConvF(8.12, 8.12, 8.12); Calibrated: 2018/08/31;
- Sensor-Surface: 1.4mm (Mechanical Surface Detection)
- Electronics: DAE4 Sn1341; Calibrated: 2018/08/28
- Phantom: Front Phantom with CRP v5.0; Type: QD000P40CD; Serial: TP:1695
- Measurement SW: DASY52, Version 52.8 (8); SEMCAD X Version 14.6.10 (7331)

Pin=250mW/Area Scan (71x81x1): Interpolated grid: dx=1.500 mm, dy=1.500 mm
Maximum value of SAR (interpolated) = 16.2 W/kg

Pin=250mW/Zoom Scan (5x5x7)/Cube 0: Measurement grid: dx=8mm, dy=8mm, dz=5mm
Reference Value = 101.9 V/m; Power Drift = 0.10 dB
Peak SAR (extrapolated) = 19.3 W/kg
SAR(1 g) = 10.6 W/kg; SAR(10 g) = 5.53 W/kg
Maximum value of SAR (measured) = 16.1 W/kg

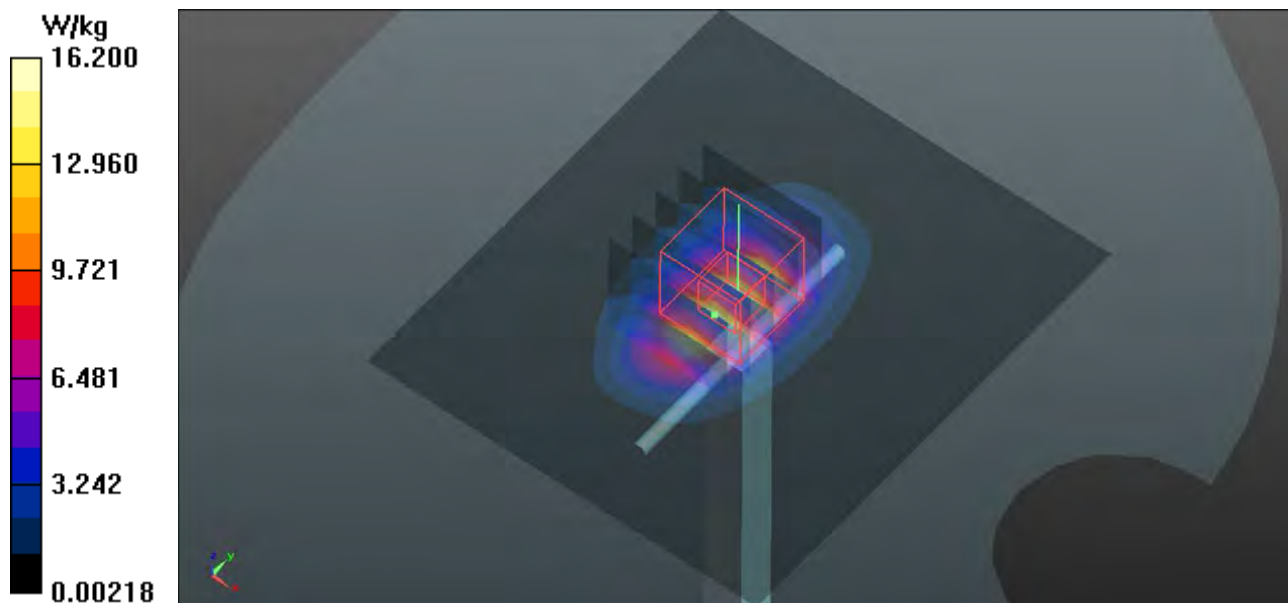

System Check_HSL2450_190327

DUT: Dipole:2450 MHz;Type:D2450V2; SN:893

Communication System: CW; Frequency: 2450 MHz;Duty Cycle: 1:1

Medium: HSL2450_0327 Medium parameters used: $f = 2450$ MHz; $\sigma = 1.783$ S/m; $\epsilon_r = 40.18$; $\rho = 1000$ kg/m³

Ambient Temperature : 23.1°C; Liquid Temperature : 22.1°C

DASY5 Configuration:

- Probe: EX3DV4 - SN3873; ConvF(7.19, 7.19, 7.19); Calibrated: 2018/08/31;
- Sensor-Surface: 1.4mm (Mechanical Surface Detection)
- Electronics: DAE4 Sn1341; Calibrated: 2018/08/28
- Phantom: Front Phantom with CRP v5.0; Type: QD000P40CD; Serial: TP:1695
- Measurement SW: DASY52, Version 52.8 (8); SEMCAD X Version 14.6.10 (7331)

Pin=250mW/Area Scan (91x101x1): Interpolated grid: dx=1.200 mm, dy=1.200 mm
Maximum value of SAR (interpolated) = 23.9 W/kg

Pin=250mW/Zoom Scan (7x7x7)/Cube 0: Measurement grid: dx=5mm, dy=5mm, dz=5mm
Reference Value = 114.0 V/m; Power Drift = 0.02 dB
Peak SAR (extrapolated) = 29.7 W/kg
SAR(1 g) = 14.1 W/kg; SAR(10 g) = 6.48 W/kg
Maximum value of SAR (measured) = 23.7 W/kg

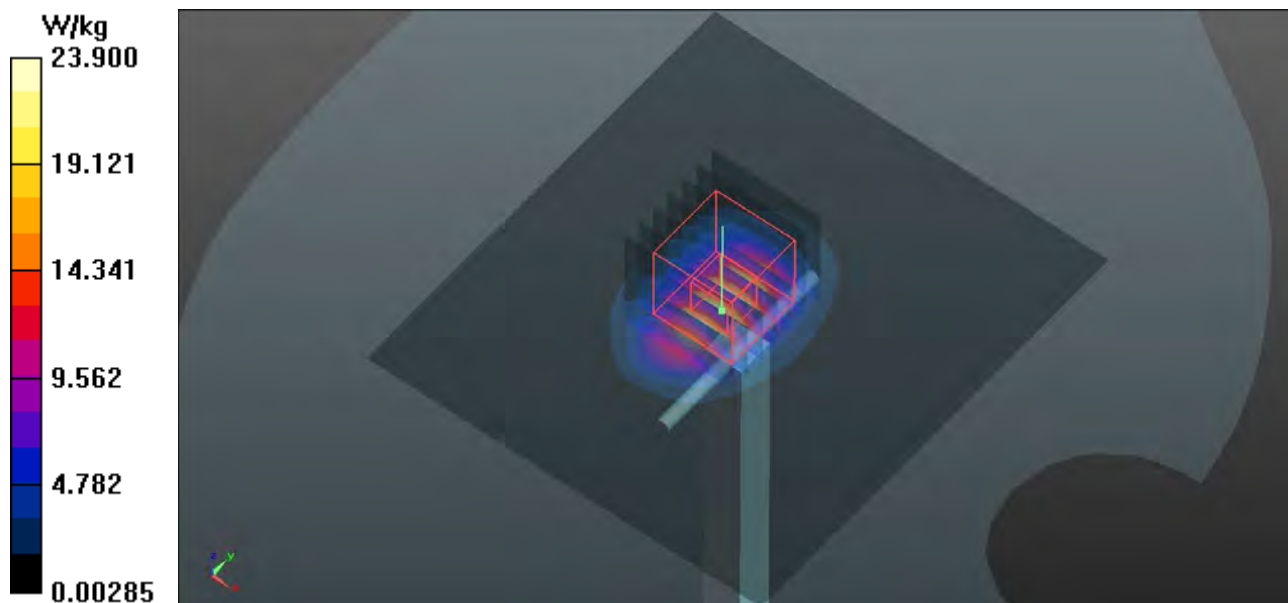

System Check_HSL2600_190326

DUT: Dipole:2600 MHz;Type:D2600V2; SN:1110

Communication System: CW; Frequency: 2600 MHz;Duty Cycle: 1:1

Medium: HSL2600_0326 Medium parameters used: $f = 2600$ MHz; $\sigma = 1.989$ S/m; $\epsilon_r = 38.32$; $\rho = 1000$ kg/m³

Ambient Temperature : 23.2°C; Liquid Temperature : 22.2°C

DASY5 Configuration:

- Probe: EX3DV4 - SN3873; ConvF(7.11, 7.11, 7.11); Calibrated: 2018/08/31;
- Sensor-Surface: 1.4mm (Mechanical Surface Detection)
- Electronics: DAE4 Sn1341; Calibrated: 2018/08/28
- Phantom: Front Phantom with CRP v5.0; Type: QD000P40CD; Serial: TP:1695
- Measurement SW: DASY52, Version 52.8 (8); SEMCAD X Version 14.6.10 (7331)

Pin=250mW/Area Scan (81x101x1): Interpolated grid: dx=1.200 mm, dy=1.200 mm
Maximum value of SAR (interpolated) = 23.6 W/kg

Pin=250mW/Zoom Scan (7x7x7)/Cube 0: Measurement grid: dx=5mm, dy=5mm, dz=5mm
Reference Value = 110.3 V/m; Power Drift = 0.15 dB
Peak SAR (extrapolated) = 30.3 W/kg
SAR(1 g) = 13.6 W/kg; SAR(10 g) = 5.98 W/kg
Maximum value of SAR (measured) = 24.0 W/kg

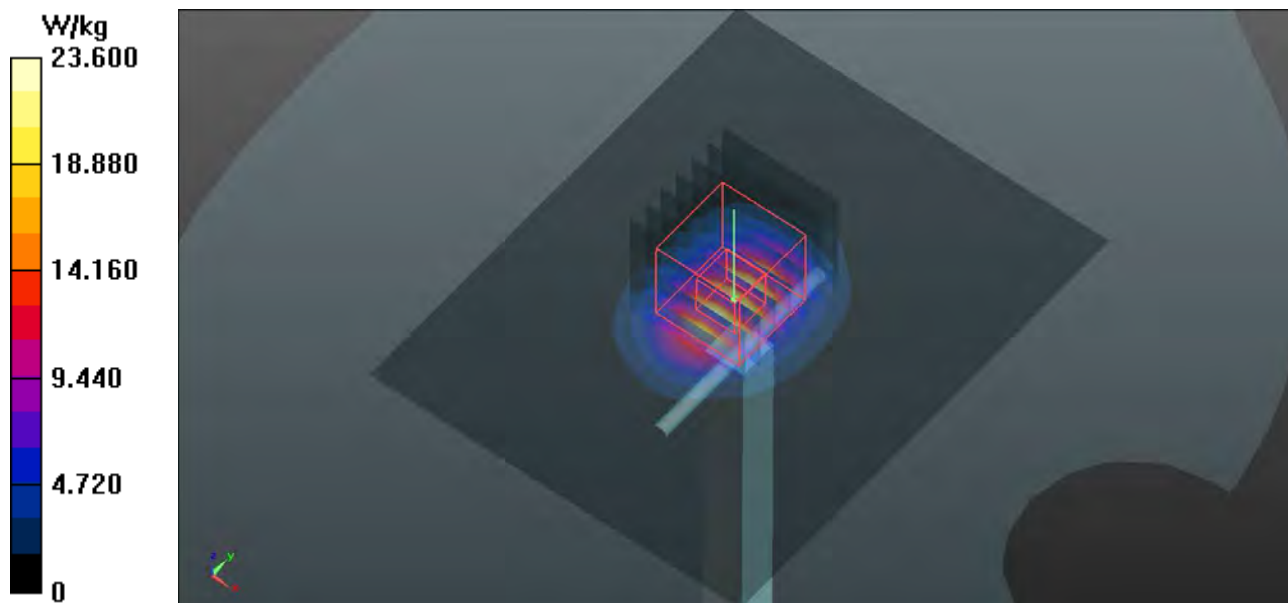

System Check_MSL750_190328

DUT: Dipole:750 MHz;Type:D750V3;SN:1067

Communication System: CW; Frequency: 750 MHz;Duty Cycle: 1:1

Medium: MSL750_0328 Medium parameters used: $f = 750 \text{ MHz}$; $\sigma = 0.967 \text{ S/m}$; $\epsilon_r = 55.261$; $\rho = 1000 \text{ kg/m}^3$

Ambient Temperature : 22.9°C; Liquid Temperature : 21.9°C

DASY5 Configuration:

- Probe: EX3DV4 - SN3873; ConvF(9.67, 9.67, 9.67); Calibrated: 2018/08/31;
- Sensor-Surface: 1.4mm (Mechanical Surface Detection)
- Electronics: DAE4 Sn1341; Calibrated: 2018/08/28
- Phantom: Left Phantom with CRP v5.0; Type: QD000P40CD; Serial: TP:1722
- Measurement SW: DASY52, Version 52.8 (8); SEMCAD X Version 14.6.10 (7331)

Pin=250mW/Area Scan (71x131x1): Interpolated grid: $dx=1.500 \text{ mm}$, $dy=1.500 \text{ mm}$
Maximum value of SAR (interpolated) = 2.93 W/kg

Pin=250mW/Zoom Scan (5x5x7)/Cube 0: Measurement grid: $dx=8\text{mm}$, $dy=8\text{mm}$, $dz=5\text{mm}$
Reference Value = 54.94 V/m; Power Drift = 0.00 dB
Peak SAR (extrapolated) = 3.38 W/kg
SAR(1 g) = 2.28 W/kg; SAR(10 g) = 1.53 W/kg
Maximum value of SAR (measured) = 3.02 W/kg

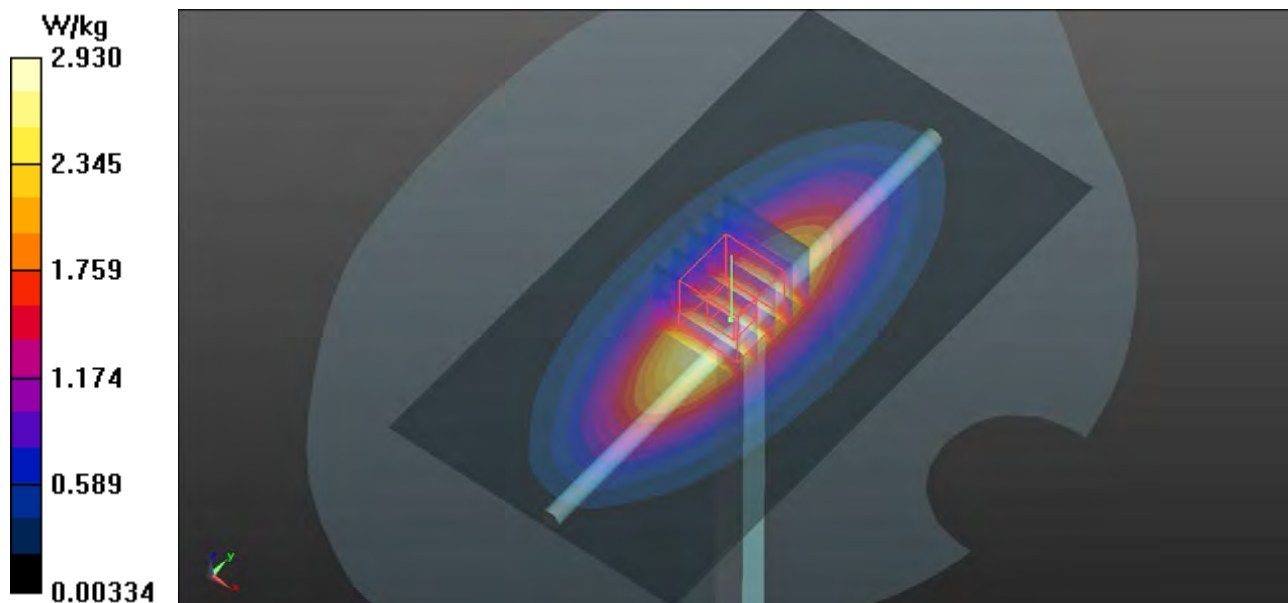

System Check_MSL835_190328

DUT: Dipole:835 MHz;Type:D835V2; SN:4d139

Communication System: CW; Frequency: 835 MHz;Duty Cycle: 1:1

Medium: MSL835_0328 Medium parameters used: $f = 835 \text{ MHz}$; $\sigma = 0.992 \text{ S/m}$; $\epsilon_r = 55.615$; $\rho = 1000 \text{ kg/m}^3$

Ambient Temperature : 22.9°C ; Liquid Temperature : 21.9°C

DASY5 Configuration:

- Probe: EX3DV4 - SN3873; ConvF(9.49, 9.49, 9.49); Calibrated: 2018/08/31;
- Sensor-Surface: 1.4mm (Mechanical Surface Detection)
- Electronics: DAE4 Sn1341; Calibrated: 2018/08/28
- Phantom: Left Phantom with CRP v5.0; Type: QD000P40CD; Serial: TP:1722
- Measurement SW: DASY52, Version 52.8 (8); SEMCAD X Version 14.6.10 (7331)

Pin=250mW/Area Scan (71x121x1): Interpolated grid: $dx=1.500 \text{ mm}$, $dy=1.500 \text{ mm}$
Maximum value of SAR (interpolated) = 3.47 W/kg

Pin=250mW/Zoom Scan (5x5x7)/Cube 0: Measurement grid: $dx=8\text{mm}$, $dy=8\text{mm}$, $dz=5\text{mm}$
Reference Value = 59.22 V/m ; Power Drift = 0.03 dB
Peak SAR (extrapolated) = 3.92 W/kg
SAR(1 g) = 2.48 W/kg ; SAR(10 g) = 1.38 W/kg
Maximum value of SAR (measured) = 3.51 W/kg

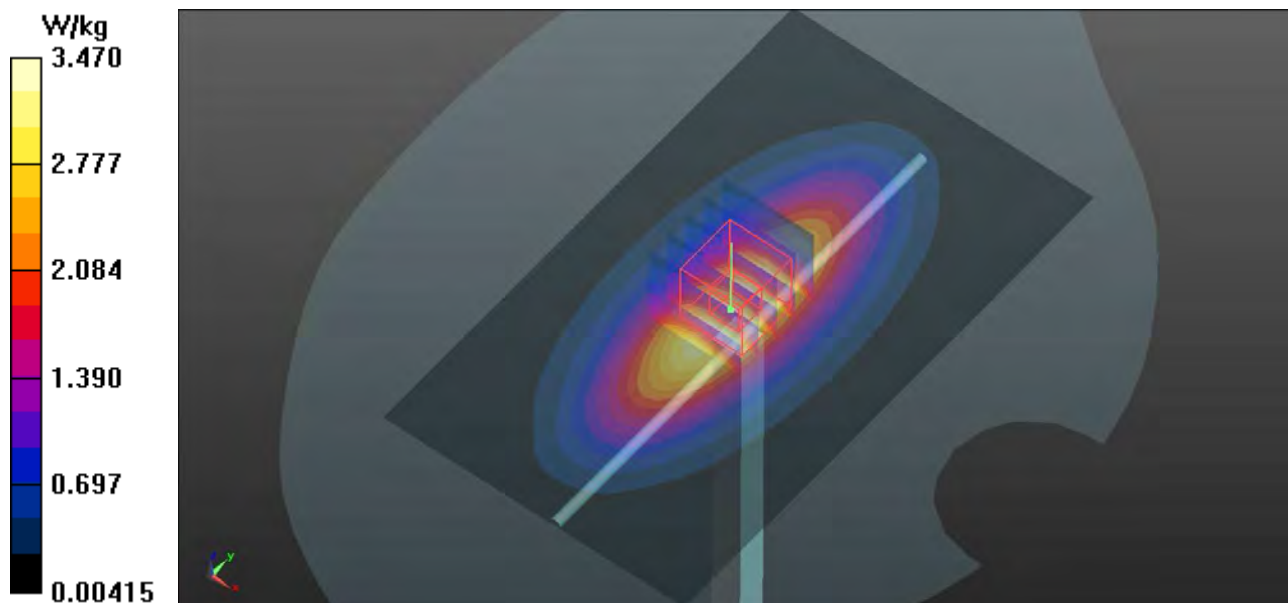

System Check_MSL1900_190329

DUT: Dipole:1900MHz;Type:D1900V2; SN:5d159

Communication System: CW; Frequency: 1900 MHz;Duty Cycle: 1:1

Medium: MSL1900_0329 Medium parameters used: $f = 1900$ MHz; $\sigma = 1.544$ S/m; $\epsilon_r = 52.838$; $\rho = 1000$ kg/m³

Ambient Temperature : 22.8°C; Liquid Temperature : 21.8°C

DASY5 Configuration:

- Probe: EX3DV4 - SN3873; ConvF(7.61, 7.61, 7.61); Calibrated: 2018/08/31;
- Sensor-Surface: 1.4mm (Mechanical Surface Detection)
- Electronics: DAE4 Sn1341; Calibrated: 2018/08/28
- Phantom: Front Phantom with CRP v5.0; Type: QD000P40CD; Serial: TP:1695
- Measurement SW: DASY52, Version 52.8 (8); SEMCAD X Version 14.6.10 (7331)

Pin=250mW/Area Scan (81x81x1): Interpolated grid: dx=1.500 mm, dy=1.500 mm
Maximum value of SAR (interpolated) = 14.8 W/kg

Pin=250mW/Zoom Scan (5x5x7)/Cube 0: Measurement grid: dx=8mm, dy=8mm, dz=5mm
Reference Value = 94.43 V/m; Power Drift = 0.15 dB
Peak SAR (extrapolated) = 18.0 W/kg
SAR(1 g) = 10.2 W/kg; SAR(10 g) = 5.41 W/kg
Maximum value of SAR (measured) = 15.5 W/kg

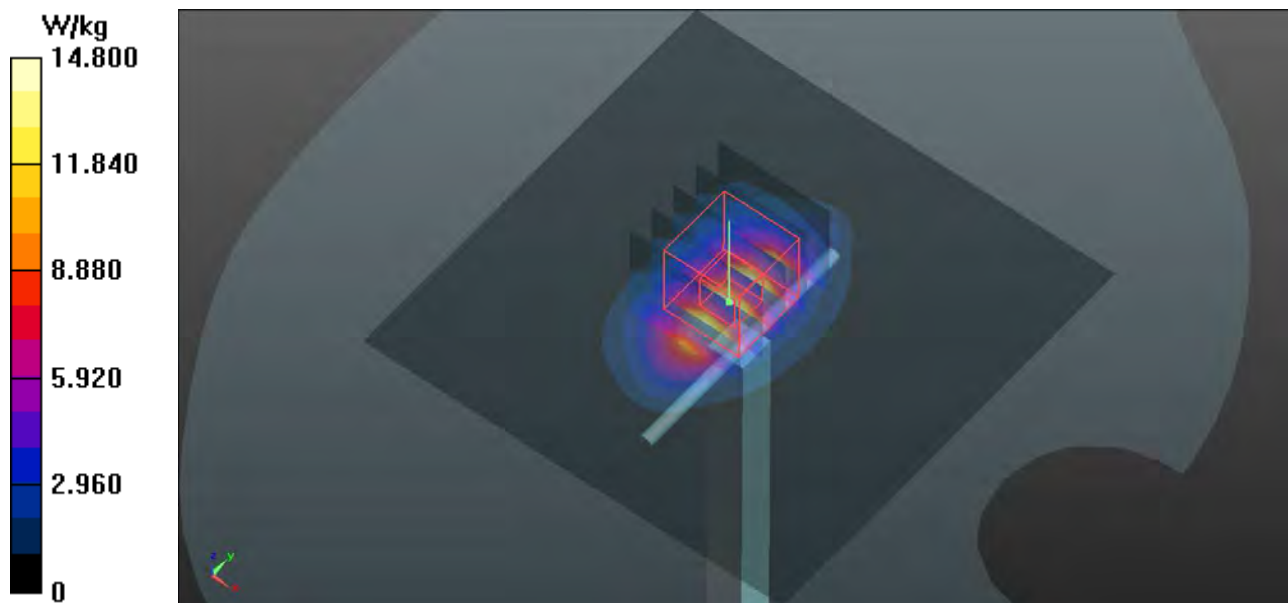

System Check_MSL2450_190327

DUT: Dipole:2450 MHz;Type:D2450V2; SN:893

Communication System: CW; Frequency: 2450 MHz;Duty Cycle: 1:1

Medium: MSL2450_0327 Medium parameters used: $f = 2450$ MHz; $\sigma = 1.902$ S/m; $\epsilon_r = 51.445$; $\rho = 1000$ kg/m³

Ambient Temperature : 23.1°C; Liquid Temperature : 22.1°C

DASY5 Configuration:

- Probe: EX3DV4 - SN3873; ConvF(7.39, 7.39, 7.39); Calibrated: 2018/08/31;
- Sensor-Surface: 1.4mm (Mechanical Surface Detection)
- Electronics: DAE4 Sn1341; Calibrated: 2018/08/28
- Phantom: Front Phantom with CRP v5.0; Type: QD000P40CD; Serial: TP:1695
- Measurement SW: DASY52, Version 52.8 (8); SEMCAD X Version 14.6.10 (7331)

Pin=250mW/Area Scan (91x101x1): Interpolated grid: dx=1.200 mm, dy=1.200 mm
Maximum value of SAR (interpolated) = 21.2 W/kg

Pin=250mW/Zoom Scan (7x7x7)/Cube 0: Measurement grid: dx=5mm, dy=5mm, dz=5mm
Reference Value = 104.4 V/m; Power Drift = 0.19 dB
Peak SAR (extrapolated) = 26.1 W/kg
SAR(1 g) = 12.6 W/kg; SAR(10 g) = 5.77 W/kg
Maximum value of SAR (measured) = 21.0 W/kg

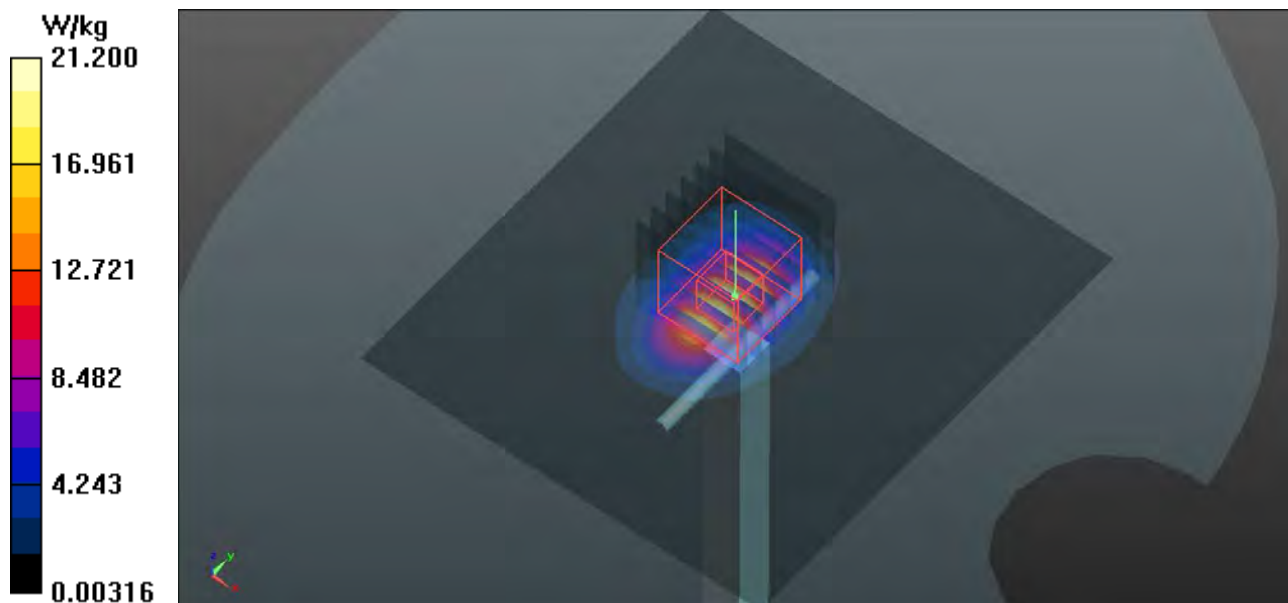

System Check_MSL2600_190326

DUT: Dipole:2600 MHz;Type:D2600V2; SN:1110

Communication System: CW; Frequency: 2600 MHz;Duty Cycle: 1:1

Medium: MSL2600_0326 Medium parameters used: $f = 2600$ MHz; $\sigma = 2.096$ S/m; $\epsilon_r = 50.743$; $\rho = 1000$ kg/m³

Ambient Temperature : 23.2°C; Liquid Temperature : 22.2°C

DASY5 Configuration:

- Probe: EX3DV4 - SN3873; ConvF(7.28, 7.28, 7.28); Calibrated: 2018/08/31;
- Sensor-Surface: 1.4mm (Mechanical Surface Detection)
- Electronics: DAE4 Sn1341; Calibrated: 2018/08/28
- Phantom: Front Phantom with CRP v5.0; Type: QD000P40CD; Serial: TP:1695
- Measurement SW: DASY52, Version 52.8 (8); SEMCAD X Version 14.6.10 (7331)

Pin=250mW/Area Scan (81x101x1): Interpolated grid: dx=1.200 mm, dy=1.200 mm
Maximum value of SAR (interpolated) = 24.6 W/kg

Pin=250mW/Zoom Scan (7x7x7)/Cube 0: Measurement grid: dx=5mm, dy=5mm, dz=5mm
Reference Value = 105.4 V/m; Power Drift = 0.04 dB
Peak SAR (extrapolated) = 32.1 W/kg
SAR(1 g) = 14.4 W/kg; SAR(10 g) = 6.31 W/kg
Maximum value of SAR (measured) = 25.0 W/kg

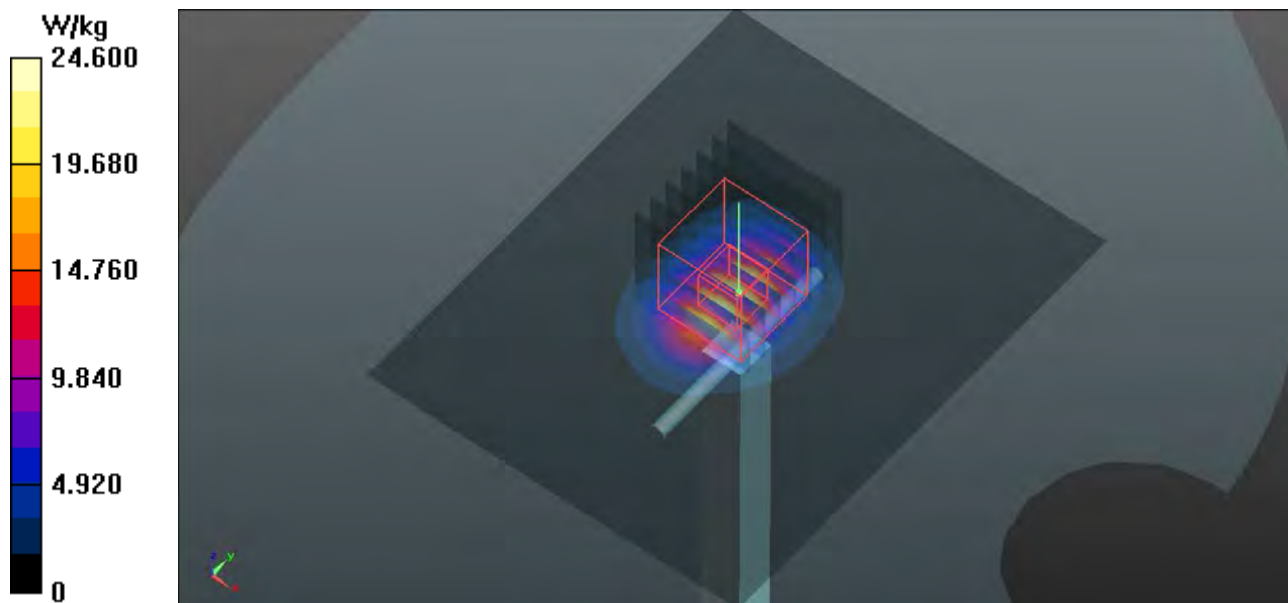

Appendix B. SAR Plots of SAR Measurement

The SAR plots for highest measured SAR in each exposure configuration, wireless mode and frequency band combination, and measured SAR > 1.5 W/kg are shown as follows.

P01 GSM850_GPRS12_Left Cheek_Ch189

DUT: 190322W004

Communication System: GPRS12; Frequency: 836.4 MHz; Duty Cycle: 1:2

Medium: HSL835_0328 Medium parameters used: $f = 836.4$ MHz; $\sigma = 0.907$ S/m; $\epsilon_r = 41.853$; $\rho = 1000$ kg/m³

Ambient Temperature : 22.9°C; Liquid Temperature : 21.9°C

DASY5 Configuration:

- Probe: EX3DV4 - SN3873; ConvF(9.69, 9.69, 9.69); Calibrated: 2018/08/31;
- Sensor-Surface: 1.4mm (Mechanical Surface Detection)
- Electronics: DAE4 Sn1341; Calibrated: 2018/08/28
- Phantom: Left Phantom with CRP v5.0; Type: QD000P40CD; Serial: TP:1722
- Measurement SW: DASY52, Version 52.8 (8); SEMCAD X Version 14.6.10 (7331)

- **Area Scan (71x121x1):** Interpolated grid: dx=1.500 mm, dy=1.500 mm

Maximum value of SAR (interpolated) = 0.520 W/kg

- **Zoom Scan (5x5x7)/Cube 0:** Measurement grid: dx=8mm, dy=8mm, dz=5mm

Reference Value = 6.483 V/m; Power Drift = -0.02 dB

Peak SAR (extrapolated) = 0.562 W/kg

SAR(1 g) = 0.460 W/kg; SAR(10 g) = 0.356 W/kg

Maximum value of SAR (measured) = 0.533 W/kg

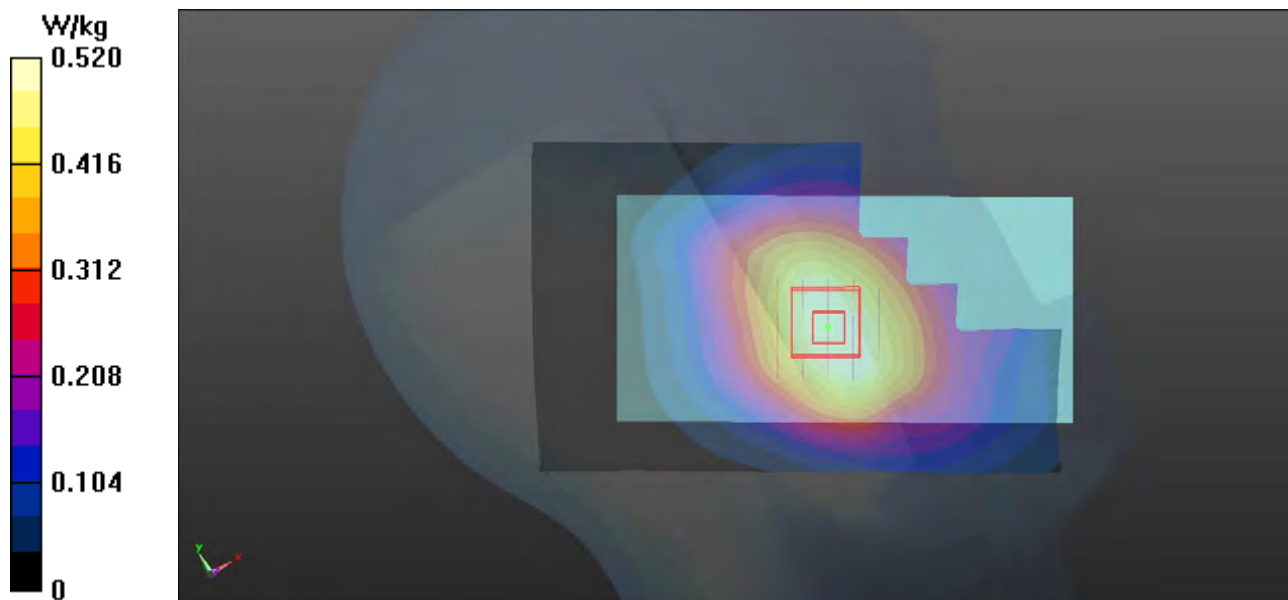

P02 GSM1900_GPRS8_Right Cheek_Ch512

DUT: 190322W004

Communication System: GPRS8; Frequency: 1850.2 MHz; Duty Cycle: 1:8.3

Medium: HSL1900_0329 Medium parameters used: $f = 1850.2$ MHz; $\sigma = 1.385$ S/m; $\epsilon_r = 39.971$; $\rho = 1000$ kg/m³

Ambient Temperature : 22.8°C; Liquid Temperature : 21.8°C

DASY5 Configuration:

- Probe: EX3DV4 - SN3873; ConvF(8.12, 8.12, 8.12); Calibrated: 2018/08/31;
- Sensor-Surface: 1.4mm (Mechanical Surface Detection)
- Electronics: DAE4 Sn1341; Calibrated: 2018/08/28
- Phantom: Front Phantom with CRP v5.0; Type: QD000P40CD; Serial: TP:1695
- Measurement SW: DASY52, Version 52.8 (8); SEMCAD X Version 14.6.10 (7331)

- **Area Scan (71x121x1):** Interpolated grid: dx=1.500 mm, dy=1.500 mm

Maximum value of SAR (interpolated) = 0.212 W/kg

- **Zoom Scan (5x5x7)/Cube 0:** Measurement grid: dx=8mm, dy=8mm, dz=5mm

Reference Value = 3.646 V/m; Power Drift = 0.04 dB

Peak SAR (extrapolated) = 0.228 W/kg

SAR(1 g) = 0.162 W/kg; SAR(10 g) = 0.108 W/kg

Maximum value of SAR (measured) = 0.204 W/kg

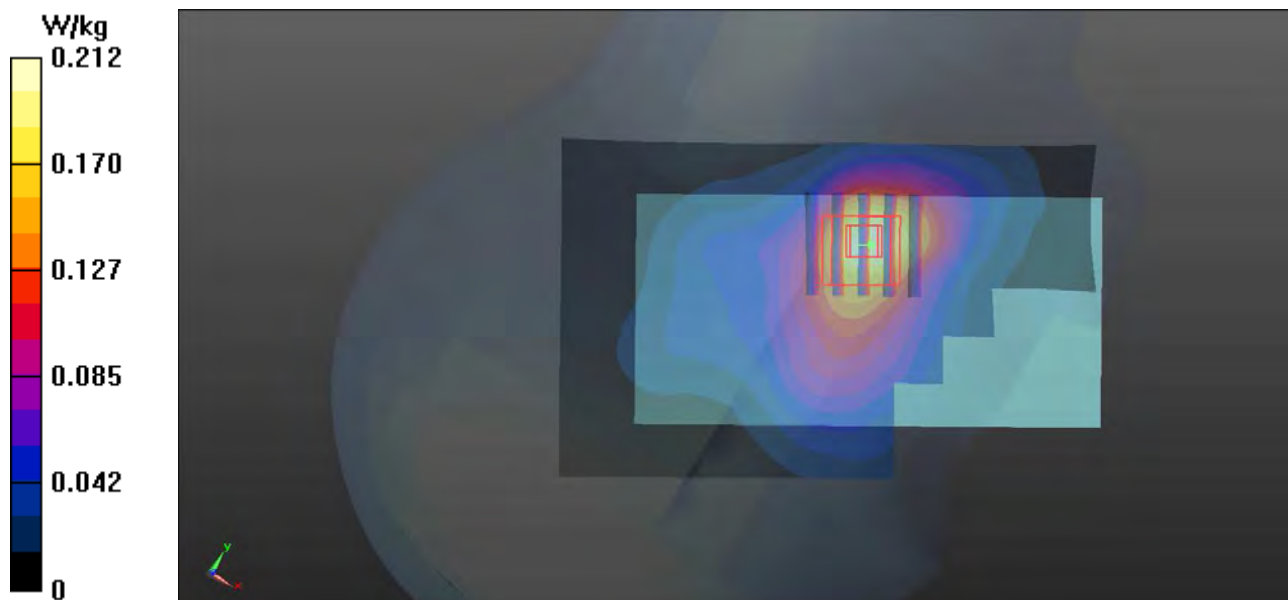

P03 WCDMA V_RMC12.2K_Right Cheek_Ch4182

DUT: 190322W004

Communication System: WCDMA; Frequency: 836.4 MHz; Duty Cycle: 1:1

Medium: HSL835_0328 Medium parameters used: $f = 836.4$ MHz; $\sigma = 0.907$ S/m; $\epsilon_r = 41.853$; $\rho = 1000$ kg/m³

Ambient Temperature : 22.9°C; Liquid Temperature : 21.9°C

DASY5 Configuration:

- Probe: EX3DV4 - SN3873; ConvF(9.69, 9.69, 9.69); Calibrated: 2018/08/31;
- Sensor-Surface: 1.4mm (Mechanical Surface Detection)
- Electronics: DAE4 Sn1341; Calibrated: 2018/08/28
- Phantom: Left Phantom with CRP v5.0; Type: QD000P40CD; Serial: TP:1722
- Measurement SW: DASY52, Version 52.8 (8); SEMCAD X Version 14.6.10 (7331)

- **Area Scan (71x121x1):** Interpolated grid: dx=1.500 mm, dy=1.500 mm

Maximum value of SAR (interpolated) = 0.184 W/kg

- **Zoom Scan (5x5x7)/Cube 0:** Measurement grid: dx=8mm, dy=8mm, dz=5mm

Reference Value = 3.603 V/m; Power Drift = -0.08 dB

Peak SAR (extrapolated) = 0.177 W/kg

SAR(1 g) = 0.145 W/kg; SAR(10 g) = 0.113 W/kg

Maximum value of SAR (measured) = 0.168 W/kg

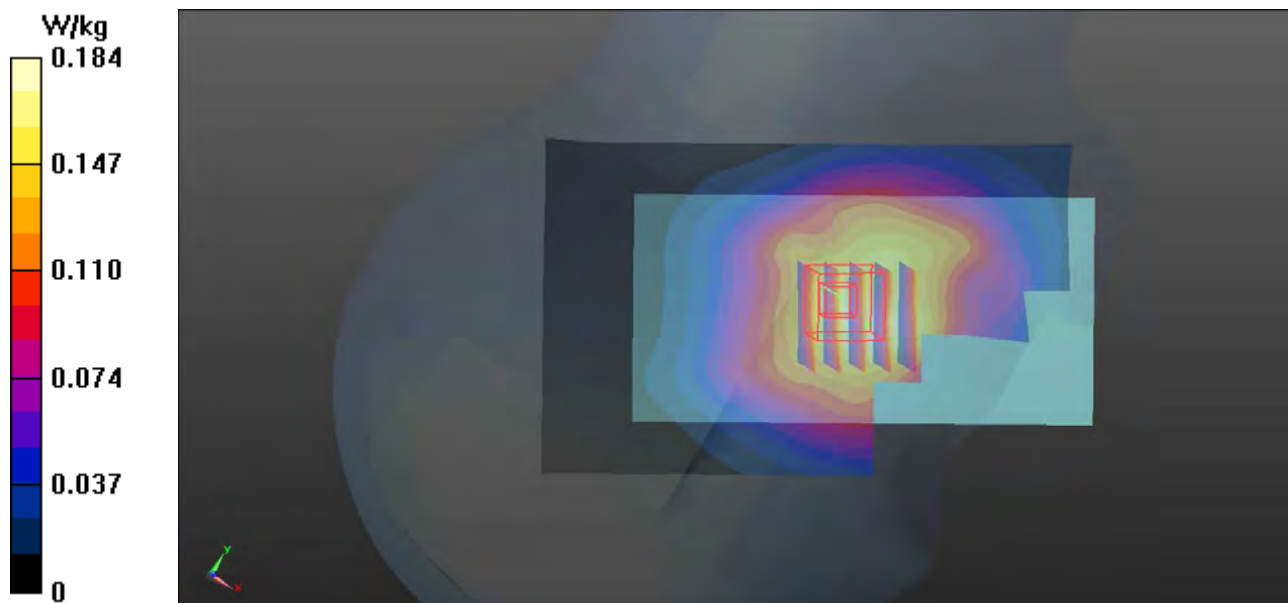

P04 LTE 5_QPSK10M_Right Cheek_Ch20600_1RB_OS24

DUT: 190322W004

Communication System: LTE; Frequency: 844 MHz; Duty Cycle: 1:1

Medium: HSL835_0328 Medium parameters used: $f = 844 \text{ MHz}$; $\sigma = 0.91 \text{ S/m}$; $\epsilon_r = 41.792$; $\rho = 1000 \text{ kg/m}^3$

Ambient Temperature : 22.9°C; Liquid Temperature : 21.9°C

DASY5 Configuration:

- Probe: EX3DV4 - SN3873; ConvF(9.69, 9.69, 9.69); Calibrated: 2018/08/31;
- Sensor-Surface: 1.4mm (Mechanical Surface Detection)
- Electronics: DAE4 Sn1341; Calibrated: 2018/08/28
- Phantom: Left Phantom with CRP v5.0; Type: QD000P40CD; Serial: TP:1722
- Measurement SW: DASY52, Version 52.8 (8); SEMCAD X Version 14.6.10 (7331)

- **Area Scan (71x121x1):** Interpolated grid: $dx=1.500 \text{ mm}$, $dy=1.500 \text{ mm}$

Maximum value of SAR (interpolated) = 0.378 W/kg

- **Zoom Scan (5x5x7)/Cube 0:** Measurement grid: $dx=8\text{mm}$, $dy=8\text{mm}$, $dz=5\text{mm}$

Reference Value = 4.951 V/m; Power Drift = 0.08 dB

Peak SAR (extrapolated) = 0.397 W/kg

SAR(1 g) = 0.329 W/kg; SAR(10 g) = 0.256 W/kg

Maximum value of SAR (measured) = 0.378 W/kg

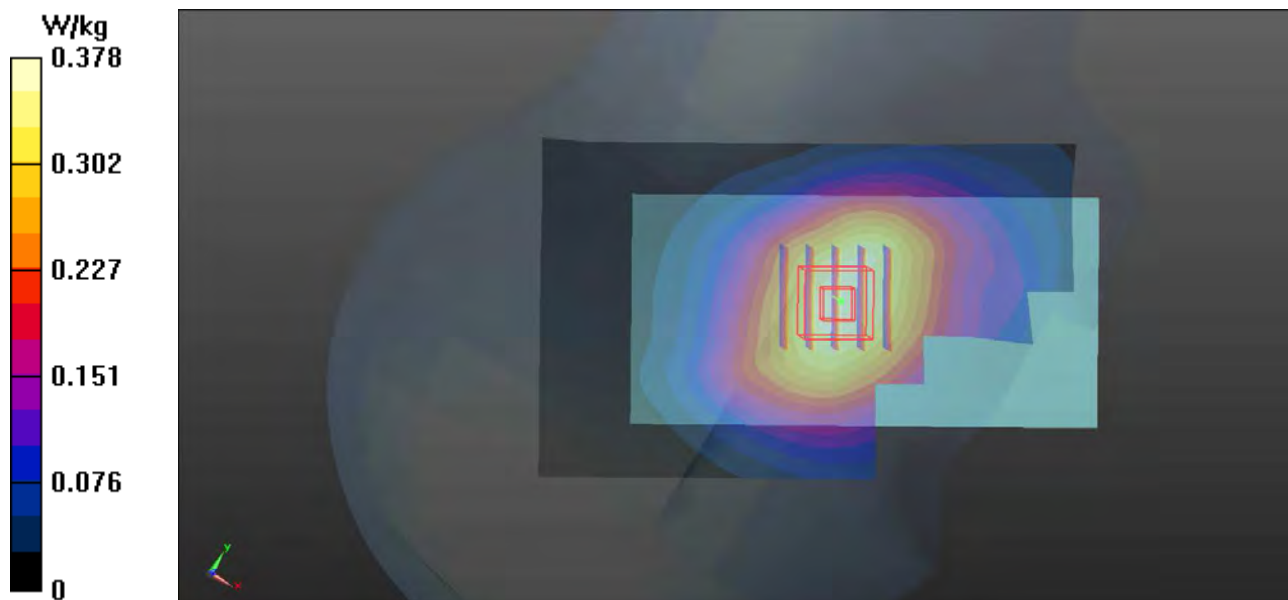

P05 LTE 7_QPSK20M_Left Cheek_Ch21350_1RB_OS50

DUT: 190322W004

Communication System: LTE; Frequency: 2560 MHz; Duty Cycle: 1:1

Medium: HSL2600_0326 Medium parameters used: $f = 2560$ MHz; $\sigma = 1.946$ S/m; $\epsilon_r = 38.458$; $\rho = 1000$ kg/m³

Ambient Temperature : 23.2°C; Liquid Temperature : 22.2°C

DASY5 Configuration:

- Probe: EX3DV4 - SN3873; ConvF(7.11, 7.11, 7.11); Calibrated: 2018/08/31;
- Sensor-Surface: 1.4mm (Mechanical Surface Detection)
- Electronics: DAE4 Sn1341; Calibrated: 2018/08/28
- Phantom: Front Phantom with CRP v5.0; Type: QD000P40CD; Serial: TP:1695
- Measurement SW: DASY52, Version 52.8 (8); SEMCAD X Version 14.6.10 (7331)

- **Area Scan (91x151x1):** Interpolated grid: dx=1.200 mm, dy=1.200 mm

Maximum value of SAR (interpolated) = 0.369 W/kg

- **Zoom Scan (7x7x7)/Cube 0:** Measurement grid: dx=5mm, dy=5mm, dz=5mm

Reference Value = 1.972 V/m; Power Drift = 0.01 dB

Peak SAR (extrapolated) = 0.421 W/kg

SAR(1 g) = 0.225 W/kg; SAR(10 g) = 0.118 W/kg

Maximum value of SAR (measured) = 0.346 W/kg

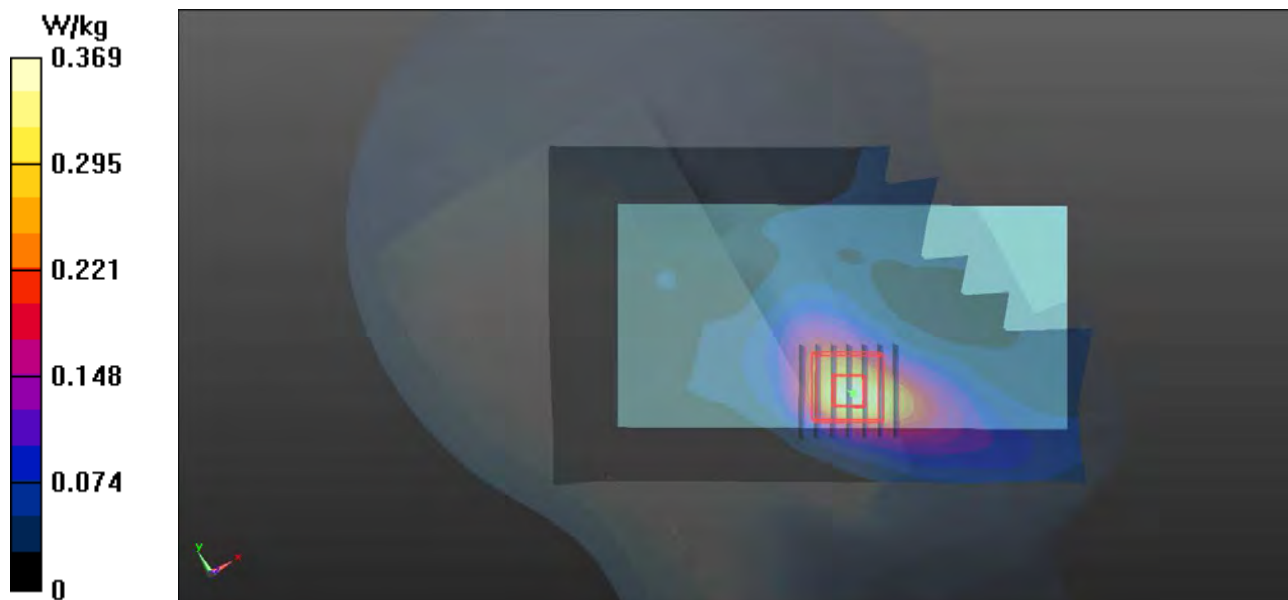

P06 LTE 28_QPSK20M_Right Cheek_Ch27310_1RB_OS50

DUT: 190322W004

Communication System: LTE; Frequency: 713 MHz; Duty Cycle: 1:1

Medium: HSL750_0328 Medium parameters used: $f = 713 \text{ MHz}$; $\sigma = 0.865 \text{ S/m}$; $\epsilon_r = 40.722$; $\rho = 1000 \text{ kg/m}^3$

Ambient Temperature : 22.9°C; Liquid Temperature : 21.9°C

DASY5 Configuration:

- Probe: EX3DV4 - SN3873; ConvF(10.15, 10.15, 10.15); Calibrated: 2018/08/31;
- Sensor-Surface: 1.4mm (Mechanical Surface Detection)
- Electronics: DAE4 Sn1341; Calibrated: 2018/08/28
- Phantom: Left Phantom with CRP v5.0; Type: QD000P40CD; Serial: TP:1722
- Measurement SW: DASY52, Version 52.8 (8); SEMCAD X Version 14.6.10 (7331)

- **Area Scan (71x121x1):** Interpolated grid: $dx=1.500 \text{ mm}$, $dy=1.500 \text{ mm}$

Maximum value of SAR (interpolated) = 0.195 W/kg

- **Zoom Scan (5x5x7)/Cube 0:** Measurement grid: $dx=8\text{mm}$, $dy=8\text{mm}$, $dz=5\text{mm}$

Reference Value = 3.664 V/m; Power Drift = 0.17 dB

Peak SAR (extrapolated) = 0.190 W/kg

SAR(1 g) = 0.161 W/kg; SAR(10 g) = 0.129 W/kg

Maximum value of SAR (measured) = 0.181 W/kg

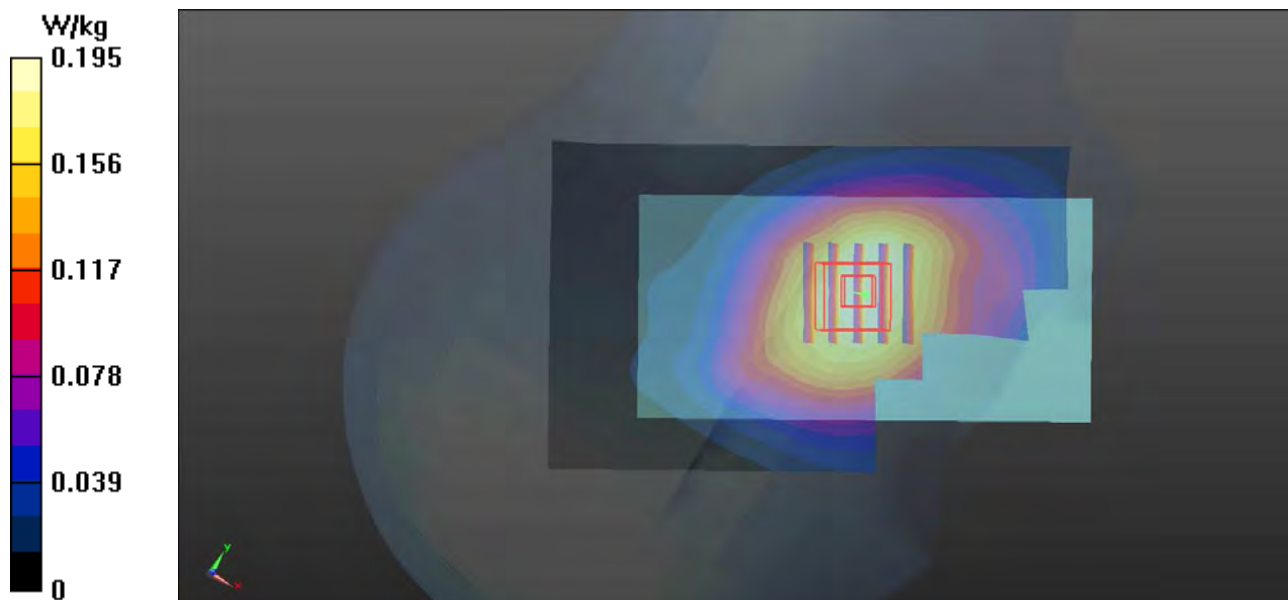

P07 LTE 38_QPSK20M_Left Cheek_Ch37850_1RB_OS50

DUT: 190322W004

Communication System: LTE; Frequency: 2580 MHz; Duty Cycle: 1:1.58

Medium: HSL2600_0326 Medium parameters used: $f = 2580$ MHz; $\sigma = 1.969$ S/m; $\epsilon_r = 38.385$; $\rho = 1000$ kg/m³

Ambient Temperature : 23.2°C; Liquid Temperature : 22.2°C

DASY5 Configuration:

- Probe: EX3DV4 - SN3873; ConvF(7.11, 7.11, 7.11); Calibrated: 2018/08/31;
- Sensor-Surface: 1.4mm (Mechanical Surface Detection)
- Electronics: DAE4 Sn1341; Calibrated: 2018/08/28
- Phantom: Front Phantom with CRP v5.0; Type: QD000P40CD; Serial: TP:1695
- Measurement SW: DASY52, Version 52.8 (8); SEMCAD X Version 14.6.10 (7331)

- **Area Scan (81x151x1):** Interpolated grid: dx=1.200 mm, dy=1.200 mm

Maximum value of SAR (interpolated) = 0.235 W/kg

- **Zoom Scan (7x7x7)/Cube 0:** Measurement grid: dx=5mm, dy=5mm, dz=5mm

Reference Value = 1.139 V/m; Power Drift = 0.09 dB

Peak SAR (extrapolated) = 0.288 W/kg

SAR(1 g) = 0.149 W/kg; SAR(10 g) = 0.077 W/kg

Maximum value of SAR (measured) = 0.229 W/kg

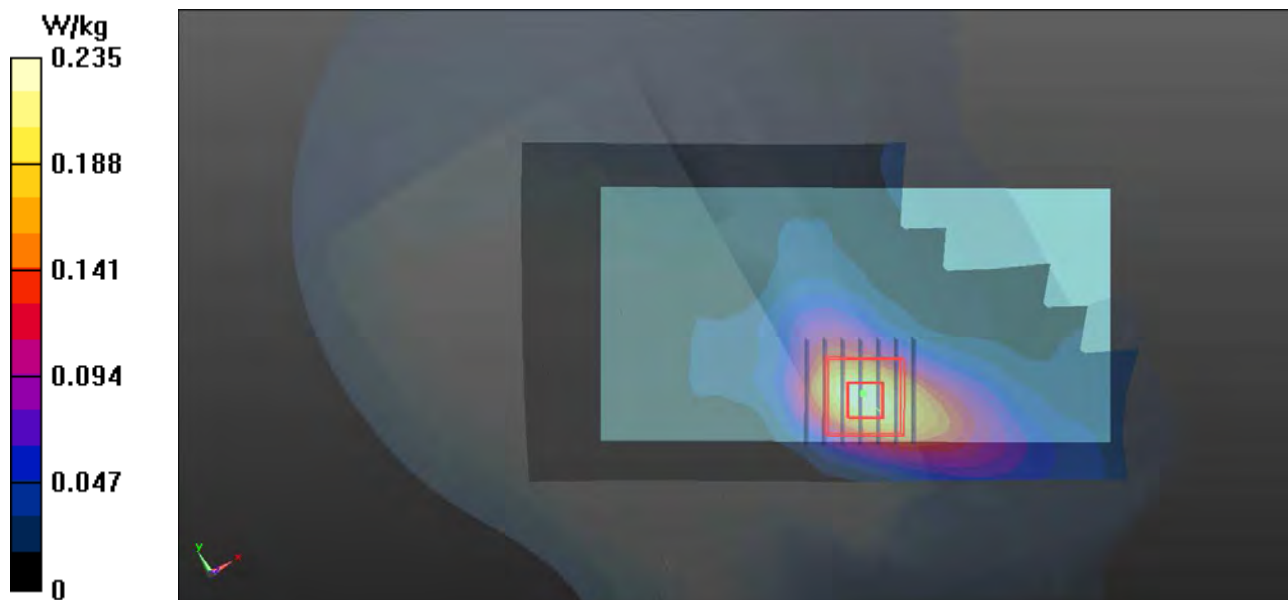

P08 802.11b_Right Cheek_Ch11

DUT: 190322W004

Communication System: 802.11b; Frequency: 2462 MHz; Duty Cycle: 1:1

Medium: HSL2450_0327 Medium parameters used: $f = 2462 \text{ MHz}$; $\sigma = 1.802 \text{ S/m}$; $\epsilon_r = 40.157$; $\rho = 1000 \text{ kg/m}^3$

Ambient Temperature : 23.1°C; Liquid Temperature : 22.1°C

DASY5 Configuration:

- Probe: EX3DV4 - SN3873; ConvF(7.19, 7.19, 7.19); Calibrated: 2018/08/31;
- Sensor-Surface: 1.4mm (Mechanical Surface Detection)
- Electronics: DAE4 Sn1341; Calibrated: 2018/08/28
- Phantom: Front Phantom with CRP v5.0; Type: QD000P40CD; Serial: TP:1695
- Measurement SW: DASY52, Version 52.8 (8); SEMCAD X Version 14.6.10 (7331)

- **Area Scan (81x151x1):** Interpolated grid: $dx=1.200 \text{ mm}$, $dy=1.200 \text{ mm}$

Maximum value of SAR (interpolated) = 1.18 W/kg

- **Zoom Scan (7x7x7)/Cube 0:** Measurement grid: $dx=5\text{mm}$, $dy=5\text{mm}$, $dz=5\text{mm}$

Reference Value = 8.899 V/m; Power Drift = 0.04 dB

Peak SAR (extrapolated) = 1.39 W/kg

SAR(1 g) = 0.649 W/kg; SAR(10 g) = 0.296 W/kg

Maximum value of SAR (measured) = 1.08 W/kg

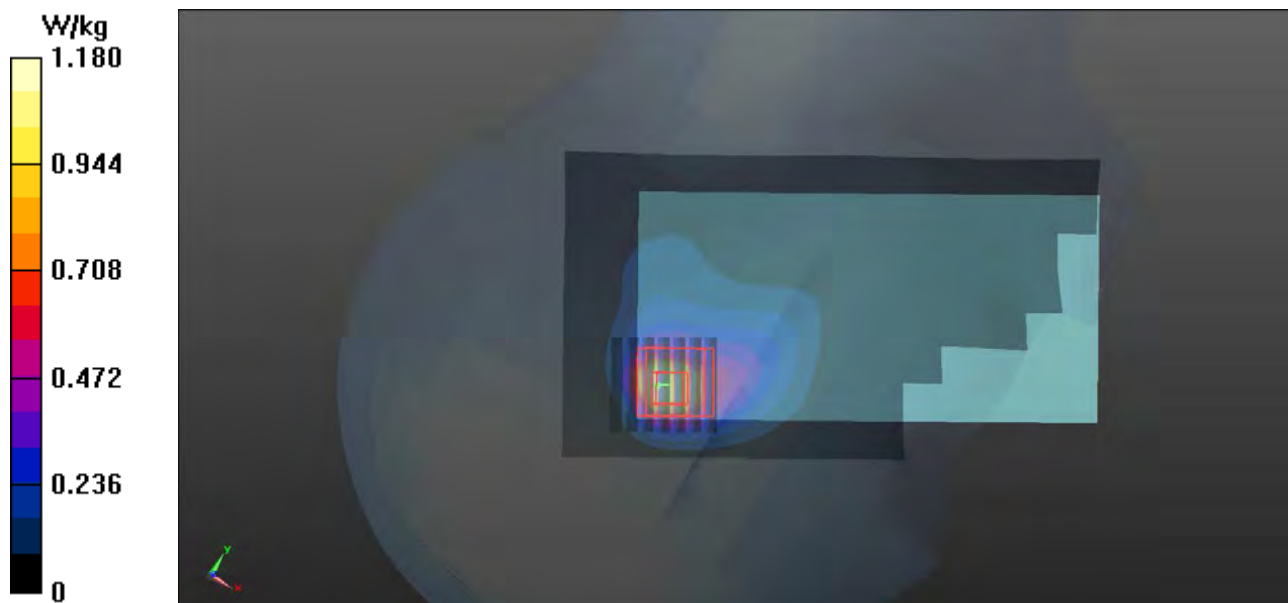

P09 GSM850_GPRS12_Rear Face_1.5cm_Ch189

DUT: 190322W004

Communication System: GPRS12; Frequency: 836.4 MHz; Duty Cycle: 1:2

Medium: MSL835_0328 Medium parameters used: $f = 836.4$ MHz; $\sigma = 0.993$ S/m; $\epsilon_r = 55.599$; $\rho = 1000$ kg/m³

Ambient Temperature : 22.9°C; Liquid Temperature : 21.9°C

DASY5 Configuration:

- Probe: EX3DV4 - SN3873; ConvF(9.49, 9.49, 9.49); Calibrated: 2018/08/31;
- Sensor-Surface: 1.4mm (Mechanical Surface Detection)
- Electronics: DAE4 Sn1341; Calibrated: 2018/08/28
- Phantom: Left Phantom with CRP v5.0; Type: QD000P40CD; Serial: TP:1722
- Measurement SW: DASY52, Version 52.8 (8); SEMCAD X Version 14.6.10 (7331)

- **Area Scan (71x121x1):** Interpolated grid: dx=1.500 mm, dy=1.500 mm

Maximum value of SAR (interpolated) = 0.528 W/kg

- **Zoom Scan (5x5x7)/Cube 0:** Measurement grid: dx=8mm, dy=8mm, dz=5mm

Reference Value = 21.62 V/m; Power Drift = -0.05 dB

Peak SAR (extrapolated) = 0.568 W/kg

SAR(1 g) = 0.446 W/kg; SAR(10 g) = 0.343 W/kg

Maximum value of SAR (measured) = 0.529 W/kg

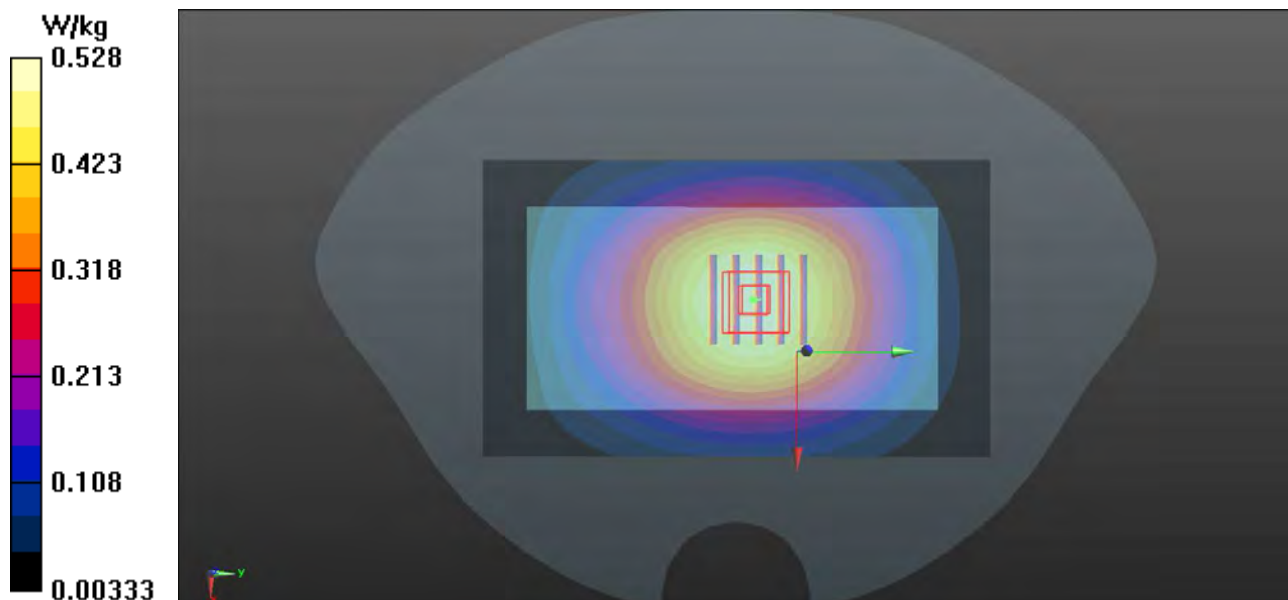

P10 GSM1900_GPRS8_Rear Face_1.5cm_Ch512

DUT: 190322W004

Communication System: GPRS8; Frequency: 1850.2 MHz; Duty Cycle: 1:8.3

Medium: MSL1900_0328 Medium parameters used: $f = 1850.2$ MHz; $\sigma = 1.478$ S/m; $\epsilon_r = 53.038$; $\rho = 1000$ kg/m³

Ambient Temperature : 22.8°C; Liquid Temperature : 21.8°C

DASY5 Configuration:

- Probe: EX3DV4 - SN3873; ConvF(7.61, 7.61, 7.61); Calibrated: 2018/08/31;
- Sensor-Surface: 1.4mm (Mechanical Surface Detection)
- Electronics: DAE4 Sn1341; Calibrated: 2018/08/28
- Phantom: Front Phantom with CRP v5.0; Type: QD000P40CD; Serial: TP:1695
- Measurement SW: DASY52, Version 52.8 (8); SEMCAD X Version 14.6.10 (7331)

- **Area Scan (71x121x1):** Interpolated grid: dx=1.500 mm, dy=1.500 mm

Maximum value of SAR (interpolated) = 0.205 W/kg

- **Zoom Scan (5x5x7)/Cube 0:** Measurement grid: dx=8mm, dy=8mm, dz=5mm

Reference Value = 7.390 V/m; Power Drift = -0.07 dB

Peak SAR (extrapolated) = 0.243 W/kg

SAR(1 g) = 0.138 W/kg; SAR(10 g) = 0.072 W/kg

Maximum value of SAR (measured) = 0.205 W/kg

- **Zoom Scan (5x5x7)/Cube 1:** Measurement grid: dx=8mm, dy=8mm, dz=5mm

Reference Value = 7.390 V/m; Power Drift = -0.07 dB

Peak SAR (extrapolated) = 0.165 W/kg

SAR(1 g) = 0.108 W/kg; SAR(10 g) = 0.071 W/kg

Maximum value of SAR (measured) = 0.144 W/kg

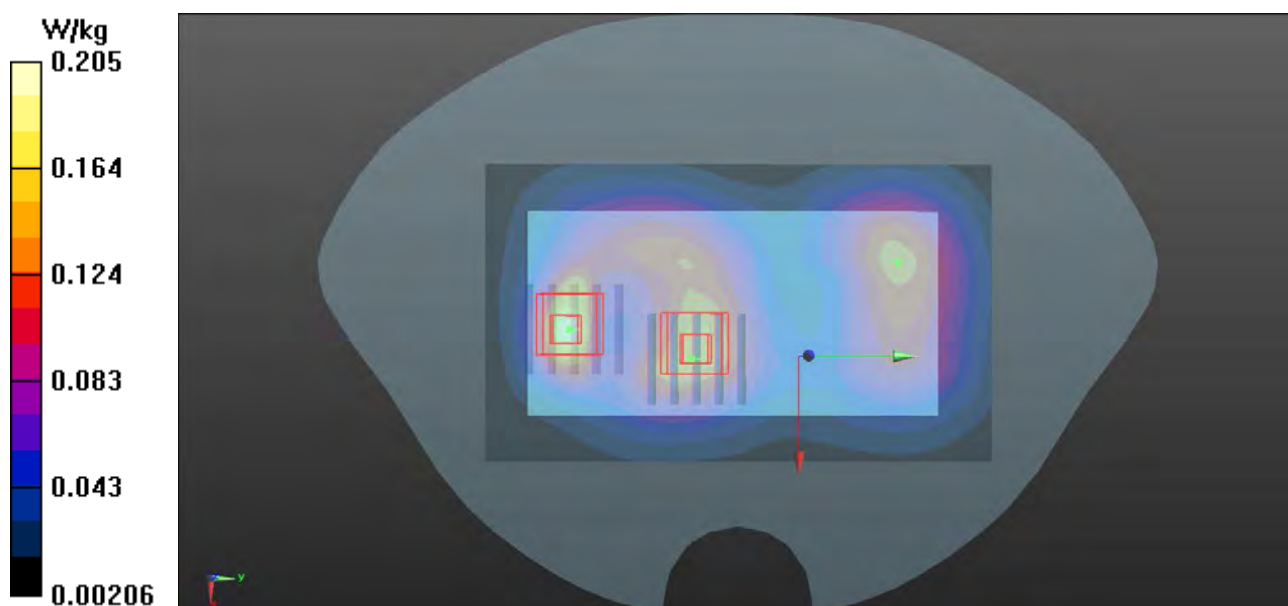

P11 WCDMA V_RMC12.2K_Rear Face_1.5cm_Ch4182

DUT: 190322W004

Communication System: WCDMA; Frequency: 836.4 MHz; Duty Cycle: 1:1

Medium: MSL835_0328 Medium parameters used: $f = 836.4$ MHz; $\sigma = 0.993$ S/m; $\epsilon_r = 55.599$; $\rho = 1000$ kg/m³

Ambient Temperature : 22.9°C; Liquid Temperature : 21.9°C

DASY5 Configuration:

- Probe: EX3DV4 - SN3873; ConvF(9.49, 9.49, 9.49); Calibrated: 2018/08/31;
- Sensor-Surface: 1.4mm (Mechanical Surface Detection)
- Electronics: DAE4 Sn1341; Calibrated: 2018/08/28
- Phantom: Left Phantom with CRP v5.0; Type: QD000P40CD; Serial: TP:1722
- Measurement SW: DASY52, Version 52.8 (8); SEMCAD X Version 14.6.10 (7331)

- **Area Scan (71x121x1):** Interpolated grid: dx=1.500 mm, dy=1.500 mm

Maximum value of SAR (interpolated) = 0.241 W/kg

- **Zoom Scan (5x5x7)/Cube 0:** Measurement grid: dx=8mm, dy=8mm, dz=5mm

Reference Value = 12.76 V/m; Power Drift = 0.01 dB

Peak SAR (extrapolated) = 0.203 W/kg

SAR(1 g) = 0.158 W/kg; SAR(10 g) = 0.120 W/kg

Maximum value of SAR (measured) = 0.188 W/kg

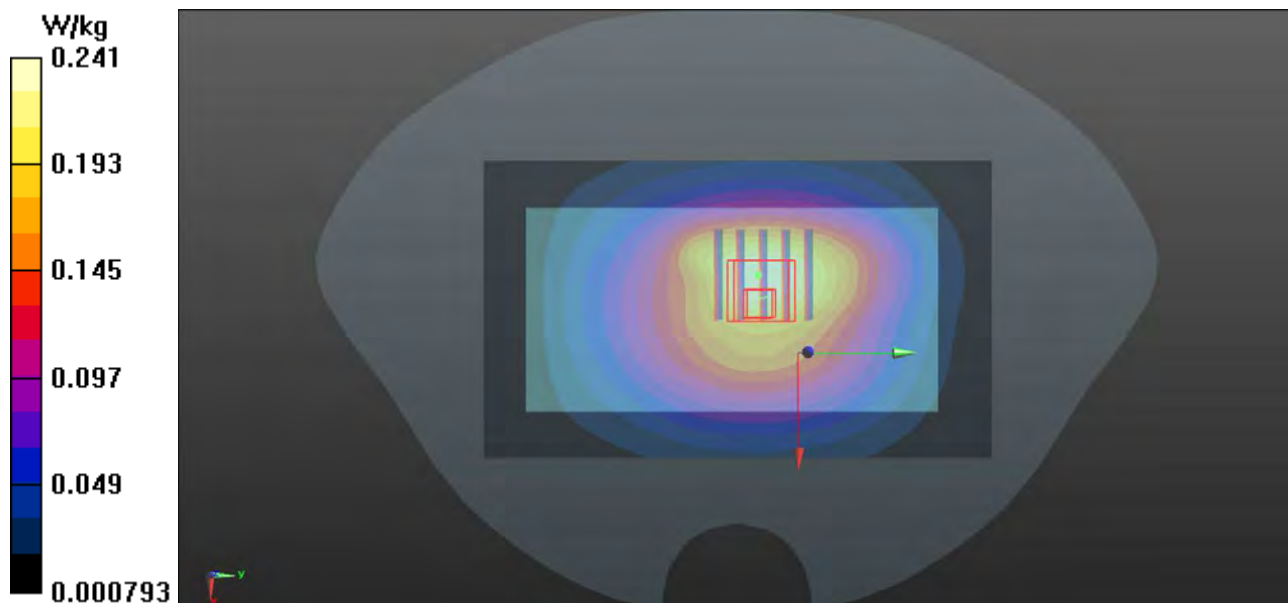

P12 LTE 5_QPSK10M_Rear Face_1.5cm_Ch20600_1RB_OS24

DUT: 190322W004

Communication System: LTE; Frequency: 844 MHz; Duty Cycle: 1:1

Medium: MSL835_0328 Medium parameters used: $f = 844 \text{ MHz}$; $\sigma = 1.001 \text{ S/m}$; $\epsilon_r = 55.521$; $\rho = 1000 \text{ kg/m}^3$

Ambient Temperature : 22.9°C; Liquid Temperature : 21.9°C

DASY5 Configuration:

- Probe: EX3DV4 - SN3873; ConvF(9.49, 9.49, 9.49); Calibrated: 2018/08/31;
- Sensor-Surface: 1.4mm (Mechanical Surface Detection)
- Electronics: DAE4 Sn1341; Calibrated: 2018/08/28
- Phantom: Left Phantom with CRP v5.0; Type: QD000P40CD; Serial: TP:1722
- Measurement SW: DASY52, Version 52.8 (8); SEMCAD X Version 14.6.10 (7331)

- **Area Scan (71x121x1):** Interpolated grid: $dx=1.500 \text{ mm}$, $dy=1.500 \text{ mm}$

Maximum value of SAR (interpolated) = 0.576 W/kg

- **Zoom Scan (5x5x7)/Cube 0:** Measurement grid: $dx=8\text{mm}$, $dy=8\text{mm}$, $dz=5\text{mm}$

Reference Value = 20.90 V/m; Power Drift = 0.02 dB

Peak SAR (extrapolated) = 0.622 W/kg

SAR(1 g) = 0.485 W/kg; SAR(10 g) = 0.372 W/kg

Maximum value of SAR (measured) = 0.578 W/kg

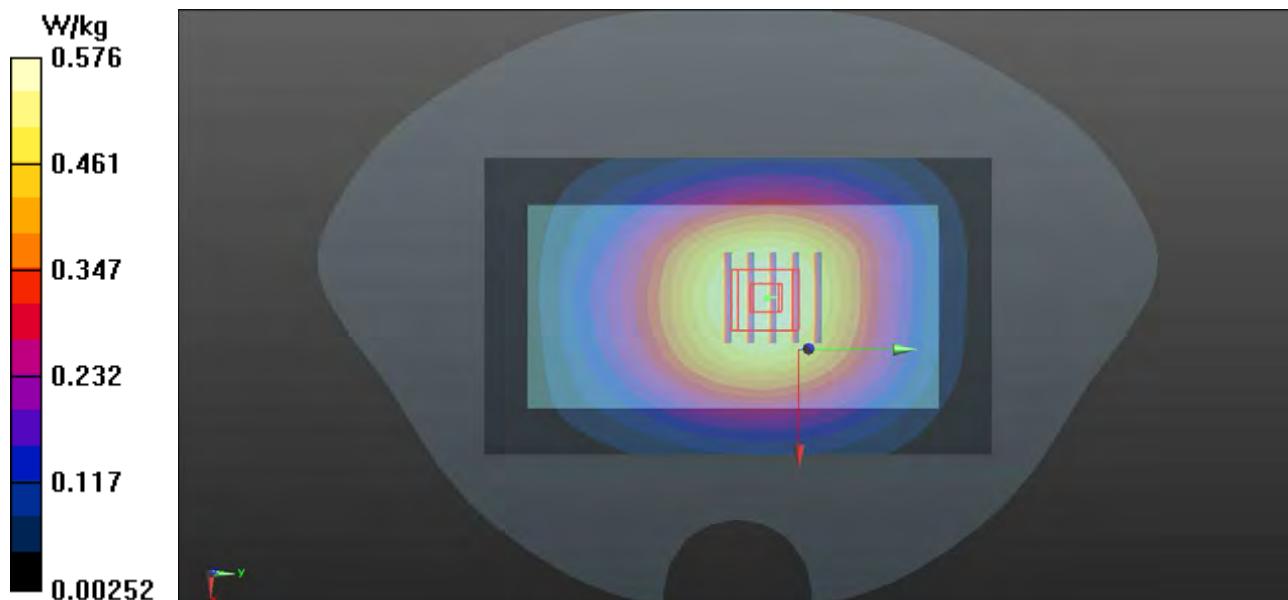

P13 LTE 7_QPSK20M_Rear Face_1.5cm_Ch21350_1RB_OS50

DUT: 180928W015

Communication System: LTE; Frequency: 2560 MHz; Duty Cycle: 1:1

Medium: MSL2600_0326 Medium parameters used: $f = 2560$ MHz; $\sigma = 2.046$ S/m; $\epsilon_r = 50.875$; $\rho = 1000$ kg/m³

Ambient Temperature : 23.2°C; Liquid Temperature : 22.2°C

DASY5 Configuration:

- Probe: EX3DV4 - SN3873; ConvF(7.28, 7.28, 7.28); Calibrated: 2018/08/31;
- Sensor-Surface: 1.4mm (Mechanical Surface Detection)
- Electronics: DAE4 Sn1341; Calibrated: 2018/08/28
- Phantom: Front Phantom with CRP v5.0; Type: QD000P40CD; Serial: TP:1695
- Measurement SW: DASY52, Version 52.8 (8); SEMCAD X Version 14.6.10 (7331)

- **Area Scan (91x151x1):** Interpolated grid: dx=1.200 mm, dy=1.200 mm

Maximum value of SAR (interpolated) = 0.578 W/kg

- **Zoom Scan (7x7x7)/Cube 0:** Measurement grid: dx=5mm, dy=5mm, dz=5mm

Reference Value = 3.504 V/m; Power Drift = -0.08 dB

Peak SAR (extrapolated) = 0.724 W/kg

SAR(1 g) = 0.372 W/kg; SAR(10 g) = 0.185 W/kg

Maximum value of SAR (measured) = 0.592 W/kg

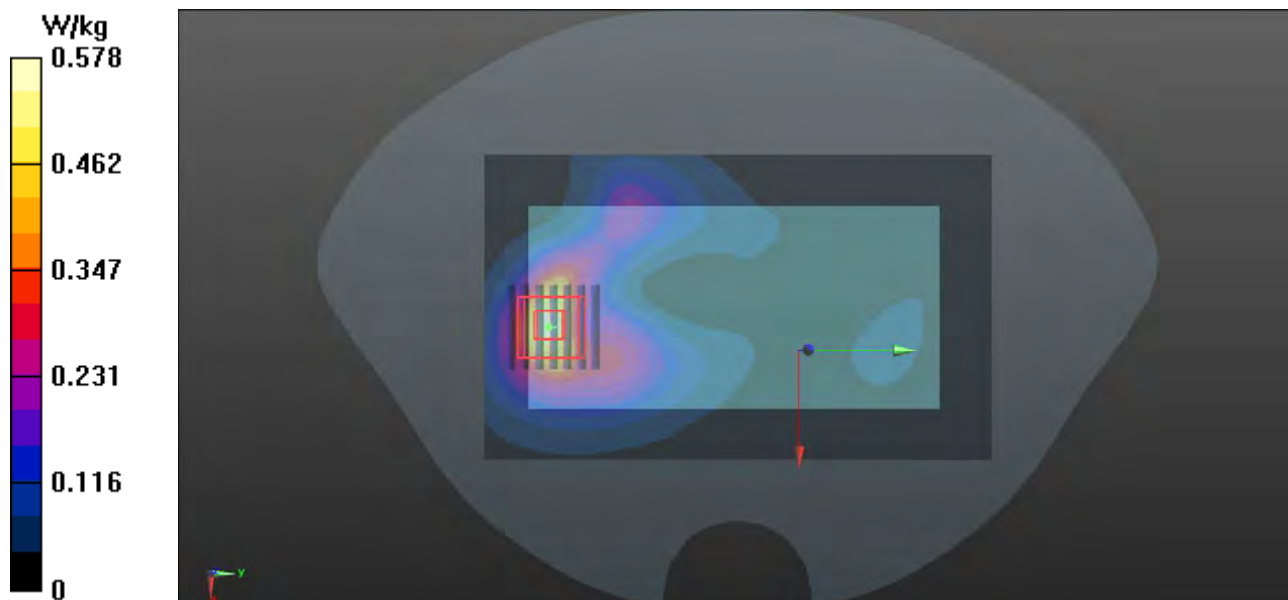

P14 LTE 28_QPSK20M_Rear Face_1.5cm_Ch27310_1RB_OS50

DUT: 190322W004

Communication System: LTE; Frequency: 713 MHz; Duty Cycle: 1:1

Medium: MSL750_0328 Medium parameters used: $f = 713 \text{ MHz}$; $\sigma = 0.935 \text{ S/m}$; $\epsilon_r = 55.565$; $\rho = 1000 \text{ kg/m}^3$

Ambient Temperature : 22.9°C; Liquid Temperature : 21.9°C

DASY5 Configuration:

- Probe: EX3DV4 - SN3873; ConvF(9.67, 9.67, 9.67); Calibrated: 2018/08/31;
- Sensor-Surface: 1.4mm (Mechanical Surface Detection)
- Electronics: DAE4 Sn1341; Calibrated: 2018/08/28
- Phantom: Left Phantom with CRP v5.0; Type: QD000P40CD; Serial: TP:1722
- Measurement SW: DASY52, Version 52.8 (8); SEMCAD X Version 14.6.10 (7331)

- **Area Scan (71x121x1):** Interpolated grid: $dx=1.500 \text{ mm}$, $dy=1.500 \text{ mm}$

Maximum value of SAR (interpolated) = 0.327 W/kg

- **Zoom Scan (5x5x7)/Cube 0:** Measurement grid: $dx=8\text{mm}$, $dy=8\text{mm}$, $dz=5\text{mm}$

Reference Value = 17.36 V/m; Power Drift = 0.00 dB

Peak SAR (extrapolated) = 0.351 W/kg

SAR(1 g) = 0.278 W/kg; SAR(10 g) = 0.217 W/kg

Maximum value of SAR (measured) = 0.328 W/kg

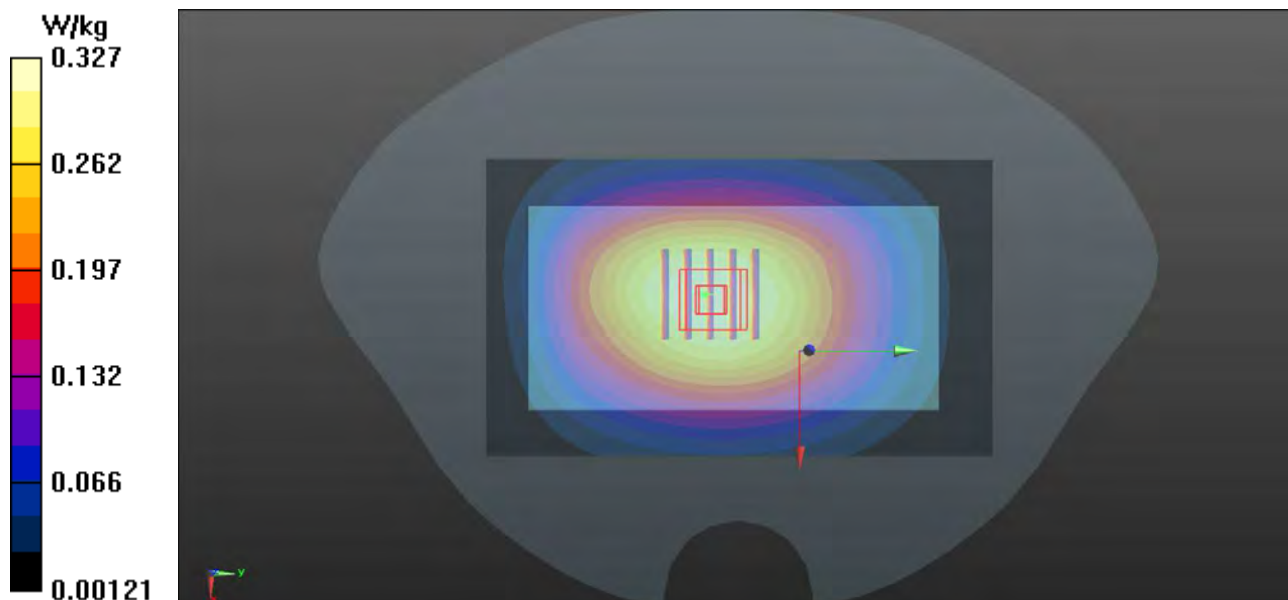

P15 LTE 38_QPSK20M_Rear Face_1.5cm_Ch37850_1RB_OS50

DUT: 180928W015

Communication System: LTE; Frequency: 2580 MHz; Duty Cycle: 1:1.58

Medium: MSL2600_0326 Medium parameters used: $f = 2580$ MHz; $\sigma = 2.07$ S/m; $\epsilon_r = 50.804$; $\rho = 1000$ kg/m³

Ambient Temperature : 23.2°C; Liquid Temperature : 22.2°C

DASY5 Configuration:

- Probe: EX3DV4 - SN3873; ConvF(7.28, 7.28, 7.28); Calibrated: 2018/08/31;
- Sensor-Surface: 1.4mm (Mechanical Surface Detection)
- Electronics: DAE4 Sn1341; Calibrated: 2018/08/28
- Phantom: Front Phantom with CRP v5.0; Type: QD000P40CD; Serial: TP:1695
- Measurement SW: DASY52, Version 52.8 (8); SEMCAD X Version 14.6.10 (7331)

- **Area Scan (91x151x1):** Interpolated grid: dx=1.200 mm, dy=1.200 mm

Maximum value of SAR (interpolated) = 0.344 W/kg

- **Zoom Scan (7x7x7)/Cube 0:** Measurement grid: dx=5mm, dy=5mm, dz=5mm

Reference Value = 2.524 V/m; Power Drift = -0.12 dB

Peak SAR (extrapolated) = 0.424 W/kg

SAR(1 g) = 0.218 W/kg; SAR(10 g) = 0.108 W/kg

Maximum value of SAR (measured) = 0.340 W/kg

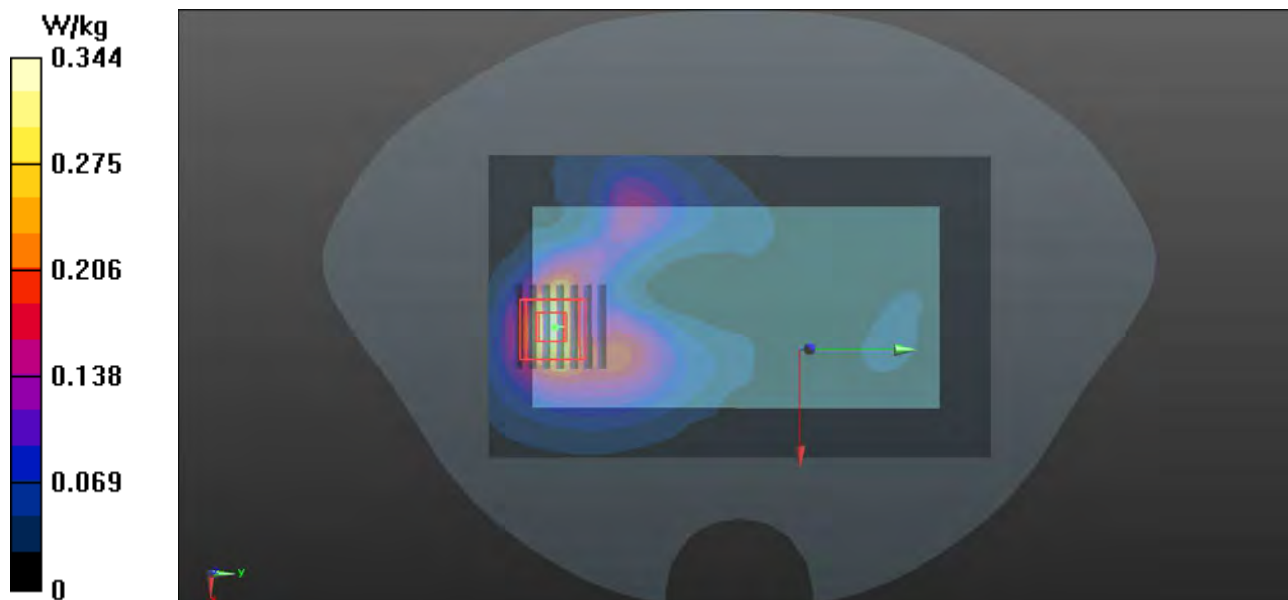

P16 802.11b_Front Face_1.5cm_Ch6

DUT: 190322W004

Communication System: 802.11b; Frequency: 2437 MHz; Duty Cycle: 1:1

Medium: MSL2450_0327 Medium parameters used: $f = 2437$ MHz; $\sigma = 1.884$ S/m; $\epsilon_r = 51.482$; $\rho = 1000$ kg/m³

Ambient Temperature : 23.1°C; Liquid Temperature : 22.1°C

DASY5 Configuration:

- Probe: EX3DV4 - SN3873; ConvF(7.39, 7.39, 7.39); Calibrated: 2018/08/31;
- Sensor-Surface: 1.4mm (Mechanical Surface Detection)
- Electronics: DAE4 Sn1341; Calibrated: 2018/08/28
- Phantom: Front Phantom with CRP v5.0; Type: QD000P40CD; Serial: TP:1695
- Measurement SW: DASY52, Version 52.8 (8); SEMCAD X Version 14.6.10 (7331)

- **Area Scan (91x151x1):** Interpolated grid: dx=1.200 mm, dy=1.200 mm

Maximum value of SAR (interpolated) = 0.0683 W/kg

- **Zoom Scan (7x7x7)/Cube 0:** Measurement grid: dx=5mm, dy=5mm, dz=5mm

Reference Value = 4.393 V/m; Power Drift = -0.19 dB

Peak SAR (extrapolated) = 0.0820 W/kg

SAR(1 g) = 0.044 W/kg; SAR(10 g) = 0.025 W/kg

Maximum value of SAR (measured) = 0.0665 W/kg

- **Zoom Scan (7x7x7)/Cube 1:** Measurement grid: dx=5mm, dy=5mm, dz=5mm

Reference Value = 4.393 V/m; Power Drift = -0.19 dB

Peak SAR (extrapolated) = 0.0640 W/kg

SAR(1 g) = 0.035 W/kg; SAR(10 g) = 0.020 W/kg

Maximum value of SAR (measured) = 0.0529 W/kg

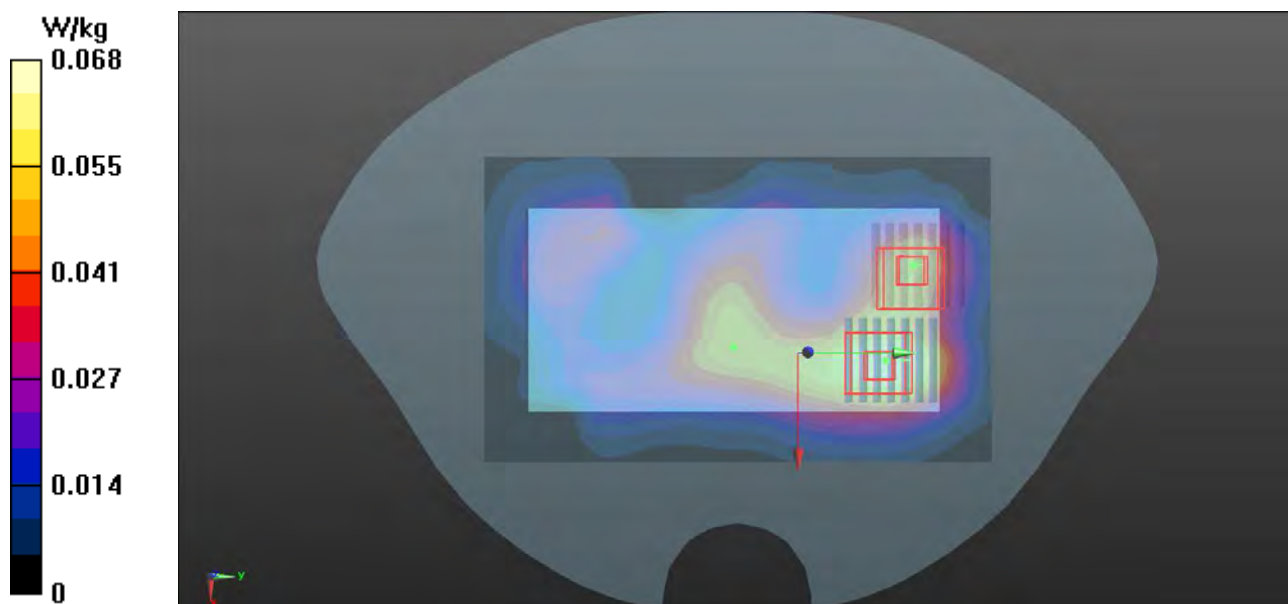

P17 GSM850_GPRS12_Rear Face_1cm_Ch189

DUT: 190322W004

Communication System: GPRS12; Frequency: 836.4 MHz; Duty Cycle: 1:2

Medium: MSL835_0328 Medium parameters used: $f = 836.4$ MHz; $\sigma = 0.993$ S/m; $\epsilon_r = 55.599$; $\rho = 1000$ kg/m³

Ambient Temperature : 22.9°C; Liquid Temperature : 21.9°C

DASY5 Configuration:

- Probe: EX3DV4 - SN3873; ConvF(9.49, 9.49, 9.49); Calibrated: 2018/08/31;
- Sensor-Surface: 1.4mm (Mechanical Surface Detection)
- Electronics: DAE4 Sn1341; Calibrated: 2018/08/28
- Phantom: Left Phantom with CRP v5.0; Type: QD000P40CD; Serial: TP:1722
- Measurement SW: DASY52, Version 52.8 (8); SEMCAD X Version 14.6.10 (7331)

- **Area Scan (71x121x1):** Interpolated grid: dx=1.500 mm, dy=1.500 mm
Maximum value of SAR (interpolated) = 0.621 W/kg

- **Zoom Scan (5x5x7)/Cube 0:** Measurement grid: dx=8mm, dy=8mm, dz=5mm
Reference Value = 23.09 V/m; Power Drift = 0.03 dB
Peak SAR (extrapolated) = 0.656 W/kg
SAR(1 g) = 0.519 W/kg; SAR(10 g) = 0.402 W/kg
Maximum value of SAR (measured) = 0.612 W/kg

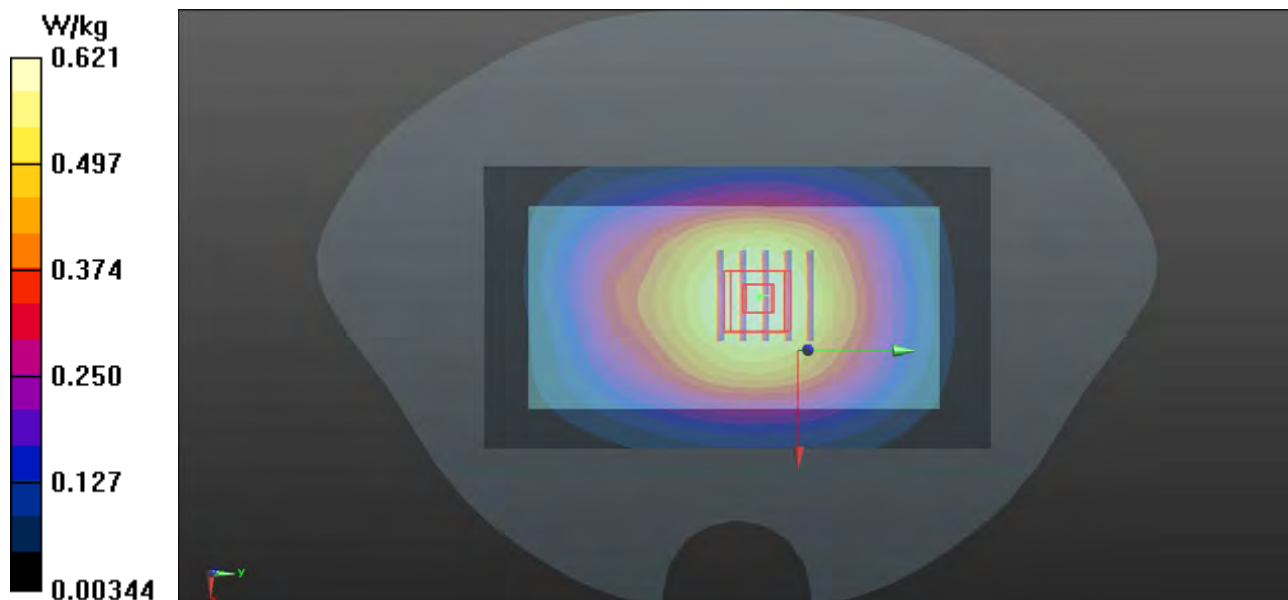

P18 GSM1900_GPRS8_Rear Face_1cm_Ch512

DUT: 190322W004

Communication System: GPRS8; Frequency: 1850.2 MHz; Duty Cycle: 1:8.3

Medium: MSL1900_0329 Medium parameters used: $f = 1850.2$ MHz; $\sigma = 1.478$ S/m; $\epsilon_r = 53.038$; $\rho = 1000$ kg/m³

Ambient Temperature : 22.8°C; Liquid Temperature : 21.8°C

DASY5 Configuration:

- Probe: EX3DV4 - SN3873; ConvF(7.61, 7.61, 7.61); Calibrated: 2018/08/31;
- Sensor-Surface: 1.4mm (Mechanical Surface Detection)
- Electronics: DAE4 Sn1341; Calibrated: 2018/08/28
- Phantom: Front Phantom with CRP v5.0; Type: QD000P40CD; Serial: TP:1695
- Measurement SW: DASY52, Version 52.8 (8); SEMCAD X Version 14.6.10 (7331)

- **Area Scan (71x121x1):** Interpolated grid: dx=1.500 mm, dy=1.500 mm

Maximum value of SAR (interpolated) = 0.476 W/kg

- **Zoom Scan (5x5x7)/Cube 0:** Measurement grid: dx=8mm, dy=8mm, dz=5mm

Reference Value = 5.066 V/m; Power Drift = 0.03 dB

Peak SAR (extrapolated) = 0.587 W/kg

SAR(1 g) = 0.316 W/kg; SAR(10 g) = 0.153 W/kg

Maximum value of SAR (measured) = 0.477 W/kg

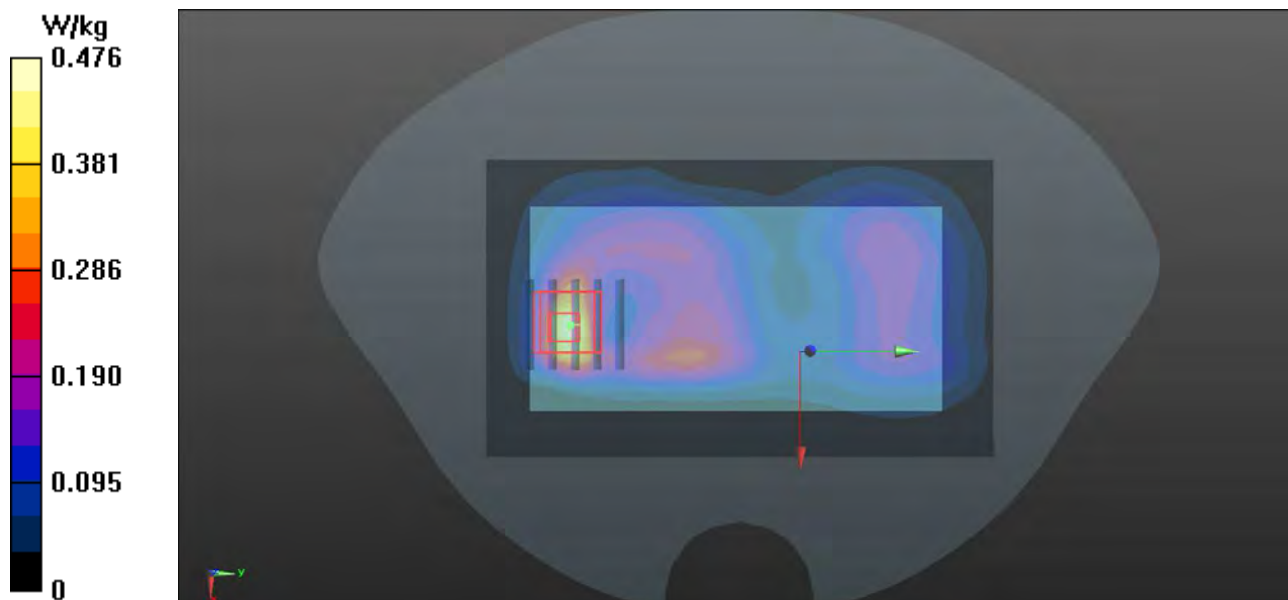

P19 WCDMA V_RMC12.2K_Rear Face_1cm_Ch4182

DUT: 190322W004

Communication System: WCDMA; Frequency: 836.4 MHz; Duty Cycle: 1:1

Medium: MSL835_0328 Medium parameters used: $f = 836.4$ MHz; $\sigma = 0.993$ S/m; $\epsilon_r = 55.599$; $\rho = 1000$ kg/m³

Ambient Temperature : 22.9°C; Liquid Temperature : 21.9°C

DASY5 Configuration:

- Probe: EX3DV4 - SN3873; ConvF(9.49, 9.49, 9.49); Calibrated: 2018/08/31;
- Sensor-Surface: 1.4mm (Mechanical Surface Detection)
- Electronics: DAE4 Sn1341; Calibrated: 2018/08/28
- Phantom: Left Phantom with CRP v5.0; Type: QD000P40CD; Serial: TP:1722
- Measurement SW: DASY52, Version 52.8 (8); SEMCAD X Version 14.6.10 (7331)

- **Area Scan (71x121x1):** Interpolated grid: dx=1.500 mm, dy=1.500 mm

Maximum value of SAR (interpolated) = 0.540 W/kg

- **Zoom Scan (5x5x7)/Cube 0:** Measurement grid: dx=8mm, dy=8mm, dz=5mm

Reference Value = 22.26 V/m; Power Drift = -0.02 dB

Peak SAR (extrapolated) = 0.479 W/kg

SAR(1 g) = 0.379 W/kg; SAR(10 g) = 0.290 W/kg

Maximum value of SAR (measured) = 0.443 W/kg

- **Zoom Scan (5x5x7)/Cube 1:** Measurement grid: dx=8mm, dy=8mm, dz=5mm

Reference Value = 22.26 V/m; Power Drift = -0.02 dB

Peak SAR (extrapolated) = 0.482 W/kg

SAR(1 g) = 0.375 W/kg; SAR(10 g) = 0.271 W/kg

Maximum value of SAR (measured) = 0.445 W/kg

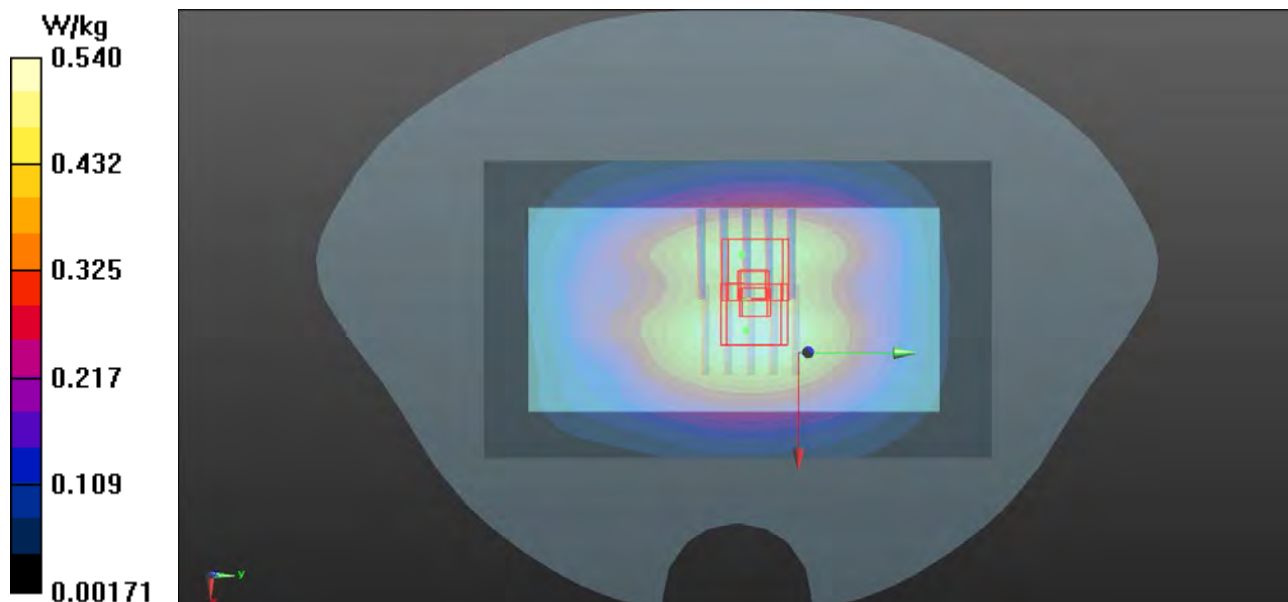

P20 LTE 5_QPSK10M_Rear Face_1cm_Ch20600_1RB_OS24

DUT: 190322W004

Communication System: LTE; Frequency: 844 MHz; Duty Cycle: 1:1

Medium: MSL835_0328 Medium parameters used: $f = 844 \text{ MHz}$; $\sigma = 1.001 \text{ S/m}$; $\epsilon_r = 55.521$; $\rho = 1000 \text{ kg/m}^3$

Ambient Temperature : 22.9°C ; Liquid Temperature : 21.9°C

DASY5 Configuration:

- Probe: EX3DV4 - SN3873; ConvF(9.49, 9.49, 9.49); Calibrated: 2018/08/31;
- Sensor-Surface: 1.4mm (Mechanical Surface Detection)
- Electronics: DAE4 Sn1341; Calibrated: 2018/08/28
- Phantom: Left Phantom with CRP v5.0; Type: QD000P40CD; Serial: TP:1722
- Measurement SW: DASY52, Version 52.8 (8); SEMCAD X Version 14.6.10 (7331)

- **Area Scan (71x121x1):** Interpolated grid: $dx=1.500 \text{ mm}$, $dy=1.500 \text{ mm}$

Maximum value of SAR (interpolated) = 0.675 W/kg

- **Zoom Scan (5x5x7)/Cube 0:** Measurement grid: $dx=8\text{mm}$, $dy=8\text{mm}$, $dz=5\text{mm}$

Reference Value = 24.21 V/m ; Power Drift = 0.01 dB

Peak SAR (extrapolated) = 0.730 W/kg

SAR(1 g) = 0.576 W/kg ; SAR(10 g) = 0.445 W/kg

Maximum value of SAR (measured) = 0.678 W/kg

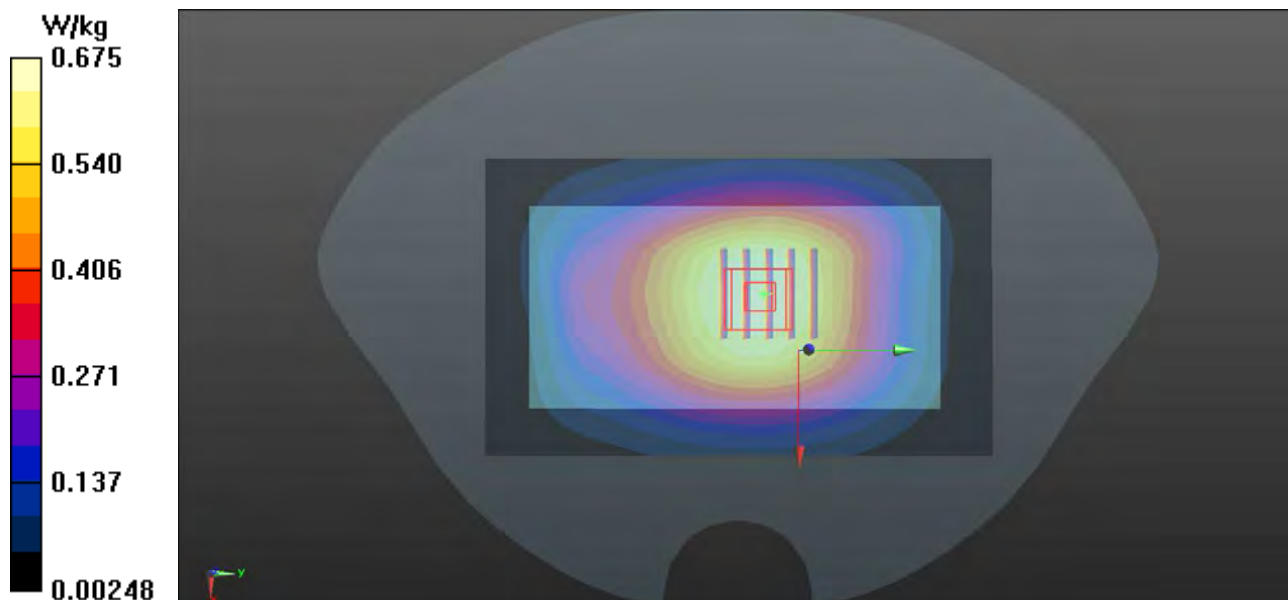

P21 LTE 7_QPSK20M_Bottom Side_1cm_Ch21350_1RB_OS50

DUT: 190322W004

Communication System: LTE; Frequency: 2560 MHz; Duty Cycle: 1:1

Medium: MSL2600_0326 Medium parameters used: $f = 2560$ MHz; $\sigma = 2.046$ S/m; $\epsilon_r = 50.875$; $\rho = 1000$ kg/m³

Ambient Temperature : 23.2°C; Liquid Temperature : 22.2°C

DASY5 Configuration:

- Probe: EX3DV4 - SN3873; ConvF(7.28, 7.28, 7.28); Calibrated: 2018/08/31;
- Sensor-Surface: 1.4mm (Mechanical Surface Detection)
- Electronics: DAE4 Sn1341; Calibrated: 2018/08/28
- Phantom: Front Phantom with CRP v5.0; Type: QD000P40CD; Serial: TP:1695
- Measurement SW: DASY52, Version 52.8 (8); SEMCAD X Version 14.6.10 (7331)

- **Area Scan (41x81x1):** Interpolated grid: dx=1.200 mm, dy=1.200 mm

Maximum value of SAR (interpolated) = 1.05 W/kg

- **Zoom Scan (7x7x7)/Cube 0:** Measurement grid: dx=5mm, dy=5mm, dz=5mm

Reference Value = 8.127 V/m; Power Drift = 0.00 dB

Peak SAR (extrapolated) = 1.30 W/kg

SAR(1 g) = 0.619 W/kg; SAR(10 g) = 0.266 W/kg

Maximum value of SAR (measured) = 1.05 W/kg

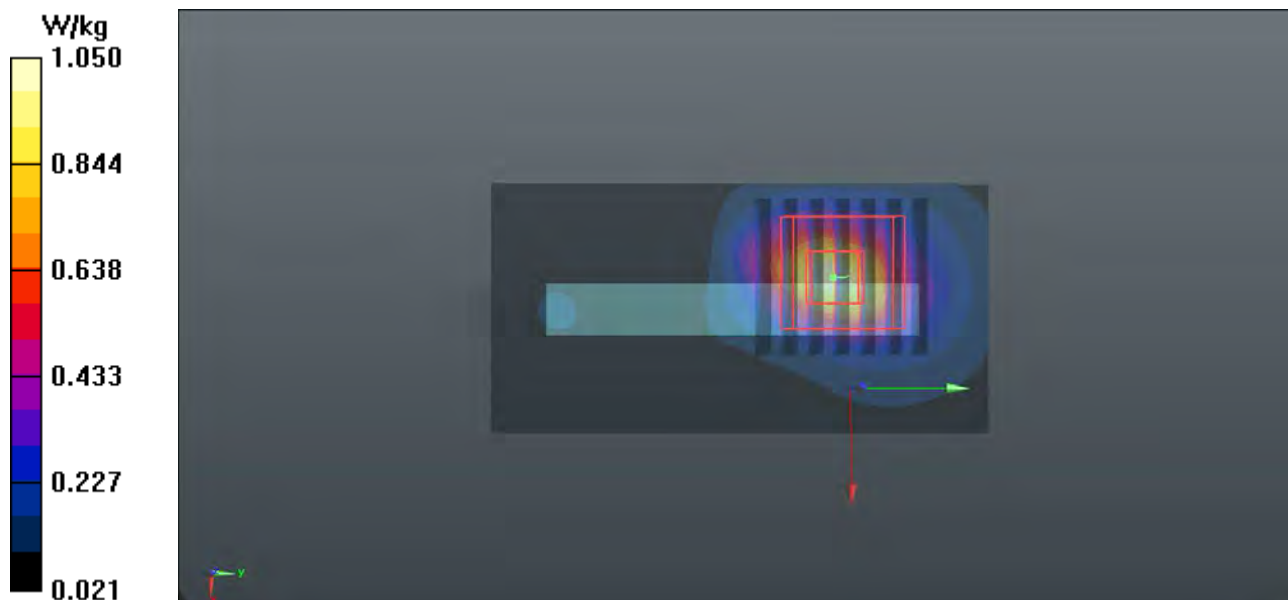

P22 LTE 28_QPSK20M_Rear Face_1cm_Ch27310_1RB_OS50

DUT: 190322W004

Communication System: LTE; Frequency: 713 MHz; Duty Cycle: 1:1

Medium: MSL750_0328 Medium parameters used: $f = 713 \text{ MHz}$; $\sigma = 0.935 \text{ S/m}$; $\epsilon_r = 55.565$; $\rho = 1000 \text{ kg/m}^3$

Ambient Temperature : 22.9°C ; Liquid Temperature : 21.9°C

DASY5 Configuration:

- Probe: EX3DV4 - SN3873; ConvF(9.67, 9.67, 9.67); Calibrated: 2018/08/31;
- Sensor-Surface: 1.4mm (Mechanical Surface Detection)
- Electronics: DAE4 Sn1341; Calibrated: 2018/08/28
- Phantom: Left Phantom with CRP v5.0; Type: QD000P40CD; Serial: TP:1722
- Measurement SW: DASY52, Version 52.8 (8); SEMCAD X Version 14.6.10 (7331)

- **Area Scan (71x121x1):** Interpolated grid: $dx=1.500 \text{ mm}$, $dy=1.500 \text{ mm}$

Maximum value of SAR (interpolated) = 0.384 W/kg

- **Zoom Scan (5x5x7)/Cube 0:** Measurement grid: $dx=8\text{mm}$, $dy=8\text{mm}$, $dz=5\text{mm}$

Reference Value = 19.05 V/m ; Power Drift = -0.11 dB

Peak SAR (extrapolated) = 0.406 W/kg

SAR(1 g) = 0.327 W/kg ; SAR(10 g) = 0.257 W/kg

Maximum value of SAR (measured) = 0.381 W/kg

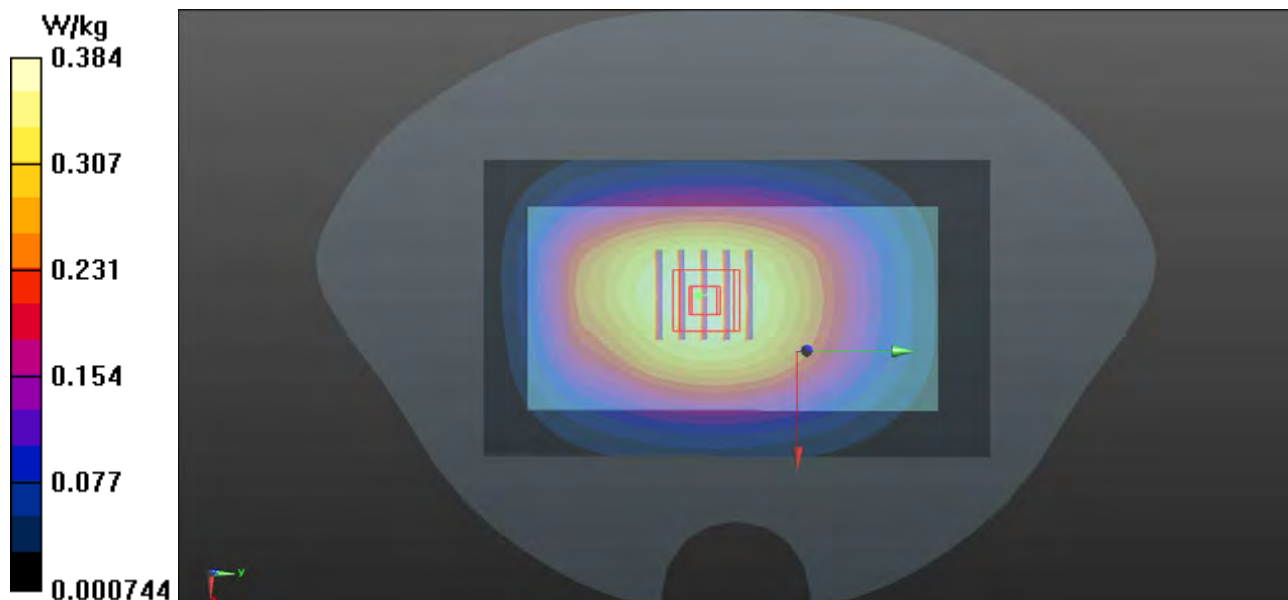

P23 LTE 38_QPSK20M_Bottom Side_1cm_Ch37850_1RB_OS50

DUT: 190322W004

Communication System: LTE; Frequency: 2580 MHz; Duty Cycle: 1:1.58

Medium: MSL2600_0326 Medium parameters used: $f = 2580$ MHz; $\sigma = 2.07$ S/m; $\epsilon_r = 50.804$; $\rho = 1000$ kg/m³

Ambient Temperature : 23.2°C; Liquid Temperature : 22.2°C

DASY5 Configuration:

- Probe: EX3DV4 - SN3873; ConvF(7.28, 7.28, 7.28); Calibrated: 2018/08/31;
- Sensor-Surface: 1.4mm (Mechanical Surface Detection)
- Electronics: DAE4 Sn1341; Calibrated: 2018/08/28
- Phantom: Front Phantom with CRP v5.0; Type: QD000P40CD; Serial: TP:1695
- Measurement SW: DASY52, Version 52.8 (8); SEMCAD X Version 14.6.10 (7331)

- **Area Scan (41x81x1):** Interpolated grid: dx=1.200 mm, dy=1.200 mm

Maximum value of SAR (interpolated) = 1.01 W/kg

- **Zoom Scan (7x7x7)/Cube 0:** Measurement grid: dx=5mm, dy=5mm, dz=5mm

Reference Value = 7.384 V/m; Power Drift = 0.01 dB

Peak SAR (extrapolated) = 1.36 W/kg

SAR(1 g) = 0.640 W/kg; SAR(10 g) = 0.270 W/kg

Maximum value of SAR (measured) = 1.08 W/kg

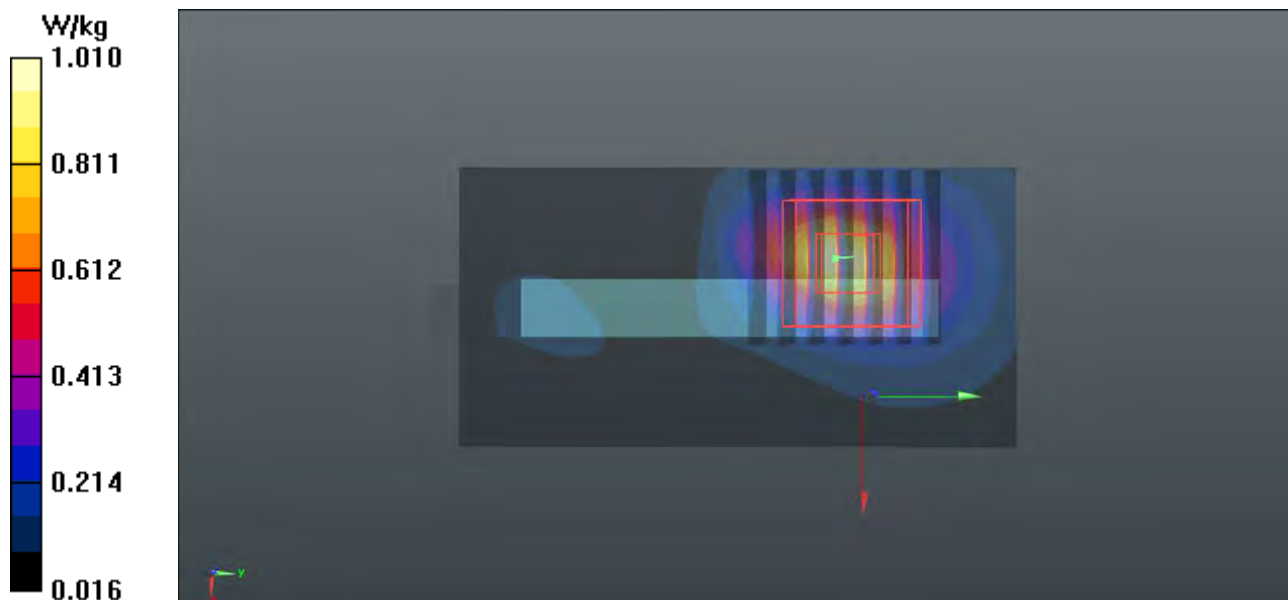

P24 802.11b_Front Face_1cm_Ch6

DUT: 190322W004

Communication System: 802.11b; Frequency: 2437 MHz; Duty Cycle: 1:1

Medium: MSL2450_0327 Medium parameters used: $f = 2437$ MHz; $\sigma = 1.884$ S/m; $\epsilon_r = 51.482$; $\rho = 1000$ kg/m³

Ambient Temperature : 23.1°C; Liquid Temperature : 22.1°C

DASY5 Configuration:

- Probe: EX3DV4 - SN3873; ConvF(7.39, 7.39, 7.39); Calibrated: 2018/08/31;
- Sensor-Surface: 1.4mm (Mechanical Surface Detection)
- Electronics: DAE4 Sn1341; Calibrated: 2018/08/28
- Phantom: Front Phantom with CRP v5.0; Type: QD000P40CD; Serial: TP:1695
- Measurement SW: DASY52, Version 52.8 (8); SEMCAD X Version 14.6.10 (7331)

- **Area Scan (91x151x1):** Interpolated grid: dx=1.200 mm, dy=1.200 mm

Maximum value of SAR (interpolated) = 0.208 W/kg

- **Zoom Scan (7x7x7)/Cube 0:** Measurement grid: dx=5mm, dy=5mm, dz=5mm

Reference Value = 5.012 V/m; Power Drift = 0.03 dB

Peak SAR (extrapolated) = 0.247 W/kg

SAR(1 g) = 0.130 W/kg; SAR(10 g) = 0.071 W/kg

Maximum value of SAR (measured) = 0.201 W/kg

