

FCC Test Report

(PART 27)

Report No.: RF180626C10D-2

FCC ID: 2AJOTTA-1095

Test Model: TA-1095

Received Date: Jun. 26, 2018

Test Date: Jul. 02, 2018 ~ Jul. 26, 2018

Issued Date: Aug. 01, 2018

Applicant: HMD Global Oy

Address: Karaportti 2, 02610 Espoo, Finland

Issued By: Bureau Veritas Consumer Products Services (H.K.) Ltd., Taoyuan Branch

Lab Address: No. 47-2, 14th Ling, Chia Pau Vil., Lin Kou Dist., New Taipei City, Taiwan (R.O.C)

Test Location (1): No. 19, Hwa Ya 2nd Rd, Wen Hwa Vil, Kwei Shan Dist., Taoyuan City 33383, Taiwan (R.O.C)

Test Location (2): No.215, Sec. 3, Beixin Rd., Xindian Dist., New Taipei City 231, Taiwan, R.O.C

**FCC Registration /
Designation Number:** 427177 / TW0011



This report is for your exclusive use. Any copying or replication of this report to or for any other person or entity, or use of our name or trademark, is permitted only with our prior written permission. This report sets forth our findings solely with respect to the test samples identified herein. The results set forth in this report are not indicative or representative of the quality or characteristics of the lot from which a test sample was taken or any similar or identical product unless specifically and expressly noted. Our report includes all of the tests requested by you and the results thereof based upon the information that you provided to us. You have 60 days from date of issuance of this report to notify us of any material error or omission caused by our negligence, provided, however, that such notice shall be in writing and shall specifically address the issue you wish to raise. A failure to raise such issue within the prescribed time shall constitute your unqualified acceptance of the completeness of this report, the tests conducted and the correctness of the report contents. Unless specific mention, the uncertainty of measurement has been explicitly taken into account to declare the compliance or non-compliance to the specification. The report must not be used by the client to claim product certification, approval, or endorsement by TAF or any government agencies

Table of Contents

Release Control Record	4
1 Certificate of Conformity	5
2 Summary of Test Results	6
2.1 Measurement Uncertainty	6
2.2 Test Site and Instruments	7
3 General Information	9
3.1 General Description of EUT	9
3.2 Configuration of System under Test	11
3.2.1 Description of Support Units	11
3.3 Test Mode Applicability and Tested Channel Detail	12
3.4 EUT Operating Conditions	14
3.5 General Description of Applied Standards	14
4 Test Types and Results	15
4.1 Output Power Measurement	15
4.1.1 Limits of Output Power Measurement	15
4.1.2 Test Procedures	15
4.1.3 Test Setup	16
4.1.4 Test Results	17
4.2 Modulation Characteristics Measurement	24
4.2.1 Limits of Modulation Characteristics	24
4.2.2 Test Setup	24
4.2.3 Test Procedure	24
4.2.4 Test Results	25
4.3 Frequency Stability Measurement	26
4.3.1 Limits of Frequency Stability Measurement	26
4.3.2 Test Procedure	26
4.3.3 Test Setup	26
4.3.4 Test Results	27
4.4 Occupied Bandwidth Measurement	35
4.4.1 Limits of Occupied Bandwidth Measurement	35
4.4.2 Test Procedure	35
4.4.3 Test Setup	35
4.4.4 Test Results	36
4.5 Out-of-Band Emissions Measurement	40
4.5.1 Limits of Out-of-Band Emissions Measurement	40
4.5.2 Test Setup	40
4.5.3 Test Procedures	40
4.5.4 Test Results	41
4.6 Peak to Average Ratio	57
4.6.1 Limits of Peak to Average Ratio Measurement	57
4.6.2 Test Setup	57
4.6.3 Test Procedures	57
4.6.4 Test Results	58
4.7 Conducted Spurious Emissions	62
4.7.1 Limits of Conducted Spurious Emissions Measurement	62
4.7.2 Test Setup	62
4.7.3 Test Procedure	62
4.7.4 Test Results	63
4.8 Radiated Emission Measurement	87
4.8.1 Limits of Radiated Emission Measurement	87
4.8.2 Test Procedure	87
4.8.3 Deviation from Test Standard	87
4.8.4 Test Setup	88

4.8.5 Test Results	89
5 Pictures of Test Arrangements.....	119
Appendix – Information on the Testing Laboratories	120



Release Control Record

Issue No.	Description	Date Issued
RF180626C10D-2	Original Release	Aug. 01, 2018

1 Certificate of Conformity

Product: Smart Phone
Brand: NOKIA
Test Model: TA-1095
Sample Status: Engineering Sample
Applicant: HMD Global Oy
Test Date: Jul. 02, 2018 ~ Jul. 26, 2018
Standards: FCC Part 27, Subpart C, M

The above equipment has been tested by **Bureau Veritas Consumer Products Services (H.K.) Ltd., Taoyuan Branch**, and found compliance with the requirement of the above standards. The test record, data evaluation & Equipment Under Test (EUT) configurations represented herein are true and accurate accounts of the measurements of the sample's RF characteristics under the conditions specified in this report.

Prepared by : , **Date:** Aug. 01, 2018
Ivonne Wu / Supervisor

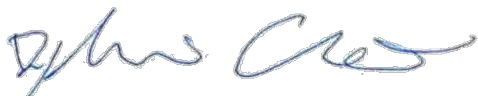
Approved by : , **Date:** Aug. 01, 2018
Dylan Chiou / Project Engineer

2 Summary of Test Results

Applied Standard: FCC Part 27 & Part 2			
FCC Clause	Test Item	Result	Remarks
2.1046 27.50(h)	Equivalent Isotropic Radiated Power	Pass	Meet the requirement of limit.
2.1047	Modulation Characteristics	Pass	Meet the requirement.
2.1055 27.54	Frequency Stability	Pass	Meet the requirement of limit.
2.1049	Occupied Bandwidth	Pass	Meet the requirement of limit.
--	Peak to Average Ratio	Pass	Meet the requirement of limit.
2.1051 27.53(l)	Out-of-Band Emissions Measurements	Pass	Meet the requirement of limit.
2.1051 27.53(m)	Conducted Spurious Emissions	Pass	Meet the requirement of limit.
2.1053 27.53(m)	Radiated Spurious Emissions	Pass	Meet the requirement of limit. Minimum passing margin is -9.84 dB at 10140.00 MHz.

2.1 Measurement Uncertainty

Where relevant, the following measurement uncertainty levels have been estimated for tests performed on the EUT as specified in CISPR 16-4-2:

Measurement	Frequency	Expanded Uncertainty (k=2) (\pm)
Radiated Emissions up to 1 GHz	30 MHz ~ 200 MHz	2.0153 dB
	200 MHz ~ 1000 MHz	2.0224 dB
Radiated Emissions above 1 GHz	1 GHz ~ 18 GHz	1.0121 dB
	18 GHz ~ 40 GHz	1.1508 dB

2.2 Test Site and Instruments

Description & Manufacturer	Model No.	Serial No.	Date of Calibration	Due Date of Calibration
Test Receiver Agilent Technologies	N9010A	MY52220314	Nov. 24, 2017	Nov. 23, 2018
Spectrum Analyzer ROHDE & SCHWARZ	FSU43	101261	Jan. 11, 2018	Jan. 10, 2019
Double Ridge Guide Horn Antenna EMCO	3115	5619	Nov. 30, 2017	Nov. 29, 2018
BILOG Antenna SCHWARZBECK	VULB 9168	9168-153	Dec. 06, 2017	Dec. 05, 2018
HORN Antenna Schwarzbeck	BBHA 9120D	9120D-969	Dec. 12, 2017	Dec. 11, 2018
Fixed Attenuator Woken	00801A1GGAM02Y	NA	May 17, 2018	May 16, 2019
MXG Vector signal generator Agilent	N5182B	MY53050430	Oct. 24, 2017	Oct. 23, 2018
Preamplifier Agilent	310N	187226	Jun. 19, 2018	Jun. 18, 2019
Preamplifier Agilent	83017A	MY39501357	Jun. 19, 2018	Jun. 18, 2019
RF signal cable ETS-LINDGREN	5D-FB	Cable-CH1-01(RF C-SMS-100-SMS- 120+RFC-SMS-1 00-SMS-400)	Jun. 19, 2018	Jun. 18, 2019
RF signal cable ETS-LINDGREN	8D-FB	Cable-CH1-02(RF C-SMS-100-SMS- 24)	Jun. 19, 2018	Jun. 18, 2019
Boresight Antenna Fixture	FBA-01	FBA-SIP01	NA	NA
Software BV ADT	E3 8.130425b	NA	NA	NA
Antenna Tower MF	NA	NA	NA	NA
Turn Table MF	NA	NA	NA	NA
Antenna Tower & Turn Table Controller MF	MF-7802	NA	NA	NA
Radio Communication Analyzer Anritsu	MT8820C	6201010284	Dec. 28, 2017	Dec. 27, 2018
Temperature & Humidity Chamber	GTH-120-40-CP-AR	MAA1306-019	Sep. 08, 2017	Sep. 07, 2018
DC Power Supply Topward	33010D	807748	Oct. 25, 2016	Oct. 24, 2018
Digital Multimeter Fluke	87-III	70360742	Jun. 29, 2018	Jun. 28, 2019

- Note:
1. The calibration interval of the above test instruments is 12 / 24 months and the calibrations are traceable to NML/ROC and NIST/USA.
 2. The test was performed in HsinTien Chamber 1.
 3. The horn antenna and preamplifier (model: 83017A) are used only for the measurement of emission frequency above 1 GHz if tested.
 4. The IC Site Registration No. is IC7450I-1.

3 General Information

3.1 General Description of EUT

Product	Smart Phone	
Brand	NOKIA	
Test Model	TA-1095	
Status of EUT	Engineering Sample	
Power Supply Rating	5.0 Vdc or 9 Vdc or 12 Vdc (adapter) 5.0 Vdc (host equipment) 3.85 Vdc (Li-ion battery)	
Modulation Type	QPSK, 16QAM	
Frequency Range	LTE Band 7 (Channel Bandwidth: 5 MHz)	2502.5 ~ 2567.5 MHz
	LTE Band 7 (Channel Bandwidth: 10 MHz)	2505 ~ 2565 MHz
	LTE Band 7 (Channel Bandwidth: 15 MHz)	2507.5 ~ 2562.5 MHz
	LTE Band 7 (Channel Bandwidth: 20 MHz)	2510 ~ 2560 MHz
	LTE Band 38 (Channel Bandwidth: 5 MHz)	2572.5 ~ 2617.5 MHz
	LTE Band 38 (Channel Bandwidth: 10 MHz)	2575.0 ~ 2615.0 MHz
	LTE Band 38 (Channel Bandwidth: 15 MHz)	2577.5 ~ 2612.5 MHz
	LTE Band 38 (Channel Bandwidth: 20 MHz)	2580.0 ~ 2610.0 MHz
Max. EIRP Power	LTE Band 7 (Channel Bandwidth: 5 MHz)	179.76 mW
	LTE Band 7 (Channel Bandwidth: 10 MHz)	180.18 mW
	LTE Band 7 (Channel Bandwidth: 15 MHz)	181.43 mW
	LTE Band 7 (Channel Bandwidth: 20 MHz)	183.10 mW
	LTE Band 38 (Channel Bandwidth: 5 MHz)	198.98 mW
	LTE Band 38 (Channel Bandwidth: 10 MHz)	200.96 mW
	LTE Band 38 (Channel Bandwidth: 15 MHz)	202.21 mW
	LTE Band 38 (Channel Bandwidth: 20 MHz)	203.70 mW
Emission Designator	LTE Band 7 (Channel Bandwidth: 5 MHz)	4M50W7D
	LTE Band 7 (Channel Bandwidth: 10 MHz)	8M97W7D
	LTE Band 7 (Channel Bandwidth: 15 MHz)	13M5G7D
	LTE Band 7 (Channel Bandwidth: 20 MHz)	17M9W7D
	LTE Band 38 (Channel Bandwidth: 5 MHz)	4M49W7D
	LTE Band 38 (Channel Bandwidth: 10 MHz)	8M97W7D
	LTE Band 38 (Channel Bandwidth: 15 MHz)	13M5G7D
	LTE Band 38 (Channel Bandwidth: 20 MHz)	17M9G7D
Antenna Type	LTE Band 7: PIFA Antenna with -0.04 dBi gain LTE Band 38: PIFA Antenna with -0.26 dBi gain	
Accessory Device	Refer to Note as below	
Data Cable Supplied	Refer to Note as below	

Note:

1. This report is issued as a duplicate report to BV CPS report no.: RF180626C09-3. The difference compared with original report is WWAN supported band. Therefore, only EIRP and radiated spurious emission tests were re-tested.
2. There're 2 configurations for the EUT listed as below.
Main Sample: EUT + Battery 1
2nd Sample: EUT + Battery 2
✧ Only the worst test data was presented in the report.
3. The EUT's accessories list refers to Ext. Pho.
4. The above EUT information is declared by manufacturer and for more detailed features description, please refers to the manufacturer's specifications or user's manual.

3.2 Configuration of System under Test

<Radiated Emission Test>

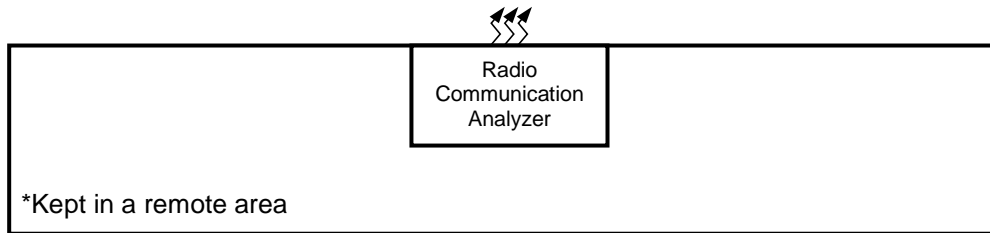
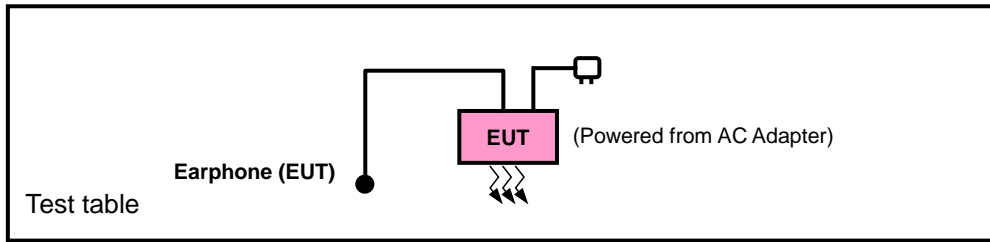

<E.I.R.P. Test>

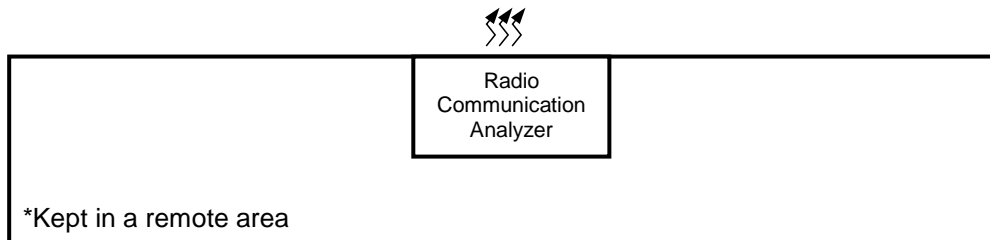
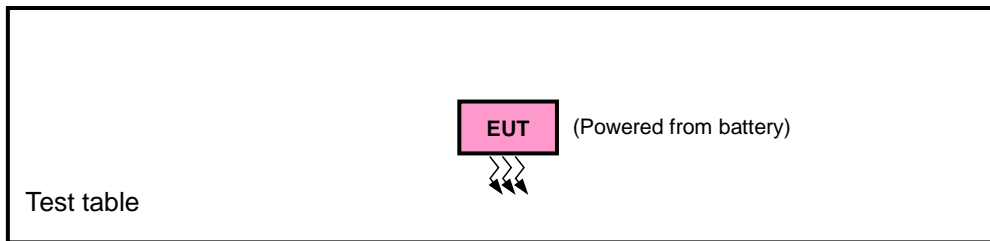

3.2.1 Description of Support Units

The EUT has been tested as an independent unit together with other necessary accessories or support units.

3.3 Test Mode Applicability and Tested Channel Detail

Pre-Scan has been conducted to determine the worst-case mode from all possible combinations between available modulations, data rates, XYZ axis, and antenna ports.

The worst case was found when positioned as the table below. Following channel(s) was (were) selected for the final test as listed below:

EUT Configure Mode	Description
A	Main Sample
B	2 nd Sample

SIM	Band	EIRP	Radiated Emission
1	LTE Band 7	Z-plane	Z-axis
	LTE Band 38	X-plane	Y-axis

LTE Band 7

EUT Configure Mode	Test Item	Available Channel	Tested Channel	Channel Bandwidth	Modulation	Mode
A	EIRP	20775 to 21425	20775, 21100, 21425	5 MHz	QPSK, 16QAM	1 RB / 0 RB Offset
		20800 to 21400	20800, 21100, 21400	10 MHz	QPSK, 16QAM	1 RB / 0 RB Offset
		20825 to 21375	20825, 21100, 21375	15 MHz	QPSK, 16QAM	1 RB / 0 RB Offset
		20850 to 21350	20850, 21100 21350	20 MHz	QPSK, 16QAM	1 RB / 0 RB Offset
B		20850 to 21350	20850, 21100 21350	20 MHz	QPSK, 16QAM	1 RB / 0 RB Offset
A	Modulation Characteristics	20850 to 21350	21100	5 MHz	QPSK, 16QAM	25 RB / 0 RB Offset
A	Frequency Stability	20775 to 21425	20775, 21425	5 MHz	QPSK	1 RB / 0 RB Offset
		20800 to 21400	20800, 21400	10 MHz	QPSK	1 RB / 0 RB Offset
		20825 to 21375	20825, 21375	15 MHz	QPSK	1 RB / 0 RB Offset
		20850 to 21350	20850, 21350	20 MHz	QPSK	1 RB / 0 RB Offset
A	Occupied Bandwidth	20775 to 21425	20775, 21100, 21425	5 MHz	QPSK, 16QAM	25 RB / 0 RB Offset
		20800 to 21400	20800, 21100, 21400	10 MHz	QPSK, 16QAM	50 RB / 0 RB Offset
		20825 to 21375	20825, 21100, 21375	15 MHz	QPSK, 16QAM	75 RB / 0 RB Offset
		20850 to 21350	20850, 21100 21350	20 MHz	QPSK, 16QAM	100 RB / 0 RB Offset
A	Peak to Average Ratio	20775 to 21425	20775, 21100, 21425	5 MHz	QPSK, 16QAM	1 RB / 0 RB Offset
		20800 to 21400	20800, 21100, 21400	10 MHz	QPSK, 16QAM	1 RB / 0 RB Offset
		20825 to 21375	20825, 21100, 21375	15 MHz	QPSK, 16QAM	1 RB / 0 RB Offset
		20850 to 21350	20850, 21100 21350	20 MHz	QPSK, 16QAM	1 RB / 0 RB Offset
A	Out-of-Band Emissions	20775 to 21425	20775, 21425	5 MHz	QPSK, 16QAM	25 RB / 0 RB Offset
		20800 to 21400	20800, 21400	10 MHz	QPSK, 16QAM	50 RB / 0 RB Offset
		20825 to 21375	20825, 21375	15 MHz	QPSK, 16QAM	75 RB / 0 RB Offset
		20850 to 21350	20850, 21350	20 MHz	QPSK, 16QAM	100 RB / 0 RB Offset
A	Conducted Emission	20775 to 21425	20775, 21100, 21425	5 MHz	QPSK	1 RB / 0 RB Offset
		20800 to 21400	20800, 21100, 21400	10 MHz	QPSK	1 RB / 0 RB Offset
		20825 to 21375	20825, 21100, 21375	15 MHz	QPSK	1 RB / 0 RB Offset
		20850 to 21350	20850, 21100 21350	20 MHz	QPSK	1 RB / 0 RB Offset
A	Radiated Emission	20775 to 21425	20775, 21100, 21425	5 MHz	QPSK	1 RB / 0 RB Offset
		20850 to 21350	20850, 21100 21350	20 MHz	QPSK	1 RB / 0 RB Offset
B		20850 to 21350	20850, 21100 21350	20 MHz	QPSK	1 RB / 0 RB Offset

Note: This device was tested under all bandwidths, RB configurations and modulations. The worst case was found in QPSK modulation.

LTE Band 38

EUT Configure Mode	Test Item	Available Channel	Tested Channel	Channel Bandwidth	Modulation	Mode
A	EIRP	37775 to 38225	37775, 38000, 38225	5 MHz	QPSK, 16QAM	1 RB / 0 RB Offset
		37800 to 38200	37800, 38000, 38200	10 MHz	QPSK, 16QAM	1 RB / 0 RB Offset
		37825 to 38175	37825, 38000, 38175	15 MHz	QPSK, 16QAM	1 RB / 0 RB Offset
		37850 to 38150	37850, 38000, 38150	20 MHz	QPSK, 16QAM	1 RB / 0 RB Offset
A	Modulation Characteristics	37850 to 38150	38000	5 MHz	QPSK, 16QAM	25 RB / 0 RB Offset
A	Frequency Stability	37775 to 38225	37775, 38225	5 MHz	QPSK	1 RB / 0 RB Offset
		37800 to 38200	37800, 38200	10 MHz	QPSK	1 RB / 0 RB Offset
		37825 to 38175	37825, 38175	15 MHz	QPSK	1 RB / 0 RB Offset
		37850 to 38150	37850, 38150	20 MHz	QPSK	1 RB / 0 RB Offset
A	Occupied Bandwidth	37775 to 38225	37775, 38000, 38225	5 MHz	QPSK, 16QAM	25 RB / 0 RB Offset
		37800 to 38200	37800, 38000, 38200	10 MHz	QPSK, 16QAM	50 RB / 0 RB Offset
		37825 to 38175	37825, 38000, 38175	15 MHz	QPSK, 16QAM	75 RB / 0 RB Offset
		37850 to 38150	37850, 38000, 38150	20 MHz	QPSK, 16QAM	100 RB / 0 RB Offset
A	Peak to Average Ratio	37775 to 38225	37775, 38000, 38225	5 MHz	QPSK, 16QAM	1 RB / 0 RB Offset
		37800 to 38200	37800, 38000, 38200	10 MHz	QPSK, 16QAM	1 RB / 0 RB Offset
		37825 to 38175	37825, 38000, 38175	15 MHz	QPSK, 16QAM	1 RB / 0 RB Offset
		37850 to 38150	37850, 38000, 38150	20 MHz	QPSK, 16QAM	1 RB / 0 RB Offset
A	Out-of-Band Emissions	37775 to 38225	37775, 38225	5 MHz	QPSK, 16QAM	25 RB / 0 RB Offset
		37800 to 38200	37800, 38200	10 MHz	QPSK, 16QAM	50 RB / 0 RB Offset
		37825 to 38175	37825, 38175	15 MHz	QPSK, 16QAM	75 RB / 0 RB Offset
		37850 to 38150	37850, 38150	20 MHz	QPSK, 16QAM	100 RB / 0 RB Offset
A	Conducted Emission	37775 to 38225	37775, 38000, 38225	5 MHz	QPSK	1 RB / 0 RB Offset
		37800 to 38200	37800, 38000, 38200	10 MHz	QPSK	1 RB / 0 RB Offset
		37825 to 38175	37825, 38000, 38175	15 MHz	QPSK	1 RB / 0 RB Offset
		37850 to 38150	37850, 38000, 38150	20 MHz	QPSK	1 RB / 0 RB Offset
A	Radiated Emission	37775 to 38225	37775, 38000, 38225	5 MHz	QPSK	1 RB / 0 RB Offset
		37850 to 38150	37850, 38000, 38150	20 MHz	QPSK	1 RB / 0 RB Offset

Note: This device was tested under all bandwidths, RB configurations and modulations. The worst case was found in QPSK modulation.

Test Condition:

Test Item	Environmental Conditions	Input Power	Tested By
EIRP	25 deg. C, 65 % RH	3.85 Vdc	Karl Lee
Modulation Characteristics	25 deg. C, 65 % RH	3.85 Vdc	Wayne Lin
Frequency Stability	25 deg. C, 65 % RH	3.85 Vdc	Wayne Lin
Occupied Bandwidth	25 deg. C, 65 % RH	3.85 Vdc	Wayne Lin
Out-of-Band Emissions	25 deg. C, 65 % RH	3.85 Vdc	Wayne Lin
Peak to Average Ratio	25 deg. C, 65 % RH	3.85 Vdc	Wayne Lin
Conducted Emission	25 deg. C, 65 % RH	3.85 Vdc	Wayne Lin
Radiated Emission	25 deg. C, 65 % RH	120 Vac, 60 Hz	Karl Lee / Harry Hsueh

3.4 EUT Operating Conditions

The EUT makes a call to the communication simulator. The communication simulator station system controlled a EUT to export maximum output power under transmission mode and specific channel frequency

3.5 General Description of Applied Standards

The EUT is a RF Product. According to the specifications of the manufacturer, it must comply with the requirements of the following standards:

FCC 47 CFR Part 2

FCC 47 CFR Part 27

KDB 971168 D01 Power Meas License Digital Systems v03r01

ANSI/TIA/EIA-603-E 2016

ANSI 63.26-2015

Note: All test items have been performed and recorded as per the above standards.

4 Test Types and Results

4.1 Output Power Measurement

4.1.1 Limits of Output Power Measurement

The radiated peak output power shall be according to the specific rule Part 27.50(h)(2) that “User stations are limited to 2 watts” and 27.50(i) specific that “Peak transmit power must be measure over any interval of continuous transmission using instrumentation calibration in terms of rms-equivalent voltage.”

4.1.2 Test Procedures

EIRP Measurement:

- a. All measurements were done at low, middle and high operational frequency range. RBW and VBW is 10 MHz for LTE mode.
- b. Substitution method is used for E.I.R.P measurement. In the semi-anechoic chamber, EUT placed on the 0.8 m (below or equal 1 GHz) and/or 1.5 m (above 1 GHz) height of Turn Table, rotated the table around 360 degrees to search the maximum radiation power and receiver antenna shall be rotated vertical and horizontal polarization and moved height from 1 m to 4 m to find the maximum polar radiated power. The “Read Value” is the spectrum reading the maximum power value.
- c. The substitution horn antenna is substituted for EUT at the same position and signals generator export the CW signal to the substitution antenna via a tx cable. Rotated the Turn Table and moved receiving antenna to find the maximum radiation power. Adjust output power level of S.G to get a Value of spectrum reading equal to “Read Value“ of step b. Record the power level of S.G.
- d. $EIRP = \text{Output power level of S.G} - \text{TX cable loss} + \text{Antenna gain of substitution horn}.$

Conducted Power Measurement:

- a. The EUT was set up for the maximum power with LTE link data modulation and link up with simulator.
- b. Set the EUT to transmit under low, middle and high channel and record the power level shown on simulator.

4.1.3 Test Setup

**EIRP / ERP Measurement:
<Radiated Emission below or equal 1 GHz>**

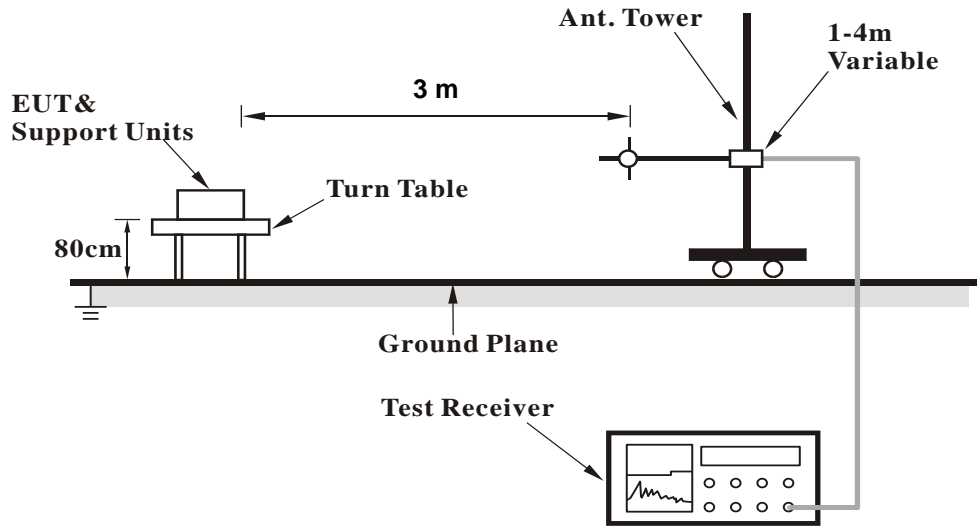

<Radiated Emission above 1 GHz>

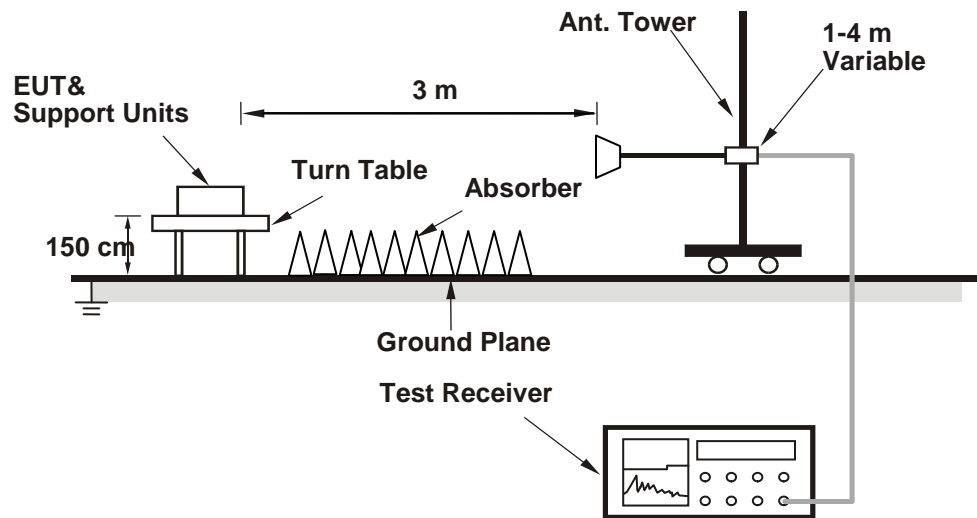

For the actual test configuration, please refer to the attached file (Test Setup Photo).

Conducted Power Measurement:



4.1.4 Test Results

Conducted Output Power (dBm)

LTE Band 7															
BW	MCS Index	RB Size	RB Offset	Low	Mid	High	3GPP MPR (dB)	BW	MCS Index	RB Size	RB Offset	Low	Mid	High	3GPP MPR (dB)
				20850	21100	21350						20825	21100	21375	
		Channel Frequency (MHz)	2510.0	2535.0	2560.0	Channel Frequency (MHz)	2507.5			2535.0	2562.5				
20M	QPSK	1	0	22.54	22.58	22.41	0	15M	QPSK	1	0	22.42	22.46	22.29	0
		1	50	22.47	22.51	22.34	0			1	37	22.35	22.39	22.22	0
		1	99	22.45	22.49	22.32	0			1	74	22.33	22.37	22.20	0
		50	0	21.62	21.66	21.49	1			36	0	21.50	21.54	21.37	1
		50	25	21.61	21.65	21.48	1			36	19	21.49	21.53	21.36	1
		50	50	21.59	21.63	21.46	1			36	39	21.47	21.51	21.34	1
		100	0	21.60	21.64	21.47	1			75	0	21.48	21.52	21.35	1
	16QAM	1	0	21.48	21.52	21.35	1		16QAM	1	0	21.36	21.40	21.23	1
		1	50	21.41	21.45	21.28	1			1	37	21.29	21.33	21.16	1
		1	99	21.39	21.43	21.26	1			1	74	21.27	21.31	21.14	1
		50	0	20.56	20.60	20.43	2			36	0	20.44	20.48	20.31	2
		50	25	20.55	20.59	20.42	2			36	19	20.43	20.47	20.30	2
		50	50	20.53	20.57	20.40	2			36	39	20.41	20.45	20.28	2
		100	0	20.54	20.58	20.41	2			75	0	20.42	20.46	20.29	2
BW	MCS Index	RB Size	RB Offset	Low	Mid	High	3GPP MPR (dB)	BW	MCS Index	RB Size	RB Offset	Low	Mid	High	3GPP MPR (dB)
				20800	21100	21400						20775	21100	21425	
		Channel Frequency (MHz)	2505.0	2535.0	2565.0	Channel Frequency (MHz)	2502.5			2535.0	2567.5				
10M	QPSK	1	0	22.33	22.37	22.20	0	5M	QPSK	1	0	22.19	22.23	22.06	0
		1	24	22.26	22.30	22.13	0			1	12	22.12	22.16	21.99	0
		1	49	22.24	22.28	22.11	0			1	24	22.10	22.14	21.97	0
		25	0	21.41	21.45	21.28	1			12	0	21.27	21.31	21.14	1
		25	12	21.40	21.44	21.27	1			12	6	21.26	21.30	21.13	1
		25	25	21.38	21.42	21.25	1			12	13	21.24	21.28	21.11	1
		50	0	21.39	21.43	21.26	1			25	0	21.25	21.29	21.12	1
	16QAM	1	0	21.27	21.31	21.14	1		16QAM	1	0	21.13	21.17	21.00	1
		1	24	21.20	21.24	21.07	1			1	12	21.06	21.10	20.93	1
		1	49	21.18	21.22	21.05	1			1	24	21.04	21.08	20.91	1
		25	0	20.35	20.39	20.22	2			12	0	20.21	20.25	20.08	2
		25	12	20.34	20.38	20.21	2			12	6	20.20	20.24	20.07	2
		25	25	20.32	20.36	20.19	2			12	13	20.18	20.22	20.05	2
		50	0	20.33	20.37	20.20	2			25	0	20.19	20.23	20.06	2

LTE Band 38

BW	MCS Index	RB Size	RB Offset	Low	Mid	High	3GPP MPR (dB)	BW	MCS Index	RB Size	RB Offset	Low	Mid	High	3GPP MPR (dB)
				37850	38000	38150						37825	38000	38175	
				Channel Frequency (MHz)	2580.0	2595.0						2610.0	2577.5	2595.0	
20M	QPSK	1	0	23.21	23.19	23.09	0	15M	QPSK	1	0	23.08	23.06	22.96	0
		1	50	23.18	23.16	23.06	0			1	37	23.05	23.03	22.93	0
		1	99	23.14	23.12	23.02	0			1	74	23.01	22.99	22.89	0
		50	0	22.20	22.18	22.08	1			36	0	22.07	22.05	21.95	1
		50	25	22.17	22.15	22.05	1			36	19	22.04	22.02	21.92	1
		50	50	22.15	22.13	22.03	1			36	39	22.02	22.00	21.90	1
		100	0	22.13	22.11	22.01	1			75	0	22.00	21.98	21.88	1
	16QAM	1	0	22.19	22.17	22.07	1		16QAM	1	0	22.06	22.04	21.94	1
		1	50	22.16	22.14	22.04	1			1	37	22.03	22.01	21.91	1
		1	99	22.12	22.10	22.00	1			1	74	21.99	21.97	21.87	1
		50	0	21.18	21.16	21.06	2			36	0	21.05	21.03	20.93	2
		50	25	21.15	21.13	21.03	2			36	19	21.02	21.00	20.90	2
		50	50	21.13	21.11	21.01	2			36	39	21.00	20.98	20.88	2
		100	0	21.11	21.09	20.99	2			75	0	20.98	20.96	20.86	2
BW	MCS Index	RB Size	RB Offset	Low	Mid	High	3GPP MPR (dB)	BW	MCS Index	RB Size	RB Offset	Low	Mid	High	3GPP MPR (dB)
				37800	38000	38200						37775	38000	38225	
				Channel Frequency (MHz)	2575.0	2595.0						2615.0	2572.5	2595.0	
10M	QPSK	1	0	23.00	22.98	22.88	0	5M	QPSK	1	0	22.88	22.86	22.76	0
		1	24	22.97	22.95	22.85	0			1	12	22.85	22.83	22.73	0
		1	49	22.93	22.91	22.81	0			1	24	22.81	22.79	22.69	0
		25	0	21.99	21.97	21.87	1			12	0	21.87	21.85	21.75	1
		25	12	21.96	21.94	21.84	1			12	6	21.84	21.82	21.72	1
		25	25	21.94	21.92	21.82	1			12	13	21.82	21.80	21.70	1
		50	0	21.92	21.90	21.80	1			25	0	21.80	21.78	21.68	1
	16QAM	1	0	21.98	21.96	21.86	1		16QAM	1	0	21.86	21.84	21.74	1
		1	24	21.95	21.93	21.83	1			1	12	21.83	21.81	21.71	1
		1	49	21.91	21.89	21.79	1			1	24	21.79	21.77	21.67	1
		25	0	20.97	20.95	20.85	2			12	0	20.85	20.83	20.73	2
		25	12	20.94	20.92	20.82	2			12	6	20.82	20.80	20.70	2
		25	25	20.92	20.90	20.80	2			12	13	20.80	20.78	20.68	2
		50	0	20.90	20.88	20.78	2			25	0	20.78	20.76	20.66	2

**EIRP Power (dBm)
Mode A**

LTE Band 7							
Channel Bandwidth: 5 MHz / QPSK							
Plane	Channel	Frequency (MHz)	Reading (dBm)	Correction Factor (dB)	EIRP (dBm)	EIRP (mW)	Polarization (H/V)
Z	20775	2502.5	-21.75	44.24	22.49	177.34	H
	21100	2535.0	-21.65	44.20	22.55	179.76	
	21425	2567.5	-22.30	44.80	22.50	177.87	
	20775	2502.5	-27.70	44.19	16.49	44.58	V
	21100	2535.0	-27.58	44.09	16.51	44.75	
	21425	2567.5	-28.02	44.50	16.48	44.45	
Channel Bandwidth: 5 MHz / 16QAM							
Z	20775	2502.5	-22.77	44.24	21.47	140.22	H
	21100	2535.0	-22.68	44.20	21.52	141.81	
	21425	2567.5	-23.31	44.80	21.49	140.96	
	20775	2502.5	-28.72	44.19	15.47	35.25	V
	21100	2535.0	-28.60	44.09	15.49	35.38	
	21425	2567.5	-29.03	44.50	15.47	35.23	

Note: EIRP (dBm) = Reading (dBm) + Correction Factor (dB)

LTE Band 7							
Channel Bandwidth: 10 MHz / QPSK							
Plane	Channel	Frequency (MHz)	Reading (dBm)	Correction Factor (dB)	EIRP (dBm)	EIRP (mW)	Polarization (H/V)
Z	20800	2505.0	-21.86	44.34	22.48	177.05	H
	21100	2535.0	-21.64	44.20	22.56	180.18	
	21400	2565.0	-22.25	44.72	22.47	176.73	
	20800	2505.0	-27.73	44.23	16.50	44.63	V
	21100	2535.0	-27.56	44.09	16.53	44.96	
	21400	2565.0	-27.94	44.41	16.47	44.32	
Channel Bandwidth: 10 MHz / 16QAM							
Z	20800	2505.0	-22.85	44.34	21.49	140.96	H
	21100	2535.0	-22.63	44.20	21.57	143.45	
	21400	2565.0	-23.24	44.72	21.48	140.70	
	20800	2505.0	-28.74	44.23	15.49	35.37	V
	21100	2535.0	-28.57	44.09	15.52	35.63	
	21400	2565.0	-28.96	44.41	15.45	35.04	

Note: EIRP (dBm) = Reading (dBm) + Correction Factor (dB)

LTE Band 7							
Channel Bandwidth: 15 MHz / QPSK							
Plane	Channel	Frequency (MHz)	Reading (dBm)	Correction Factor (dB)	EIRP (dBm)	EIRP (mW)	Polarization (H/V)
Z	20825	2507.5	-21.80	44.32	22.52	178.57	H
	21100	2535.0	-21.61	44.20	22.59	181.43	
	21375	2562.5	-22.35	44.85	22.50	177.75	
	20825	2507.5	-27.43	43.99	16.56	45.31	V
	21100	2535.0	-27.52	44.09	16.57	45.37	
	21375	2562.5	-27.98	44.51	16.53	44.98	
Channel Bandwidth: 15 MHz / 16QAM							
Z	20825	2507.5	-22.81	44.32	21.51	141.51	H
	21100	2535.0	-22.62	44.20	21.58	143.78	
	21375	2562.5	-23.38	44.85	21.47	140.22	
	20825	2507.5	-28.46	43.99	15.53	35.74	V
	21100	2535.0	-28.51	44.09	15.58	36.12	
	21375	2562.5	-29.02	44.51	15.49	35.40	

Note: EIRP (dBm) = Reading (dBm) + Correction Factor (dB)

LTE Band 7							
Channel Bandwidth: 20 MHz / QPSK							
Plane	Channel	Frequency (MHz)	Reading (dBm)	Correction Factor (dB)	EIRP (dBm)	EIRP (mW)	Polarization (H/V)
Z	20850.0	2510.0	-21.61	44.16	22.55	179.89	H
	21100.0	2535.0	-21.57	44.20	22.63	183.10	
	21350.0	2560.0	-22.27	44.81	22.54	179.35	
	20850.0	2510.0	-28.21	44.78	16.57	45.39	V
	21100.0	2535.0	-27.49	44.09	16.60	45.69	
	21350.0	2560.0	-28.17	44.72	16.55	45.19	
Channel Bandwidth: 20 MHz / 16QAM							
Z	20850.0	2510.0	-22.61	44.16	21.55	142.89	H
	21100.0	2535.0	-22.55	44.20	21.65	146.12	
	21350.0	2560.0	-23.28	44.81	21.53	142.13	
	20850.0	2510.0	-29.22	44.78	15.56	35.97	V
	21100.0	2535.0	-28.50	44.09	15.59	36.21	
	21350.0	2560.0	-29.17	44.72	15.55	35.89	

Note: EIRP (dBm) = Reading (dBm) + Correction Factor (dB)

LTE Band 38							
Channel Bandwidth: 5 MHz / QPSK							
Plane	Channel	Frequency (MHz)	Reading (dBm)	Correction Factor (dB)	EIRP (dBm)	EIRP (mW)	Polarization (H/V)
X	37775	2572.5	-21.25	44.24	22.99	198.98	H
	38000	2595.0	-21.23	44.20	22.97	198.02	
	38225	2617.5	-21.88	44.80	22.92	195.93	
	37775	2572.5	-23.21	44.19	20.98	125.34	V
	38000	2595.0	-23.16	44.09	20.93	123.82	
	38225	2617.5	-23.60	44.50	20.90	123.00	
Channel Bandwidth: 5 MHz / 16QAM							
X	37775	2572.5	-22.27	44.24	21.97	157.33	H
	38000	2595.0	-22.26	44.20	21.94	156.21	
	38225	2617.5	-22.91	44.80	21.89	154.56	
	37775	2572.5	-25.22	44.19	18.97	78.90	V
	38000	2595.0	-24.17	44.09	19.92	98.13	
	38225	2617.5	-24.61	44.50	19.89	97.48	

Note: EIRP (dBm) = Reading (dBm) + Correction Factor (dB)

LTE Band 38							
Channel Bandwidth: 10 MHz / QPSK							
Plane	Channel	Frequency (MHz)	Reading (dBm)	Correction Factor (dB)	EIRP (dBm)	EIRP (mW)	Polarization (H/V)
X	37800	2575.0	-21.31	44.34	23.03	200.96	H
	38000	2595.0	-21.23	44.20	22.97	198.02	
	38200	2615.0	-21.80	44.72	22.92	196.02	
	37800	2575.0	-23.23	44.23	21.00	125.78	V
	38000	2595.0	-23.14	44.09	20.95	124.39	
	38200	2615.0	-23.49	44.41	20.92	123.48	
Channel Bandwidth: 10 MHz / 16QAM							
X	37800	2575.0	-22.32	44.34	22.02	159.26	H
	38000	2595.0	-22.23	44.20	21.97	157.29	
	38200	2615.0	-22.78	44.72	21.94	156.42	
	37800	2575.0	-24.24	44.23	19.99	99.68	V
	38000	2595.0	-24.15	44.09	19.94	98.58	
	38200	2615.0	-24.49	44.41	19.92	98.08	

Note: EIRP (dBm) = Reading (dBm) + Correction Factor (dB)

LTE Band 38							
Channel Bandwidth: 15 MHz / QPSK							
Plane	Channel	Frequency (MHz)	Reading (dBm)	Correction Factor (dB)	EIRP (dBm)	EIRP (mW)	Polarization (H/V)
X	37825	2577.5	-21.26	44.32	23.06	202.21	H
	38000	2595.0	-21.17	44.20	23.03	200.77	
	38175	2612.5	-21.89	44.85	22.96	197.61	
	37825	2577.5	-22.92	43.99	21.07	128.00	V
	38000	2595.0	-23.10	44.09	20.99	125.55	
	38175	2612.5	-23.55	44.51	20.96	124.74	
Channel Bandwidth: 15 MHz / 16QAM							
X	37825	2577.5	-22.27	44.32	22.05	160.25	H
	38000	2595.0	-22.20	44.20	22.00	158.38	
	38175	2612.5	-22.89	44.85	21.96	156.96	
	37825	2577.5	-23.93	43.99	20.06	101.44	V
	38000	2595.0	-24.09	44.09	20.00	99.95	
	38175	2612.5	-24.56	44.51	19.95	98.86	

Note: EIRP (dBm) = Reading (dBm) + Correction Factor (dB)

LTE Band 38							
Channel Bandwidth: 20 MHz / QPSK							
Plane	Channel	Frequency (MHz)	Reading (dBm)	Correction Factor (dB)	EIRP (dBm)	EIRP (mW)	Polarization (H/V)
X	37850	2580.0	-21.07	44.16	23.09	203.70	H
	38000	2595.0	-21.16	44.20	23.04	201.23	
	38150	2610.0	-21.78	44.81	23.03	200.77	
	37850	2580.0	-23.71	44.78	21.07	127.94	V
	38000	2595.0	-23.06	44.09	21.03	126.71	
	38150	2610.0	-23.73	44.72	21.00	125.75	
Channel Bandwidth: 20 MHz / 16QAM							
X	37850	2580.0	-22.08	44.16	22.08	161.44	H
	38000	2595.0	-22.16	44.20	22.04	159.85	
	38150	2610.0	-22.81	44.81	22.00	158.38	
	37850	2580.0	-24.70	44.78	20.08	101.86	V
	38000	2595.0	-24.06	44.09	20.03	100.65	
	38150	2610.0	-24.73	44.72	19.99	99.77	

Note: EIRP (dBm) = Reading (dBm) + Correction Factor (dB)

Mode B

LTE Band 7							
Channel Bandwidth: 20 MHz / QPSK							
Plane	Channel	Frequency (MHz)	Reading (dBm)	Correction Factor (dB)	EIRP (dBm)	EIRP (mW)	Polarization (H/V)
Z	20850.0	2510.0	-22.62	44.16	21.54	142.56	H
	21100.0	2535.0	-22.58	44.20	21.62	145.11	
	21350.0	2560.0	-23.27	44.81	21.54	142.46	
	20850.0	2510.0	-29.22	44.78	15.56	35.97	V
	21100.0	2535.0	-28.50	44.09	15.59	36.21	
	21350.0	2560.0	-29.18	44.72	15.54	35.81	
Channel Bandwidth: 20 MHz / 16QAM							
Z	20850.0	2510.0	-23.61	44.16	20.55	113.50	H
	21100.0	2535.0	-23.56	44.20	20.64	115.80	
	21350.0	2560.0	-24.29	44.81	20.52	112.64	
	20850.0	2510.0	-30.23	44.78	14.55	28.51	V
	21100.0	2535.0	-29.51	44.09	14.58	28.69	
	21350.0	2560.0	-30.18	44.72	14.54	28.44	

4.2 Modulation Characteristics Measurement

4.2.1 Limits of Modulation Characteristics

N/A

4.2.2 Test Setup



4.2.3 Test Procedure

Connect the EUT to Communication Simulator via the antenna connector. The frequency band is set as EUT supported Modulation and Channels, the EUT output is matched with 50 ohm load, the waveform quality and constellation of the EUT was tested.

4.2.4 Test Results

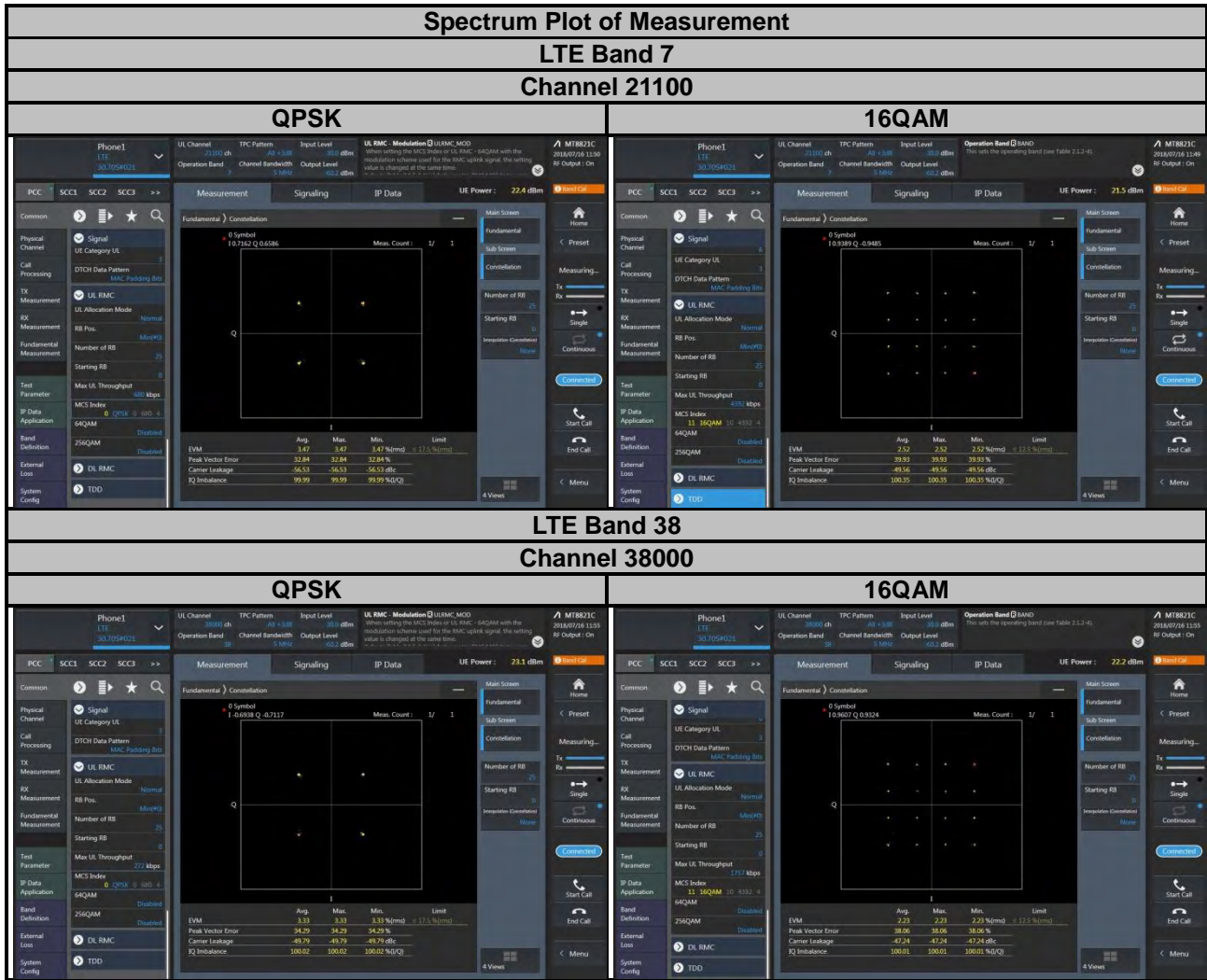

4.3 Frequency Stability Measurement

4.3.1 Limits of Frequency Stability Measurement

According to the FCC part 2.1055 shall be tested the frequency stability. The rule is defined that "The frequency stability shall be sufficient to ensure that the fundamental emission stays within the authorized frequency block." The test extreme voltage is according to the 2.1055(d)(1) Vary primary supply voltage from 85 to 115 percent of the nominal value for other than hand carried battery equipment and the extreme temperature rule is comply with specification of EUT $-30^{\circ}\text{C} \sim 50^{\circ}\text{C}$.

4.3.2 Test Procedure

- Device is placed at the oven room. The oven room could control the temperatures and humidity. Power warm up is at least 15 min and power applied should perform before recording frequency error.
- EUT is connected the external power supply to control the DC input power. The test voltage range is from minimum to maximum working voltage. Each step shall be record the frequency error rate.
- The temperature range step is 10 degrees in this test items. All temperature levels shall be hold the $\pm 0.5^{\circ}\text{C}$ during the measurement testing. The each temperature step shall be at least 0.5 hours, consider the EUT could be test under the stability condition.

NOTE: The frequency error was recorded frequency error from the communication simulator.

4.3.3 Test Setup

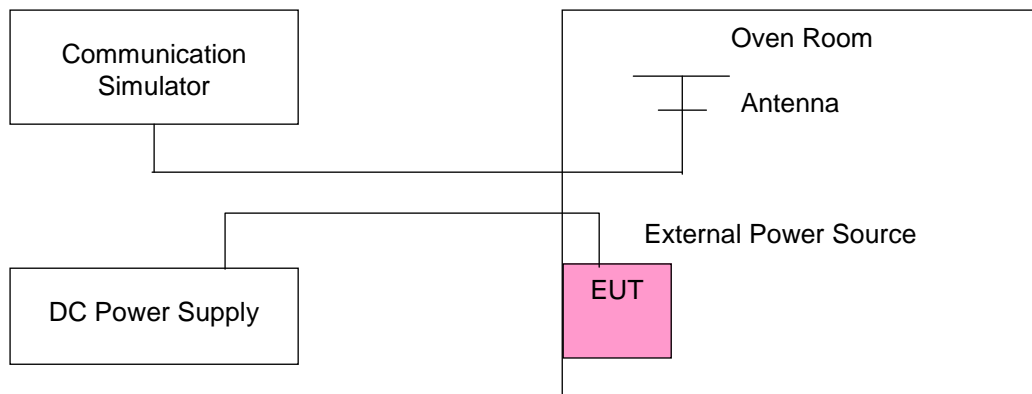

4.3.4 Test Results

Frequency Error vs. Voltage

Voltage (Volts)	LTE Band 7				Limit (ppm)
	Channel Bandwidth: 5 MHz				
	Low Channel		High Channel		
	Frequency (MHz)	Frequency Error (ppm)	Frequency (MHz)	Frequency Error (ppm)	
3.85	2502.500002	0.0008	2567.500003	0.0010	2.5
3.27	2502.500001	0.0005	2567.500001	0.0005	2.5
4.42	2502.500002	0.0008	2567.500002	0.0007	2.5

Note: The applicant defined the normal working voltage of the battery is from 3.27 Vdc to 4.42 Vdc.

Frequency Error vs. Temperature

Temp. (°C)	LTE Band 7				Limit (ppm)
	Channel Bandwidth: 5 MHz				
	Low Channel		High Channel		
	Frequency (MHz)	Frequency Error (ppm)	Frequency (MHz)	Frequency Error (ppm)	
-30	2502.500003	0.0011	2567.500002	0.0006	2.5
-20	2502.500002	0.0007	2567.500003	0.0011	2.5
-10	2502.500004	0.0014	2567.500002	0.0009	2.5
0	2502.500003	0.0010	2567.500001	0.0004	2.5
10	2502.500002	0.0008	2567.500002	0.0007	2.5
20	2502.499999	-0.0005	2567.499996	-0.0015	2.5
30	2502.499998	-0.0010	2567.499999	-0.0005	2.5
40	2502.499998	-0.0007	2567.499999	-0.0004	2.5
50	2502.499997	-0.0012	2567.499998	-0.0007	2.5
55	2502.499997	-0.0013	2567.499997	-0.0013	2.5

Frequency Error vs. Voltage

Voltage (Volts)	LTE Band 7				Limit (ppm)
	Channel Bandwidth: 10 MHz				
	Low Channel		High Channel		
	Frequency (MHz)	Frequency Error (ppm)	Frequency (MHz)	Frequency Error (ppm)	
3.85	2505.000002	0.0008	2565.000003	0.0012	2.5
3.27	2505.000002	0.0009	2565.000001	0.0005	2.5
4.42	2505.000002	0.0008	2565.000001	0.0005	2.5

Note: The applicant defined the normal working voltage of the battery is from 3.27 Vdc to 4.42 Vdc.

Frequency Error vs. Temperature

Temp. (°C)	LTE Band 7				Limit (ppm)
	Channel Bandwidth: 10 MHz				
	Low Channel		High Channel		
	Frequency (MHz)	Frequency Error (ppm)	Frequency (MHz)	Frequency Error (ppm)	
-30	2505.000004	0.0014	2565.000002	0.0006	2.5
-20	2505.000002	0.0008	2565.000001	0.0004	2.5
-10	2505.000004	0.0015	2565.000004	0.0015	2.5
0	2505.000001	0.0004	2565.000001	0.0005	2.5
10	2505.000002	0.0007	2565.000004	0.0015	2.5
20	2504.999996	-0.0015	2564.999998	-0.0007	2.5
30	2504.999997	-0.0010	2564.999999	-0.0004	2.5
40	2504.999997	-0.0010	2564.999997	-0.0013	2.5
50	2504.999996	-0.0016	2564.999998	-0.0008	2.5
55	2504.999997	-0.0013	2564.999998	-0.0008	2.5

Frequency Error vs. Voltage

Voltage (Volts)	LTE Band 7				Limit (ppm)
	Channel Bandwidth: 15 MHz				
	Low Channel		High Channel		
	Frequency (MHz)	Frequency Error (ppm)	Frequency (MHz)	Frequency Error (ppm)	
3.85	2507.500004	0.0015	2562.500002	0.0006	2.5
3.27	2507.500001	0.0004	2562.500002	0.0009	2.5
4.42	2507.500002	0.0008	2562.500001	0.0005	2.5

Note: The applicant defined the normal working voltage of the battery is from 3.27 Vdc to 4.42 Vdc.

Frequency Error vs. Temperature

Temp. (°C)	LTE Band 7				Limit (ppm)
	Channel Bandwidth: 15 MHz				
	Low Channel		High Channel		
	Frequency (MHz)	Frequency Error (ppm)	Frequency (MHz)	Frequency Error (ppm)	
-30	2507.500002	0.0008	2562.500003	0.0011	2.5
-20	2507.500003	0.0012	2562.500003	0.0013	2.5
-10	2507.500003	0.0010	2562.500003	0.0012	2.5
0	2507.500002	0.0007	2562.500003	0.0011	2.5
10	2507.500002	0.0009	2562.500002	0.0007	2.5
20	2507.499997	-0.0011	2562.499998	-0.0006	2.5
30	2507.499996	-0.0016	2562.499999	-0.0005	2.5
40	2507.499997	-0.0013	2562.499996	-0.0016	2.5
50	2507.499999	-0.0006	2562.499997	-0.0012	2.5
55	2507.499996	-0.0014	2562.499998	-0.0007	2.5

Frequency Error vs. Voltage

Voltage (Volts)	LTE Band 7				Limit (ppm)
	Channel Bandwidth: 20 MHz				
	Low Channel		High Channel		
	Frequency (MHz)	Frequency Error (ppm)	Frequency (MHz)	Frequency Error (ppm)	
3.85	2510.000003	0.0012	2560.000003	0.0010	2.5
3.27	2510.000003	0.0012	2560.000001	0.0004	2.5
4.42	2510.000004	0.0015	2560.000002	0.0007	2.5

Note: The applicant defined the normal working voltage of the battery is from 3.27 Vdc to 4.42 Vdc.

Frequency Error vs. Temperature

Temp. (°C)	LTE Band 7				Limit (ppm)
	Channel Bandwidth: 20 MHz				
	Low Channel		High Channel		
	Frequency (MHz)	Frequency Error (ppm)	Frequency (MHz)	Frequency Error (ppm)	
-30	2510.000001	0.0005	2560.000001	0.0005	2.5
-20	2510.000002	0.0009	2560.000001	0.0004	2.5
-10	2510.000003	0.0013	2560.000003	0.0012	2.5
0	2510.000003	0.0012	2560.000003	0.0010	2.5
10	2510.000002	0.0007	2560.000001	0.0005	2.5
20	2509.999999	-0.0004	2559.999997	-0.0010	2.5
30	2509.999997	-0.0014	2559.999996	-0.0015	2.5
40	2509.999997	-0.0011	2559.999999	-0.0005	2.5
50	2509.999997	-0.0014	2559.999998	-0.0010	2.5
55	2509.999998	-0.0006	2559.999996	-0.0016	2.5

Frequency Error vs. Voltage

Voltage (Volts)	LTE Band 38				Limit (ppm)
	Channel Bandwidth: 5 MHz				
	Low Channel		High Channel		
	Frequency (MHz)	Frequency Error (ppm)	Frequency (MHz)	Frequency Error (ppm)	
3.85	2572.500004	0.0014	2617.500002	0.0008	2.5
3.27	2572.500004	0.0014	2617.500003	0.0011	2.5
4.42	2572.500003	0.0012	2617.500002	0.0008	2.5

Note: The applicant defined the normal working voltage of the battery is from 3.27 Vdc to 4.42 Vdc.

Frequency Error vs. Temperature

Temp. (°C)	LTE Band 38				Limit (ppm)
	Channel Bandwidth: 5 MHz				
	Low Channel		High Channel		
	Frequency (MHz)	Frequency Error (ppm)	Frequency (MHz)	Frequency Error (ppm)	
-30	2572.500001	0.0005	2617.500002	0.0006	2.5
-20	2572.500001	0.0005	2617.500001	0.0005	2.5
-10	2572.500004	0.0014	2617.500002	0.0006	2.5
0	2572.500004	0.0015	2617.500004	0.0015	2.5
10	2572.500002	0.0008	2617.500004	0.0014	2.5
20	2572.499996	-0.0014	2617.499998	-0.0008	2.5
30	2572.499997	-0.0012	2617.499998	-0.0006	2.5
40	2572.499997	-0.0012	2617.499997	-0.0010	2.5
50	2572.499997	-0.0012	2617.499997	-0.0013	2.5
55	2572.499999	-0.0005	2617.499998	-0.0009	2.5

Frequency Error vs. Voltage

Voltage (Volts)	LTE Band 38				Limit (ppm)
	Channel Bandwidth: 10 MHz				
	Low Channel		High Channel		
	Frequency (MHz)	Frequency Error (ppm)	Frequency (MHz)	Frequency Error (ppm)	
3.85	2575.000001	0.0005	2615.000002	0.0008	2.5
3.27	2575.000002	0.0009	2615.000002	0.0009	2.5
4.42	2575.000003	0.0012	2615.000003	0.0011	2.5

Note: The applicant defined the normal working voltage of the battery is from 3.27 Vdc to 4.42 Vdc.

Frequency Error vs. Temperature

Temp. (°C)	LTE Band 38				Limit (ppm)
	Channel Bandwidth: 10 MHz				
	Low Channel		High Channel		
	Frequency (MHz)	Frequency Error (ppm)	Frequency (MHz)	Frequency Error (ppm)	
-30	2575.000002	0.0007	2615.000003	0.0012	2.5
-20	2575.000002	0.0008	2615.000003	0.0010	2.5
-10	2575.000002	0.0007	2615.000004	0.0014	2.5
0	2575.000003	0.0013	2615.000004	0.0014	2.5
10	2575.000002	0.0007	2615.000002	0.0007	2.5
20	2574.999999	-0.0005	2614.999997	-0.0013	2.5
30	2574.999997	-0.0013	2614.999997	-0.0013	2.5
40	2574.999998	-0.0010	2614.999997	-0.0010	2.5
50	2574.999999	-0.0005	2614.999997	-0.0012	2.5
55	2574.999997	-0.0010	2614.999999	-0.0005	2.5

Frequency Error vs. Voltage

Voltage (Volts)	LTE Band 38				Limit (ppm)
	Channel Bandwidth: 15 MHz				
	Low Channel		High Channel		
	Frequency (MHz)	Frequency Error (ppm)	Frequency (MHz)	Frequency Error (ppm)	
3.85	2577.500003	0.0011	2612.500003	0.0010	2.5
3.27	2577.500004	0.0015	2612.500003	0.0011	2.5
4.42	2577.500001	0.0005	2612.500002	0.0009	2.5

Note: The applicant defined the normal working voltage of the battery is from 3.27 Vdc to 4.42 Vdc.

Frequency Error vs. Temperature

Temp. (°C)	LTE Band 38				Limit (ppm)
	Channel Bandwidth: 15 MHz				
	Low Channel		High Channel		
	Frequency (MHz)	Frequency Error (ppm)	Frequency (MHz)	Frequency Error (ppm)	
-30	2577.500004	0.0014	2612.500001	0.0005	2.5
-20	2577.500001	0.0004	2612.500004	0.0014	2.5
-10	2577.500004	0.0014	2612.500004	0.0015	2.5
0	2577.500002	0.0007	2612.500003	0.0012	2.5
10	2577.500003	0.0013	2612.500004	0.0014	2.5
20	2577.499997	-0.0011	2612.499997	-0.0013	2.5
30	2577.499998	-0.0008	2612.499998	-0.0009	2.5
40	2577.499999	-0.0005	2612.499998	-0.0007	2.5
50	2577.499997	-0.0013	2612.499998	-0.0010	2.5
55	2577.499997	-0.0013	2612.499998	-0.0006	2.5

Frequency Error vs. Voltage

Voltage (Volts)	LTE Band 38				Limit (ppm)
	Channel Bandwidth: 20 MHz				
	Low Channel		High Channel		
	Frequency (MHz)	Frequency Error (ppm)	Frequency (MHz)	Frequency Error (ppm)	
3.85	2580.000004	0.0015	2610.000003	0.0011	2.5
3.27	2580.000003	0.0011	2610.000002	0.0007	2.5
4.42	2580.000003	0.0010	2610.000003	0.0011	2.5

Note: The applicant defined the normal working voltage of the battery is from 3.27 Vdc to 4.42 Vdc.

Frequency Error vs. Temperature

Temp. (°C)	LTE Band 38				Limit (ppm)
	Channel Bandwidth: 20 MHz				
	Low Channel		High Channel		
	Frequency (MHz)	Frequency Error (ppm)	Frequency (MHz)	Frequency Error (ppm)	
-30	2580.000001	0.0004	2610.000003	0.0013	2.5
-20	2580.000003	0.0012	2610.000002	0.0008	2.5
-10	2580.000002	0.0009	2610.000004	0.0014	2.5
0	2580.000002	0.0008	2610.000002	0.0009	2.5
10	2580.000002	0.0007	2610.000004	0.0015	2.5
20	2579.999998	-0.0006	2609.999996	-0.0014	2.5
30	2579.999996	-0.0016	2609.999997	-0.0011	2.5
40	2579.999998	-0.0008	2609.999998	-0.0007	2.5
50	2579.999999	-0.0005	2609.999997	-0.0010	2.5
55	2579.999997	-0.0011	2609.999996	-0.0014	2.5

4.4 Occupied Bandwidth Measurement

4.4.1 Limits of Occupied Bandwidth Measurement

The width of a frequency band such that, below the lower and above the upper frequency limits, the mean powers emitted are each equal to a specified percentage 0.5 % of the total mean power of a given emission.

4.4.2 Test Procedure

- The conducted occupied bandwidth used the power splitter via EUT RF power connector between simulation base station and spectrum analyzer.
- Use OBW measurement function of Spectrum analyzer to measure 99 % occupied bandwidth.

4.4.3 Test Setup

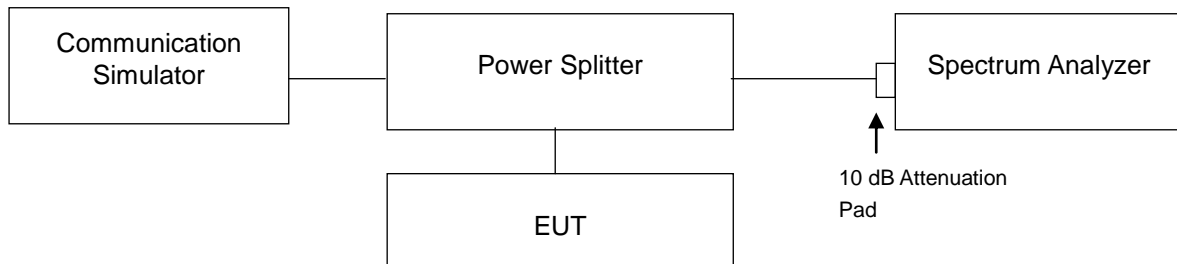

4.4.4 Test Results

LTE Band 7							
Channel Bandwidth: 5 MHz				Channel Bandwidth: 10 MHz			
Channel	Frequency (MHz)	99 % Occupied Bandwidth (MHz)		Channel	Frequency (MHz)	99 % Occupied Bandwidth (MHz)	
		QPSK	16QAM			QPSK	16QAM
20775	2502.5	4.4923	4.4956	20800	2505.0	8.9616	8.9689
21100	2535.0	4.4939	4.4944	21100	2535.0	8.9669	8.9711
21425	2567.5	4.4926	4.4933	21400	2565.0	8.9628	8.9650

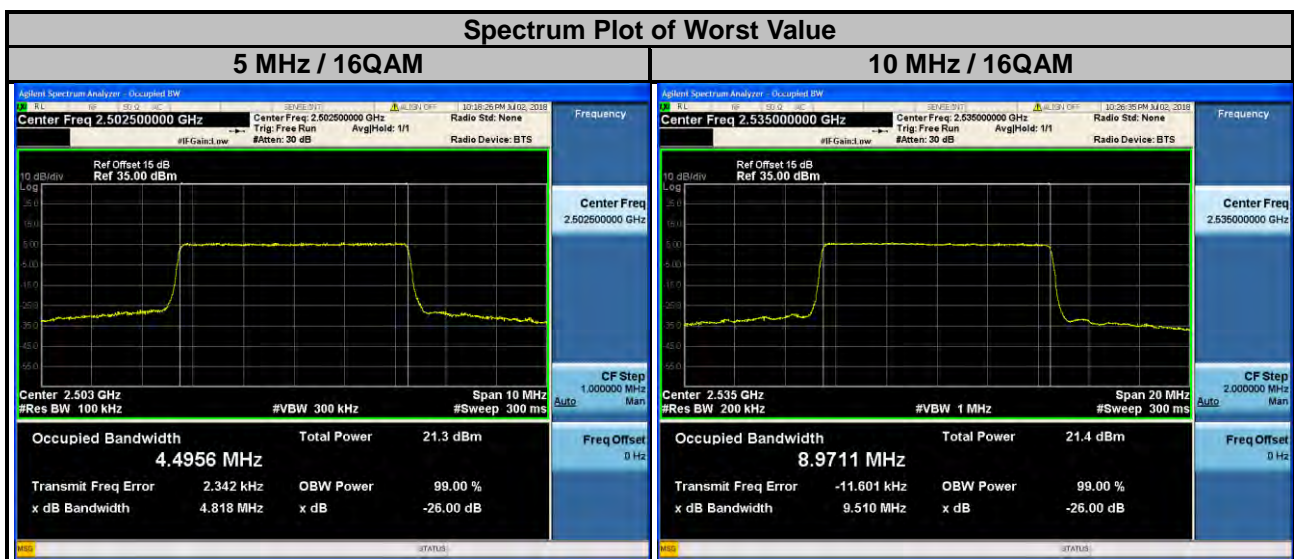

LTE Band 7

Channel Bandwidth: 15 MHz				Channel Bandwidth: 20 MHz			
Channel	Frequency (MHz)	99 % Occupied Bandwidth (MHz)		Channel	Frequency (MHz)	99 % Occupied Bandwidth (MHz)	
		QPSK	16QAM			QPSK	16QAM
20825	2507.5	13.443	13.438	20850	2510.0	17.908	17.919
21100	2535.0	13.450	13.439	21100	2535.0	17.914	17.949
21375	2562.5	13.447	13.438	21350	2560.0	17.900	17.918

Spectrum Plot of Worst Value



LTE Band 38

Channel Bandwidth: 5 MHz				Channel Bandwidth: 10 MHz			
Channel	Frequency (MHz)	99 % Occupied Bandwidth (MHz)		Channel	Frequency (MHz)	99 % Occupied Bandwidth (MHz)	
		QPSK	16QAM			QPSK	16QAM
37775	2572.5	4.4902	4.4859	37800	2575.0	8.9522	8.9640
38000	2595.0	4.4911	4.4879	38000	2595.0	8.9555	8.9591
38225	2617.5	4.4926	4.4929	38200	2615.0	8.9607	8.9718

Spectrum Plot of Worst Value

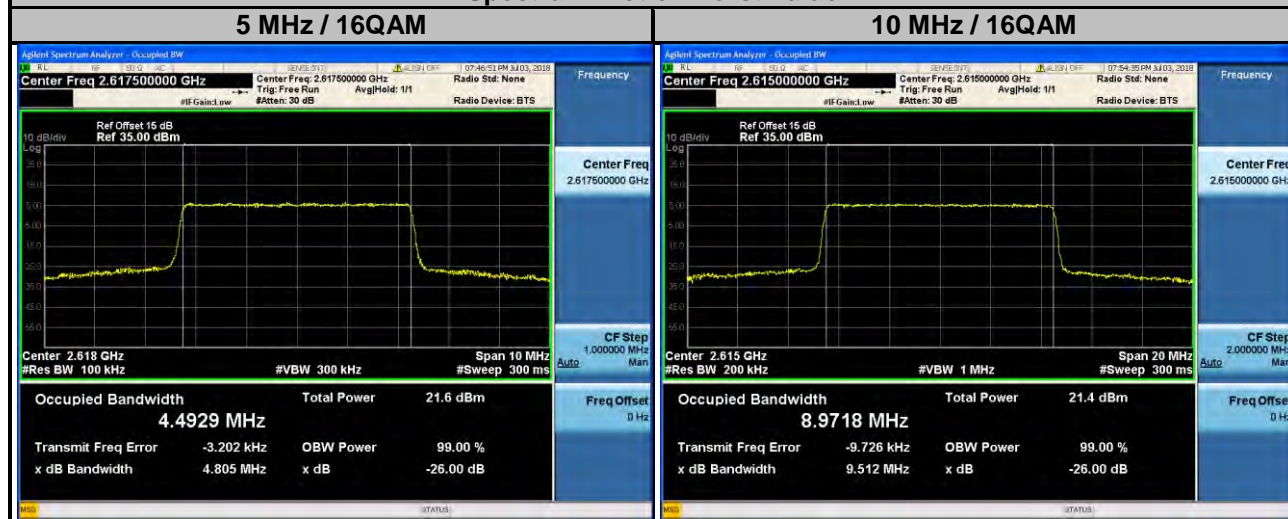

LTE Band 38

Channel Bandwidth: 15 MHz				Channel Bandwidth: 20 MHz			
Channel	Frequency (MHz)	99 % Occupied Bandwidth (MHz)		Channel	Frequency (MHz)	99 % Occupied Bandwidth (MHz)	
		QPSK	16QAM			QPSK	16QAM
37825	2577.5	13.433	13.426	37850	2580.0	17.883	17.878
38000	2595.0	13.439	13.429	38000	2595.0	17.894	17.890
38175	2612.5	13.458	13.450	38150	2610.0	17.932	17.924

Spectrum Plot of Worst Value

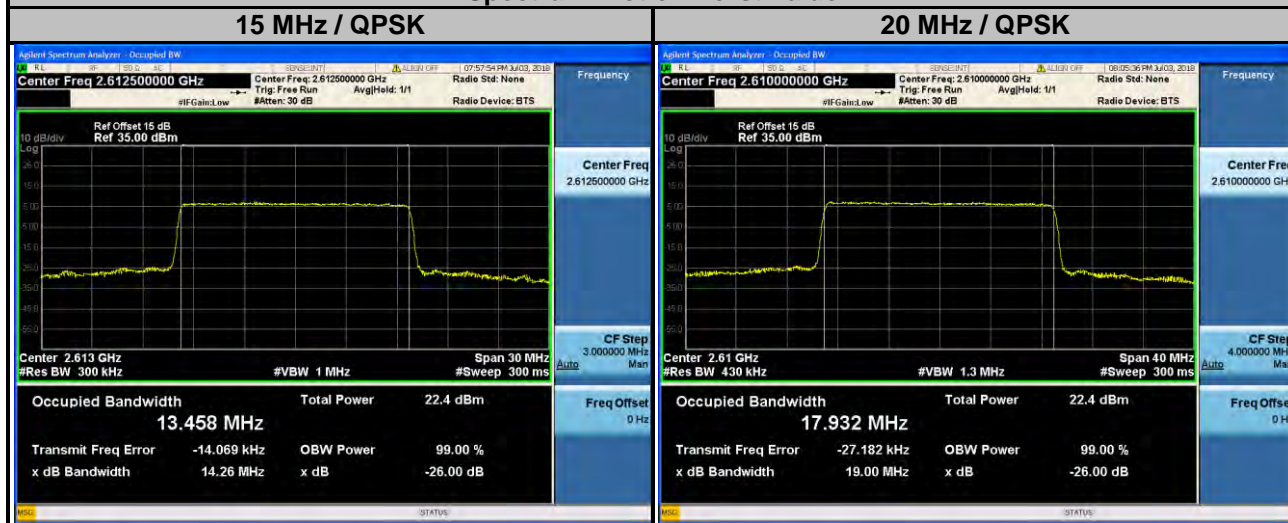

4.5 Out-of-Band Emissions Measurement

4.5.1 Limits of Out-of-Band Emissions Measurement

According to FCC 27.53(l)(4) specified that power of any emission outside of the channel edge must be attenuated below the transmitting power (P) by a factor shall be not less than $40 + 10 \log (P)$ dB on all frequencies between the channel edge and 5 megahertz from the channel edge, $43 + 10 \log (P)$ dB on all frequencies between 5 megahertz and X megahertz from the channel edge, and $55 + 10 \log (P)$ dB on all frequencies more than X megahertz from the channel edge, where X is the greater of 6 megahertz or the actual emission bandwidth. In addition, the attenuation factor shall not be less that $43 + 10 \log (P)$ dB on all frequencies between 2490.5 MHz and 2496 MHz and $55 + 10 \log (P)$ dB at or below 2490.5 MHz. In the 1 MHz bands immediately outside and adjacent to the frequency block a resolution bandwidth of at least two percent may be employed, except when the 1 megahertz band is 2495-2496 MHz, in which case a resolution bandwidth of at least one percent may be employed.

4.5.2 Test Setup

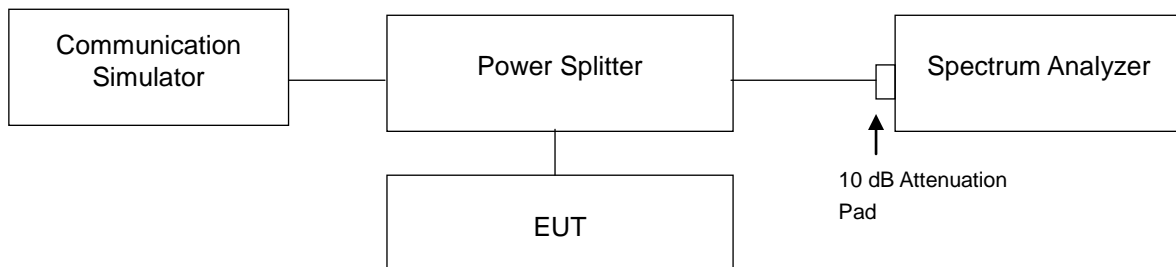

4.5.3 Test Procedures

- The EUT was set up for the maximum peak power with LTE link data modulation. The power was measured with R&S Spectrum Analyzer. All measurements were done at 2 channels (low and high operational frequency range).
- The out-of-band emissions measurement used the power splitter via EUT RF power connector between simulation base station and spectrum analyzer.
- Record the max. trace plot into the test report.

4.5.4 Test Results

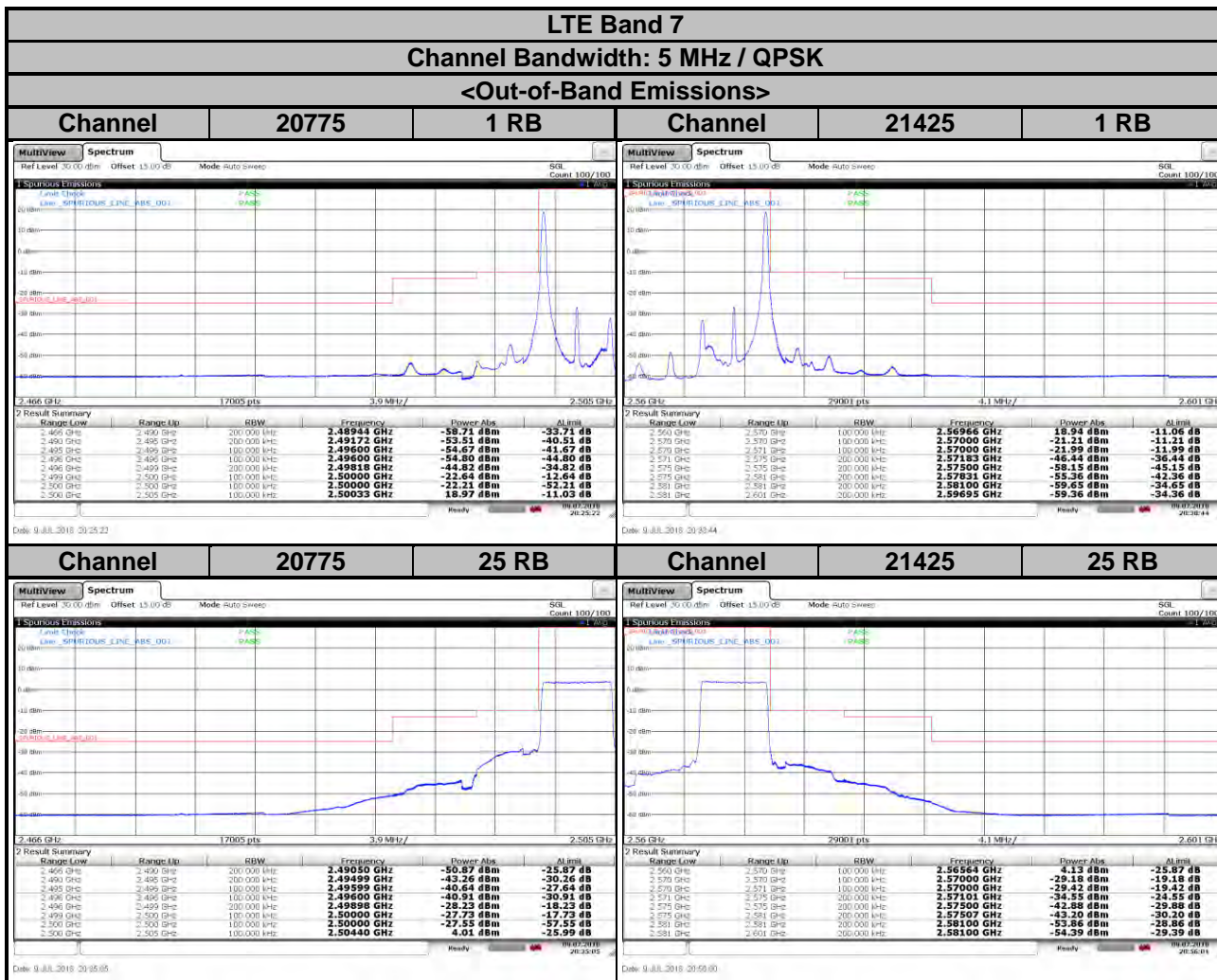

LTE Band 7
Channel Bandwidth: 5 MHz / 16QAM

<Out-of-Band Emissions>

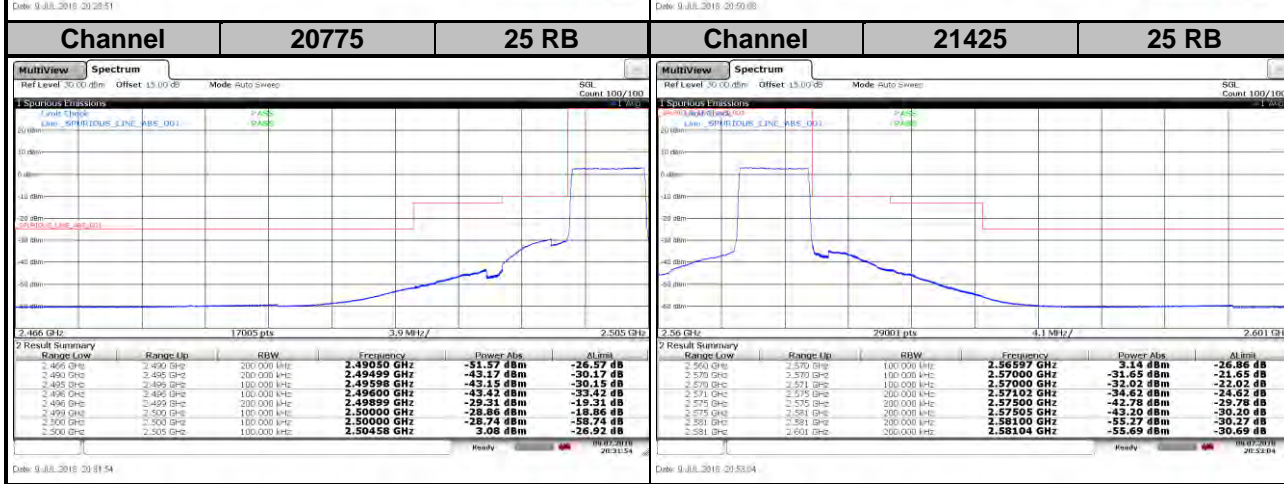
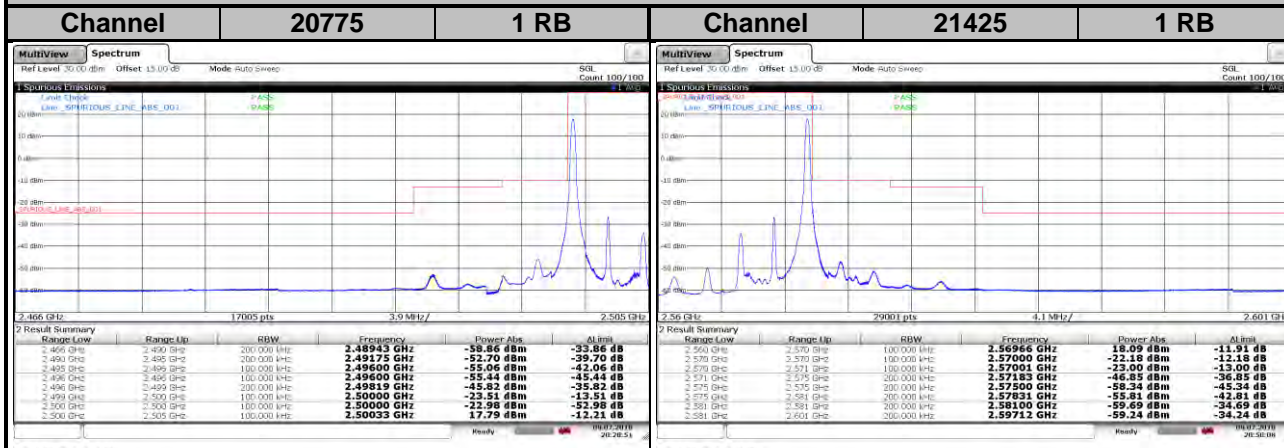

LTE Band 7
Channel Bandwidth: 10 MHz / QPSK

<Out-of-Band Emissions>

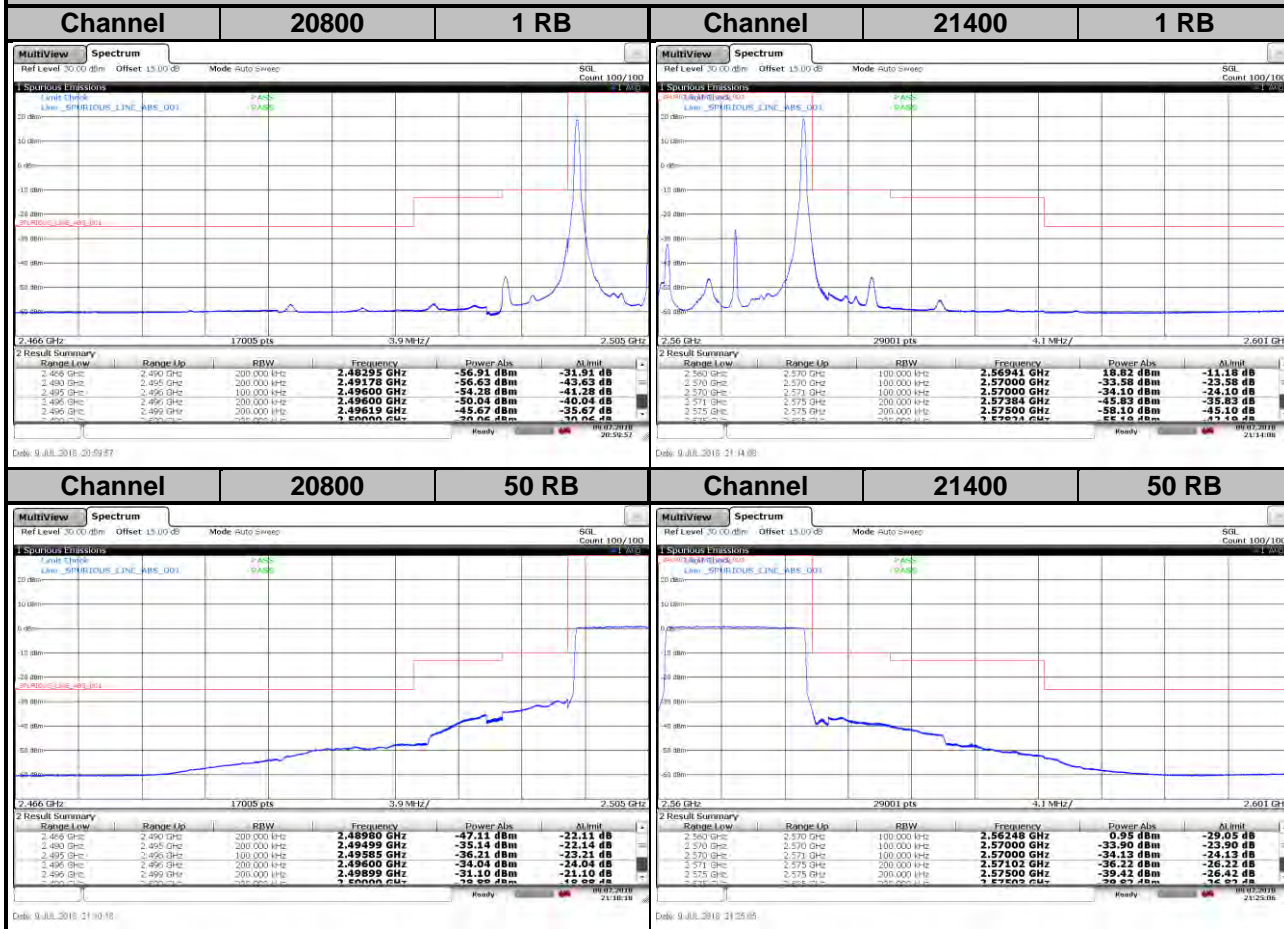

LTE Band 7
Channel Bandwidth: 10 MHz / 16QAM

<Out-of-Band Emissions>

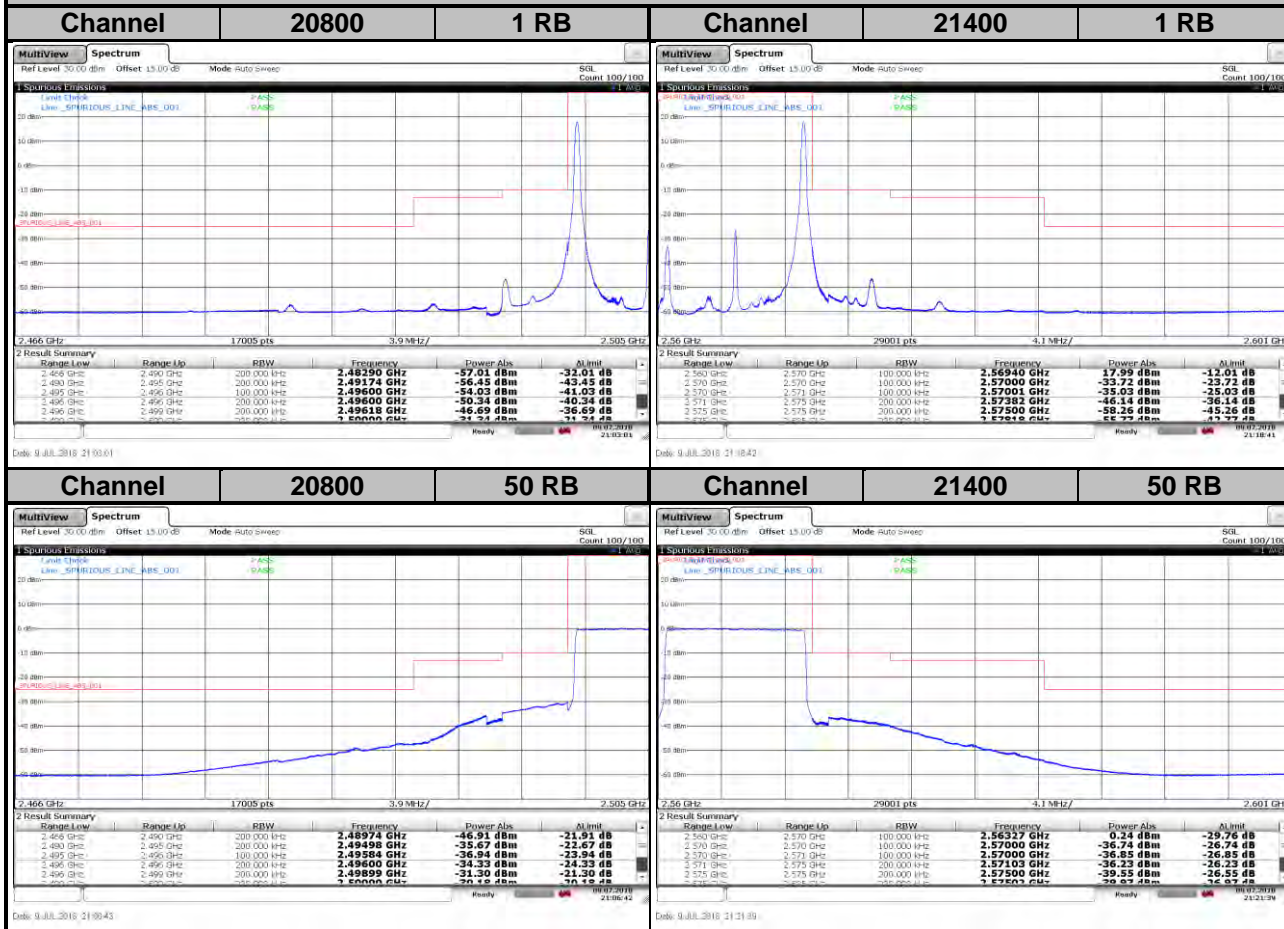

LTE Band 7
Channel Bandwidth: 15 MHz / QPSK

<Out-of-Band Emissions>

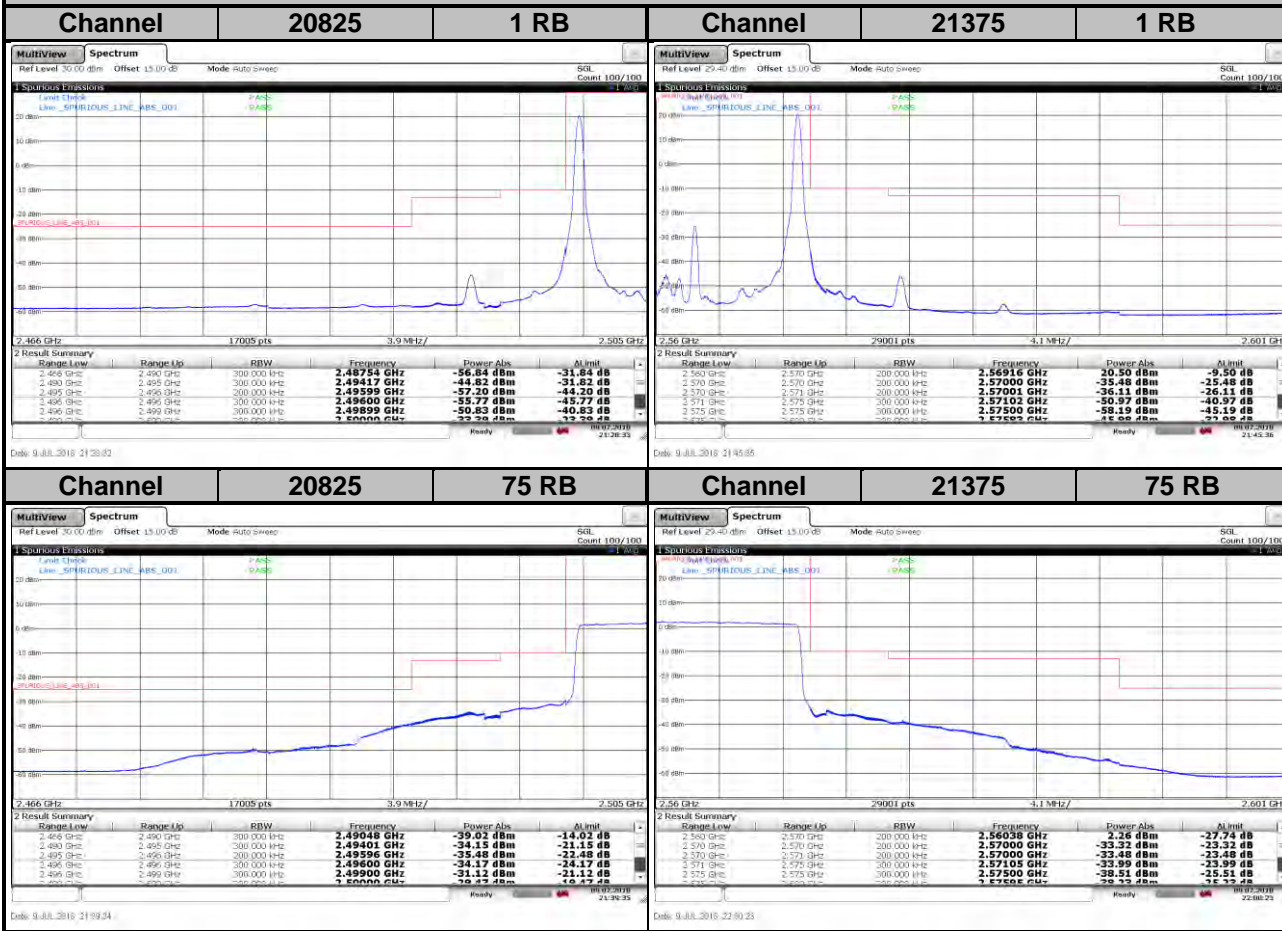

LTE Band 7
Channel Bandwidth: 15 MHz / 16QAM

<Out-of-Band Emissions>

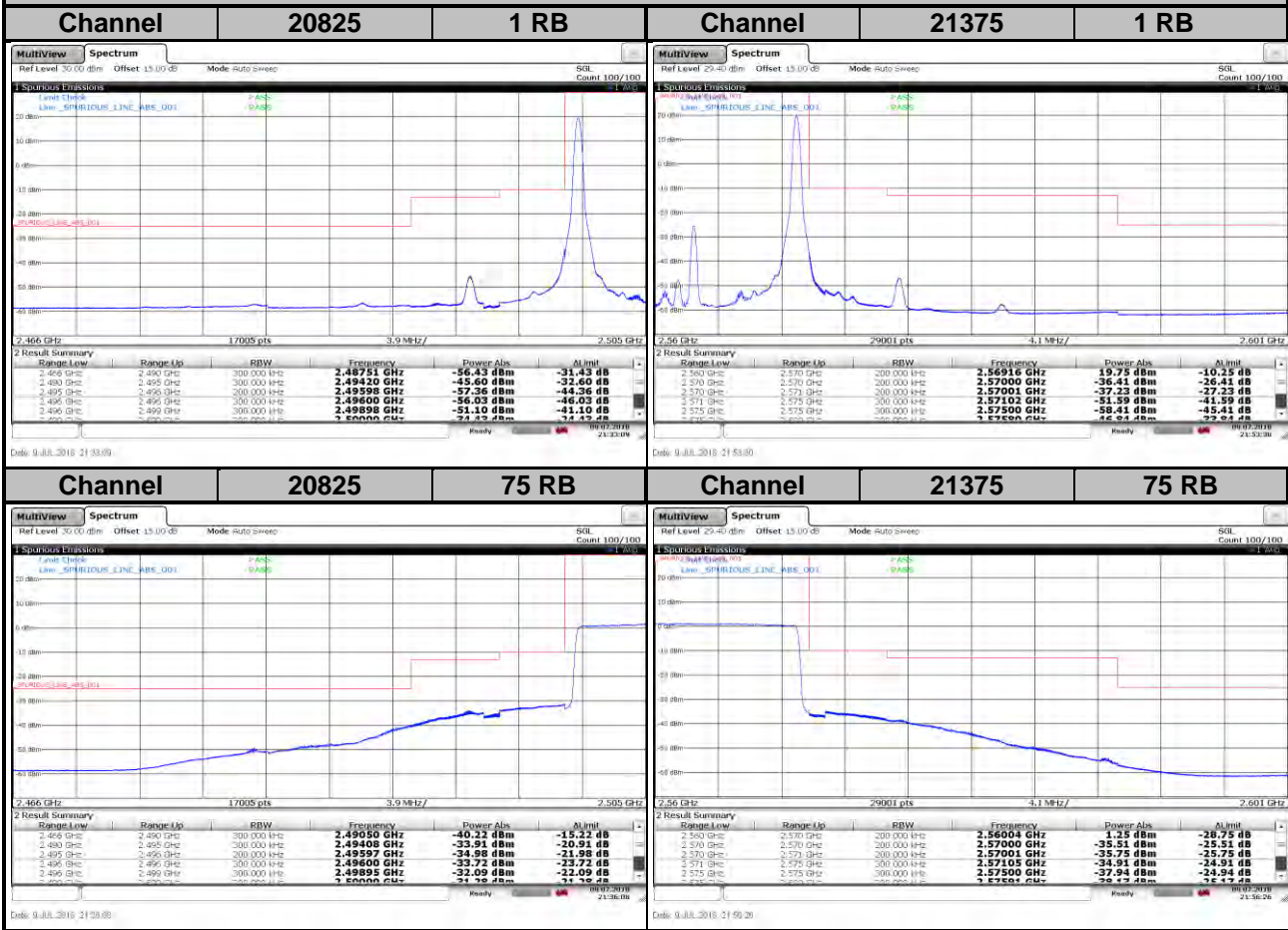

LTE Band 7
Channel Bandwidth: 20 MHz / QPSK

<Out-of-Band Emissions>

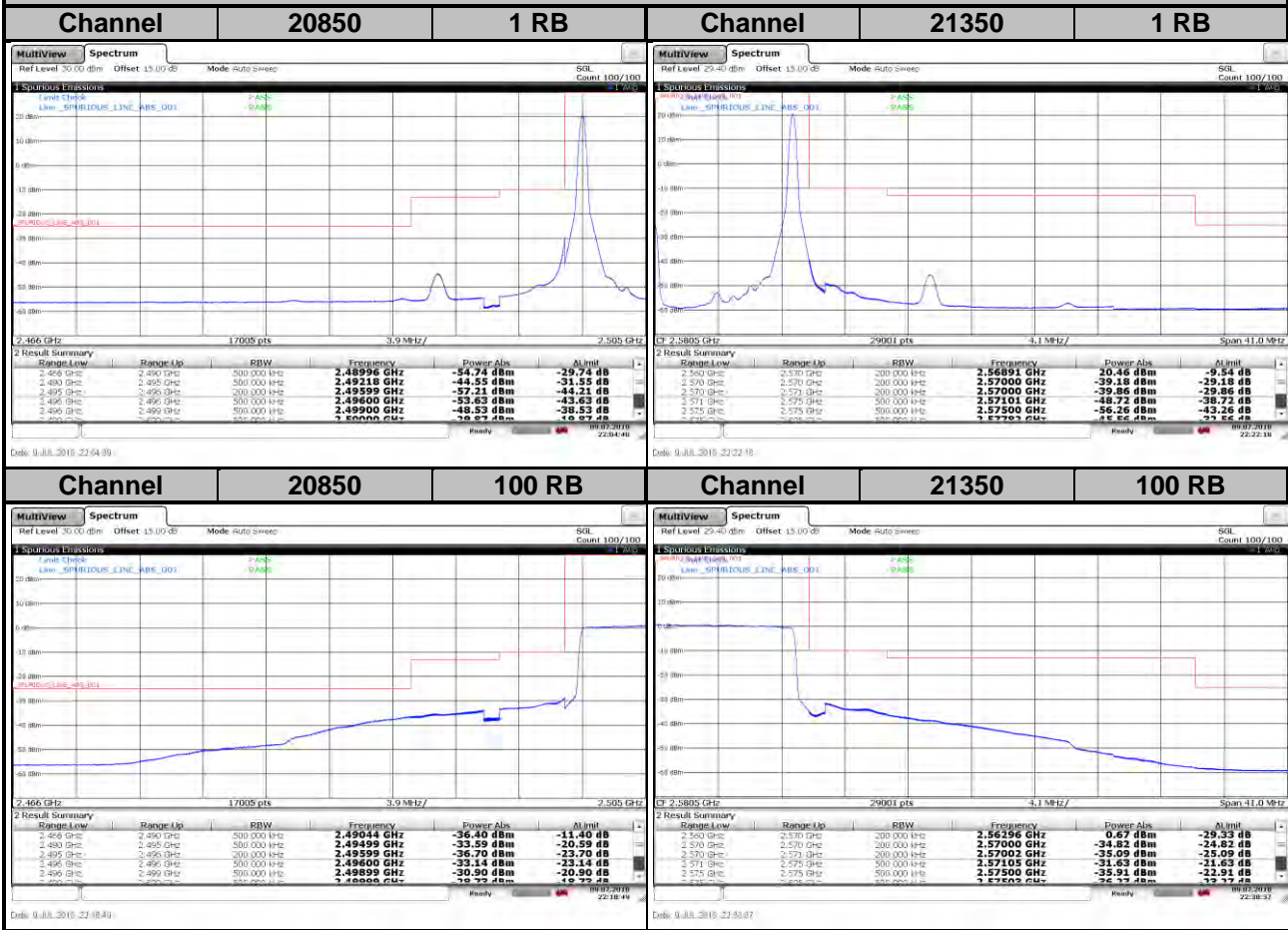

LTE Band 7
Channel Bandwidth: 20 MHz / 16QAM

<Out-of-Band Emissions>

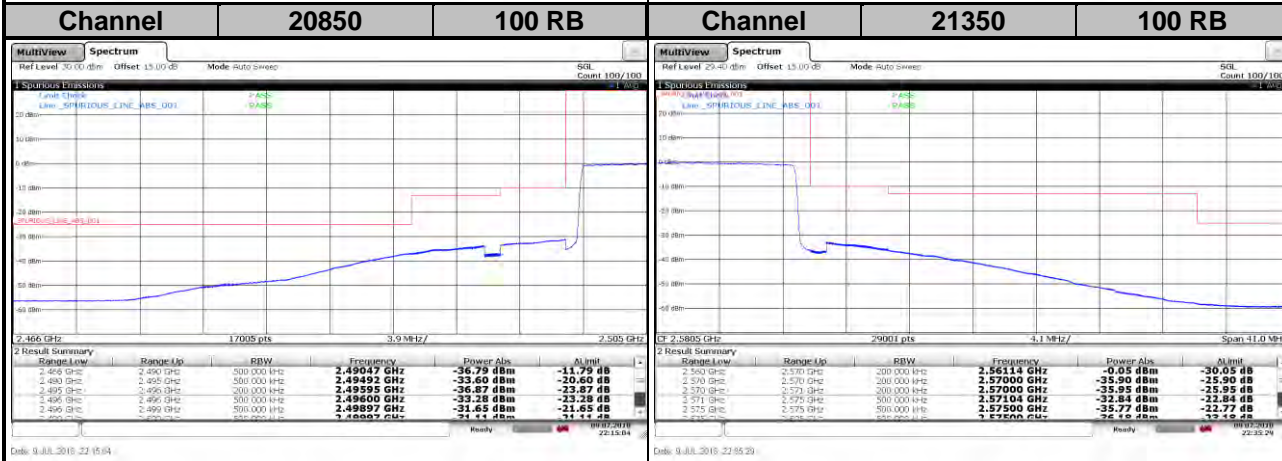
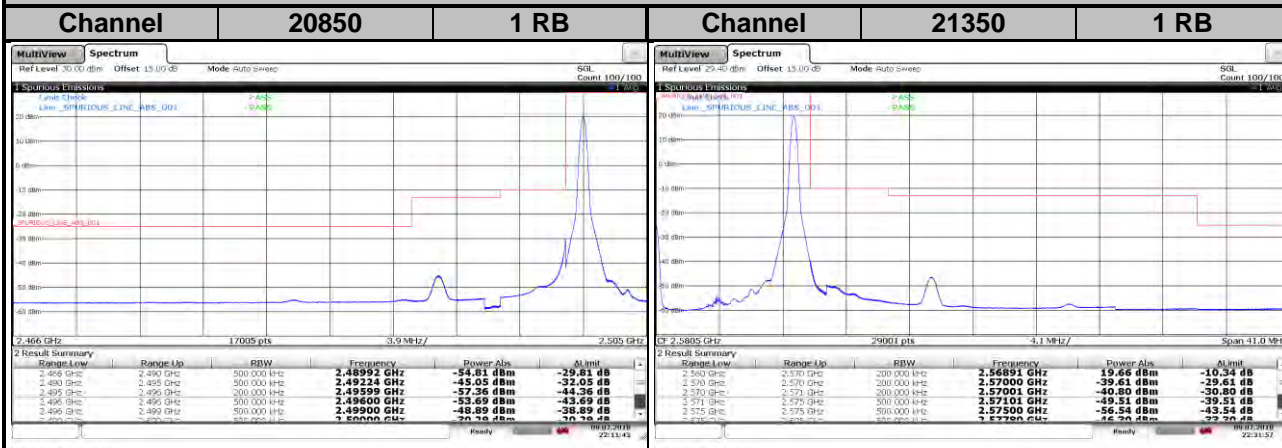

LTE Band 38
Channel Bandwidth: 5 MHz / QPSK
<Out-of-Band Emissions>

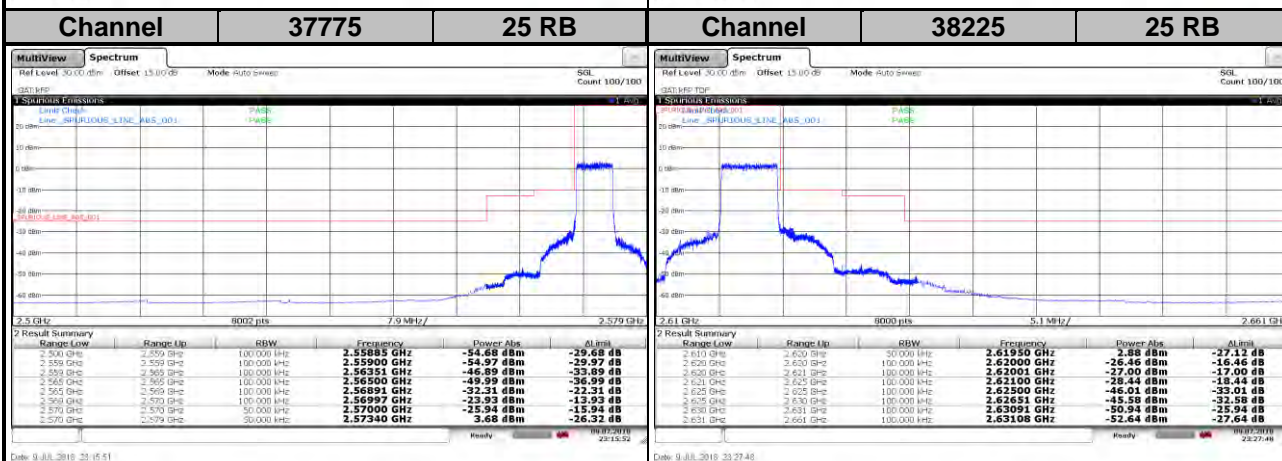
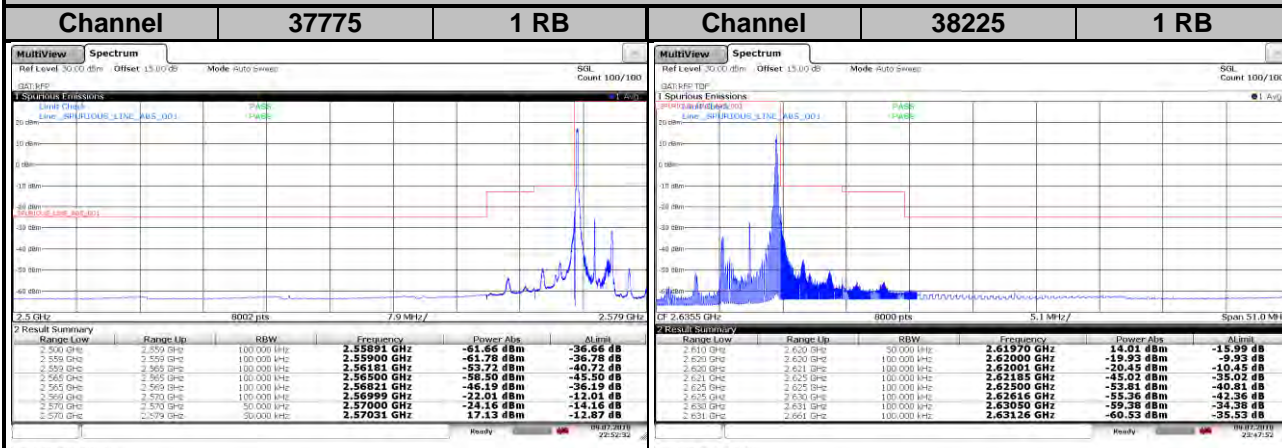

LTE Band 38
Channel Bandwidth: 5 MHz / 16QAM
<Out-of-Band Emissions>

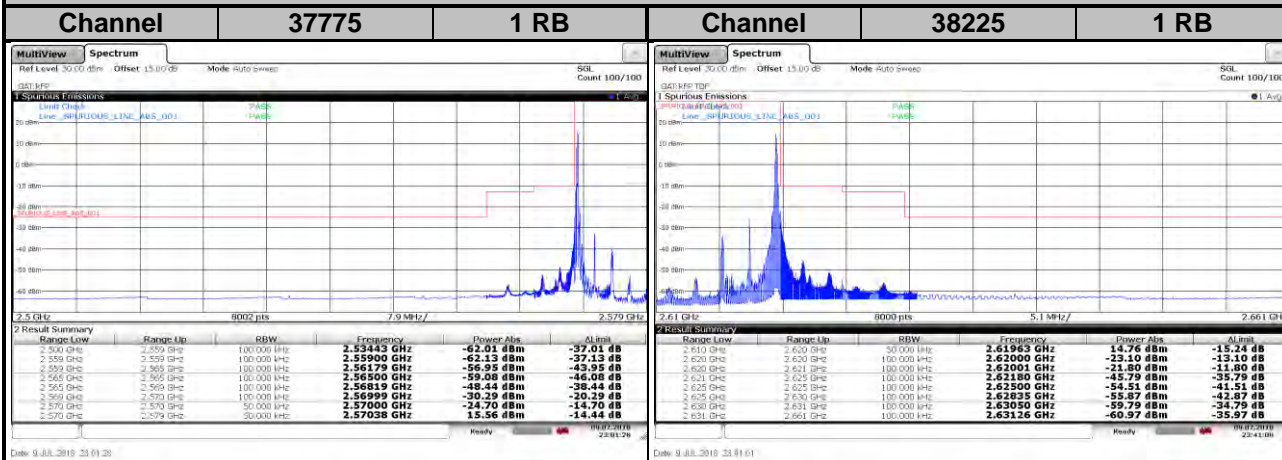

LTE Band 38
Channel Bandwidth: 10 MHz / QPSK

<Out-of-Band Emissions>

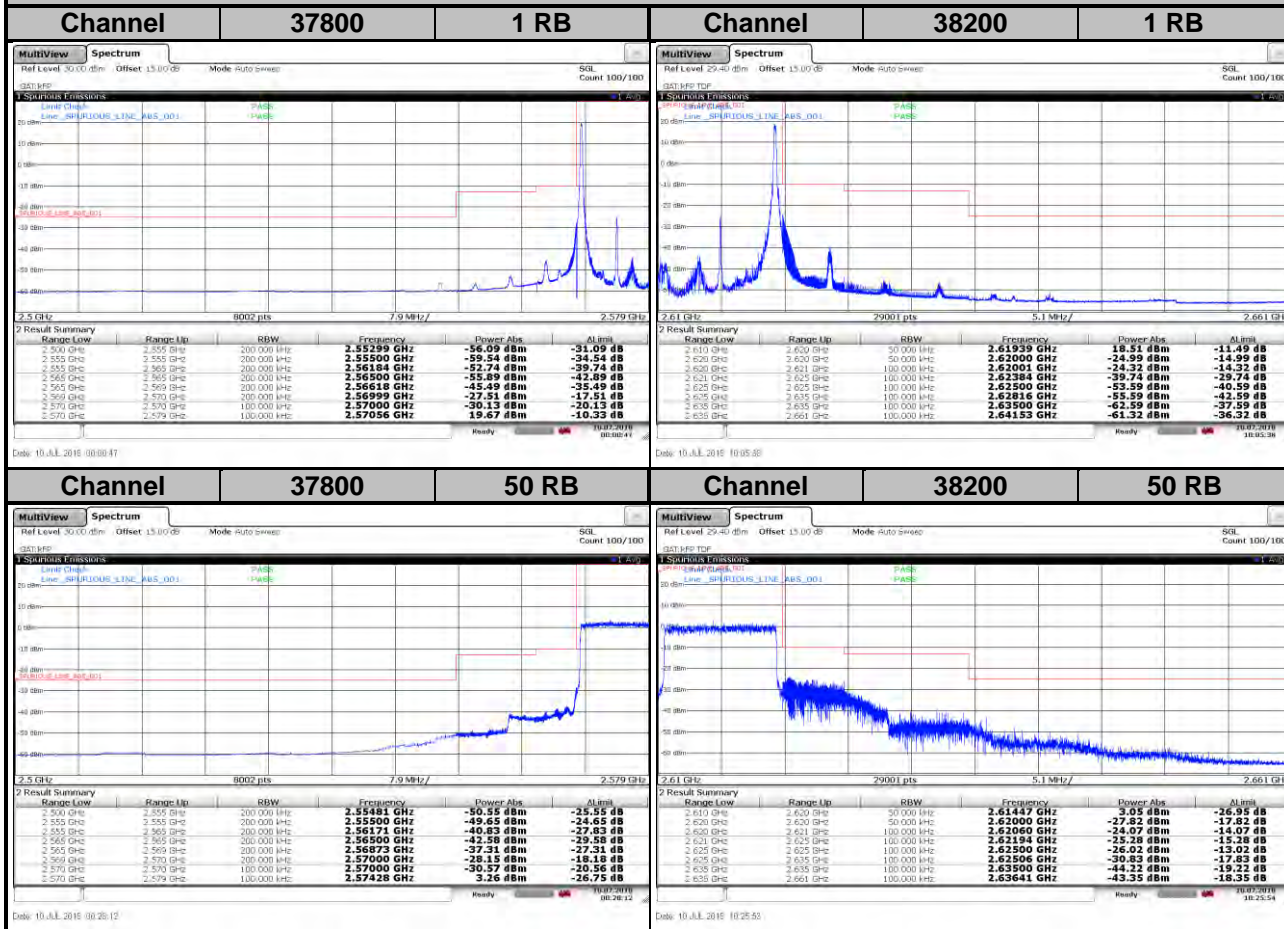

LTE Band 38
Channel Bandwidth: 10 MHz / 16QAM
<Out-of-Band Emissions>

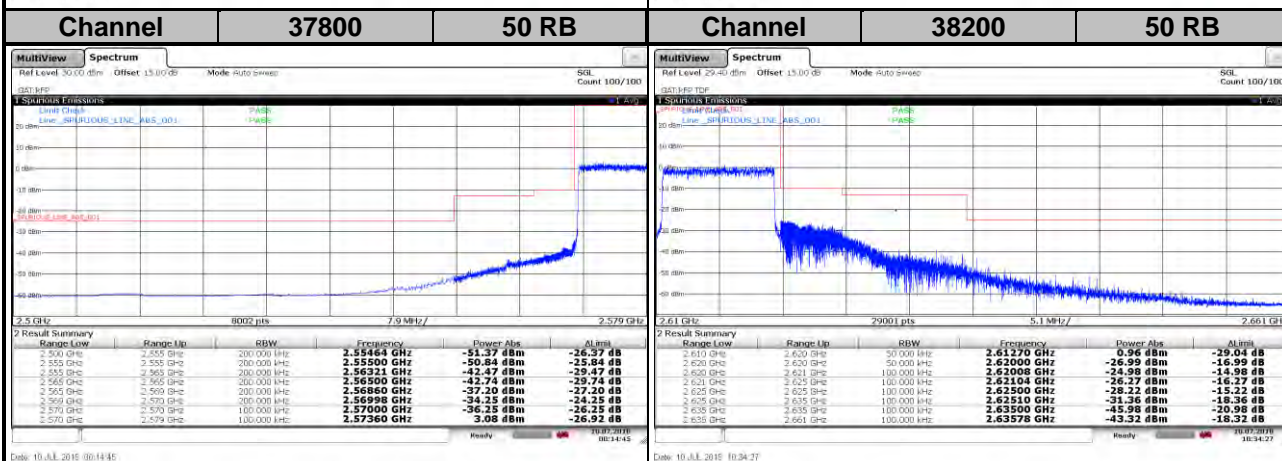
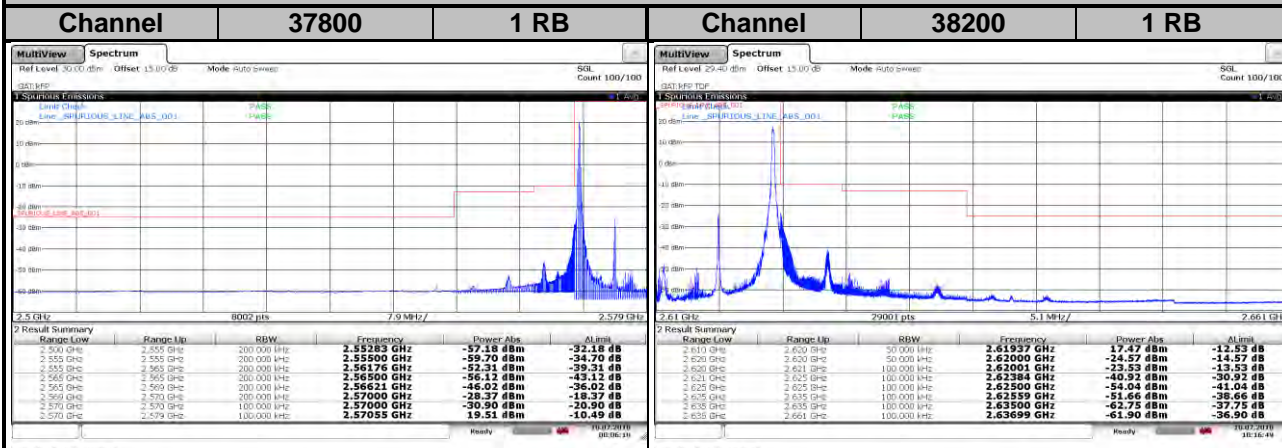

LTE Band 38

Channel Bandwidth: 15 MHz / QPSK

<Out-of-Band Emissions>

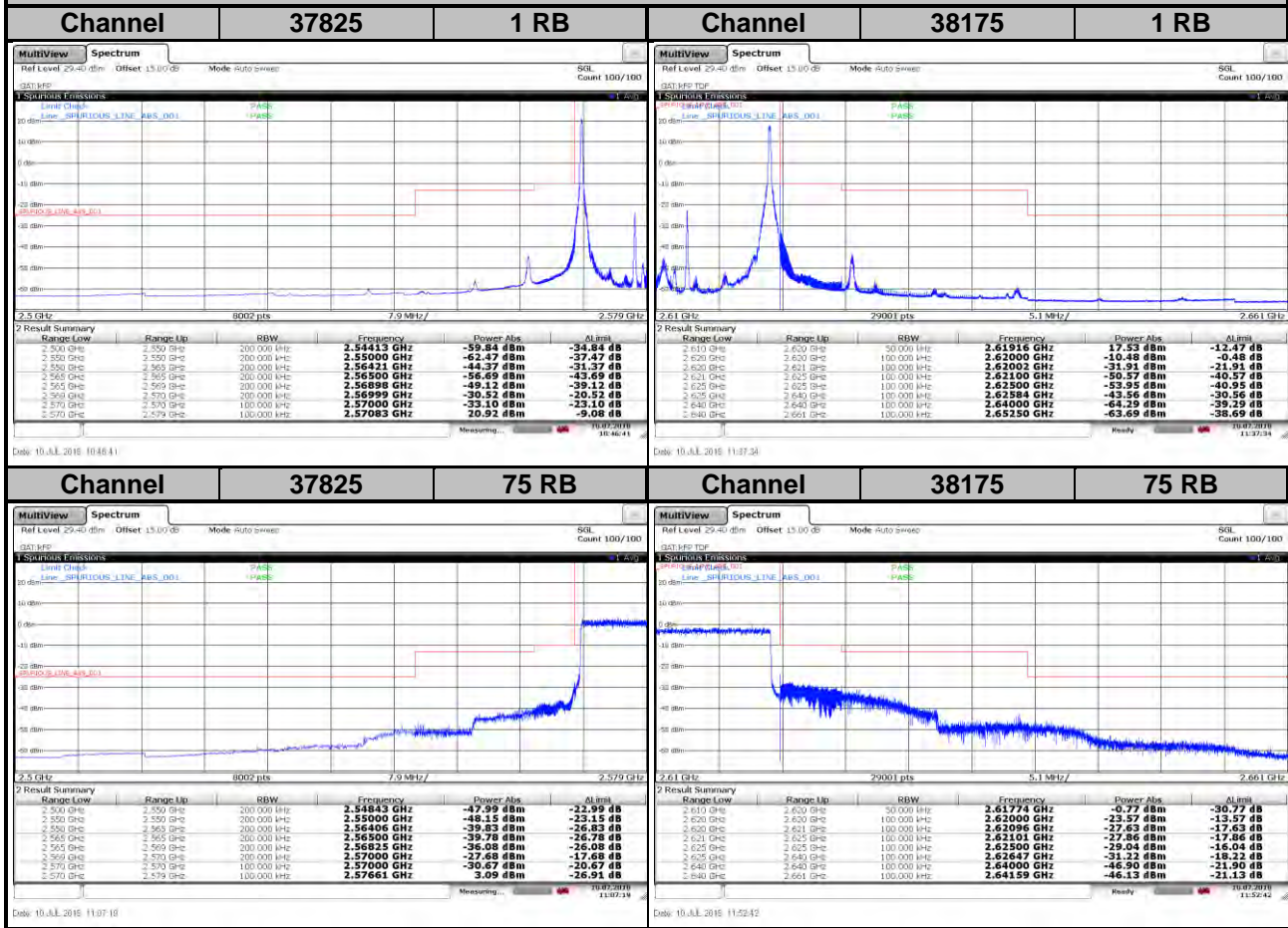

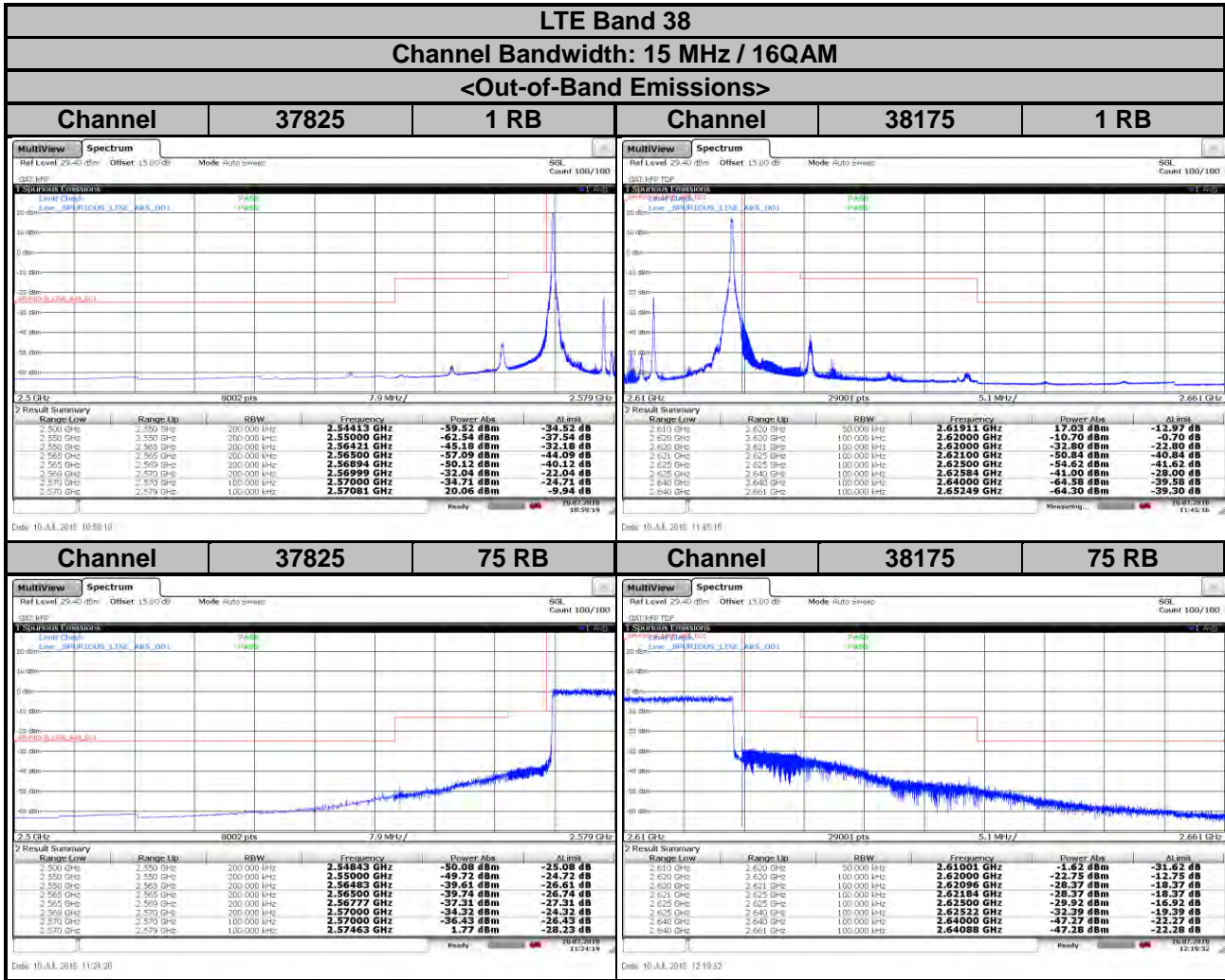

LTE Band 38
Channel Bandwidth: 20 MHz / QPSK

<Out-of-Band Emissions>

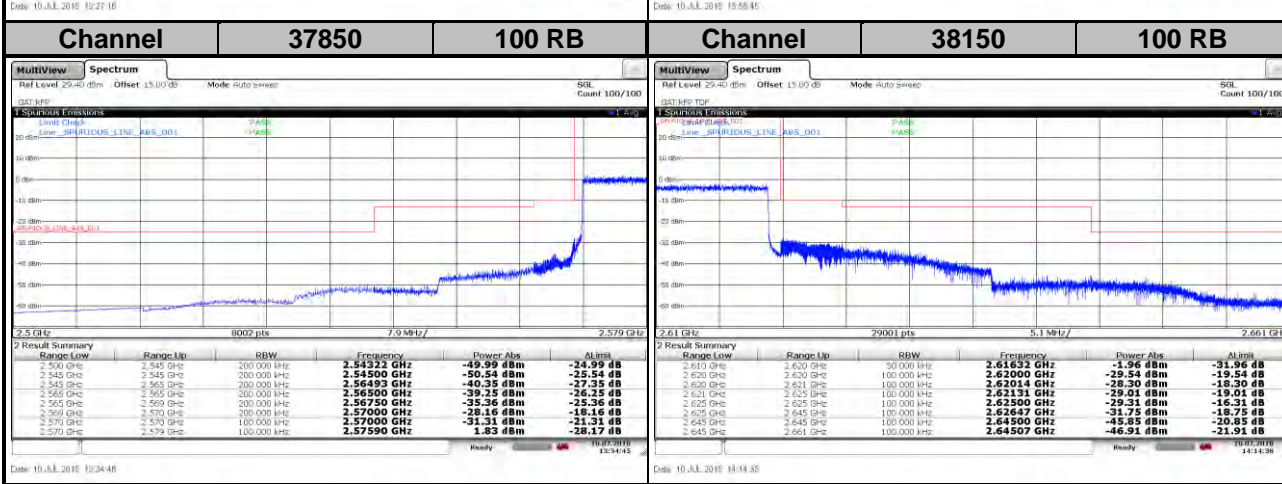
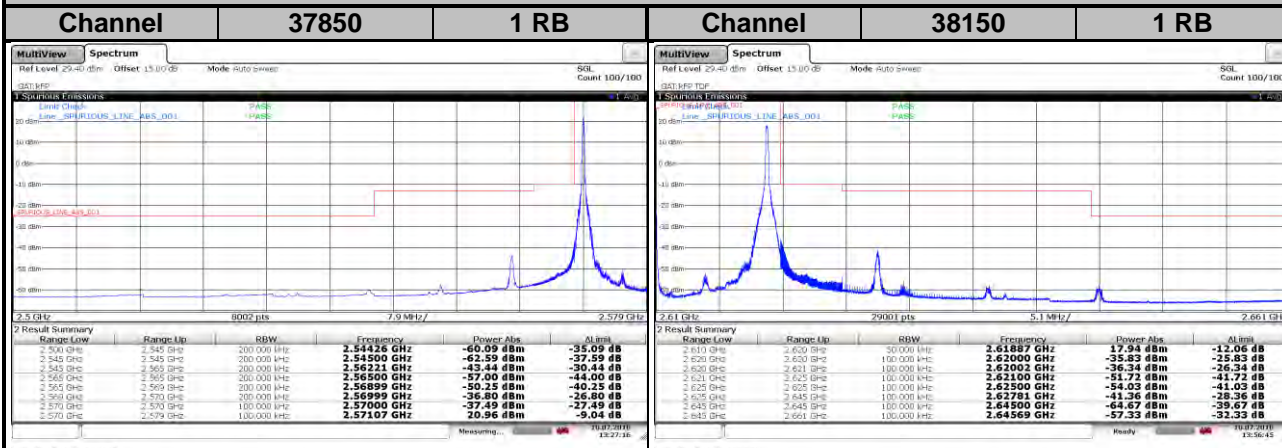

LTE Band 38
Channel Bandwidth: 20 MHz / 16QAM
<Out-of-Band Emissions>

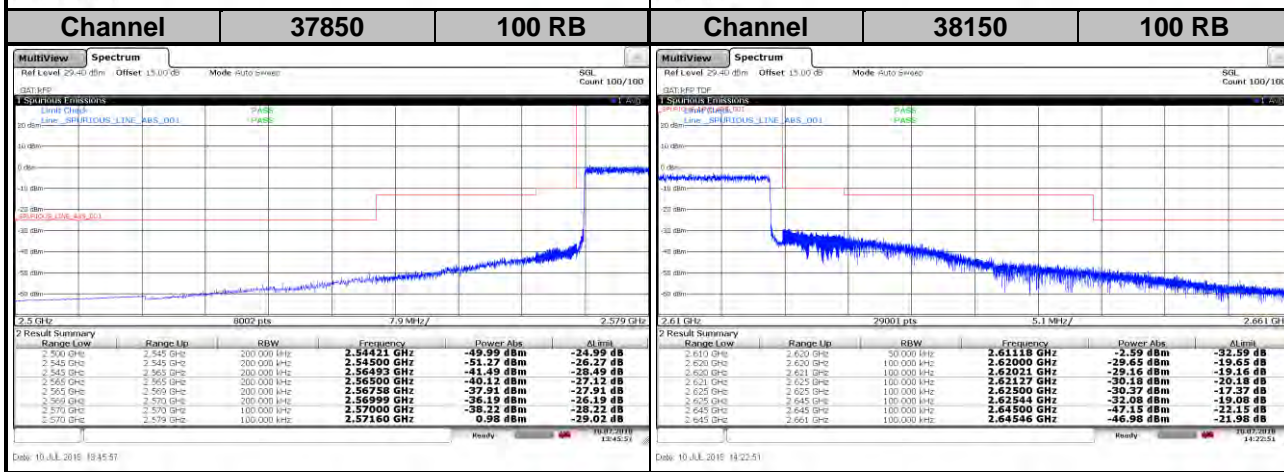
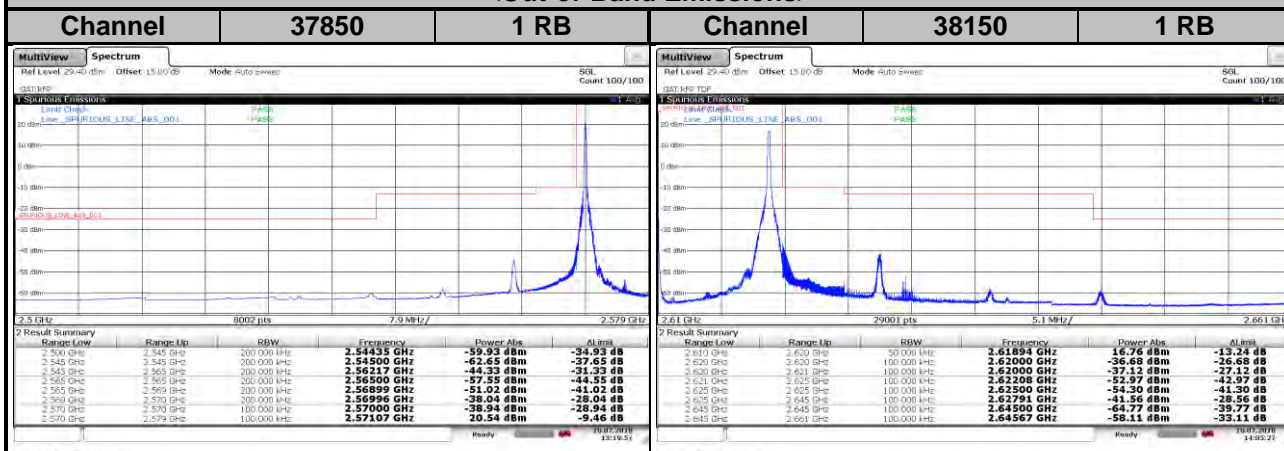

4.6 Peak to Average Ratio

4.6.1 Limits of Peak to Average Ratio Measurement

In measuring transmissions in this band using an average power technique, the peak to-average ratio (PAR) of the transmission may not exceed 13 dB.

4.6.2 Test Setup

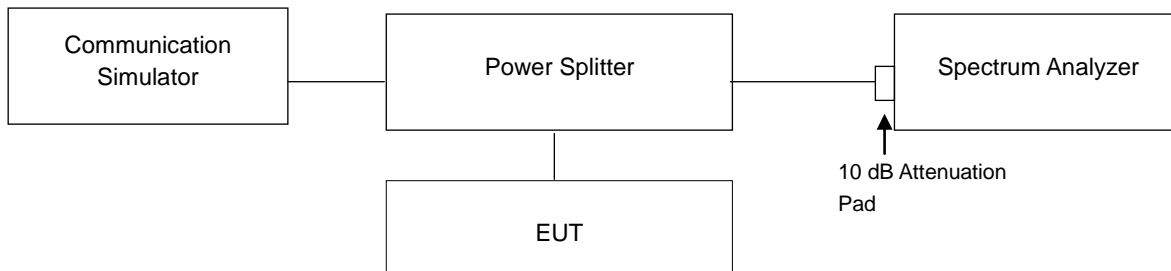

4.6.3 Test Procedures

1. Set resolution/measurement bandwidth \geq signal's occupied bandwidth;
2. Set the number of counts to a value that stabilizes the measured CCDF curve;
3. Record the maximum PAPR level associated with a probability of 0.1 %.

4.6.4 Test Results

LTE Band 7							
Channel Bandwidth: 5 MHz				Channel Bandwidth: 10 MHz			
Channel	Frequency (MHz)	Peak to Average Ratio (dB)		Channel	Frequency (MHz)	Peak to Average Ratio (dB)	
		QPSK	16QAM			QPSK	16QAM
20775	2502.5	4.04	5.80	20800	2505.0	4.00	5.76
21100	2535.0	3.80	5.58	21100	2535.0	3.59	5.37
21425	2567.5	3.73	5.44	21400	2565.0	3.66	5.34

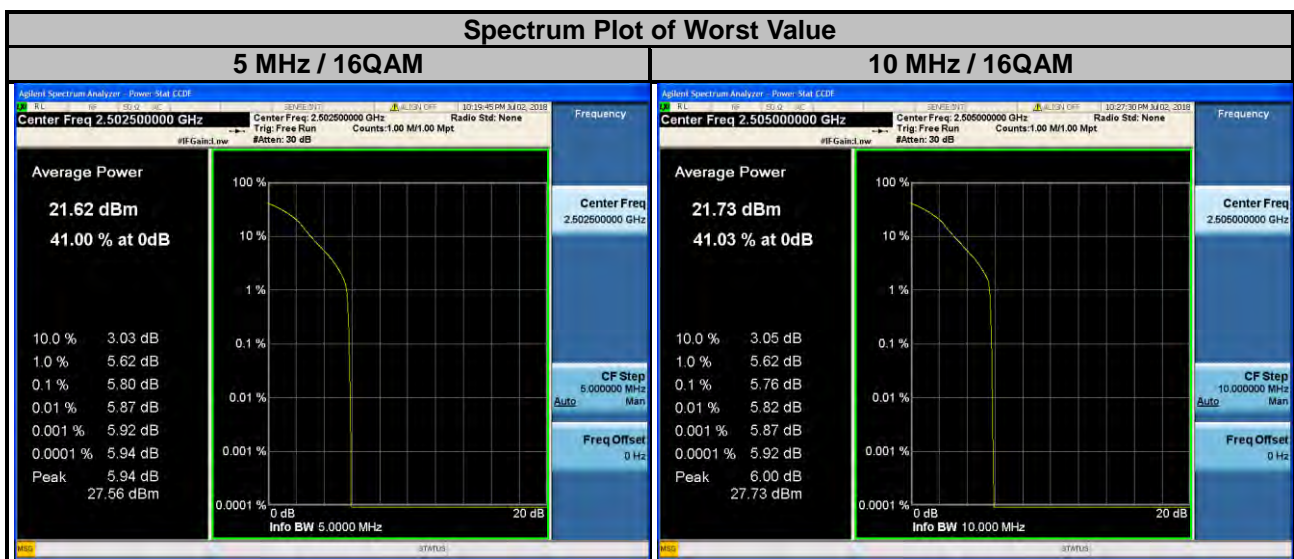

LTE Band 7

Channel Bandwidth: 15 MHz				Channel Bandwidth: 20 MHz			
Channel	Frequency (MHz)	Peak to Average Ratio (dB)		Channel	Frequency (MHz)	Peak to Average Ratio (dB)	
		QPSK	16QAM			QPSK	16QAM
20825	2507.5	3.98	5.78	20850	2510.0	3.96	5.73
21100	2535.0	3.56	5.22	21100	2535.0	3.49	5.24
21375	2562.5	3.80	5.59	21350	2560.0	3.92	5.64

Spectrum Plot of Worst Value

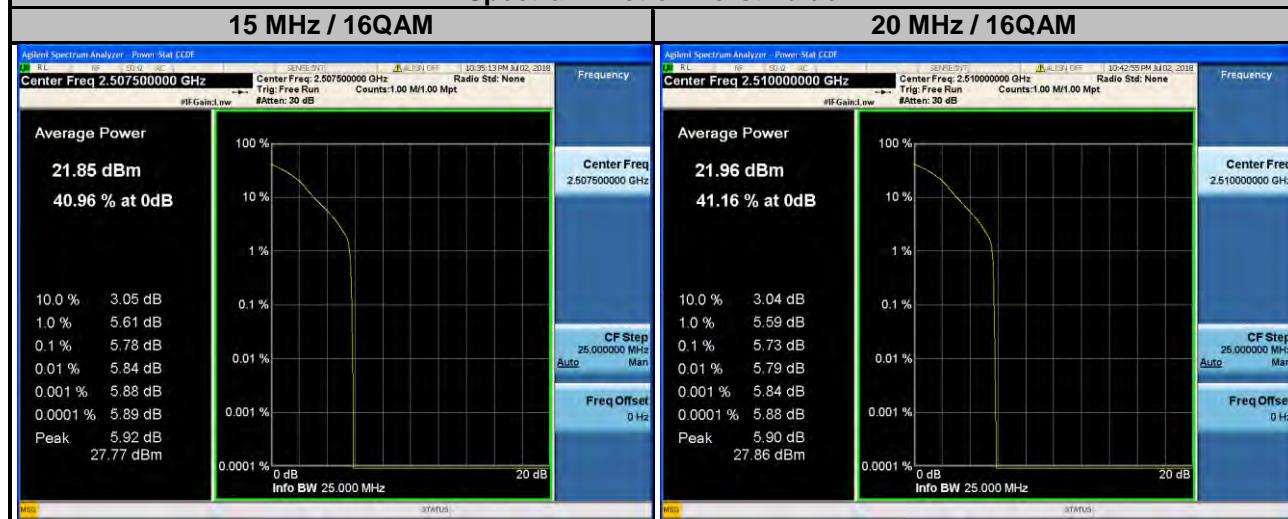

LTE Band 38

Channel Bandwidth: 5 MHz				Channel Bandwidth: 10 MHz			
Channel	Frequency (MHz)	Peak to Average Ratio (dB)		Channel	Frequency (MHz)	Peak to Average Ratio (dB)	
		QPSK	16QAM			QPSK	16QAM
37775	2572.5	3.78	5.23	37800	2575.0	4.41	5.59
38000	2595.0	3.97	6.10	38000	2595.0	4.77	5.92
38225	2617.5	4.44	5.98	38200	2615.0	5.06	6.24

Spectrum Plot of Worst Value

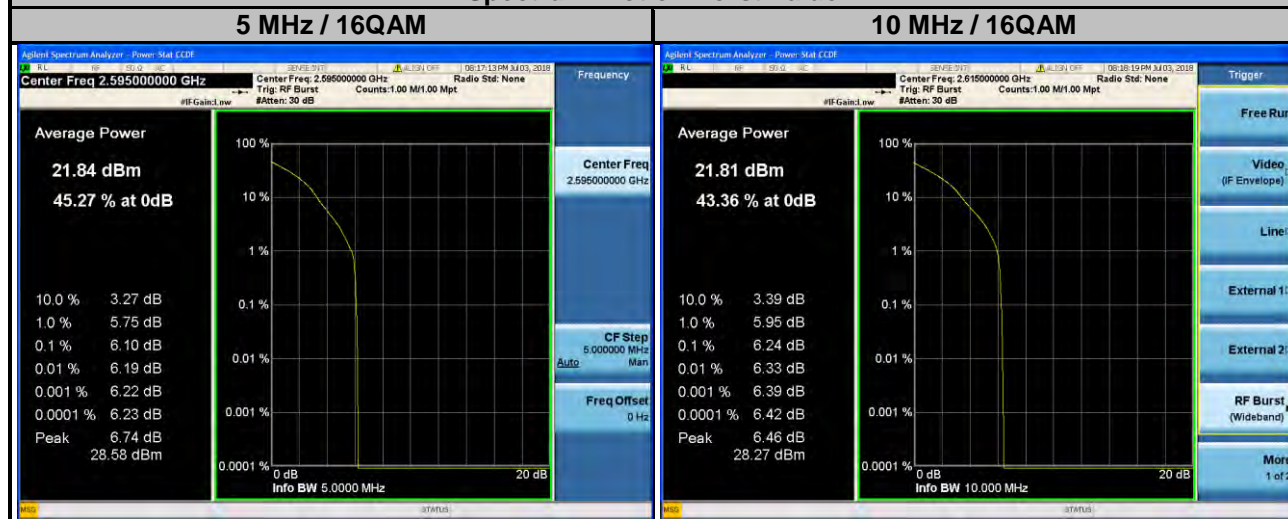

LTE Band 38

Channel Bandwidth: 15 MHz				Channel Bandwidth: 20 MHz			
Channel	Frequency (MHz)	Peak to Average Ratio (dB)		Channel	Frequency (MHz)	Peak to Average Ratio (dB)	
		QPSK	16QAM			QPSK	16QAM
37825	2577.5	3.42	4.68	37850	2580.0	3.48	5.92
38000	2595.0	3.58	6.10	38000	2595.0	3.53	6.13
38175	2612.5	4.56	6.51	38150	2610.0	4.14	6.27

Spectrum Plot of Worst Value

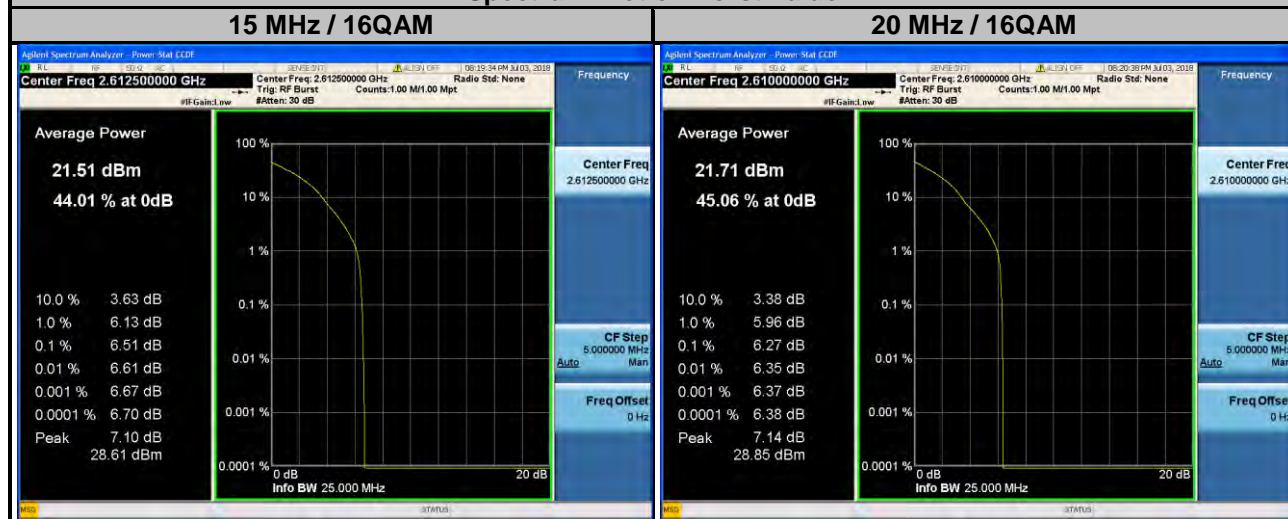

4.7 Conducted Spurious Emissions

4.7.1 Limits of Conducted Spurious Emissions Measurement

The power of any emission outside a licensee's frequency block shall be attenuated below the transmitter power (P) by at least $55 + 10 \log_{10}(P)$ dB. The limit of emission is equal to -25 dBm.

4.7.2 Test Setup

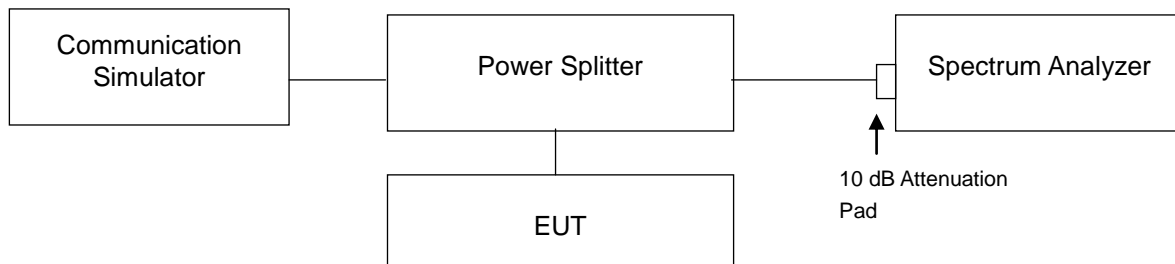

4.7.3 Test Procedure

- The EUT makes a phone call to the communication simulator. All measurements were done at low, middle and high operational frequency range.
- Measuring frequency range from 9 kHz to 1 GHz, 10 dB attenuation pad is connected with spectrum. RBW = 100 kHz and VBW = 300 kHz are used for conducted emission measurement.
- Measuring frequency range from 1 GHz to 27 GHz, 10 dB attenuation pad is connected with spectrum. RBW = 1 MHz and VBW = 3 MHz are used for conducted emission measurement.

4.7.4 Test Results

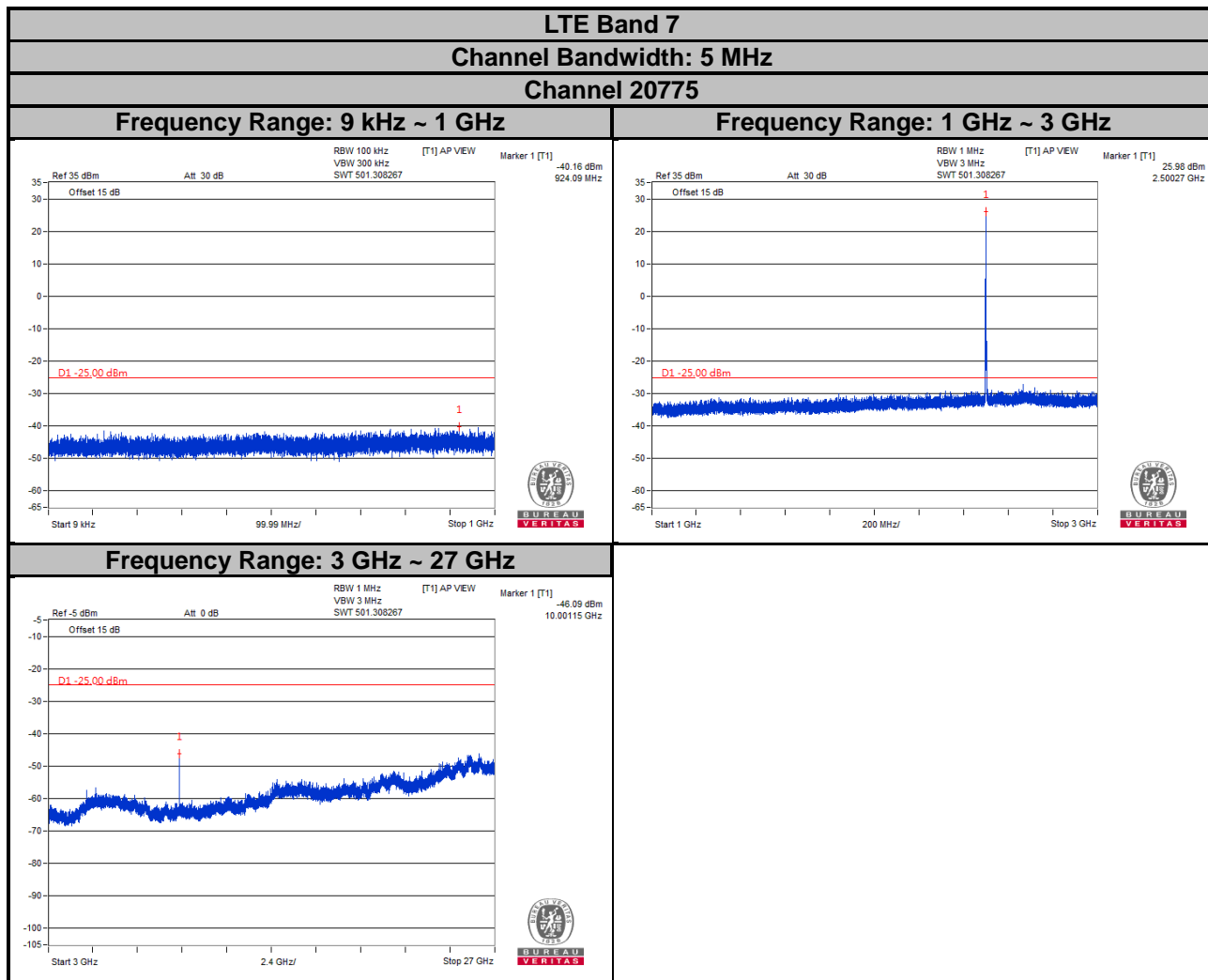

LTE Band 7

Channel Bandwidth: 5 MHz

Channel 21100

Frequency Range: 9 kHz ~ 1 GHz

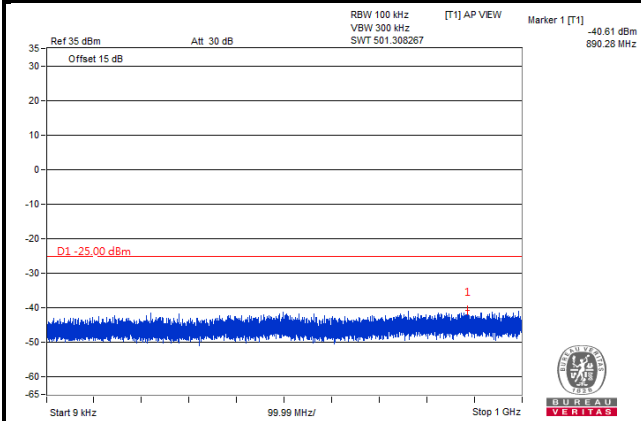

Frequency Range: 1 GHz ~ 3 GHz

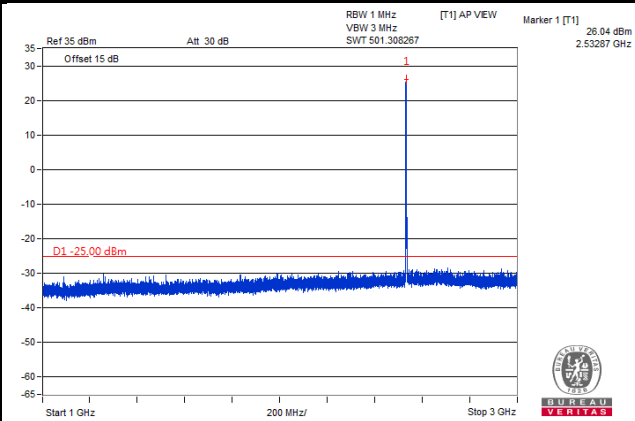

Frequency Range: 3 GHz ~ 27 GHz

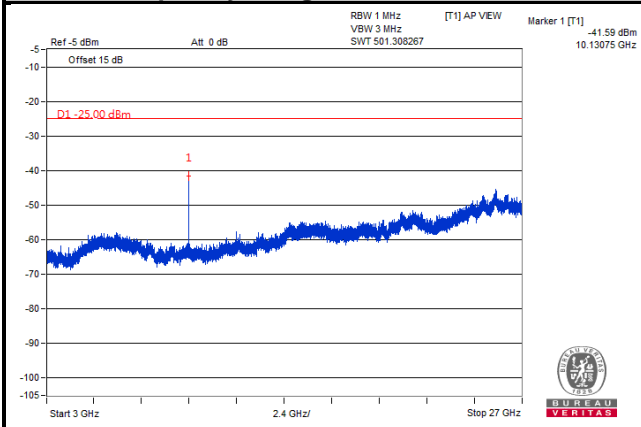

LTE Band 7

Channel Bandwidth: 5 MHz

Channel 21425

Frequency Range: 9 kHz ~ 1 GHz

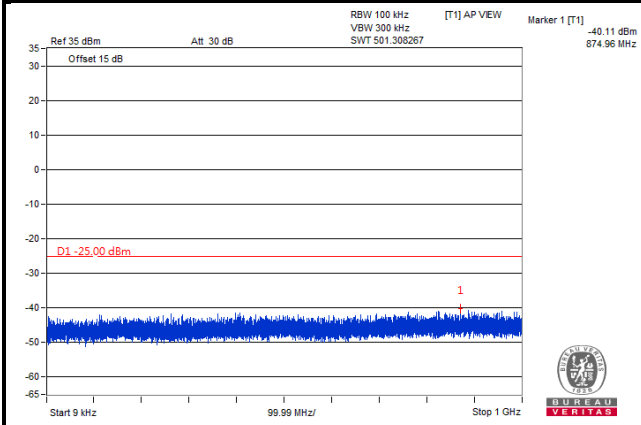

Frequency Range: 1 GHz ~ 3 GHz

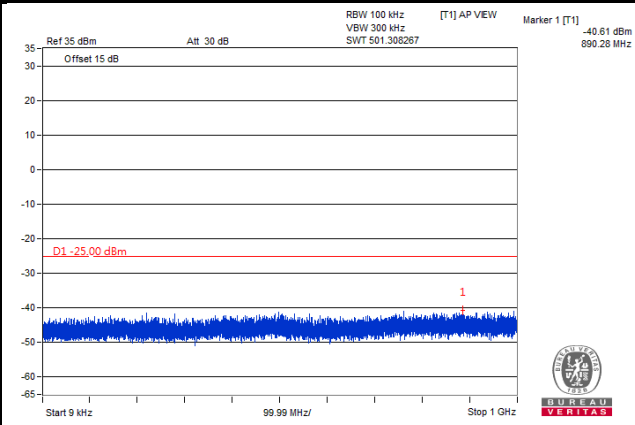

Frequency Range: 3 GHz ~ 27 GHz

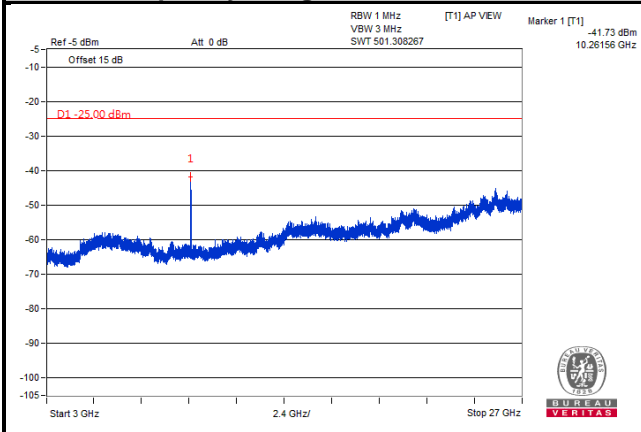

LTE Band 7
Channel Bandwidth: 10 MHz
Channel 20800

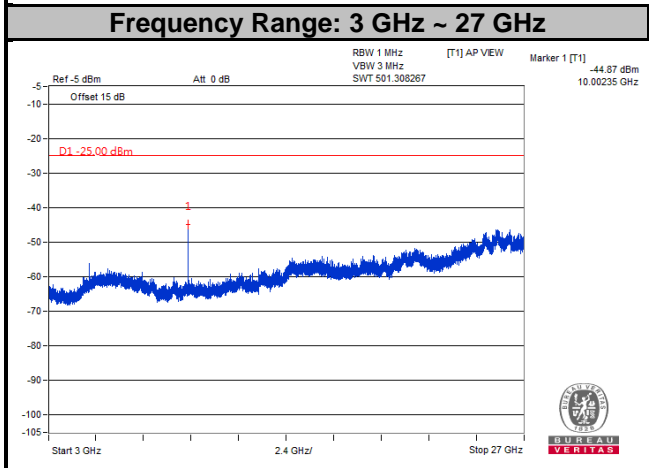
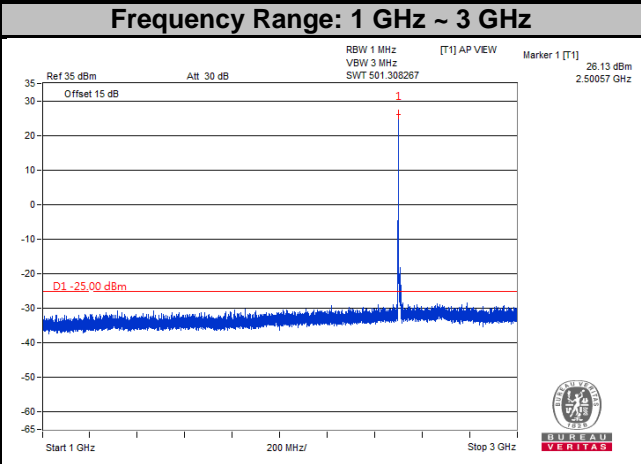
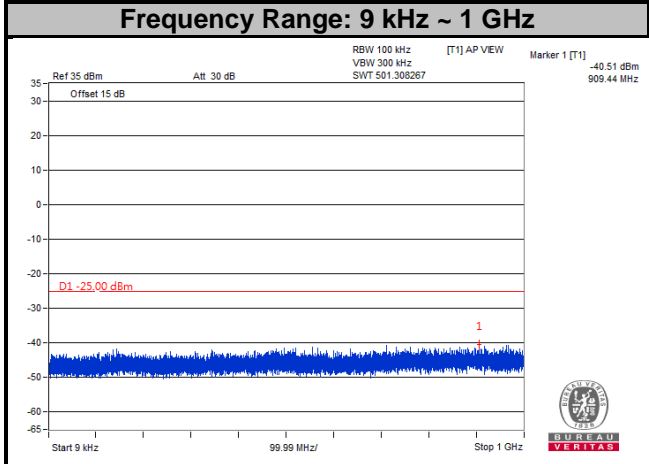

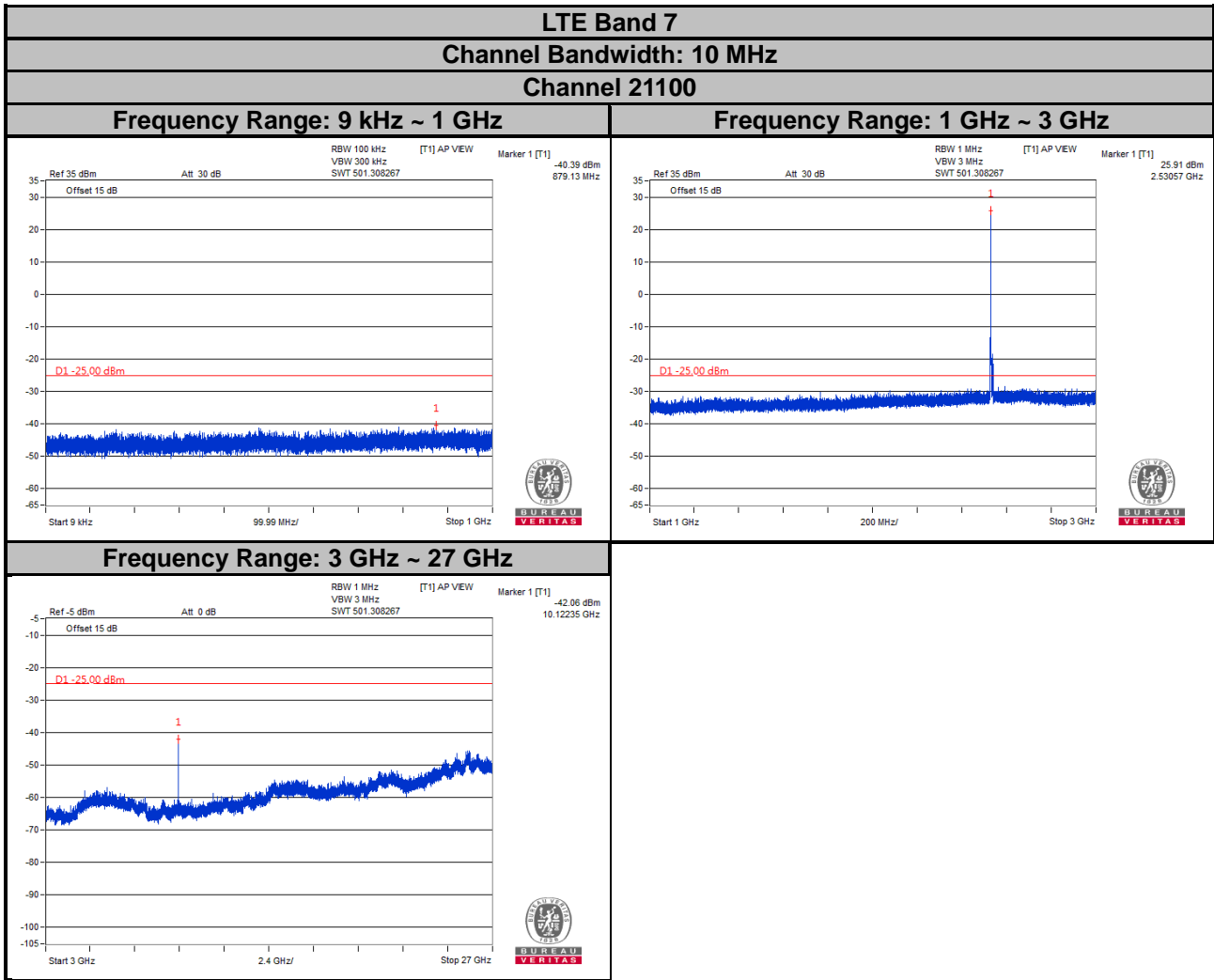

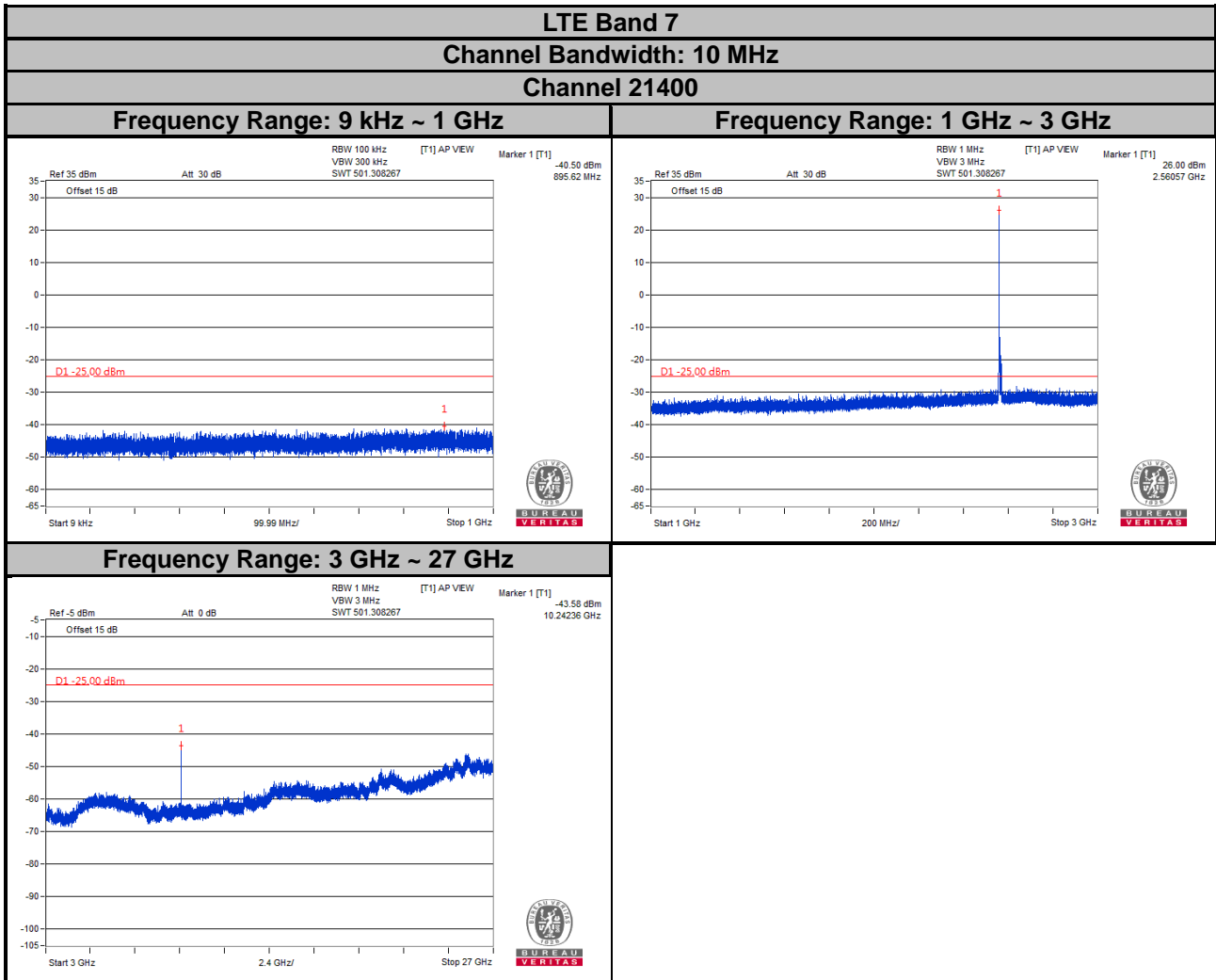

LTE Band 7
Channel Bandwidth: 15 MHz
Channel 20825

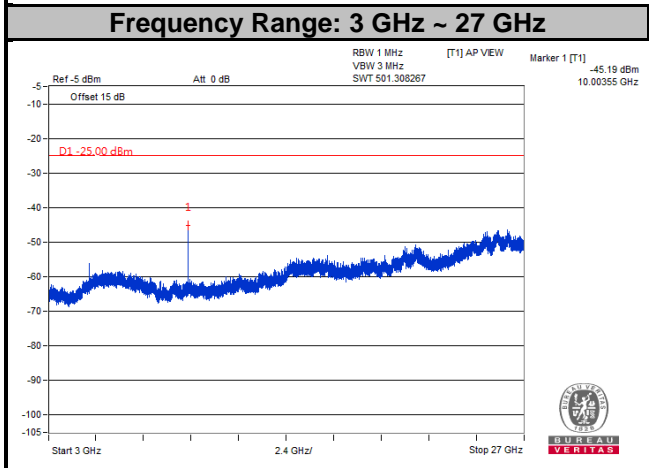
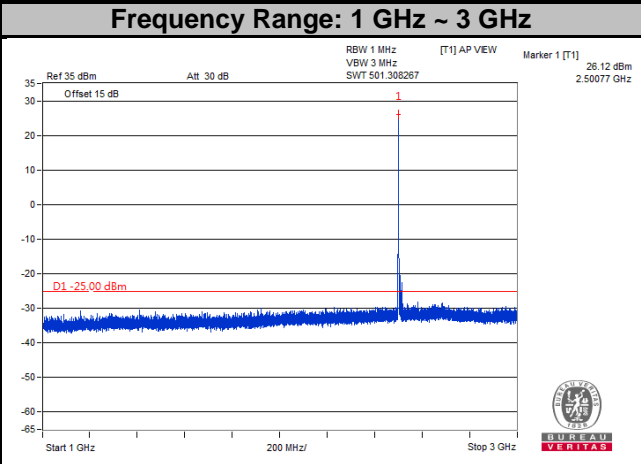
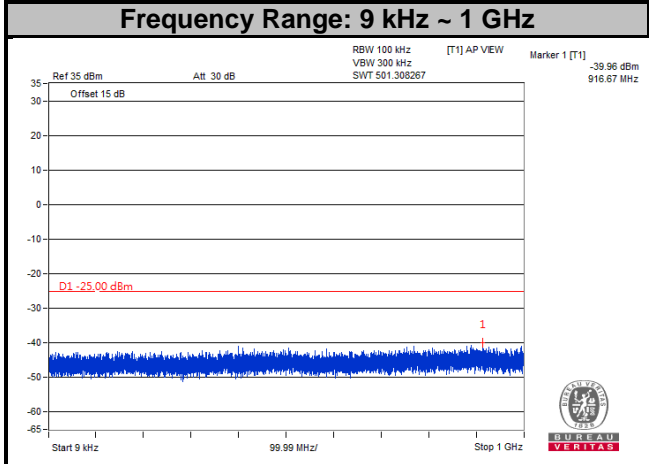

LTE Band 7

Channel Bandwidth: 15 MHz

Channel 21100

Frequency Range: 9 kHz ~ 1 GHz

Frequency Range: 1 GHz ~ 3 GHz

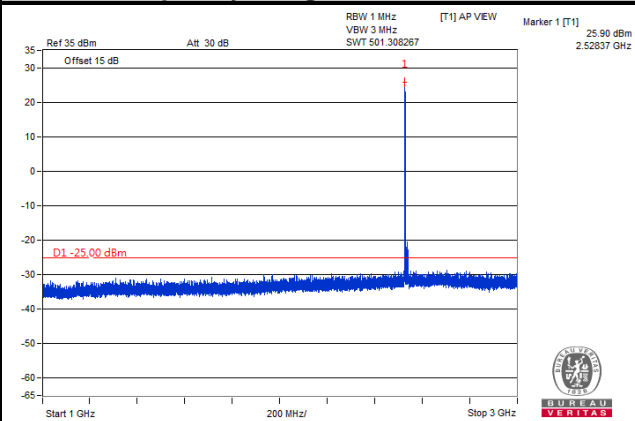
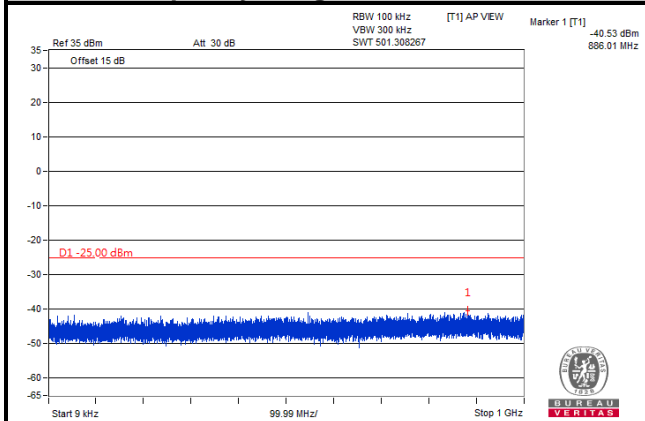

Frequency Range: 3 GHz ~ 27 GHz

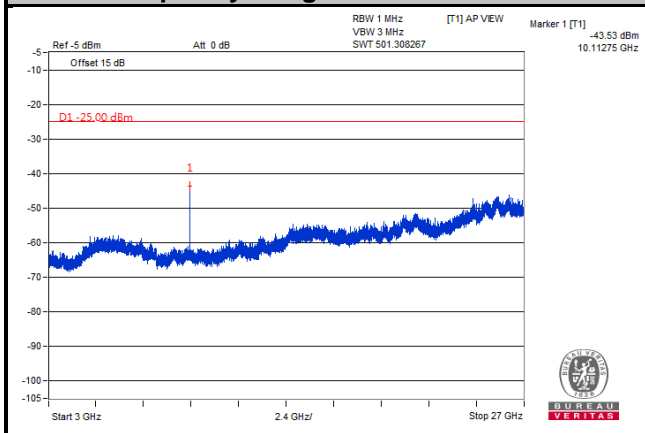

LTE Band 7
Channel Bandwidth: 15 MHz
Channel 21375

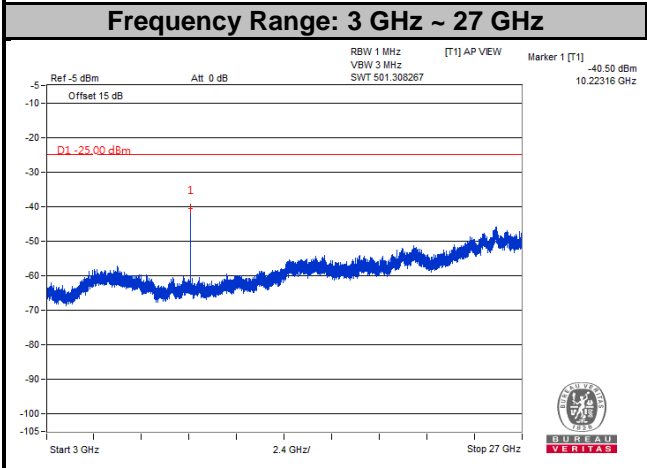
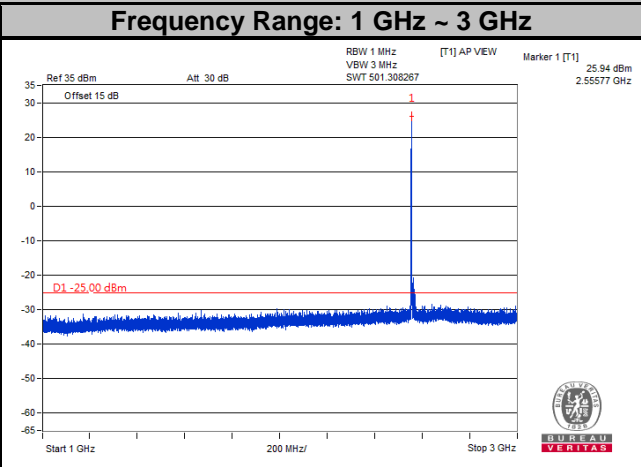
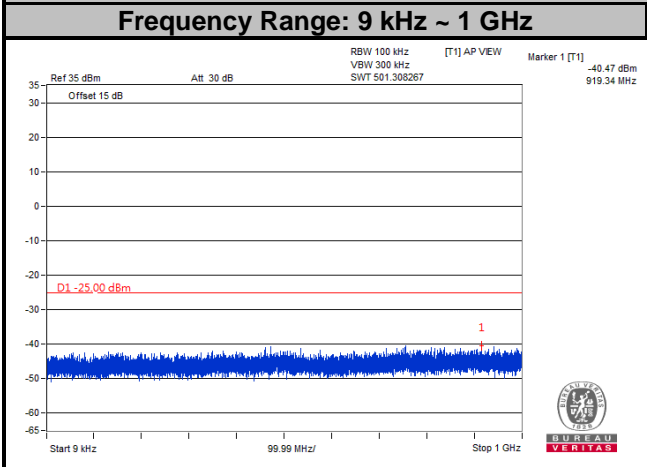

LTE Band 7
Channel Bandwidth: 20 MHz
Channel 20850

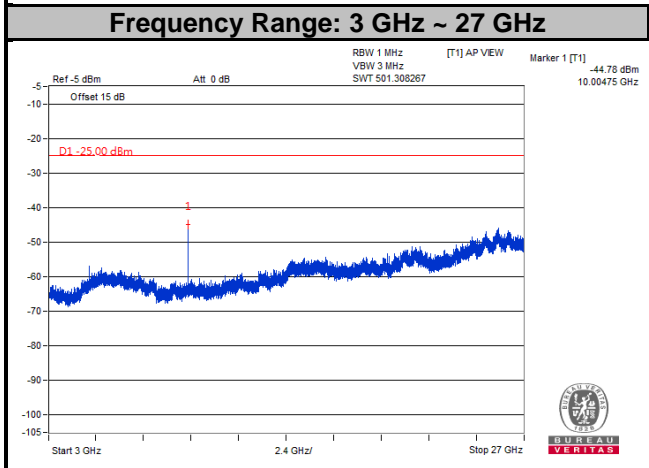
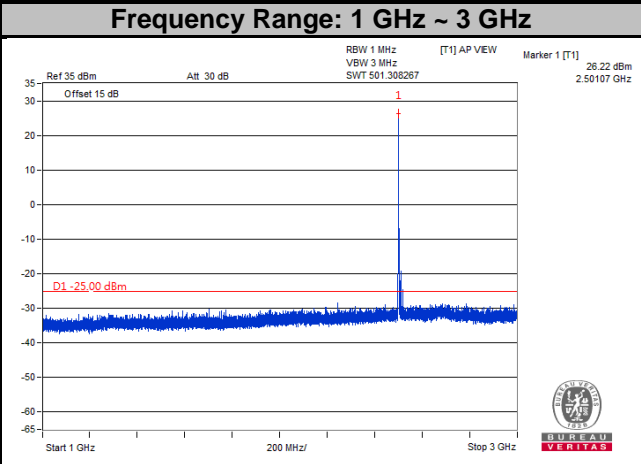
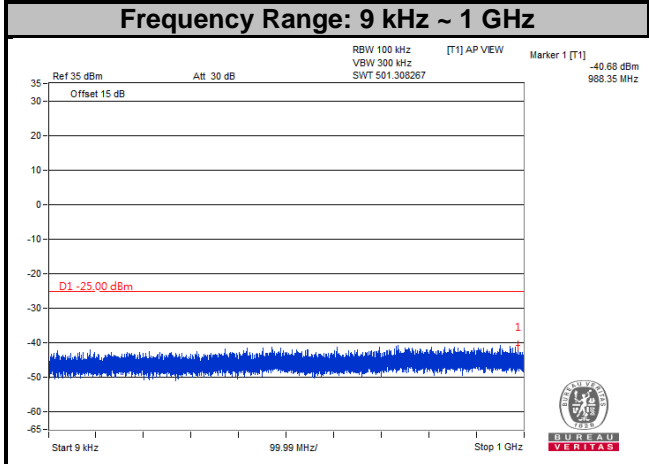

LTE Band 7
Channel Bandwidth: 20 MHz
Channel 21100

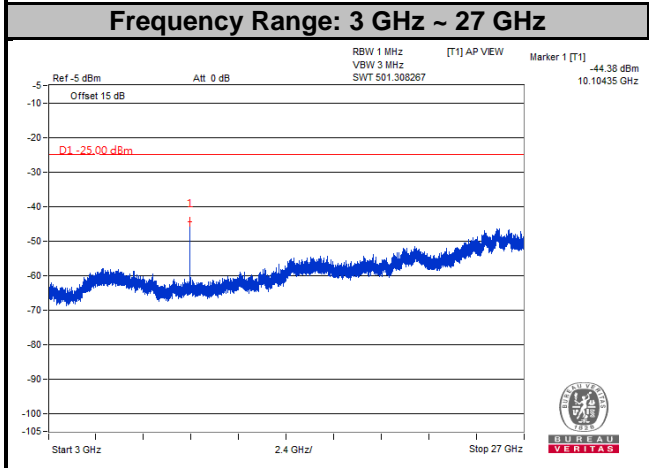
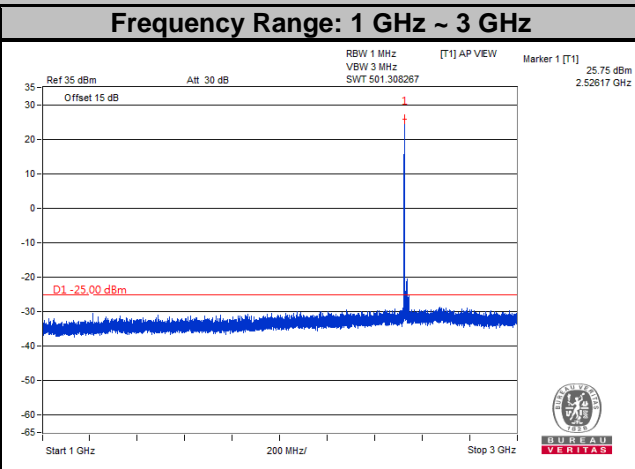
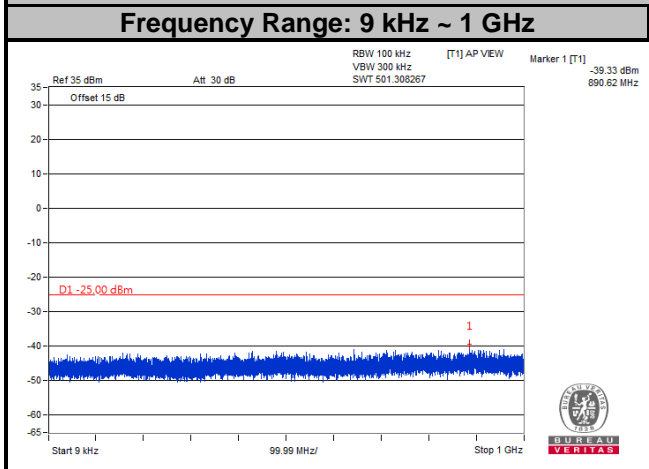

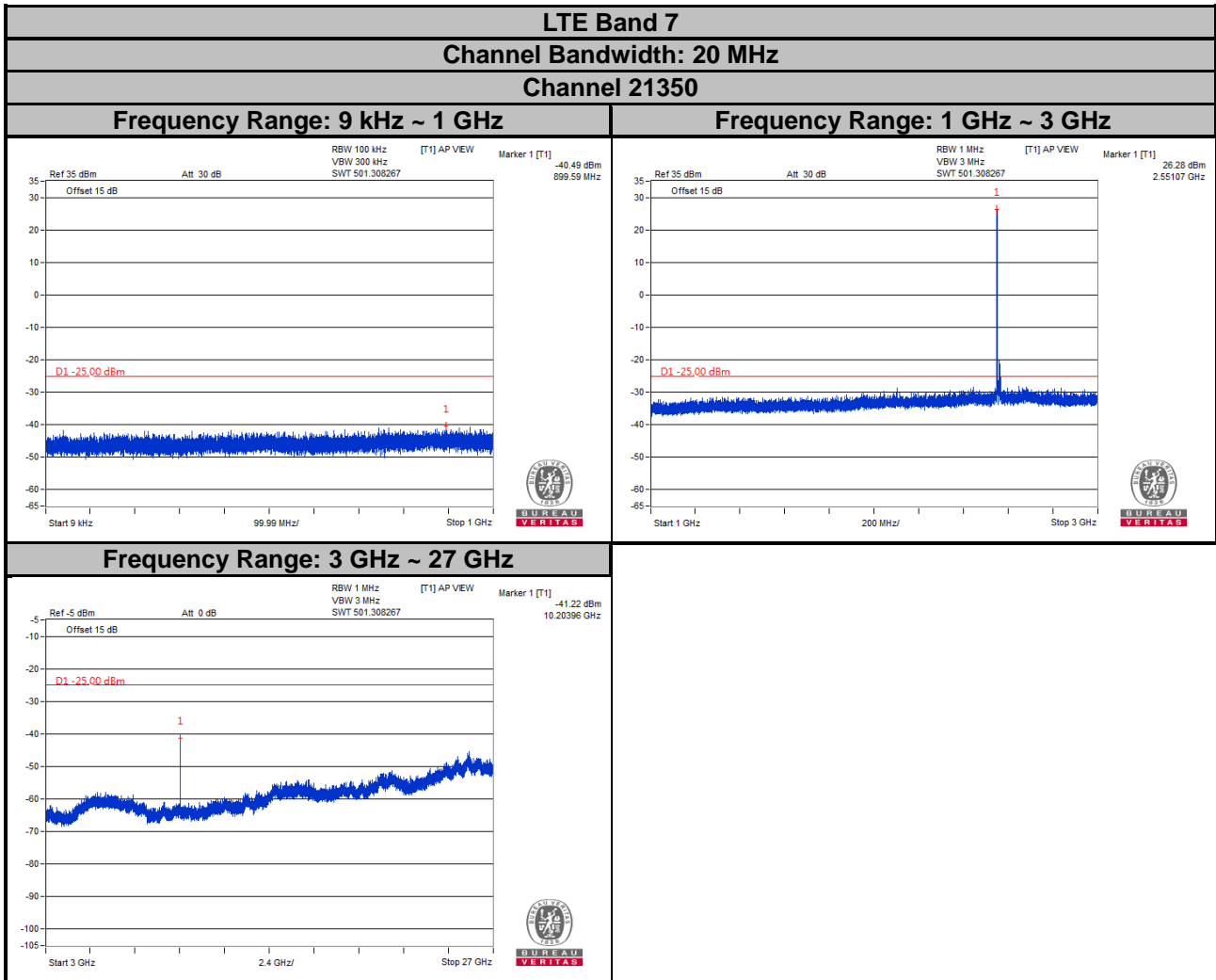

LTE Band 38
Channel Bandwidth: 5 MHz

Channel 37775

Frequency Range: 9 kHz ~ 1 GHz

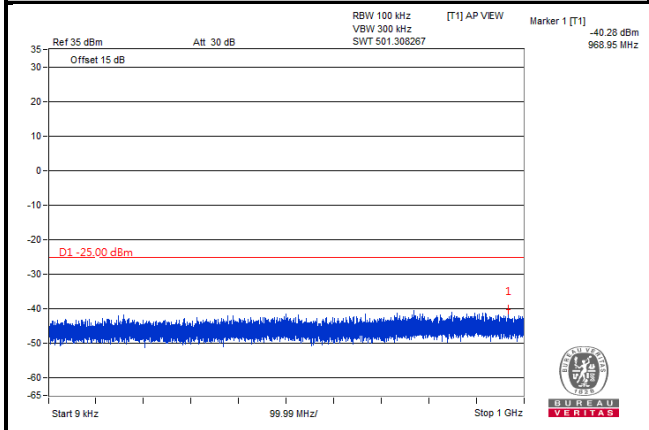

Frequency Range: 1 GHz ~ 3 GHz

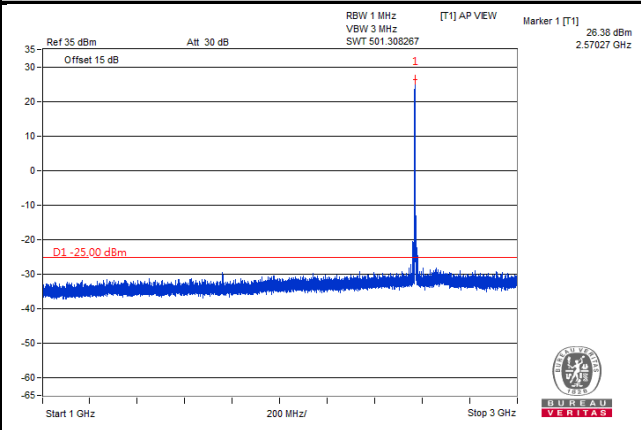

Frequency Range: 3 GHz ~ 27 GHz

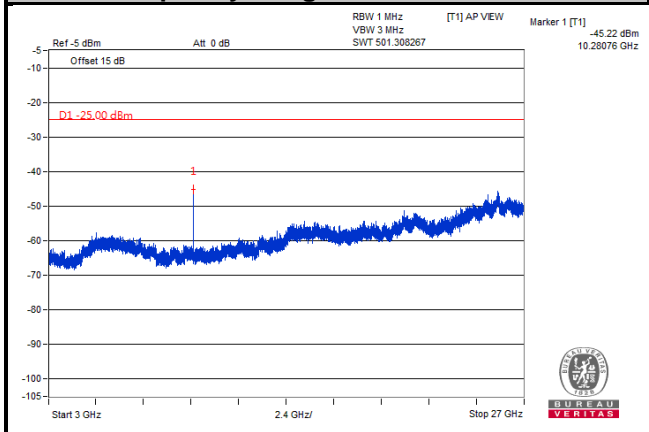

LTE Band 38
Channel Bandwidth: 5 MHz
Channel 38000

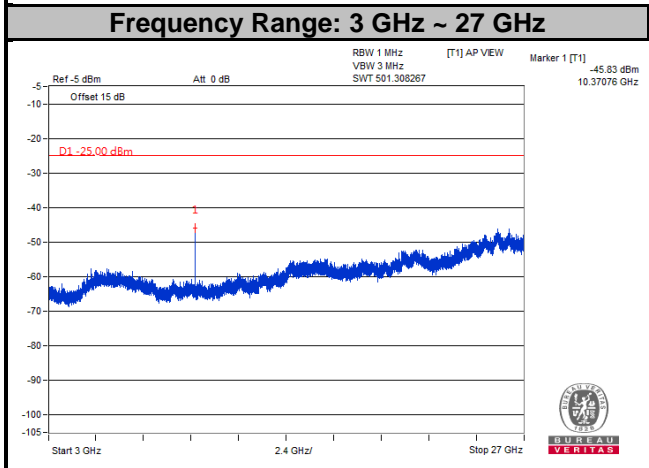
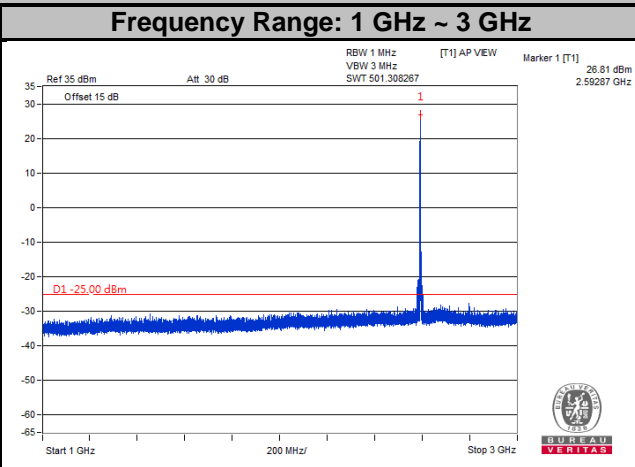
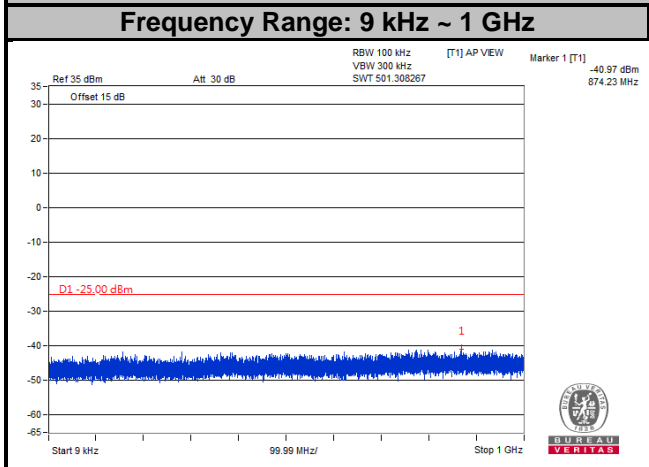

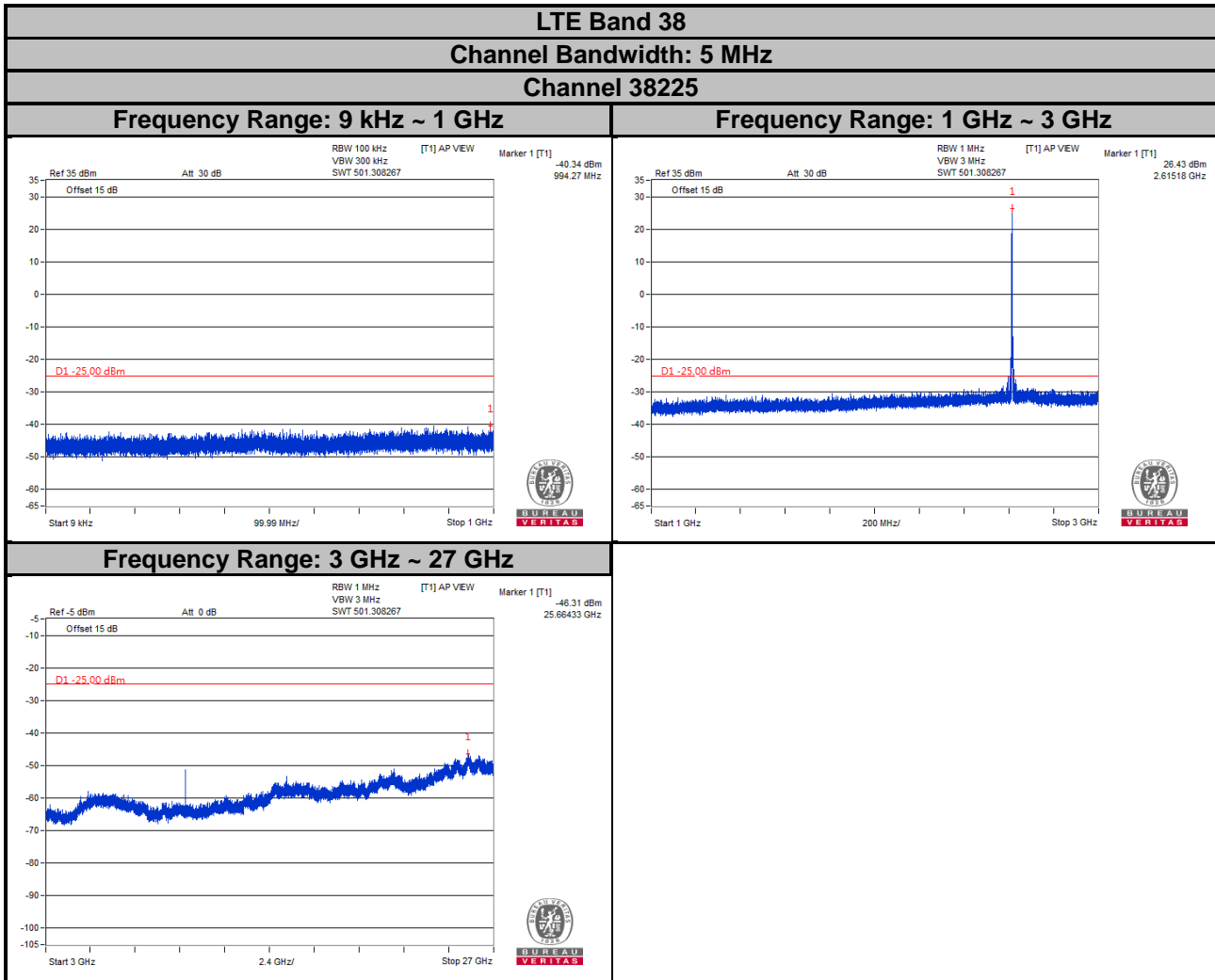

LTE Band 38
Channel Bandwidth: 10 MHz
Channel 37800

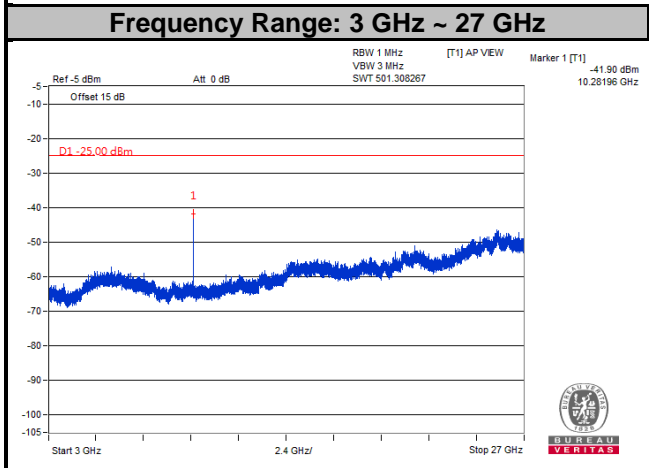
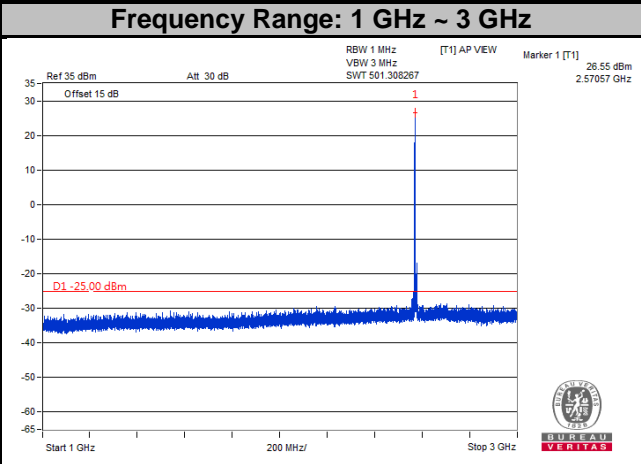
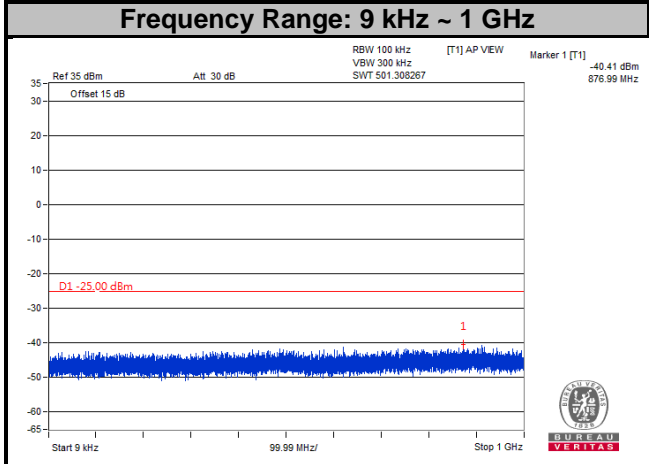

LTE Band 38
Channel Bandwidth: 10 MHz
Channel 38000

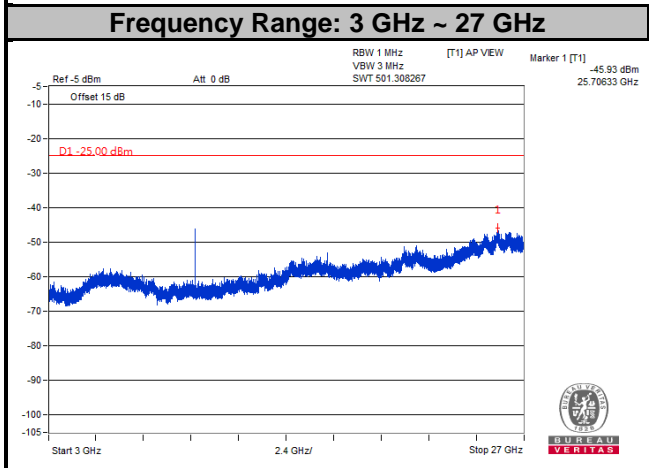
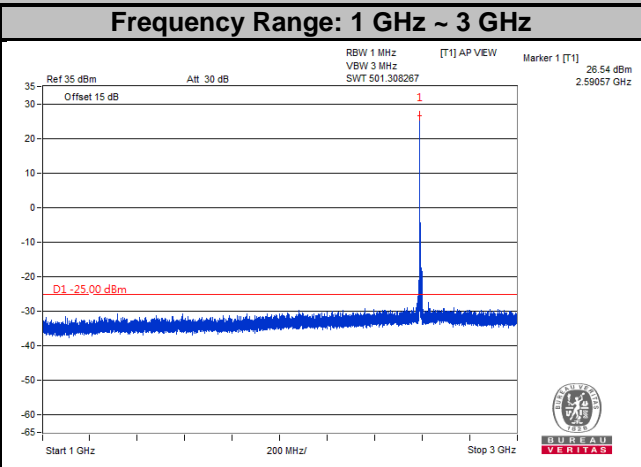
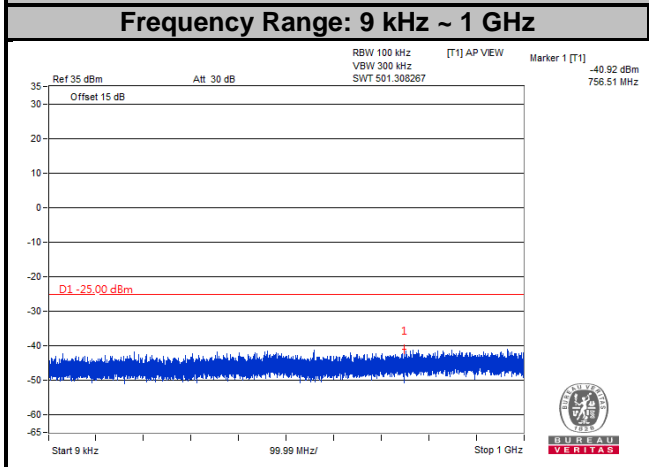

LTE Band 38
Channel Bandwidth: 10 MHz
Channel 38200

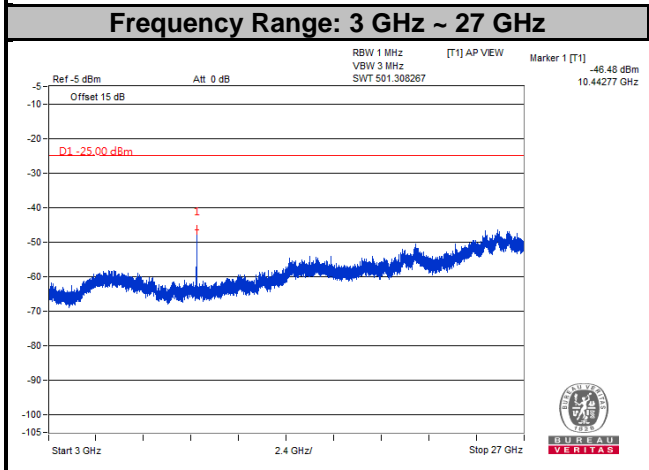
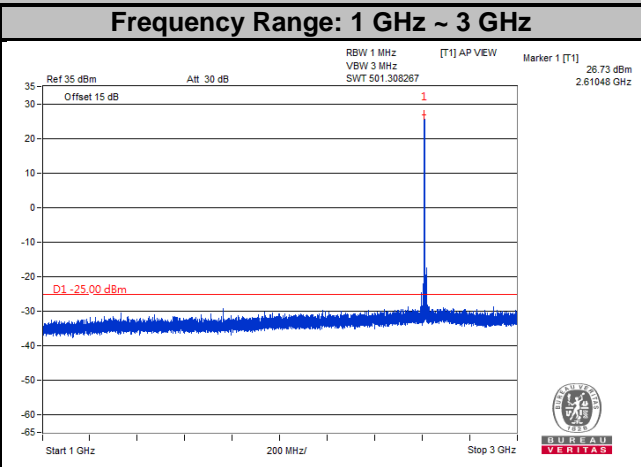
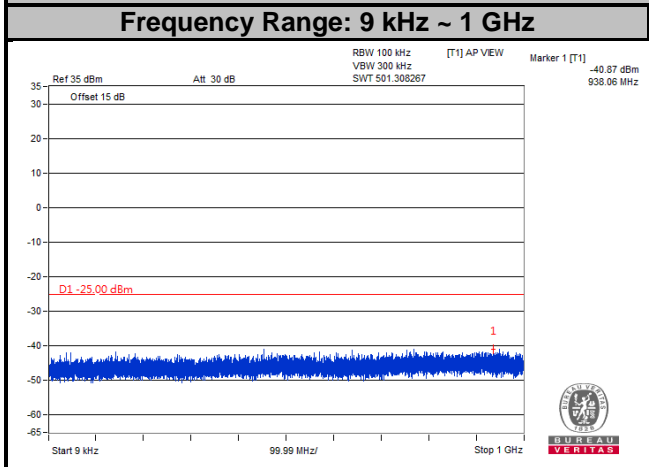

LTE Band 38
Channel Bandwidth: 15 MHz
Channel 37825

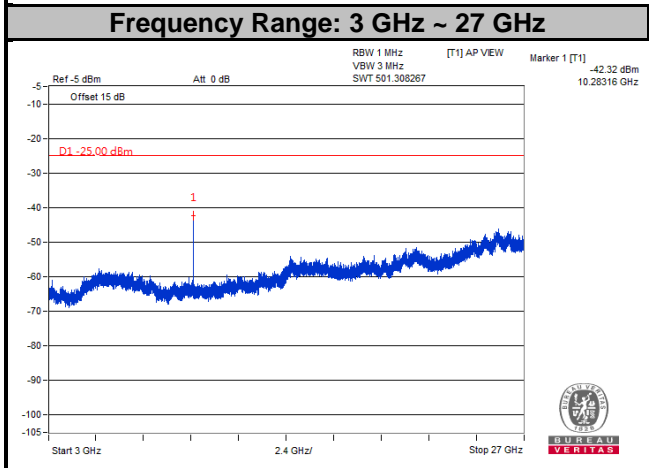
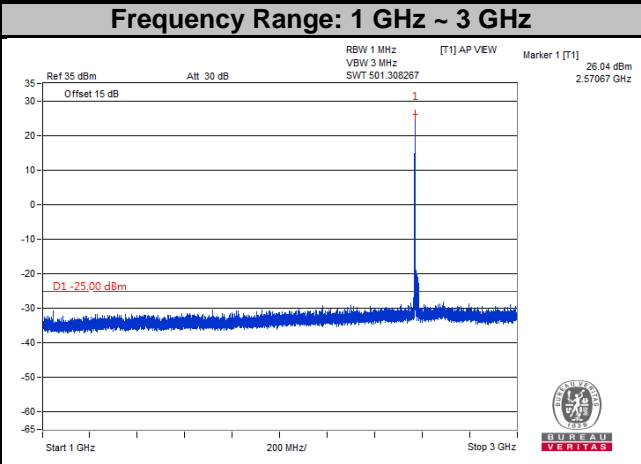
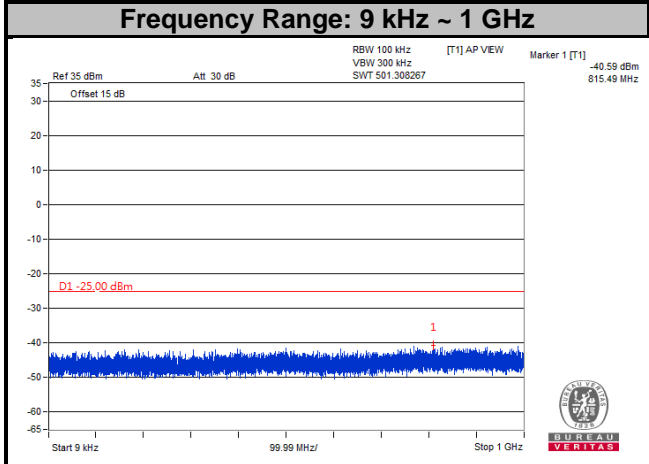

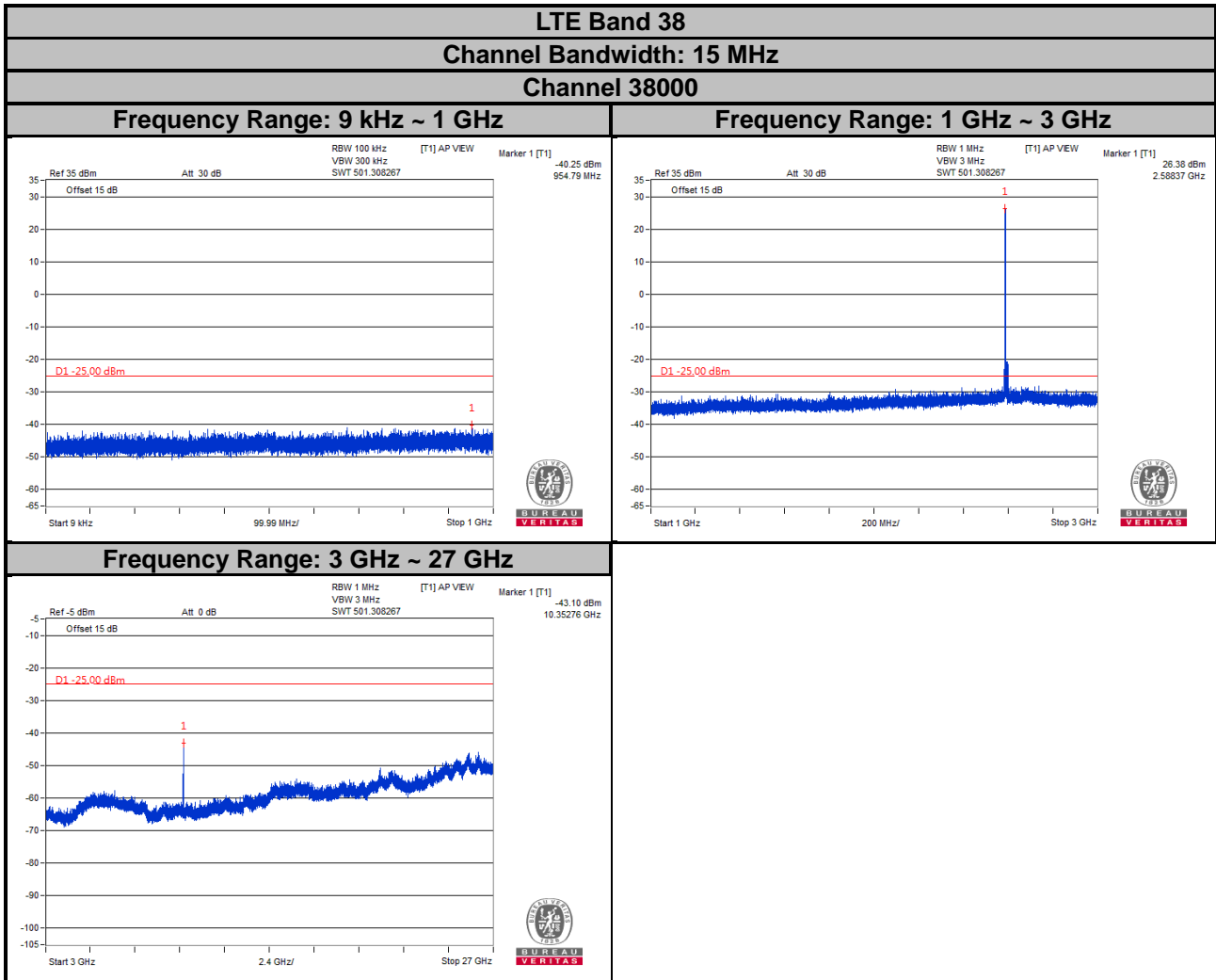

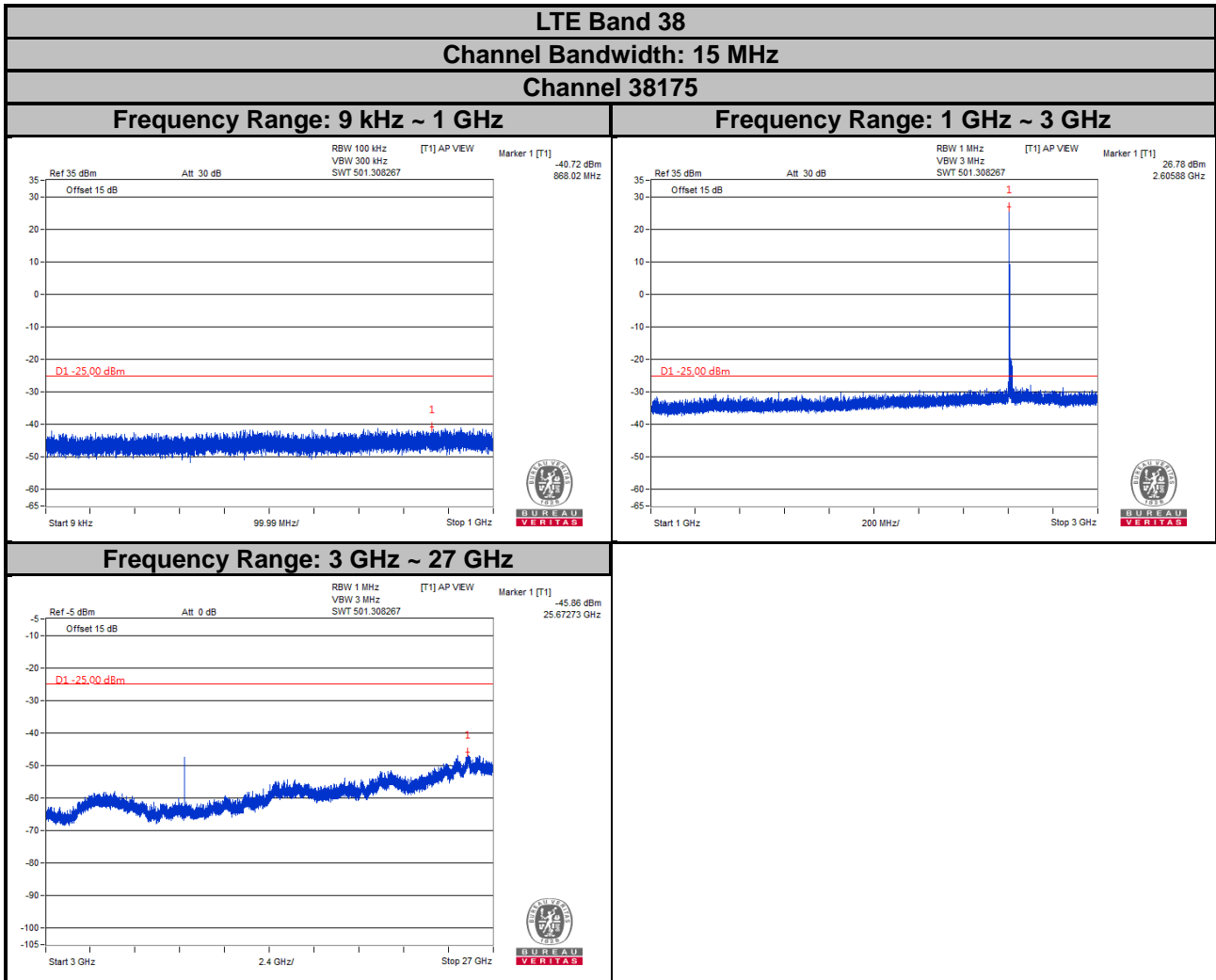

LTE Band 38
Channel Bandwidth: 20 MHz
Channel 37850

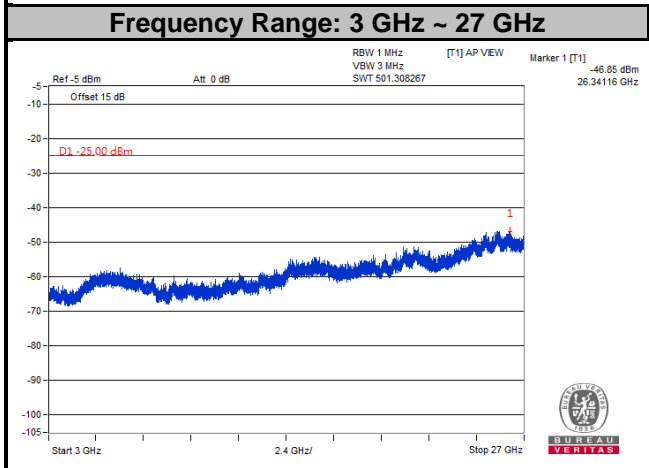
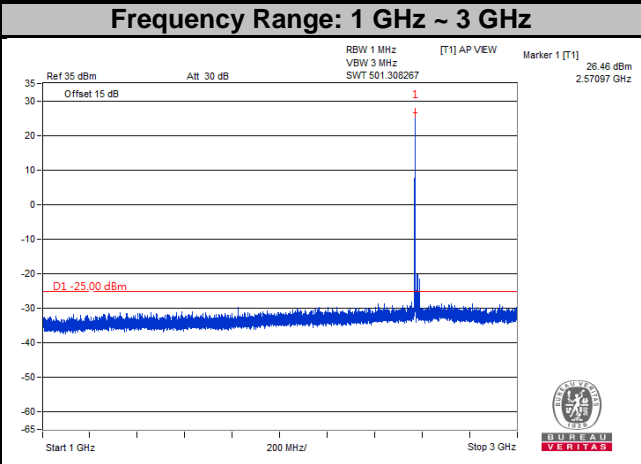
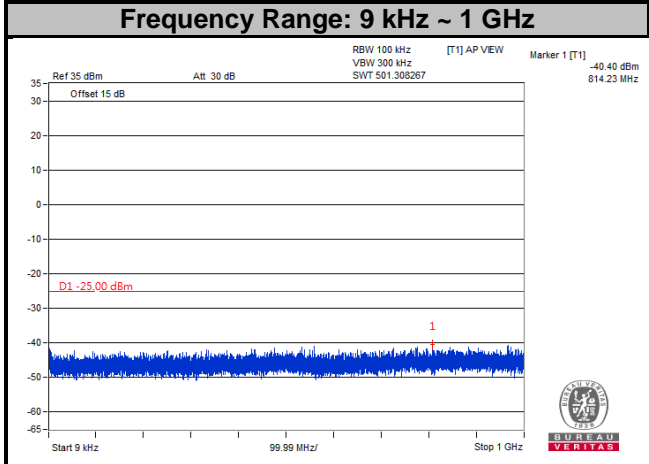

LTE Band 38
Channel Bandwidth: 20 MHz
Channel 38000

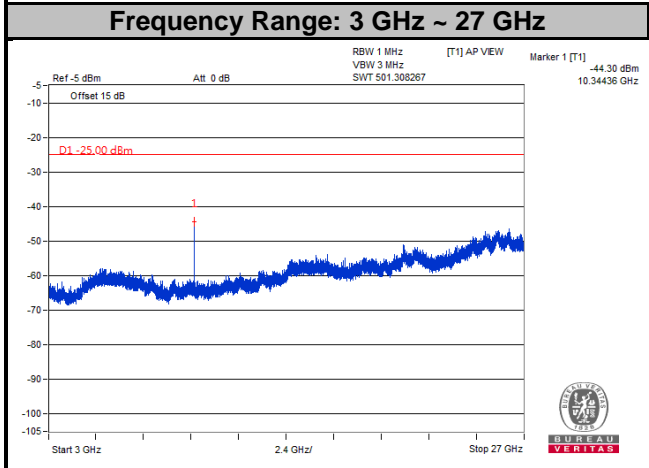
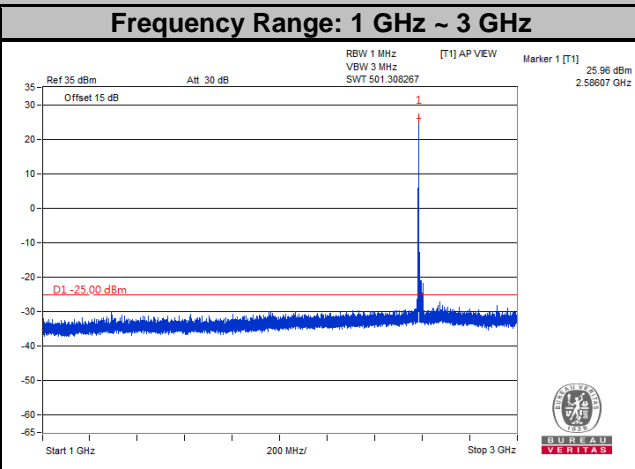
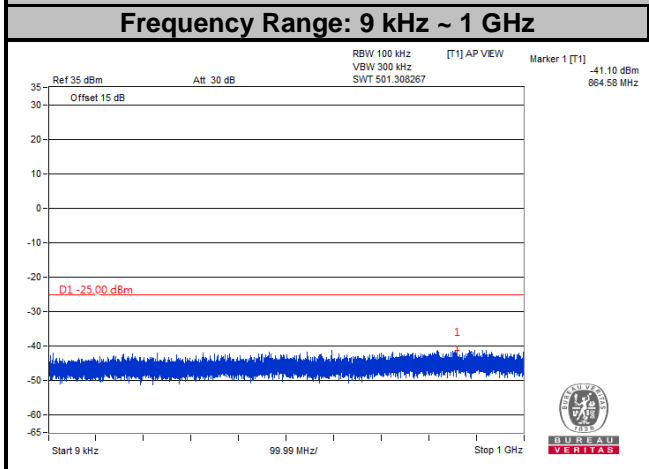

LTE Band 38
Channel Bandwidth: 20 MHz
Channel 38150

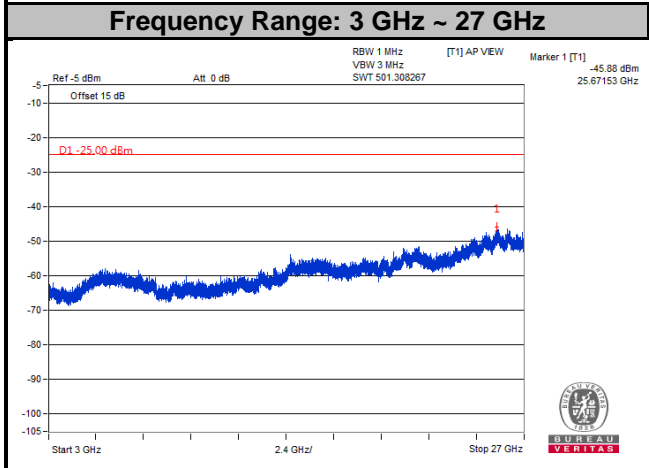
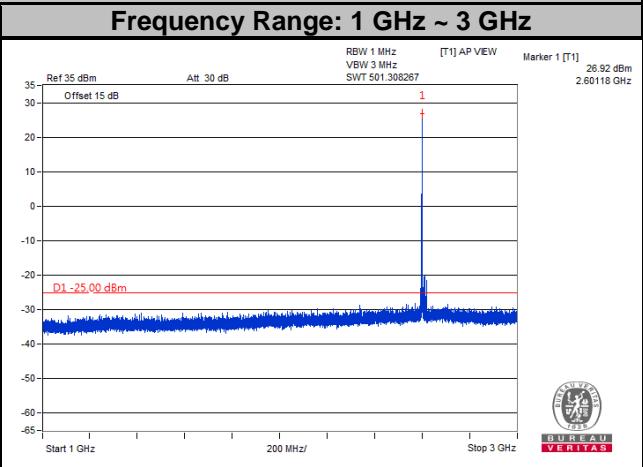
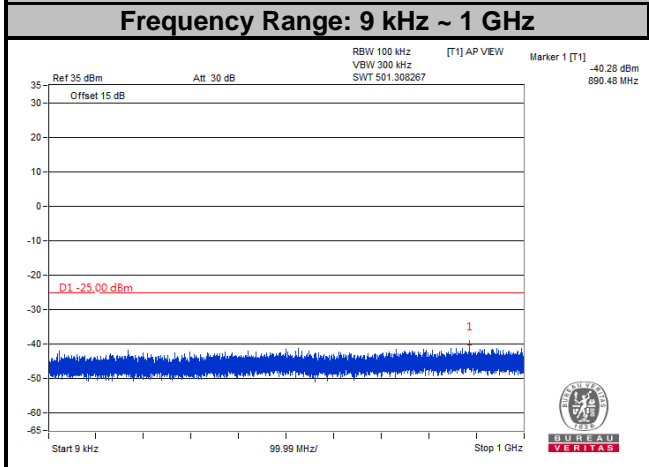

4.8 Radiated Emission Measurement

4.8.1 Limits of Radiated Emission Measurement

The power of any emission outside a licensee's frequency block shall be attenuated below the transmitter power (P) by at least $55 + 10 \log_{10}(P)$ dB. The limit of emission is equal to -25 dBm.

4.8.2 Test Procedure

- a. Substitution method is used for E.I.R.P measurement. In the semi-anechoic chamber, EUT placed on the 0.8 m (below or equal 1 GHz) and/or 1.5 m (above 1 GHz) height of Turn Table, rotated the table around 360 degrees to search the maximum radiation power and receiver antenna shall be rotated vertical and horizontal polarization and moved height from 1 m to 4 m to find the maximum polar radiated power. The "Read Value" is the spectrum reading the maximum power value.
- b. The substitution horn antenna is substituted for EUT at the same position and signals generator export the CW signal to the substitution antenna via a TX cable. Rotated the Turn Table and moved receiving antenna to find the maximum radiation power. Adjust output power level of S.G to get a Value of spectrum reading equal to "Read Value" of step a. Record the power level of S.G.
- c. EIRP = Output power level of S.G – TX cable loss + Antenna gain of substitution horn.
- d. E.R.P power can be calculated form E.I.R.P power by subtracting the gain of dipole, E.R.P power = E.I.R.P power - 2.15 dB.

NOTE: The resolution bandwidth of spectrum analyzer is 1 MHz and the video bandwidth is 3 MHz.

4.8.3 Deviation from Test Standard

No deviation.

4.8.4 Test Setup

<Radiated Emission below or equal 1 GHz>

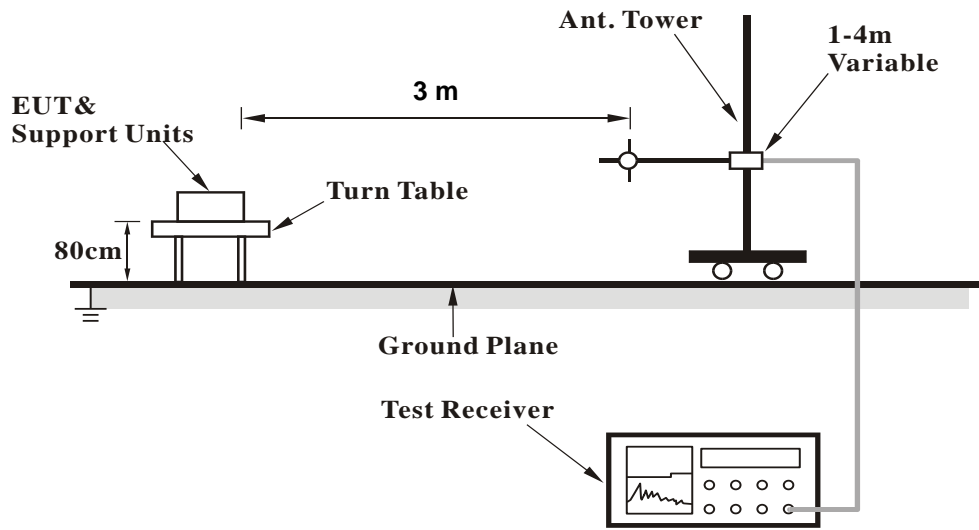

<Radiated Emission above 1 GHz>

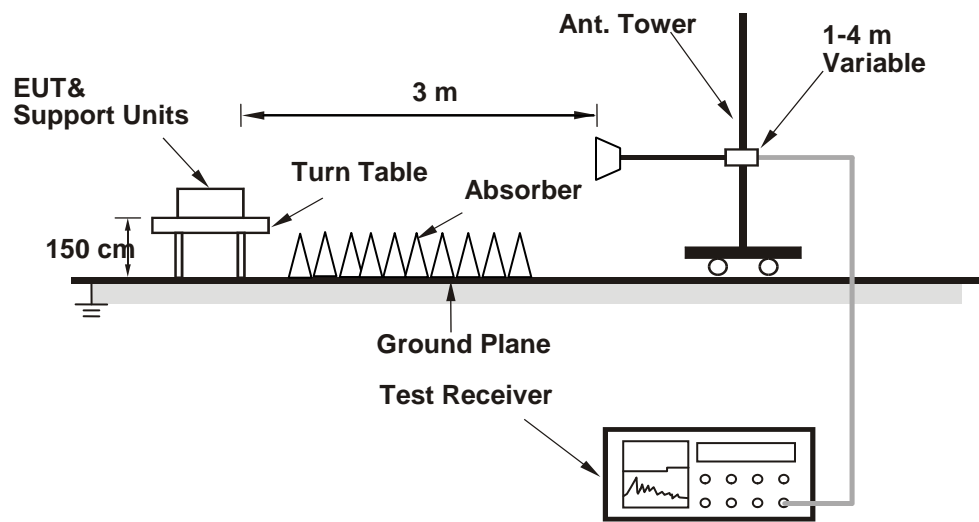

For the actual test configuration, please refer to the attached file (Test Setup Photo).

4.8.5 Test Results

Mode A

LTE Band 7

Channel Bandwidth: 5 MHz / QPSK

Low Channel



Bureau Veritas Consumer Products Services Ltd., Taoyuan Branch

A D T

Data: 9

Date: 2018-07-25

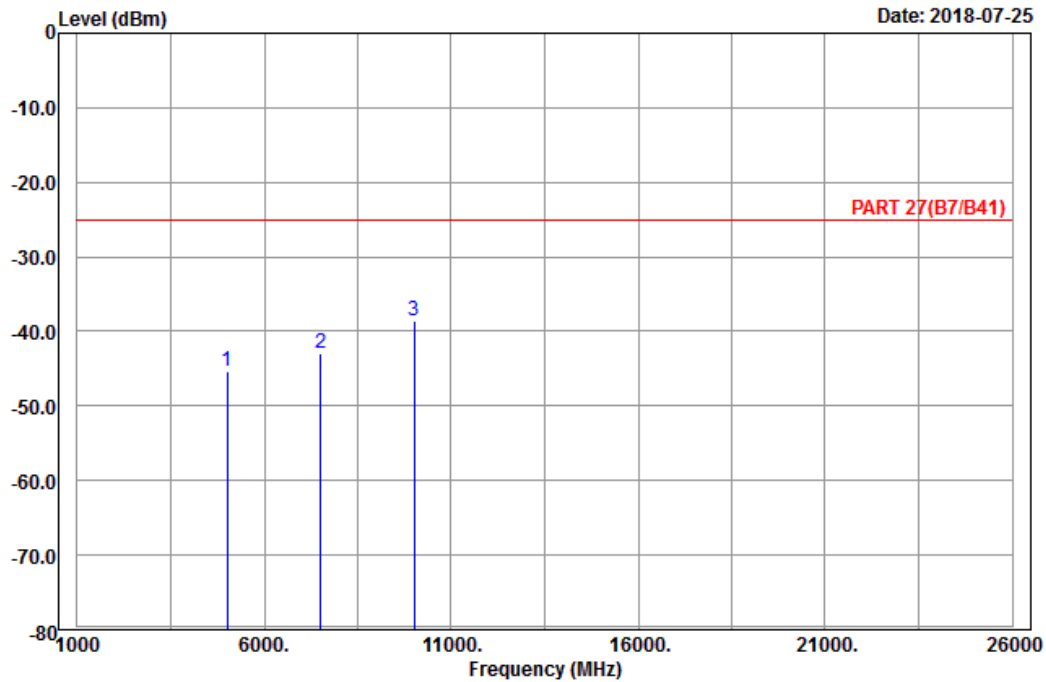

Site : 966 chamber 1
 Condition: PART 27(B7/B41) Horizontal
 Remark : LTE_Band 7_Link_CH20775
 Tested by: Karl Lee

	Freq	Level	Read Level	Limit Line	Over Limit	Factor	Remark
	MHz	dBm	dBm	dBm	dB	dB	
1	5005.00	-45.24	-64.82	-25.00	-20.24	19.58	Peak
2	7507.50	-43.04	-65.72	-25.00	-18.04	22.68	Peak
3 pp	10010.00	-38.51	-64.76	-25.00	-13.51	26.25	Peak



A D T

Data: 10

Date: 2018-07-25

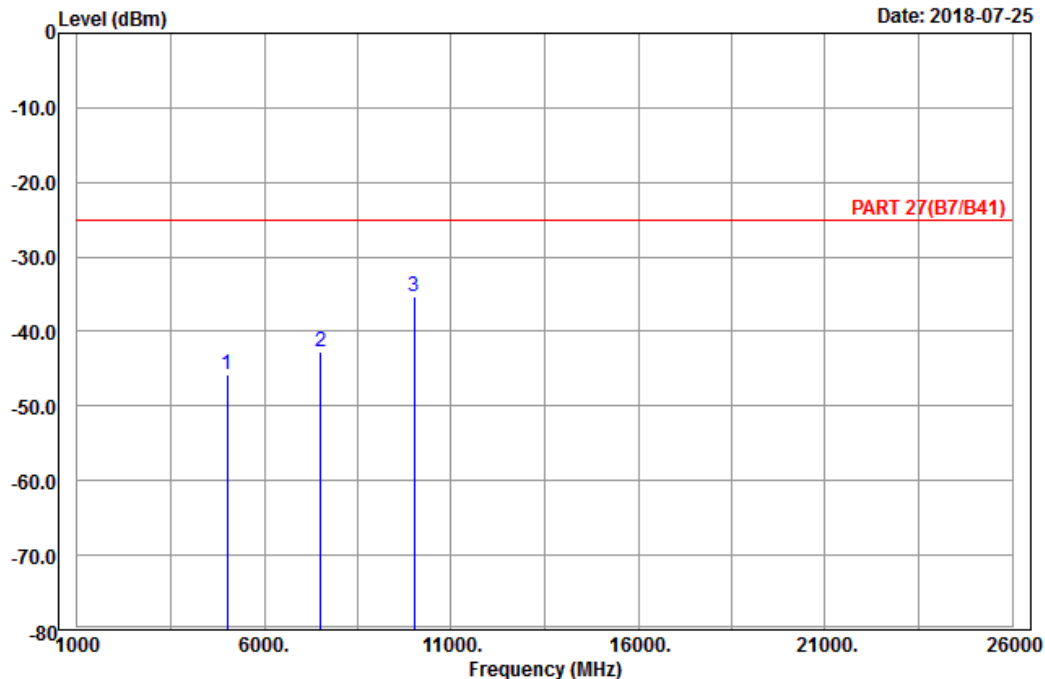

Site : 966 chamber 1
 Condition: PART 27(B7/B41) Vertical
 Remark : LTE_Band 7_Link_CH20775
 Tested by: Karl Lee

	Freq	Level	Read Level	Limit Line	Over Limit	Factor	Remark
	MHz	dBm	dBm	dBm	dB	dB	
1	5005.00	-45.68	-65.26	-25.00	-20.68	19.58	Peak
2	7507.50	-42.72	-65.40	-25.00	-17.72	22.68	Peak
3 pp	10010.00	-35.28	-61.53	-25.00	-10.28	26.25	Peak

Middle Channel



Bureau Veritas Consumer Products Services Ltd., Taoyuan Branch

A D T

Data: 9

Date: 2018-07-25

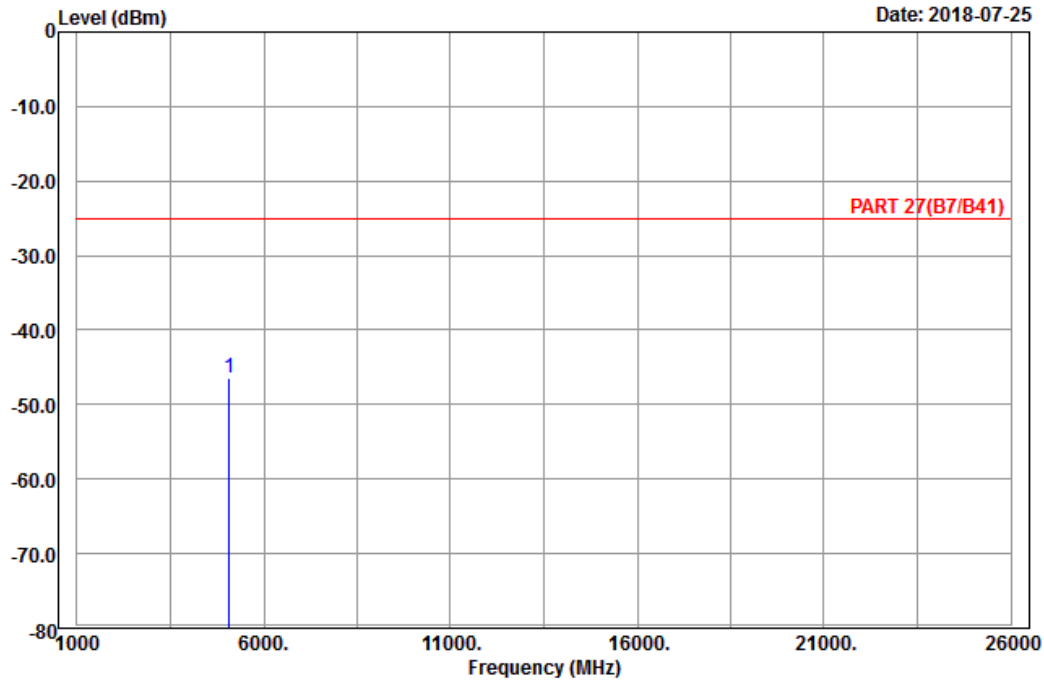

Site : 966 chamber 1
 Condition: PART 27(B7/B41) Horizontal
 Remark : LTE_Band 7_Link_CH21100
 Tested by: Harry Hsueh

	Freq	Level	Read Level	Limit	Over	Factor	Remark
	MHz	dBm	dBm	dBm	dB	dB	
1	pp 5070.00	-46.41	-65.80	-25.00	-21.41	19.39	Peak



A D T

Data: 10

Date: 2018-07-25

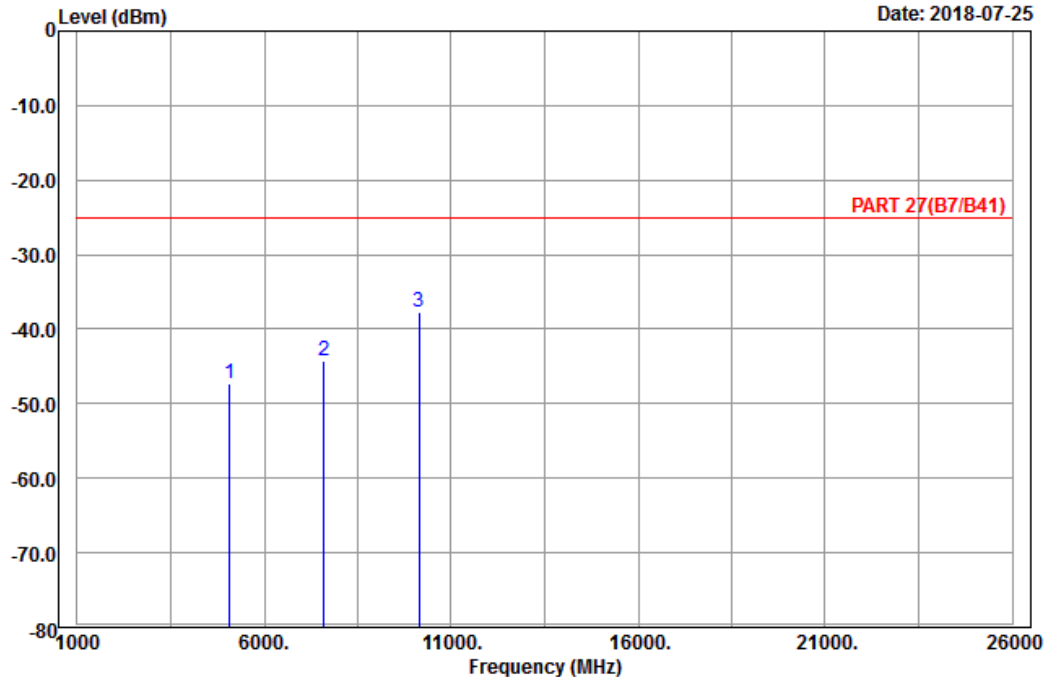

Site : 966 chamber 1
 Condition: PART 27(B7/B41) Vertical
 Remark : LTE_Band 7_Link_CH21100
 Tested by: Harry Hsueh

	Freq	Level	Read Level	Limit Line	Over Limit	Factor	Remark
	MHz	dBm	dBm	dBm	dB	dB	
1	5070.00	-47.40	-66.79	-25.00	-22.40	19.39	Peak
2	7605.00	-44.33	-67.32	-25.00	-19.33	22.99	Peak
3 pp	10140.00	-37.79	-64.21	-25.00	-12.79	26.42	Peak

High Channel



Bureau Veritas Consumer Products Services Ltd., Taoyuan Branch

A D T

Data: 9

Date: 2018-07-25

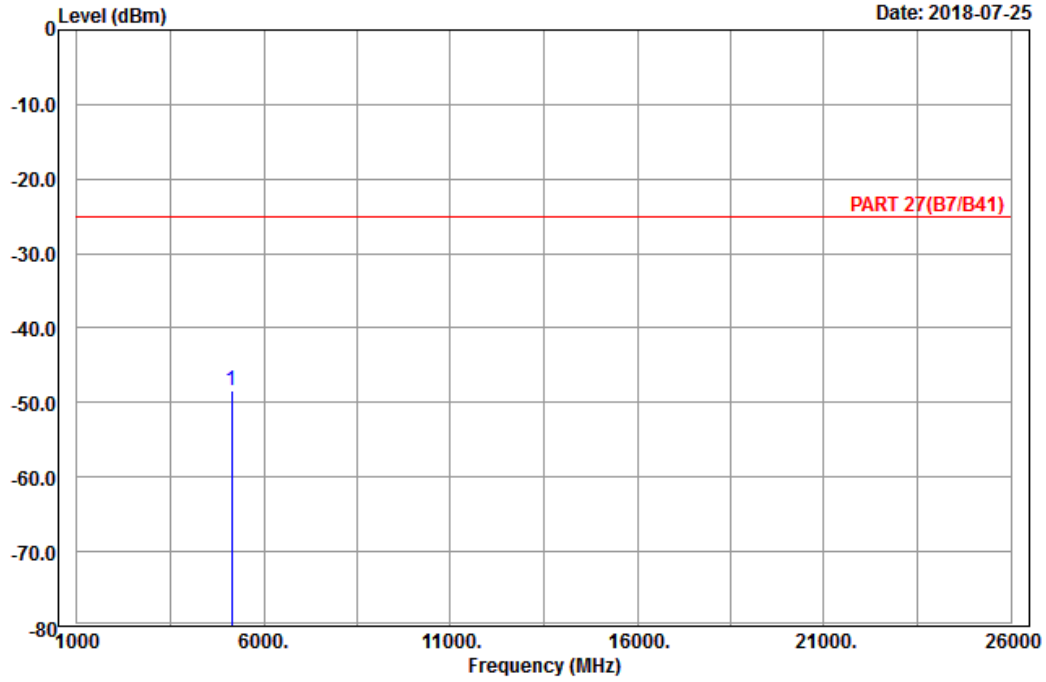

Site : 966 chamber 1
 Condition: PART 27(B7/B41) Horizontal
 Remark : LTE_Band 7_Link_CH21425
 Tested by: Karl Lee

Freq	Level	Read Level	Limit Line	Over Limit	Factor	Remark
MHz	dBm	dBm	dBm	dB	dB	
1 pp 5135.00	-48.47	-68.28	-25.00	-23.47	19.81	Peak



A D T

Data: 10

Date: 2018-07-25

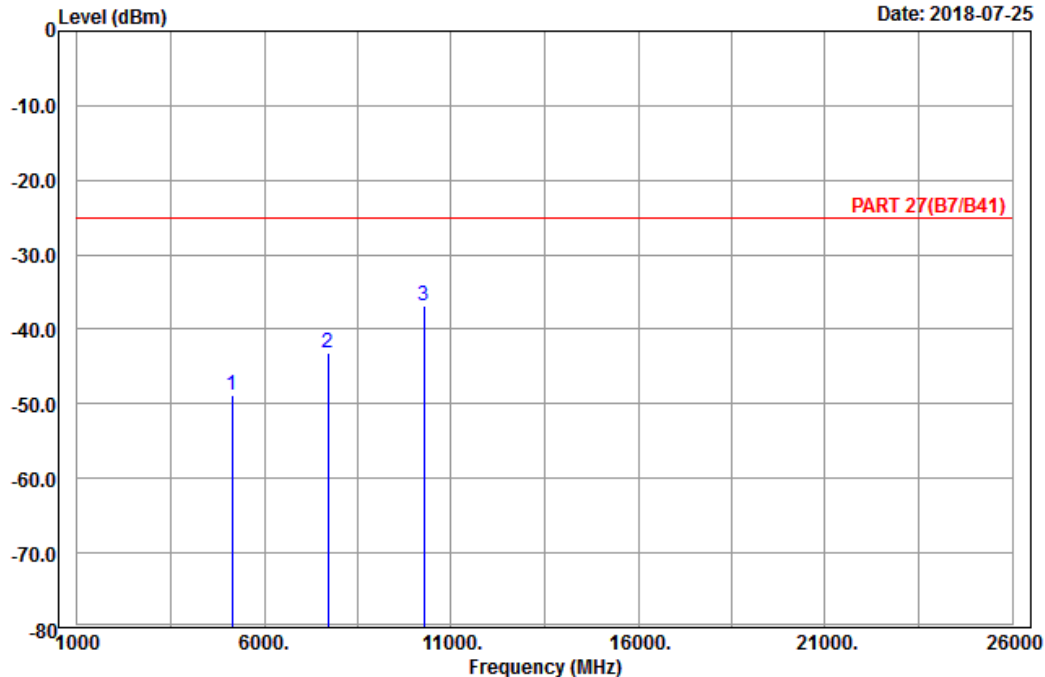

Site : 966 chamber 1
 Condition: PART 27(B7/B41) Vertical
 Remark : LTE_Band 7_Link_CH21425
 Tested by: Karl Lee

	Freq	Level	Read Level	Limit Line	Over Limit	Factor	Remark
	MHz	dBm	dBm	dBm	dB	dB	
1	5135.00	-48.88	-68.69	-25.00	-23.88	19.81	Peak
2	7702.50	-43.21	-66.37	-25.00	-18.21	23.16	Peak
3 pp	10270.00	-36.86	-63.45	-25.00	-11.86	26.59	Peak

Channel Bandwidth: 20 MHz / QPSK
Low Channel



Bureau Veritas Consumer Products Services Ltd., Taoyuan Branch

A D T

Data: 9

Date: 2018-07-25

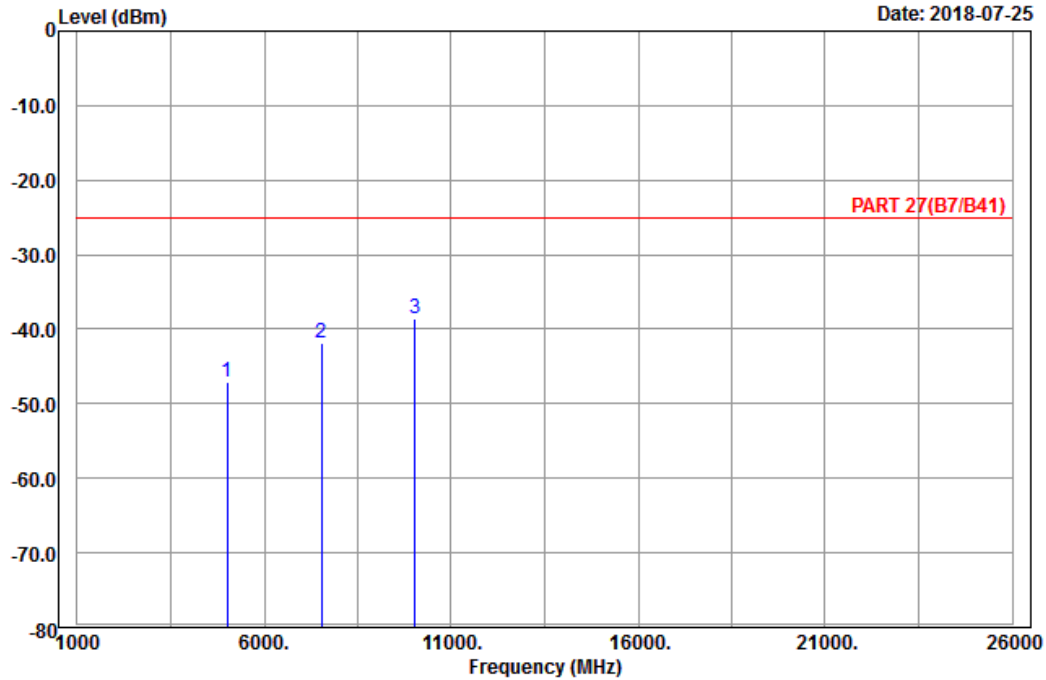

Site : 966 chamber 1
Condition: PART 27(B7/B41) Horizontal
Remark : LTE_Band 7_Link_CH20850
Tested by: Harry Hsueh

	Freq	Level	Read Level	Limit Line	Over Limit	Factor	Remark
	MHz	dBm	dBm	dBm	dB	dB	
1	5020.00	-47.06	-66.14	-25.00	-22.06	19.08	Peak
2	7530.00	-41.90	-64.75	-25.00	-16.90	22.85	Peak
3	pp 10040.00	-38.58	-64.85	-25.00	-13.58	26.27	Peak



A D T

Data: 10

Date: 2018-07-25

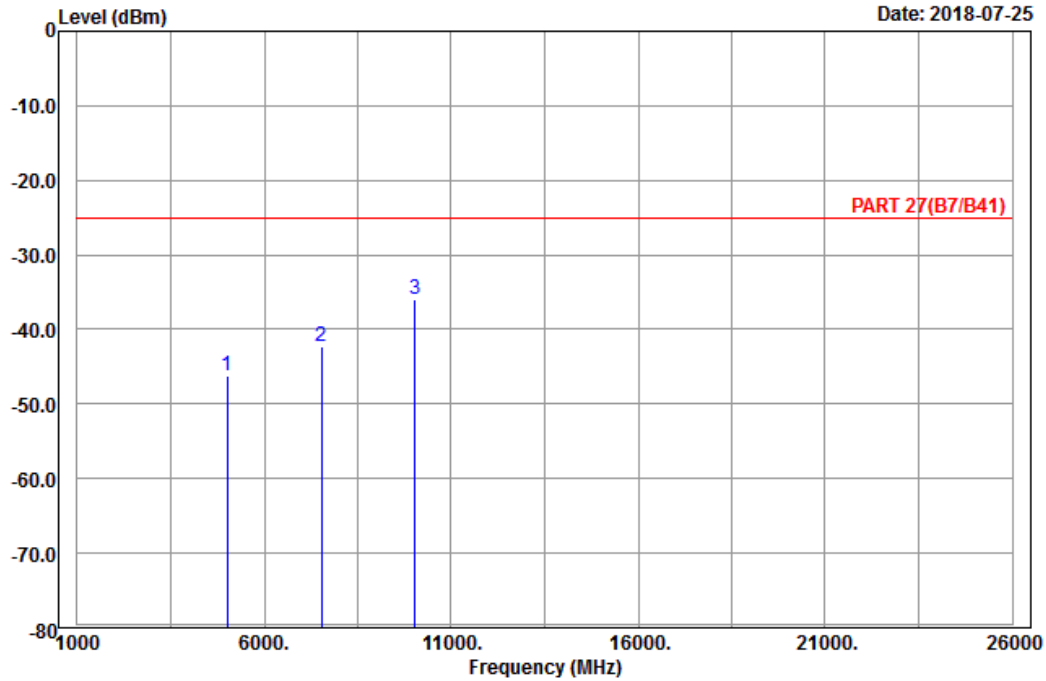

Site : 966 chamber 1
 Condition: PART 27(B7/B41) Vertical
 Remark : LTE_Band 7_Link_CH20850
 Tested by: Harry Hsueh

	Freq	Level	Read Level	Limit Line	Over Limit	Factor	Remark
	MHz	dBm	dBm	dBm	dB	dB	
1	5020.00	-46.11	-65.19	-25.00	-21.11	19.08	Peak
2	7530.00	-42.25	-65.10	-25.00	-17.25	22.85	Peak
3 pp	10040.00	-35.95	-62.22	-25.00	-10.95	26.27	Peak

Middle Channel



Bureau Veritas Consumer Products Services Ltd., Taoyuan Branch

A D T

Data: 13

Date: 2018-07-25

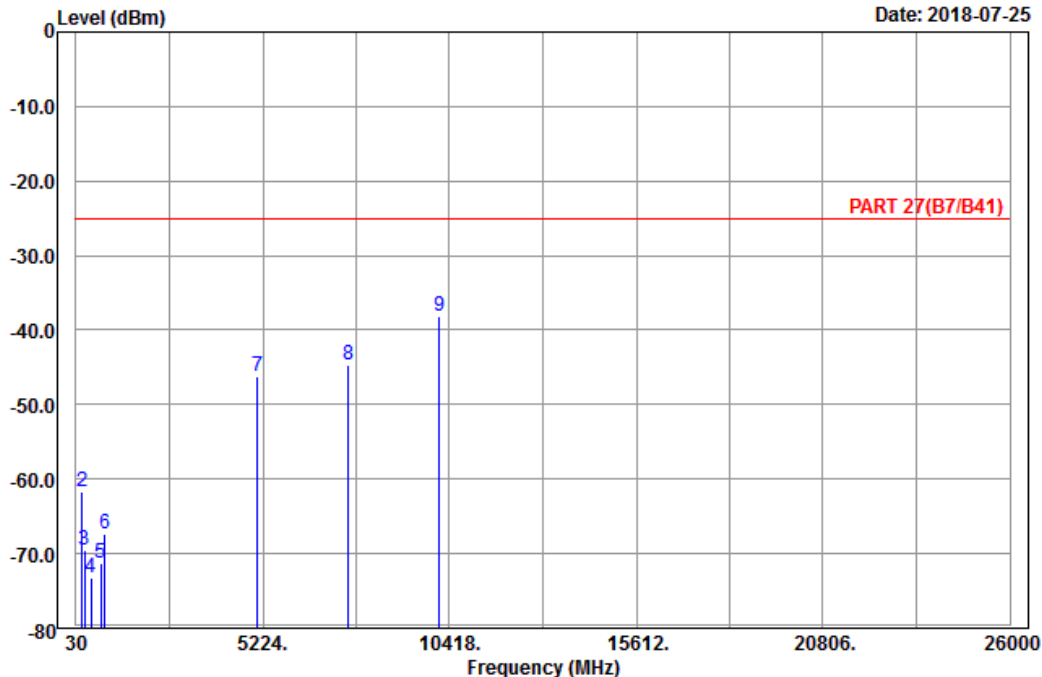

Site : 966 chamber 1
 Condition: PART 27(B7/B41) Horizontal
 Remark : LTE_Band 7_Link_CH21100
 Tested by: Harry Hsueh

	Freq	Level	Read Level	Limit Line	Over Limit	Factor	Remark
	MHz	dBm	dBm	dBm	dB	dB	
1	81.84	-84.09	-72.43	-25.00	-59.09	-11.66	Peak
2	198.48	-61.77	-55.63	-25.00	-36.77	-6.14	Peak
3	278.40	-69.61	-63.85	-25.00	-44.61	-5.76	Peak
4	439.30	-73.27	-69.66	-25.00	-48.27	-3.61	Peak
5	728.40	-71.37	-70.46	-25.00	-46.37	-0.91	Peak
6	841.80	-67.41	-68.95	-25.00	-42.41	1.54	Peak
7	5070.00	-46.14	-65.53	-25.00	-21.14	19.39	Peak
8	7605.00	-44.62	-67.61	-25.00	-19.62	22.99	Peak
9	pp 10140.00	-38.10	-64.52	-25.00	-13.10	26.42	Peak



Bureau Veritas Consumer Products Services Ltd., Taoyuan Branch

A D T

Data: 14

Date: 2018-07-25

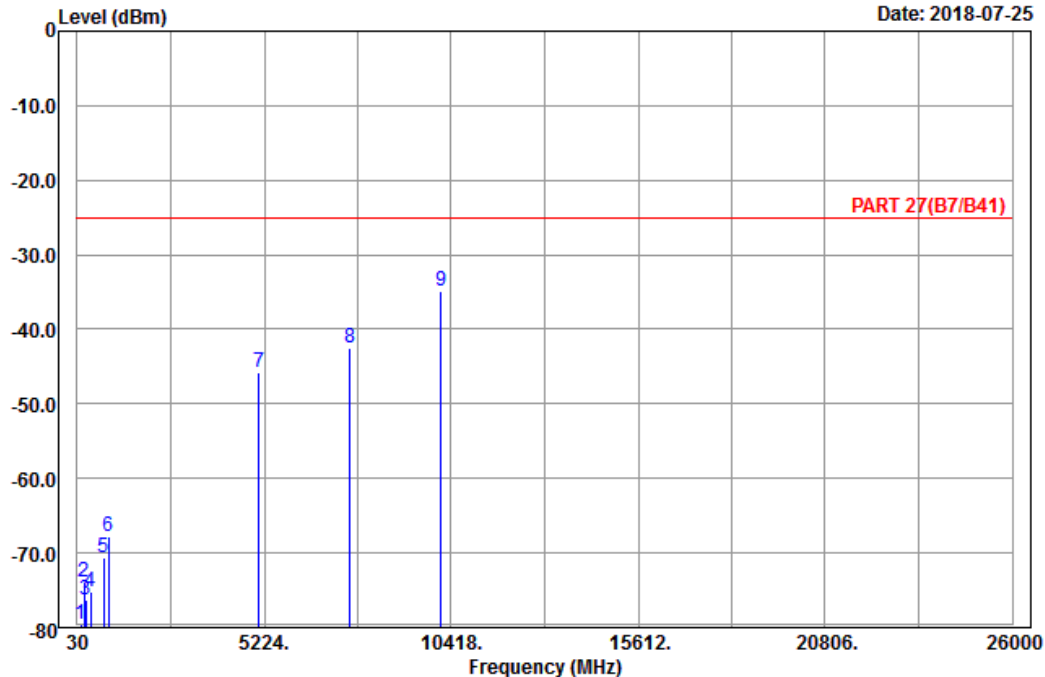

Site : 966 chamber 1
 Condition: PART 27(B7/B41) Vertical
 Remark : LTE_Band 7_Link_CH21100
 Tested by: Harry Hsueh

	Freq	Level	Read Level	Limit Line	Over Limit	Factor	Remark
	MHz	dBm	dBm	dBm	dB	dB	
1	130.98	-79.65	-72.00	-25.00	-54.65	-7.65	Peak
2	221.16	-73.83	-67.93	-25.00	-48.83	-5.90	Peak
3	275.70	-76.24	-70.50	-25.00	-51.24	-5.74	Peak
4	413.40	-75.21	-72.17	-25.00	-50.21	-3.04	Peak
5	771.80	-70.65	-70.81	-25.00	-45.65	0.16	Peak
6	909.70	-67.86	-71.18	-25.00	-42.86	3.32	Peak
7	5070.00	-45.73	-65.12	-25.00	-20.73	19.39	Peak
8	7605.00	-42.45	-65.44	-25.00	-17.45	22.99	Peak
9 pp	10140.00	-34.84	-61.26	-25.00	-9.84	26.42	Peak

High Channel



Bureau Veritas Consumer Products Services Ltd., Taoyuan Branch

A D T

Data: 9

Date: 2018-07-25

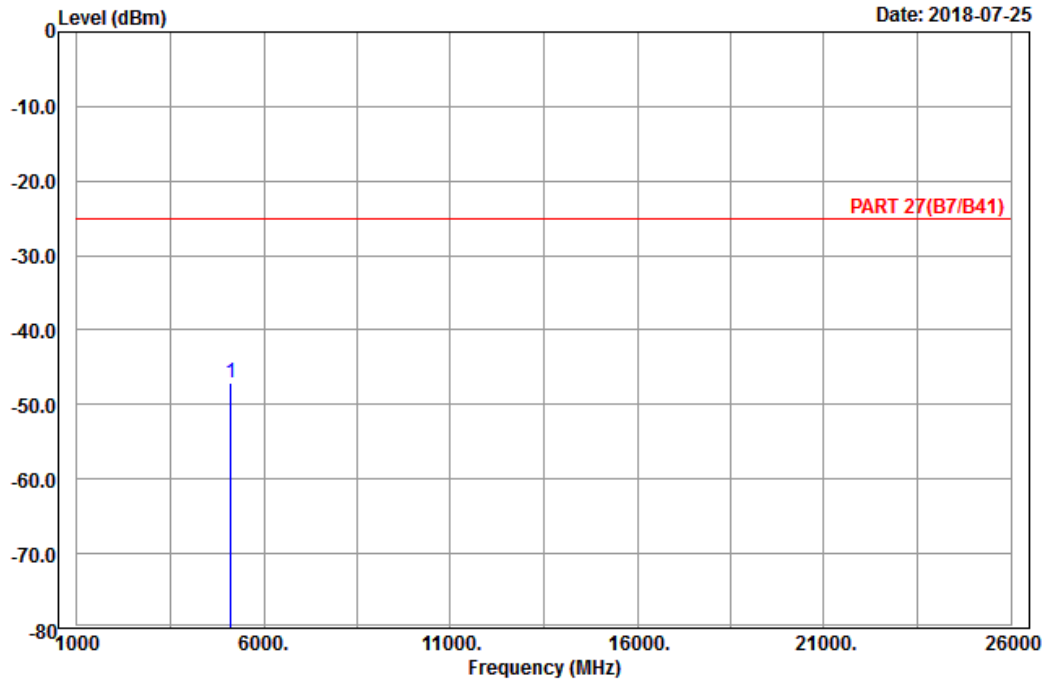

Site : 966 chamber 1
 Condition: PART 27(B7/B41) Horizontal
 Remark : LTE_Band 7_Link_CH21350
 Tested by: Karl Lee

	Freq	Level	Read Level	Limit Line	Over Limit	Factor	Remark
	MHz	dBm	dBm	dBm	dB	dB	
1	pp 5120.00	-47.07	-66.78	-25.00	-22.07	19.71	Peak



A D T

Data: 10

Date: 2018-07-25

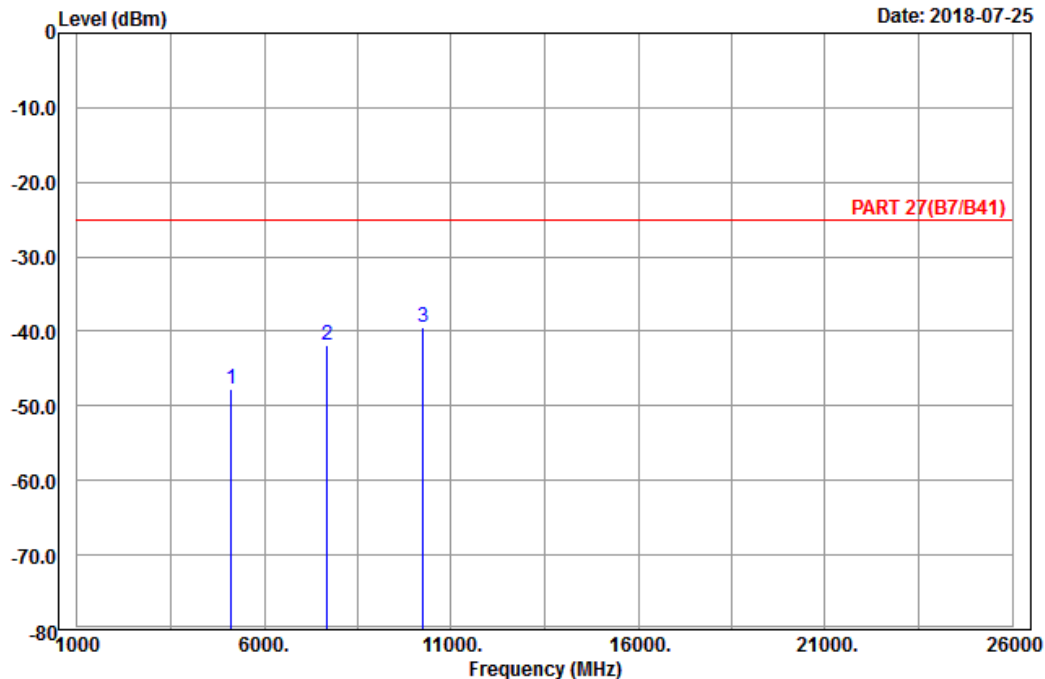

Site : 966 chamber 1
 Condition: PART 27(B7/B41) Vertical
 Remark : LTE_Band 7_Link_CH21350
 Tested by: Karl Lee

	Freq	Level	Read Level	Limit Line	Over Limit	Factor	Remark
	MHz	dBm	dBm	dBm	dB	dB	
1	5120.00	-47.75	-67.46	-25.00	-22.75	19.71	Peak
2	7680.00	-41.89	-65.01	-25.00	-16.89	23.12	Peak
3 pp	10240.00	-39.42	-65.96	-25.00	-14.42	26.54	Peak

LTE Band 38
 Channel Bandwidth: 5 MHz / QPSK
 Low Channel



Bureau Veritas Consumer Products Services Ltd., Taoyuan Branch

A D T

Data: 9

Date: 2018-07-26

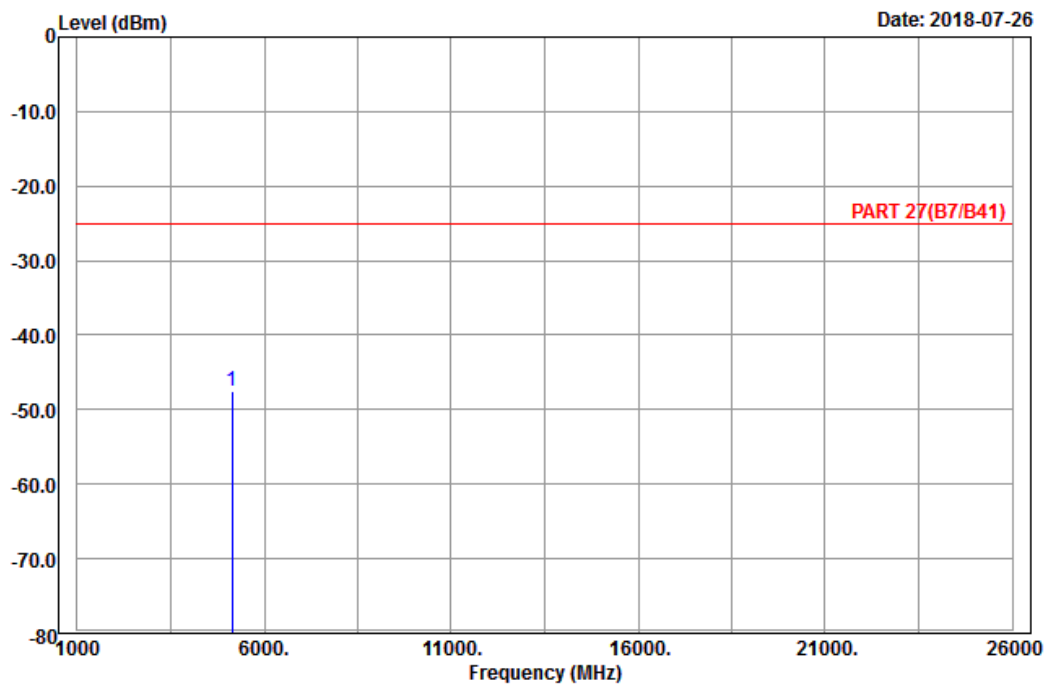

Site : 966 chamber 1
 Condition: PART 27(B7/B41) Horizontal
 Remark : LTE_Band 38_Link_CH37775
 Tested by: Karl Lee

	Read	Limit	Over			
Freq	Level	Level	Line	Limit	Factor	Remark
MHz	dBm	dBm	dBm	dB	dB	
1 pp 5145.00	-47.51	-67.32	-25.00	-22.51	19.81	Peak



A D T

Data: 10

Date: 2018-07-26

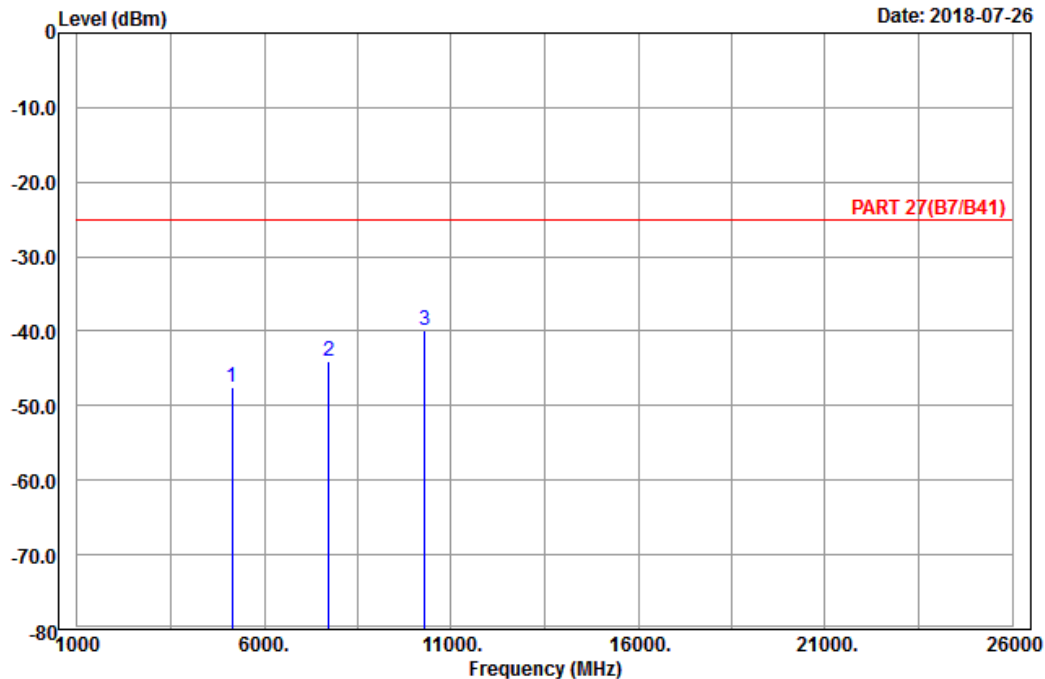

Site : 966 chamber 1
 Condition: PART 27(B7/B41) Vertical
 Remark : LTE_Band 38_Link_CH37775
 Tested by: Karl Lee

	Freq	Level	Read Level	Limit Line	Over Limit	Factor	Remark
	MHz	dBm	dBm	dBm	dB	dB	
1	5145.00	-47.62	-67.43	-25.00	-22.62	19.81	Peak
2	7717.50	-44.08	-67.27	-25.00	-19.08	23.19	Peak
3 pp	10290.00	-39.79	-66.41	-25.00	-14.79	26.62	Peak

Middle Channel



Bureau Veritas Consumer Products Services Ltd., Taoyuan Branch

A D T

Data: 9

Date: 2018-07-26

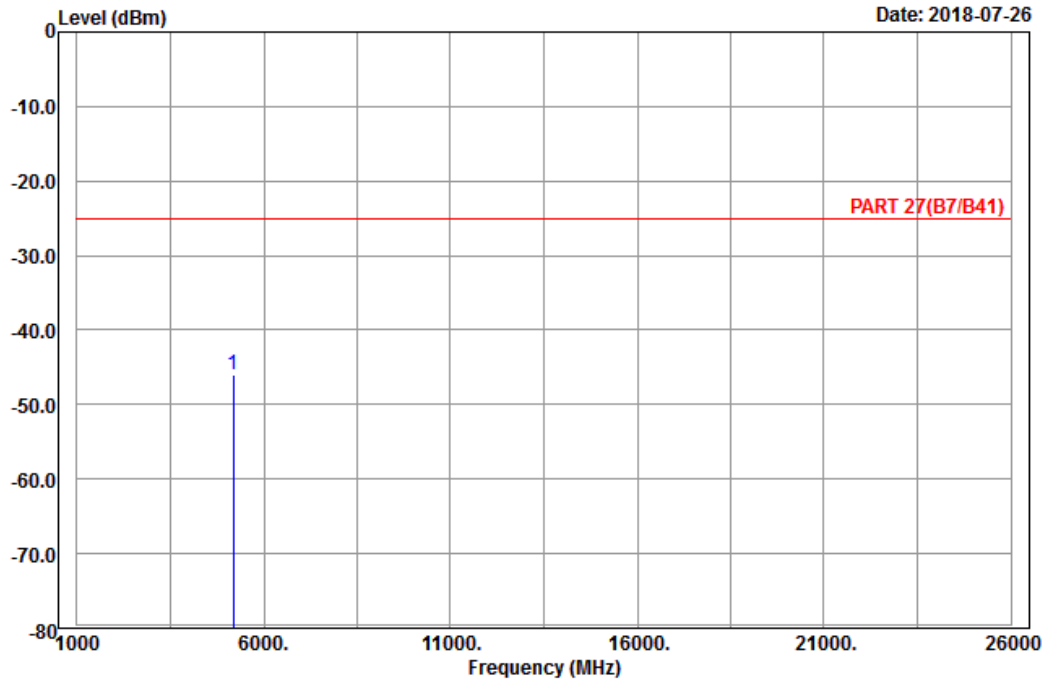

Site : 966 chamber 1
 Condition: PART 27(B7/B41) Horizontal
 Remark : LTE_Band 38_Link_CH38000
 Tested by: Karl Lee

	Freq	Level	Read Level	Limit Line	Over Limit	Factor	Remark
	MHz	dBm	dBm	dBm	dB	dB	
1	pp 5190.00	-45.90	-66.02	-25.00	-20.90	20.12	Peak



Bureau Veritas Consumer Products Services Ltd., Taoyuan Branch

A D T

Data: 10

Date: 2018-07-26

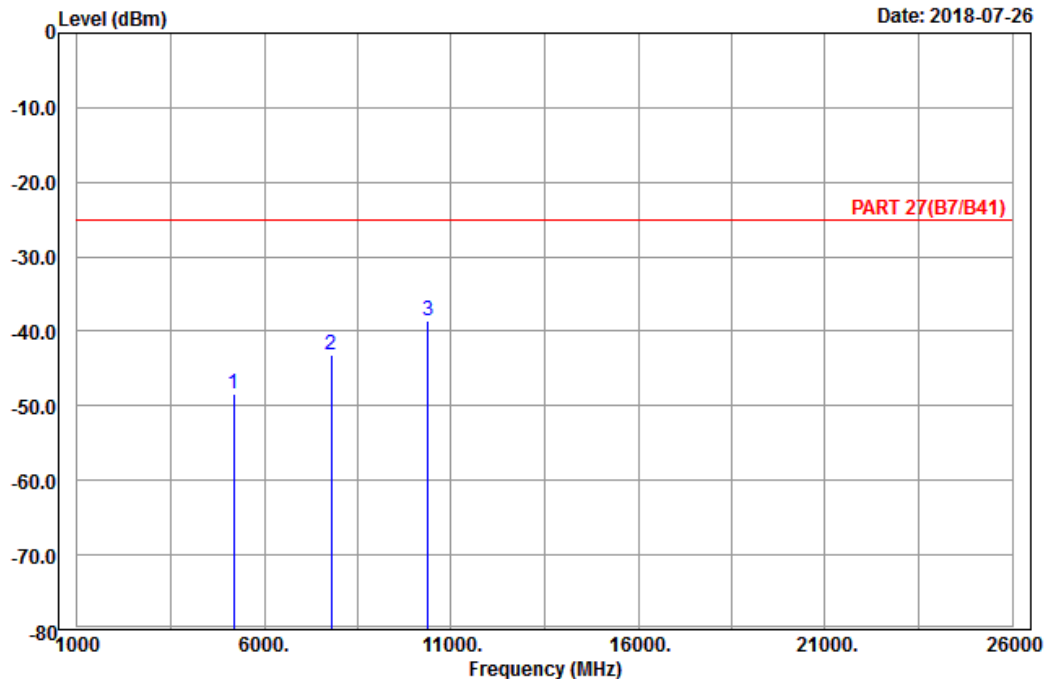

Site : 966 chamber 1
 Condition: PART 27(B7/B41) Vertical
 Remark : LTE_Band 38_Link_CH38000
 Tested by: Karl Lee

	Freq	Level	Read Level	Limit Line	Over Limit	Factor	Remark
	MHz	dBm	dBm	dBm	dB	dB	
1	5190.00	-48.40	-68.52	-25.00	-23.40	20.12	Peak
2	7785.00	-43.26	-66.59	-25.00	-18.26	23.33	Peak
3 pp	10380.00	-38.50	-65.24	-25.00	-13.50	26.74	Peak

High Channel



Bureau Veritas Consumer Products Services Ltd., Taoyuan Branch

A D T

Data: 9

Date: 2018-07-26

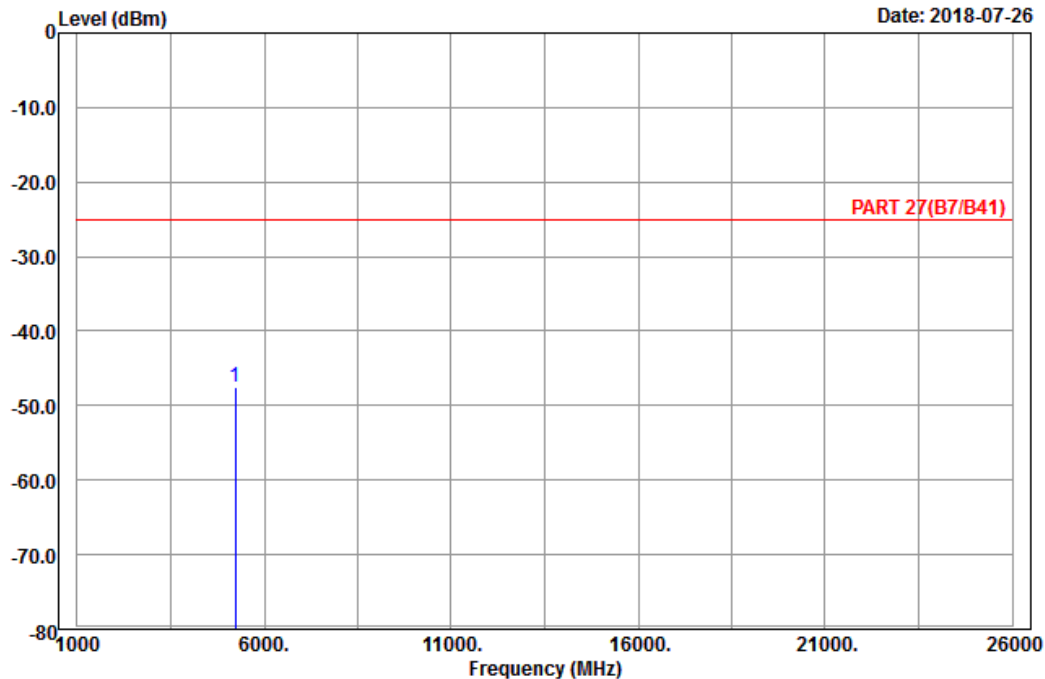

Site : 966 chamber 1
 Condition: PART 27(B7/B41) Horizontal
 Remark : LTE_Band 38_Link_CH38225
 Tested by: Karl Lee

Freq	Level	Read Level	Limit Line	Over Limit	Factor	Remark
MHz	dBm	dBm	dBm	dB	dB	
1 pp 5235.00	-47.41	-67.57	-25.00	-22.41	20.16	Peak



Bureau Veritas Consumer Products Services Ltd., Taoyuan Branch

A D T

Data: 10

Date: 2018-07-26

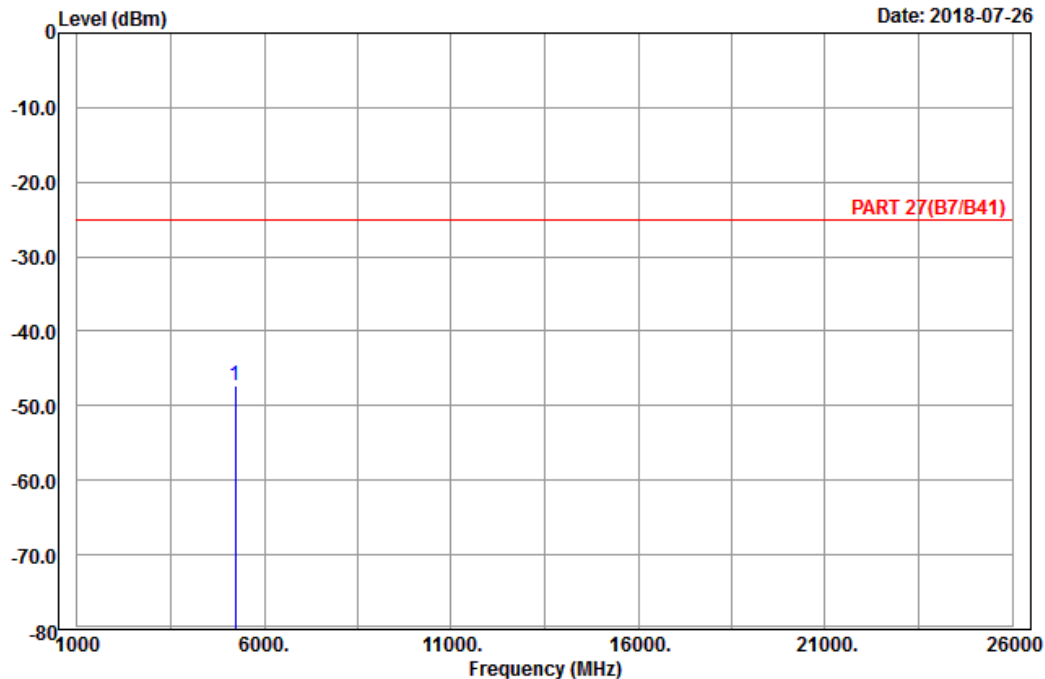

Site : 966 chamber 1
 Condition: PART 27(B7/B41) Vertical
 Remark : LTE_Band 38_Link_CH38225
 Tested by: Karl Lee

	Freq	Level	Read Level	Limit Line	Over Limit	Factor	Remark
	MHz	dBm	dBm	dBm	dB	dB	
1 pp	5235.00	-47.21	-67.37	-25.00	-22.21	20.16	Peak

Channel Bandwidth: 20 MHz / QPSK
Low Channel



Bureau Veritas Consumer Products Services Ltd., Taoyuan Branch

A D T

Data: 9

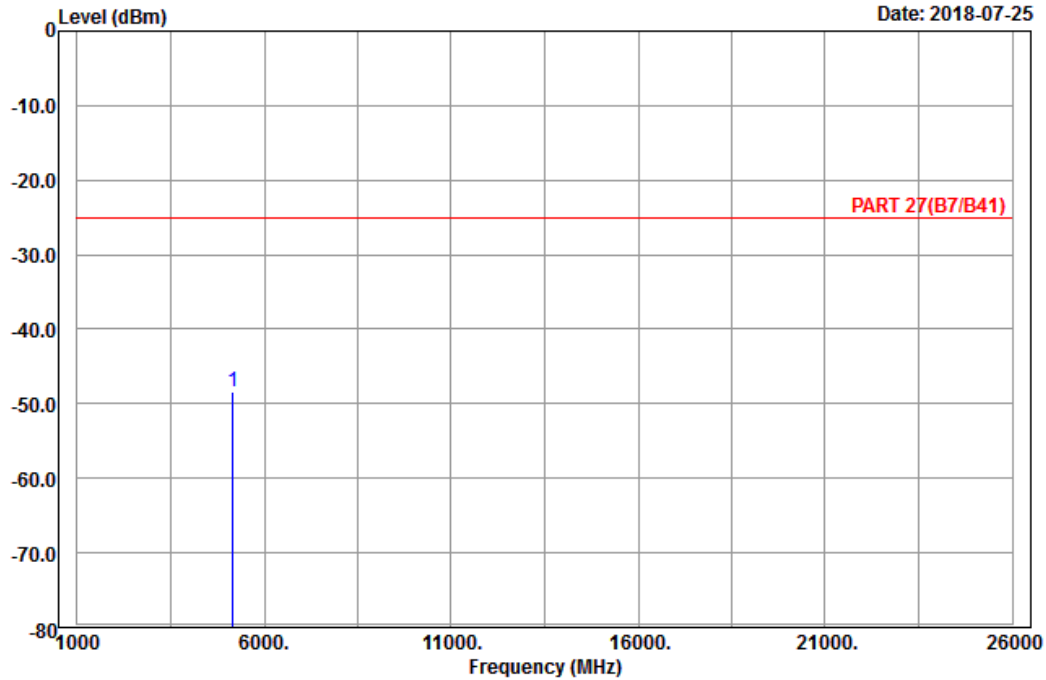

Site : 966 chamber 1
Condition: PART 27(B7/B41) Horizontal
Remark : LTE_Band 38_Link_CH37850
Tested by: Karl Lee

	Read	Limit	Over			
Freq	Level	Level	Line	Limit	Factor	Remark
MHz	dBm	dBm	dBm	dB	dB	
1 pp 5160.00	-48.34	-68.26	-25.00	-23.34	19.92	Peak



A D T

Data: 10

Date: 2018-07-25

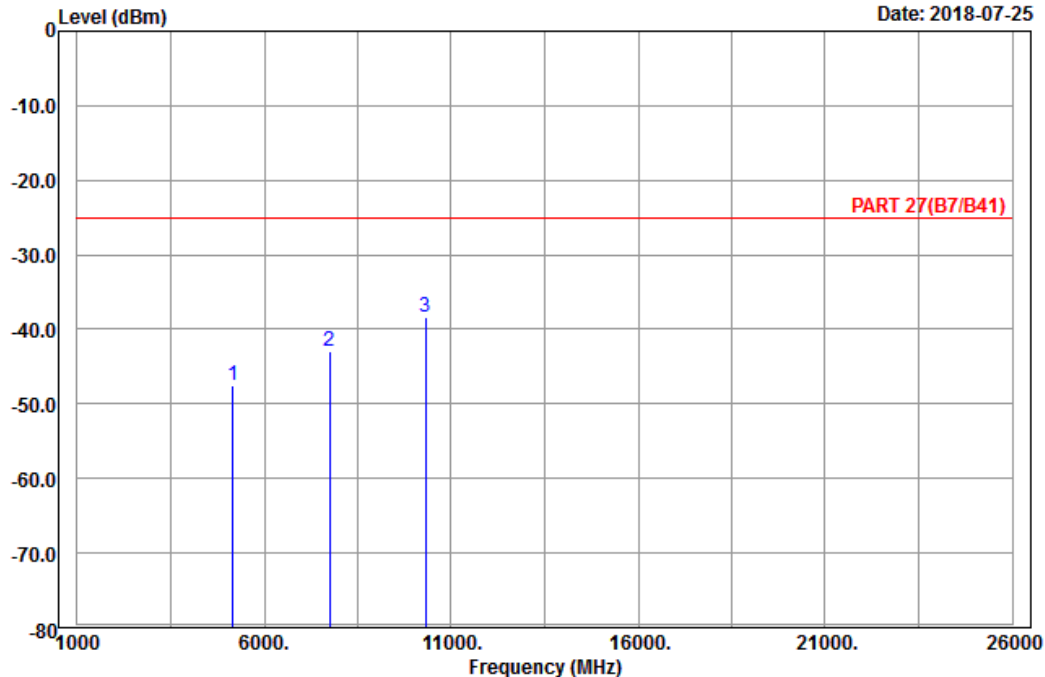

Site : 966 chamber 1
 Condition: PART 27(B7/B41) Vertical
 Remark : LTE_Band 38_Link_CH37850
 Tested by: Karl Lee

	Freq	Level	Read Level	Limit Line	Over Limit	Factor	Remark
	MHz	dBm	dBm	dBm	dB	dB	
1	5160.00	-47.52	-67.44	-25.00	-22.52	19.92	Peak
2	7740.00	-42.98	-66.21	-25.00	-17.98	23.23	Peak
3 pp	10320.00	-38.27	-64.94	-25.00	-13.27	26.67	Peak

Middle Channel



Bureau Veritas Consumer Products Services Ltd., Taoyuan Branch

A D T

Data: 13

Date: 2018-07-25

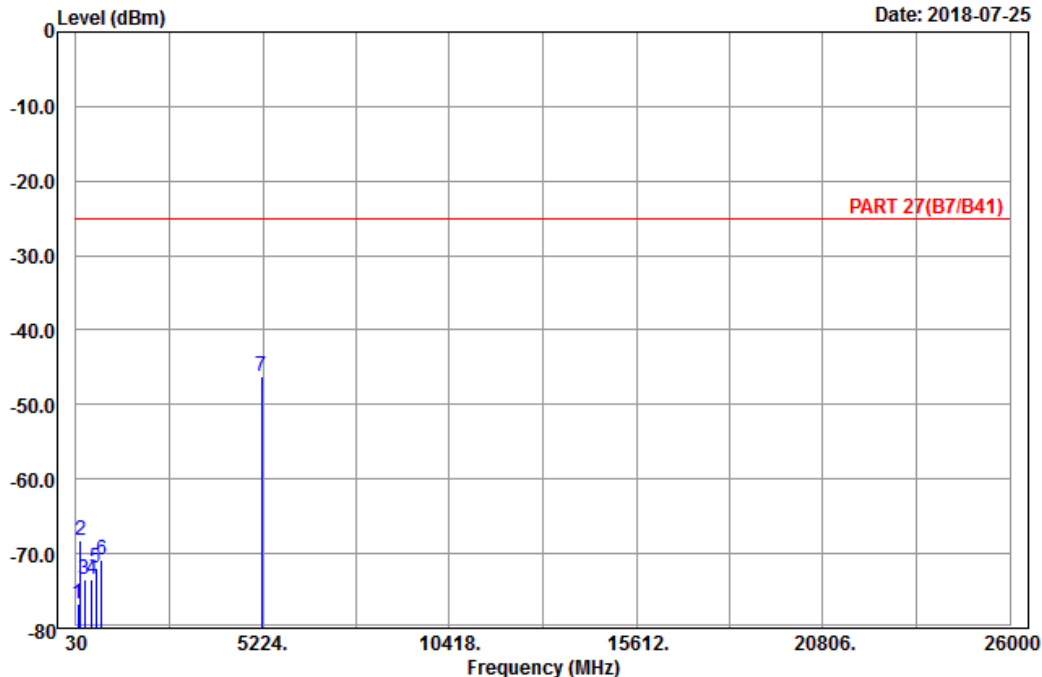

Site : 966 chamber 1
 Condition: PART 27(B7/B41) Horizontal
 Remark : LTE_Band 38_Link_CH38000
 Tested by: Karl Lee

	Freq	Level	Read Level	Limit Line	Over Limit	Factor	Remark
	MHz	dBm	dBm	dBm	dB	dB	
1	92.64	-76.79	-66.28	-25.00	-51.79	-10.51	Peak
2	163.11	-68.24	-60.86	-25.00	-43.24	-7.38	Peak
3	274.89	-73.45	-67.72	-25.00	-48.45	-5.73	Peak
4	462.40	-73.46	-69.25	-25.00	-48.46	-4.21	Peak
5	581.40	-71.89	-71.51	-25.00	-46.89	-0.38	Peak
6	745.20	-70.93	-69.71	-25.00	-45.93	-1.22	Peak
7 pp	5190.00	-46.23	-66.35	-25.00	-21.23	20.12	Peak



Bureau Veritas Consumer Products Services Ltd., Taoyuan Branch

A D T

Data: 14

Date: 2018-07-25

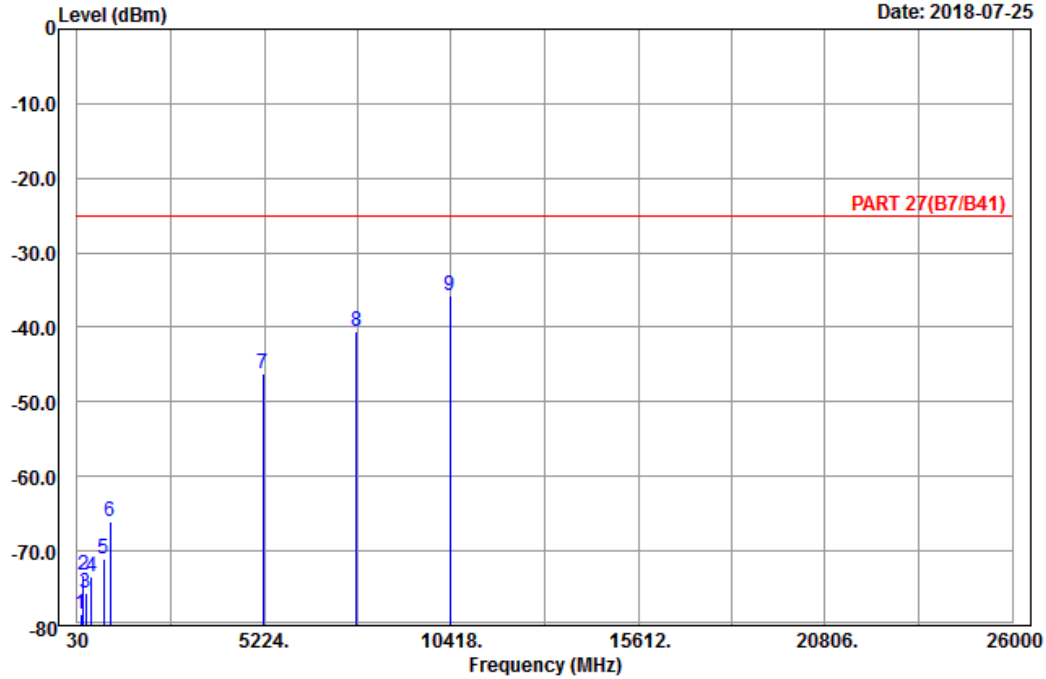

Site : 966 chamber 1
 Condition: PART 27(B7/B41) Vertical
 Remark : LTE_Band 38_Link_CH38000
 Tested by: Karl Lee

	Freq	Level	Read Level	Limit Line	Over Limit	Factor	Remark
	MHz	dBm	dBm	dBm	dB	dB	
1	129.90	-78.54	-70.89	-25.00	-53.54	-7.65	Peak
2	199.83	-73.17	-66.99	-25.00	-48.17	-6.18	Peak
3	276.51	-75.68	-69.93	-25.00	-50.68	-5.75	Peak
4	432.30	-73.40	-69.94	-25.00	-48.40	-3.46	Peak
5	758.50	-71.00	-70.26	-25.00	-46.00	-0.74	Peak
6	934.90	-66.12	-70.57	-25.00	-41.12	4.45	Peak
7	5190.00	-46.24	-66.36	-25.00	-21.24	20.12	Peak
8	7785.00	-40.55	-63.88	-25.00	-15.55	23.33	Peak
9	pp 10390.00	-35.82	-62.58	-25.00	-10.82	26.76	Peak

High Channel



Bureau Veritas Consumer Products Services Ltd., Taoyuan Branch

A D T

Data: 9

Date: 2018-07-25

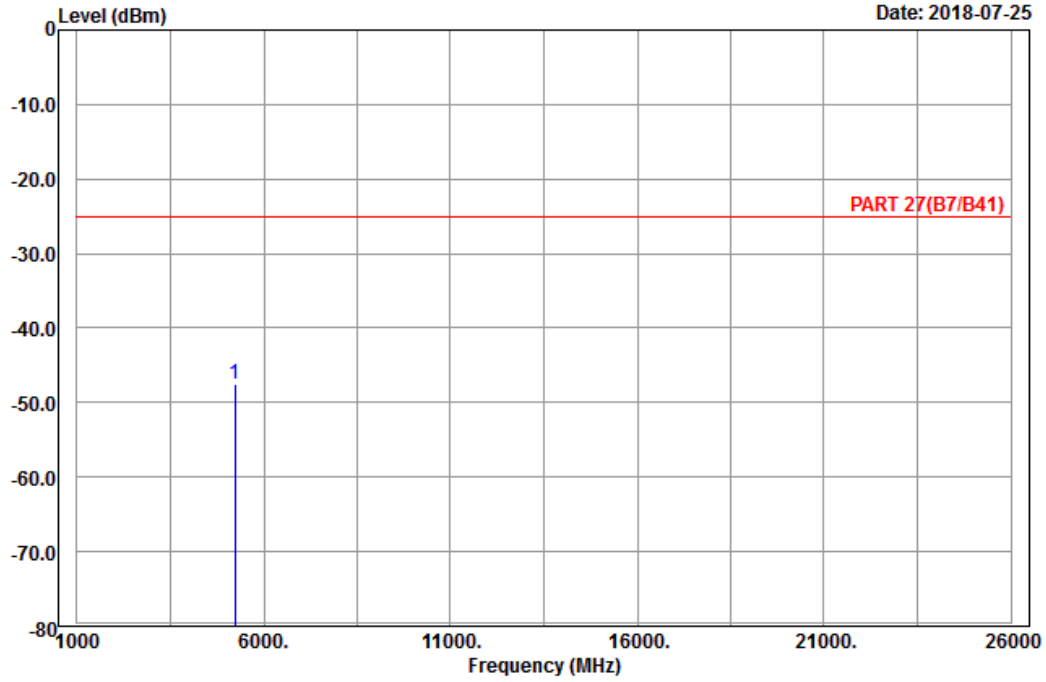

Site : 966 chamber 1
 Condition: PART 27(B7/B41) Horizontal
 Remark : LTE_Band 38_Link_CH38150
 Tested by: Karl Lee

	Read	Limit	Over			
Freq	Level	Level	Line	Limit	Factor	Remark
MHz	dBm	dBm	dBm	dB	dB	
1 pp 5220.00	-47.56	-67.70	-25.00	-22.56	20.14	Peak



Bureau Veritas Consumer Products Services Ltd., Taoyuan Branch

A D T

Data: 10

Date: 2018-07-25

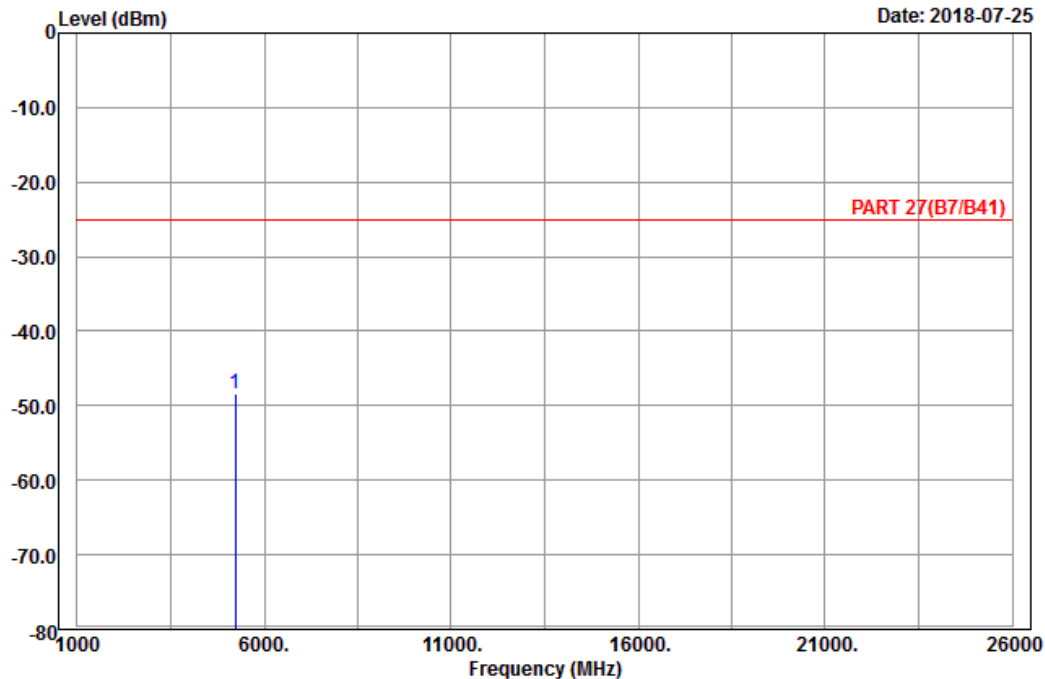

Site : 966 chamber 1
 Condition: PART 27(B7/B41) Vertical
 Remark : LTE_Band 38_Link_CH38150
 Tested by: Karl Lee

	Freq	Level	Read Level	Limit Line	Over Limit	Factor	Remark
	MHz	dBm	dBm	dBm	dB	dB	
1	pp 5220.00	-48.34	-68.48	-25.00	-23.34	20.14	Peak

Mode B
 LTE Band 7
 Channel Bandwidth: 20 MHz / QPSK
 Low Channel



Bureau Veritas Consumer Products Services Ltd., Taoyuan Branch

A D T

Data: 9

Date: 2018-07-25

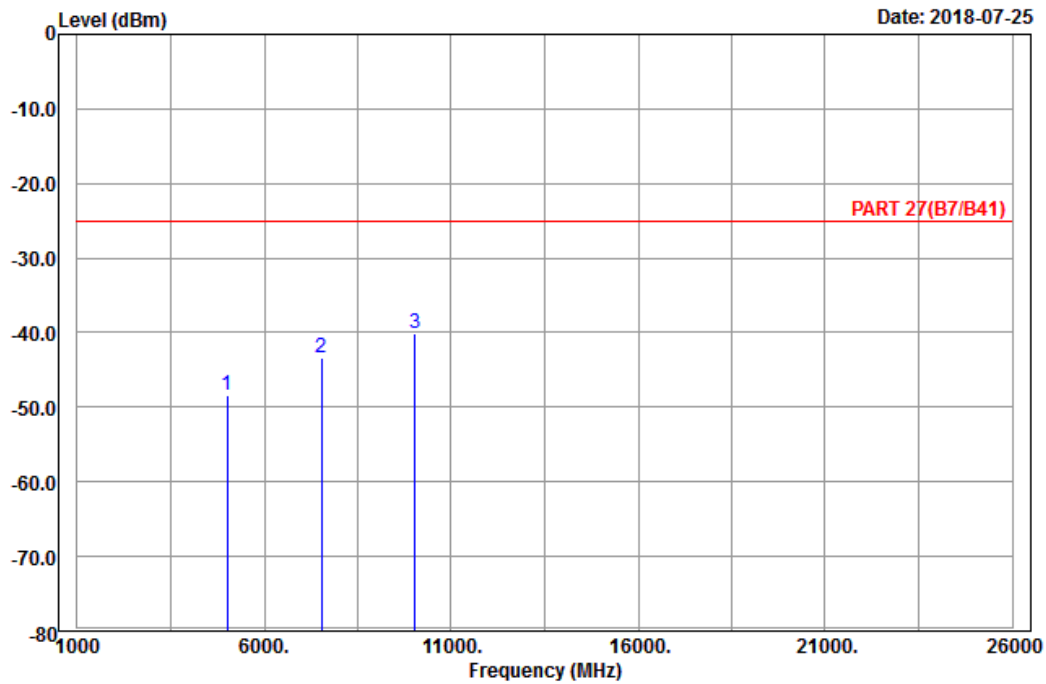

Site : 966 chamber 1
 Condition: PART 27(B7/B41) Horizontal
 Remark : LTE_Band 7_Link_CH20850
 Tested by: Harry Hsueh

	Freq	Level	Read Level	Limit Line	Over Limit	Factor	Remark
	MHz	dBm	dBm	dBm	dB	dB	
1	5020.00	-48.36	-67.44	-25.00	-23.36	19.08	Peak
2	7530.00	-43.36	-66.21	-25.00	-18.36	22.85	Peak
3 pp	10040.00	-40.14	-66.41	-25.00	-15.14	26.27	Peak



A D T

Data: 10

Date: 2018-07-25

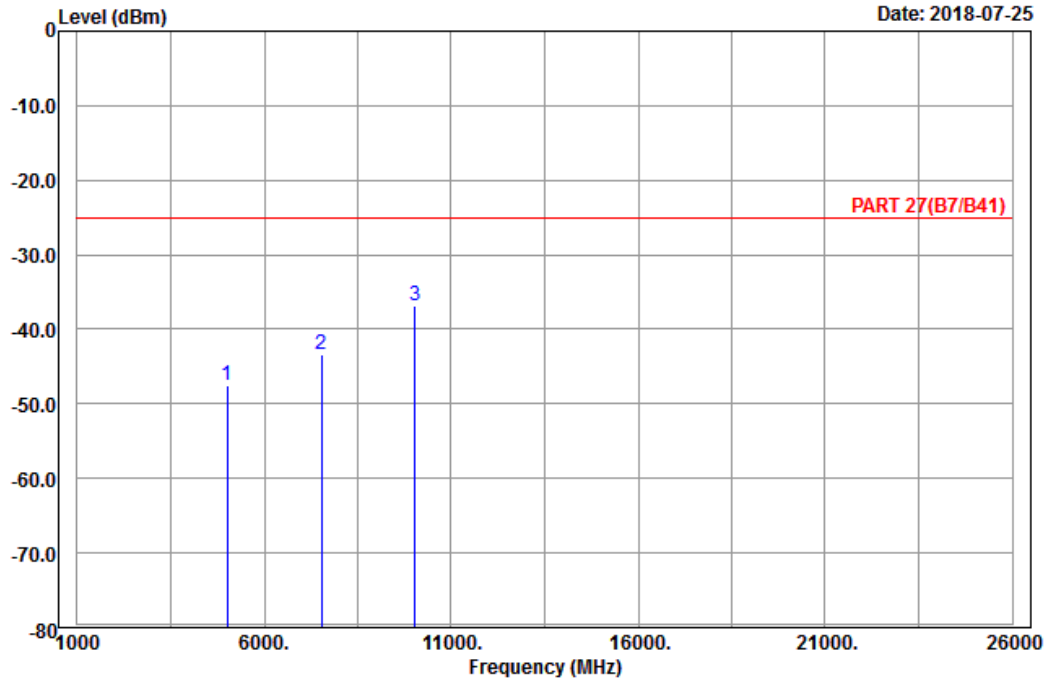

Site : 966 chamber 1
 Condition: PART 27(B7/B41) Vertical
 Remark : LTE_Band 7_Link_CH20850
 Tested by: Harry Hsueh

	Freq	Level	Read Level	Limit Line	Over Limit	Factor	Remark
	MHz	dBm	dBm	dBm	dB	dB	
1	5020.00	-47.50	-66.58	-25.00	-22.50	19.08	Peak
2	7530.00	-43.39	-66.24	-25.00	-18.39	22.85	Peak
3 pp	10040.00	-36.88	-63.15	-25.00	-11.88	26.27	Peak

Middle Channel



Bureau Veritas Consumer Products Services Ltd., Taoyuan Branch

A D T

Data: 13

Date: 2018-07-25

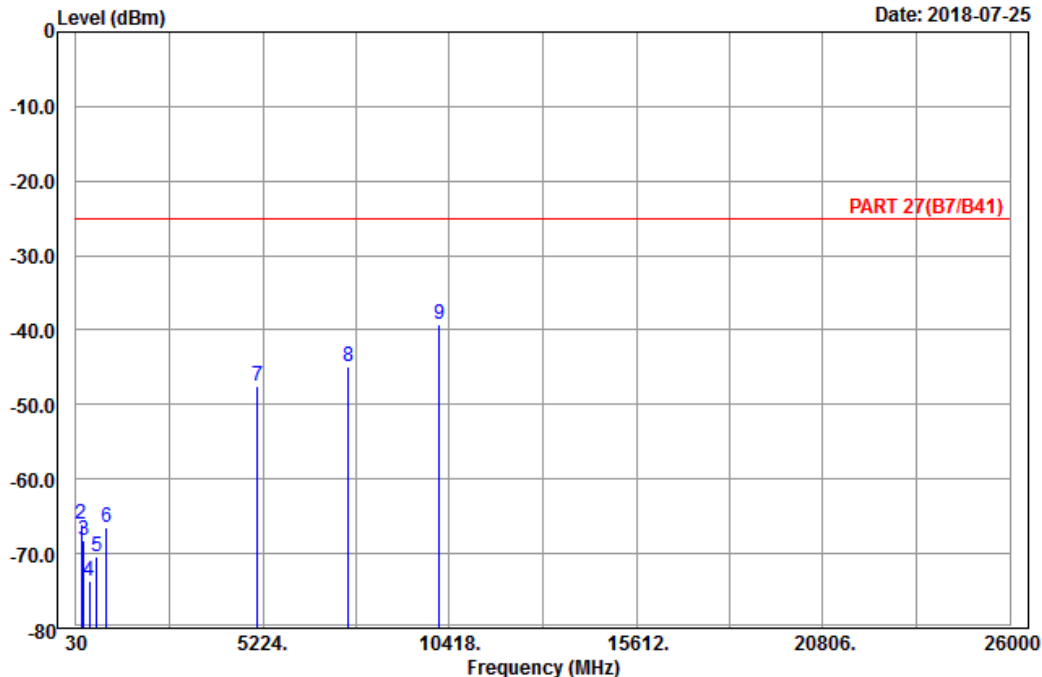

Site : 966 chamber 1
 Condition: PART 27(B7/B41) Horizontal
 Remark : LTE_Band 7_Link_CH21100
 Tested by: Harry Hsueh

	Freq	Level	Read Level	Limit Line	Over Limit	Factor	Remark
	MHz	dBm	dBm	dBm	dB	dB	
1	58.89	-86.43	-72.37	-25.00	-61.43	-14.06	Peak
2	180.12	-65.97	-60.39	-25.00	-40.97	-5.58	Peak
3	243.03	-68.16	-62.56	-25.00	-43.16	-5.60	Peak
4	393.10	-73.60	-70.50	-25.00	-48.60	-3.10	Peak
5	610.80	-70.45	-70.76	-25.00	-45.45	0.31	Peak
6	885.20	-66.40	-68.87	-25.00	-41.40	2.47	Peak
7	5070.00	-47.58	-66.97	-25.00	-22.58	19.39	Peak
8	7605.00	-45.00	-67.99	-25.00	-20.00	22.99	Peak
9	pp 10140.00	-39.25	-65.67	-25.00	-14.25	26.42	Peak



Bureau Veritas Consumer Products Services Ltd., Taoyuan Branch

A D T

Data: 14

Date: 2018-07-25

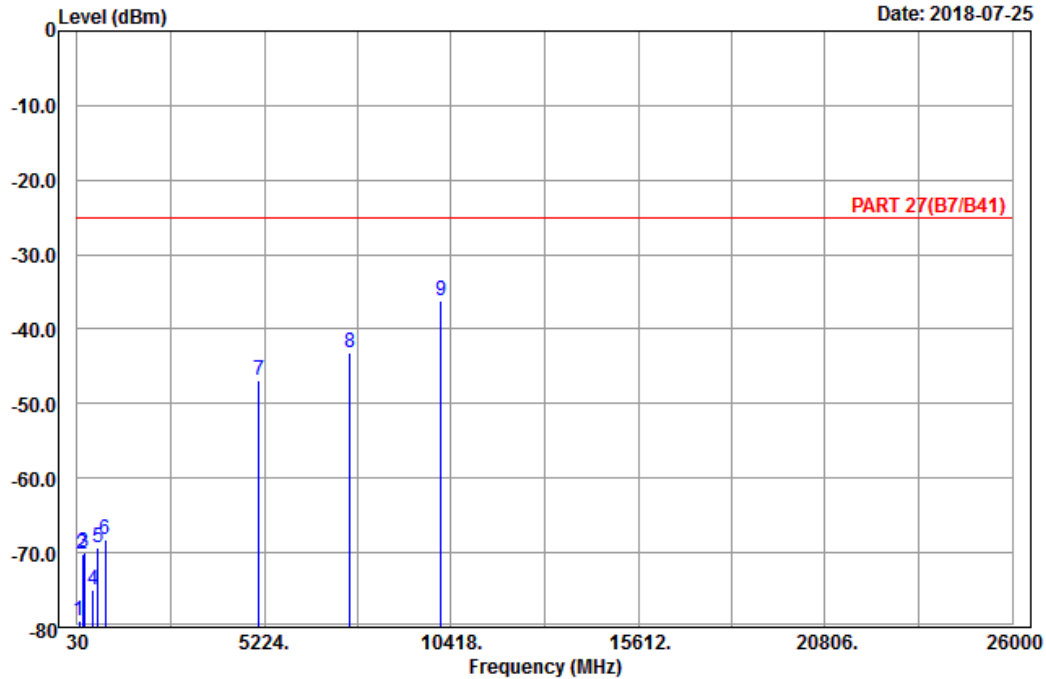

Site : 966 chamber 1
 Condition: PART 27(B7/B41) Vertical
 Remark : LTE_Band 7_Link_CH21100
 Tested by: Harry Hsueh

	Freq	Level	Read Level	Limit Line	Over Limit	Factor	Remark
	MHz	dBm	dBm	dBm	dB	dB	
1	92.10	-79.11	-68.55	-25.00	-54.11	-10.56	Peak
2	187.68	-70.10	-64.40	-25.00	-45.10	-5.70	Peak
3	220.08	-70.00	-64.09	-25.00	-45.00	-5.91	Peak
4	477.80	-75.08	-70.43	-25.00	-50.08	-4.65	Peak
5	607.30	-69.22	-69.57	-25.00	-44.22	0.35	Peak
6	803.30	-68.16	-70.14	-25.00	-43.16	1.98	Peak
7	5070.00	-46.87	-66.26	-25.00	-21.87	19.39	Peak
8	7605.00	-43.25	-66.24	-25.00	-18.25	22.99	Peak
9 pp	10140.00	-36.25	-62.67	-25.00	-11.25	26.42	Peak

High Channel



Bureau Veritas Consumer Products Services Ltd., Taoyuan Branch

A D T

Data: 9

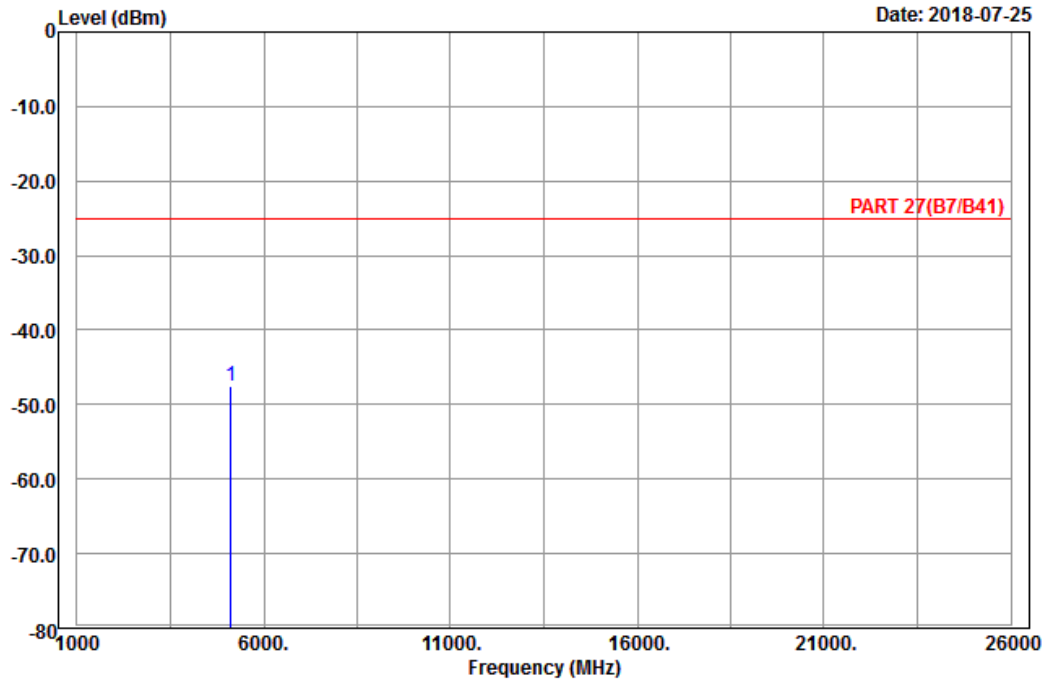

Site : 966 chamber 1
 Condition: PART 27(B7/B41) Horizontal
 Remark : LTE_Band 7_Link_CH21350
 Tested by: Karl Lee

Freq	Level	Read Level	Limit Line	Over Limit	Factor	Remark
MHz	dBm	dBm	dBm	dB	dB	
1 pp 5120.00	-47.44	-67.15	-25.00	-22.44	19.71	Peak



Bureau Veritas Consumer Products Services Ltd., Taoyuan Branch

A D T

Data: 10

Date: 2018-07-25

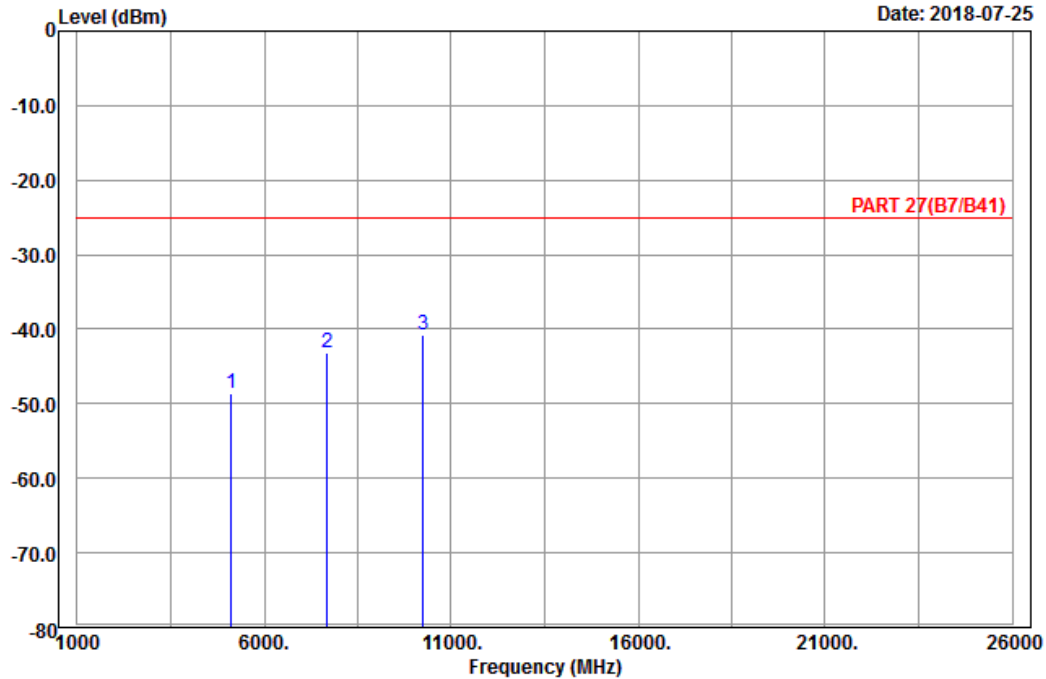

Site : 966 chamber 1
 Condition: PART 27(B7/B41) Vertical
 Remark : LTE_Band 7_Link_CH21350
 Tested by: Karl Lee

	Freq	Level	Read Level	Limit Line	Over Limit	Factor	Remark
	MHz	dBm	dBm	dBm	dB	dB	
1	5120.00	-48.62	-68.33	-25.00	-23.62	19.71	Peak
2	7680.00	-43.10	-66.22	-25.00	-18.10	23.12	Peak
3 pp	10240.00	-40.74	-67.28	-25.00	-15.74	26.54	Peak

5 Pictures of Test Arrangements

Please refer to the attached file (Test Setup Photo).

Appendix – Information on the Testing Laboratories

We, Bureau Veritas Consumer Products Services (H.K.) Ltd., Taoyuan Branch, were founded in 1988 to provide our best service in EMC, Radio, Telecom and Safety consultation. Our laboratories are FCC recognized accredited test firms and accredited according to ISO/IEC 17025.

If you have any comments, please feel free to contact us at the following:

Linko EMC/RF Lab

Tel: 886-2-26052180

Fax: 886-2-26051924

Hsin Chu EMC/RF/Telecom Lab

Tel: 886-3-6668565

Fax: 886-3-6668323

Hwa Ya EMC/RF/Safety

Tel: 886-3-3183232

Fax: 886-3-3270892

Email: service.adt@tw.bureauveritas.com

Web Site: www.bureauveritas-adt.com

The address and road map of all our labs can be found in our web site also.

--- END ---