

## FCC Test Report

### (PART 24)

**Report No.:** RF180626C10D-1

**FCC ID:** 2AJOTTA-1095

**Test Model:** TA-1095

**Received Date:** Jun. 26, 2018

**Test Date:** Jul. 05, 2018 ~ Jul. 26, 2018

**Issued Date:** Aug. 01, 2018

**Applicant:** HMD Global Oy

**Address:** Karaportti 2, 02610 Espoo, Finland

**Issued By:** Bureau Veritas Consumer Products Services (H.K.) Ltd., Taoyuan Branch

**Lab Address:** No. 47-2, 14th Ling, Chia Pau Vil., Lin Kou Dist., New Taipei City, Taiwan  
( R.O.C )

**Test Location (1):** No. 19, Hwa Ya 2nd Rd, Wen Hwa Vil, Kwei Shan Dist., Taoyuan City  
33383, Taiwan (R.O.C)

**Test Location (2):** No.215, Sec. 3, Beixin Rd., Xindian Dist., New Taipei City 231, Taiwan,  
R.O.C

**FCC Registration /  
Designation Number:** 427177 / TW0011



This report is for your exclusive use. Any copying or replication of this report to or for any other person or entity, or use of our name or trademark, is permitted only with our prior written permission. This report sets forth our findings solely with respect to the test samples identified herein. The results set forth in this report are not indicative or representative of the quality or characteristics of the lot from which a test sample was taken or any similar or identical product unless specifically and expressly noted. Our report includes all of the tests requested by you and the results thereof based upon the information that you provided to us. You have 60 days from date of issuance of this report to notify us of any material error or omission caused by our negligence, provided, however, that such notice shall be in writing and shall specifically address the issue you wish to raise. A failure to raise such issue within the prescribed time shall constitute your unqualified acceptance of the completeness of this report, the tests conducted and the correctness of the report contents. Unless specific mention, the uncertainty of measurement has been explicitly taken into account to declare the compliance or non-compliance to the specification. The report must not be used by the client to claim product certification, approval, or endorsement by TAF or any government agencies.

## Table of Contents

<b>Release Control Record</b> .....	<b>4</b>
<b>1 Certificate of Conformity</b> .....	<b>5</b>
<b>2 Summary of Test Results</b> .....	<b>6</b>
2.1 Measurement Uncertainty .....	6
2.2 Test Site and Instruments .....	7
<b>3 General Information</b> .....	<b>9</b>
3.1 General Description of EUT .....	9
3.2 Configuration of System under Test .....	10
3.2.1 Description of Support Units .....	10
3.3 Test Mode Applicability and Tested Channel Detail .....	11
3.4 EUT Operating Conditions .....	12
3.5 General Description of Applied Standards .....	12
<b>4 Test Types and Results</b> .....	<b>13</b>
4.1 Output Power Measurement .....	13
4.1.1 Limits of Output Power Measurement .....	13
4.1.2 Test Procedures .....	13
4.1.3 Test Setup .....	14
4.1.4 Test Results .....	15
4.2 Modulation Characteristics Measurement .....	18
4.2.1 Limits of Modulation Characteristics .....	18
4.2.2 Test Setup .....	18
4.2.3 Test Procedure .....	18
4.2.4 Test Results .....	18
4.3 Frequency Stability Measurement .....	19
4.3.1 Limits of Frequency Stability Measurement .....	19
4.3.2 Test Procedure .....	19
4.3.3 Test Setup .....	19
4.3.4 Test Results .....	20
4.4 Occupied Bandwidth Measurement .....	23
4.4.1 Test Procedure .....	23
4.4.2 Test Setup .....	23
4.4.3 Test Result .....	24
4.5 Band Edge Measurement .....	25
4.5.1 Limits of Band Edge Measurement .....	25
4.5.2 Test Setup .....	25
4.5.3 Test Procedures .....	25
4.5.4 Test Results .....	26
4.6 Peak to Average Ratio .....	27
4.6.1 Limits of Peak to Average Ratio Measurement .....	27
4.6.2 Test Setup .....	27
4.6.3 Test Procedures .....	27
4.6.4 Test Results .....	28
4.7 Conducted Spurious Emissions .....	29
4.7.1 Limits of Conducted Spurious Emissions Measurement .....	29
4.7.2 Test Setup .....	29
4.7.3 Test Procedure .....	29
4.7.4 Test Results .....	30
4.8 Radiated Emission Measurement .....	39
4.8.1 Limits of Radiated Emission Measurement .....	39
4.8.2 Test Procedure .....	39
4.8.3 Deviation from Test Standard .....	39
4.8.4 Test Setup .....	40
4.8.5 Test Results .....	41

<b>5 Pictures of Test Arrangements.....</b>	<b>65</b>
<b>Appendix – Information on the Testing Laboratories .....</b>	<b>66</b>

### Release Control Record

Issue No.	Description	Date Issued
RF180626C10D-1	Original Release	Aug. 01, 2018

## 1 Certificate of Conformity

**Product:** Smart Phone

**Brand:** NOKIA

**Test Model:** TA-1095

**Sample Status:** Engineering Sample

**Applicant:** HMD Global Oy

**Test Date:** Jul. 05, 2018 ~ Jul. 26, 2018

**Standards:** FCC Part 24, Subpart E

The above equipment has been tested by **Bureau Veritas Consumer Products Services (H.K.) Ltd., Taoyuan Branch**, and found compliance with the requirement of the above standards. The test record, data evaluation & Equipment Under Test (EUT) configurations represented herein are true and accurate accounts of the measurements of the sample's RF characteristics under the conditions specified in this report.

**Prepared by :** , **Date:** Aug. 01, 2018  
Ivonne Wu / Supervisor

**Approved by :** , **Date:** Aug. 01, 2018  
Dylan Chiou / Project Engineer

## 2 Summary of Test Results

Applied Standard: FCC Part 24 & Part 2			
FCC Clause	Test Item	Result	Remarks
2.1046 24.232	Effective Isotropic Radiated Power	Pass	Meet the requirement of limit.
2.1047	Modulation Characteristics	Pass	Meet the requirement.
2.1046 24.232(d)	Peak to Average Ratio	Pass	Meet the requirement of limit.
2.1055 24.235	Frequency Stability	Pass	Meet the requirement of limit.
2.1049 24.238(b)	Occupied Bandwidth	Pass	Meet the requirement of limit.
24.238(b)	Band Edge Measurements	Pass	Meet the requirement of limit.
2.1051 24.238	Conducted Spurious Emissions	Pass	Meet the requirement of limit.
2.1053 24.238	Radiated Spurious Emissions	Pass	Meet the requirement of limit. Minimum passing margin is -24.04 dB at 5729.40 MHz.

### 2.1 Measurement Uncertainty

Where relevant, the following measurement uncertainty levels have been estimated for tests performed on the EUT as specified in CISPR 16-4-2:

Measurement	Frequency	Expanded Uncertainty (k=2) (±)
Radiated Emissions up to 1 GHz	30 MHz ~ 200 MHz	2.0153 dB
	200 MHz ~ 1000 MHz	2.0224 dB
Radiated Emissions above 1 GHz	1 GHz ~ 18 GHz	1.0121 dB
	18 GHz ~ 40 GHz	1.1508 dB

## 2.2 Test Site and Instruments

Description & Manufacturer	Model No.	Serial No.	Date of Calibration	Due Date of Calibration
Test Receiver Agilent Technologies	N9010A	MY52220314	Nov. 24, 2017	Nov. 23, 2018
Spectrum Analyzer ROHDE & SCHWARZ	FSU43	101261	Jan. 11, 2018	Jan. 10, 2019
Double Ridge Guide Horn Antenna EMCO	3115	5619	Nov. 30, 2017	Nov. 29, 2018
BILOG Antenna SCHWARZBECK	VULB 9168	9168-153	Dec. 06, 2017	Dec. 05, 2018
HORN Antenna Schwarzbeck	BBHA 9120D	9120D-969	Dec. 12, 2017	Dec. 11, 2018
Fixed Attenuator Woken	00801A1GGAM02Y	NA	May 17, 2018	May 16, 2019
MXG Vector signal generator Agilent	N5182B	MY53050430	Oct. 24, 2017	Oct. 23, 2018
Preamplifier Agilent	310N	187226	Jun. 19, 2018	Jun. 18, 2019
Preamplifier Agilent	83017A	MY39501357	Jun. 19, 2018	Jun. 18, 2019
RF signal cable ETS-LINDGREN	5D-FB	Cable-CH1-01(RF C-SMS-100-SMS- 120+RFC-SMS-1 00-SMS-400)	Jun. 19, 2018	Jun. 18, 2019
RF signal cable ETS-LINDGREN	8D-FB	Cable-CH1-02(RF C-SMS-100-SMS- 24)	Jun. 19, 2018	Jun. 18, 2019
Boresight Antenna Fixture	FBA-01	FBA-SIP01	NA	NA
Software BV ADT	E3 8.130425b	NA	NA	NA
Antenna Tower MF	NA	NA	NA	NA
Turn Table MF	NA	NA	NA	NA
Antenna Tower & Turn Table Controller MF	MF-7802	NA	NA	NA
Communications Tester-Wireless Agilent	8960 Series 10	MY53201073	Jun. 28, 2017	Jun. 27, 2019
Radio Communication Analyzer Anritsu	MT8820C	6201010284	Dec. 28, 2017	Dec. 27, 2018
Temperature & Humidity Chamber	GTH-120-40-CP-AR	MAA1306-019	Sep. 08, 2017	Sep. 07, 2018
DC Power Supply Topward	33010D	807748	Oct. 25, 2016	Oct. 24, 2018
Digital Multimeter Fluke	87-III	70360742	Jun. 29, 2018	Jun. 28, 2019

- Note:
1. The calibration interval of the above test instruments is 12 / 24 months and the calibrations are traceable to NML/ROC and NIST/USA.
  2. The test was performed in HsinTien Chamber 1.
  3. The horn antenna and preamplifier (model: 83017A) are used only for the measurement of emission frequency above 1 GHz if tested.
  4. The IC Site Registration No. is IC7450I-1.



### 3 General Information

#### 3.1 General Description of EUT

<b>Product</b>	Smart Phone	
<b>Brand</b>	NOKIA	
<b>Test Model</b>	TA-1095	
<b>Status of EUT</b>	Engineering Sample	
<b>Power Supply Rating</b>	5.0 Vdc or 9 Vdc or 12 Vdc (adapter) 5.0 Vdc (host equipment) 3.85 Vdc (Li-ion battery)	
<b>Modulation Type</b>	GSM/GPRS	GMSK
	EDGE	GMSK, 8PSK
	WCDMA	QPSK
<b>Frequency Range</b>	GSM/GPRS/EDGE	1850.2 ~ 1909.8 MHz
	WCDMA	1852.4 ~ 1907.6 MHz
<b>Max. EIRP Power</b>	GSM/GPRS	1137.63 mW
	EDGE	404.58 mW
	WCDMA	255.86 mW
<b>Emission Designator</b>	GSM/GPRS	248KGXW
	EDGE	248KG7W
	WCDMA	4M15F9W
<b>Antenna Type</b>	PIFA Antenna with 0.62 dBi gain	
<b>Accessory Device</b>	Refer to Note as below	
<b>Data Cable Supplied</b>	Refer to Note as below	

Note:

1. This report is issued as a duplicate report to BV CPS report no.: RF180626C09-1. The difference compared with original report is WWAN supported band. Therefore, only EIRP and radiated spurious emission tests were re-tested.
2. There're 2 configurations for the EUT listed as below.  
Main Sample: EUT + Battery 1  
2<sup>nd</sup> Sample: EUT + Battery 2  
✧ Only the worst test data was presented in the report.
3. The EUT's accessories list refers to Ext. Pho.
4. The above EUT information is declared by manufacturer and for more detailed features description, please refers to the manufacturer's specifications or user's manual.

### 3.2 Configuration of System under Test

#### <Radiated Emission Test>

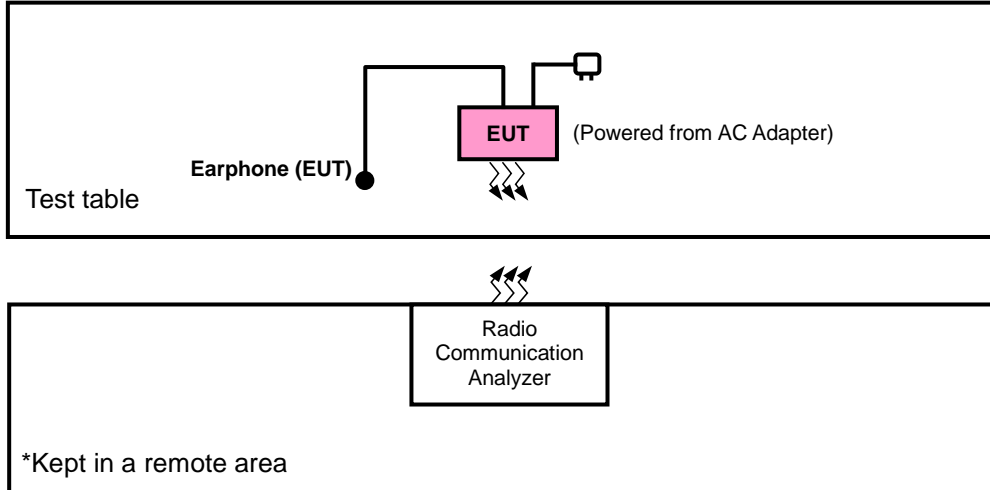

#### <E.I.R.P. Test>

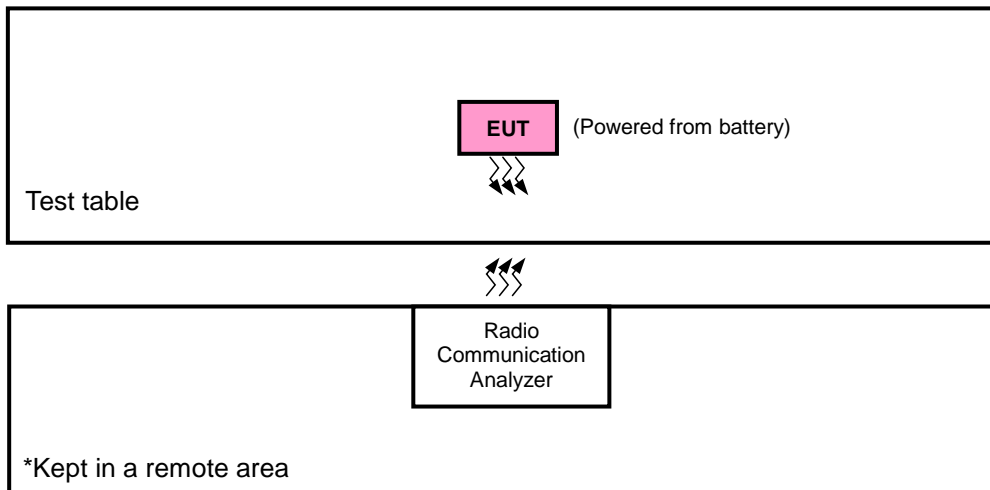

#### 3.2.1 Description of Support Units

The EUT has been tested as an independent unit together with other necessary accessories or support units.

### 3.3 Test Mode Applicability and Tested Channel Detail

Pre-Scan has been conducted to determine the worst-case mode from all possible combinations between available modulations, data rates, XYZ axis, and antenna ports.

The worst case was found when positioned as the table below. Following channel(s) was (were) selected for the final test as listed below:

EUT Configure Mode	Description
A	Main Sample
B	2 <sup>nd</sup> Sample

SIM	Band	EIRP	Radiated Emission
1	GSM	X-plane	Y-axis
	EDGE	X-plane	Y-axis
	WCDMA	X-plane	Y-axis

#### GSM

EUT Configure Mode	Test Item	Available Channel	Tested Channel	Mode
A	EIRP	512 to 810	512, 661, 810	GSM, EDGE
B		512 to 810	512, 661, 810	GSM
A	Modulation Characteristics	512 to 810	661	GSM, EDGE
A	Frequency Stability	512 to 810	512, 810	GSM, EDGE
A	Occupied Bandwidth	512 to 810	512, 661, 810	GSM, EDGE
A	Band Edge	512 to 810	512, 810	GSM, EDGE
A	Peak to Average Ratio	512 to 810	512, 661, 810	GSM, EDGE
A	Conducted Emission	512 to 810	512, 661, 810	GSM, EDGE
A	Radiated Emission	512 to 810	512, 661, 810	GSM, EDGE
B		512 to 810	512, 661, 810	GSM

## WCDMA

EUT Configure Mode	Test Item	Available Channel	Tested Channel	Mode
A	EIRP	9262 to 9538	9262, 9400, 9538	WCDMA
A	Modulation Characteristics	9262 to 9538	9400	WCDMA
A	Frequency Stability	9262 to 9538	9262, 9538	WCDMA
A	Occupied Bandwidth	9262 to 9538	9262, 9400, 9538	WCDMA
A	Band Edge	9262 to 9538	9262, 9538	WCDMA
A	Peak to Average Ratio	9262 to 9538	9262, 9400, 9538	WCDMA
A	Conducted Emission	9262 to 9538	9262, 9400, 9538	WCDMA
A	Radiated Emission	9262 to 9538	9262, 9400, 9538	WCDMA

### Test Condition:

Test Item	Environmental Conditions	Input Power	Tested By
EIRP	26 deg. C, 58 % RH	3.85 Vdc	Karl Lee
Modulation Characteristics	26 deg. C, 58 % RH	3.85 Vdc	Wayne Lin
Frequency Stability	26 deg. C, 58 % RH	3.85 Vdc	Wayne Lin
Occupied Bandwidth	26 deg. C, 58 % RH	3.85 Vdc	Wayne Lin
Band Edge	26 deg. C, 58 % RH	3.85 Vdc	Wayne Lin
Peak to Average Ratio	26 deg. C, 58 % RH	3.85 Vdc	Wayne Lin
Conducted Emission	26 deg. C, 58 % RH	3.85 Vdc	Wayne Lin
Radiated Emission	25 deg. C, 65 % RH	120 Vac, 60 Hz	Karl Lee

### 3.4 EUT Operating Conditions

The EUT makes a call to the communication simulator. The communication simulator station system controlled a EUT to export maximum output power under transmission mode and specific channel frequency

### 3.5 General Description of Applied Standards

The EUT is a RF Product. According to the specifications of the manufacturer, it must comply with the requirements of the following standards:

**FCC 47 CFR Part 2**

**FCC 47 CFR Part 24**

**KDB 971168 D01 Power Meas License Digital Systems v03r01**

**ANSI/TIA/EIA-603-E 2016**

**ANSI 63.26-2015**

**NOTE:** All test items have been performed and recorded as per the above standards.

## 4 Test Types and Results

### 4.1 Output Power Measurement

#### 4.1.1 Limits of Output Power Measurement

Mobile / Portable station are limited to 2 watts e.i.r.p.

#### 4.1.2 Test Procedures

##### **EIRP / ERP Measurement:**

- a. All measurements were done at low, middle and high operational frequency range. RBW and VBW is 1 MHz for GSM, GPRS & EDGE, and 5 MHz for WCDMA mode.
- b. Substitution method is used for E.I.R.P measurement. In the semi-anechoic chamber, EUT placed on the 0.8 m (below or equal 1 GHz) and/or 1.5 m (above 1 GHz) height of Turn Table, rotated the table around 360 degrees to search the maximum radiation power and receiver antenna shall be rotated vertical and horizontal polarization and moved height from 1 m to 4 m to find the maximum polar radiated power. The "Read Value" is the spectrum reading the maximum power value.
- c. The substitution horn antenna is substituted for EUT at the same position and signals generator export the CW signal to the substitution antenna via a tx cable. Rotated the Turn Table and moved receiving antenna to find the maximum radiation power. Adjust output power level of S.G to get a Value of spectrum reading equal to "Read Value" of step b. Record the power level of S.G.
- d.  $EIRP = \text{Output power level of S.G} - \text{TX cable loss} + \text{Antenna gain of substitution horn}$ . E.R.P power can be calculated form E.I.R.P power by subtracting the gain of dipole,  $E.R.P \text{ power} = E.I.R.P \text{ power} - 2.15 \text{ dB}$ .

##### **Conducted Power Measurement:**

The EUT was set up for the maximum power with GSM, GPRS, EDGE, and WCDMA link data modulation and link up with simulator. Set the EUT to transmit under low, middle and high channel and record the power level shown on simulator.

4.1.3 Test Setup

**EIRP / ERP Measurement:**

**<Radiated Emission below or equal 1 GHz>**

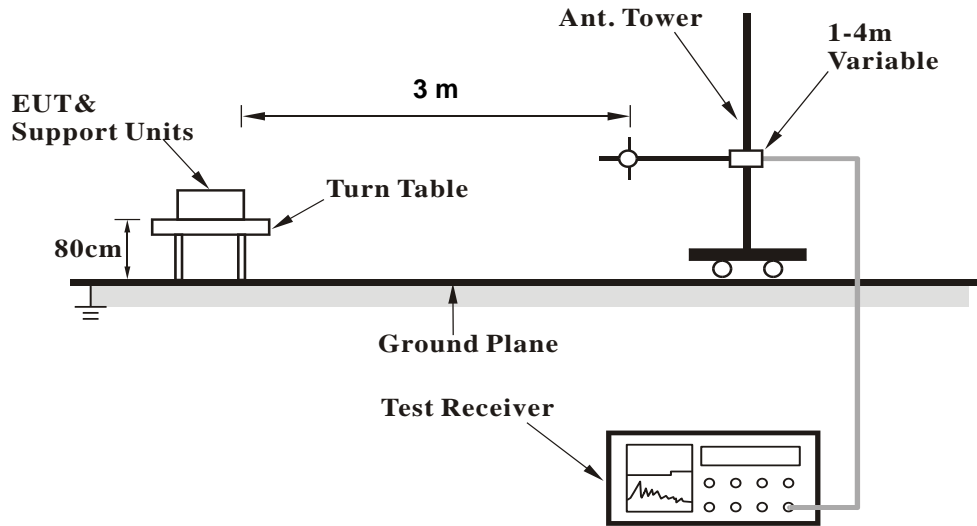

**<Radiated Emission above 1 GHz>**

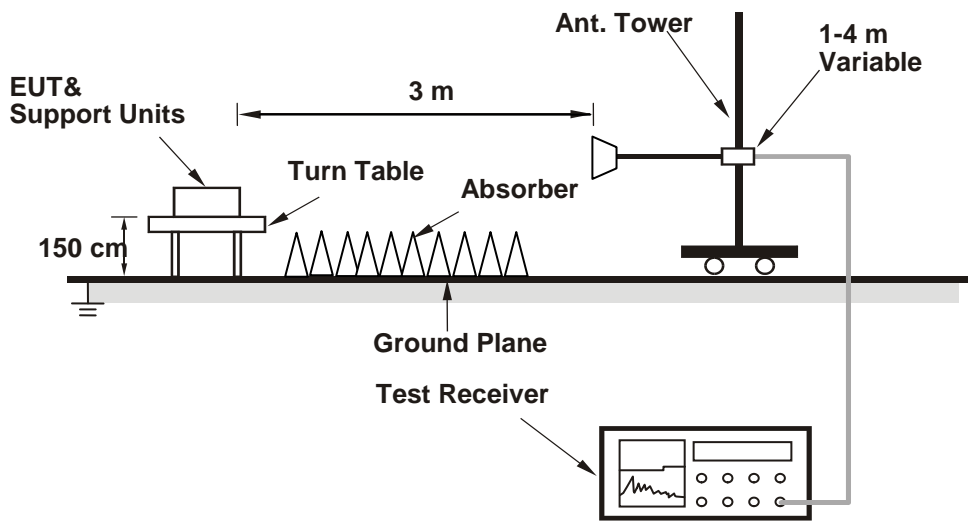

For the actual test configuration, please refer to the attached file (Test Setup Photo).

**Conducted Power Measurement:**

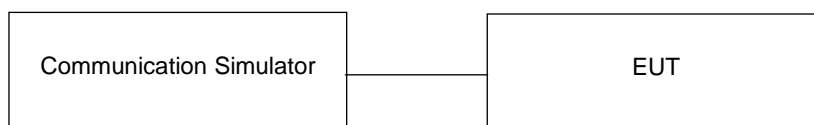

#### 4.1.4 Test Results

##### Conducted Output Power (dBm)

Band	GSM1900		
	512	661	810
Channel			
Frequency (MHz)	<b>1850.2</b>	<b>1880.0</b>	<b>1909.8</b>
GSM (GMSK, 1Tx-slot)	29.87	29.95	29.63
GPRS (GMSK, 1Tx-slot)	29.83	29.91	29.59
GPRS (GMSK, 2Tx-slot)	28.06	28.14	27.82
GPRS (GMSK, 3Tx-slot)	26.87	26.95	26.63
GPRS (GMSK, 4Tx-slot)	25.90	25.98	25.66
EDGE (8PSK, 1Tx-slot)	25.15	25.23	24.91
EDGE (8PSK, 2Tx-slot)	23.96	24.04	23.72
EDGE (8PSK, 3Tx-slot)	22.81	22.89	22.57
EDGE (8PSK, 4Tx-slot)	22.19	22.27	21.95

Band	WCDMA II		
	9262	9400	9538
Channel			
Frequency (MHz)	<b>1852.4</b>	<b>1880.0</b>	<b>1907.6</b>
RMC 12.2K	23.37	23.31	23.16
HSDPA Subtest-1	22.47	22.41	22.26
HSDPA Subtest-2	22.40	22.34	22.19
HSDPA Subtest-3	22.03	21.97	21.82
HSDPA Subtest-4	22.01	21.95	21.80
DC-HSDPA Subtest-1	22.38	22.32	22.17
DC-HSDPA Subtest-2	22.31	22.25	22.10
DC-HSDPA Subtest-3	21.94	21.88	21.73
DC-HSDPA Subtest-4	21.92	21.86	21.71
HSUPA Subtest-1	22.52	22.46	22.31
HSUPA Subtest-2	20.47	20.41	20.26
HSUPA Subtest-3	21.45	21.39	21.24
HSUPA Subtest-4	20.48	20.42	20.27
HSUPA Subtest-5	22.47	22.41	22.26

**EIRP Power (dBm)**
**Mode A**

GSM							
Plane	Channel	Frequency (MHz)	Reading (dBm)	Correction Factor (dB)	EIRP (dBm)	EIRP (mW)	Polarization (H/V)
X	512	1850.2	-7.63	38.19	30.56	1137.63	H
	661	1880.0	-8.17	38.70	30.53	1129.80	
	810	1909.8	-8.87	39.35	30.48	1116.86	
	512	1850.2	-13.91	38.48	24.57	286.42	V
	661	1880.0	-14.05	38.59	24.54	284.45	
	810	1909.8	-14.36	38.87	24.51	282.49	

Note: EIRP (dBm) = Reading (dBm) + Correction Factor (dB)

EDGE							
Plane	Channel	Frequency (MHz)	Reading (dBm)	Correction Factor (dB)	EIRP (dBm)	EIRP (mW)	Polarization (H/V)
X	512	1850.2	-12.12	38.19	26.07	404.58	H
	661	1880.0	-12.66	38.70	26.04	401.79	
	810	1909.8	-13.35	39.35	26.00	398.11	
	512	1850.2	-18.44	38.48	20.04	100.93	V
	661	1880.0	-18.56	38.59	20.03	100.69	
	810	1909.8	-18.88	38.87	19.99	99.77	

Note: EIRP (dBm) = Reading (dBm) + Correction Factor (dB)

WCDMA							
Plane	Channel	Frequency (MHz)	Reading (dBm)	Correction Factor (dB)	EIRP (dBm)	EIRP (mW)	Polarization (H/V)
X	9262	1852.4	-14.11	38.19	24.08	255.86	H
	9400	1880.0	-14.66	38.70	24.04	253.51	
	9538	1907.6	-15.32	39.35	24.03	252.93	
	9262	1852.4	-19.44	38.48	19.04	80.17	V
	9400	1880.0	-19.59	38.59	19.00	79.43	
	9538	1907.6	-19.92	38.87	18.95	78.52	

Note: EIRP (dBm) = Reading (dBm) + Correction Factor (dB)



**Mode B**

GSM							
Plane	Channel	Frequency (MHz)	Reading (dBm)	Correction Factor (dB)	EIRP (dBm)	EIRP (mW)	Polarization (H/V)
X	512	1850.2	-8.64	38.19	29.55	901.57	H
	661	1880.0	-9.18	38.70	29.52	895.36	
	810	1909.8	-9.88	39.35	29.47	885.12	
	512	1850.2	-14.92	38.48	23.56	226.99	V
	661	1880.0	-15.06	38.59	23.53	225.42	
	810	1909.8	-15.35	38.87	23.52	224.91	

Note: EIRP (dBm) = Reading (dBm) + Correction Factor (dB)

## 4.2 Modulation Characteristics Measurement

### 4.2.1 Limits of Modulation Characteristics

N/A

### 4.2.2 Test Setup

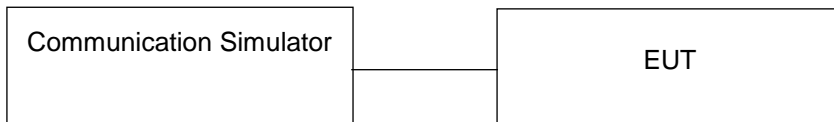

### 4.2.3 Test Procedure

Connect the EUT to Communication Simulator via the antenna connector. The frequency band is set as EUT supported Modulation and Channels, the EUT output is matched with 50 ohm load, the waveform quality and constellation of the EUT was tested.

### 4.2.4 Test Results

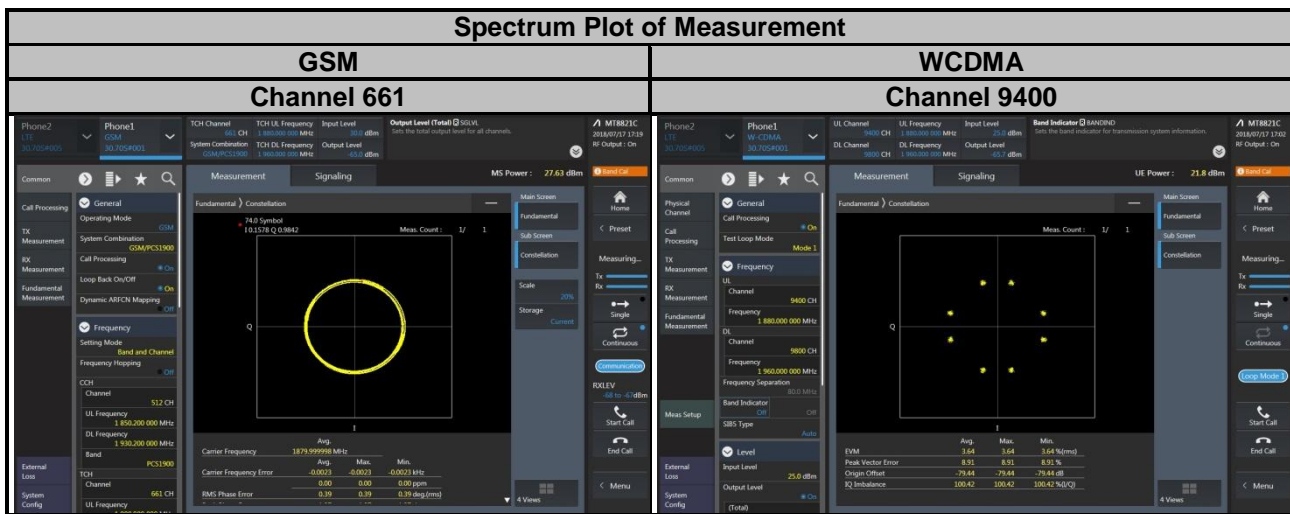

### 4.3 Frequency Stability Measurement

#### 4.3.1 Limits of Frequency Stability Measurement

The frequency stability shall be sufficient to ensure that the fundamental emission stays within the authorized frequency block.

#### 4.3.2 Test Procedure

- Device is placed at the oven room. The oven room could control the temperatures and humidity. Power warm up is at least 15 min and power applied should perform before recording frequency error.
- EUT is connected the external power supply to control the DC input power. The test voltage range is from minimum to maximum working voltage. Each step shall be record the frequency error rate.
- The temperature range step is 10 degrees in this test items. All temperature levels shall be hold the  $\pm 0.5$  °C during the measurement testing. The each temperature step shall be at least 0.5 hours, consider the EUT could be test under the stability condition.

**NOTE:** The frequency error was recorded frequency error from the communication simulator.

#### 4.3.3 Test Setup

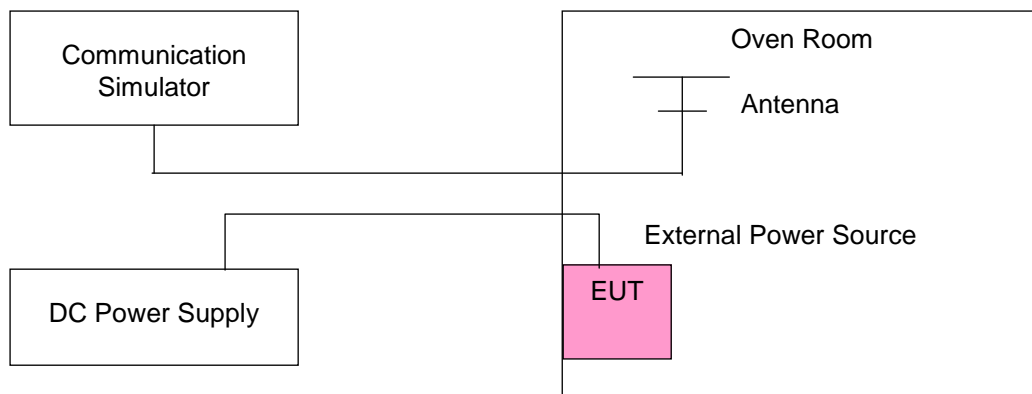

#### 4.3.4 Test Results

##### Frequency Error vs. Voltage

Voltage (Volts)	GSM				Limit (ppm)
	Low Channel		High Channel		
	Frequency (MHz)	Frequency Error (ppm)	Frequency (MHz)	Frequency Error (ppm)	
3.85	1850.200001	0.001	1909.800002	0.001	2.5
3.27	1850.200003	0.001	1909.800002	0.001	2.5
4.42	1850.200004	0.002	1909.800002	0.001	2.5

**Note:** The applicant defined the normal working voltage of the battery is from 3.27 Vdc to 4.42 Vdc.

##### Frequency Error vs. Temperature

Temp. (°C)	GSM				Limit (ppm)
	Low Channel		High Channel		
	Frequency (MHz)	Frequency Error (ppm)	Frequency (MHz)	Frequency Error (ppm)	
-30	1850.200003	0.001	1909.800003	0.002	2.5
-20	1850.200002	0.001	1909.800003	0.002	2.5
-10	1850.200002	0.001	1909.800001	0.001	2.5
0	1850.200002	0.001	1909.800002	0.001	2.5
10	1850.200004	0.002	1909.800004	0.002	2.5
20	1850.199997	-0.002	1909.799997	-0.001	2.5
30	1850.199996	-0.002	1909.799996	-0.002	2.5
40	1850.199999	-0.001	1909.799998	-0.001	2.5
50	1850.199997	-0.002	1909.799999	-0.001	2.5
55	1850.199998	-0.001	1909.799998	-0.001	2.5

Frequency Error vs. Voltage

Voltage (Volts)	EDGE				Limit (ppm)
	Low Channel		High Channel		
	Frequency (MHz)	Frequency Error (ppm)	Frequency (MHz)	Frequency Error (ppm)	
3.85	1850.200003	0.001	1909.800001	0.001	2.5
3.27	1850.200001	0.001	1909.800003	0.002	2.5
4.42	1850.200002	0.001	1909.800002	0.001	2.5

**Note:** The applicant defined the normal working voltage of the battery is from 3.27 Vdc to 4.42 Vdc.

Frequency Error vs. Temperature

Temp. (°C)	EDGE				Limit (ppm)
	Low Channel		High Channel		
	Frequency (MHz)	Frequency Error (ppm)	Frequency (MHz)	Frequency Error (ppm)	
-30	1850.200002	0.001	1909.800003	0.001	2.5
-20	1850.200004	0.002	1909.800004	0.002	2.5
-10	1850.200002	0.001	1909.800003	0.001	2.5
0	1850.200003	0.002	1909.800004	0.002	2.5
10	1850.200003	0.002	1909.800001	0.001	2.5
20	1850.199999	-0.001	1909.799999	-0.001	2.5
30	1850.199998	-0.001	1909.799997	-0.002	2.5
40	1850.199997	-0.002	1909.799999	-0.001	2.5
50	1850.199998	-0.001	1909.799996	-0.002	2.5
55	1850.199998	-0.001	1909.799997	-0.002	2.5

## Frequency Error vs. Voltage

Voltage (Volts)	WCDMA				Limit (ppm)
	Low Channel		High Channel		
	Frequency (MHz)	Frequency Error (ppm)	Frequency (MHz)	Frequency Error (ppm)	
3.85	1852.400002	0.001	1907.600002	0.001	2.5
3.27	1852.400004	0.002	1907.600002	0.001	2.5
4.42	1852.400004	0.002	1907.600001	0.001	2.5

**Note:** The applicant defined the normal working voltage of the battery is from 3.27 Vdc to 4.42 Vdc.

## Frequency Error vs. Temperature

Temp. (°C)	WCDMA				Limit (ppm)
	Low Channel		High Channel		
	Frequency (MHz)	Frequency Error (ppm)	Frequency (MHz)	Frequency Error (ppm)	
-30	1852.400004	0.002	1907.600002	0.001	2.5
-20	1852.400002	0.001	1907.600002	0.001	2.5
-10	1852.400002	0.001	1907.600002	0.001	2.5
0	1852.400001	0.001	1907.600003	0.002	2.5
10	1852.400004	0.002	1907.600003	0.002	2.5
20	1852.399996	-0.002	1907.599997	-0.001	2.5
30	1852.399998	-0.001	1907.599998	-0.001	2.5
40	1852.399996	-0.002	1907.599999	-0.001	2.5
50	1852.399999	-0.001	1907.599997	-0.002	2.5
55	1852.399998	-0.001	1907.599997	-0.001	2.5

## 4.4 Occupied Bandwidth Measurement

### 4.4.1 Test Procedure

The EUT makes a call to the communication simulator. All measurements were done at low, middle and high operational frequency range. The communication simulator station system controlled a EUT to export maximum output power under transmission mode and specific channel frequency. Use OBW measurement function of Spectrum analyzer to measure 99 % occupied bandwidth.

### 4.4.2 Test Setup

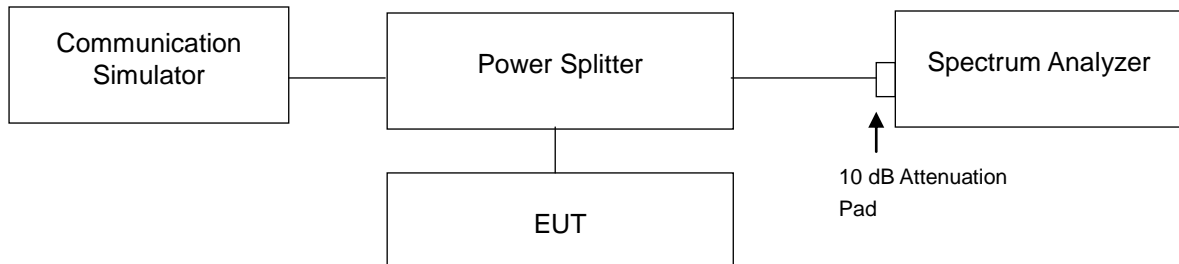

### 4.4.3 Test Result

Channel	Frequency (MHz)	99 % Occupied Bandwidth (kHz)		Channel	Frequency (MHz)	99 % Occupied Bandwidth (MHz)
		GSM	EDGE			WCDMA
512	1850.2	243.52	247.62	9262	1852.4	4.1475
661	1880.0	245.80	243.25	9400	1880.0	4.1422
810	1909.8	247.70	247.47	9538	1907.6	4.1433

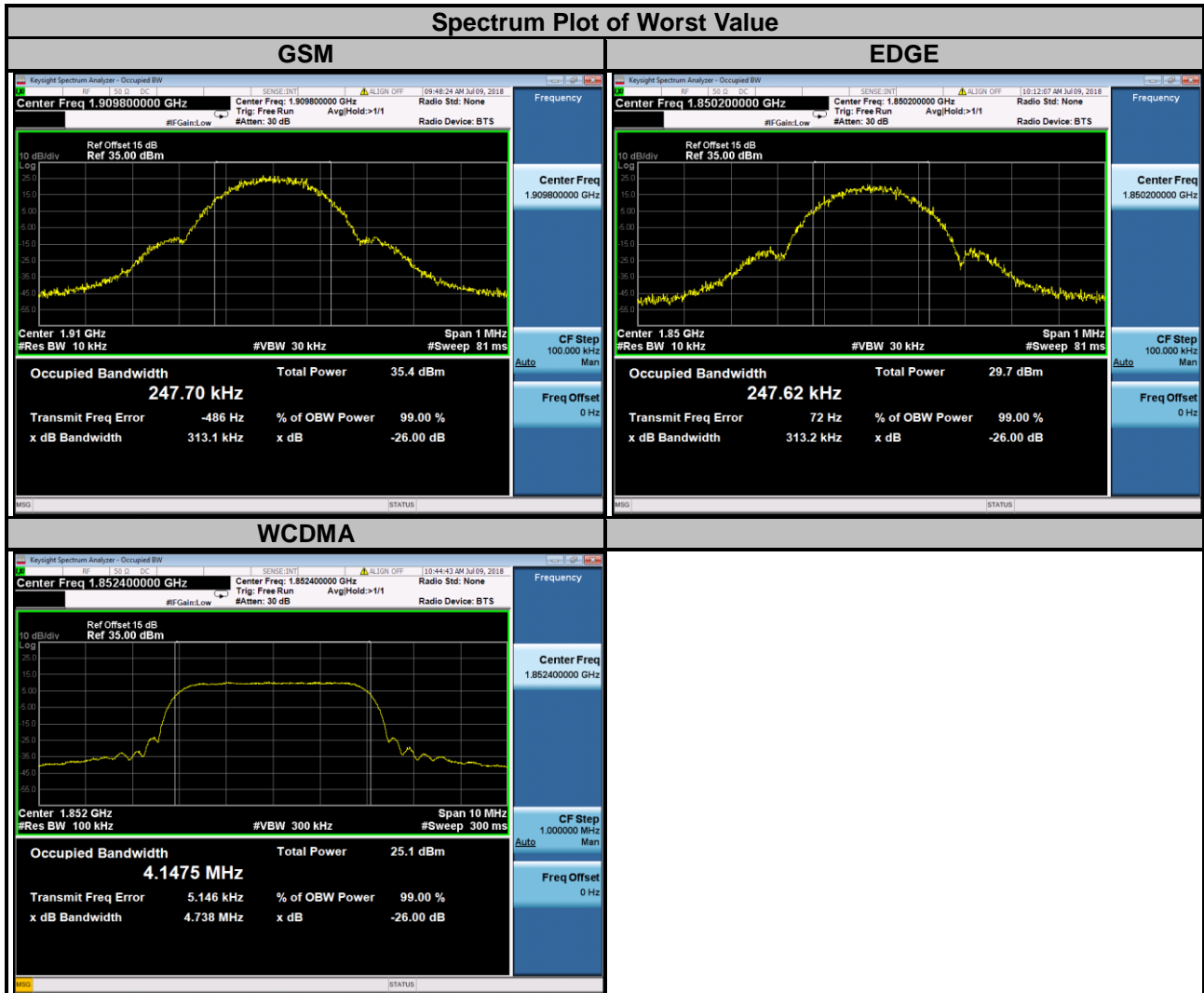



## 4.5 Band Edge Measurement

### 4.5.1 Limits of Band Edge Measurement

Power of any emission outside of the authorized operating frequency ranges must be attenuated below the transmitting power (P) by a factor of at least  $43 + 10 \log(P)$  dB. In the 1 MHz bands immediately outside and adjacent to the frequency block a resolution bandwidth of at least one percent of the emission bandwidth of the fundamental emission of the transmitter may be employed.

### 4.5.2 Test Setup

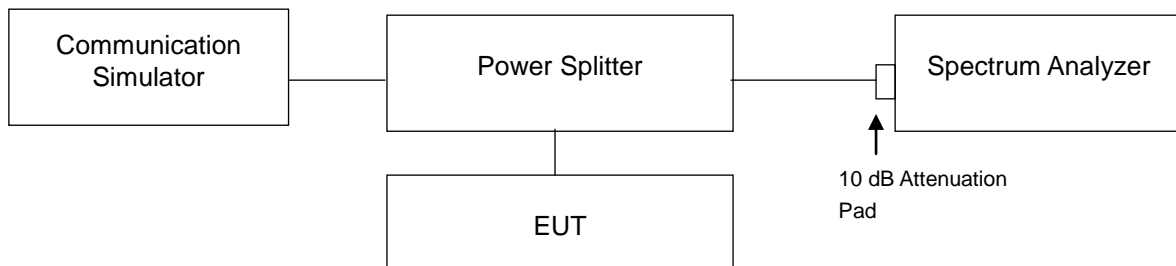

### 4.5.3 Test Procedures

- All measurements were done at low and high operational frequency range.
- The center frequency of spectrum is the band edge frequency and span is 1 MHz. RB of the spectrum is 10 kHz and VB of the spectrum is 30 kHz (GSM/GPRS/EDGE).
- The center frequency of spectrum is the band edge frequency and span is 5 MHz. RB of the spectrum is 100 kHz and VB of the spectrum is 300 kHz (WCDMA).
- Record the max trace plot into the test report.

### 4.5.4 Test Results

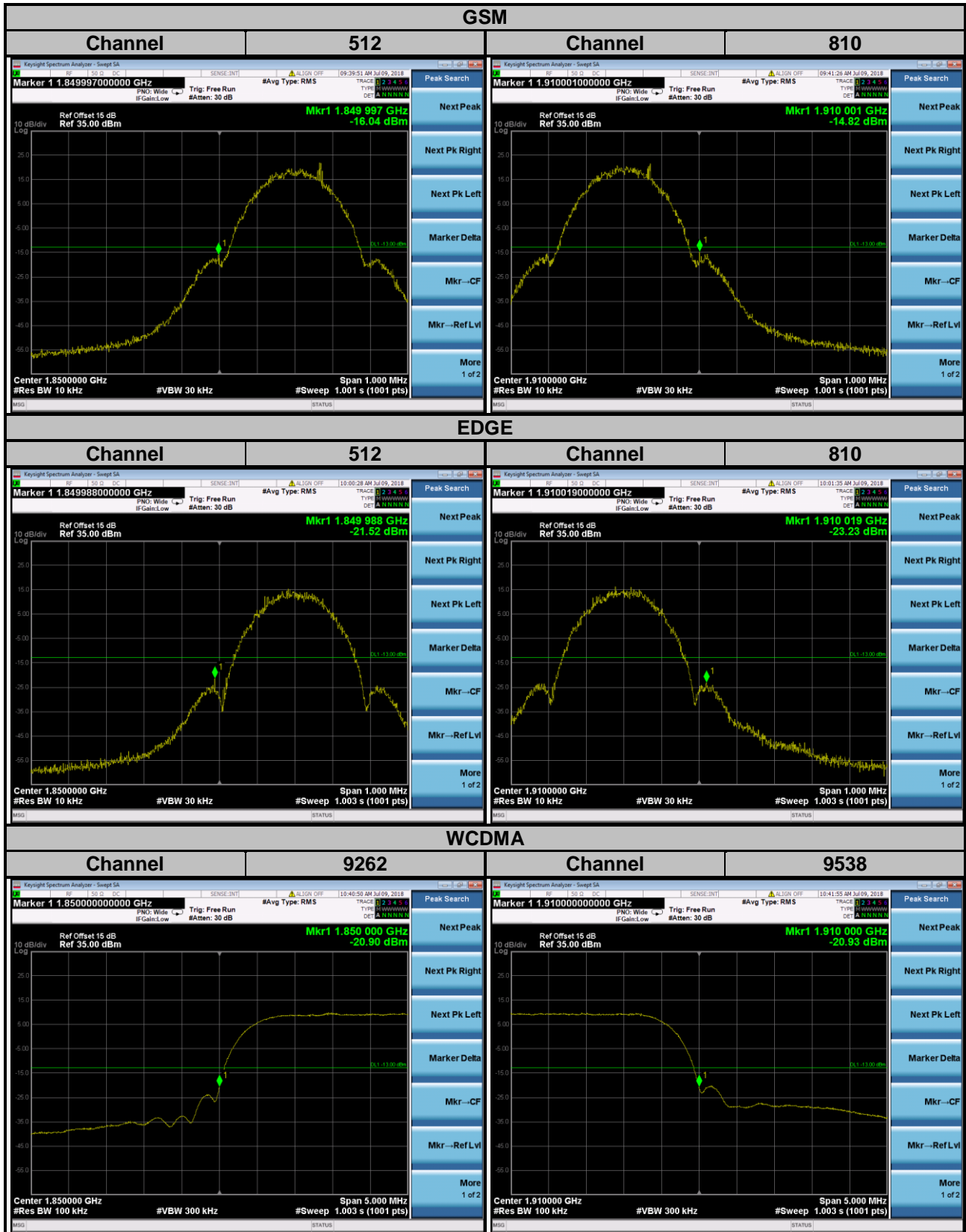

## 4.6 Peak to Average Ratio

### 4.6.1 Limits of Peak to Average Ratio Measurement

In measuring transmissions in this band using an average power technique, the peak to-average ratio (PAR) of the transmission may not exceed 13 dB.

### 4.6.2 Test Setup

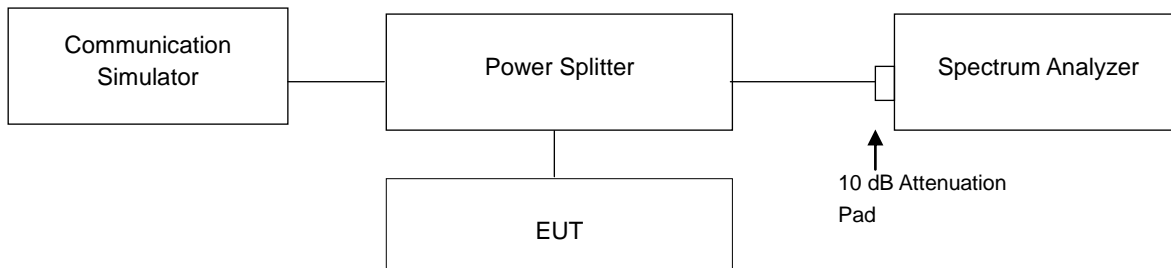

### 4.6.3 Test Procedures

1. Set resolution/measurement bandwidth  $\geq$  signal's occupied bandwidth;
2. Set the number of counts to a value that stabilizes the measured CCDF curve;
3. Record the maximum PAPR level associated with a probability of 0.1 %.

#### 4.6.4 Test Results

Channel	Frequency (MHz)	Peak to Average Ratio (dB)		Channel	Frequency (MHz)	Peak to Average Ratio (dB)
		GSM	EDGE			
512	1850.2	0.42	3.41	9262	1852.4	3.02
661	1880.0	0.39	3.28	9400	1880.0	3.42
810	1909.8	0.36	3.24	9538	1907.6	3.29



## 4.7 Conducted Spurious Emissions

### 4.7.1 Limits of Conducted Spurious Emissions Measurement

The power of any emission outside of the authorized operating frequency ranges must be attenuated below the transmitting power (P) by a factor of at least  $43 + 10 \log(P)$  dB. The emission limit equal to -13 dBm.

### 4.7.2 Test Setup

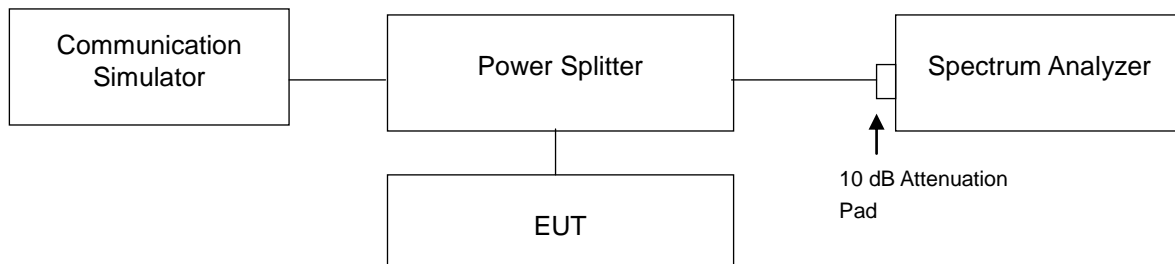

### 4.7.3 Test Procedure

- The EUT makes a phone call to the communication simulator. All measurements were done at low, middle and high operational frequency range.
- Measuring frequency range from 9 kHz to 1 GHz, 10 dB attenuation pad is connected with spectrum. RBW = 100 kHz and VBW = 300 kHz is used for conducted emission measurement.
- Measuring frequency range from 9 kHz to 26.5 GHz, 10 dB attenuation pad is connected with spectrum. RBW = 1 MHz and VBW = 3 MHz is used for conducted emission measurement.

### 4.7.4 Test Results

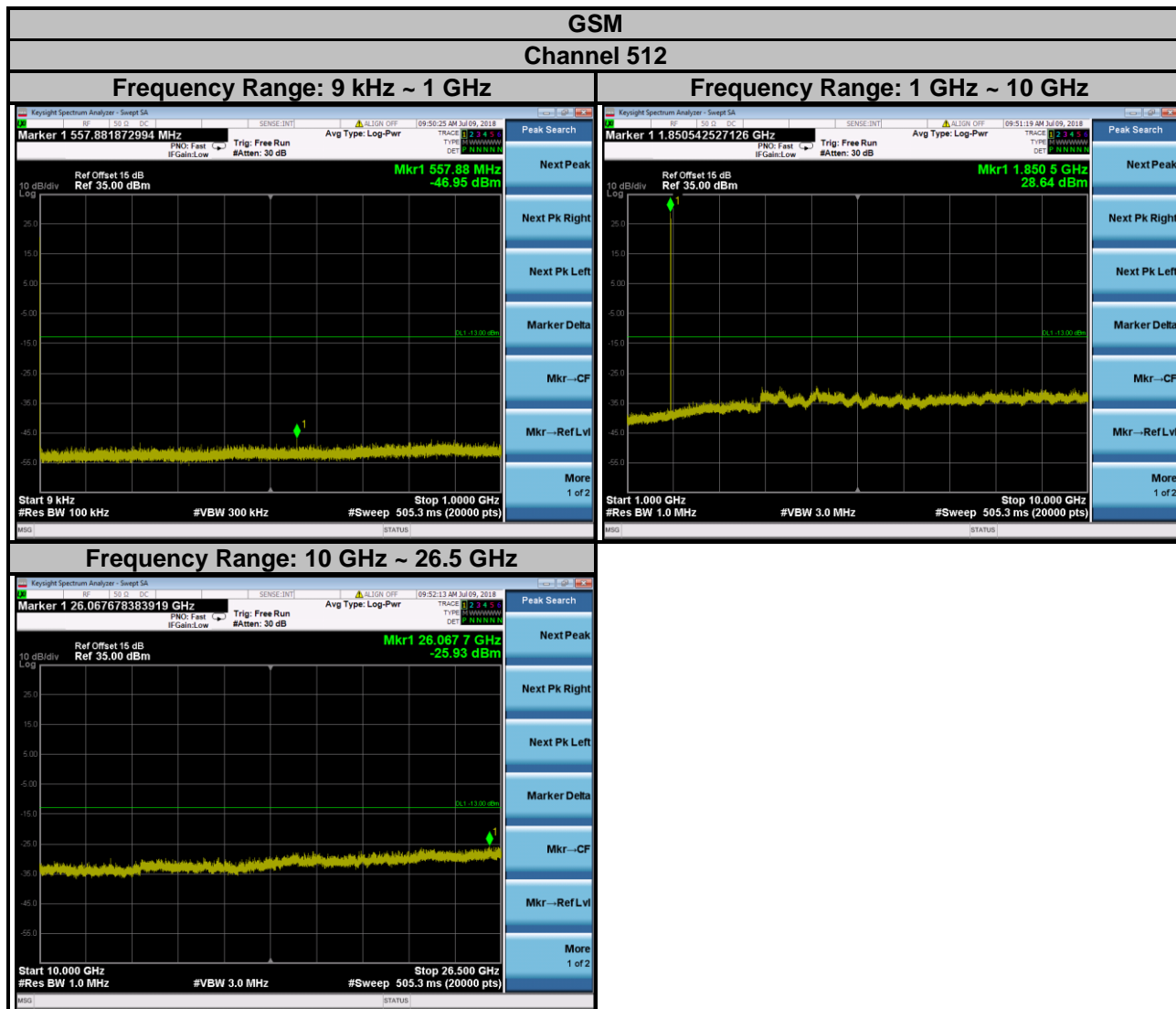

### GSM

#### Channel 661

Frequency Range: 9 kHz ~ 1 GHz

Frequency Range: 1 GHz ~ 10 GHz

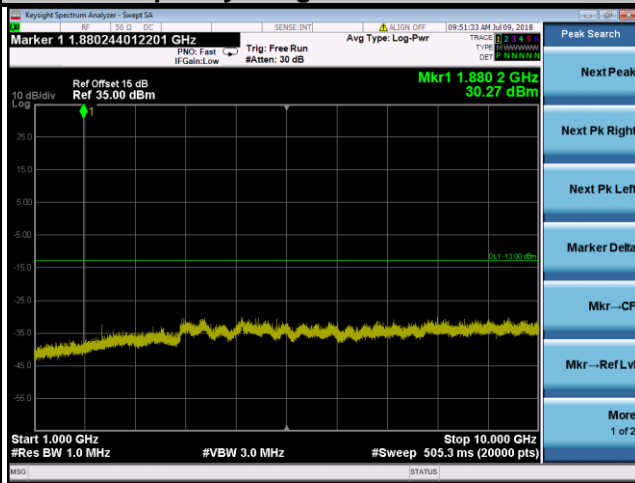
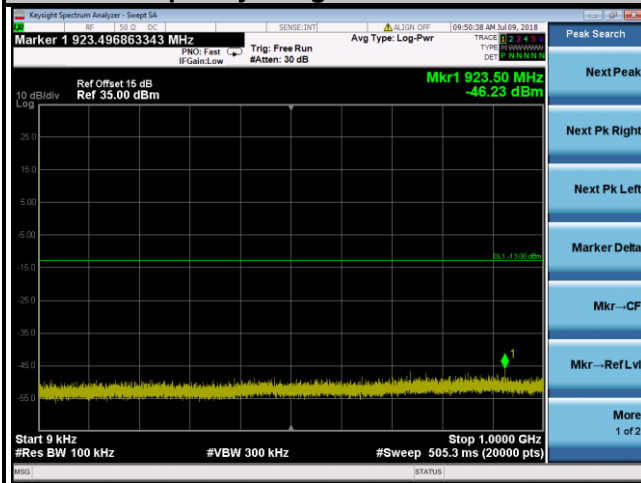

Frequency Range: 10 GHz ~ 26.5 GHz

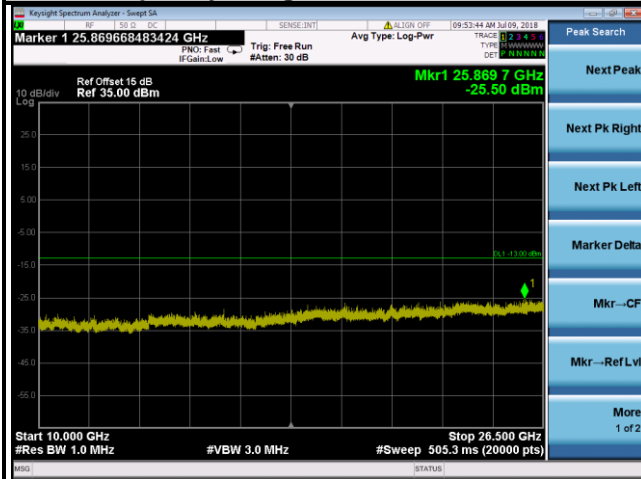

### GSM

#### Channel 810

#### Frequency Range: 9 kHz ~ 1 GHz

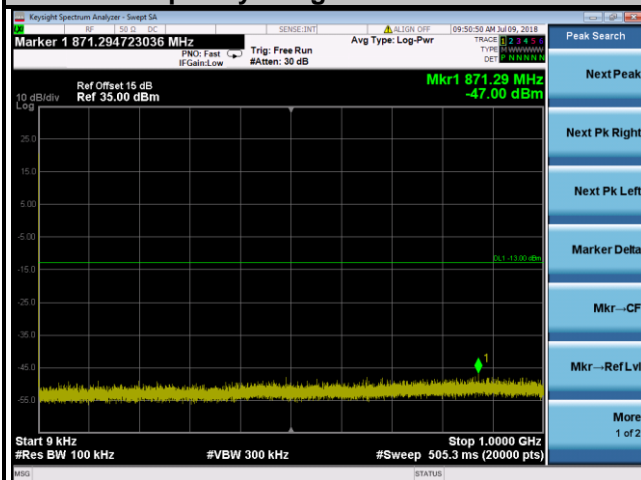

#### Frequency Range: 1 GHz ~ 10 GHz

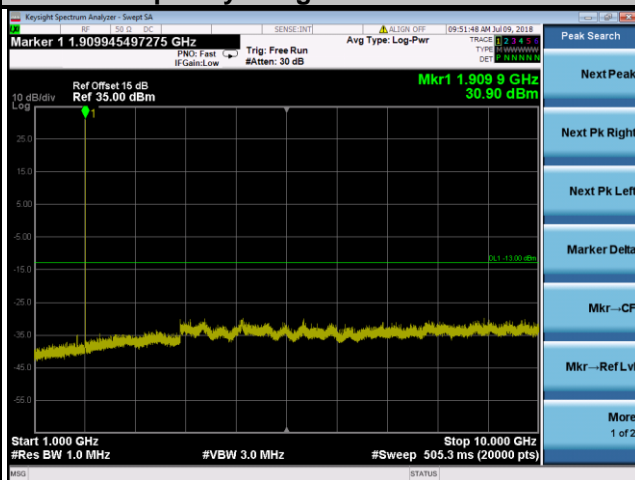

#### Frequency Range: 10 GHz ~ 26.5 GHz

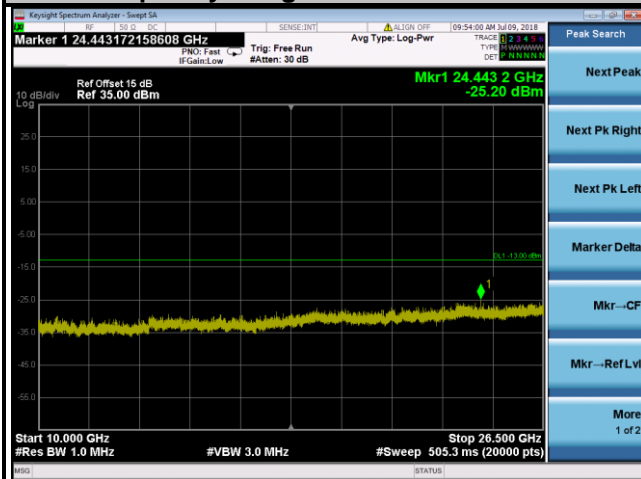



EDGE

Channel 512

Frequency Range: 9 kHz ~ 1 GHz

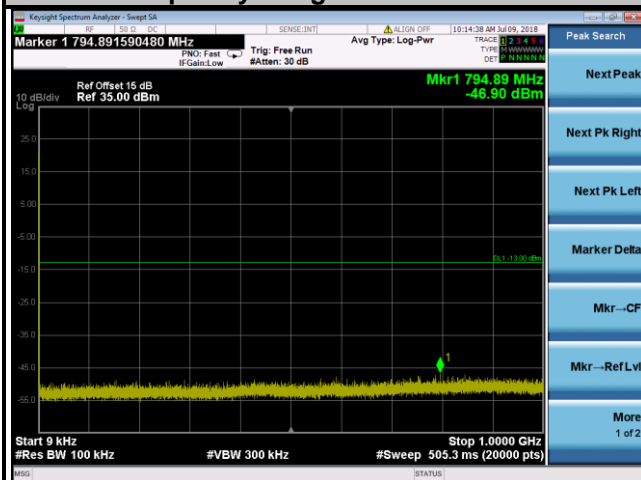

Frequency Range: 1 GHz ~ 10 GHz

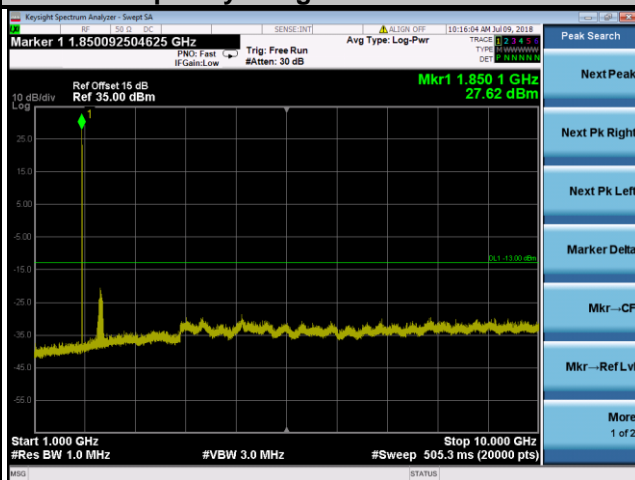

Frequency Range: 10 GHz ~ 26.5 GHz

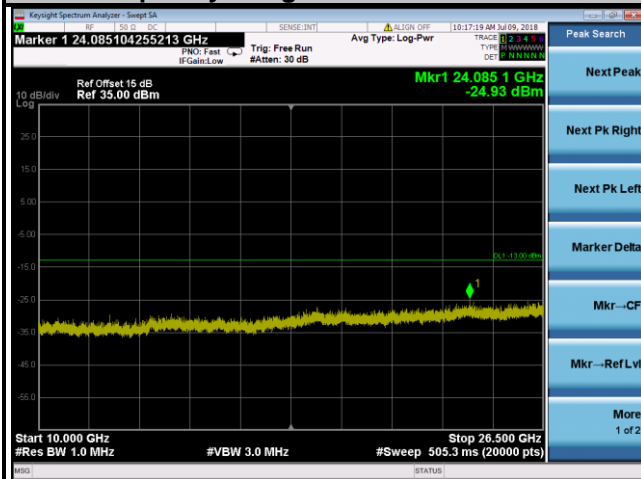

EDGE

Channel 661

Frequency Range: 9 kHz ~ 1 GHz

Frequency Range: 1 GHz ~ 10 GHz

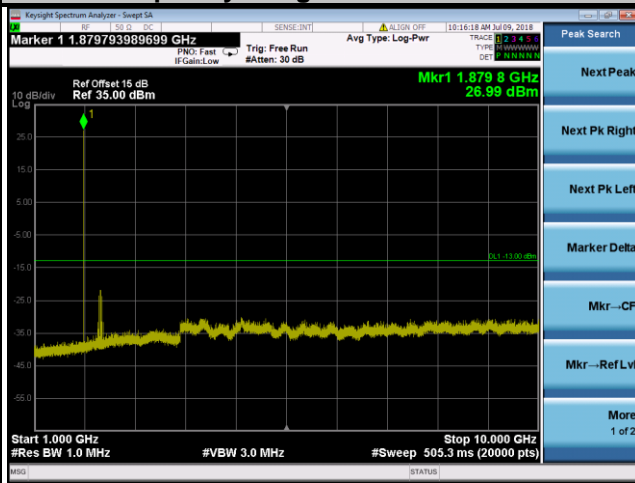
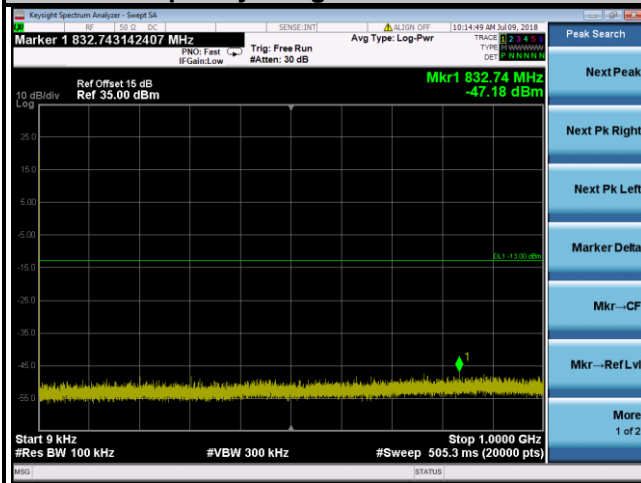

Frequency Range: 10 GHz ~ 26.5 GHz

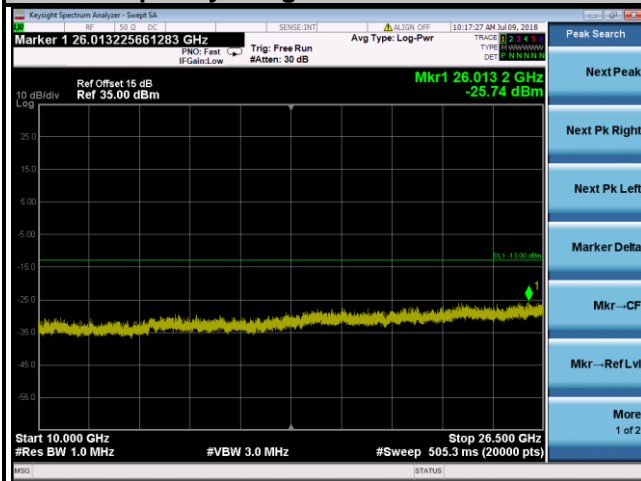

EDGE

Channel 810

Frequency Range: 9 kHz ~ 1 GHz

Frequency Range: 1 GHz ~ 10 GHz

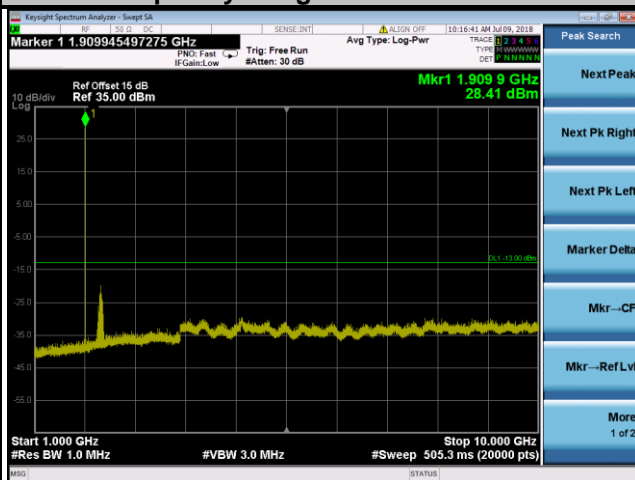
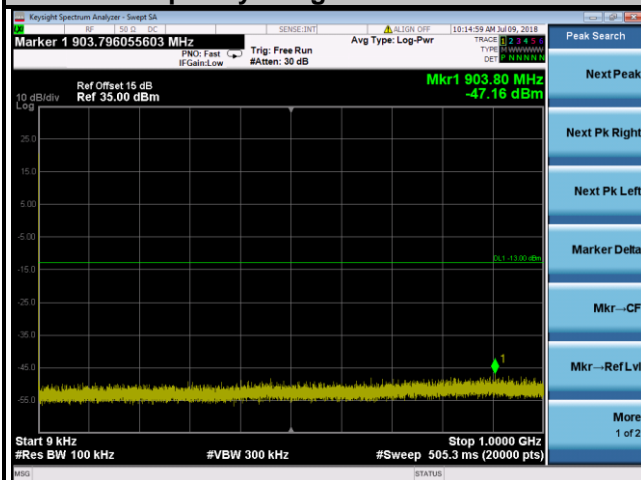

Frequency Range: 10 GHz ~ 26.5 GHz

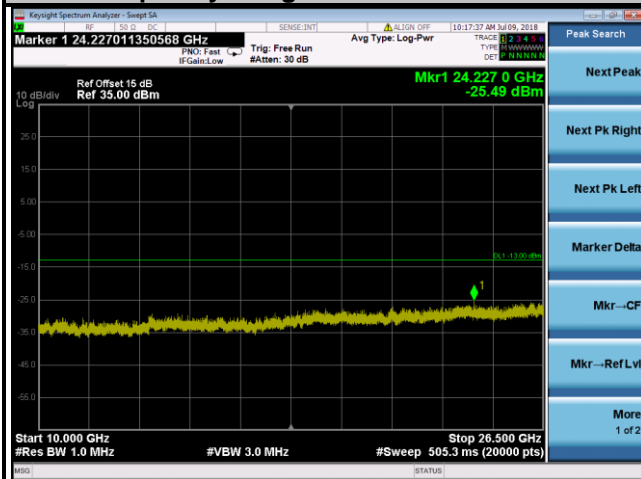

## WCDMA Channel 9262

**Frequency Range: 9 kHz ~ 1 GHz**

**Frequency Range: 1 GHz ~ 10 GHz**

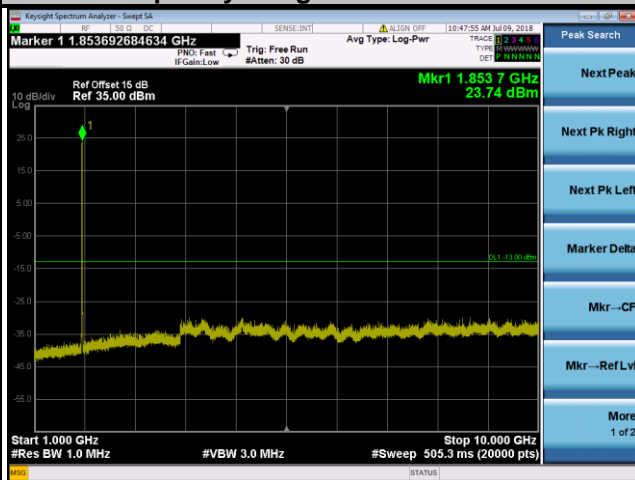
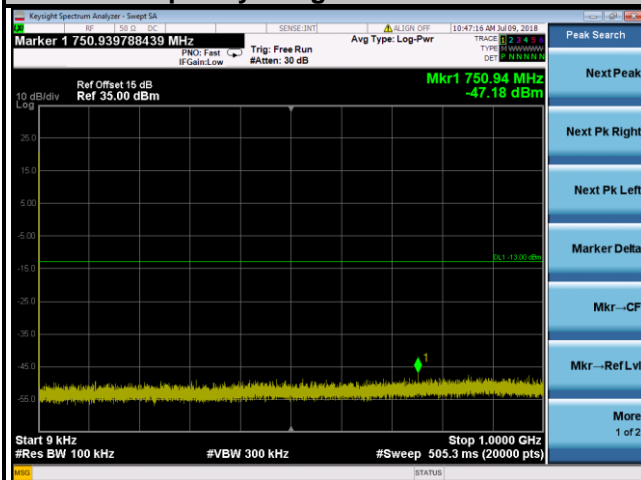

**Frequency Range: 10 GHz ~ 26.5 GHz**

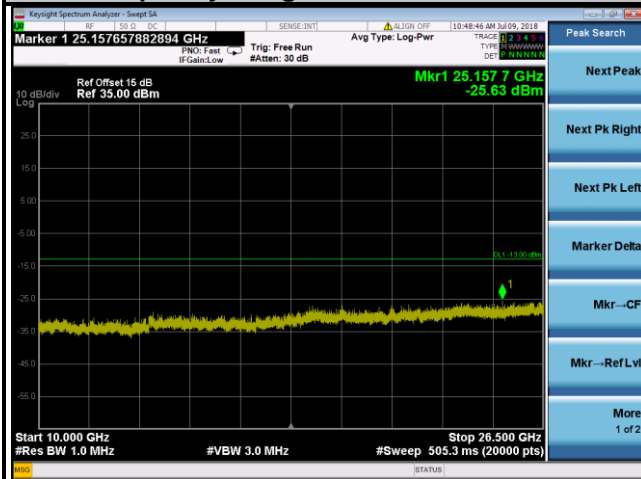

**WCDMA**  
**Channel 9400**

**Frequency Range: 9 kHz ~ 1 GHz**

**Frequency Range: 1 GHz ~ 10 GHz**

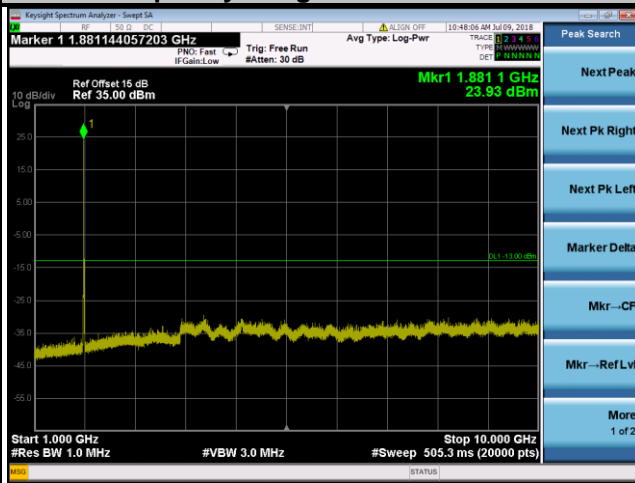
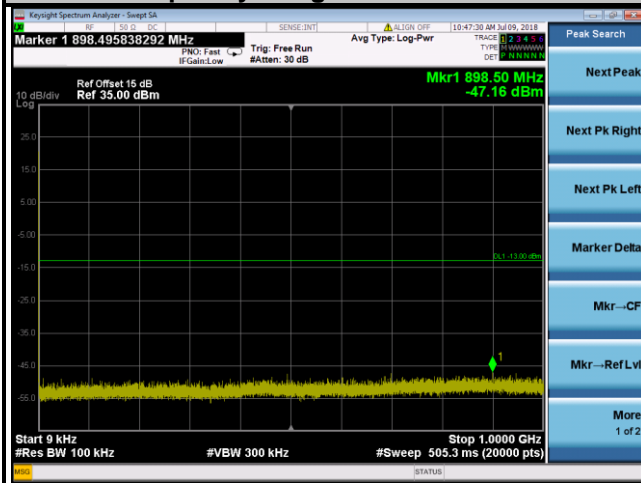

**Frequency Range: 10 GHz ~ 26.5 GHz**

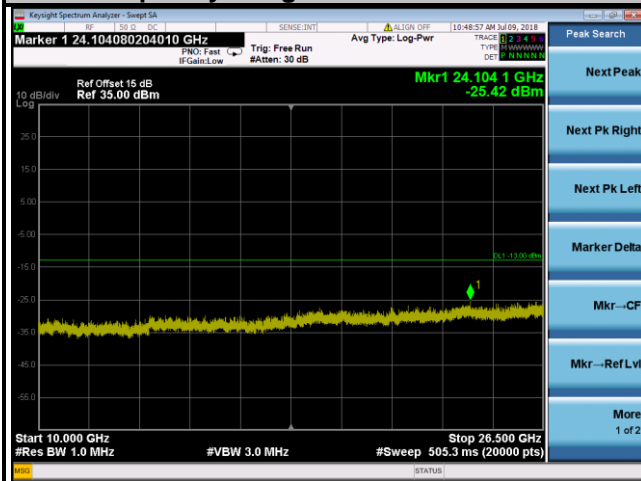

**WCDMA**  
**Channel 9538**

**Frequency Range: 9 kHz ~ 1 GHz**

**Frequency Range: 1 GHz ~ 10 GHz**

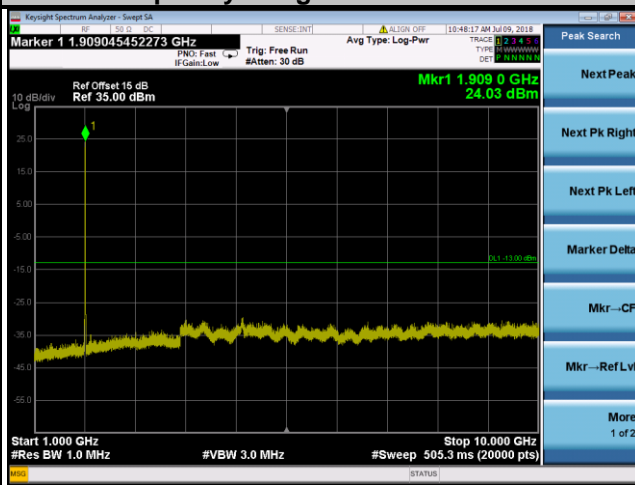
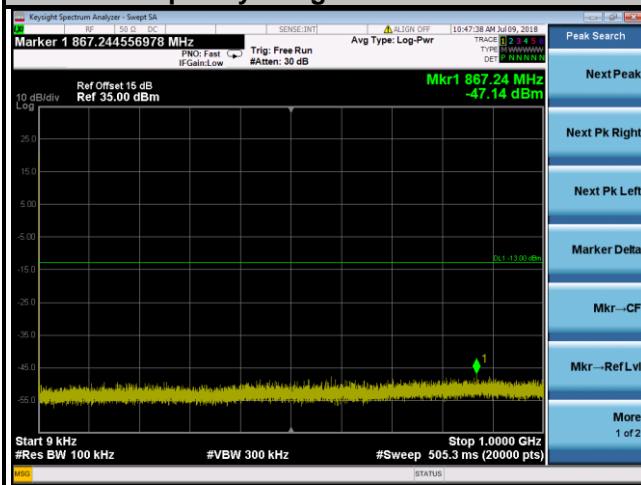

**Frequency Range: 10 GHz ~ 26.5 GHz**

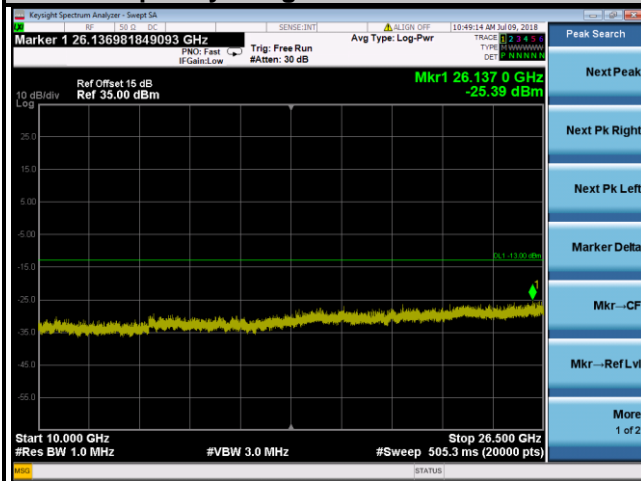

## 4.8 Radiated Emission Measurement

### 4.8.1 Limits of Radiated Emission Measurement

The power of any emission outside of the authorized operating frequency ranges must be attenuated below the transmitting power (P) by a factor of at least  $43 + 10 \log(P)$  dB. The emission limit is equal to -13 dBm.

### 4.8.2 Test Procedure

- a. Substitution method is used for E.I.R.P measurement. In the semi-anechoic chamber, EUT placed on the 0.8 m (below or equal 1 GHz) and/or 1.5 m (above 1 GHz) height of Turn Table, rotated the table around 360 degrees to search the maximum radiation power and receiver antenna shall be rotated vertical and horizontal polarization and moved height from 1 m to 4 m to find the maximum polar radiated power. The "Read Value" is the spectrum reading the maximum power value.
- b. The substitution horn antenna is substituted for EUT at the same position and signals generator export the CW signal to the substitution antenna via a TX cable. Rotated the Turn Table and moved receiving antenna to find the maximum radiation power. Adjust output power level of S.G to get a Value of spectrum reading equal to "Read Value" of step a. Record the power level of S.G.
- c. EIRP = Output power level of S.G – TX cable loss + Antenna gain of substitution horn.
- d. E.R.P power can be calculated form E.I.R.P power by subtracting the gain of dipole, E.R.P power = E.I.R.P power - 2.15 dB.

**NOTE:** The resolution bandwidth and video bandwidth of test receiver/spectrum analyzer is 1 MHz/3 MHz.

### 4.8.3 Deviation from Test Standard

No deviation.

4.8.4 Test Setup

<Radiated Emission below or equal 1 GHz>

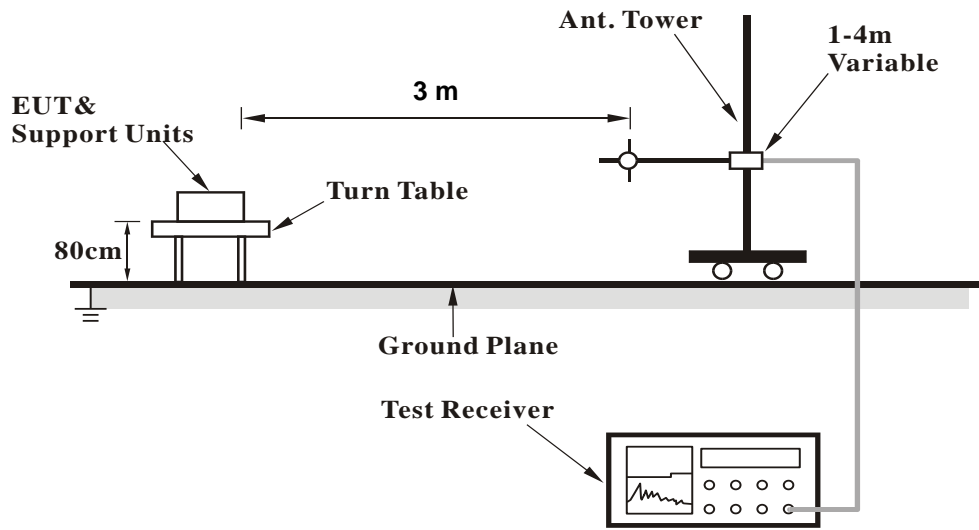

<Radiated Emission above 1 GHz>

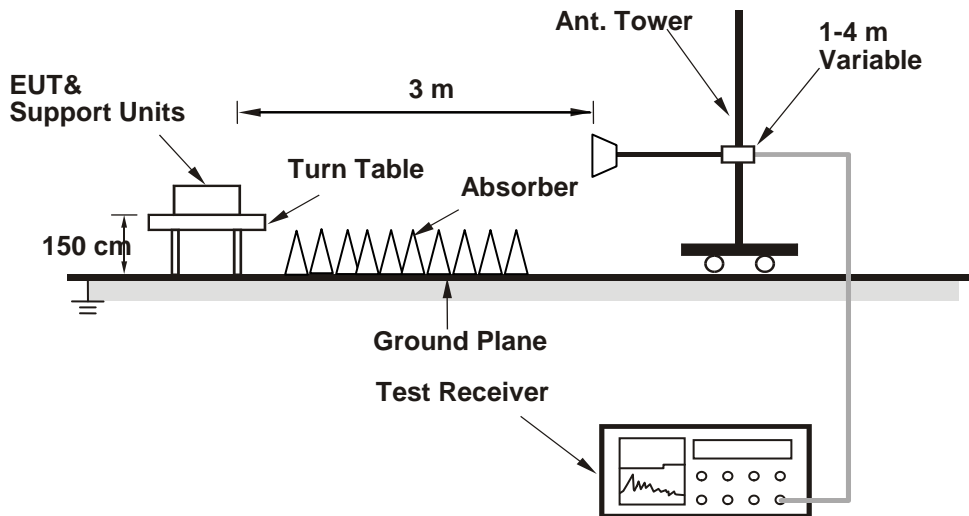

For the actual test configuration, please refer to the attached file (Test Setup Photo).



4.8.5 Test Results

Mode A

GSM:

Low Channel



Bureau Veritas Consumer Products Services Ltd., Taoyuan Branch

A D T

Data: 9

Date: 2018-07-26

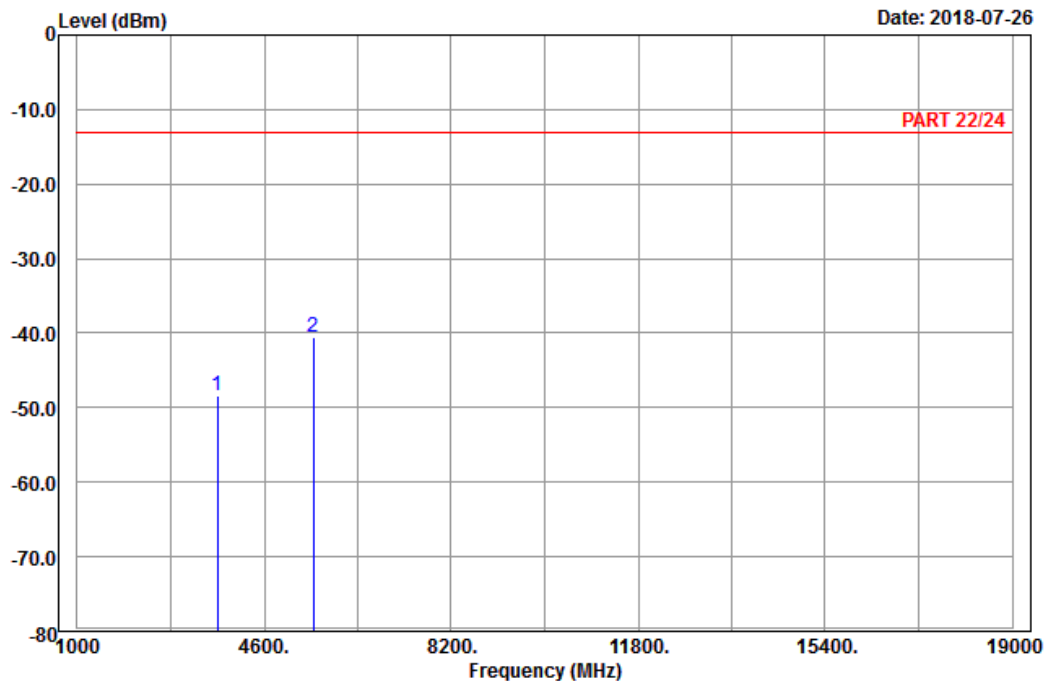

Site : 966 chamber 1  
 Condition: PART 22/24 Horizontal  
 Remark : PCS 1900\_Link\_CH512  
 Tested by: Karl Lee

	Read	Limit	Over				
Freq	Level	Level	Line	Limit	Factor	Remark	
MHz	dBm	dBm	dBm	dB	dB		
1	3700.40	-48.34	-64.22	-13.00	-35.34	15.88	Peak
2 pp	5550.60	-40.58	-60.92	-13.00	-27.58	20.34	Peak



A D T

Data: 10

Date: 2018-07-26

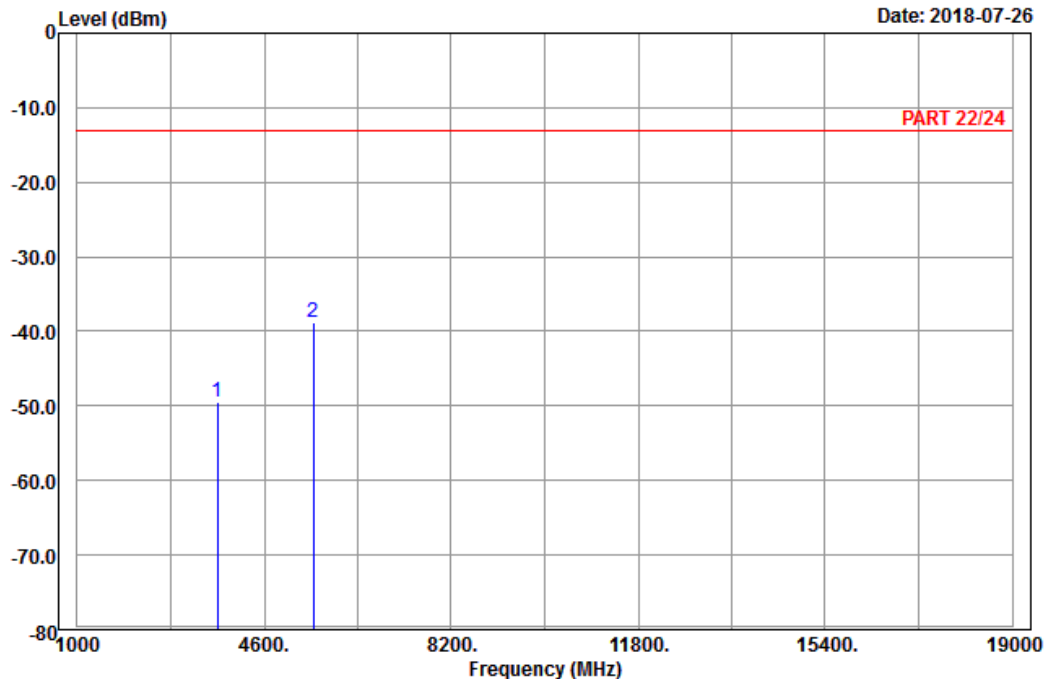

Site : 966 chamber 1  
 Condition: PART 22/24 Vertical  
 Remark : PCS 1900\_Link\_CH512  
 Tested by: Karl Lee

	Freq	Level	Read Level	Limit Line	Over Limit	Factor	Remark
	MHz	dBm	dBm	dBm	dB	dB	
1	3700.40	-49.46	-65.34	-13.00	-36.46	15.88	Peak
2 pp	5550.60	-38.89	-59.23	-13.00	-25.89	20.34	Peak

Middle Channel



Bureau Veritas Consumer Products Services Ltd., Taoyuan Branch

A D T

Data: 9

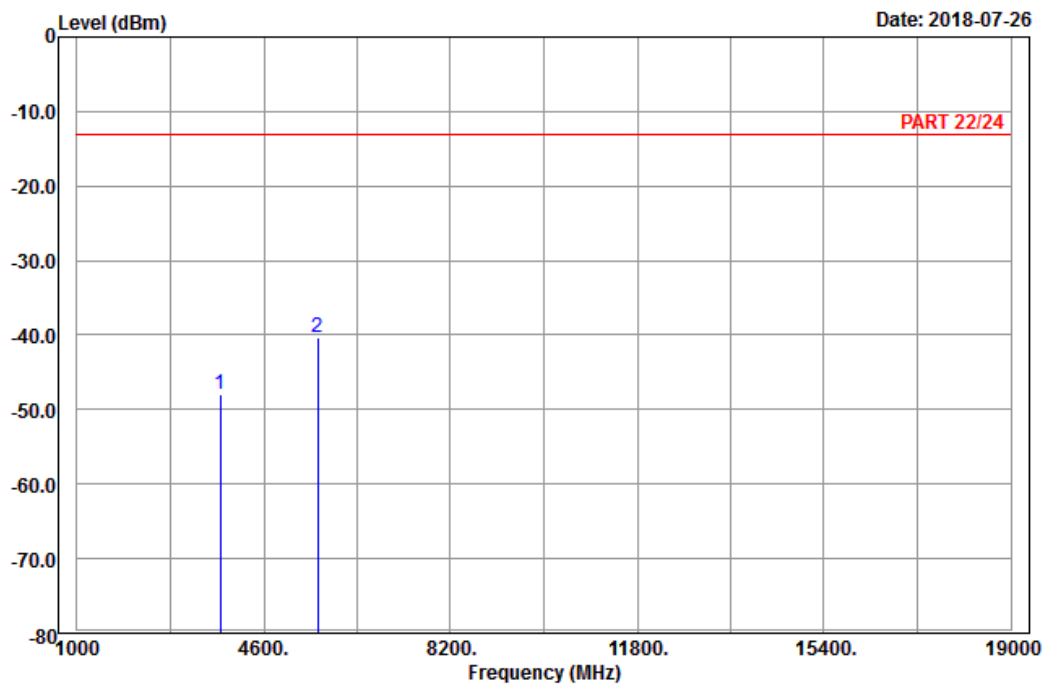

Site : 966 chamber 1  
 Condition: PART 22/24 Horizontal  
 Remark : PCS 1900\_Link\_CH661  
 Tested by: Karl Lee

	Freq	Level	Read Level	Limit Line	Over Limit	Factor	Remark
	MHz	dBm	dBm	dBm	dB	dB	
1	3760.00	-47.94	-64.08	-13.00	-34.94	16.14	Peak
2	5640.00	-40.33	-60.80	-13.00	-27.33	20.47	Peak



Bureau Veritas Consumer Products Services Ltd., Taoyuan Branch

A D T

Data: 10

Date: 2018-07-26

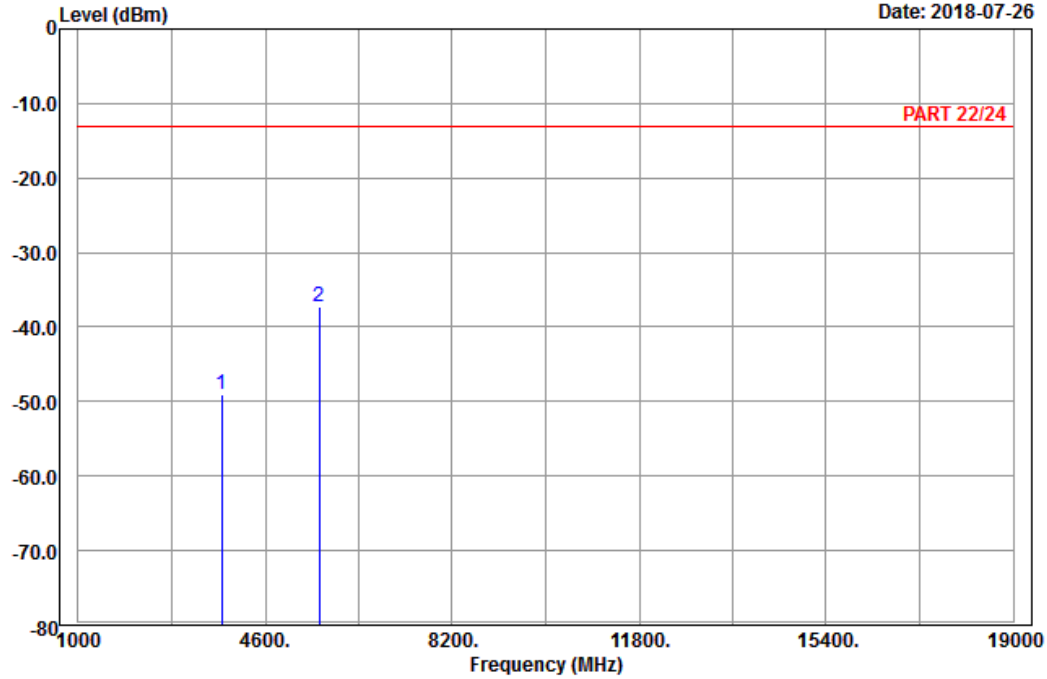

Site : 966 chamber 1  
 Condition: PART 22/24 Vertical  
 Remark : PCS 1900\_Link\_CH661  
 Tested by: Karl Lee

	Freq	Level	Read Level	Limit Line	Over Limit	Factor	Remark
	MHz	dBm	dBm	dBm	dB	dB	
1	3760.00	-49.05	-65.19	-13.00	-36.05	16.14	Peak
2 pp	5640.00	-37.35	-57.82	-13.00	-24.35	20.47	Peak

# High Channel



Bureau Veritas Consumer Products Services Ltd., Taoyuan Branch

A D T

Data: 13

Date: 2018-07-26

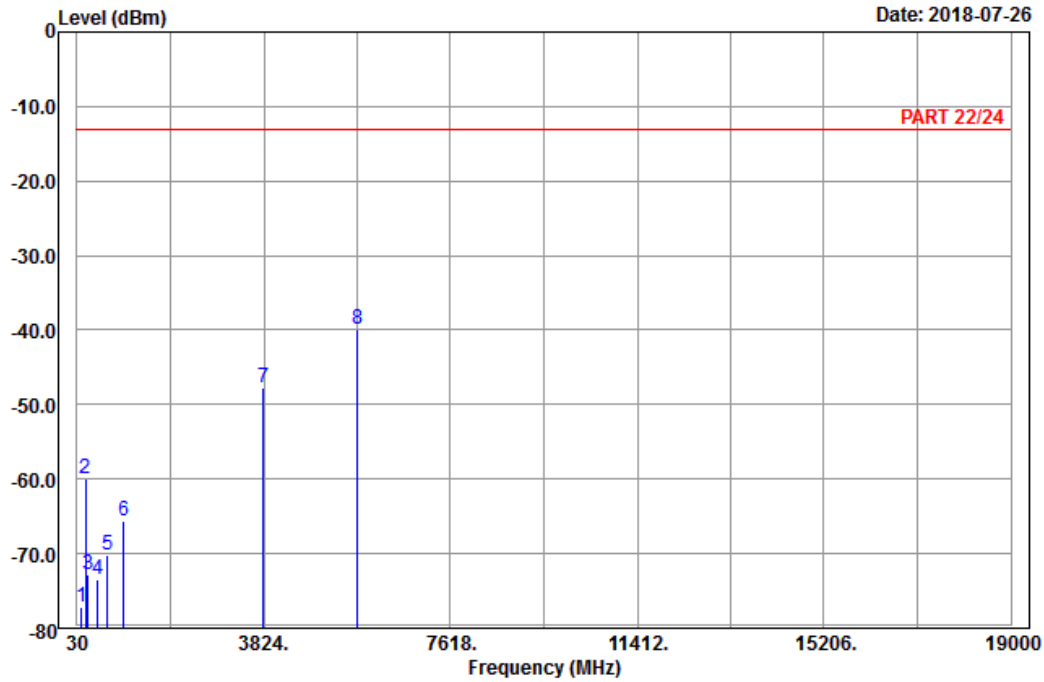

Site : 966 chamber 1  
 Condition: PART 22/24 Horizontal  
 Remark : PCS 1900\_Link\_CH810  
 Tested by: Karl Lee

	Freq	Level	Read Level	Limit Line	Over Limit	Factor	Remark
	MHz	dBm	dBm	dBm	dB	dB	
1	121.26	-77.11	-68.92	-13.00	-64.11	-8.19	Peak
2	200.64	-60.00	-53.83	-13.00	-47.00	-6.17	Peak
3	251.13	-72.71	-67.19	-13.00	-59.71	-5.52	Peak
4	445.60	-73.52	-69.78	-13.00	-60.52	-3.74	Peak
5	656.30	-70.11	-69.94	-13.00	-57.11	-0.17	Peak
6	986.70	-65.54	-70.76	-13.00	-52.54	5.22	Peak
7	3819.60	-47.71	-64.21	-13.00	-34.71	16.50	Peak
8 pp	5729.40	-39.84	-60.18	-13.00	-26.84	20.34	Peak



Bureau Veritas Consumer Products Services Ltd., Taoyuan Branch

A D T

Data: 14

Date: 2018-07-26

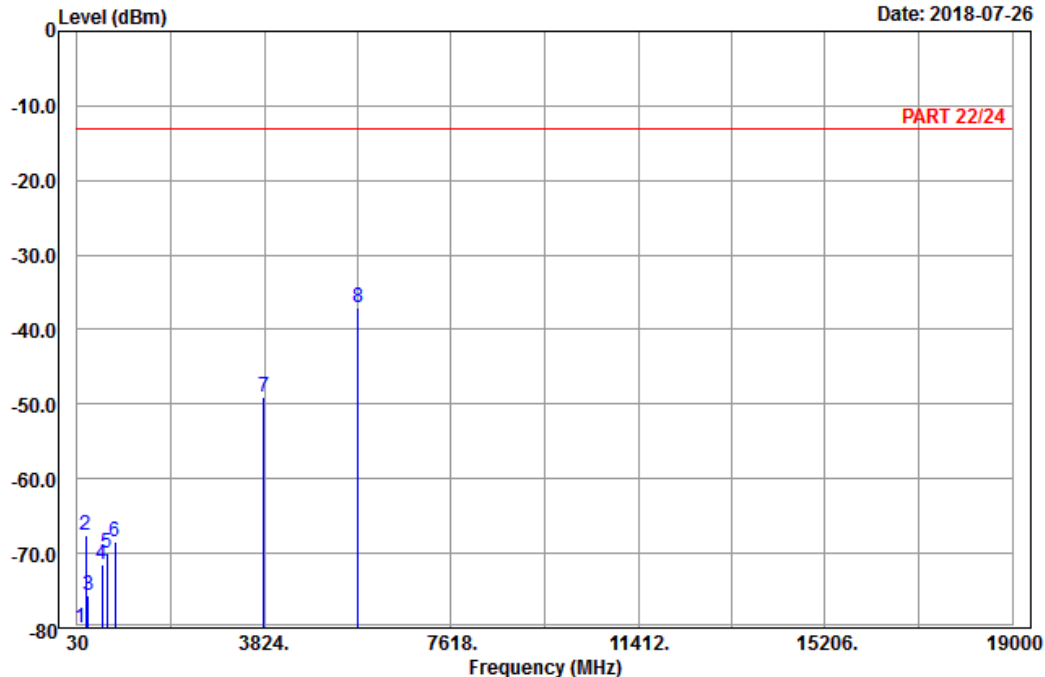

Site : 966 chamber 1  
 Condition: PART 22/24 Vertical  
 Remark : PCS 1900\_Link\_CH810  
 Tested by: Karl Lee

	Freq	Level	Read Level	Limit Line	Over Limit	Factor	Remark
	MHz	dBm	dBm	dBm	dB	dB	
1	101.01	-80.06	-70.06	-13.00	-67.06	-10.00	Peak
2	210.90	-67.48	-61.44	-13.00	-54.48	-6.04	Peak
3	248.43	-75.63	-70.10	-13.00	-62.63	-5.53	Peak
4	527.50	-71.43	-68.14	-13.00	-58.43	-3.29	Peak
5	631.80	-70.00	-70.07	-13.00	-57.00	0.07	Peak
6	791.40	-68.45	-69.89	-13.00	-55.45	1.44	Peak
7	3819.60	-49.04	-65.54	-13.00	-36.04	16.50	Peak
8 pp	5729.40	-37.04	-57.38	-13.00	-24.04	20.34	Peak

EDGE:  
Low Channel



Bureau Veritas Consumer Products Services Ltd., Taoyuan Branch

A D T

Data: 9

Date: 2018-07-26

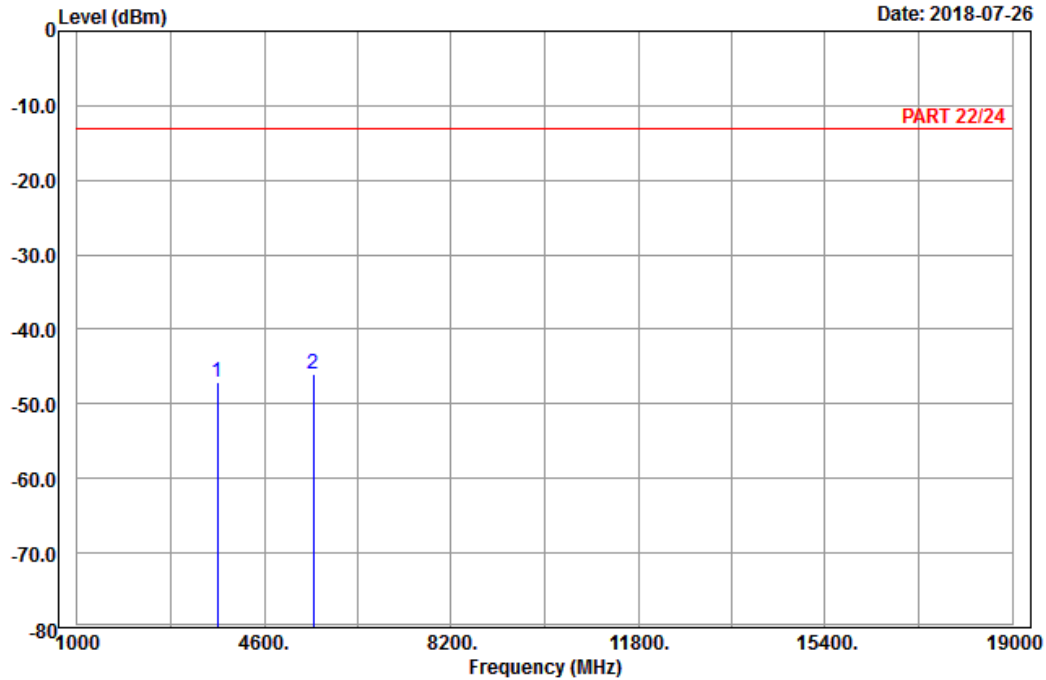

Site : 966 chamber 1  
Condition: PART 22/24 Horizontal  
Remark : EDGE 1900\_Link\_CH512  
Tested by: Karl Lee

	Freq	Level	Read Level	Limit Line	Over Limit	Factor	Remark
	MHz	dBm	dBm	dBm	dB	dB	
1	3700.40	-47.12	-63.00	-13.00	-34.12	15.88	Peak
2 pp	5550.60	-46.00	-66.34	-13.00	-33.00	20.34	Peak



Bureau Veritas Consumer Products Services Ltd., Taoyuan Branch

A D T

Data: 10

Date: 2018-07-26

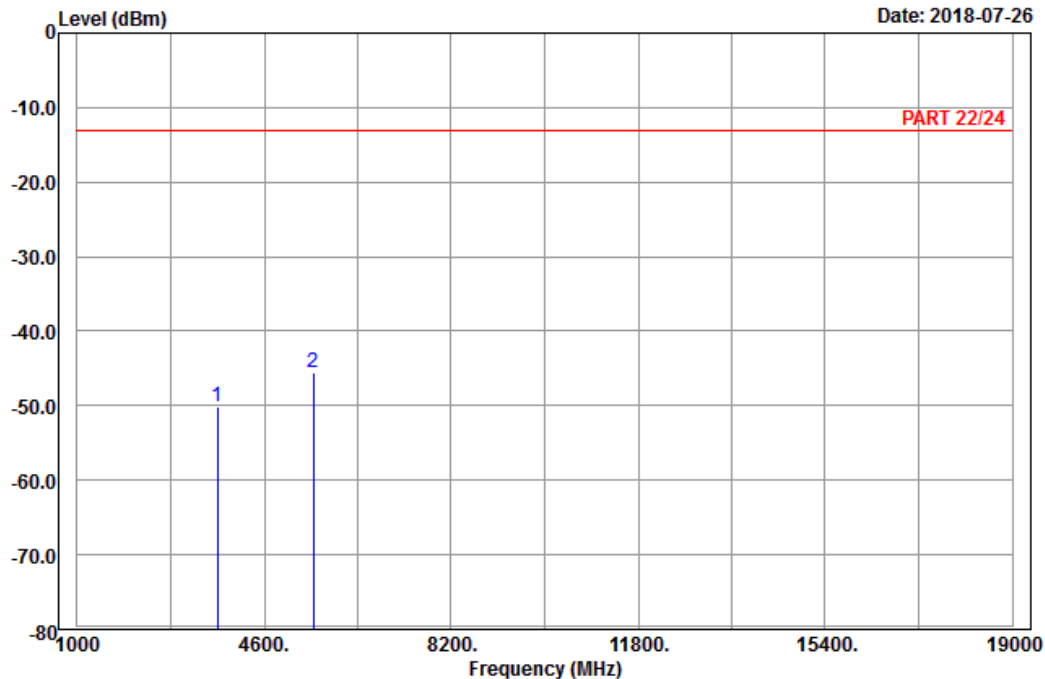

Site : 966 chamber 1  
 Condition: PART 22/24 Vertical  
 Remark : EDGE 1900\_Link\_CH512  
 Tested by: Karl Lee

	Freq	Level	Read Level	Limit Line	Over Limit	Factor	Remark
	MHz	dBm	dBm	dBm	dB	dB	
1	3700.40	-50.19	-66.07	-13.00	-37.19	15.88	Peak
2 pp	5550.60	-45.53	-65.87	-13.00	-32.53	20.34	Peak



Middle Channel



Bureau Veritas Consumer Products Services Ltd., Taoyuan Branch

A D T

Data: 9

Date: 2018-07-26

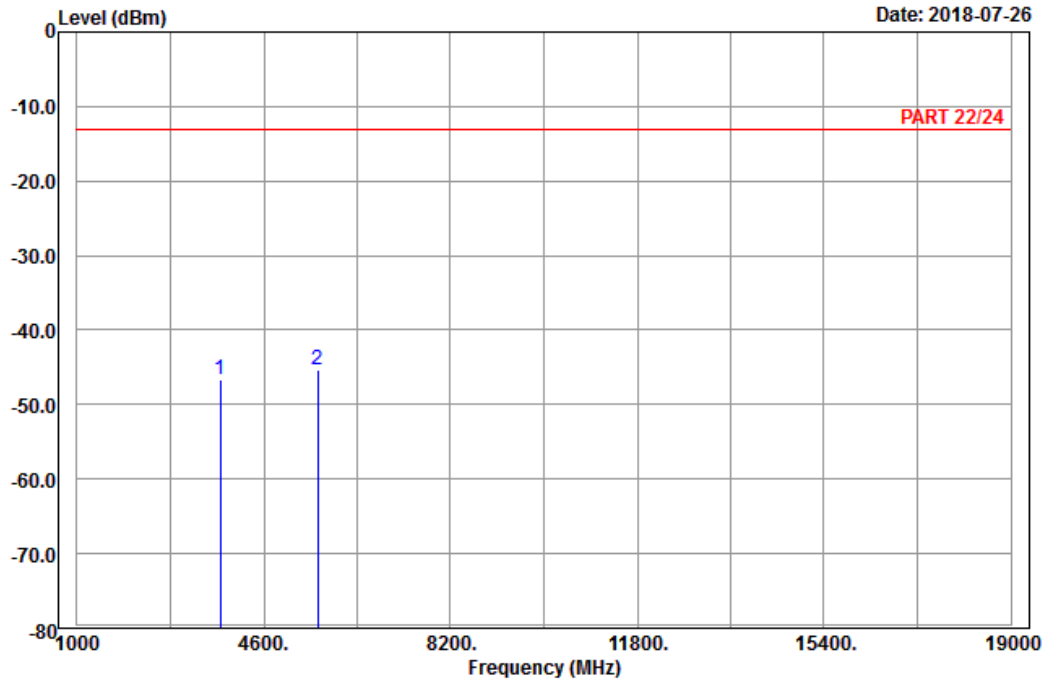

Site : 966 chamber 1  
 Condition: PART 22/24 Horizontal  
 Remark : EDGE 1900\_Link\_CH661  
 Tested by: Karl Lee

	Freq	Level	Read Level	Limit Line	Over Limit	Factor	Remark
	MHz	dBm	dBm	dBm	dB	dB	
1	3760.00	-46.73	-62.87	-13.00	-33.73	16.14	Peak
2	5640.00	-45.38	-65.85	-13.00	-32.38	20.47	Peak



Bureau Veritas Consumer Products Services Ltd., Taoyuan Branch

A D T

Data: 10

Date: 2018-07-26

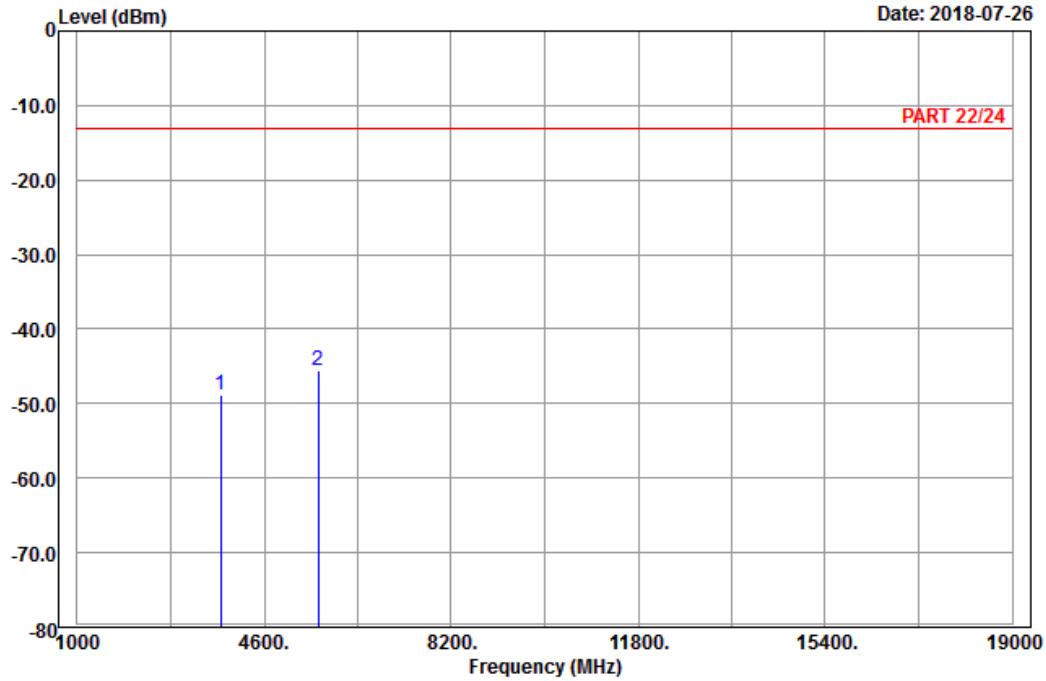

Site : 966 chamber 1  
 Condition: PART 22/24 Vertical  
 Remark : EDGE 1900\_Link\_CH661  
 Tested by: Karl Lee

	Freq	Level	Read Level	Limit Line	Over Limit	Factor	Remark
	MHz	dBm	dBm	dBm	dB	dB	
1	3760.00	-48.81	-64.95	-13.00	-35.81	16.14	Peak
2 pp	5640.00	-45.49	-65.96	-13.00	-32.49	20.47	Peak

High Channel



Bureau Veritas Consumer Products Services Ltd., Taoyuan Branch

A D T

Data: 9

Date: 2018-07-26

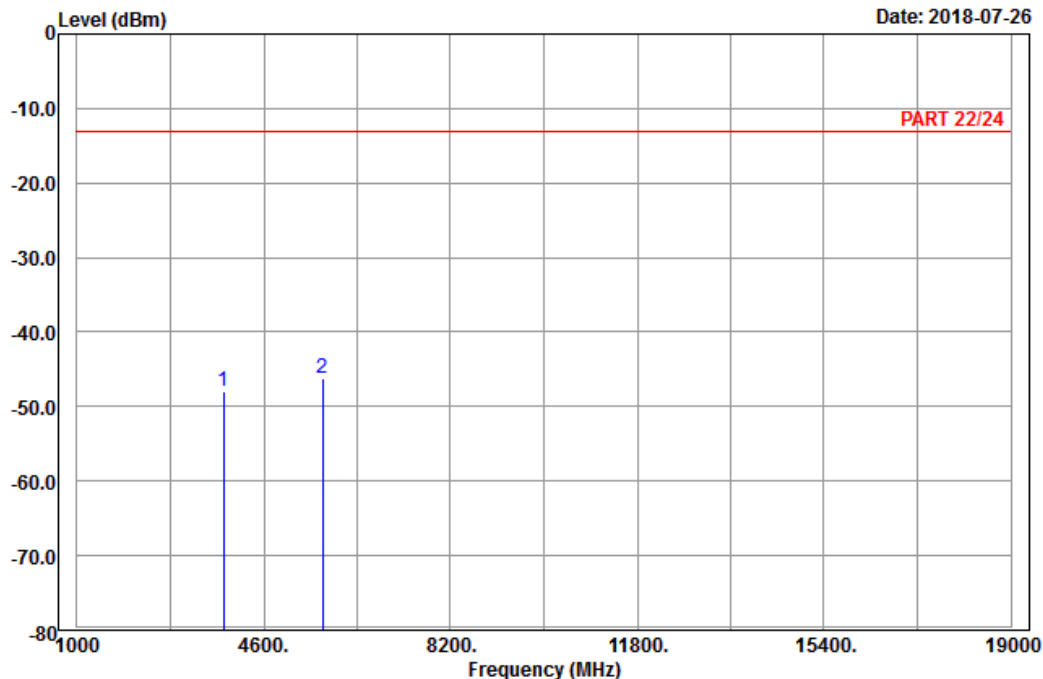

Site : 966 chamber 1  
 Condition: PART 22/24 Horizontal  
 Remark : EDGE 1900\_Link\_CH810  
 Tested by: Karl Lee

	Freq	Level	Read Level	Limit Line	Over Limit	Factor	Remark
	MHz	dBm	dBm	dBm	dB	dB	
1	3819.60	-47.88	-64.38	-13.00	-34.88	16.50	Peak
2	5729.40	-46.23	-66.57	-13.00	-33.23	20.34	Peak



Bureau Veritas Consumer Products Services Ltd., Taoyuan Branch

A D T

Data: 10

Date: 2018-07-26

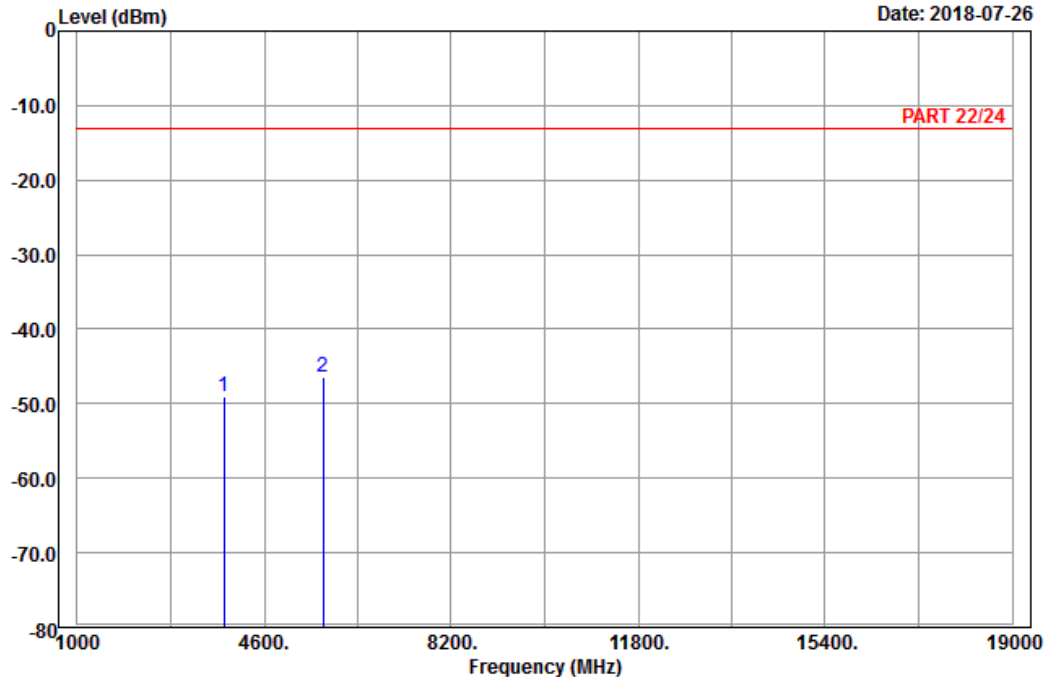

Site : 966 chamber 1  
 Condition: PART 22/24 Vertical  
 Remark : EDGE 1900\_Link\_CH810  
 Tested by: Karl Lee

	Freq	Level	Read Level	Limit Line	Over Limit	Factor	Remark
	MHz	dBm	dBm	dBm	dB	dB	
1	3819.60	-49.01	-65.51	-13.00	-36.01	16.50	Peak
2 pp	5729.40	-46.40	-66.74	-13.00	-33.40	20.34	Peak

WCDMA:  
Low Channel



Bureau Veritas Consumer Products Services Ltd., Taoyuan Branch

A D T

Data: 9

Date: 2018-07-26

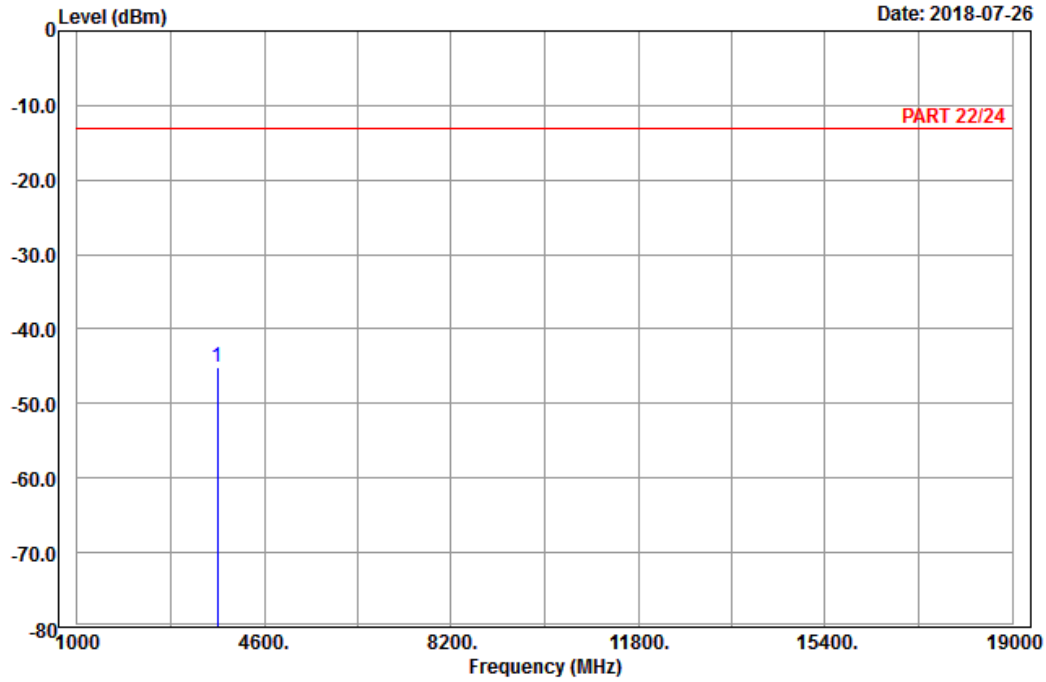

Site : 966 chamber 1  
Condition: PART 22/24 Horizontal  
Remark : Band II\_Link\_CH9262  
Tested by: Karl Lee

	Freq	Level	Read Level	Limit Line	Over Limit	Factor	Remark
	MHz	dBm	dBm	dBm	dB	dB	
1	pp 3704.80	-45.22	-61.10	-13.00	-32.22	15.88	Peak



Bureau Veritas Consumer Products Services Ltd., Taoyuan Branch

A D T

Data: 10

Date: 2018-07-26

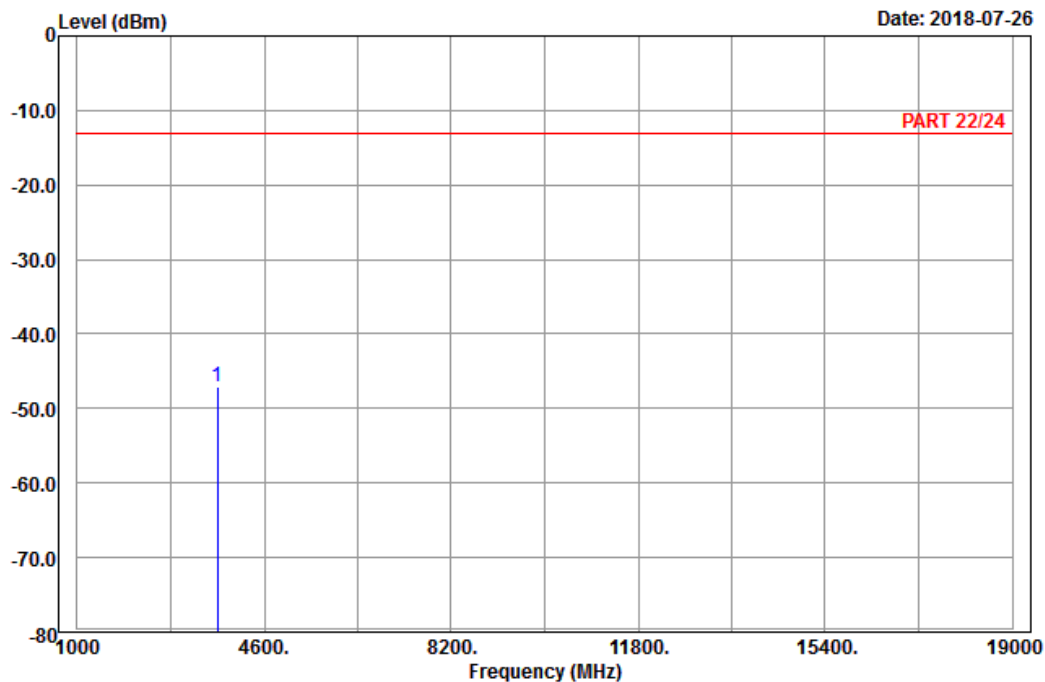

Site : 966 chamber 1  
 Condition: PART 22/24 Vertical  
 Remark : Band II\_Link\_CH9262  
 Tested by: Karl Lee

	Freq	Level	Read Level	Limit Line	Over Limit	Factor	Remark
	MHz	dBm	dBm	dBm	dB	dB	
1	pp 3704.80	-47.16	-63.04	-13.00	-34.16	15.88	Peak

Middle Channel



Bureau Veritas Consumer Products Services Ltd., Taoyuan Branch

A D T

Data: 9

Date: 2018-07-26

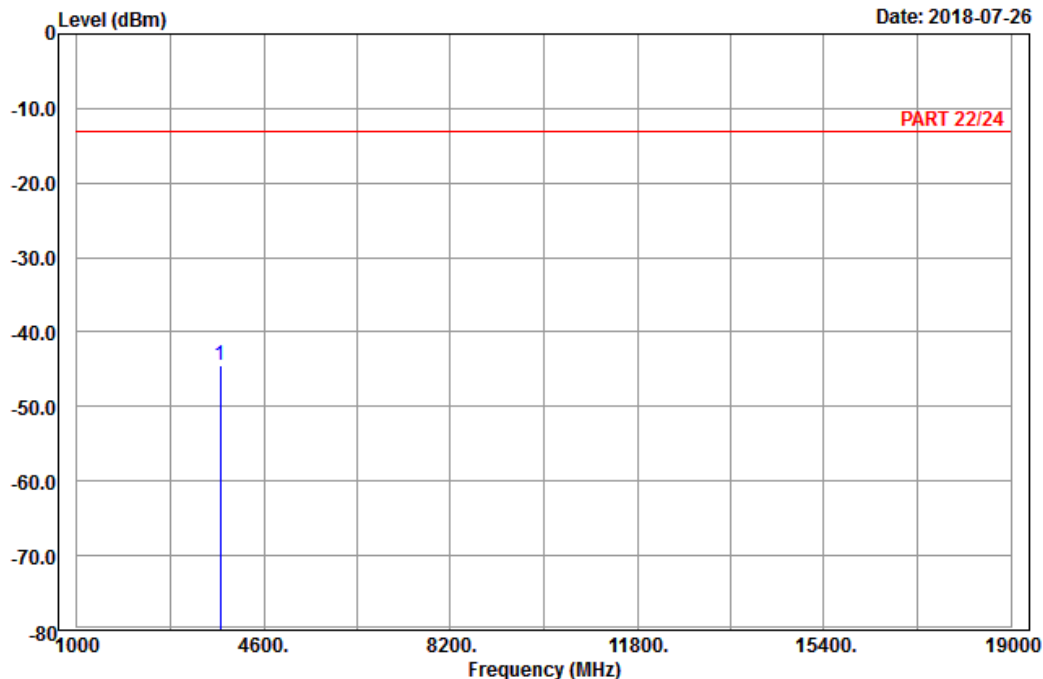

Site : 966 chamber 1  
 Condition: PART 22/24 Horizontal  
 Remark : Band II\_Link\_CH9400  
 Tested by: Karl Lee

Freq	Level	Read Level	Limit Line	Over Limit	Factor	Remark
MHz	dBm	dBm	dBm	dB	dB	
1 pp 3760.00	-44.56	-60.70	-13.00	-31.56	16.14	Peak



Bureau Veritas Consumer Products Services Ltd., Taoyuan Branch

A D T

Data: 10

Date: 2018-07-26

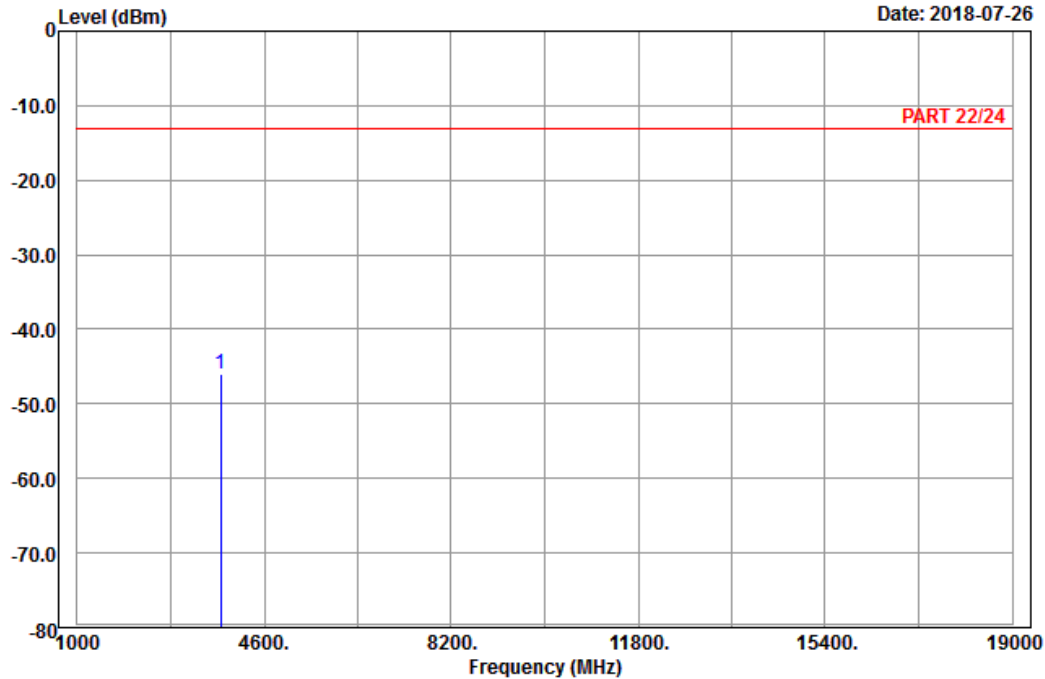

Site : 966 chamber 1  
 Condition: PART 22/24 Vertical  
 Remark : Band II\_Link\_CH9400  
 Tested by: Karl Lee

	Freq	Level	Read Level	Limit Line	Over Limit	Factor	Remark
	MHz	dBm	dBm	dBm	dB	dB	
1	pp 3760.00	-45.98	-62.12	-13.00	-32.98	16.14	Peak



High Channel



Bureau Veritas Consumer Products Services Ltd., Taoyuan Branch

A D T

Data: 9

Date: 2018-07-26

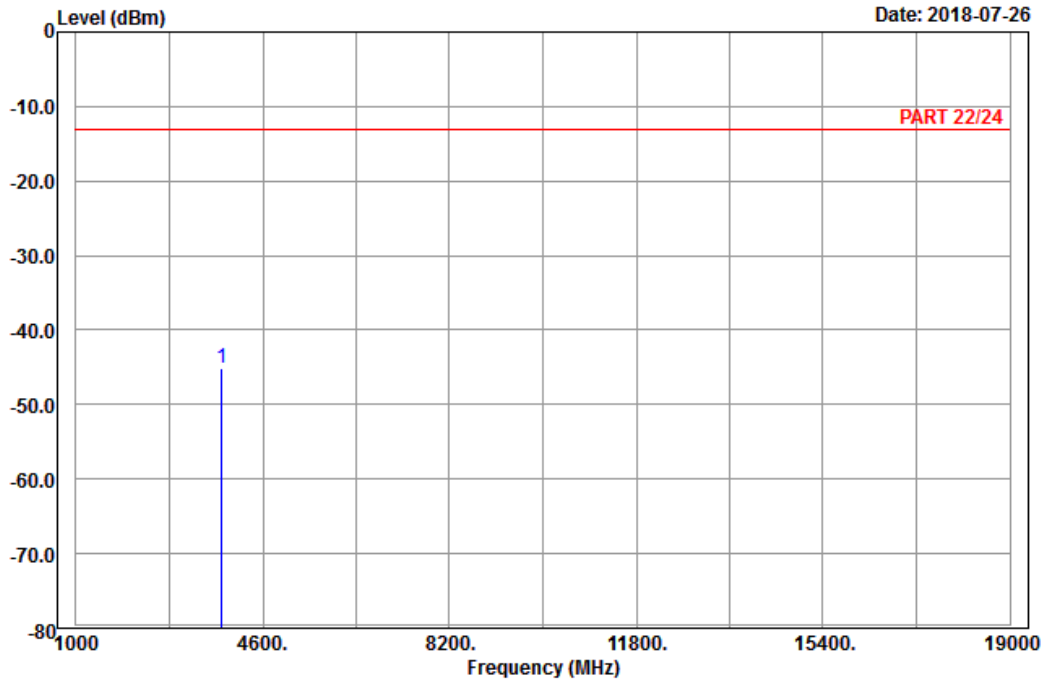

Site : 966 chamber 1  
 Condition: PART 22/24 Horizontal  
 Remark : Band II\_Link\_CH9538  
 Tested by: Karl Lee

Freq	Level	Read Level	Limit Line	Over Limit	Factor	Remark
MHz	dBm	dBm	dBm	dB	dB	
1 pp 3815.20	-45.02	-61.43	-13.00	-32.02	16.41	Peak



Bureau Veritas Consumer Products Services Ltd., Taoyuan Branch

A D T

Data: 10

Date: 2018-07-26

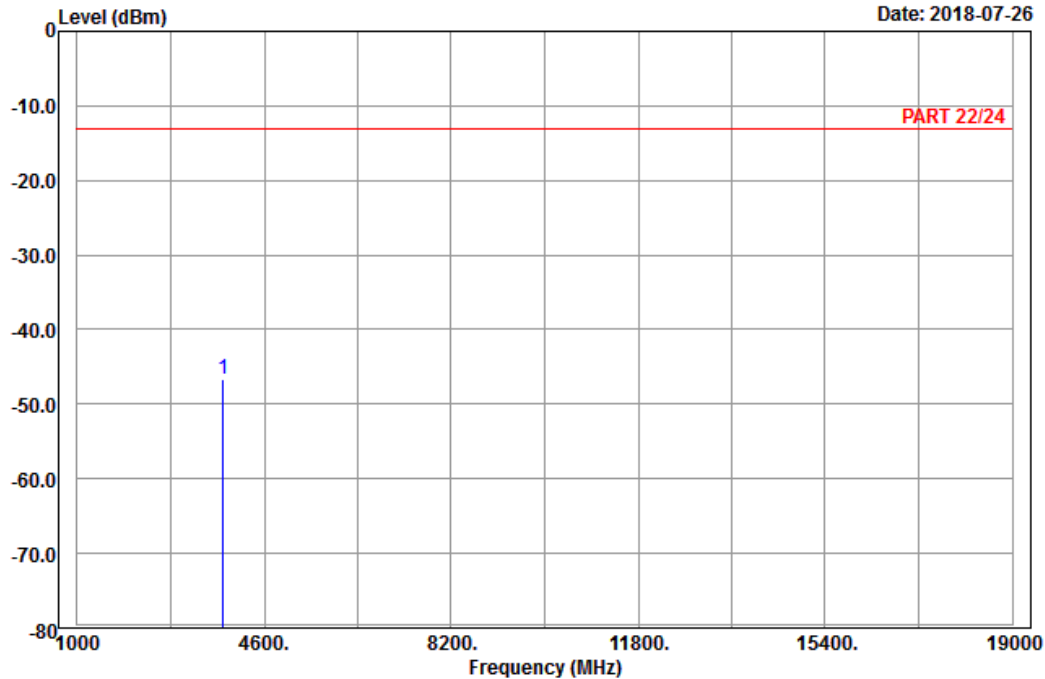

Site : 966 chamber 1  
 Condition: PART 22/24 Vertical  
 Remark : Band II\_Link\_CH9538  
 Tested by: Karl Lee

	Freq	Level	Read Level	Limit Line	Over Limit	Factor	Remark
	MHz	dBm	dBm	dBm	dB	dB	
1	pp 3815.20	-46.75	-63.16	-13.00	-33.75	16.41	Peak

Mode B  
GSM:  
Low Channel



Bureau Veritas Consumer Products Services Ltd., Taoyuan Branch

A D T

Data: 9

Date: 2018-07-26

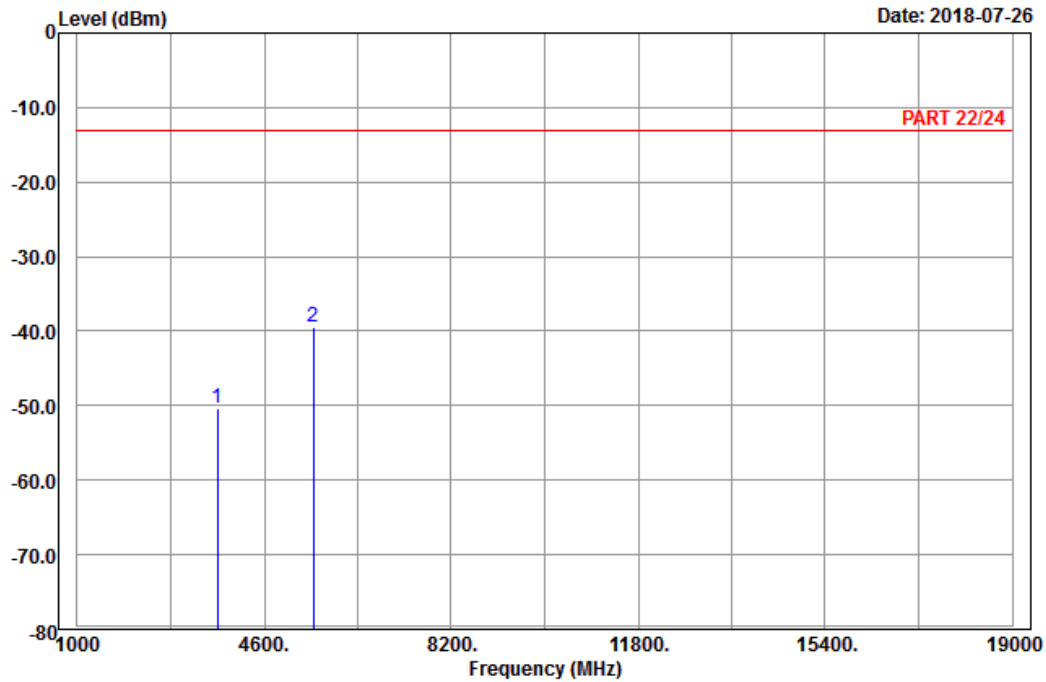

Site : 966 chamber 1  
Condition: PART 22/24 Horizontal  
Remark : PCS 1900\_Link\_CH512  
Tested by: Karl Lee

	Read	Limit	Over				
Freq	Level	Level	Line	Limit	Factor	Remark	
MHz	dBm	dBm	dBm	dB	dB		
1	3700.40	-50.25	-66.13	-13.00	-37.25	15.88	Peak
2 pp	5550.60	-39.45	-59.79	-13.00	-26.45	20.34	Peak



Bureau Veritas Consumer Products Services Ltd., Taoyuan Branch

A D T

Data: 10

Date: 2018-07-26

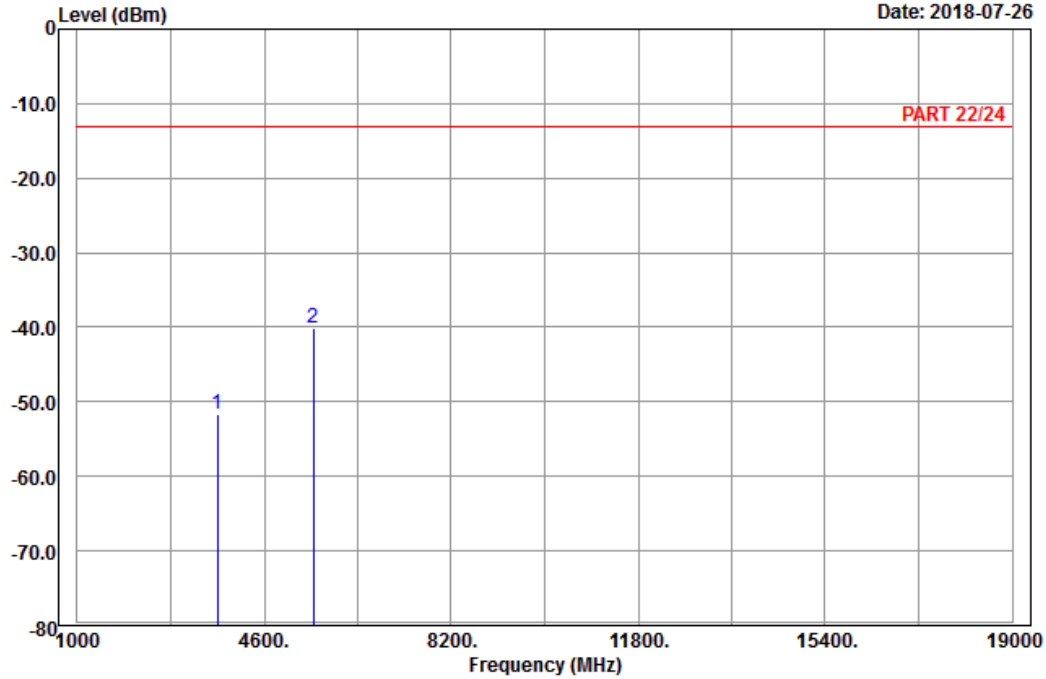

Site : 966 chamber 1  
 Condition: PART 22/24 Vertical  
 Remark : PCS 1900\_Link\_CH512  
 Tested by: Karl Lee

	Freq	Level	Read Level	Limit Line	Over Limit	Factor	Remark
	MHz	dBm	dBm	dBm	dB	dB	
1	3700.40	-51.77	-67.65	-13.00	-38.77	15.88	Peak
2 pp	5550.60	-40.10	-60.44	-13.00	-27.10	20.34	Peak

Middle Channel



Bureau Veritas Consumer Products Services Ltd., Taoyuan Branch

A D T

Data: 9

Date: 2018-07-26

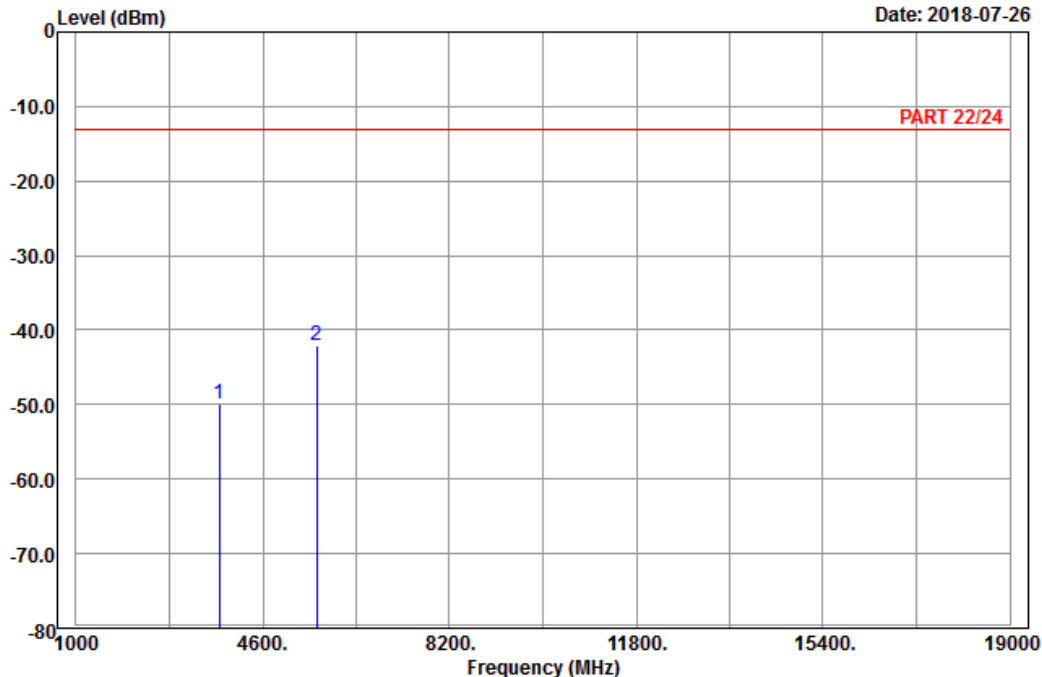

Site : 966 chamber 1  
 Condition: PART 22/24 Horizontal  
 Remark : PCS 1900\_Link\_CH661  
 Tested by: Karl Lee

	Freq	Level	Read Level	Limit Line	Over Limit	Factor	Remark
	MHz	dBm	dBm	dBm	dB	dB	
1	3760.00	-50.00	-66.14	-13.00	-37.00	16.14	Peak
2	5640.00	-42.14	-62.61	-13.00	-29.14	20.47	Peak



Bureau Veritas Consumer Products Services Ltd., Taoyuan Branch

A D T

Data: 10

Date: 2018-07-26

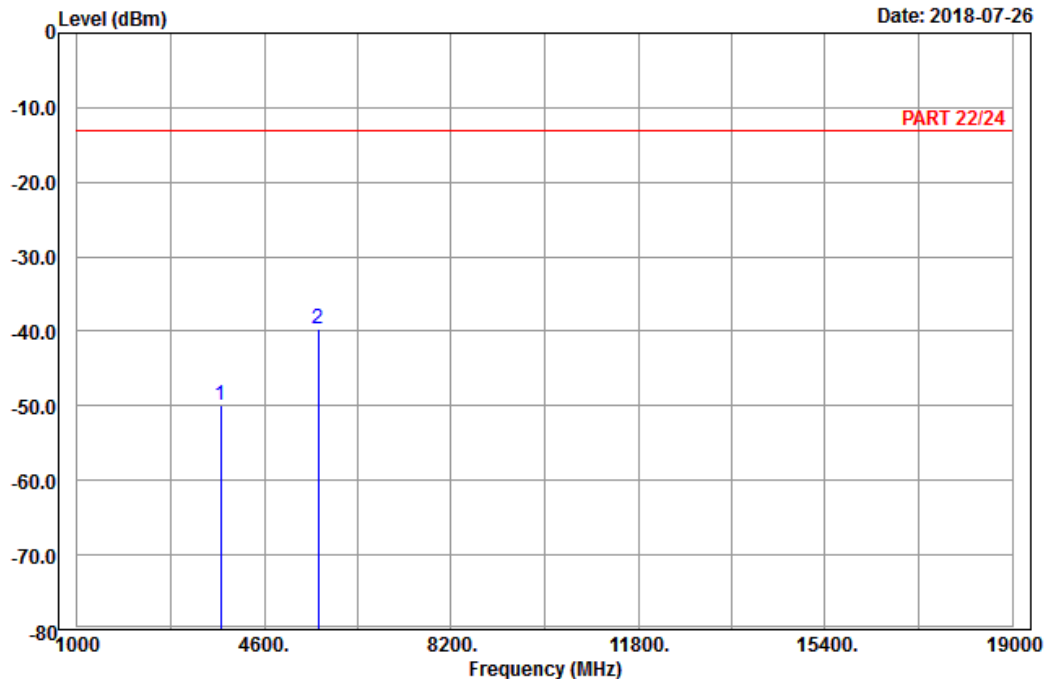

Site : 966 chamber 1  
 Condition: PART 22/24 Vertical  
 Remark : PCS 1900\_Link\_CH661  
 Tested by: Karl Lee

	Freq	Level	Read Level	Limit Line	Over Limit	Factor	Remark
	MHz	dBm	dBm	dBm	dB	dB	
1	3760.00	-49.99	-66.13	-13.00	-36.99	16.14	Peak
2 pp	5640.00	-39.57	-60.04	-13.00	-26.57	20.47	Peak

High Channel



Bureau Veritas Consumer Products Services Ltd., Taoyuan Branch

A D T

Data: 13

Date: 2018-07-26

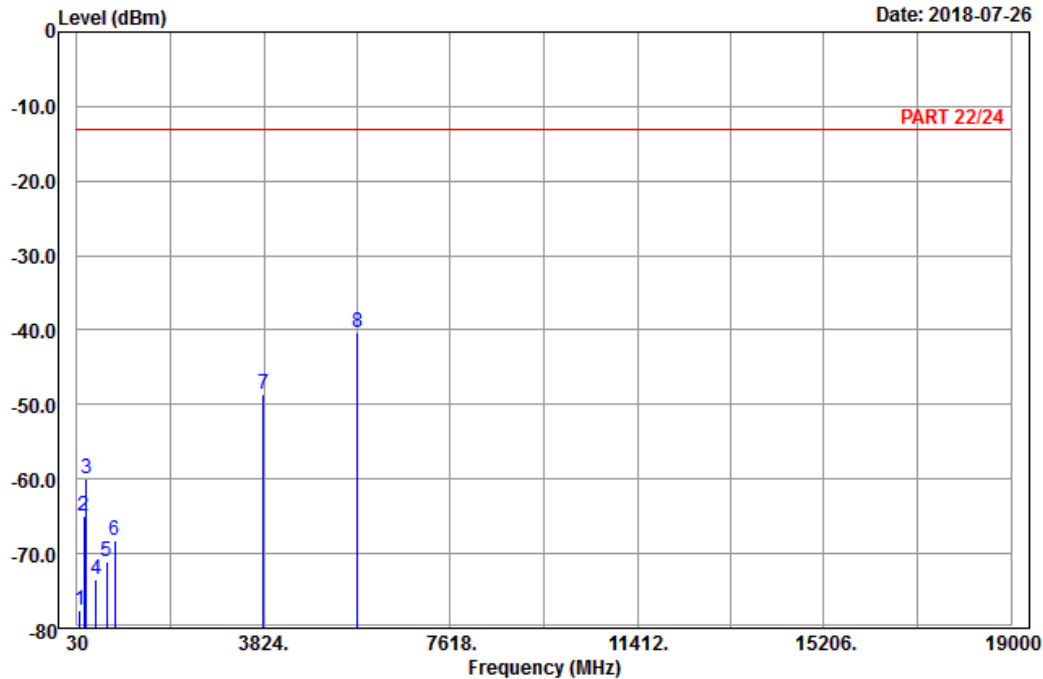

Site : 966 chamber 1  
 Condition: PART 22/24 Horizontal  
 Remark : PCS 1900\_Link\_CH810  
 Tested by: Karl Lee

	Freq	Level	Read Level	Limit Line	Over Limit	Factor	Remark
	MHz	dBm	dBm	dBm	dB	dB	
1	92.64	-77.58	-67.07	-13.00	-64.58	-10.51	Peak
2	173.91	-64.95	-58.65	-13.00	-51.95	-6.30	Peak
3	227.91	-59.93	-54.12	-13.00	-46.93	-5.81	Peak
4	422.50	-73.45	-70.20	-13.00	-60.45	-3.25	Peak
5	632.50	-71.05	-71.11	-13.00	-58.05	0.06	Peak
6	800.50	-68.18	-70.19	-13.00	-55.18	2.01	Peak
7	3819.60	-48.54	-65.04	-13.00	-35.54	16.50	Peak
8 pp	5729.40	-40.25	-60.59	-13.00	-27.25	20.34	Peak



Bureau Veritas Consumer Products Services Ltd., Taoyuan Branch

A D T

Data: 14

Date: 2018-07-26

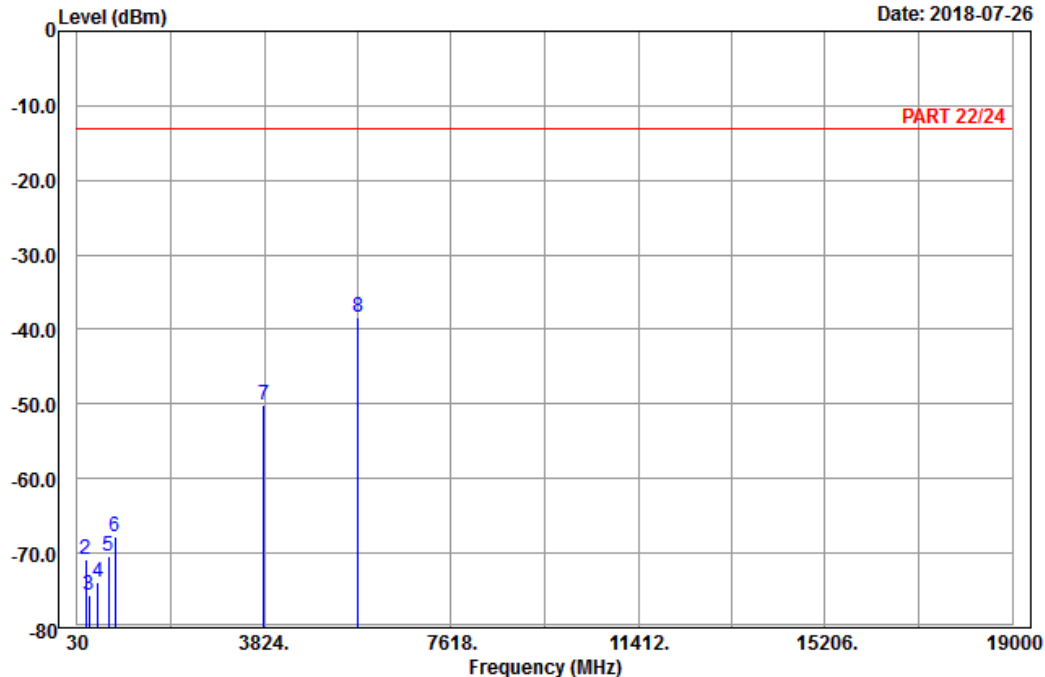

Site : 966 chamber 1  
 Condition: PART 22/24 Vertical  
 Remark : PCS 1900\_Link\_CH810  
 Tested by: Karl Lee

	Freq	Level	Read Level	Limit Line	Over Limit	Factor	Remark
	MHz	dBm	dBm	dBm	dB	dB	
1	109.92	-82.73	-73.78	-13.00	-69.73	-8.95	Peak
2	199.83	-70.78	-64.60	-13.00	-57.78	-6.18	Peak
3	268.68	-75.62	-69.94	-13.00	-62.62	-5.68	Peak
4	453.30	-73.86	-69.93	-13.00	-60.86	-3.93	Peak
5	671.70	-70.42	-70.18	-13.00	-57.42	-0.24	Peak
6	804.00	-67.78	-69.75	-13.00	-54.78	1.97	Peak
7	3819.60	-50.19	-66.69	-13.00	-37.19	16.50	Peak
8 pp	5729.40	-38.26	-58.60	-13.00	-25.26	20.34	Peak



## 5 Pictures of Test Arrangements

Please refer to the attached file (Test Setup Photo).

## Appendix – Information on the Testing Laboratories

We, Bureau Veritas Consumer Products Services (H.K.) Ltd., Taoyuan Branch, were founded in 1988 to provide our best service in EMC, Radio, Telecom and Safety consultation. Our laboratories are FCC recognized accredited test firms and accredited according to ISO/IEC 17025.

If you have any comments, please feel free to contact us at the following:

**Linko EMC/RF Lab**

Tel: 886-2-26052180

Fax: 886-2-26051924

**Hsin Chu EMC/RF/Telecom Lab**

Tel: 886-3-6668565

Fax: 886-3-6668323

**Hwa Ya EMC/RF/Safety**

Tel: 886-3-3183232

Fax: 886-3-3270892

**Email:** [service.adt@tw.bureauveritas.com](mailto:service.adt@tw.bureauveritas.com)

**Web Site:** [www.bureauveritas-adt.com](http://www.bureauveritas-adt.com)

The address and road map of all our labs can be found in our web site also.

--- END ---