

FCC SAR Test Report

Report No. : SA180523C09 R1
Applicant : HMD Global Oy
Address : Bertel Jungin aukio 9, 02600 Espoo, Finland
Product : Smart Phone
FCC ID : 2AJOTTA-1087
Brand : NOKIA
Model No. : TA-1087
Standards : FCC 47 CFR Part 2 (2.1093), IEEE C95.1:1992, IEEE Std 1528:2013
 KDB 865664 D01 v01r04, KDB 865664 D02 v01r02
 KDB 248227 D01 v02r02, KDB 447498 D01 v06, KDB 648474 D04 v01r03
 KDB 941225 D01 v03r01, KDB 941225 D05 v02r05, KDB 941225 D05A v01r02
 KDB 941225 D06 v02r01
Sample Received Date : May 23, 2018
Date of Testing : May 24, 2018 ~ Oct. 11, 2018
Lab Address : No. 47-2, 14th Ling, Chia Pau Vil., Lin Kou Dist., New Taipei City, Taiwan, R.O.C.
Test Location : No. 19, Hwa Ya 2nd Rd, Wen Hwa Vil, Kwei Shan Dist., Taoyuan City 33383, Taiwan (R.O.C)

CERTIFICATION: The above equipment have been tested by **Bureau Veritas Consumer Products Services (H.K.) Ltd., Taoyuan Branch – Lin Kou Laboratories**, and found compliance with the requirement of the above standards. The test record, data evaluation & Equipment Under Test (EUT) configurations represented herein are true and accurate accounts of the measurements of the sample’s SAR characteristics under the conditions specified in this report. It should not be reproduced except in full, without the written approval of our laboratory. The client should not use it to claim product certification, approval, or endorsement by TAF or any government agencies.

Prepared By : Ivonne Wu
 Ivonne Wu / Supervisor
Approved By : Gordon Lin
 Gordon Lin / Assistant Manager



This report is for your exclusive use. Any copying or replication of this report to or for any other person or entity, or use of our name or trademark, is permitted only with our prior written permission. This report sets forth our findings solely with respect to the test samples identified herein. The results set forth in this report are not indicative or representative of the quality or characteristics of the lot from which a test sample was taken or any similar or identical product unless specifically and expressly noted. Our report includes all of the tests requested by you and the results thereof based upon the information that you provided to us. You have 60 days from date of issuance of this report to notify us of any material error or omission caused by our negligence, provided, however, that such notice shall be in writing and shall specifically address the issue you wish to raise. A failure to raise such issue within the prescribed time shall constitute your unqualified acceptance of the completeness of this report, the tests conducted and the correctness of the report contents. Unless specific mention, the uncertainty of measurement has been explicitly taken into account to declare the compliance or non-compliance to the specification.

Table of Contents

Release Control Record	3
1. Summary of Maximum SAR Value	4
2. Description of Equipment Under Test	5
3. SAR Measurement System	6
3.1 Definition of Specific Absorption Rate (SAR)	6
3.2 SPEAG DASY52 System	6
3.2.1 Robot.....	7
3.2.2 Probes.....	8
3.2.3 Data Acquisition Electronics (DAE)	8
3.2.4 Phantoms	9
3.2.5 Device Holder.....	10
3.2.6 System Validation Dipoles.....	10
3.2.7 Tissue Simulating Liquids.....	11
3.3 SAR System Verification	14
3.4 SAR Measurement Procedure	15
3.4.1 Area & Zoom Scan Procedure	15
3.4.2 Volume Scan Procedure.....	15
3.4.3 Power Drift Monitoring.....	16
3.4.4 Spatial Peak SAR Evaluation	16
3.4.5 SAR Averaged Methods	16
4. SAR Measurement Evaluation	17
4.1 EUT Configuration and Setting.....	17
4.2 EUT Testing Position	30
4.2.1 Head Exposure Conditions.....	30
4.2.2 Body-worn Accessory Exposure Conditions.....	32
4.2.3 Hotspot Mode Exposure Conditions	33
4.2.4 Product Specific (Phablet) Exposure Conditions	34
4.3 Tissue Verification	35
4.4 System Validation.....	36
4.5 System Verification.....	38
4.6 Maximum Output Power.....	40
4.6.1 Maximum Target Conducted Power	40
4.6.2 Measured Conducted Power Result.....	43
4.7 SAR Testing Results	61
4.7.1 SAR Test Reduction Considerations	61
4.7.2 SAR Results for Head Exposure Condition	67
4.7.3 SAR Results for Body-worn Exposure Condition (Test Separation Distance is 15 mm).....	73
4.7.4 SAR Results for Hotspot Exposure Condition (Test Separation Distance is 10 mm).....	77
4.7.5 SAR Results for Product Specific (Phablet) Exposure Condition (Test Separation Distance is 0 mm).....	83
4.7.6 SAR Measurement Variability.....	84
4.7.7 Simultaneous Multi-band Transmission Evaluation	85
5. Calibration of Test Equipment.....	140
6. Measurement Uncertainty.....	141
7. Information on the Testing Laboratories.....	145
Appendix A. SAR Plots of System Verification	
Appendix B. SAR Plots of SAR Measurement	
Appendix C. Calibration Certificate for Probe and Dipole	
Appendix D. Photographs of EUT and Setup	

1. Summary of Maximum SAR Value

Equipment Class	Mode	Highest SAR-1g Head (W/kg)	Highest SAR-1g Body-worn Tested at 15 mm (W/kg)	Highest SAR-1g Hotspot Tested at 10 mm (W/kg)	Highest SAR-10g Product Specific Tested at 0 mm (W/kg)
PCE	GSM850	1.07	0.21	0.35	N/A
	GSM1900	0.16	0.58	0.95	N/A
	WCDMA II	0.22	0.78	1.13	N/A
	WCDMA IV	0.28	0.90	1.04	N/A
	WCDMA V	1.07	0.21	0.30	N/A
	LTE 2	0.18	0.57	0.71	N/A
	LTE 4	0.24	0.75	0.74	N/A
	LTE 5	0.94	0.26	0.36	N/A
	LTE 7	0.08	0.47	0.80	N/A
	LTE 12	0.61	0.11	0.21	N/A
	LTE 13	0.60	0.23	0.20	N/A
	LTE 17	1.01	0.11	0.20	N/A
	LTE 38	0.05	0.30	1.13	N/A
	LTE 41	0.05	0.30	1.10	N/A
LTE 66	0.22	0.63	0.79	N/A	
DTS	2.4G WLAN	0.51	0.15	0.36	N/A
NII	5.2G WLAN	N/A	N/A	0.62	N/A
	5.3G WLAN	0.32	0.37	N/A	2.21
	5.6G WLAN	0.13	0.64	N/A	2.87
	5.8G WLAN	0.32	0.44	0.70	N/A
DSS	Bluetooth	0.02	0.00	0.01	N/A
DXX	ANT+	N/A	N/A	N/A	N/A
DXX	NFC	N/A	N/A	N/A	N/A
Highest Simultaneous Transmission SAR		Head	Body-worn	Hotspot	Product Specific
		1.57	1.53	1.36	N/A

Note:

- The SAR criteria (Head & Body: SAR-1g 1.6 W/kg, and Extremity: SAR-10g 4.0 W/kg) for general population / uncontrolled exposure is specified in FCC 47 CFR part 2 (2.1093) and ANSI/IEEE C95.1-1992.

FCC SAR Test Report

2. Description of Equipment Under Test

EUT Type	Smart Phone
FCC ID	2AJOTTA-1087
Brand Name	NOKIA
Model Name	TA-1087
Tx Frequency Bands (Unit: MHz)	GSM850 : 824.2 ~ 848.8 GSM1900 : 1850.2 ~ 1909.8 WCDMA Band II : 1852.4 ~ 1907.6 WCDMA Band IV : 1712.4 ~ 1752.6 WCDMA Band V : 826.4 ~ 846.6 LTE Band 2 : 1850.7 ~ 1909.3 (BW: 1.4M, 3M, 5M, 10M, 15M, 20M) LTE Band 4 : 1710.7 ~ 1754.3 (BW: 1.4M, 3M, 5M, 10M, 15M, 20M) LTE Band 5 : 824.7 ~ 848.3 (BW: 1.4M, 3M, 5M, 10M) LTE Band 7 : 2502.5 ~ 2567.5 (BW: 5M, 10M, 15M, 20M) LTE Band 12 : 699.7 ~ 715.3 (BW: 1.4M, 3M, 5M, 10M) LTE Band 13 : 779.5 ~ 784.5 (BW: 5M, 10M) LTE Band 17 : 706.5 ~ 713.5 (BW: 5M, 10M) LTE Band 38 : 2572.5 ~ 2617.5 (BW: 5M, 10M, 15M, 20M) LTE Band 41 : 2535 ~ 2655 (BW: 5M, 10M, 15M, 20M) LTE Band 66 : 1710.7 ~ 1779.3 (BW: 1.4M, 3M, 5M, 10M, 15M, 20M) WLAN : 2412 ~ 2462, 5180 ~ 5240, 5260 ~ 5320, 5500 ~ 5720, 5745 ~ 5825 Bluetooth : 2402 ~ 2480 ANT+ : 2402 ~ 2480 NFC : 13.56
Uplink Modulations	GSM & GPRS : GMSK EDGE : 8PSK WCDMA : QPSK LTE : QPSK, 16QAM, 64QAM 802.11b : DSSS 802.11a/g/n/ac : OFDM Bluetooth : GFSK, $\pi/4$ -DQPSK, 8-DPSK ANT+ : GFSK NFC : ASK
Maximum Tune-up Conducted Power (Unit: dBm)	Please refer to section 4.6.1 of this report
Antenna Type	Refer to Note as below
EUT Stage	Production Unit

Note:

- The antenna information is listed as below.

Type	Fixed Internal Antenna														
Band	GSM		WCDMA			LTE									
	850	1900	2	4	5	2	4	5	7	12	13	17	38	41	66
Gain (dBi)	Main														
	-4	0.2	0.2	1.6	-4	0.2	1.6	-4	0.2	-2.1	-2.1	-2.1	0.2	0.7	1.6
	Aux.														
	-2.5	-1.3	-1.3	-3.3	-2.5	-1.3	-3.3	-2.5	-1.2	-1.2	-1.2	-1.2	-1.2	-1.2	-3.3
Type	PIFA Antenna														
Band	WLAN 2.4G				WLAN 5G				BT						
	Main		Aux.		Main		Aux.		-						
Gain (dBi)	-1.5		-3.4		1.3		-2.2		-1.5						

- The above EUT information is declared by manufacturer and for more detailed features description please refers to the manufacturer's specifications or User's Manual.

3. SAR Measurement System

3.1 Definition of Specific Absorption Rate (SAR)

SAR is related to the rate at which energy is absorbed per unit mass in an object exposed to a radio field. The SAR distribution in a biological body is complicated and is usually carried out by experimental techniques or numerical modeling. The standard recommends limits for two tiers of groups, occupational/controlled and general population/uncontrolled, based on a person's awareness and ability to exercise control over his or her exposure. In general, occupational/controlled exposure limits are higher than the limits for general population/uncontrolled.

The SAR definition is the time derivative (rate) of the incremental energy (dW) absorbed by (dissipated in) an incremental mass (dm) contained in a volume element (dv) of a given density (ρ). The equation description is as below:

$$\text{SAR} = \frac{d}{dt} \left(\frac{dW}{dm} \right) = \frac{d}{dt} \left(\frac{dW}{\rho dv} \right)$$

SAR is expressed in units of Watts per kilogram (W/kg)

SAR measurement can be related to the electrical field in the tissue by

$$\text{SAR} = \frac{\sigma |E|^2}{\rho}$$

Where: σ is the conductivity of the tissue, ρ is the mass density of the tissue and E is the RMS electrical field strength.

3.2 SPEAG DASY52 System

DASY52 system consists of high precision robot, probe alignment sensor, phantom, robot controller, controlled measurement server and near-field probe. The robot includes six axes that can move to the precision position of the DASY52 software defined. The DASY52 software can define the area that is detected by the probe. The robot is connected to controlled box. Controlled measurement server is connected to the controlled robot box. The DAE includes amplifier, signal multiplexing, AD converter, offset measurement and surface detection. It is connected to the Electro-optical coupler (ECO). The ECO performs the conversion from the optical into digital electric signal of the DAE and transfers data to the PC.

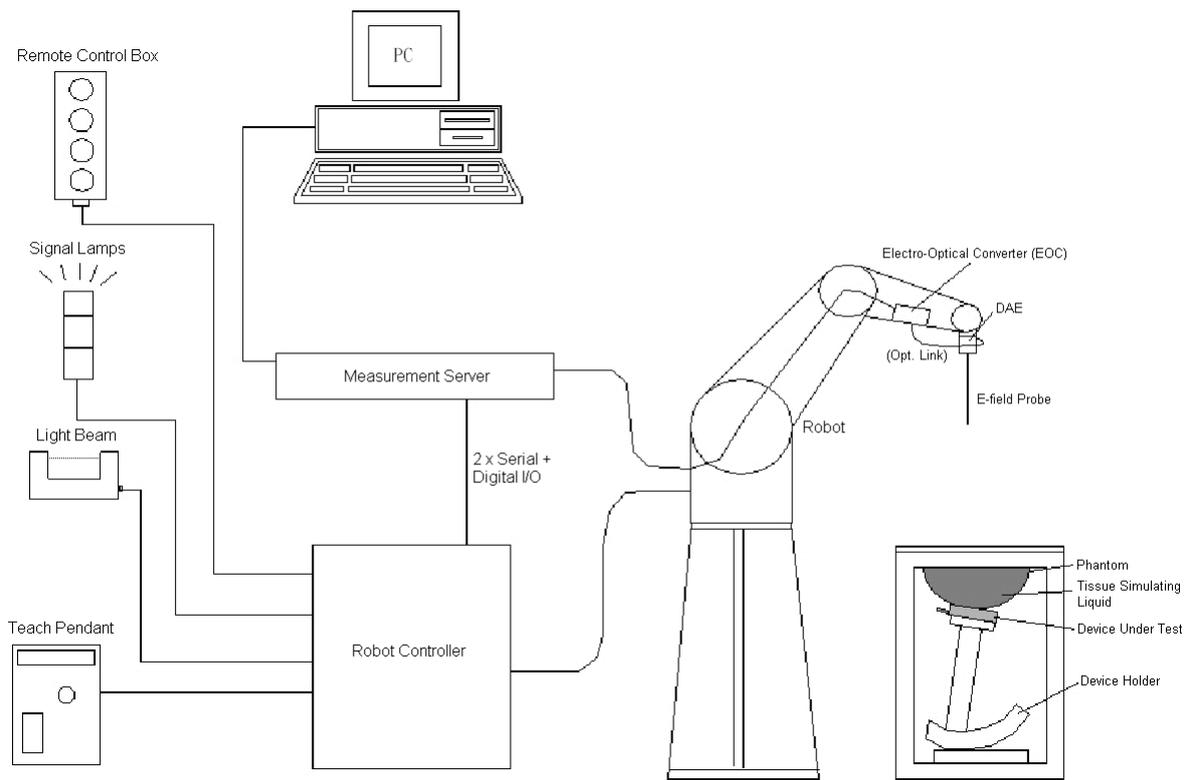

Fig-3.1 SPEAG DASY52 System Setup

3.2.1 Robot

The DASY52 systems use the high precision robots from Stäubli SA (France). For the 6-axis controller system, the robot controller version of CS8c from Stäubli is used. The Stäubli robot series have many features that are important for our application:

- High precision (repeatability ± 0.035 mm)
- High reliability (industrial design)
- Jerk-free straight movements
- Low ELF interference (the closed metallic construction shields against motor control fields)



Fig-3.2 SPEAG DASY52 System

FCC SAR Test Report

3.2.2 Probes

The SAR measurement is conducted with the dosimetric probe. The probe is specially designed and calibrated for use in liquid with high permittivity. The dosimetric probe has special calibration in liquid at different frequency.

Model	EX3DV4	
Construction	Symmetrical design with triangular core. Built-in shielding against static charges. PEEK enclosure material (resistant to organic solvents, e.g., DGBE).	
Frequency	10 MHz to 6 GHz Linearity: ± 0.2 dB	
Directivity	± 0.3 dB in HSL (rotation around probe axis) ± 0.5 dB in tissue material (rotation normal to probe axis)	
Dynamic Range	10 μ W/g to 100 mW/g Linearity: ± 0.2 dB (noise: typically < 1 μ W/g)	
Dimensions	Overall length: 337 mm (Tip: 20 mm) Tip diameter: 2.5 mm (Body: 12 mm) Typical distance from probe tip to dipole centers: 1 mm	

Model	ES3DV3	
Construction	Symmetrical design with triangular core. Interleaved sensors. Built-in shielding against static charges. PEEK enclosure material (resistant to organic solvents, e.g., DGBE).	
Frequency	10 MHz to 4 GHz Linearity: ± 0.2 dB	
Directivity	± 0.2 dB in HSL (rotation around probe axis) ± 0.3 dB in tissue material (rotation normal to probe axis)	
Dynamic Range	5 μ W/g to 100 mW/g Linearity: ± 0.2 dB	
Dimensions	Overall length: 337 mm (Tip: 20 mm) Tip diameter: 3.9 mm (Body: 12 mm) Distance from probe tip to dipole centers: 2.0 mm	

Model	ET3DV6	
Construction	Symmetrical design with triangular core Built-in optical fiber for surface detection system. Built-in shielding against static charges. PEEK enclosure material (resistant to organic solvents, e.g., DGBE)	
Frequency	10 MHz to 2.3 GHz; Linearity: ± 0.2 dB	
Directivity	± 0.2 dB in TSL (rotation around probe axis) ± 0.4 dB in TSL (rotation normal to probe axis)	
Dynamic Range	5 μ W/g to 100 mW/g; Linearity: ± 0.2 dB	
Dimensions	Overall length: 337 mm (Tip: 16 mm) Tip diameter: 6.8 mm (Body: 12 mm) Distance from probe tip to dipole centers: 2.7 mm	

3.2.3 Data Acquisition Electronics (DAE)

Model	DAE3, DAE4	
Construction	Signal amplifier, multiplexer, A/D converter and control logic. Serial optical link for communication with DASY embedded system (fully remote controlled). Two step probe touch detector for mechanical surface detection and emergency robot stop.	
Measurement Range	-100 to +300 mV (16 bit resolution and two range settings: 4mV, 400mV)	
Input Offset Voltage	$< 5\mu$ V (with auto zero)	
Input Bias Current	< 50 fA	
Dimensions	60 x 60 x 68 mm	

FCC SAR Test Report

3.2.4 Phantoms

Model	Twin SAM	
Construction	The shell corresponds to the specifications of the Specific Anthropomorphic Mannequin (SAM) phantom defined in IEEE 1528 and IEC 62209-1. It enables the dosimetric evaluation of left and right hand phone usage as well as body mounted usage at the flat phantom region. A cover prevents evaporation of the liquid. Reference markings on the phantom allow the complete setup of all predefined phantom positions and measurement grids by teaching three points with the robot.	
Material	Vinylester, glass fiber reinforced (VE-GF)	
Shell Thickness	2 ± 0.2 mm (6 ± 0.2 mm at ear point)	
Dimensions	Length: 1000 mm Width: 500 mm Height: adjustable feet	
Filling Volume	approx. 25 liters	

Model	ELI	
Construction	Phantom for compliance testing of handheld and body-mounted wireless devices in the frequency range of 30 MHz to 6 GHz. ELI is fully compatible with the IEC 62209-2 standard and all known tissue simulating liquids. ELI has been optimized regarding its performance and can be integrated into our standard phantom tables. A cover prevents evaporation of the liquid. Reference markings on the phantom allow installation of the complete setup, including all predefined phantom positions and measurement grids, by teaching three points. The phantom is compatible with all SPEAG dosimetric probes and dipoles.	
Material	Vinylester, glass fiber reinforced (VE-GF)	
Shell Thickness	2.0 ± 0.2 mm (bottom plate)	
Dimensions	Major axis: 600 mm Minor axis: 400 mm	
Filling Volume	approx. 30 liters	

FCC SAR Test Report

3.2.5 Device Holder

Model	Mounting Device	
Construction	In combination with the Twin SAM Phantom or ELI4, the Mounting Device enables the rotation of the mounted transmitter device in spherical coordinates. Rotation point is the ear opening point. Transmitter devices can be easily and accurately positioned according to IEC, IEEE, FCC or other specifications. The device holder can be locked for positioning at different phantom sections (left head, right head, flat).	
Material	POM	

Model	Laptop Extensions Kit	
Construction	Simple but effective and easy-to-use extension for Mounting Device that facilitates the testing of larger devices according to IEC 62209-2 (e.g., laptops, cameras, etc.). It is lightweight and fits easily on the upper part of the Mounting Device in place of the phone positioner.	
Material	POM, Acrylic glass, Foam	

3.2.6 System Validation Dipoles

Model	D-Serial	
Construction	Symmetrical dipole with 1/4 balun. Enables measurement of feed point impedance with NWA. Matched for use near flat phantoms filled with tissue simulating solutions.	
Frequency	750 MHz to 5800 MHz	
Return Loss	> 20 dB	
Power Capability	> 100 W (f < 1GHz), > 40 W (f > 1GHz)	

3.2.7 Tissue Simulating Liquids

For SAR measurement of the field distribution inside the phantom, the phantom must be filled with homogeneous tissue simulating liquid to a depth of at least 15 cm. For head SAR testing, the liquid height from the ear reference point (ERP) of the phantom to the liquid top surface is larger than 15 cm. For body SAR testing, the liquid height from the center of the flat phantom to the liquid top surface is larger than 15 cm. The nominal dielectric values of the tissue simulating liquids in the phantom and the tolerance of 5% are listed in Table-3.1.

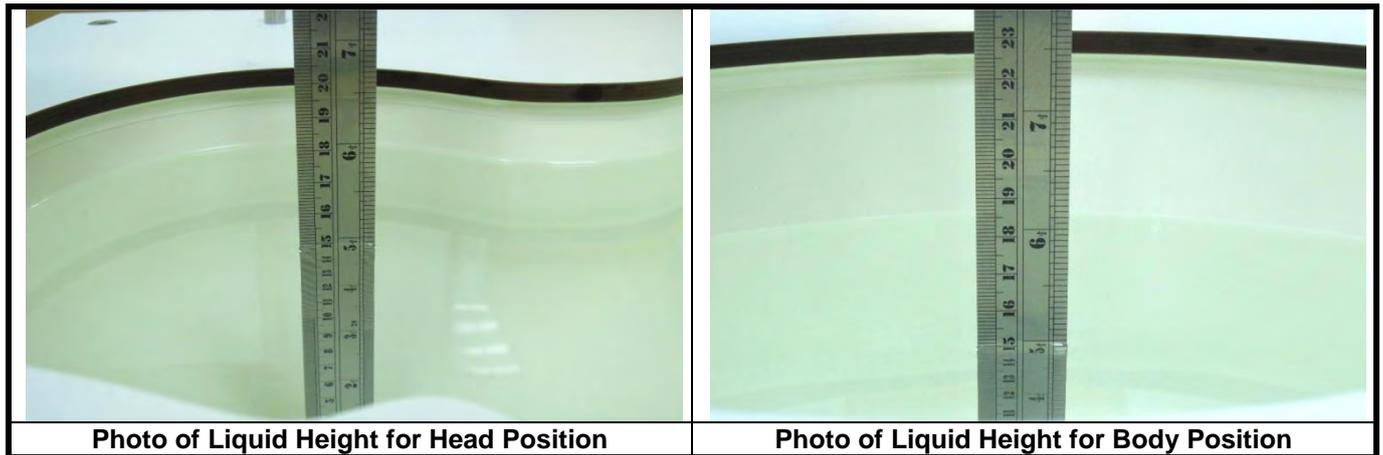

The dielectric properties of the head tissue simulating liquids are defined in IEEE 1528, and KDB 865664 D01 Appendix A. For the body tissue simulating liquids, the dielectric properties are defined in KDB 865664 D01 Appendix A. The dielectric properties of the tissue simulating liquids were verified prior to the SAR evaluation using a dielectric assessment kit and a network analyzer.

Table-3.1 Targets of Tissue Simulating Liquid

Frequency (MHz)	Target Permittivity	Range of $\pm 5\%$	Target Conductivity	Range of $\pm 5\%$
For Head				
750	41.9	39.8 ~ 44.0	0.89	0.85 ~ 0.93
835	41.5	39.4 ~ 43.6	0.90	0.86 ~ 0.95
900	41.5	39.4 ~ 43.6	0.97	0.92 ~ 1.02
1450	40.5	38.5 ~ 42.5	1.20	1.14 ~ 1.26
1640	40.3	38.3 ~ 42.3	1.29	1.23 ~ 1.35
1750	40.1	38.1 ~ 42.1	1.37	1.30 ~ 1.44
1800	40.0	38.0 ~ 42.0	1.40	1.33 ~ 1.47
1900	40.0	38.0 ~ 42.0	1.40	1.33 ~ 1.47
2000	40.0	38.0 ~ 42.0	1.40	1.33 ~ 1.47
2300	39.5	37.5 ~ 41.5	1.67	1.59 ~ 1.75
2450	39.2	37.2 ~ 41.2	1.80	1.71 ~ 1.89
2600	39.0	37.1 ~ 41.0	1.96	1.86 ~ 2.06
3500	37.9	36.0 ~ 39.8	2.91	2.76 ~ 3.06
5200	36.0	34.2 ~ 37.8	4.66	4.43 ~ 4.89
5300	35.9	34.1 ~ 37.7	4.76	4.52 ~ 5.00
5500	35.6	33.8 ~ 37.4	4.96	4.71 ~ 5.21
5600	35.5	33.7 ~ 37.3	5.07	4.82 ~ 5.32
5800	35.3	33.5 ~ 37.1	5.27	5.01 ~ 5.53
For Body				
750	55.5	52.7 ~ 58.3	0.96	0.91 ~ 1.01
835	55.2	52.4 ~ 58.0	0.97	0.92 ~ 1.02
900	55.0	52.3 ~ 57.8	1.05	1.00 ~ 1.10
1450	54.0	51.3 ~ 56.7	1.30	1.24 ~ 1.37
1640	53.8	51.1 ~ 56.5	1.40	1.33 ~ 1.47
1750	53.4	50.7 ~ 56.1	1.49	1.42 ~ 1.56
1800	53.3	50.6 ~ 56.0	1.52	1.44 ~ 1.60
1900	53.3	50.6 ~ 56.0	1.52	1.44 ~ 1.60
2000	53.3	50.6 ~ 56.0	1.52	1.44 ~ 1.60
2300	52.9	50.3 ~ 55.5	1.81	1.72 ~ 1.90
2450	52.7	50.1 ~ 55.3	1.95	1.85 ~ 2.05
2600	52.5	49.9 ~ 55.1	2.16	2.05 ~ 2.27
3500	51.3	48.7 ~ 53.9	3.31	3.14 ~ 3.48
5200	49.0	46.6 ~ 51.5	5.30	5.04 ~ 5.57
5300	48.9	46.5 ~ 51.3	5.42	5.15 ~ 5.69
5500	48.6	46.2 ~ 51.0	5.65	5.37 ~ 5.93
5600	48.5	46.1 ~ 50.9	5.77	5.48 ~ 6.06
5800	48.2	45.8 ~ 50.6	6.00	5.70 ~ 6.30

FCC SAR Test Report

The following table gives the recipes for tissue simulating liquids.

Table-3.2 Recipes of Tissue Simulating Liquid

Tissue Type	Bactericide	DGBE	HEC	NaCl	Sucrose	Triton X-100	Water	Diethylene Glycol Mono-hexylether
H750	0.2	-	0.2	1.5	56.0	-	42.1	-
H835	0.2	-	0.2	1.5	57.0	-	41.1	-
H900	0.2	-	0.2	1.4	58.0	-	40.2	-
H1450	-	43.3	-	0.6	-	-	56.1	-
H1640	-	45.8	-	0.5	-	-	53.7	-
H1750	-	47.0	-	0.4	-	-	52.6	-
H1800	-	44.5	-	0.3	-	-	55.2	-
H1900	-	44.5	-	0.2	-	-	55.3	-
H2000	-	44.5	-	0.1	-	-	55.4	-
H2300	-	44.9	-	0.1	-	-	55.0	-
H2450	-	45.0	-	0.1	-	-	54.9	-
H2600	-	45.1	-	0.1	-	-	54.8	-
H3500	-	8.0	-	0.2	-	20.0	71.8	-
H5G	-	-	-	-	-	17.2	65.5	17.3
B750	0.2	-	0.2	0.8	48.8	-	50.0	-
B835	0.2	-	0.2	0.9	48.5	-	50.2	-
B900	0.2	-	0.2	0.9	48.2	-	50.5	-
B1450	-	34.0	-	0.3	-	-	65.7	-
B1640	-	32.5	-	0.3	-	-	67.2	-
B1750	-	31.0	-	0.2	-	-	68.8	-
B1800	-	29.5	-	0.4	-	-	70.1	-
B1900	-	29.5	-	0.3	-	-	70.2	-
B2000	-	30.0	-	0.2	-	-	69.8	-
B2300	-	31.0	-	0.1	-	-	68.9	-
B2450	-	31.4	-	0.1	-	-	68.5	-
B2600	-	31.8	-	0.1	-	-	68.1	-
B3500	-	28.8	-	0.1	-	-	71.1	-
B5G	-	-	-	-	-	10.7	78.6	10.7

3.3 SAR System Verification

The system check verifies that the system operates within its specifications. It is performed daily or before every SAR measurement. The system check uses normal SAR measurements in the flat section of the phantom with a matched dipole at a specified distance. The system verification setup is shown as below.

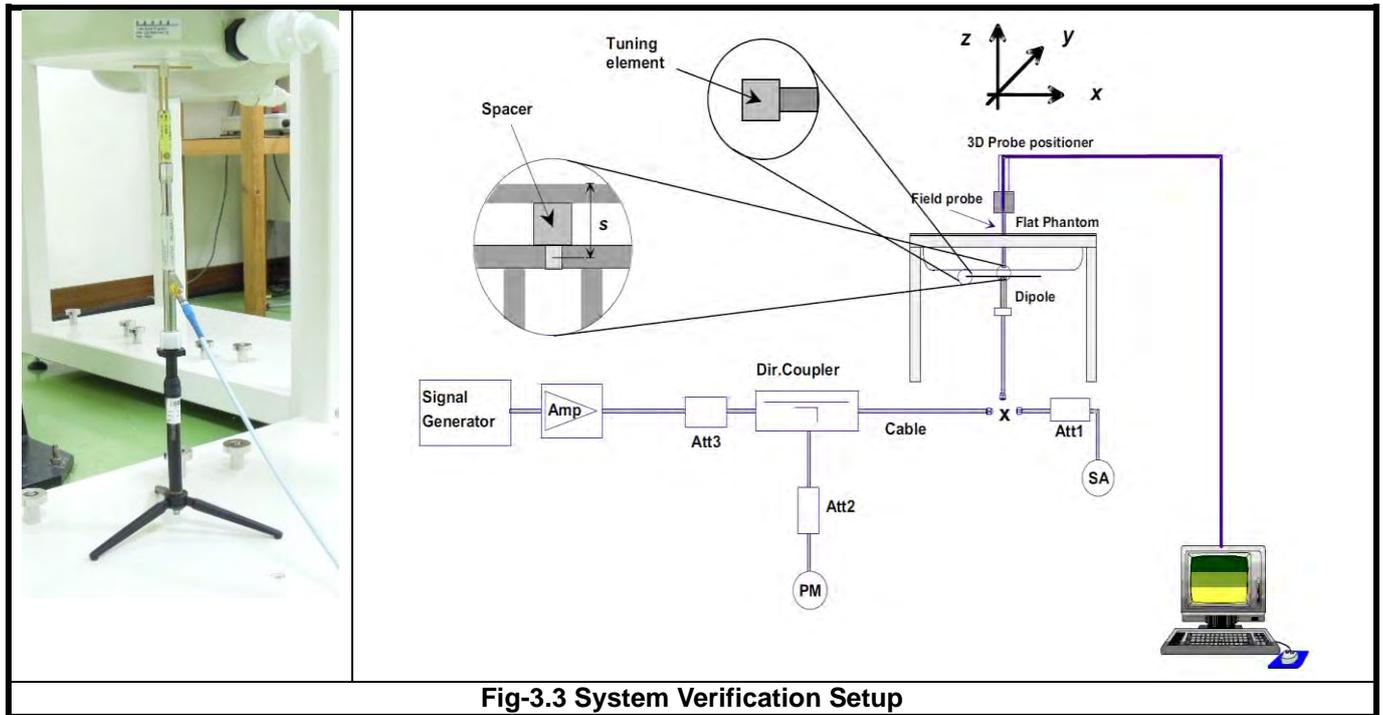

Fig-3.3 System Verification Setup

The validation dipole is placed beneath the flat phantom with the specific spacer in place. The distance spacer is touch the phantom surface with a light pressure at the reference marking and be oriented parallel to the long side of the phantom. The spectrum analyzer measures the forward power at the location of the system check dipole connector. The signal generator is adjusted for the desired forward power (250 mW is used for 700 MHz to 3 GHz, 100 mW is used for 3.5 GHz to 6 GHz) at the dipole connector and the power meter is read at that level. After connecting the cable to the dipole, the signal generator is readjusted for the same reading at power meter.

After system check testing, the SAR result will be normalized to 1W forward input power and compared with the reference SAR value derived from validation dipole certificate report. The deviation of system check should be within 10 %.

3.4 SAR Measurement Procedure

According to the SAR test standard, the recommended procedure for assessing the peak spatial-average SAR value consists of the following steps:

- (a) Power reference measurement
- (b) Area scan
- (c) Zoom scan
- (d) Power drift measurement

The SAR measurement procedures for each of test conditions are as follows:

- (a) Make EUT to transmit maximum output power
- (b) Measure conducted output power through RF cable
- (c) Place the EUT in the specific position of phantom
- (d) Perform SAR testing steps on the DASY system
- (e) Record the SAR value

3.4.1 Area & Zoom Scan Procedure

First Area Scan is used to locate the approximate location(s) of the local peak SAR value(s). The measurement grid within an Area Scan is defined by the grid extent, grid step size and grid offset. Next, in order to determine the EM field distribution in a three-dimensional spatial extension, Zoom Scan is required. The Zoom Scan is performed around the highest E-field value to determine the averaged SAR-distribution over 10 g. According to KDB 865664 D01, the resolution for Area and Zoom scan is specified in the table below.

Items	<= 2 GHz	2-3 GHz	3-4 GHz	4-5 GHz	5-6 GHz
Area Scan ($\Delta x, \Delta y$)	<= 15 mm	<= 12 mm	<= 12 mm	<= 10 mm	<= 10 mm
Zoom Scan ($\Delta x, \Delta y$)	<= 8 mm	<= 5 mm	<= 5 mm	<= 4 mm	<= 4 mm
Zoom Scan (Δz)	<= 5 mm	<= 5 mm	<= 4 mm	<= 3 mm	<= 2 mm
Zoom Scan Volume	>= 30 mm	>= 30 mm	>= 28 mm	>= 25 mm	>= 22 mm

Note:

When zoom scan is required and report SAR is <= 1.4 W/kg, the zoom scan resolution of $\Delta x / \Delta y$ (2-3GHz: <= 8 mm, 3-4GHz: <= 7 mm, 4-6GHz: <= 5 mm) may be applied.

3.4.2 Volume Scan Procedure

The volume scan is used for assess overlapping SAR distributions for antennas transmitting in different frequency bands. It is equivalent to an oversized zoom scan used in standalone measurements. The measurement volume will be used to enclose all the simultaneous transmitting antennas. For antennas transmitting simultaneously in different frequency bands, the volume scan is measured separately in each frequency band. In order to sum correctly to compute the 1g aggregate SAR, the EUT remain in the same test position for all measurements and all volume scan use the same spatial resolution and grid spacing. When all volume scan were completed, the software, SEMCAD postprocessor can combine and subsequently superpose these measurement data to calculating the multiband SAR.

3.4.3 Power Drift Monitoring

All SAR testing is under the EUT install full charged battery and transmit maximum output power. In DASY measurement software, the power reference measurement and power drift measurement procedures are used for monitoring the power drift of EUT during SAR test. Both these procedures measure the field at a specified reference position before and after the SAR testing. The software will calculate the field difference in dB. If the power drift more than 5%, the SAR will be retested.

3.4.4 Spatial Peak SAR Evaluation

The procedure for spatial peak SAR evaluation has been implemented according to the test standard. It can be conducted for 1g and 10g, as well as for user-specific masses. The DASY software includes all numerical procedures necessary to evaluate the spatial peak SAR value.

The base for the evaluation is a "cube" measurement. The measured volume must include the 1g and 10g cubes with the highest averaged SAR values. For that purpose, the center of the measured volume is aligned to the interpolated peak SAR value of a previously performed area scan.

The entire evaluation of the spatial peak values is performed within the post-processing engine (SEMCAD). The system always gives the maximum values for the 1g and 10g cubes. The algorithm to find the cube with highest averaged SAR is divided into the following stages:

- (a) Extraction of the measured data (grid and values) from the Zoom Scan
- (b) Calculation of the SAR value at every measurement point based on all stored data (A/D values and measurement parameters)
- (c) Generation of a high-resolution mesh within the measured volume
- (d) Interpolation of all measured values from the measurement grid to the high-resolution grid
- (e) Extrapolation of the entire 3-D field distribution to the phantom surface over the distance from sensor to surface
- (f) Calculation of the averaged SAR within masses of 1g and 10g

3.4.5 SAR Averaged Methods

In DASY, the interpolation and extrapolation are both based on the modified Quadratic Shepard's method. The interpolation scheme combines a least-square fitted function method and a weighted average method which are the two basic types of computational interpolation and approximation.

Extrapolation routines are used to obtain SAR values between the lowest measurement points and the inner phantom surface. The extrapolation distance is determined by the surface detection distance and the probe sensor offset. The uncertainty increases with the extrapolation distance. To keep the uncertainty within 1% for the 1 g and 10 g cubes, the extrapolation distance should not be larger than 5 mm.

4. SAR Measurement Evaluation

4.1 EUT Configuration and Setting

<Connections between EUT and System Simulator>

For WWAN SAR testing, the EUT was linked and controlled by base station emulator. Communication between the EUT and the emulator was established by air link. The distance between the EUT and the communicating antenna of the emulator is larger than 50 cm and the output power radiated from the emulator antenna is at least 30 dB smaller than the output power of EUT. The EUT was set from the emulator to radiate maximum output power during SAR testing.

<Considerations Related to GSM / GPRS / EDGE for Setup and Testing>

The maximum multi-slot capability supported by this device is as below.

1. This EUT is class B device
2. This EUT supports GPRS multi-slot class 12 (max. uplink: 4, max. downlink: 4, total timeslots: 5)
3. This EUT supports EDGE multi-slot class 12 (max. uplink: 4, max. downlink: 4, total timeslots: 5)

For GSM850 frequency band, the power control level is set to 5 for GSM mode and GPRS (GMSK: CS1), and set to 8 for EDGE (GMSK: MCS1, 8PSK: MCS9). For GSM1900 frequency band, the power control level is set to 0 for GSM mode and GPRS (GMSK: CS1), and set to 2 for EDGE (GMSK: MCS1, 8PSK: MCS9).

SAR test reduction for GPRS and EDGE modes is determined by the source-based time-averaged output power specified for production units, including tune-up tolerance. The data mode with highest specified time-averaged output power should be tested for SAR compliance in the applicable exposure conditions. For modes with the same specified maximum output power and tolerance, the higher number time-slot configuration should be tested.

<Considerations Related to WCDMA for Setup and Testing>

WCDMA Handsets Head SAR

SAR for next to the ear head exposure is measured using a 12.2 kbps RMC with TPC bits configured to all "1's". The 3G SAR test reduction procedure is applied to AMR configurations with 12.2 kbps RMC as the primary mode.

WCDMA Handsets Body-worn SAR

SAR for body-worn configurations is measured using a 12.2 kbps RMC with TPC bits configured to all "1's". The 3G SAR test reduction procedure is applied to other spreading codes and multiple DPDCH_n configurations supported by the handset with 12.2 kbps RMC as the primary mode.

Handsets with Release 5 HSDPA

The 3G SAR test reduction procedure is applied to HSDPA body-worn configurations with 12.2 kbps RMC as the primary mode. Otherwise, SAR is measured for HSDPA using the HSDPA body SAR procedures in the “Release 5 HSDPA Data Devices”, for the highest reported SAR body-worn exposure configuration in 12.2 kbps RMC. Handsets with both HSDPA and HSUPA are tested according to Release 6 HSPA test procedures.

Handsets with Release 6 HSUPA

The 3G SAR test reduction procedure is applied to HSPA (HSUPA/HSDPA with RMC) body-worn configurations with 12.2 kbps RMC as the primary mode. Otherwise, SAR is measured for HSPA using the HSPA body SAR procedures in the “Release 6 HSPA Data Devices”, for the highest reported body-worn exposure SAR configuration in 12.2 kbps RMC. When VOIP is applicable for next to the ear head exposure in HSPA, the 3G SAR test reduction procedure is applied to HSPA with 12.2 kbps RMC as the primary mode; otherwise, the same HSPA configuration used for body-worn measurements is tested for next to the ear head exposure.

Release 5 HSDPA Data Devices

The 3G SAR test reduction procedure is applied to body SAR with 12.2 kbps RMC as the primary mode. Otherwise, body SAR for HSDPA is measured using an FRC with H-Set 1 in Sub-test 1 and a 12.2 kbps RMC configured in Test Loop Mode 1, for the highest reported SAR configuration in 12.2 kbps RMC without HSDPA. HSDPA is configured according to the applicable UE category of a test device. The number of HS-DSCH / HS-PDSCHs, HARQ processes, minimum inter-TTI interval, transport block sizes and RV coding sequence are defined by the H-set. To maintain a consistent test configuration and stable transmission conditions, QPSK is used in the H-set for SAR testing. HS-DPCCH should be configured with a CQI feedback cycle of 4 ms and a CQI repetition factor of 2 to maintain a constant rate of active CQI slots. DPCCH and DPDCH gain factors (β_c , β_d), and HS-DPCCH power offset parameters (Δ_{ACK} , Δ_{NACK} , Δ_{CQI}) are set according to values indicated in below. The CQI value is determined by the UE category, transport block size, number of HS-PDSCHs and modulation used in the H-set.

Sub-test	β_c	β_d	β_d (SF)	β_c/β_d	$\beta_{HS}^{(1)(2)}$	CM ⁽³⁾ (dB)	MPR ⁽³⁾ (dB)
1	2/15	15/15	64	2/15	4/15	0.0	0.0
2	12/15 ⁽⁴⁾	15/15 ⁽⁴⁾	64	12/15 ⁽⁴⁾	24/15	1.0	0.0
3	15/15	8/15	64	15/8	30/15	1.5	0.5
4	15/15	4/15	64	15/4	30/15	1.5	0.5

Note 1: Δ_{ACK} , Δ_{NACK} and $\Delta_{CQI} = 30/15$ with $\beta_{HS} = 30/15 * \beta_c$.

Note 2: For the HS-DPCCH power mask requirement test in clause 5.2C, 5.7A, and the Error Vector Magnitude (EVM) with HS-DPCCH test in clause 5.13.1A, and HSDPA EVM with phase discontinuity in clause 5.13.1AA, Δ_{ACK} and $\Delta_{NACK} = 30/15$ with $\beta_{HS} = 30/15 * \beta_c$, and $\Delta_{CQI} = 24/15$ with $\beta_{HS} = 24/15 * \beta_c$.

Note 3: CM = 1 for $\beta_c/\beta_d = 12/15$, $\beta_{HS}/\beta_c = 24/15$. For all other combinations of DPDCH, DPCCH and HS-DPCCH the MPR is based on the relative CM difference. This is applicable for only UEs that support HSDPA in release 6 and later releases.

Note 4: For subtest 2 the β_c/β_d ratio of 12/15 for the TFC during the measurement period (TF1, TF0) is achieved by setting the signalled gain factors for the reference TFC (TF1, TF1) to $\beta_c = 11/15$ and $\beta_d = 15/15$.

FCC SAR Test Report

Release 6 HSPA Data Devices

The 3G SAR test reduction procedure is applied to body SAR with 12.2 kbps RMC as the primary mode. Otherwise, body SAR for HSPA is measured with E-DCH Sub-test 5, using H-Set 1 and QPSK for FRC and a 12.2 kbps RMC configured in Test Loop Mode 1 and power control algorithm 2, according to the highest reported body SAR configuration in 12.2 kbps RMC without HSPA. When VOIP applies to head exposure, the 3G SAR test reduction procedure is applied with 12.2 kbps RMC as the primary mode. Otherwise, the same HSPA configuration used for body SAR measurements are applied to head exposure testing. Due to inner loop power control requirements in HSPA, a communication test set is required for output power and SAR tests. The 12.2 kbps RMC, FRC H-set 1 and E-DCH configurations for HSPA are configured according to the β values indicated in below.

Sub-test	β_c	β_d	β_d (SF)	β_c / β_d	$\beta_{HS}^{(1)}$	β_{ec}	$\beta_{ed}^{(4)(5)}$	β_{ed} (SF)	β_{ed} (Codes)	CM ⁽²⁾ (dB)	MPR ⁽²⁾⁽⁶⁾ (dB)	AG ⁽⁵⁾ Index	E-TFCI
1	11/15 ⁽³⁾	15/15 ⁽³⁾	64	11/15 ⁽³⁾	22/15	209/225	1309/225	4	1	1.0	0.0	20	75
2	6/15	15/15	64	6/15	12/15	12/15	94/75	4	1	3.0	2.0	12	67
3	15/15	9/15	64	15/9	30/15	30/15	β_{ed1} : 47/15 β_{ed2} : 47/15	4 4	2	2.0	1.0	15	92
4	2/15	15/15	64	2/15	4/15	2/15	56/75	4	1	3.0	2.0	17	71
5	15/15	0	-	-	5/15	5/15	47/15	4	1	1.0	0.0	12	67

Note 1: For sub-test 1 to 4, Δ_{ACK} , Δ_{NACK} and $\Delta_{CQI} = 30/15$ with $\beta_{HS} = 30/15 * \beta_c$. For sub-test 5, Δ_{ACK} , Δ_{NACK} and $\Delta_{CQI} = 5/15$ with $\beta_{HS} = 5/15 * \beta_c$.
Note 2: CM = 1 for $\beta_c/\beta_d = 12/15$, $\beta_{HS}/\beta_c = 24/15$. For all other combinations of DPDCH, DPCCH, HS-DPCCH, E-DPDCH and E-DPCCH the MPR is based on the relative CM difference.
Note 3: For subtest 1 the β_c/β_d ratio of 11/15 for the TFC during the measurement period (TF1, TF0) is achieved by setting the signalled gain factors for the reference TFC (TF1, TF1) to $\beta_c = 10/15$ and $\beta_d = 15/15$.
Note 4: In case of testing by UE using E-DPDCH Physical Layer category 1, Sub-test 3 is omitted according to TS25.306 Table 5.1g.
Note 5: β_{ed} can not be set directly; it is set by Absolute Grant Value.
Note 6: For subtests 2, 3 and 4, UE may perform E-DPDCH power scaling at max power which could results in slightly smaller MPR values.

HSPA+ SAR Guidance

The 3G SAR test reduction procedure is applied to HSPA+ (uplink) with 12.2 kbps RMC as the primary mode. Otherwise, when SAR is required for Rel. 6 HSPA, SAR is required for Rel. 7 HSPA+. Power is measured for HSPA+ that supports uplink 16QAM according to configurations in Table C.11.1.4 of 3GPP TS 34.121-1 to determine SAR test reduction.

Sub-test	$\beta_c^{(3)}$	β_d	$\beta_{HS}^{(1)}$	β_{ec}	$\beta_{ed}^{(4)}$ (2xSF2)	$\beta_{ed}^{(4)}$ (2xSF4)	CM ⁽²⁾ (dB)	MPR ⁽²⁾ (dB)	AG ⁽⁴⁾ Index	E-TFCI ⁽⁵⁾	E-TFCI (boost)
1	1	0	30/15	30/15	β_{ed1} : 30/15 β_{ed2} : 30/15	β_{ed3} : 24/15 β_{ed4} : 24/15	3.5	2.5	14	105	105

Note 1: Δ_{ACK} , Δ_{NACK} and $\Delta_{CQI} = 30/15$ with $\beta_{HS} = 30/15 * \beta_c$.
Note 2: CM = 3.5 and the MPR is based on the relative CM difference, MPR = MAX(CM-1,0).
Note 3: DPDCH is not configured, therefore the β_c is set to 1 and $\beta_d = 0$ by default.
Note 4: β_{ed} can not be set directly; it is set by Absolute Grant Value.
Note 5: All the sub-tests require the UE to transmit 2SF2+2SF4 16QAM EDCH and they apply for UE using E-DPDCH category 7. E-DCH TTI is set to 2ms TTI and E-DCH table index = 2. To support these E-DCH configurations DPDCH is not allocated. The UE is signalled to use the extrapolation algorithm.

FCC SAR Test Report

DC-HSDPA SAR Guidance

The 3G SAR test reduction procedure is applied to DC-HSDPA with 12.2 kbps RMC as the primary mode. Otherwise, when SAR is required for Rel. 5 HSDPA, SAR is required for Rel. 8 DC-HSDPA. Power is measured for DC-HSDPA according to the H-Set 12, FRC configuration in Table C.8.1.12 of 3GPP TS 34.121-1 to determine SAR test reduction. A primary and a secondary serving HS-DSCH Cell are required to perform the power measurement and for the results to be acceptable.

<Considerations Related to LTE for Setup and Testing>

This device contains LTE transmitter which follows 3GPP standards, is category 3, supports both QPSK and QAM modulations, and supported LTE band and channel bandwidth is listed in below. The output power was tested per 3GPP TS 36.521-1 maximum transmit procedures for both QPSK and QAM modulation. The results please refer to section 4.6 of this report.

EUT Supported LTE Band and Channel Bandwidth						
LTE Band	BW 1.4 MHz	BW 3 MHz	BW 5 MHz	BW 10 MHz	BW 15 MHz	BW 20 MHz
2	V	V	V	V	V	V
4	V	V	V	V	V	V
5	V	V	V	V		
7			V	V	V	V
12	V	V	V	V		
13			V	V		
17			V	V		
38			V	V	V	V
41			V	V	V	V
66	V	V	V	V	V	V

The LTE maximum power reduction (MPR) in accordance with 3GPP TS 36.101 is active all times during LTE operation. The allowed MPR for the maximum output power is specified in below.

Modulation	Channel Bandwidth / RB Configurations						LTE MPR Setting (dB)
	BW 1.4 MHz	BW 3 MHz	BW 5 MHz	BW 10 MHz	BW 15 MHz	BW 20 MHz	
QPSK	> 5	> 4	> 8	> 12	> 16	> 18	1
16QAM	<= 5	<= 4	<= 8	<= 12	<= 16	<= 18	1
16QAM	> 5	> 4	> 8	> 12	> 16	> 18	2
64QAM	<= 5	<= 4	<= 8	<= 12	<= 16	<= 18	2
64QAM	> 5	> 4	> 8	> 12	> 16	> 18	3

Note: MPR is according to the standard and implemented in the circuit (mandatory).

In addition, the device is compliant with additional maximum power reduction (A-MPR) requirements defined in 3GPP TS 36.101 section 6.2.4 that was disabled for all FCC compliance testing.

During LTE SAR testing, the related parameters of operating band, channel bandwidth, uplink channel number, modulation type, and RB was set in base station simulator. When the EUT has registered and communicated to base station simulator, the simulator set to make EUT transmitting the maximum radiated power.

FCC SAR Test Report

TDD-LTE Setup Configurations

According to KDB 941225 D05, SAR testing for TDD-LTE device must be tested using a fixed periodic duty factor according to the highest transmission duty factor implemented for the device and supported by the defined 3GPP TDD-LTE configurations. The TDD-LTE of this device supports frame structure type 2 defined in 3GPP TS 36.211 section 4.2, and the frame structure configuration can be referred to below.

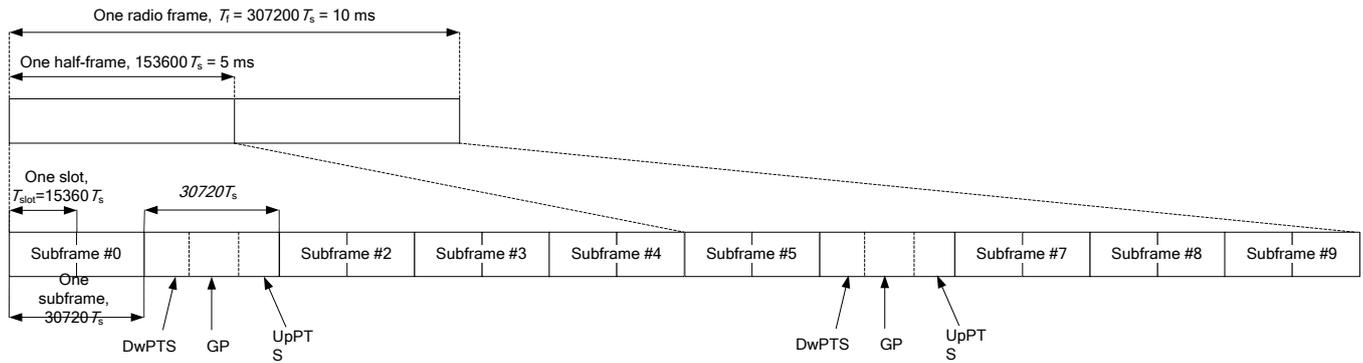

3GPP TS 36.211 Figure 4.2-1: Frame Structure Type 2

Special Subframe Configuration	Normal Cyclic Prefix in Downlink			Extended Cyclic Prefix in Downlink		
	DwPTS	UpPTS		DwPTS	UpPTS	
		Normal Cyclic Prefix in Uplink	Extended Cyclic Prefix in Uplink		Normal Cyclic Prefix in Uplink	Extended Cyclic Prefix in Uplink
0	$6592 \cdot T_s$	$2192 \cdot T_s$	$2560 \cdot T_s$	$7680 \cdot T_s$	$2192 \cdot T_s$	$2560 \cdot T_s$
1	$19760 \cdot T_s$			$20480 \cdot T_s$		
2	$21952 \cdot T_s$			$23040 \cdot T_s$		
3	$24144 \cdot T_s$			$25600 \cdot T_s$		
4	$26336 \cdot T_s$			$7680 \cdot T_s$		
5	$6592 \cdot T_s$	$4384 \cdot T_s$	$5120 \cdot T_s$	$20480 \cdot T_s$	$4384 \cdot T_s$	$5120 \cdot T_s$
6	$19760 \cdot T_s$			$23040 \cdot T_s$		
7	$21952 \cdot T_s$			$12800 \cdot T_s$		
8	$24144 \cdot T_s$			-		
9	$13168 \cdot T_s$	-	-	-	-	-

3GPP TS 36.211 Table 4.2-1: Configuration of Special Subframe

Uplink-Downlink Configuration	Downlink-to-Uplink Switch-Point Periodicity	Subframe Number										
		0	1	2	3	4	5	6	7	8	9	
0	5 ms	D	S	U	U	U	D	S	U	U	U	
1	5 ms	D	S	U	U	D	D	S	U	U	D	
2	5 ms	D	S	U	D	D	D	S	U	D	D	
3	10 ms	D	S	U	U	U	D	D	D	D	D	
4	10 ms	D	S	U	U	D	D	D	D	D	D	
5	10 ms	D	S	U	D	D	D	D	D	D	D	
6	5 ms	D	S	U	U	U	D	S	U	U	D	

3GPP TS 36.211 Table 4.2-2: Uplink-Downlink Configurations

FCC SAR Test Report

The variety of different TD-LTE uplink-downlink configurations allows a network operator to allocate the network's capacity between uplink and downlink traffic to meet the needs of the network. The uplink duty cycle of these seven configurations can readily be computed and shown in below.

UL-DL Configuration	0	1	2	3	4	5	6
Highest Duty-Cycle	63.33%	43.33%	23.33%	31.67%	21.67%	11.67%	53.33%

Considering the highest transmission duty cycle, TDD-LTE was tested using Uplink-Downlink Configuration 0 with 6 uplink subframe and 2 special subframe. The special subframe was set to special subframe configuration 7 using extended cyclic prefix uplink. Therefore, SAR testing for TDD-LTE was performed at the maximum output power with highest transmission duty cycle of 63.33%.

LTE Downlink Carrier Aggregation (CA) Setup Configurations

LTE Carrier Aggregation (CA) was defined in 3GPP release 10 and higher. The LTE device in CA mode has one Primary Component Carrier (PCC) and one or more Secondary Component Carriers (SCC). PCC acts as the anchor carrier and can optionally cross-schedule data transmission on SCC. The RRC connection is only handled by one cell, the PCC for downlink and uplink communications. After making a data connection to the PCC, the LTE device adds the SCC on the downlink only. All uplink communications and acknowledgements remain identical to release 8 specifications on the PCC. The combinations of downlink carrier aggregation supported by this device are listed in below.

LTE CA Configurations and Bandwidth Combination Sets defined for Intra-Band Contiguous CA

Downlink CA Configuration	Component carriers in order of increasing carrier frequency			Maximum Aggregated Bandwidth (MHz)	Bandwidth Combination Set
	Channel bandwidths for carrier-1 (MHz)	Channel bandwidths for carrier-2 (MHz)	Channel bandwidths for carrier-3 (MHz)		
CA_2C	5	20		40	0
	10	15, 20			
	15	10, 15, 20			
	20	5, 10, 15, 20			
CA_5B	5, 10	10		20	0
	10	5			
	3	5		8	1
	5	3			
CA_7C	15	15		40	0
	20	20			
	10	20		40	1
	15	15, 20			
	20	10, 15, 20		40	2
	15	10, 15			
CA_38C	15	15		40	0
	20	20			
CA_41C	10	20		40	0
	15	15, 20			
	20	10, 15, 20			
	5, 10	20		40	1
	15	15, 20			
	20	5, 10, 15, 20		40	2
	10	15, 20			
	15	10, 15, 20		40	3
	20	10, 15, 20			
10	20				
CA_66B	5	5, 10, 15		20	0
	10	5, 10			
	15	5			
CA_66C	5	20		40	0
	10	15, 20			
	15	10, 15, 20			
	20	5, 10, 15, 20			

FCC SAR Test Report

LTE CA Configurations and Bandwidth Combination Sets defined for Intra-Band Non-Contiguous CA

Downlink CA Configuration	Component Carriers in order of Increasing Carrier Frequency			Maximum Aggregated Bandwidth (MHz)	Bandwidth Combination Set
	Channel Bandwidths for Carrier-1 (MHz)	Channel Bandwidths for Carrier-2 (MHz)	Channel Bandwidths for Carrier-3 (MHz)		
CA_2A-2A	5, 10, 15, 20	5, 10, 15, 20		40	0
CA_4A-4A	5, 10, 15, 20	5, 10, 15, 20		40	0
	5, 10	5, 10		20	1
CA_7A-7A	5	15		40	0
	10	10, 15			
	15	15, 20			
	20	20		40	1
	5, 10, 15, 20	5, 10, 15, 20		30	2
	5, 10, 15, 20	5, 10		40	3
CA_41A-41A	10, 15, 20	10, 15, 20		40	0
	5, 10, 15, 20	5, 10, 15, 20		40	1
CA_66A-66A	5, 10, 15, 20	5, 10, 15, 20		40	0

LTE CA Configurations and Bandwidth Combination Sets defined for Inter-Band CA (Two Bands)

Downlink CA Configuration	LTE Bands	Channel Bandwidths for Carrier (MHz)	Maximum Aggregated Bandwidth (MHz)	Bandwidth Combination Set
CA_2A-4A	2	1.4, 3, 5, 10, 15, 20	40	0
	4	5, 10, 15, 20		
	2	5, 10	20	1
	4	5, 10		
	2	5, 10, 15, 20	40	2
4	5, 10, 15, 20			
CA_2A-2A-4A	2	Refer to CA_2A-2A (BCS0)	60	0
	4	5, 10, 15, 20		
CA_2A-4A-4A	2	5, 10, 15, 20	60	0
	4	Refer to CA_4A-4A (BCS0)		
CA_2A-5A	2	5, 10, 15, 20	30	0
	5	5, 10		
	2	5, 10	20	1
5	5, 10			
CA_2A-2A-5A	2	Refer to CA_2A-2A (BCS0)	50	0
	5	5, 10		
CA_2A-12A	2	5, 10, 15, 20	30	0
	12	5, 10		
	2	5, 10, 15, 20	30	1
	12	3, 5, 10		
	2	5, 10	20	2
12	5, 10			
CA_2A-2A-12A	2	Refer to CA_2A-2A (BCS0)	50	0
	12	5, 10		

FCC SAR Test Report

Downlink CA Configuration	LTE Bands	Channel Bandwidths for Carrier (MHz)	Maximum Aggregated Bandwidth (MHz)	Bandwidth Combination Set
CA_2A-13A	2	5, 10, 15, 20	30	0
	13	10		
	2	5, 10	20	1
	13	10		
CA_2A-2A-13A	2	Refer to CA_2A-2A (BCS0)	50	0
	13	10		
CA_2A-66A	2	1.4, 3, 5, 10, 15, 20	40	0
	66	5, 10, 15, 20	20	1
	2	5, 10		
	66	5, 10		
	2	5, 10, 15, 20	40	2
66	5, 10, 15, 20			
CA_2A-66C	2	5, 10, 15, 20	60	0
	66	Refer to CA_66C (BCS0)		
CA_2A-2A-66A	2	Refer to CA_2A-2A (BCS0)	60	0
	66	5, 10, 15, 20		
CA_2A-2A-66A-66A	2	5, 10, 15, 20	60	0
	66	Refer to CA_66A-66A (BCS0)		
CA_2A-2A-66C	2	Refer to CA_2A-2A (BCS0)	80	0
	66	Refer to CA_66C (BCS0)		
CA_4A-5A	4	5, 10	20	0
	5	5, 10		
	4	5, 10, 15, 20	30	1
	5	5, 10		
CA_4A-4A-5A	4	Refer to CA_4A-4A (BCS0)	50	0
	5	5, 10		
CA_4A-7A	4	5, 10	30	0
	7	5, 10, 15, 20	40	1
	4	5, 10, 15, 20		
	7	5, 10, 15, 20		
CA_4A-12A	4	1.4, 3, 5, 10	20	0
	12	5, 10		
	4	1.4, 3, 5, 10, 15, 20	30	1
	12	5, 10		
	4	5, 10, 15, 20	30	2
	12	3, 5, 10		
	4	5, 10	20	3
	12	5, 10		
	4	5, 10, 15, 20	30	4
	12	5, 10		
4	5, 10, 15	20	5	
12	5			
CA_4A-4A-12A	4	Refer to CA_4A-4A (BCS0)	50	0
	12	5, 10		
CA_4A-13A	4	5, 10, 15, 20	30	0
	13	10		
	4	5, 10	20	1
	13	10		
CA_4A-4A-13A	4	Refer to CA_4A-4A (BCS0)	50	0
	13	10		
CA_5A-66A	5	5, 10	30	0
	66	5, 10, 15, 20		
CA_5A-66A-66A	5	5, 10	50	0
	66	Refer to CA_66A-66A (BCS0)		

FCC SAR Test Report

Downlink CA Configuration	LTE Bands	Channel Bandwidths for Carrier (MHz)	Maximum Aggregated Bandwidth (MHz)	Bandwidth Combination Set
CA_12A-66A	12	5, 10	20	0
	66	1.4, 3, 5, 10		
	12	5, 10	30	1
	66	1.4, 3, 5, 10, 15, 20		
	12	3, 5, 10	30	2
	66	5, 10, 15, 20		
	12	5, 10	20	3
	66	5, 10		
	12	5, 10	30	4
	66	5, 10, 15, 20		
12	5	20	5	
66	5, 10, 15			
CA_12A-66A-66A	12	5, 10	50	0
	66	Refer to CA_66A-66A (BCS0)		
CA_12A-66C	12	5, 10	50	0
	66	Refer to CA_66C (BCS0)		
CA_13A-66A	13	5, 10	30	0
	66	5, 10, 15, 20		
CA_13A-66A-66A	13	5, 10	50	0
	66	Refer to CA_66A-66A (BCS0)		

LTE CA Configurations and Bandwidth Combination Sets defined for Inter-Band CA (Three Bands)

Downlink CA Configuration	LTE Bands	Channel Bandwidths for Carrier (MHz)	Maximum Aggregated Bandwidth (MHz)	Bandwidth Combination Set
CA_2A-4A-5A	2	5, 10, 15, 20	50	0
	4	5, 10, 15, 20		
	5	5, 10		
CA_2A-4A-13A	2	5, 10, 15, 20	50	0
	4	5, 10, 15, 20		
	13	10		
CA_2A-5A-66A	2	5, 10, 15, 20	50	0
	5	5, 10		
	66	5, 10, 15, 20		
CA_2A-5A-66A-66A	2	5, 10, 15, 20	70	0
	5	5, 10		
CA_2A-12A-66A	66	Refer to CA_66A-66A (BCS0)	50	0
	2	5, 10, 15, 20		
	12	5, 10		
	66	5, 10, 15, 20	40	1
	2	5, 10		
	12	5, 10		
CA_2A-2A-12A-66A	66	5, 10, 15, 20	70	0
	2	Refer to CA_2A-2A (BCS0)		
	12	5, 10		
CA_2A-12A-66A-66A	66	5, 10, 15, 20	70	0
	2	5, 10, 15, 20		
	12	5, 10		
CA_2A-12A-66C	66	Refer to 66A-66A (BCS0)	70	0
	2	5, 10, 15, 20		
	12	5, 10		
CA_2A-13A-66A	66	Refer to CA_66C (BCS0)	50	0
	2	5, 10, 15, 20		
	13	5, 10		
	66	5, 10, 15, 20		

LTE Uplink Carrier Aggregation (CA) Setup Configurations

This device supports LTE uplink CA with a maximum of two 20 MHz carrier components in the uplink. The maximum output power for uplink intra-band contiguous CA specified in Table 6.2.2A-1 of 3GPP TS 36.101 is the same as single carrier specified in Table 6.2.2-1 of 3GPP TS 36.101. In Table 6.2.3A-1 of 3GPP TS 36.101, the MPR (maximum power reduction) for several dB is allowed due to modulation and contiguously aggregated transmit bandwidth configuration. All the RF parameters in this device have followed above 3GPP criteria.

LTE CA Configurations and Bandwidth Combination Sets defined for Intra-Band Contiguous CA

Uplink CA Configuration	Component carriers in order of increasing carrier frequency			Maximum Aggregated Bandwidth (MHz)	Bandwidth Combination Set
	Channel bandwidths for carrier-1 (MHz)	Channel bandwidths for carrier-2 (MHz)	Channel bandwidths for carrier-3 (MHz)		
CA_7C	15	15		40	0
	20	20			
	10	20		40	1
	15	15, 20			
	20	10, 15, 20			
	15	10, 15		40	2
20	15, 20				

LTE CA Configurations and Bandwidth Combination Sets defined for Inter-Band CA (Two Bands)

Uplink CA Configuration	LTE Bands	Channel Bandwidths for Carrier (MHz)	Maximum Aggregated Bandwidth (MHz)	Bandwidth Combination Set
CA_2A-12A	2	5, 10, 15, 20	30	0
	12	5, 10		
	2	5, 10, 15, 20	30	1
	12	3, 5, 10		
	2	5, 10	20	2
12	5, 10			
CA_4A-12A	4	1.4, 3, 5, 10	20	0
	12	5, 10		
	4	1.4, 3, 5, 10, 15, 20	30	1
	12	5, 10		
	4	5, 10, 15, 20	30	2
	12	3, 5, 10		
	4	5, 10	20	3
	12	5, 10		
	4	5, 10, 15, 20	30	4
	12	5, 10		
4	5, 10, 15	20	5	
12	5			
CA_13A-66A	13	5, 10	30	0
	66	5, 10, 15, 20		

This device does not support full CA (Carrier Aggregation) features on 3GPP release 12. Its supported configuration is shown in below. For network enhancement features, it does not support Wi-Fi Offloading, Enhanced SC-FDMA, Uplink MIMO, CoMP, HetNet, Relay, SON, Cross-Carrier Scheduling, eICIC, Enhanced Downlink MIMO, MBMS, M2M/D2D. All other uplink communications are identical to the LTE Release 8 specifications.

<Considerations Related to WLAN for Setup and Testing>

In general, various vendor specific external test software and chipset based internal test modes are typically used for SAR measurement. These chipset based test mode utilities are generally hardware and manufacturer dependent, and often include substantial flexibility to reconfigure or reprogram a device. A Wi-Fi device must be configured to transmit continuously at the required data rate, channel bandwidth and signal modulation, using the highest transmission duty factor supported by the test mode tools for SAR measurement. The test frequencies established using test mode must correspond to the actual channel frequencies. When 802.11 frame gaps are accounted for in the transmission, a maximum transmission duty factor of 92 - 96% is typically achievable in most test mode configurations. A minimum transmission duty factor of 85% is required to avoid certain hardware and device implementation issues related to wide range SAR scaling. In addition, a periodic transmission duty factor is required for current generation SAR systems to measure SAR correctly. The reported SAR must be scaled to 100% transmission duty factor to determine compliance at the maximum tune-up tolerance limit.

According to KDB 248227 D01, this device has installed WLAN engineering testing software which can provide continuous transmitting RF signal. During WLAN SAR testing, this device was operated to transmit continuously at the maximum transmission duty with specified transmission mode, operating frequency, lowest data rate, and maximum output power.

Initial Test Configuration

An initial test configuration is determined for OFDM transmission modes in 2.4 GHz and 5 GHz bands according to the channel bandwidth, modulation and data rate combination(s) with the highest maximum output power specified for production units in each standalone and aggregated frequency band. When the same maximum power is specified for multiple transmission modes in a frequency band, the largest channel bandwidth, lowest order modulation, lowest data rate and lowest order 802.11a/g/n/ac mode is used for SAR measurement, on the highest measured output power channel in the initial test configuration, for each frequency band.

Subsequent Test Configuration

SAR measurement requirements for the remaining 802.11 transmission mode configurations that have not been tested in the initial test configuration are determined separately for each standalone and aggregated frequency band, in each exposure condition, according to the maximum output power specified for production units. Additional power measurements may be required to determine if SAR measurements are required for subsequent highest output power channels in a subsequent test configuration. When the highest reported SAR for the initial test configuration according to the initial test position or fixed exposure position requirements, is adjusted by the ratio of the subsequent test configuration to initial test configuration specified maximum output power and the adjusted SAR is ≤ 1.2 W/kg, SAR is not required for that subsequent test configuration.

SAR Test Configuration and Channel Selection

When multiple channel bandwidth configurations in a frequency band have the same specified maximum output power, the initial test configuration is using largest channel bandwidth, lowest order modulation, lowest data rate, and lowest order 802.11 mode (i.e., 802.11a is chosen over 802.11n then 802.11ac or 802.11g is chosen over 802.11n). After an initial test configuration is determined, if multiple test channels have the same measured maximum output power, the channel chosen for SAR measurement is determined according to the following.

- 1) The channel closest to mid-band frequency is selected for SAR measurement.
- 2) For channels with equal separation from mid-band frequency; for example, high and low channels or two mid-band channels, the higher frequency (number) channel is selected for SAR measurement.

Test Reduction for U-NII-1 (5.2 GHz) and U-NII-2A (5.3 GHz) Bands

For devices that operate in both U-NII bands using the same transmitter and antenna(s), SAR test reduction is determined according to the following.

- 1) When the same maximum output power is specified for both bands, begin SAR measurement in U-NII-2A band by applying the OFDM SAR requirements. If the highest reported SAR for a test configuration is ≤ 1.2 W/kg, SAR is not required for U-NII-1 band for that configuration (802.11 mode and exposure condition).
- 2) When different maximum output power is specified for the bands, begin SAR measurement in the band with higher specified maximum output power. The highest reported SAR for the tested configuration is adjusted by the ratio of lower to higher specified maximum output power for the two bands. When the adjusted SAR is ≤ 1.2 W/kg, SAR is not required for the band with lower maximum output power in that test configuration.

<Considerations Related to Bluetooth for Setup and Testing>

This device has installed Bluetooth engineering testing software which can provide continuous transmitting RF signal. During Bluetooth SAR testing, this device was operated to transmit continuously at the maximum transmission duty with specified transmission mode, operating frequency, lowest data rate, and maximum output power.

4.2 EUT Testing Position

According to KDB 648474 D04, handsets are tested for SAR compliance in head, body-worn accessory and other use configurations described in the following subsections.

4.2.1 Head Exposure Conditions

Head exposure is limited to next to the ear voice mode operations. Head SAR compliance is tested according to the test positions defined in IEEE Std 1528-2003 using the SAM phantom illustrated as below.

1. Define two imaginary lines on the handset
 - (a) The vertical centerline passes through two points on the front side of the handset - the midpoint of the width w_t of the handset at the level of the acoustic output, and the midpoint of the width w_b of the bottom of the handset.
 - (b) The horizontal line is perpendicular to the vertical centerline and passes through the center of the acoustic output. The horizontal line is also tangential to the face of the handset at point A.
 - (c) The two lines intersect at point A. Note that for many handsets, point A coincides with the center of the acoustic output; however, the acoustic output may be located elsewhere on the horizontal line. Also note that the vertical centerline is not necessarily parallel to the front face of the handset, especially for clamshell handsets, handsets with flip covers, and other irregularly shaped handsets.

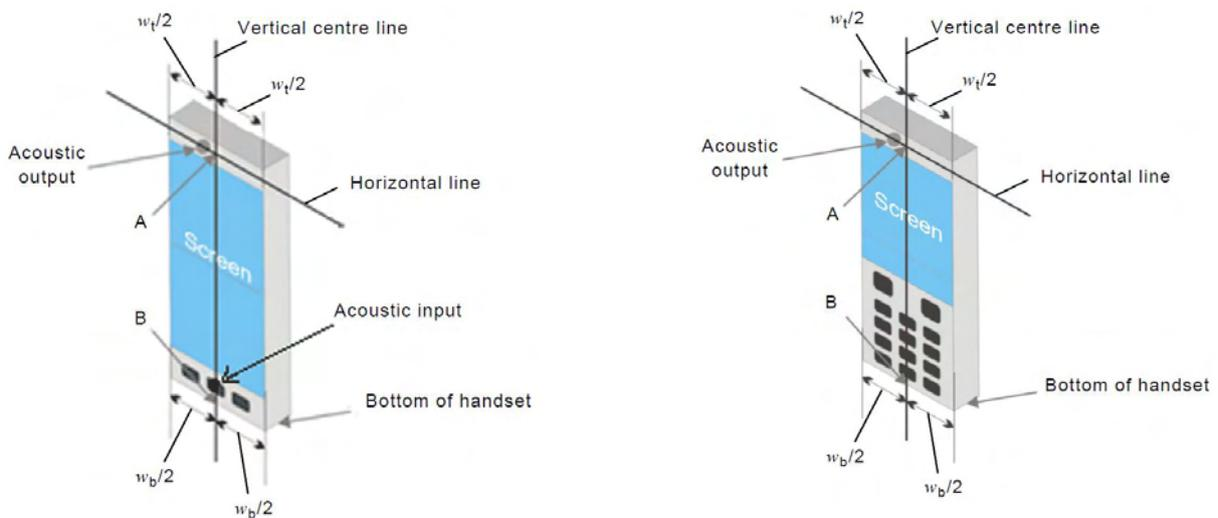

Fig-4.1 Illustration for Handset Vertical and Horizontal Reference Lines

2. Cheek Position

- (a) To position the device with the vertical center line of the body of the device and the horizontal line crossing the center piece in a plane parallel to the sagittal plane of the phantom. While maintaining the device in this plane, align the vertical center line with the reference plane containing the three ear and mouth reference point (M: Mouth, RE: Right Ear, and LE: Left Ear) and align the center of the ear piece with the line RE-LE.
- (b) To move the device towards the phantom with the ear piece aligned with the line LE-RE until the phone touched the ear. While maintaining the device in the reference plane and maintaining the phone contact with the ear, move the bottom of the phone until any point on the front side is in contact with the cheek of the phantom or until contact with the ear is lost (see Fig-4.2).

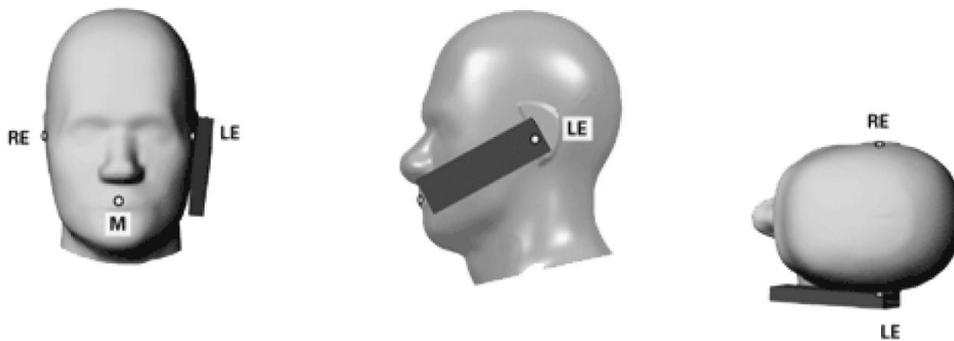

Fig-4.2 Illustration for Cheek Position

3. Tilted Position

- (a) To position the device in the “cheek” position described above.
- (b) While maintaining the device the reference plane described above and pivoting against the ear, moves it outward away from the mouth by an angle of 15 degrees or until contact with the ear is lost (see Fig-4.3).

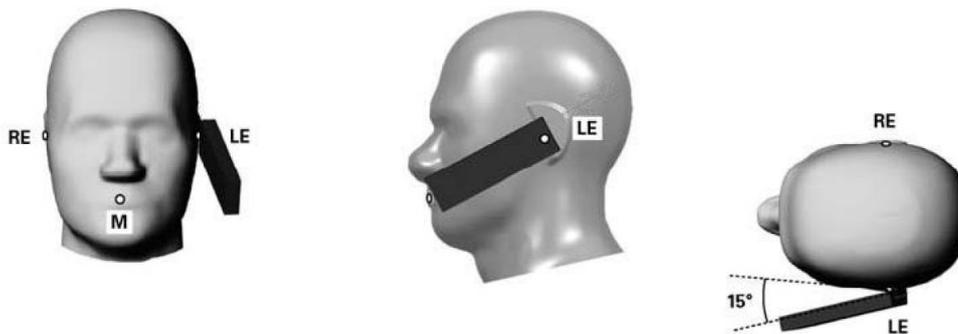

Fig-4.3 Illustration for Tilted Position

4.2.2 Body-worn Accessory Exposure Conditions

Body-worn accessory exposure is typically related to voice mode operations when handsets are carried in body-worn accessories. The body-worn accessory procedures in KDB 447498 D01 are used to test for body-worn accessory SAR compliance, without a headset connected to it. This enables the test results for such configuration to be compatible with that required for hotspot mode when the body-worn accessory test separation distance is greater than or equal to that required for hotspot mode. When the reported SAR for a body-worn accessory, measured without a headset connected to the handset, is > 1.2 W/kg, the highest reported SAR configuration for that wireless mode and frequency band should be repeated for that body-worn accessory with a headset attached to the handset.

Body-worn accessories that do not contain metallic or conductive components may be tested according to worst-case exposure configurations, typically according to the smallest test separation distance required for the group of body-worn accessories with similar operating and exposure characteristics. All body-worn accessories containing metallic components are tested in conjunction with the host device.

Body-worn accessory SAR compliance is based on a single minimum test separation distance for all wireless and operating modes applicable to each body-worn accessory used by the host, and according to the relevant voice and/or data mode transmissions and operations. If a body-worn accessory supports voice only operations in its normal and expected use conditions, testing of data mode for body-worn compliance is not required.

A conservative minimum test separation distance for supporting off-the-shelf body-worn accessories that may be acquired by users of consumer handsets is used to test for body-worn accessory SAR compliance. This distance is determined by the handset manufacturer, according to the requirements of Supplement C 01-01. Devices that are designed to operate on the body of users using lanyards and straps, or without requiring additional body-worn accessories, will be tested using a conservative minimum test separation distance ≤ 5 mm to support compliance.

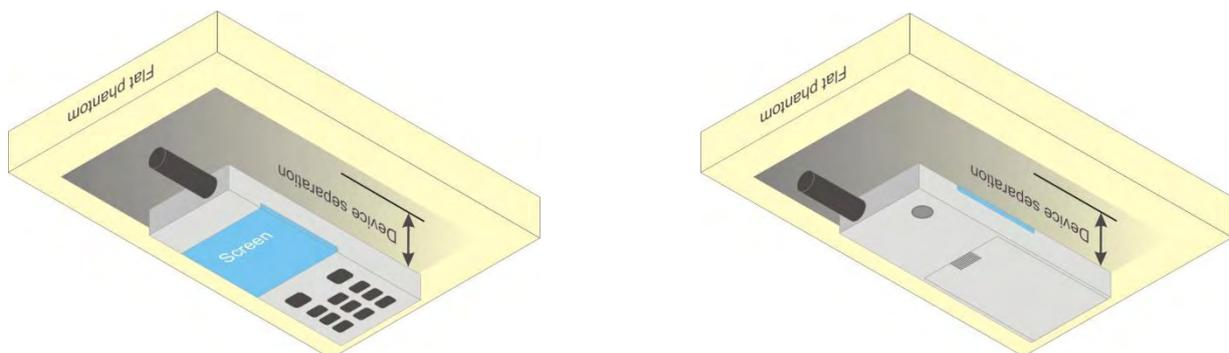
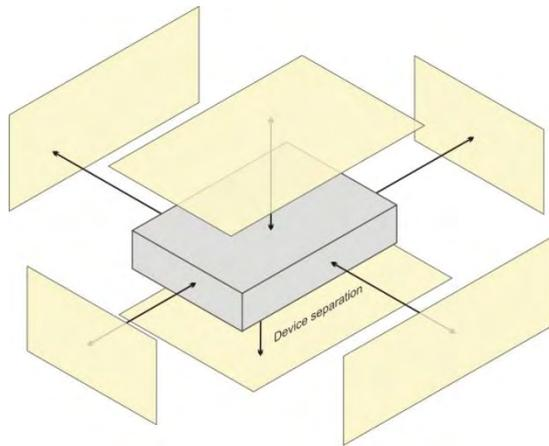

Fig-4.4 Illustration for Body Worn Position

4.2.3 Hotspot Mode Exposure Conditions

For handsets that support hotspot mode operations, with wireless router capabilities and various web browsing functions, the relevant hand and body exposure conditions are tested according to the hotspot SAR procedures in KDB 941225 D06. A test separation distance of 10 mm is required between the phantom and all surfaces and edges with a transmitting antenna located within 25 mm from that surface or edge. When the form factor of a handset is smaller than 9 cm x 5 cm, a test separation distance of 5 mm (instead of 10 mm) is required for testing hotspot mode. When the separation distance required for body-worn accessory testing is larger than or equal to that tested for hotspot mode, in the same wireless mode and for the same surface of the phone, the hotspot mode SAR data may be used to support body-worn accessory SAR compliance for that particular configuration (surface).



Based on the antenna location shown on appendix D of this report, the SAR testing required for hotspot mode is listed as below.

Antenna	Front Face	Rear Face	Left Side	Right Side	Top Side	Bottom Side
WWAN Ant-0	✓	✓	✓	✓		✓
WWAN Ant-1	✓	✓	✓	✓	✓	
BT / WLAN-0	✓	✓		✓	✓	
WLAN-1	✓	✓		✓	✓	
WLAN-0+1	✓	✓		✓	✓	

4.2.4 Product Specific (Phablet) Exposure Conditions

For smart phones with a display diagonal dimension > 15 cm or an overall diagonal dimension > 16 cm that provide similar mobile web access and multimedia support found in mini-tablets or UMPC mini-tablets that support voice calls next to the ear, the following phablet procedures should be applied to evaluate SAR compliance for each applicable wireless modes and frequency band. Devices marketed as phablets, regardless of form factors and operating characteristics must be tested as a phablet to determine SAR compliance.

1. The normally required head and body-worn accessory SAR test procedures for handsets, including hotspot mode, must be applied.
2. The UMPC mini-tablet procedures must also be applied to test the SAR of all surfaces and edges with an antenna located at ≤ 25 mm from that surface or edge, in direct contact with a flat phantom, for 10-g extremity SAR according to the body-equivalent tissue dielectric parameters in KDB 865664 to address interactive hand use exposure conditions. The UMPC mini-tablet 1-g SAR at 5 mm is not required. When hotspot mode applies, 10-g extremity SAR is required only for the surfaces and edges with hotspot mode 1-g SAR > 1.2 W/kg. The normal tablet procedures in KDB 616217 are required when the over diagonal dimension of the device is > 20 cm. Hotspot mode SAR is not required when normal tablet procedures are applied. Extremity 10-g SAR is also not required for the front (top) surface of large form factor full size tablets. The more conservative tablet SAR results can be used to support the 10-g extremity SAR for phablet mode.
3. The simultaneous transmission operating configurations applicable to voice and data transmissions for both phone and mini-tablet modes must be taken into consideration separately for 1-g and 10-g SAR to determine the simultaneous transmission SAR test exclusion and measurement requirements for the relevant wireless modes and exposure conditions.

FCC SAR Test Report

4.3 Tissue Verification

The measuring results for tissue simulating liquid are shown as below.

Test Date	Tissue Type	Frequency (MHz)	Liquid Temp. (°C)	Measured Conductivity (σ)	Measured Permittivity (ϵ_r)	Target Conductivity (σ)	Target Permittivity (ϵ_r)	Conductivity Deviation (%)	Permittivity Deviation (%)
May. 25, 2018	Head	750	23.6	0.9	43.366	0.89	41.9	1.12	3.50
May. 29, 2018	Head	750	23.4	0.888	41.631	0.89	41.9	-0.22	-0.64
May. 25, 2018	Head	835	23.6	0.918	41.678	0.9	41.5	2.00	0.43
May. 31, 2018	Head	835	23.6	0.909	41.672	0.9	41.5	1.00	0.41
May. 31, 2018	Head	1750	23.6	1.318	39.352	1.37	40.1	-3.80	-1.87
Sep. 06, 2018	Head	1750	23.2	1.329	40.317	1.37	40.1	-2.99	0.54
Oct. 09, 2018	Head	1750	23.3	1.323	40.866	1.37	40.1	-3.43	1.91
May. 31, 2018	Head	1900	23.6	1.444	38.836	1.4	40	3.14	-2.91
Sep. 06, 2018	Head	1900	23.2	1.455	39.669	1.4	40	3.93	-0.83
Oct. 09, 2018	Head	1900	23.3	1.453	40.451	1.4	40	3.79	1.13
May. 31, 2018	Head	2300	23.6	1.715	38.875	1.67	39.5	2.69	-1.58
May. 29, 2018	Head	2450	23.4	1.88	37.794	1.8	39.2	4.44	-3.59
May. 30, 2018	Head	2450	23.4	1.843	38.569	1.8	39.2	2.39	-1.61
May. 31, 2018	Head	2450	23.6	1.873	38.311	1.8	39.2	4.06	-2.27
May. 31, 2018	Head	2600	23.6	2.028	37.803	1.96	39	3.47	-3.07
Jun. 09, 2018	Head	2600	23.3	2.03	38.454	1.96	39	3.57	-1.40
Aug. 29, 2018	Head	2600	23.5	2.041	37.147	1.96	39	4.13	-4.75
May. 29, 2018	Head	5250	23.4	4.788	35.102	4.71	35.9	1.66	-2.22
May. 29, 2018	Head	5600	23.4	5.142	34.624	5.07	35.5	1.42	-2.47
Jun. 01, 2018	Head	5600	23.4	4.871	33.999	5.07	35.5	-3.93	-4.23
May. 29, 2018	Head	5800	23.4	5.336	34.373	5.27	35.3	1.25	-2.63
Jun. 01, 2018	Head	5800	23.4	5.079	33.721	5.27	35.3	-3.62	-4.47
Jun. 04, 2018	Body	750	23.2	0.972	53.438	0.96	55.5	1.25	-3.72
May. 25, 2018	Body	835	23.3	0.985	54.032	0.97	55.2	1.55	-2.12
May. 31, 2018	Body	835	23.5	1.014	55.981	0.97	55.2	4.54	1.41
Jun. 04, 2018	Body	835	23.2	1.007	54.216	0.97	55.2	3.81	-1.78
Jun. 06, 2018	Body	835	23.3	0.993	54.659	0.97	55.2	2.37	-0.98
May. 25, 2018	Body	1750	23.5	1.429	52.672	1.49	53.4	-4.09	-1.36
May. 31, 2018	Body	1750	23.5	1.447	52.512	1.49	53.4	-2.89	-1.66
Jun. 01, 2018	Body	1750	23.5	1.431	51.633	1.49	53.4	-3.96	-3.31
Jun. 04, 2018	Body	1750	23.2	1.437	52.601	1.49	53.4	-3.56	-1.50
Sep. 06, 2018	Body	1750	23.2	1.436	53.447	1.49	53.4	-3.62	0.09
Oct. 10, 2018	Body	1750	23.4	1.442	51.72	1.49	53.4	-3.22	-3.15
Oct. 11, 2018	Body	1750	23.4	1.44	51.498	1.49	53.4	-3.36	-3.56
May. 25, 2018	Body	1900	23.5	1.564	52.198	1.52	53.3	2.89	-2.07
Jun. 01, 2018	Body	1900	23.3	1.568	51.277	1.52	53.3	3.16	-3.80
Jun. 04, 2018	Body	1900	23.2	1.581	52.161	1.52	53.3	4.01	-2.14
Sep. 06, 2018	Body	1900	23.2	1.554	53.398	1.52	53.3	2.24	0.18
Oct. 10, 2018	Body	1900	23.4	1.56	51.445	1.52	53.3	2.63	-3.48
Jun. 06, 2018	Body	2300	23.3	1.837	51.573	1.81	52.9	1.49	-2.51
May. 25, 2018	Body	2450	23.6	2.008	50.638	1.95	52.7	2.97	-3.91
May. 30, 2018	Body	2450	23.4	2.021	51.11	1.95	52.7	3.64	-3.02
May. 31, 2018	Body	2450	23.5	2.023	51.011	1.95	52.7	3.74	-3.20
Jun. 07, 2018	Body	2450	23.3	2.023	51.287	1.95	52.7	3.74	-2.68
May. 24, 2018	Body	2600	23.3	2.211	50.451	2.16	52.5	2.36	-3.90
May. 25, 2018	Body	2600	23.5	2.173	50.236	2.16	52.5	0.60	-4.31
May. 31, 2018	Body	2600	23.5	2.193	50.596	2.16	52.5	1.53	-3.63
Jun. 06, 2018	Body	2600	23.3	2.17	50.799	2.16	52.5	0.46	-3.24
Aug. 29, 2018	Body	2600	23.3	2.151	50.352	2.16	52.5	-0.42	-4.09

FCC SAR Test Report

Test Date	Tissue Type	Frequency (MHz)	Liquid Temp. (°C)	Measured Conductivity (σ)	Measured Permittivity (ϵ_r)	Target Conductivity (σ)	Target Permittivity (ϵ_r)	Conductivity Deviation (%)	Permittivity Deviation (%)
May. 25, 2018	Body	5250	23.6	5.375	46.739	5.36	48.9	0.28	-4.42
Jun. 07, 2018	Body	5250	23.3	5.108	49.907	5.36	48.9	-4.70	2.06
May. 30, 2018	Body	5600	23.4	5.818	47.42	5.77	48.5	0.83	-2.23
May. 25, 2018	Body	5800	23.6	6.031	46.015	6	48.2	0.52	-4.53
Jun. 07, 2018	Body	5800	23.3	5.992	49.713	6	48.2	-0.13	3.14
Sep. 11, 2018	Body	5800	23.3	6.093	46.283	6	48.2	1.55	-3.98
Sep. 21, 2018	Body	5800	23.5	6.142	50.003	6	48.2	2.37	3.74

Test Date	Tissue Type	Frequency (MHz)	Liquid Temp. (°C)	Measured Conductivity (σ)	Measured Permittivity (ϵ_r)	Target Conductivity (σ)	Target Permittivity (ϵ_r)	Conductivity Deviation (%)	Permittivity Deviation (%)
Jun. 20, 2018	Body	5250	23.3	5.511	47.154	5.36	48.9	2.82	-3.57
Jun. 20, 2018	Body	5600	23.3	5.926	46.661	5.77	48.5	2.70	-3.79

Note:

The dielectric properties of the tissue simulating liquid must be measured within 24 hours before the SAR testing and within $\pm 5\%$ of the target values. Liquid temperature during the SAR testing must be within $\pm 2^\circ\text{C}$.

4.4 System Validation

The SAR measurement system was validated according to procedures in KDB 865664 D01. The validation status in tabulated summary is as below.

Test Date	Probe S/N	Calibration Point		Measured Conductivity (σ)	Measured Permittivity (ϵ_r)	Validation for CW			Validation for Modulation		
						Sensitivity Range	Probe Linearity	Probe Isotropy	Modulation Type	Duty Factor	PAR
May. 25, 2018	3971	Head	750	0.9	43.366	Pass	Pass	Pass	N/A	N/A	N/A
May. 29, 2018	3971	Head	750	0.888	41.631	Pass	Pass	Pass	N/A	N/A	N/A
May. 25, 2018	3971	Head	835	0.918	41.678	Pass	Pass	Pass	GMSK	Pass	N/A
May. 31, 2018	3650	Head	835	0.909	41.672	Pass	Pass	Pass	N/A	N/A	N/A
May. 31, 2018	3650	Head	1750	1.318	39.352	Pass	Pass	Pass	N/A	N/A	N/A
Sep. 06, 2018	3971	Head	1750	1.329	40.317	Pass	Pass	Pass	N/A	N/A	N/A
Oct. 09, 2018	3971	Head	1750	1.323	40.866	Pass	Pass	Pass	N/A	N/A	N/A
May. 31, 2018	3650	Head	1900	1.444	38.836	Pass	Pass	Pass	GMSK	Pass	N/A
Sep. 06, 2018	3971	Head	1900	1.455	39.669	Pass	Pass	Pass	GMSK	Pass	N/A
Oct. 09, 2018	3971	Head	1900	1.453	40.451	Pass	Pass	Pass	GMSK	Pass	N/A
May. 31, 2018	3650	Head	2300	1.715	38.875	Pass	Pass	Pass	N/A	N/A	N/A
May. 29, 2018	3650	Head	2450	1.88	37.794	Pass	Pass	Pass	GMSK	Pass	N/A
May. 30, 2018	3650	Head	2450	1.843	38.569	Pass	Pass	Pass	N/A	N/A	N/A
May. 31, 2018	3650	Head	2450	1.873	38.311	Pass	Pass	Pass	OFDM	N/A	Pass
May. 31, 2018	3650	Head	2600	2.028	37.803	Pass	Pass	Pass	N/A	N/A	N/A
Jun. 09, 2018	3971	Head	2600	2.03	38.454	Pass	Pass	Pass	N/A	N/A	N/A
Aug. 29, 2018	3650	Head	2600	2.041	37.147	Pass	Pass	Pass	N/A	N/A	N/A
May. 29, 2018	3650	Head	5250	4.788	35.102	Pass	Pass	Pass	OFDM	N/A	Pass
May. 29, 2018	3650	Head	5600	5.142	34.624	Pass	Pass	Pass	OFDM	N/A	Pass
Jun. 01, 2018	3650	Head	5600	4.871	33.999	Pass	Pass	Pass	OFDM	N/A	Pass
May. 29, 2018	3650	Head	5800	5.336	34.373	Pass	Pass	Pass	OFDM	N/A	Pass
Jun. 01, 2018	3650	Head	5800	5.079	33.721	Pass	Pass	Pass	OFDM	N/A	Pass

FCC SAR Test Report

Test Date	Probe S/N	Calibration Point		Measured Conductivity (σ)	Measured Permittivity (ϵ_r)	Validation for CW			Validation for Modulation		
						Pass	Pass	Pass	N/A	N/A	N/A
Jun. 04, 2018	3820	Body	750	0.972	53.438	Pass	Pass	Pass	N/A	N/A	N/A
May. 25, 2018	3971	Body	835	0.985	54.032	Pass	Pass	Pass	N/A	N/A	N/A
May. 31, 2018	3650	Body	835	1.014	55.981	Pass	Pass	Pass	GMSK	Pass	N/A
Jun. 04, 2018	3820	Body	835	1.007	54.216	Pass	Pass	Pass	N/A	N/A	N/A
Jun. 06, 2018	3971	Body	835	0.993	54.659	Pass	Pass	Pass	N/A	N/A	N/A
May. 25, 2018	3971	Body	1750	1.429	52.672	Pass	Pass	Pass	N/A	N/A	N/A
May. 31, 2018	3650	Body	1750	1.447	52.512	Pass	Pass	Pass	N/A	N/A	N/A
Jun. 01, 2018	3650	Body	1750	1.431	51.633	Pass	Pass	Pass	N/A	N/A	N/A
Jun. 04, 2018	3820	Body	1750	1.437	52.601	Pass	Pass	Pass	N/A	N/A	N/A
Sep. 06, 2018	3971	Body	1750	1.436	53.447	Pass	Pass	Pass	N/A	N/A	N/A
Oct. 10, 2018	3971	Body	1750	1.442	51.72	Pass	Pass	Pass	N/A	N/A	N/A
Oct. 11, 2018	3971	Body	1750	1.44	51.498	Pass	Pass	Pass	N/A	N/A	N/A
May. 25, 2018	3971	Body	1900	1.564	52.198	Pass	Pass	Pass	N/A	N/A	N/A
Jun. 01, 2018	3650	Body	1900	1.568	51.277	Pass	Pass	Pass	GMSK	Pass	N/A
Jun. 04, 2018	3820	Body	1900	1.581	52.161	Pass	Pass	Pass	GMSK	Pass	N/A
Sep. 06, 2018	3971	Body	1900	1.554	53.398	Pass	Pass	Pass	N/A	Pass	N/A
Oct. 10, 2018	3971	Body	1900	1.56	51.445	Pass	Pass	Pass	N/A	Pass	N/A
Jun. 06, 2018	3971	Body	2300	1.837	51.573	Pass	Pass	Pass	N/A	N/A	N/A
May. 25, 2018	3971	Body	2450	2.008	50.638	Pass	Pass	Pass	OFDM	N/A	Pass
May. 30, 2018	3650	Body	2450	2.021	51.11	Pass	Pass	Pass	OFDM	N/A	Pass
May. 31, 2018	3650	Body	2450	2.023	51.011	Pass	Pass	Pass	OFDM	N/A	Pass
Jun. 07, 2018	3971	Body	2450	2.023	51.287	Pass	Pass	Pass	OFDM	N/A	Pass
May. 24, 2018	3971	Body	2600	2.211	50.451	Pass	Pass	Pass	N/A	N/A	N/A
May. 25, 2018	3971	Body	2600	2.173	50.236	Pass	Pass	Pass	N/A	N/A	N/A
May. 31, 2018	3650	Body	2600	2.193	50.596	Pass	Pass	Pass	N/A	N/A	N/A
Jun. 06, 2018	3971	Body	2600	2.17	50.799	Pass	Pass	Pass	N/A	N/A	N/A
Aug. 29, 2018	3650	Body	2600	2.151	50.352	Pass	Pass	Pass	N/A	N/A	N/A
May. 25, 2018	3971	Body	5250	5.375	46.739	Pass	Pass	Pass	OFDM	N/A	Pass
Jun. 07, 2018	3820	Body	5250	5.108	49.907	Pass	Pass	Pass	OFDM	N/A	Pass
May. 30, 2018	3650	Body	5600	5.818	47.42	Pass	Pass	Pass	OFDM	N/A	Pass
May. 25, 2018	3971	Body	5800	6.031	46.015	Pass	Pass	Pass	OFDM	N/A	Pass
Jun. 07, 2018	3820	Body	5800	5.992	49.713	Pass	Pass	Pass	OFDM	N/A	Pass
Sep. 11, 2018	3898	Body	5800	6.093	46.283	Pass	Pass	Pass	OFDM	N/A	Pass
Sep. 21, 2018	7472	Body	5800	6.142	50.003	Pass	Pass	Pass	OFDM	N/A	Pass

Test Date	Probe S/N	Calibration Point		Measured Conductivity (σ)	Measured Permittivity (ϵ_r)	Validation for CW			Validation for Modulation		
						Sensitivity Range	Probe Linearity	Probe Isotropy	Modulation Type	Duty Factor	PAR
Jun. 20, 2018	7346	Body	5250	5.511	47.154	Pass	Pass	Pass	OFDM	N/A	Pass
Jun. 20, 2018	7346	Body	5600	5.926	46.661	Pass	Pass	Pass	OFDM	N/A	Pass

FCC SAR Test Report

4.5 System Verification

The measuring result for system verification is tabulated as below.

Test Date	Mode	Frequency (MHz)	1W Target SAR-1g (W/kg)	Measured SAR-1g (W/kg)	Normalized to 1W SAR-1g (W/kg)	Deviation (%)	Dipole S/N	Probe S/N	DAE S/N
May. 25, 2018	Head	750	8.25	2	8.00	-3.03	1013	3971	1431
May. 29, 2018	Head	750	8.25	1.92	7.68	-6.91	1013	3971	1431
May. 25, 2018	Head	835	9.41	2.33	9.32	-0.96	4d121	3971	1431
May. 31, 2018	Head	835	9.41	2.28	9.12	-3.08	4d121	3650	1277
May. 31, 2018	Head	1750	36.20	9.01	36.04	-0.44	1055	3650	1277
Sep. 06, 2018	Head	1750	36.90	8.99	35.96	-2.55	1055	3971	1431
Oct. 09, 2018	Head	1750	36.90	9.28	37.12	0.60	1055	3971	1431
May. 31, 2018	Head	1900	40.70	10.5	42.00	3.19	5d036	3650	1277
Sep. 06, 2018	Head	1900	40.70	10.1	40.40	-0.74	5d036	3971	1431
Oct. 09, 2018	Head	1900	40.70	10.2	40.80	0.25	5d036	3971	1431
May. 31, 2018	Head	2300	49.50	12.5	50.00	1.01	1004	3650	1277
May. 29, 2018	Head	2450	50.80	13.1	52.40	3.15	737	3650	1277
May. 30, 2018	Head	2450	50.80	12.7	50.80	0.00	737	3650	1277
May. 31, 2018	Head	2450	50.80	13	52.00	2.36	737	3650	1277
May. 31, 2018	Head	2600	56.90	13.9	55.60	-2.28	1020	3650	1277
Jun. 09, 2018	Head	2600	56.90	13.7	54.80	-3.69	1020	3971	1431
Aug. 29, 2018	Head	2600	55.80	14.1	56.40	1.08	1058	3650	1232
May. 29, 2018	Head	5250	78.60	8.28	82.80	5.34	1019	3650	1277
May. 29, 2018	Head	5600	84.90	8.21	82.10	-3.30	1019	3650	1277
Jun. 01, 2018	Head	5600	84.90	8.08	80.80	-4.83	1019	3650	1277
May. 29, 2018	Head	5800	80.90	8.44	84.40	4.33	1019	3650	1277
Jun. 01, 2018	Head	5800	80.90	8.19	81.90	1.24	1019	3650	1277

FCC SAR Test Report

Test Date	Mode	Frequency (MHz)	1W Target SAR-1g (W/kg)	Measured SAR-1g (W/kg)	Normalized to 1W SAR-1g (W/kg)	Deviation (%)	Dipole S/N	Probe S/N	DAE S/N
Jun. 04, 2018	Body	750	8.72	2.27	9.08	4.13	1013	3820	917
May. 25, 2018	Body	835	9.61	2.54	10.16	5.72	4d121	3971	1431
May. 31, 2018	Body	835	9.61	2.24	8.96	-6.76	4d121	3650	1277
Jun. 04, 2018	Body	835	9.61	2.26	9.04	-5.93	4d121	3820	917
Jun. 06, 2018	Body	835	9.61	2.36	9.44	-1.77	4d121	3971	1431
May. 25, 2018	Body	1750	37.10	8.89	35.56	-4.15	1055	3971	1431
May. 31, 2018	Body	1750	37.10	8.88	35.52	-4.26	1055	3650	1277
Jun. 01, 2018	Body	1750	37.10	8.94	35.76	-3.61	1055	3650	1277
Jun. 04, 2018	Body	1750	37.10	9.47	37.88	2.10	1055	3820	917
Sep. 06, 2018	Body	1750	36.90	9.20	36.80	-0.27	1055	3971	1431
Oct. 10, 2018	Body	1750	36.90	8.97	35.88	-2.76	1055	3971	1431
Oct. 11, 2018	Body	1750	36.90	9.57	38.28	3.74	1055	3971	1431
May. 25, 2018	Body	1900	40.20	10.3	41.20	2.49	5d036	3971	1431
Jun. 01, 2018	Body	1900	40.20	10.2	40.80	1.49	5d036	3650	1277
Jun. 04, 2018	Body	1900	40.20	10.5	42.00	4.48	5d036	3820	917
Sep. 06, 2018	Body	1900	40.20	9.8	39.20	-2.49	5d036	3971	1431
Oct. 10, 2018	Body	1900	40.20	10.1	40.40	0.50	5d036	3971	1431
Jun. 06, 2018	Body	2300	47.30	12	48.00	1.48	1004	3971	1431
May. 25, 2018	Body	2450	49.70	11.9	47.60	-4.23	737	3971	1431
May. 30, 2018	Body	2450	49.70	12.1	48.40	-2.62	737	3650	1277
May. 31, 2018	Body	2450	49.70	11.8	47.20	-5.03	737	3650	1277
Jun. 07, 2018	Body	2450	49.70	12.1	48.40	-2.62	737	3971	1431
May. 24, 2018	Body	2600	54.30	12.5	50.00	-7.92	1020	3971	1431
May. 25, 2018	Body	2600	54.30	13.4	53.60	-1.29	1020	3971	1431
May. 31, 2018	Body	2600	54.30	13	52.00	-4.24	1020	3650	1277
Jun. 06, 2018	Body	2600	54.30	14	56.00	3.13	1020	3971	1431
Aug. 29, 2018	Body	2600	54.40	13.1	52.40	-3.68	1058	3650	1232
May. 25, 2018	Body	5250	74.90	7.58	75.80	1.20	1019	3971	1431
Jun. 07, 2018	Body	5250	74.90	7.29	72.90	-2.67	1019	3820	917
May. 30, 2018	Body	5600	79.30	7.7	77.00	-2.90	1019	3650	1277
May. 25, 2018	Body	5800	75.20	7.45	74.50	-0.93	1019	3971	1431
Jun. 07, 2018	Body	5800	75.20	7.89	78.90	4.92	1019	3820	917
Sep. 11, 2018	Body	5800	75.20	7.87	78.70	4.65	1019	3898	1277
Sep. 21, 2018	Body	5800	75.20	7.81	78.10	3.86	1019	7472	679

Test Date	Mode	Frequency (MHz)	1W Target SAR-10g (W/kg)	Measured SAR-10g (W/kg)	Normalized to 1W SAR-10g (W/kg)	Deviation (%)	Dipole S/N	Probe S/N	DAE S/N
Jun. 20, 2018	Body	5250	20.80	2.11	21.10	1.44	1019	7346	861
Jun. 20, 2018	Body	5600	22.20	2.26	22.60	1.80	1019	7346	861

Note:

Comparing to the reference SAR value provided by SPEAG, the validation data should be within its specification of 10 %. The result indicates the system check can meet the variation criterion and the plots can be referred to Appendix A of this report.

4.6 Maximum Output Power

4.6.1 Maximum Target Conducted Power

The maximum conducted average power (Unit: dBm) including tune-up tolerance is shown as below.

Mode	Maximum Burst-Averaged Output Power	Maximum Frame-Averaged Output Power
	GSM850	GSM850
GSM (GMSK, 1Tx-slot)	33.0	24.0
GPRS (GMSK, 1Tx-slot)	33.0	24.0
GPRS (GMSK, 2Tx-slot)	30.0	24.0
GPRS (GMSK, 3Tx-slot)	28.5	24.2
GPRS (GMSK, 4Tx-slot)	27.0	24.0
EDGE (8PSK, 1Tx-slot)	27.0	18.0
EDGE (8PSK, 2Tx-slot)	24.0	18.0
EDGE (8PSK, 3Tx-slot)	23.0	18.7
EDGE (8PSK, 4Tx-slot)	22.0	19.0

Mode	Maximum Burst-Averaged Output Power		Maximum Frame-Averaged Output Power	
	GSM1900 (Head/Body mode)	GSM1900 (Hotspot mode)	GSM1900 (Head/Body mode)	GSM1900 (Hotspot mode)
GSM (GMSK, 1Tx-slot)	30.5	26.5	21.5	17.5
GPRS (GMSK, 1Tx-slot)	30.5	26.5	21.5	17.5
GPRS (GMSK, 2Tx-slot)	27.5	23.0	21.5	17.0
GPRS (GMSK, 3Tx-slot)	26.5	22.0	22.2	17.7
GPRS (GMSK, 4Tx-slot)	25.5	20.5	22.5	17.5
EDGE (8PSK, 1Tx-slot)	26.0	25.5	17.0	16.5
EDGE (8PSK, 2Tx-slot)	23.0	22.5	17.0	16.5
EDGE (8PSK, 3Tx-slot)	22.0	21.5	17.7	17.2
EDGE (8PSK, 4Tx-slot)	21.0	20.5	18.0	17.5

Note:

1. SAR testing was performed on the maximum frame-averaged power mode.
2. The frame-averaged power is linearly proportion to the slot number configured and it is linearly scaled the maximum burst-averaged power based on time slots. The calculated method is shown as below:

$$\text{Frame-averaged power} = 10 \times \log (\text{Burst-averaged power mW} \times \text{Slot used} / 8)$$

Mode	WCDMA Band II (Head/Body mode)	WCDMA Band II (Hotspot mode)
RMC 12.2K	23.5	18.0
HSDPA / HSUPA / DC-HSDPA	22.5	17.0

Mode	WCDMA Band IV (Head/Body mode)	WCDMA Band IV (Hotspot mode)
RMC 12.2K	23.5	19.0
HSDPA / HSUPA / DC-HSDPA	22.5	18.0

FCC SAR Test Report

Mode	WCDMA Band V
RMC 12.2K	23.5
HSDPA / HSUPA / DC-HSDPA	22.5

Mode	LTE 2 (Head/Body mode)	LTE 2 (Hotspot mode)
QPSK	23.0	18.0
16QAM	22.0	17.0
64QAM	21.0	16.0

Mode	LTE 4 (Head/Body mode)	LTE 4 (Hotspot mode)
QPSK	23.0	18.0
16QAM	22.0	18.0
64QAM	21.0	17.5

Mode	LTE 5
QPSK	23.0
16QAM	22.0
64QAM	21.0

Mode	LTE 7 (Head/Body mode)	LTE 7 (Hotspot mode)
QPSK	22.0	19.0
16QAM	21.0	18.0
64QAM	20.0	17.5

Mode	LTE 12	LTE 13	LTE 17	LTE 38	LTE 41
QPSK	23.0	23.0	23.0	22.5	23.0
16QAM	22.0	22.0	22.0	21.5	22.0
64QAM	21.0	21.0	21.0	20.5	21.0

Mode	LTE 66 (Head/Body mode)	LTE 66 (Hotspot mode)
QPSK	23.0	19.5
16QAM	22.0	18.5
64QAM	21.0	17.5

FCC SAR Test Report

Head mode

Mode	Tx Antenna	2.4G WLAN	5.2G WLAN	5.3G WLAN	5.6G WLAN	5.8G WLAN
802.11b	Ant-0	18.5	N/A	N/A	N/A	N/A
	Ant-1	19.0	N/A	N/A	N/A	N/A
802.11g	Ant-0	19.0	N/A	N/A	N/A	N/A
	Ant-1	19.0	N/A	N/A	N/A	N/A
802.11a	Ant-0	N/A	9.5	9.5	9.5	9.5
	Ant-1	N/A	19.0	19.0	19.0	19.0
802.11n HT20	Ant-0	19.0	9.5	9.5	9.5	9.5
	Ant-1	19.0	19.0	19.0	19.0	19.0
	Ant-0+Ant-1	20.0	12.5	12.5	12.5	12.5
802.11n HT40	Ant-0	18.0	9.5	9.5	9.5	9.5
	Ant-1	18.0	18.0	18.0	18.0	18.0
	Ant-0+Ant-1	20.0	12.5	12.5	12.5	12.5
802.11ac VHT80	Ant-0	N/A	9.5	9.5	9.5	9.5
	Ant-1	N/A	17.0	17.0	17.0	17.0
	Ant-0+Ant-1	N/A	12.5	12.5	12.5	12.5

Mode	2.4G Bluetooth
Bluetooth DH	10.0
Bluetooth LE	3.0

Body / Hotspot / Phablet mode

Mode	Tx Antenna	2.4G WLAN	5.2G WLAN	5.3G WLAN	5.6G WLAN	5.8G WLAN
802.11b	Ant-0	20.0	N/A	N/A	N/A	N/A
	Ant-1	20.0	N/A	N/A	N/A	N/A
802.11g	Ant-0	19.0	N/A	N/A	N/A	N/A
	Ant-1	19.0	N/A	N/A	N/A	N/A
802.11a	Ant-0	N/A	19.0	19.0	19.0	19.0
	Ant-1	N/A	19.0	19.0	19.0	19.0
802.11n HT20	Ant-0	19.0	19.0	19.0	19.0	19.0
	Ant-1	19.0	19.0	19.0	19.0	19.0
	Ant-0+Ant-1	22.0	22.0	22.0	22.0	22.0
802.11n HT40	Ant-0	18.0	18.0	18.0	18.0	18.0
	Ant-1	18.0	18.0	18.0	18.0	18.0
	Ant-0+Ant-1	21.0	21.0	21.0	21.0	21.0
802.11ac VHT80	Ant-0	N/A	17.0	17.0	17.0	17.0
	Ant-1	N/A	17.0	17.0	17.0	17.0
	Ant-0+Ant-1	N/A	20.0	20.0	20.0	20.0

Mode	2.4G Bluetooth
Bluetooth DH	10.0
Bluetooth LE	3.0

FCC SAR Test Report

4.6.2 Measured Conducted Power Result

The measuring conducted average power (Unit: dBm) is shown as below.

Band	GSM850		
Channel	128	189	251
Frequency (MHz)	824.2	836.4	848.8
Maximum Burst-Averaged Output Power			
GSM (GMSK, 1Tx-slot)	32.28	32.44	32.34
GPRS (GMSK, 1Tx-slot)	32.01	32.17	32.07
GPRS (GMSK, 2Tx-slot)	29.81	29.97	29.87
GPRS (GMSK, 3Tx-slot)	28.42	28.49	28.48
GPRS (GMSK, 4Tx-slot)	26.96	26.99	26.97
EDGE (8PSK, 1Tx-slot)	26.05	26.21	26.11
EDGE (8PSK, 2Tx-slot)	23.41	23.57	23.47
EDGE (8PSK, 3Tx-slot)	22.20	22.36	22.26
EDGE (8PSK, 4Tx-slot)	21.06	21.22	21.12

Band	GSM1900					
Channel	512	661	810	512	661	810
Frequency (MHz)	1850.2	1880.0	1909.8	1850.2	1880.0	1909.8
	Head/Body mode			Hotspot Mode		
Maximum Burst-Averaged Output Power						
GSM (GMSK, 1Tx-slot)	29.94	30.09	30.06	26.01	26.15	25.94
GPRS (GMSK, 1Tx-slot)	29.80	29.95	29.92	25.95	26.09	25.88
GPRS (GMSK, 2Tx-slot)	26.57	26.72	26.69	22.57	22.71	22.50
GPRS (GMSK, 3Tx-slot)	25.32	25.47	25.44	21.44	21.58	21.37
GPRS (GMSK, 4Tx-slot)	23.99	24.14	24.11	20.20	20.34	20.13
EDGE (8PSK, 1Tx-slot)	25.03	25.18	25.15	25.12	25.26	25.05
EDGE (8PSK, 2Tx-slot)	22.47	22.62	22.59	22.35	22.49	22.28
EDGE (8PSK, 3Tx-slot)	21.35	21.50	21.47	21.19	21.33	21.12
EDGE (8PSK, 4Tx-slot)	20.13	20.28	20.25	19.92	20.06	19.85

FCC SAR Test Report

Band Channel	WCDMA Band II			WCDMA Band IV			3GPP MPR (dB)
	9262	9400	9538	1312	1413	1513	
Frequency (MHz)	1852.4	1880.0	1907.6	1712.4	1732.6	1752.6	
Head/Body mode							
RMC 12.2K	23.08	23.18	23.12	22.94	23.03	22.89	-
HSDPA Subtest-1	22.15	22.25	22.19	21.89	21.98	21.84	0
HSDPA Subtest-2	22.10	22.20	22.14	21.86	21.95	21.81	0
HSDPA Subtest-3	21.67	21.77	21.71	21.34	21.43	21.29	0.5
HSDPA Subtest-4	21.64	21.74	21.68	21.32	21.41	21.27	0.5
DC-HSDPA Subtest-1	22.11	22.22	22.16	21.87	21.94	21.82	0
DC-HSDPA Subtest-2	22.06	22.17	22.13	21.82	21.88	21.75	0
DC-HSDPA Subtest-3	21.63	21.71	21.69	21.36	21.39	21.28	0.5
DC-HSDPA Subtest-4	21.60	21.68	21.65	21.32	21.38	21.23	0.5
HSUPA Subtest-1	22.18	22.28	22.22	21.88	21.97	21.83	0
HSUPA Subtest-2	20.19	20.29	20.23	19.87	19.96	19.82	2
HSUPA Subtest-3	21.21	21.31	21.25	20.85	20.94	20.80	1
HSUPA Subtest-4	20.18	20.28	20.22	19.89	19.98	19.84	2
HSUPA Subtest-5	22.20	22.30	22.24	21.91	22.00	21.86	0
Hotspot Mode							
RMC 12.2K	17.22	17.52	17.48	18.87	18.93	18.83	-
HSDPA Subtest-1	16.24	16.54	16.50	17.83	17.89	17.79	-
HSDPA Subtest-2	16.22	16.52	16.48	17.79	17.85	17.75	-
HSDPA Subtest-3	15.79	16.09	16.05	17.34	17.40	17.30	-
HSDPA Subtest-4	15.74	16.04	16.00	17.30	17.36	17.26	-
DC-HSDPA Subtest-1	16.21	16.51	16.47	17.79	17.85	17.75	-
DC-HSDPA Subtest-2	16.17	16.47	16.43	17.75	17.81	17.71	-
DC-HSDPA Subtest-3	15.67	15.97	15.93	17.26	17.32	17.22	-
DC-HSDPA Subtest-4	15.62	15.92	15.88	17.25	17.31	17.21	-
HSUPA Subtest-1	16.17	16.47	16.43	17.84	17.90	17.80	-
HSUPA Subtest-2	14.25	14.55	14.51	15.83	15.89	15.79	-
HSUPA Subtest-3	15.23	15.53	15.49	16.81	16.87	16.77	-
HSUPA Subtest-4	14.26	14.56	14.52	15.86	15.92	15.82	-
HSUPA Subtest-5	16.20	16.50	16.46	17.84	17.90	17.80	-

Band Channel	WCDMA Band V			3GPP MPR (dB)
	4132	4182	4233	
Frequency (MHz)	826.4	836.4	846.6	
RMC 12.2K	23.00	23.18	22.97	-
HSDPA Subtest-1	21.80	21.98	21.77	0
HSDPA Subtest-2	21.77	21.95	21.74	0
HSDPA Subtest-3	21.33	21.51	21.30	0.5
HSDPA Subtest-4	21.31	21.49	21.28	0.5
DC-HSDPA Subtest-1	21.76	21.96	21.74	0
DC-HSDPA Subtest-2	21.75	21.87	21.69	0
DC-HSDPA Subtest-3	21.29	21.45	21.28	0.5
DC-HSDPA Subtest-4	21.29	21.43	21.24	0.5
HSUPA Subtest-1	21.88	22.06	21.85	0
HSUPA Subtest-2	19.87	20.05	19.84	2
HSUPA Subtest-3	20.88	21.06	20.85	1
HSUPA Subtest-4	19.88	20.06	19.85	2
HSUPA Subtest-5	21.82	22.00	21.79	0

FCC SAR Test Report

LTE Band 2															
Head/Body mode															
BW	MCS Index	RB Size	RB Offset	Low	Mid	High	3GPP MPR (dB)	BW	MCS Index	RB Size	RB Offset	Low	Mid	High	3GPP MPR (dB)
		Channel		18700	18900	19100				Channel		18675	18900	19125	
		Frequency (MHz)		1860.0	1880.0	1900.0				Frequency (MHz)		1857.5	1880.0	1902.5	
20M	QPSK	1	0	22.57	22.76	22.70	0	15M	QPSK	1	0	22.56	22.72	22.68	0
		1	50	22.36	22.55	22.49	0			1	37	22.26	22.46	22.49	0
		1	99	22.22	22.41	22.35	0			1	74	22.12	22.38	22.29	0
		50	0	21.49	21.68	21.62	1			36	0	21.43	21.67	21.56	1
		50	25	21.40	21.59	21.53	1			36	19	21.30	21.58	21.45	1
		50	50	21.32	21.51	21.45	1			36	39	21.31	21.46	21.44	1
		100	0	21.41	21.60	21.54	1			75	0	21.38	21.51	21.46	1
	16QAM	1	0	21.54	21.73	21.63	1		16QAM	1	0	21.45	21.56	21.54	1
		1	50	21.30	21.49	21.45	1			1	37	21.23	21.42	21.41	1
		1	99	21.18	21.32	21.34	1			1	74	21.18	21.26	21.24	1
		50	0	20.40	20.63	20.54	2			36	0	20.33	20.51	20.54	2
		50	25	20.40	20.49	20.47	2			36	19	20.31	20.51	20.41	2
		50	50	20.24	20.43	20.37	2			36	39	20.23	20.34	20.36	2
		100	0	20.33	20.60	20.44	2			75	0	20.28	20.47	20.42	2
	64QAM	1	0	20.54	20.68	20.68	2		64QAM	1	0	20.49	20.58	20.66	2
		1	50	20.29	20.54	20.41	2			1	37	20.21	20.49	20.39	2
		1	99	20.21	20.39	20.28	2			1	74	20.14	20.31	20.31	2
		50	0	19.44	19.68	19.61	3			36	0	19.38	19.65	19.53	3
		50	25	19.31	19.50	19.48	3			36	19	19.26	19.46	19.40	3
		50	50	19.27	19.48	19.43	3			36	39	19.25	19.44	19.35	3
		100	0	19.33	19.50	19.49	3			75	0	19.31	19.51	19.51	3
10M	QPSK	1	0	22.33	22.66	22.55	0	5M	QPSK	1	0	22.47	22.64	22.52	0
		1	24	22.21	22.52	22.38	0			1	12	22.23	22.47	22.28	0
		1	49	22.01	22.36	22.13	0			1	24	22.04	22.19	22.15	0
		25	0	21.32	21.55	21.52	1			12	0	21.28	21.60	21.37	1
		25	12	21.31	21.39	21.35	1			12	6	21.22	21.40	21.35	1
		25	25	21.10	21.34	21.36	1			12	13	21.28	21.38	21.22	1
		50	0	21.37	21.39	21.31	1			25	0	21.35	21.40	21.40	1
	16QAM	1	0	21.43	21.55	21.50	1		16QAM	1	0	21.49	21.56	21.57	1
		1	24	21.19	21.27	21.25	1			1	12	21.30	21.33	21.34	1
		1	49	21.06	21.27	21.21	1			1	24	21.07	21.24	21.19	1
		25	0	20.17	20.52	20.52	2			12	0	20.36	20.45	20.46	2
		25	12	20.21	20.48	20.50	2			12	6	20.22	20.37	20.42	2
		25	25	20.28	20.28	20.21	2			12	13	20.17	20.41	20.19	2
		50	0	20.32	20.43	20.33	2			25	0	20.14	20.29	20.23	2
	64QAM	1	0	20.40	20.54	20.57	2		64QAM	1	0	20.47	20.54	20.48	2
		1	24	20.19	20.34	20.44	2			1	12	20.10	20.35	20.26	2
		1	49	20.13	20.29	20.18	2			1	24	20.08	20.28	20.18	2
		25	0	19.26	19.59	19.56	3			12	0	19.30	19.42	19.50	3
		25	12	19.16	19.44	19.28	3			12	6	19.23	19.40	19.36	3
		25	25	19.05	19.31	19.21	3			12	13	19.12	19.45	19.41	3
		50	0	19.19	19.41	19.49	3			25	0	19.30	19.31	19.38	3
3M	QPSK	1	0	22.33	22.60	22.59	0	1.4M	QPSK	1	0	22.49	22.58	22.56	0
		1	7	22.24	22.50	22.34	0			1	2	22.20	22.45	22.26	0
		1	14	22.10	22.19	22.15	0			1	5	22.10	22.32	22.31	0
		8	0	21.27	21.61	21.57	1			3	0	22.32	22.57	22.47	0
		8	3	21.24	21.50	21.39	1			3	1	22.30	22.49	22.45	0
		8	7	21.25	21.34	21.41	1			3	3	22.23	22.47	22.31	0
		15	0	21.21	21.42	21.40	1			6	0	21.22	21.54	21.37	1
	16QAM	1	0	21.36	21.59	21.47	1		16QAM	1	0	21.43	21.63	21.44	1
		1	7	21.12	21.41	21.32	1			1	2	21.21	21.36	21.37	1
		1	14	21.09	21.20	21.20	1			1	5	21.03	21.17	21.29	1
		8	0	20.27	20.52	20.44	2			3	0	21.28	21.44	21.55	1
		8	3	20.27	20.41	20.27	2			3	1	21.25	21.43	21.36	1
		8	7	20.11	20.38	20.24	2			3	3	21.11	21.33	21.19	1
		15	0	20.28	20.45	20.25	2			6	0	20.27	20.33	20.44	2
	64QAM	1	0	20.32	20.57	20.56	2		64QAM	1	0	20.36	20.53	20.48	2
		1	7	20.24	20.48	20.38	2			1	2	20.17	20.47	20.32	2
		1	14	20.04	20.23	20.12	2			1	5	19.98	20.11	20.17	2
		8	0	19.35	19.56	19.44	3			3	0	20.26	20.51	20.52	2
		8	3	19.18	19.47	19.31	3			3	1	20.34	20.37	20.33	2
		8	7	19.11	19.37	19.27	3			3	3	20.18	20.24	20.33	2
		15	0	19.23	19.44	19.34	3			6	0	19.14	19.36	19.33	3

FCC SAR Test Report

LTE Band 2															
Hotspot Mode															
BW	MCS Index	RB Size	RB Offset	Low	Mid	High	3GPP MPR (dB)	BW	MCS Index	RB Size	RB Offset	Low	Mid	High	3GPP MPR (dB)
		Channel		18700	18900	19100				Channel		18675	18900	19125	
		Frequency (MHz)		1860.0	1880.0	1900.0				Frequency (MHz)		1857.5	1880.0	1902.5	
20M	QPSK	1	0	17.45	17.80	17.48	0	15M	QPSK	1	0	17.17	17.74	17.44	0
		1	50	17.19	17.74	17.42	0			1	37	17.16	17.68	17.41	0
		1	99	17.05	17.60	17.28	0			1	74	17.05	17.56	17.18	0
		50	0	16.39	16.94	16.62	1			36	0	16.31	16.87	16.52	1
		50	25	16.32	16.87	16.55	1			36	19	16.24	16.87	16.48	1
		50	50	16.23	16.78	16.46	1			36	39	16.20	16.68	16.43	1
		100	0	16.33	16.88	16.56	1			75	0	16.25	16.82	16.48	1
	16QAM	1	0	16.15	16.80	16.40	1		16QAM	1	0	16.10	16.71	16.33	1
		1	50	16.09	16.74	16.33	1			1	37	16.16	16.58	16.30	1
		1	99	16.01	16.55	16.18	1			1	74	15.93	16.50	16.13	1
		50	0	15.30	15.94	15.58	2			36	0	15.33	15.87	15.55	2
		50	25	15.29	15.86	15.46	2			36	19	15.26	15.77	15.45	2
		50	50	15.17	15.69	15.43	2			36	39	15.11	15.66	15.36	2
		100	0	15.30	15.83	15.50	2			75	0	15.26	15.76	15.51	2
	64QAM	1	0	17.45	17.80	17.48	2		64QAM	1	0	17.17	17.74	17.44	2
		1	50	17.19	17.74	17.42	2			1	37	17.16	17.68	17.41	2
		1	99	17.05	17.60	17.28	2			1	74	17.05	17.56	17.18	2
		50	0	16.39	16.94	16.62	3			36	0	16.31	16.87	16.52	3
		50	25	16.32	16.87	16.55	3			36	19	16.24	16.87	16.48	3
		50	50	16.23	16.78	16.46	3			36	39	16.20	16.68	16.43	3
		100	0	16.33	16.88	16.56	3			75	0	16.25	16.82	16.48	3
10M	QPSK	1	0	17.16	17.65	17.30	0	5M	QPSK	1	0	17.23	17.61	17.41	0
		1	24	17.02	17.63	17.21	0			1	12	17.01	17.57	17.31	0
		1	49	16.95	17.49	17.23	0			1	24	16.81	17.31	17.21	0
		25	0	16.23	16.79	16.49	1			12	0	16.18	16.73	16.60	1
		25	12	16.25	16.75	16.49	1			12	6	16.29	16.65	16.43	1
		25	25	16.06	16.68	16.34	1			12	13	16.13	16.53	16.34	1
		50	0	16.10	16.70	16.48	1			25	0	16.32	16.66	16.50	1
	16QAM	1	0	16.09	16.68	16.33	1		16QAM	1	0	16.12	16.68	16.29	1
		1	24	16.07	16.53	16.20	1			1	12	16.04	16.59	16.22	1
		1	49	15.95	16.32	16.07	1			1	24	15.80	16.51	16.22	1
		25	0	15.26	15.82	15.46	2			12	0	15.27	15.76	15.43	2
		25	12	15.15	15.76	15.33	2			12	6	15.16	15.61	15.31	2
		25	25	15.08	15.57	15.23	2			12	13	15.14	15.68	15.20	2
		50	0	15.08	15.75	15.30	2			25	0	15.20	15.66	15.34	2
	64QAM	1	0	17.16	17.65	17.30	2		64QAM	1	0	17.23	17.61	17.41	2
		1	24	17.02	17.63	17.21	2			1	12	17.01	17.57	17.31	2
		1	49	16.95	17.49	17.23	2			1	24	16.81	17.31	17.21	2
		25	0	16.23	16.79	16.49	3			12	0	16.18	16.73	16.60	3
		25	12	16.25	16.75	16.49	3			12	6	16.29	16.65	16.43	3
		25	25	16.06	16.68	16.34	3			12	13	16.13	16.53	16.34	3
		50	0	16.10	16.70	16.48	3			25	0	16.32	16.66	16.50	3
3M	QPSK	1	0	17.21	17.67	17.39	0	1.4M	QPSK	1	0	17.05	17.62	17.33	2
		1	7	17.06	17.60	17.22	0			1	2	17.11	17.71	17.32	0
		1	14	16.91	17.51	17.18	0			1	5	16.90	17.48	17.04	0
		8	0	16.26	16.78	16.48	1			3	0	17.32	17.77	17.51	0
		8	3	16.21	16.81	16.49	1			3	1	17.18	17.75	17.38	0
		8	7	16.07	16.63	16.39	1			3	3	17.09	17.69	17.41	0
		15	0	16.27	16.75	16.34	1			6	0	16.17	16.83	16.42	1
	16QAM	1	0	15.98	16.55	16.37	1		16QAM	1	0	16.17	16.64	16.23	1
		1	7	15.98	16.50	16.19	1			1	2	15.92	16.58	16.26	1
		1	14	15.83	16.34	16.05	1			1	5	15.73	16.39	16.19	1
		8	0	15.15	15.86	15.34	2			3	0	16.29	16.72	16.38	1
		8	3	15.27	15.77	15.35	2			3	1	16.19	16.75	16.36	1
		8	7	14.94	15.62	15.22	2			3	3	16.08	16.55	16.33	1
		15	0	15.10	15.84	15.41	2			6	0	15.20	15.75	15.49	2
	64QAM	1	0	17.21	17.67	17.39	2		64QAM	1	0	17.05	17.62	17.33	2
		1	7	17.06	17.60	17.22	2			1	2	17.11	17.71	17.32	2
		1	14	16.91	17.51	17.18	2			1	5	16.90	17.48	17.04	2
		8	0	16.26	16.78	16.48	3			3	0	17.32	17.77	17.51	2
		8	3	16.21	16.81	16.49	3			3	1	17.18	17.75	17.38	2
		8	7	16.07	16.63	16.39	3			3	3	17.09	17.69	17.41	2
		15	0	16.27	16.75	16.34	3			6	0	16.17	16.83	16.42	3

FCC SAR Test Report

LTE Band 4															
Head/Body mode															
BW	MCS Index	RB Size	RB Offset	Low	Mid	High	3GPP MPR (dB)	BW	MCS Index	RB Size	RB Offset	Low	Mid	High	3GPP MPR (dB)
		Channel		20050	20175	20300				Channel		20025	20175	20325	
		Frequency (MHz)		1720.0	1732.5	1745.0				Frequency (MHz)		1717.5	1732.5	1747.5	
20M	QPSK	1	0	22.64	22.69	22.63	0	15M	QPSK	1	0	22.57	22.61	22.57	0
		1	50	22.34	22.39	22.33	0			1	37	22.27	22.30	22.33	0
		1	99	22.26	22.31	22.25	0			1	74	22.18	22.26	22.19	0
		50	0	21.51	21.56	21.50	1			36	0	21.45	21.48	21.45	1
		50	25	21.42	21.47	21.41	1			36	19	21.33	21.41	21.36	1
		50	50	21.33	21.38	21.32	1			36	39	21.24	21.32	21.32	1
		100	0	21.41	21.46	21.40	1			75	0	21.31	21.46	21.33	1
	16QAM	1	0	21.54	21.65	21.58	1		16QAM	1	0	21.58	21.51	21.48	1
		1	50	21.29	21.37	21.27	1			1	37	21.31	21.28	21.21	1
		1	99	21.19	21.31	21.18	1			1	74	21.24	21.19	21.15	1
		50	0	20.49	20.56	20.42	2			36	0	20.46	20.41	20.46	2
		50	25	20.36	20.38	20.40	2			36	19	20.31	20.42	20.27	2
		50	50	20.31	20.29	20.32	2			36	39	20.15	20.32	20.23	2
		100	0	20.36	20.43	20.35	2			75	0	20.32	20.30	20.31	2
	64QAM	1	0	20.54	20.69	20.55	2		64QAM	1	0	20.50	20.61	20.44	2
		1	50	20.34	20.37	20.31	2			1	37	20.24	20.29	20.26	2
		1	99	20.23	20.23	20.24	2			1	74	20.20	20.12	20.07	2
		50	0	19.43	19.50	19.50	3			36	0	19.32	19.53	19.40	3
		50	25	19.33	19.46	19.38	3			36	19	19.37	19.29	19.30	3
		50	50	19.32	19.29	19.28	3			36	39	19.22	19.20	19.16	3
		100	0	19.41	19.40	19.33	3			75	0	19.23	19.38	19.31	3
10M	QPSK	1	0	22.54	22.65	22.52	0	5M	QPSK	1	0	22.60	22.52	22.44	0
		1	24	22.21	22.28	22.32	0			1	12	22.31	22.23	22.07	0
		1	49	22.09	22.24	22.22	0			1	24	22.21	22.17	22.07	0
		25	0	21.48	21.40	21.35	1			12	0	21.36	21.47	21.35	1
		25	12	21.31	21.31	21.18	1			12	6	21.25	21.30	21.25	1
		25	25	21.16	21.29	21.22	1			12	13	21.16	21.22	21.15	1
		50	0	21.29	21.31	21.29	1			25	0	21.28	21.33	21.24	1
	16QAM	1	0	21.36	21.61	21.54	1		16QAM	1	0	21.50	21.53	21.61	1
		1	24	21.18	21.28	21.08	1			1	12	21.03	21.32	21.22	1
		1	49	21.04	21.20	21.03	1			1	24	21.09	21.14	21.05	1
		25	0	20.47	20.37	20.30	2			12	0	20.32	20.37	20.39	2
		25	12	20.27	20.26	20.27	2			12	6	20.20	20.34	20.13	2
		25	25	20.32	20.15	20.13	2			12	13	20.16	20.25	20.16	2
		50	0	20.34	20.26	20.16	2			25	0	20.19	20.27	20.23	2
	64QAM	1	0	20.55	20.44	20.48	2		64QAM	1	0	20.42	20.61	20.48	2
		1	24	20.11	20.21	20.17	2			1	12	20.21	20.20	20.14	2
		1	49	20.00	20.07	20.07	2			1	24	20.13	20.17	20.18	2
		25	0	19.33	19.46	19.31	3			12	0	19.38	19.38	19.44	3
		25	12	19.16	19.24	19.30	3			12	6	19.27	19.25	19.23	3
		25	25	19.23	19.24	19.03	3			12	13	19.20	19.16	19.20	3
		50	0	19.17	19.36	19.23	3			25	0	19.21	19.17	19.27	3
3M	QPSK	1	0	22.53	22.61	22.56	0	1.4M	QPSK	1	0	22.47	22.57	22.53	0
		1	7	22.22	22.34	22.17	0			1	2	22.19	22.25	22.29	0
		1	14	22.19	22.25	22.18	0			1	5	22.12	22.22	22.18	0
		8	0	21.40	21.34	21.42	1			3	0	22.41	22.39	22.45	0
		8	3	21.30	21.39	21.27	1			3	1	22.20	22.39	22.30	0
		8	7	21.13	21.33	21.27	1			3	3	22.24	22.19	22.18	0
		15	0	21.33	21.35	21.16	1			6	0	21.40	21.44	21.30	1
	16QAM	1	0	21.30	21.38	21.56	1		16QAM	1	0	21.46	21.52	21.44	1
		1	7	21.23	21.31	21.10	1			1	2	21.18	21.14	21.13	1
		1	14	21.12	21.13	21.05	1			1	5	21.01	21.12	21.13	1
		8	0	20.31	20.41	20.41	2			3	0	21.42	21.42	21.42	1
		8	3	20.22	20.44	20.16	2			3	1	21.24	21.26	21.13	1
		8	7	20.20	20.21	20.25	2			3	3	21.19	21.17	21.14	1
		15	0	20.24	20.19	20.14	2			6	0	20.19	20.20	20.31	2
	64QAM	1	0	20.55	20.49	20.36	2		64QAM	1	0	20.47	20.63	20.49	2
		1	7	20.03	20.14	20.12	2			1	2	20.17	20.28	20.14	2
		1	14	20.13	20.19	19.98	2			1	5	20.04	20.23	20.09	2
		8	0	19.42	19.31	19.37	3			3	0	20.22	20.45	20.33	2
		8	3	19.25	19.30	19.23	3			3	1	20.29	20.37	20.23	2
		8	7	19.03	19.21	19.05	3			3	3	20.31	20.17	20.10	2
		15	0	19.26	19.31	19.16	3			6	0	19.28	19.25	19.28	3

FCC SAR Test Report

LTE Band 4																	
Hotspot Mode																	
BW	MCS Index	RB Size	RB Offset	Low	Mid	High	3GPP MPR (dB)	BW	MCS Index	RB Size	RB Offset	Low	Mid	High	3GPP MPR (dB)		
		Channel		20050	20175	20300				Channel		20025	20175	20325			
		Frequency (MHz)		1720.0	1732.5	1745.0				Frequency (MHz)		1717.5	1732.5	1747.5			
20M	QPSK	1	0	17.78	17.93	17.89	0	15M	QPSK	1	0	17.68	17.86	17.89	0		
		1	50	17.60	17.75	17.71	0			1	37	17.53	17.75	17.66	0		
		1	99	17.68	17.83	17.79	0			1	74	17.68	17.74	17.72	0		
		50	0	16.77	16.92	16.88	1			36	0	16.67	16.85	16.83	1		
		50	25	16.71	16.86	16.82	1			36	19	16.64	16.84	16.74	1		
		50	50	16.65	16.80	16.76	1			36	39	16.61	16.73	16.68	1		
	100	0	16.69	16.84	16.80	1	75		0	16.62	16.76	16.70	1				
	16QAM	1	0	16.73	16.89	16.84	1		16QAM	1	0	16.68	16.81	16.79	1		
		1	50	16.57	16.75	16.70	1			1	37	16.47	16.64	16.60	1		
		1	99	16.59	16.80	16.73	1			1	74	16.51	16.67	16.68	1		
		50	0	15.71	15.82	15.82	2			36	0	15.67	15.88	15.81	2		
		50	25	15.68	15.79	15.72	2			36	19	15.63	15.78	15.79	2		
		50	50	15.62	15.70	15.66	2			36	39	15.50	15.71	15.64	2		
	100	0	15.61	15.83	15.76	2	75		0	15.61	15.80	15.71	2				
	64QAM	1	0	17.78	17.93	17.89	2		64QAM	1	0	17.68	17.86	17.89	2		
		1	50	17.60	17.75	17.71	2			1	37	17.53	17.75	17.66	2		
		1	99	17.68	17.83	17.79	2			1	74	17.68	17.74	17.72	2		
		50	0	16.77	16.92	16.88	3			36	0	16.67	16.85	16.83	3		
		50	25	16.71	16.86	16.82	3			36	19	16.64	16.84	16.74	3		
		50	50	16.65	16.80	16.76	3			36	39	16.61	16.73	16.68	3		
	100	0	16.69	16.84	16.80	3	75		0	16.62	16.76	16.70	3				
	10M	QPSK	1	0	17.65	17.90	17.74		0	5M	QPSK	1	0	17.73	17.91	17.82	0
			1	24	17.42	17.58	17.58		0			1	12	17.56	17.60	17.58	0
			1	49	17.49	17.75	17.73		0			1	24	17.55	17.68	17.60	0
25			0	16.65	16.82	16.70	1	12	0			16.61	16.70	16.75	1		
25			12	16.64	16.83	16.63	1	12	6			16.62	16.74	16.65	1		
25			25	16.57	16.63	16.57	1	12	13			16.60	16.66	16.66	1		
50		0	16.55	16.81	16.66	1	25	0	16.47		16.72	16.70	1				
16QAM		1	0	16.62	16.70	16.74	1	16QAM	1		0	16.58	16.76	16.84	1		
		1	24	16.45	16.61	16.51	1		1		12	16.46	16.59	16.48	1		
		1	49	16.64	16.60	16.64	1		1		24	16.51	16.66	16.68	1		
		25	0	15.63	15.63	15.72	2		12		0	15.68	15.75	15.70	2		
		25	12	15.51	15.67	15.55	2		12		6	15.54	15.71	15.62	2		
		25	25	15.40	15.56	15.66	2		12		13	15.47	15.61	15.74	2		
50		0	15.49	15.66	15.64	2	25	0	15.43		15.73	15.61	2				
64QAM		1	0	17.65	17.90	17.74	2	64QAM	1		0	17.73	17.91	17.82	2		
		1	24	17.42	17.58	17.58	2		1		12	17.56	17.60	17.58	2		
		1	49	17.49	17.75	17.73	2		1		24	17.55	17.68	17.60	2		
		25	0	16.65	16.82	16.70	3		12		0	16.61	16.70	16.75	3		
		25	12	16.64	16.83	16.63	3		12		6	16.62	16.74	16.65	3		
		25	25	16.57	16.63	16.57	3		12		13	16.60	16.66	16.66	3		
50		0	16.55	16.81	16.66	3	25	0	16.47		16.72	16.70	3				
3M		QPSK	1	0	17.71	17.76	17.71	0	1.4M		QPSK	1	0	17.66	17.91	17.74	2
			1	7	17.58	17.56	17.60	0				1	2	17.44	17.67	17.59	0
			1	14	17.57	17.66	17.58	0				1	5	17.56	17.69	17.73	0
	8		0	16.65	16.67	16.81	1	3		0		17.55	17.83	17.78	0		
	8		3	16.54	16.77	16.76	1	3		1		17.61	17.71	17.64	0		
	8		7	16.49	16.57	16.71	1	3		3		17.56	17.65	17.51	0		
	15	0	16.52	16.61	16.70	1	6	0		16.54	16.75	16.77	1				
	16QAM	1	0	16.63	16.79	16.74	1	16QAM		1	0	16.53	16.76	16.61	1		
		1	7	16.51	16.48	16.50	1			1	2	16.50	16.55	16.55	1		
		1	14	16.45	16.64	16.61	1			1	5	16.48	16.66	16.68	1		
		8	0	15.62	15.75	15.73	2			3	0	16.66	16.88	16.70	1		
		8	3	15.50	15.60	15.68	2			3	1	16.54	16.75	16.59	1		
		8	7	15.45	15.64	15.50	2			3	3	16.50	16.67	16.62	1		
	15	0	15.48	15.54	15.68	2	6	0		15.40	15.69	15.63	2				
	64QAM	1	0	17.71	17.76	17.71	2	64QAM		1	0	17.66	17.91	17.74	2		
		1	7	17.58	17.56	17.60	2			1	2	17.44	17.67	17.59	2		
		1	14	17.57	17.66	17.58	2			1	5	17.56	17.69	17.73	2		
		8	0	16.65	16.67	16.81	3			3	0	17.55	17.83	17.78	2		
		8	3	16.54	16.77	16.76	3			3	1	17.61	17.71	17.64	2		
		8	7	16.49	16.57	16.71	3			3	3	17.56	17.65	17.51	2		
	15	0	16.52	16.61	16.70	3	6	0		16.54	16.75	16.77	3				

FCC SAR Test Report

LTE Band 5															
BW	MCS Index	RB Size	RB Offset	Low	Mid	High	3GPP MPR (dB)	BW	MCS Index	RB Size	RB Offset	Low	Mid	High	3GPP MPR (dB)
		Channel		20450	20525	20600				Channel		20425	20525	20625	
		Frequency (MHz)		829.0	836.5	844.0				Frequency (MHz)		826.5	836.5	846.5	
10M	QPSK	1	0	22.57	22.75	22.61	0	5M	QPSK	1	0	22.54	22.73	22.54	0
		1	24	22.38	22.56	22.42	0			1	12	22.36	22.55	22.33	0
		1	49	22.45	22.63	22.49	0			1	24	22.43	22.54	22.44	0
		25	0	21.44	21.62	21.48	1			12	0	21.44	21.58	21.44	1
		25	12	21.41	21.59	21.45	1			12	6	21.32	21.51	21.44	1
		25	25	21.38	21.56	21.42	1			12	13	21.36	21.50	21.42	1
	50	0	21.43	21.61	21.47	1	25		0	21.37	21.52	21.45	1		
	16QAM	1	0	21.54	21.67	21.53	1		16QAM	1	0	21.43	21.72	21.46	1
		1	24	21.34	21.46	21.32	1			1	12	21.30	21.47	21.34	1
		1	49	21.45	21.56	21.43	1			1	24	21.37	21.50	21.41	1
		25	0	20.39	20.60	20.42	2			12	0	20.25	20.52	20.33	2
		25	12	20.32	20.49	20.36	2			12	6	20.29	20.57	20.28	2
		25	25	20.37	20.55	20.41	2			12	13	20.21	20.46	20.35	2
	50	0	20.34	20.55	20.39	2	25		0	20.32	20.42	20.41	2		
	64QAM	1	0	20.48	20.49	20.57	2		64QAM	1	0	20.45	20.41	20.42	2
		1	24	20.24	20.17	20.12	2			1	12	20.24	20.33	20.21	2
		1	49	20.03	20.14	20.09	2			1	24	20.16	20.16	20.05	2
		25	0	19.43	19.41	19.41	3			12	0	19.28	19.35	19.23	3
		25	12	19.28	19.34	19.21	3			12	6	19.27	19.32	19.08	3
		25	25	19.16	19.27	19.29	3			12	13	19.19	19.18	19.09	3
	50	0	19.22	19.29	19.28	3	25		0	19.33	19.20	19.26	3		
3M	QPSK	1	0	22.44	22.57	22.49	0	1.4M	QPSK	1	0	22.50	22.60	22.48	0
		1	7	22.29	22.51	22.27	0			1	2	22.20	22.35	22.22	0
		1	14	22.36	22.48	22.36	0			1	5	22.32	22.48	22.42	0
		8	0	21.34	21.51	21.25	1			3	0	22.37	22.51	22.42	0
		8	3	21.22	21.58	21.26	1			3	1	22.30	22.56	22.23	0
		8	7	21.33	21.36	21.32	1			3	3	22.18	22.55	22.26	0
	15	0	21.29	21.49	21.40	1	6		0	21.25	21.47	21.37	1		
	16QAM	1	0	21.38	21.57	21.35	1		16QAM	1	0	21.46	21.50	21.36	1
		1	7	21.22	21.46	21.31	1			1	2	21.11	21.42	21.23	1
		1	14	21.22	21.46	21.15	1			1	5	21.36	21.43	21.31	1
		8	0	20.14	20.49	20.28	2			3	0	21.25	21.59	21.34	1
		8	3	20.19	20.46	20.39	2			3	1	21.19	21.44	21.23	1
		8	7	20.26	20.41	20.24	2			3	3	21.16	21.30	21.31	1
	15	0	20.15	20.32	20.43	2	6		0	20.30	20.44	20.30	2		
	64QAM	1	0	20.44	20.54	20.36	2		64QAM	1	0	20.45	20.59	20.43	2
		1	7	20.19	20.14	20.18	2			1	2	20.19	20.28	20.20	2
		1	14	20.17	20.31	20.17	2			1	5	20.14	20.16	20.07	2
		8	0	19.38	19.28	19.32	3			3	0	20.29	20.31	20.26	2
		8	3	19.33	19.29	19.16	3			3	1	20.28	20.21	20.25	2
		8	7	19.17	19.15	19.14	3			3	3	20.09	20.36	20.19	2
		15	0	19.32	19.26	19.17	3			6	0	19.22	19.27	19.10	3

FCC SAR Test Report

LTE Band 7																	
Head/Body mode																	
BW	MCS Index	RB Size	RB Offset	Low	Mid	High	3GPP MPR (dB)	BW	MCS Index	RB Size	RB Offset	Low	Mid	High	3GPP MPR (dB)		
		Channel		20850	21100	21350				Channel		20825	21100	21375			
		Frequency (MHz)		2510.0	2535.0	2560.0				Frequency (MHz)		2507.5	2535.0	2562.5			
20M	QPSK	1	0	21.13	21.17	21.08	0	15M	QPSK	1	0	21.04	21.15	21.01	0		
		1	50	21.01	21.05	20.96	0			1	37	20.99	21.02	20.86	0		
		1	99	20.97	21.01	20.92	0			1	74	20.91	21.00	20.86	0		
		50	0	20.07	20.11	20.02	1			36	0	20.04	20.09	19.99	1		
		50	25	20.05	20.09	20.00	1			36	19	19.95	20.05	19.98	1		
		50	50	20.02	20.06	19.97	1			36	39	19.94	19.97	19.93	1		
		100	0	20.04	20.08	19.99	1			75	0	20.04	20.05	19.92	1		
	16QAM	1	0	20.13	20.17	20.08	1		16QAM	1	0	20.00	19.99	19.94	1		
		1	50	19.96	20.04	19.91	1			1	37	19.94	19.91	19.77	1		
		1	99	19.94	19.94	19.86	1			1	74	19.92	19.88	19.85	1		
		50	0	19.07	19.08	18.93	2			36	0	19.01	18.96	18.94	2		
		50	25	19.05	19.03	18.99	2			36	19	18.91	18.96	18.91	2		
		50	50	19.00	19.06	18.89	2			36	39	18.98	18.96	18.78	2		
		100	0	18.99	19.02	18.97	2			75	0	18.90	19.02	18.86	2		
	64QAM	1	0	19.09	19.15	19.00	2		64QAM	1	0	19.04	19.05	18.98	2		
		1	50	18.91	19.00	18.91	2			1	37	18.98	18.95	18.92	2		
		1	99	18.88	18.96	18.83	2			1	74	18.93	18.89	18.82	2		
		50	0	18.01	18.06	17.98	3			36	0	17.95	17.97	17.93	3		
		50	25	17.97	17.99	17.92	3			36	19	17.94	17.99	17.94	3		
		50	50	17.92	18.02	17.89	3			36	39	17.86	18.00	17.89	3		
		100	0	18.00	18.05	17.91	3			75	0	17.92	17.97	17.88	3		
	10M	QPSK	RB Size	RB Offset	Low	Mid	High		3GPP MPR (dB)	BW	MCS Index	RB Size	RB Offset	Low	Mid	High	3GPP MPR (dB)
			Channel		20800	21100	21400					Channel		20775	21100	21425	
			Frequency (MHz)		2505.0	2535.0	2565.0					Frequency (MHz)		2502.5	2535.0	2567.5	
10M			QPSK	1	0	20.91	21.04	20.96	0	5M	QPSK	1	0	20.93	21.06	20.86	0
				1	24	20.83	20.94	20.79	0			1	12	20.83	20.93	20.80	0
				1	49	20.82	20.84	20.70	0			1	24	20.77	20.96	20.71	0
				25	0	20.00	20.05	19.92	1			12	0	19.97	19.96	19.91	1
		25		12	19.84	19.86	19.97	1	12			6	19.97	19.92	19.73	1	
		25		25	19.84	19.92	19.79	1	12			13	19.93	20.02	19.76	1	
		50		0	19.98	19.85	19.83	1	25			0	19.96	19.92	19.72	1	
		16QAM	1	0	19.95	20.05	19.79	1	16QAM		1	0	19.98	19.98	19.92	1	
			1	24	19.83	19.75	19.83	1			1	12	19.93	20.02	19.77	1	
			1	49	19.83	19.77	19.86	1			1	24	19.82	19.83	19.70	1	
			25	0	18.82	18.93	18.89	2			12	0	18.91	18.96	18.75	2	
			25	12	18.88	18.96	18.72	2			12	6	18.94	18.94	18.81	2	
			25	25	18.87	18.90	18.82	2			12	13	18.87	18.85	18.77	2	
			50	0	18.80	18.90	18.82	2			25	0	18.89	18.94	18.82	2	
		64QAM	1	0	19.00	18.99	18.88	2	64QAM		1	0	18.85	19.05	18.86	2	
			1	24	18.69	18.77	18.73	2			1	12	18.83	18.84	18.88	2	
			1	49	18.84	18.79	18.82	2			1	24	18.72	18.80	18.77	2	
			25	0	17.96	17.88	17.83	3			12	0	17.86	18.03	17.69	3	
			25	12	17.79	17.85	17.84	3			12	6	17.86	17.82	17.77	3	
			25	25	17.94	17.86	17.73	3			12	13	17.73	17.84	17.82	3	
			50	0	17.85	17.88	17.97	3			25	0	17.85	17.89	17.87	3	

FCC SAR Test Report

LTE Band 7																	
Hotspot Mode																	
BW	MCS Index	RB Size	RB Offset	Low	Mid	High	3GPP MPR (dB)	BW	MCS Index	RB Size	RB Offset	Low	Mid	High	3GPP MPR (dB)		
		Channel		20850	21100	21350				Channel		20825	21100	21375			
		Frequency (MHz)		2510.0	2535.0	2560.0				Frequency (MHz)		2507.5	2535.0	2562.5			
20M	QPSK	1	0	18.55	18.66	18.53	0	15M	QPSK	1	0	18.49	18.60	18.45	0		
		1	50	18.36	18.47	18.34	0			1	37	18.30	18.39	18.24	0		
		1	99	18.33	18.44	18.31	0			1	74	18.27	18.39	18.21	0		
		50	0	17.43	17.54	17.41	1			36	0	17.42	17.53	17.32	1		
		50	25	17.39	17.50	17.37	1			36	19	17.38	17.40	17.28	1		
		50	50	17.38	17.49	17.36	1			36	39	17.37	17.43	17.33	1		
		100	0	17.40	17.51	17.38	1			75	0	17.37	17.42	17.31	1		
	16QAM	1	0	17.46	17.59	17.43	1		16QAM	1	0	17.47	17.57	17.39	1		
		1	50	17.28	17.44	17.32	1			1	37	17.27	17.47	17.25	1		
		1	99	17.33	17.41	17.21	1			1	74	17.15	17.36	17.19	1		
		50	0	16.33	16.48	16.39	2			36	0	16.31	16.48	16.27	2		
		50	25	16.33	16.48	16.30	2			36	19	16.32	16.46	16.24	2		
		50	50	16.29	16.42	16.29	2			36	39	16.33	16.43	16.33	2		
		100	0	16.32	16.51	16.36	2			75	0	16.28	16.37	16.23	2		
	64QAM	1	0	18.55	18.66	18.53	2		64QAM	1	0	18.49	18.60	18.45	2		
		1	50	18.36	18.47	18.34	2			1	37	18.30	18.39	18.24	2		
		1	99	18.33	18.44	18.31	2			1	74	18.27	18.39	18.21	2		
		50	0	17.43	17.54	17.41	3			36	0	17.42	17.53	17.32	3		
		50	25	17.39	17.50	17.37	3			36	19	17.38	17.40	17.28	3		
		50	50	17.38	17.49	17.36	3			36	39	17.37	17.43	17.33	3		
		100	0	17.40	17.51	17.38	3			75	0	17.37	17.42	17.31	3		
	BW	MCS Index	RB Size	RB Offset	Low	Mid	High		3GPP MPR (dB)	BW	MCS Index	RB Size	RB Offset	Low	Mid	High	3GPP MPR (dB)
			Channel		20800	21100	21400					Channel		20775	21100	21425	
			Frequency (MHz)		2505.0	2535.0	2565.0					Frequency (MHz)		2502.5	2535.0	2567.5	
10M	QPSK	1	0	18.35	18.62	18.47	0	5M	QPSK	1	0	18.46	18.49	18.43	0		
		1	24	18.17	18.38	18.18	0			1	12	18.28	18.36	18.18	0		
		1	49	18.27	18.28	18.22	0			1	24	18.13	18.26	18.23	0		
		25	0	17.30	17.38	17.34	1			12	0	17.31	17.39	17.19	1		
		25	12	17.25	17.45	17.30	1			12	6	17.33	17.43	17.25	1		
		25	25	17.18	17.25	17.29	1			12	13	17.22	17.37	17.16	1		
		50	0	17.20	17.35	17.22	1			25	0	17.33	17.47	17.09	1		
	16QAM	1	0	17.22	17.57	17.26	1		16QAM	1	0	17.32	17.54	17.39	1		
		1	24	17.31	17.38	17.25	1			1	12	17.26	17.24	17.20	1		
		1	49	17.16	17.27	17.21	1			1	24	17.18	17.35	17.13	1		
		25	0	16.28	16.40	16.15	2			12	0	16.28	16.35	16.12	2		
		25	12	16.05	16.27	16.22	2			12	6	16.21	16.26	16.25	2		
		25	25	16.15	16.20	16.31	2			12	13	16.14	16.40	16.05	2		
		50	0	16.26	16.32	16.17	2			25	0	16.14	16.38	16.12	2		
	64QAM	1	0	18.35	18.62	18.47	2		64QAM	1	0	18.46	18.49	18.43	2		
		1	24	18.17	18.38	18.18	2			1	12	18.28	18.36	18.18	2		
		1	49	18.27	18.28	18.22	2			1	24	18.13	18.26	18.23	2		
		25	0	17.30	17.38	17.34	3			12	0	17.31	17.39	17.19	3		
		25	12	17.25	17.45	17.30	3			12	6	17.33	17.43	17.25	3		
		25	25	17.18	17.25	17.29	3			12	13	17.22	17.37	17.16	3		
		50	0	17.20	17.35	17.22	3			25	0	17.33	17.47	17.09	3		

FCC SAR Test Report

LTE Band 12																
BW	MCS Index	RB Size	RB Offset	Low	Mid	High	3GPP MPR (dB)	BW	MCS Index	RB Size	RB Offset	Low	Mid	High	3GPP MPR (dB)	
		Channel		23060	23095	23130				Channel		23035	23095	23155		
		Frequency (MHz)		704.0	707.5	711.0				Frequency (MHz)		701.5	707.5	713.5		
10M	QPSK	1	0	22.62	22.75	22.71	0	5M	QPSK	1	0	22.62	22.73	22.65	0	
		1	24	22.61	22.74	22.70	0			1	12	22.59	22.71	22.69	0	
		1	49	22.59	22.72	22.68	0			1	24	22.51	22.72	22.66	0	
		25	0	21.69	21.82	21.78	1			12	0	21.59	21.78	21.68	1	
		25	12	21.66	21.79	21.75	1			12	6	21.58	21.73	21.69	1	
		25	25	21.63	21.76	21.72	1			12	13	21.54	21.70	21.64	1	
	16QAM	50	0	21.64	21.77	21.73	1		25	0	21.64	21.76	21.63	1		
		1	0	21.59	21.68	21.63	1		16QAM	1	0	21.51	21.67	21.59	1	
		1	24	21.58	21.72	21.68	1			1	12	21.49	21.57	21.61	1	
		1	49	21.58	21.65	21.65	1			1	24	21.49	21.59	21.49	1	
		25	0	20.63	20.74	20.73	2			12	0	20.65	20.67	20.77	2	
		25	12	20.63	20.77	20.74	2			12	6	20.54	20.76	20.59	2	
	25	25	20.59	20.75	20.62	2	12			13	20.56	20.60	20.54	2		
	64QAM	50	0	20.64	20.69	20.68	2		25	0	20.60	20.62	20.68	2		
		1	0	20.35	20.60	20.52	2		64QAM	1	0	20.42	20.65	20.57	2	
		1	24	20.52	20.52	20.60	2			1	12	20.45	20.56	20.49	2	
		1	49	20.34	20.57	20.45	2			1	24	20.31	20.54	20.60	2	
		25	0	19.60	19.62	19.63	3			12	0	19.55	19.65	19.59	3	
		25	12	19.60	19.51	19.60	3			12	6	19.51	19.62	19.66	3	
	25	25	19.39	19.60	19.56	3	12			13	19.35	19.52	19.51	3		
	50	0	19.45	19.59	19.63	3	25		0	19.36	19.61	19.50	3			
3M	QPSK	RB Size	RB Offset	Low	Mid	High	3GPP MPR (dB)	BW	MCS Index	RB Size	RB Offset	Low	Mid	High	3GPP MPR (dB)	
		Channel		23025	23095	23165				Channel		23017	23095	23173		
		Frequency (MHz)		700.5	707.5	714.5				Frequency (MHz)		699.7	707.5	715.3		
		QPSK	1	0	22.54	22.68	22.55	0	1.4M	QPSK	1	0	22.46	22.70	22.63	0
			1	7	22.42	22.64	22.53	0			1	2	22.39	22.52	22.46	0
			1	14	22.39	22.62	22.48	0			1	5	22.39	22.58	22.54	0
	8		0	21.59	21.66	21.58	1	3			0	22.49	22.71	22.65	0	
	8		3	21.46	21.62	21.64	1	3			1	22.58	22.66	22.53	0	
	8		7	21.60	21.62	21.60	1	3			3	22.50	22.64	22.64	0	
	16QAM	15	0	21.53	21.59	21.62	1	6		0	21.45	21.72	21.70	1		
		1	0	21.33	21.56	21.57	1	16QAM		1	0	21.56	21.53	21.48	1	
		1	7	21.40	21.62	21.54	1			1	2	21.42	21.53	21.59	1	
		1	14	21.49	21.44	21.49	1			1	5	21.33	21.55	21.56	1	
		8	0	20.53	20.65	20.70	2			3	0	21.48	21.68	21.69	1	
		8	3	20.52	20.44	20.66	2			3	1	21.47	21.74	21.68	1	
	8	7	20.49	20.63	20.50	2	3			3	21.57	21.52	21.52	1		
	64QAM	15	0	20.51	20.52	20.46	2	6		0	20.52	20.58	20.56	2		
		1	0	20.49	20.45	20.43	2	64QAM		1	0	20.40	20.47	20.48	2	
		1	7	20.45	20.57	20.57	2			1	2	20.46	20.51	20.57	2	
		1	14	20.44	20.49	20.40	2			1	5	20.29	20.51	20.42	2	
		8	0	19.49	19.78	19.55	3			3	0	20.56	20.74	20.64	2	
		8	3	19.50	19.52	19.48	3			3	1	20.53	20.67	20.66	2	
	8	7	19.54	19.59	19.64	3	3			3	20.48	20.48	20.41	2		
	15	0	19.49	19.65	19.56	3	6	0		19.41	19.67	19.52	3			

FCC SAR Test Report

LTE Band 13														
BW	MCS Index	RB Size	RB Offset	Mid	3GPP MPR (dB)	BW	MCS Index	RB Size	RB Offset	Low	Mid	High	3GPP MPR (dB)	
		Channel						23230	Channel		23205	23230		23225
		Frequency (MHz)						782.0	Frequency (MHz)		779.5	782.0		784.5
10M	QPSK	1	0	22.55	0	5M	QPSK	1	0	22.38	22.50	22.39	0	
		1	24	22.44	0			1	12	22.27	22.39	22.28	0	
		1	49	22.42	0			1	24	22.25	22.37	22.26	0	
		25	0	21.48	1			12	0	21.31	21.43	21.32	1	
		25	12	21.43	1			12	6	21.26	21.38	21.27	1	
		25	25	21.41	1			12	13	21.24	21.36	21.25	1	
	50	0	21.42	1	25		0	21.25	21.37	21.26	1			
	16QAM	1	0	21.51	1		16QAM	1	0	21.31	21.49	21.33	1	
		1	24	21.44	1			1	12	21.26	21.30	21.24	1	
		1	49	21.41	1			1	24	21.17	21.33	21.24	1	
		25	0	20.46	2			12	0	20.25	20.43	20.27	2	
		25	12	20.38	2			12	6	20.25	20.33	20.18	2	
		25	25	20.33	2			12	13	20.14	20.33	20.17	2	
	50	0	20.33	2	25		0	20.24	20.34	20.18	2			
	64QAM	1	0	20.29	2		64QAM	1	0	20.38	20.43	20.30	2	
		1	24	20.33	2			1	12	20.25	20.37	20.22	2	
		1	49	20.30	2			1	24	20.24	20.31	20.22	2	
		25	0	19.32	3			12	0	19.24	19.36	19.25	3	
		25	12	19.18	3			12	6	19.20	19.35	19.25	3	
		25	25	19.25	3			12	13	19.18	19.27	19.20	3	
	50	0	19.18	3	25		0	19.25	19.37	19.20	3			

LTE Band 17															
BW	MCS Index	RB Size	RB Offset	Low	Mid	High	3GPP MPR (dB)	BW	MCS Index	RB Size	RB Offset	Low	Mid	High	3GPP MPR (dB)
		Channel		23780	23790	23800				Channel		23755	23790	23825	
		Frequency (MHz)		709.0	710.0	711.0				Frequency (MHz)		706.5	710.0	713.5	
10M	QPSK	1	0	22.69	22.70	22.65	0	5M	QPSK	1	0	22.69	22.65	22.59	0
		1	24	22.60	22.61	22.56	0			1	12	22.55	22.57	22.48	0
		1	49	22.57	22.58	22.53	0			1	24	22.52	22.56	22.52	0
		25	0	21.67	21.68	21.63	1			12	0	21.67	21.68	21.54	1
		25	12	21.66	21.67	21.62	1			12	6	21.58	21.64	21.57	1
		25	25	21.64	21.65	21.60	1			12	13	21.58	21.55	21.57	1
	50	0	21.63	21.64	21.59	1	25		0	21.63	21.59	21.51	1		
	16QAM	1	0	21.59	21.65	21.61	1		16QAM	1	0	21.58	21.59	21.52	1
		1	24	21.59	21.56	21.46	1			1	12	21.53	21.50	21.41	1
		1	49	21.54	21.58	21.43	1			1	24	21.49	21.46	21.46	1
		25	0	20.66	20.58	20.60	2			12	0	20.52	20.60	20.49	2
		25	12	20.61	20.66	20.56	2			12	6	20.57	20.58	20.50	2
		25	25	20.54	20.57	20.51	2			12	13	20.50	20.57	20.51	2
	50	0	20.63	20.55	20.50	2	25		0	20.62	20.57	20.44	2		
	64QAM	1	0	20.59	20.46	20.40	2		64QAM	1	0	20.48	20.44	20.64	2
		1	24	20.33	20.56	20.23	2			1	12	20.46	20.41	20.42	2
		1	49	20.40	20.49	20.40	2			1	24	20.44	20.43	20.22	2
		25	0	19.58	19.50	19.42	3			12	0	19.59	19.55	19.54	3
		25	12	19.53	19.46	19.39	3			12	6	19.44	19.61	19.46	3
		25	25	19.39	19.38	19.37	3			12	13	19.40	19.35	19.37	3
	50	0	19.45	19.54	19.38	3	25		0	19.53	19.44	19.44	3		

FCC SAR Test Report

LTE Band 38																	
BW	MCS Index	RB Size	RB Offset	Low	Mid	High	3GPP MPR (dB)	BW	MCS Index	RB Size	RB Offset	Low	Mid	High	3GPP MPR (dB)		
		Channel		37850	38000	38150				Channel		37825	38000	38175			
		Frequency (MHz)		2580	2595	2610				Frequency (MHz)		2577.5	2595	2612.5			
20M	QPSK	1	0	22.35	22.50	22.42	0	15M	QPSK	1	0	22.27	22.48	22.39	0		
		1	50	22.20	22.35	22.27	0			1	37	22.13	22.25	22.23	0		
		1	99	22.11	22.26	22.18	0			1	74	22.08	22.17	22.08	0		
		50	0	21.21	21.36	21.28	1			36	0	21.15	21.30	21.19	1		
		50	25	21.18	21.33	21.25	1			36	19	21.15	21.27	21.20	1		
		50	50	21.14	21.29	21.21	1			36	39	21.13	21.23	21.20	1		
	16QAM	100	0	21.00	21.15	21.07	1		75	0	20.96	21.14	20.98	1			
		1	0	21.26	21.41	21.37	1		16QAM	1	0	21.23	21.45	21.26	1		
		1	50	21.10	21.27	21.26	1			1	37	21.05	21.31	21.19	1		
		1	99	21.10	21.21	21.16	1			1	74	21.06	21.19	21.06	1		
		50	0	20.21	20.33	20.21	2			36	0	20.12	20.26	20.22	2		
		50	25	20.15	20.31	20.25	2			36	19	20.01	20.29	20.12	2		
	50	50	20.08	20.29	20.21	2	36			39	20.07	20.10	20.08	2			
	64QAM	100	0	19.95	20.14	20.07	2		75	0	19.87	19.97	19.94	2			
		1	0	20.33	20.42	20.33	2		64QAM	1	0	20.27	20.36	20.28	2		
		1	50	20.10	20.35	20.22	2			1	37	20.16	20.21	20.13	2		
		1	99	20.08	20.19	20.14	2			1	74	20.10	20.16	20.11	2		
		50	0	19.15	19.35	19.23	3			36	0	19.05	19.34	19.11	3		
		50	25	19.16	19.32	19.20	3			36	19	19.12	19.18	19.13	3		
	50	50	19.12	19.23	19.20	3	36			39	19.00	19.11	19.04	3			
	10M	QPSK	100	0	18.90	19.11	19.07		3	75	0	18.92	19.09	18.99	3		
RB Size			RB Offset	Low	Mid	High	3GPP MPR (dB)	BW	MCS Index	RB Size	RB Offset	Low	Mid	High	3GPP MPR (dB)		
Channel			37800	38000	38200	Channel				37775	38000	38225					
Frequency (MHz)			2575	2595	2615	Frequency (MHz)				2572.5	2595	2617.5					
10M			QPSK	1	0	22.26	22.35	22.27	0	5M	QPSK	1	0	22.25	22.49	22.22	0
				1	24	21.98	22.14	22.15	0			1	12	22.05	22.16	21.95	0
		1		49	21.97	22.17	22.08	0	1			24	21.90	22.13	21.98	0	
		25		0	21.09	21.16	21.08	1	12			0	21.06	21.28	21.19	1	
		25		12	21.10	21.11	21.10	1	12			6	21.02	21.22	21.00	1	
		25		25	21.00	21.18	21.09	1	12			13	21.06	21.22	20.93	1	
		16QAM	50	0	20.80	21.07	20.90	1	25		0	20.81	20.99	20.78	1		
			1	0	21.01	21.30	21.21	1	16QAM		1	0	21.13	21.22	21.31	1	
			1	24	20.97	21.09	21.07	1			1	12	20.92	21.31	21.13	1	
			1	49	20.95	20.95	21.01	1			1	24	21.06	21.04	21.04	1	
			25	0	20.01	20.08	20.11	2			12	0	20.11	20.15	20.07	2	
			25	12	20.07	20.12	20.06	2			12	6	20.04	20.05	19.96	2	
		25	25	19.91	20.15	20.13	2	12			13	20.02	20.03	20.06	2		
		64QAM	50	0	19.89	20.01	19.89	2	25		0	19.91	20.04	19.87	2		
			1	0	20.17	20.36	20.34	2	64QAM		1	0	20.31	20.27	20.23	2	
			1	24	20.12	20.12	20.26	2			1	12	19.94	20.10	20.12	2	
			1	49	20.07	20.17	20.10	2			1	24	19.91	20.04	20.02	2	
	25		0	19.04	19.10	18.99	3	12			0	18.91	19.15	19.20	3		
25	12		18.94	19.14	19.01	3	12	6		19.03	19.08	19.18	3				
25	25	18.97	19.11	19.00	3	12	13	18.97		19.01	19.00	3					
50	0	18.72	18.93	18.84	3	25	0	18.81	19.00	18.84	3						

FCC SAR Test Report

LTE Band 41																	
BW	MCS Index	RB Size	RB Offset	Low	Mid	High	3GPP MPR (dB)	BW	MCS Index	RB Size	RB Offset	Low	Mid	High	3GPP MPR (dB)		
		Channel		40140	40640	41140				Channel		40115	40640	41165			
		Frequency (MHz)		2545	2595	2645				Frequency (MHz)		2542.5	2595	2647.5			
20M	QPSK	1	0	22.30	22.53	22.73	0	15M	QPSK	1	0	22.23	22.48	22.70	0		
		1	50	22.21	22.44	22.64	0			1	37	22.21	22.37	22.61	0		
		1	99	22.13	22.36	22.56	0			1	74	22.05	22.33	22.51	0		
		50	0	21.36	21.59	21.79	1			36	0	21.28	21.49	21.70	1		
		50	25	21.32	21.55	21.75	1			36	19	21.30	21.46	21.66	1		
		50	50	21.26	21.49	21.69	1			36	39	21.16	21.46	21.61	1		
		100	0	21.31	21.54	21.74	1			75	0	21.25	21.50	21.68	1		
	16QAM	1	0	21.28	21.46	21.73	1		16QAM	1	0	21.22	21.41	21.62	1		
		1	50	21.15	21.37	21.56	1			1	37	21.05	21.28	21.54	1		
		1	99	21.07	21.32	21.49	1			1	74	21.07	21.21	21.40	1		
		50	0	20.34	20.52	20.72	2			36	0	20.28	20.55	20.72	2		
		50	25	20.28	20.48	20.70	2			36	19	20.19	20.43	20.60	2		
		50	50	20.17	20.39	20.67	2			36	39	20.12	20.31	20.59	2		
		100	0	20.26	20.47	20.71	2			75	0	20.16	20.42	20.69	2		
	64QAM	1	0	20.23	20.45	20.63	2		64QAM	1	0	20.27	20.50	20.64	2		
		1	50	20.21	20.39	20.57	2			1	37	20.07	20.33	20.58	2		
		1	99	20.08	20.28	20.50	2			1	74	20.07	20.26	20.41	2		
		50	0	19.30	19.49	19.70	3			36	0	19.34	19.46	19.66	3		
		50	25	19.31	19.45	19.74	3			36	19	19.13	19.47	19.65	3		
		50	50	19.25	19.43	19.69	3			36	39	19.10	19.46	19.56	3		
		100	0	19.24	19.54	19.69	3			75	0	19.21	19.50	19.70	3		
	BW	MCS Index	RB Size	RB Offset	Low	Mid	High		3GPP MPR (dB)	BW	MCS Index	RB Size	RB Offset	Low	Mid	High	3GPP MPR (dB)
			Channel		40090	40640	41190					Channel		40065	40640	41215	
			Frequency (MHz)		2540	2595	2650					Frequency (MHz)		2537.5	2595	2652.5	
10M	QPSK	1	0	22.15	22.38	22.56	0	5M	QPSK	1	0	22.16	22.43	22.46	0		
		1	24	22.11	22.23	22.55	0			1	12	21.99	22.23	22.38	0		
		1	49	22.06	22.24	22.45	0			1	24	21.98	22.20	22.37	0		
		25	0	21.16	21.46	21.70	1			12	0	21.22	21.45	21.60	1		
		25	12	21.20	21.50	21.65	1			12	6	21.27	21.55	21.57	1		
		25	25	21.09	21.32	21.57	1			12	13	21.06	21.30	21.52	1		
		50	0	21.19	21.35	21.64	1			25	0	21.20	21.40	21.51	1		
	16QAM	1	0	21.01	21.41	21.50	1		16QAM	1	0	21.12	21.30	21.56	1		
		1	24	21.02	21.21	21.46	1			1	12	21.01	21.28	21.32	1		
		1	49	20.94	21.17	21.48	1			1	24	20.84	21.19	21.41	1		
		25	0	20.18	20.53	20.69	2			12	0	20.31	20.50	20.59	2		
		25	12	20.12	20.34	20.63	2			12	6	20.07	20.46	20.56	2		
		25	25	20.01	20.35	20.50	2			12	13	20.16	20.34	20.44	2		
		50	0	20.05	20.39	20.53	2			25	0	20.15	20.36	20.62	2		
	64QAM	1	0	20.08	20.39	20.60	2		64QAM	1	0	20.18	20.23	20.57	2		
		1	24	20.01	20.26	20.53	2			1	12	19.94	20.16	20.55	2		
		1	49	19.95	20.20	20.28	2			1	24	19.98	20.21	20.30	2		
		25	0	19.19	19.45	19.54	3			12	0	19.15	19.49	19.50	3		
		25	12	19.14	19.35	19.70	3			12	6	19.16	19.34	19.54	3		
		25	25	19.15	19.27	19.65	3			12	13	19.05	19.35	19.45	3		
		50	0	19.14	19.29	19.57	3			25	0	19.16	19.29	19.67	3		

FCC SAR Test Report

LTE Band 66																	
Head/Body mode																	
BW	MCS Index	RB Size	RB Offset	Low	Mid	High	3GPP MPR (dB)	BW	MCS Index	RB Size	RB Offset	Low	Mid	High	3GPP MPR (dB)		
				Channel	132072	132322						132572	Channel	132047		132322	132597
				Frequency (MHz)	1720.0	1745.0						1770.0	Frequency (MHz)	1717.5		1745.0	1772.5
20M	QPSK	1	0	22.98	22.99	22.97	0	15M	QPSK	1	0	22.88	22.91	22.89	0		
		1	50	22.78	22.82	22.77	0			1	37	22.74	22.75	22.69	0		
		1	99	22.72	22.76	22.71	0			1	74	22.70	22.71	22.71	0		
		50	0	21.88	21.92	21.87	1			36	0	21.85	21.87	21.85	1		
		50	25	21.80	21.84	21.79	1			36	19	21.80	21.78	21.70	1		
		50	50	21.75	21.79	21.74	1			36	39	21.66	21.75	21.73	1		
	100	0	21.78	21.82	21.77	1	75		0	21.71	21.73	21.69	1				
	16QAM	1	0	21.94	21.98	21.94	1		16QAM	1	0	21.97	21.91	21.84	1		
		1	50	21.78	21.82	21.72	1			1	37	21.78	21.67	21.68	1		
		1	99	21.69	21.67	21.68	1			1	74	21.58	21.68	21.61	1		
		50	0	20.83	20.92	20.81	2			36	0	20.83	20.80	20.68	2		
		50	25	20.78	20.80	20.74	2			36	19	20.73	20.74	20.67	2		
		50	50	20.75	20.78	20.70	2			36	39	20.62	20.71	20.68	2		
	100	0	20.74	20.81	20.68	2	75		0	20.68	20.72	20.73	2				
	64QAM	1	0	20.89	20.90	20.97	2		64QAM	1	0	20.90	20.88	20.89	2		
		1	50	20.78	20.75	20.75	2			1	37	20.71	20.71	20.63	2		
		1	99	20.71	20.70	20.71	2			1	74	20.70	20.66	20.62	2		
		50	0	19.87	19.88	19.78	3			36	0	19.78	19.86	19.80	3		
		50	25	19.77	19.76	19.71	3			36	19	19.63	19.77	19.67	3		
		50	50	19.73	19.75	19.64	3			36	39	19.56	19.70	19.61	3		
	100	0	19.72	19.77	19.75	3	75		0	19.67	19.72	19.63	3				
	10M	QPSK	1	0	22.87	22.92	22.95		0	5M	QPSK	1	0	22.87	22.86	22.87	0
			1	24	22.72	22.65	22.70		0			1	12	22.65	22.67	22.63	0
			1	49	22.47	22.63	22.61		0			1	24	22.57	22.62	22.49	0
25			0	21.77	21.80	21.72	1	12	0			21.74	21.85	21.61	1		
25			12	21.77	21.74	21.68	1	12	6			21.65	21.68	21.57	1		
25			25	21.57	21.67	21.60	1	12	13			21.55	21.58	21.44	1		
50		0	21.66	21.65	21.69	1	25	0	21.66		21.76	21.70	1				
16QAM		1	0	21.86	21.82	21.79	1	16QAM	1		0	21.74	21.96	21.68	1		
		1	24	21.63	21.59	21.60	1		1		12	21.64	21.60	21.63	1		
		1	49	21.55	21.57	21.51	1		1		24	21.65	21.62	21.56	1		
		25	0	20.83	20.75	20.63	2		12		0	20.75	20.58	20.70	2		
		25	12	20.70	20.73	20.66	2		12		6	20.61	20.62	20.55	2		
		25	25	20.58	20.62	20.39	2		12		13	20.59	20.63	20.45	2		
50		0	20.59	20.74	20.69	2	25	0	20.72		20.65	20.70	2				
64QAM		1	0	20.77	20.83	20.91	2	64QAM	1		0	20.68	20.83	20.76	2		
		1	24	20.71	20.60	20.61	2		1		12	20.55	20.63	20.59	2		
		1	49	20.55	20.56	20.48	2		1		24	20.58	20.61	20.47	2		
		25	0	19.66	19.76	19.72	3		12		0	19.67	19.67	19.69	3		
		25	12	19.71	19.55	19.53	3		12		6	19.61	19.65	19.44	3		
		25	25	19.53	19.64	19.64	3		12		13	19.50	19.62	19.66	3		
50		0	19.51	19.73	19.59	3	25	0	19.67		19.68	19.56	3				
3M		QPSK	1	0	22.76	22.95	22.91	0	1.4M		QPSK	1	0	22.85	22.82	22.82	0
			1	7	22.75	22.68	22.66	0				1	2	22.74	22.70	22.60	0
			1	14	22.64	22.73	22.57	0				1	5	22.62	22.66	22.57	0
	8		0	21.72	21.78	21.71	1	3		0		22.78	22.85	22.73	0		
	8		3	21.62	21.82	21.64	1	3		1		22.63	22.71	22.70	0		
	8		7	21.70	21.74	21.57	1	3		3		22.61	22.65	22.61	0		
	15	0	21.63	21.64	21.62	1	6	0		21.75	21.74	21.65	1				
	16QAM	1	0	21.74	21.93	21.91	1	16QAM		1	0	21.75	21.79	21.83	1		
		1	7	21.47	21.69	21.53	1			1	2	21.57	21.63	21.53	1		
		1	14	21.41	21.69	21.45	1			1	5	21.69	21.53	21.66	1		
		8	0	20.77	20.71	20.58	2			3	0	21.74	21.81	21.75	1		
		8	3	20.66	20.72	20.66	2			3	1	21.60	21.60	21.73	1		
		8	7	20.64	20.68	20.46	2			3	3	21.66	21.67	21.58	1		
	15	0	20.54	20.64	20.51	2	6	0		20.70	20.60	20.68	2				
	64QAM	1	0	20.71	20.88	20.87	2	64QAM		1	0	20.85	20.69	20.67	2		
		1	7	20.59	20.61	20.61	2			1	2	20.53	20.70	20.54	2		
		1	14	20.46	20.70	20.46	2			1	5	20.47	20.54	20.47	2		
		8	0	19.66	19.67	19.71	3			3	0	20.76	20.61	20.74	2		
		8	3	19.59	19.72	19.56	3			3	1	20.69	20.62	20.51	2		
		8	7	19.57	19.54	19.50	3			3	3	20.52	20.70	20.52	2		
	15	0	19.65	19.58	19.49	3	6	0		19.57	19.58	19.59	3				

FCC SAR Test Report

LTE Band 66																	
Hotspot Mode																	
BW	MCS Index	RB Size	RB Offset	Low	Mid	High	3GPP MPR (dB)	BW	MCS Index	RB Size	RB Offset	Low	Mid	High	3GPP MPR (dB)		
				Channel	132072	132322						132572	Channel	132047		132322	132597
				Frequency (MHz)	1720.0	1745.0						1770.0	Frequency (MHz)	1717.5		1745.0	1772.5
20M	QPSK	1	0	19.10	19.13	19.08	0	15M	QPSK	1	0	19.02	19.11	18.98	0		
		1	50	18.84	18.87	18.82	0			1	37	18.82	18.79	18.76	0		
		1	99	18.79	18.82	18.77	0			1	74	18.78	18.79	18.74	0		
		50	0	18.06	18.09	18.04	1			36	0	18.02	18.06	18.01	1		
		50	25	17.98	18.01	17.96	1			36	19	17.92	17.96	17.88	1		
		50	50	17.88	17.91	17.86	1			36	39	17.81	17.91	17.80	1		
	100	0	17.98	18.01	17.96	1	75		0	17.92	17.97	17.96	1				
	16QAM	1	0	18.06	18.08	18.03	1		16QAM	1	0	17.90	17.93	17.97	1		
		1	50	17.81	17.77	17.77	1			1	37	17.66	17.72	17.73	1		
		1	99	17.71	17.75	17.75	1			1	74	17.67	17.70	17.68	1		
		50	0	17.06	17.05	17.03	2			36	0	16.92	17.00	16.93	2		
		50	25	16.95	16.97	16.87	2			36	19	16.89	16.92	16.89	2		
		50	50	16.78	16.87	16.80	2			36	39	16.76	16.79	16.81	2		
	100	0	16.97	16.92	16.86	2	75		0	16.86	16.93	16.79	2				
	64QAM	1	0	19.10	19.13	19.08	2		64QAM	1	0	19.02	19.11	18.98	2		
		1	50	18.84	18.87	18.82	2			1	37	18.82	18.79	18.76	2		
		1	99	18.79	18.82	18.77	2			1	74	18.78	18.79	18.74	2		
		50	0	18.06	18.09	18.04	3			36	0	18.02	18.06	18.01	3		
		50	25	17.98	18.01	17.96	3			36	19	17.92	17.96	17.88	3		
		50	50	17.88	17.91	17.86	3			36	39	17.81	17.91	17.80	3		
	100	0	17.98	18.01	17.96	3	75		0	17.92	17.97	17.96	3				
	10M	QPSK	1	0	19.02	18.93	18.97		0	5M	QPSK	1	0	18.94	18.98	19.03	0
			1	24	18.79	18.71	18.59		0			1	12	18.66	18.70	18.58	0
			1	49	18.75	18.79	18.57		0			1	24	18.61	18.58	18.49	0
25			0	17.87	18.03	17.94	1	12	0			18.00	17.86	17.76	1		
25			12	17.81	17.83	17.84	1	12	6			17.90	17.84	17.75	1		
25			25	17.76	17.84	17.83	1	12	13			17.73	17.75	17.60	1		
50		0	17.91	17.86	17.85	1	25	0	17.85		17.97	17.82	1				
16QAM		1	0	17.89	17.98	17.82	1	16QAM	1		0	17.97	18.00	17.90	1		
		1	24	17.66	17.73	17.51	1		1		12	17.55	17.71	17.66	1		
		1	49	17.69	17.62	17.56	1		1		24	17.45	17.69	17.61	1		
		25	0	16.85	16.89	16.86	2		12		0	16.90	16.91	16.92	2		
		25	12	16.89	16.87	16.74	2		12		6	16.89	16.85	16.85	2		
		25	25	16.62	16.71	16.71	2		12		13	16.70	16.68	16.77	2		
50		0	16.78	16.76	16.71	2	25	0	16.85		16.83	16.83	2				
64QAM		1	0	19.02	18.93	18.97	2	64QAM	1		0	18.94	18.98	19.03	2		
		1	24	18.79	18.71	18.59	2		1		12	18.66	18.70	18.58	2		
		1	49	18.75	18.79	18.57	2		1		24	18.61	18.58	18.49	2		
		25	0	17.87	18.03	17.94	3		12		0	18.00	17.86	17.76	3		
		25	12	17.81	17.83	17.84	3		12		6	17.90	17.84	17.75	3		
		25	25	17.76	17.84	17.83	3		12		13	17.73	17.75	17.60	3		
50		0	17.91	17.86	17.85	3	25	0	17.85		17.97	17.82	3				
3M		QPSK	1	0	19.01	18.98	18.98	0	1.4M		QPSK	1	0	19.03	19.09	18.92	0
			1	7	18.62	18.77	18.74	0				1	2	18.73	18.85	18.69	0
			1	14	18.66	18.71	18.68	0				1	5	18.75	18.72	18.61	0
	8		0	17.95	17.89	17.90	1	3		0		19.00	18.96	18.86	0		
	8		3	17.90	17.89	17.78	1	3		1		18.81	19.00	18.75	0		
	8		7	17.76	17.80	17.75	1	3		3		18.72	18.76	18.71	0		
	15	0	17.79	17.86	17.94	1	6	0		17.84	17.90	17.80	1				
	16QAM	1	0	17.91	17.97	17.94	1	16QAM		1	0	17.97	17.92	17.79	1		
		1	7	17.63	17.69	17.76	1			1	2	17.56	17.78	17.67	1		
		1	14	17.63	17.65	17.60	1			1	5	17.66	17.65	17.46	1		
		8	0	16.98	16.91	16.90	2			3	0	17.92	17.85	17.76	1		
		8	3	16.82	16.78	16.68	2			3	1	17.83	17.90	17.85	1		
		8	7	16.77	16.79	16.67	2			3	3	17.62	17.79	17.63	1		
	15	0	16.82	16.74	16.74	2	6	0		16.75	16.76	16.74	2				
	64QAM	1	0	19.01	18.98	18.98	2	64QAM		1	0	19.03	19.09	18.92	2		
		1	7	18.62	18.77	18.74	2			1	2	18.73	18.85	18.69	2		
		1	14	18.66	18.71	18.68	2			1	5	18.75	18.72	18.61	2		
		8	0	17.95	17.89	17.90	3			3	0	19.00	18.96	18.86	2		
		8	3	17.90	17.89	17.78	3			3	1	18.81	19.00	18.75	2		
		8	7	17.76	17.80	17.75	3			3	3	18.72	18.76	18.71	2		
	15	0	17.79	17.86	17.94	3	6	0		17.84	17.90	17.80	3				

FCC SAR Test Report

Head mode

<WLAN 2.4G>

Mode	Channel	Frequency (MHz)	Average Power (Ant-0)	Average Power (Ant-1)	Average Power (Ant-0 + Ant-1)
802.11b	1	2412	18.49	18.91	-
	6	2437	18.39	18.74	-
	11	2462	18.28	18.65	-
802.11n (HT40)	3	2422	-	-	19.96
	6	2437	-	-	19.90
	9	2452	-	-	19.82

<WLAN 5.3G>

Mode	Channel	Frequency (MHz)	Average Power (Ant-0)	Average Power (Ant-1)	Average Power (Ant-0 + Ant-1)
802.11a	52	5260	-	18.76	-
	56	5280	-	18.60	-
	60	5300	-	18.77	-
	64	5320	-	18.64	-
802.11ac (VHT80)	58	5290	9.37	-	12.23

<WLAN 5.6G>

Mode	Channel	Frequency (MHz)	Average Power (Ant-0)	Average Power (Ant-1)	Average Power (Ant-0 + Ant-1)
802.11a	100	5500	-	18.64	-
	116	5580	-	18.69	-
	120	5600	-	18.55	-
	124	5620	-	18.43	-
	132	5660	-	18.47	-
	140	5700	-	18.34	-
	144	5720	-	18.31	-
802.11ac (VHT80)	106	5530	9.48	-	12.49
	122	5610	9.29	-	12.23
	138	5690	9.18	-	12.11

FCC SAR Test Report

<WLAN 5.8G>

Mode	Channel	Frequency (MHz)	Average Power (Ant-0)	Average Power (Ant-1)	Average Power (Ant-0 + Ant-1)
802.11a	149	5745	-	18.16	-
	153	5765	-	18.22	-
	157	5785	-	18.21	-
	161	5805	-	18.35	-
	165	5825	-	18.59	-
802.11ac (VHT80)	155	5775	9.49	-	12.33

<Bluetooth>

Mode	Channel	Frequency (MHz)	Average Power
Bluetooth EDR	0	2402	9.42
	39	2441	8.59
	78	2480	8.69
Bluetooth LE	0	2402	2.86
	19	2440	2.59
	39	2480	2.98

Body / Hotspot / Phablet mode

<WLAN 2.4G>

Mode	Channel	Frequency (MHz)	Average Power (Ant-0)	Average Power (Ant-1)	Average Power (Ant-0 + Ant-1)
802.11b	1	2412	19.56	19.64	-
	6	2437	19.38	19.21	-
	11	2462	19.21	19.32	-
802.11n (HT20)	1	2412	-	-	21.96
	6	2437	-	-	21.32
	11	2462	-	-	21.93

<WLAN 5.2G>

Mode	Channel	Frequency (MHz)	Average Power (Ant-0)	Average Power (Ant-1)	Average Power (Ant-0 + Ant-1)
802.11a	36	5180	18.97	18.73	-
	40	5200	18.98	18.77	-
	44	5220	18.96	18.71	-
	48	5240	18.91	18.63	-
802.11n (HT20)	36	5180	-	-	21.96
	40	5200	-	-	21.98
	44	5220	-	-	21.28
	48	5240	-	-	21.29

FCC SAR Test Report

<WLAN 5.3G>

Mode	Channel	Frequency (MHz)	Average Power (Ant-0)	Average Power (Ant-1)	Average Power (Ant-0 + Ant-1)
802.11a	52	5260	18.95	18.76	-
	56	5280	18.96	18.60	-
	60	5300	18.99	18.77	-
	64	5320	18.97	18.64	-
802.11n (HT20)	52	5260	-	-	21.32
	56	5280	-	-	21.25
	60	5300	-	-	21.93
	64	5320	-	-	21.87

<WLAN 5.6G>

Mode	Channel	Frequency (MHz)	Average Power (Ant-0)	Average Power (Ant-1)	Average Power (Ant-0 + Ant-1)
802.11a	100	5500	18.92	18.64	-
	116	5580	18.98	18.69	-
	120	5600	18.74	18.55	-
	124	5620	18.71	18.43	-
	132	5660	18.54	18.47	-
	140	5700	18.45	18.34	-
	144	5720	18.32	18.31	-
802.11n (HT20)	100	5500	-	-	21.37
	116	5580	-	-	21.98
	120	5600	-	-	21.95
	124	5620	-	-	21.16
	132	5660	-	-	21.96
	140	5700	-	-	21.67
	144	5720	-	-	21.54

<WLAN 5.8G>

Mode	Channel	Frequency (MHz)	Average Power (Ant-0)	Average Power (Ant-1)	Average Power (Ant-0 + Ant-1)
802.11a	149	5745	18.22	18.16	-
	153	5765	18.23	18.22	-
	157	5785	18.33	18.21	-
	161	5805	18.55	18.35	-
	165	5825	18.64	18.59	-
802.11n (HT20)	149	5745	-	-	21.49
	153	5765	-	-	21.56
	157	5785	-	-	21.62
	161	5805	-	-	21.87
	165	5825	-	-	21.91

<Bluetooth>

Mode	Channel	Frequency (MHz)	Average Power
Bluetooth EDR	0	2402	9.42
	39	2441	8.59
	78	2480	8.69
Bluetooth LE	0	2402	2.86
	19	2440	2.59
	39	2480	2.98

4.7 SAR Testing Results

4.7.1 SAR Test Reduction Considerations

<KDB 447498 D01, General RF Exposure Guidance>

Testing of other required channels within the operating mode of a frequency band is not required when the reported SAR for the mid-band or highest output power channel is:

- (1) ≤ 0.8 W/kg or 2.0 W/kg, for 1-g or 10-g respectively, when the transmission band is ≤ 100 MHz
- (2) ≤ 0.6 W/kg or 1.5 W/kg, for 1-g or 10-g respectively, when the transmission band is between 100 MHz and 200 MHz
- (3) ≤ 0.4 W/kg or 1.0 W/kg, for 1-g or 10-g respectively, when the transmission band is ≥ 200 MHz

<KDB 941225 D01, 3G SAR Measurement Procedures>

The mode tested for SAR is referred to as the primary mode. The equivalent modes considered for SAR test reduction are denoted as secondary modes. Both primary and secondary modes must be in the same frequency band. When the maximum output power and tune-up tolerance specified for production units in a secondary mode is $\leq 1/4$ dB higher than the primary mode or when the highest reported SAR of the primary mode is scaled by the ratio of specified maximum output power and tune-up tolerance of secondary to primary mode and the adjusted SAR is ≤ 1.2 W/kg, SAR measurement is not required for the secondary mode.

<KDB 941225 D05, SAR Evaluation Considerations for LTE Devices>

(1) QPSK with 1 RB and 50% RB allocation

Start with the largest channel bandwidth and measure SAR, using the RB offset and required test channel combination with the highest maximum output power among RB offsets at the upper edge, middle and lower edge of each required test channel. When the reported SAR is ≤ 0.8 W/kg, testing of the remaining RB offset configurations and required test channels is not required; otherwise, SAR is required for the remaining required test channels and only for the RB offset configuration with the highest output power for that channel. When the reported SAR of a required test channel is > 1.45 W/kg, SAR is required for all three RB offset configurations for that required test channel.

(2) QPSK with 100% RB allocation

SAR is not required when the highest maximum output power for 100% RB allocation is less than the highest maximum output power in 50% and 1 RB allocations and the highest reported SAR for 1 RB and 50% RB allocation are ≤ 0.8 W/kg. Otherwise, SAR is measured for the highest output power channel; and if the reported SAR is > 1.45 W/kg, the remaining required test channels must also be tested.

(3) Higher order modulations

SAR is required only when the highest maximum output power for the configuration in the higher order modulation is $> 1/2$ dB higher than the same configuration in QPSK or when the reported SAR for the QPSK configuration is > 1.45 W/kg.

(4) Other channel bandwidth

SAR is required when the highest maximum output power of the smaller channel bandwidth is $> 1/2$ dB higher than the equivalent channel configurations in the largest channel bandwidth configuration or the reported SAR of a configuration for the largest channel bandwidth is > 1.45 W/kg.

FCC SAR Test Report

<SAR Test Exclusion Evaluations for LTE Downlink CA>

According to Nov 2017 TCB Workshop, SAR test exclusion for LTE downlink Carrier Aggregation is determined by power measurements according to the number of component carriers (CCs) supported by the product implementation. The downlink Carrier Aggregation configurations are tabulated in separate columns. DL CA would be listed in the columns corresponding to Intra Band contiguous, Intra Band Non-contiguous, 2bands/2CCs, 2bands/3CCs and 3bands/3CCs. The CA/CC combinations in each columns are sorted so that frequency bands listed in subsequent columns on each row are ascending subsets, as illustrated below; i.e., columns to the right correspond to increasing number of frequency bands and CCs.

	Intra Band		Inter Band				
	Contiguous	Non-Contiguous	2 Bands / 2CC	2 Bands / 3CC	2 Bands / 4CC	3 Bands / 3CC	3 Bands / 4CC
Configure		CA_66A_66A	CA_5A_66A	CA_5A_66A_66A		CA_2A_5A_66A	
				CA_2A_66A_66A			CA_2A_5A_66A_66A
			CA_2A_5A	CA_2A_2A_5A			
			CA_2A_12A	CA_2A_2A_12A	CA_2A_2A_66A-66A	CA_2A_12A_66A	CA_2A_2A_12A_66A
			CA_2A_66A	CA_2A_2A_66A	CA_2A_2A_66C		CA_2A_12A_66A_66A
			CA_12A_66A	CA_12A_66A_66A			CA_2A_12A_66C
				CA_2A_66C			
				CA_12A_66C			
		CA_2A_2A	CA_2A_4A	CA_2A_2A_4A			
		CA_4A_4A		CA_2A_4A_4A		CA_2A_4A_5A*	
			CA_4A_5A	CA_4A_4A_5A			
			CA_2A_13A	CA_2A_2A_13A		CA_2A_4A_13A	
			CA_4A_13A	CA_4A_4A_13A			
			CA_13A_66A	CA_13A_66A_66A		CA_2A_13A_66A	
			CA_4A_12A	CA_4A_4A_12A			
		CA_7A_7A	CA_4A_7A				
		CA_41A_41A					
		CA_5B					
		CA_2C					
		CA_7C					
	CA_38C						
	CA_41C						
	CA_66B						
	CA_66C						

Notes: Only yellow highlighted cells need power measurement.

FCC SAR Test Report

<Power Confirmation for SAR Test Exclusion for LTE Downlink CA>

According to KDB 941225 D05A, the uplink maximum output power below was measured with downlink CA active on the channel with highest measured maximum output power when downlink CA is inactive. The downlink SCC channel was paired with the uplink channel as normal operation. For intra-band contiguous CA, the downlink channel spacing between the component carriers was set to multiple of 300 kHz less than the nominal channel spacing per section 5.4.1A of 3GPP TS36.521. For intra-band non-contiguous CA, the downlink channel spacing between the component carriers was set to maximum separation from PCC and remain fully within the downlink transmission band. For Inter-band CA, the SCC downlink channel was set to near the middle of its transmission band.

< Head/Body mode >

Power Measurements for Intra-Band Contiguous Downlink CA

CA Combination	PCC								SCC1				Power	
	LTE Band	BW (MHz)	UL Channel	UL Freq. (MHz)	RB Size	RB Offset	DL Channel	DL Freq. (MHz)	LTE Band	BW (MHz)	DL Channel	DL Freq. (MHz)	Single Carrier Tx Power (dBm)	Tx Power with DL-CA Active (dBm)
CA_2C	2	20	18900	1880	1	0	900	1960	2	20	1098	1979.8	22.76	22.54
CA_5B	5	10	20450	829	1	0	2450	874	5	10	2549	883.9	22.75	22.73
CA_7C	7	20	21100	2535	1	0	3100	2655	7	20	3298	2674.8	21.17	20.68
CA_38C	38	20	37850	2580	1	0	37850	2580	38	20	38048	2599.8	22.50	22.46
CA_41C	41	20	41140	2645	1	0	41140	2645	41	20	40942	2625.2	22.73	22.64
CA_66B	66	15	132322	1745	1	0	66786	2145	66	5	66879	2154.3	22.91	22.81
CA_66C	66	20	132322	1745	1	0	66786	2145	66	20	66984	2164.8	22.99	22.87

Power Measurements for Intra-Band Non-Contiguous Downlink CA

CA Combination	PCC								SCC1				Power	
	LTE Band	BW (MHz)	UL Channel	UL Freq. (MHz)	RB Size	RB Offset	DL Channel	DL Freq. (MHz)	LTE Band	BW (MHz)	DL Channel	DL Freq. (MHz)	Single Carrier Tx Power (dBm)	Tx Power with DL-CA Active (dBm)
CA_7A-7A	7	20	21100	2535	1	0	3100	2655	7	20	3350	2680	21.17	20.48
CA_41A-41A	41	20	41140	2645	1	0	41140	2645	41	20	40140	2545	22.73	22.68

Power Measurements for Inter-Band Downlink CA

CA Combination	PCC								SCC1				SCC2				SCC3				Power	
	LTE Band	BW (MHz)	UL Ch	UL Freq. (MHz)	RB Size	RB Offset	DL Ch	DL Freq. (MHz)	LTE Band	BW (MHz)	DL Ch	DL Freq. (MHz)	LTE Band	BW (MHz)	DL Ch	DL Freq. (MHz)	LTE Band	BW (MHz)	DL Ch	DL Freq. (MHz)	Single Carrier Tx Power (dBm)	Tx Power with DL-CA Active (dBm)
CA_2A-4A-5A	2	20	18900	1880	1	0	900	1960	4	20	2175	2132.5	5	10	2525	881.5					22.76	22.53
CA_2A-5A-66A-66A	2	20	18900	1880	1	0	900	1960	5	10	2525	881.5	66	20	66786	2145	66	20	67036	2170	22.76	22.13
CA_2A-2A-12A-66A	2	20	18900	1880	1	0	900	1960	2	20	1100	1980	12	10	5095	737.5	66	20	66786	2145	22.76	22.08
CA_2A-12A-66A-66A	2	20	18900	1880	1	0	900	1960	12	10	5095	737.5	66	20	66786	2145	66	20	67036	2170	22.76	22.57
CA_2A-12A-66C	2	20	18900	1880	1	0	900	1960	12	10	5095	737.5	66	20	66786	2145	66	20	66984	2164.8	22.76	22.48
CA_2A-4A-13A	2	20	18900	1880	1	0	900	1960	4	20	2175	2132.5	13	10	5230	751					22.76	22.34
CA_2A-13A-66A	2	20	18900	1880	1	0	900	1960	13	10	5230	751	66	20	66786	2145					22.76	22.41
CA_4A-4A-12A	4	10	20175	1732.5	1	0	2175	2132.5	4	10	2350	2150	12	10	5095	737.5					22.69	22.51
CA_4A-7A	4	20	20175	1732.5	1	0	2175	2132.5	7	20	3100	2655									22.69	22.33

FCC SAR Test Report

< Hotspot Mode >

Power Measurements for Intra-Band Contiguous Downlink CA

CA Combination	PCC								SCC1				Power	
	LTE Band	BW (MHz)	UL Channel	UL Freq. (MHz)	RB Size	RB Offset	DL Channel	DL Freq. (MHz)	LTE Band	BW (MHz)	DL Channel	DL Freq. (MHz)	Single Carrier Tx Power (dBm)	Tx Power with DL-CA Active (dBm)
CA_2C	2	20	18900	1880	1	0	900	1960	2	20	1098	1979.8	17.80	17.01
CA_7C	5	10	20525	836.5	1	0	2525	881.5	5	10	2549	883.9	18.66	18.02
CA_66B	66	15	132322	1745	1	0	66786	2145	66	5	66884	2154.8	19.13	18.51
CA_66C	66	20	132322	1745	1	0	66786	2145	66	20	66984	2164.8	19.13	18.56

Power Measurements for Intra-Band Non-Contiguous Downlink CA

CA Combination	PCC								SCC1				Power	
	LTE Band	BW (MHz)	UL Channel	UL Freq. (MHz)	RB Size	RB Offset	DL Channel	DL Freq. (MHz)	LTE Band	BW (MHz)	DL Channel	DL Freq. (MHz)	Single Carrier Tx Power (dBm)	Tx Power with DL-CA Active (dBm)
CA_7A-7A	7	20	21100	2535	1	0	3100	2655	7	20	3350	2680	18.66	18.03

Power Measurements for Inter-Band Downlink CA

CA Combination	PCC								SCC1				SCC2				SCC3				Power	
	LTE Band	BW (MHz)	UL Ch	UL Freq. (MHz)	RB Size	RB Offset	DL Ch	DL Freq. (MHz)	LTE Band	BW (MHz)	DL Ch	DL Freq. (MHz)	LTE Band	BW (MHz)	DL Ch	DL Freq. (MHz)	LTE Band	BW (MHz)	DL Ch	DL Freq. (MHz)	Single Carrier Tx Power (dBm)	Tx Power with DL-CA Active (dBm)
CA_2A-4A-5A	2	20	18900	1880	1	0	900	1960	4	20	2175	2132.5	5	10	2525	881.5					17.80	16.93
CA_2A-5A-66A-66A	2	20	18900	1880	1	0	900	1960	5	10	2525	881.5	66	20	66786	2145					17.80	16.89
CA_2A-2A-12A-66A	2	20	18900	1880	1	0	900	1960	2	20	1100	1980	12	10	5095	737.5	66	20	66786	2145	17.80	16.85
CA_2A-12A-66A-66A	2	20	18900	1880	1	0	900	1960	12	10	5095	737.5	66	20	66786	2145	66	20	67036	2170	17.80	16.96
CA_2A-12A-66C	2	20	18900	1880	1	0	900	1960	12	10	5095	737.5	66	20	66786	2145	66	20	66984	2164.8	17.80	16.90
CA_2A-4A-13A	2	20	18900	1880	1	0	900	1960	4	20	2175	2132.5	13	10	5230	751					17.80	16.91
CA_2A-13A-66A	2	20	18900	1880	1	0	900	1960	13	10	5230	751	66	20	66786	2145					17.80	16.88
CA_4A-4A-12A	4	10	20175	1732.5	1	0	2175	2132.5	4	10	2350	2150	12	10	5095	737.5					17.93	17.80
CA_4A-7A	4	20	20175	1732.5	1	0	2175	2132.5	7	20	3100	2655									17.93	18.29

Summary for SAR Test Exclusion for LTE Downlink CA

Per power confirmation results in above, the uplink maximum output power with downlink CA active remains within the specified tune-up tolerance and not more than 0.25 dB higher than the maximum output power with downlink CA inactive. According to KDB 941225 D05A, the SAR test exclusion applies to LTE downlink CA operation.

FCC SAR Test Report

<Power Confirmation for SAR Testing for LTE Uplink CA>

The conducted power for uplink CA active was measured on the highest reported SAR configuration for each exposure condition with both two carrier components was set to largest channel bandwidth.

< Head/Body mode >

PCC							SCC						Power		
Band	BW (MHz)	Modulation	RB Size	RB Offset	UL Channel	UL Frequency (MHz)	Band	BW (MHz)	Modulation	RB Size	RB Offset	UL Channel	UL Frequency (MHz)	MPR Level (dB)	Tx Power with UL-CA Active (dBm)
2	20	QPSK	1	0	18700	1860	12	10	QPSK	1	49	23095	707.5	0	22.54
			1	99						1	0			0	22.19
2	20	QPSK	1	0	18900	1880	12	10	QPSK	1	49	23095	707.5	0	22.64
			1	99						1	0			0	22.36
2	20	QPSK	1	0	19100	1900	12	10	QPSK	1	49	23095	707.5	0	22.53
			1	99						1	0			0	22.15
4	20	QPSK	1	0	20050	1720	12	10	QPSK	1	49	23095	707.5	0	22.54
			1	99						1	0			0	22.17
4	20	QPSK	1	0	20175	1732.5	12	10	QPSK	1	49	23095	707.5	0	22.50
			1	99						1	0			0	22.21
4	20	QPSK	1	0	20300	1745	12	10	QPSK	1	49	23095	707.5	0	22.52
			1	99						1	0			0	22.19
7	20	QPSK	1	0	20850	2510	7	20	QPSK	1	99	21048	2529.8	0-8.5	12.69
			1	99						1	0			0	20.84
7	20	QPSK	1	0	21100	2535	7	20	QPSK	1	99	21298	2554.8	0-8.5	12.73
			1	99						1	0			0	20.93
7	20	QPSK	1	0	21152	2540.2	7	20	QPSK	1	99	21350	2560	0-8.5	12.55
			1	99						1	0			0	20.79
13	10	QPSK	1	0	23230	782	66	20	QPSK	1	99	132322	1745	0	22.38
			1	49						1	0			0	22.38

< Hotspot Mode>

PCC							SCC						Power		
Band	BW (MHz)	Modulation	RB Size	RB Offset	UL Channel	UL Frequency (MHz)	Band	BW (MHz)	Modulation	RB Size	RB Offset	UL Channel	UL Frequency (MHz)	MPR Level (dB)	Tx Power with UL-CA Active (dBm)
7	20	QPSK	1	0	20850	2510	7	20	QPSK	1	99	21048	2529.8	0-8.5	8.82
			1	99						1	0			0	17.66
7	20	QPSK	1	0	21100	2535	7	20	QPSK	1	99	21298	2554.8	0-8.5	8.75
			1	99						1	0			0	17.59
7	20	QPSK	1	0	21152	2540.2	7	20	QPSK	1	99	21350	2560	0-8.5	8.76
			1	99						1	0			0	17.63

SAR Measurements for Intra-Band Contiguous CA

The SAR testing was performed with the single carrier (uplink CA is inactive) for all test positions for each exposure condition. The LTE uplink CA active was verified with maximum output power on the highest SAR configuration of single carrier for each exposure condition. For intra-band contiguous CA, the SCC channel was set to closest available contiguous channel.

<KDB 248227 D01, SAR Guidance for Wi-Fi Transmitters>

- (1) For handsets operating next to ear, hotspot mode or mini-tablet configurations, the initial test position procedures were applied. The test position with the highest extrapolated peak SAR will be used as the initial test position. When the reported SAR of initial test position is ≤ 0.4 W/kg, SAR testing for remaining test positions is not required. Otherwise, SAR is evaluated at the subsequent highest peak SAR positions until the reported SAR result is ≤ 0.8 W/kg or all test positions are measured.
- (2) For WLAN 2.4 GHz, the highest measured maximum output power channel for DSSS was selected for SAR measurement. When the reported SAR is ≤ 0.8 W/kg, no further SAR testing is required. Otherwise, SAR is evaluated at the next highest measured output power channel. When any reported SAR is > 1.2 W/kg, SAR is required for the third channel. For OFDM modes (802.11g/n), SAR is not required when the highest reported SAR for DSSS is adjusted by the ratio of OFDM to DSSS specified maximum output power and it is ≤ 1.2 W/kg.
- (3) For WLAN 5 GHz, the initial test configuration was selected according to the transmission mode with the highest maximum output power. When the reported SAR of initial test configuration is > 0.8 W/kg, SAR is required for the subsequent highest measured output power channel until the reported SAR result is ≤ 1.2 W/kg or all required channels are measured. For other transmission modes, SAR is not required when the highest reported SAR for initial test configuration is adjusted by the ratio of subsequent test configuration to initial test configuration specified maximum output power and it is ≤ 1.2 W/kg.
- (4) For WLAN MIMO mode, the power-based standalone SAR test exclusion or the sum of SAR provision in KDB 447498 to determine simultaneous transmission SAR test exclusion should be applied. Otherwise, SAR for MIMO mode will be measured with all applicable antennas transmitting simultaneously at the specified maximum output power of MIMO operation.

FCC SAR Test Report

4.7.2 SAR Results for Head Exposure Condition

Plot No.	Band	Mode	Test Position	Ch.	Tx Antenna	Max. Tune-up Power (dBm)	Measured Conducted Power (dBm)	Scaling Factor	Power Drift (dB)	Measured SAR-1g (W/kg)	Scaled SAR-1g (W/kg)
	GSM850	GPRS11	Right Cheek	189	Ant 0	28.5	28.49	1.00	-0.08	0.242	0.24
	GSM850	GPRS11	Right Tilted	189	Ant 0	28.5	28.49	1.00	0.12	0.110	0.11
	GSM850	GPRS11	Left Cheek	189	Ant 0	28.5	28.49	1.00	-0.06	0.185	0.19
	GSM850	GPRS11	Left Tilted	189	Ant 0	28.5	28.49	1.00	0.05	0.129	0.13
	GSM850	GPRS11	Right Cheek	189	Ant 1	28.5	28.49	1.00	0.02	0.908	0.91
	GSM850	GPRS11	Right Tilted	189	Ant 1	28.5	28.49	1.00	0.05	0.583	0.58
	GSM850	GPRS11	Left Cheek	189	Ant 1	28.5	28.49	1.00	0.07	0.82	0.82
	GSM850	GPRS11	Left Tilted	189	Ant 1	28.5	28.49	1.00	-0.01	0.665	0.67
	GSM850	GPRS11	Right Cheek	128	Ant 1	28.5	28.42	1.02	-0.09	0.818	0.83
01	GSM850	GPRS11	Right Cheek	251	Ant 1	28.5	28.48	1.00	-0.07	1.07	1.07
	GSM850	GPRS11	Left Cheek	128	Ant 1	28.5	28.42	1.02	0.05	0.756	0.77
	GSM850	GPRS11	Left Cheek	251	Ant 1	28.5	28.48	1.00	-0.03	0.808	0.81
	GSM850	GPRS11	Right Cheek	251	Ant 1	28.5	28.48	1.00	-0.02	1.03	1.03
	GSM1900	GPRS12	Right Cheek	661	Ant 0	25.5	24.14	1.37	0.01	0.079	0.11
	GSM1900	GPRS12	Right Tilted	661	Ant 0	25.5	24.14	1.37	0.00	0.001	0.00
	GSM1900	GPRS12	Left Cheek	661	Ant 0	25.5	24.14	1.37	-0.05	0.091	0.12
	GSM1900	GPRS12	Left Tilted	661	Ant 0	25.5	24.14	1.37	0.00	0.001	0.00
02	GSM1900	GPRS12	Left Cheek	512	Ant 0	25.5	23.99	1.42	0.08	0.111	0.16
	GSM1900	GPRS12	Left Cheek	810	Ant 0	25.5	24.11	1.38	-0.02	0.083	0.11
	WCDMA II	RMC12.2K	Right Cheek	9400	Ant 0	23.5	23.18	1.08	-0.06	0.112	0.12
	WCDMA II	RMC12.2K	Right Tilted	9400	Ant 0	23.5	23.18	1.08	0.03	0.081	0.09
	WCDMA II	RMC12.2K	Left Cheek	9400	Ant 0	23.5	23.18	1.08	-0.12	0.177	0.19
	WCDMA II	RMC12.2K	Left Tilted	9400	Ant 0	23.5	23.18	1.08	0.05	0.087	0.09
03	WCDMA II	RMC12.2K	Left Cheek	9262	Ant 0	23.5	23.08	1.10	0.03	0.196	0.22
	WCDMA II	RMC12.2K	Left Cheek	9538	Ant 0	23.5	23.12	1.09	0.06	0.161	0.18
	WCDMA IV	RMC12.2K	Right Cheek	1413	Ant 0	23.5	23.03	1.11	0.03	0.136	0.15
	WCDMA IV	RMC12.2K	Right Tilted	1413	Ant 0	23.5	23.03	1.11	0.14	0.06	0.07
	WCDMA IV	RMC12.2K	Left Cheek	1413	Ant 0	23.5	23.03	1.11	-0.05	0.208	0.23
	WCDMA IV	RMC12.2K	Left Tilted	1413	Ant 0	23.5	23.03	1.11	-0.01	0.103	0.11
04	WCDMA IV	RMC12.2K	Left Cheek	1312	Ant 0	23.5	22.94	1.14	-0.01	0.245	0.28
	WCDMA IV	RMC12.2K	Left Cheek	1513	Ant 0	23.5	22.89	1.15	0.11	0.222	0.26
	WCDMA V	RMC12.2K	Right Cheek	4182	Ant 0	23.5	23.18	1.08	-0.13	0.213	0.23
	WCDMA V	RMC12.2K	Right Tilted	4182	Ant 0	23.5	23.18	1.08	0.02	0.111	0.12
	WCDMA V	RMC12.2K	Left Cheek	4182	Ant 0	23.5	23.18	1.08	-0.14	0.121	0.13
	WCDMA V	RMC12.2K	Left Tilted	4182	Ant 0	23.5	23.18	1.08	0.11	0.087	0.09
	WCDMA V	RMC12.2K	Right Cheek	4182	Ant 1	23.5	23.18	1.08	0.06	0.927	1.00
	WCDMA V	RMC12.2K	Right Tilted	4182	Ant 1	23.5	23.18	1.08	-0.08	0.729	0.78
	WCDMA V	RMC12.2K	Left Cheek	4182	Ant 1	23.5	23.18	1.08	-0.01	0.701	0.75
	WCDMA V	RMC12.2K	Left Tilted	4182	Ant 1	23.5	23.18	1.08	-0.10	0.655	0.71
	WCDMA V	RMC12.2K	Right Cheek	4132	Ant 1	23.5	23.00	1.12	0.07	0.928	1.04
05	WCDMA V	RMC12.2K	Right Cheek	4233	Ant 1	23.5	22.97	1.13	0.03	0.944	1.07
	WCDMA V	RMC12.2K	Right Cheek	4233	Ant 1	23.5	22.97	1.13	0.01	0.932	1.05

Note: The "< 0.001" means there is no SAR value or the SAR is too low to be measured.



FCC SAR Test Report

Plot No.	Band	Mode	Test Position	Ch.	RB#	RB Offset	Tx Antenna	Max. Tune-up Power (dBm)	Measured Conducted Power (dBm)	Scaling Factor	Power Drift (dB)	Measured SAR-1g (W/kg)	Scaled SAR-1g (W/kg)
	LTE 2	QPSK20M	Right Cheek	18900	1	0	Ant 0	23.0	22.76	1.06	0.06	0.104	0.11
	LTE 2	QPSK20M	Right Tilted	18900	1	0	Ant 0	23.0	22.76	1.06	-0.11	0.066	0.07
	LTE 2	QPSK20M	Left Cheek	18900	1	0	Ant 0	23.0	22.76	1.06	0.06	0.15	0.16
	LTE 2	QPSK20M	Left Tilted	18900	1	0	Ant 0	23.0	22.76	1.06	0.05	0.049	0.05
	LTE 2	QPSK20M	Right Cheek	18900	50	0	Ant 0	22.0	21.68	1.08	-0.15	0.084	0.09
	LTE 2	QPSK20M	Right Tilted	18900	50	0	Ant 0	22.0	21.68	1.08	0.07	0.053	0.06
	LTE 2	QPSK20M	Left Cheek	18900	50	0	Ant 0	22.0	21.68	1.08	0.19	0.113	0.12
	LTE 2	QPSK20M	Left Tilted	18900	50	0	Ant 0	22.0	21.68	1.08	-0.08	0.04	0.04
06	LTE 2	QPSK20M	Left Cheek	18700	1	0	Ant 0	23.0	22.57	1.10	-0.02	0.166	0.18
	LTE 2	QPSK20M	Left Cheek	19100	1	0	Ant 0	23.0	22.70	1.07	0.17	0.149	0.16
	LTE 4	QPSK20M	Right Cheek	20175	1	0	Ant 0	23.0	22.69	1.07	-0.16	0.125	0.13
	LTE 4	QPSK20M	Right Tilted	20175	1	0	Ant 0	23.0	22.69	1.07	-0.05	0.081	0.09
	LTE 4	QPSK20M	Left Cheek	20175	1	0	Ant 0	23.0	22.69	1.07	0.09	0.205	0.22
	LTE 4	QPSK20M	Left Tilted	20175	1	0	Ant 0	23.0	22.69	1.07	0.07	0.102	0.11
	LTE 4	QPSK20M	Right Cheek	20175	50	0	Ant 0	22.0	21.56	1.11	-0.11	0.095	0.11
	LTE 4	QPSK20M	Right Tilted	20175	50	0	Ant 0	22.0	21.56	1.11	0.16	0.061	0.07
	LTE 4	QPSK20M	Left Cheek	20175	50	0	Ant 0	22.0	21.56	1.11	-0.02	0.164	0.18
	LTE 4	QPSK20M	Left Tilted	20175	50	0	Ant 0	22.0	21.56	1.11	0.04	0.077	0.09
07	LTE 4	QPSK20M	Left Cheek	20050	1	0	Ant 0	23.0	22.64	1.09	-0.03	0.216	0.24
	LTE 4	QPSK20M	Left Cheek	20300	1	0	Ant 0	23.0	22.63	1.09	0.10	0.193	0.21
	LTE 5	QPSK10M	Right Cheek	20525	1	0	Ant 0	23.0	22.75	1.06	0.03	0.085	0.09
	LTE 5	QPSK10M	Right Tilted	20525	1	0	Ant 0	23.0	22.75	1.06	0.01	0.051	0.05
	LTE 5	QPSK10M	Left Cheek	20525	1	0	Ant 0	23.0	22.75	1.06	-0.04	0.072	0.08
	LTE 5	QPSK10M	Left Tilted	20525	1	0	Ant 0	23.0	22.75	1.06	0.05	0.052	0.06
	LTE 5	QPSK10M	Right Cheek	20525	25	0	Ant 0	22.0	21.62	1.09	-0.01	0.065	0.07
	LTE 5	QPSK10M	Right Tilted	20525	25	0	Ant 0	22.0	21.62	1.09	-0.11	0.036	0.04
	LTE 5	QPSK10M	Left Cheek	20525	25	0	Ant 0	22.0	21.62	1.09	-0.07	0.059	0.06
	LTE 5	QPSK10M	Left Tilted	20525	25	0	Ant 0	22.0	21.62	1.09	0.04	0.041	0.04
08	LTE 5	QPSK10M	Right Cheek	20525	1	0	Ant 1	23.0	22.75	1.06	0.02	0.884	0.94
	LTE 5	QPSK10M	Right Tilted	20525	1	0	Ant 1	23.0	22.75	1.06	-0.03	0.621	0.66
	LTE 5	QPSK10M	Left Cheek	20525	1	0	Ant 1	23.0	22.75	1.06	0.06	0.741	0.78
	LTE 5	QPSK10M	Left Tilted	20525	1	0	Ant 1	23.0	22.75	1.06	0.02	0.581	0.62
	LTE 5	QPSK10M	Right Cheek	20525	25	0	Ant 1	22.0	21.62	1.09	0.05	0.606	0.66
	LTE 5	QPSK10M	Right Tilted	20525	25	0	Ant 1	22.0	21.62	1.09	0.07	0.653	0.71
	LTE 5	QPSK10M	Left Cheek	20525	25	0	Ant 1	22.0	21.62	1.09	-0.09	0.702	0.77
	LTE 5	QPSK10M	Left Tilted	20525	25	0	Ant 1	22.0	21.62	1.09	0.02	0.541	0.59
	LTE 5	QPSK10M	Right Cheek	20450	1	0	Ant 1	23.0	22.57	1.10	0.11	0.729	0.80
	LTE 5	QPSK10M	Right Cheek	20600	1	0	Ant 1	23.0	22.61	1.09	-0.03	0.785	0.86
	LTE 5	QPSK10M	Right Cheek	20525	50	0	Ant 1	22.0	21.61	1.09	0.05	0.591	0.65
	LTE 5	QPSK10M	Right Cheek	20525	1	0	Ant 1	23.0	22.75	1.06	0.01	0.856	0.91

FCC SAR Test Report

Uplink Mode	Plot No.	Band	Mode	Test Position	Ch.	RB#	RB Offset	Tx Antenna	Max. Tune-up Power (dBm)	Measured Conducted Power (dBm)	Scaling Factor	Power Drift (dB)	Measured SAR-1g (W/kg)	Scaled SAR-1g (W/kg)
Single Carrier (CA inactive)		LTE 7	QPSK20M	Right Cheek	21100	1	0	Ant 0	22.0	21.17	1.21	-0.15	0.056	0.07
		LTE 7	QPSK20M	Right Tilted	21100	1	0	Ant 0	22.0	21.17	1.21	0.00	0.001	0.00
		LTE 7	QPSK20M	Left Cheek	21100	1	0	Ant 0	22.0	21.17	1.21	0.17	0.052	0.06
		LTE 7	QPSK20M	Left Tilted	21100	1	0	Ant 0	22.0	21.17	1.21	0.00	0.001	0.00
		LTE 7	QPSK20M	Right Cheek	21100	50	0	Ant 0	21.0	20.11	1.23	-0.15	0.041	0.05
		LTE 7	QPSK20M	Right Tilted	21100	50	0	Ant 0	21.0	20.11	1.23	0.00	0.001	0.00
		LTE 7	QPSK20M	Left Cheek	21100	50	0	Ant 0	21.0	20.11	1.23	-0.10	0.038	0.05
		LTE 7	QPSK20M	Left Tilted	21100	50	0	Ant 0	21.0	20.11	1.23	0.00	0.001	0.00
2 CC (CA active)	09	LTE 7	QPSK20M	Right Cheek	20850	1	0	Ant 0	22.0	21.13	1.22	0.09	0.062	0.08
		LTE 7	QPSK20M	Right Cheek	21350	1	0	Ant 0	22.0	21.08	1.24	-0.17	0.046	0.06
		LTE 7	QPSK20M	Right Cheek	PCC: 20850 SCC: 21048	PCC: 1 SCC: 1	PCC: 99 SCC: 0	Ant 0	22.0	20.84	1.31	0.10	0.055	0.07
		LTE 7	QPSK20M	Right Cheek	PCC: 21100 SCC: 21298	PCC: 1 SCC: 1	PCC: 99 SCC: 0	Ant 0	22.0	20.93	1.28	0.02	0.051	0.07
		LTE 7	QPSK20M	Right Cheek	PCC: 21152 SCC: 21350	PCC: 1 SCC: 1	PCC: 99 SCC: 0	Ant 0	22.0	20.79	1.32	0.16	0.056	0.07

Plot No.	Band	Mode	Test Position	Ch.	RB#	RB Offset	Tx Antenna	Max. Tune-up Power (dBm)	Measured Conducted Power (dBm)	Scaling Factor	Power Drift (dB)	Measured SAR-1g (W/kg)	Scaled SAR-1g (W/kg)
	LTE 12	QPSK10M	Right Cheek	23095	1	0	Ant 0	23.0	22.75	1.06	0.09	0.05	0.05
	LTE 12	QPSK10M	Right Tilted	23095	1	0	Ant 0	23.0	22.75	1.06	0.00	0.001	0.00
	LTE 12	QPSK10M	Left Cheek	23095	1	0	Ant 0	23.0	22.75	1.06	0.03	0.049	0.05
	LTE 12	QPSK10M	Left Tilted	23095	1	0	Ant 0	23.0	22.75	1.06	0.00	0.001	0.00
	LTE 12	QPSK10M	Right Cheek	23095	25	0	Ant 0	22.0	21.82	1.04	0.00	0.001	0.00
	LTE 12	QPSK10M	Right Tilted	23095	25	0	Ant 0	22.0	21.82	1.04	0.00	0.001	0.00
	LTE 12	QPSK10M	Left Cheek	23095	25	0	Ant 0	22.0	21.82	1.04	0.00	0.001	0.00
	LTE 12	QPSK10M	Left Tilted	23095	25	0	Ant 0	22.0	21.82	1.04	0.00	0.001	0.00
	LTE 12	QPSK10M	Right Cheek	23095	1	0	Ant 1	23.0	22.75	1.06	-0.06	0.529	0.56
	LTE 12	QPSK10M	Right Tilted	23095	1	0	Ant 1	23.0	22.75	1.06	-0.07	0.519	0.55
	LTE 12	QPSK10M	Left Cheek	23095	1	0	Ant 1	23.0	22.75	1.06	0.09	0.535	0.57
10	LTE 12	QPSK10M	Left Tilted	23095	1	0	Ant 1	23.0	22.75	1.06	0.14	0.577	0.61
	LTE 12	QPSK10M	Right Cheek	23095	25	0	Ant 1	22.0	21.82	1.04	0.07	0.431	0.45
	LTE 12	QPSK10M	Right Tilted	23095	25	0	Ant 1	22.0	21.82	1.04	-0.15	0.405	0.42
	LTE 12	QPSK10M	Left Cheek	23095	25	0	Ant 1	22.0	21.82	1.04	-0.09	0.426	0.44
	LTE 12	QPSK10M	Left Tilted	23095	25	0	Ant 1	22.0	21.82	1.04	0.11	0.463	0.48
	LTE 12	QPSK10M	Left Tilted	23060	1	0	Ant 1	23.0	22.62	1.09	0.08	0.501	0.55
	LTE 12	QPSK10M	Left Tilted	23130	1	0	Ant 1	23.0	22.71	1.07	0.00	0.531	0.57
	LTE 13	QPSK10M	Right Cheek	23230	1	0	Ant 0	23.0	22.55	1.11	0.10	0.121	0.13
	LTE 13	QPSK10M	Right Tilted	23230	1	0	Ant 0	23.0	22.55	1.11	0.17	0.078	0.09
	LTE 13	QPSK10M	Left Cheek	23230	1	0	Ant 0	23.0	22.55	1.11	-0.01	0.087	0.10
	LTE 13	QPSK10M	Left Tilted	23230	1	0	Ant 0	23.0	22.55	1.11	-0.13	0.065	0.07
	LTE 13	QPSK10M	Right Cheek	23230	25	0	Ant 0	22.0	21.48	1.13	-0.03	0.102	0.11
	LTE 13	QPSK10M	Right Tilted	23230	25	0	Ant 0	22.0	21.48	1.13	0.16	0.065	0.07
	LTE 13	QPSK10M	Left Cheek	23230	25	0	Ant 0	22.0	21.48	1.13	-0.15	0.076	0.09
	LTE 13	QPSK10M	Left Tilted	23230	25	0	Ant 0	22.0	21.48	1.13	-0.11	0.059	0.07
11	LTE 13	QPSK10M	Right Cheek	23230	1	0	Ant 1	23.0	22.55	1.11	0.06	0.537	0.60
	LTE 13	QPSK10M	Right Tilted	23230	1	0	Ant 1	23.0	22.55	1.11	0.06	0.368	0.41
	LTE 13	QPSK10M	Left Cheek	23230	1	0	Ant 1	23.0	22.55	1.11	-0.02	0.459	0.51
	LTE 13	QPSK10M	Left Tilted	23230	1	0	Ant 1	23.0	22.55	1.11	-0.02	0.463	0.51
	LTE 13	QPSK10M	Right Cheek	23230	25	0	Ant 1	22.0	21.48	1.13	0.08	0.431	0.49
	LTE 13	QPSK10M	Right Tilted	23230	25	0	Ant 1	22.0	21.48	1.13	-0.07	0.294	0.33
	LTE 13	QPSK10M	Left Cheek	23230	25	0	Ant 1	22.0	21.48	1.13	0.01	0.338	0.38
	LTE 13	QPSK10M	Left Tilted	23230	25	0	Ant 1	22.0	21.48	1.13	0.03	0.376	0.42

FCC SAR Test Report

Plot No.	Band	Mode	Test Position	Ch.	RB#	RB Offset	Tx Antenna	Max. Tune-up Power (dBm)	Measured Conducted Power (dBm)	Scaling Factor	Power Drift (dB)	Measured SAR-1g (W/kg)	Scaled SAR-1g (W/kg)
	LTE 17	QPSK10M	Right Cheek	23790	1	0	Ant 0	23.0	22.70	1.07	0.12	0.054	0.06
	LTE 17	QPSK10M	Right Tilted	23790	1	0	Ant 0	23.0	22.70	1.07	-0.09	0.032	0.03
	LTE 17	QPSK10M	Left Cheek	23790	1	0	Ant 0	23.0	22.70	1.07	-0.10	0.045	0.05
	LTE 17	QPSK10M	Left Tilted	23790	1	0	Ant 0	23.0	22.70	1.07	0.06	0.033	0.04
	LTE 17	QPSK10M	Right Cheek	23790	25	0	Ant 0	22.0	21.68	1.08	-0.13	0.041	0.04
	LTE 17	QPSK10M	Right Tilted	23790	25	0	Ant 0	22.0	21.68	1.08	-0.02	0.023	0.02
	LTE 17	QPSK10M	Left Cheek	23790	25	0	Ant 0	22.0	21.68	1.08	0.19	0.037	0.04
	LTE 17	QPSK10M	Left Tilted	23790	25	0	Ant 0	22.0	21.68	1.08	0.13	0.026	0.03
	LTE 17	QPSK10M	Right Cheek	23790	1	0	Ant 1	23.0	22.70	1.07	0.17	0.875	0.94
	LTE 17	QPSK10M	Right Tilted	23790	1	0	Ant 1	23.0	22.70	1.07	-0.01	0.713	0.76
	LTE 17	QPSK10M	Left Cheek	23790	1	0	Ant 1	23.0	22.70	1.07	-0.13	0.762	0.82
	LTE 17	QPSK10M	Left Tilted	23790	1	0	Ant 1	23.0	22.70	1.07	-0.03	0.902	0.97
	LTE 17	QPSK10M	Right Cheek	23790	25	0	Ant 1	22.0	21.68	1.08	0.16	0.566	0.61
	LTE 17	QPSK10M	Right Tilted	23790	25	0	Ant 1	22.0	21.68	1.08	0.07	0.555	0.60
	LTE 17	QPSK10M	Left Cheek	23790	25	0	Ant 1	22.0	21.68	1.08	-0.15	0.592	0.64
	LTE 17	QPSK10M	Left Tilted	23790	25	0	Ant 1	22.0	21.68	1.08	-0.09	0.629	0.68
12	LTE 17	QPSK10M	Right Cheek	23780	1	0	Ant 1	23.0	22.69	1.07	0.11	0.937	1.01
	LTE 17	QPSK10M	Right Cheek	23800	1	0	Ant 1	23.0	22.65	1.08	0.08	0.826	0.90
	LTE 17	QPSK10M	Right Cheek	23790	50	0	Ant 1	22.0	21.64	1.09	0.08	0.668	0.73
	LTE 17	QPSK10M	Left Cheek	23780	1	0	Ant 1	23.0	22.69	1.07	-0.07	0.742	0.80
	LTE 17	QPSK10M	Left Cheek	23800	1	0	Ant 1	23.0	22.65	1.08	0.01	0.751	0.81
	LTE 17	QPSK10M	Left Cheek	23790	50	0	Ant 1	22.0	21.64	1.09	0.01	0.738	0.80
	LTE 17	QPSK10M	Left Tilted	23780	1	0	Ant 1	23.0	22.69	1.07	0.02	0.919	0.99
	LTE 17	QPSK10M	Left Tilted	23800	1	0	Ant 1	23.0	22.65	1.08	0.06	0.892	0.97
	LTE 17	QPSK10M	Left Tilted	23790	50	0	Ant 1	22.0	21.64	1.09	0.02	0.902	0.98
	LTE 17	QPSK10M	Right Cheek	23780	1	0	Ant 1	23.0	22.69	1.07	0.02	0.927	1.00
13	LTE 38	QPSK20M	Right Cheek	38000	1	0	Ant 0	22.5	22.50	1.00	0.10	0.045	0.05
	LTE 38	QPSK20M	Right Tilted	38000	1	0	Ant 0	22.5	22.50	1.00	0.00	0.001	0.00
	LTE 38	QPSK20M	Left Cheek	38000	1	0	Ant 0	22.5	22.50	1.00	0.00	0.001	0.00
	LTE 38	QPSK20M	Left Tilted	38000	1	0	Ant 0	22.5	22.50	1.00	0.00	0.001	0.00
	LTE 38	QPSK20M	Right Cheek	38000	50	0	Ant 0	21.5	21.36	1.03	0.12	0.039	0.04
	LTE 38	QPSK20M	Right Tilted	38000	50	0	Ant 0	21.5	21.36	1.03	0.00	0.001	0.00
	LTE 38	QPSK20M	Left Cheek	38000	50	0	Ant 0	21.5	21.36	1.03	0.00	0.001	0.00
	LTE 38	QPSK20M	Left Tilted	38000	50	0	Ant 0	21.5	21.36	1.03	0.00	0.001	0.00
	LTE 38	QPSK20M	Right Cheek	37850	1	0	Ant 0	22.5	22.35	1.04	-0.14	0.031	0.03
	LTE 38	QPSK20M	Right Cheek	38150	1	0	Ant 0	22.5	22.42	1.02	0.02	0.038	0.04
14	LTE 41	QPSK20M	Right Cheek	41140	1	0	Ant 0	23.0	22.73	1.06	-0.16	0.048	0.05
	LTE 41	QPSK20M	Right Tilted	41140	1	0	Ant 0	23.0	22.73	1.06	0.03	0.045	0.05
	LTE 41	QPSK20M	Left Cheek	41140	1	0	Ant 0	23.0	22.73	1.06	0.00	0.001	0.00
	LTE 41	QPSK20M	Left Tilted	41140	1	0	Ant 0	23.0	22.73	1.06	0.00	0.001	0.00
	LTE 41	QPSK20M	Right Cheek	41140	50	0	Ant 0	22.0	21.79	1.05	0.05	0.045	0.05
	LTE 41	QPSK20M	Right Tilted	41140	50	0	Ant 0	22.0	21.79	1.05	0.09	0.042	0.04
	LTE 41	QPSK20M	Left Cheek	41140	50	0	Ant 0	22.0	21.79	1.05	0.00	0.001	0.00
	LTE 41	QPSK20M	Left Tilted	41140	50	0	Ant 0	22.0	21.79	1.05	0.00	0.001	0.00
	LTE 41	QPSK20M	Right Cheek	40140	1	0	Ant 0	23.0	22.30	1.17	-0.08	0.038	0.04
	LTE 41	QPSK20M	Right Cheek	40640	1	0	Ant 0	23.0	22.53	1.11	0.02	0.038	0.04
	LTE 66	QPSK20M	Right Cheek	132322	1	0	Ant 0	23.0	22.99	1.00	0.05	0.098	0.10
	LTE 66	QPSK20M	Right Tilted	132322	1	0	Ant 0	23.0	22.99	1.00	-0.13	0.061	0.06
	LTE 66	QPSK20M	Left Cheek	132322	1	0	Ant 0	23.0	22.99	1.00	-0.02	0.19	0.19
	LTE 66	QPSK20M	Left Tilted	132322	1	0	Ant 0	23.0	22.99	1.00	0.04	0.087	0.09
	LTE 66	QPSK20M	Right Cheek	132322	50	0	Ant 0	22.0	21.92	1.02	-0.16	0.073	0.07
	LTE 66	QPSK20M	Right Tilted	132322	50	0	Ant 0	22.0	21.92	1.02	0.07	0.048	0.05
	LTE 66	QPSK20M	Left Cheek	132322	50	0	Ant 0	22.0	21.92	1.02	-0.19	0.146	0.15
	LTE 66	QPSK20M	Left Tilted	132322	50	0	Ant 0	22.0	21.92	1.02	0.08	0.069	0.07
15	LTE 66	QPSK20M	Left Cheek	132072	1	0	Ant 0	23.0	22.98	1.00	-0.11	0.215	0.22
	LTE 66	QPSK20M	Left Cheek	132572	1	0	Ant 0	23.0	22.97	1.01	0.06	0.182	0.18

FCC SAR Test Report

Plot No.	Band	Mode	Test Position	Ch.	Tx Antenna	Max. Tune-up Power (dBm)	Measured Conducted Power (dBm)	Scaling Factor	Power Drift (dB)	Measured SAR-1g (W/kg)	Scaled SAR-1g (W/kg)
	WLAN2.4G	802.11b	Right Cheek	1	Ant 0	18.5	18.49	1.00	-0.03	0.318	0.32
	WLAN2.4G	802.11b	Right Tilted	1	Ant 0	18.5	18.49	1.00	0.05	0.271	0.27
	WLAN2.4G	802.11b	Left Cheek	1	Ant 0	18.5	18.49	1.00	0.09	0.485	0.49
	WLAN2.4G	802.11b	Left Tilted	1	Ant 0	18.5	18.49	1.00	-0.12	0.209	0.21
	WLAN2.4G	802.11b	Right Cheek	1	Ant 1	19.0	18.91	1.02	0.03	0.136	0.14
	WLAN2.4G	802.11b	Right Tilted	1	Ant 1	19.0	18.91	1.02	-0.05	0.091	0.09
	WLAN2.4G	802.11b	Left Cheek	1	Ant 1	19.0	18.91	1.02	-0.15	0.409	0.42
	WLAN2.4G	802.11b	Left Tilted	1	Ant 1	19.0	18.91	1.02	-0.01	0.284	0.29
	WLAN2.4G	802.11n HT40	Right Cheek	3	Ant 0+1	20.0	19.96	1.01	0.06	0.215	0.22
	WLAN2.4G	802.11n HT40	Right Tilted	3	Ant 0+1	20.0	19.96	1.01	0.12	0.175	0.18
16	WLAN2.4G	802.11n HT40	Left Cheek	3	Ant 0+1	20.0	19.96	1.01	0.15	0.507	0.51
	WLAN2.4G	802.11n HT40	Left Tilted	3	Ant 0+1	20.0	19.96	1.01	0.09	0.377	0.38
	WLAN2.4G	802.11n HT40	Left Cheek	6	Ant 0+1	20.0	19.90	1.02	0.08	0.478	0.49
	WLAN2.4G	802.11n HT40	Left Cheek	9	Ant 0+1	20.0	19.82	1.04	0.10	0.488	0.51
	WLAN5G	802.11ac VHT80	Right Cheek	58	Ant 0	9.5	9.37	1.03	0.06	0.11	0.11
	WLAN5G	802.11ac VHT80	Right Tilted	58	Ant 0	9.5	9.37	1.03	-0.13	0.001	0.00
17	WLAN5G	802.11ac VHT80	Left Cheek	58	Ant 0	9.5	9.37	1.03	0.12	0.308	0.32
	WLAN5G	802.11ac VHT80	Left Tilted	58	Ant 0	9.5	9.37	1.03	0.05	0.212	0.22
	WLAN5G	802.11a	Right Cheek	58	Ant 1	19.0	18.77	1.05	0.03	0.001	0.00
	WLAN5G	802.11a	Right Tilted	58	Ant 1	19.0	18.77	1.05	0.04	0.001	0.00
	WLAN5G	802.11a	Left Cheek	58	Ant 1	19.0	18.77	1.05	0.00	0.001	0.00
	WLAN5G	802.11a	Left Tilted	58	Ant 1	19.0	18.77	1.05	0.08	0.001	0.00
	WLAN5G	802.11ac VHT80	Right Cheek	58	Ant 0+1	12.5	12.23	1.06	0.06	0.151	0.16
	WLAN5G	802.11ac VHT80	Right Tilted	58	Ant 0+1	12.5	12.23	1.06	0.07	0.153	0.16
	WLAN5G	802.11ac VHT80	Left Cheek	58	Ant 0+1	12.5	12.23	1.06	0.14	0.289	0.31
	WLAN5G	802.11ac VHT80	Left Tilted	58	Ant 0+1	12.5	12.23	1.06	-0.06	0.196	0.21
	WLAN5G	802.11ac VHT80	Right Cheek	106	Ant 0	9.5	9.48	1.00	0.00	0.001	0.00
	WLAN5G	802.11ac VHT80	Right Tilted	106	Ant 0	9.5	9.48	1.00	0.00	0.001	0.00
	WLAN5G	802.11ac VHT80	Left Cheek	106	Ant 0	9.5	9.48	1.00	0.00	0.001	0.00
	WLAN5G	802.11ac VHT80	Left Tilted	106	Ant 0	9.5	9.48	1.00	0.00	0.001	0.00
	WLAN5G	802.11a	Right Cheek	116	Ant 1	19.0	18.69	1.07	0.03	0.001	0.00
	WLAN5G	802.11a	Right Tilted	116	Ant 1	19.0	18.69	1.07	-0.11	0.001	0.00
18	WLAN5G	802.11a	Left Cheek	116	Ant 1	19.0	18.69	1.07	0.06	0.122	0.13
	WLAN5G	802.11a	Left Tilted	116	Ant 1	19.0	18.69	1.07	0.08	0.117	0.13
	WLAN5G	802.11ac VHT80	Right Cheek	106	Ant 0+1	12.5	12.49	1.00	0.00	0.001	0.00
	WLAN5G	802.11ac VHT80	Right Tilted	106	Ant 0+1	12.5	12.49	1.00	0.00	0.001	0.00
	WLAN5G	802.11ac VHT80	Left Cheek	106	Ant 0+1	12.5	12.49	1.00	0.00	0.001	0.00
	WLAN5G	802.11ac VHT80	Left Tilted	106	Ant 0+1	12.5	12.49	1.00	0.00	0.001	0.00
	WLAN5G	802.11a	Left Cheek	100	Ant 1	19.0	18.64	1.09	-0.12	0.117	0.13
	WLAN5G	802.11a	Left Cheek	120	Ant 1	19.0	18.55	1.11	-0.08	0.112	0.12
	WLAN5G	802.11a	Left Cheek	124	Ant 1	19.0	18.43	1.14	-0.12	0.109	0.12
	WLAN5G	802.11a	Left Cheek	132	Ant 1	19.0	18.47	1.13	-0.08	0.115	0.13
	WLAN5G	802.11a	Left Cheek	140	Ant 1	19.0	18.34	1.16	-0.12	0.111	0.13
	WLAN5G	802.11a	Left Cheek	144	Ant 1	19.0	18.31	1.17	-0.08	0.109	0.13

FCC SAR Test Report

Plot No.	Band	Mode	Test Position	Ch.	Tx Antenna	Max. Tune-up Power (dBm)	Measured Conducted Power (dBm)	Scaling Factor	Power Drift (dB)	Measured SAR-1g (W/kg)	Scaled SAR-1g (W/kg)
	WLAN5G	802.11ac VHT80	Right Cheek	155	Ant 0	9.5	9.49	1.00	-0.04	0.167	0.17
	WLAN5G	802.11ac VHT80	Right Tilted	155	Ant 0	9.5	9.49	1.00	0.16	0.161	0.16
19	WLAN5G	802.11ac VHT80	Left Cheek	155	Ant 0	9.5	9.49	1.00	0.05	0.323	0.32
	WLAN5G	802.11ac VHT80	Left Tilted	155	Ant 0	9.5	9.49	1.00	0.05	0.23	0.23
	WLAN5G	802.11a	Right Cheek	165	Ant 1	19.0	18.59	1.10	0.06	0.127	0.14
	WLAN5G	802.11a	Right Tilted	165	Ant 1	19.0	18.59	1.10	0.05	0.119	0.13
	WLAN5G	802.11a	Left Cheek	165	Ant 1	19.0	18.59	1.10	0.13	0.237	0.26
	WLAN5G	802.11a	Left Tilted	165	Ant 1	19.0	18.59	1.10	-0.02	0.212	0.23
	WLAN5G	802.11ac VHT80	Right Cheek	155	Ant 0+1	12.5	12.33	1.04	-0.06	0.151	0.16
	WLAN5G	802.11ac VHT80	Right Tilted	155	Ant 0+1	12.5	12.33	1.04	0.04	0.142	0.15
	WLAN5G	802.11ac VHT80	Left Cheek	155	Ant 0+1	12.5	12.33	1.04	0.10	0.284	0.30
	WLAN5G	802.11ac VHT80	Left Tilted	155	Ant 0+1	12.5	12.33	1.04	0.16	0.248	0.26

Plot No.	Band	Mode	Test Position	Ch.	Max. Tune-up Power (dBm)	Measured Conducted Power (dBm)	Scaling Factor	Power Drift (dB)	Measured SAR-1g (W/kg)	Scaled SAR-1g (W/kg)
	BT	BR / EDR	Right Cheek	0	10.0	9.42	1.14	0.01	0.00643	0.01
	BT	BR / EDR	Right Tilted	0	10.0	9.42	1.14	-0.10	0.00522	0.01
20	BT	BR / EDR	Left Cheek	0	10.0	9.42	1.14	-0.08	0.015	0.02
	BT	BR / EDR	Left Tilted	0	10.0	9.42	1.14	0.07	0.011	0.01
	BT	BR / EDR	Left Cheek	39	10.0	8.59	1.38	0.12	0.012	0.02
	BT	BR / EDR	Left Cheek	78	10.0	8.69	1.35	0.03	0.012	0.02

FCC SAR Test Report

4.7.3 SAR Results for Body-worn Exposure Condition (Test Separation Distance is 15 mm)

Plot No.	Band	Mode	Test Position	Ch.	Tx Antenna	Max. Tune-up Power (dBm)	Measured Conducted Power (dBm)	Scaling Factor	Power Drift (dB)	Measured SAR-1g (W/kg)	Scaled SAR-1g (W/kg)
	GSM850	GPRS11	Front Face	189	Ant 0	28.5	28.49	1.00	-0.03	0.182	0.18
	GSM850	GPRS11	Rear Face	189	Ant 0	28.5	28.49	1.00	-0.08	0.145	0.15
	GSM850	GPRS11	Front Face	189	Ant 1	28.5	28.49	1.00	-0.14	0.132	0.13
	GSM850	GPRS11	Rear Face	189	Ant 1	28.5	28.49	1.00	-0.13	0.115	0.12
	GSM850	GPRS11	Front Face	128	Ant 0	28.5	28.42	1.02	0.04	0.144	0.15
21	GSM850	GPRS11	Front Face	251	Ant 0	28.5	28.48	1.00	-0.12	0.208	0.21
	GSM1900	GPRS12	Front Face	661	Ant 0	25.5	24.14	1.37	-0.05	0.362	0.50
	GSM1900	GPRS12	Rear Face	661	Ant 0	25.5	24.14	1.37	0.07	0.377	0.52
22	GSM1900	GPRS12	Rear Face	512	Ant 0	25.5	23.99	1.42	0.02	0.410	0.58
	GSM1900	GPRS12	Rear Face	810	Ant 0	25.5	24.11	1.38	0.05	0.344	0.47
	WCDMA II	RMC12.2K	Front Face	9400	Ant 0	23.5	23.18	1.08	0.07	0.660	0.71
	WCDMA II	RMC12.2K	Rear Face	9400	Ant 0	23.5	23.18	1.08	-0.02	0.702	0.76
23	WCDMA II	RMC12.2K	Rear Face	9262	Ant 0	23.5	23.08	1.10	-0.05	0.705	0.78
	WCDMA II	RMC12.2K	Rear Face	9538	Ant 0	23.5	23.12	1.09	0.17	0.659	0.72
	WCDMA IV	RMC12.2K	Front Face	1413	Ant 0	23.5	23.03	1.11	-0.03	0.761	0.85
	WCDMA IV	RMC12.2K	Rear Face	1413	Ant 0	23.5	23.03	1.11	0.07	0.763	0.85
24	WCDMA IV	RMC12.2K	Front Face	1312	Ant 0	23.5	22.94	1.14	0.11	0.790	0.90
	WCDMA IV	RMC12.2K	Front Face	1513	Ant 0	23.5	22.89	1.15	-0.05	0.726	0.84
	WCDMA IV	RMC12.2K	Rear Face	1312	Ant 0	23.5	22.94	1.14	0.08	0.785	0.89
	WCDMA IV	RMC12.2K	Rear Face	1513	Ant 0	23.5	22.89	1.15	0.02	0.719	0.83
	WCDMA V	RMC12.2K	Front Face	4182	Ant 0	23.5	23.18	1.08	0.03	0.191	0.21
25	WCDMA V	RMC12.2K	Rear Face	4182	Ant 0	23.5	23.18	1.08	-0.02	0.199	0.21
	WCDMA V	RMC12.2K	Front Face	4182	Ant 1	23.5	23.18	1.08	0.16	0.152	0.16
	WCDMA V	RMC12.2K	Rear Face	4182	Ant 1	23.5	23.18	1.08	-0.05	0.121	0.13
	WCDMA V	RMC12.2K	Rear Face	4132	Ant 0	23.5	23.00	1.12	-0.12	0.144	0.16
	WCDMA V	RMC12.2K	Rear Face	4233	Ant 0	23.5	22.97	1.13	0.10	0.179	0.20

Plot No.	Band	Mode	Test Position	Ch.	RB#	RB Offset	Tx Antenna	Max. Tune-up Power (dBm)	Measured Conducted Power (dBm)	Scaling Factor	Power Drift (dB)	Measured SAR-1g (W/kg)	Scaled SAR-1g (W/kg)
26	LTE 2	QPSK20M	Front Face	18900	1	0	Ant 0	23.0	22.76	1.06	0.11	0.486	0.52
	LTE 2	QPSK20M	Rear Face	18900	1	0	Ant 0	23.0	22.76	1.06	0.02	0.535	0.57
	LTE 2	QPSK20M	Front Face	18900	50	0	Ant 0	22.0	21.68	1.08	-0.06	0.416	0.45
	LTE 2	QPSK20M	Rear Face	18900	50	0	Ant 0	22.0	21.68	1.08	-0.07	0.429	0.46
	LTE 2	QPSK20M	Rear Face	18700	1	0	Ant 0	23.0	22.57	1.10	0.19	0.508	0.56
	LTE 2	QPSK20M	Rear Face	19100	1	0	Ant 0	23.0	22.70	1.07	0.04	0.446	0.48
	LTE 4	QPSK20M	Front Face	20175	1	0	Ant 0	23.0	22.69	1.07	0.07	0.670	0.72
	LTE 4	QPSK20M	Rear Face	20175	1	0	Ant 0	23.0	22.69	1.07	-0.11	0.665	0.71
	LTE 4	QPSK20M	Front Face	20175	50	0	Ant 0	22.0	21.56	1.11	0.06	0.532	0.59
	LTE 4	QPSK20M	Rear Face	20175	50	0	Ant 0	22.0	21.56	1.11	-0.12	0.535	0.59
	LTE 4	QPSK20M	Front Face	20050	1	0	Ant 0	23.0	22.64	1.09	0.08	0.667	0.73
27	LTE 4	QPSK20M	Front Face	20300	1	0	Ant 0	23.0	22.63	1.09	0.16	0.691	0.75
28	LTE 5	QPSK10M	Front Face	20525	1	0	Ant 0	23.0	22.75	1.06	-0.05	0.242	0.26
	LTE 5	QPSK10M	Rear Face	20525	1	0	Ant 0	23.0	22.75	1.06	0.03	0.231	0.24
	LTE 5	QPSK10M	Front Face	20525	25	0	Ant 0	22.0	21.62	1.09	0.07	0.192	0.21
	LTE 5	QPSK10M	Rear Face	20525	25	0	Ant 0	22.0	21.62	1.09	-0.02	0.184	0.20
	LTE 5	QPSK10M	Front Face	20525	1	0	Ant 1	23.0	22.75	1.06	0.08	0.113	0.12
	LTE 5	QPSK10M	Rear Face	20525	1	0	Ant 1	23.0	22.75	1.06	0.03	0.129	0.14
	LTE 5	QPSK10M	Front Face	20525	25	0	Ant 1	22.0	21.62	1.09	0.01	0.105	0.11
	LTE 5	QPSK10M	Rear Face	20525	25	0	Ant 1	22.0	21.62	1.09	0.07	0.089	0.10
	LTE 5	QPSK10M	Front Face	20450	1	0	Ant 0	23.0	22.57	1.10	0.08	0.220	0.24
	LTE 5	QPSK10M	Front Face	20600	1	0	Ant 0	23.0	22.61	1.09	-0.11	0.225	0.25

FCC SAR Test Report

Uplink Mode	Plot No.	Band	Mode	Test Position	Ch.	RB#	RB Offset	Tx Antenna	Max. Tune-up Power (dBm)	Measured Conducted Power (dBm)	Scaling Factor	Power Drift (dB)	Measured SAR-1g (W/kg)	Scaled SAR-1g (W/kg)
Single Carrier (CA inactive)		LTE 7	QPSK20M	Front Face	21100	1	0	Ant 0	22.0	21.17	1.21	-0.05	0.331	0.40
		LTE 7	QPSK20M	Rear Face	21100	1	0	Ant 0	22.0	21.17	1.21	-0.14	0.366	0.44
		LTE 7	QPSK20M	Front Face	21100	50	0	Ant 0	21.0	20.11	1.23	-0.03	0.257	0.32
		LTE 7	QPSK20M	Rear Face	21100	50	0	Ant 0	21.0	20.11	1.23	0.05	0.281	0.34
	29	LTE 7	QPSK20M	Rear Face	20850	1	0	Ant 0	22.0	21.13	1.22	-0.09	0.387	0.47
		LTE 7	QPSK20M	Rear Face	21350	1	0	Ant 0	22.0	21.08	1.24	-0.13	0.361	0.45
2 CC (CA active)		LTE 7	QPSK20M	Rear Face	PCC: 20850 SCC: 21048	PCC: 1 PCC: 1	SCC: 99 SCC: 0	Ant 0	22.0	20.84	1.31	0.02	0.311	0.41
		LTE 7	QPSK20M	Rear Face	PCC: 21100 SCC: 21298	PCC: 1 PCC: 1	SCC: 99 SCC: 0	Ant 0	22.0	20.93	1.28	0.07	0.279	0.36
		LTE 7	QPSK20M	Rear Face	PCC: 21152 SCC: 21350	PCC: 1 PCC: 1	SCC: 99 SCC: 0	Ant 0	22.0	20.79	1.32	-0.05	0.279	0.37

Plot No.	Band	Mode	Test Position	Ch.	RB#	RB Offset	Tx Antenna	Max. Tune-up Power (dBm)	Measured Conducted Power (dBm)	Scaling Factor	Power Drift (dB)	Measured SAR-1g (W/kg)	Scaled SAR-1g (W/kg)
	LTE 12	QPSK10M	Front Face	23095	1	0	Ant 0	23.0	22.75	1.06	0.01	0.097	0.10
	LTE 12	QPSK10M	Rear Face	23095	1	0	Ant 0	23.0	22.75	1.06	-0.05	0.096	0.10
	LTE 12	QPSK10M	Front Face	23095	25	0	Ant 0	22.0	21.82	1.04	0.04	0.081	0.08
	LTE 12	QPSK10M	Rear Face	23095	25	0	Ant 0	22.0	21.82	1.04	0.03	0.078	0.08
	LTE 12	QPSK10M	Front Face	23095	1	0	Ant 1	23.0	22.75	1.06	-0.05	0.087	0.09
	LTE 12	QPSK10M	Rear Face	23095	1	0	Ant 1	23.0	22.75	1.06	0.11	0.084	0.09
	LTE 12	QPSK10M	Front Face	23095	25	0	Ant 1	22.0	21.82	1.04	0.08	0.081	0.08
	LTE 12	QPSK10M	Rear Face	23095	25	0	Ant 1	22.0	21.82	1.04	0.09	0.069	0.07
	LTE 12	QPSK10M	Front Face	23060	1	0	Ant 1	23.0	22.62	1.09	-0.07	0.092	0.10
30	LTE 12	QPSK10M	Front Face	23130	1	0	Ant 1	23.0	22.71	1.07	-0.06	0.102	0.11
	LTE 13	QPSK10M	Front Face	23230	1	0	Ant 0	23.0	22.55	1.11	-0.04	0.206	0.23
	LTE 13	QPSK10M	Rear Face	23230	1	0	Ant 0	23.0	22.55	1.11	0.08	0.193	0.21
	LTE 13	QPSK10M	Front Face	23230	25	0	Ant 0	22.0	21.48	1.13	0.02	0.171	0.19
	LTE 13	QPSK10M	Rear Face	23230	25	0	Ant 0	22.0	21.48	1.13	0.04	0.168	0.19
31	LTE 13	QPSK10M	Front Face	23230	1	0	Ant 1	23.0	22.55	1.11	-0.02	0.207	0.23
	LTE 13	QPSK10M	Rear Face	23230	1	0	Ant 1	23.0	22.55	1.11	0.08	0.186	0.21
	LTE 13	QPSK10M	Front Face	23230	25	0	Ant 1	22.0	21.48	1.13	0.03	0.164	0.18
	LTE 13	QPSK10M	Rear Face	23230	25	0	Ant 1	22.0	21.48	1.13	-0.11	0.145	0.16
	LTE 17	QPSK10M	Front Face	23790	1	0	Ant 0	23.0	22.70	1.07	0.03	0.097	0.10
	LTE 17	QPSK10M	Rear Face	23790	1	0	Ant 0	23.0	22.70	1.07	-0.02	0.098	0.11
	LTE 17	QPSK10M	Front Face	23790	25	0	Ant 0	22.0	21.68	1.08	0.07	0.082	0.09
	LTE 17	QPSK10M	Rear Face	23790	25	0	Ant 0	22.0	21.68	1.08	0.05	0.085	0.09
	LTE 17	QPSK10M	Front Face	23790	1	0	Ant 1	23.0	22.70	1.07	-0.02	0.082	0.09
	LTE 17	QPSK10M	Rear Face	23790	1	0	Ant 1	23.0	22.70	1.07	0.07	0.075	0.08
	LTE 17	QPSK10M	Front Face	23790	25	0	Ant 1	22.0	21.68	1.08	0.11	0.079	0.09
	LTE 17	QPSK10M	Rear Face	23790	25	0	Ant 1	22.0	21.68	1.08	-0.05	0.071	0.08
	LTE 17	QPSK10M	Rear Face	23780	1	0	Ant 0	23.0	22.69	1.07	0.08	0.089	0.10
32	LTE 17	QPSK10M	Rear Face	23800	1	0	Ant 0	23.0	22.65	1.08	-0.01	0.099	0.11
	LTE 38	QPSK20M	Front Face	38000	1	0	Ant 0	22.5	22.50	1.00	-0.03	0.271	0.27
33	LTE 38	QPSK20M	Rear Face	38000	1	0	Ant 0	22.5	22.50	1.00	-0.06	0.302	0.30
	LTE 38	QPSK20M	Front Face	38000	50	0	Ant 0	21.5	21.36	1.03	-0.13	0.213	0.22
	LTE 38	QPSK20M	Rear Face	38000	50	0	Ant 0	21.5	21.36	1.03	0.05	0.226	0.23
	LTE 38	QPSK20M	Rear Face	37850	1	0	Ant 0	22.5	22.35	1.04	-0.02	0.291	0.30
	LTE 38	QPSK20M	Rear Face	38150	1	0	Ant 0	22.5	22.42	1.02	0.05	0.288	0.29

FCC SAR Test Report

Plot No.	Band	Mode	Test Position	Ch.	RB#	RB Offset	Tx Antenna	Max. Tune-up Power (dBm)	Measured Conducted Power (dBm)	Scaling Factor	Power Drift (dB)	Measured SAR-1g (W/kg)	Scaled SAR-1g (W/kg)
	LTE 41	QPSK20M	Front Face	41140	1	0	Ant 0	23.0	22.73	1.06	0.06	0.195	0.21
	LTE 41	QPSK20M	Rear Face	41140	1	0	Ant 0	23.0	22.73	1.06	-0.05	0.197	0.21
	LTE 41	QPSK20M	Front Face	41140	50	0	Ant 0	22.0	21.79	1.05	0.01	0.147	0.15
	LTE 41	QPSK20M	Rear Face	41140	50	0	Ant 0	22.0	21.79	1.05	-0.05	0.158	0.17
34	LTE 41	QPSK20M	Rear Face	40140	1	0	Ant 0	23.0	22.30	1.17	-0.11	0.258	0.30
	LTE 41	QPSK20M	Rear Face	40640	1	0	Ant 0	23.0	22.53	1.11	-0.09	0.207	0.23
	LTE 66	QPSK20M	Front Face	132322	1	0	Ant 0	23.0	22.99	1.00	-0.15	0.613	0.61
35	LTE 66	QPSK20M	Rear Face	132322	1	0	Ant 0	23.0	22.99	1.00	0.01	0.632	0.63
	LTE 66	QPSK20M	Front Face	132322	50	0	Ant 0	22.0	21.92	1.02	0.06	0.469	0.48
	LTE 66	QPSK20M	Rear Face	132322	50	0	Ant 0	22.0	21.92	1.02	-0.11	0.467	0.48
	LTE 66	QPSK20M	Rear Face	132072	1	0	Ant 0	23.0	22.98	1.00	0.18	0.608	0.61
	LTE 66	QPSK20M	Rear Face	132572	1	0	Ant 0	23.0	22.97	1.01	-0.14	0.603	0.61

Plot No.	Band	Mode	Test Position	Ch.	Tx Antenna	Max. Tune-up Power (dBm)	Measured Conducted Power (dBm)	Scaling Factor	Power Drift (dB)	Measured SAR-1g (W/kg)	Scaled SAR-1g (W/kg)
	WLAN2.4G	802.11b	Front Face	1	Ant 0	20.0	19.56	1.11	0.04	0.055	0.06
	WLAN2.4G	802.11b	Rear Face	1	Ant 0	20.0	19.56	1.11	-0.07	0.063	0.07
	WLAN2.4G	802.11b	Front Face	1	Ant 1	20.0	19.64	1.09	-0.12	0.001	0.00
	WLAN2.4G	802.11b	Rear Face	1	Ant 1	20.0	19.64	1.09	-0.14	0.093	0.10
	WLAN2.4G	802.11n HT20	Front Face	1	Ant 0+1	22.0	21.96	1.01	0.01	0.062	0.06
36	WLAN2.4G	802.11n HT20	Rear Face	1	Ant 0+1	22.0	21.96	1.01	-0.17	0.153	0.15
	WLAN2.4G	802.11n HT20	Rear Face	6	Ant 0+1	22.0	21.32	1.17	0.05	0.123	0.14
	WLAN2.4G	802.11n HT20	Rear Face	11	Ant 0+1	22.0	21.93	1.02	-0.07	0.138	0.14
	WLAN5G	802.11a	Front Face	60	Ant 0	19.0	18.99	1.00	-0.07	0.184	0.18
	WLAN5G	802.11a	Rear Face	60	Ant 0	19.0	18.99	1.00	-0.17	0.361	0.36
	WLAN5G	802.11a	Front Face	60	Ant 1	19.0	18.77	1.05	0	0.001	0.00
	WLAN5G	802.11a	Rear Face	60	Ant 1	19.0	18.77	1.05	-0.04	0.024	0.03
	WLAN5G	802.11n HT20	Front Face	60	Ant 0+1	22.0	21.93	1.02	-0.05	0.139	0.14
37	WLAN5G	802.11n HT20	Rear Face	60	Ant 0+1	22.0	21.93	1.02	-0.05	0.368	0.37
	WLAN5G	802.11n HT20	Rear Face	52	Ant 0+1	22.0	21.32	1.17	0.03	0.279	0.33
	WLAN5G	802.11n HT20	Rear Face	56	Ant 0+1	22.0	21.25	1.19	-0.11	0.285	0.34
	WLAN5G	802.11n HT20	Rear Face	64	Ant 0+1	22.0	21.87	1.03	0.08	0.359	0.37

FCC SAR Test Report

Plot No.	Band	Mode	Test Position	Ch.	Tx Antenna	Max. Tune-up Power (dBm)	Measured Conducted Power (dBm)	Scaling Factor	Power Drift (dB)	Measured SAR-1g (W/kg)	Scaled SAR-1g (W/kg)
	WLAN5G	802.11a	Front Face	116	Ant 0	19.0	18.98	1.00	-0.03	0.250	0.25
	WLAN5G	802.11a	Rear Face	116	Ant 0	19.0	18.98	1.00	-0.02	0.506	0.51
	WLAN5G	802.11a	Front Face	116	Ant 1	19.0	18.69	1.07	0	0.001	0.00
	WLAN5G	802.11a	Rear Face	116	Ant 1	19.0	18.69	1.07	-0.05	0.072	0.08
	WLAN5G	802.11n HT20	Front Face	116	Ant 0+1	22.0	21.98	1.00	-0.08	0.281	0.28
38	WLAN5G	802.11n HT20	Rear Face	116	Ant 0+1	22.0	21.98	1.00	-0.07	0.638	0.64
	WLAN5G	802.11n HT20	Rear Face	100	Ant 0+1	22.0	21.37	1.16	0.03	0.532	0.62
	WLAN5G	802.11n HT20	Rear Face	120	Ant 0+1	22.0	21.95	1.01	-0.07	0.615	0.62
	WLAN5G	802.11n HT20	Rear Face	124	Ant 0+1	22.0	21.16	1.21	0.02	0.504	0.61
	WLAN5G	802.11n HT20	Rear Face	132	Ant 0+1	22.0	21.96	1.01	0.01	0.558	0.56
	WLAN5G	802.11n HT20	Rear Face	140	Ant 0+1	22.0	21.67	1.08	-0.03	0.478	0.52
	WLAN5G	802.11n HT20	Rear Face	144	Ant 0+1	22.0	21.54	1.11	0.05	0.467	0.52
	WLAN5G	802.11a	Front Face	165	Ant 0	19.0	18.64	1.09	-0.07	0.148	0.16
	WLAN5G	802.11a	Rear Face	165	Ant 0	19.0	18.64	1.09	-0.1	0.182	0.20
	WLAN5G	802.11a	Front Face	165	Ant 1	19.0	18.59	1.10	0	0.001	0.00
	WLAN5G	802.11a	Rear Face	165	Ant 1	19.0	18.59	1.10	-0.05	0.154	0.17
	WLAN5G	802.11n HT20	Front Face	165	Ant 0+1	22.0	21.91	1.02	-0.08	0.289	0.30
	WLAN5G	802.11n HT20	Rear Face	165	Ant 0+1	22.0	21.91	1.02	0.02	0.321	0.33
39	WLAN5G	802.11n HT20	Rear Face	149	Ant 0+1	22.0	21.49	1.12	-0.02	0.387	0.44
	WLAN5G	802.11n HT20	Rear Face	153	Ant 0+1	22.0	21.56	1.11	-0.1	0.359	0.40
	WLAN5G	802.11n HT20	Rear Face	157	Ant 0+1	22.0	21.62	1.09	0.03	0.337	0.37
	WLAN5G	802.11n HT20	Rear Face	161	Ant 0+1	22.0	21.87	1.03	-0.05	0.351	0.36

Plot No.	Band	Mode	Test Position	Ch.	Max. Tune-up Power (dBm)	Measured Conducted Power (dBm)	Scaling Factor	Power Drift (dB)	Measured SAR-1g (W/kg)	Scaled SAR-1g (W/kg)
	BT	BR / EDR	Front Face	0	10.0	9.42	1.14	0.06	0.00103	0.00
40	BT	BR / EDR	Rear Face	0	10.0	9.42	1.14	-0.04	0.00254	0.00
	BT	BR / EDR	Rear Face	39	10.0	8.59	1.38	0.04	0.00197	0.00
	BT	BR / EDR	Rear Face	78	10.0	8.69	1.35	-0.12	0.00211	0.00

FCC SAR Test Report

4.7.4 SAR Results for Hotspot Exposure Condition (Test Separation Distance is 10 mm)

Plot No.	Band	Mode	Test Position	Ch.	Tx Antenna	Max. Tune-up Power (dBm)	Measured Conducted Power (dBm)	Scaling Factor	Power Drift (dB)	Measured SAR-1g (W/kg)	Scaled SAR-1g (W/kg)
	GSM850	GPRS11	Front Face	189	Ant 0	28.5	28.49	1.00	0.06	0.317	0.32
41	GSM850	GPRS11	Rear Face	189	Ant 0	28.5	28.49	1.00	-0.14	0.351	0.35
	GSM850	GPRS11	Left Side	189	Ant 0	28.5	28.49	1.00	-0.06	0.075	0.08
	GSM850	GPRS11	Right Side	189	Ant 0	28.5	28.49	1.00	0.08	0.114	0.11
	GSM850	GPRS11	Bottom Side	189	Ant 0	28.5	28.49	1.00	0.13	0.170	0.17
	GSM850	GPRS11	Front Face	189	Ant 1	28.5	28.49	1.00	0.09	0.213	0.21
	GSM850	GPRS11	Rear Face	189	Ant 1	28.5	28.49	1.00	0.15	0.192	0.19
	GSM850	GPRS11	Left Side	189	Ant 1	28.5	28.49	1.00	-0.07	0.048	0.05
	GSM850	GPRS11	Right Side	189	Ant 1	28.5	28.49	1.00	0.06	0.114	0.11
	GSM850	GPRS11	Top Side	189	Ant 1	28.5	28.49	1.00	0.03	0.117	0.12
	GSM850	GPRS11	Rear Face	128	Ant 0	28.5	28.42	1.02	-0.13	0.344	0.35
	GSM850	GPRS11	Rear Face	251	Ant 0	28.5	28.48	1.00	0.08	0.342	0.34
	GSM1900	GPRS11	Front Face	661	Ant 0	22.0	21.58	1.10	-0.02	0.360	0.40
	GSM1900	GPRS11	Rear Face	661	Ant 0	22.0	21.58	1.10	0.06	0.374	0.41
	GSM1900	GPRS11	Left Side	661	Ant 0	22.0	21.58	1.10	0.04	0.026	0.03
	GSM1900	GPRS11	Right Side	661	Ant 0	22.0	21.58	1.10	-0.05	0.050	0.06
42	GSM1900	GPRS11	Bottom Side	661	Ant 0	22.0	21.58	1.10	-0.14	0.865	0.95
	GSM1900	GPRS11	Bottom Side	512	Ant 0	22.0	21.44	1.14	-0.03	0.745	0.85
	GSM1900	GPRS11	Bottom Side	810	Ant 0	22.0	21.37	1.16	0.05	0.697	0.81
	GSM1900	GPRS11	Bottom Side	661	Ant 0	22.0	21.58	1.10	0.06	0.849	0.94
	WCDMA II	RMC12.2K	Front Face	9400	Ant 0	18.0	17.52	1.12	0.06	0.448	0.50
	WCDMA II	RMC12.2K	Rear Face	9400	Ant 0	18.0	17.52	1.12	0.03	0.451	0.50
	WCDMA II	RMC12.2K	Left Side	9400	Ant 0	18.0	17.52	1.12	0.04	0.021	0.02
	WCDMA II	RMC12.2K	Right Side	9400	Ant 0	18.0	17.52	1.12	-0.05	0.043	0.05
	WCDMA II	RMC12.2K	Bottom Side	9400	Ant 0	18.0	17.52	1.12	-0.02	0.952	1.06
	WCDMA II	RMC12.2K	Bottom Side	9262	Ant 0	18.0	17.22	1.20	0.13	0.785	0.94
43	WCDMA II	RMC12.2K	Bottom Side	9538	Ant 0	18.0	17.48	1.13	0.03	1	1.13
	WCDMA II	RMC12.2K	Bottom Side	9538	Ant 0	18.0	17.48	1.13	0.01	0.982	1.11
	WCDMA IV	RMC12.2K	Front Face	1413	Ant 0	19.0	18.93	1.02	0.03	0.684	0.70
	WCDMA IV	RMC12.2K	Rear Face	1413	Ant 0	19.0	18.93	1.02	-0.12	0.638	0.65
	WCDMA IV	RMC12.2K	Left Side	1413	Ant 0	19.0	18.93	1.02	0.03	0.041	0.04
	WCDMA IV	RMC12.2K	Right Side	1413	Ant 0	19.0	18.93	1.02	0.05	0.066	0.07
	WCDMA IV	RMC12.2K	Bottom Side	1413	Ant 0	19.0	18.93	1.02	0.06	0.919	0.93
	WCDMA IV	RMC12.2K	Bottom Side	1312	Ant 0	19.0	18.87	1.03	0.05	0.954	0.98
44	WCDMA IV	RMC12.2K	Bottom Side	1513	Ant 0	19.0	18.83	1.04	0.04	1	1.04
	WCDMA IV	RMC12.2K	Bottom Side	1513	Ant 0	19.0	18.83	1.04	0.04	0.993	1.03
45	WCDMA V	RMC12.2K	Front Face	4182	Ant 0	23.5	23.18	1.08	-0.07	0.280	0.30
	WCDMA V	RMC12.2K	Rear Face	4182	Ant 0	23.5	23.18	1.08	0.03	0.215	0.23
	WCDMA V	RMC12.2K	Left Side	4182	Ant 0	23.5	23.18	1.08	0.06	0.091	0.10
	WCDMA V	RMC12.2K	Right Side	4182	Ant 0	23.5	23.18	1.08	0.03	0.116	0.12
	WCDMA V	RMC12.2K	Bottom Side	4182	Ant 0	23.5	23.18	1.08	-0.03	0.183	0.20
	WCDMA V	RMC12.2K	Front Face	4182	Ant 1	23.5	23.18	1.08	0.05	0.192	0.21
	WCDMA V	RMC12.2K	Rear Face	4182	Ant 1	23.5	23.18	1.08	-0.04	0.221	0.24
	WCDMA V	RMC12.2K	Left Side	4182	Ant 1	23.5	23.18	1.08	0.03	0.051	0.05
	WCDMA V	RMC12.2K	Right Side	4182	Ant 1	23.5	23.18	1.08	0.05	0.147	0.16
	WCDMA V	RMC12.2K	Top Side	4182	Ant 1	23.5	23.18	1.08	0.04	0.099	0.11
	WCDMA V	RMC12.2K	Front Face	4132	Ant 0	23.5	23.00	1.12	0.06	0.261	0.29
	WCDMA V	RMC12.2K	Front Face	4233	Ant 0	23.5	22.97	1.13	-0.02	0.256	0.29

FCC SAR Test Report

Plot No.	Band	Mode	Test Position	Ch.	RB#	RB Offset	Tx Antenna	Max. Tune-up Power (dBm)	Measured Conducted Power (dBm)	Scaling Factor	Power Drift (dB)	Measured SAR-1g (W/kg)	Scaled SAR-1g (W/kg)
	LTE 2	QPSK20M	Front Face	18900	1	0	Ant 0	18.0	17.80	1.05	0.08	0.311	0.33
	LTE 2	QPSK20M	Rear Face	18900	1	0	Ant 0	18.0	17.80	1.05	-0.19	0.310	0.33
	LTE 2	QPSK20M	Left Side	18900	1	0	Ant 0	18.0	17.80	1.05	0.04	0.025	0.03
	LTE 2	QPSK20M	Right Side	18900	1	0	Ant 0	18.0	17.80	1.05	-0.01	0.040	0.04
46	LTE 2	QPSK20M	Bottom Side	18900	1	0	Ant 0	18.0	17.80	1.05	-0.16	0.675	0.71
	LTE 2	QPSK20M	Front Face	18900	50	0	Ant 0	17.0	16.94	1.01	-0.06	0.251	0.25
	LTE 2	QPSK20M	Rear Face	18900	50	0	Ant 0	17.0	16.94	1.01	0.06	0.248	0.25
	LTE 2	QPSK20M	Left Side	18900	50	0	Ant 0	17.0	16.94	1.01	-0.14	0.015	0.02
	LTE 2	QPSK20M	Right Side	18900	50	0	Ant 0	17.0	16.94	1.01	0.02	0.033	0.03
	LTE 2	QPSK20M	Bottom Side	18900	50	0	Ant 0	17.0	16.94	1.01	0.07	0.552	0.56
	LTE 2	QPSK20M	Bottom Side	18700	1	0	Ant 0	18.0	17.45	1.14	-0.11	0.618	0.70
	LTE 2	QPSK20M	Bottom Side	19100	1	0	Ant 0	18.0	17.48	1.13	0.05	0.577	0.65
	LTE 4	QPSK20M	Front Face	20175	1	0	Ant 0	18.0	17.93	1.02	0.02	0.423	0.43
	LTE 4	QPSK20M	Rear Face	20175	1	0	Ant 0	18.0	17.93	1.02	-0.03	0.410	0.42
	LTE 4	QPSK20M	Left Side	20175	1	0	Ant 0	18.0	17.93	1.02	-0.14	0.030	0.03
	LTE 4	QPSK20M	Right Side	20175	1	0	Ant 0	18.0	17.93	1.02	0.05	0.076	0.08
	LTE 4	QPSK20M	Bottom Side	20175	1	0	Ant 0	18.0	17.93	1.02	0.19	0.707	0.72
	LTE 4	QPSK20M	Front Face	20175	50	0	Ant 0	17.0	16.92	1.02	-0.08	0.340	0.35
	LTE 4	QPSK20M	Rear Face	20175	50	0	Ant 0	17.0	16.92	1.02	0.07	0.325	0.33
	LTE 4	QPSK20M	Left Side	20175	50	0	Ant 0	17.0	16.92	1.02	-0.05	0.027	0.03
	LTE 4	QPSK20M	Right Side	20175	50	0	Ant 0	17.0	16.92	1.02	-0.13	0.055	0.06
	LTE 4	QPSK20M	Bottom Side	20175	50	0	Ant 0	17.0	16.92	1.02	-0.11	0.457	0.47
	LTE 4	QPSK20M	Bottom Side	20050	1	0	Ant 0	18.0	17.78	1.05	0.06	0.699	0.73
47	LTE 4	QPSK20M	Bottom Side	20300	1	0	Ant 0	18.0	17.89	1.03	-0.17	0.717	0.74
	LTE 5	QPSK10M	Front Face	20525	1	0	Ant 0	23.0	22.75	1.06	0.1	0.306	0.32
	LTE 5	QPSK10M	Rear Face	20525	1	0	Ant 0	23.0	22.75	1.06	0.06	0.307	0.33
	LTE 5	QPSK10M	Left Side	20525	1	0	Ant 0	23.0	22.75	1.06	-0.05	0.071	0.08
	LTE 5	QPSK10M	Right Side	20525	1	0	Ant 0	23.0	22.75	1.06	-0.16	0.145	0.15
	LTE 5	QPSK10M	Bottom Side	20525	1	0	Ant 0	23.0	22.75	1.06	-0.03	0.177	0.19
	LTE 5	QPSK10M	Front Face	20525	25	0	Ant 0	22.0	21.62	1.09	-0.17	0.221	0.24
	LTE 5	QPSK10M	Rear Face	20525	25	0	Ant 0	22.0	21.62	1.09	-0.19	0.192	0.21
	LTE 5	QPSK10M	Left Side	20525	25	0	Ant 0	22.0	21.62	1.09	-0.1	0.056	0.06
	LTE 5	QPSK10M	Right Side	20525	25	0	Ant 0	22.0	21.62	1.09	0.07	0.115	0.13
	LTE 5	QPSK10M	Bottom Side	20525	25	0	Ant 0	22.0	21.62	1.09	0.1	0.127	0.14
	LTE 5	QPSK10M	Front Face	20525	1	0	Ant 1	23.0	22.75	1.06	0.01	0.225	0.24
	LTE 5	QPSK10M	Rear Face	20525	1	0	Ant 1	23.0	22.75	1.06	0.16	0.191	0.20
	LTE 5	QPSK10M	Left Side	20525	1	0	Ant 1	23.0	22.75	1.06	0.07	0.053	0.06
	LTE 5	QPSK10M	Right Side	20525	1	0	Ant 1	23.0	22.75	1.06	0.11	0.096	0.10
	LTE 5	QPSK10M	Top Side	20525	1	0	Ant 1	23.0	22.75	1.06	0.05	0.091	0.10
	LTE 5	QPSK10M	Front Face	20525	25	0	Ant 1	22.0	21.62	1.09	0.12	0.171	0.19
	LTE 5	QPSK10M	Rear Face	20525	25	0	Ant 1	22.0	21.62	1.09	-0.13	0.152	0.17
	LTE 5	QPSK10M	Left Side	20525	25	0	Ant 1	22.0	21.62	1.09	-0.02	0.001	0.00
	LTE 5	QPSK10M	Right Side	20525	25	0	Ant 1	22.0	21.62	1.09	0.12	0.089	0.10
	LTE 5	QPSK10M	Top Side	20525	25	0	Ant 1	22.0	21.62	1.09	0.07	0.071	0.08
	LTE 5	QPSK10M	Rear Face	20450	1	0	Ant 0	23.0	22.57	1.10	0.05	0.304	0.34
48	LTE 5	QPSK10M	Rear Face	20600	1	0	Ant 0	23.0	22.61	1.09	-0.04	0.329	0.36

FCC SAR Test Report

Uplink Mode	Plot No.	Band	Mode	Test Position	Ch.	RB#	RB Offset	Tx Antenna	Max. Tune-up Power (dBm)	Measured Conducted Power (dBm)	Scaling Factor	Power Drift (dB)	Measured SAR-1g (W/kg)	Scaled SAR-1g (W/kg)
Single Carrier (CA inactive)		LTE 7	QPSK20M	Front Face	21100	1	0	Ant 0	19.0	18.66	1.08	0.05	0.321	0.35
		LTE 7	QPSK20M	Rear Face	21100	1	0	Ant 0	19.0	18.66	1.08	0.06	0.323	0.35
		LTE 7	QPSK20M	Left Side	21100	1	0	Ant 0	19.0	18.66	1.08	0.01	0.061	0.07
		LTE 7	QPSK20M	Right Side	21100	1	0	Ant 0	19.0	18.66	1.08	0.11	0.047	0.05
	49	LTE 7	QPSK20M	Bottom Side	21100	1	0	Ant 0	19.0	18.66	1.08	0.04	0.740	0.80
		LTE 7	QPSK20M	Front Face	21100	50	0	Ant 0	18.0	17.54	1.11	0.03	0.257	0.29
		LTE 7	QPSK20M	Rear Face	21100	50	0	Ant 0	18.0	17.54	1.11	0.12	0.257	0.29
		LTE 7	QPSK20M	Left Side	21100	50	0	Ant 0	18.0	17.54	1.11	-0.13	0.053	0.06
	LTE 7	QPSK20M	Right Side	21100	50	0	Ant 0	18.0	17.54	1.11	-0.02	0.001	0.00	
	LTE 7	QPSK20M	Bottom Side	21100	50	0	Ant 0	18.0	17.54	1.11	0.07	0.513	0.57	
2 CC (CA active)		LTE 7	QPSK20M	Bottom Side	PCC: 20850 SCC: 21048	PCC: 1 PCC: 1	SCC: 99 SCC: 0	Ant 0	19.0	17.66	1.36	0	0.572	0.78
		LTE 7	QPSK20M	Bottom Side	PCC: 21100 SCC: 21298	PCC: 1 PCC: 1	SCC: 99 SCC: 0	Ant 0	19.0	17.59	1.38	0.05	0.540	0.75
		LTE 7	QPSK20M	Bottom Side	PCC: 21152 SCC: 21350	PCC: 1 PCC: 1	SCC: 99 SCC: 0	Ant 0	19.0	17.63	1.37	0.04	0.509	0.70

Plot No.	Band	Mode	Test Position	Ch.	RB#	RB Offset	Tx Antenna	Max. Tune-up Power (dBm)	Measured Conducted Power (dBm)	Scaling Factor	Power Drift (dB)	Measured SAR-1g (W/kg)	Scaled SAR-1g (W/kg)
	LTE 12	QPSK10M	Front Face	23095	1	0	Ant 0	23.0	22.75	1.06	0.02	0.105	0.11
	LTE 12	QPSK10M	Rear Face	23095	1	0	Ant 0	23.0	22.75	1.06	-0.11	0.076	0.08
	LTE 12	QPSK10M	Left Side	23095	1	0	Ant 0	23.0	22.75	1.06	-0.1	0.048	0.05
	LTE 12	QPSK10M	Right Side	23095	1	0	Ant 0	23.0	22.75	1.06	0.04	0.047	0.05
	LTE 12	QPSK10M	Bottom Side	23095	1	0	Ant 0	23.0	22.75	1.06	0.01	0.047	0.05
	LTE 12	QPSK10M	Front Face	23095	25	0	Ant 0	22.0	21.82	1.04	0.1	0.075	0.08
	LTE 12	QPSK10M	Rear Face	23095	25	0	Ant 0	22.0	21.82	1.04	0.15	0.061	0.06
	LTE 12	QPSK10M	Left Side	23095	25	0	Ant 0	22.0	21.82	1.04	0.18	0.053	0.06
	LTE 12	QPSK10M	Right Side	23095	25	0	Ant 0	22.0	21.82	1.04	-0.15	0.001	0.00
	LTE 12	QPSK10M	Bottom Side	23095	25	0	Ant 0	22.0	21.82	1.04	0.05	0.044	0.05
	LTE 12	QPSK10M	Front Face	23095	1	0	Ant 1	23.0	22.75	1.06	0.06	0.169	0.18
	LTE 12	QPSK10M	Rear Face	23095	1	0	Ant 1	23.0	22.75	1.06	0.01	0.152	0.16
	LTE 12	QPSK10M	Left Side	23095	1	0	Ant 1	23.0	22.75	1.06	0.11	0.041	0.04
	LTE 12	QPSK10M	Right Side	23095	1	0	Ant 1	23.0	22.75	1.06	-0.19	0.082	0.09
	LTE 12	QPSK10M	Top Side	23095	1	0	Ant 1	23.0	22.75	1.06	0.01	0.099	0.10
	LTE 12	QPSK10M	Front Face	23095	25	0	Ant 1	22.0	21.82	1.04	0.16	0.144	0.15
	LTE 12	QPSK10M	Rear Face	23095	25	0	Ant 1	22.0	21.82	1.04	-0.01	0.124	0.13
	LTE 12	QPSK10M	Left Side	23095	25	0	Ant 1	22.0	21.82	1.04	0.02	0.001	0.00
	LTE 12	QPSK10M	Right Side	23095	25	0	Ant 1	22.0	21.82	1.04	0.12	0.054	0.06
	LTE 12	QPSK10M	Top Side	23095	25	0	Ant 1	22.0	21.82	1.04	0.02	0.075	0.08
	LTE 12	QPSK10M	Front Face	23060	1	0	Ant 1	23.0	22.62	1.09	0.01	0.168	0.18
50	LTE 12	QPSK10M	Front Face	23130	1	0	Ant 1	23.0	22.71	1.07	0.04	0.192	0.21

FCC SAR Test Report

Plot No.	Band	Mode	Test Position	Ch.	RB#	RB Offset	Tx Antenna	Max. Tune-up Power (dBm)	Measured Conducted Power (dBm)	Scaling Factor	Power Drift (dB)	Measured SAR-1g (W/kg)	Scaled SAR-1g (W/kg)
	LTE 13	QPSK10M	Front Face	23230	1	0	Ant 0	23.0	22.55	1.11	-0.03	0.147	0.16
	LTE 13	QPSK10M	Rear Face	23230	1	0	Ant 0	23.0	22.55	1.11	-0.1	0.167	0.19
	LTE 13	QPSK10M	Left Side	23230	1	0	Ant 0	23.0	22.55	1.11	0.11	0.106	0.12
	LTE 13	QPSK10M	Right Side	23230	1	0	Ant 0	23.0	22.55	1.11	-0.02	0.066	0.07
	LTE 13	QPSK10M	Bottom Side	23230	1	0	Ant 0	23.0	22.55	1.11	-0.07	0.125	0.14
	LTE 13	QPSK10M	Front Face	23230	25	0	Ant 0	22.0	21.48	1.13	0.08	0.136	0.15
	LTE 13	QPSK10M	Rear Face	23230	25	0	Ant 0	22.0	21.48	1.13	-0.18	0.137	0.15
	LTE 13	QPSK10M	Left Side	23230	25	0	Ant 0	22.0	21.48	1.13	0.14	0.055	0.06
	LTE 13	QPSK10M	Right Side	23230	25	0	Ant 0	22.0	21.48	1.13	-0.12	0.042	0.05
	LTE 13	QPSK10M	Bottom Side	23230	25	0	Ant 0	22.0	21.48	1.13	0.05	0.094	0.11
51	LTE 13	QPSK10M	Front Face	23230	1	0	Ant 1	23.0	22.55	1.11	0.03	0.176	0.20
	LTE 13	QPSK10M	Rear Face	23230	1	0	Ant 1	23.0	22.55	1.11	0	0.167	0.19
	LTE 13	QPSK10M	Left Side	23230	1	0	Ant 1	23.0	22.55	1.11	0.15	0.041	0.05
	LTE 13	QPSK10M	Right Side	23230	1	0	Ant 1	23.0	22.55	1.11	-0.18	0.098	0.11
	LTE 13	QPSK10M	Top Side	23230	1	0	Ant 1	23.0	22.55	1.11	0.04	0.105	0.12
	LTE 13	QPSK10M	Front Face	23230	25	0	Ant 1	22.0	21.48	1.13	0.04	0.143	0.16
	LTE 13	QPSK10M	Rear Face	23230	25	0	Ant 1	22.0	21.48	1.13	0.07	0.128	0.14
	LTE 13	QPSK10M	Left Side	23230	25	0	Ant 1	22.0	21.48	1.13	0.01	0.001	0.00
	LTE 13	QPSK10M	Right Side	23230	25	0	Ant 1	22.0	21.48	1.13	0.13	0.061	0.07
	LTE 13	QPSK10M	Top Side	23230	25	0	Ant 1	22.0	21.48	1.13	0.11	0.089	0.10
	LTE 17	QPSK10M	Front Face	23790	1	0	Ant 0	23.0	22.70	1.07	-0.01	0.112	0.12
	LTE 17	QPSK10M	Rear Face	23790	1	0	Ant 0	23.0	22.70	1.07	0.06	0.109	0.12
	LTE 17	QPSK10M	Left Side	23790	1	0	Ant 0	23.0	22.70	1.07	-0.13	0.073	0.08
	LTE 17	QPSK10M	Right Side	23790	1	0	Ant 0	23.0	22.70	1.07	-0.05	0.001	0.00
	LTE 17	QPSK10M	Bottom Side	23790	1	0	Ant 0	23.0	22.70	1.07	-0.15	0.073	0.08
	LTE 17	QPSK10M	Front Face	23790	25	0	Ant 0	22.0	21.68	1.08	-0.03	0.096	0.10
	LTE 17	QPSK10M	Rear Face	23790	25	0	Ant 0	22.0	21.68	1.08	0.05	0.095	0.10
	LTE 17	QPSK10M	Left Side	23790	25	0	Ant 0	22.0	21.68	1.08	0.08	0.069	0.07
	LTE 17	QPSK10M	Right Side	23790	25	0	Ant 0	22.0	21.68	1.08	-0.14	0.001	0.00
	LTE 17	QPSK10M	Bottom Side	23790	25	0	Ant 0	22.0	21.68	1.08	0.16	0.051	0.05
	LTE 17	QPSK10M	Front Face	23790	1	0	Ant 1	23.0	22.70	1.07	-0.19	0.181	0.19
	LTE 17	QPSK10M	Rear Face	23790	1	0	Ant 1	23.0	22.70	1.07	-0.03	0.137	0.15
	LTE 17	QPSK10M	Left Side	23790	1	0	Ant 1	23.0	22.70	1.07	-0.13	0.052	0.06
	LTE 17	QPSK10M	Right Side	23790	1	0	Ant 1	23.0	22.70	1.07	0.07	0.073	0.08
	LTE 17	QPSK10M	Top Side	23790	1	0	Ant 1	23.0	22.70	1.07	0.11	0.099	0.11
	LTE 17	QPSK10M	Front Face	23790	25	0	Ant 1	22.0	21.68	1.08	-0.07	0.136	0.15
	LTE 17	QPSK10M	Rear Face	23790	25	0	Ant 1	22.0	21.68	1.08	0.1	0.134	0.14
	LTE 17	QPSK10M	Left Side	23790	25	0	Ant 1	22.0	21.68	1.08	0.11	0.044	0.05
	LTE 17	QPSK10M	Right Side	23780	25	0	Ant 1	22.0	21.68	1.08	-0.1	0.067	0.07
	LTE 17	QPSK10M	Top Side	23790	25	0	Ant 1	22.0	21.68	1.08	-0.17	0.068	0.07
	LTE 17	QPSK10M	Front Face	23780	1	0	Ant 1	23.0	22.69	1.07	0.06	0.162	0.17
52	LTE 17	QPSK10M	Front Face	23800	1	0	Ant 1	23.0	22.65	1.08	0.07	0.185	0.20
	LTE 38	QPSK20M	Front Face	38000	1	0	Ant 0	22.5	22.50	1.00	0.03	0.494	0.49
	LTE 38	QPSK20M	Rear Face	38000	1	0	Ant 0	22.5	22.50	1.00	-0.16	0.507	0.51
	LTE 38	QPSK20M	Left Side	38000	1	0	Ant 0	22.5	22.50	1.00	-0.07	0.107	0.11
	LTE 38	QPSK20M	Right Side	38000	1	0	Ant 0	22.5	22.50	1.00	0.09	0.084	0.08
53	LTE 38	QPSK20M	Bottom Side	38000	1	0	Ant 0	22.5	22.50	1.00	0.03	1.13	1.13
	LTE 38	QPSK20M	Front Face	38000	50	0	Ant 0	21.5	21.36	1.03	-0.02	0.401	0.41
	LTE 38	QPSK20M	Rear Face	38000	50	0	Ant 0	21.5	21.36	1.03	0.08	0.398	0.41
	LTE 38	QPSK20M	Left Side	38000	50	0	Ant 0	21.5	21.36	1.03	-0.19	0.061	0.06
	LTE 38	QPSK20M	Right Side	38000	50	0	Ant 0	21.5	21.36	1.03	-0.13	0.053	0.05
	LTE 38	QPSK20M	Bottom Side	38000	50	0	Ant 0	21.5	21.36	1.03	-0.13	0.801	0.83
	LTE 38	QPSK20M	Bottom Side	37850	1	0	Ant 0	22.5	22.35	1.04	0.14	1.08	1.12
	LTE 38	QPSK20M	Bottom Side	38150	1	0	Ant 0	22.5	22.42	1.02	0.12	0.946	0.96
	LTE 38	QPSK20M	Bottom Side	37850	50	0	Ant 0	21.5	21.21	1.07	0.06	0.778	0.83
	LTE 38	QPSK20M	Bottom Side	38150	50	0	Ant 0	21.5	21.28	1.05	0.12	0.782	0.82
	LTE 38	QPSK20M	Bottom Side	38000	100	0	Ant 0	21.5	21.15	1.08	0.17	0.788	0.85
	LTE 38	QPSK20M	Bottom Side	38000	1	0	Ant 0	22.5	22.50	1.00	0.04	1.11	1.11

FCC SAR Test Report

Plot No.	Band	Mode	Test Position	Ch.	RB#	RB Offset	Tx Antenna	Max. Tune-up Power (dBm)	Measured Conducted Power (dBm)	Scaling Factor	Power Drift (dB)	Measured SAR-1g (W/kg)	Scaled SAR-1g (W/kg)
	LTE 41	QPSK20M	Front Face	41140	1	0	Ant 0	23.0	22.73	1.06	-0.08	0.387	0.41
	LTE 41	QPSK20M	Rear Face	41140	1	0	Ant 0	23.0	22.73	1.06	0.02	0.376	0.40
	LTE 41	QPSK20M	Left Side	41140	1	0	Ant 0	23.0	22.73	1.06	0.13	0.080	0.08
	LTE 41	QPSK20M	Right Side	41140	1	0	Ant 0	23.0	22.73	1.06	0.05	0.036	0.04
	LTE 41	QPSK20M	Bottom Side	41140	1	0	Ant 0	23.0	22.73	1.06	0.04	0.893	0.95
	LTE 41	QPSK20M	Front Face	41140	50	0	Ant 0	22.0	21.79	1.05	0.07	0.288	0.30
	LTE 41	QPSK20M	Rear Face	41140	50	0	Ant 0	22.0	21.79	1.05	0.03	0.266	0.28
	LTE 41	QPSK20M	Left Side	41140	50	0	Ant 0	22.0	21.79	1.05	0.01	0.109	0.11
	LTE 41	QPSK20M	Right Side	41140	50	0	Ant 0	22.0	21.79	1.05	-0.05	0.036	0.04
	LTE 41	QPSK20M	Bottom Side	41140	50	0	Ant 0	22.0	21.79	1.05	0.09	0.671	0.70
	LTE 41	QPSK20M	Bottom Side	40140	1	0	Ant 0	23.0	22.30	1.17	0.03	0.944	1.10
54	LTE 41	QPSK20M	Bottom Side	40640	1	0	Ant 0	23.0	22.53	1.11	-0.02	0.991	1.10
	LTE 41	QPSK20M	Bottom Side	41140	100	0	Ant 0	22.0	21.74	1.06	0.05	0.651	0.69
	LTE 41	QPSK20M	Bottom Side	40640	1	0	Ant 0	23.0	22.53	1.11	0.01	0.983	1.09
	LTE 66	QPSK20M	Front Face	132322	1	0	Ant 0	19.5	19.13	1.09	0.18	0.396	0.43
	LTE 66	QPSK20M	Rear Face	132322	1	0	Ant 0	19.5	19.13	1.09	-0.06	0.417	0.45
	LTE 66	QPSK20M	Left Side	132322	1	0	Ant 0	19.5	19.13	1.09	0.07	0.028	0.03
	LTE 66	QPSK20M	Right Side	132322	1	0	Ant 0	19.5	19.13	1.09	-0.18	0.043	0.05
	LTE 66	QPSK20M	Bottom Side	132322	1	0	Ant 0	19.5	19.13	1.09	0.09	0.611	0.67
	LTE 66	QPSK20M	Front Face	132322	50	0	Ant 0	18.5	18.09	1.10	-0.01	0.344	0.38
	LTE 66	QPSK20M	Rear Face	132322	50	0	Ant 0	18.5	18.09	1.10	-0.12	0.341	0.38
	LTE 66	QPSK20M	Left Side	132322	50	0	Ant 0	18.5	18.09	1.10	0.15	0.027	0.03
	LTE 66	QPSK20M	Right Side	132322	50	0	Ant 0	18.5	18.09	1.10	0.04	0.04	0.04
	LTE 66	QPSK20M	Bottom Side	132322	50	0	Ant 0	18.5	18.09	1.10	0.06	0.501	0.55
55	LTE 66	QPSK20M	Bottom Side	132072	1	0	Ant 0	19.5	19.10	1.10	-0.15	0.721	0.79
	LTE 66	QPSK20M	Bottom Side	132572	1	0	Ant 0	19.5	19.08	1.10	-0.03	0.658	0.72

Plot No.	Band	Mode	Test Position	Ch.	Tx Antenna	Max. Tune-up Power (dBm)	Measured Conducted Power (dBm)	Scaling Factor	Power Drift (dB)	Measured SAR-1g (W/kg)	Scaled SAR-1g (W/kg)
	WLAN2.4G	802.11b	Front Face	1	Ant 0	20.0	19.56	1.11	-0.06	0.123	0.14
	WLAN2.4G	802.11b	Rear Face	1	Ant 0	20.0	19.56	1.11	0.05	0.190	0.21
	WLAN2.4G	802.11b	Right Side	1	Ant 0	20.0	19.56	1.11	0.12	0.047	0.05
	WLAN2.4G	802.11b	Top Side	1	Ant 0	20.0	19.56	1.11	-0.17	0.057	0.06
	WLAN2.4G	802.11b	Front Face	1	Ant 1	20.0	19.64	1.09	0.01	0.065	0.07
	WLAN2.4G	802.11b	Rear Face	1	Ant 1	20.0	19.64	1.09	-0.05	0.266	0.29
	WLAN2.4G	802.11b	Right Side	1	Ant 1	20.0	19.64	1.09	0.02	0.101	0.11
	WLAN2.4G	802.11b	Top Side	1	Ant 1	20.0	19.64	1.09	0	0.001	0.00
	WLAN2.4G	802.11n HT20	Front Face	1	Ant 0+1	22.0	21.96	1.01	-0.03	0.118	0.12
56	WLAN2.4G	802.11n HT20	Rear Face	1	Ant 0+1	22.0	21.96	1.01	-0.08	0.358	0.36
	WLAN2.4G	802.11n HT20	Right Side	1	Ant 0+1	22.0	21.96	1.01	0.09	0.119	0.12
	WLAN2.4G	802.11n HT20	Top Side	1	Ant 0+1	22.0	21.96	1.01	0.13	0.057	0.06
	WLAN2.4G	802.11n HT20	Rear Face	6	Ant 0+1	22.0	21.32	1.17	-0.05	0.302	0.35
	WLAN2.4G	802.11n HT20	Rear Face	11	Ant 0+1	22.0	21.93	1.02	0.06	0.319	0.32

FCC SAR Test Report

Plot No.	Band	Mode	Test Position	Ch.	Tx Antenna	Max. Tune-up Power (dBm)	Measured Conducted Power (dBm)	Scaling Factor	Power Drift (dB)	Measured SAR-1g (W/kg)	Scaled SAR-1g (W/kg)	
57	WLAN5G	802.11a	Front Face	40	Ant 0	19.0	18.98	1.00	0.02	0.289	0.29	
	WLAN5G	802.11a	Rear Face	40	Ant 0	19.0	18.98	1.00	-0.01	0.619	0.62	
	WLAN5G	802.11a	Right Side	40	Ant 0	19.0	18.98	1.00	0.12	0.158	0.16	
	WLAN5G	802.11a	Top Side	40	Ant 0	19.0	18.98	1.00	-0.09	0.181	0.18	
	WLAN5G	802.11a	Front Face	40	Ant 1	19.0	18.77	1.05	-0.09	0.001	0.00	
	WLAN5G	802.11a	Rear Face	40	Ant 1	19.0	18.77	1.05	-0.15	0.081	0.09	
	WLAN5G	802.11a	Right Side	40	Ant 1	19.0	18.77	1.05	-0.03	0.046	0.05	
	WLAN5G	802.11a	Top Side	40	Ant 1	19.0	18.77	1.05	-0.19	0.001	0.00	
	WLAN5G	802.11n HT20	Front Face	40	Ant 0+1	22.0	21.98	1.00	0.06	0.257	0.26	
	WLAN5G	802.11n HT20	Rear Face	40	Ant 0+1	22.0	21.98	1.00	-0.03	0.599	0.60	
	WLAN5G	802.11n HT20	Right Side	40	Ant 0+1	22.0	21.98	1.00	-0.07	0.197	0.20	
	WLAN5G	802.11n HT20	Top Side	40	Ant 0+1	22.0	21.98	1.00	-0.19	0.181	0.18	
	WLAN5G	802.11a	Rear Face	36	Ant 0	19.0	18.97	1.01	-0.09	0.605	0.61	
	WLAN5G	802.11a	Rear Face	44	Ant 0	19.0	18.96	1.01	-0.03	0.553	0.56	
	WLAN5G	802.11a	Rear Face	48	Ant 0	19.0	18.91	1.02	-0.09	0.578	0.59	
	58	WLAN5G	802.11a	Front Face	165	Ant 0	19.0	18.64	1.09	0.17	0.320	0.35
		WLAN5G	802.11a	Rear Face	165	Ant 0	19.0	18.64	1.09	0.06	0.227	0.25
WLAN5G		802.11a	Right Side	165	Ant 0	19.0	18.64	1.09	0.13	0.113	0.12	
WLAN5G		802.11a	Top Side	165	Ant 0	19.0	18.64	1.09	0.05	0.071	0.08	
WLAN5G		802.11a	Front Face	165	Ant 1	19.0	18.59	1.10	0	0.001	0.00	
WLAN5G		802.11a	Rear Face	165	Ant 1	19.0	18.59	1.10	-0.13	0.298	0.33	
WLAN5G		802.11a	Right Side	165	Ant 1	19.0	18.59	1.10	-0.02	0.173	0.19	
WLAN5G		802.11a	Top Side	165	Ant 1	19.0	18.59	1.10	0	0.001	0.00	
WLAN5G		802.11n HT20	Front Face	165	Ant 0+1	22.0	21.91	1.02	-0.08	0.536	0.55	
WLAN5G		802.11n HT20	Rear Face	165	Ant 0+1	22.0	21.91	1.02	0.05	0.609	0.62	
WLAN5G		802.11n HT20	Right Side	165	Ant 0+1	22.0	21.91	1.02	-0.16	0.174	0.18	
WLAN5G		802.11n HT20	Top Side	165	Ant 0+1	22.0	21.91	1.02	0.09	0.124	0.13	
WLAN5G		802.11n HT20	Rear Face	149	Ant 0+1	22.0	21.49	1.12	-0.02	0.612	0.69	
WLAN5G		802.11n HT20	Rear Face	153	Ant 0+1	22.0	21.56	1.11	-0.13	0.482	0.54	
WLAN5G		802.11n HT20	Rear Face	157	Ant 0+1	22.0	21.62	1.09	-0.05	0.646	0.70	
WLAN5G		802.11n HT20	Rear Face	161	Ant 0+1	22.0	21.87	1.03	0.06	0.579	0.60	

Plot No.	Band	Mode	Test Position	Ch.	Max. Tune-up Power (dBm)	Measured Conducted Power (dBm)	Scaling Factor	Power Drift (dB)	Measured SAR-1g (W/kg)	Scaled SAR-1g (W/kg)
59	BT	BR/EDR	Front Face	0	10.0	9.42	1.14	0.03	0.00648	0.01
	BT	BR/EDR	Rear Face	0	10.0	9.42	1.14	0.04	0.010	0.01
	BT	BR/EDR	Right Side	0	10.0	9.42	1.14	0.04	0.00247	0.00
	BT	BR/EDR	Top Side	0	10.0	9.42	1.14	0.06	0.00301	0.00
	BT	BR/EDR	Rear Face	39	10.0	8.59	1.38	0.04	0.00462	0.01
	BT	BR/EDR	Rear Face	78	10.0	8.69	1.35	0.12	0.00537	0.01

FCC SAR Test Report

4.7.5 SAR Results for Product Specific (Phablet) Exposure Condition (Test Separation Distance is 0 mm)

Plot No.	Band	Mode	Test Position	Ch.	Tx Antenna	Max. Tune-up Power (dBm)	Measured Conducted Power (dBm)	Scaling Factor	Power Drift (dB)	Measured SAR-10g (W/kg)	Scaled SAR-10g (W/kg)
	WLAN5G	802.11a	Front Face	60	Ant 0	19.0	18.99	1.00	-0.03	1.89	1.89
	WLAN5G	802.11a	Rear Face	60	Ant 0	19.0	18.99	1.00	-0.09	2.16	2.16
	WLAN5G	802.11a	Right Side	60	Ant 0	19.0	18.99	1.00	0.09	0.331	0.33
	WLAN5G	802.11a	Top Side	60	Ant 0	19.0	18.99	1.00	0.13	0.382	0.38
	WLAN5G	802.11a	Front Face	60	Ant 1	19.0	18.77	1.05	-0.03	0.001	0.00
	WLAN5G	802.11a	Rear Face	60	Ant 1	19.0	18.77	1.05	-0.12	0.395	0.42
	WLAN5G	802.11a	Right Side	60	Ant 1	19.0	18.77	1.05	0.06	0.055	0.06
	WLAN5G	802.11a	Top Side	60	Ant 1	19.0	18.77	1.05	0.02	0.001	0.00
	WLAN5G	802.11n HT20	Front Face	60	Ant 0+1	22.0	21.93	1.02	0.16	1.2	1.22
	WLAN5G	802.11n HT20	Rear Face	60	Ant 0+1	22.0	21.93	1.02	-0.08	2.04	2.07
	WLAN5G	802.11n HT20	Right Side	60	Ant 0+1	22.0	21.93	1.02	-0.13	0.337	0.34
	WLAN5G	802.11n HT20	Top Side	60	Ant 0+1	22.0	21.93	1.02	0.02	0.352	0.36
	WLAN5G	802.11a	Rear Face	52	Ant 0	19.0	18.95	1.01	-0.03	2.03	2.05
	WLAN5G	802.11a	Rear Face	56	Ant 0	19.0	18.96	1.01	0.05	1.75	1.77
60	WLAN5G	802.11a	Rear Face	64	Ant 0	19.0	18.97	1.01	-0.09	2.19	2.21
	WLAN5G	802.11n HT20	Rear Face	52	Ant 0+1	22.0	21.32	1.17	0.04	1.75	2.05
	WLAN5G	802.11n HT20	Rear Face	56	Ant 0+1	22.0	21.25	1.19	0.06	1.81	2.15
	WLAN5G	802.11n HT20	Rear Face	64	Ant 0+1	22.0	21.87	1.03	-0.12	1.61	1.66
	WLAN5G	802.11a	Rear Face	64	Ant 0	19.0	18.97	1.01	0.05	2.12	2.13
	WLAN5G	802.11a	Front Face	116	Ant 0	19.0	18.98	1.00	-0.06	1.17	1.18
	WLAN5G	802.11a	Rear Face	116	Ant 0	19.0	18.98	1.00	-0.09	1.93	1.94
	WLAN5G	802.11a	Right Side	116	Ant 0	19.0	18.98	1.00	-0.12	0.319	0.32
	WLAN5G	802.11a	Top Side	116	Ant 0	19.0	18.98	1.00	0.06	0.388	0.39
	WLAN5G	802.11a	Front Face	116	Ant 1	19.0	18.69	1.07	-0.03	0.053	0.06
	WLAN5G	802.11a	Rear Face	116	Ant 1	19.0	18.69	1.07	-0.12	0.919	0.99
	WLAN5G	802.11a	Right Side	116	Ant 1	19.0	18.69	1.07	0.05	0.146	0.16
	WLAN5G	802.11a	Top Side	116	Ant 1	19.0	18.69	1.07	-0.12	0.039	0.04
	WLAN5G	802.11n HT20	Front Face	116	Ant 0+1	22.0	21.98	1.00	-0.03	1.61	1.62
61	WLAN5G	802.11n HT20	Rear Face	116	Ant 0+1	22.0	21.98	1.00	-0.09	2.86	2.87
	WLAN5G	802.11n HT20	Right Side	116	Ant 0+1	22.0	21.98	1.00	0.02	0.442	0.44
	WLAN5G	802.11n HT20	Top Side	116	Ant 0+1	22.0	21.98	1.00	0.09	0.437	0.44
	WLAN5G	802.11n HT20	Rear Face	100	Ant 0+1	22.0	21.37	1.16	0.02	2.41	2.79
	WLAN5G	802.11n HT20	Rear Face	120	Ant 0+1	22.0	21.95	1.01	0.04	2.76	2.79
	WLAN5G	802.11n HT20	Rear Face	124	Ant 0+1	22.0	21.16	1.21	0.06	1.95	2.37
	WLAN5G	802.11n HT20	Rear Face	132	Ant 0+1	22.0	21.96	1.01	-0.12	2.32	2.34
	WLAN5G	802.11n HT20	Rear Face	140	Ant 0+1	22.0	21.67	1.08	0.03	2.34	2.52
	WLAN5G	802.11n HT20	Rear Face	144	Ant 0+1	22.0	21.54	1.11	0.06	2.56	2.85
	WLAN5G	802.11n HT20	Rear Face	116	Ant 0+1	22.0	21.98	1.00	0.05	2.79	2.80

4.7.6 SAR Measurement Variability

According to KDB 865664 D01, SAR measurement variability was assessed for each frequency band, which is determined by the SAR probe calibration point and tissue-equivalent medium used for the device measurements. When both head and body tissue-equivalent media are required for SAR measurements in a frequency band, the variability measurement procedures should be applied to the tissue medium with the highest measured SAR, using the highest measured SAR configuration for that tissue-equivalent medium. Alternatively, if the highest measured SAR for both head and body tissue-equivalent media are ≤ 1.45 W/kg and the ratio of these highest SAR values, i.e., largest divided by smallest value, is ≤ 1.10 , the highest SAR configuration for either head or body tissue-equivalent medium may be used to perform the repeated measurement. These additional measurements are repeated after the completion of all measurements requiring the same head or body tissue-equivalent medium in a frequency band. The test device should be returned to ambient conditions (normal room temperature) with the battery fully charged before it is re-mounted on the device holder for the repeated measurement(s) to minimize any unexpected variations in the repeated results.

SAR repeated measurement procedure:

1. When the highest measured SAR is < 0.80 W/kg, repeated measurement is not required.
2. When the highest measured SAR is ≥ 0.80 W/kg, repeat that measurement once.
3. If the ratio of largest to smallest SAR for the original and first repeated measurements is > 1.20 , or when the original or repeated measurement is ≥ 1.45 W/kg, perform a second repeated measurement.
4. If the ratio of largest to smallest SAR for the original, first and second repeated measurements is > 1.20 , and the original, first or second repeated measurement is ≥ 1.5 W/kg, perform a third repeated measurement.

Band	Mode	Test Position	Ch.	Original Measured SAR-1g (W/kg)	1st Repeated SAR-1g (W/kg)	L/S Ratio	2nd Repeated SAR-1g (W/kg)	L/S Ratio	3rd Repeated SAR-1g (W/kg)	L/S Ratio
GSM850	GPRS11	Right Cheek	251	1.07	1.03	1.04	N/A	N/A	N/A	N/A
WCDMA V	RMC12.2K	Right Cheek	4233	0.944	0.932	1.01	N/A	N/A	N/A	N/A
LTE 5	QPSK10M	Right Cheek	20525	0.884	0.856	1.03	N/A	N/A	N/A	N/A
LTE 17	QPSK10M	Right Cheek	23780	0.937	0.927	1.01	N/A	N/A	N/A	N/A
GSM1900	GPRS11	Bottom Side	661	0.865	0.849	1.02	N/A	N/A	N/A	N/A
WCDMA II	RMC12.2K	Bottom Side	9538	1	0.982	1.02	N/A	N/A	N/A	N/A
WCDMA IV	RMC12.2K	Bottom Side	1513	1	0.993	1.01	N/A	N/A	N/A	N/A
LTE 38	QPSK20M	Bottom Side	38000	1.13	1.11	1.02	N/A	N/A	N/A	N/A
LTE 41	QPSK20M	Bottom Side	40640	0.991	0.983	1.01	N/A	N/A	N/A	N/A

Band	Mode	Test Position	Ch.	Original Measured SAR-10g (W/kg)	1st Repeated SAR-10g (W/kg)	L/S Ratio	2nd Repeated SAR-10g (W/kg)	L/S Ratio	3rd Repeated SAR-10g (W/kg)	L/S Ratio
WLAN5G	802.11a	Rear Face	64	2.19	2.12	1.03	N/A	N/A	N/A	N/A
WLAN5G	802.11n HT20	Rear Face	116	2.86	2.79	1.03	N/A	N/A	N/A	N/A

FCC SAR Test Report

4.7.7 Simultaneous Multi-band Transmission Evaluation

<Possibilities of Simultaneous Transmission>

The simultaneous transmission possibilities for this device are listed as below.

Simultaneous TX Combination	Capable Transmit Configurations	Head Exposure Condition	Body-worn Exposure Condition	Hotspot Exposure Condition
1	WWAN + WLAN (DTS)	Yes	Yes	Yes
2	WWAN + WLAN (NII)	Yes	Yes	Yes
3	WWAN + BT	Yes	Yes	Yes
4	WLAN (DTS) + BT	Yes	Yes	Yes
5	WLAN (NII) + BT	Yes	Yes	Yes
6	WLAN (DTS) Ant0 + WLAN (NII) Ant1	Yes	Yes	Yes
7	WWAN + WLAN (DTS) Ant1 + BT	Yes	Yes	Yes
8	WWAN + WLAN (NII) Ant1 + BT	Yes	Yes	Yes
9	WWAN + WLAN (DTS) Ant0 + WLAN 5G Ant1	Yes	Yes	Yes
10	WWAN + WLAN (NII) Ant0+1 + BT	Yes	Yes	Yes

LTE Uplink CA

Simultaneous TX Combination	Capable Transmit Configurations	Head Exposure Condition	Body-worn Exposure Condition	Hotspot Exposure Condition
1	LTE2 + LTE12 + WLAN (DTS)	Yes	Yes	Yes
2	LTE2 + LTE12 + WLAN (NII)	Yes	Yes	Yes
3	LTE2 + LTE12 + BT	Yes	Yes	Yes
4	LTE2 + LTE12 + WLAN (DTS) Ant1 + BT	Yes	Yes	Yes
5	LTE2 + LTE12 + WLAN (NII) Ant1 + BT	Yes	Yes	Yes
6	LTE2 + LTE12 + WLAN (NII) Ant0+1 + BT	Yes	Yes	Yes
7	LTE4 + LTE12 + WLAN (DTS)	Yes	Yes	Yes
8	LTE4 + LTE12 + WLAN (NII)	Yes	Yes	Yes
9	LTE4 + LTE12 + BT	Yes	Yes	Yes
10	LTE4 + LTE12 + WLAN (DTS) Ant1 + BT	Yes	Yes	Yes
11	LTE4 + LTE12 + WLAN (NII) Ant1 + BT	Yes	Yes	Yes
12	LTE4 + LTE12 + WLAN (NII) Ant0+1 + BT	Yes	Yes	Yes
13	LTE13 + LTE66 + WLAN (DTS)	Yes	Yes	Yes
14	LTE13 + LTE66 + WLAN (NII)	Yes	Yes	Yes
15	LTE13 + LTE66 + BT	Yes	Yes	Yes
16	LTE13 + LTE66 + WLAN (DTS) Ant1 + BT	Yes	Yes	Yes
17	LTE13 + LTE66 + WLAN (NII) Ant1 + BT	Yes	Yes	Yes
18	LTE13 + LTE66 + WLAN (NII) Ant0+1 + BT	Yes	Yes	Yes

Note :

1. The WLAN 2.4G and Bluetooth cannot transmit simultaneously.

FCC SAR Test Report

<SAR Summation Analysis>

Simultaneous transmission SAR test exclusion is determined for each operating configuration and exposure condition according to the reported standalone SAR of each applicable simultaneous transmitting antenna. When the sum of SAR_{1g} of all simultaneously transmitting antennas in an operating mode and exposure condition combination is within the SAR limit (SAR_{1g} 1.6 W/kg), the simultaneous transmission SAR is not required. When the sum of SAR_{1g} is greater than the SAR limit (SAR_{1g} 1.6 W/kg), SAR test exclusion is determined by the SPLSR.

No.	Conditions (SAR1 + SAR2 + SAR3)	Exposure Condition	Test Position	Max. SAR1	Max. SAR2	SAR Summation	SPLSR Analysis
1	GSM850 + WLAN (DTS)	Head	Right Cheek	1.07	0.32	1.39	Σ SAR < 1.6, Not required
			Right Tilted	0.58	0.27	0.85	Σ SAR < 1.6, Not required
			Left Cheek	0.82	0.51	1.33	Σ SAR < 1.6, Not required
			Left Tilted	0.67	0.38	1.05	Σ SAR < 1.6, Not required
		Body-Worn	Front Face	0.21	0.06	0.27	Σ SAR < 1.6, Not required
			Rear Face	0.15	0.15	0.30	Σ SAR < 1.6, Not required
		Hotspot	Front Face	0.32	0.14	0.46	Σ SAR < 1.6, Not required
			Rear Face	0.35	0.36	0.71	Σ SAR < 1.6, Not required
			Left Side	0.08	0.00	0.08	Σ SAR < 1.6, Not required
			Right Side	0.11	0.12	0.23	Σ SAR < 1.6, Not required
			Top Side	0.12	0.06	0.18	Σ SAR < 1.6, Not required
			Bottom Side	0.17	0.00	0.17	Σ SAR < 1.6, Not required
2	GSM850 + WLAN (NII)	Head	Right Cheek	1.07	0.17	1.24	Σ SAR < 1.6, Not required
			Right Tilted	0.58	0.16	0.74	Σ SAR < 1.6, Not required
			Left Cheek	0.82	0.32	1.14	Σ SAR < 1.6, Not required
			Left Tilted	0.67	0.26	0.93	Σ SAR < 1.6, Not required
		Body-Worn	Front Face	0.21	0.30	0.51	Σ SAR < 1.6, Not required
			Rear Face	0.15	0.64	0.79	Σ SAR < 1.6, Not required
		Hotspot	Front Face	0.32	0.55	0.87	Σ SAR < 1.6, Not required
			Rear Face	0.35	0.70	1.05	Σ SAR < 1.6, Not required
			Left Side	0.08	0.00	0.08	Σ SAR < 1.6, Not required
			Right Side	0.11	0.20	0.31	Σ SAR < 1.6, Not required
			Top Side	0.12	0.18	0.30	Σ SAR < 1.6, Not required
			Bottom Side	0.17	0.00	0.17	Σ SAR < 1.6, Not required

FCC SAR Test Report

No.	Conditions (SAR1 + SAR2 + SAR3)	Exposure Condition	Test Position	Max. SAR1	Max. SAR2	Max. SAR3	SAR Summation	SPLSR Analysis
3	GSM850 + WLAN (DTS) ANT-1 + BT	Head	Right Cheek	1.07	0.14	0.01	1.22	Σ SAR < 1.6, Not required
			Right Tilted	0.58	0.09	0.01	0.68	Σ SAR < 1.6, Not required
			Left Cheek	0.82	0.42	0.02	1.26	Σ SAR < 1.6, Not required
			Left Tilted	0.67	0.29	0.01	0.97	Σ SAR < 1.6, Not required
		Body-Worn	Front Face	0.21	0.00	0.00	0.21	Σ SAR < 1.6, Not required
			Rear Face	0.15	0.10	0.00	0.25	Σ SAR < 1.6, Not required
		Hotspot	Front Face	0.32	0.07	0.01	0.40	Σ SAR < 1.6, Not required
			Rear Face	0.35	0.29	0.01	0.65	Σ SAR < 1.6, Not required
			Left Side	0.08	0.00	0.00	0.08	Σ SAR < 1.6, Not required
			Right Side	0.11	0.11	0.00	0.22	Σ SAR < 1.6, Not required
			Top Side	0.12	0.00	0.00	0.12	Σ SAR < 1.6, Not required
			Bottom Side	0.17	0.00	0.00	0.17	Σ SAR < 1.6, Not required
4	GSM850 + WLAN (NII) ANT-1 + BT	Head	Right Cheek	1.07	0.14	0.01	1.22	Σ SAR < 1.6, Not required
			Right Tilted	0.58	0.13	0.01	0.72	Σ SAR < 1.6, Not required
			Left Cheek	0.82	0.26	0.02	1.10	Σ SAR < 1.6, Not required
			Left Tilted	0.67	0.23	0.01	0.91	Σ SAR < 1.6, Not required
		Body-Worn	Front Face	0.21	0.00	0.00	0.21	Σ SAR < 1.6, Not required
			Rear Face	0.15	0.17	0.00	0.32	Σ SAR < 1.6, Not required
		Hotspot	Front Face	0.32	0.00	0.01	0.33	Σ SAR < 1.6, Not required
			Rear Face	0.35	0.33	0.01	0.69	Σ SAR < 1.6, Not required
			Left Side	0.08	0.00	0.00	0.08	Σ SAR < 1.6, Not required
			Right Side	0.11	0.19	0.00	0.30	Σ SAR < 1.6, Not required
			Top Side	0.12	0.00	0.00	0.12	Σ SAR < 1.6, Not required
			Bottom Side	0.17	0.00	0.00	0.17	Σ SAR < 1.6, Not required

FCC SAR Test Report

No.	Conditions (SAR1 + SAR2 + SAR3)	Exposure Condition	Test Position	Max. SAR1	Max. SAR2	Max. SAR3	SAR Summation	SPLSR Analysis
5	GSM850 + WLAN (DTS) ANT0 + WLAN (NII) ANT-1	Head	Right Cheek	1.07	0.32	0.14	1.53	Σ SAR < 1.6, Not required
			Right Tilted	0.58	0.27	0.13	0.98	Σ SAR < 1.6, Not required
			Left Cheek	0.82	0.49	0.26	1.57	Σ SAR < 1.6, Not required
			Left Tilted	0.67	0.21	0.23	1.11	Σ SAR < 1.6, Not required
		Body-Worn	Front Face	0.21	0.06	0.00	0.27	Σ SAR < 1.6, Not required
			Rear Face	0.15	0.07	0.17	0.39	Σ SAR < 1.6, Not required
		Hotspot	Front Face	0.32	0.14	0.00	0.46	Σ SAR < 1.6, Not required
			Rear Face	0.35	0.21	0.33	0.89	Σ SAR < 1.6, Not required
			Left Side	0.08	0.00	0.00	0.08	Σ SAR < 1.6, Not required
			Right Side	0.11	0.05	0.19	0.35	Σ SAR < 1.6, Not required
			Top Side	0.12	0.06	0.00	0.18	Σ SAR < 1.6, Not required
			Bottom Side	0.17	0.00	0.00	0.17	Σ SAR < 1.6, Not required
6	GSM850 + WLAN (NII) ANT-0+1 + BT	Head	Right Cheek	1.07	0.16	0.01	1.24	Σ SAR < 1.6, Not required
			Right Tilted	0.58	0.16	0.01	0.75	Σ SAR < 1.6, Not required
			Left Cheek	0.82	0.31	0.02	1.15	Σ SAR < 1.6, Not required
			Left Tilted	0.67	0.26	0.01	0.94	Σ SAR < 1.6, Not required
		Body-Worn	Front Face	0.21	0.30	0.00	0.51	Σ SAR < 1.6, Not required
			Rear Face	0.15	0.64	0.00	0.79	Σ SAR < 1.6, Not required
		Hotspot	Front Face	0.32	0.55	0.01	0.88	Σ SAR < 1.6, Not required
			Rear Face	0.35	0.70	0.01	1.06	Σ SAR < 1.6, Not required
			Left Side	0.08	0.00	0.00	0.08	Σ SAR < 1.6, Not required
			Right Side	0.11	0.20	0.00	0.31	Σ SAR < 1.6, Not required
			Top Side	0.12	0.18	0.00	0.30	Σ SAR < 1.6, Not required
			Bottom Side	0.17	0.00	0.00	0.17	Σ SAR < 1.6, Not required

FCC SAR Test Report

No.	Conditions (SAR1 + SAR2 + SAR3)	Exposure Condition	Test Position	Max. SAR1	Max. SAR2	SAR Summation	SPLSR Analysis
7	GSM1900 + WLAN (DTS)	Head	Right Cheek	0.11	0.32	0.43	Σ SAR < 1.6, Not required
			Right Tilted	0.00	0.27	0.27	Σ SAR < 1.6, Not required
			Left Cheek	0.16	0.51	0.67	Σ SAR < 1.6, Not required
			Left Tilted	0.00	0.38	0.38	Σ SAR < 1.6, Not required
		Body-Worn	Front Face	0.50	0.06	0.56	Σ SAR < 1.6, Not required
			Rear Face	0.58	0.15	0.73	Σ SAR < 1.6, Not required
		Hotspot	Front Face	0.40	0.14	0.54	Σ SAR < 1.6, Not required
			Rear Face	0.41	0.36	0.77	Σ SAR < 1.6, Not required
			Left Side	0.03	0.00	0.03	Σ SAR < 1.6, Not required
			Right Side	0.06	0.12	0.18	Σ SAR < 1.6, Not required
			Top Side	0.00	0.06	0.06	Σ SAR < 1.6, Not required
			Bottom Side	0.95	0.00	0.95	Σ SAR < 1.6, Not required
8	GSM1900 + WLAN (NII)	Head	Right Cheek	0.11	0.17	0.28	Σ SAR < 1.6, Not required
			Right Tilted	0.00	0.16	0.16	Σ SAR < 1.6, Not required
			Left Cheek	0.16	0.32	0.48	Σ SAR < 1.6, Not required
			Left Tilted	0.00	0.26	0.26	Σ SAR < 1.6, Not required
		Body-Worn	Front Face	0.50	0.30	0.80	Σ SAR < 1.6, Not required
			Rear Face	0.58	0.64	1.22	Σ SAR < 1.6, Not required
		Hotspot	Front Face	0.40	0.55	0.95	Σ SAR < 1.6, Not required
			Rear Face	0.41	0.70	1.11	Σ SAR < 1.6, Not required
			Left Side	0.03	0.00	0.03	Σ SAR < 1.6, Not required
			Right Side	0.06	0.20	0.26	Σ SAR < 1.6, Not required
			Top Side	0.00	0.18	0.18	Σ SAR < 1.6, Not required
			Bottom Side	0.95	0.00	0.95	Σ SAR < 1.6, Not required

FCC SAR Test Report

No.	Conditions (SAR1 + SAR2 + SAR3)	Exposure Condition	Test Position	Max. SAR1	Max. SAR2	Max. SAR3	SAR Summation	SPLSR Analysis
9	GSM1900 + WLAN (DTS) ANT-1 + BT	Head	Right Cheek	0.11	0.14	0.01	0.26	Σ SAR < 1.6, Not required
			Right Tilted	0.00	0.09	0.01	0.10	Σ SAR < 1.6, Not required
			Left Cheek	0.16	0.42	0.02	0.60	Σ SAR < 1.6, Not required
			Left Tilted	0.00	0.29	0.01	0.30	Σ SAR < 1.6, Not required
		Body-Worn	Front Face	0.50	0.00	0.00	0.50	Σ SAR < 1.6, Not required
			Rear Face	0.58	0.10	0.00	0.68	Σ SAR < 1.6, Not required
		Hotspot	Front Face	0.40	0.07	0.01	0.48	Σ SAR < 1.6, Not required
			Rear Face	0.41	0.33	0.01	0.75	Σ SAR < 1.6, Not required
			Left Side	0.03	0.00	0.00	0.03	Σ SAR < 1.6, Not required
			Right Side	0.06	0.19	0.00	0.25	Σ SAR < 1.6, Not required
			Top Side	0.00	0.00	0.00	0.00	Σ SAR < 1.6, Not required
			Bottom Side	0.95	0.00	0.00	0.95	Σ SAR < 1.6, Not required
10	GSM1900 + WLAN (NII) ANT-1 + BT	Head	Right Cheek	0.11	0.14	0.01	0.26	Σ SAR < 1.6, Not required
			Right Tilted	0.00	0.13	0.01	0.14	Σ SAR < 1.6, Not required
			Left Cheek	0.16	0.26	0.02	0.44	Σ SAR < 1.6, Not required
			Left Tilted	0.00	0.23	0.01	0.24	Σ SAR < 1.6, Not required
		Body-Worn	Front Face	0.50	0.00	0.00	0.50	Σ SAR < 1.6, Not required
			Rear Face	0.58	0.17	0.00	0.75	Σ SAR < 1.6, Not required
		Hotspot	Front Face	0.40	0.00	0.01	0.41	Σ SAR < 1.6, Not required
			Rear Face	0.41	0.25	0.01	0.67	Σ SAR < 1.6, Not required
			Left Side	0.03	0.00	0.00	0.03	Σ SAR < 1.6, Not required
			Right Side	0.06	0.15	0.00	0.21	Σ SAR < 1.6, Not required
			Top Side	0.00	0.00	0.00	0.00	Σ SAR < 1.6, Not required
			Bottom Side	0.95	0.00	0.00	0.95	Σ SAR < 1.6, Not required

FCC SAR Test Report

No.	Conditions (SAR1 + SAR2 + SAR3)	Exposure Condition	Test Position	Max. SAR1	Max. SAR2	Max. SAR3	SAR Summation	SPLSR Analysis
11	GSM1900 + WLAN (DTS) ANT0 + WLAN (NII) ANT-1	Head	Right Cheek	0.11	0.32	0.14	0.57	Σ SAR < 1.6, Not required
			Right Tilted	0.00	0.27	0.13	0.40	Σ SAR < 1.6, Not required
			Left Cheek	0.16	0.49	0.26	0.91	Σ SAR < 1.6, Not required
			Left Tilted	0.00	0.21	0.23	0.44	Σ SAR < 1.6, Not required
		Body-Worn	Front Face	0.50	0.06	0.00	0.56	Σ SAR < 1.6, Not required
			Rear Face	0.58	0.07	0.17	0.82	Σ SAR < 1.6, Not required
		Hotspot	Front Face	0.40	0.14	0.00	0.54	Σ SAR < 1.6, Not required
			Rear Face	0.41	0.21	0.33	0.95	Σ SAR < 1.6, Not required
			Left Side	0.03	0.00	0.00	0.03	Σ SAR < 1.6, Not required
			Right Side	0.06	0.05	0.19	0.30	Σ SAR < 1.6, Not required
			Top Side	0.00	0.06	0.00	0.06	Σ SAR < 1.6, Not required
			Bottom Side	0.95	0.00	0.00	0.95	Σ SAR < 1.6, Not required
12	GSM1900 + WLAN (NII) ANT-0+1 + BT	Head	Right Cheek	0.11	0.16	0.01	0.28	Σ SAR < 1.6, Not required
			Right Tilted	0.00	0.16	0.01	0.17	Σ SAR < 1.6, Not required
			Left Cheek	0.16	0.31	0.02	0.49	Σ SAR < 1.6, Not required
			Left Tilted	0.00	0.26	0.01	0.27	Σ SAR < 1.6, Not required
		Body-Worn	Front Face	0.50	0.30	0.00	0.80	Σ SAR < 1.6, Not required
			Rear Face	0.58	0.64	0.00	1.22	Σ SAR < 1.6, Not required
		Hotspot	Front Face	0.40	0.55	0.01	0.96	Σ SAR < 1.6, Not required
			Rear Face	0.41	0.70	0.01	1.12	Σ SAR < 1.6, Not required
			Left Side	0.03	0.00	0.00	0.03	Σ SAR < 1.6, Not required
			Right Side	0.06	0.20	0.00	0.26	Σ SAR < 1.6, Not required
			Top Side	0.00	0.18	0.00	0.18	Σ SAR < 1.6, Not required
			Bottom Side	0.95	0.00	0.00	0.95	Σ SAR < 1.6, Not required

FCC SAR Test Report

No.	Conditions (SAR1 + SAR2 + SAR3)	Exposure Condition	Test Position	Max. SAR1	Max. SAR2	SAR Summation	SPLSR Analysis
13	WCDMA II + WLAN (DTS)	Head	Right Cheek	0.12	0.32	0.44	Σ SAR < 1.6, Not required
			Right Tilted	0.09	0.27	0.36	Σ SAR < 1.6, Not required
			Left Cheek	0.22	0.51	0.73	Σ SAR < 1.6, Not required
			Left Tilted	0.09	0.38	0.47	Σ SAR < 1.6, Not required
		Body-Worn	Front Face	0.71	0.06	0.77	Σ SAR < 1.6, Not required
			Rear Face	0.78	0.15	0.93	Σ SAR < 1.6, Not required
		Hotspot	Front Face	0.50	0.14	0.64	Σ SAR < 1.6, Not required
			Rear Face	0.50	0.36	0.86	Σ SAR < 1.6, Not required
			Left Side	0.02	0.00	0.02	Σ SAR < 1.6, Not required
			Right Side	0.05	0.12	0.17	Σ SAR < 1.6, Not required
			Top Side	0.00	0.06	0.06	Σ SAR < 1.6, Not required
			Bottom Side	1.13	0.00	1.13	Σ SAR < 1.6, Not required
14	WCDMA II + WLAN (NII)	Head	Right Cheek	0.12	0.17	0.29	Σ SAR < 1.6, Not required
			Right Tilted	0.09	0.16	0.25	Σ SAR < 1.6, Not required
			Left Cheek	0.22	0.32	0.54	Σ SAR < 1.6, Not required
			Left Tilted	0.09	0.26	0.35	Σ SAR < 1.6, Not required
		Body-Worn	Front Face	0.71	0.30	1.01	Σ SAR < 1.6, Not required
			Rear Face	0.78	0.64	1.42	Σ SAR < 1.6, Not required
		Hotspot	Front Face	0.50	0.55	1.05	Σ SAR < 1.6, Not required
			Rear Face	0.50	0.70	1.20	Σ SAR < 1.6, Not required
			Left Side	0.02	0.00	0.02	Σ SAR < 1.6, Not required
			Right Side	0.05	0.20	0.25	Σ SAR < 1.6, Not required
			Top Side	0.00	0.18	0.18	Σ SAR < 1.6, Not required
			Bottom Side	1.13	0.00	1.13	Σ SAR < 1.6, Not required

FCC SAR Test Report

No.	Conditions (SAR1 + SAR2 + SAR3)	Exposure Condition	Test Position	Max. SAR1	Max. SAR2	Max. SAR3	SAR Summation	SPLSR Analysis
15	WCDMA II + WLAN (DTS) ANT-1 + BT	Head	Right Cheek	0.12	0.14	0.01	0.27	Σ SAR < 1.6, Not required
			Right Tilted	0.09	0.09	0.01	0.19	Σ SAR < 1.6, Not required
			Left Cheek	0.22	0.42	0.02	0.66	Σ SAR < 1.6, Not required
			Left Tilted	0.09	0.29	0.01	0.39	Σ SAR < 1.6, Not required
		Body-Worn	Front Face	0.71	0.00	0.00	0.71	Σ SAR < 1.6, Not required
			Rear Face	0.78	0.10	0.00	0.88	Σ SAR < 1.6, Not required
		Hotspot	Front Face	0.50	0.07	0.01	0.58	Σ SAR < 1.6, Not required
			Rear Face	0.50	0.29	0.01	0.80	Σ SAR < 1.6, Not required
			Left Side	0.02	0.00	0.00	0.02	Σ SAR < 1.6, Not required
			Right Side	0.05	0.11	0.00	0.16	Σ SAR < 1.6, Not required
			Top Side	0.00	0.00	0.00	0.00	Σ SAR < 1.6, Not required
			Bottom Side	1.13	0.00	0.00	1.13	Σ SAR < 1.6, Not required
16	WCDMA II + WLAN (NII) ANT-1 + BT	Head	Right Cheek	0.12	0.14	0.01	0.27	Σ SAR < 1.6, Not required
			Right Tilted	0.09	0.13	0.01	0.23	Σ SAR < 1.6, Not required
			Left Cheek	0.22	0.26	0.02	0.50	Σ SAR < 1.6, Not required
			Left Tilted	0.09	0.23	0.01	0.33	Σ SAR < 1.6, Not required
		Body-Worn	Front Face	0.71	0.00	0.00	0.71	Σ SAR < 1.6, Not required
			Rear Face	0.78	0.17	0.00	0.95	Σ SAR < 1.6, Not required
		Hotspot	Front Face	0.50	0.00	0.01	0.51	Σ SAR < 1.6, Not required
			Rear Face	0.50	0.33	0.01	0.84	Σ SAR < 1.6, Not required
			Left Side	0.02	0.00	0.00	0.02	Σ SAR < 1.6, Not required
			Right Side	0.05	0.19	0.00	0.24	Σ SAR < 1.6, Not required
			Top Side	0.00	0.00	0.00	0.00	Σ SAR < 1.6, Not required
			Bottom Side	1.13	0.00	0.00	1.13	Σ SAR < 1.6, Not required

FCC SAR Test Report

No.	Conditions (SAR1 + SAR2 + SAR3)	Exposure Condition	Test Position	Max. SAR1	Max. SAR2	Max. SAR3	SAR Summation	SPLSR Analysis
17	WCDMA II + WLAN (DTS) ANT0 + WLAN (NII) ANT-1	Head	Right Cheek	0.12	0.32	0.14	0.58	Σ SAR < 1.6, Not required
			Right Tilted	0.09	0.27	0.13	0.49	Σ SAR < 1.6, Not required
			Left Cheek	0.22	0.49	0.26	0.97	Σ SAR < 1.6, Not required
			Left Tilted	0.09	0.21	0.23	0.53	Σ SAR < 1.6, Not required
		Body-Worn	Front Face	0.71	0.06	0.00	0.77	Σ SAR < 1.6, Not required
			Rear Face	0.78	0.07	0.17	1.02	Σ SAR < 1.6, Not required
		Hotspot	Front Face	0.50	0.14	0.00	0.64	Σ SAR < 1.6, Not required
			Rear Face	0.50	0.21	0.33	1.04	Σ SAR < 1.6, Not required
			Left Side	0.02	0.00	0.00	0.02	Σ SAR < 1.6, Not required
			Right Side	0.05	0.05	0.19	0.29	Σ SAR < 1.6, Not required
			Top Side	0.00	0.06	0.00	0.06	Σ SAR < 1.6, Not required
Bottom Side	1.13	0.00	0.00	1.13	Σ SAR < 1.6, Not required			
18	WCDMA II + WLAN (NII) ANT-0+1 + BT	Head	Right Cheek	0.12	0.16	0.01	0.29	Σ SAR < 1.6, Not required
			Right Tilted	0.09	0.16	0.01	0.26	Σ SAR < 1.6, Not required
			Left Cheek	0.22	0.31	0.02	0.55	Σ SAR < 1.6, Not required
			Left Tilted	0.09	0.26	0.01	0.36	Σ SAR < 1.6, Not required
		Body-Worn	Front Face	0.71	0.30	0.00	1.01	Σ SAR < 1.6, Not required
			Rear Face	0.78	0.64	0.00	1.42	Σ SAR < 1.6, Not required
		Hotspot	Front Face	0.50	0.55	0.01	1.06	Σ SAR < 1.6, Not required
			Rear Face	0.50	0.70	0.01	1.21	Σ SAR < 1.6, Not required
			Left Side	0.02	0.00	0.00	0.02	Σ SAR < 1.6, Not required
			Right Side	0.05	0.20	0.00	0.25	Σ SAR < 1.6, Not required
			Top Side	0.00	0.18	0.00	0.18	Σ SAR < 1.6, Not required
Bottom Side	1.13	0.00	0.00	1.13	Σ SAR < 1.6, Not required			

FCC SAR Test Report

No.	Conditions (SAR1 + SAR2 + SAR3)	Exposure Condition	Test Position	Max. SAR1	Max. SAR2	SAR Summation	SPLSR Analysis
19	WCDMA IV + WLAN (DTS)	Head	Right Cheek	0.15	0.32	0.47	Σ SAR < 1.6, Not required
			Right Tilted	0.07	0.27	0.34	Σ SAR < 1.6, Not required
			Left Cheek	0.28	0.51	0.79	Σ SAR < 1.6, Not required
			Left Tilted	0.11	0.38	0.49	Σ SAR < 1.6, Not required
		Body-Worn	Front Face	0.90	0.06	0.96	Σ SAR < 1.6, Not required
			Rear Face	0.89	0.15	1.04	Σ SAR < 1.6, Not required
		Hotspot	Front Face	0.70	0.14	0.84	Σ SAR < 1.6, Not required
			Rear Face	0.65	0.36	1.01	Σ SAR < 1.6, Not required
			Left Side	0.04	0.00	0.04	Σ SAR < 1.6, Not required
			Right Side	0.07	0.12	0.19	Σ SAR < 1.6, Not required
			Top Side	0.00	0.06	0.06	Σ SAR < 1.6, Not required
			Bottom Side	1.04	0.00	1.04	Σ SAR < 1.6, Not required
20	WCDMA IV + WLAN (NII)	Head	Right Cheek	0.15	0.17	0.32	Σ SAR < 1.6, Not required
			Right Tilted	0.07	0.16	0.23	Σ SAR < 1.6, Not required
			Left Cheek	0.28	0.32	0.60	Σ SAR < 1.6, Not required
			Left Tilted	0.11	0.26	0.37	Σ SAR < 1.6, Not required
		Body-Worn	Front Face	0.90	0.30	1.20	Σ SAR < 1.6, Not required
			Rear Face	0.89	0.64	1.53	Σ SAR < 1.6, Not required
		Hotspot	Front Face	0.70	0.55	1.25	Σ SAR < 1.6, Not required
			Rear Face	0.65	0.70	1.35	Σ SAR < 1.6, Not required
			Left Side	0.04	0.00	0.04	Σ SAR < 1.6, Not required
			Right Side	0.07	0.20	0.27	Σ SAR < 1.6, Not required
			Top Side	0.00	0.18	0.18	Σ SAR < 1.6, Not required
			Bottom Side	1.04	0.00	1.04	Σ SAR < 1.6, Not required

FCC SAR Test Report

No.	Conditions (SAR1 + SAR2 + SAR3)	Exposure Condition	Test Position	Max. SAR1	Max. SAR2	Max. SAR3	SAR Summation	SPLSR Analysis
21	WCDMA IV + WLAN (DTS) ANT-1 + BT	Head	Right Cheek	0.15	0.14	0.01	0.30	Σ SAR < 1.6, Not required
			Right Tilted	0.07	0.09	0.01	0.17	Σ SAR < 1.6, Not required
			Left Cheek	0.28	0.42	0.02	0.72	Σ SAR < 1.6, Not required
			Left Tilted	0.11	0.29	0.01	0.41	Σ SAR < 1.6, Not required
		Body-Worn	Front Face	0.90	0.00	0.00	0.90	Σ SAR < 1.6, Not required
			Rear Face	0.89	0.10	0.00	0.99	Σ SAR < 1.6, Not required
		Hotspot	Front Face	0.70	0.07	0.01	0.78	Σ SAR < 1.6, Not required
			Rear Face	0.65	0.29	0.01	0.95	Σ SAR < 1.6, Not required
			Left Side	0.04	0.00	0.00	0.04	Σ SAR < 1.6, Not required
			Right Side	0.07	0.11	0.00	0.18	Σ SAR < 1.6, Not required
			Top Side	0.00	0.00	0.00	0.00	Σ SAR < 1.6, Not required
			Bottom Side	1.04	0.00	0.00	1.04	Σ SAR < 1.6, Not required
22	WCDMA IV + WLAN (NII) ANT-1 + BT	Head	Right Cheek	0.15	0.14	0.01	0.30	Σ SAR < 1.6, Not required
			Right Tilted	0.07	0.13	0.01	0.21	Σ SAR < 1.6, Not required
			Left Cheek	0.28	0.26	0.02	0.56	Σ SAR < 1.6, Not required
			Left Tilted	0.11	0.23	0.01	0.35	Σ SAR < 1.6, Not required
		Body-Worn	Front Face	0.90	0.00	0.00	0.90	Σ SAR < 1.6, Not required
			Rear Face	0.89	0.17	0.00	1.06	Σ SAR < 1.6, Not required
		Hotspot	Front Face	0.70	0.00	0.01	0.71	Σ SAR < 1.6, Not required
			Rear Face	0.65	0.33	0.01	0.99	Σ SAR < 1.6, Not required
			Left Side	0.04	0.00	0.00	0.04	Σ SAR < 1.6, Not required
			Right Side	0.07	0.19	0.00	0.26	Σ SAR < 1.6, Not required
			Top Side	0.00	0.00	0.00	0.00	Σ SAR < 1.6, Not required
			Bottom Side	1.04	0.00	0.00	1.04	Σ SAR < 1.6, Not required

FCC SAR Test Report

No.	Conditions (SAR1 + SAR2 + SAR3)	Exposure Condition	Test Position	Max. SAR1	Max. SAR2	Max. SAR3	SAR Summation	SPLSR Analysis
23	WCDMA IV + WLAN (DTS) ANT0 + WLAN (NII) ANT-1	Head	Right Cheek	0.15	0.32	0.14	0.61	Σ SAR < 1.6, Not required
			Right Tilted	0.07	0.27	0.13	0.47	Σ SAR < 1.6, Not required
			Left Cheek	0.28	0.49	0.26	1.03	Σ SAR < 1.6, Not required
			Left Tilted	0.11	0.21	0.23	0.55	Σ SAR < 1.6, Not required
		Body-Worn	Front Face	0.90	0.06	0.00	0.96	Σ SAR < 1.6, Not required
			Rear Face	0.89	0.07	0.17	1.13	Σ SAR < 1.6, Not required
		Hotspot	Front Face	0.70	0.14	0.00	0.84	Σ SAR < 1.6, Not required
			Rear Face	0.65	0.21	0.33	1.19	Σ SAR < 1.6, Not required
			Left Side	0.04	0.00	0.00	0.04	Σ SAR < 1.6, Not required
			Right Side	0.07	0.05	0.19	0.31	Σ SAR < 1.6, Not required
			Top Side	0.00	0.06	0.00	0.06	Σ SAR < 1.6, Not required
			Bottom Side	1.04	0.00	0.00	1.04	Σ SAR < 1.6, Not required
24	WCDMA IV + WLAN (NII) ANT-0+1 + BT	Head	Right Cheek	0.15	0.16	0.01	0.32	Σ SAR < 1.6, Not required
			Right Tilted	0.07	0.16	0.01	0.24	Σ SAR < 1.6, Not required
			Left Cheek	0.28	0.31	0.02	0.61	Σ SAR < 1.6, Not required
			Left Tilted	0.11	0.26	0.01	0.38	Σ SAR < 1.6, Not required
		Body-Worn	Front Face	0.90	0.30	0.00	1.20	Σ SAR < 1.6, Not required
			Rear Face	0.89	0.64	0.00	1.53	Σ SAR < 1.6, Not required
		Hotspot	Front Face	0.70	0.55	0.01	1.26	Σ SAR < 1.6, Not required
			Rear Face	0.65	0.70	0.01	1.36	Σ SAR < 1.6, Not required
			Left Side	0.04	0.00	0.00	0.04	Σ SAR < 1.6, Not required
			Right Side	0.07	0.20	0.00	0.27	Σ SAR < 1.6, Not required
			Top Side	0.00	0.18	0.00	0.18	Σ SAR < 1.6, Not required
			Bottom Side	1.04	0.00	0.00	1.04	Σ SAR < 1.6, Not required

FCC SAR Test Report

No.	Conditions (SAR1 + SAR2 + SAR3)	Exposure Condition	Test Position	Max. SAR1	Max. SAR2	SAR Summation	SPLSR Analysis
25	WCDMA V + WLAN (DTS)	Head	Right Cheek	1.07	0.32	1.39	Σ SAR < 1.6, Not required
			Right Tilted	0.78	0.27	1.05	Σ SAR < 1.6, Not required
			Left Cheek	0.75	0.51	1.26	Σ SAR < 1.6, Not required
			Left Tilted	0.71	0.38	1.09	Σ SAR < 1.6, Not required
		Body-Worn	Front Face	0.21	0.06	0.27	Σ SAR < 1.6, Not required
			Rear Face	0.21	0.15	0.36	Σ SAR < 1.6, Not required
		Hotspot	Front Face	0.30	0.14	0.44	Σ SAR < 1.6, Not required
			Rear Face	0.24	0.36	0.60	Σ SAR < 1.6, Not required
			Left Side	0.10	0.00	0.10	Σ SAR < 1.6, Not required
			Right Side	0.16	0.12	0.28	Σ SAR < 1.6, Not required
			Top Side	0.11	0.06	0.17	Σ SAR < 1.6, Not required
			Bottom Side	0.20	0.00	0.20	Σ SAR < 1.6, Not required
26	WCDMA V + WLAN (NII)	Head	Right Cheek	1.07	0.17	1.24	Σ SAR < 1.6, Not required
			Right Tilted	0.78	0.16	0.94	Σ SAR < 1.6, Not required
			Left Cheek	0.75	0.32	1.07	Σ SAR < 1.6, Not required
			Left Tilted	0.71	0.26	0.97	Σ SAR < 1.6, Not required
		Body-Worn	Front Face	0.21	0.30	0.51	Σ SAR < 1.6, Not required
			Rear Face	0.21	0.64	0.85	Σ SAR < 1.6, Not required
		Hotspot	Front Face	0.30	0.55	0.85	Σ SAR < 1.6, Not required
			Rear Face	0.24	0.70	0.94	Σ SAR < 1.6, Not required
			Left Side	0.10	0.00	0.10	Σ SAR < 1.6, Not required
			Right Side	0.16	0.20	0.36	Σ SAR < 1.6, Not required
			Top Side	0.11	0.18	0.29	Σ SAR < 1.6, Not required
			Bottom Side	0.20	0.00	0.20	Σ SAR < 1.6, Not required

FCC SAR Test Report

No.	Conditions (SAR1 + SAR2 + SAR3)	Exposure Condition	Test Position	Max. SAR1	Max. SAR2	Max. SAR3	SAR Summation	SPLSR Analysis
27	WCDMA V + WLAN (DTS) ANT-1 + BT	Head	Right Cheek	1.07	0.14	0.01	1.22	Σ SAR < 1.6, Not required
			Right Tilted	0.78	0.09	0.01	0.88	Σ SAR < 1.6, Not required
			Left Cheek	0.75	0.42	0.02	1.19	Σ SAR < 1.6, Not required
			Left Tilted	0.71	0.29	0.01	1.01	Σ SAR < 1.6, Not required
		Body-Worn	Front Face	0.21	0.00	0.00	0.21	Σ SAR < 1.6, Not required
			Rear Face	0.21	0.10	0.00	0.31	Σ SAR < 1.6, Not required
		Hotspot	Front Face	0.30	0.07	0.01	0.38	Σ SAR < 1.6, Not required
			Rear Face	0.24	0.29	0.01	0.54	Σ SAR < 1.6, Not required
			Left Side	0.10	0.00	0.00	0.10	Σ SAR < 1.6, Not required
			Right Side	0.16	0.11	0.00	0.27	Σ SAR < 1.6, Not required
			Top Side	0.11	0.00	0.00	0.11	Σ SAR < 1.6, Not required
			Bottom Side	0.20	0.00	0.00	0.20	Σ SAR < 1.6, Not required
28	WCDMA V + WLAN (NII) ANT-1 + BT	Head	Right Cheek	1.07	0.14	0.01	1.22	Σ SAR < 1.6, Not required
			Right Tilted	0.78	0.13	0.01	0.92	Σ SAR < 1.6, Not required
			Left Cheek	0.75	0.26	0.02	1.03	Σ SAR < 1.6, Not required
			Left Tilted	0.71	0.23	0.01	0.95	Σ SAR < 1.6, Not required
		Body-Worn	Front Face	0.21	0.00	0.00	0.21	Σ SAR < 1.6, Not required
			Rear Face	0.21	0.17	0.00	0.38	Σ SAR < 1.6, Not required
		Hotspot	Front Face	0.30	0.00	0.01	0.31	Σ SAR < 1.6, Not required
			Rear Face	0.24	0.33	0.01	0.58	Σ SAR < 1.6, Not required
			Left Side	0.10	0.00	0.00	0.10	Σ SAR < 1.6, Not required
			Right Side	0.16	0.19	0.00	0.35	Σ SAR < 1.6, Not required
			Top Side	0.11	0.00	0.00	0.11	Σ SAR < 1.6, Not required
			Bottom Side	0.20	0.00	0.00	0.20	Σ SAR < 1.6, Not required

FCC SAR Test Report

No.	Conditions (SAR1 + SAR2 + SAR3)	Exposure Condition	Test Position	Max. SAR1	Max. SAR2	Max. SAR3	SAR Summation	SPLSR Analysis
29	WCDMA V + WLAN (DTS) ANT0 + WLAN (NII) ANT-1	Head	Right Cheek	1.07	0.32	0.14	1.53	Σ SAR < 1.6, Not required
			Right Tilted	0.78	0.27	0.13	1.18	Σ SAR < 1.6, Not required
			Left Cheek	0.75	0.49	0.26	1.50	Σ SAR < 1.6, Not required
			Left Tilted	0.71	0.21	0.23	1.15	Σ SAR < 1.6, Not required
		Body-Worn	Front Face	0.21	0.06	0.00	0.27	Σ SAR < 1.6, Not required
			Rear Face	0.21	0.07	0.17	0.45	Σ SAR < 1.6, Not required
		Hotspot	Front Face	0.30	0.14	0.00	0.44	Σ SAR < 1.6, Not required
			Rear Face	0.24	0.21	0.33	0.78	Σ SAR < 1.6, Not required
			Left Side	0.10	0.00	0.00	0.10	Σ SAR < 1.6, Not required
			Right Side	0.16	0.05	0.19	0.40	Σ SAR < 1.6, Not required
			Top Side	0.11	0.06	0.00	0.17	Σ SAR < 1.6, Not required
			Bottom Side	0.20	0.00	0.00	0.20	Σ SAR < 1.6, Not required
30	WCDMA V + WLAN (NII) ANT-0+1 + BT	Head	Right Cheek	1.07	0.16	0.01	1.24	Σ SAR < 1.6, Not required
			Right Tilted	0.78	0.16	0.01	0.95	Σ SAR < 1.6, Not required
			Left Cheek	0.75	0.31	0.02	1.08	Σ SAR < 1.6, Not required
			Left Tilted	0.71	0.26	0.01	0.98	Σ SAR < 1.6, Not required
		Body-Worn	Front Face	0.21	0.30	0.00	0.51	Σ SAR < 1.6, Not required
			Rear Face	0.21	0.64	0.00	0.85	Σ SAR < 1.6, Not required
		Hotspot	Front Face	0.30	0.55	0.01	0.86	Σ SAR < 1.6, Not required
			Rear Face	0.24	0.70	0.01	0.95	Σ SAR < 1.6, Not required
			Left Side	0.10	0.00	0.00	0.10	Σ SAR < 1.6, Not required
			Right Side	0.16	0.20	0.00	0.36	Σ SAR < 1.6, Not required
			Top Side	0.11	0.18	0.00	0.29	Σ SAR < 1.6, Not required
			Bottom Side	0.20	0.00	0.00	0.20	Σ SAR < 1.6, Not required

FCC SAR Test Report

No.	Conditions (SAR1 + SAR2 + SAR3)	Exposure Condition	Test Position	Max. SAR1	Max. SAR2	SAR Summation	SPLSR Analysis
31	LTE 2 + WLAN (DTS)	Head	Right Cheek	0.11	0.32	0.43	Σ SAR < 1.6, Not required
			Right Tilted	0.07	0.27	0.34	Σ SAR < 1.6, Not required
			Left Cheek	0.18	0.51	0.69	Σ SAR < 1.6, Not required
			Left Tilted	0.05	0.38	0.43	Σ SAR < 1.6, Not required
		Body-Worn	Front Face	0.52	0.06	0.58	Σ SAR < 1.6, Not required
			Rear Face	0.57	0.15	0.72	Σ SAR < 1.6, Not required
		Hotspot	Front Face	0.33	0.14	0.47	Σ SAR < 1.6, Not required
			Rear Face	0.33	0.36	0.69	Σ SAR < 1.6, Not required
			Left Side	0.03	0.00	0.03	Σ SAR < 1.6, Not required
			Right Side	0.04	0.12	0.16	Σ SAR < 1.6, Not required
			Top Side	0	0.06	0.06	Σ SAR < 1.6, Not required
			Bottom Side	0.71	0.00	0.71	Σ SAR < 1.6, Not required
		32	LTE 2 + WLAN (NII)	Head	Right Cheek	0.11	0.17
Right Tilted	0.07				0.16	0.23	Σ SAR < 1.6, Not required
Left Cheek	0.18				0.32	0.5	Σ SAR < 1.6, Not required
Left Tilted	0.05				0.26	0.31	Σ SAR < 1.6, Not required
Body-Worn	Front Face			0.52	0.30	0.82	Σ SAR < 1.6, Not required
	Rear Face			0.57	0.64	1.21	Σ SAR < 1.6, Not required
Hotspot	Front Face			0.33	0.55	0.88	Σ SAR < 1.6, Not required
	Rear Face			0.33	0.70	1.03	Σ SAR < 1.6, Not required
	Left Side			0.03	0.00	0.03	Σ SAR < 1.6, Not required
	Right Side			0.04	0.20	0.24	Σ SAR < 1.6, Not required
	Top Side			0	0.18	0.18	Σ SAR < 1.6, Not required
	Bottom Side			0.71	0.00	0.71	Σ SAR < 1.6, Not required

FCC SAR Test Report

No.	Conditions (SAR1 + SAR2 + SAR3)	Exposure Condition	Test Position	Max. SAR1	Max. SAR2	Max. SAR3	SAR Summation	SPLSR Analysis
33	LTE 2 + WLAN (DTS) ANT-1 + BT	Head	Right Cheek	0.11	0.14	0.01	0.26	Σ SAR < 1.6, Not required
			Right Tilted	0.07	0.09	0.01	0.17	Σ SAR < 1.6, Not required
			Left Cheek	0.18	0.42	0.02	0.62	Σ SAR < 1.6, Not required
			Left Tilted	0.05	0.29	0.01	0.35	Σ SAR < 1.6, Not required
		Body-Worn	Front Face	0.52	0.00	0.00	0.52	Σ SAR < 1.6, Not required
			Rear Face	0.57	0.10	0.00	0.67	Σ SAR < 1.6, Not required
		Hotspot	Front Face	0.33	0.07	0.01	0.41	Σ SAR < 1.6, Not required
			Rear Face	0.33	0.29	0.01	0.63	Σ SAR < 1.6, Not required
			Left Side	0.03	0.00	0.00	0.03	Σ SAR < 1.6, Not required
			Right Side	0.04	0.11	0.00	0.15	Σ SAR < 1.6, Not required
			Top Side	0	0.00	0.00	0	Σ SAR < 1.6, Not required
			Bottom Side	0.71	0.00	0.00	0.71	Σ SAR < 1.6, Not required
34	LTE 2 + WLAN (NII) ANT-1 + BT	Head	Right Cheek	0.11	0.14	0.01	0.26	Σ SAR < 1.6, Not required
			Right Tilted	0.07	0.13	0.01	0.21	Σ SAR < 1.6, Not required
			Left Cheek	0.18	0.26	0.02	0.46	Σ SAR < 1.6, Not required
			Left Tilted	0.05	0.23	0.01	0.29	Σ SAR < 1.6, Not required
		Body-Worn	Front Face	0.52	0.00	0.00	0.52	Σ SAR < 1.6, Not required
			Rear Face	0.57	0.17	0.00	0.74	Σ SAR < 1.6, Not required
		Hotspot	Front Face	0.33	0.00	0.01	0.34	Σ SAR < 1.6, Not required
			Rear Face	0.33	0.33	0.01	0.67	Σ SAR < 1.6, Not required
			Left Side	0.03	0.00	0.00	0.03	Σ SAR < 1.6, Not required
			Right Side	0.04	0.19	0.00	0.23	Σ SAR < 1.6, Not required
			Top Side	0	0.00	0.00	0	Σ SAR < 1.6, Not required
			Bottom Side	0.71	0.00	0.00	0.71	Σ SAR < 1.6, Not required

FCC SAR Test Report

No.	Conditions (SAR1 + SAR2 + SAR3)	Exposure Condition	Test Position	Max. SAR1	Max. SAR2	Max. SAR3	SAR Summation	SPLSR Analysis
35	LTE 2 + WLAN (DTS) ANT0 + WLAN (NII) ANT-1	Head	Right Cheek	0.11	0.32	0.14	0.57	Σ SAR < 1.6, Not required
			Right Tilted	0.07	0.27	0.13	0.47	Σ SAR < 1.6, Not required
			Left Cheek	0.18	0.49	0.26	0.93	Σ SAR < 1.6, Not required
			Left Tilted	0.05	0.21	0.23	0.49	Σ SAR < 1.6, Not required
		Body-Worn	Front Face	0.52	0.06	0.00	0.58	Σ SAR < 1.6, Not required
			Rear Face	0.57	0.07	0.17	0.81	Σ SAR < 1.6, Not required
		Hotspot	Front Face	0.33	0.14	0.00	0.47	Σ SAR < 1.6, Not required
			Rear Face	0.33	0.21	0.33	0.87	Σ SAR < 1.6, Not required
			Left Side	0.03	0.00	0.00	0.03	Σ SAR < 1.6, Not required
			Right Side	0.04	0.05	0.19	0.28	Σ SAR < 1.6, Not required
			Top Side	0	0.06	0.00	0.06	Σ SAR < 1.6, Not required
			Bottom Side	0.71	0.00	0.00	0.71	Σ SAR < 1.6, Not required
36	LTE 2 + WLAN (NII) ANT-0+1 + BT	Head	Right Cheek	0.11	0.16	0.01	0.28	Σ SAR < 1.6, Not required
			Right Tilted	0.07	0.16	0.01	0.24	Σ SAR < 1.6, Not required
			Left Cheek	0.18	0.31	0.02	0.51	Σ SAR < 1.6, Not required
			Left Tilted	0.05	0.26	0.01	0.32	Σ SAR < 1.6, Not required
		Body-Worn	Front Face	0.52	0.30	0.00	0.82	Σ SAR < 1.6, Not required
			Rear Face	0.57	0.64	0.00	1.21	Σ SAR < 1.6, Not required
		Hotspot	Front Face	0.33	0.55	0.01	0.89	Σ SAR < 1.6, Not required
			Rear Face	0.33	0.70	0.01	1.04	Σ SAR < 1.6, Not required
			Left Side	0.03	0.00	0.00	0.03	Σ SAR < 1.6, Not required
			Right Side	0.04	0.20	0.00	0.24	Σ SAR < 1.6, Not required
			Top Side	0	0.18	0.00	0.18	Σ SAR < 1.6, Not required
			Bottom Side	0.71	0.00	0.00	0.71	Σ SAR < 1.6, Not required

FCC SAR Test Report

No.	Conditions (SAR1 + SAR2 + SAR3)	Exposure Condition	Test Position	Max. SAR1	Max. SAR2	SAR Summation	SPLSR Analysis
37	LTE 4 + WLAN (DTS)	Head	Right Cheek	0.13	0.32	0.45	Σ SAR < 1.6, Not required
			Right Tilted	0.09	0.27	0.36	Σ SAR < 1.6, Not required
			Left Cheek	0.24	0.51	0.75	Σ SAR < 1.6, Not required
			Left Tilted	0.11	0.38	0.49	Σ SAR < 1.6, Not required
		Body-Worn	Front Face	0.75	0.06	0.81	Σ SAR < 1.6, Not required
			Rear Face	0.71	0.15	0.86	Σ SAR < 1.6, Not required
		Hotspot	Front Face	0.43	0.14	0.57	Σ SAR < 1.6, Not required
			Rear Face	0.42	0.36	0.78	Σ SAR < 1.6, Not required
			Left Side	0.03	0.00	0.03	Σ SAR < 1.6, Not required
			Right Side	0.08	0.12	0.2	Σ SAR < 1.6, Not required
			Top Side	0	0.06	0.06	Σ SAR < 1.6, Not required
			Bottom Side	0.74	0.00	0.74	Σ SAR < 1.6, Not required
38	LTE 4 + WLAN (NII)	Head	Right Cheek	0.13	0.17	0.3	Σ SAR < 1.6, Not required
			Right Tilted	0.09	0.16	0.25	Σ SAR < 1.6, Not required
			Left Cheek	0.24	0.32	0.56	Σ SAR < 1.6, Not required
			Left Tilted	0.11	0.26	0.37	Σ SAR < 1.6, Not required
		Body-Worn	Front Face	0.75	0.30	1.05	Σ SAR < 1.6, Not required
			Rear Face	0.71	0.64	1.35	Σ SAR < 1.6, Not required
		Hotspot	Front Face	0.43	0.55	0.98	Σ SAR < 1.6, Not required
			Rear Face	0.42	0.70	1.12	Σ SAR < 1.6, Not required
			Left Side	0.03	0.00	0.03	Σ SAR < 1.6, Not required
			Right Side	0.08	0.20	0.28	Σ SAR < 1.6, Not required
			Top Side	0	0.18	0.18	Σ SAR < 1.6, Not required
			Bottom Side	0.74	0.00	0.74	Σ SAR < 1.6, Not required

FCC SAR Test Report

No.	Conditions (SAR1 + SAR2 + SAR3)	Exposure Condition	Test Position	Max. SAR1	Max. SAR2	Max. SAR3	SAR Summation	SPLSR Analysis
39	LTE 4 + WLAN (DTS) ANT-1 + BT	Head	Right Cheek	0.13	0.14	0.01	0.28	Σ SAR < 1.6, Not required
			Right Tilted	0.09	0.09	0.01	0.19	Σ SAR < 1.6, Not required
			Left Cheek	0.24	0.42	0.02	0.68	Σ SAR < 1.6, Not required
			Left Tilted	0.11	0.29	0.01	0.41	Σ SAR < 1.6, Not required
		Body-Worn	Front Face	0.75	0.00	0.00	0.75	Σ SAR < 1.6, Not required
			Rear Face	0.71	0.10	0.00	0.81	Σ SAR < 1.6, Not required
		Hotspot	Front Face	0.43	0.07	0.01	0.51	Σ SAR < 1.6, Not required
			Rear Face	0.42	0.29	0.01	0.72	Σ SAR < 1.6, Not required
			Left Side	0.03	0.00	0.00	0.03	Σ SAR < 1.6, Not required
			Right Side	0.08	0.11	0.00	0.19	Σ SAR < 1.6, Not required
			Top Side	0	0.00	0.00	0	Σ SAR < 1.6, Not required
			Bottom Side	0.74	0.00	0.00	0.74	Σ SAR < 1.6, Not required
40	LTE 4 + WLAN (NII) ANT-1 + BT	Head	Right Cheek	0.13	0.14	0.01	0.28	Σ SAR < 1.6, Not required
			Right Tilted	0.09	0.13	0.01	0.23	Σ SAR < 1.6, Not required
			Left Cheek	0.24	0.26	0.02	0.52	Σ SAR < 1.6, Not required
			Left Tilted	0.11	0.23	0.01	0.35	Σ SAR < 1.6, Not required
		Body-Worn	Front Face	0.75	0.00	0.00	0.75	Σ SAR < 1.6, Not required
			Rear Face	0.71	0.17	0.00	0.88	Σ SAR < 1.6, Not required
		Hotspot	Front Face	0.43	0.00	0.01	0.44	Σ SAR < 1.6, Not required
			Rear Face	0.42	0.33	0.01	0.76	Σ SAR < 1.6, Not required
			Left Side	0.03	0.00	0.00	0.03	Σ SAR < 1.6, Not required
			Right Side	0.08	0.19	0.00	0.27	Σ SAR < 1.6, Not required
			Top Side	0	0.00	0.00	0	Σ SAR < 1.6, Not required
			Bottom Side	0.74	0.00	0.00	0.74	Σ SAR < 1.6, Not required

FCC SAR Test Report

No.	Conditions (SAR1 + SAR2 + SAR3)	Exposure Condition	Test Position	Max. SAR1	Max. SAR2	Max. SAR3	SAR Summation	SPLSR Analysis
41	LTE 4 + WLAN (DTS) ANT0 + WLAN (NII) ANT-1	Head	Right Cheek	0.13	0.32	0.14	0.59	Σ SAR < 1.6, Not required
			Right Tilted	0.09	0.27	0.13	0.49	Σ SAR < 1.6, Not required
			Left Cheek	0.24	0.49	0.26	0.99	Σ SAR < 1.6, Not required
			Left Tilted	0.11	0.21	0.23	0.55	Σ SAR < 1.6, Not required
		Body-Worn	Front Face	0.75	0.06	0.00	0.81	Σ SAR < 1.6, Not required
			Rear Face	0.71	0.07	0.17	0.95	Σ SAR < 1.6, Not required
		Hotspot	Front Face	0.43	0.14	0.00	0.57	Σ SAR < 1.6, Not required
			Rear Face	0.42	0.21	0.33	0.96	Σ SAR < 1.6, Not required
			Left Side	0.03	0.00	0.00	0.03	Σ SAR < 1.6, Not required
			Right Side	0.08	0.05	0.19	0.32	Σ SAR < 1.6, Not required
			Top Side	0	0.06	0.00	0.06	Σ SAR < 1.6, Not required
			Bottom Side	0.74	0.00	0.00	0.74	Σ SAR < 1.6, Not required
42	LTE 4 + WLAN (NII) ANT-0+1 + BT	Head	Right Cheek	0.13	0.16	0.01	0.3	Σ SAR < 1.6, Not required
			Right Tilted	0.09	0.16	0.01	0.26	Σ SAR < 1.6, Not required
			Left Cheek	0.24	0.31	0.02	0.57	Σ SAR < 1.6, Not required
			Left Tilted	0.11	0.26	0.01	0.38	Σ SAR < 1.6, Not required
		Body-Worn	Front Face	0.75	0.30	0.00	1.05	Σ SAR < 1.6, Not required
			Rear Face	0.71	0.64	0.00	1.35	Σ SAR < 1.6, Not required
		Hotspot	Front Face	0.43	0.55	0.01	0.99	Σ SAR < 1.6, Not required
			Rear Face	0.42	0.70	0.01	1.13	Σ SAR < 1.6, Not required
			Left Side	0.03	0.00	0.00	0.03	Σ SAR < 1.6, Not required
			Right Side	0.08	0.20	0.00	0.28	Σ SAR < 1.6, Not required
			Top Side	0	0.18	0.00	0.18	Σ SAR < 1.6, Not required
			Bottom Side	0.74	0.00	0.00	0.74	Σ SAR < 1.6, Not required

FCC SAR Test Report

No.	Conditions (SAR1 + SAR2 + SAR3)	Exposure Condition	Test Position	Max. SAR1	Max. SAR2	SAR Summation	SPLSR Analysis
43	LTE 5 + WLAN (DTS)	Head	Right Cheek	0.94	0.32	1.26	Σ SAR < 1.6, Not required
			Right Tilted	0.71	0.27	0.98	Σ SAR < 1.6, Not required
			Left Cheek	0.78	0.51	1.29	Σ SAR < 1.6, Not required
			Left Tilted	0.62	0.38	1.00	Σ SAR < 1.6, Not required
		Body-Worn	Front Face	0.26	0.06	0.32	Σ SAR < 1.6, Not required
			Rear Face	0.24	0.15	0.39	Σ SAR < 1.6, Not required
		Hotspot	Front Face	0.32	0.14	0.46	Σ SAR < 1.6, Not required
			Rear Face	0.36	0.36	0.72	Σ SAR < 1.6, Not required
			Left Side	0.08	0.00	0.08	Σ SAR < 1.6, Not required
			Right Side	0.15	0.12	0.27	Σ SAR < 1.6, Not required
			Top Side	0.10	0.06	0.16	Σ SAR < 1.6, Not required
			Bottom Side	0.19	0.00	0.19	Σ SAR < 1.6, Not required
44	LTE 5 + WLAN (NII)	Head	Right Cheek	0.94	0.17	1.11	Σ SAR < 1.6, Not required
			Right Tilted	0.71	0.16	0.87	Σ SAR < 1.6, Not required
			Left Cheek	0.78	0.32	1.10	Σ SAR < 1.6, Not required
			Left Tilted	0.62	0.26	0.88	Σ SAR < 1.6, Not required
		Body-Worn	Front Face	0.26	0.30	0.56	Σ SAR < 1.6, Not required
			Rear Face	0.24	0.64	0.88	Σ SAR < 1.6, Not required
		Hotspot	Front Face	0.32	0.55	0.87	Σ SAR < 1.6, Not required
			Rear Face	0.36	0.70	1.06	Σ SAR < 1.6, Not required
			Left Side	0.08	0.00	0.08	Σ SAR < 1.6, Not required
			Right Side	0.15	0.20	0.35	Σ SAR < 1.6, Not required
			Top Side	0.10	0.18	0.28	Σ SAR < 1.6, Not required
			Bottom Side	0.19	0.00	0.19	Σ SAR < 1.6, Not required

FCC SAR Test Report

No.	Conditions (SAR1 + SAR2 + SAR3)	Exposure Condition	Test Position	Max. SAR1	Max. SAR2	Max. SAR3	SAR Summation	SPLSR Analysis
45	LTE 5 + WLAN (DTS) ANT-1 + BT	Head	Right Cheek	0.94	0.14	0.01	1.09	Σ SAR < 1.6, Not required
			Right Tilted	0.71	0.09	0.01	0.81	Σ SAR < 1.6, Not required
			Left Cheek	0.78	0.42	0.02	1.22	Σ SAR < 1.6, Not required
			Left Tilted	0.62	0.29	0.01	0.92	Σ SAR < 1.6, Not required
		Body-Worn	Front Face	0.26	0.00	0.00	0.26	Σ SAR < 1.6, Not required
			Rear Face	0.24	0.10	0.00	0.34	Σ SAR < 1.6, Not required
		Hotspot	Front Face	0.32	0.07	0.01	0.40	Σ SAR < 1.6, Not required
			Rear Face	0.36	0.29	0.01	0.66	Σ SAR < 1.6, Not required
			Left Side	0.08	0.00	0.00	0.08	Σ SAR < 1.6, Not required
			Right Side	0.15	0.11	0.00	0.26	Σ SAR < 1.6, Not required
			Top Side	0.10	0.00	0.00	0.10	Σ SAR < 1.6, Not required
			Bottom Side	0.19	0.00	0.00	0.19	Σ SAR < 1.6, Not required
46	LTE 5 + WLAN (NII) ANT-1 + BT	Head	Right Cheek	0.94	0.14	0.01	1.09	Σ SAR < 1.6, Not required
			Right Tilted	0.71	0.13	0.01	0.85	Σ SAR < 1.6, Not required
			Left Cheek	0.78	0.26	0.02	1.06	Σ SAR < 1.6, Not required
			Left Tilted	0.62	0.23	0.01	0.86	Σ SAR < 1.6, Not required
		Body-Worn	Front Face	0.26	0.00	0.00	0.26	Σ SAR < 1.6, Not required
			Rear Face	0.24	0.17	0.00	0.41	Σ SAR < 1.6, Not required
		Hotspot	Front Face	0.32	0.00	0.01	0.33	Σ SAR < 1.6, Not required
			Rear Face	0.36	0.33	0.01	0.70	Σ SAR < 1.6, Not required
			Left Side	0.08	0.00	0.00	0.08	Σ SAR < 1.6, Not required
			Right Side	0.15	0.19	0.00	0.34	Σ SAR < 1.6, Not required
			Top Side	0.10	0.00	0.00	0.10	Σ SAR < 1.6, Not required
			Bottom Side	0.19	0.00	0.00	0.19	Σ SAR < 1.6, Not required

FCC SAR Test Report

No.	Conditions (SAR1 + SAR2 + SAR3)	Exposure Condition	Test Position	Max. SAR1	Max. SAR2	Max. SAR3	SAR Summation	SPLSR Analysis
47	LTE 5 + WLAN (DTS) ANT0 + WLAN (NII) ANT-1	Head	Right Cheek	0.94	0.32	0.14	1.40	Σ SAR < 1.6, Not required
			Right Tilted	0.71	0.27	0.13	1.11	Σ SAR < 1.6, Not required
			Left Cheek	0.78	0.49	0.26	1.53	Σ SAR < 1.6, Not required
			Left Tilted	0.62	0.21	0.23	1.06	Σ SAR < 1.6, Not required
		Body-Worn	Front Face	0.26	0.06	0.00	0.32	Σ SAR < 1.6, Not required
			Rear Face	0.24	0.07	0.17	0.48	Σ SAR < 1.6, Not required
		Hotspot	Front Face	0.32	0.14	0.00	0.46	Σ SAR < 1.6, Not required
			Rear Face	0.36	0.21	0.33	0.90	Σ SAR < 1.6, Not required
			Left Side	0.08	0.00	0.00	0.08	Σ SAR < 1.6, Not required
			Right Side	0.15	0.05	0.19	0.39	Σ SAR < 1.6, Not required
			Top Side	0.10	0.06	0.00	0.16	Σ SAR < 1.6, Not required
			Bottom Side	0.19	0.00	0.00	0.19	Σ SAR < 1.6, Not required
48	LTE 5 + WLAN (NII) ANT-0+1 + BT	Head	Right Cheek	0.94	0.16	0.01	1.11	Σ SAR < 1.6, Not required
			Right Tilted	0.71	0.16	0.01	0.88	Σ SAR < 1.6, Not required
			Left Cheek	0.78	0.31	0.02	1.11	Σ SAR < 1.6, Not required
			Left Tilted	0.62	0.26	0.01	0.89	Σ SAR < 1.6, Not required
		Body-Worn	Front Face	0.26	0.30	0.00	0.56	Σ SAR < 1.6, Not required
			Rear Face	0.24	0.64	0.00	0.88	Σ SAR < 1.6, Not required
		Hotspot	Front Face	0.32	0.55	0.01	0.88	Σ SAR < 1.6, Not required
			Rear Face	0.36	0.70	0.01	1.07	Σ SAR < 1.6, Not required
			Left Side	0.08	0.00	0.00	0.08	Σ SAR < 1.6, Not required
			Right Side	0.15	0.20	0.00	0.35	Σ SAR < 1.6, Not required
			Top Side	0.10	0.18	0.00	0.28	Σ SAR < 1.6, Not required
			Bottom Side	0.19	0.00	0.00	0.19	Σ SAR < 1.6, Not required

FCC SAR Test Report

No.	Conditions (SAR1 + SAR2 + SAR3)	Exposure Condition	Test Position	Max. SAR1	Max. SAR2	SAR Summation	SPLSR Analysis
49	LTE 7 + WLAN (DTS)	Head	Right Cheek	0.08	0.32	0.40	Σ SAR < 1.6, Not required
			Right Tilted	0.00	0.27	0.27	Σ SAR < 1.6, Not required
			Left Cheek	0.06	0.51	0.57	Σ SAR < 1.6, Not required
			Left Tilted	0.00	0.38	0.38	Σ SAR < 1.6, Not required
		Body-Worn	Front Face	0.40	0.06	0.46	Σ SAR < 1.6, Not required
			Rear Face	0.47	0.15	0.62	Σ SAR < 1.6, Not required
		Hotspot	Front Face	0.35	0.14	0.49	Σ SAR < 1.6, Not required
			Rear Face	0.35	0.36	0.71	Σ SAR < 1.6, Not required
			Left Side	0.07	0.00	0.07	Σ SAR < 1.6, Not required
			Right Side	0.05	0.12	0.17	Σ SAR < 1.6, Not required
			Top Side	0.00	0.06	0.06	Σ SAR < 1.6, Not required
			Bottom Side	0.80	0.00	0.80	Σ SAR < 1.6, Not required
50	LTE 7 + WLAN (NII)	Head	Right Cheek	0.08	0.17	0.25	Σ SAR < 1.6, Not required
			Right Tilted	0.00	0.16	0.16	Σ SAR < 1.6, Not required
			Left Cheek	0.06	0.32	0.38	Σ SAR < 1.6, Not required
			Left Tilted	0.00	0.26	0.26	Σ SAR < 1.6, Not required
		Body-Worn	Front Face	0.40	0.30	0.70	Σ SAR < 1.6, Not required
			Rear Face	0.47	0.64	1.11	Σ SAR < 1.6, Not required
		Hotspot	Front Face	0.35	0.55	0.90	Σ SAR < 1.6, Not required
			Rear Face	0.35	0.70	1.05	Σ SAR < 1.6, Not required
			Left Side	0.07	0.00	0.07	Σ SAR < 1.6, Not required
			Right Side	0.05	0.20	0.25	Σ SAR < 1.6, Not required
			Top Side	0.00	0.18	0.18	Σ SAR < 1.6, Not required
			Bottom Side	0.80	0.00	0.80	Σ SAR < 1.6, Not required

FCC SAR Test Report

No.	Conditions (SAR1 + SAR2 + SAR3)	Exposure Condition	Test Position	Max. SAR1	Max. SAR2	Max. SAR3	SAR Summation	SPLSR Analysis
51	LTE 7 + WLAN (DTS) ANT-1 + BT	Head	Right Cheek	0.08	0.14	0.01	0.23	Σ SAR < 1.6, Not required
			Right Tilted	0.00	0.09	0.01	0.10	Σ SAR < 1.6, Not required
			Left Cheek	0.06	0.42	0.02	0.50	Σ SAR < 1.6, Not required
			Left Tilted	0.00	0.29	0.01	0.30	Σ SAR < 1.6, Not required
		Body-Worn	Front Face	0.40	0.00	0.00	0.40	Σ SAR < 1.6, Not required
			Rear Face	0.47	0.10	0.00	0.57	Σ SAR < 1.6, Not required
		Hotspot	Front Face	0.35	0.07	0.01	0.43	Σ SAR < 1.6, Not required
			Rear Face	0.35	0.29	0.01	0.65	Σ SAR < 1.6, Not required
			Left Side	0.07	0.00	0.00	0.07	Σ SAR < 1.6, Not required
			Right Side	0.05	0.11	0.00	0.16	Σ SAR < 1.6, Not required
			Top Side	0.00	0.00	0.00	0.00	Σ SAR < 1.6, Not required
			Bottom Side	0.80	0.00	0.00	0.80	Σ SAR < 1.6, Not required
52	LTE 7 + WLAN (NII) ANT-1 + BT	Head	Right Cheek	0.08	0.14	0.01	0.23	Σ SAR < 1.6, Not required
			Right Tilted	0.00	0.13	0.01	0.14	Σ SAR < 1.6, Not required
			Left Cheek	0.06	0.26	0.02	0.34	Σ SAR < 1.6, Not required
			Left Tilted	0.00	0.23	0.01	0.24	Σ SAR < 1.6, Not required
		Body-Worn	Front Face	0.40	0.00	0.00	0.40	Σ SAR < 1.6, Not required
			Rear Face	0.47	0.17	0.00	0.64	Σ SAR < 1.6, Not required
		Hotspot	Front Face	0.35	0.00	0.01	0.36	Σ SAR < 1.6, Not required
			Rear Face	0.35	0.33	0.01	0.69	Σ SAR < 1.6, Not required
			Left Side	0.07	0.00	0.00	0.07	Σ SAR < 1.6, Not required
			Right Side	0.05	0.19	0.00	0.24	Σ SAR < 1.6, Not required
			Top Side	0.00	0.00	0.00	0.00	Σ SAR < 1.6, Not required
			Bottom Side	0.80	0.00	0.00	0.80	Σ SAR < 1.6, Not required

FCC SAR Test Report

No.	Conditions (SAR1 + SAR2 + SAR3)	Exposure Condition	Test Position	Max. SAR1	Max. SAR2	Max. SAR3	SAR Summation	SPLSR Analysis
53	LTE 7 + WLAN (DTS) ANT0 + WLAN (NII) ANT-1	Head	Right Cheek	0.08	0.32	0.14	0.54	Σ SAR < 1.6, Not required
			Right Tilted	0.00	0.27	0.13	0.40	Σ SAR < 1.6, Not required
			Left Cheek	0.06	0.49	0.26	0.81	Σ SAR < 1.6, Not required
			Left Tilted	0.00	0.21	0.23	0.44	Σ SAR < 1.6, Not required
		Body-Worn	Front Face	0.40	0.06	0.00	0.46	Σ SAR < 1.6, Not required
			Rear Face	0.47	0.07	0.17	0.71	Σ SAR < 1.6, Not required
		Hotspot	Front Face	0.35	0.14	0.00	0.49	Σ SAR < 1.6, Not required
			Rear Face	0.35	0.21	0.33	0.89	Σ SAR < 1.6, Not required
			Left Side	0.07	0.00	0.00	0.07	Σ SAR < 1.6, Not required
			Right Side	0.05	0.05	0.19	0.29	Σ SAR < 1.6, Not required
			Top Side	0.00	0.06	0.00	0.06	Σ SAR < 1.6, Not required
			Bottom Side	0.80	0.00	0.00	0.80	Σ SAR < 1.6, Not required
54	LTE 7 + WLAN (NII) ANT-0+1 + BT	Head	Right Cheek	0.08	0.16	0.01	0.25	Σ SAR < 1.6, Not required
			Right Tilted	0.00	0.16	0.01	0.17	Σ SAR < 1.6, Not required
			Left Cheek	0.06	0.31	0.02	0.39	Σ SAR < 1.6, Not required
			Left Tilted	0.00	0.26	0.01	0.27	Σ SAR < 1.6, Not required
		Body-Worn	Front Face	0.40	0.30	0.00	0.70	Σ SAR < 1.6, Not required
			Rear Face	0.47	0.64	0.00	1.11	Σ SAR < 1.6, Not required
		Hotspot	Front Face	0.35	0.55	0.01	0.91	Σ SAR < 1.6, Not required
			Rear Face	0.35	0.70	0.01	1.06	Σ SAR < 1.6, Not required
			Left Side	0.07	0.00	0.00	0.07	Σ SAR < 1.6, Not required
			Right Side	0.05	0.20	0.00	0.25	Σ SAR < 1.6, Not required
			Top Side	0.00	0.18	0.00	0.18	Σ SAR < 1.6, Not required
			Bottom Side	0.80	0.00	0.00	0.80	Σ SAR < 1.6, Not required

FCC SAR Test Report

No.	Conditions (SAR1 + SAR2 + SAR3)	Exposure Condition	Test Position	Max. SAR1	Max. SAR2	SAR Summation	SPLSR Analysis
55	LTE 12 + WLAN (DTS)	Head	Right Cheek	0.56	0.32	0.88	Σ SAR < 1.6, Not required
			Right Tilted	0.55	0.27	0.82	Σ SAR < 1.6, Not required
			Left Cheek	0.57	0.51	1.08	Σ SAR < 1.6, Not required
			Left Tilted	0.61	0.38	0.99	Σ SAR < 1.6, Not required
		Body-Worn	Front Face	0.11	0.06	0.17	Σ SAR < 1.6, Not required
			Rear Face	0.10	0.15	0.25	Σ SAR < 1.6, Not required
		Hotspot	Front Face	0.21	0.14	0.35	Σ SAR < 1.6, Not required
			Rear Face	0.16	0.36	0.52	Σ SAR < 1.6, Not required
			Left Side	0.06	0.00	0.06	Σ SAR < 1.6, Not required
			Right Side	0.09	0.12	0.21	Σ SAR < 1.6, Not required
			Top Side	0.10	0.06	0.16	Σ SAR < 1.6, Not required
			Bottom Side	0.05	0.00	0.05	Σ SAR < 1.6, Not required
56	LTE 12 + WLAN (NII)	Head	Right Cheek	0.56	0.17	0.73	Σ SAR < 1.6, Not required
			Right Tilted	0.55	0.16	0.71	Σ SAR < 1.6, Not required
			Left Cheek	0.57	0.32	0.89	Σ SAR < 1.6, Not required
			Left Tilted	0.61	0.26	0.87	Σ SAR < 1.6, Not required
		Body-Worn	Front Face	0.11	0.30	0.41	Σ SAR < 1.6, Not required
			Rear Face	0.10	0.64	0.74	Σ SAR < 1.6, Not required
		Hotspot	Front Face	0.21	0.55	0.76	Σ SAR < 1.6, Not required
			Rear Face	0.16	0.70	0.86	Σ SAR < 1.6, Not required
			Left Side	0.06	0.00	0.06	Σ SAR < 1.6, Not required
			Right Side	0.09	0.20	0.29	Σ SAR < 1.6, Not required
			Top Side	0.10	0.18	0.28	Σ SAR < 1.6, Not required
			Bottom Side	0.05	0.00	0.05	Σ SAR < 1.6, Not required

FCC SAR Test Report

No.	Conditions (SAR1 + SAR2 + SAR3)	Exposure Condition	Test Position	Max. SAR1	Max. SAR2	Max. SAR3	SAR Summation	SPLSR Analysis
57	LTE 12 + WLAN (DTS) ANT-1 + BT	Head	Right Cheek	0.56	0.14	0.01	0.71	Σ SAR < 1.6, Not required
			Right Tilted	0.55	0.09	0.01	0.65	Σ SAR < 1.6, Not required
			Left Cheek	0.57	0.42	0.02	1.01	Σ SAR < 1.6, Not required
			Left Tilted	0.61	0.29	0.01	0.91	Σ SAR < 1.6, Not required
		Body-Worn	Front Face	0.11	0.00	0.00	0.11	Σ SAR < 1.6, Not required
			Rear Face	0.10	0.10	0.00	0.20	Σ SAR < 1.6, Not required
		Hotspot	Front Face	0.21	0.07	0.01	0.29	Σ SAR < 1.6, Not required
			Rear Face	0.16	0.29	0.01	0.46	Σ SAR < 1.6, Not required
			Left Side	0.06	0.00	0.00	0.06	Σ SAR < 1.6, Not required
			Right Side	0.09	0.11	0.00	0.20	Σ SAR < 1.6, Not required
			Top Side	0.10	0.00	0.00	0.10	Σ SAR < 1.6, Not required
			Bottom Side	0.05	0.00	0.00	0.05	Σ SAR < 1.6, Not required
58	LTE 12 + WLAN (NII) ANT-1 + BT	Head	Right Cheek	0.56	0.14	0.01	0.71	Σ SAR < 1.6, Not required
			Right Tilted	0.55	0.13	0.01	0.69	Σ SAR < 1.6, Not required
			Left Cheek	0.57	0.26	0.02	0.85	Σ SAR < 1.6, Not required
			Left Tilted	0.61	0.23	0.01	0.85	Σ SAR < 1.6, Not required
		Body-Worn	Front Face	0.11	0.00	0.00	0.11	Σ SAR < 1.6, Not required
			Rear Face	0.10	0.17	0.00	0.27	Σ SAR < 1.6, Not required
		Hotspot	Front Face	0.21	0.00	0.01	0.22	Σ SAR < 1.6, Not required
			Rear Face	0.16	0.33	0.01	0.50	Σ SAR < 1.6, Not required
			Left Side	0.06	0.00	0.00	0.06	Σ SAR < 1.6, Not required
			Right Side	0.09	0.19	0.00	0.28	Σ SAR < 1.6, Not required
			Top Side	0.10	0.00	0.00	0.10	Σ SAR < 1.6, Not required
			Bottom Side	0.05	0.00	0.00	0.05	Σ SAR < 1.6, Not required

FCC SAR Test Report

No.	Conditions (SAR1 + SAR2 + SAR3)	Exposure Condition	Test Position	Max. SAR1	Max. SAR2	Max. SAR3	SAR Summation	SPLSR Analysis
59	LTE 12 + WLAN (DTS) ANT0 + WLAN (NII) ANT-1	Head	Right Cheek	0.56	0.32	0.14	1.02	Σ SAR < 1.6, Not required
			Right Tilted	0.55	0.27	0.13	0.95	Σ SAR < 1.6, Not required
			Left Cheek	0.57	0.49	0.26	1.32	Σ SAR < 1.6, Not required
			Left Tilted	0.61	0.21	0.23	1.05	Σ SAR < 1.6, Not required
		Body-Worn	Front Face	0.11	0.06	0.00	0.17	Σ SAR < 1.6, Not required
			Rear Face	0.10	0.07	0.17	0.34	Σ SAR < 1.6, Not required
		Hotspot	Front Face	0.21	0.14	0.00	0.35	Σ SAR < 1.6, Not required
			Rear Face	0.16	0.21	0.33	0.70	Σ SAR < 1.6, Not required
			Left Side	0.06	0.00	0.00	0.06	Σ SAR < 1.6, Not required
			Right Side	0.09	0.05	0.19	0.33	Σ SAR < 1.6, Not required
			Top Side	0.10	0.06	0.00	0.16	Σ SAR < 1.6, Not required
			Bottom Side	0.05	0.00	0.00	0.05	Σ SAR < 1.6, Not required
60	LTE 12 + WLAN (NII) ANT-0+1 + BT	Head	Right Cheek	0.56	0.16	0.01	0.73	Σ SAR < 1.6, Not required
			Right Tilted	0.55	0.16	0.01	0.72	Σ SAR < 1.6, Not required
			Left Cheek	0.57	0.31	0.02	0.90	Σ SAR < 1.6, Not required
			Left Tilted	0.61	0.26	0.01	0.88	Σ SAR < 1.6, Not required
		Body-Worn	Front Face	0.11	0.30	0.00	0.41	Σ SAR < 1.6, Not required
			Rear Face	0.10	0.64	0.00	0.74	Σ SAR < 1.6, Not required
		Hotspot	Front Face	0.21	0.55	0.01	0.77	Σ SAR < 1.6, Not required
			Rear Face	0.16	0.70	0.01	0.87	Σ SAR < 1.6, Not required
			Left Side	0.06	0.00	0.00	0.06	Σ SAR < 1.6, Not required
			Right Side	0.09	0.20	0.00	0.29	Σ SAR < 1.6, Not required
			Top Side	0.10	0.18	0.00	0.28	Σ SAR < 1.6, Not required
			Bottom Side	0.05	0.00	0.00	0.05	Σ SAR < 1.6, Not required

FCC SAR Test Report

No.	Conditions (SAR1 + SAR2 + SAR3)	Exposure Condition	Test Position	Max. SAR1	Max. SAR2	SAR Summation	SPLSR Analysis
61	LTE 13 + WLAN (DTS)	Head	Right Cheek	0.60	0.32	0.92	Σ SAR < 1.6, Not required
			Right Tilted	0.41	0.27	0.68	Σ SAR < 1.6, Not required
			Left Cheek	0.51	0.51	1.02	Σ SAR < 1.6, Not required
			Left Tilted	0.51	0.38	0.89	Σ SAR < 1.6, Not required
		Body-Worn	Front Face	0.23	0.06	0.29	Σ SAR < 1.6, Not required
			Rear Face	0.21	0.15	0.36	Σ SAR < 1.6, Not required
		Hotspot	Front Face	0.20	0.14	0.34	Σ SAR < 1.6, Not required
			Rear Face	0.19	0.36	0.55	Σ SAR < 1.6, Not required
			Left Side	0.12	0.00	0.12	Σ SAR < 1.6, Not required
			Right Side	0.11	0.12	0.23	Σ SAR < 1.6, Not required
			Top Side	0.12	0.06	0.18	Σ SAR < 1.6, Not required
			Bottom Side	0.14	0.00	0.14	Σ SAR < 1.6, Not required
62	LTE 13 + WLAN (NII)	Head	Right Cheek	0.60	0.17	0.77	Σ SAR < 1.6, Not required
			Right Tilted	0.41	0.16	0.57	Σ SAR < 1.6, Not required
			Left Cheek	0.51	0.32	0.83	Σ SAR < 1.6, Not required
			Left Tilted	0.51	0.26	0.77	Σ SAR < 1.6, Not required
		Body-Worn	Front Face	0.23	0.30	0.53	Σ SAR < 1.6, Not required
			Rear Face	0.21	0.64	0.85	Σ SAR < 1.6, Not required
		Hotspot	Front Face	0.20	0.55	0.75	Σ SAR < 1.6, Not required
			Rear Face	0.19	0.70	0.89	Σ SAR < 1.6, Not required
			Left Side	0.12	0.00	0.12	Σ SAR < 1.6, Not required
			Right Side	0.11	0.20	0.31	Σ SAR < 1.6, Not required
			Top Side	0.12	0.18	0.30	Σ SAR < 1.6, Not required
			Bottom Side	0.14	0.00	0.14	Σ SAR < 1.6, Not required

FCC SAR Test Report

No.	Conditions (SAR1 + SAR2 + SAR3)	Exposure Condition	Test Position	Max. SAR1	Max. SAR2	Max. SAR3	SAR Summation	SPLSR Analysis
63	LTE 13 + WLAN (DTS) ANT-1 + BT	Head	Right Cheek	0.60	0.14	0.01	0.75	Σ SAR < 1.6, Not required
			Right Tilted	0.41	0.09	0.01	0.51	Σ SAR < 1.6, Not required
			Left Cheek	0.51	0.42	0.02	0.95	Σ SAR < 1.6, Not required
			Left Tilted	0.51	0.29	0.01	0.81	Σ SAR < 1.6, Not required
		Body-Worn	Front Face	0.23	0.00	0.00	0.23	Σ SAR < 1.6, Not required
			Rear Face	0.21	0.10	0.00	0.31	Σ SAR < 1.6, Not required
		Hotspot	Front Face	0.20	0.07	0.01	0.28	Σ SAR < 1.6, Not required
			Rear Face	0.19	0.29	0.01	0.49	Σ SAR < 1.6, Not required
			Left Side	0.12	0.00	0.00	0.12	Σ SAR < 1.6, Not required
			Right Side	0.11	0.11	0.00	0.22	Σ SAR < 1.6, Not required
			Top Side	0.12	0.00	0.00	0.12	Σ SAR < 1.6, Not required
			Bottom Side	0.14	0.00	0.00	0.14	Σ SAR < 1.6, Not required
64	LTE 13 + WLAN (NII) ANT-1 + BT	Head	Right Cheek	0.60	0.14	0.01	0.75	Σ SAR < 1.6, Not required
			Right Tilted	0.41	0.13	0.01	0.55	Σ SAR < 1.6, Not required
			Left Cheek	0.51	0.26	0.02	0.79	Σ SAR < 1.6, Not required
			Left Tilted	0.51	0.23	0.01	0.75	Σ SAR < 1.6, Not required
		Body-Worn	Front Face	0.23	0.00	0.00	0.23	Σ SAR < 1.6, Not required
			Rear Face	0.21	0.17	0.00	0.38	Σ SAR < 1.6, Not required
		Hotspot	Front Face	0.20	0.00	0.01	0.21	Σ SAR < 1.6, Not required
			Rear Face	0.19	0.33	0.01	0.53	Σ SAR < 1.6, Not required
			Left Side	0.12	0.00	0.00	0.12	Σ SAR < 1.6, Not required
			Right Side	0.11	0.19	0.00	0.30	Σ SAR < 1.6, Not required
			Top Side	0.12	0.00	0.00	0.12	Σ SAR < 1.6, Not required
			Bottom Side	0.14	0.00	0.00	0.14	Σ SAR < 1.6, Not required

FCC SAR Test Report

No.	Conditions (SAR1 + SAR2 + SAR3)	Exposure Condition	Test Position	Max. SAR1	Max. SAR2	Max. SAR3	SAR Summation	SPLSR Analysis
65	LTE 13 + WLAN (DTS) ANT0 + WLAN (NII) ANT-1	Head	Right Cheek	0.60	0.32	0.14	1.06	Σ SAR < 1.6, Not required
			Right Tilted	0.41	0.27	0.13	0.81	Σ SAR < 1.6, Not required
			Left Cheek	0.51	0.49	0.26	1.26	Σ SAR < 1.6, Not required
			Left Tilted	0.51	0.21	0.23	0.95	Σ SAR < 1.6, Not required
		Body-Worn	Front Face	0.23	0.06	0.00	0.29	Σ SAR < 1.6, Not required
			Rear Face	0.21	0.07	0.17	0.45	Σ SAR < 1.6, Not required
		Hotspot	Front Face	0.20	0.14	0.00	0.34	Σ SAR < 1.6, Not required
			Rear Face	0.19	0.21	0.33	0.73	Σ SAR < 1.6, Not required
			Left Side	0.12	0.00	0.00	0.12	Σ SAR < 1.6, Not required
			Right Side	0.11	0.05	0.19	0.35	Σ SAR < 1.6, Not required
			Top Side	0.12	0.06	0.00	0.18	Σ SAR < 1.6, Not required
			Bottom Side	0.14	0.00	0.00	0.14	Σ SAR < 1.6, Not required
66	LTE 13 + WLAN (NII) ANT-0+1 + BT	Head	Right Cheek	0.60	0.16	0.01	0.77	Σ SAR < 1.6, Not required
			Right Tilted	0.41	0.16	0.01	0.58	Σ SAR < 1.6, Not required
			Left Cheek	0.51	0.31	0.02	0.84	Σ SAR < 1.6, Not required
			Left Tilted	0.51	0.26	0.01	0.78	Σ SAR < 1.6, Not required
		Body-Worn	Front Face	0.23	0.30	0.00	0.53	Σ SAR < 1.6, Not required
			Rear Face	0.21	0.64	0.00	0.85	Σ SAR < 1.6, Not required
		Hotspot	Front Face	0.20	0.55	0.01	0.76	Σ SAR < 1.6, Not required
			Rear Face	0.19	0.70	0.01	0.90	Σ SAR < 1.6, Not required
			Left Side	0.12	0.00	0.00	0.12	Σ SAR < 1.6, Not required
			Right Side	0.11	0.20	0.00	0.31	Σ SAR < 1.6, Not required
			Top Side	0.12	0.18	0.00	0.30	Σ SAR < 1.6, Not required
			Bottom Side	0.14	0.00	0.00	0.14	Σ SAR < 1.6, Not required

FCC SAR Test Report

No.	Conditions (SAR1 + SAR2 + SAR3)	Exposure Condition	Test Position	Max. SAR1	Max. SAR2	SAR Summation	SPLSR Analysis
67	LTE 17 + WLAN (DTS)	Head	Right Cheek	1.01	0.32	1.33	Σ SAR < 1.6, Not required
			Right Tilted	0.76	0.27	1.03	Σ SAR < 1.6, Not required
			Left Cheek	0.82	0.51	1.33	Σ SAR < 1.6, Not required
			Left Tilted	0.99	0.38	1.37	Σ SAR < 1.6, Not required
		Body-Worn	Front Face	0.10	0.06	0.16	Σ SAR < 1.6, Not required
			Rear Face	0.11	0.15	0.26	Σ SAR < 1.6, Not required
		Hotspot	Front Face	0.20	0.14	0.34	Σ SAR < 1.6, Not required
			Rear Face	0.15	0.36	0.51	Σ SAR < 1.6, Not required
			Left Side	0.08	0.00	0.08	Σ SAR < 1.6, Not required
			Right Side	0.08	0.12	0.20	Σ SAR < 1.6, Not required
			Top Side	0.11	0.06	0.17	Σ SAR < 1.6, Not required
			Bottom Side	0.08	0.00	0.08	Σ SAR < 1.6, Not required
68	LTE 17 + WLAN (NII)	Head	Right Cheek	1.01	0.17	1.18	Σ SAR < 1.6, Not required
			Right Tilted	0.76	0.16	0.92	Σ SAR < 1.6, Not required
			Left Cheek	0.82	0.32	1.14	Σ SAR < 1.6, Not required
			Left Tilted	0.99	0.26	1.25	Σ SAR < 1.6, Not required
		Body-Worn	Front Face	0.10	0.30	0.40	Σ SAR < 1.6, Not required
			Rear Face	0.11	0.64	0.75	Σ SAR < 1.6, Not required
		Hotspot	Front Face	0.20	0.55	0.75	Σ SAR < 1.6, Not required
			Rear Face	0.15	0.70	0.85	Σ SAR < 1.6, Not required
			Left Side	0.08	0.00	0.08	Σ SAR < 1.6, Not required
			Right Side	0.08	0.20	0.28	Σ SAR < 1.6, Not required
			Top Side	0.11	0.18	0.29	Σ SAR < 1.6, Not required
			Bottom Side	0.08	0.00	0.08	Σ SAR < 1.6, Not required

FCC SAR Test Report

No.	Conditions (SAR1 + SAR2 + SAR3)	Exposure Condition	Test Position	Max. SAR1	Max. SAR2	Max. SAR3	SAR Summation	SPLSR Analysis
69	LTE 17 + WLAN (DTS) ANT-1 + BT	Head	Right Cheek	1.01	0.14	0.01	1.16	Σ SAR < 1.6, Not required
			Right Tilted	0.76	0.09	0.01	0.86	Σ SAR < 1.6, Not required
			Left Cheek	0.82	0.42	0.02	1.26	Σ SAR < 1.6, Not required
			Left Tilted	0.99	0.29	0.01	1.29	Σ SAR < 1.6, Not required
		Body-Worn	Front Face	0.10	0.00	0.00	0.10	Σ SAR < 1.6, Not required
			Rear Face	0.11	0.10	0.00	0.21	Σ SAR < 1.6, Not required
		Hotspot	Front Face	0.20	0.07	0.01	0.28	Σ SAR < 1.6, Not required
			Rear Face	0.15	0.29	0.01	0.45	Σ SAR < 1.6, Not required
			Left Side	0.08	0.00	0.00	0.08	Σ SAR < 1.6, Not required
			Right Side	0.08	0.11	0.00	0.19	Σ SAR < 1.6, Not required
			Top Side	0.11	0.00	0.00	0.11	Σ SAR < 1.6, Not required
			Bottom Side	0.08	0.00	0.00	0.08	Σ SAR < 1.6, Not required
70	LTE 17 + WLAN (NII) ANT-1 + BT	Head	Right Cheek	1.01	0.14	0.01	1.16	Σ SAR < 1.6, Not required
			Right Tilted	0.76	0.13	0.01	0.90	Σ SAR < 1.6, Not required
			Left Cheek	0.82	0.26	0.02	1.10	Σ SAR < 1.6, Not required
			Left Tilted	0.99	0.23	0.01	1.23	Σ SAR < 1.6, Not required
		Body-Worn	Front Face	0.10	0.00	0.00	0.10	Σ SAR < 1.6, Not required
			Rear Face	0.11	0.17	0.00	0.28	Σ SAR < 1.6, Not required
		Hotspot	Front Face	0.20	0.00	0.01	0.21	Σ SAR < 1.6, Not required
			Rear Face	0.15	0.33	0.01	0.49	Σ SAR < 1.6, Not required
			Left Side	0.08	0.00	0.00	0.08	Σ SAR < 1.6, Not required
			Right Side	0.08	0.19	0.00	0.27	Σ SAR < 1.6, Not required
			Top Side	0.11	0.00	0.00	0.11	Σ SAR < 1.6, Not required
			Bottom Side	0.08	0.00	0.00	0.08	Σ SAR < 1.6, Not required

FCC SAR Test Report

No.	Conditions (SAR1 + SAR2 + SAR3)	Exposure Condition	Test Position	Max. SAR1	Max. SAR2	Max. SAR3	SAR Summation	SPLSR Analysis
71	LTE 17 + WLAN (DTS) ANT0 + WLAN (NII) ANT-1	Head	Right Cheek	1.01	0.32	0.14	1.47	Σ SAR < 1.6, Not required
			Right Tilted	0.76	0.27	0.13	1.16	Σ SAR < 1.6, Not required
			Left Cheek	0.82	0.49	0.26	1.57	Σ SAR < 1.6, Not required
			Left Tilted	0.99	0.21	0.23	1.43	Σ SAR < 1.6, Not required
		Body-Worn	Front Face	0.10	0.06	0.00	0.16	Σ SAR < 1.6, Not required
			Rear Face	0.11	0.07	0.17	0.35	Σ SAR < 1.6, Not required
		Hotspot	Front Face	0.20	0.14	0.00	0.34	Σ SAR < 1.6, Not required
			Rear Face	0.15	0.21	0.33	0.69	Σ SAR < 1.6, Not required
			Left Side	0.08	0.00	0.00	0.08	Σ SAR < 1.6, Not required
			Right Side	0.08	0.05	0.19	0.32	Σ SAR < 1.6, Not required
			Top Side	0.11	0.06	0.00	0.17	Σ SAR < 1.6, Not required
			Bottom Side	0.08	0.00	0.00	0.08	Σ SAR < 1.6, Not required
72	LTE 17 + WLAN (NII) ANT-0+1 + BT	Head	Right Cheek	1.01	0.16	0.01	1.18	Σ SAR < 1.6, Not required
			Right Tilted	0.76	0.16	0.01	0.93	Σ SAR < 1.6, Not required
			Left Cheek	0.82	0.31	0.02	1.15	Σ SAR < 1.6, Not required
			Left Tilted	0.99	0.26	0.01	1.26	Σ SAR < 1.6, Not required
		Body-Worn	Front Face	0.10	0.30	0.00	0.40	Σ SAR < 1.6, Not required
			Rear Face	0.11	0.64	0.00	0.75	Σ SAR < 1.6, Not required
		Hotspot	Front Face	0.20	0.55	0.01	0.76	Σ SAR < 1.6, Not required
			Rear Face	0.15	0.70	0.01	0.86	Σ SAR < 1.6, Not required
			Left Side	0.08	0.00	0.00	0.08	Σ SAR < 1.6, Not required
			Right Side	0.08	0.20	0.00	0.28	Σ SAR < 1.6, Not required
			Top Side	0.11	0.18	0.00	0.29	Σ SAR < 1.6, Not required
			Bottom Side	0.08	0.00	0.00	0.08	Σ SAR < 1.6, Not required

FCC SAR Test Report

No.	Conditions (SAR1 + SAR2 + SAR3)	Exposure Condition	Test Position	Max. SAR1	Max. SAR2	SAR Summation	SPLSR Analysis
73	LTE 38 + WLAN (DTS)	Head	Right Cheek	0.05	0.32	0.37	Σ SAR < 1.6, Not required
			Right Tilted	0.00	0.27	0.27	Σ SAR < 1.6, Not required
			Left Cheek	0.00	0.51	0.51	Σ SAR < 1.6, Not required
			Left Tilted	0.00	0.38	0.38	Σ SAR < 1.6, Not required
		Body-Worn	Front Face	0.27	0.06	0.33	Σ SAR < 1.6, Not required
			Rear Face	0.30	0.15	0.45	Σ SAR < 1.6, Not required
		Hotspot	Front Face	0.49	0.14	0.63	Σ SAR < 1.6, Not required
			Rear Face	0.51	0.36	0.87	Σ SAR < 1.6, Not required
			Left Side	0.11	0.00	0.11	Σ SAR < 1.6, Not required
			Right Side	0.08	0.12	0.20	Σ SAR < 1.6, Not required
			Top Side	0.00	0.06	0.06	Σ SAR < 1.6, Not required
			Bottom Side	1.13	0.00	1.13	Σ SAR < 1.6, Not required
74	LTE 38 + WLAN (NII)	Head	Right Cheek	0.05	0.17	0.22	Σ SAR < 1.6, Not required
			Right Tilted	0.00	0.16	0.16	Σ SAR < 1.6, Not required
			Left Cheek	0.00	0.32	0.32	Σ SAR < 1.6, Not required
			Left Tilted	0.00	0.26	0.26	Σ SAR < 1.6, Not required
		Body-Worn	Front Face	0.27	0.30	0.57	Σ SAR < 1.6, Not required
			Rear Face	0.30	0.64	0.94	Σ SAR < 1.6, Not required
		Hotspot	Front Face	0.49	0.55	1.04	Σ SAR < 1.6, Not required
			Rear Face	0.51	0.70	1.21	Σ SAR < 1.6, Not required
			Left Side	0.11	0.00	0.11	Σ SAR < 1.6, Not required
			Right Side	0.08	0.20	0.28	Σ SAR < 1.6, Not required
			Top Side	0.00	0.18	0.18	Σ SAR < 1.6, Not required
			Bottom Side	1.13	0.00	1.13	Σ SAR < 1.6, Not required

FCC SAR Test Report

No.	Conditions (SAR1 + SAR2 + SAR3)	Exposure Condition	Test Position	Max. SAR1	Max. SAR2	Max. SAR3	SAR Summation	SPLSR Analysis
75	LTE 38 + WLAN (DTS) ANT-1 + BT	Head	Right Cheek	0.05	0.14	0.01	0.20	Σ SAR < 1.6, Not required
			Right Tilted	0.00	0.09	0.01	0.10	Σ SAR < 1.6, Not required
			Left Cheek	0.00	0.42	0.02	0.44	Σ SAR < 1.6, Not required
			Left Tilted	0.00	0.29	0.01	0.30	Σ SAR < 1.6, Not required
		Body-Worn	Front Face	0.27	0.00	0.00	0.27	Σ SAR < 1.6, Not required
			Rear Face	0.30	0.10	0.00	0.40	Σ SAR < 1.6, Not required
		Hotspot	Front Face	0.49	0.07	0.01	0.57	Σ SAR < 1.6, Not required
			Rear Face	0.51	0.29	0.01	0.81	Σ SAR < 1.6, Not required
			Left Side	0.11	0.00	0.00	0.11	Σ SAR < 1.6, Not required
			Right Side	0.08	0.11	0.00	0.19	Σ SAR < 1.6, Not required
			Top Side	0.00	0.00	0.00	0.00	Σ SAR < 1.6, Not required
			Bottom Side	1.13	0.00	0.00	1.13	Σ SAR < 1.6, Not required
76	LTE 38 + WLAN (NII) ANT-1 + BT	Head	Right Cheek	0.05	0.14	0.01	0.20	Σ SAR < 1.6, Not required
			Right Tilted	0.00	0.13	0.01	0.14	Σ SAR < 1.6, Not required
			Left Cheek	0.00	0.26	0.02	0.28	Σ SAR < 1.6, Not required
			Left Tilted	0.00	0.23	0.01	0.24	Σ SAR < 1.6, Not required
		Body-Worn	Front Face	0.27	0.00	0.00	0.27	Σ SAR < 1.6, Not required
			Rear Face	0.30	0.17	0.00	0.47	Σ SAR < 1.6, Not required
		Hotspot	Front Face	0.49	0.00	0.01	0.50	Σ SAR < 1.6, Not required
			Rear Face	0.51	0.33	0.01	0.85	Σ SAR < 1.6, Not required
			Left Side	0.11	0.00	0.00	0.11	Σ SAR < 1.6, Not required
			Right Side	0.08	0.19	0.00	0.27	Σ SAR < 1.6, Not required
			Top Side	0.00	0.00	0.00	0.00	Σ SAR < 1.6, Not required
			Bottom Side	1.13	0.00	0.00	1.13	Σ SAR < 1.6, Not required

FCC SAR Test Report

No.	Conditions (SAR1 + SAR2 + SAR3)	Exposure Condition	Test Position	Max. SAR1	Max. SAR2	Max. SAR3	SAR Summation	SPLSR Analysis
77	LTE 38 + WLAN (DTS) ANT0 + WLAN (NII) ANT-1	Head	Right Cheek	0.05	0.32	0.14	0.51	Σ SAR < 1.6, Not required
			Right Tilted	0.00	0.27	0.13	0.40	Σ SAR < 1.6, Not required
			Left Cheek	0.00	0.49	0.26	0.75	Σ SAR < 1.6, Not required
			Left Tilted	0.00	0.21	0.23	0.44	Σ SAR < 1.6, Not required
		Body-Worn	Front Face	0.27	0.06	0.00	0.33	Σ SAR < 1.6, Not required
			Rear Face	0.30	0.07	0.17	0.54	Σ SAR < 1.6, Not required
		Hotspot	Front Face	0.49	0.14	0.00	0.63	Σ SAR < 1.6, Not required
			Rear Face	0.51	0.21	0.33	1.05	Σ SAR < 1.6, Not required
			Left Side	0.11	0.00	0.00	0.11	Σ SAR < 1.6, Not required
			Right Side	0.08	0.05	0.19	0.32	Σ SAR < 1.6, Not required
			Top Side	0.00	0.06	0.00	0.06	Σ SAR < 1.6, Not required
			Bottom Side	1.13	0.00	0.00	1.13	Σ SAR < 1.6, Not required
78	LTE 38 + WLAN (NII) ANT-0+1 + BT	Head	Right Cheek	0.05	0.16	0.01	0.22	Σ SAR < 1.6, Not required
			Right Tilted	0.00	0.16	0.01	0.17	Σ SAR < 1.6, Not required
			Left Cheek	0.00	0.31	0.02	0.33	Σ SAR < 1.6, Not required
			Left Tilted	0.00	0.26	0.01	0.27	Σ SAR < 1.6, Not required
		Body-Worn	Front Face	0.27	0.30	0.00	0.57	Σ SAR < 1.6, Not required
			Rear Face	0.30	0.64	0.00	0.94	Σ SAR < 1.6, Not required
		Hotspot	Front Face	0.49	0.55	0.01	1.05	Σ SAR < 1.6, Not required
			Rear Face	0.51	0.70	0.01	1.22	Σ SAR < 1.6, Not required
			Left Side	0.11	0.00	0.00	0.11	Σ SAR < 1.6, Not required
			Right Side	0.08	0.20	0.00	0.28	Σ SAR < 1.6, Not required
			Top Side	0.00	0.18	0.00	0.18	Σ SAR < 1.6, Not required
			Bottom Side	1.13	0.00	0.00	1.13	Σ SAR < 1.6, Not required

FCC SAR Test Report

No.	Conditions (SAR1 + SAR2 + SAR3)	Exposure Condition	Test Position	Max. SAR1	Max. SAR2	SAR Summation	SPLSR Analysis
79	LTE 41 + WLAN (DTS)	Head	Right Cheek	0.05	0.32	0.37	Σ SAR < 1.6, Not required
			Right Tilted	0.05	0.27	0.32	Σ SAR < 1.6, Not required
			Left Cheek	0.00	0.51	0.51	Σ SAR < 1.6, Not required
			Left Tilted	0.00	0.38	0.38	Σ SAR < 1.6, Not required
		Body-Worn	Front Face	0.21	0.06	0.27	Σ SAR < 1.6, Not required
			Rear Face	0.30	0.15	0.45	Σ SAR < 1.6, Not required
		Hotspot	Front Face	0.41	0.14	0.55	Σ SAR < 1.6, Not required
			Rear Face	0.40	0.36	0.76	Σ SAR < 1.6, Not required
			Left Side	0.11	0.00	0.11	Σ SAR < 1.6, Not required
			Right Side	0.04	0.12	0.16	Σ SAR < 1.6, Not required
			Top Side	0.00	0.06	0.06	Σ SAR < 1.6, Not required
			Bottom Side	1.10	0.00	1.10	Σ SAR < 1.6, Not required
80	LTE 41 + WLAN (NII)	Head	Right Cheek	0.05	0.17	0.22	Σ SAR < 1.6, Not required
			Right Tilted	0.05	0.16	0.21	Σ SAR < 1.6, Not required
			Left Cheek	0.00	0.32	0.32	Σ SAR < 1.6, Not required
			Left Tilted	0.00	0.26	0.26	Σ SAR < 1.6, Not required
		Body-Worn	Front Face	0.21	0.30	0.51	Σ SAR < 1.6, Not required
			Rear Face	0.30	0.64	0.94	Σ SAR < 1.6, Not required
		Hotspot	Front Face	0.41	0.55	0.96	Σ SAR < 1.6, Not required
			Rear Face	0.40	0.70	1.10	Σ SAR < 1.6, Not required
			Left Side	0.11	0.00	0.11	Σ SAR < 1.6, Not required
			Right Side	0.04	0.20	0.24	Σ SAR < 1.6, Not required
			Top Side	0.00	0.18	0.18	Σ SAR < 1.6, Not required
			Bottom Side	1.10	0.00	1.10	Σ SAR < 1.6, Not required

FCC SAR Test Report

No.	Conditions (SAR1 + SAR2 + SAR3)	Exposure Condition	Test Position	Max. SAR1	Max. SAR2	Max. SAR3	SAR Summation	SPLSR Analysis
81	LTE 41 + WLAN (DTS) ANT-1 + BT	Head	Right Cheek	0.05	0.14	0.01	0.20	Σ SAR < 1.6, Not required
			Right Tilted	0.05	0.09	0.01	0.15	Σ SAR < 1.6, Not required
			Left Cheek	0.00	0.42	0.02	0.44	Σ SAR < 1.6, Not required
			Left Tilted	0.00	0.29	0.01	0.30	Σ SAR < 1.6, Not required
		Body-Worn	Front Face	0.21	0.00	0.00	0.21	Σ SAR < 1.6, Not required
			Rear Face	0.30	0.10	0.00	0.40	Σ SAR < 1.6, Not required
		Hotspot	Front Face	0.41	0.07	0.01	0.49	Σ SAR < 1.6, Not required
			Rear Face	0.40	0.29	0.01	0.70	Σ SAR < 1.6, Not required
			Left Side	0.11	0.00	0.00	0.11	Σ SAR < 1.6, Not required
			Right Side	0.04	0.11	0.00	0.15	Σ SAR < 1.6, Not required
			Top Side	0.00	0.00	0.00	0.00	Σ SAR < 1.6, Not required
			Bottom Side	1.10	0.00	0.00	1.10	Σ SAR < 1.6, Not required
82	LTE 41 + WLAN (NII) ANT-1 + BT	Head	Right Cheek	0.05	0.14	0.01	0.20	Σ SAR < 1.6, Not required
			Right Tilted	0.05	0.13	0.01	0.19	Σ SAR < 1.6, Not required
			Left Cheek	0.00	0.26	0.02	0.28	Σ SAR < 1.6, Not required
			Left Tilted	0.00	0.23	0.01	0.24	Σ SAR < 1.6, Not required
		Body-Worn	Front Face	0.21	0.00	0.00	0.21	Σ SAR < 1.6, Not required
			Rear Face	0.30	0.17	0.00	0.47	Σ SAR < 1.6, Not required
		Hotspot	Front Face	0.41	0.00	0.01	0.42	Σ SAR < 1.6, Not required
			Rear Face	0.40	0.33	0.01	0.74	Σ SAR < 1.6, Not required
			Left Side	0.11	0.00	0.00	0.11	Σ SAR < 1.6, Not required
			Right Side	0.04	0.19	0.00	0.23	Σ SAR < 1.6, Not required
			Top Side	0.00	0.00	0.00	0.00	Σ SAR < 1.6, Not required
			Bottom Side	1.10	0.00	0.00	1.10	Σ SAR < 1.6, Not required

FCC SAR Test Report

No.	Conditions (SAR1 + SAR2 + SAR3)	Exposure Condition	Test Position	Max. SAR1	Max. SAR2	Max. SAR3	SAR Summation	SPLSR Analysis
83	LTE 41 + WLAN (DTS) ANT0 + WLAN (NII) ANT-1	Head	Right Cheek	0.05	0.32	0.14	0.51	Σ SAR < 1.6, Not required
			Right Tilted	0.05	0.27	0.13	0.45	Σ SAR < 1.6, Not required
			Left Cheek	0.00	0.49	0.26	0.75	Σ SAR < 1.6, Not required
			Left Tilted	0.00	0.21	0.23	0.44	Σ SAR < 1.6, Not required
		Body-Worn	Front Face	0.21	0.06	0.00	0.27	Σ SAR < 1.6, Not required
			Rear Face	0.30	0.07	0.17	0.54	Σ SAR < 1.6, Not required
		Hotspot	Front Face	0.41	0.14	0.00	0.55	Σ SAR < 1.6, Not required
			Rear Face	0.40	0.21	0.33	0.94	Σ SAR < 1.6, Not required
			Left Side	0.11	0.00	0.00	0.11	Σ SAR < 1.6, Not required
			Right Side	0.04	0.05	0.19	0.28	Σ SAR < 1.6, Not required
			Top Side	0.00	0.06	0.00	0.06	Σ SAR < 1.6, Not required
			Bottom Side	1.10	0.00	0.00	1.10	Σ SAR < 1.6, Not required
84	LTE 41 + WLAN (NII) ANT-0+1 + BT	Head	Right Cheek	0.05	0.16	0.01	0.22	Σ SAR < 1.6, Not required
			Right Tilted	0.05	0.16	0.01	0.22	Σ SAR < 1.6, Not required
			Left Cheek	0.00	0.31	0.02	0.33	Σ SAR < 1.6, Not required
			Left Tilted	0.00	0.26	0.01	0.27	Σ SAR < 1.6, Not required
		Body-Worn	Front Face	0.21	0.30	0.00	0.51	Σ SAR < 1.6, Not required
			Rear Face	0.30	0.64	0.00	0.94	Σ SAR < 1.6, Not required
		Hotspot	Front Face	0.41	0.55	0.01	0.97	Σ SAR < 1.6, Not required
			Rear Face	0.40	0.70	0.01	1.11	Σ SAR < 1.6, Not required
			Left Side	0.11	0.00	0.00	0.11	Σ SAR < 1.6, Not required
			Right Side	0.04	0.20	0.00	0.24	Σ SAR < 1.6, Not required
			Top Side	0.00	0.18	0.00	0.18	Σ SAR < 1.6, Not required
			Bottom Side	1.10	0.00	0.00	1.10	Σ SAR < 1.6, Not required

FCC SAR Test Report

No.	Conditions (SAR1 + SAR2 + SAR3)	Exposure Condition	Test Position	Max. SAR1	Max. SAR2	SAR Summation	SPLSR Analysis
85	LTE 66 + WLAN (DTS)	Head	Right Cheek	0.1	0.32	0.42	Σ SAR < 1.6, Not required
			Right Tilted	0.06	0.27	0.33	Σ SAR < 1.6, Not required
			Left Cheek	0.22	0.51	0.73	Σ SAR < 1.6, Not required
			Left Tilted	0.09	0.38	0.47	Σ SAR < 1.6, Not required
		Body-Worn	Front Face	0.61	0.06	0.67	Σ SAR < 1.6, Not required
			Rear Face	0.63	0.15	0.78	Σ SAR < 1.6, Not required
		Hotspot	Front Face	0.43	0.14	0.57	Σ SAR < 1.6, Not required
			Rear Face	0.45	0.36	0.81	Σ SAR < 1.6, Not required
			Left Side	0.03	0.00	0.03	Σ SAR < 1.6, Not required
			Right Side	0.05	0.12	0.17	Σ SAR < 1.6, Not required
			Top Side	0	0.06	0.06	Σ SAR < 1.6, Not required
			Bottom Side	0.79	0.00	0.79	Σ SAR < 1.6, Not required
86	LTE 66 + WLAN (NII)	Head	Right Cheek	0.1	0.17	0.27	Σ SAR < 1.6, Not required
			Right Tilted	0.06	0.16	0.22	Σ SAR < 1.6, Not required
			Left Cheek	0.22	0.32	0.54	Σ SAR < 1.6, Not required
			Left Tilted	0.09	0.26	0.35	Σ SAR < 1.6, Not required
		Body-Worn	Front Face	0.61	0.30	0.91	Σ SAR < 1.6, Not required
			Rear Face	0.63	0.64	1.27	Σ SAR < 1.6, Not required
		Hotspot	Front Face	0.43	0.55	0.98	Σ SAR < 1.6, Not required
			Rear Face	0.45	0.70	1.15	Σ SAR < 1.6, Not required
			Left Side	0.03	0.00	0.03	Σ SAR < 1.6, Not required
			Right Side	0.05	0.20	0.25	Σ SAR < 1.6, Not required
			Top Side	0	0.18	0.18	Σ SAR < 1.6, Not required
			Bottom Side	0.79	0.00	0.79	Σ SAR < 1.6, Not required

FCC SAR Test Report

No.	Conditions (SAR1 + SAR2 + SAR3)	Exposure Condition	Test Position	Max. SAR1	Max. SAR2	Max. SAR3	SAR Summation	SPLSR Analysis
87	LTE 66 + WLAN (DTS) ANT-1 + BT	Head	Right Cheek	0.1	0.14	0.01	0.25	Σ SAR < 1.6, Not required
			Right Tilted	0.06	0.09	0.01	0.16	Σ SAR < 1.6, Not required
			Left Cheek	0.22	0.42	0.02	0.66	Σ SAR < 1.6, Not required
			Left Tilted	0.09	0.29	0.01	0.39	Σ SAR < 1.6, Not required
		Body-Worn	Front Face	0.61	0.00	0.00	0.61	Σ SAR < 1.6, Not required
			Rear Face	0.63	0.10	0.00	0.73	Σ SAR < 1.6, Not required
		Hotspot	Front Face	0.43	0.07	0.01	0.51	Σ SAR < 1.6, Not required
			Rear Face	0.45	0.29	0.01	0.75	Σ SAR < 1.6, Not required
			Left Side	0.03	0.00	0.00	0.03	Σ SAR < 1.6, Not required
			Right Side	0.05	0.11	0.00	0.16	Σ SAR < 1.6, Not required
			Top Side	0	0.00	0.00	0	Σ SAR < 1.6, Not required
			Bottom Side	0.79	0.00	0.00	0.79	Σ SAR < 1.6, Not required
88	LTE 66 + WLAN (NII) ANT-1 + BT	Head	Right Cheek	0.1	0.14	0.01	0.25	Σ SAR < 1.6, Not required
			Right Tilted	0.06	0.13	0.01	0.2	Σ SAR < 1.6, Not required
			Left Cheek	0.22	0.26	0.02	0.5	Σ SAR < 1.6, Not required
			Left Tilted	0.09	0.23	0.01	0.33	Σ SAR < 1.6, Not required
		Body-Worn	Front Face	0.61	0.00	0.00	0.61	Σ SAR < 1.6, Not required
			Rear Face	0.63	0.17	0.00	0.8	Σ SAR < 1.6, Not required
		Hotspot	Front Face	0.43	0.00	0.01	0.44	Σ SAR < 1.6, Not required
			Rear Face	0.45	0.33	0.01	0.79	Σ SAR < 1.6, Not required
			Left Side	0.03	0.00	0.00	0.03	Σ SAR < 1.6, Not required
			Right Side	0.05	0.19	0.00	0.24	Σ SAR < 1.6, Not required
			Top Side	0	0.00	0.00	0	Σ SAR < 1.6, Not required
			Bottom Side	0.79	0.00	0.00	0.79	Σ SAR < 1.6, Not required

FCC SAR Test Report

No.	Conditions (SAR1 + SAR2 + SAR3)	Exposure Condition	Test Position	Max. SAR1	Max. SAR2	Max. SAR3	SAR Summation	SPLSR Analysis
89	LTE 66 + WLAN (DTS) ANT0 + WLAN (NII) ANT-1	Head	Right Cheek	0.1	0.32	0.14	0.56	Σ SAR < 1.6, Not required
			Right Tilted	0.06	0.27	0.13	0.46	Σ SAR < 1.6, Not required
			Left Cheek	0.22	0.49	0.26	0.97	Σ SAR < 1.6, Not required
			Left Tilted	0.09	0.21	0.23	0.53	Σ SAR < 1.6, Not required
		Body-Worn	Front Face	0.61	0.06	0.00	0.67	Σ SAR < 1.6, Not required
			Rear Face	0.63	0.07	0.17	0.87	Σ SAR < 1.6, Not required
		Hotspot	Front Face	0.43	0.14	0.00	0.57	Σ SAR < 1.6, Not required
			Rear Face	0.45	0.21	0.33	0.99	Σ SAR < 1.6, Not required
			Left Side	0.03	0.00	0.00	0.03	Σ SAR < 1.6, Not required
			Right Side	0.05	0.05	0.19	0.29	Σ SAR < 1.6, Not required
			Top Side	0	0.06	0.00	0.06	Σ SAR < 1.6, Not required
			Bottom Side	0.79	0.00	0.00	0.79	Σ SAR < 1.6, Not required
90	LTE 66 + WLAN (NII) ANT-0+1 + BT	Head	Right Cheek	0.1	0.16	0.01	0.27	Σ SAR < 1.6, Not required
			Right Tilted	0.06	0.16	0.01	0.23	Σ SAR < 1.6, Not required
			Left Cheek	0.22	0.31	0.02	0.55	Σ SAR < 1.6, Not required
			Left Tilted	0.09	0.26	0.01	0.36	Σ SAR < 1.6, Not required
		Body-Worn	Front Face	0.61	0.30	0.00	0.91	Σ SAR < 1.6, Not required
			Rear Face	0.63	0.64	0.00	1.27	Σ SAR < 1.6, Not required
		Hotspot	Front Face	0.43	0.55	0.01	0.99	Σ SAR < 1.6, Not required
			Rear Face	0.45	0.70	0.01	1.16	Σ SAR < 1.6, Not required
			Left Side	0.03	0.00	0.00	0.03	Σ SAR < 1.6, Not required
			Right Side	0.05	0.20	0.00	0.25	Σ SAR < 1.6, Not required
			Top Side	0	0.18	0.00	0.18	Σ SAR < 1.6, Not required
			Bottom Side	0.79	0.00	0.00	0.79	Σ SAR < 1.6, Not required

FCC SAR Test Report

LTE Uplink CA

No.	Conditions (SAR1 + SAR2 + SAR3)	Exposure Condition	Test Position	Max. SAR1	Max. SAR2	Max. SAR3	SAR Summation	SPLSR Analysis
91	LTE 2 + LTE 12 + WLAN (DTS)	Head	Right Cheek	0.11	0.56	0.32	0.99	Σ SAR < 1.6, Not required
			Right Tilted	0.07	0.55	0.27	0.89	Σ SAR < 1.6, Not required
			Left Cheek	0.18	0.57	0.51	1.26	Σ SAR < 1.6, Not required
			Left Tilted	0.05	0.61	0.38	1.04	Σ SAR < 1.6, Not required
		Body-Worn	Front Face	0.52	0.11	0.06	0.69	Σ SAR < 1.6, Not required
			Rear Face	0.57	0.10	0.15	0.82	Σ SAR < 1.6, Not required
		Hotspot	Front Face	0.33	0.21	0.14	0.68	Σ SAR < 1.6, Not required
			Rear Face	0.33	0.16	0.36	0.85	Σ SAR < 1.6, Not required
			Left Side	0.03	0.06	0.00	0.09	Σ SAR < 1.6, Not required
			Right Side	0.04	0.09	0.12	0.25	Σ SAR < 1.6, Not required
			Top Side	0	0.10	0.06	0.16	Σ SAR < 1.6, Not required
			Bottom Side	0.71	0.05	0.00	0.76	Σ SAR < 1.6, Not required
92	LTE 2 + LTE 12 + WLAN (NII)	Head	Right Cheek	0.11	0.56	0.17	0.84	Σ SAR < 1.6, Not required
			Right Tilted	0.07	0.55	0.16	0.78	Σ SAR < 1.6, Not required
			Left Cheek	0.18	0.57	0.32	1.07	Σ SAR < 1.6, Not required
			Left Tilted	0.05	0.61	0.26	0.92	Σ SAR < 1.6, Not required
		Body-Worn	Front Face	0.52	0.11	0.30	0.93	Σ SAR < 1.6, Not required
			Rear Face	0.57	0.10	0.64	1.31	Σ SAR < 1.6, Not required
		Hotspot	Front Face	0.33	0.21	0.55	1.09	Σ SAR < 1.6, Not required
			Rear Face	0.33	0.16	0.70	1.19	Σ SAR < 1.6, Not required
			Left Side	0.03	0.06	0.00	0.09	Σ SAR < 1.6, Not required
			Right Side	0.04	0.09	0.20	0.33	Σ SAR < 1.6, Not required
			Top Side	0	0.10	0.18	0.28	Σ SAR < 1.6, Not required
			Bottom Side	0.71	0.05	0.00	0.76	Σ SAR < 1.6, Not required

FCC SAR Test Report

No.	Conditions (SAR1 + SAR2 + SAR3)	Exposure Condition	Test Position	Max. SAR1	Max. SAR2	Max. SAR3	Max. SAR4	SAR Summation	SPLSR Analysis
93	LTE 2 + LTE 12 + WLAN (DTS) ANT-1 + BT	Head	Right Cheek	0.11	0.56	0.14	0.01	0.82	Σ SAR < 1.6, Not required
			Right Tilted	0.07	0.55	0.09	0.01	0.72	Σ SAR < 1.6, Not required
			Left Cheek	0.18	0.57	0.42	0.02	1.19	Σ SAR < 1.6, Not required
			Left Tilted	0.05	0.61	0.29	0.01	0.96	Σ SAR < 1.6, Not required
		Body-Worn	Front Face	0.52	0.11	0.00	0.00	0.63	Σ SAR < 1.6, Not required
			Rear Face	0.57	0.10	0.10	0.00	0.77	Σ SAR < 1.6, Not required
		Hotspot	Front Face	0.33	0.21	0.07	0.01	0.62	Σ SAR < 1.6, Not required
			Rear Face	0.33	0.16	0.29	0.01	0.79	Σ SAR < 1.6, Not required
			Left Side	0.03	0.06	0.00	0.00	0.09	Σ SAR < 1.6, Not required
			Right Side	0.04	0.09	0.11	0.00	0.24	Σ SAR < 1.6, Not required
			Top Side	0	0.10	0.00	0.00	0.1	Σ SAR < 1.6, Not required
			Bottom Side	0.71	0.05	0.00	0.00	0.76	Σ SAR < 1.6, Not required
94	LTE 2 + LTE 12 + WLAN (NII) ANT-1 + BT	Head	Right Cheek	0.11	0.56	0.14	0.01	0.82	Σ SAR < 1.6, Not required
			Right Tilted	0.07	0.55	0.13	0.01	0.76	Σ SAR < 1.6, Not required
			Left Cheek	0.18	0.57	0.26	0.02	1.03	Σ SAR < 1.6, Not required
			Left Tilted	0.05	0.61	0.23	0.01	0.9	Σ SAR < 1.6, Not required
		Body-Worn	Front Face	0.52	0.11	0.00	0.00	0.63	Σ SAR < 1.6, Not required
			Rear Face	0.57	0.10	0.17	0.00	0.84	Σ SAR < 1.6, Not required
		Hotspot	Front Face	0.33	0.21	0.00	0.01	0.55	Σ SAR < 1.6, Not required
			Rear Face	0.33	0.16	0.33	0.01	0.83	Σ SAR < 1.6, Not required
			Left Side	0.03	0.06	0.00	0.00	0.09	Σ SAR < 1.6, Not required
			Right Side	0.04	0.09	0.19	0.00	0.32	Σ SAR < 1.6, Not required
			Top Side	0	0.10	0.00	0.00	0.1	Σ SAR < 1.6, Not required
			Bottom Side	0.71	0.05	0.00	0.00	0.76	Σ SAR < 1.6, Not required

FCC SAR Test Report

No.	Conditions (SAR1 + SAR2 + SAR3)	Exposure Condition	Test Position	Max. SAR1	Max. SAR2	Max. SAR3	Max. SAR4	SAR Summation	SPLSR Analysis
95	LTE 2 + LTE 12 + WLAN (DTS) ANT0 + WLAN (NII) ANT-1	Head	Right Cheek	0.11	0.56	0.32	0.14	1.13	Σ SAR < 1.6, Not required
			Right Tilted	0.07	0.55	0.27	0.13	1.02	Σ SAR < 1.6, Not required
			Left Cheek	0.18	0.57	0.49	0.26	1.5	Σ SAR < 1.6, Not required
			Left Tilted	0.05	0.61	0.21	0.23	1.1	Σ SAR < 1.6, Not required
		Body-Worn	Front Face	0.52	0.11	0.06	0.00	0.69	Σ SAR < 1.6, Not required
			Rear Face	0.57	0.10	0.07	0.17	0.91	Σ SAR < 1.6, Not required
		Hotspot	Front Face	0.33	0.21	0.14	0.00	0.68	Σ SAR < 1.6, Not required
			Rear Face	0.33	0.16	0.21	0.33	1.03	Σ SAR < 1.6, Not required
			Left Side	0.03	0.06	0.00	0.00	0.09	Σ SAR < 1.6, Not required
			Right Side	0.04	0.09	0.05	0.19	0.37	Σ SAR < 1.6, Not required
			Top Side	0	0.10	0.06	0.00	0.16	Σ SAR < 1.6, Not required
			Bottom Side	0.71	0.05	0.00	0.00	0.76	Σ SAR < 1.6, Not required
96	LTE 2 + LTE 12 + WLAN (NII) ANT-0+1 + BT	Head	Right Cheek	0.11	0.56	0.16	0.01	0.84	Σ SAR < 1.6, Not required
			Right Tilted	0.07	0.55	0.16	0.01	0.79	Σ SAR < 1.6, Not required
			Left Cheek	0.18	0.57	0.31	0.02	1.08	Σ SAR < 1.6, Not required
			Left Tilted	0.05	0.61	0.26	0.01	0.93	Σ SAR < 1.6, Not required
		Body-Worn	Front Face	0.52	0.11	0.30	0.00	0.93	Σ SAR < 1.6, Not required
			Rear Face	0.57	0.10	0.64	0.00	1.31	Σ SAR < 1.6, Not required
		Hotspot	Front Face	0.33	0.21	0.55	0.01	1.1	Σ SAR < 1.6, Not required
			Rear Face	0.33	0.16	0.70	0.01	1.20	Σ SAR < 1.6, Not required
			Left Side	0.03	0.06	0.00	0.00	0.09	Σ SAR < 1.6, Not required
			Right Side	0.04	0.09	0.20	0.00	0.33	Σ SAR < 1.6, Not required
			Top Side	0	0.10	0.18	0.00	0.28	Σ SAR < 1.6, Not required
			Bottom Side	0.71	0.05	0.00	0.00	0.76	Σ SAR < 1.6, Not required

FCC SAR Test Report

No.	Conditions (SAR1 + SAR2 + SAR3)	Exposure Condition	Test Position	Max. SAR1	Max. SAR2	Max. SAR3	SAR Summation	SPLSR Analysis
97	LTE 4 + LTE 12 + WLAN (DTS)	Head	Right Cheek	0.13	0.56	0.32	1.01	Σ SAR < 1.6, Not required
			Right Tilted	0.09	0.55	0.27	0.91	Σ SAR < 1.6, Not required
			Left Cheek	0.24	0.57	0.51	1.32	Σ SAR < 1.6, Not required
			Left Tilted	0.11	0.61	0.38	1.1	Σ SAR < 1.6, Not required
		Body-Worn	Front Face	0.75	0.11	0.06	0.92	Σ SAR < 1.6, Not required
			Rear Face	0.71	0.10	0.15	0.96	Σ SAR < 1.6, Not required
		Hotspot	Front Face	0.43	0.21	0.14	0.78	Σ SAR < 1.6, Not required
			Rear Face	0.42	0.16	0.36	0.94	Σ SAR < 1.6, Not required
			Left Side	0.03	0.06	0.00	0.09	Σ SAR < 1.6, Not required
			Right Side	0.08	0.09	0.12	0.29	Σ SAR < 1.6, Not required
			Top Side	0	0.10	0.06	0.16	Σ SAR < 1.6, Not required
			Bottom Side	0.74	0.05	0.00	0.79	Σ SAR < 1.6, Not required
98	LTE 4 + LTE 12 + WLAN (NII)	Head	Right Cheek	0.13	0.56	0.17	0.86	Σ SAR < 1.6, Not required
			Right Tilted	0.09	0.55	0.16	0.8	Σ SAR < 1.6, Not required
			Left Cheek	0.24	0.57	0.32	1.13	Σ SAR < 1.6, Not required
			Left Tilted	0.11	0.61	0.26	0.98	Σ SAR < 1.6, Not required
		Body-Worn	Front Face	0.75	0.11	0.30	1.16	Σ SAR < 1.6, Not required
			Rear Face	0.71	0.10	0.64	1.45	Σ SAR < 1.6, Not required
		Hotspot	Front Face	0.43	0.21	0.55	1.19	Σ SAR < 1.6, Not required
			Rear Face	0.42	0.16	0.70	1.28	Σ SAR < 1.6, Not required
			Left Side	0.03	0.06	0.00	0.09	Σ SAR < 1.6, Not required
			Right Side	0.08	0.09	0.20	0.37	Σ SAR < 1.6, Not required
			Top Side	0	0.10	0.18	0.28	Σ SAR < 1.6, Not required
			Bottom Side	0.74	0.05	0.00	0.79	Σ SAR < 1.6, Not required

FCC SAR Test Report

No.	Conditions (SAR1 + SAR2 + SAR3)	Exposure Condition	Test Position	Max. SAR1	Max. SAR2	Max. SAR3	Max. SAR4	SAR Summation	SPLSR Analysis
99	LTE 4 + LTE 12 + WLAN (DTS) ANT-1 + BT	Head	Right Cheek	0.13	0.56	0.14	0.01	0.84	Σ SAR < 1.6, Not required
			Right Tilted	0.09	0.55	0.09	0.01	0.74	Σ SAR < 1.6, Not required
			Left Cheek	0.24	0.57	0.42	0.02	1.25	Σ SAR < 1.6, Not required
			Left Tilted	0.11	0.61	0.29	0.01	1.02	Σ SAR < 1.6, Not required
		Body-Worn	Front Face	0.75	0.11	0.00	0.00	0.86	Σ SAR < 1.6, Not required
			Rear Face	0.71	0.10	0.10	0.00	0.91	Σ SAR < 1.6, Not required
		Hotspot	Front Face	0.43	0.21	0.07	0.01	0.72	Σ SAR < 1.6, Not required
			Rear Face	0.42	0.16	0.29	0.01	0.88	Σ SAR < 1.6, Not required
			Left Side	0.03	0.06	0.00	0.00	0.09	Σ SAR < 1.6, Not required
			Right Side	0.08	0.09	0.11	0.00	0.28	Σ SAR < 1.6, Not required
			Top Side	0	0.10	0.00	0.00	0.1	Σ SAR < 1.6, Not required
			Bottom Side	0.74	0.05	0.00	0.00	0.79	Σ SAR < 1.6, Not required
100	LTE 4 + LTE 12 + WLAN (NII) ANT-1 + BT	Head	Right Cheek	0.13	0.56	0.14	0.01	0.84	Σ SAR < 1.6, Not required
			Right Tilted	0.09	0.55	0.13	0.01	0.78	Σ SAR < 1.6, Not required
			Left Cheek	0.24	0.57	0.26	0.02	1.09	Σ SAR < 1.6, Not required
			Left Tilted	0.11	0.61	0.23	0.01	0.96	Σ SAR < 1.6, Not required
		Body-Worn	Front Face	0.75	0.11	0.00	0.00	0.86	Σ SAR < 1.6, Not required
			Rear Face	0.71	0.10	0.17	0.00	0.98	Σ SAR < 1.6, Not required
		Hotspot	Front Face	0.43	0.21	0.00	0.01	0.65	Σ SAR < 1.6, Not required
			Rear Face	0.42	0.16	0.33	0.01	0.92	Σ SAR < 1.6, Not required
			Left Side	0.03	0.06	0.00	0.00	0.09	Σ SAR < 1.6, Not required
			Right Side	0.08	0.09	0.19	0.00	0.36	Σ SAR < 1.6, Not required
			Top Side	0	0.10	0.00	0.00	0.1	Σ SAR < 1.6, Not required
			Bottom Side	0.74	0.05	0.00	0.00	0.79	Σ SAR < 1.6, Not required

FCC SAR Test Report

No.	Conditions (SAR1 + SAR2 + SAR3)	Exposure Condition	Test Position	Max. SAR1	Max. SAR2	Max. SAR3	Max. SAR4	SAR Summation	SPLSR Analysis
101	LTE 4 + LTE 12 + WLAN (DTS) ANT0 + WLAN (NII) ANT-1	Head	Right Cheek	0.13	0.56	0.32	0.14	1.15	Σ SAR < 1.6, Not required
			Right Tilted	0.09	0.55	0.27	0.13	1.04	Σ SAR < 1.6, Not required
			Left Cheek	0.24	0.57	0.49	0.26	1.56	Σ SAR < 1.6, Not required
			Left Tilted	0.11	0.61	0.21	0.23	1.16	Σ SAR < 1.6, Not required
		Body-Worn	Front Face	0.75	0.11	0.06	0.00	0.92	Σ SAR < 1.6, Not required
			Rear Face	0.71	0.10	0.07	0.17	1.05	Σ SAR < 1.6, Not required
		Hotspot	Front Face	0.43	0.21	0.14	0.00	0.78	Σ SAR < 1.6, Not required
			Rear Face	0.42	0.16	0.21	0.33	1.12	Σ SAR < 1.6, Not required
			Left Side	0.03	0.06	0.00	0.00	0.09	Σ SAR < 1.6, Not required
			Right Side	0.08	0.09	0.05	0.19	0.41	Σ SAR < 1.6, Not required
			Top Side	0	0.10	0.06	0.00	0.16	Σ SAR < 1.6, Not required
Bottom Side	0.74	0.05	0.00	0.00	0.79	Σ SAR < 1.6, Not required			
102	LTE 4 + LTE 12 + WLAN (NII) ANT-0+1 + BT	Head	Right Cheek	0.13	0.56	0.16	0.01	0.86	Σ SAR < 1.6, Not required
			Right Tilted	0.09	0.55	0.16	0.01	0.81	Σ SAR < 1.6, Not required
			Left Cheek	0.24	0.57	0.31	0.02	1.14	Σ SAR < 1.6, Not required
			Left Tilted	0.11	0.61	0.26	0.01	0.99	Σ SAR < 1.6, Not required
		Body-Worn	Front Face	0.75	0.11	0.30	0.00	1.16	Σ SAR < 1.6, Not required
			Rear Face	0.71	0.10	0.64	0.00	1.45	Σ SAR < 1.6, Not required
		Hotspot	Front Face	0.43	0.21	0.55	0.01	1.2	Σ SAR < 1.6, Not required
			Rear Face	0.42	0.16	0.70	0.01	1.29	Σ SAR < 1.6, Not required
			Left Side	0.03	0.06	0.00	0.00	0.09	Σ SAR < 1.6, Not required
			Right Side	0.08	0.09	0.20	0.00	0.37	Σ SAR < 1.6, Not required
			Top Side	0	0.10	0.18	0.00	0.28	Σ SAR < 1.6, Not required
Bottom Side	0.74	0.05	0.00	0.00	0.79	Σ SAR < 1.6, Not required			

FCC SAR Test Report

No.	Conditions (SAR1 + SAR2 + SAR3)	Exposure Condition	Test Position	Max. SAR1	Max. SAR2	Max. SAR3	SAR Summation	SPLSR Analysis
103	LTE 13 + LTE 66 + WLAN (DTS)	Head	Right Cheek	0.60	0.1	0.32	1.02	Σ SAR < 1.6, Not required
			Right Tilted	0.41	0.06	0.27	0.74	Σ SAR < 1.6, Not required
			Left Cheek	0.51	0.22	0.51	1.24	Σ SAR < 1.6, Not required
			Left Tilted	0.51	0.09	0.38	0.98	Σ SAR < 1.6, Not required
		Body-Worn	Front Face	0.23	0.61	0.06	0.9	Σ SAR < 1.6, Not required
			Rear Face	0.21	0.63	0.15	0.99	Σ SAR < 1.6, Not required
		Hotspot	Front Face	0.20	0.43	0.14	0.77	Σ SAR < 1.6, Not required
			Rear Face	0.19	0.45	0.36	1	Σ SAR < 1.6, Not required
			Left Side	0.12	0.03	0.00	0.15	Σ SAR < 1.6, Not required
			Right Side	0.11	0.05	0.12	0.28	Σ SAR < 1.6, Not required
			Top Side	0.12	0	0.06	0.18	Σ SAR < 1.6, Not required
			Bottom Side	0.14	0.79	0.00	0.93	Σ SAR < 1.6, Not required
104	LTE 13 + LTE 66 + WLAN (NII)	Head	Right Cheek	0.60	0.1	0.17	0.87	Σ SAR < 1.6, Not required
			Right Tilted	0.41	0.06	0.16	0.63	Σ SAR < 1.6, Not required
			Left Cheek	0.51	0.22	0.32	1.05	Σ SAR < 1.6, Not required
			Left Tilted	0.51	0.09	0.26	0.86	Σ SAR < 1.6, Not required
		Body-Worn	Front Face	0.23	0.61	0.30	1.14	Σ SAR < 1.6, Not required
			Rear Face	0.21	0.63	0.64	1.48	Σ SAR < 1.6, Not required
		Hotspot	Front Face	0.20	0.43	0.55	1.18	Σ SAR < 1.6, Not required
			Rear Face	0.19	0.45	0.70	1.34	Σ SAR < 1.6, Not required
			Left Side	0.12	0.03	0.00	0.15	Σ SAR < 1.6, Not required
			Right Side	0.11	0.05	0.20	0.36	Σ SAR < 1.6, Not required
			Top Side	0.12	0	0.18	0.3	Σ SAR < 1.6, Not required
			Bottom Side	0.14	0.79	0.00	0.93	Σ SAR < 1.6, Not required

FCC SAR Test Report

No.	Conditions (SAR1 + SAR2 + SAR3)	Exposure Condition	Test Position	Max. SAR1	Max. SAR2	Max. SAR3	Max. SAR4	SAR Summation	SPLSR Analysis
105	LTE 13 + LTE 66 + WLAN (DTS) ANT-1 + BT	Head	Right Cheek	0.60	0.1	0.14	0.01	0.85	Σ SAR < 1.6, Not required
			Right Tilted	0.41	0.06	0.09	0.01	0.57	Σ SAR < 1.6, Not required
			Left Cheek	0.51	0.22	0.42	0.02	1.17	Σ SAR < 1.6, Not required
			Left Tilted	0.51	0.09	0.29	0.01	0.9	Σ SAR < 1.6, Not required
		Body-Worn	Front Face	0.23	0.61	0.00	0.00	0.84	Σ SAR < 1.6, Not required
			Rear Face	0.21	0.63	0.10	0.00	0.94	Σ SAR < 1.6, Not required
		Hotspot	Front Face	0.20	0.43	0.07	0.01	0.71	Σ SAR < 1.6, Not required
			Rear Face	0.19	0.45	0.29	0.01	0.94	Σ SAR < 1.6, Not required
			Left Side	0.12	0.03	0.00	0.00	0.15	Σ SAR < 1.6, Not required
			Right Side	0.11	0.05	0.11	0.00	0.27	Σ SAR < 1.6, Not required
			Top Side	0.12	0	0.00	0.00	0.12	Σ SAR < 1.6, Not required
			Bottom Side	0.14	0.79	0.00	0.00	0.93	Σ SAR < 1.6, Not required
106	LTE 13 + LTE 66 + WLAN (NII) ANT-1 + BT	Head	Right Cheek	0.60	0.1	0.14	0.01	0.85	Σ SAR < 1.6, Not required
			Right Tilted	0.41	0.06	0.13	0.01	0.61	Σ SAR < 1.6, Not required
			Left Cheek	0.51	0.22	0.26	0.02	1.01	Σ SAR < 1.6, Not required
			Left Tilted	0.51	0.09	0.23	0.01	0.84	Σ SAR < 1.6, Not required
		Body-Worn	Front Face	0.23	0.61	0.00	0.00	0.84	Σ SAR < 1.6, Not required
			Rear Face	0.21	0.63	0.17	0.00	1.01	Σ SAR < 1.6, Not required
		Hotspot	Front Face	0.20	0.43	0.00	0.01	0.64	Σ SAR < 1.6, Not required
			Rear Face	0.19	0.45	0.33	0.01	0.98	Σ SAR < 1.6, Not required
			Left Side	0.12	0.03	0.00	0.00	0.15	Σ SAR < 1.6, Not required
			Right Side	0.11	0.05	0.19	0.00	0.35	Σ SAR < 1.6, Not required
			Top Side	0.12	0	0.00	0.00	0.12	Σ SAR < 1.6, Not required
			Bottom Side	0.14	0.79	0.00	0.00	0.93	Σ SAR < 1.6, Not required

FCC SAR Test Report

No.	Conditions (SAR1 + SAR2 + SAR3)	Exposure Condition	Test Position	Max. SAR1	Max. SAR2	Max. SAR3	Max. SAR4	SAR Summation	SPLSR Analysis
107	LTE 13 + LTE 66 + WLAN (DTS) ANT0 + WLAN (NII) ANT-1	Head	Right Cheek	0.60	0.1	0.32	0.14	1.16	Σ SAR < 1.6, Not required
			Right Tilted	0.41	0.06	0.27	0.13	0.87	Σ SAR < 1.6, Not required
			Left Cheek	0.51	0.22	0.49	0.26	1.48	Σ SAR < 1.6, Not required
			Left Tilted	0.51	0.09	0.21	0.23	1.04	Σ SAR < 1.6, Not required
		Body-Worn	Front Face	0.23	0.61	0.06	0.00	0.9	Σ SAR < 1.6, Not required
			Rear Face	0.21	0.63	0.07	0.17	1.08	Σ SAR < 1.6, Not required
		Hotspot	Front Face	0.20	0.43	0.14	0.00	0.77	Σ SAR < 1.6, Not required
			Rear Face	0.19	0.45	0.21	0.33	1.18	Σ SAR < 1.6, Not required
			Left Side	0.12	0.03	0.00	0.00	0.15	Σ SAR < 1.6, Not required
			Right Side	0.11	0.05	0.05	0.19	0.4	Σ SAR < 1.6, Not required
			Top Side	0.12	0	0.06	0.00	0.18	Σ SAR < 1.6, Not required
			Bottom Side	0.14	0.79	0.00	0.00	0.93	Σ SAR < 1.6, Not required
108	LTE 13 + LTE 66 + WLAN (NII) ANT-0+1 + BT	Head	Right Cheek	0.60	0.1	0.16	0.01	0.87	Σ SAR < 1.6, Not required
			Right Tilted	0.41	0.06	0.16	0.01	0.64	Σ SAR < 1.6, Not required
			Left Cheek	0.51	0.22	0.31	0.02	1.06	Σ SAR < 1.6, Not required
			Left Tilted	0.51	0.09	0.26	0.01	0.87	Σ SAR < 1.6, Not required
		Body-Worn	Front Face	0.23	0.61	0.30	0.00	1.14	Σ SAR < 1.6, Not required
			Rear Face	0.21	0.63	0.64	0.00	1.48	Σ SAR < 1.6, Not required
		Hotspot	Front Face	0.20	0.43	0.55	0.01	1.19	Σ SAR < 1.6, Not required
			Rear Face	0.19	0.45	0.70	0.01	1.35	Σ SAR < 1.6, Not required
			Left Side	0.12	0.03	0.00	0.00	0.15	Σ SAR < 1.6, Not required
			Right Side	0.11	0.05	0.20	0.00	0.36	Σ SAR < 1.6, Not required
			Top Side	0.12	0	0.18	0.00	0.3	Σ SAR < 1.6, Not required
			Bottom Side	0.14	0.79	0.00	0.00	0.93	Σ SAR < 1.6, Not required

Test Engineer : Willy Chang, and Isaac Liao

5. Calibration of Test Equipment

Equipment	Manufacturer	Model	SN	Cal. Date	Cal. Interval
System Validation Dipole	SPEAG	D750V3	1013	Aug. 21, 2017	1 Year
System Validation Dipole	SPEAG	D835V2	4d121	Aug. 21, 2017	1 Year
System Validation Dipole	SPEAG	D1750V2	1055	Aug. 21, 2017	1 Year
System Validation Dipole	SPEAG	D1750V2	1055	Aug. 27, 2018	1 Year
System Validation Dipole	SPEAG	D1900V2	5d036	Jan. 18, 2018	1 Year
System Validation Dipole	SPEAG	D2300V2	1004	Jan. 17, 2018	1 Year
System Validation Dipole	SPEAG	D2450V2	737	Aug. 17, 2017	1 Year
System Validation Dipole	SPEAG	D2600V2	1020	Aug. 17, 2017	1 Year
System Validation Dipole	SPEAG	D2600V2	1058	Jun. 19, 2018	1 Year
System Validation Dipole	SPEAG	D5GHzV2	1019	Mar. 22, 2018	1 Year
Dosimetric E-Field Probe	SPEAG	EX3DV4	3650	Jul. 24, 2017	1 Year
Dosimetric E-Field Probe	SPEAG	EX3DV4	3650	Jul. 27, 2018	1 Year
Dosimetric E-Field Probe	SPEAG	EX3DV4	3898	Jun. 26, 2018	1 Year
Dosimetric E-Field Probe	SPEAG	EX3DV4	7472	Aug. 29, 2018	1 Year
Dosimetric E-Field Probe	SPEAG	EX3DV4	3971	Mar. 26, 2018	1 Year
Dosimetric E-Field Probe	SPEAG	EX3DV4	3820	Jun. 27, 2017	1 Year
Dosimetric E-Field Probe	SPEAG	EX3DV4	7346	Feb. 28, 2018	1 Year
Data Acquisition Electronics	SPEAG	DAE4	1431	Mar. 16, 2018	1 Year
Data Acquisition Electronics	SPEAG	DAE4	1277	Jan. 18, 2018	1 Year
Data Acquisition Electronics	SPEAG	DAE4	917	Dec. 14, 2017	1 Year
Data Acquisition Electronics	SPEAG	DAE4	861	May. 30, 2017	1 Year
Data Acquisition Electronics	SPEAG	DAE4	1232	May. 22, 2018	1 Year
Data Acquisition Electronics	SPEAG	DAE4	679	Mar. 05, 2018	1 Year
Wireless Communication Test Set	Agilent	E5515C	MY50266628	Dec. 06, 2017	1 Year
Radio Communication Analyzer	Anritsu	MT8820C	6201300638	Jul. 11, 2017	1 Year
Universal Radio Communication Tester	Anritsu	MT8821C	6261786083	Dec. 21, 2017	1 Year
Spectrum Analyzer	R&S	FSL6	102006	Mar. 23, 2018	1 Year
EXA Spectrum Analyzer	Agilent	N9010A	MY53470455	May. 19, 2017	N/A
ENA Series Network Analyzer	Agilent	E5071C	MY46214281	Jun. 09, 2017	1 Year
ENA Series Network Analyzer	Agilent	E5071C	MY46214281	Jun. 08, 2018	1 Year
MXG Analog Signal Generator	Agilent	N5181A	MY50143868	Jul. 10, 2017	1 Year
MXG Analog Signal Generator	Agilent	N5181A	MY50143868	Jul. 03, 2018	1 Year
Vector Signal Generator	Anritsu	MG3710A	6201599977	Mar. 16, 2018	1 Year
Power Meter	Anritsu	ML2495A	1218009	Jul. 12, 2017	1 Year
Power Meter	Anritsu	ML2495A	1218009	Jul. 03, 2018	1 Year
Power Sensor	Anritsu	MA2411B	1207252	Jul. 12, 2017	1 Year
Power Sensor	Anritsu	MA2411B	1207252	Jul. 03, 2018	1 Year
Thermometer	YFE	YF-160A	130504591	Mar. 23, 2018	1 Year

6. Measurement Uncertainty

Source of Uncertainty	Uncertainty (± %)	Probability Distribution	Divisor	C _i (1g)	C _i (10g)	Standard Uncertainty (± %, 1g)	Standard Uncertainty (± %, 10g)	V _i
Measurement System								
Probe Calibration	6.0	Normal	1	1	1	6.0	6.0	∞
Axial Isotropy	4.7	Rectangular	√3	√0.5	√0.5	1.9	1.9	∞
Hemispherical Isotropy	9.6	Rectangular	√3	√0.5	√0.5	3.9	3.9	∞
Boundary Effect	1.0	Rectangular	√3	1	1	0.6	0.6	∞
Linearity	4.7	Rectangular	√3	1	1	2.7	2.7	∞
Detection Limits	0.25	Rectangular	√3	1	1	0.14	0.14	∞
Probe Modulation Response	3.5	Rectangular	√3	1	1	2.0	2.0	∞
Readout Electronics	0.3	Normal	1	1	1	0.3	0.3	∞
Response Time	0.0	Rectangular	√3	1	1	0.0	0.0	∞
Integration Time	1.7	Rectangular	√3	1	1	1.0	1.0	∞
RF Ambient Conditions – Noise	3.0	Rectangular	√3	1	1	1.7	1.7	∞
RF Ambient Conditions – Reflections	3.0	Rectangular	√3	1	1	1.7	1.7	∞
Probe Positioner Mechanical Tolerance	0.4	Rectangular	√3	1	1	0.2	0.2	∞
Probe Positioning with Respect to Phantom	2.9	Rectangular	√3	1	1	1.7	1.7	∞
Post-processing	2.0	Rectangular	√3	1	1	1.2	1.2	∞
Test Sample Related								
Test Sample Positioning	3.9 / 2.06	Normal	1	1	1	3.9	2.1	35
Device Holder Uncertainty	2.9 / 4.1	Normal	1	1	1	2.9	4.1	11
Power Drift of Measurement	5.0	Rectangular	√3	1	1	2.9	2.9	∞
Power Scaling	0.0	Rectangular	√3	1	1	0.0	0.0	∞
Phantom and Setup								
Phantom Uncertainty (Shape and Thickness Tolerances)	6.1	Rectangular	√3	1	1	3.5	3.5	∞
Liquid Conductivity (Temperature Uncertainty)	3.24	Rectangular	√3	0.78	0.71	1.5	1.3	∞
Liquid Conductivity (Measured)	2.88	Normal	1	0.78	0.71	2.2	2.0	43
Liquid Permittivity (Temperature Uncertainty)	1.13	Rectangular	√3	0.23	0.26	0.2	0.2	∞
Liquid Permittivity (Measured)	2.50	Normal	1	0.23	0.26	0.6	0.7	54
Combined Standard Uncertainty						± 11.4 %	± 11.2 %	
Expanded Uncertainty (K=2)						± 22.8 %	± 22.4 %	

Head SAR Uncertainty Budget for Frequency Range of 300 MHz to 3 GHz

FCC SAR Test Report

Source of Uncertainty	Uncertainty (± %)	Probability Distribution	Divisor	Ci (1g)	Ci (10g)	Standard Uncertainty (± %, 1g)	Standard Uncertainty (± %, 10g)	Vi
Measurement System								
Probe Calibration	6.55	Normal	1	1	1	6.55	6.55	∞
Axial Isotropy	4.7	Rectangular	√3	0.7	0.7	1.9	1.9	∞
Hemispherical Isotropy	9.6	Rectangular	√3	0.7	0.7	3.9	3.9	∞
Boundary Effect	2.0	Rectangular	√3	1	1	1.2	1.2	∞
Linearity	4.7	Rectangular	√3	1	1	2.7	2.7	∞
Detection Limits	0.25	Rectangular	√3	1	1	0.14	0.14	∞
Probe Modulation Response	3.5	Rectangular	√3	1	1	2.0	2.0	∞
Readout Electronics	0.3	Normal	1	1	1	0.3	0.3	∞
Response Time	0.0	Rectangular	√3	1	1	0.0	0.0	∞
Integration Time	1.7	Rectangular	√3	1	1	1.0	1.0	∞
RF Ambient Conditions – Noise	3.0	Rectangular	√3	1	1	1.7	1.7	∞
RF Ambient Conditions – Reflections	3.0	Rectangular	√3	1	1	1.7	1.7	∞
Probe Positioner Mechanical Tolerance	0.4	Rectangular	√3	1	1	0.2	0.2	∞
Probe Positioning with Respect to Phantom	6.7	Rectangular	√3	1	1	3.9	3.9	∞
Post-processing	4.0	Rectangular	√3	1	1	2.3	2.3	∞
Test Sample Related								
Test Sample Positioning	3.9 / 2.06	Normal	1	1	1	3.9	2.1	35
Device Holder Uncertainty	2.9 / 4.1	Normal	1	1	1	2.9	4.1	11
Power Drift of Measurement	5.0	Rectangular	√3	1	1	2.9	2.9	∞
Power Scaling	0.0	Rectangular	√3	1	1	0.0	0.0	∞
Phantom and Setup								
Phantom Uncertainty (Shape and Thickness Tolerances)	6.6	Rectangular	√3	1	1	3.8	3.8	∞
Liquid Conductivity (Temperature Uncertainty)	3.24	Rectangular	√3	0.78	0.71	1.5	1.3	∞
Liquid Conductivity (Measured)	2.88	Normal	1	0.78	0.71	2.2	2.0	43
Liquid Permittivity (Temperature Uncertainty)	1.13	Rectangular	√3	0.23	0.26	0.2	0.2	∞
Liquid Permittivity (Measured)	2.50	Normal	1	0.23	0.26	0.6	0.7	54
Combined Standard Uncertainty						± 12.5 %	± 12.3 %	
Expanded Uncertainty (K=2)						± 25.0 %	± 24.6 %	

Head SAR Uncertainty Budget for Frequency Range of 3 GHz to 6 GHz

FCC SAR Test Report

Source of Uncertainty	Uncertainty (± %)	Probability Distribution	Divisor	Ci (1g)	Ci (10g)	Standard Uncertainty (± %, 1g)	Standard Uncertainty (± %, 10g)	Vi
Measurement System								
Probe Calibration	6.0	Normal	1	1	1	6.0	6.0	∞
Axial Isotropy	4.7	Rectangular	√3	√0.5	√0.5	1.9	1.9	∞
Hemispherical Isotropy	9.6	Rectangular	√3	√0.5	√0.5	3.9	3.9	∞
Boundary Effect	1.0	Rectangular	√3	1	1	0.6	0.6	∞
Linearity	4.7	Rectangular	√3	1	1	2.7	2.7	∞
Detection Limits	0.25	Rectangular	√3	1	1	0.14	0.14	∞
Probe Modulation Response	3.5	Rectangular	√3	1	1	2.0	2.0	∞
Readout Electronics	0.3	Normal	1	1	1	0.3	0.3	∞
Response Time	0.0	Rectangular	√3	1	1	0.0	0.0	∞
Integration Time	1.7	Rectangular	√3	1	1	1.0	1.0	∞
RF Ambient Conditions – Noise	3.0	Rectangular	√3	1	1	1.7	1.7	∞
RF Ambient Conditions – Reflections	3.0	Rectangular	√3	1	1	1.7	1.7	∞
Probe Positioner Mechanical Tolerance	0.4	Rectangular	√3	1	1	0.2	0.2	∞
Probe Positioning with Respect to Phantom	2.9	Rectangular	√3	1	1	1.7	1.7	∞
Post-processing	2.0	Rectangular	√3	1	1	1.2	1.2	∞
Test Sample Related								
Test Sample Positioning	4.38 / 1.35	Normal	1	1	1	4.4	1.4	29
Device Holder Uncertainty	2.9 / 4.1	Normal	1	1	1	2.9	4.1	11
Power Drift of Measurement	5.0	Rectangular	√3	1	1	2.9	2.9	∞
Power Scaling	0.0	Rectangular	√3	1	1	0.0	0.0	∞
Phantom and Setup								
Phantom Uncertainty (Shape and Thickness Tolerances)	7.2	Rectangular	√3	1	1	4.2	4.2	∞
Liquid Conductivity (Temperature Uncertainty)	3.24	Rectangular	√3	0.78	0.71	1.5	1.3	∞
Liquid Conductivity (Measured)	2.88	Normal	1	0.78	0.71	2.2	2.0	43
Liquid Permittivity (Temperature Uncertainty)	1.13	Rectangular	√3	0.23	0.26	0.2	0.2	∞
Liquid Permittivity (Measured)	2.50	Normal	1	0.23	0.26	0.6	0.7	54
Combined Standard Uncertainty						± 11.8 %	± 11.3 %	
Expanded Uncertainty (K=2)						± 23.6 %	± 22.6 %	

Body SAR Uncertainty Budget for Frequency Range of 300 MHz to 3 GHz

FCC SAR Test Report

Source of Uncertainty	Uncertainty (± %)	Probability Distribution	Divisor	C _i (1g)	C _i (10g)	Standard Uncertainty (± %, 1g)	Standard Uncertainty (± %, 10g)	V _i
Measurement System								
Probe Calibration	6.55	Normal	1	1	1	6.55	6.55	∞
Axial Isotropy	4.7	Rectangular	√3	0.7	0.7	1.9	1.9	∞
Hemispherical Isotropy	9.6	Rectangular	√3	0.7	0.7	3.9	3.9	∞
Boundary Effect	2.0	Rectangular	√3	1	1	1.2	1.2	∞
Linearity	4.7	Rectangular	√3	1	1	2.7	2.7	∞
Detection Limits	0.25	Rectangular	√3	1	1	0.14	0.14	∞
Probe Modulation Response	3.5	Rectangular	√3	1	1	2.0	2.0	∞
Readout Electronics	0.3	Normal	1	1	1	0.3	0.3	∞
Response Time	0.0	Rectangular	√3	1	1	0.0	0.0	∞
Integration Time	1.7	Rectangular	√3	1	1	1.0	1.0	∞
RF Ambient Conditions – Noise	3.0	Rectangular	√3	1	1	1.7	1.7	∞
RF Ambient Conditions – Reflections	3.0	Rectangular	√3	1	1	1.7	1.7	∞
Probe Positioner Mechanical Tolerance	0.4	Rectangular	√3	1	1	0.2	0.2	∞
Probe Positioning with Respect to Phantom	6.7	Rectangular	√3	1	1	3.9	3.9	∞
Post-processing	4.0	Rectangular	√3	1	1	2.3	2.3	∞
Test Sample Related								
Test Sample Positioning	4.38 / 1.35	Normal	1	1	1	4.4	1.4	29
Device Holder Uncertainty	2.9 / 4.1	Normal	1	1	1	2.9	4.1	11
Power Drift of Measurement	5.0	Rectangular	√3	1	1	2.9	2.9	∞
Power Scaling	0.0	Rectangular	√3	1	1	0.0	0.0	∞
Phantom and Setup								
Phantom Uncertainty (Shape and Thickness Tolerances)	7.6	Rectangular	√3	1	1	4.4	4.4	∞
Liquid Conductivity (Temperature Uncertainty)	3.24	Rectangular	√3	0.78	0.71	1.5	1.3	∞
Liquid Conductivity (Measured)	2.88	Normal	1	0.78	0.71	2.2	2.0	43
Liquid Permittivity (Temperature Uncertainty)	1.13	Rectangular	√3	0.23	0.26	0.2	0.2	∞
Liquid Permittivity (Measured)	2.50	Normal	1	0.23	0.26	0.6	0.7	54
Combined Standard Uncertainty						± 12.8 %	± 12.4 %	
Expanded Uncertainty (K=2)						± 25.6 %	± 24.8 %	

Body SAR Uncertainty Budget for Frequency Range of 3 GHz to 6 GHz

7. Information on the Testing Laboratories

We, Bureau Veritas Consumer Products Services (H.K.) Ltd., Taoyuan Branch, were founded in 1988 to provide our best service in EMC, Radio, Telecom and Safety consultation. Our laboratories are accredited and approved according to ISO/IEC 17025.

If you have any comments, please feel free to contact us at the following:

Taiwan HwaYa EMC/RF/Safety/Telecom Lab:

Add: No. 19, Hwa Ya 2nd Rd, Wen Hwa Vil., Kwei Shan Hsiang, Taoyuan Hsien 333, Taiwan, R.O.C.

Tel: 886-3-318-3232

Fax: 886-3-327-0892

Taiwan LinKo EMC/RF Lab:

Add: No. 47-2, 14th Ling, Chia Pau Vil., Linkou Dist., New Taipei City 244, Taiwan, R.O.C.

Tel: 886-2-2605-2180

Fax: 886-2-2605-1924

Taiwan HsinChu EMC/RF Lab:

Add: E-2, No.1, Li Hsin 1st Road, Hsinchu Science Park, Hsinchu City 30078, Taiwan, R.O.C.

Tel: 886-3-593-5343

Fax: 886-3-593-5342

Email: service.adt@tw.bureauveritas.com

Web Site: www.bureauveritas-adt.com

The road map of all our labs can be found in our web site also.

---END---



Appendix A. SAR Plots of System Verification

The plots for system verification with largest deviation for each SAR system combination are shown as follows.

System Check_H750_180529

DUT: Dipole 750 MHz; Type: D750V3; SN: 1013

Communication System: CW; Frequency: 750 MHz; Duty Cycle: 1:1

Medium: H06T09N1_0529 Medium parameters used: $f = 750 \text{ MHz}$; $\sigma = 0.888 \text{ S/m}$; $\epsilon_r = 41.631$; $\rho = 1000 \text{ kg/m}^3$

Ambient Temperature : $23.6 \text{ }^\circ\text{C}$; Liquid Temperature : $23.4 \text{ }^\circ\text{C}$

DASY5 Configuration:

- Probe: EX3DV4 - SN3971; ConvF(10.7, 10.7, 10.7); Calibrated: 2018/03/26
- Sensor-Surface: 1.4mm (Mechanical Surface Detection)
- Electronics: DAE4 Sn1431; Calibrated: 2018/03/16
- Phantom: Twin SAM Phantom_1654; Type: QD000P40;
- Measurement SW: DASY52, Version 52.10 (1); SEMCAD X Version 14.6.11 (7439)

Pin=250mW/Area Scan (61x81x1): Interpolated grid: $dx=1.500 \text{ mm}$, $dy=1.500 \text{ mm}$
Maximum value of SAR (interpolated) = 2.60 W/kg

Pin=250mW/Zoom Scan (5x5x7)/Cube 0: Measurement grid: $dx=8\text{mm}$, $dy=8\text{mm}$, $dz=5\text{mm}$

Reference Value = 56.43 V/m ; Power Drift = -0.03 dB

Peak SAR (extrapolated) = 2.96 W/kg

SAR(1 g) = 1.92 W/kg ; SAR(10 g) = 1.25 W/kg

Maximum value of SAR (measured) = 2.60 W/kg

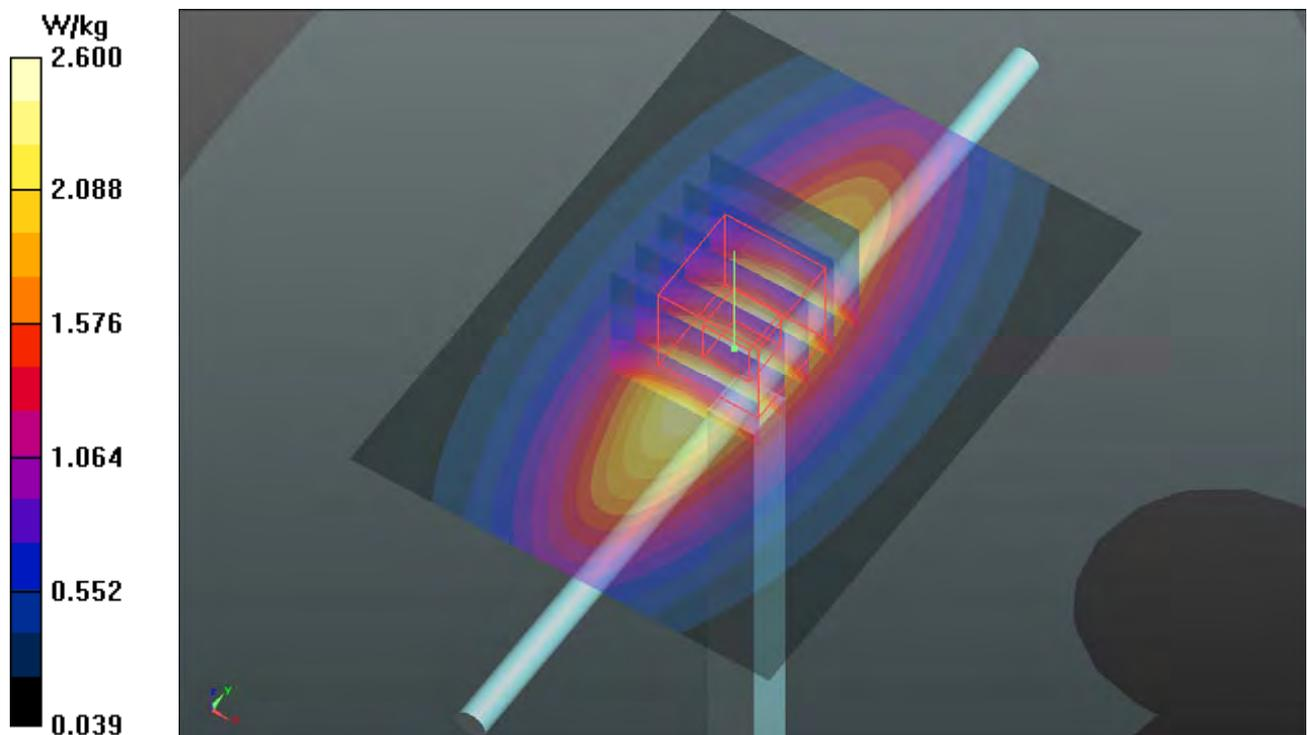

System Check_H835_180531

DUT: Dipole 835 MHz; Type: D835V2; SN: 4d121

Communication System: CW; Frequency: 835 MHz; Duty Cycle: 1:1

Medium: H07T10N1_0531 Medium parameters used: $f = 835 \text{ MHz}$; $\sigma = 0.909 \text{ S/m}$; $\epsilon_r = 41.672$; $\rho = 1000 \text{ kg/m}^3$

Ambient Temperature : $23.9 \text{ }^\circ\text{C}$; Liquid Temperature : $23.6 \text{ }^\circ\text{C}$

DASY5 Configuration:

- Probe: EX3DV4 - SN3650; ConvF(9.91, 9.91, 9.91); Calibrated: 2017/07/24;
- Sensor-Surface: 1.4mm (Mechanical Surface Detection)
- Electronics: DAE4 Sn1277; Calibrated: 2018/01/18
- Phantom: Twin SAM Phantom_1654; Type: QD000P40;
- Measurement SW: DASY52, Version 52.10 (1); SEMCAD X Version 14.6.11 (7439)

Pin=250mW/Area Scan (61x61x1): Interpolated grid: $dx=1.500 \text{ mm}$, $dy=1.500 \text{ mm}$
Maximum value of SAR (interpolated) = 3.00 W/kg

Pin=250mW/Zoom Scan (5x5x7)/Cube 0: Measurement grid: $dx=8\text{mm}$, $dy=8\text{mm}$, $dz=5\text{mm}$
Reference Value = 54.63 V/m ; Power Drift = -0.04 dB
Peak SAR (extrapolated) = 3.35 W/kg
SAR(1 g) = 2.28 W/kg ; SAR(10 g) = 1.51 W/kg
Maximum value of SAR (measured) = 3.01 W/kg

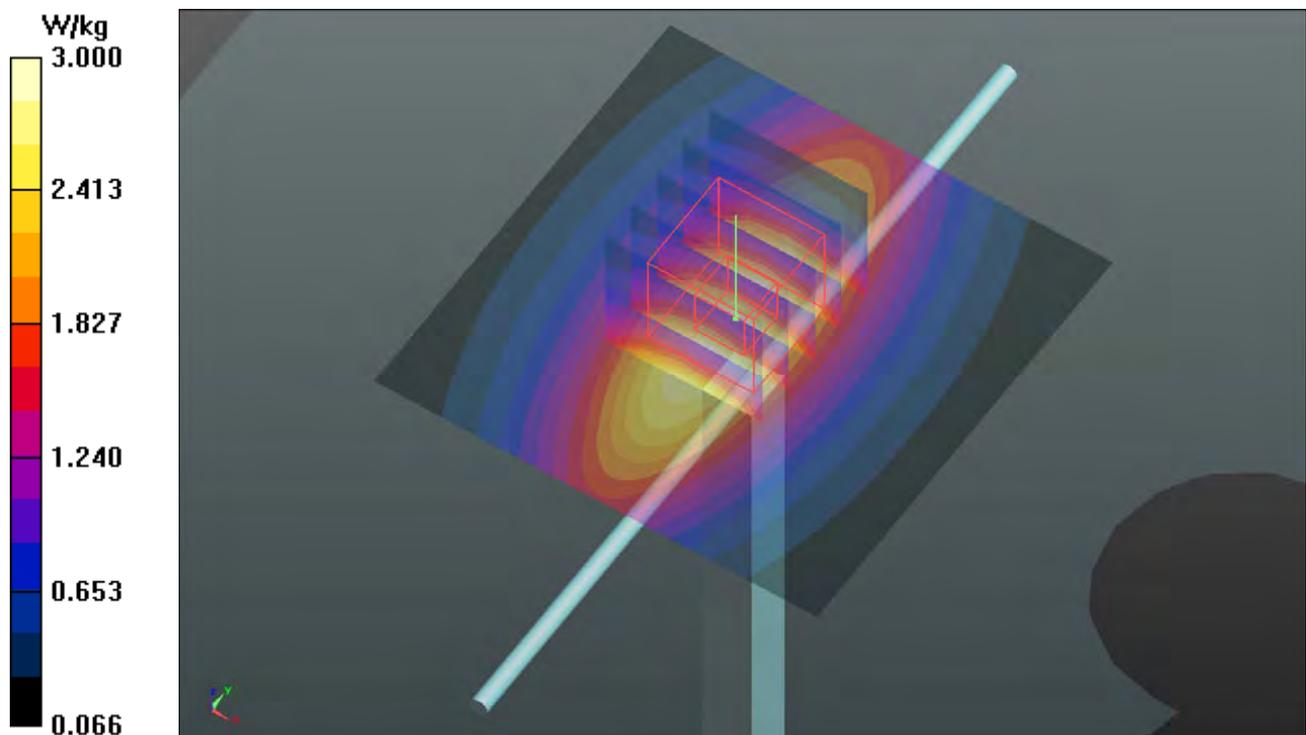

System Check_H1750_180906

DUT: Dipole 1750 MHz; Type: D1750V2; SN: 1055

Communication System: CW; Frequency: 1750 MHz; Duty Cycle: 1:1

Medium: H16T20N1_0906 Medium parameters used: $f = 1750$ MHz; $\sigma = 1.329$ S/m; $\epsilon_r = 40.317$; $\rho = 1000$ kg/m³

Ambient Temperature : 23.7 °C ; Liquid Temperature : 23.2 °C

DASY5 Configuration:

- Probe: EX3DV4 - SN3971; ConvF(8.9, 8.9, 8.9); Calibrated: 2018/03/26
- Sensor-Surface: 1.4mm (Mechanical Surface Detection)
- Electronics: DAE4 Sn1431; Calibrated: 2018/03/16
- Phantom: Twin SAM Phantom_1654; Type: QD000P40;
- Measurement SW: DASY52, Version 52.10 (1); SEMCAD X Version 14.6.11 (7439)

Pin=250mW/Area Scan (61x61x1): Interpolated grid: dx=1.500 mm, dy=1.500 mm
Maximum value of SAR (interpolated) = 13.9 W/kg

Pin=250mW/Zoom Scan (5x5x7)/Cube 0: Measurement grid: dx=8mm, dy=8mm, dz=5mm

Reference Value = 106.4 V/m; Power Drift = -0.04 dB

Peak SAR (extrapolated) = 16.4 W/kg

SAR(1 g) = 8.99 W/kg; SAR(10 g) = 4.76 W/kg

Maximum value of SAR (measured) = 13.9 W/kg

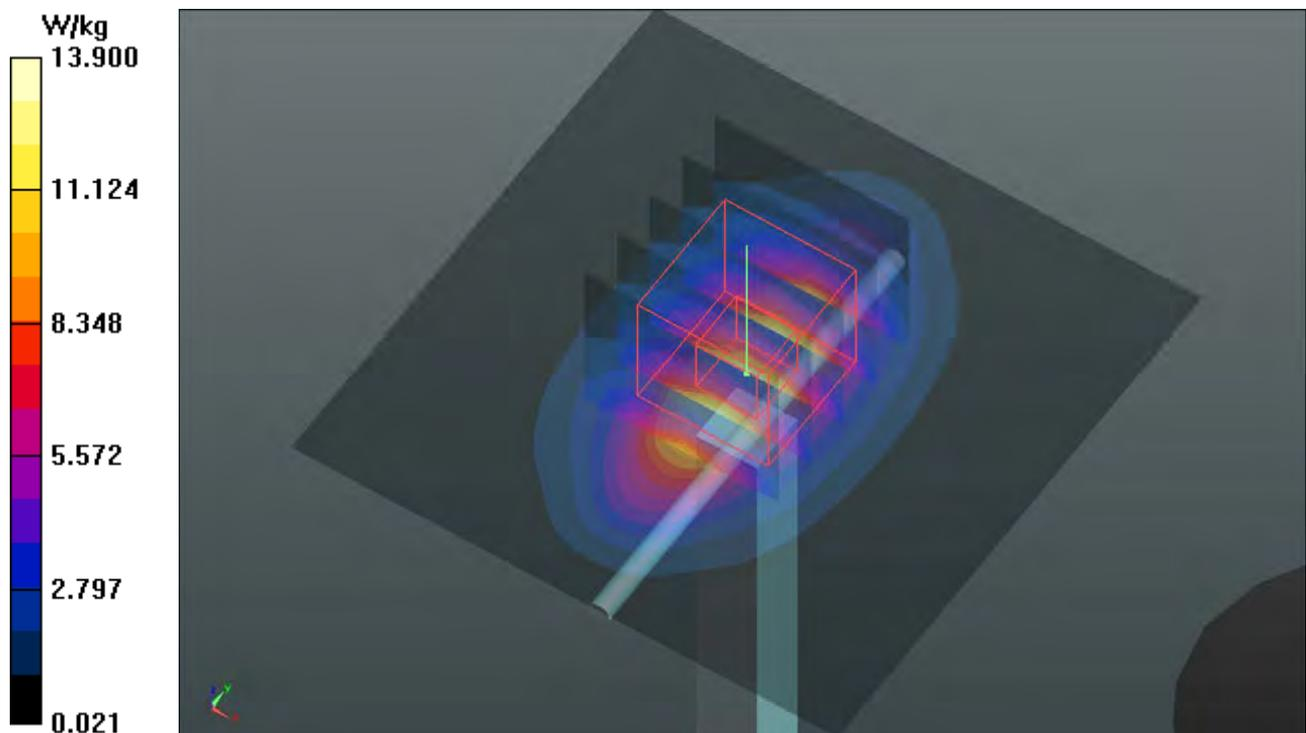

System Check_H1900_180531

DUT: Dipole 1900 MHz; Type: D1900V2; SN: 5d036

Communication System: CW; Frequency: 1900 MHz; Duty Cycle: 1:1

Medium: H16T20N1_0531 Medium parameters used: $f = 1900$ MHz; $\sigma = 1.444$ S/m; $\epsilon_r = 38.836$; $\rho = 1000$ kg/m³

Ambient Temperature : 23.9 °C ; Liquid Temperature : 23.6 °C

DASY5 Configuration:

- Probe: EX3DV4 - SN3650; ConvF(8.28, 8.28, 8.28); Calibrated: 2017/07/24;
- Sensor-Surface: 1.4mm (Mechanical Surface Detection)
- Electronics: DAE4 Sn1277; Calibrated: 2018/01/18
- Phantom: Twin SAM Phantom_1654; Type: QD000P40;
- Measurement SW: DASY52, Version 52.10 (1); SEMCAD X Version 14.6.11 (7439)

Pin=250mW/Area Scan (61x61x1): Interpolated grid: dx=1.500 mm, dy=1.500 mm
Maximum value of SAR (interpolated) = 16.5 W/kg

Pin=250mW/Zoom Scan (5x5x7)/Cube 0: Measurement grid: dx=8mm, dy=8mm, dz=5mm

Reference Value = 103.4 V/m; Power Drift = -0.07 dB

Peak SAR (extrapolated) = 19.4 W/kg

SAR(1 g) = 10.5 W/kg; SAR(10 g) = 5.44 W/kg

Maximum value of SAR (measured) = 16.3 W/kg

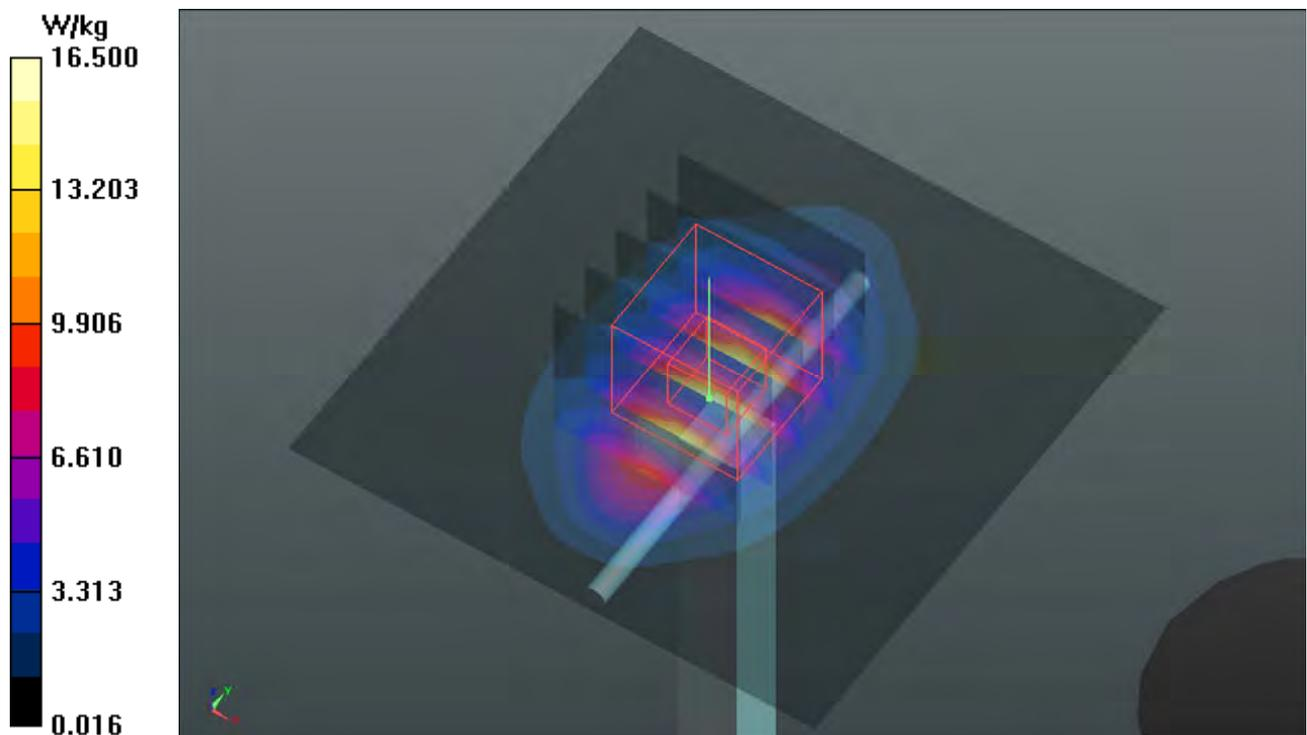

System Check_H2300_180531

DUT: Dipole 2300 MHz; Type: D2300V2; SN: 1004

Communication System: CW; Frequency: 2300 MHz; Duty Cycle: 1:1

Medium: H19T27N1_0531 Medium parameters used: $f = 2300$ MHz; $\sigma = 1.715$ S/m; $\epsilon_r = 38.875$; $\rho = 1000$ kg/m³

Ambient Temperature : 23.9 °C ; Liquid Temperature : 23.6 °C

DASY5 Configuration:

- Probe: EX3DV4 - SN3650; ConvF(8.06, 8.06, 8.06); Calibrated: 2017/07/24
- Sensor-Surface: 1.4mm (Mechanical Surface Detection)
- Electronics: DAE4 Sn1277; Calibrated: 2018/01/18
- Phantom: Twin SAM Phantom_1654; Type: QD000P40;
- Measurement SW: DASY52, Version 52.10 (1); SEMCAD X Version 14.6.11 (7439)

Pin=250mW/Area Scan (81x81x1): Interpolated grid: dx=1.200 mm, dy=1.200 mm
Maximum value of SAR (interpolated) = 20.8 W/kg

Pin=250mW/Zoom Scan (7x7x7)/Cube 0: Measurement grid: dx=5mm, dy=5mm, dz=5mm
Reference Value = 115.6 V/m; Power Drift = -0.06 dB
Peak SAR (extrapolated) = 25.2 W/kg
SAR(1 g) = 12.5 W/kg; SAR(10 g) = 5.93 W/kg
Maximum value of SAR (measured) = 20.6 W/kg

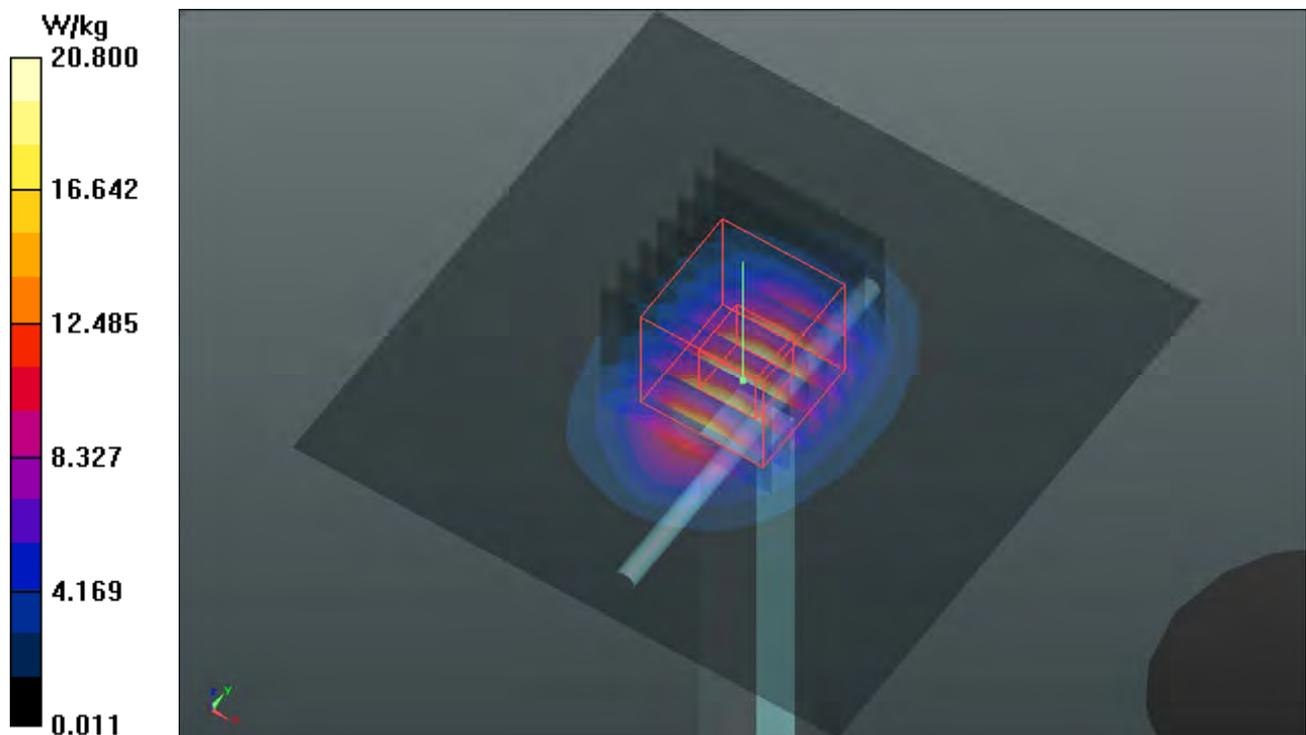

System Check_H2450_180529

DUT: Dipole 2450 MHz; Type: D2450V2; SN: 737

Communication System: CW; Frequency: 2450 MHz; Duty Cycle: 1:1

Medium: H19T27N2_0529 Medium parameters used: $f = 2450$ MHz; $\sigma = 1.88$ S/m; $\epsilon_r = 37.794$; $\rho = 1000$ kg/m³

Ambient Temperature : 23.6 °C ; Liquid Temperature : 23.4 °C

DASY5 Configuration:

- Probe: EX3DV4 - SN3650; ConvF(7.58, 7.58, 7.58); Calibrated: 2017/07/24
- Sensor-Surface: 1.4mm (Mechanical Surface Detection)
- Electronics: DAE4 Sn1277; Calibrated: 2018/01/18
- Phantom: Twin SAM Phantom_1654; Type: QD000P40;
- Measurement SW: DASY52, Version 52.10 (1); SEMCAD X Version 14.6.11 (7439)

Pin=250mW/Area Scan (81x81x1): Interpolated grid: dx=1.200 mm, dy=1.200 mm
Maximum value of SAR (interpolated) = 22.2 W/kg

Pin=250mW/Zoom Scan (7x7x7)/Cube 0: Measurement grid: dx=5mm, dy=5mm, dz=5mm
Reference Value = 106.6 V/m; Power Drift = -0.02 dB
Peak SAR (extrapolated) = 27.2 W/kg
SAR(1 g) = 13.1 W/kg; SAR(10 g) = 5.99 W/kg
Maximum value of SAR (measured) = 22.2 W/kg

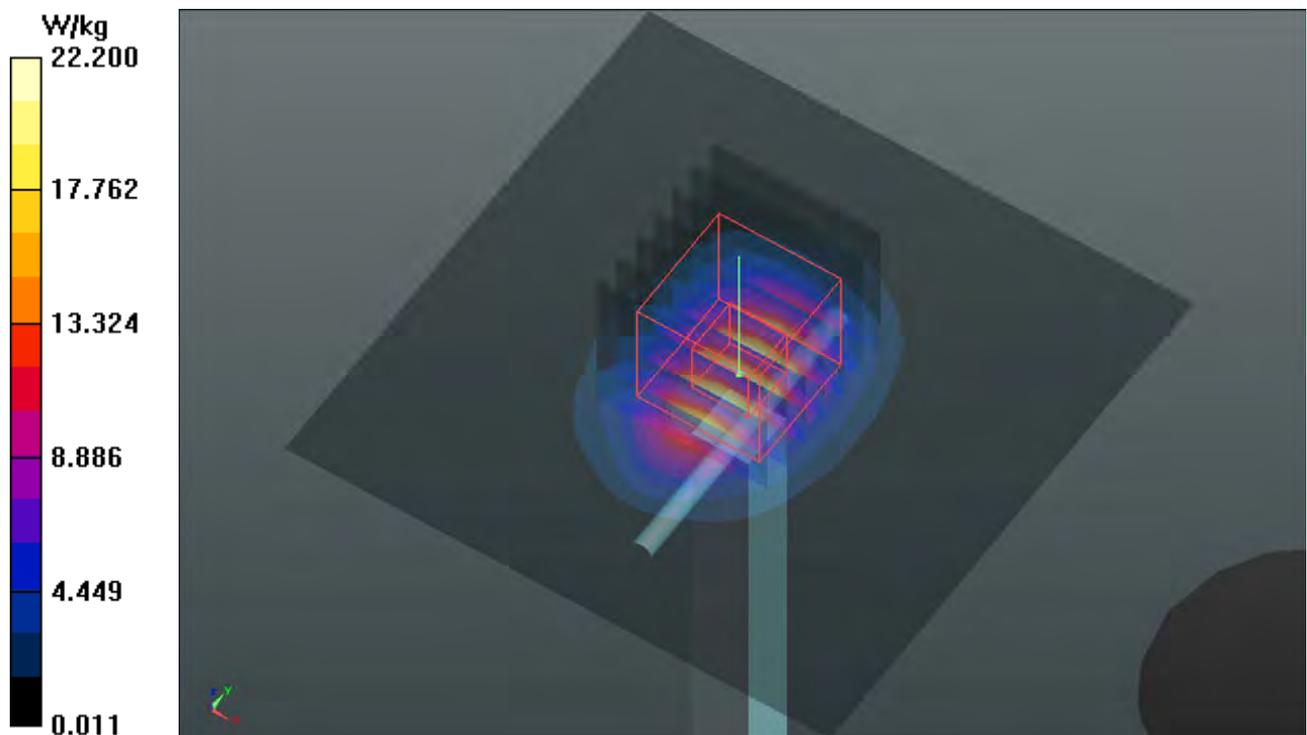

System Check_H2600_180609

DUT: Dipole 2600 MHz; Type: D2600V2; SN: 1020

Communication System: CW; Frequency: 2600 MHz; Duty Cycle: 1:1

Medium: H19T27N3_0609 Medium parameters used: $f = 2600$ MHz; $\sigma = 2.03$ S/m; $\epsilon_r = 38.454$; $\rho = 1000$ kg/m³

Ambient Temperature : 23.5 °C ; Liquid Temperature : 23.3 °C

DASY5 Configuration:

- Probe: EX3DV4 - SN3971; ConvF(7.59, 7.59, 7.59); Calibrated: 2018/03/26
- Sensor-Surface: 1.4mm (Mechanical Surface Detection)
- Electronics: DAE4 Sn1431; Calibrated: 2018/03/16
- Phantom: Twin SAM Phantom_1654; Type: QD000P40;
- Measurement SW: DASY52, Version 52.10 (1); SEMCAD X Version 14.6.11 (7439)

Pin=250mW/Area Scan (81x81x1): Interpolated grid: dx=1.200 mm, dy=1.200 mm
Maximum value of SAR (interpolated) = 23.7 W/kg

Pin=250mW/Zoom Scan (7x7x7)/Cube 0: Measurement grid: dx=5mm, dy=5mm, dz=5mm
Reference Value = 104.5 V/m; Power Drift = 0.00 dB
Peak SAR (extrapolated) = 29.6 W/kg
SAR(1 g) = 13.7 W/kg; SAR(10 g) = 6.16 W/kg
Maximum value of SAR (measured) = 23.6 W/kg

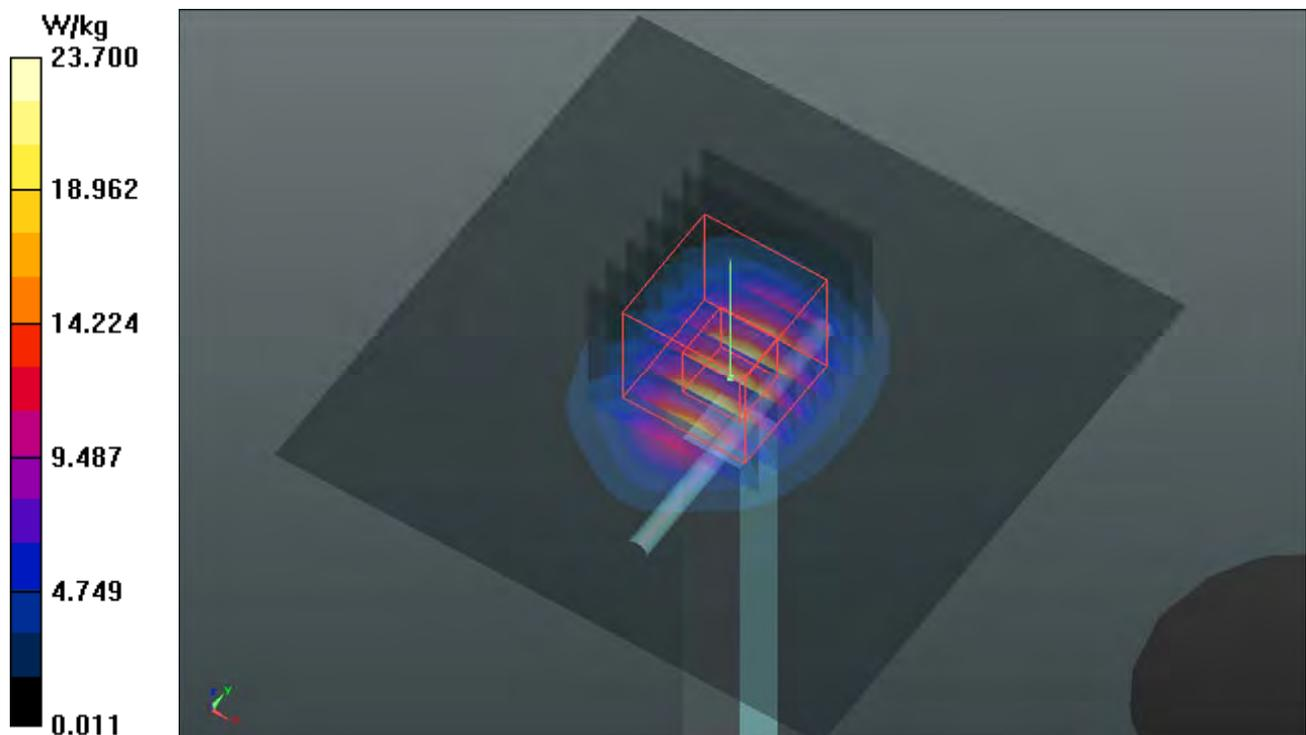

System Check_H5250_180529

DUT: Dipole 5 GHz; Type: D5GHzV2; SN: 1019

Communication System: CW; Frequency: 5250 MHz; Duty Cycle: 1:1

Medium: H34T60N2_0529 Medium parameters used: $f = 5250$ MHz; $\sigma = 4.788$ S/m; $\epsilon_r = 35.102$; $\rho = 1000$ kg/m³

Ambient Temperature : 23.6 °C ; Liquid Temperature : 23.4 °C

DASY5 Configuration:

- Probe: EX3DV4 - SN3650; ConvF(5.6, 5.6, 5.6); Calibrated: 2017/07/24
- Sensor-Surface: 1.4mm (Mechanical Surface Detection)
- Electronics: DAE4 Sn1277; Calibrated: 2018/01/18
- Phantom: Twin SAM Phantom_1654; Type: QD000P40;
- Measurement SW: DASY52, Version 52.10 (1); SEMCAD X Version 14.6.11 (7439)

Pin=100mW/Area Scan (91x91x1): Interpolated grid: dx=1.000 mm, dy=1.000 mm
Maximum value of SAR (interpolated) = 19.0 W/kg

Pin=100mW/Zoom Scan (7x7x12)/Cube 0: Measurement grid: dx=4mm, dy=4mm, dz=2mm
Reference Value = 71.61 V/m; Power Drift = 0.05 dB
Peak SAR (extrapolated) = 35.7 W/kg
SAR(1 g) = 8.28 W/kg; SAR(10 g) = 2.37 W/kg
Maximum value of SAR (measured) = 21.0 W/kg

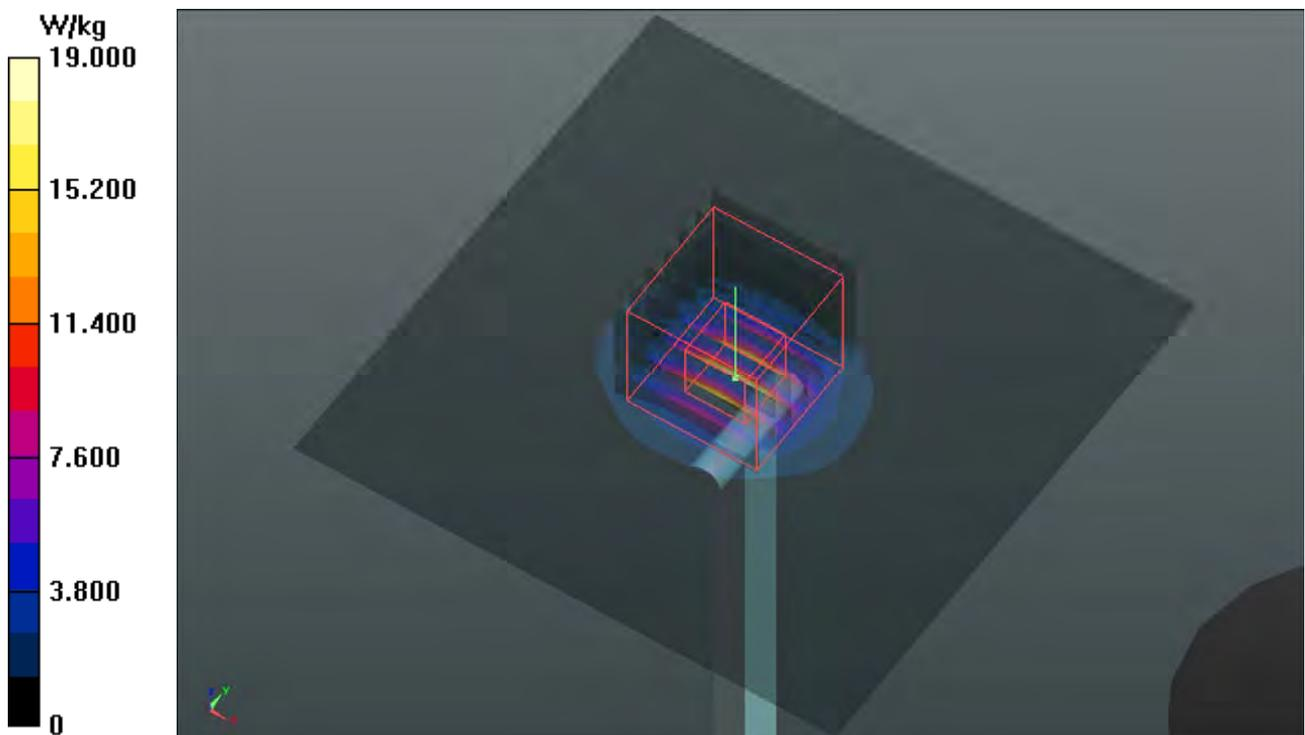

System Check_H5600_180601

DUT: Dipole 5 GHz; Type: D5GHzV2; SN: 1019

Communication System: CW; Frequency: 5600 MHz; Duty Cycle: 1:1

Medium: H34T60N2_0601 Medium parameters used: $f = 5600$ MHz; $\sigma = 4.871$ S/m; $\epsilon_r = 33.999$; $\rho = 1000$ kg/m³

Ambient Temperature : 23.7 °C ; Liquid Temperature : 23.4 °C

DASY5 Configuration:

- Probe: EX3DV4 - SN3650; ConvF(4.9, 4.9, 4.9); Calibrated: 2017/07/24
- Sensor-Surface: 1.4mm (Mechanical Surface Detection)
- Electronics: DAE4 Sn1277; Calibrated: 2018/01/18
- Phantom: Twin SAM Phantom_1654; Type: QD000P40;
- Measurement SW: DASY52, Version 52.10 (1); SEMCAD X Version 14.6.11 (7439)

Pin=100mW/Area Scan (91x91x1): Interpolated grid: dx=1.000 mm, dy=1.000 mm
Maximum value of SAR (interpolated) = 20.3 W/kg

Pin=100mW/Zoom Scan (7x7x12)/Cube 0: Measurement grid: dx=4mm, dy=4mm, dz=2mm
Reference Value = 76.75 V/m; Power Drift = -0.05 dB
Peak SAR (extrapolated) = 35.2 W/kg
SAR(1 g) = 8.08 W/kg; SAR(10 g) = 2.3 W/kg
Maximum value of SAR (measured) = 21.0 W/kg

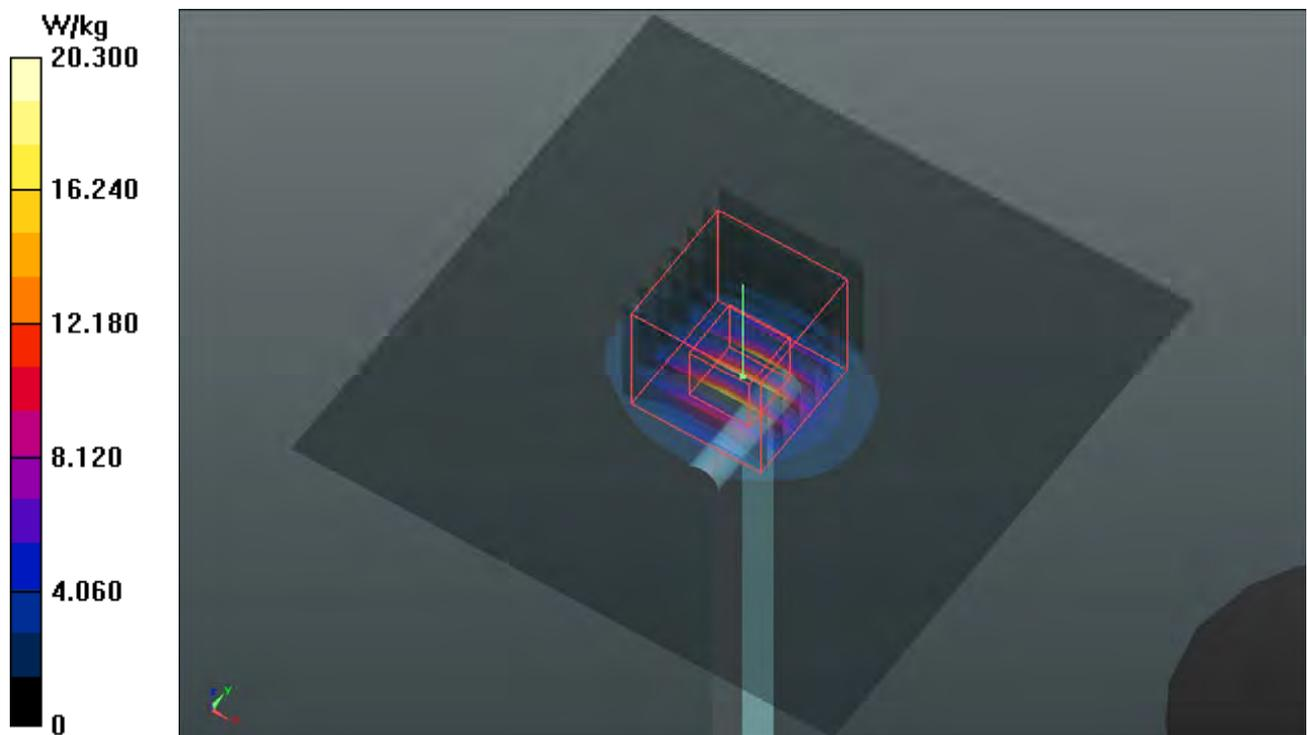

System Check_H5800_180529

DUT: Dipole 5 GHz; Type: D5GHzV2; SN: 1019

Communication System: CW; Frequency: 5800 MHz; Duty Cycle: 1:1

Medium: H34T60N2_0529 Medium parameters used: $f = 5800$ MHz; $\sigma = 5.336$ S/m; $\epsilon_r = 34.373$; $\rho = 1000$ kg/m³

Ambient Temperature : 23.6 °C ; Liquid Temperature : 23.4 °C

DASY5 Configuration:

- Probe: EX3DV4 - SN3650; ConvF(4.94, 4.94, 4.94); Calibrated: 2017/07/24
- Sensor-Surface: 1.4mm (Mechanical Surface Detection)
- Electronics: DAE4 Sn1277; Calibrated: 2018/01/18
- Phantom: Twin SAM Phantom_1654; Type: QD000P40;
- Measurement SW: DASY52, Version 52.10 (1); SEMCAD X Version 14.6.11 (7439)

Pin=100mW/Area Scan (91x91x1): Interpolated grid: dx=1.000 mm, dy=1.000 mm
Maximum value of SAR (interpolated) = 19.9 W/kg

Pin=100mW/Zoom Scan (7x7x12)/Cube 0: Measurement grid: dx=4mm, dy=4mm, dz=2mm
Reference Value = 71.78 V/m; Power Drift = -0.09 dB
Peak SAR (extrapolated) = 34.7 W/kg
SAR(1 g) = 8.44 W/kg; SAR(10 g) = 2.43 W/kg
Maximum value of SAR (measured) = 21.6 W/kg

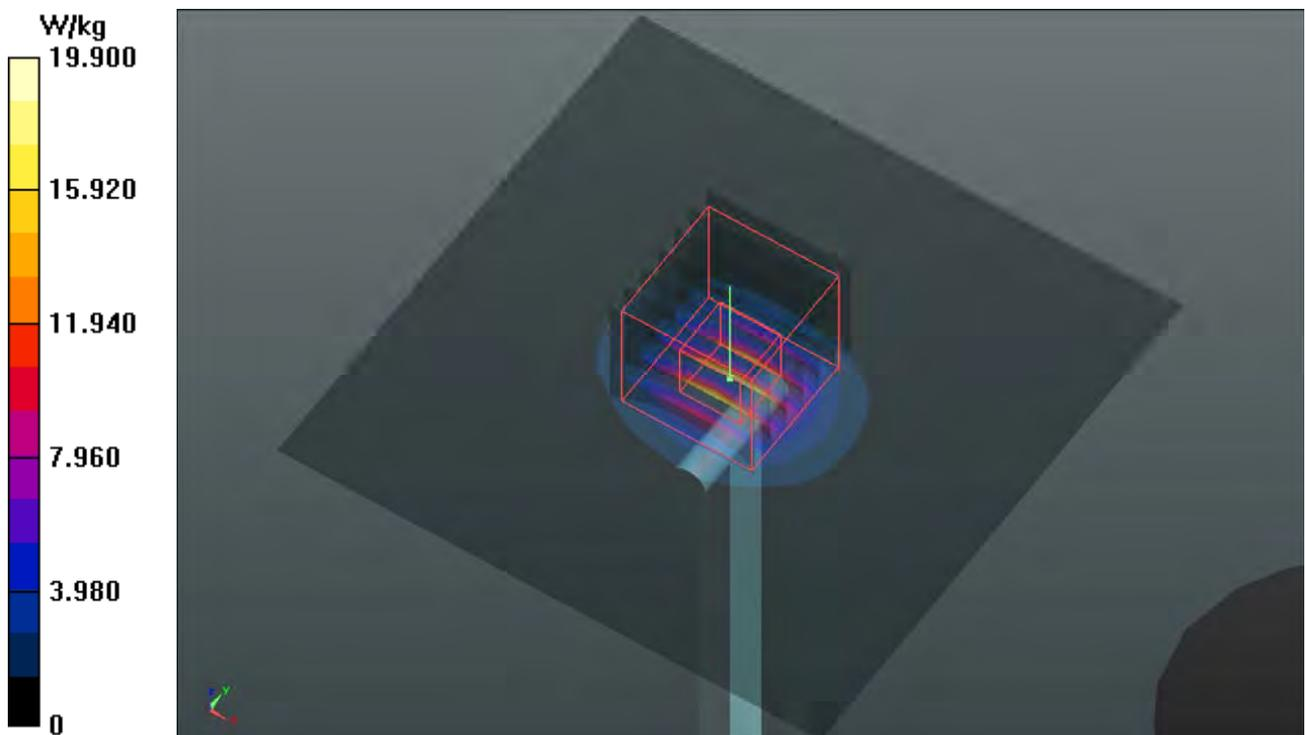

System Check_B750_180604

DUT: Dipole 750 MHz; Type: D750V3; SN: 1013

Communication System: CW; Frequency: 750 MHz; Duty Cycle: 1:1

Medium: B06T09N1_0604 Medium parameters used: $f = 750 \text{ MHz}$; $\sigma = 0.972 \text{ S/m}$; $\epsilon_r = 53.438$; $\rho = 1000 \text{ kg/m}^3$

Ambient Temperature : $23.5 \text{ }^\circ\text{C}$; Liquid Temperature : $23.2 \text{ }^\circ\text{C}$

DASY5 Configuration:

- Probe: EX3DV4 - SN3820; ConvF(9.47, 9.47, 9.47); Calibrated: 2017/06/27
- Sensor-Surface: 1.4mm (Mechanical Surface Detection)
- Electronics: DAE4 Sn917; Calibrated: 2017/12/14
- Phantom: Twin SAM Phantom_1496; Type: QD000P40CA;
- Measurement SW: DASY52, Version 52.10 (1); SEMCAD X Version 14.6.11 (7439)

Pin=250mW/Area Scan (61x81x1): Interpolated grid: $dx=1.500 \text{ mm}$, $dy=1.500 \text{ mm}$
Maximum value of SAR (interpolated) = 2.82 W/kg

Pin=250mW/Zoom Scan (5x5x7)/Cube 0: Measurement grid: $dx=8\text{mm}$, $dy=8\text{mm}$, $dz=5\text{mm}$
Reference Value = 54.62 V/m ; Power Drift = 0.04 dB
Peak SAR (extrapolated) = 3.26 W/kg
SAR(1 g) = 2.27 W/kg ; SAR(10 g) = 1.53 W/kg
Maximum value of SAR (measured) = 2.82 W/kg

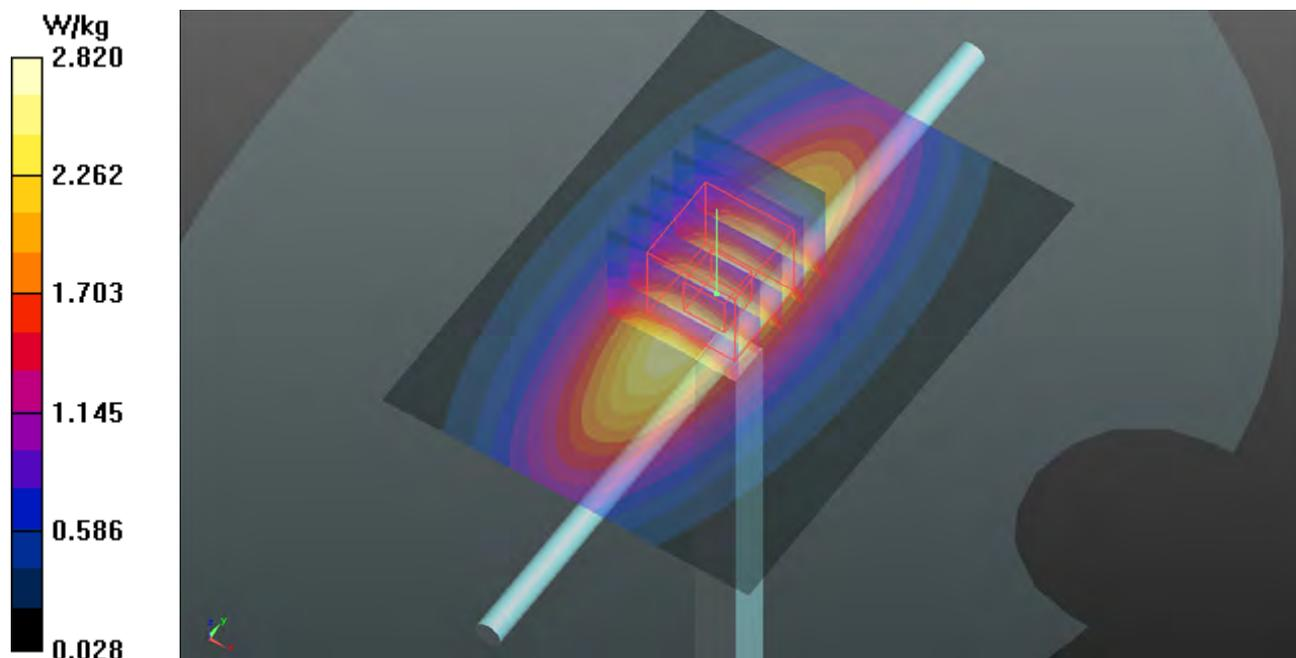

System Check_B835_180531

DUT: Dipole 835 MHz; Type: D835V2; SN: 4d121

Communication System: CW; Frequency: 835 MHz; Duty Cycle: 1:1

Medium: B07T10N1_0531 Medium parameters used: $f = 835 \text{ MHz}$; $\sigma = 1.014 \text{ S/m}$; $\epsilon_r = 55.981$; $\rho = 1000 \text{ kg/m}^3$

Ambient Temperature : $23.8 \text{ }^\circ\text{C}$; Liquid Temperature : $23.5 \text{ }^\circ\text{C}$

DASY5 Configuration:

- Probe: EX3DV4 - SN3650; ConvF(9.76, 9.76, 9.76); Calibrated: 2017/07/24
- Sensor-Surface: 1.4mm (Mechanical Surface Detection)
- Electronics: DAE4 Sn1277; Calibrated: 2018/01/18
- Phantom: Twin SAM Phantom_1822; Type: QD000P40;
- Measurement SW: DASY52, Version 52.10 (1); SEMCAD X Version 14.6.11 (7439)

Pin=250mW/Area Scan (61x61x1): Interpolated grid: $dx=1.500 \text{ mm}$, $dy=1.500 \text{ mm}$
Maximum value of SAR (interpolated) = 3.00 W/kg

Pin=250mW/Zoom Scan (5x5x7)/Cube 0: Measurement grid: $dx=8\text{mm}$, $dy=8\text{mm}$, $dz=5\text{mm}$
Reference Value = 56.66 V/m ; Power Drift = -0.04 dB
Peak SAR (extrapolated) = 3.37 W/kg
SAR(1 g) = 2.24 W/kg ; SAR(10 g) = 1.47 W/kg
Maximum value of SAR (measured) = 2.99 W/kg

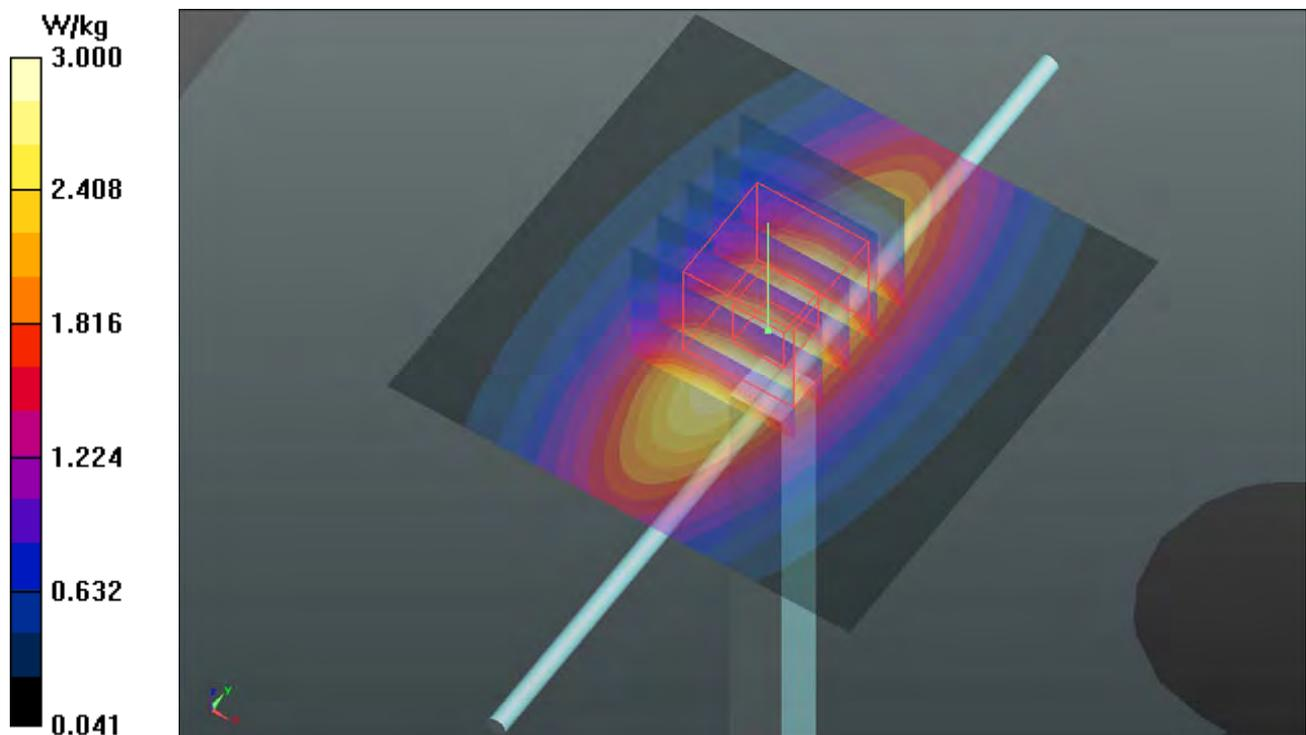

System Check_B1750_180531

DUT: Dipole 1750 MHz; Type: D1750V2; SN: 1055

Communication System: CW; Frequency: 1750 MHz; Duty Cycle: 1:1

Medium: B16T20N1_0531 Medium parameters used: $f = 1750$ MHz; $\sigma = 1.447$ S/m; $\epsilon_r = 52.512$; $\rho = 1000$ kg/m³

Ambient Temperature : 23.8 °C ; Liquid Temperature : 23.5 °C

DASY5 Configuration:

- Probe: EX3DV4 - SN3650; ConvF(8.27, 8.27, 8.27); Calibrated: 2017/07/24
- Sensor-Surface: 1.4mm (Mechanical Surface Detection)
- Electronics: DAE4 Sn1277; Calibrated: 2018/01/18
- Phantom: Twin SAM Phantom_1822; Type: QD000P40CD;
- Measurement SW: DASY52, Version 52.10 (1); SEMCAD X Version 14.6.11 (7439)

Pin=250mW/Area Scan (61x61x1): Interpolated grid: dx=1.500 mm, dy=1.500 mm
Maximum value of SAR (interpolated) = 13.6 W/kg

Pin=250mW/Zoom Scan (5x5x7)/Cube 0: Measurement grid: dx=8mm, dy=8mm, dz=5mm
Reference Value = 100.6 V/m; Power Drift = -0.08 dB
Peak SAR (extrapolated) = 15.8 W/kg
SAR(1 g) = 8.88 W/kg; SAR(10 g) = 4.73 W/kg
Maximum value of SAR (measured) = 13.5 W/kg

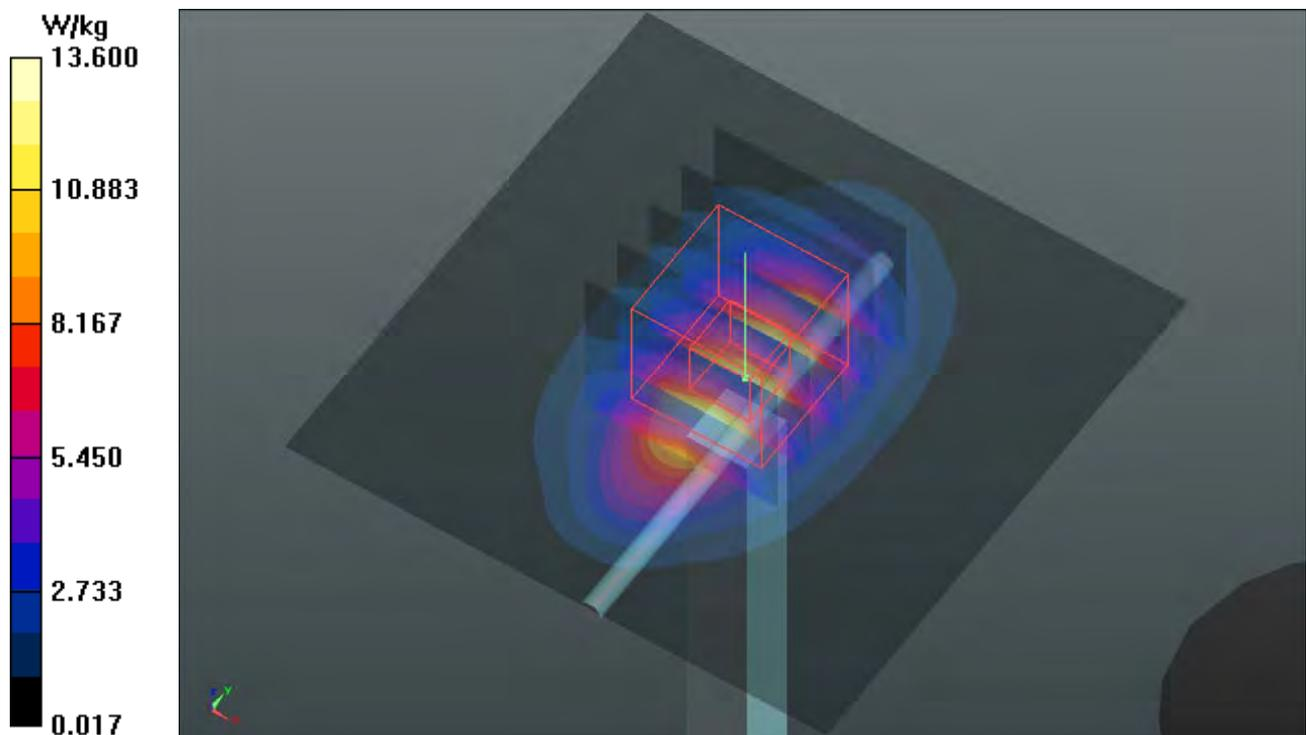

System Check_B1900_180604

DUT: Dipole 1900 MHz; Type: D1900V2; SN: 5d036

Communication System: CW; Frequency: 1900 MHz; Duty Cycle: 1:1

Medium: B16T20N1_0604 Medium parameters used: $f = 1900$ MHz; $\sigma = 1.581$ S/m; $\epsilon_r = 52.161$; $\rho = 1000$ kg/m³

Ambient Temperature : 23.5 °C ; Liquid Temperature : 23.2 °C

DASY5 Configuration:

- Probe: EX3DV4 - SN3820; ConvF(7.62, 7.62, 7.62); Calibrated: 2017/06/27;
- Sensor-Surface: 1.4mm (Mechanical Surface Detection)
- Electronics: DAE4 Sn917; Calibrated: 2017/12/14
- Phantom: Twin SAM Phantom_1496; Type: QD000P40CA;
- Measurement SW: DASY52, Version 52.10 (1); SEMCAD X Version 14.6.11 (7439)

Pin=250mW/Area Scan (61x61x1): Interpolated grid: dx=1.500 mm, dy=1.500 mm
Maximum value of SAR (interpolated) = 16.0 W/kg

Pin=250mW/Zoom Scan (5x5x7)/Cube 0: Measurement grid: dx=8mm, dy=8mm, dz=5mm
Reference Value = 103.2 V/m; Power Drift = -0.13 dB
Peak SAR (extrapolated) = 19.0 W/kg
SAR(1 g) = 10.5 W/kg; SAR(10 g) = 5.42 W/kg
Maximum value of SAR (measured) = 16.2 W/kg

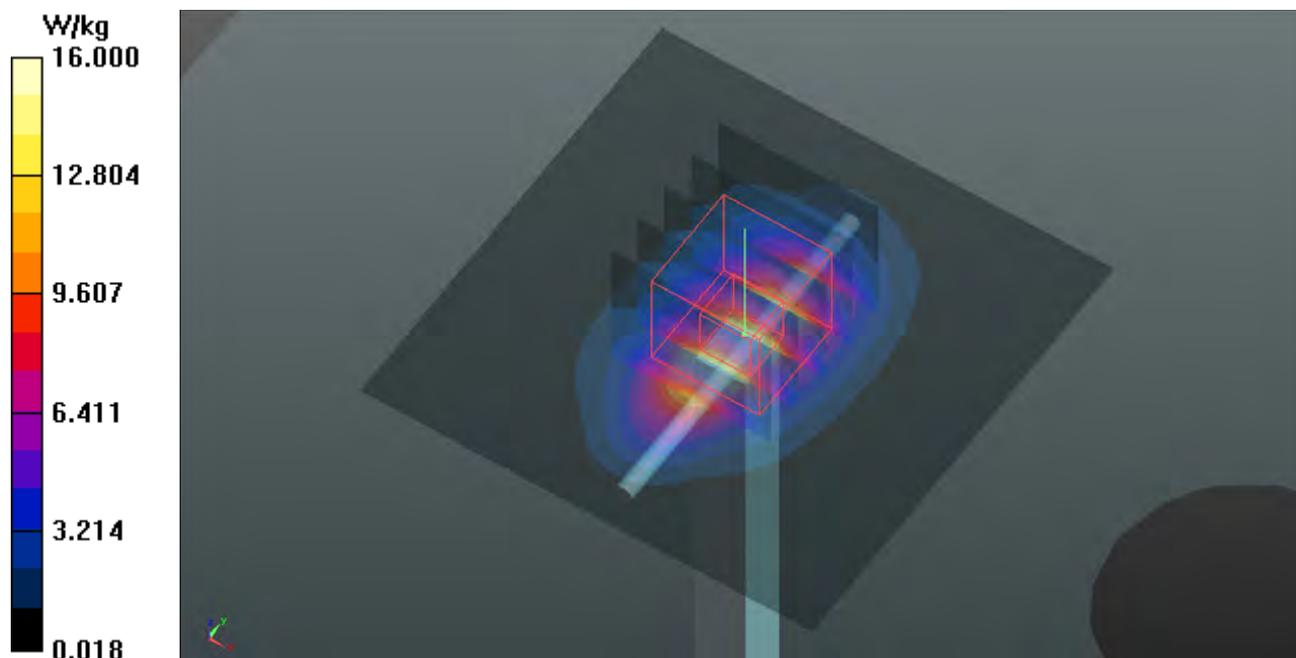

System Check_B2300_180606

DUT: Dipole 2300 MHz; Type: D2300V2; SN: 1004

Communication System: CW; Frequency: 2300 MHz; Duty Cycle: 1:1

Medium: B19T27N1_0606 Medium parameters used: $f = 2300$ MHz; $\sigma = 1.837$ S/m; $\epsilon_r = 51.573$; $\rho = 1000$ kg/m³

Ambient Temperature : 23.6 °C ; Liquid Temperature : 23.3 °C

DASY5 Configuration:

- Probe: EX3DV4 - SN3971; ConvF(7.75, 7.75, 7.75); Calibrated: 2018/03/26
- Sensor-Surface: 1.4mm (Mechanical Surface Detection)
- Electronics: DAE4 Sn1431; Calibrated: 2018/03/16
- Phantom: Twin SAM Phantom_1822; Type: QD000P40CD;
- Measurement SW: DASY52, Version 52.10 (1); SEMCAD X Version 14.6.11 (7439)

Pin=250mW/Area Scan (81x81x1): Interpolated grid: dx=1.200 mm, dy=1.200 mm
Maximum value of SAR (interpolated) = 19.2 W/kg

Pin=250mW/Zoom Scan (7x7x7)/Cube 0: Measurement grid: dx=5mm, dy=5mm, dz=5mm
Reference Value = 104.4 V/m; Power Drift = -0.12 dB
Peak SAR (extrapolated) = 23.3 W/kg
SAR(1 g) = 12 W/kg; SAR(10 g) = 5.77 W/kg
Maximum value of SAR (measured) = 19.3 W/kg

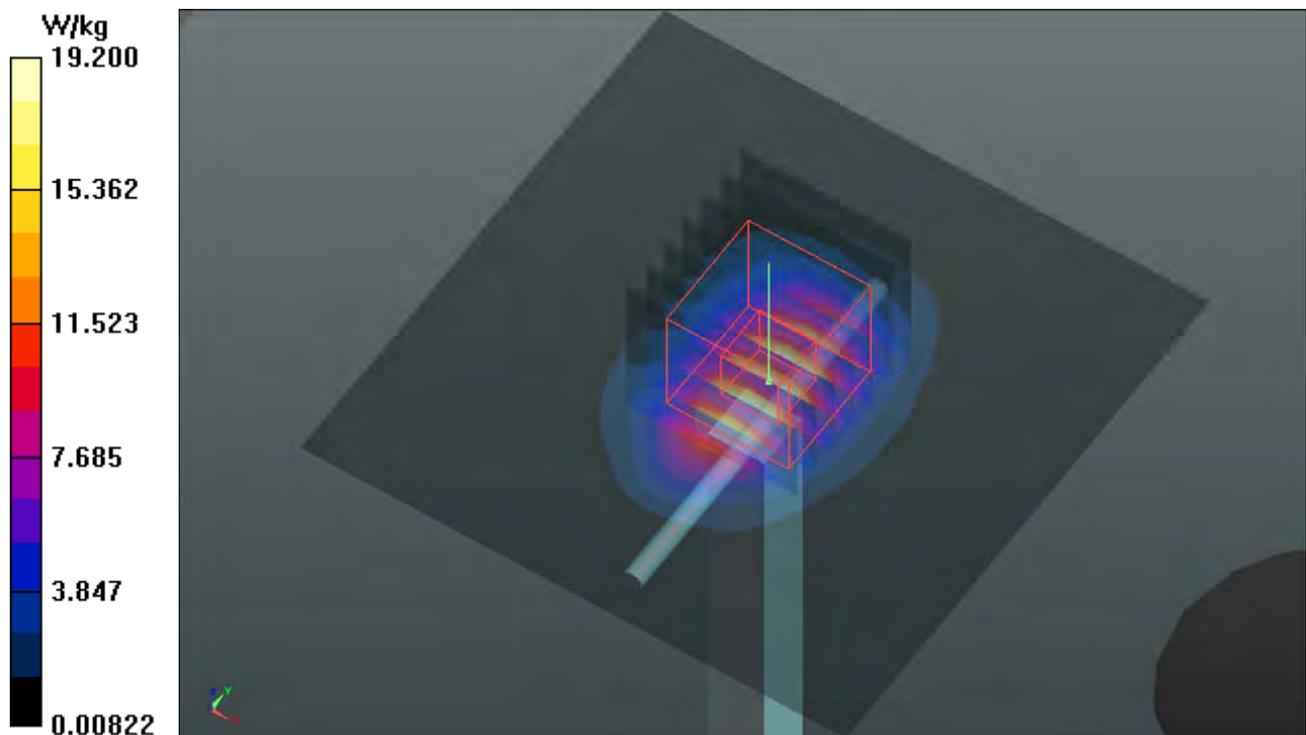

System Check_B2450_180531

DUT: Dipole 2450 MHz; Type: D2450V2; SN: 737

Communication System: CW; Frequency: 2450 MHz; Duty Cycle: 1:1

Medium: B19T27N1_0531 Medium parameters used: $f = 2450$ MHz; $\sigma = 2.023$ S/m; $\epsilon_r = 51.011$; $\rho = 1000$ kg/m³

Ambient Temperature : 23.8 °C ; Liquid Temperature : 23.5 °C

DASY5 Configuration:

- Probe: EX3DV4 - SN3650; ConvF(7.68, 7.68, 7.68); Calibrated: 2017/07/24
- Sensor-Surface: 1.4mm (Mechanical Surface Detection)
- Electronics: DAE4 Sn1277; Calibrated: 2018/01/18
- Phantom: Twin SAM Phantom_1822; Type: QD000P40CD;
- Measurement SW: DASY52, Version 52.10 (1); SEMCAD X Version 14.6.11 (7439)

Pin=250mW/Area Scan (81x81x1): Interpolated grid: dx=1.200 mm, dy=1.200 mm
Maximum value of SAR (interpolated) = 19.3 W/kg

Pin=250mW/Zoom Scan (7x7x7)/Cube 0: Measurement grid: dx=5mm, dy=5mm, dz=5mm

Reference Value = 91.26 V/m; Power Drift = -0.51 dB

Peak SAR (extrapolated) = 24.5 W/kg

SAR(1 g) = 11.8 W/kg; SAR(10 g) = 5.47 W/kg

Maximum value of SAR (measured) = 19.9 W/kg

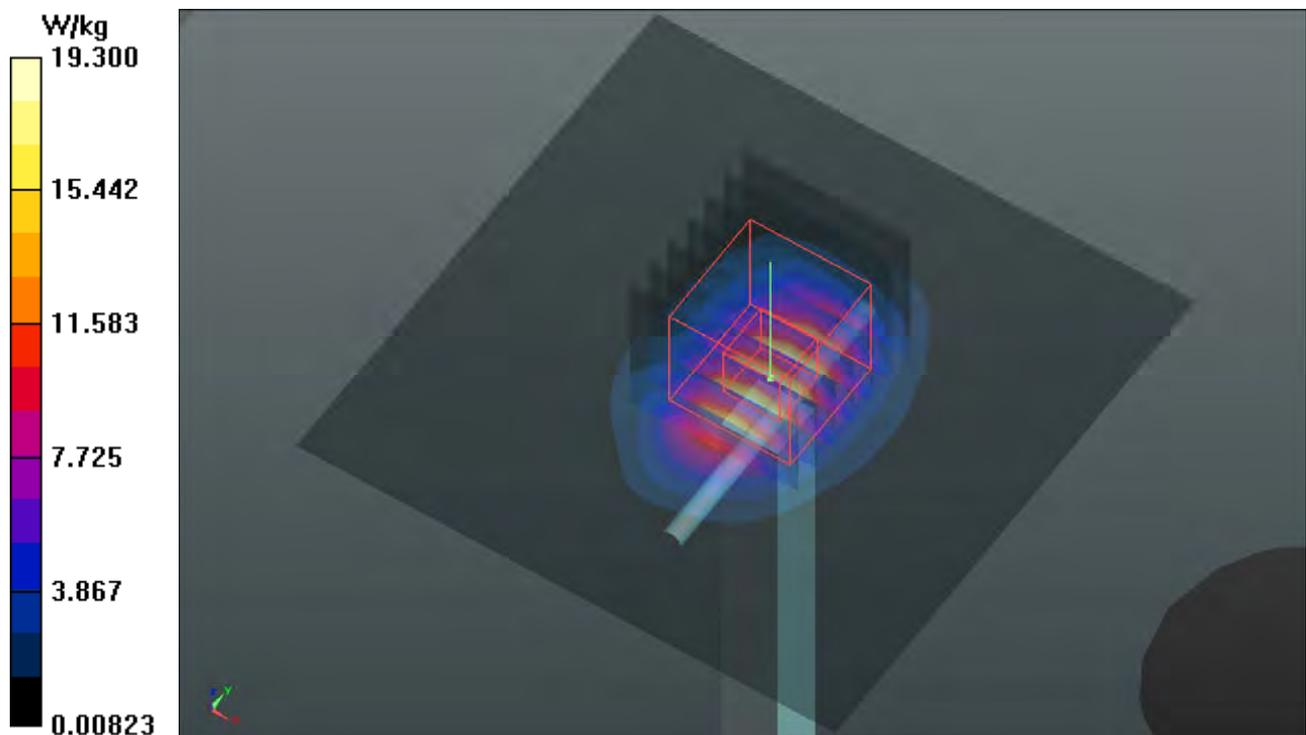

System Check_B2600_180524

DUT: Dipole 2600 MHz; Type: D2600V2; SN: 1020

Communication System: CW; Frequency: 2600 MHz; Duty Cycle: 1:1

Medium: B19T27N1_0524 Medium parameters used: $f = 2600$ MHz; $\sigma = 2.211$ S/m; $\epsilon_r = 50.451$; $\rho = 1000$ kg/m³

Ambient Temperature : 23.6 °C ; Liquid Temperature : 23.3 °C

DASY5 Configuration:

- Probe: EX3DV4 - SN3971; ConvF(7.36, 7.36, 7.36); Calibrated: 2018/03/26;
- Sensor-Surface: 1.4mm (Mechanical Surface Detection)
- Electronics: DAE4 Sn1431; Calibrated: 2018/03/16
- Phantom: Twin SAM Phantom_1822; Type: QD000P40CD;
- Measurement SW: DASY52, Version 52.10 (1); SEMCAD X Version 14.6.11 (7439)

Pin=250mW/Area Scan (81x81x1): Interpolated grid: dx=1.200 mm, dy=1.200 mm
Maximum value of SAR (interpolated) = 21.6 W/kg

Pin=250mW/Zoom Scan (7x7x7)/Cube 0: Measurement grid: dx=5mm, dy=5mm, dz=5mm

Reference Value = 103.0 V/m; Power Drift = -0.12 dB

Peak SAR (extrapolated) = 26.6 W/kg

SAR(1 g) = 12.5 W/kg; SAR(10 g) = 5.59 W/kg

Maximum value of SAR (measured) = 21.4 W/kg

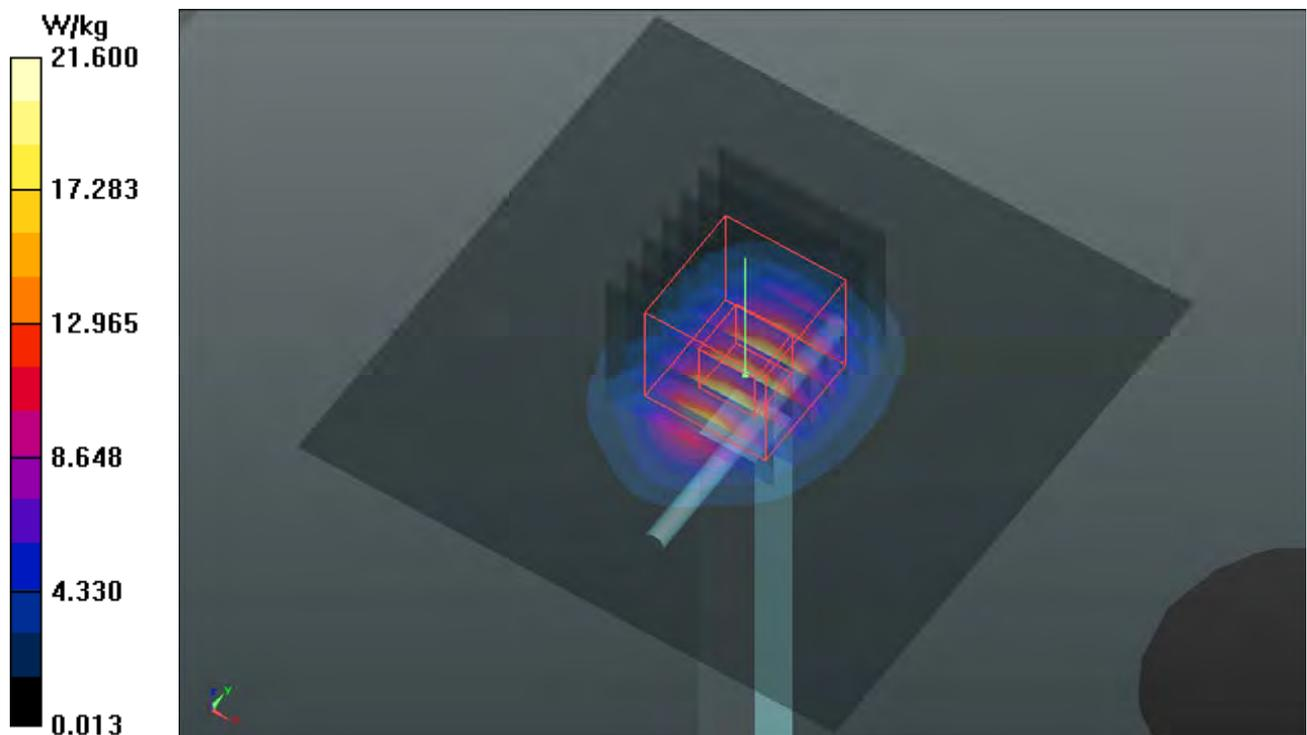

System Check_B5250_180607

DUT: Dipole 5 GHz; Type: D5GHzV2; SN: 1019

Communication System: CW; Frequency: 5250 MHz; Duty Cycle: 1:1

Medium: B34T60N1_0607 Medium parameters used: $f = 5250$ MHz; $\sigma = 5.108$ S/m; $\epsilon_r = 49.907$; $\rho = 1000$ kg/m³

Ambient Temperature : 23.5 °C ; Liquid Temperature : 23.3 °C

DASY5 Configuration:

- Probe: EX3DV4 - SN3820; ConvF(4.59, 4.59, 4.59); Calibrated: 2017/06/27
- Sensor-Surface: 1.4mm (Mechanical Surface Detection)
- Electronics: DAE4 Sn917; Calibrated: 2017/12/14
- Phantom: Twin SAM Phantom_1822; Type: QD000P40CD;
- Measurement SW: DASY52, Version 52.10 (1); SEMCAD X Version 14.6.11 (7439)

Pin=100mW/Area Scan (91x91x1): Interpolated grid: dx=1.000 mm, dy=1.000 mm
Maximum value of SAR (interpolated) = 13.9 W/kg

Pin=100mW/Zoom Scan (7x7x12)/Cube 0: Measurement grid: dx=4mm, dy=4mm, dz=2mm
Reference Value = 59.75 V/m; Power Drift = -0.01 dB
Peak SAR (extrapolated) = 28.1 W/kg
SAR(1 g) = 7.29 W/kg; SAR(10 g) = 2.07 W/kg
Maximum value of SAR (measured) = 15.1 W/kg

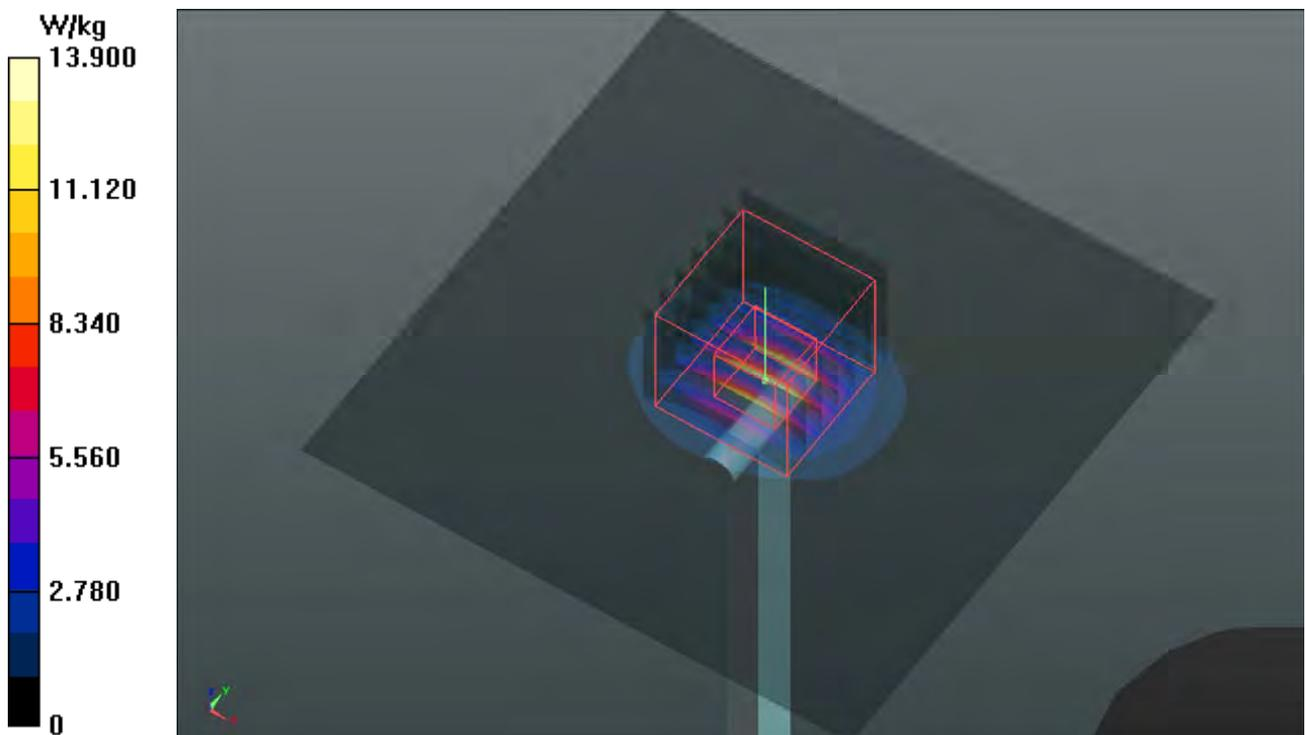

System Check_B5600_180530

DUT: Dipole 5 GHz; Type: D5GHzV2; SN: 1019

Communication System: CW; Frequency: 5600 MHz; Duty Cycle: 1:1

Medium: B34T60N1_0530 Medium parameters used: $f = 5600$ MHz; $\sigma = 5.818$ S/m; $\epsilon_r = 47.42$; $\rho = 1000$ kg/m³

Ambient Temperature : 23.6 °C ; Liquid Temperature : 23.4 °C

DASY5 Configuration:

- Probe: EX3DV4 - SN3650; ConvF(4.29, 4.29, 4.29); Calibrated: 2017/07/24
- Sensor-Surface: 1.4mm (Mechanical Surface Detection)
- Electronics: DAE4 Sn1277; Calibrated: 2018/01/18
- Phantom: Twin SAM Phantom_1822; Type: QD000P40CD;
- Measurement SW: DASY52, Version 52.10 (1); SEMCAD X Version 14.6.11 (7439)

Pin=100mW/Area Scan (91x91x1): Interpolated grid: dx=1.000 mm, dy=1.000 mm
Maximum value of SAR (interpolated) = 18.1 W/kg

Pin=100mW/Zoom Scan (7x7x12)/Cube 0: Measurement grid: dx=4mm, dy=4mm, dz=2mm
Reference Value = 58.52 V/m; Power Drift = -0.08 dB
Peak SAR (extrapolated) = 33.1 W/kg
SAR(1 g) = 7.7 W/kg; SAR(10 g) = 2.18 W/kg
Maximum value of SAR (measured) = 20.0 W/kg

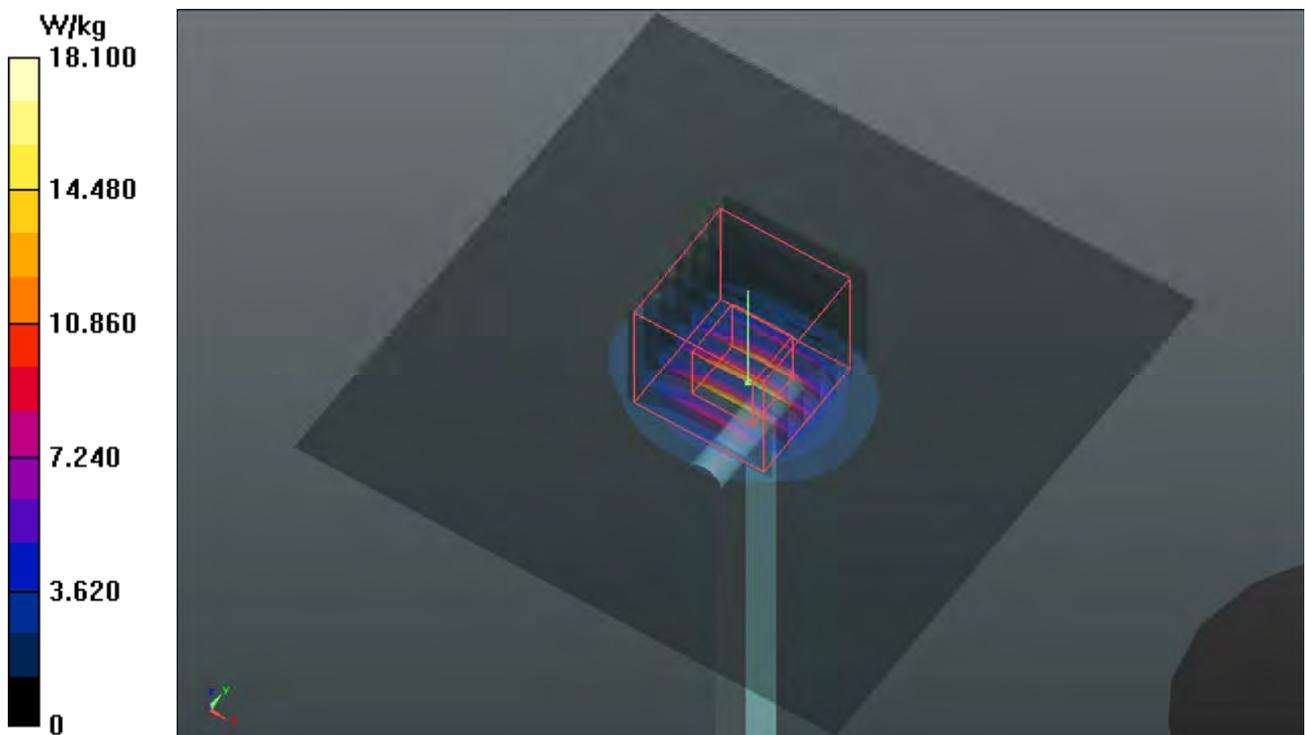

System Check_B5800_180607

DUT: Dipole 5 GHz; Type: D5GHzV2; SN: 1019

Communication System: CW; Frequency: 5800 MHz; Duty Cycle: 1:1

Medium: B34T60N1_0607 Medium parameters used: $f = 5800$ MHz; $\sigma = 5.992$ S/m; $\epsilon_r = 49.713$; $\rho = 1000$ kg/m³

Ambient Temperature : 23.5 °C ; Liquid Temperature : 23.3 °C

DASY5 Configuration:

- Probe: EX3DV4 - SN3820; ConvF(4.04, 4.04, 4.04); Calibrated: 2017/06/27
- Sensor-Surface: 1.4mm (Mechanical Surface Detection)
- Electronics: DAE4 Sn917; Calibrated: 2017/12/14
- Phantom: Twin SAM Phantom_1822; Type: QD000P40CD;
- Measurement SW: DASY52, Version 52.10 (1); SEMCAD X Version 14.6.11 (7439)

Pin=100mW/Area Scan (91x91x1): Interpolated grid: dx=1.000 mm, dy=1.000 mm
Maximum value of SAR (interpolated) = 15.1 W/kg

Pin=100mW/Zoom Scan (7x7x12)/Cube 0: Measurement grid: dx=4mm, dy=4mm, dz=2mm
Reference Value = 56.73 V/m; Power Drift = -0.03 dB
Peak SAR (extrapolated) = 33.2 W/kg
SAR(1 g) = 7.89 W/kg; SAR(10 g) = 2.2 W/kg
Maximum value of SAR (measured) = 16.5 W/kg

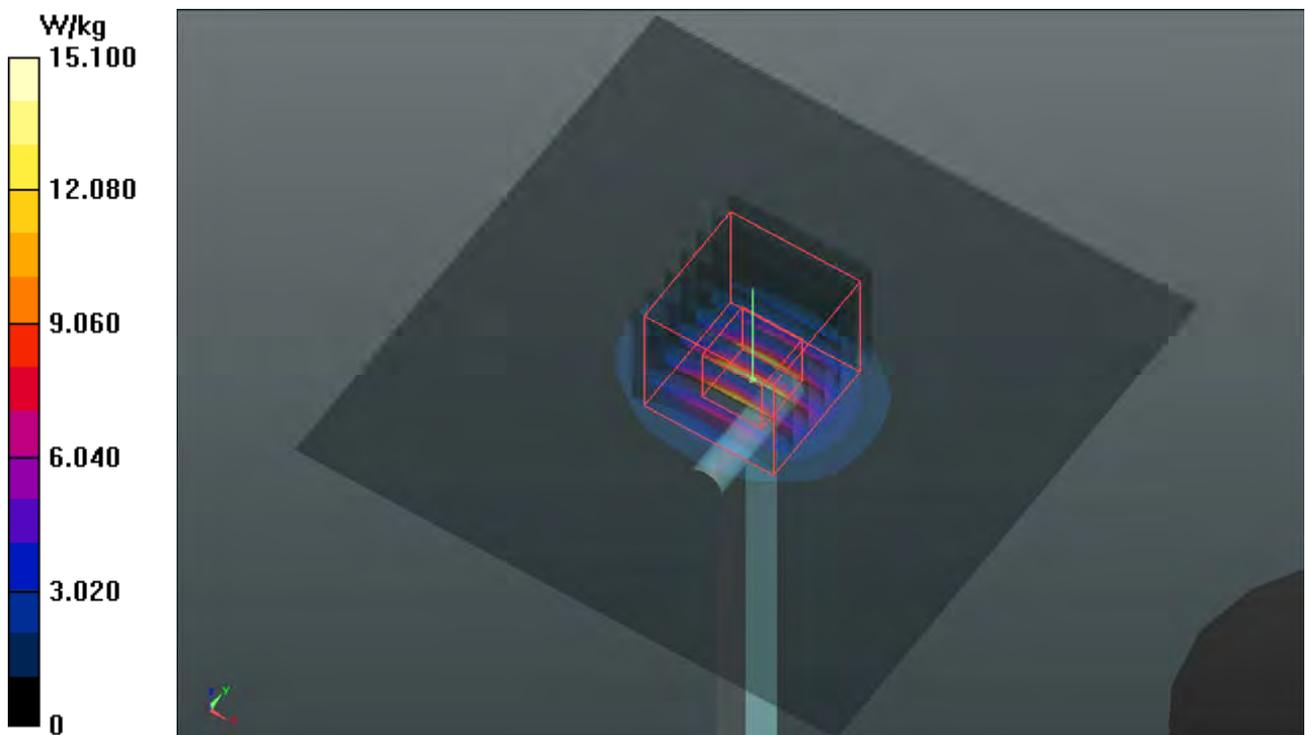

System Check_B5250_180620

DUT: Dipole 5 GHz; Type: D5GHzV2; SN: 1019

Communication System: CW; Frequency: 5250 MHz; Duty Cycle: 1:1

Medium: B34T60N3_0620 Medium parameters used: $f = 5250$ MHz; $\sigma = 5.511$ S/m; $\epsilon_r = 47.154$; $\rho = 1000$ kg/m³

Ambient Temperature : 23.7 °C ; Liquid Temperature : 23.3 °C

DASY5 Configuration:

- Probe: EX3DV4 - SN7346; ConvF(5.06, 5.06, 5.06); Calibrated: 2018/02/28
- Sensor-Surface: 1.4mm (Mechanical Surface Detection)
- Electronics: DAE4 Sn861; Calibrated: 2018/05/30
- Phantom: Twin SAM Phantom_1496; Type: QD000P40CA;
- Measurement SW: DASY52, Version 52.10 (1); SEMCAD X Version 14.6.11 (7439)

Pin=100mW/Area Scan (91x91x1): Interpolated grid: dx=1.000 mm, dy=1.000 mm
Maximum value of SAR (interpolated) = 15.8 W/kg

Pin=100mW/Zoom Scan (7x7x12)/Cube 0: Measurement grid: dx=4mm, dy=4mm, dz=2mm
Reference Value = 57.44 V/m; Power Drift = -0.14 dB
Peak SAR (extrapolated) = 28.5 W/kg
SAR(1 g) = 7.4 W/kg; SAR(10 g) = 2.11 W/kg
Maximum value of SAR (measured) = 18.8 W/kg

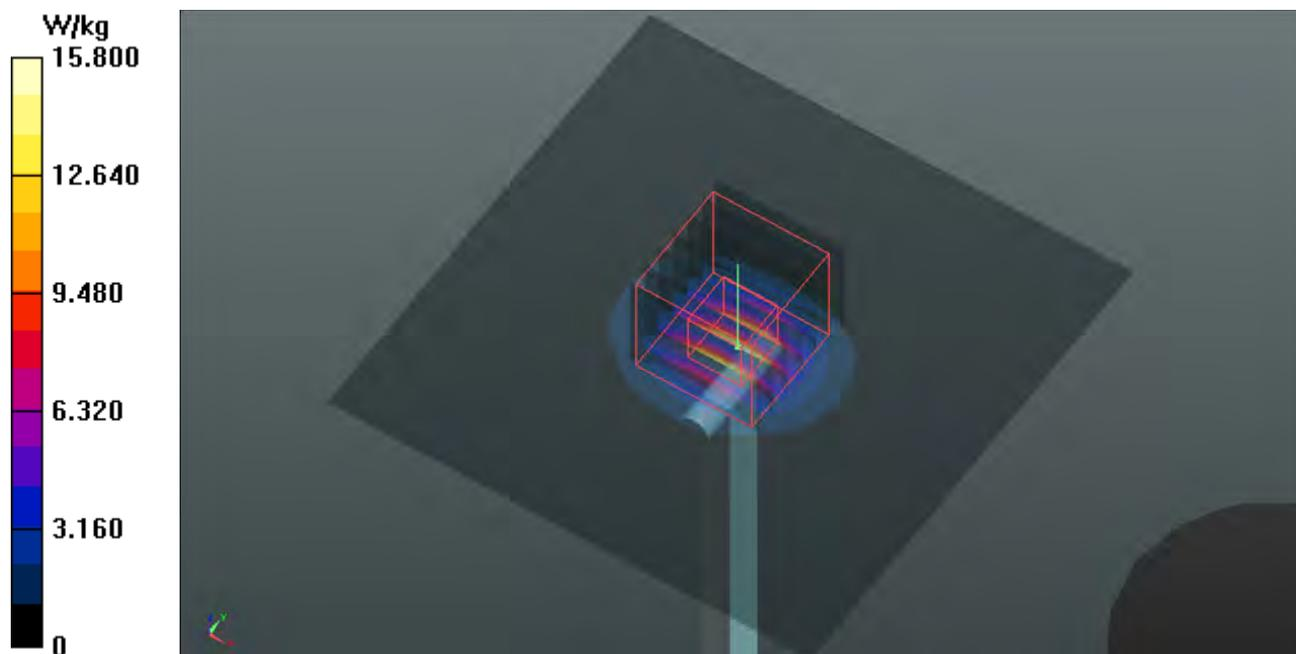

System Check_B5600_180620

DUT: Dipole 5 GHz; Type: D5GHzV2; SN: 1019

Communication System: CW; Frequency: 5600 MHz; Duty Cycle: 1:1

Medium: B34T60N3_0620 Medium parameters used: $f = 5600$ MHz; $\sigma = 5.926$ S/m; $\epsilon_r = 46.661$; $\rho = 1000$ kg/m³

Ambient Temperature : 23.7 °C ; Liquid Temperature : 23.3 °C

DASY5 Configuration:

- Probe: EX3DV4 - SN7346; ConvF(4.35, 4.35, 4.35); Calibrated: 2018/02/28
- Sensor-Surface: 1.4mm (Mechanical Surface Detection)
- Electronics: DAE4 Sn861; Calibrated: 2018/05/30
- Phantom: Twin SAM Phantom_1496; Type: QD000P40CA;
- Measurement SW: DASY52, Version 52.10 (1); SEMCAD X Version 14.6.11 (7439)

Pin=100mW/Area Scan (91x91x1): Interpolated grid: dx=1.000 mm, dy=1.000 mm
Maximum value of SAR (interpolated) = 18.9 W/kg

Pin=100mW/Zoom Scan (7x7x12)/Cube 0: Measurement grid: dx=4mm, dy=4mm, dz=2mm
Reference Value = 66.09 V/m; Power Drift = -0.09 dB
Peak SAR (extrapolated) = 34.7 W/kg
SAR(1 g) = 8.03 W/kg; SAR(10 g) = 2.26 W/kg
Maximum value of SAR (measured) = 20.2 W/kg

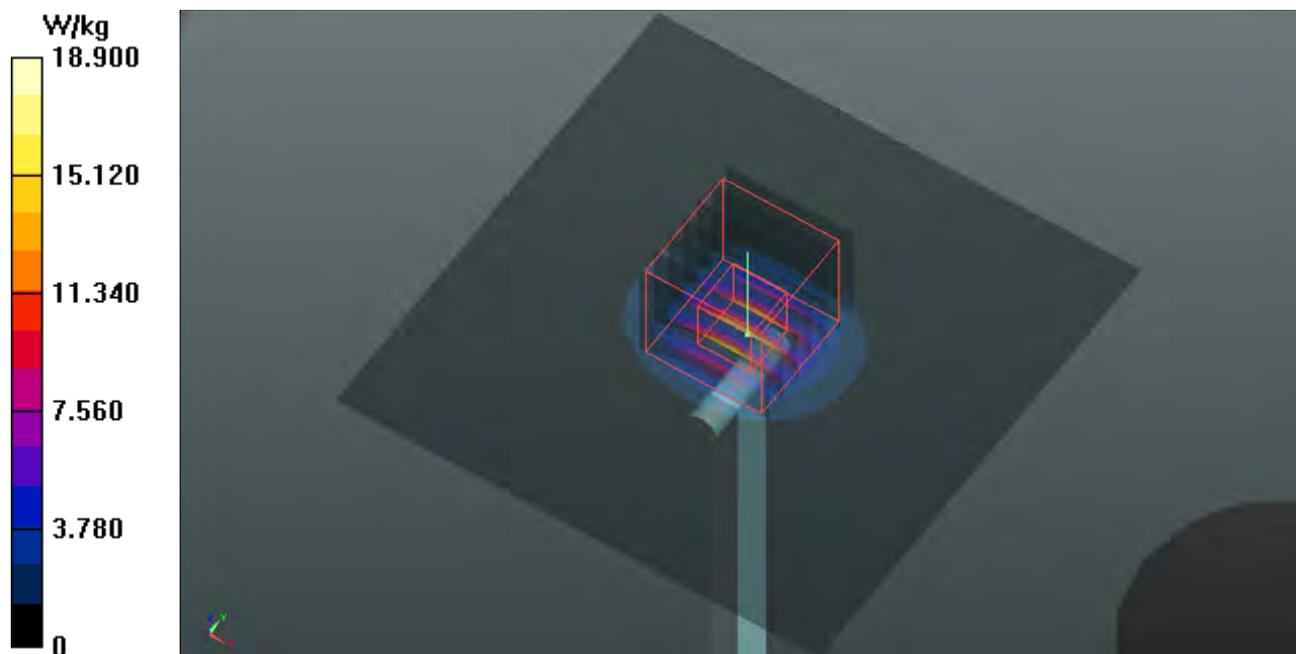



Appendix B. SAR Plots of SAR Measurement

The SAR plots for highest measured SAR in each exposure configuration, wireless mode and frequency band combination, and measured SAR > 1.5 W/kg are shown as follows.

P01 GSM850_GPRS11_Right Cheek_Ch251_Ant1

DUT: 18Q1-021

Communication System: GPRS11; Frequency: 848.8 MHz; Duty Cycle: 1:2.67

Medium: H07T10N1_0525 Medium parameters used: $f = 849$ MHz; $\sigma = 0.93$ S/m; $\epsilon_r = 41.513$; $\rho = 1000$ kg/m³

Ambient Temperature : 23.8 °C ; Liquid Temperature : 23.5 °C

DASY5 Configuration:

- Probe: EX3DV4 - SN3971; ConvF(10.34, 10.34, 10.34); Calibrated: 2018/03/26;
- Sensor-Surface: 1.4mm (Mechanical Surface Detection)
- Electronics: DAE4 Sn1431; Calibrated: 2018/03/16
- Phantom: Twin SAM Phantom_1654; Type: QD000P40;
- Measurement SW: DASY52, Version 52.10 (1); SEMCAD X Version 14.6.11 (7439)

- **Area Scan (71x121x1):** Interpolated grid: dx=1.500 mm, dy=1.500 mm

Maximum value of SAR (interpolated) = 1.57 W/kg

- **Zoom Scan (5x5x7)/Cube 0:** Measurement grid: dx=8mm, dy=8mm, dz=5mm

Reference Value = 37.95 V/m; Power Drift = -0.07 dB

Peak SAR (extrapolated) = 2.04 W/kg

SAR(1 g) = 1.07 W/kg; SAR(10 g) = 0.623 W/kg

Maximum value of SAR (measured) = 1.65 W/kg

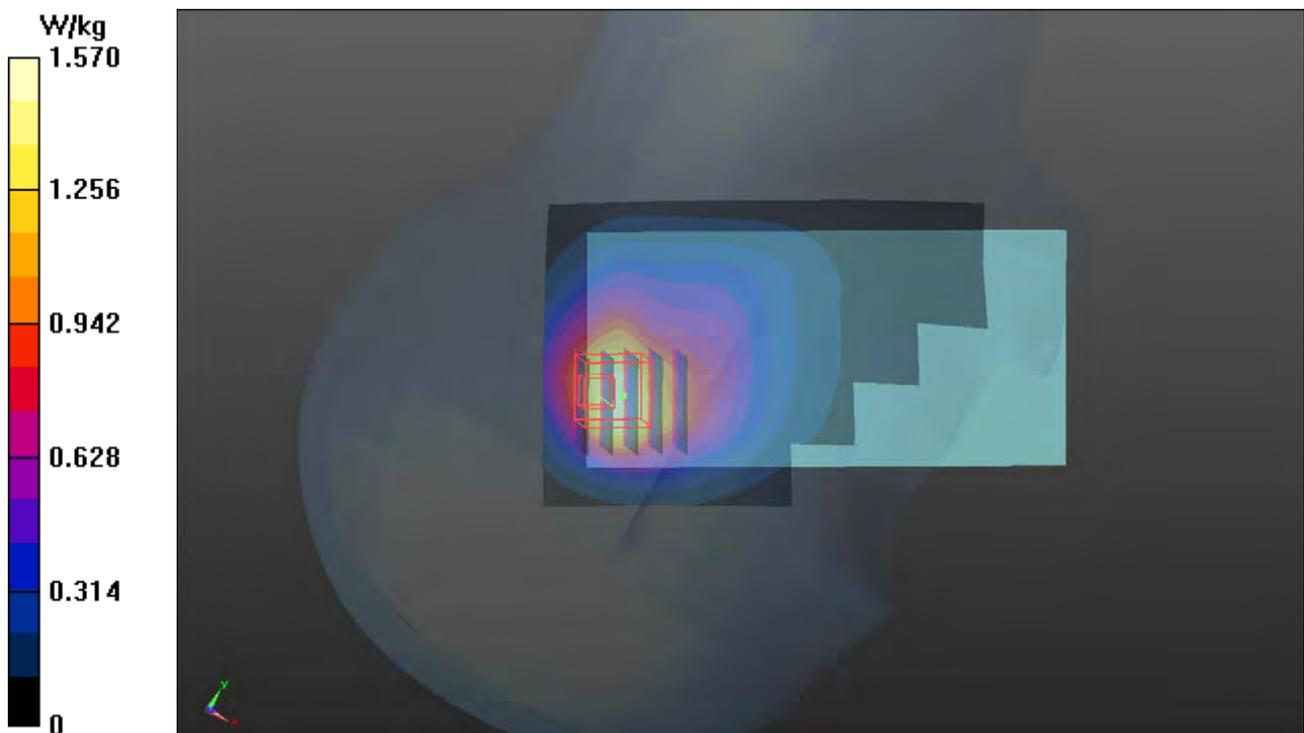

P02 GSM1900_GPRS12_Left Cheek_Ch512_Ant0

DUT: 18Q1-021

Communication System: GPRS12; Frequency: 1850.2 MHz; Duty Cycle: 1:2

Medium: H16T20N1_0531 Medium parameters used $f = 1850.2$ MHz; $\sigma = 1.399$ S/m; $\epsilon_r = 39.02$; $\rho = 1000$ kg/m³

Ambient Temperature : 23.9 °C ; Liquid Temperature : 23.6 °C

DASY5 Configuration:

- Probe: EX3DV4 - SN3650; ConvF(8.28, 8.28, 8.28); Calibrated: 2017/07/24;
- Sensor-Surface: 1.4mm (Mechanical Surface Detection)
- Electronics: DAE4 Sn1277; Calibrated: 2018/01/18
- Phantom: Twin SAM Phantom_1654; Type: QD000P40;
- Measurement SW: DASY52, Version 52.10 (1); SEMCAD X Version 14.6.11 (7439)

- **Area Scan (71x121x1):** Interpolated grid: dx=1.500 mm, dy=1.500 mm

Maximum value of SAR (interpolated) = 0.166 W/kg

- **Zoom Scan (5x5x7)/Cube 0:** Measurement grid: dx=8mm, dy=8mm, dz=5mm

Reference Value = 9.728 V/m; Power Drift = 0.08 dB

Peak SAR (extrapolated) = 0.167 W/kg

SAR(1 g) = 0.111 W/kg; SAR(10 g) = 0.070 W/kg

Maximum value of SAR (measured) = 0.149 W/kg

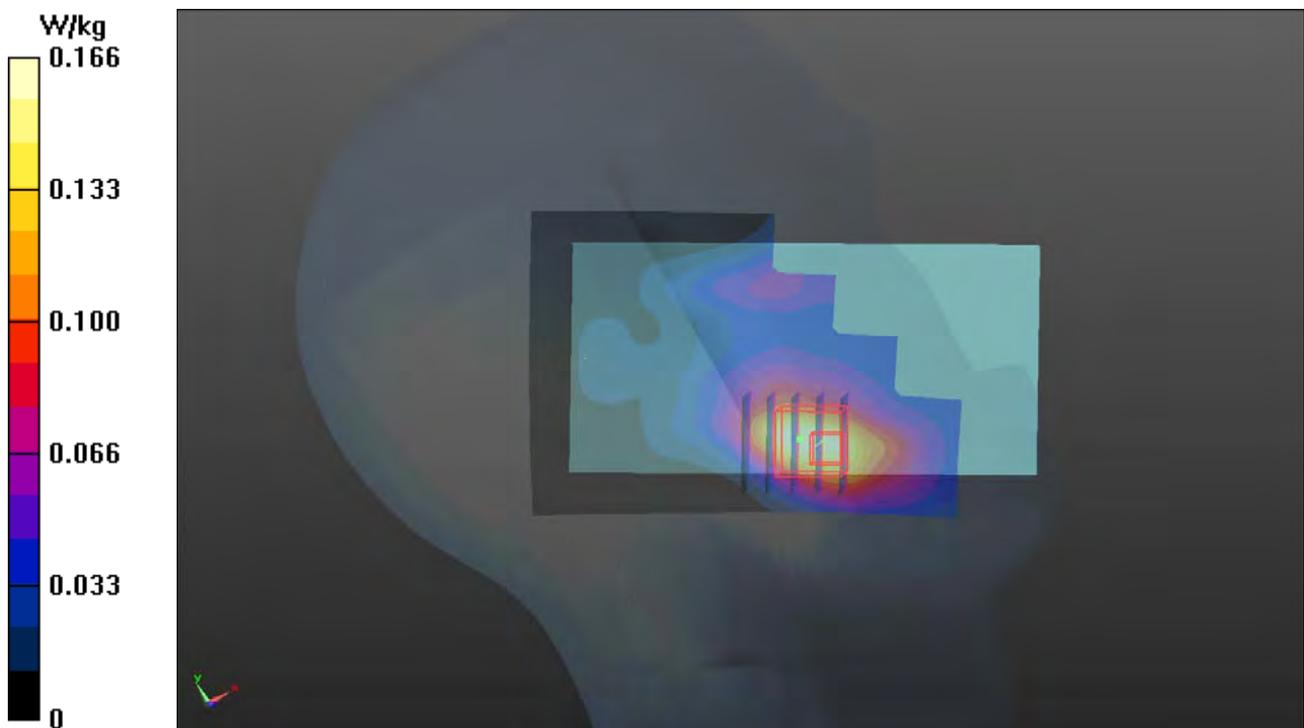

P03 WCDMA II_RMC12.2K_Left Cheek_Ch9262_Ant0

DUT: 18Q1-021

Communication System: WCDMA; Frequency: 1852.4 MHz; Duty Cycle: 1:1

Medium: H16T20N1_0531 Medium parameters used $f = 1852.4$ MHz; $\sigma = 1.401$ S/m; $\epsilon_r = 39.013$; $\rho = 1000$ kg/m³

Ambient Temperature : 23.9 °C ; Liquid Temperature : 23.6 °C

DASY5 Configuration:

- Probe: EX3DV4 - SN3650; ConvF(8.28, 8.28, 8.28); Calibrated: 2017/07/24;
- Sensor-Surface: 1.4mm (Mechanical Surface Detection)
- Electronics: DAE4 Sn1277; Calibrated: 2018/01/18
- Phantom: Twin SAM Phantom_1654; Type: QD000P40;
- Measurement SW: DASY52, Version 52.10 (1); SEMCAD X Version 14.6.11 (7439)

- **Area Scan (71x121x1):** Interpolated grid: dx=1.500 mm, dy=1.500 mm

Maximum value of SAR (interpolated) = 0.264 W/kg

- **Zoom Scan (5x5x7)/Cube 0:** Measurement grid: dx=8mm, dy=8mm, dz=5mm

Reference Value = 12.86 V/m; Power Drift = 0.03 dB

Peak SAR (extrapolated) = 0.293 W/kg

SAR(1 g) = 0.196 W/kg; SAR(10 g) = 0.123 W/kg

Maximum value of SAR (measured) = 0.253 W/kg

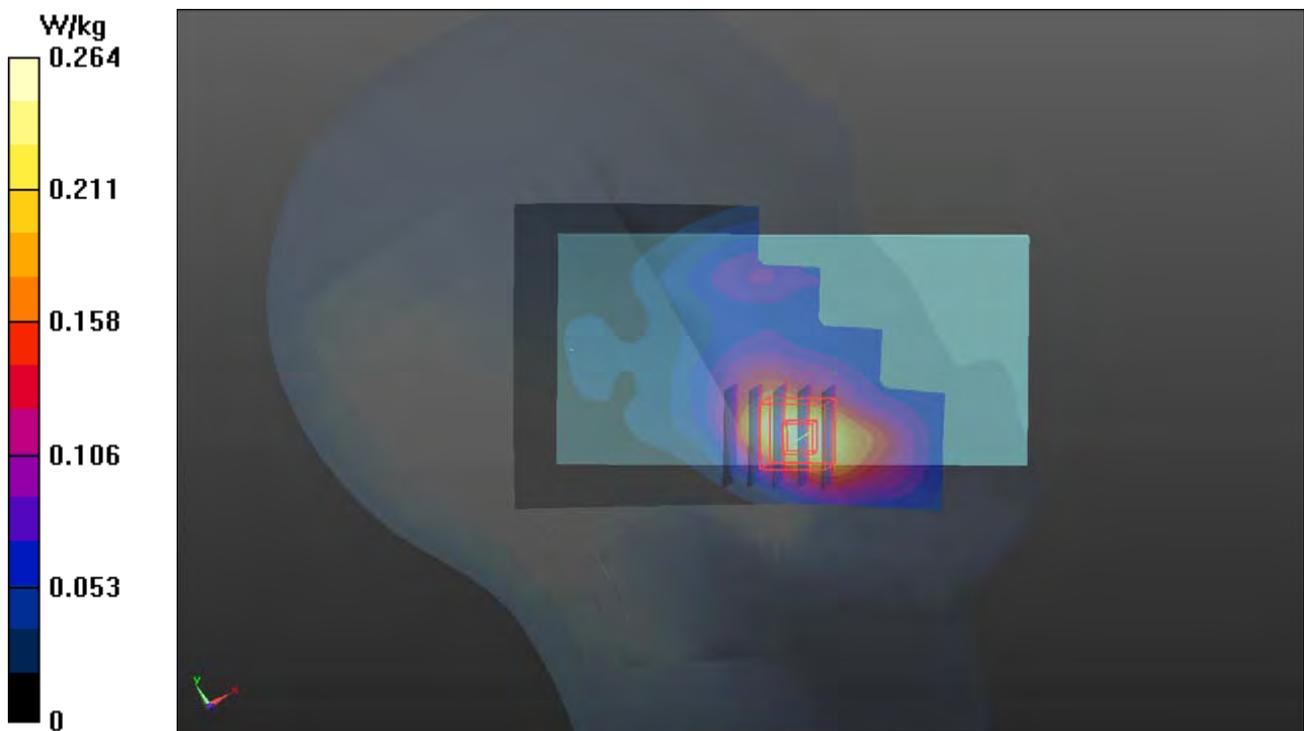

P04 WCDMA IV_RMC12.2K_Left Cheek_Ant0

DUT: 18Q1-021

Communication System: WCDMA; Frequency: 1712.4 MHz; Duty Cycle: 1:1

Medium: H16T20N1_0531 Medium parameters used: $f = 1712.4$ MHz; $\sigma = 1.286$ S/m; $\epsilon_r = 39.528$; $\rho = 1000$ kg/m³

Ambient Temperature : 23.9 °C ; Liquid Temperature : 23.6 °C

DASY5 Configuration:

- Probe: EX3DV4 - SN3650; ConvF(8.56, 8.56, 8.56); Calibrated: 2017/07/24
- Sensor-Surface: 1.4mm (Mechanical Surface Detection)
- Electronics: DAE4 Sn1277; Calibrated: 2018/01/18
- Phantom: Twin SAM Phantom_1654; Type: QD000P40;
- Measurement SW: DASY52, Version 52.10 (1); SEMCAD X Version 14.6.11 (7439)

- **Area Scan (71x121x1):** Interpolated grid: dx=1.500 mm, dy=1.500 mm

Maximum value of SAR (interpolated) = 0.341 W/kg

- **Zoom Scan (5x5x7)/Cube 0:** Measurement grid: dx=8mm, dy=8mm, dz=5mm

Reference Value = 15.02 V/m; Power Drift = -0.01 dB

Peak SAR (extrapolated) = 0.361 W/kg

SAR(1 g) = 0.245 W/kg; SAR(10 g) = 0.156 W/kg

Maximum value of SAR (measured) = 0.317 W/kg

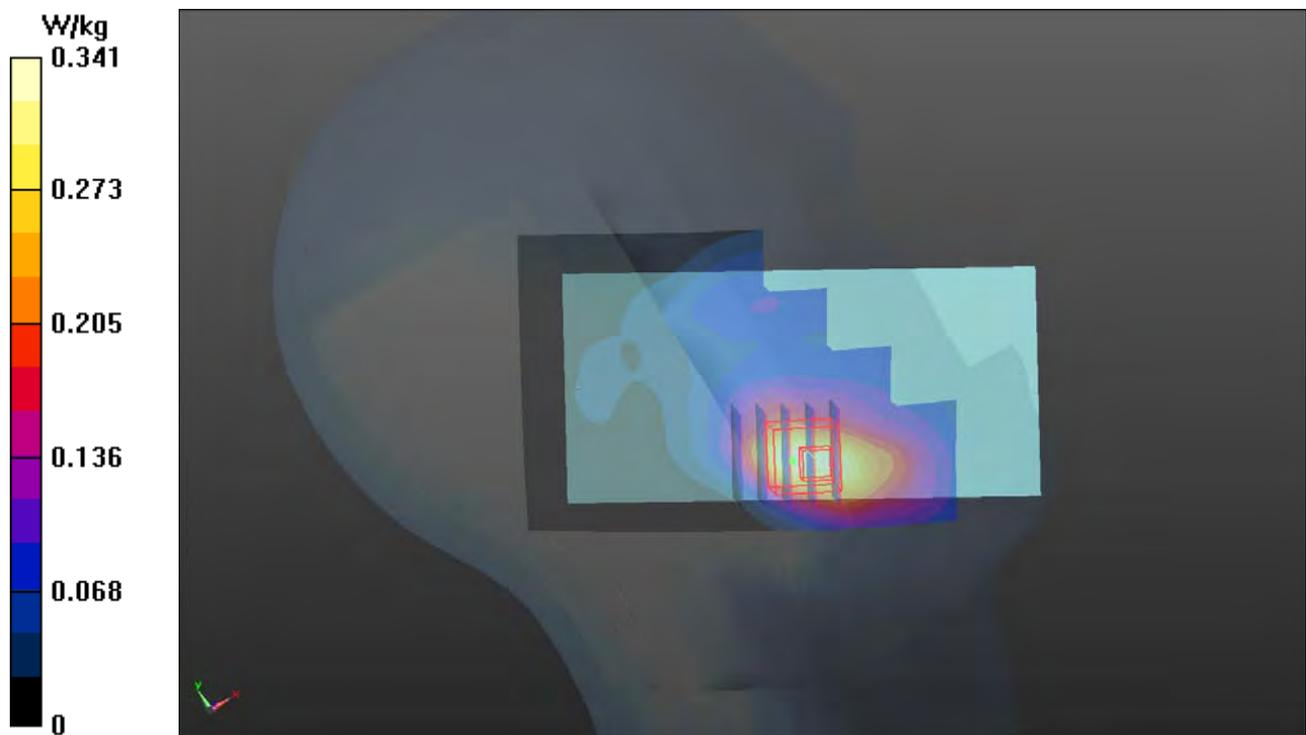

P05 WCDMA V_RMC12.2K_Right Cheek_Ch4233_Ant1

DUT: 18Q1-021

Communication System: WCDMA; Frequency: 846.6 MHz; Duty Cycle: 1:1

Medium: H07T10N1_0525 Medium parameters used: $f = 847$ MHz; $\sigma = 0.928$ S/m; $\epsilon_r = 41.536$; $\rho = 1000$ kg/m³

Ambient Temperature : 23.8 °C ; Liquid Temperature : 23.5 °C

DASY5 Configuration:

- Probe: EX3DV4 - SN3971; ConvF(10.34, 10.34, 10.34); Calibrated: 2018/03/26;
- Sensor-Surface: 1.4mm (Mechanical Surface Detection)
- Electronics: DAE4 Sn1431; Calibrated: 2018/03/16
- Phantom: Twin SAM Phantom_1654; Type: QD000P40;
- Measurement SW: DASY52, Version 52.10 (1); SEMCAD X Version 14.6.11 (7439)

- **Area Scan (71x121x1):** Interpolated grid: dx=1.500 mm, dy=1.500 mm

Maximum value of SAR (interpolated) = 1.38 W/kg

- **Zoom Scan (5x5x7)/Cube 0:** Measurement grid: dx=8mm, dy=8mm, dz=5mm

Reference Value = 35.43 V/m; Power Drift = 0.03 dB

Peak SAR (extrapolated) = 1.79 W/kg

SAR(1 g) = 0.944 W/kg; SAR(10 g) = 0.554 W/kg

Maximum value of SAR (measured) = 1.45 W/kg

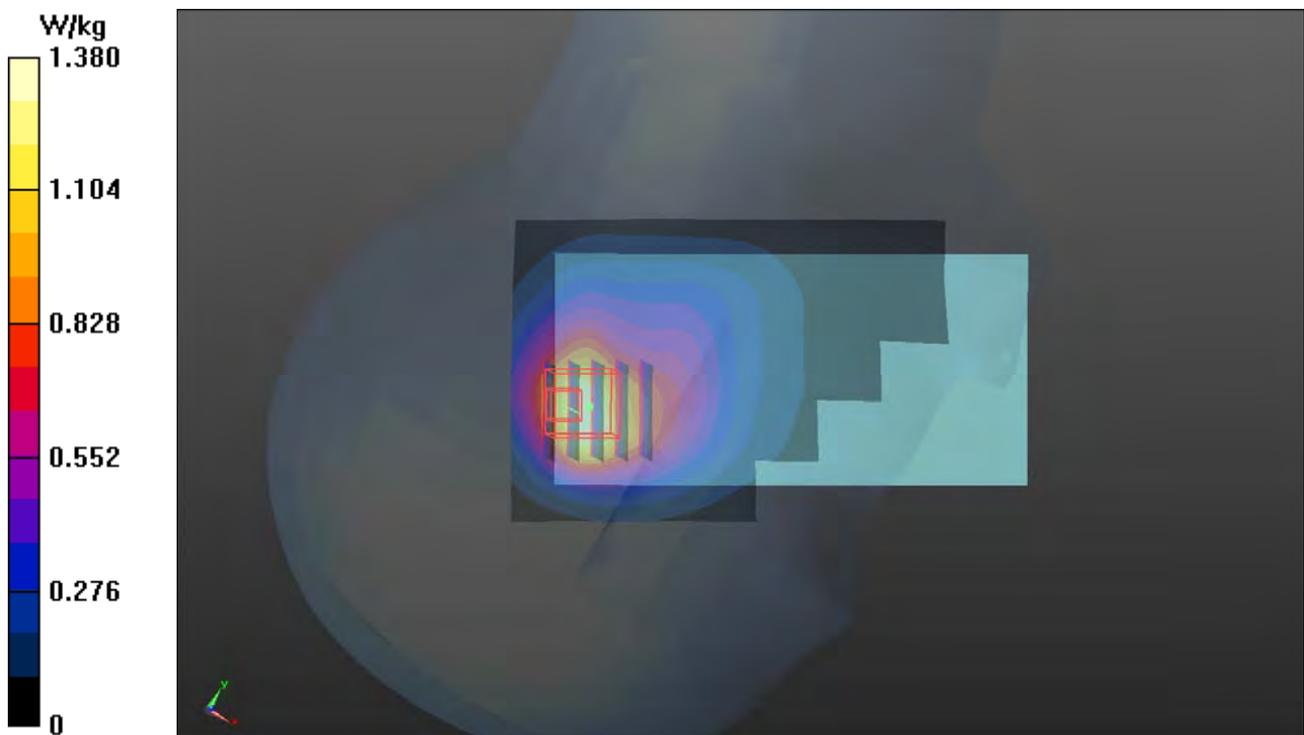

P06 LTE 2_QPSK20M_Left Cheek_Ch18700_1RB_OS0_Ant0

DUT: 180523C09

Communication System: LTE; Frequency: 1860 MHz; Duty Cycle: 1:1

Medium: H16T20N1_0906 Medium parameters used: $f = 1860$ MHz; $\sigma = 1.425$ S/m; $\epsilon_r = 39.791$; $\rho = 1000$ kg/m³

Ambient Temperature : 23.7 °C ; Liquid Temperature : 23.2 °C

DASY5 Configuration:

- Probe: EX3DV4 - SN3971; ConvF(8.52, 8.52, 8.52) ; Calibrated: 2018/03/26
- Sensor-Surface: 1.4mm (Mechanical Surface Detection)
- Electronics: DAE4 Sn1431; Calibrated: 2018/03/16
- Phantom: Twin SAM Phantom_1654; Type: QD000P40;
- Measurement SW: DASY52, Version 52.10 (1); SEMCAD X Version 14.6.11 (7439)

- **Area Scan (71x121x1):** Interpolated grid: dx=1.500 mm, dy=1.500 mm

Maximum value of SAR (interpolated) = 0.259 W/kg

- **Zoom Scan (5x5x7)/Cube 0:** Measurement grid: dx=8mm, dy=8mm, dz=5mm

Reference Value = 13.49 V/m; Power Drift = -0.02 dB

Peak SAR (extrapolated) = 0.287 W/kg

SAR(1 g) = 0.166 W/kg; SAR(10 g) = 0.096 W/kg

Maximum value of SAR (measured) = 0.250 W/kg

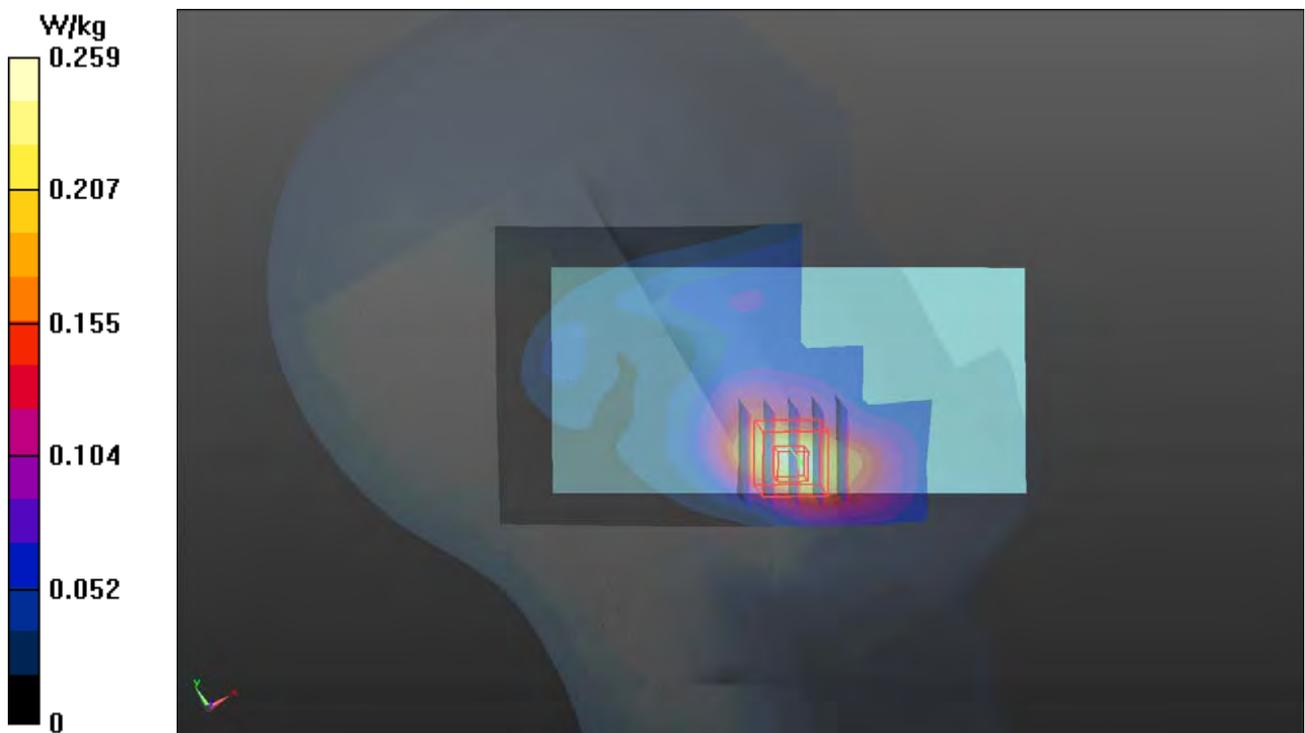

P07 LTE 4_QPSK20M_Left Cheek_Ch20050_1RB_OS0_Ant0

DUT: 180523C09

Communication System: LTE; Frequency: 1720 MHz; Duty Cycle: 1:1

Medium: H16T20N1_0906 Medium parameters used: $f = 1720$ MHz; $\sigma = 1.301$ S/m; $\epsilon_r = 40.451$; $\rho = 1000$ kg/m³

Ambient Temperature : 23.7 °C ; Liquid Temperature : 23.2 °C

DASY5 Configuration:

- Probe: EX3DV4 - SN3971; ConvF(8.9, 8.9, 8.9); Calibrated: 2018/03/26
- Sensor-Surface: 1.4mm (Mechanical Surface Detection)
- Electronics: DAE4 Sn1431; Calibrated: 2018/03/16
- Phantom: Twin SAM Phantom_1654; Type: QD000P40;
- Measurement SW: DASY52, Version 52.10 (1); SEMCAD X Version 14.6.11 (7439)

- **Area Scan (71x121x1):** Interpolated grid: dx=1.500 mm, dy=1.500 mm

Maximum value of SAR (interpolated) = 0.305 W/kg

- **Zoom Scan (5x5x7)/Cube 0:** Measurement grid: dx=8mm, dy=8mm, dz=5mm

Reference Value = 15.19 V/m; Power Drift = -0.03 dB

Peak SAR (extrapolated) = 0.319 W/kg

SAR(1 g) = 0.216 W/kg; SAR(10 g) = 0.138 W/kg

Maximum value of SAR (measured) = 0.283 W/kg

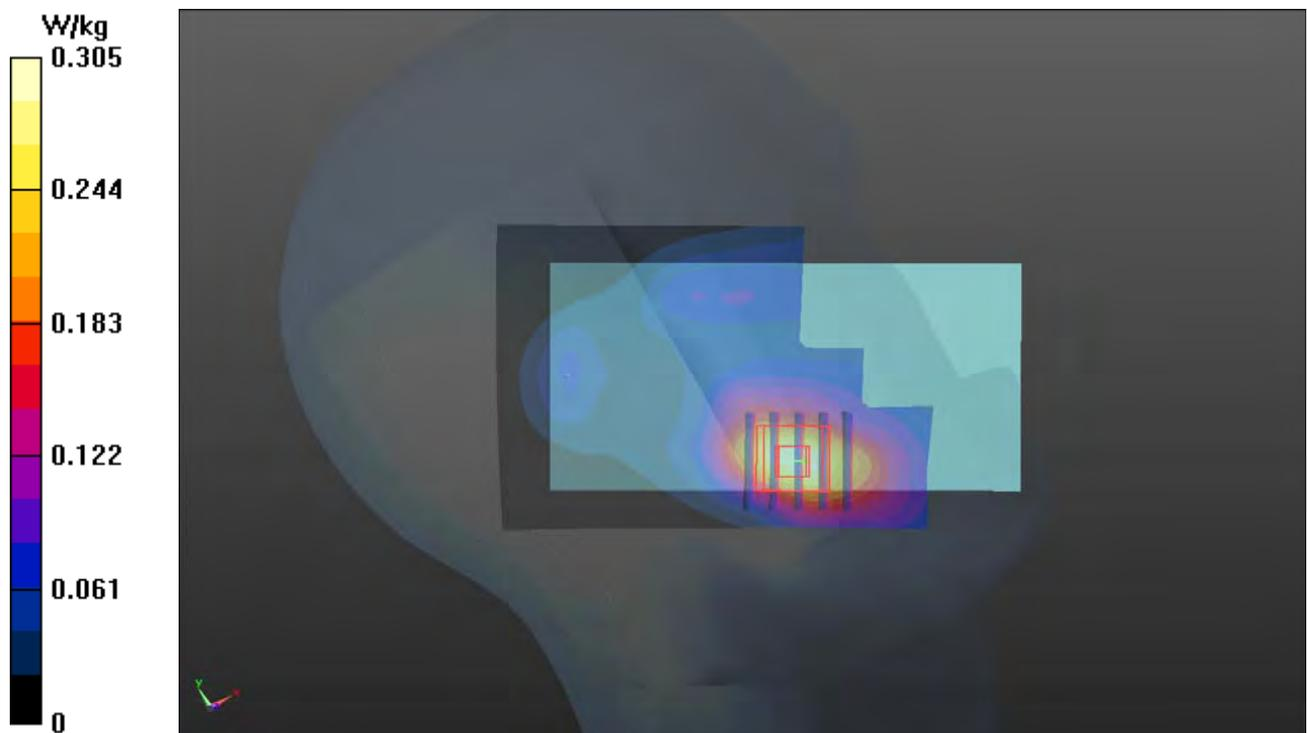

P08 LTE 5_QPSK10M_Right Cheek_Ch20525_1RB_OS0_Ant1

DUT: 18Q1-021

Communication System: LTE; Frequency: 836.5 MHz; Duty Cycle: 1:1

Medium: H07T10N1_0525 Medium parameters used: $f = 836.5 \text{ MHz}$; $\sigma = 0.919 \text{ S/m}$; $\epsilon_r = 41.663$; $\rho = 1000 \text{ kg/m}^3$

Ambient Temperature : $23.8 \text{ }^\circ\text{C}$; Liquid Temperature : $23.5 \text{ }^\circ\text{C}$

DASY5 Configuration:

- Probe: EX3DV4 - SN3971; ConvF(10.34, 10.34, 10.34); Calibrated: 2018/03/26;
- Sensor-Surface: 1.4mm (Mechanical Surface Detection)
- Electronics: DAE4 Sn1431; Calibrated: 2018/03/16
- Phantom: Twin SAM Phantom_1654; Type: QD000P40;
- Measurement SW: DASY52, Version 52.10 (1); SEMCAD X Version 14.6.11 (7439)

- **Area Scan (71x121x1):** Interpolated grid: $dx=1.500 \text{ mm}$, $dy=1.500 \text{ mm}$

Maximum value of SAR (interpolated) = 1.23 W/kg

- **Zoom Scan (5x5x7)/Cube 0:** Measurement grid: $dx=8\text{mm}$, $dy=8\text{mm}$, $dz=5\text{mm}$

Reference Value = 34.34 V/m ; Power Drift = 0.02 dB

Peak SAR (extrapolated) = 1.65 W/kg

SAR(1 g) = 0.884 W/kg ; SAR(10 g) = 0.521 W/kg

Maximum value of SAR (measured) = 1.33 W/kg

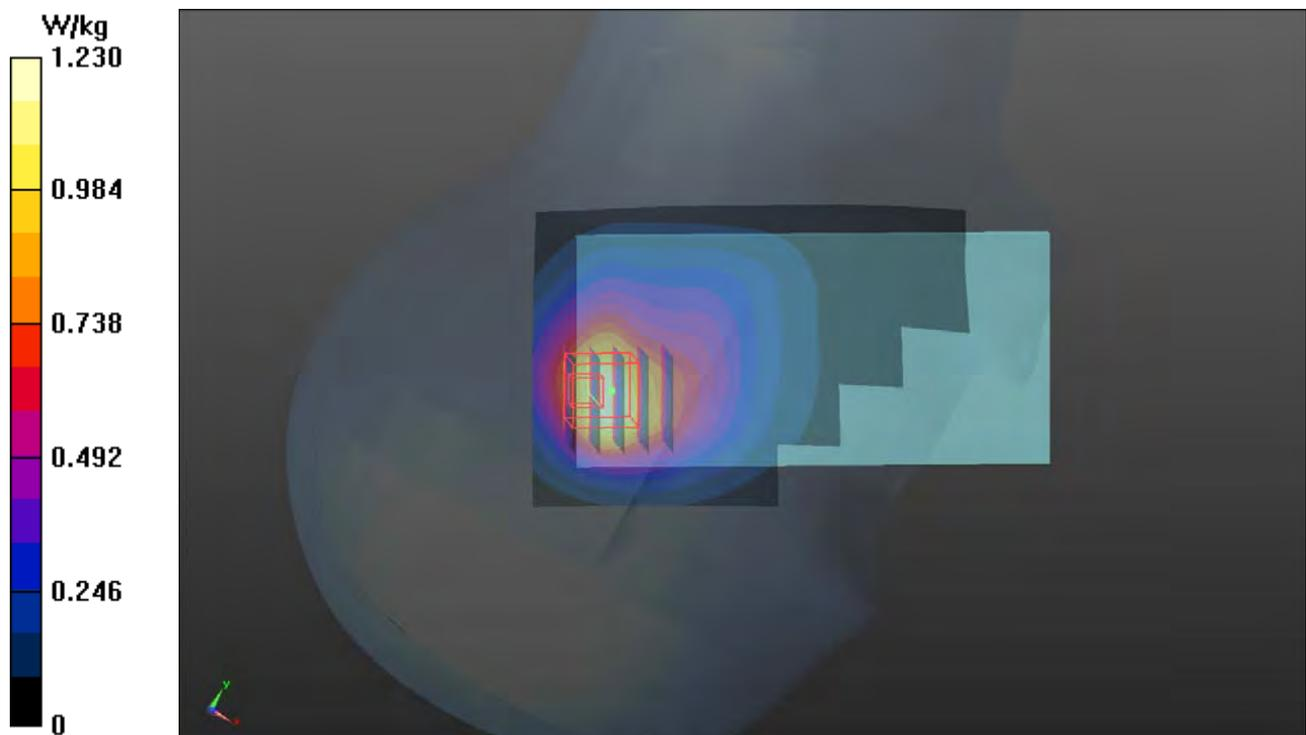

P09 LTE 7_QPSK20M_Right Cheek_Ch20850_1RB_OS0_Ant0

DUT: 18Q1-021

Communication System: LTE; Frequency: 2510 MHz; Duty Cycle: 1:1

Medium: H19T27N1_0531 Medium parameters used: $f = 2510$ MHz; $\sigma = 1.934$ S/m; $\epsilon_r = 38.1$; $\rho = 1000$ kg/m³

Ambient Temperature : 23.9 °C ; Liquid Temperature : 23.6 °C

DASY5 Configuration:

- Probe: EX3DV4 - SN3650; ConvF(7.55, 7.55, 7.55); Calibrated: 2017/07/24
- Sensor-Surface: 1.4mm (Mechanical Surface Detection)
- Electronics: DAE4 Sn1277; Calibrated: 2018/01/18
- Phantom: Twin SAM Phantom_1654; Type: QD000P40;
- Measurement SW: DASY52, Version 52.10 (1); SEMCAD X Version 14.6.11 (7439)

- **Area Scan (91x151x1):** Interpolated grid: dx=1.200 mm, dy=1.200 mm

Maximum value of SAR (interpolated) = 0.124 W/kg

- **Zoom Scan (5x5x7)/Cube 0:** Measurement grid: dx=8mm, dy=8mm, dz=5mm

Reference Value = 6.784 V/m; Power Drift = 0.09 dB

Peak SAR (extrapolated) = 0.107 W/kg

SAR(1 g) = 0.062 W/kg; SAR(10 g) = 0.033 W/kg

Maximum value of SAR (measured) = 0.0909 W/kg

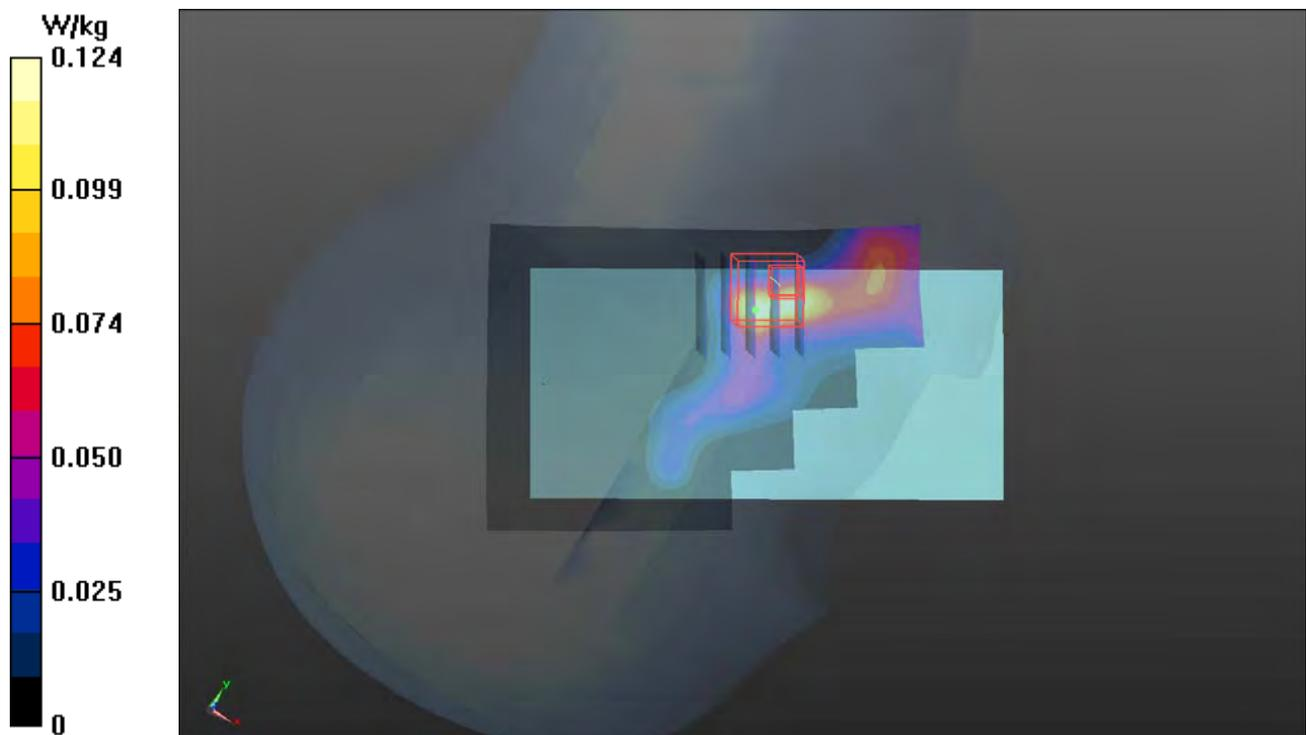

P10 LTE 12_QPSK10M_Left Tilted_Ch23095_1RB_OS0_Ant1

DUT: 18Q1-021

Communication System: LTE; Frequency: 707.5 MHz; Duty Cycle: 1:1

Medium: H06T09N1_0529 Medium parameters used: $f = 707.5 \text{ MHz}$; $\sigma = 0.851 \text{ S/m}$; $\epsilon_r = 42.153$; $\rho = 1000 \text{ kg/m}^3$

Ambient Temperature : $23.6 \text{ }^\circ\text{C}$; Liquid Temperature : $23.4 \text{ }^\circ\text{C}$

DASY5 Configuration:

- Probe: EX3DV4 - SN3971; ConvF(10.7, 10.7, 10.7); Calibrated: 2018/03/26
- Sensor-Surface: 1.4mm (Mechanical Surface Detection)
- Electronics: DAE4 Sn1431; Calibrated: 2018/03/16
- Phantom: Twin SAM Phantom_1654; Type: QD000P40;
- Measurement SW: DASY52, Version 52.10 (1); SEMCAD X Version 14.6.11 (7439)

- **Area Scan (71x121x1):** Interpolated grid: $dx=1.500 \text{ mm}$, $dy=1.500 \text{ mm}$

Maximum value of SAR (interpolated) = 0.627 W/kg

- **Zoom Scan (5x5x7)/Cube 0:** Measurement grid: $dx=8\text{mm}$, $dy=8\text{mm}$, $dz=5\text{mm}$

Reference Value = 25.35 V/m ; Power Drift = 0.14 dB

Peak SAR (extrapolated) = 1.68 W/kg

SAR(1 g) = 0.577 W/kg ; SAR(10 g) = 0.287 W/kg

Maximum value of SAR (measured) = 1.07 W/kg

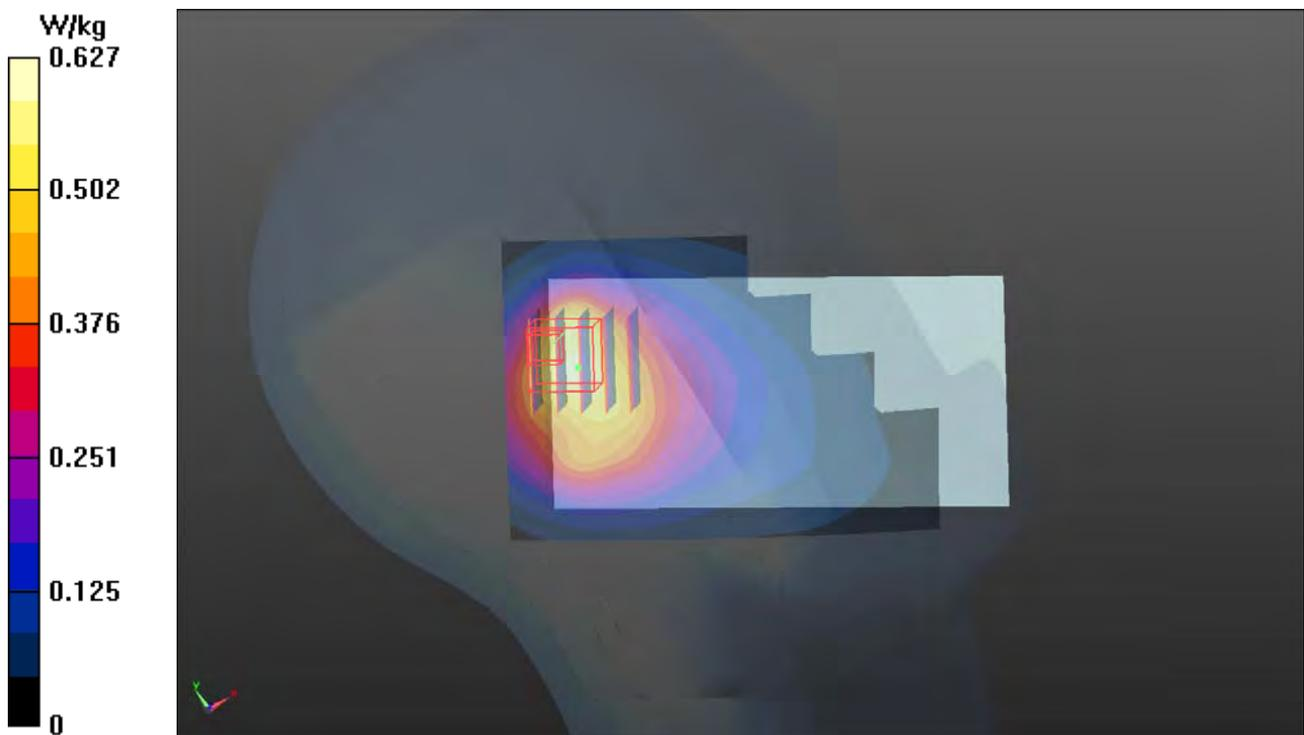

P11 LTE 13_QPSK10M_Right Cheek_Ch23230_1RB_OS0_Ant1

DUT: 18Q1-021

Communication System: LTE; Frequency: 782 MHz; Duty Cycle: 1:1

Medium: H06T09N1_0525 Medium parameters used: $f = 782 \text{ MHz}$; $\sigma = 0.931 \text{ S/m}$; $\epsilon_r = 42.994$; $\rho = 1000 \text{ kg/m}^3$

Ambient Temperature : $23.8 \text{ }^\circ\text{C}$; Liquid Temperature : $23.5 \text{ }^\circ\text{C}$

DASY5 Configuration:

- Probe: EX3DV4 - SN3971; ConvF(10.7, 10.7, 10.7); Calibrated: 2018/03/26;
- Sensor-Surface: 1.4mm (Mechanical Surface Detection)
- Electronics: DAE4 Sn1431; Calibrated: 2018/03/16
- Phantom: Twin SAM Phantom_1654; Type: QD000P40;
- Measurement SW: DASY52, Version 52.10 (1); SEMCAD X Version 14.6.11 (7439)

- **Area Scan (71x121x1):** Interpolated grid: $dx=1.500 \text{ mm}$, $dy=1.500 \text{ mm}$

Maximum value of SAR (interpolated) = 0.585 W/kg

- **Zoom Scan (5x5x7)/Cube 0:** Measurement grid: $dx=8\text{mm}$, $dy=8\text{mm}$, $dz=5\text{mm}$

Reference Value = 22.71 V/m ; Power Drift = 0.06 dB

Peak SAR (extrapolated) = 1.11 W/kg

SAR(1 g) = 0.537 W/kg ; SAR(10 g) = 0.272 W/kg

Maximum value of SAR (measured) = 0.850 W/kg

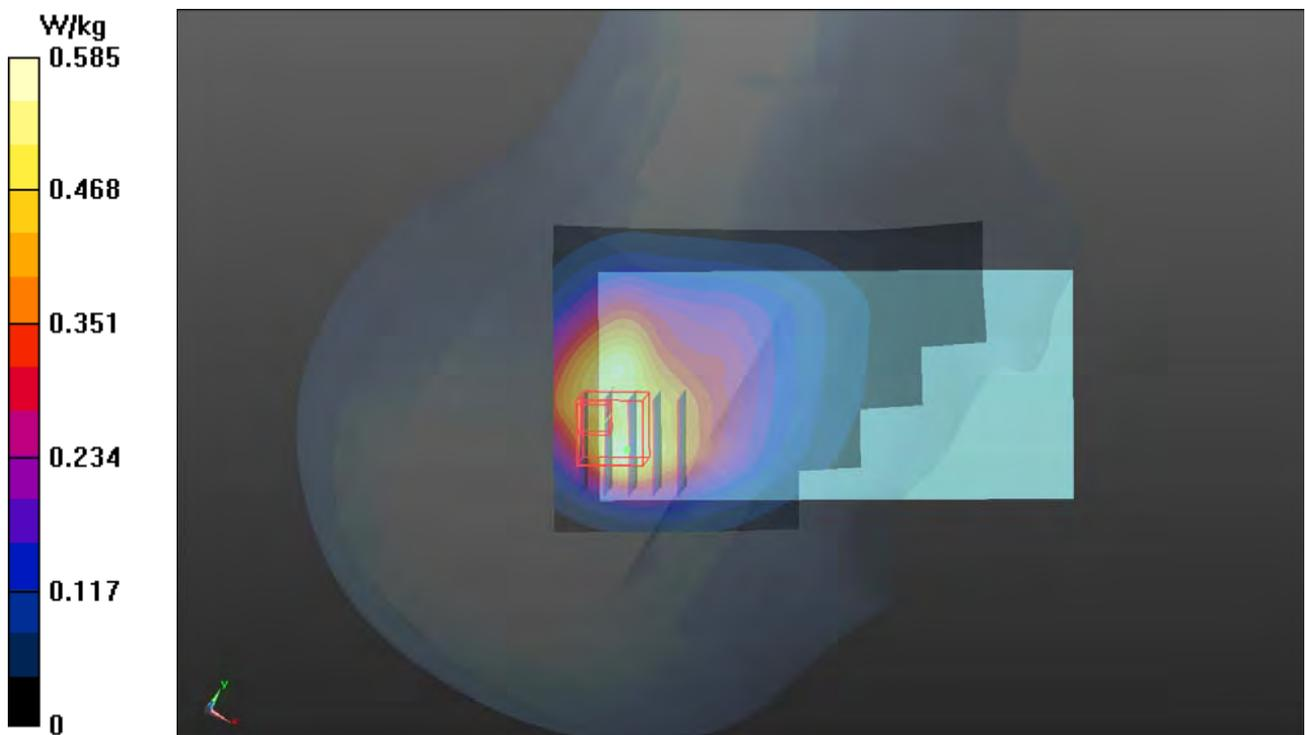

P12 LTE 17_QPSK10M_Right Cheek_Ch23780_1RB_OS0_Ant1

DUT: 18Q1-021

Communication System: LTE; Frequency: 709 MHz; Duty Cycle: 1:1

Medium: H06T09N1_0525 Medium parameters used: $f = 709 \text{ MHz}$; $\sigma = 0.863 \text{ S/m}$; $\epsilon_r = 43.915$; $\rho = 1000 \text{ kg/m}^3$

Ambient Temperature : $23.8 \text{ }^\circ\text{C}$; Liquid Temperature : $23.5 \text{ }^\circ\text{C}$

DASY5 Configuration:

- Probe: EX3DV4 - SN3971; ConvF(10.7, 10.7, 10.7); Calibrated: 2018/03/26
- Sensor-Surface: 1.4mm (Mechanical Surface Detection)
- Electronics: DAE4 Sn1431; Calibrated: 2018/03/16
- Phantom: Twin SAM Phantom_1654; Type: QD000P40;
- Measurement SW: DASY52, Version 52.10 (1); SEMCAD X Version 14.6.11 (7439)

- **Area Scan (71x121x1):** Interpolated grid: $dx=1.500 \text{ mm}$, $dy=1.500 \text{ mm}$

Maximum value of SAR (interpolated) = 1.21 W/kg

- **Zoom Scan (5x5x7)/Cube 0:** Measurement grid: $dx=8\text{mm}$, $dy=8\text{mm}$, $dz=5\text{mm}$

Reference Value = 32.83 V/m ; Power Drift = 0.11 dB

Peak SAR (extrapolated) = 1.79 W/kg

SAR(1 g) = 0.937 W/kg ; SAR(10 g) = 0.525 W/kg

Maximum value of SAR (measured) = 1.42 W/kg

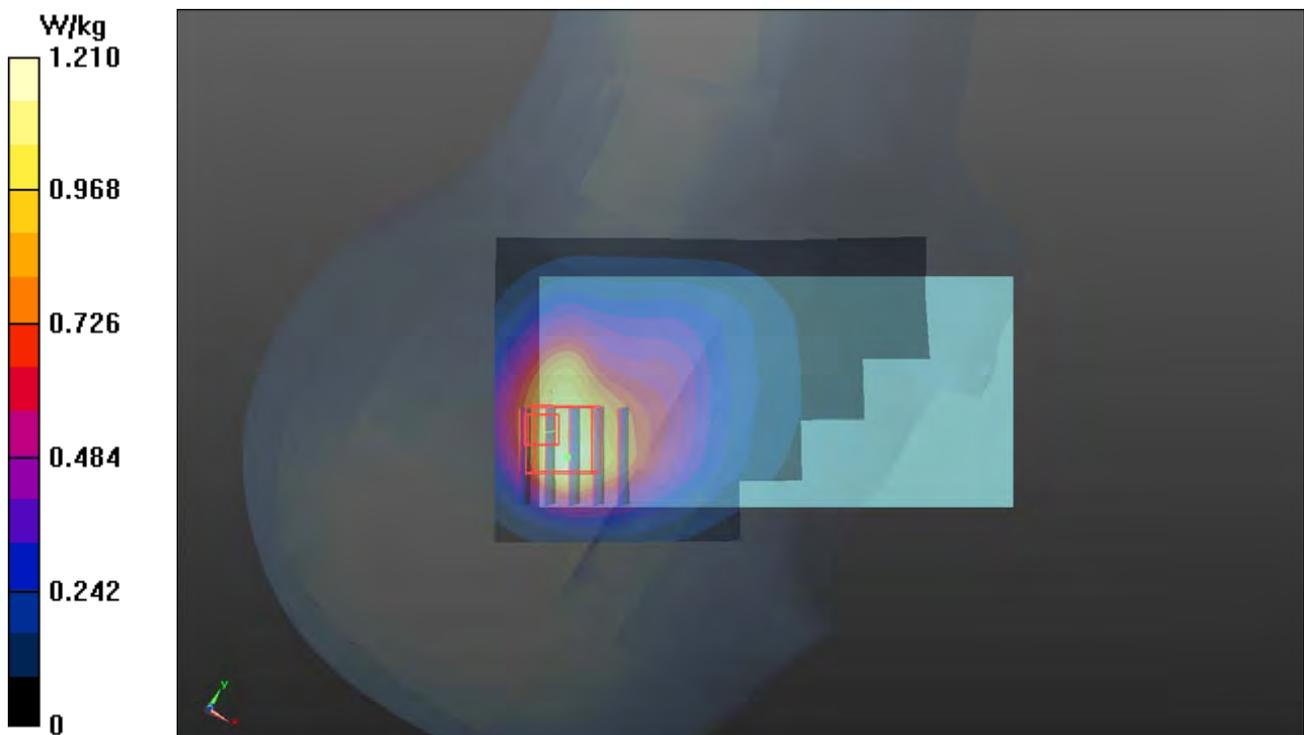

P13 LTE 38_QPSK20M_Right Cheek_Ch38000_1RB_OS0_Ant0

DUT: 18Q1-021

Communication System: LTE TDD CF0; Frequency: 2595 MHz; Duty Cycle: 1:1.58

Medium: H19T27N1_0531 Medium parameters used: $f = 2595$ MHz; $\sigma = 2.023$ S/m; $\epsilon_r = 37.818$; $\rho = 1000$ kg/m³

Ambient Temperature : 23.9 °C ; Liquid Temperature : 23.6 °C

DASY5 Configuration:

- Probe: EX3DV4 - SN3650; ConvF(7.55, 7.55, 7.55); Calibrated: 2017/07/24
- Sensor-Surface: 1.4mm (Mechanical Surface Detection)
- Electronics: DAE4 Sn1277; Calibrated: 2018/01/18
- Phantom: Twin SAM Phantom_1654; Type: QD000P40;
- Measurement SW: DASY52, Version 52.10 (1); SEMCAD X Version 14.6.11 (7439)

- **Area Scan (91x151x1):** Interpolated grid: dx=1.200 mm, dy=1.200 mm

Maximum value of SAR (interpolated) = 0.0910 W/kg

- **Zoom Scan (5x5x7)/Cube 0:** Measurement grid: dx=8mm, dy=8mm, dz=5mm

Reference Value = 5.573 V/m; Power Drift = 0.10 dB

Peak SAR (extrapolated) = 0.0780 W/kg

SAR(1 g) = 0.045 W/kg; SAR(10 g) = 0.024 W/kg

Maximum value of SAR (measured) = 0.0654 W/kg

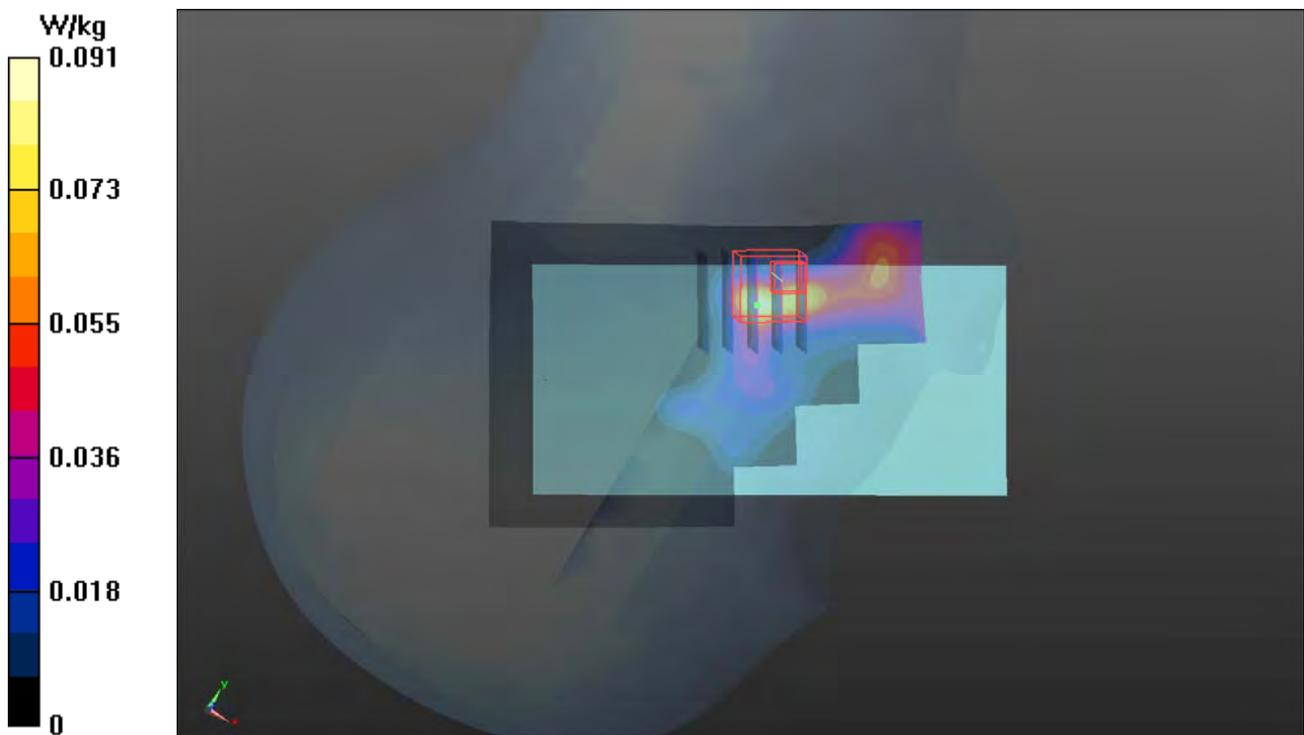

P14 LTE 41_QPSK20M_Right Cheek_Ch41140_1RB_OS0_Ant0

DUT: 18Q1-021

Communication System: LTE TDD CF0; Frequency: 2645 MHz; Duty Cycle: 1:1.58

Medium: H19T27N1_0829 Medium parameters used: $f = 2645$ MHz; $\sigma = 2.103$ S/m; $\epsilon_r = 37.076$; $\rho =$

1000 kg/m³

Ambient Temperature : 23.7 °C ; Liquid Temperature : 23.5 °C

DASY5 Configuration:

- Probe: EX3DV4 - SN3650; ConvF(7.48, 7.48, 7.48); Calibrated: 2018/07/27
- Sensor-Surface: 1.4mm (Mechanical Surface Detection)
- Electronics: DAE4 Sn1232; Calibrated: 2018/05/22
- Phantom: Twin SAM Phantom_1496; Type: QD000P40CA;
- Measurement SW: DASY52, Version 52.10 (1); SEMCAD X Version 14.6.11 (7439)

- **Area Scan (91x151x1):** Interpolated grid: $dx=1.200$ mm, $dy=1.200$ mm

Maximum value of SAR (interpolated) = 0.0939 W/kg

- **Zoom Scan (5x5x7)/Cube 0:** Measurement grid: $dx=8$ mm, $dy=8$ mm, $dz=5$ mm

Reference Value = 6.431 V/m; Power Drift = -0.16 dB

Peak SAR (extrapolated) = 0.0950 W/kg

SAR(1 g) = 0.048 W/kg; SAR(10 g) = 0.027 W/kg

Maximum value of SAR (measured) = 0.0738 W/kg

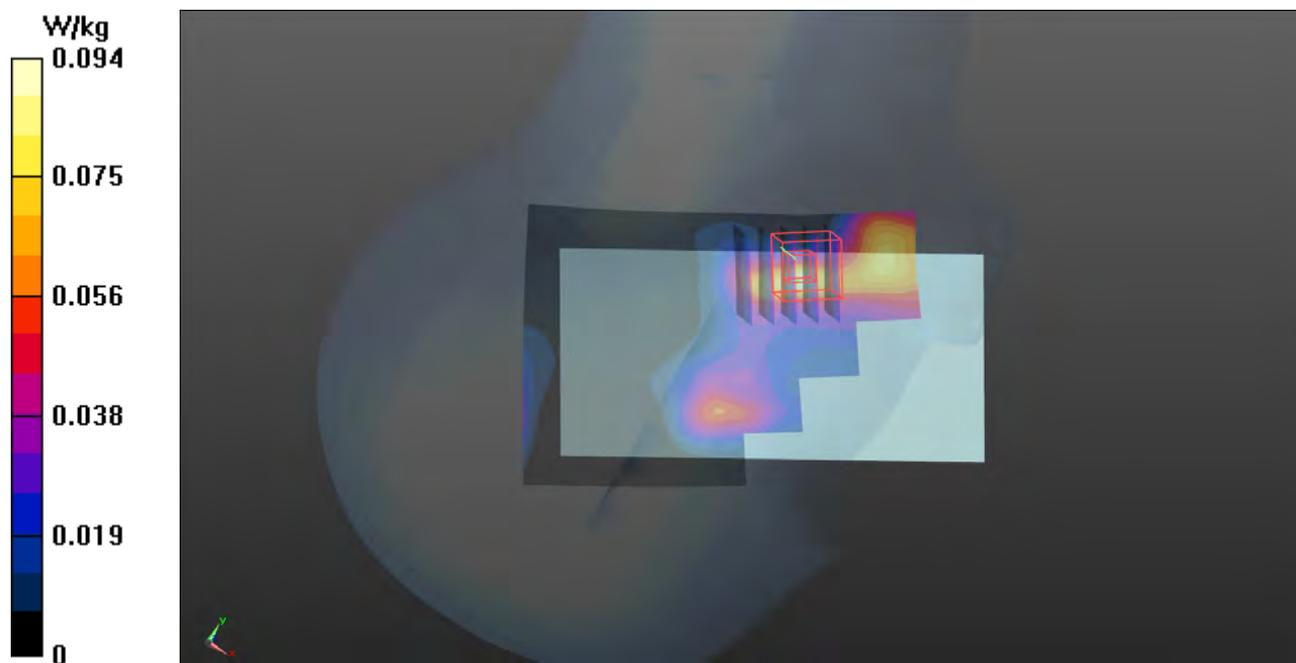

P15 LTE 66_QPSK20M_Left Cheek_Ch132072_1RB_OS0_Ant0

DUT: 180523C09

Communication System: LTE; Frequency: 1720 MHz; Duty Cycle: 1:1

Medium: H16T20N1_0906 Medium parameters used: $f = 1720$ MHz; $\sigma = 1.301$ S/m; $\epsilon_r = 40.451$; $\rho = 1000$ kg/m³

Ambient Temperature : 23.7 °C ; Liquid Temperature : 23.2 °C

DASY5 Configuration:

- Probe: EX3DV4 - SN3971; ConvF(8.9, 8.9, 8.9); Calibrated: 2018/03/26
- Sensor-Surface: 1.4mm (Mechanical Surface Detection)
- Electronics: DAE4 Sn1431; Calibrated: 2018/03/16
- Phantom: Twin SAM Phantom_1654; Type: QD000P40;
- Measurement SW: DASY52, Version 52.10 (1); SEMCAD X Version 14.6.11 (7439)

- **Area Scan (71x121x1):** Interpolated grid: dx=1.500 mm, dy=1.500 mm

Maximum value of SAR (interpolated) = 0.308 W/kg

- **Zoom Scan (5x5x7)/Cube 0:** Measurement grid: dx=8mm, dy=8mm, dz=5mm

Reference Value = 15.47 V/m; Power Drift = -0.11 dB

Peak SAR (extrapolated) = 0.325 W/kg

SAR(1 g) = 0.215 W/kg; SAR(10 g) = 0.136 W/kg

Maximum value of SAR (measured) = 0.289 W/kg

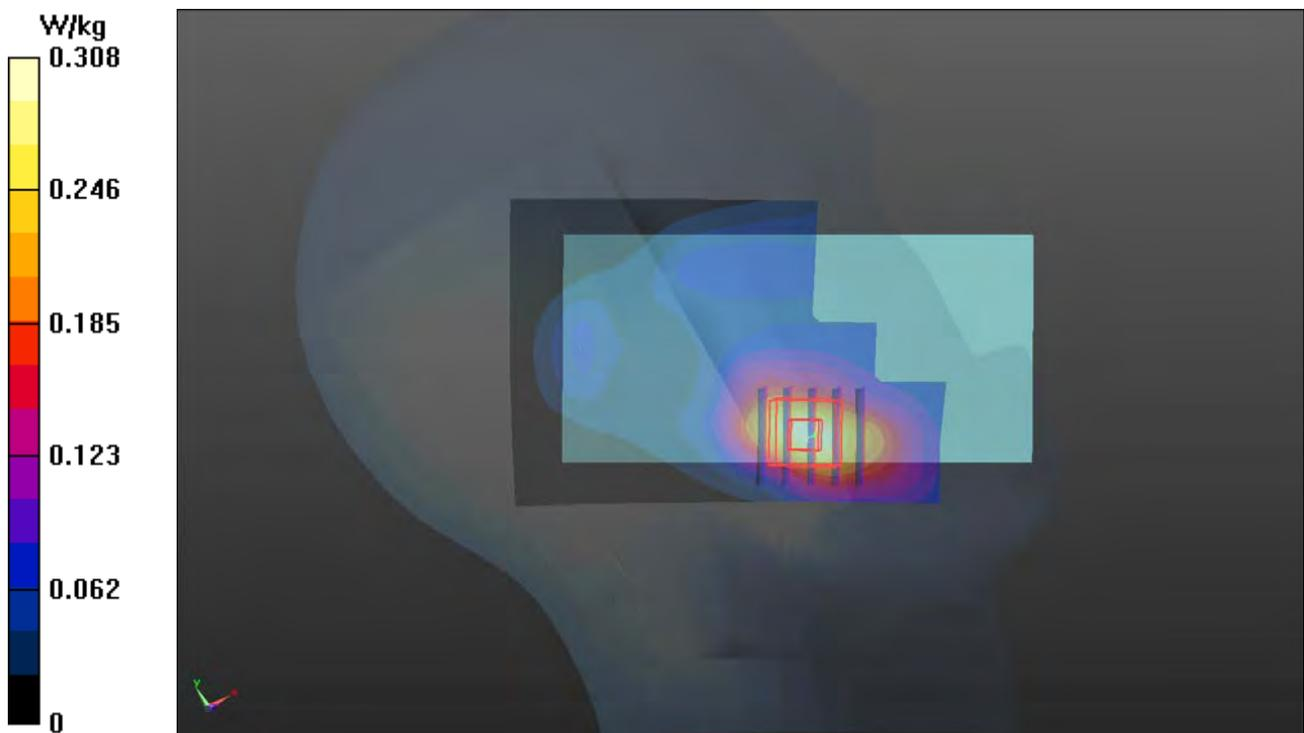

P16 WLAN2.4G_802.11n HT40_Left Cheek_Ch3_Ant 0+1

DUT: 18Q1-021

Communication System: WLAN_2.4G; Frequency: 2422 MHz; Duty Cycle: 1:1

Medium: H19T27N1_0530 Medium parameters used: $f = 2422$ MHz; $\sigma = 1.812$ S/m; $\epsilon_r = 38.719$; $\rho =$

1000 kg/m³

Ambient Temperature : 23.6 °C ; Liquid Temperature : 23.3 °C

DASY5 Configuration:

- Probe: EX3DV4 - SN3650; ConvF(7.58, 7.58, 7.58); Calibrated: 2017/07/24

- Sensor-Surface: 1.4mm (Mechanical Surface Detection)

- Electronics: DAE4 Sn1277; Calibrated: 2018/01/18

- Phantom: Twin SAM Phantom_1654; Type: QD000P40;

- Measurement SW: DASY52, Version 52.10 (1); SEMCAD X Version 14.6.11 (7439)

- **Area Scan (91x151x1):** Interpolated grid: $dx=1.200$ mm, $dy=1.200$ mm

Maximum value of SAR (interpolated) = 0.857 W/kg

- **Zoom Scan (5x5x7)/Cube 0:** Measurement grid: $dx=8$ mm, $dy=8$ mm, $dz=5$ mm

Reference Value = 18.65 V/m; Power Drift = 0.15 dB

Peak SAR (extrapolated) = 1.12 W/kg

SAR(1 g) = 0.507 W/kg; SAR(10 g) = 0.230 W/kg

Maximum value of SAR (measured) = 0.839 W/kg

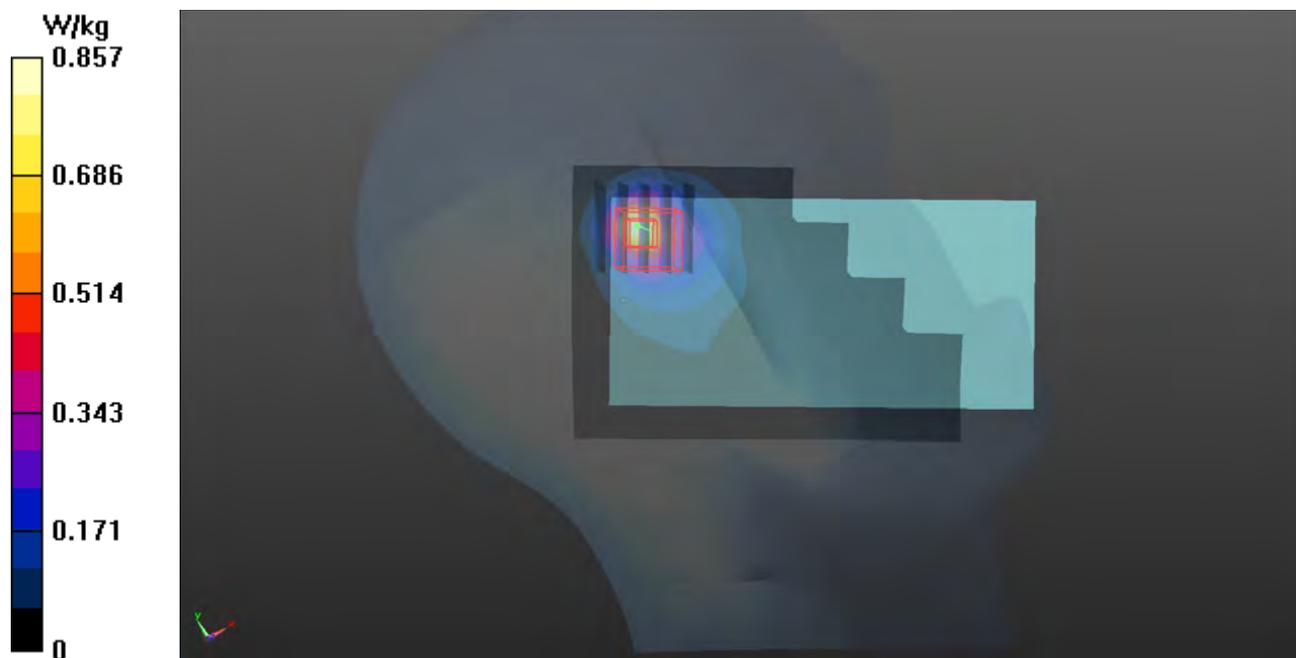

P17 WLAN5G_802.11ac VHT80_Left Cheek_Ch58_Ant 0

DUT: 18Q1-021

Communication System: WLAN_5G; Frequency: 5290 MHz; Duty Cycle: 1:1

Medium: H34T60N2_0601 Medium parameters used: $f = 5290$ MHz; $\sigma = 4.57$ S/m; $\epsilon_r = 34.442$; $\rho = 1000$ kg/m³

Ambient Temperature : 23.7 °C ; Liquid Temperature : 23.4 °C

DASY5 Configuration:

- Probe: EX3DV4 - SN3650; ConvF(5.6, 5.6, 5.6); Calibrated: 2017/07/24
- Sensor-Surface: 1.4mm (Mechanical Surface Detection)
- Electronics: DAE4 Sn1277; Calibrated: 2018/01/18
- Phantom: Twin SAM Phantom_1654; Type: QD000P40;
- Measurement SW: DASY52, Version 52.10 (1); SEMCAD X Version 14.6.11 (7439)

- **Area Scan (101x181x1):** Interpolated grid: dx=1.000 mm, dy=1.000 mm

Maximum value of SAR (interpolated) = 0.848 W/kg

- **Zoom Scan (6x6x12)/Cube 0:** Measurement grid: dx=5mm, dy=5mm, dz=2mm

Reference Value = 12.14 V/m; Power Drift = 0.12 dB

Peak SAR (extrapolated) = 1.56 W/kg

SAR(1 g) = 0.308 W/kg; SAR(10 g) = 0.087 W/kg

Maximum value of SAR (measured) = 0.768 W/kg

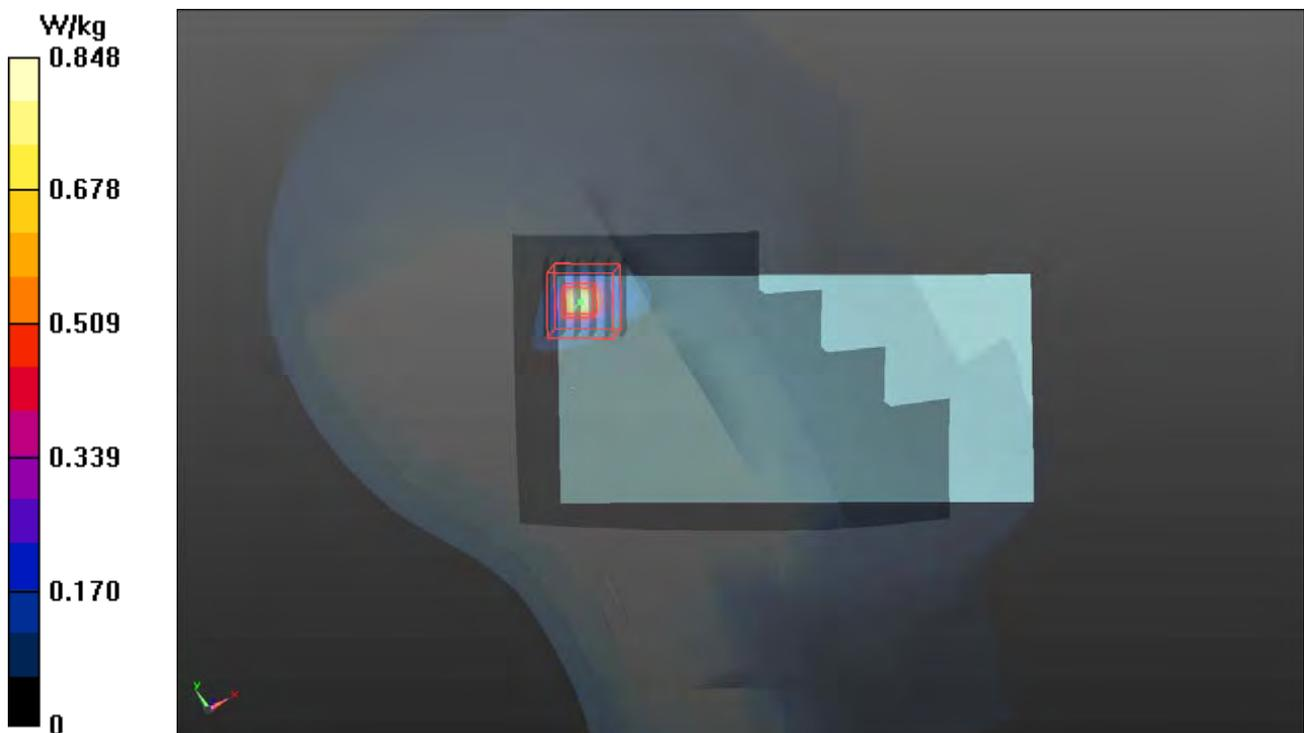

P18 WLAN5G_802.11a_Left Cheek_Ch116_Ant 1

DUT: 18Q1-021

Communication System: WLAN_5G; Frequency: 5580 MHz; Duty Cycle: 1:1

Medium: H34T60N2_0529 Medium parameters used: $f = 5580$ MHz; $\sigma = 5.116$ S/m; $\epsilon_r = 34.648$; $\rho = 1000$ kg/m³

Ambient Temperature : 23.6 °C ; Liquid Temperature : 23.4 °C

DASY5 Configuration:

- Probe: EX3DV4 - SN3650; ConvF(4.9, 4.9, 4.9); Calibrated: 2017/07/24
- Sensor-Surface: 1.4mm (Mechanical Surface Detection)
- Electronics: DAE4 Sn1277; Calibrated: 2018/01/18
- Phantom: Twin SAM Phantom_1654; Type: QD000P40;
- Measurement SW: DASY52, Version 52.10 (1); SEMCAD X Version 14.6.11 (7439)

- **Area Scan (101x181x1):** Interpolated grid: dx=1.000 mm, dy=1.000 mm

Maximum value of SAR (interpolated) = 0.270 W/kg

- **Zoom Scan (6x6x12)/Cube 0:** Measurement grid: dx=5mm, dy=5mm, dz=2mm

Reference Value = 7.163 V/m; Power Drift = 0.06 dB

Peak SAR (extrapolated) = 0.430 W/kg

SAR(1 g) = 0.122 W/kg; SAR(10 g) = 0.030 W/kg

Maximum value of SAR (measured) = 0.328 W/kg

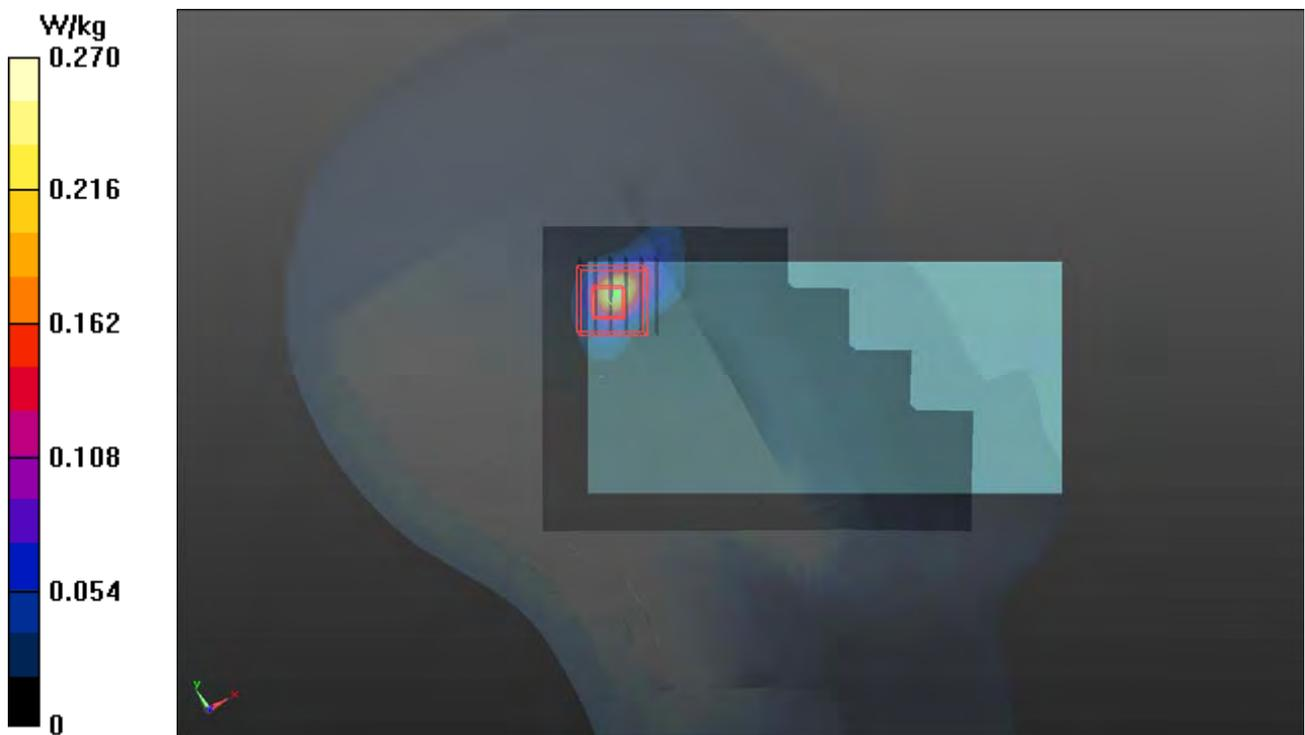

P19 WLAN5G_802.11ac VHT80_Left Cheek_Ch155_Ant 0

DUT: 18Q1-021

Communication System: WLAN_5G; Frequency: 5775 MHz; Duty Cycle: 1:1

Medium: H34T60N2_0601 Medium parameters used: $f = 5775$ MHz; $\sigma = 5.048$ S/m; $\epsilon_r = 33.745$; $\rho = 1000$ kg/m³

Ambient Temperature : 23.7 °C ; Liquid Temperature : 23.4 °C

DASY5 Configuration:

- Probe: EX3DV4 - SN3650; ConvF(4.94, 4.94, 4.94); Calibrated: 2017/07/24
- Sensor-Surface: 1.4mm (Mechanical Surface Detection)
- Electronics: DAE4 Sn1277; Calibrated: 2018/01/18
- Phantom: Twin SAM Phantom_1654; Type: QD000P40;
- Measurement SW: DASY52, Version 52.10 (1); SEMCAD X Version 14.6.11 (7439)

- **Area Scan (101x181x1):** Interpolated grid: dx=1.000 mm, dy=1.000 mm
Maximum value of SAR (interpolated) = 1.05 W/kg

- **Zoom Scan (6x6x12)/Cube 0:** Measurement grid: dx=5mm, dy=5mm, dz=2mm
Reference Value = 12.77 V/m; Power Drift = 0.05 dB
Peak SAR (extrapolated) = 1.58 W/kg
SAR(1 g) = 0.323 W/kg; SAR(10 g) = 0.078 W/kg
Maximum value of SAR (measured) = 0.925 W/kg

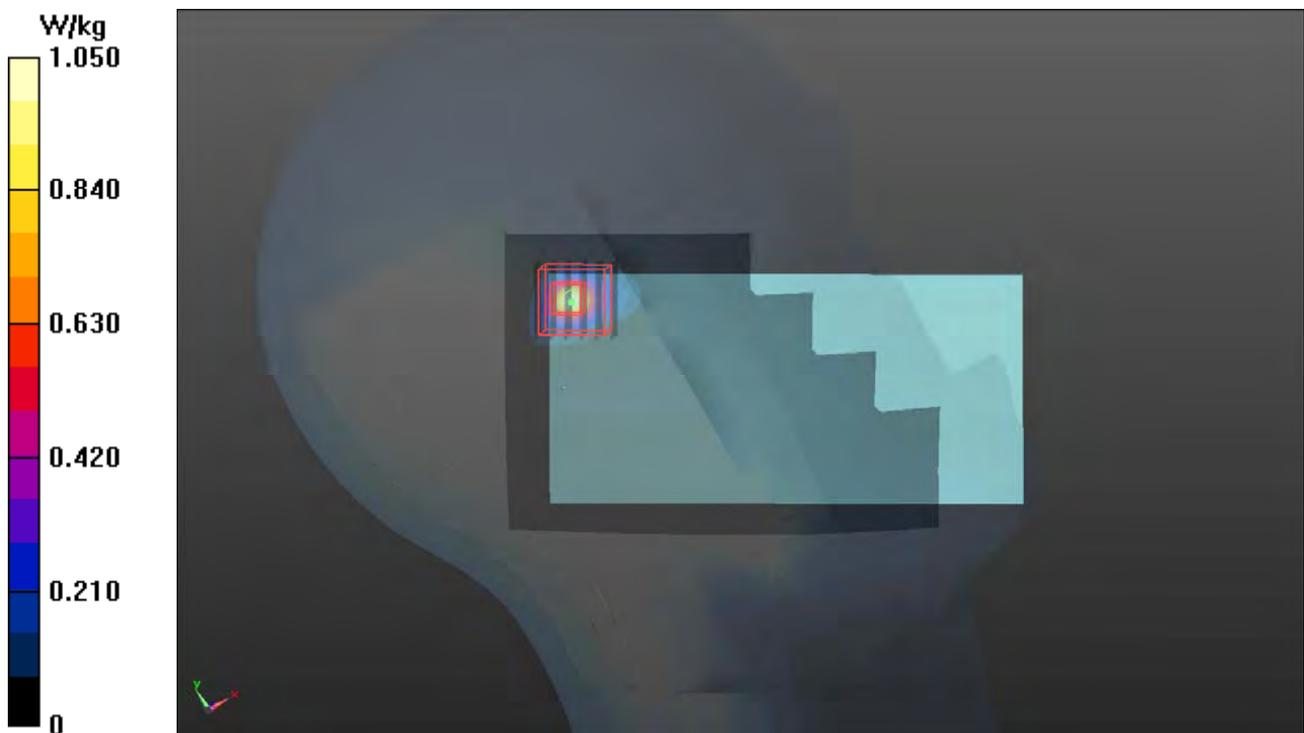

P20 BT_BR_EDR_Left Cheek_Ch0_Ant0

DUT: 18Q1-021

Communication System: BT; Frequency: 2402 MHz; Duty Cycle: 1:1

Medium: H19T27N1_0531 Medium parameters used: $f = 2402$ MHz; $\sigma = 1.824$ S/m; $\epsilon_r = 38.54$; $\rho = 1000$ kg/m³

Ambient Temperature : 23.9 °C ; Liquid Temperature : 23.6 °C

DASY5 Configuration:

- Probe: EX3DV4 - SN3650; ConvF(7.58, 7.58, 7.58); Calibrated: 2017/07/24
- Sensor-Surface: 1.4mm (Mechanical Surface Detection)
- Electronics: DAE4 Sn1277; Calibrated: 2018/01/18
- Phantom: Twin SAM Phantom_1654; Type: QD000P40;
- Measurement SW: DASY52, Version 52.10 (1); SEMCAD X Version 14.6.11 (7439)

- **Area Scan (91x151x1):** Interpolated grid: dx=1.200 mm, dy=1.200 mm

Maximum value of SAR (interpolated) = 0.114 W/kg

- **Zoom Scan (5x5x7)/Cube 0:** Measurement grid: dx=8mm, dy=8mm, dz=5mm

Reference Value = 5.034 V/m; Power Drift = -0.08 dB

Peak SAR (extrapolated) = 0.0320 W/kg

SAR(1 g) = 0.015 W/kg; SAR(10 g) = 0.0072 W/kg

Maximum value of SAR (measured) = 0.0276 W/kg

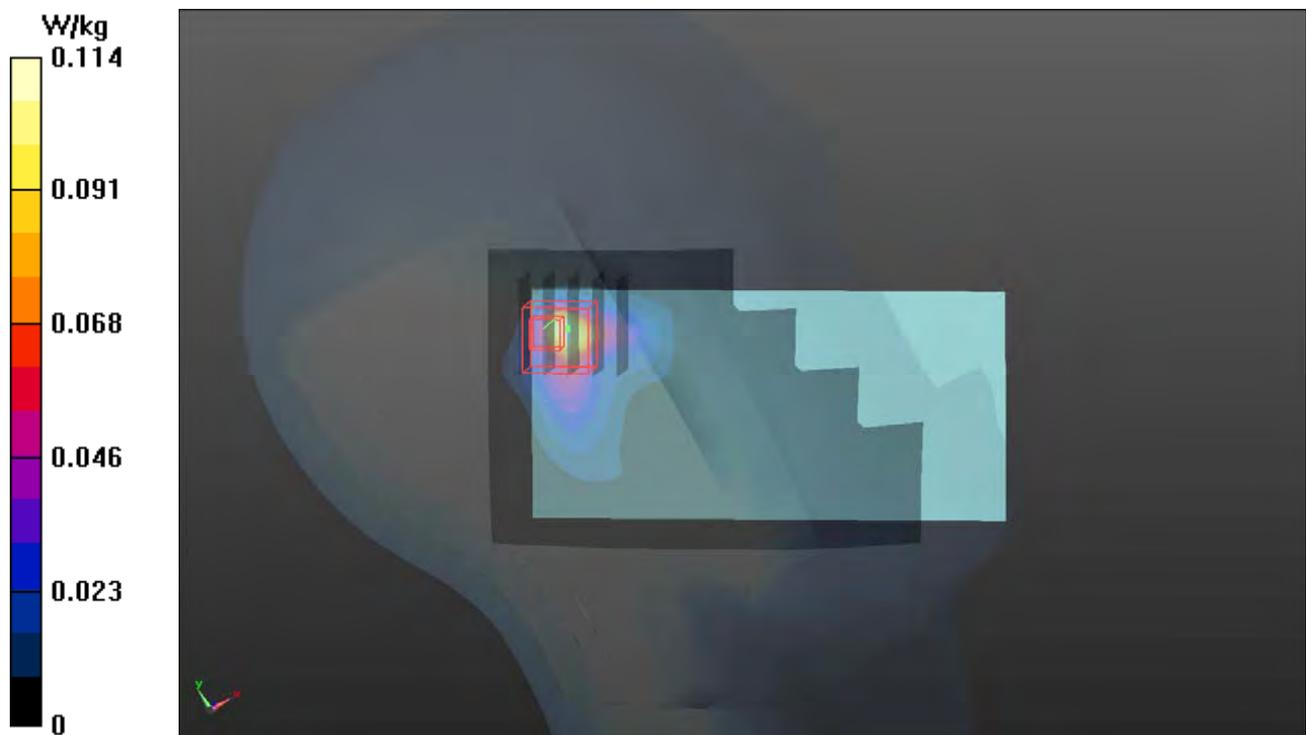

P21 GSM850_GPRS11_Front Face_15mm_Ch251_Ant0

DUT: 18Q1-021

Communication System: GPRS11; Frequency: 848.8 MHz; Duty Cycle: 1:2.67

Medium: B07T10N1_0531 Medium parameters used: $f = 849$ MHz; $\sigma = 1.028$ S/m; $\epsilon_r = 55.869$; $\rho = 1000$ kg/m³

Ambient Temperature : 23.8 °C ; Liquid Temperature : 23.5 °C

DASY5 Configuration:

- Probe: EX3DV4 - SN3650; ConvF(9.76, 9.76, 9.76); Calibrated: 2017/07/24
- Sensor-Surface: 1.4mm (Mechanical Surface Detection)
- Electronics: DAE4 Sn1277; Calibrated: 2018/01/18
- Phantom: Twin SAM Phantom_1822; Type: QD000P40CD;
- Measurement SW: DASY52, Version 52.10 (1); SEMCAD X Version 14.6.11 (7439)

- **Area Scan (71x121x1):** Interpolated grid: dx=1.500 mm, dy=1.500 mm

Maximum value of SAR (interpolated) = 0.271 W/kg

- **Zoom Scan (5x5x7)/Cube 0:** Measurement grid: dx=8mm, dy=8mm, dz=5mm

Reference Value = 15.78 V/m; Power Drift = -0.12 dB

Peak SAR (extrapolated) = 0.287 W/kg

SAR(1 g) = 0.208 W/kg; SAR(10 g) = 0.153 W/kg

Maximum value of SAR (measured) = 0.258 W/kg

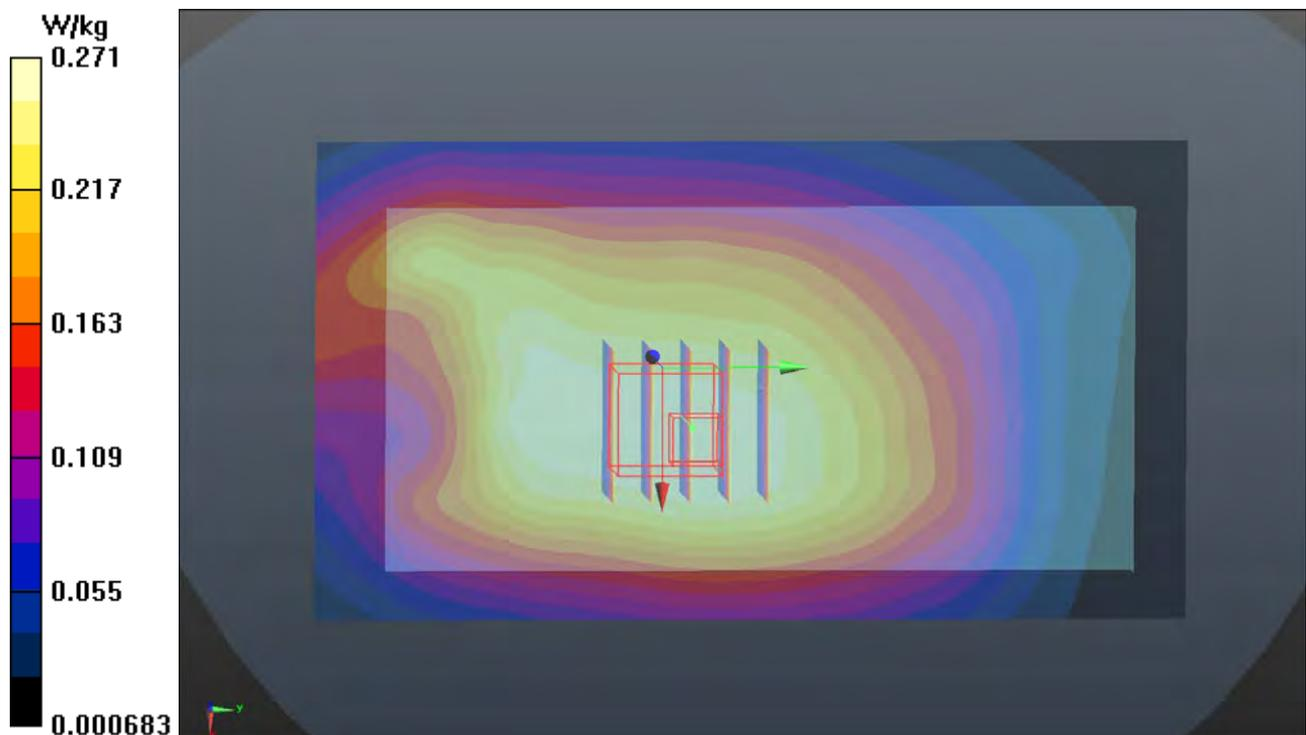

P22 GSM1900_GPRS12_Rear Face_15mm_Ch512_Ant0

DUT: 18Q1-021

Communication System: GPRS12; Frequency: 1850.2 MHz; Duty Cycle: 1:2

Medium: B16T20N1_0604 Medium parameters used: $f = 1850.2$ MHz; $\sigma = 1.534$ S/m; $\epsilon_r = 52.298$; $\rho = 1000$ kg/m³

Ambient Temperature : 23.5 °C ; Liquid Temperature : 23.2 °C

DASY5 Configuration:

- Probe: EX3DV4 - SN3820; ConvF(7.62, 7.62, 7.62); Calibrated: 2017/06/27
- Sensor-Surface: 1.4mm (Mechanical Surface Detection)
- Electronics: DAE4 Sn917; Calibrated: 2017/12/14
- Phantom: Twin SAM Phantom_1496; Type: QD000P40CA;
- Measurement SW: DASY52, Version 52.10 (1); SEMCAD X Version 14.6.11 (7439)

- **Area Scan (71x141x1):** Interpolated grid: dx=1.500 mm, dy=1.500 mm

Maximum value of SAR (interpolated) = 0.505 W/kg

- **Zoom Scan (5x5x7)/Cube 0:** Measurement grid: dx=8mm, dy=8mm, dz=5mm

Reference Value = 17.58 V/m; Power Drift = 0.02 dB

Peak SAR (extrapolated) = 0.680 W/kg

SAR(1 g) = 0.410 W/kg; SAR(10 g) = 0.235 W/kg

Maximum value of SAR (measured) = 0.551 W/kg

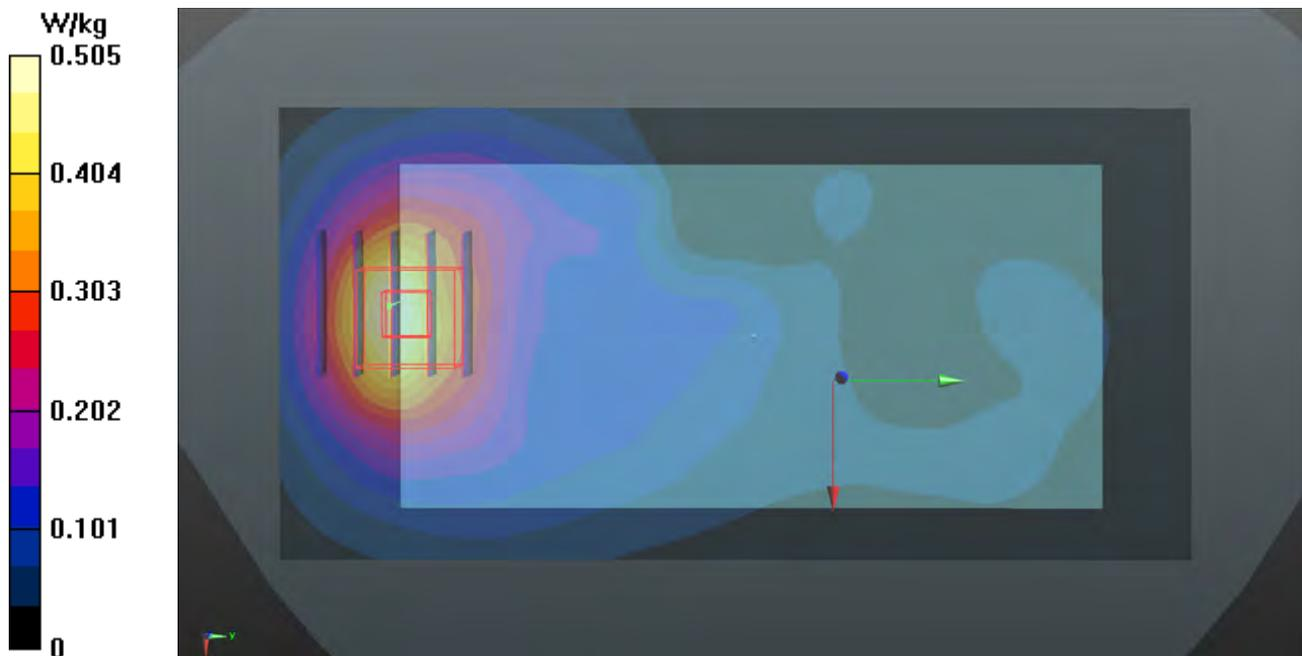

P23 WCDMA II_RMC12.2K_Rear Face_15mm_Ch9262_Ant0

DUT: 18Q1-021

Communication System: WCDMA; Frequency: 1852.4 MHz; Duty Cycle: 1:1
Medium: B16T20N1_0604 Medium parameters used: $f = 1852.4 \text{ MHz}$; $\sigma = 1.536 \text{ S/m}$; $\epsilon_r = 52.289$; $\rho = 1000 \text{ kg/m}^3$
Ambient Temperature : $23.5 \text{ }^\circ\text{C}$; Liquid Temperature : $23.2 \text{ }^\circ\text{C}$

DASY5 Configuration:

- Probe: EX3DV4 - SN3820; ConvF(7.62, 7.62, 7.62); Calibrated: 2017/06/27;
- Sensor-Surface: 1.4mm (Mechanical Surface Detection)
- Electronics: DAE4 Sn917; Calibrated: 2017/12/14
- Phantom: Twin SAM Phantom_1496; Type: QD000P40CA;
- Measurement SW: DASY52, Version 52.10 (1); SEMCAD X Version 14.6.11 (7439)

- **Area Scan (71x141x1):** Interpolated grid: $dx=1.500 \text{ mm}$, $dy=1.500 \text{ mm}$
Maximum value of SAR (interpolated) = 0.926 W/kg

- **Zoom Scan (5x5x7)/Cube 0:** Measurement grid: $dx=8\text{mm}$, $dy=8\text{mm}$, $dz=5\text{mm}$
Reference Value = 24.54 V/m ; Power Drift = -0.05 dB
Peak SAR (extrapolated) = 1.19 W/kg
SAR(1 g) = 0.705 W/kg ; SAR(10 g) = 0.412 W/kg
Maximum value of SAR (measured) = 0.989 W/kg

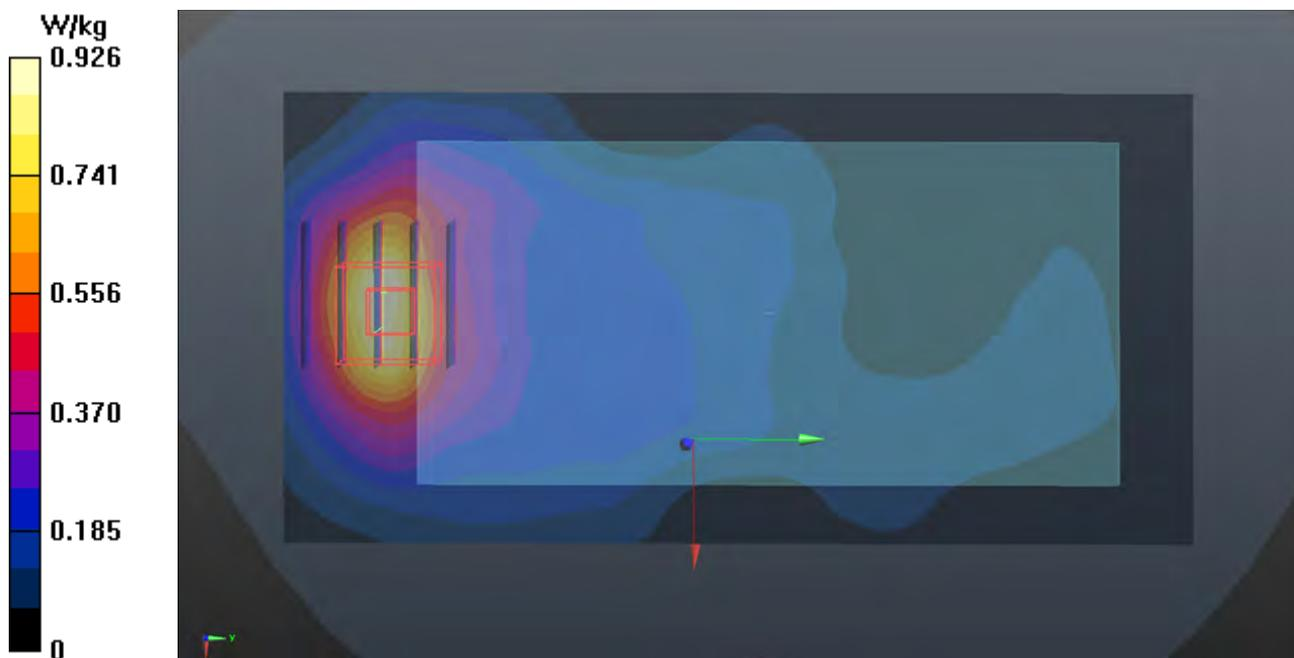

P24 WCDMA IV_RMC12.2K_Front Face_15mm_Ch1312_Ant0

DUT: 18Q1-021

Communication System: WCDMA; Frequency: 1712.4 MHz; Duty Cycle: 1:1

Medium: B16T20N1_0604 Medium parameters used: $f = 1712.4$ MHz; $\sigma = 1.402$ S/m; $\epsilon_r = 52.674$; $\rho = 1000$ kg/m³

Ambient Temperature : 23.5 °C ; Liquid Temperature : 23.2 °C

DASY5 Configuration:

- Probe: EX3DV4 - SN3820; ConvF(7.77, 7.77, 7.77); Calibrated: 2017/06/27
- Sensor-Surface: 1.4mm (Mechanical Surface Detection)
- Electronics: DAE4 Sn917; Calibrated: 2017/12/14
- Phantom: Twin SAM Phantom_1496; Type: QD000P40CA;
- Measurement SW: DASY52, Version 52.10 (1); SEMCAD X Version 14.6.11 (7439)

- **Area Scan (71x141x1)**: Interpolated grid: dx=1.500 mm, dy=1.500 mm

Maximum value of SAR (interpolated) = 0.917 W/kg

- **Zoom Scan (5x5x7)/Cube 0**: Measurement grid: dx=8mm, dy=8mm, dz=5mm

Reference Value = 24.36 V/m; Power Drift = 0.11 dB

Peak SAR (extrapolated) = 1.26 W/kg

SAR(1 g) = 0.790 W/kg; SAR(10 g) = 0.466 W/kg

Maximum value of SAR (measured) = 1.03 W/kg

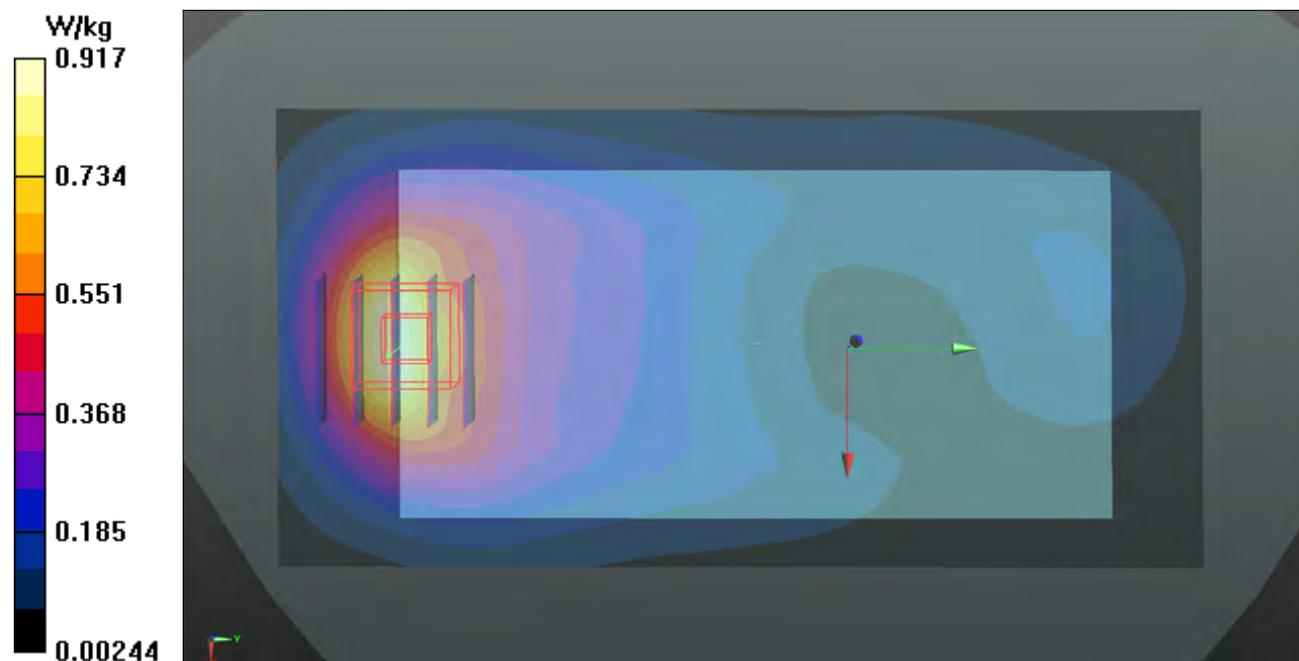

P25 WCDMA V_RMC12.2K_Rear Face_15mm_Ch4182_Ant0

DUT: 18Q1-021

Communication System: WCDMA; Frequency: 836.4 MHz; Duty Cycle: 1:1

Medium: B07T10N1_0606 Medium parameters used: $f = 836.4 \text{ MHz}$; $\sigma = 0.995 \text{ S/m}$; $\epsilon_r = 54.642$; $\rho = 1000 \text{ kg/m}^3$

Ambient Temperature : $23.6 \text{ }^\circ\text{C}$; Liquid Temperature : $23.3 \text{ }^\circ\text{C}$

DASY5 Configuration:

- Probe: EX3DV4 - SN3971; ConvF(10.15, 10.15, 10.15); Calibrated: 2018/03/26
- Sensor-Surface: 1.4mm (Mechanical Surface Detection)
- Electronics: DAE4 Sn1431; Calibrated: 2018/03/16
- Phantom: Twin SAM Phantom_1822; Type: QD000P40CD;
- Measurement SW: DASY52, Version 52.10 (1); SEMCAD X Version 14.6.11 (7439)

- **Area Scan (71x121x1)**: Interpolated grid: $dx=1.500 \text{ mm}$, $dy=1.500 \text{ mm}$

Maximum value of SAR (interpolated) = 0.252 W/kg

- **Zoom Scan (5x5x7)/Cube 0**: Measurement grid: $dx=8\text{mm}$, $dy=8\text{mm}$, $dz=5\text{mm}$

Reference Value = 15.20 V/m ; Power Drift = -0.02 dB

Peak SAR (extrapolated) = 0.279 W/kg

SAR(1 g) = 0.199 W/kg ; SAR(10 g) = 0.144 W/kg

Maximum value of SAR (measured) = 0.250 W/kg

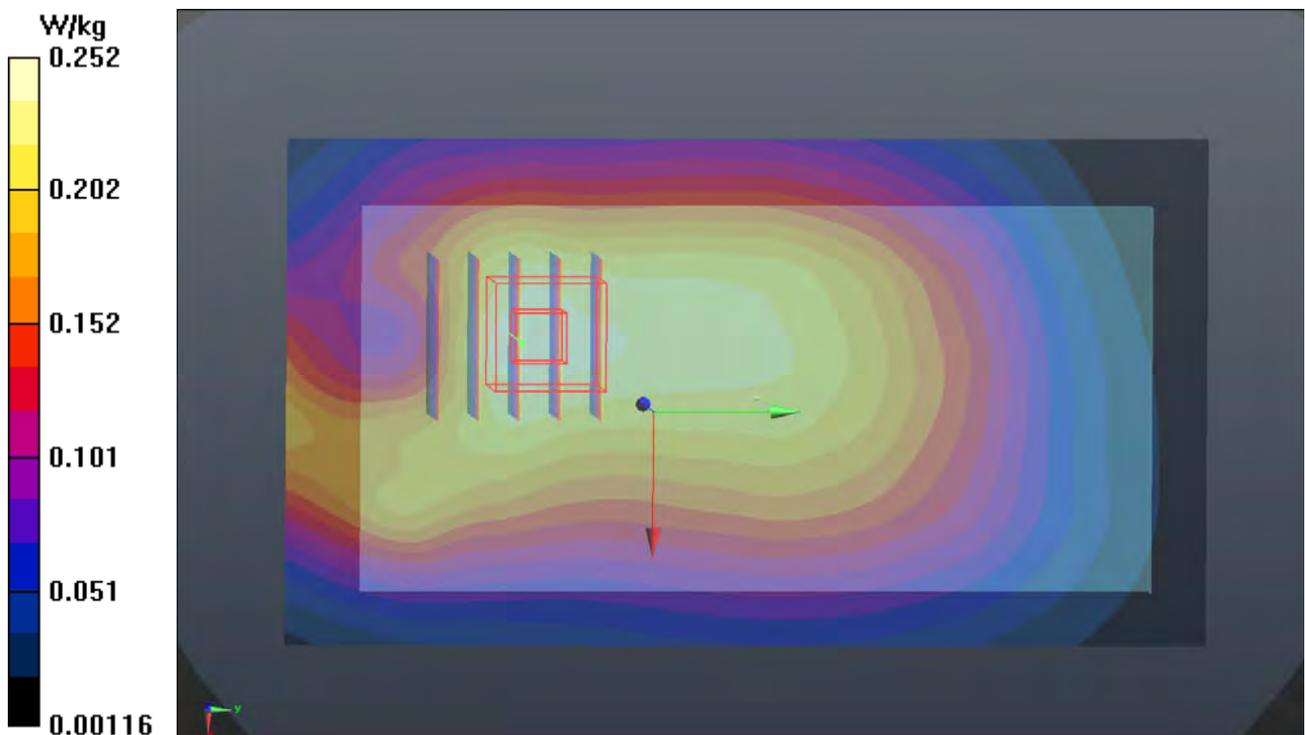

P26 LTE 2_QPSK20M_Rear Face_15mm_Ch18900_1RB_OS0_Ant0

DUT: 180523C09

Communication System: LTE; Frequency: 1880 MHz; Duty Cycle: 1:1

Medium: B16T20N1_0906 Medium parameters used: $f = 1880 \text{ MHz}$; $\sigma = 1.543 \text{ S/m}$; $\epsilon_r = 53.356$; $\rho = 1000 \text{ kg/m}^3$

Ambient Temperature : $23.7 \text{ }^\circ\text{C}$; Liquid Temperature : $23.2 \text{ }^\circ\text{C}$

DASY5 Configuration:

- Probe: EX3DV4 - SN3971; ConvF(8.08, 8.08, 8.08); Calibrated: 2018/03/26
- Sensor-Surface: 1.4mm (Mechanical Surface Detection)
- Electronics: DAE4 Sn1431; Calibrated: 2018/03/16
- Phantom: Twin SAM Phantom_1822; Type: QD000P40CD;
- Measurement SW: DASY52, Version 52.10 (1); SEMCAD X Version 14.6.11 (7439)

- **Area Scan (71x141x1):** Interpolated grid: $dx=1.500 \text{ mm}$, $dy=1.500 \text{ mm}$

Maximum value of SAR (interpolated) = 0.653 W/kg

- **Zoom Scan (5x5x7)/Cube 0:** Measurement grid: $dx=8\text{mm}$, $dy=8\text{mm}$, $dz=5\text{mm}$

Reference Value = 19.69 V/m ; Power Drift = 0.02 dB

Peak SAR (extrapolated) = 0.870 W/kg

SAR(1 g) = 0.535 W/kg ; SAR(10 g) = 0.314 W/kg

Maximum value of SAR (measured) = 0.732 W/kg

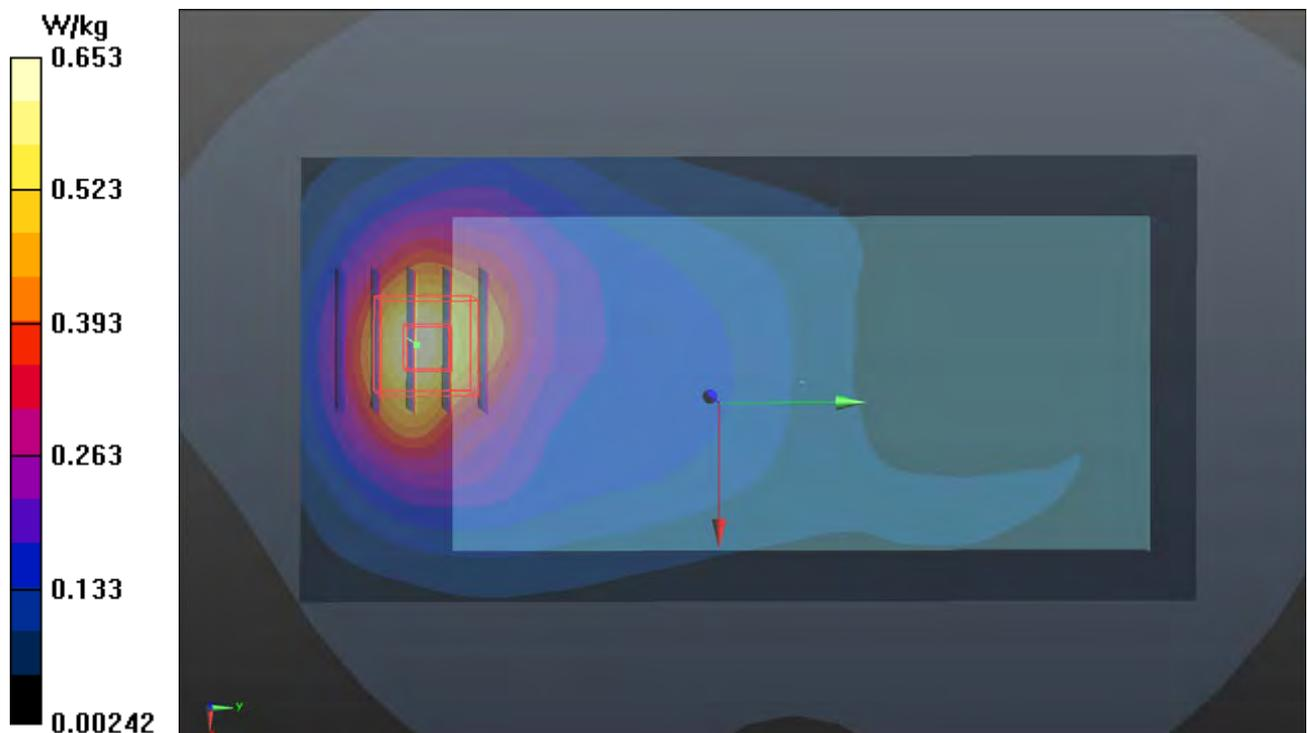

P27 LTE 4_QPSK20M_Front Face_15mm_Ch20300_1RB_OS0_Ant0

DUT: 180523C09

Communication System: LTE; Frequency: 1745 MHz; Duty Cycle: 1:1

Medium: B16T20N1_0906 Medium parameters used: $f = 1745 \text{ MHz}$; $\sigma = 1.433 \text{ S/m}$; $\epsilon_r = 53.449$; $\rho = 1000 \text{ kg/m}^3$

Ambient Temperature : 23.7 °C ; Liquid Temperature : 23.2 °C

DASY5 Configuration:

- Probe: EX3DV4 - SN3971; ConvF(8.34, 8.34, 8.34); Calibrated: 2018/03/26
- Sensor-Surface: 1.4mm (Mechanical Surface Detection)
- Electronics: DAE4 Sn1431; Calibrated: 2018/03/16
- Phantom: Twin SAM Phantom_1822; Type: QD000P40CD;
- Measurement SW: DASY52, Version 52.10 (1); SEMCAD X Version 14.6.11 (7439)

- **Area Scan (71x141x1):** Interpolated grid: dx=1.500 mm, dy=1.500 mm

Maximum value of SAR (interpolated) = 0.797 W/kg

- **Zoom Scan (5x5x7)/Cube 0:** Measurement grid: dx=8mm, dy=8mm, dz=5mm

Reference Value = 22.20 V/m; Power Drift = 0.16 dB

Peak SAR (extrapolated) = 1.11 W/kg

SAR(1 g) = 0.691 W/kg; SAR(10 g) = 0.410 W/kg

Maximum value of SAR (measured) = 0.901 W/kg

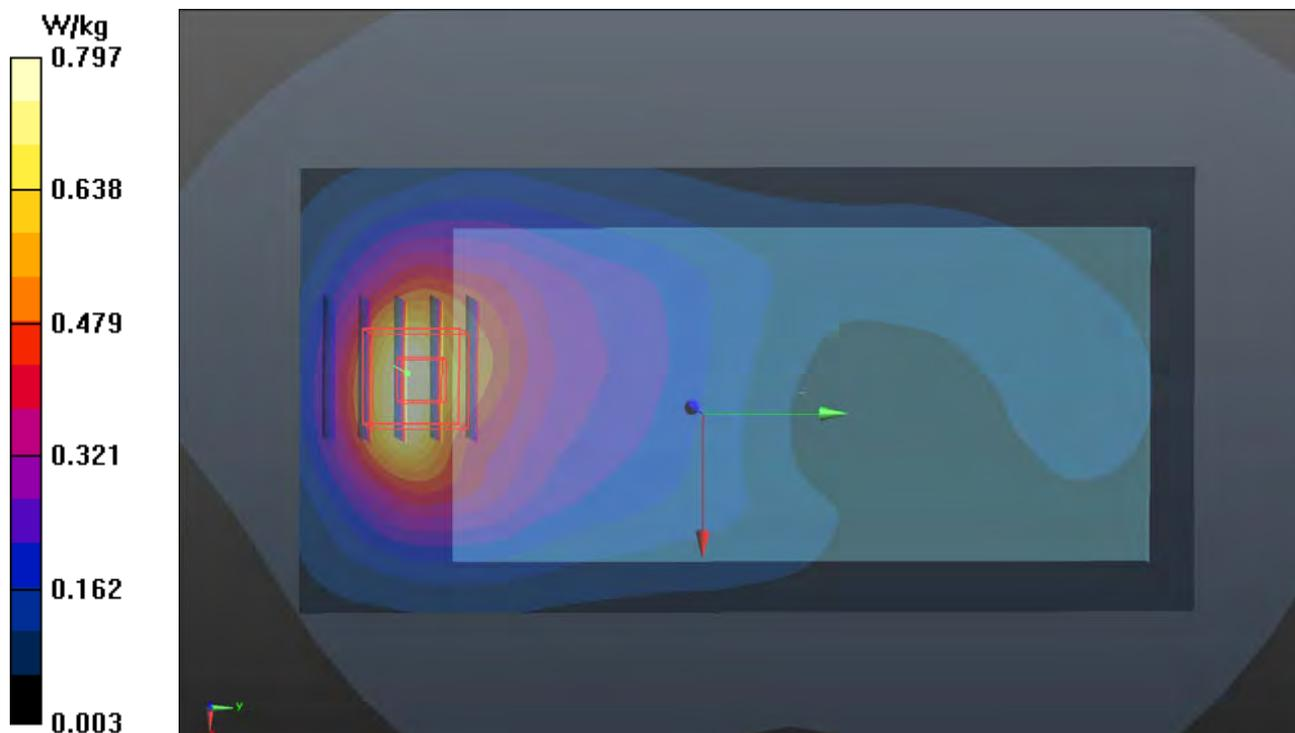

P28 LTE 5_QPSK10M_Front Face_15mm_Ch20525_1RB_OS0_Ant0

DUT: 18Q1-021

Communication System: LTE; Frequency: 836.5 MHz; Duty Cycle: 1:1

Medium: B07T10N1_0604 Medium parameters used: $f = 836.5$ MHz; $\sigma = 1.008$ S/m; $\epsilon_r = 54.205$; $\rho = 1000$ kg/m³

Ambient Temperature : 23.5 °C ; Liquid Temperature : 23.2 °C

DASY5 Configuration:

- Probe: EX3DV4 - SN3820; ConvF(9.59, 9.59, 9.59); Calibrated: 2017/06/27
- Sensor-Surface: 1.4mm (Mechanical Surface Detection)
- Electronics: DAE4 Sn917; Calibrated: 2017/12/14
- Phantom: Twin SAM Phantom_1496; Type: QD000P40CA;
- Measurement SW: DASY52, Version 52.10 (1); SEMCAD X Version 14.6.11 (7439)

- **Area Scan (71x141x1):** Interpolated grid: dx=1.500 mm, dy=1.500 mm

Maximum value of SAR (interpolated) = 0.291 W/kg

- **Zoom Scan (5x5x7)/Cube 0:** Measurement grid: dx=8mm, dy=8mm, dz=5mm

Reference Value = 17.66 V/m; Power Drift = -0.05 dB

Peak SAR (extrapolated) = 0.320 W/kg

SAR(1 g) = 0.242 W/kg; SAR(10 g) = 0.187 W/kg

Maximum value of SAR (measured) = 0.291 W/kg

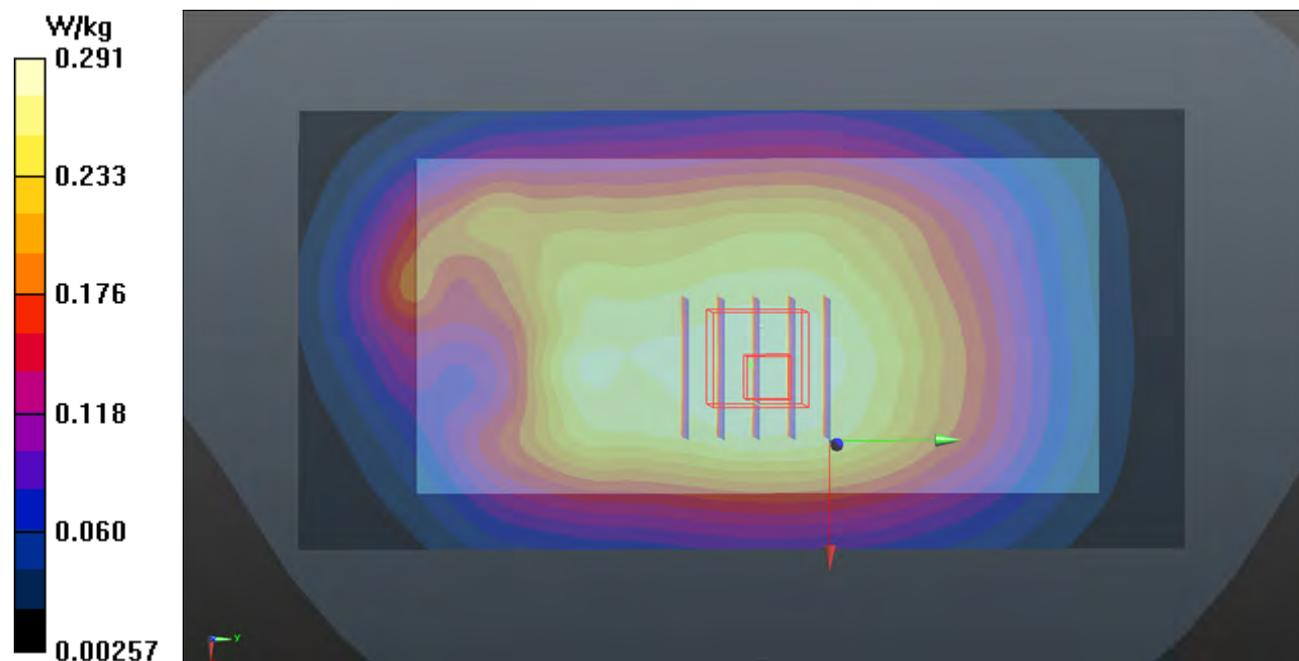

P29 LTE 7_QPSK20M_Rear Face_15mm_Ch20850_1RB_OS0_Ant0

DUT: 18Q1-021

Communication System: LTE; Frequency: 2510 MHz; Duty Cycle: 1:1

Medium: B19T27N1_0606 Medium parameters used: $f = 2510$ MHz; $\sigma = 2.066$ S/m; $\epsilon_r = 51.057$; $\rho =$

1000 kg/m³

Ambient Temperature : 23.6 °C ; Liquid Temperature : 23.3 °C

DASY5 Configuration:

- Probe: EX3DV4 - SN3971; ConvF(7.36, 7.36, 7.36); Calibrated: 2018/03/26
- Sensor-Surface: 1.4mm (Mechanical Surface Detection)
- Electronics: DAE4 Sn1431; Calibrated: 2018/03/16
- Phantom: Twin SAM Phantom_1822; Type: QD000P40CD;
- Measurement SW: DASY52, Version 52.10 (1); SEMCAD X Version 14.6.11 (7439)

- **Area Scan (91x151x1):** Interpolated grid: $dx=1.200$ mm, $dy=1.200$ mm

Maximum value of SAR (interpolated) = 0.531 W/kg

- **Zoom Scan (5x5x7)/Cube 0:** Measurement grid: $dx=8$ mm, $dy=8$ mm, $dz=5$ mm

Reference Value = 15.41 V/m; Power Drift = -0.09 dB

Peak SAR (extrapolated) = 0.707 W/kg

SAR(1 g) = 0.387 W/kg; SAR(10 g) = 0.212 W/kg

Maximum value of SAR (measured) = 0.588 W/kg

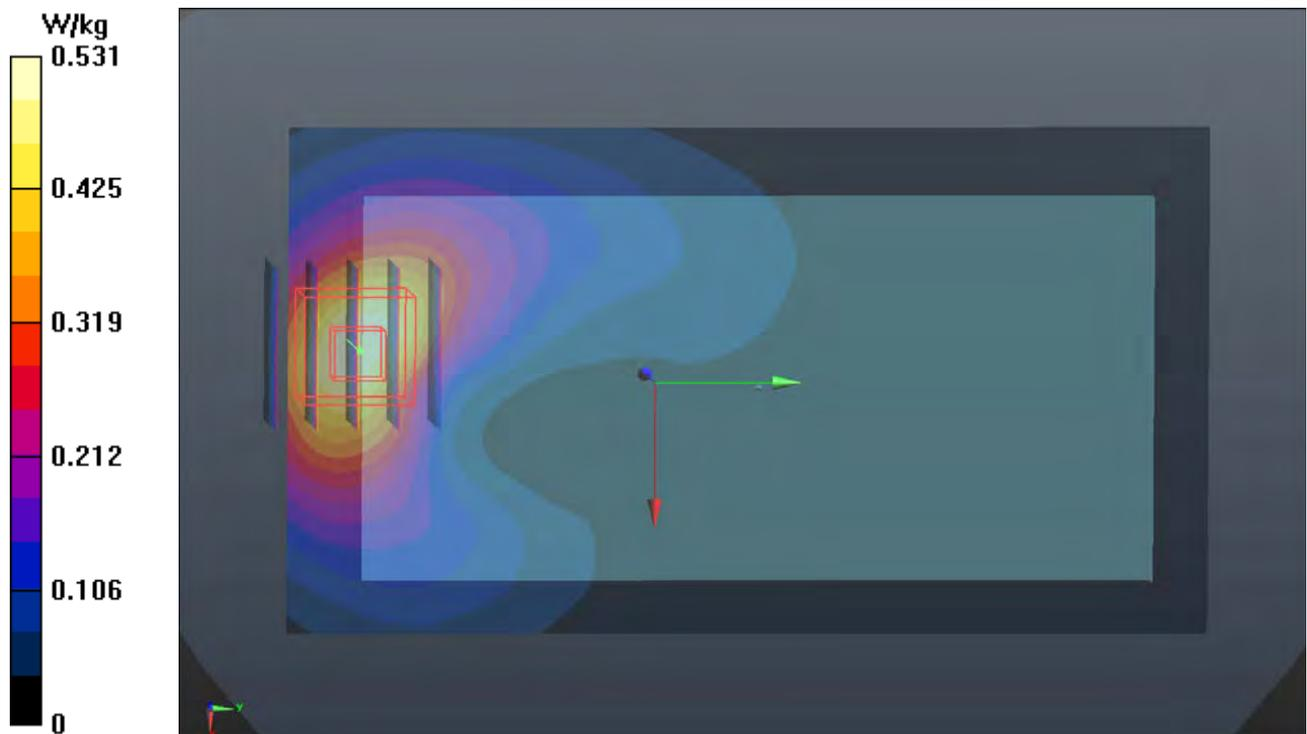

P30 LTE 12_QPSK10M_Front Fcae_15mm_Ch23130_1RB_OS0_Ant1

DUT: 18Q1-021

Communication System: LTE; Frequency: 711 MHz; Duty Cycle: 1:1

Medium: B06T09N1_0604 Medium parameters used: $f = 711$ MHz; $\sigma = 0.934$ S/m; $\epsilon_r = 53.876$; $\rho = 1000$ kg/m³

Ambient Temperature : 23.5 °C ; Liquid Temperature : 23.2 °C

DASY5 Configuration:

- Probe: EX3DV4 - SN3820; ConvF(9.47, 9.47, 9.47); Calibrated: 2017/06/27
- Sensor-Surface: 1.4mm (Mechanical Surface Detection)
- Electronics: DAE4 Sn917; Calibrated: 2017/12/14
- Phantom: Twin SAM Phantom_1496; Type: QD000P40CA;
- Measurement SW: DASY52, Version 52.10 (1); SEMCAD X Version 14.6.11 (7439)

- **Area Scan (71x121x1):** Interpolated grid: dx=1.500 mm, dy=1.500 mm

Maximum value of SAR (interpolated) = 0.173 W/kg

- **Zoom Scan (5x5x7)/Cube 0:** Measurement grid: dx=8mm, dy=8mm, dz=5mm

Reference Value = 13.15 V/m; Power Drift = -0.06 dB

Peak SAR (extrapolated) = 0.194 W/kg

SAR(1 g) = 0.102 W/kg; SAR(10 g) = 0.078 W/kg

Maximum value of SAR (measured) = 0.173 W/kg

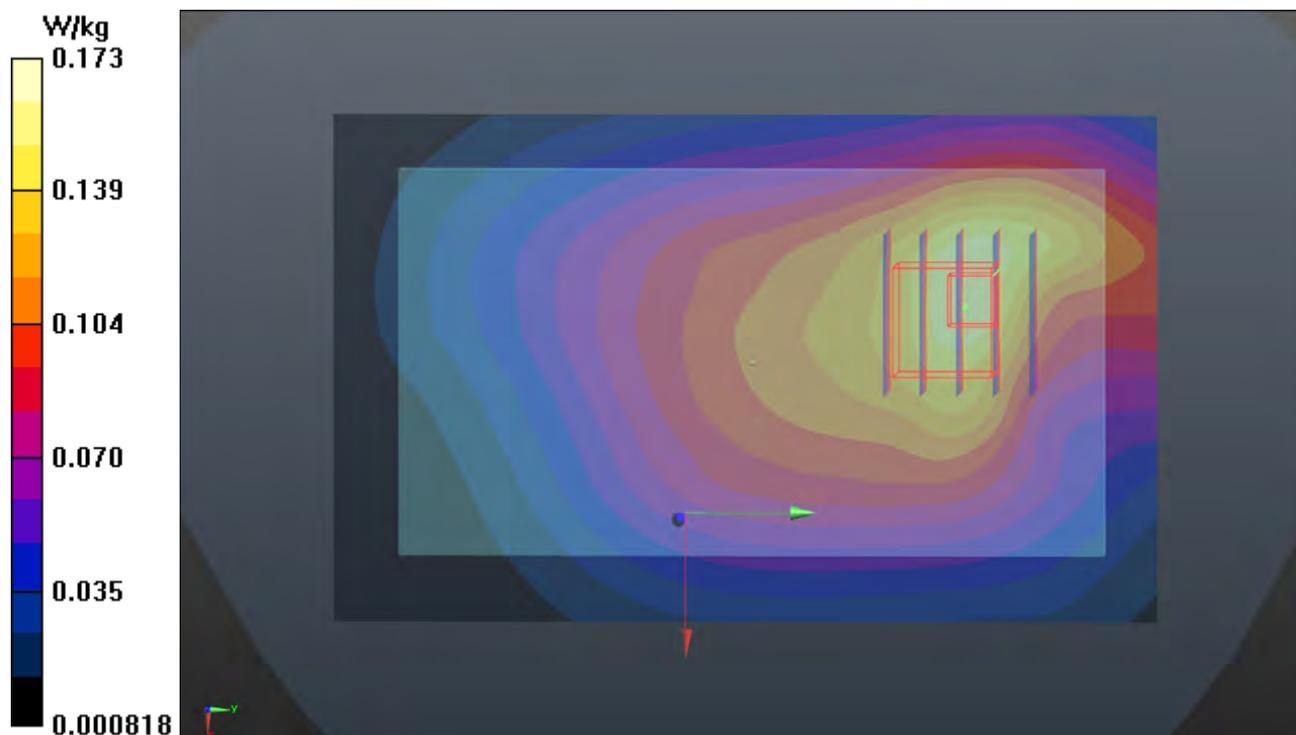

P31 LTE 13_QPSK10M_Front Fcae_15mm_Ch23230_1RB_OS0_Ant1

DUT: 18Q1-021

Communication System: LTE; Frequency: 782 MHz; Duty Cycle: 1:1

Medium: B06T09N1_0604 Medium parameters used: $f = 782 \text{ MHz}$; $\sigma = 1.003 \text{ S/m}$; $\epsilon_r = 53.111$; $\rho = 1000 \text{ kg/m}^3$

Ambient Temperature : $23.5 \text{ }^\circ\text{C}$; Liquid Temperature : $23.2 \text{ }^\circ\text{C}$

DASY5 Configuration:

- Probe: EX3DV4 - SN3820; ConvF(9.47, 9.47, 9.47); Calibrated: 2017/06/27
- Sensor-Surface: 1.4mm (Mechanical Surface Detection)
- Electronics: DAE4 Sn917; Calibrated: 2017/12/14
- Phantom: Twin SAM Phantom_1496; Type: QD000P40CA;
- Measurement SW: DASY52, Version 52.10 (1); SEMCAD X Version 14.6.11 (7439)

- **Area Scan (71x121x1):** Interpolated grid: $dx=1.500 \text{ mm}$, $dy=1.500 \text{ mm}$

Maximum value of SAR (interpolated) = 0.217 W/kg

- **Zoom Scan (5x5x7)/Cube 0:** Measurement grid: $dx=8\text{mm}$, $dy=8\text{mm}$, $dz=5\text{mm}$

Reference Value = 14.48 V/m ; Power Drift = -0.02 dB

Peak SAR (extrapolated) = 0.260 W/kg

SAR(1 g) = 0.207 W/kg ; SAR(10 g) = 0.161 W/kg

Maximum value of SAR (measured) = 0.232 W/kg

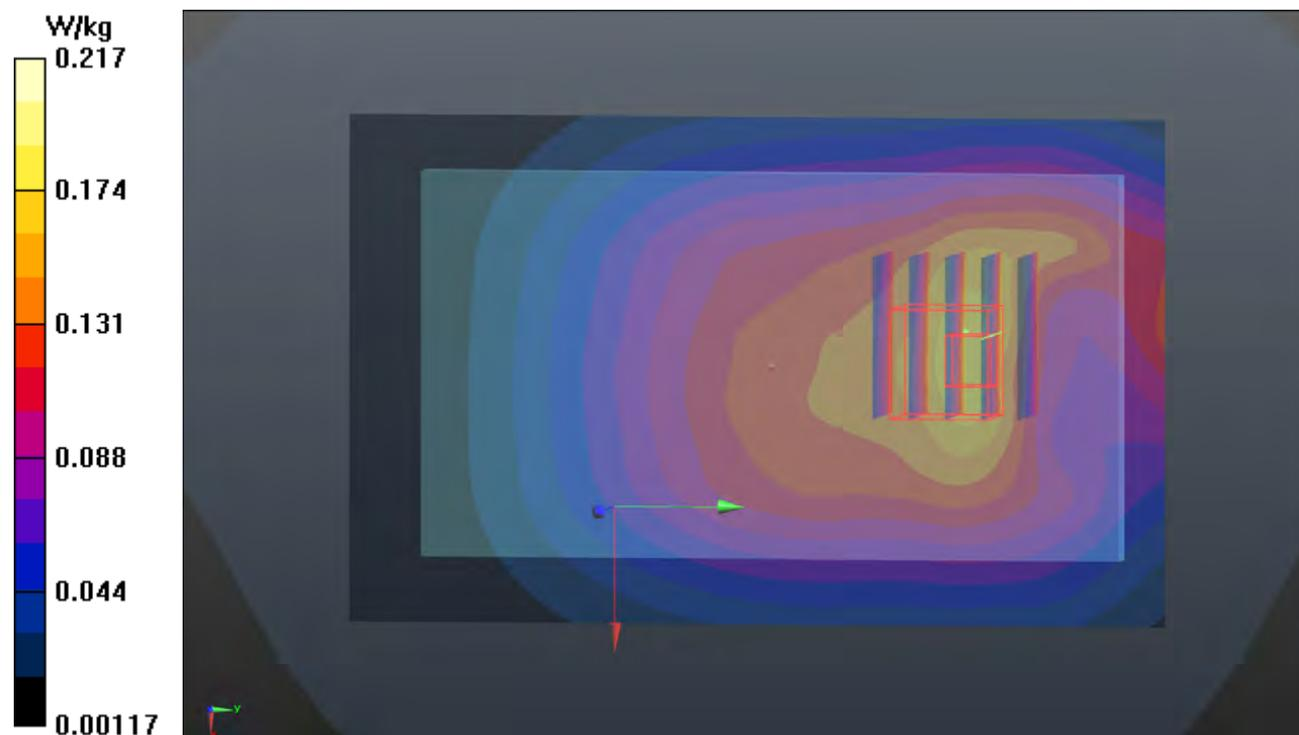

P32 LTE 17_QPSK10M_Rear Face_15mm_Ch23800_1RB_OS0_Ant0

DUT: 18Q1-021

Communication System: LTE; Frequency: 711 MHz; Duty Cycle: 1:1

Medium: B06T09N1_0604 Medium parameters used: $f = 711 \text{ MHz}$; $\sigma = 0.934 \text{ S/m}$; $\epsilon_r = 53.876$; $\rho = 1000 \text{ kg/m}^3$

Ambient Temperature : $23.5 \text{ }^\circ\text{C}$; Liquid Temperature : $23.2 \text{ }^\circ\text{C}$

DASY5 Configuration:

- Probe: EX3DV4 - SN3820; ConvF(9.47, 9.47, 9.47); Calibrated: 2017/06/27
- Sensor-Surface: 1.4mm (Mechanical Surface Detection)
- Electronics: DAE4 Sn917; Calibrated: 2017/12/14
- Phantom: Twin SAM Phantom_1496; Type: QD000P40CA;
- Measurement SW: DASY52, Version 52.10 (1); SEMCAD X Version 14.6.11 (7439)

- **Area Scan (71x141x1):** Interpolated grid: $dx=1.500 \text{ mm}$, $dy=1.500 \text{ mm}$

Maximum value of SAR (interpolated) = 0.118 W/kg

- **Zoom Scan (5x5x7)/Cube 0:** Measurement grid: $dx=8\text{mm}$, $dy=8\text{mm}$, $dz=5\text{mm}$

Reference Value = 11.72 V/m ; Power Drift = -0.01 dB

Peak SAR (extrapolated) = 0.135 W/kg

SAR(1 g) = 0.099 W/kg ; SAR(10 g) = 0.076 W/kg

Maximum value of SAR (measured) = 0.120 W/kg

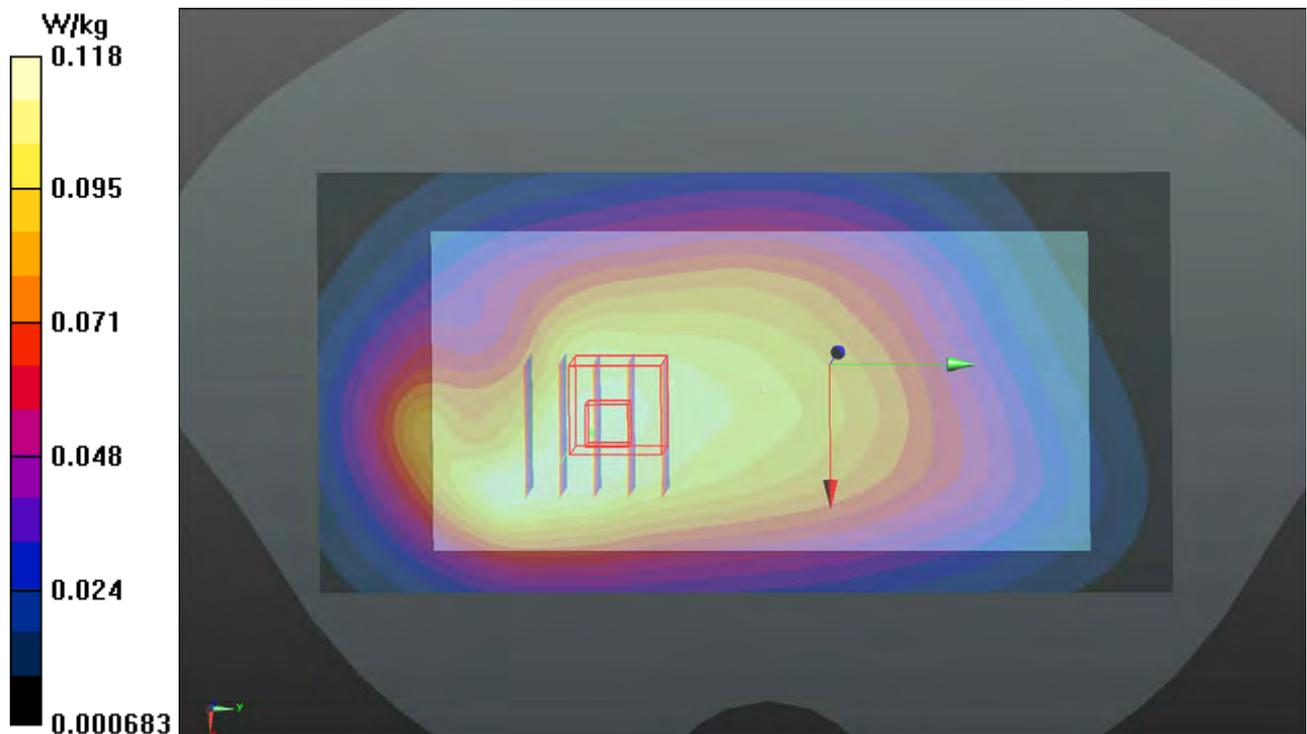

P33 LTE 38_QPSK20M_Rear Face_15mm_Ch38000_1RB_OS0_Ant0

DUT: 18Q1-021

Communication System: LTE TDD CF0; Frequency: 2595 MHz; Duty Cycle: 1:1.58

Medium: B19T27N1_0606 Medium parameters used: $f = 2595$ MHz; $\sigma = 2.164$ S/m; $\epsilon_r = 50.814$; $\rho = 1000$ kg/m³

Ambient Temperature : 23.6 °C ; Liquid Temperature : 23.3 °C

DASY5 Configuration:

- Probe: EX3DV4 - SN3971; ConvF(7.36, 7.36, 7.36); Calibrated: 2018/03/26
- Sensor-Surface: 1.4mm (Mechanical Surface Detection)
- Electronics: DAE4 Sn1431; Calibrated: 2018/03/16
- Phantom: Twin SAM Phantom_1822; Type: QD000P40CD;
- Measurement SW: DASY52, Version 52.10 (1); SEMCAD X Version 14.6.11 (7439)

- **Area Scan (91x151x1)**: Interpolated grid: dx=1.200 mm, dy=1.200 mm

Maximum value of SAR (interpolated) = 0.419 W/kg

- **Zoom Scan (5x5x7)/Cube 0**: Measurement grid: dx=8mm, dy=8mm, dz=5mm

Reference Value = 12.77 V/m; Power Drift = -0.06 dB

Peak SAR (extrapolated) = 0.565 W/kg

SAR(1 g) = 0.302 W/kg; SAR(10 g) = 0.161 W/kg

Maximum value of SAR (measured) = 0.466 W/kg

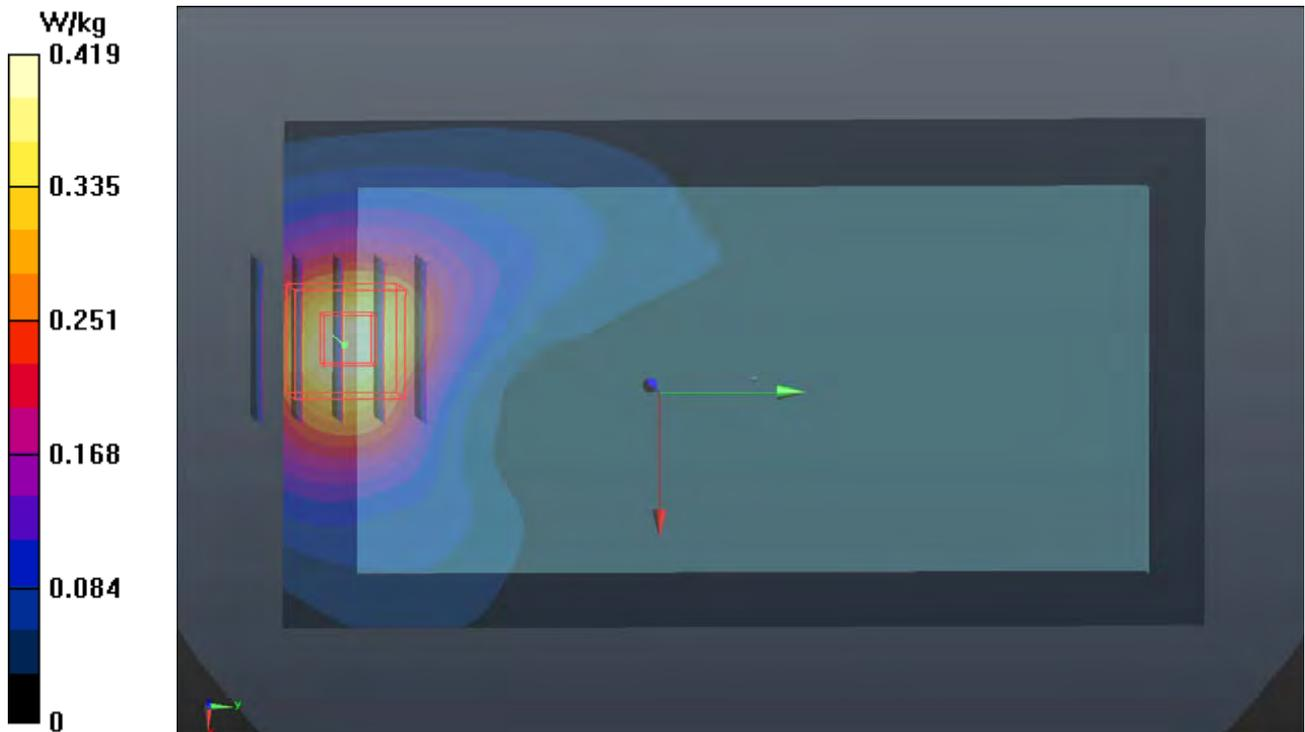

P34 LTE 41_QPSK20M_Rear Face_15mm_Ch40140_1RB_OS0_Ant0

DUT: 18Q1-021

Communication System: LTE TDD CF0; Frequency: 2545 MHz; Duty Cycle: 1:1.58

Medium: B19T27N5_0829 Medium parameters used: $f = 2545$ MHz; $\sigma = 2.086$ S/m; $\epsilon_r = 50.528$; $\rho = 1000$ kg/m³

Ambient Temperature : 23.7 °C ; Liquid Temperature : 23.3 °C

DASY5 Configuration:

- Probe: EX3DV4 - SN3650; ConvF(7.48, 7.48, 7.48); Calibrated: 2018/07/27
- Sensor-Surface: 1.4mm (Mechanical Surface Detection)
- Electronics: DAE4 Sn1232; Calibrated: 2018/05/22
- Phantom: Twin SAM Phantom_1496; Type: QD000P40CA;
- Measurement SW: DASY52, Version 52.10 (1); SEMCAD X Version 14.6.11 (7439)

- **Area Scan (91x171x1)**: Interpolated grid: dx=1.200 mm, dy=1.200 mm
Maximum value of SAR (interpolated) = 0.399 W/kg

- **Zoom Scan (5x5x7)/Cube 0**: Measurement grid: dx=8mm, dy=8mm, dz=5mm
Reference Value = 11.69 V/m; Power Drift = -0.11 dB
Peak SAR (extrapolated) = 0.495 W/kg
SAR(1 g) = 0.258 W/kg; SAR(10 g) = 0.141 W/kg
Maximum value of SAR (measured) = 0.396 W/kg

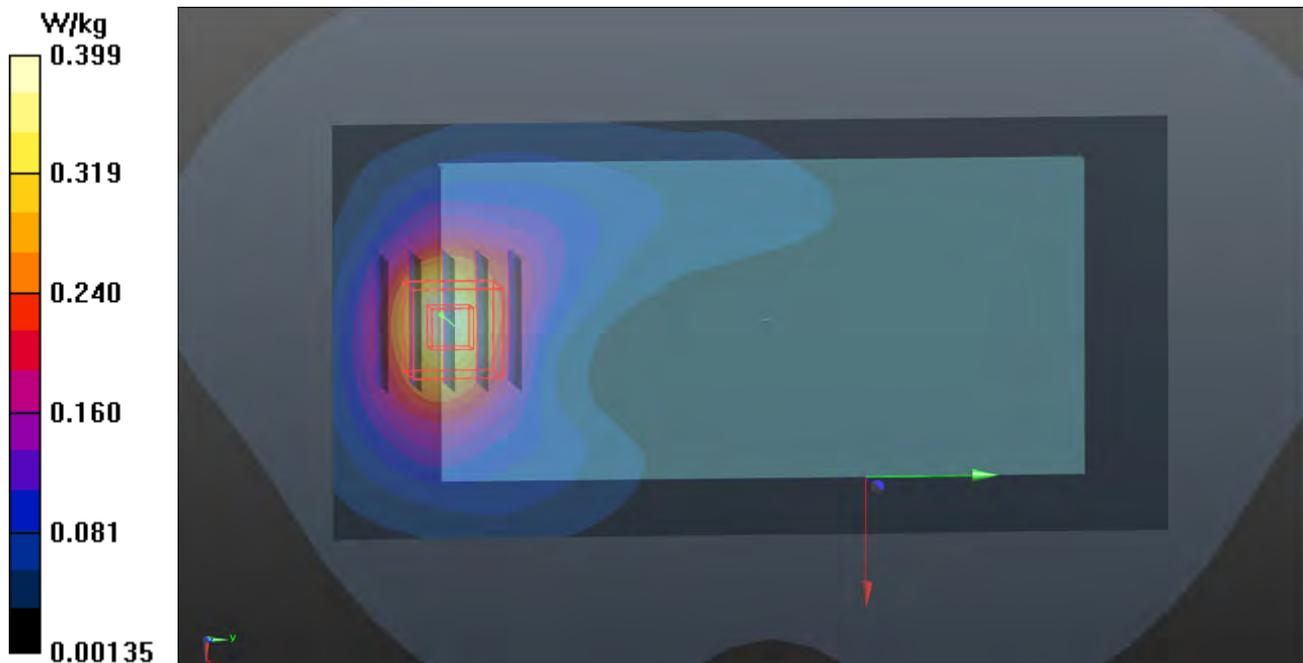

P35 LTE 66_QPSK20M_Rear Face_15mm_Ch132322_1RB_OS0_Ant0

DUT: 180523C09

Communication System: LTE; Frequency: 1745 MHz; Duty Cycle: 1:1

Medium: B16T20N1_0906 Medium parameters used: $f = 1745$ MHz; $\sigma = 1.433$ S/m; $\epsilon_r = 53.449$; $\rho = 1000$ kg/m³

Ambient Temperature : 23.7 °C ; Liquid Temperature : 23.2 °C

DASY5 Configuration:

- Probe: EX3DV4 - SN3971; ConvF(8.34, 8.34, 8.34); Calibrated: 2018/03/26
- Sensor-Surface: 1.4mm (Mechanical Surface Detection)
- Electronics: DAE4 Sn1431; Calibrated: 2018/03/16
- Phantom: Twin SAM Phantom_1822; Type: QD000P40CD;
- Measurement SW: DASY52, Version 52.10 (1); SEMCAD X Version 14.6.11 (7439)

- **Area Scan (71x141x1):** Interpolated grid: dx=1.500 mm, dy=1.500 mm

Maximum value of SAR (interpolated) = 0.764 W/kg

- **Zoom Scan (5x5x7)/Cube 0:** Measurement grid: dx=8mm, dy=8mm, dz=5mm

Reference Value = 22.54 V/m; Power Drift = 0.01 dB

Peak SAR (extrapolated) = 1.01 W/kg

SAR(1 g) = 0.632 W/kg; SAR(10 g) = 0.381 W/kg

Maximum value of SAR (measured) = 0.863 W/kg

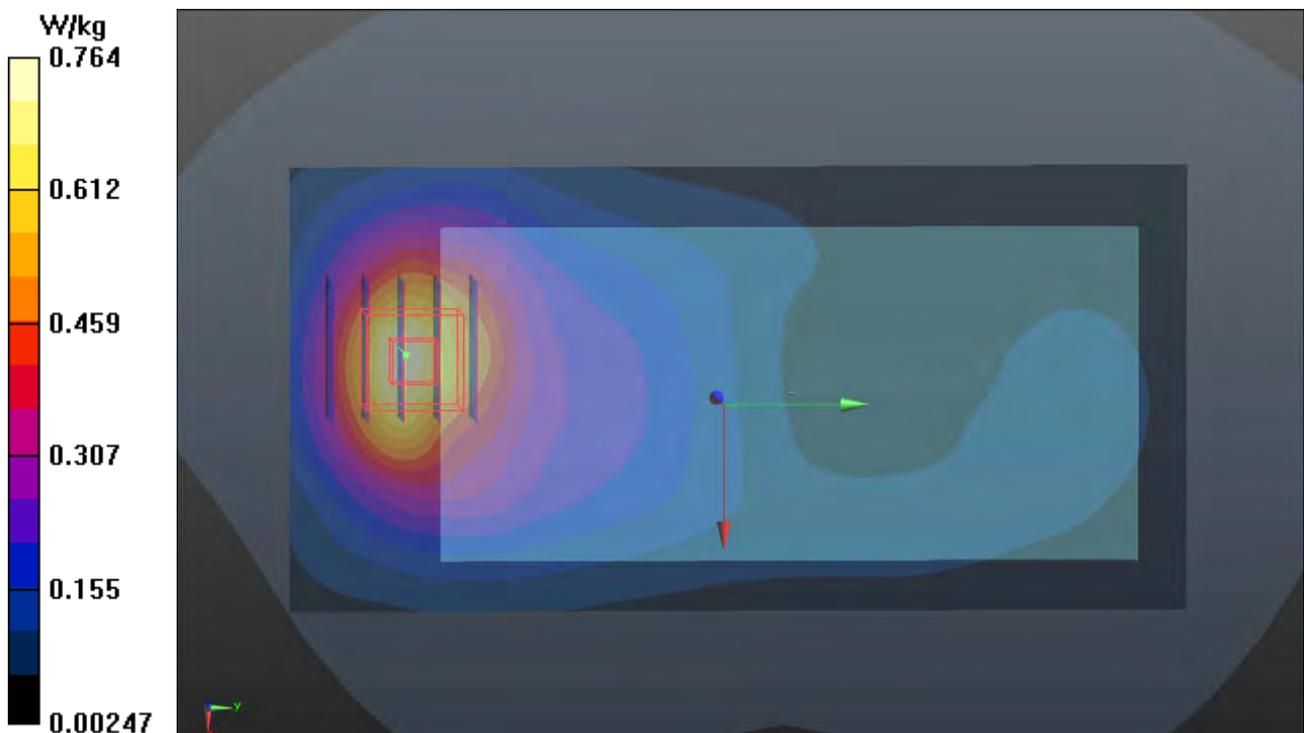

P36 WLAN2.4G_802.11n HT20_Rear Face_15mm_Ch1_Ant0+1

DUT: 18Q1-021

Communication System: WLAN_2.4G; Frequency: 2412 MHz; Duty Cycle: 1:1

Medium: B19T27N1_0530 Medium parameters used: $f = 2412$ MHz; $\sigma = 1.979$ S/m; $\epsilon_r = 51.269$; $\rho =$

1000 kg/m³

Ambient Temperature : 23.6 °C ; Liquid Temperature : 23.4 °C

DASY5 Configuration:

- Probe: EX3DV4 - SN3650; ConvF(7.68, 7.68, 7.68); Calibrated: 2017/07/24
- Sensor-Surface: 1.4mm (Mechanical Surface Detection)
- Electronics: DAE4 Sn1277; Calibrated: 2018/01/18
- Phantom: Twin SAM Phantom_1822; Type: QD000P40CD;
- Measurement SW: DASY52, Version 52.10 (1); SEMCAD X Version 14.6.11 (7439)

- **Area Scan (91x171x1):** Interpolated grid: dx=1.200 mm, dy=1.200 mm

Maximum value of SAR (interpolated) = 0.231 W/kg

- **Zoom Scan (5x5x7)/Cube 0:** Measurement grid: dx=8mm, dy=8mm, dz=5mm

Reference Value = 10.40 V/m; Power Drift = -0.17 dB

Peak SAR (extrapolated) = 0.296 W/kg

SAR(1 g) = 0.153 W/kg; SAR(10 g) = 0.077 W/kg

Maximum value of SAR (measured) = 0.238 W/kg

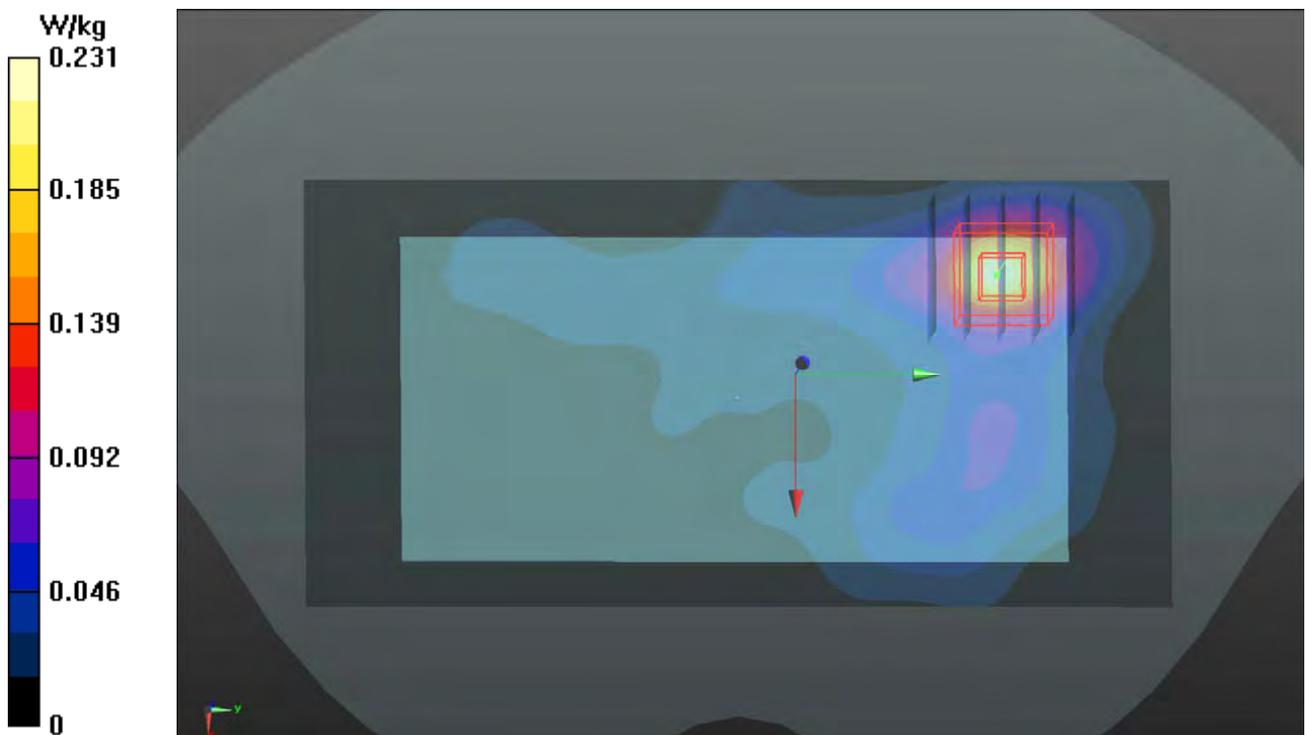

P37 WLAN5G_802.11n HT20_Rear Face_15mm_Ch60_Ant 0+1

DUT: 18Q1-021

Communication System: WLAN_5G; Frequency: 5300 MHz; Duty Cycle: 1:1

Medium: B34T60N1_0607 Medium parameters used: $f = 5300$ MHz; $\sigma = 5.266$ S/m; $\epsilon_r = 49.803$; $\rho = 1000$ kg/m³

Ambient Temperature : 23.5 °C ; Liquid Temperature : 23.3 °C

DASY5 Configuration:

- Probe: EX3DV4 - SN3820; ConvF(4.39, 4.39, 4.39); Calibrated: 2017/06/27
- Sensor-Surface: 1.4mm (Mechanical Surface Detection)
- Electronics: DAE4 Sn917; Calibrated: 2017/12/14
- Phantom: Twin SAM Phantom_1822; Type: QD000P40CD;
- Measurement SW: DASY52, Version 52.10 (1); SEMCAD X Version 14.6.11 (7439)

- **Area Scan (101x201x1):** Interpolated grid: dx=1.000 mm, dy=1.000 mm
Maximum value of SAR (interpolated) = 0.701 W/kg

- **Zoom Scan (6x6x12)/Cube 0:** Measurement grid: dx=5mm, dy=5mm, dz=2mm
Reference Value = 11.10 V/m; Power Drift = -0.05 dB
Peak SAR (extrapolated) = 1.29 W/kg
SAR(1 g) = 0.368 W/kg; SAR(10 g) = 0.152 W/kg
Maximum value of SAR (measured) = 0.758 W/kg

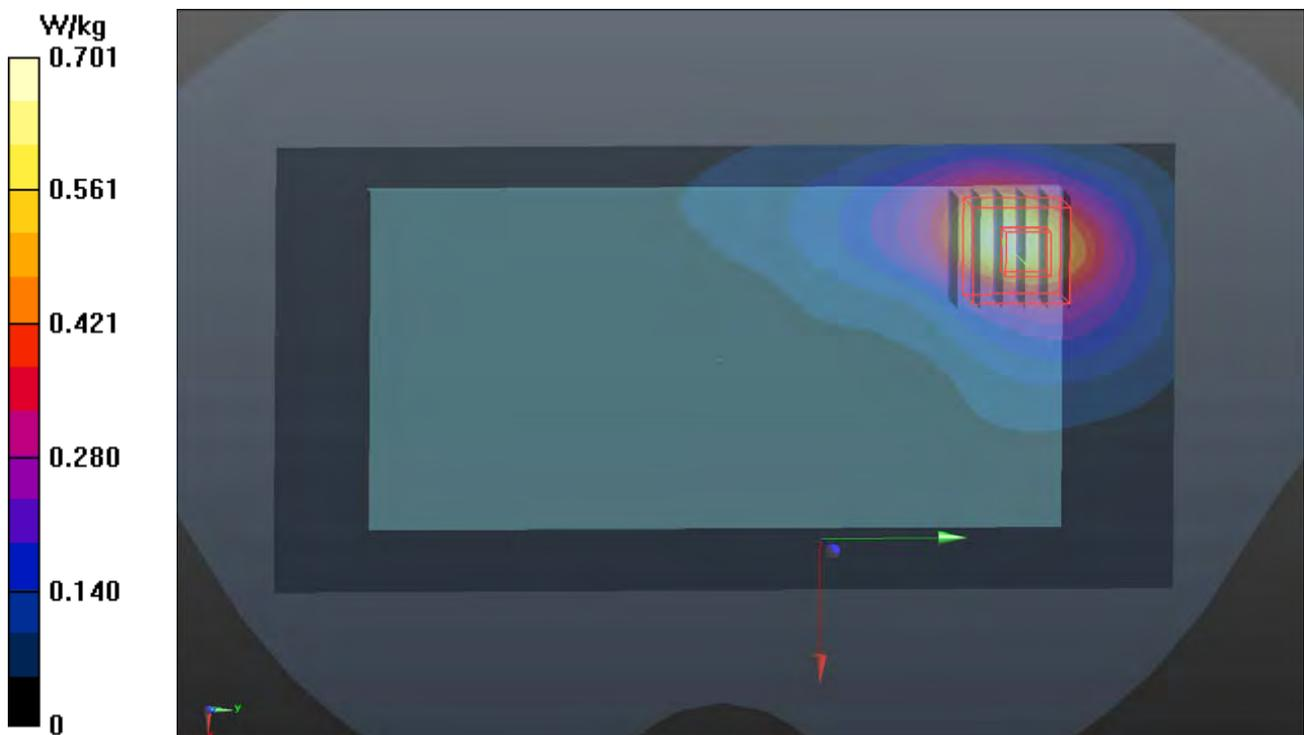

P38 WLAN5G_802.11n HT20_Rear Face_15mm_Ch116_Ant0+1

DUT: 18Q1-021

Communication System: WLAN_5G; Frequency: 5580 MHz; Duty Cycle: 1:1

Medium: B34T60N1_0530 Medium parameters used: $f = 5580$ MHz; $\sigma = 5.831$ S/m; $\epsilon_r = 47.357$; $\rho = 1000$ kg/m³

Ambient Temperature : 23.6 °C ; Liquid Temperature : 23.4 °C

DASY5 Configuration:

- Probe: EX3DV4 - SN3650; ConvF(4.29, 4.29, 4.29); Calibrated: 2017/07/24
- Sensor-Surface: 1.4mm (Mechanical Surface Detection)
- Electronics: DAE4 Sn1277; Calibrated: 2018/01/18
- Phantom: Twin SAM Phantom_1822; Type: QD000P40CD;
- Measurement SW: DASY52, Version 52.10 (1); SEMCAD X Version 14.6.11 (7439)

- **Area Scan (101x201x1):** Interpolated grid: dx=1.000 mm, dy=1.000 mm
Maximum value of SAR (interpolated) = 1.33 W/kg

- **Zoom Scan (6x6x12)/Cube 0:** Measurement grid: dx=5mm, dy=5mm, dz=2mm
Reference Value = 15.26 V/m; Power Drift = -0.07 dB
Peak SAR (extrapolated) = 2.04 W/kg
SAR(1 g) = 0.638 W/kg; SAR(10 g) = 0.260 W/kg
Maximum value of SAR (measured) = 1.32 W/kg

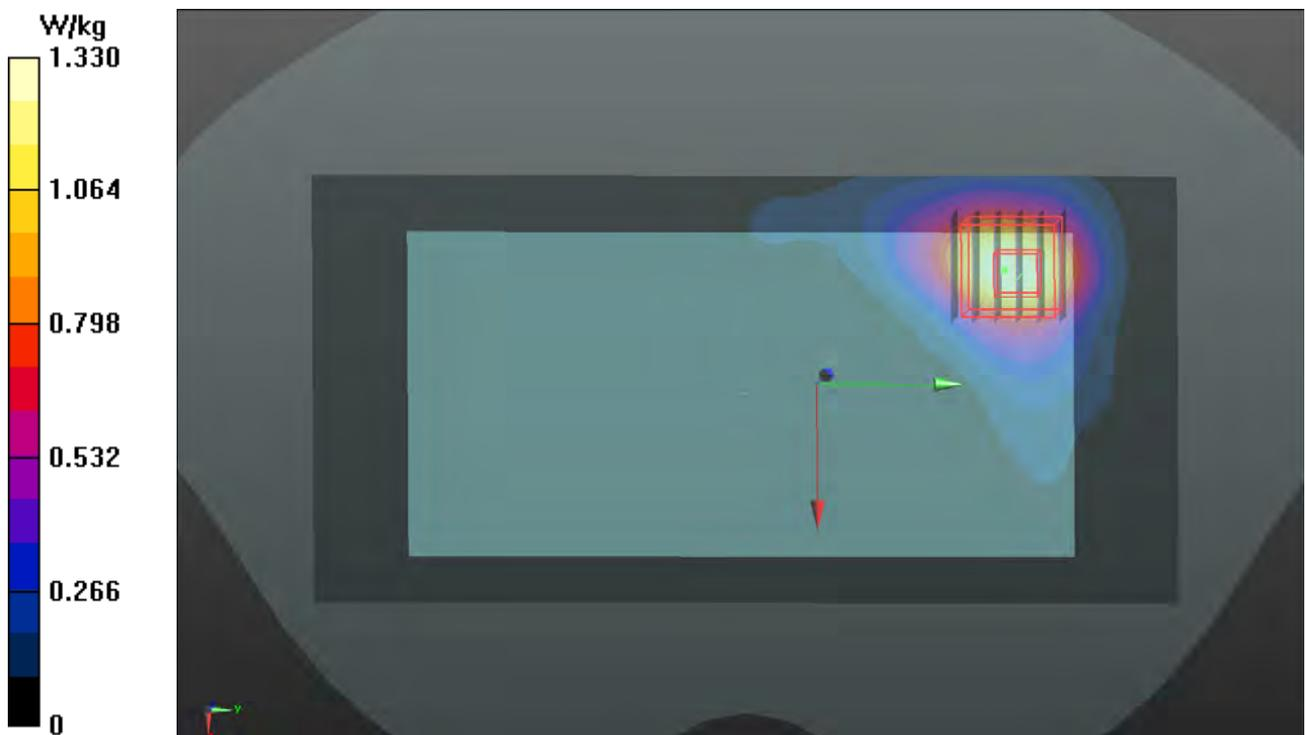

P39 WLAN5G_802.11n HT20_Rear Face_15mm_Ch149_Ant 0+1

DUT: 18Q1-021

Communication System: WLAN_5G; Frequency: 5745 MHz; Duty Cycle: 1:1

Medium: B34T60N1_0607 Medium parameters used: $f = 5745$ MHz; $\sigma = 5.861$ S/m; $\epsilon_r = 48.891$; $\rho = 1000$ kg/m³

Ambient Temperature : 23.5 °C ; Liquid Temperature : 23.3 °C

DASY5 Configuration:

- Probe: EX3DV4 - SN3820; ConvF(4.04, 4.04, 4.04); Calibrated: 2017/06/27
- Sensor-Surface: 1.4mm (Mechanical Surface Detection)
- Electronics: DAE4 Sn917; Calibrated: 2017/12/14
- Phantom: Twin SAM Phantom_1822; Type: QD000P40CD;
- Measurement SW: DASY52, Version 52.10 (1); SEMCAD X Version 14.6.11 (7439)

- **Area Scan (101x201x1):** Interpolated grid: dx=1.000 mm, dy=1.000 mm

Maximum value of SAR (interpolated) = 0.860 W/kg

- **Zoom Scan (6x6x12)/Cube 0:** Measurement grid: dx=5mm, dy=5mm, dz=2mm

Reference Value = 11.96 V/m; Power Drift = -0.02 dB

Peak SAR (extrapolated) = 1.51 W/kg

SAR(1 g) = 0.387 W/kg; SAR(10 g) = 0.149 W/kg

Maximum value of SAR (measured) = 0.862 W/kg

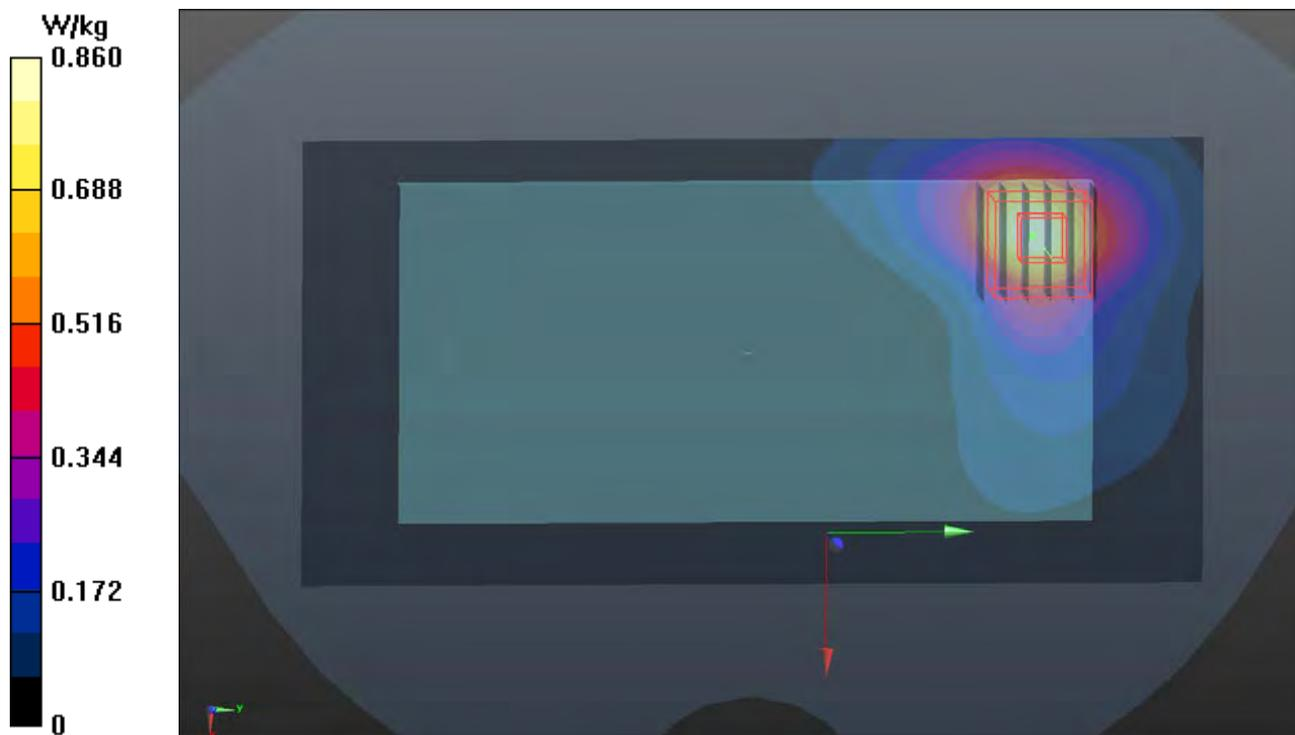

P40 BT_BR_EDR_Rear Face_15mm_Ch0_Ant 0

DUT: 18Q1-021

Communication System: BT; Frequency: 2402 MHz; Duty Cycle: 1:1

Medium: B19T27N1_0607 Medium parameters used: $f = 2402$ MHz; $\sigma = 1.962$ S/m; $\epsilon_r = 51.637$; $\rho = 1000$ kg/m³

Ambient Temperature : 23.5 °C ; Liquid Temperature : 23.3 °C

DASY5 Configuration:

- Probe: EX3DV4 - SN3971; ConvF(7.7, 7.7, 7.7); Calibrated: 2018/03/26
- Sensor-Surface: 1.4mm (Mechanical Surface Detection)
- Electronics: DAE4 Sn1431; Calibrated: 2018/03/16
- Phantom: Twin SAM Phantom_1822; Type: QD000P40CD;
- Measurement SW: DASY52, Version 52.10 (1); SEMCAD X Version 14.6.11 (7439)

- **Area Scan (91x171x1):** Interpolated grid: dx=1.200 mm, dy=1.200 mm

Maximum value of SAR (interpolated) = 0.0121 W/kg

- **Zoom Scan (5x5x7)/Cube 0:** Measurement grid: dx=8mm, dy=8mm, dz=5mm

Reference Value = 1.529 V/m; Power Drift = -0.04 dB

Peak SAR (extrapolated) = 0.0130 W/kg

SAR(1 g) = 0.00254 W/kg; SAR(10 g) = 0.000579 W/kg

Maximum value of SAR (measured) = 0.00716 W/kg

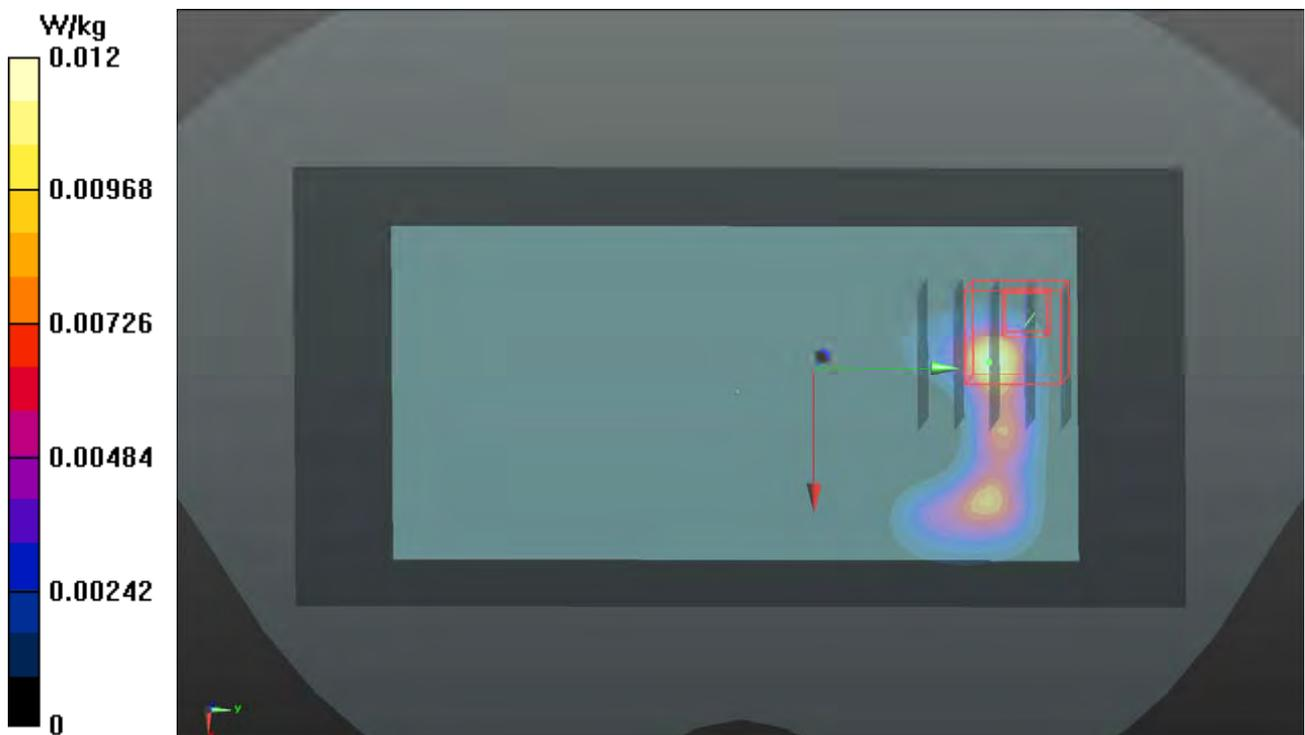

P41 GSM850_GPRS11_Rear Face_10mm_Ch189_Ant0

DUT: 18Q1-021

Communication System: GPRS11; Frequency: 836.4 MHz; Duty Cycle: 1:2.67

Medium: B07T10N1_0531 Medium parameters used: $f = 836.4$ MHz; $\sigma = 1.015$ S/m; $\epsilon_r = 55.969$; $\rho = 1000$ kg/m³

Ambient Temperature : 23.8 °C ; Liquid Temperature : 23.5 °C

DASY5 Configuration:

- Probe: EX3DV4 - SN3650; ConvF(9.76, 9.76, 9.76); Calibrated: 2017/07/24
- Sensor-Surface: 1.4mm (Mechanical Surface Detection)
- Electronics: DAE4 Sn1277; Calibrated: 2018/01/18
- Phantom: Twin SAM Phantom_1822; Type: QD000P40CD;
- Measurement SW: DASY52, Version 52.10 (1); SEMCAD X Version 14.6.11 (7439)

- **Area Scan (71x121x1):** Interpolated grid: dx=1.500 mm, dy=1.500 mm

Maximum value of SAR (interpolated) = 0.573 W/kg

- **Zoom Scan (5x5x7)/Cube 0:** Measurement grid: dx=8mm, dy=8mm, dz=5mm

Reference Value = 21.96 V/m; Power Drift = -0.14 dB

Peak SAR (extrapolated) = 0.630 W/kg

SAR(1 g) = 0.351 W/kg; SAR(10 g) = 0.204 W/kg

Maximum value of SAR (measured) = 0.505 W/kg

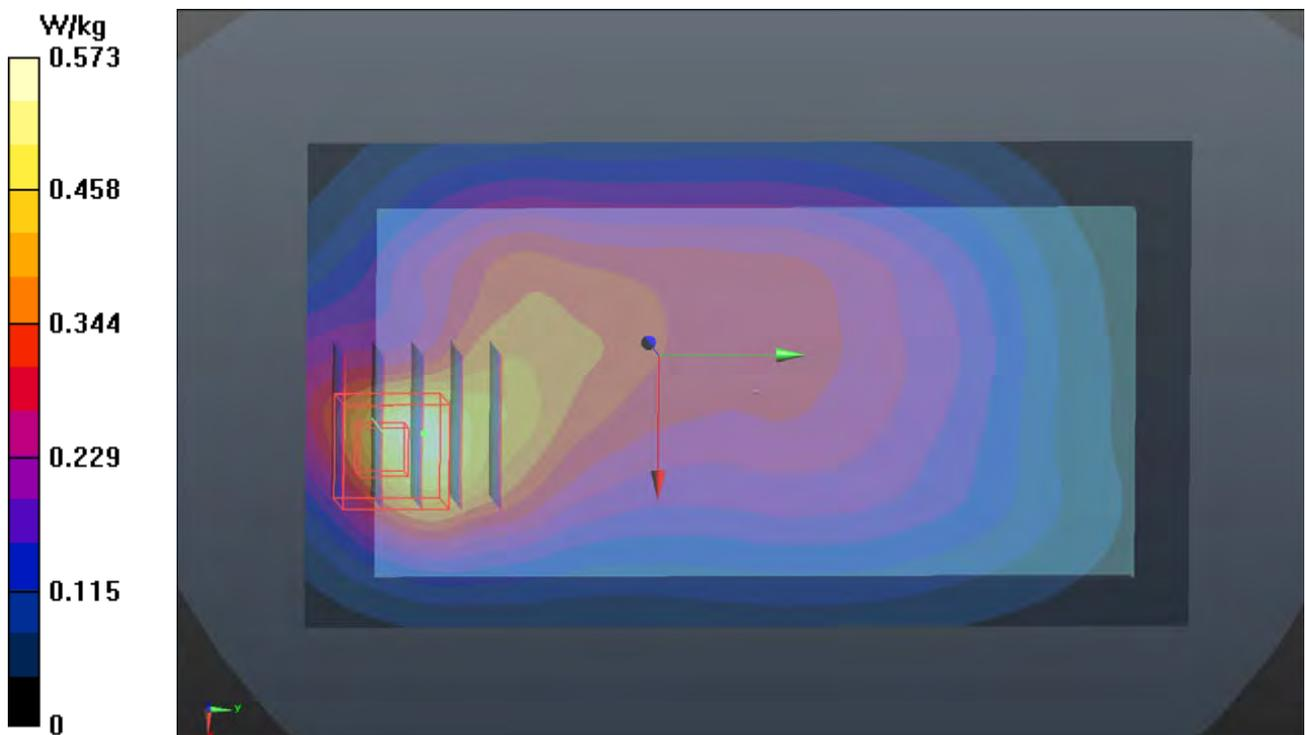

P42 GSM1900_GPRS11_Bottom Side_10mm_Ch661_Ant0

DUT: 18Q1-021

Communication System: GPRS11; Frequency: 1880 MHz; Duty Cycle: 1:2.67

Medium: B16T20N1_0601 Medium parameters used: $f = 1880$ MHz; $\sigma = 1.543$ S/m; $\epsilon_r = 51.301$; $\rho = 1000$ kg/m³

Ambient Temperature : 23.6 °C ; Liquid Temperature : 23.3 °C

DASY5 Configuration:

- Probe: EX3DV4 - SN3650; ConvF(8, 8, 8); Calibrated: 2017/07/24
- Sensor-Surface: 1.4mm (Mechanical Surface Detection)
- Electronics: DAE4 Sn1277; Calibrated: 2018/01/18
- Phantom: Twin SAM Phantom_1822; Type: QD000P40CD;
- Measurement SW: DASY52, Version 52.10 (1); SEMCAD X Version 14.6.11 (7439)

- **Area Scan (61x81x1):** Interpolated grid: dx=1.500 mm, dy=1.500 mm

Maximum value of SAR (interpolated) = 1.39 W/kg

- **Zoom Scan (5x5x7)/Cube 0:** Measurement grid: dx=8mm, dy=8mm, dz=5mm

Reference Value = 29.18 V/m; Power Drift = -0.14 dB

Peak SAR (extrapolated) = 1.65 W/kg

SAR(1 g) = 0.865 W/kg; SAR(10 g) = 0.395 W/kg

Maximum value of SAR (measured) = 1.40 W/kg

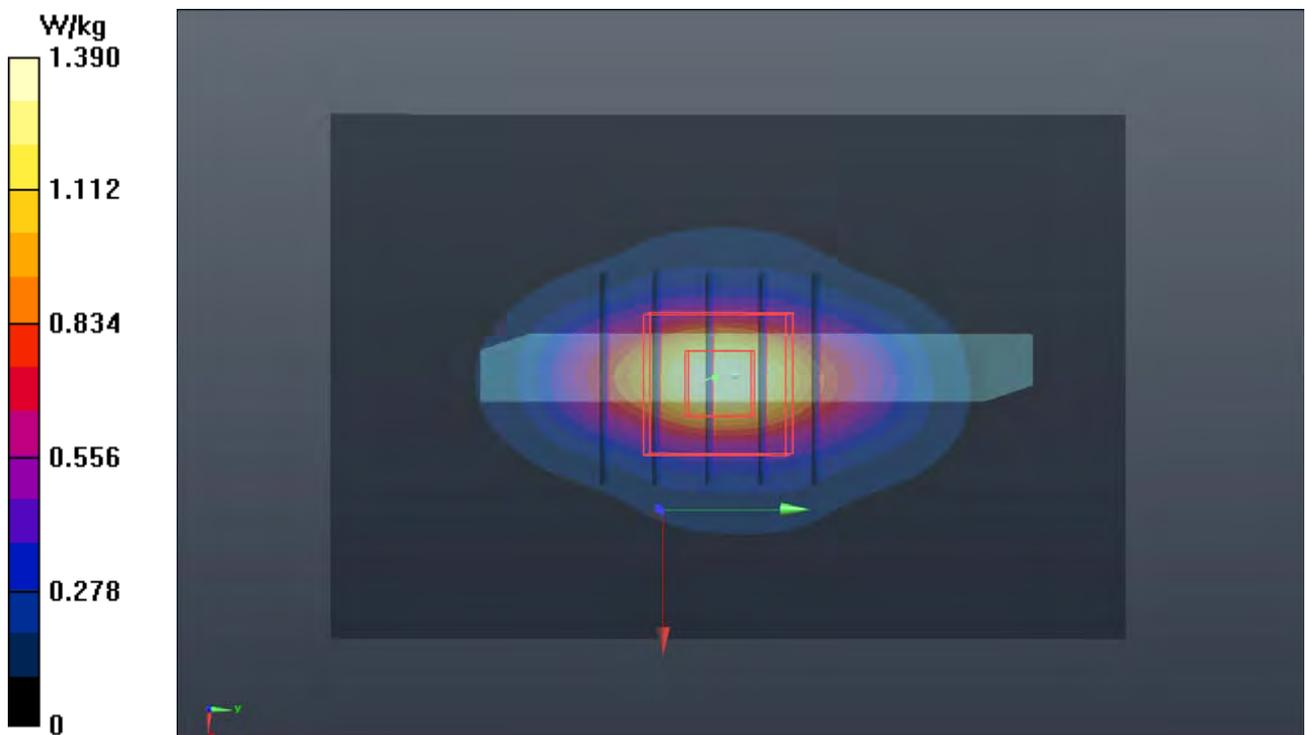

P43 WCDMA II_RMC12.2K_Bottom Side_10mm_Ch9538_Ant0

DUT: 18Q1-021

Communication System: WCDMA; Frequency: 1907.6 MHz; Duty Cycle: 1:1

Medium: B16T20N1_0525 Medium parameters used: $f = 1908 \text{ MHz}$; $\sigma = 1.571 \text{ S/m}$; $\epsilon_r = 52.184$; $\rho = 1000 \text{ kg/m}^3$

Ambient Temperature : $23.7 \text{ }^\circ\text{C}$; Liquid Temperature : $23.5 \text{ }^\circ\text{C}$

DASY5 Configuration:

- Probe: EX3DV4 - SN3971; ConvF(8.08, 8.08, 8.08); Calibrated: 2018/03/26;
- Sensor-Surface: 1.4mm (Mechanical Surface Detection)
- Electronics: DAE4 Sn1431; Calibrated: 2018/03/16
- Phantom: Twin SAM Phantom_1822; Type: QD000P40CD;
- Measurement SW: DASY52, Version 52.10 (1); SEMCAD X Version 14.6.10 (7373)

- **Area Scan (61x81x1):** Interpolated grid: $dx=1.500 \text{ mm}$, $dy=1.500 \text{ mm}$

Maximum value of SAR (interpolated) = 1.52 W/kg

- **Zoom Scan (5x5x7)/Cube 0:** Measurement grid: $dx=8\text{mm}$, $dy=8\text{mm}$, $dz=5\text{mm}$

Reference Value = 29.45 V/m ; Power Drift = 0.03 dB

Peak SAR (extrapolated) = 1.80 W/kg

SAR(1 g) = 1 W/kg ; SAR(10 g) = 0.530 W/kg

Maximum value of SAR (measured) = 1.52 W/kg

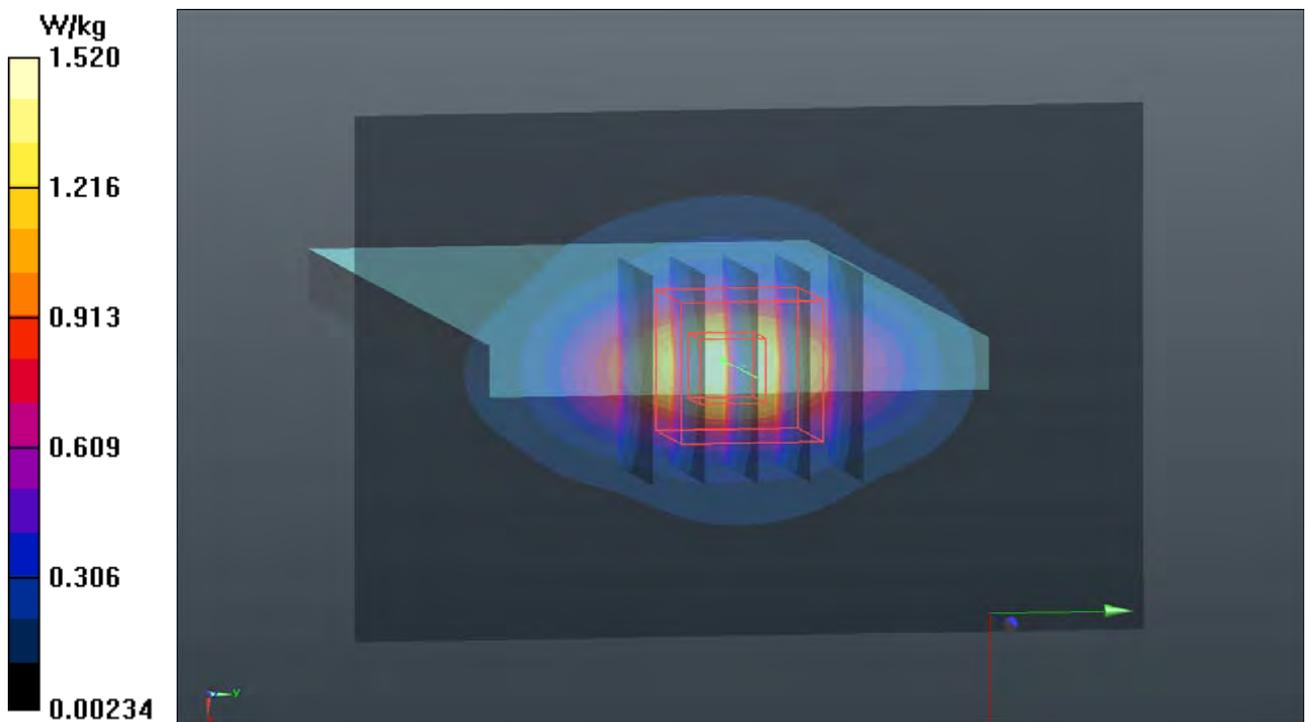

P44 WCDMA IV_RMC12.2K_Bottom Side_10mm_Ch1513_Ant0

DUT: 18Q1-021

Communication System: WCDMA; Frequency: 1752.6 MHz; Duty Cycle: 1:1

Medium: B16T20N1_0525 Medium parameters used: $f = 1753$ MHz; $\sigma = 1.432$ S/m; $\epsilon_r = 52.663$; $\rho =$

1000 kg/m³

Ambient Temperature : 23.7 °C ; Liquid Temperature : 23.5 °C

DASY5 Configuration:

- Probe: EX3DV4 - SN3971; ConvF(8.34, 8.34, 8.34); Calibrated: 2018/03/26
- Sensor-Surface: 1.4mm (Mechanical Surface Detection)
- Electronics: DAE4 Sn1431; Calibrated: 2018/03/16
- Phantom: Twin SAM Phantom_1822; Type: QD000P40CD;
- Measurement SW: DASY52, Version 52.10 (1); SEMCAD X Version 14.6.10 (7373)

- **Area Scan (61x81x1):** Interpolated grid: dx=1.500 mm, dy=1.500 mm

Maximum value of SAR (interpolated) = 1.48 W/kg

- **Zoom Scan (5x5x7)/Cube 0:** Measurement grid: dx=8mm, dy=8mm, dz=5mm

Reference Value = 31.02 V/m; Power Drift = 0.04 dB

Peak SAR (extrapolated) = 1.75 W/kg

SAR(1 g) = 1 W/kg; SAR(10 g) = 0.540 W/kg

Maximum value of SAR (measured) = 1.48 W/kg

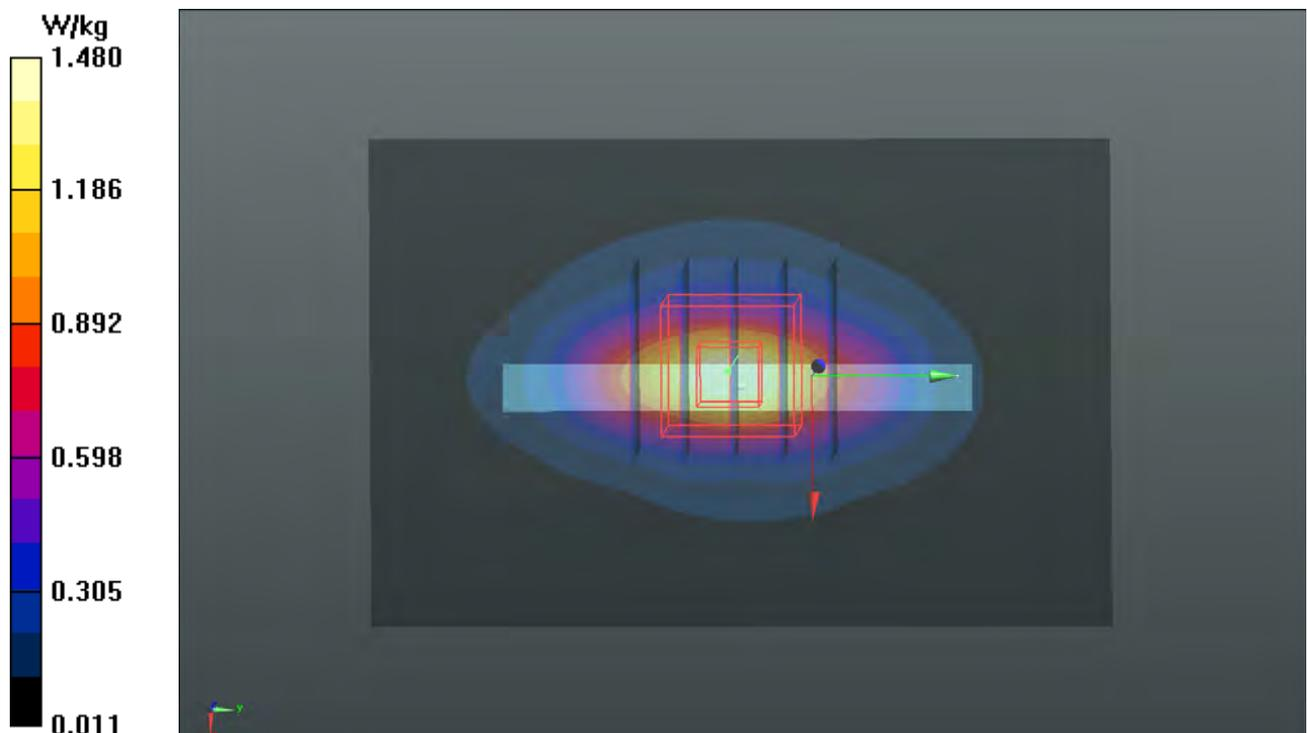

P45 WCDMA V_RMC12.2K_Front Face_10mm_Ch4182_Ant0

DUT: 18Q1-021

Communication System: WCDMA; Frequency: 836.4 MHz; Duty Cycle: 1:1

Medium: B07T10N1_0525 Medium parameters used: $f = 836.4$ MHz; $\sigma = 0.986$ S/m; $\epsilon_r = 54.013$; $\rho = 1000$ kg/m³

Ambient Temperature : 23.7 °C ; Liquid Temperature : 23.5 °C

DASY5 Configuration:

- Probe: EX3DV4 - SN3971; ConvF(10.15, 10.15, 10.15); Calibrated: 2018/03/26
- Sensor-Surface: 1.4mm (Mechanical Surface Detection)
- Electronics: DAE4 Sn1431; Calibrated: 2018/03/16
- Phantom: Twin SAM Phantom_1822; Type: QD000P40CD;
- Measurement SW: DASY52, Version 52.10 (1); SEMCAD X Version 14.6.11 (7439)

- **Area Scan (71x141x1):** Interpolated grid: dx=1.500 mm, dy=1.500 mm

Maximum value of SAR (interpolated) = 0.406 W/kg

- **Zoom Scan (5x5x7)/Cube 0:** Measurement grid: dx=8mm, dy=8mm, dz=5mm

Reference Value = 19.28 V/m; Power Drift = -0.07 dB

Peak SAR (extrapolated) = 0.502 W/kg

SAR(1 g) = 0.280 W/kg; SAR(10 g) = 0.169 W/kg

Maximum value of SAR (measured) = 0.420 W/kg

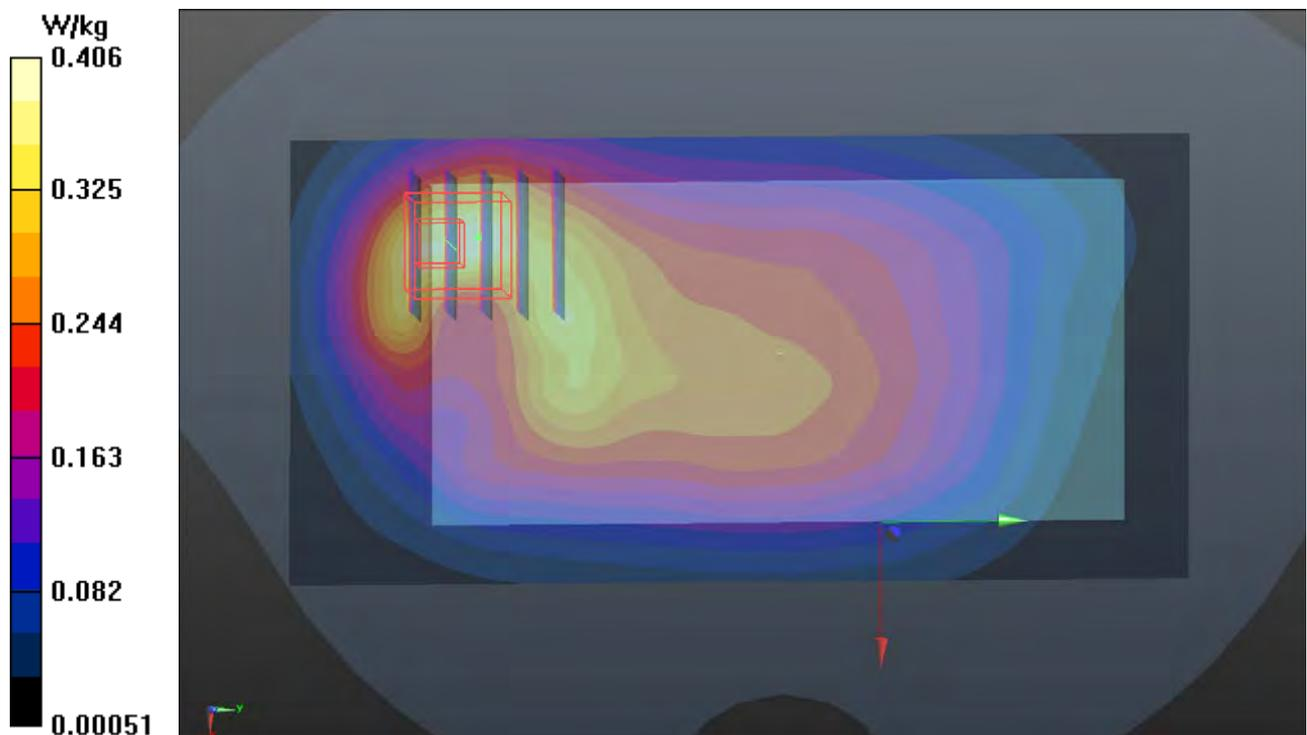

P46 LTE 2_QPSK20M_Bottom Side_10mm_Ch18900_1RB_OS0_Ant0

DUT: 180523C09

Communication System: LTE; Frequency: 1880 MHz; Duty Cycle: 1:1

Medium: B16T20N1_0906 Medium parameters used: $f = 1880$ MHz; $\sigma = 1.543$ S/m; $\epsilon_r = 53.356$; $\rho = 1000$ kg/m³

Ambient Temperature : 23.7 °C ; Liquid Temperature : 23.2 °C

DASY5 Configuration:

- Probe: EX3DV4 - SN3971; ConvF(8.08, 8.08, 8.08); Calibrated: 2018/03/26
- Sensor-Surface: 1.4mm (Mechanical Surface Detection)
- Electronics: DAE4 Sn1431; Calibrated: 2018/03/16
- Phantom: Twin SAM Phantom_1822; Type: QD000P40CD;
- Measurement SW: DASY52, Version 52.10 (1); SEMCAD X Version 14.6.11 (7439)

- Area Scan (61x81x1): Interpolated grid: dx=1.500 mm, dy=1.500 mm

Maximum value of SAR (interpolated) = 1.01 W/kg

- Zoom Scan (5x5x7)/Cube 0: Measurement grid: dx=8mm, dy=8mm, dz=5mm

Reference Value = 26.33 V/m; Power Drift = -0.16 dB

Peak SAR (extrapolated) = 1.20 W/kg

SAR(1 g) = 0.675 W/kg; SAR(10 g) = 0.361 W/kg

Maximum value of SAR (measured) = 1.01 W/kg

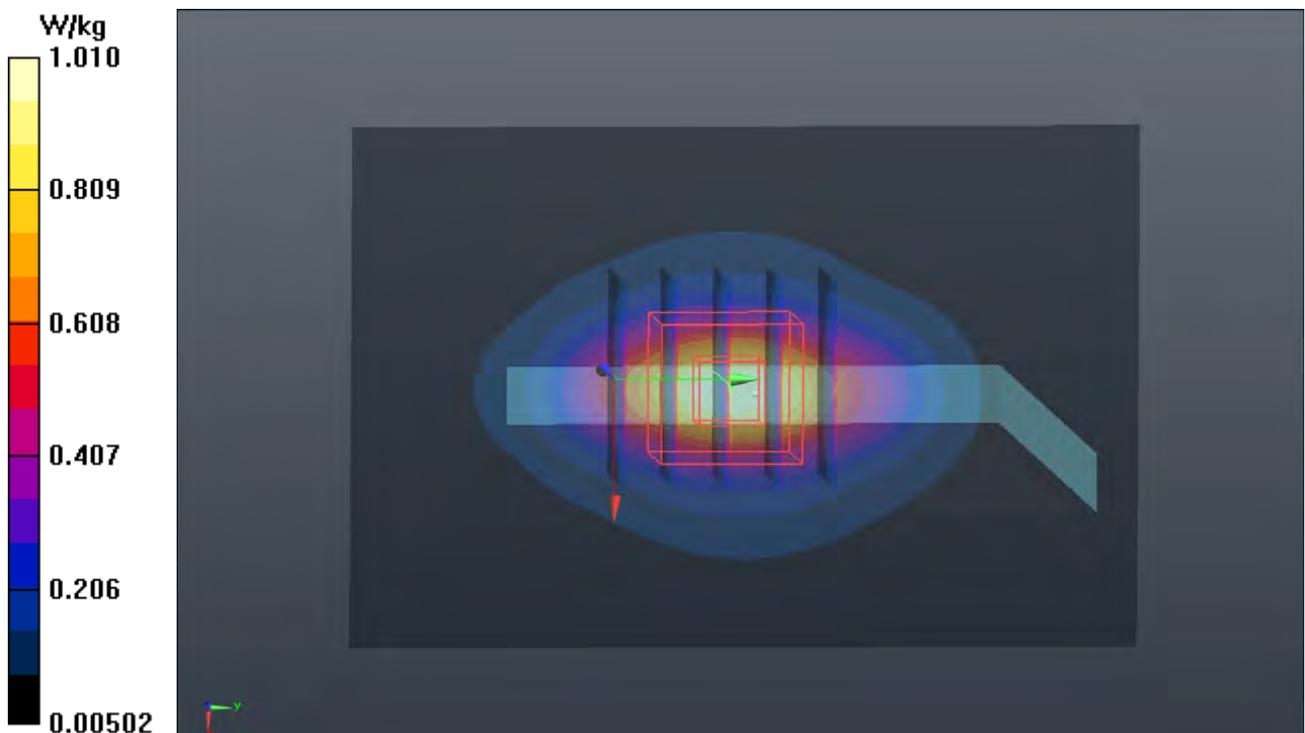

P47 LTE 4_QPSK20M_Bottom Side_10mm_Ch20300_1RB_OS0_Ant0

DUT: 180523C09

Communication System: LTE; Frequency: 1745 MHz; Duty Cycle: 1:1

Medium: B16T20N1_0906 Medium parameters used: $f = 1745 \text{ MHz}$; $\sigma = 1.433 \text{ S/m}$; $\epsilon_r = 53.449$; $\rho = 1000 \text{ kg/m}^3$

Ambient Temperature : 23.7 °C ; Liquid Temperature : 23.2 °C

DASY5 Configuration:

- Probe: EX3DV4 - SN3971; ConvF(8.34, 8.34, 8.34); Calibrated: 2018/03/26
- Sensor-Surface: 1.4mm (Mechanical Surface Detection)
- Electronics: DAE4 Sn1431; Calibrated: 2018/03/16
- Phantom: Twin SAM Phantom_1822; Type: QD000P40CD;
- Measurement SW: DASY52, Version 52.10 (1); SEMCAD X Version 14.6.11 (7439)

- **Area Scan (61x81x1):** Interpolated grid: $dx=1.500 \text{ mm}$, $dy=1.500 \text{ mm}$

Maximum value of SAR (interpolated) = 1.06 W/kg

- **Zoom Scan (5x5x7)/Cube 0:** Measurement grid: $dx=8\text{mm}$, $dy=8\text{mm}$, $dz=5\text{mm}$

Reference Value = 28.17 V/m; Power Drift = -0.17 dB

Peak SAR (extrapolated) = 1.25 W/kg

SAR(1 g) = 0.717 W/kg; SAR(10 g) = 0.389 W/kg

Maximum value of SAR (measured) = 1.06 W/kg

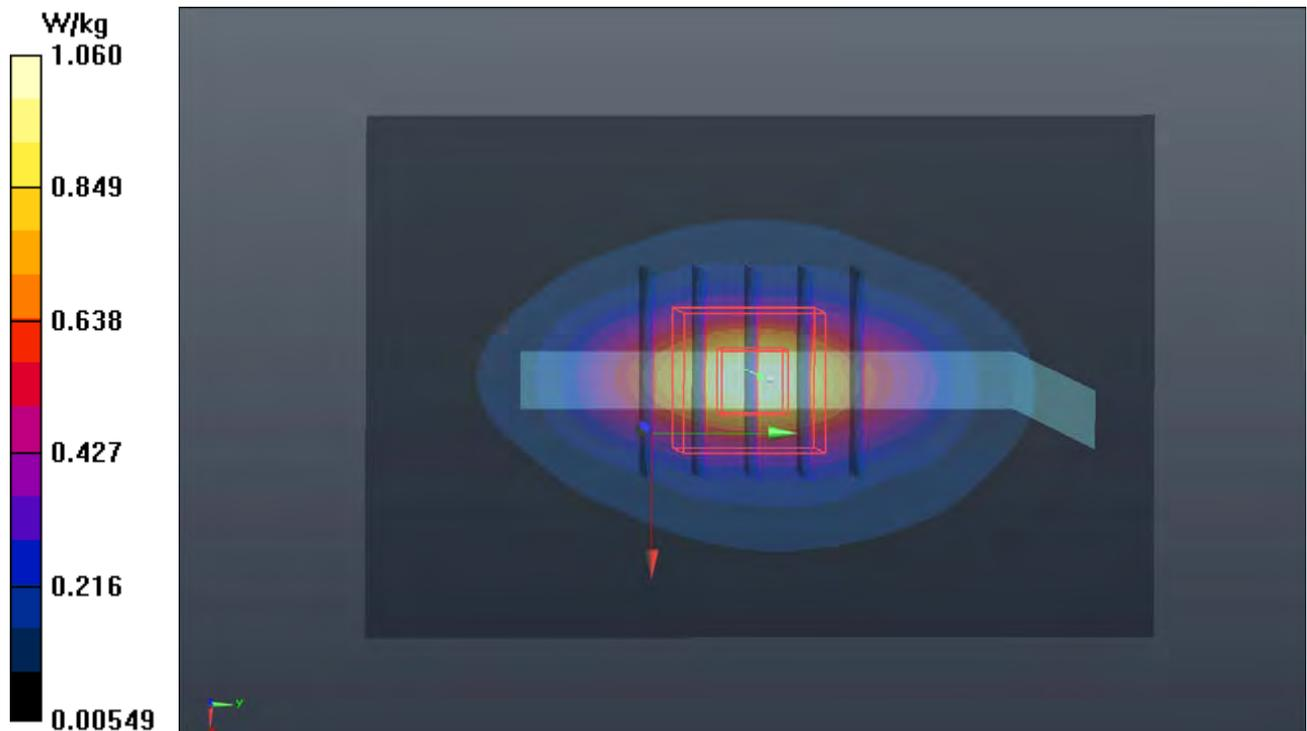

P48 LTE 5_QPSK10M_Rear Face_10mm_Ch20600_1RB_OS0_Ant0

DUT: 18Q1-021

Communication System: LTE; Frequency: 844 MHz; Duty Cycle: 1:1

Medium: B07T10N1_0525 Medium parameters used: $f = 844 \text{ MHz}$; $\sigma = 0.994 \text{ S/m}$; $\epsilon_r = 53.939$; $\rho = 1000 \text{ kg/m}^3$

Ambient Temperature : $23.7 \text{ }^\circ\text{C}$; Liquid Temperature : $23.5 \text{ }^\circ\text{C}$

DASY5 Configuration:

- Probe: EX3DV4 - SN3971; ConvF(10.15, 10.15, 10.15); Calibrated: 2018/03/26
- Sensor-Surface: 1.4mm (Mechanical Surface Detection)
- Electronics: DAE4 Sn1431; Calibrated: 2018/03/16
- Phantom: Twin SAM Phantom_1822; Type: QD000P40CD;
- Measurement SW: DASY52, Version 52.10 (1); SEMCAD X Version 14.6.11 (7439)

- **Area Scan (71x141x1)**: Interpolated grid: $dx=1.500 \text{ mm}$, $dy=1.500 \text{ mm}$

Maximum value of SAR (interpolated) = 0.472 W/kg

- **Zoom Scan (5x5x7)/Cube 0**: Measurement grid: $dx=8\text{mm}$, $dy=8\text{mm}$, $dz=5\text{mm}$

Reference Value = 19.43 V/m ; Power Drift = -0.04 dB

Peak SAR (extrapolated) = 0.614 W/kg

SAR(1 g) = 0.329 W/kg ; SAR(10 g) = 0.190 W/kg

Maximum value of SAR (measured) = 0.498 W/kg

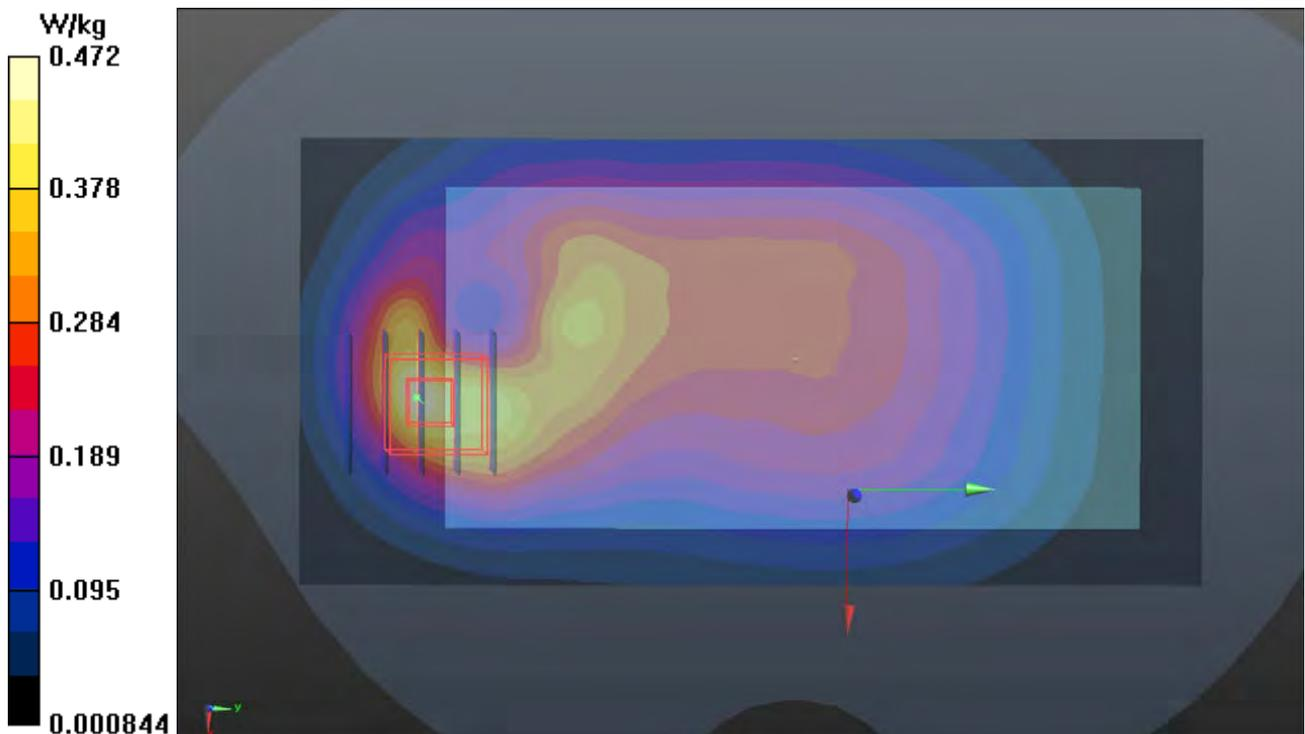

P49 LTE 7_QPSK20M_Bottom Side_10mm_Ch21100_1RB_OS0_Ant0

DUT: 18Q1-021

Communication System: LTE; Frequency: 2535 MHz; Duty Cycle: 1:1

Medium: B19T27N1_0525 Medium parameters used: $f = 2535 \text{ MHz}$; $\sigma = 2.097 \text{ S/m}$; $\epsilon_r = 50.402$; $\rho = 1000 \text{ kg/m}^3$

Ambient Temperature : $23.7 \text{ }^\circ\text{C}$; Liquid Temperature : $23.5 \text{ }^\circ\text{C}$

DASY5 Configuration:

- Probe: EX3DV4 - SN3971; ConvF(7.36, 7.36, 7.36); Calibrated: 2018/03/26
- Sensor-Surface: 1.4mm (Mechanical Surface Detection)
- Electronics: DAE4 Sn1431; Calibrated: 2018/03/16
- Phantom: Twin SAM Phantom_1822; Type: QD000P40CD;
- Measurement SW: DASY52, Version 52.10 (1); SEMCAD X Version 14.6.11 (7439)

- **Area Scan (71x101x1):** Interpolated grid: $dx=1.200 \text{ mm}$, $dy=1.200 \text{ mm}$

Maximum value of SAR (interpolated) = 1.22 W/kg

- **Zoom Scan (5x5x7)/Cube 0:** Measurement grid: $dx=8\text{mm}$, $dy=8\text{mm}$, $dz=5\text{mm}$

Reference Value = 20.48 V/m ; Power Drift = 0.04 dB

Peak SAR (extrapolated) = 1.52 W/kg

SAR(1 g) = 0.740 W/kg ; SAR(10 g) = 0.362 W/kg

Maximum value of SAR (measured) = 1.20 W/kg

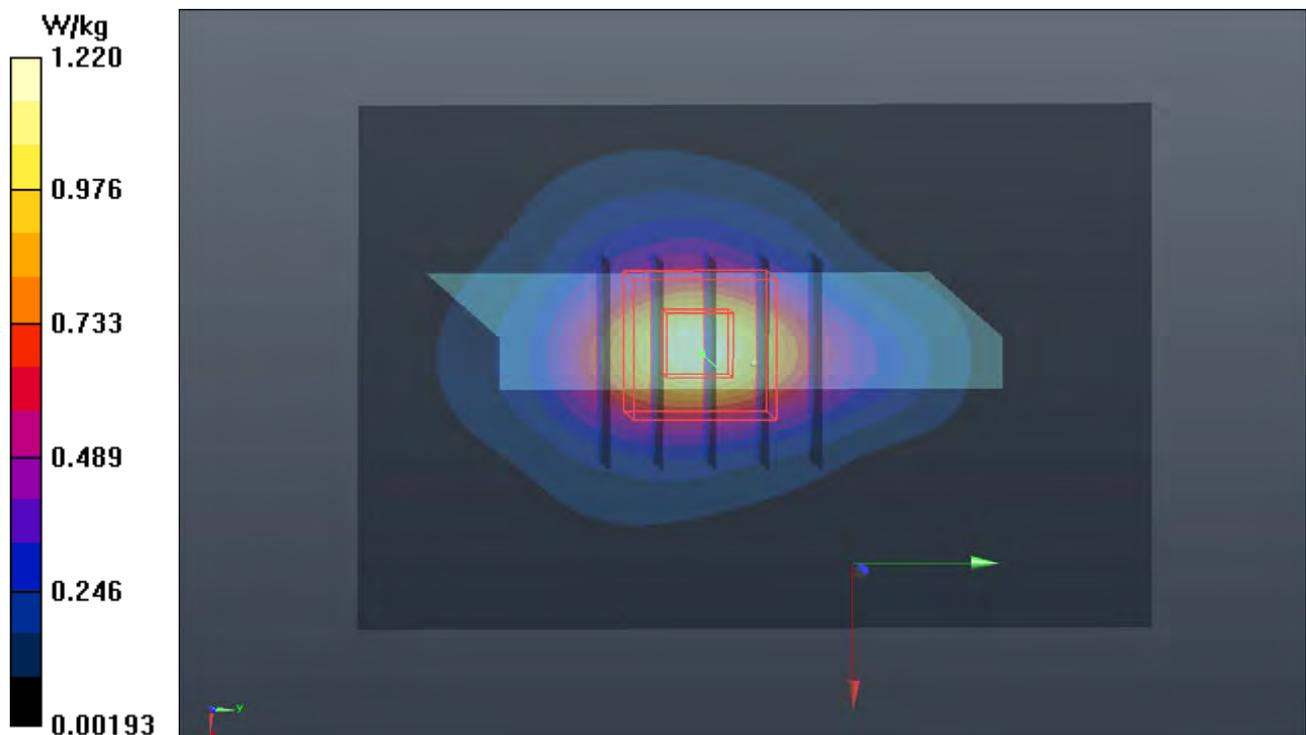

P50 LTE 12_QPSK10M_Front Face_10mm_Ch23130_1RB_OS0_Ant1

DUT: 18Q1-021

Communication System: LTE; Frequency: 711 MHz; Duty Cycle: 1:1

Medium: B06T09N1_0531 Medium parameters used: $f = 711 \text{ MHz}$; $\sigma = 0.925 \text{ S/m}$; $\epsilon_r = 55.877$; $\rho = 1000 \text{ kg/m}^3$

Ambient Temperature : $23.8 \text{ }^\circ\text{C}$; Liquid Temperature : $23.5 \text{ }^\circ\text{C}$

DASY5 Configuration:

- Probe: EX3DV4 - SN3650; ConvF(9.89, 9.89, 9.89); Calibrated: 2017/07/24
- Sensor-Surface: 1.4mm (Mechanical Surface Detection)
- Electronics: DAE4 Sn1277; Calibrated: 2018/01/18
- Phantom: Twin SAM Phantom_1822; Type: QD000P40CD;
- Measurement SW: DASY52, Version 52.10 (1); SEMCAD X Version 14.6.11 (7439)

- **Area Scan (71x121x1):** Interpolated grid: $dx=1.500 \text{ mm}$, $dy=1.500 \text{ mm}$

Maximum value of SAR (interpolated) = 0.258 W/kg

- **Zoom Scan (5x5x7)/Cube 0:** Measurement grid: $dx=8\text{mm}$, $dy=8\text{mm}$, $dz=5\text{mm}$

Reference Value = 16.25 V/m ; Power Drift = 0.04 dB

Peak SAR (extrapolated) = 0.295 W/kg

SAR(1 g) = 0.192 W/kg ; SAR(10 g) = 0.128 W/kg

Maximum value of SAR (measured) = 0.254 W/kg

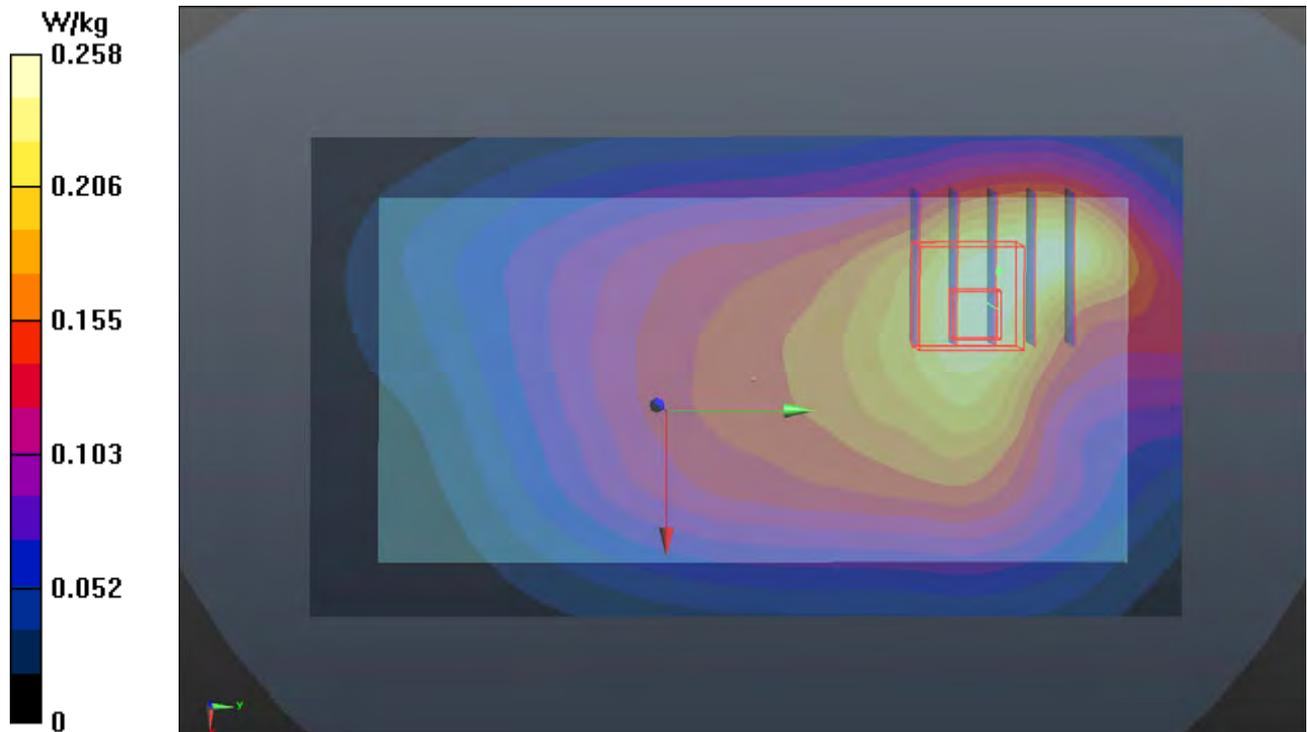

P51 LTE 13_QPSK10M_Front Face_10mm_Ch23230_1RB_OS0_Ant1

DUT: 18Q1-021

Communication System: LTE; Frequency: 782 MHz; Duty Cycle: 1:1

Medium: B06T09N1_0531 Medium parameters used: $f = 782 \text{ MHz}$; $\sigma = 0.987 \text{ S/m}$; $\epsilon_r = 55.276$; $\rho = 1000 \text{ kg/m}^3$

Ambient Temperature : $23.8 \text{ }^\circ\text{C}$; Liquid Temperature : $23.5 \text{ }^\circ\text{C}$

DASY5 Configuration:

- Probe: EX3DV4 - SN3650; ConvF(9.89, 9.89, 9.89); Calibrated: 2017/07/24
- Sensor-Surface: 1.4mm (Mechanical Surface Detection)
- Electronics: DAE4 Sn1277; Calibrated: 2018/01/18
- Phantom: Twin SAM Phantom_1822; Type: QD000P40CD;
- Measurement SW: DASY52, Version 52.10 (1); SEMCAD X Version 14.6.11 (7439)

- **Area Scan (71x121x1):** Interpolated grid: $dx=1.500 \text{ mm}$, $dy=1.500 \text{ mm}$

Maximum value of SAR (interpolated) = 0.233 W/kg

- **Zoom Scan (5x5x7)/Cube 0:** Measurement grid: $dx=8\text{mm}$, $dy=8\text{mm}$, $dz=5\text{mm}$

Reference Value = 15.04 V/m ; Power Drift = 0.03 dB

Peak SAR (extrapolated) = 0.264 W/kg

SAR(1 g) = 0.176 W/kg ; SAR(10 g) = 0.120 W/kg

Maximum value of SAR (measured) = 0.230 W/kg

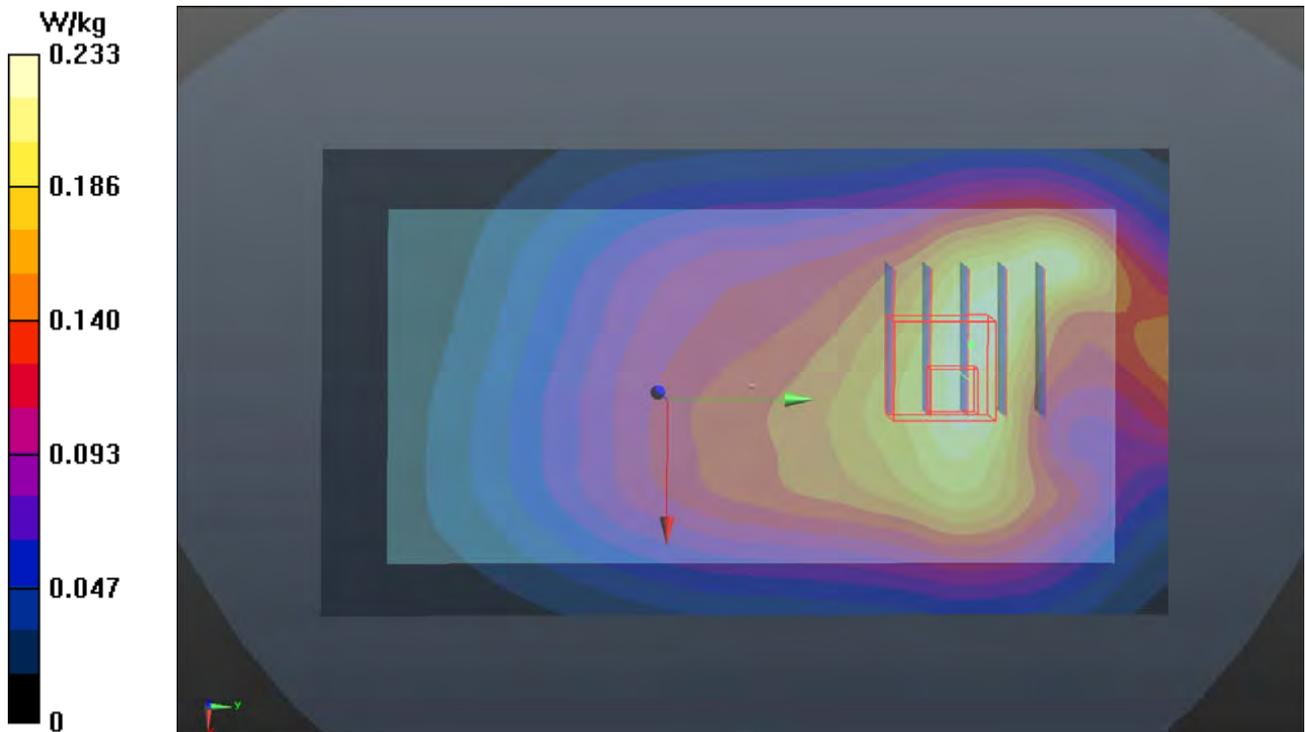

P52 LTE 17_QPSK10M_Front Face_10mm_Ch23800_1RB_OS0_Ant1

DUT: 18Q1-021

Communication System: LTE; Frequency: 711 MHz; Duty Cycle: 1:1

Medium: B06T09N1_0531 Medium parameters used: $f = 711$ MHz; $\sigma = 0.925$ S/m; $\epsilon_r = 55.877$; $\rho = 1000$ kg/m³

Ambient Temperature : 23.8 °C ; Liquid Temperature : 23.5 °C

DASY5 Configuration:

- Probe: EX3DV4 - SN3650; ConvF(9.89, 9.89, 9.89); Calibrated: 2017/07/24
- Sensor-Surface: 1.4mm (Mechanical Surface Detection)
- Electronics: DAE4 Sn1277; Calibrated: 2018/01/18
- Phantom: Twin SAM Phantom_1822; Type: QD000P40CD;
- Measurement SW: DASY52, Version 52.10 (1); SEMCAD X Version 14.6.11 (7439)

- **Area Scan (71x121x1):** Interpolated grid: dx=1.500 mm, dy=1.500 mm

Maximum value of SAR (interpolated) = 0.255 W/kg

- **Zoom Scan (5x5x7)/Cube 0:** Measurement grid: dx=8mm, dy=8mm, dz=5mm

Reference Value = 15.79 V/m; Power Drift = 0.07 dB

Peak SAR (extrapolated) = 0.281 W/kg

SAR(1 g) = 0.185 W/kg; SAR(10 g) = 0.124 W/kg

Maximum value of SAR (measured) = 0.245 W/kg

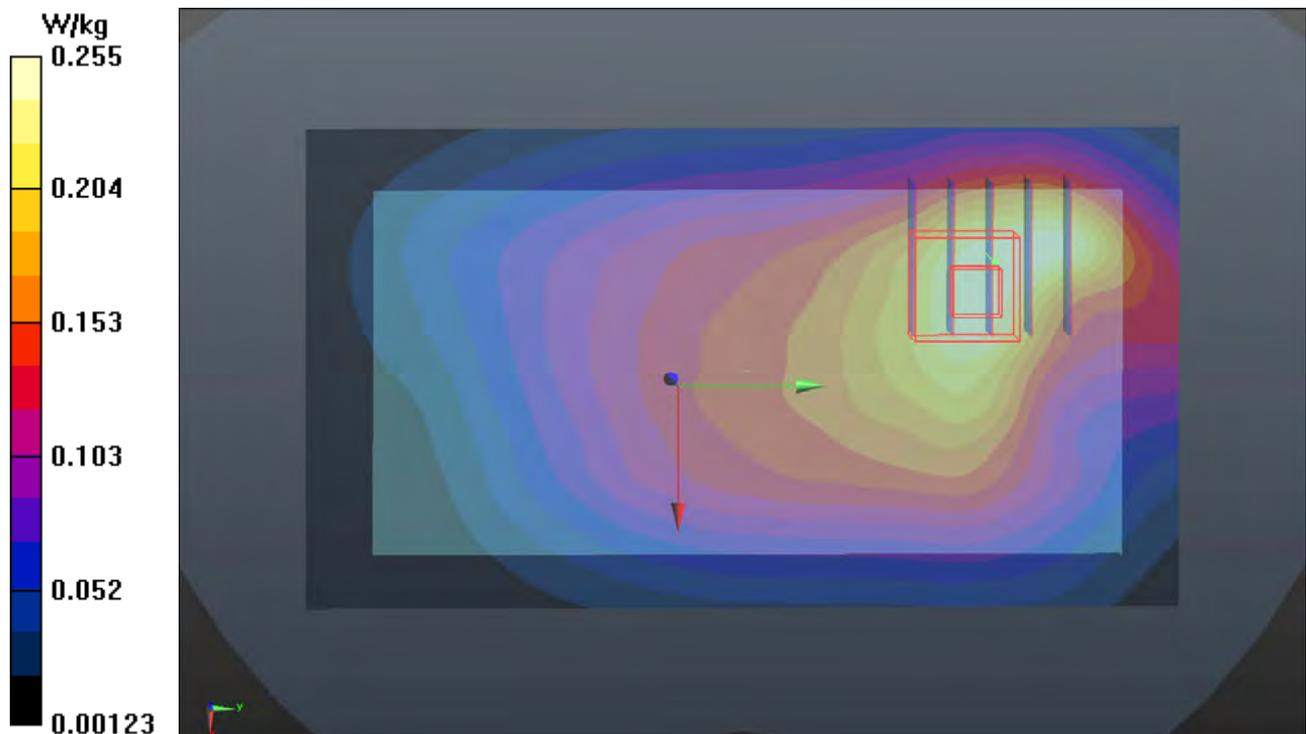

P53 LTE 38_QPSK20M_Bottom Side_10mm_Ch38000_1RB_OS0_Ant0

DUT: 18Q1-021

Communication System: LTE TDD CF0; Frequency: 2595 MHz; Duty Cycle: 1:1.58

Medium: B19T27N1_0531 Medium parameters used: $f = 2595$ MHz; $\sigma = 2.186$ S/m; $\epsilon_r = 50.608$; $\rho = 1000$ kg/m³

Ambient Temperature : 23.8 °C ; Liquid Temperature : 23.5 °C

DASY5 Configuration:

- Probe: EX3DV4 - SN3650; ConvF(7.37, 7.37, 7.37); Calibrated: 2017/07/24
- Sensor-Surface: 1.4mm (Mechanical Surface Detection)
- Electronics: DAE4 Sn1277; Calibrated: 2018/01/18
- Phantom: Twin SAM Phantom_1822; Type: QD000P40CD;
- Measurement SW: DASY52, Version 52.10 (1); SEMCAD X Version 14.6.11 (7439)

- **Area Scan (71x101x1):** Interpolated grid: dx=1.200 mm, dy=1.200 mm

Maximum value of SAR (interpolated) = 1.84 W/kg

- **Zoom Scan (5x5x7)/Cube 0:** Measurement grid: dx=8mm, dy=8mm, dz=5mm

Reference Value = 27.11 V/m; Power Drift = 0.03 dB

Peak SAR (extrapolated) = 2.34 W/kg

SAR(1 g) = 1.13 W/kg; SAR(10 g) = 0.546 W/kg

Maximum value of SAR (measured) = 1.87 W/kg

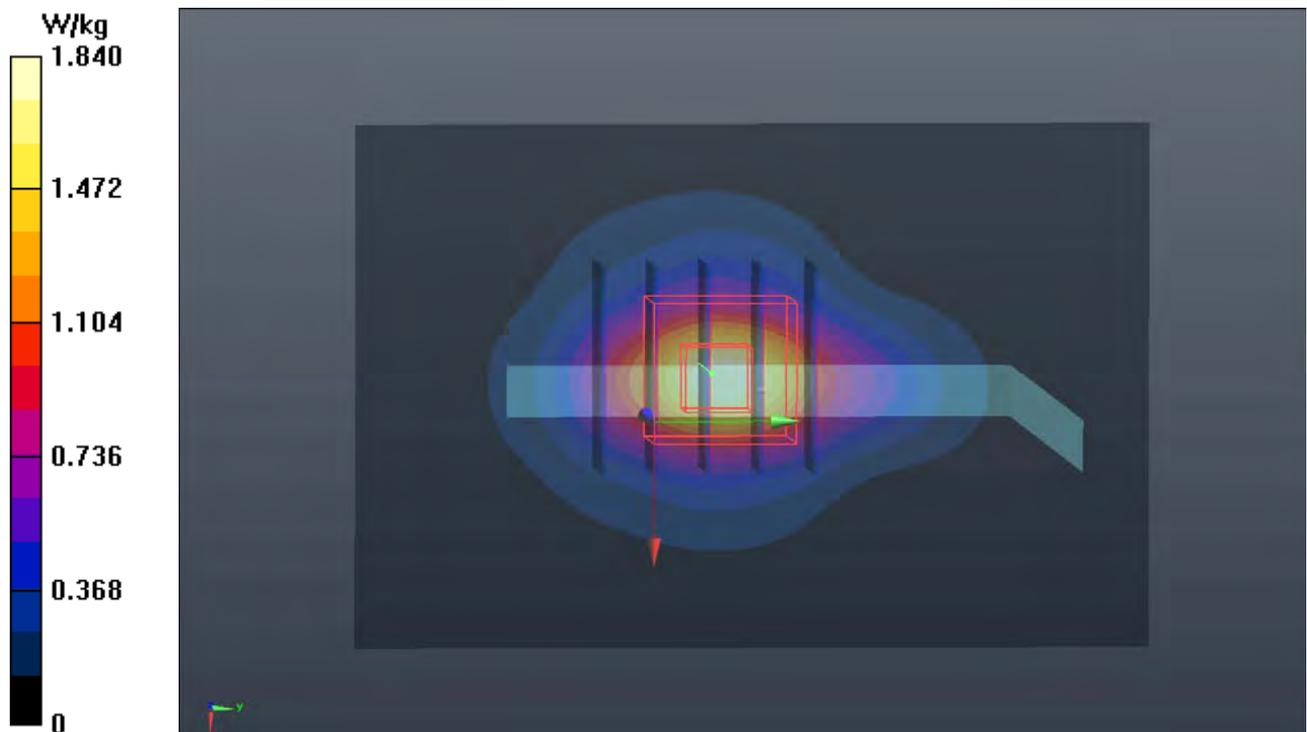

P54 LTE 41_QPSK20M_Bottom Side_10mm_Ch40640_1RB_OS0_Ant0

DUT: 18Q1-021

Communication System: LTE TDD CF0; Frequency: 2595 MHz; Duty Cycle: 1:1.58

Medium: B19T27N5_0829 Medium parameters used: $f = 2595$ MHz; $\sigma = 2.145$ S/m; $\epsilon_r = 50.363$; $\rho = 1000$ kg/m³

Ambient Temperature : 23.7 °C ; Liquid Temperature : 23.3 °C

DASY5 Configuration:

- Probe: EX3DV4 - SN3650; ConvF(7.48, 7.48, 7.48); Calibrated: 2018/07/27
- Sensor-Surface: 1.4mm (Mechanical Surface Detection)
- Electronics: DAE4 Sn1232; Calibrated: 2018/05/22
- Phantom: Twin SAM Phantom_1496; Type: QD000P40CA;
- Measurement SW: DASY52, Version 52.10 (1); SEMCAD X Version 14.6.11 (7439)

- **Area Scan (51x91x1):** Interpolated grid: dx=1.200 mm, dy=1.200 mm

Maximum value of SAR (interpolated) = 1.54 W/kg

- **Zoom Scan (5x5x7)/Cube 0:** Measurement grid: dx=8mm, dy=8mm, dz=5mm

Reference Value = 23.19 V/m; Power Drift = -0.02 dB

Peak SAR (extrapolated) = 2.25 W/kg

SAR(1 g) = 0.991 W/kg; SAR(10 g) = 0.506 W/kg

Maximum value of SAR (measured) = 1.69 W/kg

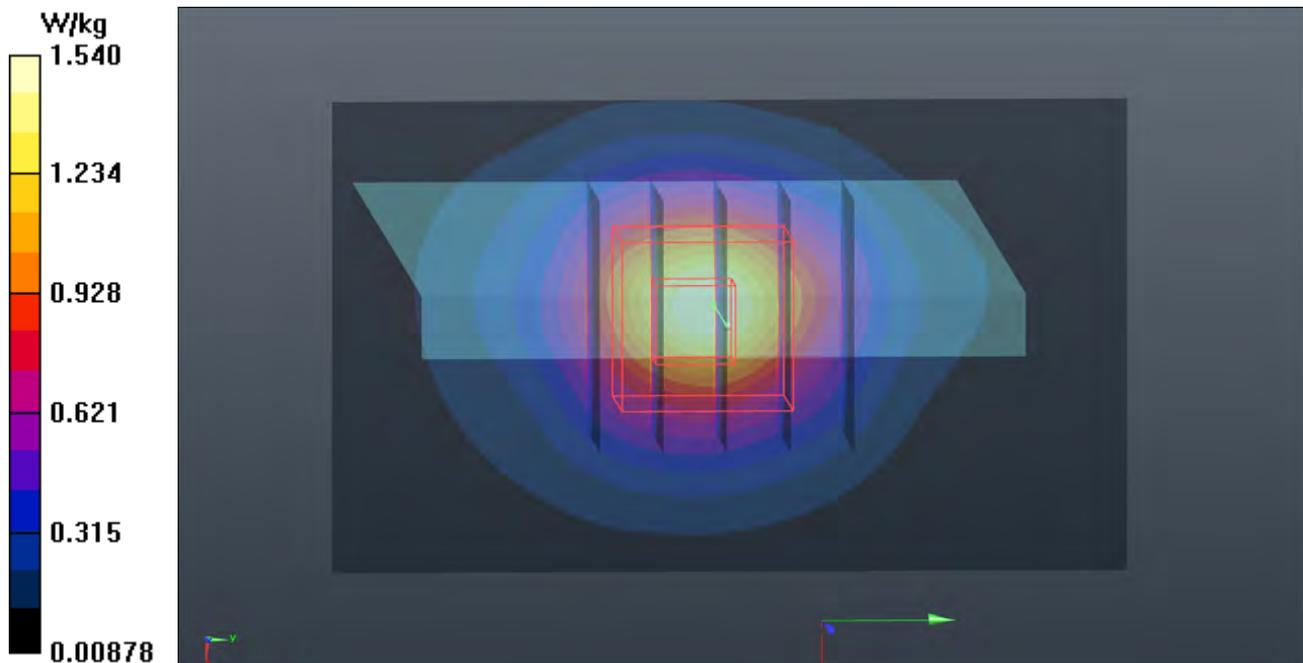

P55 LTE 66_QPSK20M_Bottom Side_10mm_Ch132072_1RB_OS0_Ant0

DUT: 180523C09

Communication System: LTE; Frequency: 1720 MHz; Duty Cycle: 1:1

Medium: B16T20N1_0906 Medium parameters used: $f = 1720 \text{ MHz}$; $\sigma = 1.408 \text{ S/m}$; $\epsilon_r = 53.442$; $\rho = 1000 \text{ kg/m}^3$

Ambient Temperature : $23.7 \text{ }^\circ\text{C}$; Liquid Temperature : $23.2 \text{ }^\circ\text{C}$

DASY5 Configuration:

- Probe: EX3DV4 - SN3971; ConvF(8.34, 8.34, 8.34); Calibrated: 2018/03/26
- Sensor-Surface: 1.4mm (Mechanical Surface Detection)
- Electronics: DAE4 Sn1431; Calibrated: 2018/03/16
- Phantom: Twin SAM Phantom_1822; Type: QD000P40CD;
- Measurement SW: DASY52, Version 52.10 (1); SEMCAD X Version 14.6.11 (7439)

- **Area Scan (61x81x1):** Interpolated grid: $dx=1.500 \text{ mm}$, $dy=1.500 \text{ mm}$

Maximum value of SAR (interpolated) = 1.07 W/kg

- **Zoom Scan (5x5x7)/Cube 0:** Measurement grid: $dx=8\text{mm}$, $dy=8\text{mm}$, $dz=5\text{mm}$

Reference Value = 28.52 V/m ; Power Drift = -0.15 dB

Peak SAR (extrapolated) = 1.26 W/kg

SAR(1 g) = 0.721 W/kg ; SAR(10 g) = 0.398 W/kg

Maximum value of SAR (measured) = 1.07 W/kg

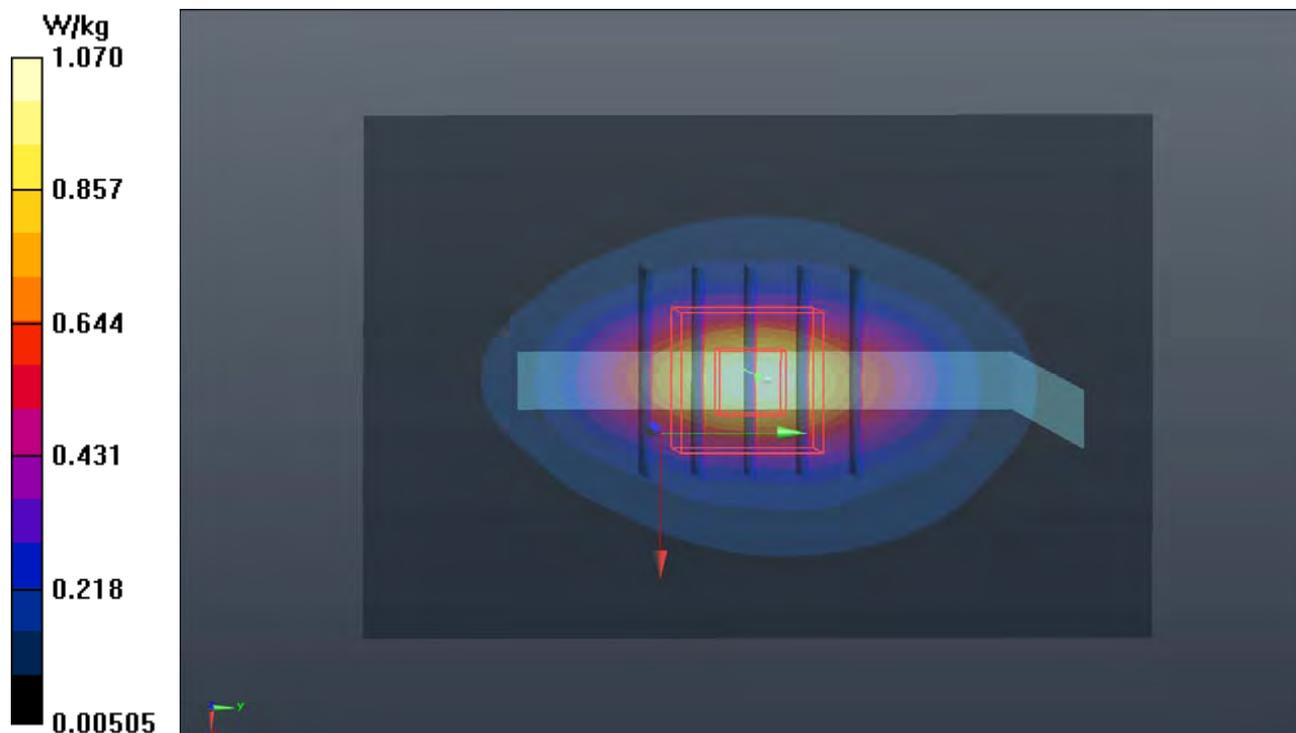

P56 WLAN2.4G_802.11n HT20_Rear Face_10mm_Ch1_Ant0+1

DUT: 18Q1-021

Communication System: WLAN_2.4G; Frequency: 2412 MHz; Duty Cycle: 1:1

Medium: B19T27N1_0525 Medium parameters used: $f = 2412 \text{ MHz}$; $\sigma = 1.967 \text{ S/m}$; $\epsilon_r = 50.769$; $\rho = 1000 \text{ kg/m}^3$

Ambient Temperature : $23.8 \text{ }^\circ\text{C}$; Liquid Temperature : $23.5 \text{ }^\circ\text{C}$

DASY5 Configuration:

- Probe: EX3DV4 - SN3971; ConvF(7.7, 7.7, 7.7); Calibrated: 2018/03/26;
- Sensor-Surface: 1.4mm (Mechanical Surface Detection)
- Electronics: DAE4 Sn1431; Calibrated: 2018/03/16
- Phantom: Twin SAM Phantom_1822; Type: QD000P40CD;
- Measurement SW: DASY52, Version 52.10 (1); SEMCAD X Version 14.6.11 (7439)

- Area Scan (91x151x1): Interpolated grid: $dx=1.200 \text{ mm}$, $dy=1.200 \text{ mm}$

Maximum value of SAR (interpolated) = 0.438 W/kg

- Zoom Scan (5x5x7)/Cube 0: Measurement grid: $dx=8\text{mm}$, $dy=8\text{mm}$, $dz=5\text{mm}$

Reference Value = 15.66 V/m ; Power Drift = -0.08 dB

Peak SAR (extrapolated) = 0.720 W/kg

SAR(1 g) = 0.358 W/kg ; SAR(10 g) = 0.166 W/kg

Maximum value of SAR (measured) = 0.572 W/kg

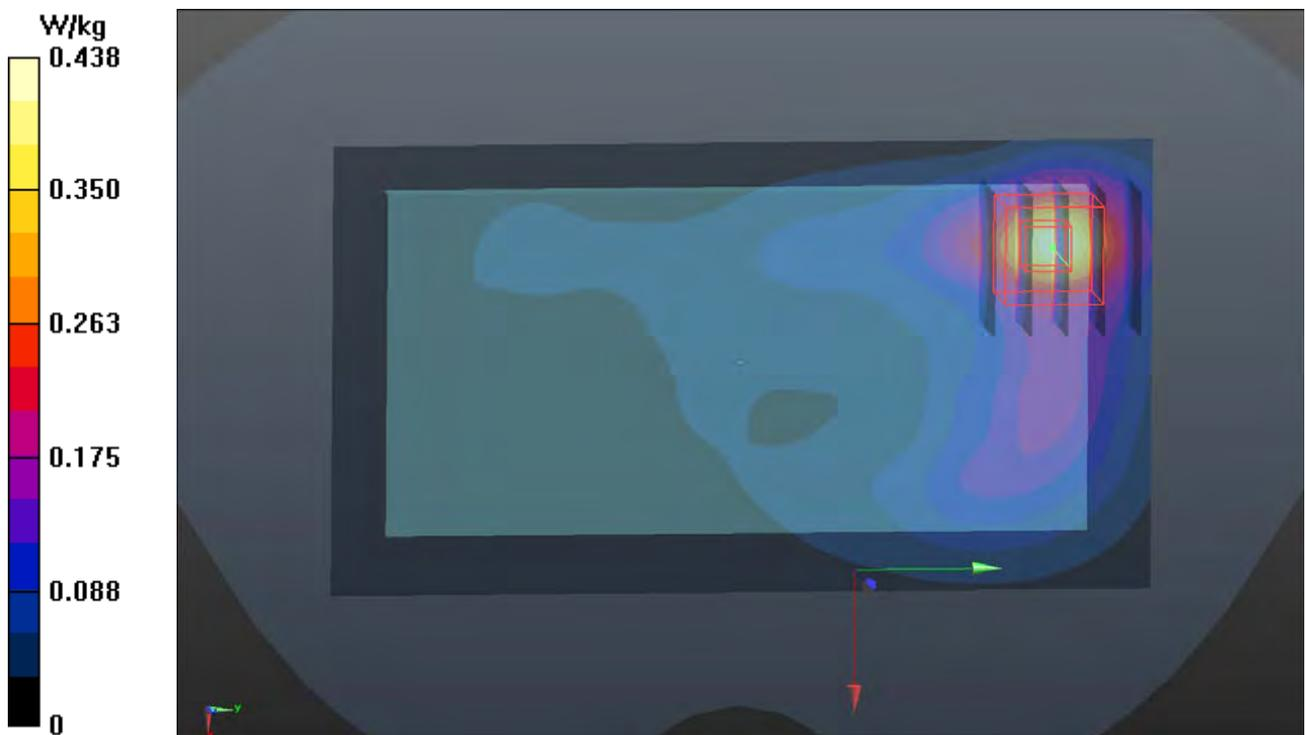

P57 WLAN5G_802.11a_Rear Face_10mm_Ch40_Ant0

DUT: 18Q1-021

Communication System: WLAN_5G; Frequency: 5200 MHz; Duty Cycle: 1:1

Medium: B34T60N1_0525 Medium parameters used: $f = 5200$ MHz; $\sigma = 5.257$ S/m; $\epsilon_r = 46.902$; $\rho =$

1000 kg/m³

Ambient Temperature : 23.8 °C ; Liquid Temperature : 23.5 °C

DASY5 Configuration:

- Probe: EX3DV4 - SN3971; ConvF(4.59, 4.59, 4.59); Calibrated: 2018/03/26;
- Sensor-Surface: 1.4mm (Mechanical Surface Detection)
- Electronics: DAE4 Sn1431; Calibrated: 2018/03/16
- Phantom: Twin SAM Phantom_1822; Type: QD000P40CD;
- Measurement SW: DASY52, Version 52.10 (1); SEMCAD X Version 14.6.11 (7439)

- **Area Scan (101x181x1):** Interpolated grid: dx=1.000 mm, dy=1.000 mm

Maximum value of SAR (interpolated) = 1.20 W/kg

- **Zoom Scan (6x6x12)/Cube 0:** Measurement grid: dx=5mm, dy=5mm, dz=2mm

Reference Value = 14.51 V/m; Power Drift = -0.01 dB

Peak SAR (extrapolated) = 2.15 W/kg

SAR(1 g) = 0.619 W/kg; SAR(10 g) = 0.210 W/kg

Maximum value of SAR (measured) = 1.35 W/kg

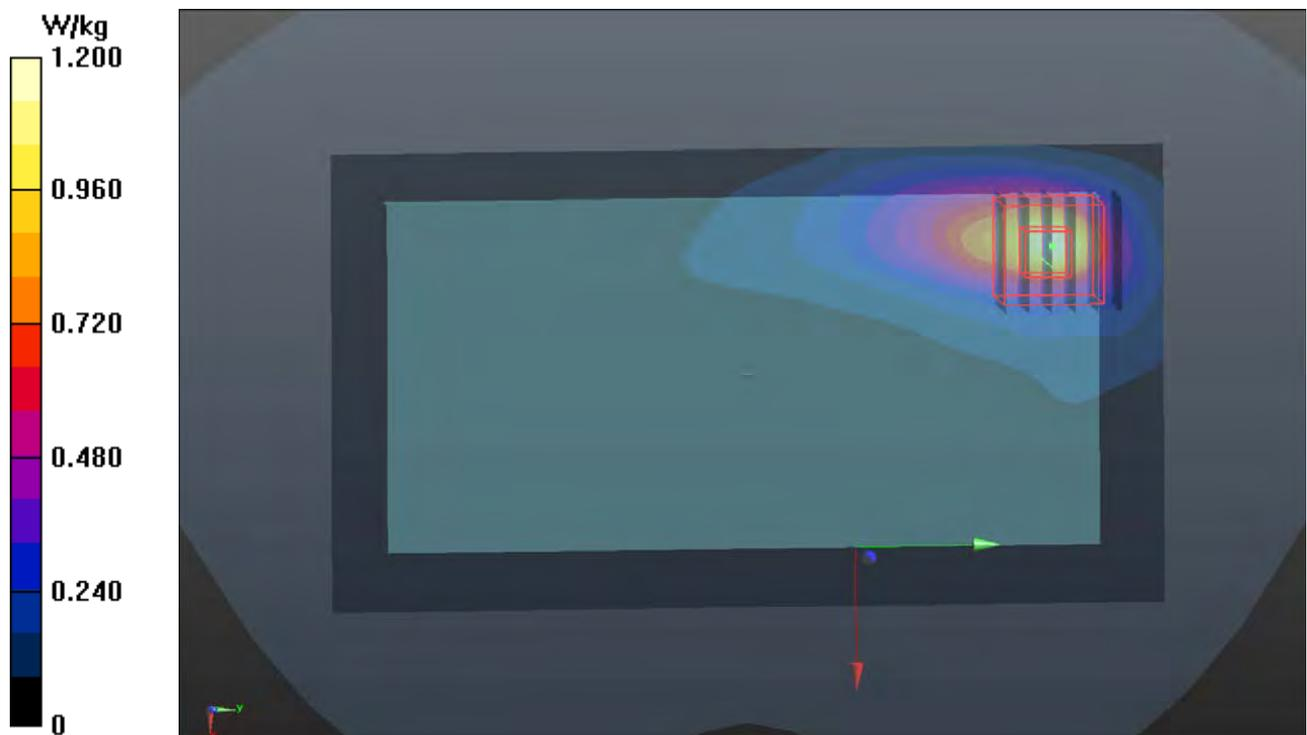

P58 WLAN5G_802.11n HT20_Rear Face_10mm_Ch157_Ant0+1

DUT: 18Q1-021

Communication System: WLAN_5G; Frequency: 5785 MHz; Duty Cycle: 1:1

Medium: B34T60N2_0911 Medium parameters used: $f = 5785$ MHz; $\sigma = 6.152$ S/m; $\epsilon_r = 46.117$; $\rho = 1000$ kg/m³

Ambient Temperature : 23.5 °C ; Liquid Temperature : 23.3 °C

DASY5 Configuration:

- Probe: EX3DV4 - SN3898; ConvF(4.45, 4.45, 4.45); Calibrated: 2018/06/26
- Sensor-Surface: 1.4mm (Mechanical Surface Detection)
- Electronics: DAE4 Sn1277; Calibrated: 2018/01/18
- Phantom: Twin SAM Phantom_1822; Type: QD000P40CD;
- Measurement SW: DASY52, Version 52.10 (1); SEMCAD X Version 14.6.11 (7439)

- **Area Scan (101x201x1):** Interpolated grid: dx=1.000 mm, dy=1.000 mm
Maximum value of SAR (interpolated) = 1.46 W/kg

- **Zoom Scan (6x6x12)/Cube 0:** Measurement grid: dx=5mm, dy=5mm, dz=2mm

Reference Value = 16.33 V/m; Power Drift = -0.05 dB

Peak SAR (extrapolated) = 2.49 W/kg

SAR(1 g) = 0.646 W/kg; SAR(10 g) = 0.243 W/kg

Maximum value of SAR (measured) = 1.48 W/kg

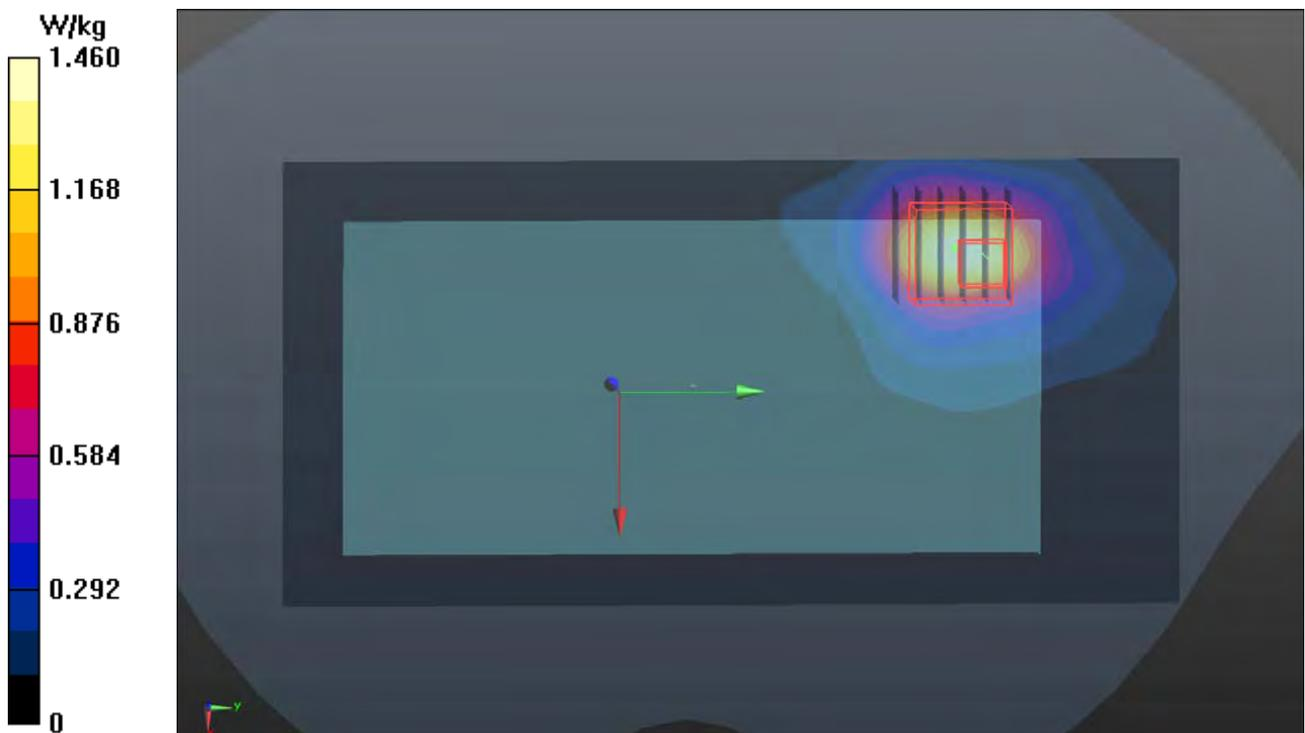

P59 BT_BR_EDR_Rear Face_10mm_Ch0_Ant0

DUT: 18Q1-021

Communication System: BT; Frequency: 2402 MHz; Duty Cycle: 1:1

Medium: B19T27N1_0531 Medium parameters used: $f = 2402$ MHz; $\sigma = 1.972$ S/m; $\epsilon_r = 51.174$; $\rho = 1000$ kg/m³

Ambient Temperature : 23.8 °C ; Liquid Temperature : 23.5 °C

DASY5 Configuration:

- Probe: EX3DV4 - SN3650; ConvF(7.68, 7.68, 7.68); Calibrated: 2017/07/24
- Sensor-Surface: 1.4mm (Mechanical Surface Detection)
- Electronics: DAE4 Sn1277; Calibrated: 2018/01/18
- Phantom: Twin SAM Phantom_1822; Type: QD000P40CD;
- Measurement SW: DASY52, Version 52.10 (1); SEMCAD X Version 14.6.11 (7439)

- **Area Scan (91x151x1)**: Interpolated grid: dx=1.200 mm, dy=1.200 mm

Maximum value of SAR (interpolated) = 0.0223 W/kg

- **Zoom Scan (5x5x7)/Cube 0**: Measurement grid: dx=8mm, dy=8mm, dz=5mm

Reference Value = 2.240 V/m; Power Drift = 0.04 dB

Peak SAR (extrapolated) = 0.0250 W/kg

SAR(1 g) = 0.010 W/kg; SAR(10 g) = 0.00559 W/kg

Maximum value of SAR (measured) = 0.0160 W/kg

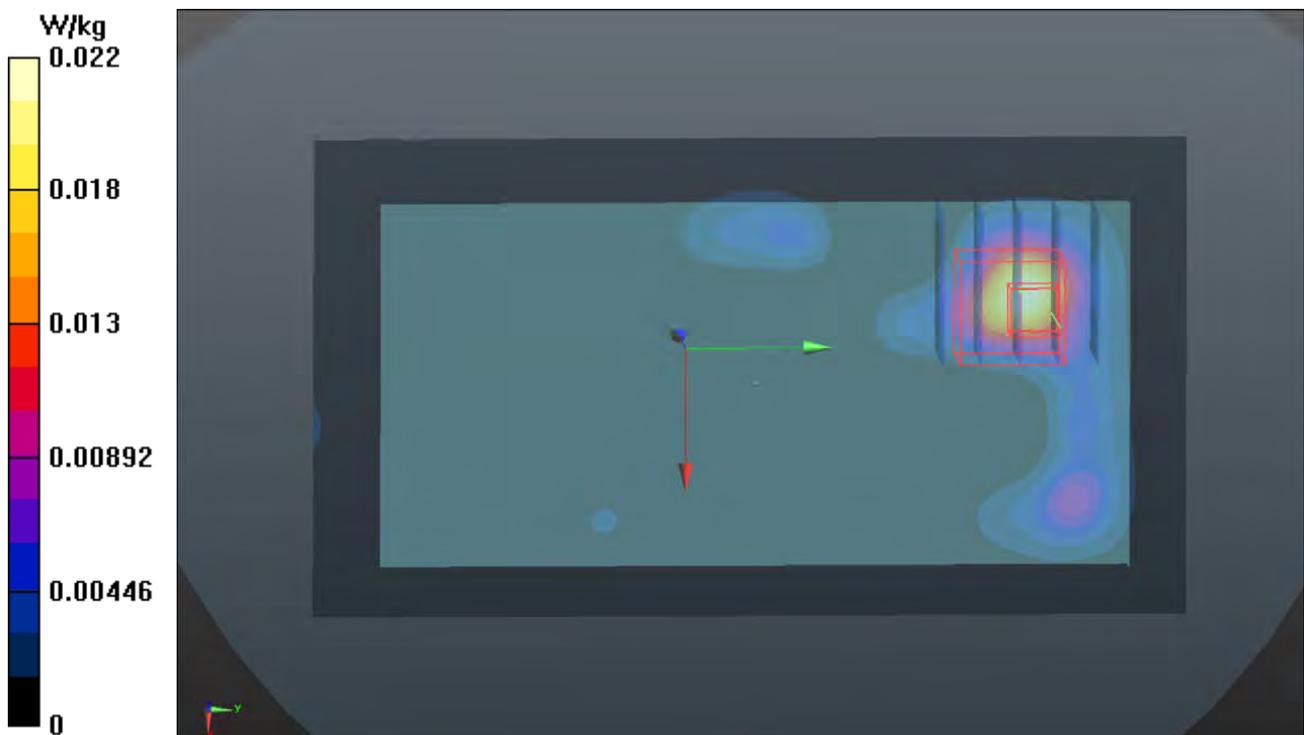

P60 WLAN5G_802.11a_Rear Face_0mm_Ch64_Ant0

DUT: 180523C09

Communication System: WLAN_5G; Frequency: 5320 MHz; Duty Cycle: 1:1

Medium: B34T60N3_0620 Medium parameters used: $f = 5320$ MHz; $\sigma = 5.566$ S/m; $\epsilon_r = 46.884$; $\rho = 1000$ kg/m³

Ambient Temperature : 23.7 °C ; Liquid Temperature : 23.3 °C

DASY5 Configuration:

- Probe: EX3DV4 - SN7346; ConvF(5.06, 5.06, 5.06); Calibrated: 2018/02/28
- Sensor-Surface: 1.4mm (Mechanical Surface Detection)
- Electronics: DAE4 Sn861; Calibrated: 2018/05/30
- Phantom: Twin SAM Phantom_1496; Type: QD000P40CA;
- Measurement SW: DASY52, Version 52.10 (1); SEMCAD X Version 14.6.11 (7439)

- **Area Scan (101x201x1):** Interpolated grid: dx=1.000 mm, dy=1.000 mm

Maximum value of SAR (interpolated) = 20.2 W/kg

- **Zoom Scan (6x6x12)/Cube 0:** Measurement grid: dx=5mm, dy=5mm, dz=2mm

Reference Value = 66.37 V/m; Power Drift = -0.09 dB

Peak SAR (extrapolated) = 56.1 W/kg

SAR(1 g) = 9.1 W/kg; SAR(10 g) = 2.19 W/kg

Maximum value of SAR (measured) = 28.6 W/kg

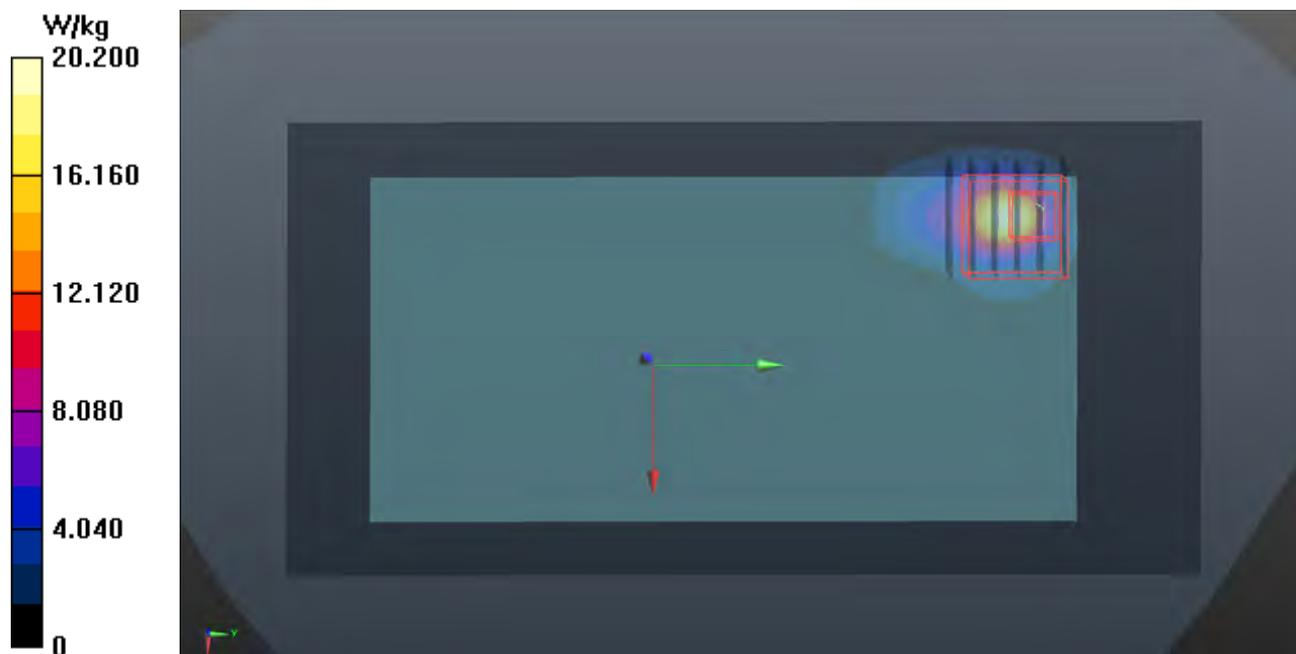

P61 WLAN5G_802.11n HT20_Rear Face_0mm_Ch116_Ant0+1

DUT: 180523C09

Communication System: WLAN_5G; Frequency: 5580 MHz; Duty Cycle: 1:1

Medium: B34T60N3_0620 Medium parameters used: $f = 5580$ MHz; $\sigma = 5.938$ S/m; $\epsilon_r = 46.601$; $\rho = 1000$ kg/m³

Ambient Temperature : 23.7 °C ; Liquid Temperature : 23.3 °C

DASY5 Configuration:

- Probe: EX3DV4 - SN7346; ConvF(4.35, 4.35, 4.35); Calibrated: 2018/02/28
- Sensor-Surface: 1.4mm (Mechanical Surface Detection)
- Electronics: DAE4 Sn861; Calibrated: 2018/05/30
- Phantom: Twin SAM Phantom_1496; Type: QD000P40CA;
- Measurement SW: DASY52, Version 52.10 (1); SEMCAD X Version 14.6.11 (7439)

- **Area Scan (101x201x1):** Interpolated grid: dx=1.000 mm, dy=1.000 mm

Maximum value of SAR (interpolated) = 16.4 W/kg

- **Zoom Scan (6x6x12)/Cube 0:** Measurement grid: dx=5mm, dy=5mm, dz=2mm

Reference Value = 58.41 V/m; Power Drift = -0.09 dB

Peak SAR (extrapolated) = 70.0 W/kg

SAR(1 g) = 10.4 W/kg; SAR(10 g) = 2.86 W/kg

Maximum value of SAR (measured) = 40.9 W/kg

