

## FCC Test Report (Part 24)

**Report No.:** RF180523C09-1 R1

**FCC ID:** 2AJOTTA-1087

**Test Model:** TA-1087

**Received Date:** May 23, 2018

**Test Date:** Jun. 07 ~ Jun. 15, 2018

**Issued Date:** Oct. 24, 2018

**Applicant:** HMD Global Oy

**Address:** Bertel Jungin aukio 9, 02600 Espoo, Finland

**Issued By:** Bureau Veritas Consumer Products Services (H.K.) Ltd., Taoyuan Branch

**Lab Address:** No. 47-2, 14th Ling, Chia Pau Vil., Lin Kou Dist., New Taipei City, Taiwan (R.O.C.)

**Test Location:** No. 19, Hwa Ya 2nd Rd., Wen Hwa Vil., Kwei Shan Dist., Taoyuan City 33383, TAIWAN (R.O.C.)



This report is for your exclusive use. Any copying or replication of this report to or for any other person or entity, or use of our name or trademark, is permitted only with our prior written permission. This report sets forth our findings solely with respect to the test samples identified herein. The results set forth in this report are not indicative or representative of the quality or characteristics of the lot from which a test sample was taken or any similar or identical product unless specifically and expressly noted. Our report includes all of the tests requested by you and the results thereof based upon the information that you provided to us. You have 60 days from date of issuance of this report to notify us of any material error or omission caused by our negligence, provided, however, that such notice shall be in writing and shall specifically address the issue you wish to raise. A failure to raise such issue within the prescribed time shall constitute your unqualified acceptance of the completeness of this report, the tests conducted and the correctness of the report contents. Unless specifically mentioned, the uncertainty of measurement has been explicitly taken into account to declare the compliance or non-compliance to the specification. The report must not be used by the client to claim product certification, approval, or endorsement by TAF or any government agencies

## Table of Contents

<b>Release Control Record</b> .....	<b>4</b>
<b>1 Certificate of Conformity</b> .....	<b>5</b>
<b>2 Summary of Test Results</b> .....	<b>6</b>
2.1 Measurement Uncertainty.....	6
2.2 Test Site and Instruments.....	7
<b>3 General Information</b> .....	<b>8</b>
3.1 General Description of EUT.....	8
3.2 Configuration of System under Test.....	9
3.2.1 Description of Support Units.....	9
3.3 Test Mode Applicability and Tested Channel Detail.....	10
3.4 EUT Operating Conditions.....	14
3.5 General Description of Applied Standards.....	14
<b>4 Test Types and Results</b> .....	<b>15</b>
4.1 Output Power Measurement.....	15
4.1.1 Limits of Output Power Measurement.....	15
4.1.2 Test Procedures.....	15
4.1.3 Test Setup.....	16
4.1.4 Test Results.....	17
4.2 Modulation Characteristics Measurement.....	45
4.2.1 Limits of Modulation Characteristics.....	45
4.2.2 Test Procedure.....	45
4.2.3 Test Setup.....	45
4.2.4 Test Results.....	46
4.3 Frequency Stability Measurement.....	48
4.3.1 Limits of Frequency Stability Measurement.....	48
4.3.2 Test Procedure.....	48
4.3.3 Test Setup.....	48
4.3.4 Test Results.....	49
4.4 Occupied Bandwidth Measurement.....	50
4.4.1 Test Procedure.....	50
4.4.2 Test Setup.....	50
4.4.3 Test Result.....	51
4.5 Band Edge Measurement.....	57
4.5.1 Limits of Band Edge Measurement.....	57
4.5.2 Test Setup.....	57
4.5.3 Test Procedures.....	57
4.5.4 Test Results.....	58
4.6 Peak to Average Ratio.....	65
4.6.1 Limits of Peak to Average Ratio Measurement.....	65
4.6.2 Test Setup.....	65
4.6.3 Test Procedures.....	65
4.6.4 Test Results.....	66
4.7 Conducted Spurious Emissions.....	70
4.7.1 Limits of Conducted Spurious Emissions Measurement.....	70
4.7.2 Test Setup.....	70
4.7.3 Test Procedure.....	70
4.7.4 Test Results.....	71
4.8 Radiated Emission Measurement.....	98
4.8.1 Limits of Radiated Emission Measurement.....	98
4.8.2 Test Procedure.....	98
4.8.3 Deviation from Test Standard.....	98
4.8.4 Test Setup.....	99
4.8.5 Test Results.....	100

<b>5</b>	<b>Pictures of Test Arrangements.....</b>	<b>127</b>
	<b>Appendix – Information on the Testing Laboratories .....</b>	<b>128</b>

### Release Control Record

Issue No.	Description	Date Issued
RF180523C09-1	Original release	Jun. 20, 2018
RF180523C09-1 R1	Revised applicant's address	Oct. 24, 2018

## 1 Certificate of Conformity

**Product:** Smart Phone  
**Brand:** NOKIA  
**Test Model:** TA-1087  
**Sample Status:** Production Unit  
**Applicant:** HMD Global Oy  
**Test Date:** Jun. 07 ~ Jun. 15, 2018  
**Standards:** FCC Part 24, Subpart E

The above equipment has been tested by **Bureau Veritas Consumer Products Services (H.K.) Ltd., Taoyuan Branch**, and found compliance with the requirement of the above standards. The test record, data evaluation & Equipment Under Test (EUT) configurations represented herein are true and accurate accounts of the measurements of the sample's RF characteristics under the conditions specified in this report.

**Prepared by :** Pettie Chen , **Date:** Oct. 24, 2018  
Pettie Chen / Senior Specialist

**Approved by :** Bruce Chen , **Date:** Oct. 24, 2018  
Bruce Chen / Project Engineer

## 2 Summary of Test Results

Applied Standard: FCC Part 24 & Part 2			
FCC Clause	Test Item	Result	Remarks
2.1046 24.232	Effective radiated power	Pass	Meet the requirement of limit.
2.1046 24.232(d)	Peak To Average Ratio	Pass	Meet the requirement of limit.
2.1047	Modulation characteristics	Pass	Meet the requirement
2.1055 24.235	Frequency Stability	Pass	Meet the requirement of limit.
2.1049 24.238(b)	Occupied Bandwidth	Pass	Meet the requirement of limit.
24.238(b)	Band Edge Measurements	Pass	Meet the requirement of limit.
2.1051 24.238	Conducted Spurious Emissions	Pass	Meet the requirement of limit.
2.1053 24.238	Radiated Spurious Emissions	Pass	Meet the requirement of limit. Minimum passing margin is -27.1dB at 31.94MHz.

### 2.1 Measurement Uncertainty

Where relevant, the following measurement uncertainty levels have been estimated for tests performed on the EUT as specified in CISPR 16-4-2:

Measurement	Frequency	Expanded Uncertainty (k=2) ( $\pm$ )
Radiated Emissions up to 1 GHz	30MHz ~ 200MHz	3.59 dB
	200MHz ~1000MHz	3.60 dB
Radiated Emissions above 1 GHz	1GHz ~ 18GHz	2.29 dB
	18GHz ~ 40GHz	2.29 dB

## 2.2 Test Site and Instruments

Description & Manufacturer	Model No.	Serial No.	Cal. Date	Cal. Due
Test Receiver KEYSIGHT	N9038A	MY55420137	Apr. 11, 2018	Apr. 10, 2019
Spectrum Analyzer ROHDE & SCHWARZ	FSP40	100269	May 29, 2018	May 28, 2019
BILOG Antenna SCHWARZBECK	VULB9168	9168-148	Dec. 11, 2017	Dec. 10, 2018
HORN Antenna SCHWARZBECK	BBHA 9120 D	9120D-1169	Dec. 12, 2017	Dec. 11, 2018
HORN Antenna SCHWARZBECK	BBHA 9170	BBHA9170241	Dec. 01, 2017	Nov. 30, 2018
Loop Antenna EMCI	EM-6879	269	Aug. 11, 2017	Aug. 10, 2018
Preamplifier Agilent (Below 1GHz)	8447D	2944A10638	Aug. 08, 2017	Aug. 07, 2018
Preamplifier Agilent (Above 1GHz)	8449B	3008A01638	Feb. 22, 2018	Feb. 21, 2019
RF signal cable HUBER+SUHNER&EMCI	SUCOFLEX 104 & EMC104-SM-SM8000	CABLE-CH9-02 (248780+171006)	Jan. 15, 2018	Jan. 14, 2019
RF signal cable HUBER+SUHNER	SUCOFLEX 104	CABLE-CH9-(250795/4)	Aug. 08, 2017	Aug. 07, 2018
RF signal cable Woken	8D-FB	Cable-CH9-01	Aug. 01, 2017	Jul. 31, 2018
Software BV ADT	ADT_Radiated_ V7.6.15.9.5	NA	NA	NA
Antenna Tower EMCO	2070/2080	512.835.4684	NA	NA
Turn Table EMCO	2087-2.03	NA	NA	NA
Antenna Tower & Turn BV ADT	AT100	AT93021705	NA	NA
Turn Table BV ADT	TT100	TT93021705	NA	NA
Turn Table Controller BV ADT	SC100	SC93021705	NA	NA
Boresight Antenna Fixture	FBA-01	FBA-SIP01	NA	NA
Turn Table Controller BV ADT	SC100	SC93021702	NA	NA
Temperature And Humidity Chamber TERCHY	HRM-120RF	931022	Nov. 20, 2017	Nov. 19, 2018
JFW 20dB attenuation	50HF-020-SMA	NA	NA	NA
Radio Communication Analyzer	MT8821C	6261786083	Dec. 21, 2017	Dec. 20, 2018

- Note: 1. The calibration interval of the above test instruments is 12 months and the calibrations are traceable to NML/ROC and NIST/USA.
2. The test was performed in HwaYa Chamber 9.
3. The FCC Designation Number is TW0003. The number will be varied with the Lab location and scope as attached.
4. The IC Site Registration No. is IC 7450F-9.

### 3 General Information

#### 3.1 General Description of EUT

Product	SmartPhone			
Brand	NOKIA			
Test Model	TA-1087			
Sample Status	Production Unit			
Power Supply Rating	5.0 Vdc or 9 Vdc or 12 Vdc (adapter) 5.0 Vdc (host equipment) 3.85 Vdc (Li-ion battery)			
Modulation Type	PCS, GPRS: GMSK EDGE: 8PSK WCDMA: BPSK, QPSK HSDPA: BPSK HSUPA: QPSK LTE: QPSK, 16QAM, 64QAM			
Operating Frequency	PCS/GPRS/ EDGE	1850.2MHz ~ 1909.8MHz		
	WCDMA	1852.4MHz ~ 1907.6MHz		
	LTE Band 2 (Channel Bandwidth 1.4MHz)	1850.7MHz ~ 1909.3MHz		
	LTE Band 2 (Channel Bandwidth 3MHz)	1851.5MHz ~ 1908.5MHz		
	LTE Band 2 (Channel Bandwidth 5MHz)	1852.5MHz ~ 1907.5MHz		
	LTE Band 2 (Channel Bandwidth 10MHz)	1855.0MHz ~ 1905.0MHz		
	LTE Band 2 (Channel Bandwidth 15MHz)	1857.5MHz ~ 1902.5MHz		
	LTE Band 2 (Channel Bandwidth 20MHz)	1860.0MHz ~ 1900.0MHz		
Max. EIRP Power	PCS/GPRS	1230.269mW (30.9dBm)		
	EDGE	389.045mW (25.9dBm)		
	WCDMA	575.440mW (27.6dBm)		
		QPSK	16QAM	64QAM
	LTE Band 2 (Channel Bandwidth 1.4MHz)	380.189mW (25.8dBm)	309.030mW (24.9dBm)	275.423mW (24.4dBm)
	LTE Band 2 (Channel Bandwidth 3MHz)	346.737mW (25.4dBm)	281.838mW (24.5dBm)	263.027mW (24.2dBm)
	LTE Band 2 (Channel Bandwidth 5MHz)	363.078mW (25.6dBm)	281.838mW (24.5dBm)	263.027mW (24.2dBm)
	LTE Band 2 (Channel Bandwidth 10MHz)	371.535mW (25.7dBm)	309.030mW (24.9dBm)	281.838mW (24.5dBm)
	LTE Band 2 (Channel Bandwidth 15MHz)	407.380mW (26.1dBm)	316.228mW (25.0dBm)	301.995mW (24.8dBm)
	LTE Band 2 (Channel Bandwidth 20MHz)	398.107mW (26.0dBm)	323.594mW (25.1dBm)	309.030mW (24.9dBm)



Emission Designator	PCS/GPRS	260KGXW		
	EDGE	260KGXW		
	WCDMA	4M15F9W		
		QPSK	16QAM	64QAM
	LTE Band 2 (Channel Bandwidth 1.4MHz)	1M09G7D	1M09W7D	1M09W7D
	LTE Band 2 (Channel Bandwidth 3MHz)	2M69G7D	2M69W7D	2M68W7D
	LTE Band 2 (Channel Bandwidth 5MHz)	4M46G7D	4M46W7D	4M48W7D
	LTE Band 2 (Channel Bandwidth 10MHz)	8M93G7D	8M90W7D	8M96W7D
	LTE Band 2 (Channel Bandwidth 15MHz)	13M4G7D	13M4W7D	13M4W7D
LTE Band 2 (Channel Bandwidth 20MHz)	17M9G7D	18M0W7D	17M9W7D	
Antenna Type	Main Ant.: Fixed Internal antenna with 0.2dBi gain Aux. Ant.: Fixed Internal antenna with -1.3dBi gain (Brand: TongDa Electrics, Model: MEAOP61010A)			
Accessory Device	Refer to Note as below			
Data Cable Supplied	Refer to Note as below			

Note: The EUT's accessories list refers to Ext. Pho.

### 3.2 Configuration of System under Test

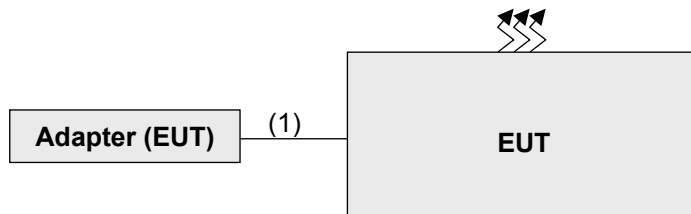

#### 3.2.1 Description of Support Units

The EUT has been tested as an independent unit together with other necessary accessories or support units. The following support units or accessories were used to form a representative test configuration during the tests.

ID	Descriptions	Qty.	Length (m)	Shielding (Yes/No)	Cores (Qty.)	Remarks
1.	USB cable	1	1.0	N	0	Accessory Device

### 3.3 Test Mode Applicability and Tested Channel Detail

Pre-Scan has been conducted to determine the worst-case mode from all possible combinations between available modulations, data rates, XYZ axis and antenna ports. The worst case was found when positioned on X-plane. Following channel(s) was (were) selected for the final test as listed below:

#### PCS Mode

EUT Configure Mode	Test Item	Available Channel	Tested Channel	Mode
-	EIRP	512 to 810	512(1850.2MHz), 661(1880.0MHz), 810(1909.8MHz)	PCS, EDGE
-	Modulation characteristics	512 to 810	661(1880.0MHz)	PCS, EDGE
-	Frequency Stability	512 to 810	661(1880.0MHz)	PCS
-	Occupied Bandwidth	512 to 810	512(1850.2MHz), 661(1880.0MHz), 810(1909.8MHz)	PCS, EDGE
-	Band Edge	512 to 810	512(1850.2MHz), 810(1909.8MHz)	PCS, EDGE
-	Peak To Average Ratio	512 to 810	512(1850.2MHz), 661(1880.0MHz), 810(1909.8MHz)	PCS, EDGE
-	Conducted Emission	512 to 810	512(1850.2MHz), 661(1880.0MHz), 810(1909.8MHz)	PCS, EDGE
-	Radiated Emission Below 1GHz	512 to 810	512(1850.2MHz)	PCS, EDGE
-	Radiated Emission Above 1GHz	512 to 810	512(1850.2MHz), 661(1880.0MHz), 810(1909.8MHz)	PCS, EDGE

## WCDMA Mode

EUT Configure Mode	Test Item	Available Channel	Tested Channel	Mode
-	EIRP	9262 to 9538	9262(1852.4MHz), 9400(1880.0MHz), 9538(1907.6MHz)	WCDMA
-	Modulation characteristics	9262 to 9538	9400(1880.0MHz)	WCDMA
-	Frequency Stability	9262 to 9538	9400(1880.0MHz)	WCDMA
-	Occupied Bandwidth	9262 to 9538	9262(1852.4MHz), 9400(1880.0MHz), 9538(1907.6MHz)	WCDMA
-	Band Edge	9262 to 9538	9262(1852.4MHz), 9538(1907.6MHz)	WCDMA
-	Peak To Average Ratio	9262 to 9538	9262(1852.4MHz), 9400(1880.0MHz), 9538(1907.6MHz)	WCDMA
-	Conducted Emission	9262 to 9538	9262(1852.4MHz), 9400(1880.0MHz), 9538(1907.6MHz)	WCDMA
-	Radiated Emission Below 1GHz	9262 to 9538	9262(1852.4MHz)	WCDMA
-	Radiated Emission Above 1GHz	9262 to 9538	9262(1852.4MHz), 9400(1880.0MHz), 9538(1907.6MHz)	WCDMA

LTE Band 2

EUT Configure Mode	Test item	Available channel	Tested Channel	Channel Bandwidth	Modulation	Mode
-	EIRP	18607 to 19193	18607(1850.70MHz), 18900(1880.00MHz), 19193(1909.30MHz)	1.4MHz	QPSK / 16QAM / 64QAM	1 RB / 5 RB Offset
		18615 to 19185	18615(1851.50MHz), 18900(1880.00MHz), 19185(1908.50MHz)	3MHz	QPSK / 16QAM / 64QAM	1 RB / 14 RB Offset
		18625 to 19175	18625(1852.50MHz), 18900(1880.00MHz), 19175(1907.50MHz)	5MHz	QPSK / 16QAM / 64QAM	1 RB / 24 RB Offset
		18650 to 19150	18650(1855.00MHz), 18900(1880.00MHz), 19150(1905.00MHz)	10MHz	QPSK / 16QAM / 64QAM	1 RB / 49 RB Offset
		18675 to 19125	18675(1857.50MHz), 18900(1880.00MHz), 19125(1902.50MHz)	15MHz	QPSK / 16QAM / 64QAM	1 RB / 74 RB Offset
		18700 to 19100	18700(1860.00MHz), 18900(1880.00MHz), 19100(1900.00MHz)	20MHz	QPSK / 16QAM / 64QAM	1 RB / 99 RB Offset
-	Modulation characteristics	18607 to 19193	18900(1880.00MHz)	1.4MHz	QPSK / 16QAM	1 RB / 5 RB Offset
		18700 to 19100	18900(1880.00MHz)	20MHz	QPSK / 16QAM	1 RB / 99 RB Offset
-	Frequency Stability	18607 to 19193	18900(1880.00MHz)	1.4MHz	QPSK	1 RB / 5 RB Offset
-	Occupied Bandwidth	18607 to 19193	18607(1850.70MHz), 18900(1880.00MHz), 19193(1909.30MHz)	1.4MHz	QPSK / 16QAM / 64QAM	1 RB / 5 RB Offset
		18615 to 19185	18615(1851.50MHz), 18900(1880.00MHz), 19185(1908.50MHz)	3MHz	QPSK / 16QAM / 64QAM	1 RB / 14 RB Offset
		18625 to 19175	18625(1852.50MHz), 18900(1880.00MHz), 19175(1907.50MHz)	5MHz	QPSK / 16QAM / 64QAM	1 RB / 24 RB Offset
		18650 to 19150	18650(1855.00MHz), 18900(1880.00MHz), 19150(1905.00MHz)	10MHz	QPSK / 16QAM / 64QAM	1 RB / 49 RB Offset
		18675 to 19125	18675(1857.50MHz), 18900(1880.00MHz), 19125(1902.50MHz)	15MHz	QPSK / 16QAM / 64QAM	1 RB / 74 RB Offset
		18700 to 19100	18700(1860.00MHz), 18900(1880.00MHz), 19100(1900.00MHz)	20MHz	QPSK / 16QAM / 64QAM	1 RB / 99 RB Offset
-	Band Edge	18607 to 19193	18607(1850.70MHz), 19193(1909.30MHz)	1.4MHz	QPSK	1 RB / 0 RB Offset 1 RB / 5 RB Offset 6 RB / 0 RB Offset
		18615 to 19185	18615(1851.50MHz), 19185(1908.50MHz)	3MHz	QPSK	1 RB / 0 RB Offset 1 RB / 14 RB Offset 15 RB / 0 RB Offset
		18625 to 19175	18625(1852.50MHz), 19175(1907.50MHz)	5MHz	QPSK	1 RB / 0 RB Offset 1 RB / 24 RB Offset 25 RB / 0 RB Offset
		18650 to 19150	18650(1855.00MHz), 19150(1905.00MHz)	10MHz	QPSK	1 RB / 0 RB Offset 1 RB / 49 RB Offset 50 RB / 0 RB Offset
		18675 to 19125	18675(1857.50MHz), 19125(1902.50MHz)	15MHz	QPSK	1 RB / 0 RB Offset 1 RB / 74 RB Offset 75 RB / 0 RB Offset
		18700 to 19100	18700(1860.00MHz), 19100(1900.00MHz)	20MHz	QPSK	1 RB / 0 RB Offset 1 RB / 99 RB Offset 100 RB / 0 RB Offset

EUT Configure Mode	Test item	Available channel	Tested Channel	Channel Bandwidth	Modulation	Mode
-	Peak to Average Ratio	18607 to 19193	18607(1850.70MHz), 18900(1880.00MHz), 19193(1909.30MHz)	1.4MHz	QPSK / 16QAM / 64QAM	1 RB / 5 RB Offset
		18615 to 19185	18615(1851.50MHz), 18900(1880.00MHz), 19185(1908.50MHz)	3MHz	QPSK / 16QAM / 64QAM	1 RB / 14 RB Offset
		18625 to 19175	18625(1852.50MHz), 18900(1880.00MHz), 19175(1907.50MHz)	5MHz	QPSK / 16QAM / 64QAM	1 RB / 24 RB Offset
		18650 to 19150	18650(1855.00MHz), 18900(1880.00MHz), 19150(1905.00MHz)	10MHz	QPSK / 16QAM / 64QAM	1 RB / 49 RB Offset
		18675 to 19125	18675(1857.50MHz), 18900(1880.00MHz), 19125(1902.50MHz)	15MHz	QPSK / 16QAM / 64QAM	1 RB / 74 RB Offset
		18700 to 19100	18700(1860.00MHz), 18900(1880.00MHz), 19100(1900.00MHz)	20MHz	QPSK / 16QAM / 64QAM	1 RB / 99 RB Offset
-	Conducted Emission	18607 to 19193	18607(1850.70MHz), 18900(1880.00MHz), 19193(1909.30MHz)	1.4MHz	QPSK	1 RB / 5 RB Offset
		18615 to 19185	18615(1851.50MHz), 18900(1880.00MHz), 19185(1908.50MHz)	3MHz	QPSK	1 RB / 14 RB Offset
		18625 to 19175	18625(1852.50MHz), 18900(1880.00MHz), 19175(1907.50MHz)	5MHz	QPSK	1 RB / 24 RB Offset
		18650 to 19150	18650(1855.00MHz), 18900(1880.00MHz), 19150(1905.00MHz)	10MHz	QPSK	1 RB / 49 RB Offset
		18675 to 19125	18675(1857.50MHz), 18900(1880.00MHz), 19125(1902.50MHz)	15MHz	QPSK	1 RB / 74 RB Offset
		18700 to 19100	18700(1860.00MHz), 18900(1880.00MHz), 19100(1900.00MHz)	20MHz	QPSK	1 RB / 99 RB Offset
-	Radiated Emission Below 1GHz	18607 to 19193	18607(1850.70MHz)	1.4MHz	QPSK	1 RB / 5 RB Offset
		18615 to 19185	18615(1851.50MHz)	3MHz	QPSK	1 RB / 14 RB Offset
		18625 to 19175	18625(1852.50MHz)	5MHz	QPSK	1 RB / 24 RB Offset
		18650 to 19150	18650(1855.00MHz)	10MHz	QPSK	1 RB / 49 RB Offset
		18675 to 19125	18675(1857.50MHz)	15MHz	QPSK	1 RB / 74 RB Offset
		18700 to 19100	18700(1860.00MHz)	20MHz	QPSK	1 RB / 99 RB Offset
-	Radiated Emission Above 1GHz	18607 to 19193	18607(1850.70MHz), 18900(1880.00MHz), 19193(1909.30MHz)	1.4MHz	QPSK	1 RB / 5 RB Offset
-		18615 to 19185	18615(1851.50MHz), 18900(1880.00MHz), 19185(1908.50MHz)	3MHz	QPSK	1 RB / 14 RB Offset
-		18625 to 19175	18625(1852.50MHz), 18900(1880.00MHz), 19175(1907.50MHz)	5MHz	QPSK	1 RB / 24 RB Offset
-		18650 to 19150	18650(1855.00MHz), 18900(1880.00MHz), 19150(1905.00MHz)	10MHz	QPSK	1 RB / 49 RB Offset
-		18675 to 19125	18675(1857.50MHz), 18900(1880.00MHz), 19125(1902.50MHz)	15MHz	QPSK	1 RB / 74 RB Offset
-		18700 to 19100	18700(1860.00MHz), 18900(1880.00MHz), 19100(1900.00MHz)	20MHz	QPSK	1 RB / 99 RB Offset

**Note:**

1. For radiated emission below 1GHz, low, mid and high channels were pre-tested in chamber with 1.4MHz mode. Low channel on mode A was found to be the worst case and therefore had been chosen for all final tests.
2. The conducted output power for QPSK, 16QAM and 64QAM, measured value of QPSK is higher than 16QAM and 64QAM mode. Therefore, only occupied bandwidth and Peak to average ratio items had been tested under QPSK, 16QAM and 64QAM modes, the other test items were performed under QPSK mode only.

**Test Condition:**

Test Item	Environmental Conditions	Input Power (System)	Tested By
EIRP	22deg. C, 66%RH	120Vac, 60Hz	Han Wu
Modulation characteristics	24deg. C, 64%RH	120Vac, 60Hz	James Yang
Frequency Stability	24deg. C, 64%RH	120Vac, 60Hz	James Yang
Occupied Bandwidth	24deg. C, 64%RH	120Vac, 60Hz	James Yang
Band Edge	24deg. C, 64%RH	120Vac, 60Hz	James Yang
Peak To Average Ratio	24deg. C, 64%RH	120Vac, 60Hz	James Yang
Conducted Emission	24deg. C, 64%RH	120Vac, 60Hz	James Yang
Radiated Emission	22deg. C, 66%RH 25deg. C, 65%RH	120Vac, 60Hz	Han Wu Greg Lin

**3.4 EUT Operating Conditions**

The EUT makes a call to the communication simulator. The communication simulator station system controlled a EUT to export maximum output power under transmission mode and specific channel frequency

**3.5 General Description of Applied Standards**

The EUT is a RF Product. According to the specifications of the manufacturer, it must comply with the requirements of the following standards:

**FCC 47 CFR Part 2**

**FCC 47 CFR Part 24**

**KDB 971168 D01 Power Meas License Digital Systems v03r01**

**ANSI/TIA/EIA-603-E 2016**

**ANSI 63.26-2015**

All test items have been performed and recorded as per the above standards.

## 4 Test Types and Results

### 4.1 Output Power Measurement

#### 4.1.1 Limits of Output Power Measurement

Mobile / Portable station are limited to 2 watts e.r.p.

#### 4.1.2 Test Procedures

##### EIRP / ERP Measurement:

- a. All measurements were done at low, middle and high operational frequency range. RBW and VBW is 1MHz for PCS, 5MHz for WCDMA mode and 10MHz for LTE mode.
- b. Substitution method is used for E.I.R.P measurement. In the semi-anechoic chamber, EUT placed on the 0.8m(below or equal 1GHz) and/or 1.5m(above 1GHz) height of Turn Table, rotated the table around 360 degrees to search the maximum radiation power and receiver antenna shall be rotated vertical and horizontal polarization and moved height from 1m to 4m to find the maximum polar radiated power. The "Read Value" is the spectrum reading the maximum power value.
- c. The substitution horn antenna is substituted for EUT at the same position and signals generator export the CW signal to the substitution antenna via a TX cable. Rotated the Turn Table and moved receiving antenna to find the maximum radiation power. Adjust output power level of S.G to get a Value of spectrum reading equal to "Read Value" of step b. Record the power level of S.G
- d. EIRP = Output power level of S.G – TX cable loss + Antenna gain of substitution horn.E.R.P power can be calculated form E.I.R.P power by subtracting the gain of dipole, E.R.P power = E.I.R.P power - 2.15dB.

Where:

$$ERP/EIRP = P_{Meas} + G_T - L_C$$

$P_{Meas}$  : Measure transmitter output power.

$G_T$  : Gain of the transmitting antenna.

$L_C$  : signal attenuation in the connecting cable between the transmitter and antenna.

##### Conducted Power Measurement:

The EUT was set up for the maximum power with PCS, WCDMA, LTE link data modulation and link up with simulator. Set the EUT to transmit under low, middle and high channel and record the power level shown on simulator.

### 4.1.3 Test Setup

EIRP / ERP Measurement:

**For Radiated Emission below or equal 1GHz**

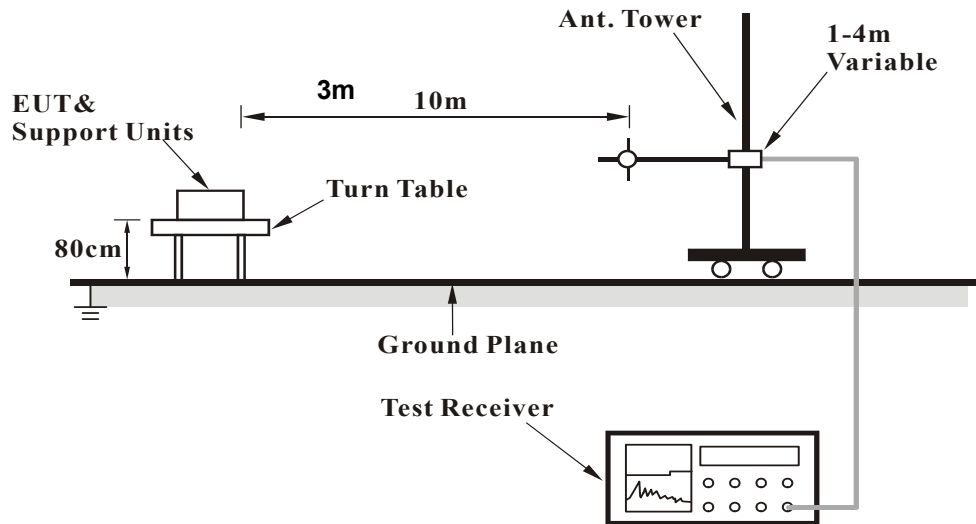

**For Radiated Emission above 1GHz**

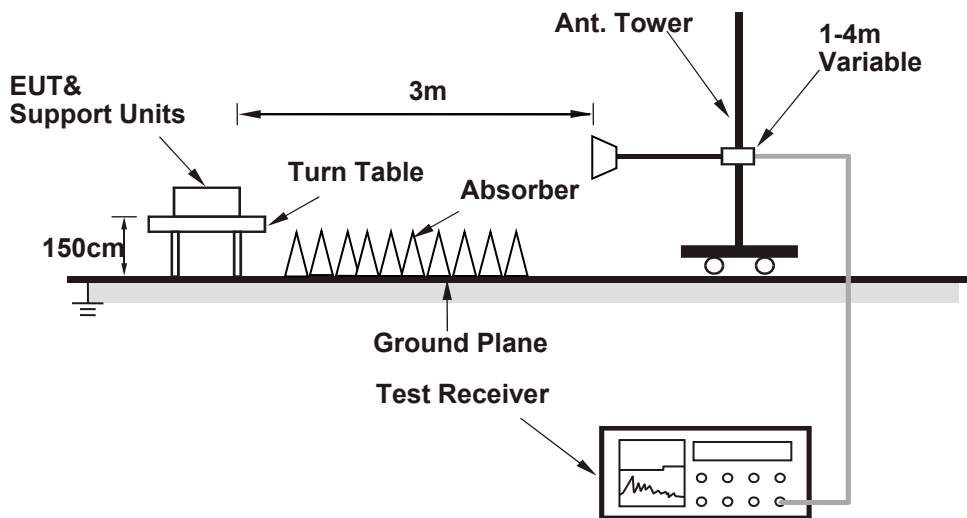

For the actual test configuration, please refer to the attached file (Test Setup Photo).

Conducted Power Measurement:



For the actual test configuration, please refer to the attached file (Test Setup Photo).



#### 4.1.4 Test Results

Conducted Output Power (dBm)

Band	PCS1900		
Channel	512	661	810
Frequency (MHz)	1850.2	1880	1909.8
PCS	29.94	30.09	30.06
GPRS 1Tx Slot	29.80	29.95	29.92
GPRS 2Tx Slot	26.57	26.72	26.69
GPRS 3Tx Slot	25.32	25.47	25.44
GPRS 4Tx Slot	23.99	24.14	24.11
EDGE 1Tx Slot (MCS9)	25.03	25.18	25.15
EDGE 2Tx Slot (MCS9)	22.47	22.62	22.59
EDGE 3Tx Slot (MCS9)	21.35	21.50	21.47
EDGE 4Tx Slot (MCS9)	20.13	20.28	20.25

Band	WCDMA Band II		
TX Channel	9262	9400	9538
Rx Channel	9662	9800	9938
Frequency (MHz)	1852.4	1880	1907.6
RMC 12.2K	23.08	23.18	23.12
HSDPA Subtest-1	22.15	22.25	22.19
HSDPA Subtest-2	22.10	22.20	22.14
HSDPA Subtest-3	21.67	21.77	21.71
HSDPA Subtest-4	21.64	21.74	21.68
DC-HSDPA Subtest-1	22.11	22.22	22.16
DC-HSDPA Subtest-2	22.06	22.17	22.13
DC-HSDPA Subtest-3	21.63	21.71	21.69
DC-HSDPA Subtest-4	21.60	21.68	21.65
HSUPA Subtest-1	22.18	22.28	22.22
HSUPA Subtest-2	20.19	20.29	20.23
HSUPA Subtest-3	21.21	21.31	21.25
HSUPA Subtest-4	20.18	20.28	20.22
HSUPA Subtest-5	22.20	22.30	22.24

## Conducted Output Power (dBm)

LTE Band 2						
BW	MCS Index	RB Size	RB Offset	Low	Mid	High
		Channel		18700	18900	19100
		Frequency (MHz)		1860	1880	1900
20M	QPSK	1	0	22.57	<b>22.76</b>	22.70
		1	50	22.36	22.55	22.49
		1	99	22.22	22.41	22.35
		50	0	21.49	21.68	21.62
		50	25	21.40	21.59	21.53
		50	50	21.32	21.51	21.45
		100	0	21.41	21.60	21.54
	16QAM	1	0	21.54	21.73	21.63
		1	50	21.30	21.49	21.45
		1	99	21.18	21.32	21.34
		50	0	20.40	20.63	20.54
		50	25	20.40	20.49	20.47
		50	50	20.24	20.43	20.37
		100	0	20.33	20.60	20.44
	64QAM	1	0	20.54	20.68	20.68
		1	50	20.29	20.54	20.41
		1	99	20.21	20.39	20.28
		50	0	19.44	19.68	19.61
		50	25	19.31	19.50	19.48
		50	50	19.27	19.48	19.43
		100	0	19.33	19.50	19.49

LTE Band 2						
BW	MCS Index	RB Size	RB Offset	Low	Mid	High
		Channel		18675	18900	19125
		Frequency (MHz)		1857.5	1880	1902.5
15M	QPSK	1	0	22.56	22.72	22.68
		1	37	22.26	22.46	22.49
		1	74	22.12	22.38	22.29
		36	0	21.43	21.67	21.56
		36	19	21.30	21.58	21.45
		36	39	21.31	21.46	21.44
		75	0	21.38	21.51	21.46
	16QAM	1	0	21.45	21.56	21.54
		1	37	21.23	21.42	21.41
		1	74	21.18	21.26	21.24
		36	0	20.33	20.51	20.54
		36	19	20.31	20.51	20.41
		36	39	20.23	20.34	20.36
		75	0	20.28	20.47	20.42
	64QAM	1	0	20.49	20.58	20.66
		1	37	20.21	20.49	20.39
		1	74	20.14	20.31	20.31
		36	0	19.38	19.65	19.53
		36	19	19.26	19.46	19.40
		36	39	19.25	19.44	19.35
		75	0	19.31	19.51	19.51

LTE Band 2						
BW	MCS Index	RB Size	RB Offset	Low	Mid	High
		Channel		18650	18900	19150
		Frequency (MHz)		1855	1880	1905
10M	QPSK	1	0	22.33	22.66	22.55
		1	24	22.21	22.52	22.38
		1	49	22.01	22.36	22.13
		25	0	21.32	21.55	21.52
		25	12	21.31	21.39	21.35
		25	25	21.10	21.34	21.36
		50	0	21.37	21.39	21.31
	16QAM	1	0	21.43	21.55	21.50
		1	24	21.19	21.27	21.25
		1	49	21.06	21.27	21.21
		25	0	20.17	20.52	20.52
		25	12	20.21	20.48	20.50
		25	25	20.28	20.28	20.21
		50	0	20.32	20.43	20.33
	64QAM	1	0	20.40	20.54	20.57
		1	24	20.19	20.34	20.44
		1	49	20.13	20.29	20.18
		25	0	19.26	19.59	19.56
		25	12	19.16	19.44	19.28
		25	25	19.05	19.31	19.21
		50	0	19.19	19.41	19.49

LTE Band 2						
BW	MCS Index	RB Size	RB Offset	Low	Mid	High
		Channel		18625	18900	19175
		Frequency (MHz)		1852.5	1880	1907.5
5M	QPSK	1	0	22.47	22.64	22.52
		1	12	22.23	22.47	22.28
		1	24	22.04	22.19	22.15
		12	0	21.28	21.60	21.37
		12	6	21.22	21.40	21.35
		12	13	21.28	21.38	21.22
		25	0	21.35	21.40	21.40
	16QAM	1	0	21.49	21.56	21.57
		1	12	21.30	21.33	21.34
		1	24	21.07	21.24	21.19
		12	0	20.36	20.45	20.46
		12	6	20.22	20.37	20.42
		12	13	20.17	20.41	20.19
		25	0	20.14	20.29	20.23
	64QAM	1	0	20.47	20.54	20.48
		1	12	20.10	20.35	20.26
		1	24	20.08	20.28	20.18
		12	0	19.30	19.42	19.50
		12	6	19.23	19.40	19.36
		12	13	19.12	19.45	19.41
		25	0	19.30	19.31	19.38

LTE Band 2						
BW	MCS Index	RB Size	RB Offset	Low	Mid	High
		Channel		18615	18900	19185
		Frequency (MHz)		1851.5	1880	1908.5
3M	QPSK	1	0	22.33	22.60	22.59
		1	7	22.24	22.50	22.34
		1	14	22.10	22.19	22.15
		8	0	21.27	21.61	21.57
		8	3	21.24	21.50	21.39
		8	7	21.25	21.34	21.41
		15	0	21.21	21.42	21.40
	16QAM	1	0	21.36	21.59	21.47
		1	7	21.12	21.41	21.32
		1	14	21.09	21.20	21.20
		8	0	20.27	20.52	20.44
		8	3	20.27	20.41	20.27
		8	7	20.11	20.38	20.24
		15	0	20.28	20.45	20.25
	64QAM	1	0	20.32	20.57	20.56
		1	7	20.24	20.48	20.38
		1	14	20.04	20.23	20.12
		8	0	19.35	19.56	19.44
		8	3	19.18	19.47	19.31
		8	7	19.11	19.37	19.27
		15	0	19.23	19.44	19.34

LTE Band 2						
BW	MCS Index	RB Size	RB Offset	Low	Mid	High
		Channel		18607	18900	19193
		Frequency (MHz)		1850.7	1880	1909.3
1.4M	QPSK	1	0	22.49	22.58	22.56
		1	2	22.20	22.45	22.26
		1	5	22.10	22.32	22.31
		3	0	22.32	22.57	22.47
		3	1	22.30	22.49	22.45
		3	3	22.23	22.47	22.31
		6	0	21.22	21.54	21.37
	16QAM	1	0	21.43	21.63	21.44
		1	2	21.21	21.36	21.37
		1	5	21.03	21.17	21.29
		3	0	21.28	21.44	21.55
		3	1	21.25	21.43	21.36
		3	3	21.11	21.33	21.19
		6	0	20.27	20.33	20.44
	64QAM	1	0	20.36	20.53	20.48
		1	2	20.17	20.47	20.32
		1	5	19.98	20.11	20.17
		3	0	20.26	20.51	20.52
		3	1	20.34	20.37	20.33
		3	3	20.18	20.24	20.33
		6	0	19.14	19.36	19.33

EIRP Power (dBm)

PCS Mode

MODE		TX channel 512					
Antenna Polarity & Test Distance: Horizontal at 3 M							
No.	Freq. (MHz)	Reading (dBm)	S.G Power Value (dBm)	Correction Factor (dB)	EIRP (dBm)	Limit (dBm)	Margin (dB)
1	1850.20	-9.4	30.8	0.1	<b>30.9</b>	33.0	-2.1
Antenna Polarity & Test Distance: Vertical at 3 M							
No.	Freq. (MHz)	Reading (dBm)	S.G Power Value (dBm)	Correction Factor (dB)	EIRP (dBm)	Limit (dBm)	Margin (dB)
1	1850.20	-13.1	27.3	0.1	27.4	33.0	-5.6

MODE		TX channel 661					
Antenna Polarity & Test Distance: Horizontal at 3 M							
No.	Freq. (MHz)	Reading (dBm)	S.G Power Value (dBm)	Correction Factor (dB)	EIRP (dBm)	Limit (dBm)	Margin (dB)
1	1880.00	-10.0	30.5	0.0	30.5	33.0	-2.5
Antenna Polarity & Test Distance: Vertical at 3 M							
No.	Freq. (MHz)	Reading (dBm)	S.G Power Value (dBm)	Correction Factor (dB)	EIRP (dBm)	Limit (dBm)	Margin (dB)
1	1880.00	-12.4	28.2	0.0	28.2	33.0	-4.8

MODE		TX channel 810					
Antenna Polarity & Test Distance: Horizontal at 3 M							
No.	Freq. (MHz)	Reading (dBm)	S.G Power Value (dBm)	Correction Factor (dB)	EIRP (dBm)	Limit (dBm)	Margin (dB)
1	1909.80	-11.5	29.1	-0.1	29.0	33.0	-4.0
Antenna Polarity & Test Distance: Vertical at 3 M							
No.	Freq. (MHz)	Reading (dBm)	S.G Power Value (dBm)	Correction Factor (dB)	EIRP (dBm)	Limit (dBm)	Margin (dB)
1	1909.80	-13.0	27.8	-0.1	27.7	33.0	-5.3

Note: EIRP (dBm) = S.G Power Value (dBm) + Correction Factor (dB).



EDGE Mode

MODE		TX channel 512					
Antenna Polarity & Test Distance: Horizontal at 3 M							
No.	Freq. (MHz)	Reading (dBm)	S.G Power Value (dBm)	Correction Factor (dB)	EIRP (dBm)	Limit (dBm)	Margin (dB)
1	1850.20	-14.4	25.8	0.1	25.9	33.0	-7.1
Antenna Polarity & Test Distance: Vertical at 3 M							
No.	Freq. (MHz)	Reading (dBm)	S.G Power Value (dBm)	Correction Factor (dB)	EIRP (dBm)	Limit (dBm)	Margin (dB)
1	1850.20	-18.0	22.4	0.1	22.5	33.0	-10.5

MODE		TX channel 661					
Antenna Polarity & Test Distance: Horizontal at 3 M							
No.	Freq. (MHz)	Reading (dBm)	S.G Power Value (dBm)	Correction Factor (dB)	EIRP (dBm)	Limit (dBm)	Margin (dB)
1	1880.00	-15.1	25.4	0.0	25.4	33.0	-7.6
Antenna Polarity & Test Distance: Vertical at 3 M							
No.	Freq. (MHz)	Reading (dBm)	S.G Power Value (dBm)	Correction Factor (dB)	EIRP (dBm)	Limit (dBm)	Margin (dB)
1	1880.00	-17.5	23.1	0.0	23.1	33.0	-9.9

MODE		TX channel 810					
Antenna Polarity & Test Distance: Horizontal at 3 M							
No.	Freq. (MHz)	Reading (dBm)	S.G Power Value (dBm)	Correction Factor (dB)	EIRP (dBm)	Limit (dBm)	Margin (dB)
1	1909.80	-16.5	24.1	-0.1	24.0	33.0	-9.0
Antenna Polarity & Test Distance: Vertical at 3 M							
No.	Freq. (MHz)	Reading (dBm)	S.G Power Value (dBm)	Correction Factor (dB)	EIRP (dBm)	Limit (dBm)	Margin (dB)
1	1909.80	-18.0	22.8	-0.1	22.7	33.0	-10.3

Note: EIRP (dBm) = S.G Power Value (dBm) + Correction Factor (dB).

WCDMA Mode

MODE		TX channel 9262					
Antenna Polarity & Test Distance: Horizontal at 3 M							
No.	Freq. (MHz)	Reading (dBm)	S.G Power Value (dBm)	Correction Factor (dB)	EIRP (dBm)	Limit (dBm)	Margin (dB)
1	1852.40	-13.4	26.8	0.1	26.9	33.0	-6.1
Antenna Polarity & Test Distance: Vertical at 3 M							
No.	Freq. (MHz)	Reading (dBm)	S.G Power Value (dBm)	Correction Factor (dB)	EIRP (dBm)	Limit (dBm)	Margin (dB)
1	1852.40	-18.5	21.9	0.1	22.0	33.0	-11.0

MODE		TX channel 9400					
Antenna Polarity & Test Distance: Horizontal at 3 M							
No.	Freq. (MHz)	Reading (dBm)	S.G Power Value (dBm)	Correction Factor (dB)	EIRP (dBm)	Limit (dBm)	Margin (dB)
1	1880.00	-13.0	27.5	0.0	27.5	33.0	-5.5
Antenna Polarity & Test Distance: Vertical at 3 M							
No.	Freq. (MHz)	Reading (dBm)	S.G Power Value (dBm)	Correction Factor (dB)	EIRP (dBm)	Limit (dBm)	Margin (dB)
1	1880.00	-16.6	24.0	0.0	24.0	33.0	-9.0

MODE		TX channel 9538					
Antenna Polarity & Test Distance: Horizontal at 3 M							
No.	Freq. (MHz)	Reading (dBm)	S.G Power Value (dBm)	Correction Factor (dB)	EIRP (dBm)	Limit (dBm)	Margin (dB)
1	1907.60	-13.0	27.7	-0.1	<b>27.6</b>	33.0	-5.4
Antenna Polarity & Test Distance: Vertical at 3 M							
No.	Freq. (MHz)	Reading (dBm)	S.G Power Value (dBm)	Correction Factor (dB)	EIRP (dBm)	Limit (dBm)	Margin (dB)
1	1907.60	-17.1	23.7	-0.1	23.6	33.0	-9.4

Note: EIRP (dBm) = S.G Power Value (dBm) + Correction Factor (dB).

**Modulation Type: QPSK**

LTE Band 2, Channel Bandwidth: 1.4MHz

MODE		TX channel 18607					
Antenna Polarity & Test Distance: Horizontal at 3 M							
No.	Freq. (MHz)	Reading (dBm)	S.G Power Value (dBm)	Correction Factor (dB)	EIRP (dBm)	Limit (dBm)	Margin (dB)
1	1850.70	-15.8	24.4	0.1	24.5	33.0	-8.5
Antenna Polarity & Test Distance: Vertical at 3 M							
No.	Freq. (MHz)	Reading (dBm)	S.G Power Value (dBm)	Correction Factor (dB)	EIRP (dBm)	Limit (dBm)	Margin (dB)
1	1850.70	-20.8	19.6	0.1	19.7	33.0	-13.3

MODE		TX channel 18900					
Antenna Polarity & Test Distance: Horizontal at 3 M							
No.	Freq. (MHz)	Reading (dBm)	S.G Power Value (dBm)	Correction Factor (dB)	EIRP (dBm)	Limit (dBm)	Margin (dB)
1	1880.00	-15.7	24.8	0.0	24.8	33.0	-8.2
Antenna Polarity & Test Distance: Vertical at 3 M							
No.	Freq. (MHz)	Reading (dBm)	S.G Power Value (dBm)	Correction Factor (dB)	EIRP (dBm)	Limit (dBm)	Margin (dB)
1	1880.00	-20.6	20.0	0.0	20.0	33.0	-13.0

MODE		TX channel 19193					
Antenna Polarity & Test Distance: Horizontal at 3 M							
No.	Freq. (MHz)	Reading (dBm)	S.G Power Value (dBm)	Correction Factor (dB)	EIRP (dBm)	Limit (dBm)	Margin (dB)
1	1909.30	-14.8	25.9	-0.1	<b>25.8</b>	33.0	-7.2
Antenna Polarity & Test Distance: Vertical at 3 M							
No.	Freq. (MHz)	Reading (dBm)	S.G Power Value (dBm)	Correction Factor (dB)	EIRP (dBm)	Limit (dBm)	Margin (dB)
1	1909.30	-18.9	21.9	-0.1	21.8	33.0	-11.2

Note: EIRP (dBm) = S.G Power Value (dBm) + Correction Factor (dB).

LTE Band 2, Channel Bandwidth: 3MHz

MODE		TX channel 18615					
Antenna Polarity & Test Distance: Horizontal at 3 M							
No.	Freq. (MHz)	Reading (dBm)	S.G Power Value (dBm)	Correction Factor (dB)	EIRP (dBm)	Limit (dBm)	Margin (dB)
1	1851.50	-15.7	24.5	0.1	24.6	33.0	-8.4
Antenna Polarity & Test Distance: Vertical at 3 M							
No.	Freq. (MHz)	Reading (dBm)	S.G Power Value (dBm)	Correction Factor (dB)	EIRP (dBm)	Limit (dBm)	Margin (dB)
1	1851.50	-20.3	20.1	0.1	20.2	33.0	-12.8

MODE		TX channel 18900					
Antenna Polarity & Test Distance: Horizontal at 3 M							
No.	Freq. (MHz)	Reading (dBm)	S.G Power Value (dBm)	Correction Factor (dB)	EIRP (dBm)	Limit (dBm)	Margin (dB)
1	1880.00	-15.8	24.7	0.0	24.7	33.0	-8.3
Antenna Polarity & Test Distance: Vertical at 3 M							
No.	Freq. (MHz)	Reading (dBm)	S.G Power Value (dBm)	Correction Factor (dB)	EIRP (dBm)	Limit (dBm)	Margin (dB)
1	1880.00	-20.6	20.0	0.0	20.0	33.0	-13.0

MODE		TX channel 19185					
Antenna Polarity & Test Distance: Horizontal at 3 M							
No.	Freq. (MHz)	Reading (dBm)	S.G Power Value (dBm)	Correction Factor (dB)	EIRP (dBm)	Limit (dBm)	Margin (dB)
1	1908.50	-15.2	25.5	-0.1	<b>25.4</b>	33.0	-7.6
Antenna Polarity & Test Distance: Vertical at 3 M							
No.	Freq. (MHz)	Reading (dBm)	S.G Power Value (dBm)	Correction Factor (dB)	EIRP (dBm)	Limit (dBm)	Margin (dB)
1	1908.50	-20.1	20.7	-0.1	20.6	33.0	-12.4

Note: EIRP (dBm) = S.G Power Value (dBm) + Correction Factor (dB).

LTE Band 2, Channel Bandwidth: 5MHz

MODE		TX channel 18625					
Antenna Polarity & Test Distance: Horizontal at 3 M							
No.	Freq. (MHz)	Reading (dBm)	S.G Power Value (dBm)	Correction Factor (dB)	EIRP (dBm)	Limit (dBm)	Margin (dB)
1	1852.50	-15.2	25.0	0.1	25.1	33.0	-7.9
Antenna Polarity & Test Distance: Vertical at 3 M							
No.	Freq. (MHz)	Reading (dBm)	S.G Power Value (dBm)	Correction Factor (dB)	EIRP (dBm)	Limit (dBm)	Margin (dB)
1	1852.50	-20.4	20.0	0.1	20.1	33.0	-12.9

MODE		TX channel 18900					
Antenna Polarity & Test Distance: Horizontal at 3 M							
No.	Freq. (MHz)	Reading (dBm)	S.G Power Value (dBm)	Correction Factor (dB)	EIRP (dBm)	Limit (dBm)	Margin (dB)
1	1880.00	-15.3	25.2	0.0	25.2	33.0	-7.8
Antenna Polarity & Test Distance: Vertical at 3 M							
No.	Freq. (MHz)	Reading (dBm)	S.G Power Value (dBm)	Correction Factor (dB)	EIRP (dBm)	Limit (dBm)	Margin (dB)
1	1880.00	-20.3	20.3	0.0	20.3	33.0	-12.7

MODE		TX channel 19175					
Antenna Polarity & Test Distance: Horizontal at 3 M							
No.	Freq. (MHz)	Reading (dBm)	S.G Power Value (dBm)	Correction Factor (dB)	EIRP (dBm)	Limit (dBm)	Margin (dB)
1	1907.50	-15.0	25.7	-0.1	<b>25.6</b>	33.0	-7.4
Antenna Polarity & Test Distance: Vertical at 3 M							
No.	Freq. (MHz)	Reading (dBm)	S.G Power Value (dBm)	Correction Factor (dB)	EIRP (dBm)	Limit (dBm)	Margin (dB)
1	1907.50	-19.8	21.0	-0.1	20.9	33.0	-12.1

Note: EIRP (dBm) = S.G Power Value (dBm) + Correction Factor (dB).

LTE Band 2, Channel Bandwidth: 10MHz

MODE		TX channel 18650					
Antenna Polarity & Test Distance: Horizontal at 3 M							
No.	Freq. (MHz)	Reading (dBm)	S.G Power Value (dBm)	Correction Factor (dB)	EIRP (dBm)	Limit (dBm)	Margin (dB)
1	1855.00	-15.0	25.3	0.0	25.3	33.0	-7.7
Antenna Polarity & Test Distance: Vertical at 3 M							
No.	Freq. (MHz)	Reading (dBm)	S.G Power Value (dBm)	Correction Factor (dB)	EIRP (dBm)	Limit (dBm)	Margin (dB)
1	1855.00	-20.0	20.5	0.0	20.5	33.0	-12.5

MODE		TX channel 18900					
Antenna Polarity & Test Distance: Horizontal at 3 M							
No.	Freq. (MHz)	Reading (dBm)	S.G Power Value (dBm)	Correction Factor (dB)	EIRP (dBm)	Limit (dBm)	Margin (dB)
1	1880.00	-14.8	25.7	0.0	25.7	33.0	-7.3
Antenna Polarity & Test Distance: Vertical at 3 M							
No.	Freq. (MHz)	Reading (dBm)	S.G Power Value (dBm)	Correction Factor (dB)	EIRP (dBm)	Limit (dBm)	Margin (dB)
1	1880.00	-19.7	20.9	0.0	20.9	33.0	-12.1

MODE		TX channel 19150					
Antenna Polarity & Test Distance: Horizontal at 3 M							
No.	Freq. (MHz)	Reading (dBm)	S.G Power Value (dBm)	Correction Factor (dB)	EIRP (dBm)	Limit (dBm)	Margin (dB)
1	1905.00	-14.9	25.8	-0.1	25.7	33.0	-7.3
Antenna Polarity & Test Distance: Vertical at 3 M							
No.	Freq. (MHz)	Reading (dBm)	S.G Power Value (dBm)	Correction Factor (dB)	EIRP (dBm)	Limit (dBm)	Margin (dB)
1	1905.00	-20.0	20.8	-0.1	20.7	33.0	-12.3

Note: EIRP (dBm) = S.G Power Value (dBm) + Correction Factor (dB).

LTE Band 2, Channel Bandwidth: 15MHz

MODE		TX channel 18675					
Antenna Polarity & Test Distance: Horizontal at 3 M							
No.	Freq. (MHz)	Reading (dBm)	S.G Power Value (dBm)	Correction Factor (dB)	EIRP (dBm)	Limit (dBm)	Margin (dB)
1	1857.50	-14.8	25.5	0.0	25.5	33.0	-7.5
Antenna Polarity & Test Distance: Vertical at 3 M							
No.	Freq. (MHz)	Reading (dBm)	S.G Power Value (dBm)	Correction Factor (dB)	EIRP (dBm)	Limit (dBm)	Margin (dB)
1	1857.50	-19.8	20.7	0.0	20.7	33.0	-12.3

MODE		TX channel 18900					
Antenna Polarity & Test Distance: Horizontal at 3 M							
No.	Freq. (MHz)	Reading (dBm)	S.G Power Value (dBm)	Correction Factor (dB)	EIRP (dBm)	Limit (dBm)	Margin (dB)
1	1880.00	-14.6	25.9	0.0	25.9	33.0	-7.1
Antenna Polarity & Test Distance: Vertical at 3 M							
No.	Freq. (MHz)	Reading (dBm)	S.G Power Value (dBm)	Correction Factor (dB)	EIRP (dBm)	Limit (dBm)	Margin (dB)
1	1880.00	-19.5	21.1	0.0	21.1	33.0	-11.9

MODE		TX channel 19125					
Antenna Polarity & Test Distance: Horizontal at 3 M							
No.	Freq. (MHz)	Reading (dBm)	S.G Power Value (dBm)	Correction Factor (dB)	EIRP (dBm)	Limit (dBm)	Margin (dB)
1	1902.50	-14.5	26.2	-0.1	<b>26.1</b>	33.0	-6.9
Antenna Polarity & Test Distance: Vertical at 3 M							
No.	Freq. (MHz)	Reading (dBm)	S.G Power Value (dBm)	Correction Factor (dB)	EIRP (dBm)	Limit (dBm)	Margin (dB)
1	1902.50	-19.6	21.2	-0.1	21.1	33.0	-11.9

Note: EIRP (dBm) = S.G Power Value (dBm) + Correction Factor (dB).

LTE Band 2, Channel Bandwidth: 20MHz

MODE		TX channel 18700					
Antenna Polarity & Test Distance: Horizontal at 3 M							
No.	Freq. (MHz)	Reading (dBm)	S.G Power Value (dBm)	Correction Factor (dB)	EIRP (dBm)	Limit (dBm)	Margin (dB)
1	1860.00	-14.8	25.5	0.0	25.5	33.0	-7.5
Antenna Polarity & Test Distance: Vertical at 3 M							
No.	Freq. (MHz)	Reading (dBm)	S.G Power Value (dBm)	Correction Factor (dB)	EIRP (dBm)	Limit (dBm)	Margin (dB)
1	1860.00	-19.9	20.6	0.0	20.6	33.0	-12.4

MODE		TX channel 18900					
Antenna Polarity & Test Distance: Horizontal at 3 M							
No.	Freq. (MHz)	Reading (dBm)	S.G Power Value (dBm)	Correction Factor (dB)	EIRP (dBm)	Limit (dBm)	Margin (dB)
1	1880.00	-14.7	25.8	0.0	25.8	33.0	-7.2
Antenna Polarity & Test Distance: Vertical at 3 M							
No.	Freq. (MHz)	Reading (dBm)	S.G Power Value (dBm)	Correction Factor (dB)	EIRP (dBm)	Limit (dBm)	Margin (dB)
1	1880.00	-19.8	20.8	0.0	20.8	33.0	-12.2

MODE		TX channel 19100					
Antenna Polarity & Test Distance: Horizontal at 3 M							
No.	Freq. (MHz)	Reading (dBm)	S.G Power Value (dBm)	Correction Factor (dB)	EIRP (dBm)	Limit (dBm)	Margin (dB)
1	1900.00	-14.6	26.1	-0.1	<b>26.0</b>	33.0	-7.0
Antenna Polarity & Test Distance: Vertical at 3 M							
No.	Freq. (MHz)	Reading (dBm)	S.G Power Value (dBm)	Correction Factor (dB)	EIRP (dBm)	Limit (dBm)	Margin (dB)
1	1900.00	-19.7	21.1	-0.1	21.0	33.0	-12.0

Note: EIRP (dBm) = S.G Power Value (dBm) + Correction Factor (dB).



**Modulation Type: 16QAM**

LTE Band 2, Channel Bandwidth: 1.4MHz

MODE		TX channel 18607					
Antenna Polarity & Test Distance: Horizontal at 3 M							
No.	Freq. (MHz)	Reading (dBm)	S.G Power Value (dBm)	Correction Factor (dB)	EIRP (dBm)	Limit (dBm)	Margin (dB)
1	1850.70	-16.6	23.6	0.1	23.7	33.0	-9.3
Antenna Polarity & Test Distance: Vertical at 3 M							
No.	Freq. (MHz)	Reading (dBm)	S.G Power Value (dBm)	Correction Factor (dB)	EIRP (dBm)	Limit (dBm)	Margin (dB)
1	1850.70	-21.6	18.8	0.1	18.9	33.0	-14.1

MODE		TX channel 18900					
Antenna Polarity & Test Distance: Horizontal at 3 M							
No.	Freq. (MHz)	Reading (dBm)	S.G Power Value (dBm)	Correction Factor (dB)	EIRP (dBm)	Limit (dBm)	Margin (dB)
1	1880.00	-16.7	23.8	0.0	23.8	33.0	-9.2
Antenna Polarity & Test Distance: Vertical at 3 M							
No.	Freq. (MHz)	Reading (dBm)	S.G Power Value (dBm)	Correction Factor (dB)	EIRP (dBm)	Limit (dBm)	Margin (dB)
1	1880.00	-21.6	19.0	0.0	19.0	33.0	-14.0

MODE		TX channel 19193					
Antenna Polarity & Test Distance: Horizontal at 3 M							
No.	Freq. (MHz)	Reading (dBm)	S.G Power Value (dBm)	Correction Factor (dB)	EIRP (dBm)	Limit (dBm)	Margin (dB)
1	1909.30	-15.7	25.0	-0.1	24.9	33.0	-8.1
Antenna Polarity & Test Distance: Vertical at 3 M							
No.	Freq. (MHz)	Reading (dBm)	S.G Power Value (dBm)	Correction Factor (dB)	EIRP (dBm)	Limit (dBm)	Margin (dB)
1	1909.30	-19.8	21.0	-0.1	20.9	33.0	-12.1

Note: EIRP (dBm) = S.G Power Value (dBm) + Correction Factor (dB).

LTE Band 2, Channel Bandwidth: 3MHz

MODE		TX channel 18615					
Antenna Polarity & Test Distance: Horizontal at 3 M							
No.	Freq. (MHz)	Reading (dBm)	S.G Power Value (dBm)	Correction Factor (dB)	EIRP (dBm)	Limit (dBm)	Margin (dB)
1	1851.50	-16.5	23.7	0.1	23.8	33.0	-9.2
Antenna Polarity & Test Distance: Vertical at 3 M							
No.	Freq. (MHz)	Reading (dBm)	S.G Power Value (dBm)	Correction Factor (dB)	EIRP (dBm)	Limit (dBm)	Margin (dB)
1	1851.50	-21.2	19.2	0.1	19.3	33.0	-13.7

MODE		TX channel 18900					
Antenna Polarity & Test Distance: Horizontal at 3 M							
No.	Freq. (MHz)	Reading (dBm)	S.G Power Value (dBm)	Correction Factor (dB)	EIRP (dBm)	Limit (dBm)	Margin (dB)
1	1880.00	-16.9	23.6	0.0	23.6	33.0	-9.4
Antenna Polarity & Test Distance: Vertical at 3 M							
No.	Freq. (MHz)	Reading (dBm)	S.G Power Value (dBm)	Correction Factor (dB)	EIRP (dBm)	Limit (dBm)	Margin (dB)
1	1880.00	-21.7	18.9	0.0	18.9	33.0	-14.1

MODE		TX channel 19185					
Antenna Polarity & Test Distance: Horizontal at 3 M							
No.	Freq. (MHz)	Reading (dBm)	S.G Power Value (dBm)	Correction Factor (dB)	EIRP (dBm)	Limit (dBm)	Margin (dB)
1	1908.50	-16.1	24.6	-0.1	24.5	33.0	-8.5
Antenna Polarity & Test Distance: Vertical at 3 M							
No.	Freq. (MHz)	Reading (dBm)	S.G Power Value (dBm)	Correction Factor (dB)	EIRP (dBm)	Limit (dBm)	Margin (dB)
1	1908.50	-21.0	19.8	-0.1	19.7	33.0	-13.3

Note: EIRP (dBm) = S.G Power Value (dBm) + Correction Factor (dB).

LTE Band 2, Channel Bandwidth: 5MHz

MODE		TX channel 18625					
Antenna Polarity & Test Distance: Horizontal at 3 M							
No.	Freq. (MHz)	Reading (dBm)	S.G Power Value (dBm)	Correction Factor (dB)	EIRP (dBm)	Limit (dBm)	Margin (dB)
1	1852.50	-16.3	23.9	0.1	24.0	33.0	-9.0
Antenna Polarity & Test Distance: Vertical at 3 M							
No.	Freq. (MHz)	Reading (dBm)	S.G Power Value (dBm)	Correction Factor (dB)	EIRP (dBm)	Limit (dBm)	Margin (dB)
1	1852.50	-21.5	18.9	0.1	19.0	33.0	-14.0

MODE		TX channel 18900					
Antenna Polarity & Test Distance: Horizontal at 3 M							
No.	Freq. (MHz)	Reading (dBm)	S.G Power Value (dBm)	Correction Factor (dB)	EIRP (dBm)	Limit (dBm)	Margin (dB)
1	1880.00	-16.3	24.2	0.0	24.2	33.0	-8.8
Antenna Polarity & Test Distance: Vertical at 3 M							
No.	Freq. (MHz)	Reading (dBm)	S.G Power Value (dBm)	Correction Factor (dB)	EIRP (dBm)	Limit (dBm)	Margin (dB)
1	1880.00	-21.3	19.3	0.0	19.3	33.0	-13.7

MODE		TX channel 19175					
Antenna Polarity & Test Distance: Horizontal at 3 M							
No.	Freq. (MHz)	Reading (dBm)	S.G Power Value (dBm)	Correction Factor (dB)	EIRP (dBm)	Limit (dBm)	Margin (dB)
1	1907.50	-16.1	24.6	-0.1	24.5	33.0	-8.5
Antenna Polarity & Test Distance: Vertical at 3 M							
No.	Freq. (MHz)	Reading (dBm)	S.G Power Value (dBm)	Correction Factor (dB)	EIRP (dBm)	Limit (dBm)	Margin (dB)
1	1907.50	-20.9	19.9	-0.1	19.8	33.0	-13.2

Note: EIRP (dBm) = S.G Power Value (dBm) + Correction Factor (dB).

LTE Band 2, Channel Bandwidth: 10MHz

MODE		TX channel 18650					
Antenna Polarity & Test Distance: Horizontal at 3 M							
No.	Freq. (MHz)	Reading (dBm)	S.G Power Value (dBm)	Correction Factor (dB)	EIRP (dBm)	Limit (dBm)	Margin (dB)
1	1855.00	-15.8	24.5	0.0	24.5	33.0	-8.5
Antenna Polarity & Test Distance: Vertical at 3 M							
No.	Freq. (MHz)	Reading (dBm)	S.G Power Value (dBm)	Correction Factor (dB)	EIRP (dBm)	Limit (dBm)	Margin (dB)
1	1855.00	-20.8	19.7	0.0	19.7	33.0	-13.3

MODE		TX channel 18900					
Antenna Polarity & Test Distance: Horizontal at 3 M							
No.	Freq. (MHz)	Reading (dBm)	S.G Power Value (dBm)	Correction Factor (dB)	EIRP (dBm)	Limit (dBm)	Margin (dB)
1	1880.00	-15.9	24.6	0.0	24.6	33.0	-8.4
Antenna Polarity & Test Distance: Vertical at 3 M							
No.	Freq. (MHz)	Reading (dBm)	S.G Power Value (dBm)	Correction Factor (dB)	EIRP (dBm)	Limit (dBm)	Margin (dB)
1	1880.00	-20.8	19.8	0.0	19.8	33.0	-13.2

MODE		TX channel 19150					
Antenna Polarity & Test Distance: Horizontal at 3 M							
No.	Freq. (MHz)	Reading (dBm)	S.G Power Value (dBm)	Correction Factor (dB)	EIRP (dBm)	Limit (dBm)	Margin (dB)
1	1905.00	-15.7	25.0	-0.1	24.9	33.0	-8.1
Antenna Polarity & Test Distance: Vertical at 3 M							
No.	Freq. (MHz)	Reading (dBm)	S.G Power Value (dBm)	Correction Factor (dB)	EIRP (dBm)	Limit (dBm)	Margin (dB)
1	1905.00	-20.9	19.9	-0.1	19.8	33.0	-13.2

Note: EIRP (dBm) = S.G Power Value (dBm) + Correction Factor (dB).

LTE Band 2, Channel Bandwidth: 15MHz

MODE		TX channel 18675					
Antenna Polarity & Test Distance: Horizontal at 3 M							
No.	Freq. (MHz)	Reading (dBm)	S.G Power Value (dBm)	Correction Factor (dB)	EIRP (dBm)	Limit (dBm)	Margin (dB)
1	1857.50	-15.8	24.5	0.0	24.5	33.0	-8.5
Antenna Polarity & Test Distance: Vertical at 3 M							
No.	Freq. (MHz)	Reading (dBm)	S.G Power Value (dBm)	Correction Factor (dB)	EIRP (dBm)	Limit (dBm)	Margin (dB)
1	1857.50	-20.7	19.8	0.0	19.8	33.0	-13.2

MODE		TX channel 18900					
Antenna Polarity & Test Distance: Horizontal at 3 M							
No.	Freq. (MHz)	Reading (dBm)	S.G Power Value (dBm)	Correction Factor (dB)	EIRP (dBm)	Limit (dBm)	Margin (dB)
1	1880.00	-15.5	25.0	0.0	25.0	33.0	-8.0
Antenna Polarity & Test Distance: Vertical at 3 M							
No.	Freq. (MHz)	Reading (dBm)	S.G Power Value (dBm)	Correction Factor (dB)	EIRP (dBm)	Limit (dBm)	Margin (dB)
1	1880.00	-20.4	20.2	0.0	20.2	33.0	-12.8

MODE		TX channel 19125					
Antenna Polarity & Test Distance: Horizontal at 3 M							
No.	Freq. (MHz)	Reading (dBm)	S.G Power Value (dBm)	Correction Factor (dB)	EIRP (dBm)	Limit (dBm)	Margin (dB)
1	1902.50	-15.6	25.1	-0.1	25.0	33.0	-8.0
Antenna Polarity & Test Distance: Vertical at 3 M							
No.	Freq. (MHz)	Reading (dBm)	S.G Power Value (dBm)	Correction Factor (dB)	EIRP (dBm)	Limit (dBm)	Margin (dB)
1	1902.50	-20.7	20.1	-0.1	20.0	33.0	-13.0

Note: EIRP (dBm) = S.G Power Value (dBm) + Correction Factor (dB).

LTE Band 2, Channel Bandwidth: 20MHz

MODE		TX channel 18700					
Antenna Polarity & Test Distance: Horizontal at 3 M							
No.	Freq. (MHz)	Reading (dBm)	S.G Power Value (dBm)	Correction Factor (dB)	EIRP (dBm)	Limit (dBm)	Margin (dB)
1	1860.00	-15.7	24.6	0.0	24.6	33.0	-8.4
Antenna Polarity & Test Distance: Vertical at 3 M							
No.	Freq. (MHz)	Reading (dBm)	S.G Power Value (dBm)	Correction Factor (dB)	EIRP (dBm)	Limit (dBm)	Margin (dB)
1	1860.00	-20.8	19.7	0.0	19.7	33.0	-13.3

MODE		TX channel 18900					
Antenna Polarity & Test Distance: Horizontal at 3 M							
No.	Freq. (MHz)	Reading (dBm)	S.G Power Value (dBm)	Correction Factor (dB)	EIRP (dBm)	Limit (dBm)	Margin (dB)
1	1880.00	-15.7	24.8	0.0	24.8	33.0	-8.2
Antenna Polarity & Test Distance: Vertical at 3 M							
No.	Freq. (MHz)	Reading (dBm)	S.G Power Value (dBm)	Correction Factor (dB)	EIRP (dBm)	Limit (dBm)	Margin (dB)
1	1880.00	-20.8	19.8	0.0	19.8	33.0	-13.2

MODE		TX channel 19100					
Antenna Polarity & Test Distance: Horizontal at 3 M							
No.	Freq. (MHz)	Reading (dBm)	S.G Power Value (dBm)	Correction Factor (dB)	EIRP (dBm)	Limit (dBm)	Margin (dB)
1	1900.00	-15.5	25.2	-0.1	25.1	33.0	-7.9
Antenna Polarity & Test Distance: Vertical at 3 M							
No.	Freq. (MHz)	Reading (dBm)	S.G Power Value (dBm)	Correction Factor (dB)	EIRP (dBm)	Limit (dBm)	Margin (dB)
1	1900.00	-20.6	20.2	-0.1	20.1	33.0	-12.9

Note: EIRP (dBm) = S.G Power Value (dBm) + Correction Factor (dB).

**Modulation Type: 64QAM**

LTE Band 2, Channel Bandwidth: 1.4MHz

MODE		TX channel 18607					
Antenna Polarity & Test Distance: Horizontal at 3 M							
No.	Freq. (MHz)	Reading (dBm)	S.G Power Value (dBm)	Correction Factor (dB)	EIRP (dBm)	Limit (dBm)	Margin (dB)
1	1850.70	-16.9	23.3	0.1	23.4	33.0	-9.6
Antenna Polarity & Test Distance: Vertical at 3 M							
No.	Freq. (MHz)	Reading (dBm)	S.G Power Value (dBm)	Correction Factor (dB)	EIRP (dBm)	Limit (dBm)	Margin (dB)
1	1850.70	-22.3	18.1	0.1	18.2	33.0	-14.8

MODE		TX channel 18900					
Antenna Polarity & Test Distance: Horizontal at 3 M							
No.	Freq. (MHz)	Reading (dBm)	S.G Power Value (dBm)	Correction Factor (dB)	EIRP (dBm)	Limit (dBm)	Margin (dB)
1	1880.00	-17.18	23.31	-0.01	23.30	33.00	-9.70
Antenna Polarity & Test Distance: Vertical at 3 M							
No.	Freq. (MHz)	Reading (dBm)	S.G Power Value (dBm)	Correction Factor (dB)	EIRP (dBm)	Limit (dBm)	Margin (dB)
1	1880.00	-21.98	18.61	-0.01	18.60	33.00	-14.40

MODE		TX channel 19193					
Antenna Polarity & Test Distance: Horizontal at 3 M							
No.	Freq. (MHz)	Reading (dBm)	S.G Power Value (dBm)	Correction Factor (dB)	EIRP (dBm)	Limit (dBm)	Margin (dB)
1	1909.30	-16.15	24.52	-0.12	24.40	33.00	-8.60
Antenna Polarity & Test Distance: Vertical at 3 M							
No.	Freq. (MHz)	Reading (dBm)	S.G Power Value (dBm)	Correction Factor (dB)	EIRP (dBm)	Limit (dBm)	Margin (dB)
1	1909.30	-20.59	20.22	-0.12	20.10	33.00	-12.90

Note: EIRP (dBm) = S.G Power Value (dBm) + Correction Factor (dB).

LTE Band 2, Channel Bandwidth: 3MHz

MODE		TX channel 18615					
Antenna Polarity & Test Distance: Horizontal at 3 M							
No.	Freq. (MHz)	Reading (dBm)	S.G Power Value (dBm)	Correction Factor (dB)	EIRP (dBm)	Limit (dBm)	Margin (dB)
1	1851.50	-17.0	23.2	0.1	23.3	33.0	-9.7
Antenna Polarity & Test Distance: Vertical at 3 M							
No.	Freq. (MHz)	Reading (dBm)	S.G Power Value (dBm)	Correction Factor (dB)	EIRP (dBm)	Limit (dBm)	Margin (dB)
1	1851.50	-21.2	19.2	0.1	19.3	33.0	-13.7

MODE		TX channel 18900					
Antenna Polarity & Test Distance: Horizontal at 3 M							
No.	Freq. (MHz)	Reading (dBm)	S.G Power Value (dBm)	Correction Factor (dB)	EIRP (dBm)	Limit (dBm)	Margin (dB)
1	1880.00	-17.28	23.21	-0.01	23.2	33.0	-9.8
Antenna Polarity & Test Distance: Vertical at 3 M							
No.	Freq. (MHz)	Reading (dBm)	S.G Power Value (dBm)	Correction Factor (dB)	EIRP (dBm)	Limit (dBm)	Margin (dB)
1	1880.00	-22.2	18.4	0.0	18.4	33.0	-14.6

MODE		TX channel 19185					
Antenna Polarity & Test Distance: Horizontal at 3 M							
No.	Freq. (MHz)	Reading (dBm)	S.G Power Value (dBm)	Correction Factor (dB)	EIRP (dBm)	Limit (dBm)	Margin (dB)
1	1908.50	-16.4	24.3	-0.1	24.2	33.0	-8.8
Antenna Polarity & Test Distance: Vertical at 3 M							
No.	Freq. (MHz)	Reading (dBm)	S.G Power Value (dBm)	Correction Factor (dB)	EIRP (dBm)	Limit (dBm)	Margin (dB)
1	1908.50	-21.4	19.4	-0.1	19.3	33.0	-13.7

Note: EIRP (dBm) = S.G Power Value (dBm) + Correction Factor (dB).



LTE Band 2, Channel Bandwidth: 5MHz

MODE		TX channel 18625					
Antenna Polarity & Test Distance: Horizontal at 3 M							
No.	Freq. (MHz)	Reading (dBm)	S.G Power Value (dBm)	Correction Factor (dB)	EIRP (dBm)	Limit (dBm)	Margin (dB)
1	1852.50	-16.5	23.7	0.1	23.8	33.0	-9.2
Antenna Polarity & Test Distance: Vertical at 3 M							
No.	Freq. (MHz)	Reading (dBm)	S.G Power Value (dBm)	Correction Factor (dB)	EIRP (dBm)	Limit (dBm)	Margin (dB)
1	1852.50	-22.1	18.3	0.1	18.4	33.0	-14.6

MODE		TX channel 18900					
Antenna Polarity & Test Distance: Horizontal at 3 M							
No.	Freq. (MHz)	Reading (dBm)	S.G Power Value (dBm)	Correction Factor (dB)	EIRP (dBm)	Limit (dBm)	Margin (dB)
1	1880.00	-16.5	24.0	0.0	24.0	33.0	-9.0
Antenna Polarity & Test Distance: Vertical at 3 M							
No.	Freq. (MHz)	Reading (dBm)	S.G Power Value (dBm)	Correction Factor (dB)	EIRP (dBm)	Limit (dBm)	Margin (dB)
1	1880.00	-21.5	19.1	0.0	19.1	33.0	-13.9

MODE		TX channel 19175					
Antenna Polarity & Test Distance: Horizontal at 3 M							
No.	Freq. (MHz)	Reading (dBm)	S.G Power Value (dBm)	Correction Factor (dB)	EIRP (dBm)	Limit (dBm)	Margin (dB)
1	1907.50	-16.4	24.3	-0.1	24.2	33.0	-8.8
Antenna Polarity & Test Distance: Vertical at 3 M							
No.	Freq. (MHz)	Reading (dBm)	S.G Power Value (dBm)	Correction Factor (dB)	EIRP (dBm)	Limit (dBm)	Margin (dB)
1	1907.50	-21.4	19.4	-0.1	19.3	33.0	-13.7

Note: EIRP (dBm) = S.G Power Value (dBm) + Correction Factor (dB).

LTE Band 2, Channel Bandwidth: 10MHz

MODE		TX channel 18650					
Antenna Polarity & Test Distance: Horizontal at 3 M							
No.	Freq. (MHz)	Reading (dBm)	S.G Power Value (dBm)	Correction Factor (dB)	EIRP (dBm)	Limit (dBm)	Margin (dB)
1	1855.00	-16.1	24.2	0.0	24.2	33.0	-8.8
Antenna Polarity & Test Distance: Vertical at 3 M							
No.	Freq. (MHz)	Reading (dBm)	S.G Power Value (dBm)	Correction Factor (dB)	EIRP (dBm)	Limit (dBm)	Margin (dB)
1	1855.00	-21.1	19.4	0.0	19.4	33.0	-13.6

MODE		TX channel 18900					
Antenna Polarity & Test Distance: Horizontal at 3 M							
No.	Freq. (MHz)	Reading (dBm)	S.G Power Value (dBm)	Correction Factor (dB)	EIRP (dBm)	Limit (dBm)	Margin (dB)
1	1880.00	-16.2	24.3	0.0	24.3	33.0	-8.7
Antenna Polarity & Test Distance: Vertical at 3 M							
No.	Freq. (MHz)	Reading (dBm)	S.G Power Value (dBm)	Correction Factor (dB)	EIRP (dBm)	Limit (dBm)	Margin (dB)
1	1880.00	-21.3	19.3	0.0	19.3	33.0	-13.7

MODE		TX channel 19150					
Antenna Polarity & Test Distance: Horizontal at 3 M							
No.	Freq. (MHz)	Reading (dBm)	S.G Power Value (dBm)	Correction Factor (dB)	EIRP (dBm)	Limit (dBm)	Margin (dB)
1	1905.00	-16.1	24.6	-0.1	24.5	33.0	-8.5
Antenna Polarity & Test Distance: Vertical at 3 M							
No.	Freq. (MHz)	Reading (dBm)	S.G Power Value (dBm)	Correction Factor (dB)	EIRP (dBm)	Limit (dBm)	Margin (dB)
1	1905.00	-21.1	19.7	-0.1	19.6	33.0	-13.4

Note: EIRP (dBm) = S.G Power Value (dBm) + Correction Factor (dB).

LTE Band 2, Channel Bandwidth: 15MHz

MODE		TX channel 18675					
Antenna Polarity & Test Distance: Horizontal at 3 M							
No.	Freq. (MHz)	Reading (dBm)	S.G Power Value (dBm)	Correction Factor (dB)	EIRP (dBm)	Limit (dBm)	Margin (dB)
1	1857.50	-16.0	24.3	0.0	24.3	33.0	-8.7
Antenna Polarity & Test Distance: Vertical at 3 M							
No.	Freq. (MHz)	Reading (dBm)	S.G Power Value (dBm)	Correction Factor (dB)	EIRP (dBm)	Limit (dBm)	Margin (dB)
1	1857.50	-21.1	19.4	0.0	19.4	33.0	-13.6

MODE		TX channel 18900					
Antenna Polarity & Test Distance: Horizontal at 3 M							
No.	Freq. (MHz)	Reading (dBm)	S.G Power Value (dBm)	Correction Factor (dB)	EIRP (dBm)	Limit (dBm)	Margin (dB)
1	1880.00	-15.7	24.8	0.0	24.8	33.0	-8.2
Antenna Polarity & Test Distance: Vertical at 3 M							
No.	Freq. (MHz)	Reading (dBm)	S.G Power Value (dBm)	Correction Factor (dB)	EIRP (dBm)	Limit (dBm)	Margin (dB)
1	1880.00	-20.6	20.0	0.0	20.0	33.0	-13.0

MODE		TX channel 19125					
Antenna Polarity & Test Distance: Horizontal at 3 M							
No.	Freq. (MHz)	Reading (dBm)	S.G Power Value (dBm)	Correction Factor (dB)	EIRP (dBm)	Limit (dBm)	Margin (dB)
1	1902.50	-15.9	24.8	-0.1	24.7	33.0	-8.3
Antenna Polarity & Test Distance: Vertical at 3 M							
No.	Freq. (MHz)	Reading (dBm)	S.G Power Value (dBm)	Correction Factor (dB)	EIRP (dBm)	Limit (dBm)	Margin (dB)
1	1902.50	-21.1	19.7	-0.1	19.6	33.0	-13.4

Note: EIRP (dBm) = S.G Power Value (dBm) + Correction Factor (dB).

LTE Band 2, Channel Bandwidth: 20MHz

MODE		TX channel 18700					
Antenna Polarity & Test Distance: Horizontal at 3 M							
No.	Freq. (MHz)	Reading (dBm)	S.G Power Value (dBm)	Correction Factor (dB)	EIRP (dBm)	Limit (dBm)	Margin (dB)
1	1860.00	-15.9	24.4	0.0	24.4	33.0	-8.6
Antenna Polarity & Test Distance: Vertical at 3 M							
No.	Freq. (MHz)	Reading (dBm)	S.G Power Value (dBm)	Correction Factor (dB)	EIRP (dBm)	Limit (dBm)	Margin (dB)
1	1860.00	-21.1	19.4	0.0	19.4	33.0	-13.6

MODE		TX channel 18900					
Antenna Polarity & Test Distance: Horizontal at 3 M							
No.	Freq. (MHz)	Reading (dBm)	S.G Power Value (dBm)	Correction Factor (dB)	EIRP (dBm)	Limit (dBm)	Margin (dB)
1	1880.00	-15.9	24.6	0.0	24.6	33.0	-8.4
Antenna Polarity & Test Distance: Vertical at 3 M							
No.	Freq. (MHz)	Reading (dBm)	S.G Power Value (dBm)	Correction Factor (dB)	EIRP (dBm)	Limit (dBm)	Margin (dB)
1	1880.00	-21.3	19.3	0.0	19.3	33.0	-13.7

MODE		TX channel 19100					
Antenna Polarity & Test Distance: Horizontal at 3 M							
No.	Freq. (MHz)	Reading (dBm)	S.G Power Value (dBm)	Correction Factor (dB)	EIRP (dBm)	Limit (dBm)	Margin (dB)
1	1900.00	-15.7	25.0	-0.1	24.9	33.0	-8.1
Antenna Polarity & Test Distance: Vertical at 3 M							
No.	Freq. (MHz)	Reading (dBm)	S.G Power Value (dBm)	Correction Factor (dB)	EIRP (dBm)	Limit (dBm)	Margin (dB)
1	1900.00	-21.0	19.8	-0.1	19.7	33.0	-13.3

Note: EIRP (dBm) = S.G Power Value (dBm) + Correction Factor (dB).

## 4.2 Modulation Characteristics Measurement

### 4.2.1 Limits of Modulation Characteristics

N/A

### 4.2.2 Test Procedure

Connect the EUT to Communication Simulator via the antenna connector, The frequency band is set as EUT supported Modulation and Channels, the EUT output is matched with 50 ohm load, the waveform quality and constellation of the EUT was tested.

### 4.2.3 Test Setup





LTE Band 2

Spectrum Plot of Measurement Value

Channel: 18900 / Frequency (MHz): 1880.0MHz

Channel Bandwidth: 1.4MHz / QPSK

Channel Bandwidth: 1.4MHz / 16QAM

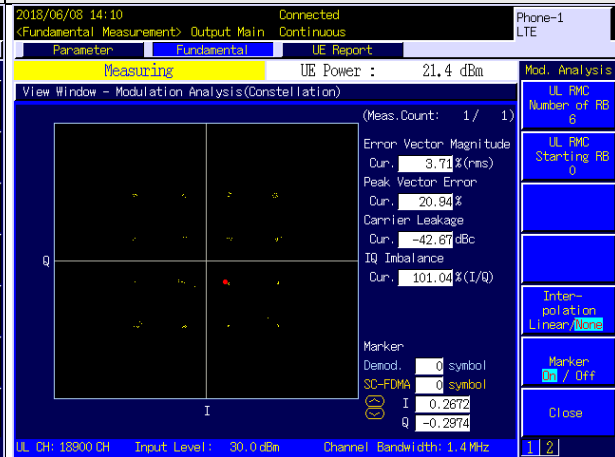
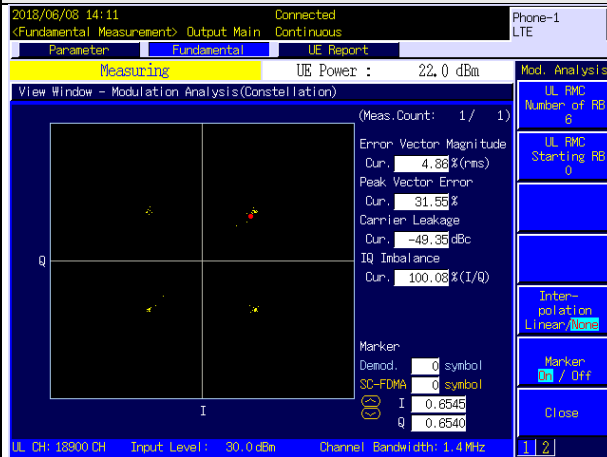

Channel Bandwidth: 20MHz / QPSK

Channel Bandwidth: 20MHz / 16QAM

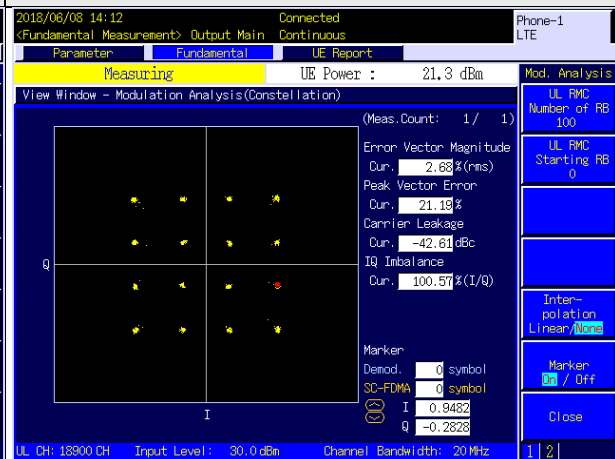
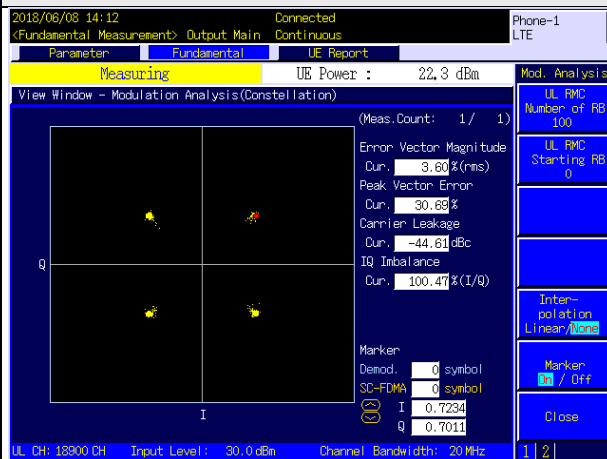

### 4.3 Frequency Stability Measurement

#### 4.3.1 Limits of Frequency Stability Measurement

1.5 ppm is for base and fixed station. 2.5 ppm is for mobile station.

#### 4.3.2 Test Procedure

- Device is placed at the oven room. The oven room could control the temperatures and humidity. Power warm up is at least 15 min and power applied should perform before recording frequency error.
- EUT is connected the external power supply to control the DC input power. The test voltage range is from minimum to maximum working voltage. Each step shall be record the frequency error rate.
- The temperature range step is 10 degrees in this test items. All temperature levels shall be hold the  $\pm 0.5$  °C during the measurement testing. The each temperature step shall be at least 0.5 hours, consider the EUT could be test under the stability condition.

NOTE: The frequency error was recorded frequency error from the communication simulator.

#### 4.3.3 Test Setup

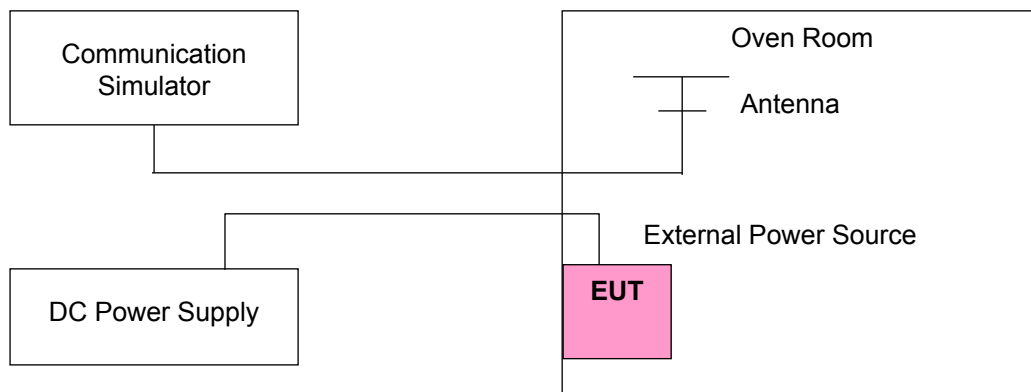



#### 4.3.4 Test Results

##### Frequency Error vs. Voltage

Voltage (Volts)	Frequency Error (ppm)			Limit (ppm)
	PCS	WCDMA	LTE Band 2	
4.3	0.04521	0.03675	0.09102	2.5
3.8	0.01042	0.08156	0.02749	2.5
3.4	0.07762	0.06588	0.07739	2.5

Note: The applicant defined the normal working voltage is from 3.4Vdc to 4.3Vdc.

##### Frequency Error vs. Temperature.

Temp. (°C)	Frequency Error (ppm)			Limit (ppm)
	PCS	WCDMA	LTE Band 2	
50	0.07062	0.00878	0.06852	2.5
40	0.10864	0.06089	0.00952	2.5
30	0.02791	0.01381	0.02701	2.5
20	0.04430	0.05554	0.00505	2.5
10	0.05271	0.06878	0.07099	2.5
0	0.11709	0.05597	0.01764	2.5
-10	0.02801	0.04581	0.01314	2.5
-20	0.00677	0.01075	0.08096	2.5
-30	0.05355	0.01286	0.11494	2.5

## 4.4 Occupied Bandwidth Measurement

### 4.4.1 Test Procedure

The EUT makes a call to the communication simulator. All measurements were done at low, middle and high operational frequency range. The communication simulator station system controlled a EUT to export maximum output power under transmission mode and specific channel frequency. Use OBW measurement function of Spectrum analyzer to measure 99 % occupied bandwidth.

### 4.4.2 Test Setup

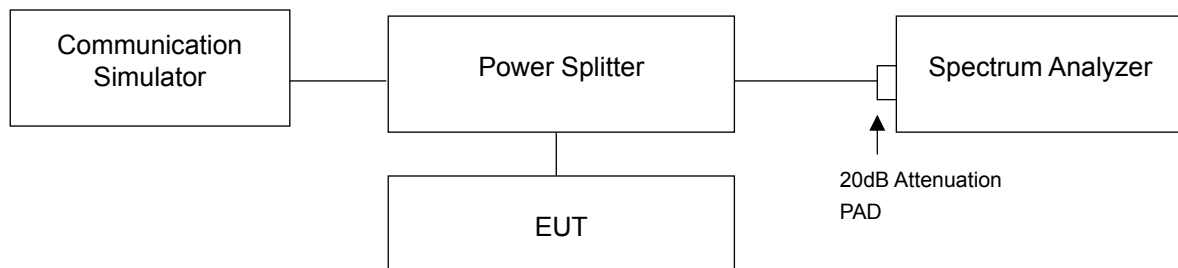

### 4.4.3 Test Result

#### Occupied Bandwidth

Channel	Frequency (MHz)	99% Occupied Bandwidth (kHz)	
		PCS	EDGE
512	1850.2	260	250
661	1880.0	260	250
810	1909.8	250	260

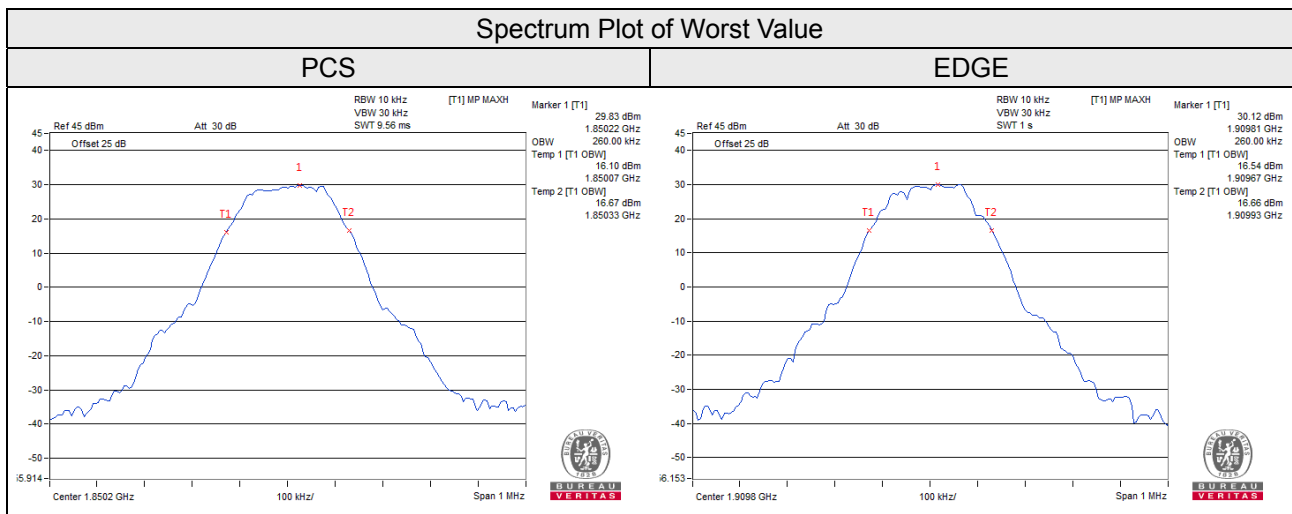

Channel	Frequency (MHz)	99% Occupied Bandwidth (MHz)
		WCDMA
9262	1852.4	4.13
9400	1880.0	4.11
9538	1907.6	4.15

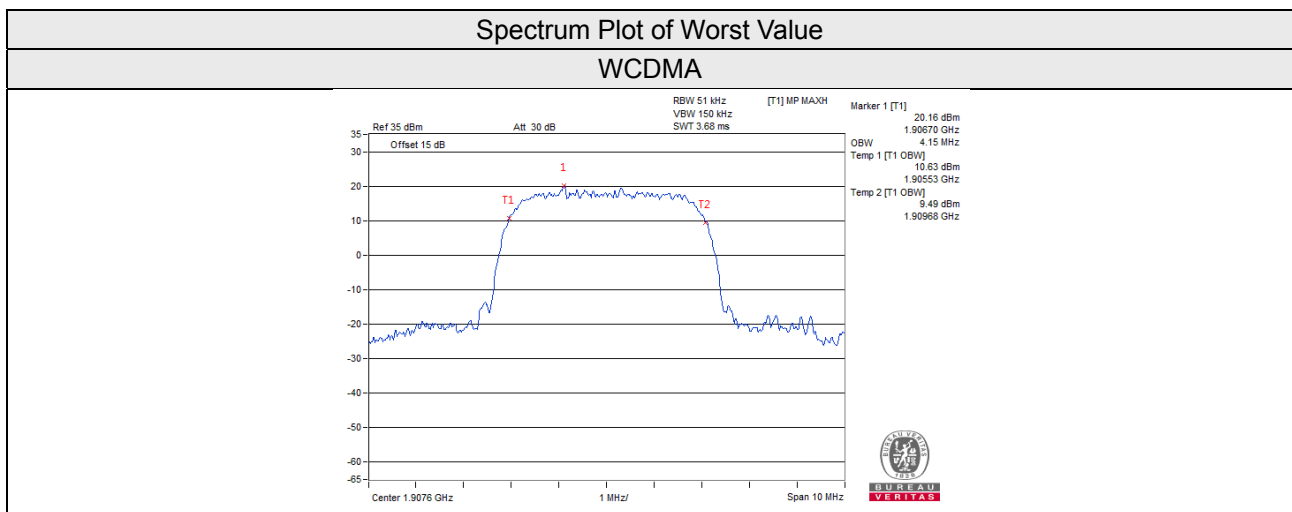

LTE Band 2, Channel Bandwidth 1.4MHz				
Channel	Frequency (MHz)	99% Occupied Bandwidth (MHz)		
		QPSK	16QAM	64QAM
18607	1850.7	1.08	1.09	1.09
18900	1880.0	1.09	1.09	1.09
19193	1909.3	1.09	1.09	1.09

LTE Band 2, Channel Bandwidth 3MHz				
Channel	Frequency (MHz)	99% Occupied Bandwidth (MHz)		
		QPSK	16QAM	64QAM
18615	1851.5	2.68	2.68	2.68
18900	1880.0	2.68	2.68	2.68
19185	1908.5	2.69	2.69	2.67

LTE Band 2, Channel Bandwidth 5MHz				
Channel	Frequency (MHz)	99% Occupied Bandwidth (MHz)		
		QPSK	16QAM	64QAM
18625	1852.5	4.46	4.45	4.48
18900	1880.0	4.46	4.46	4.48
19175	1907.5	4.45	4.45	4.48

LTE Band 2, Channel Bandwidth 10MHz				
Channel	Frequency (MHz)	99% Occupied Bandwidth (MHz)		
		QPSK	16QAM	64QAM
18650	1855.0	8.93	8.90	8.96
18900	1880.0	8.93	8.90	8.93
19150	1905.0	8.93	8.90	8.96

LTE Band 2, Channel Bandwidth 15MHz				
Channel	Frequency (MHz)	99% Occupied Bandwidth (MHz)		
		QPSK	16QAM	64QAM
18675	1857.5	13.43	13.40	13.43
18900	1880.0	13.36	13.40	13.40
19125	1902.5	13.36	13.40	13.36

### LTE Band 2, Channel Bandwidth 20MHz

Channel	Frequency (MHz)	99% Occupied Bandwidth (MHz)		
		QPSK	16QAM	64QAM
18700	1860.0	17.93	17.93	17.93
18900	1880.0	17.93	17.93	17.93
19100	1900.0	17.86	18.00	17.86

### Spectrum Plot of Worst Value

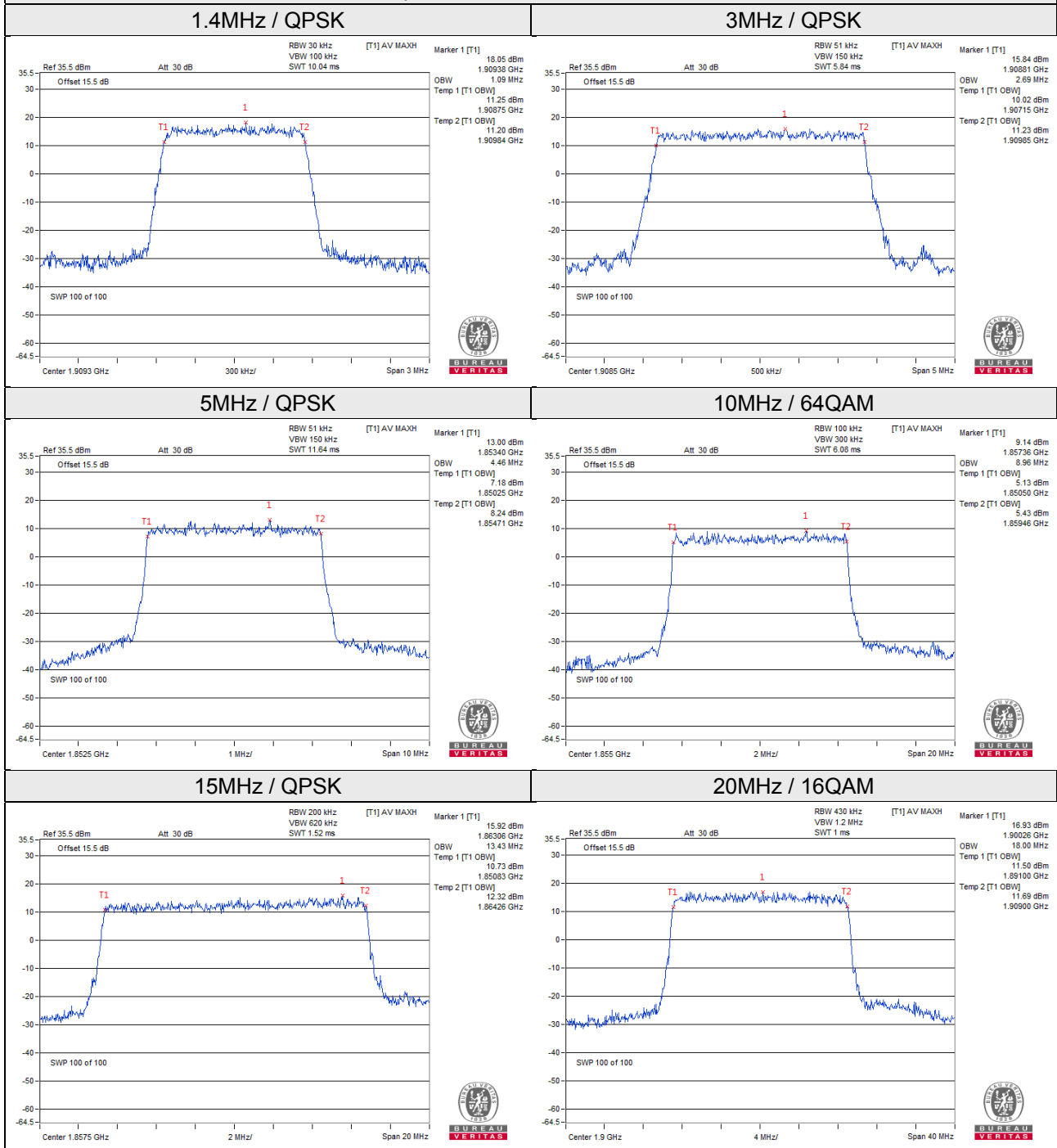

### 26dB Bandwidth

Channel	Frequency (MHz)	26dBc Bandwidth (kHz)	
		PCS	EDGE
512	1850.2	312.108	315.042
661	1880.0	310.970	311.084
810	1909.8	311.057	310.477

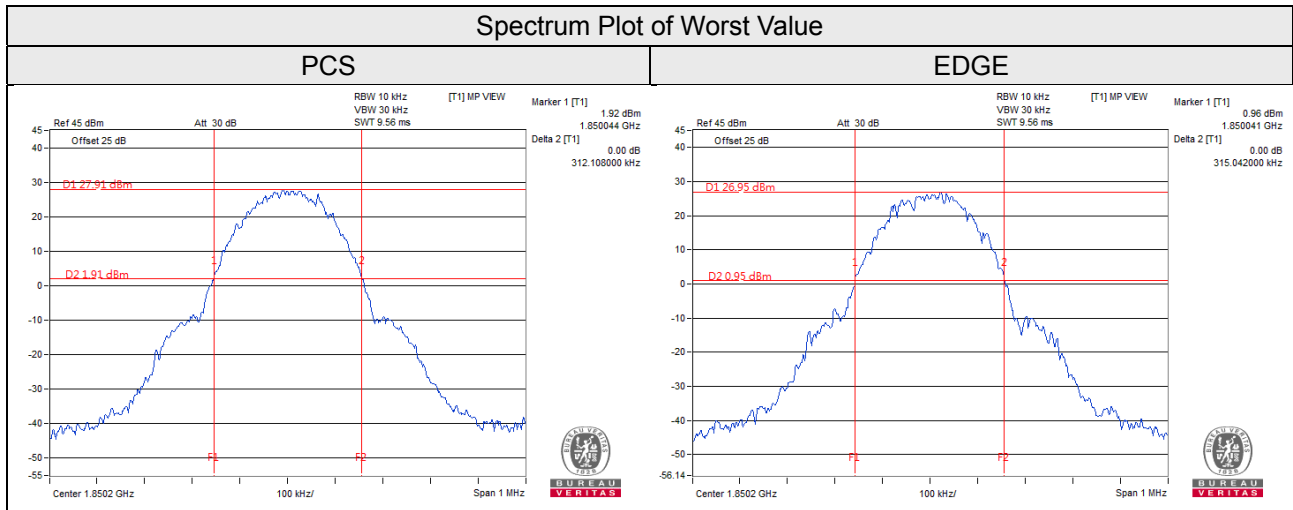

Channel	Frequency (MHz)	26dBc Bandwidth (MHz)
		WCDMA
9262	1852.4	4.698
9400	1880.0	4.676
9538	1907.6	4.719

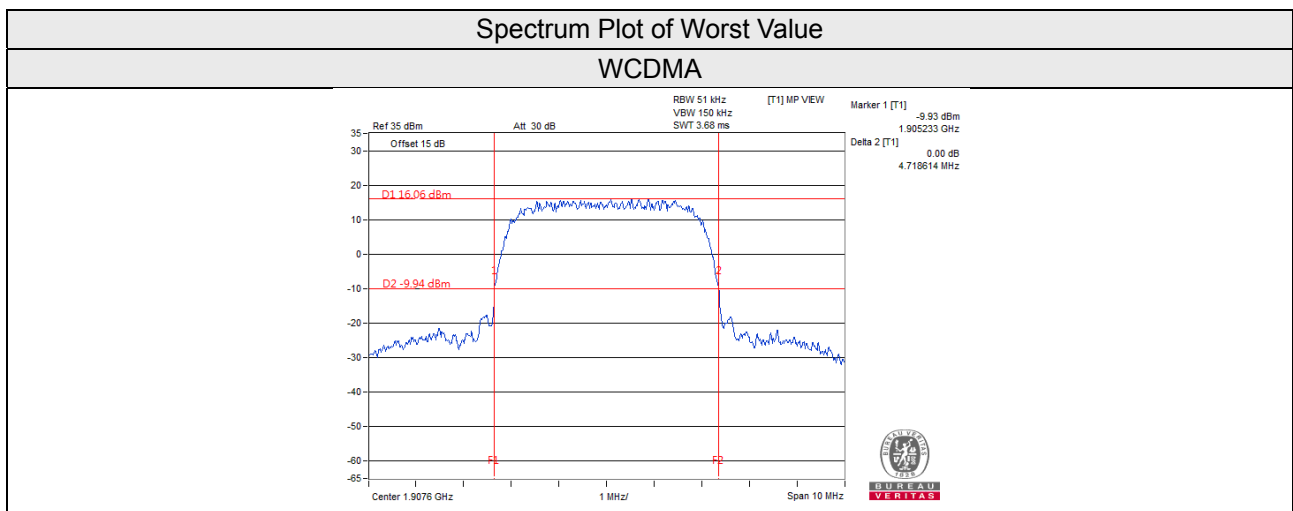

LTE Band 2, Channel Bandwidth 1.4MHz				
Channel	Frequency (MHz)	26dBc Bandwidth (MHz)		
		QPSK	16QAM	64QAM
18607	1850.7	1.239	1.234	1.235
18900	1880.0	1.232	1.242	1.239
19193	1909.3	1.218	1.223	1.235

LTE Band 2, Channel Bandwidth 3MHz				
Channel	Frequency (MHz)	26dBc Bandwidth (MHz)		
		QPSK	16QAM	64QAM
18615	1851.5	2.966	2.958	2.986
18900	1880.0	2.981	2.966	2.980
19185	1908.5	2.963	2.969	2.987

LTE Band 2, Channel Bandwidth 5MHz				
Channel	Frequency (MHz)	26dBc Bandwidth (MHz)		
		QPSK	16QAM	64QAM
18625	1852.5	4.863	4.868	4.858
18900	1880.0	4.853	4.887	4.938
19175	1907.5	4.898	4.861	4.920

LTE Band 2, Channel Bandwidth 10MHz				
Channel	Frequency (MHz)	26dBc Bandwidth (MHz)		
		QPSK	16QAM	64QAM
18650	1855.0	9.742	9.561	9.633
18900	1880.0	9.605	9.610	9.563
19150	1905.0	9.566	9.575	9.623

LTE Band 2, Channel Bandwidth 15MHz				
Channel	Frequency (MHz)	26dBc Bandwidth (MHz)		
		QPSK	16QAM	64QAM
18675	1857.5	14.453	14.409	14.520
18900	1880.0	14.530	14.506	14.521
19125	1902.5	14.531	14.435	14.523

### LTE Band 2, Channel Bandwidth 20MHz

Channel	Frequency (MHz)	26dBc Bandwidth (MHz)		
		QPSK	16QAM	64QAM
18700	1860.0	19.558	19.604	19.512
18900	1880.0	19.493	19.486	19.571
19100	1900.0	19.496	19.450	19.445

### Spectrum Plot of Worst Value

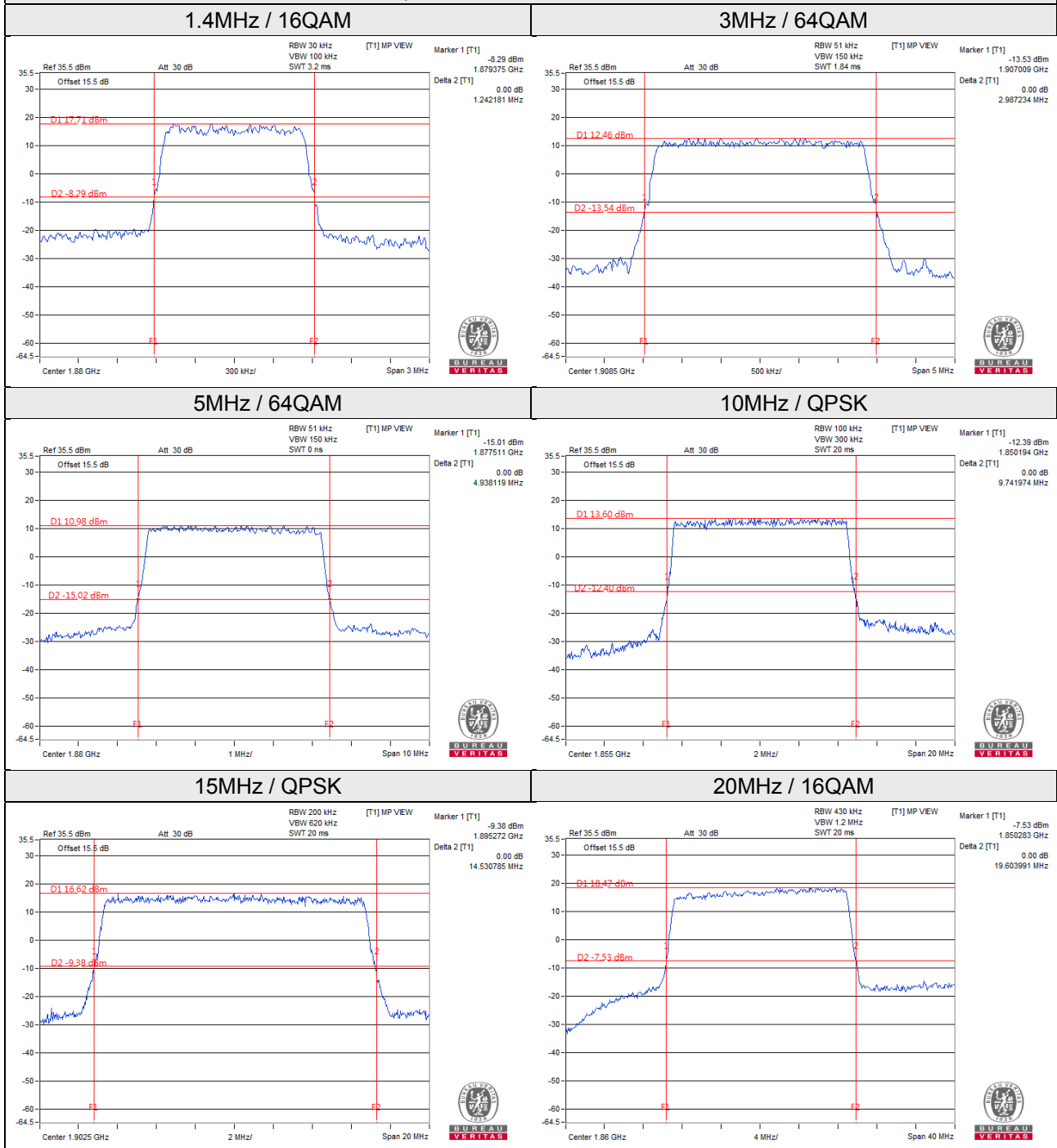



## 4.5 Band Edge Measurement

### 4.5.1 Limits of Band Edge Measurement

Power of any emission outside of the authorized operating frequency ranges must be attenuated below the transmitting power (P) by a factor of at least  $43 + 10 \log(P)$  dB. In the 1 MHz bands immediately outside and adjacent to the frequency block a resolution bandwidth of at least one percent of the emission bandwidth of the fundamental emission of the transmitter may be employed.

### 4.5.2 Test Setup

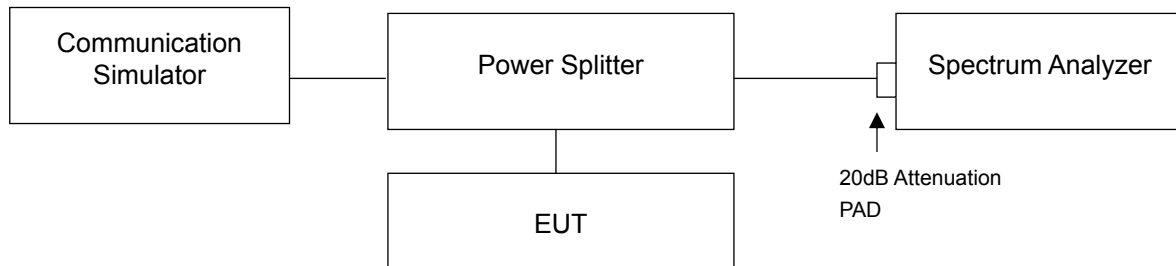

### 4.5.3 Test Procedures

- a. All measurements were done at low and high operational frequency range.
- b. The center frequency of spectrum is the band edge frequency and span is 1.5MHz. RB of the spectrum is 10kHz and VB of the spectrum is 30kHz (PCS / EDGE).
- c. The center frequency of spectrum is the band edge frequency and span is 1.5MHz. RB of the spectrum is 51kHz and VB of the spectrum is 150kHz (WCDMA).
- d. The center frequency of spectrum is the band edge frequency and span is 1.5MHz. RB of the spectrum is 30kHz and VB of the spectrum is 100kHz (LTE Channel Bandwidth 1.4MHz).
- e. The center frequency of spectrum is the band edge frequency and span is 1.5MHz. RB of the spectrum is 51kHz and VB of the spectrum is 150kHz (LTE Channel Bandwidth 3MHz and 5MHz).
- f. The center frequency of spectrum is the band edge frequency and span is 1.5MHz. RB of the spectrum is 100kHz and VB of the spectrum is 300kHz (LTE Channel Bandwidth 10MHz).
- g. The center frequency of spectrum is the band edge frequency and span is 1MHz. RB of the spectrum is 200kHz and VB of the spectrum is 620kHz (LTE Channel Bandwidth 15MHz).
- h. The center frequency of spectrum is the band edge frequency and span is 1MHz. RB of the spectrum is 430kHz and VB of the spectrum is 1200kHz (LTE Channel Bandwidth 20MHz).
- i. Record the max trace plot into the test report.

### 4.5.4 Test Results

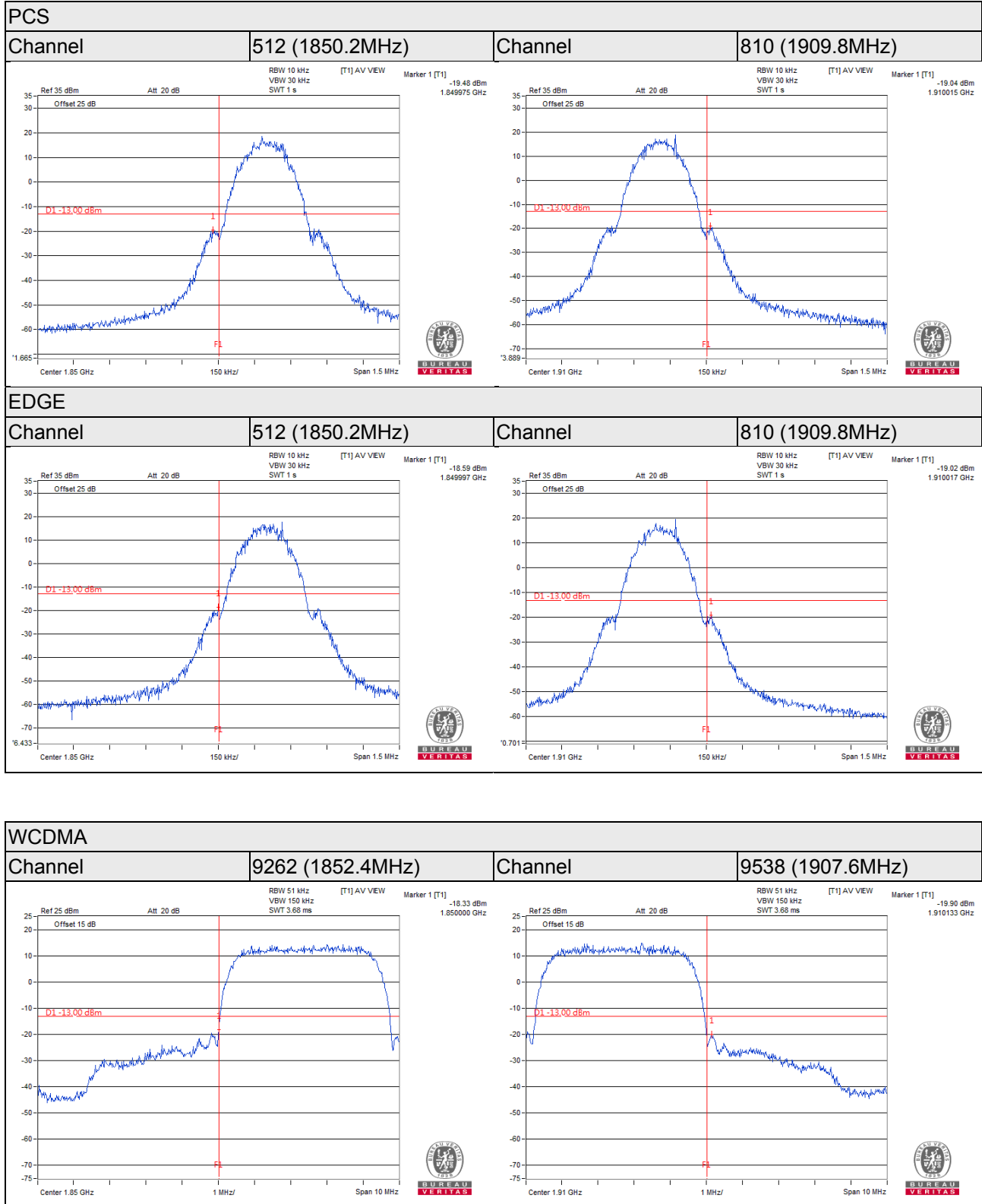

**LTE Band 2, Channel Bandwidth 1.4MHz**

<b>Channel 18607 (1850.70MHz)</b>	<b>QPSK</b>	<b>1 RB / 0 RB Offset</b>	<b>Channel 19193 (1909.30MHz)</b>	<b>QPSK</b>	<b>1 RB / 5 RB Offset</b>
---------------------------------------	-------------	---------------------------	---------------------------------------	-------------	---------------------------

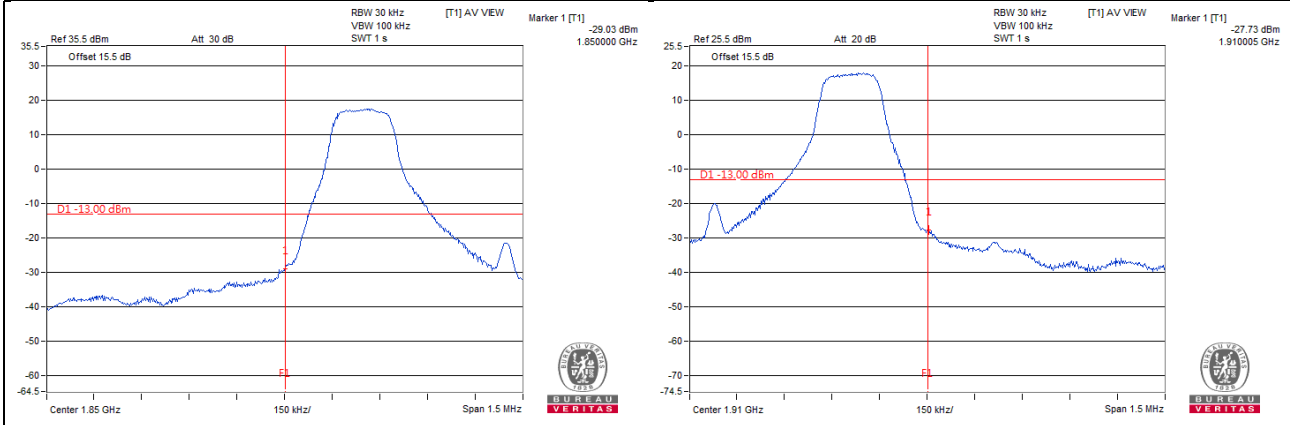

<b>Channel 18607 (1850.70MHz)</b>	<b>QPSK</b>	<b>6 RB / 0 RB Offset</b>	<b>Channel 19193 (1909.30MHz)</b>	<b>QPSK</b>	<b>6 RB / 0 RB Offset</b>
---------------------------------------	-------------	---------------------------	---------------------------------------	-------------	---------------------------

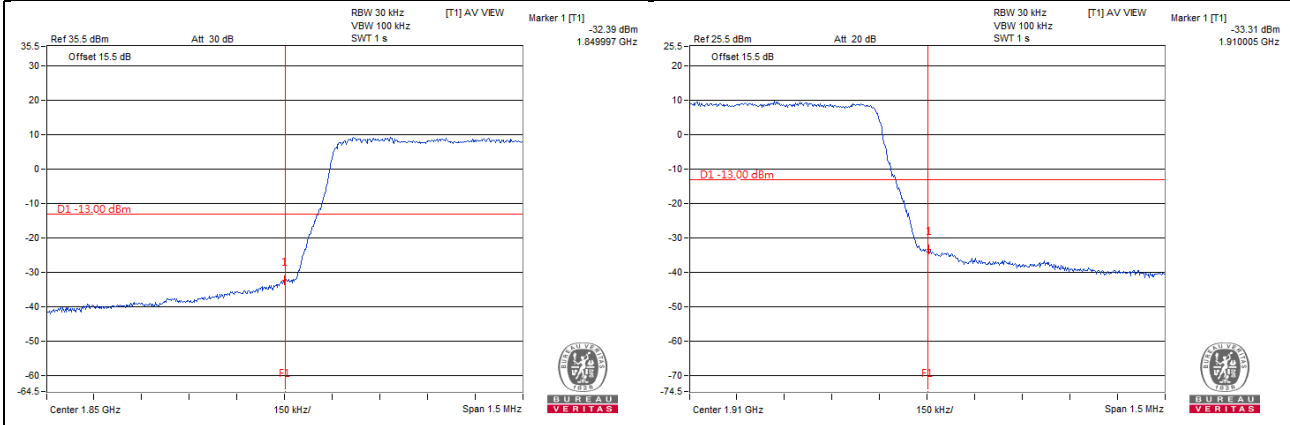

**LTE Band 2, Channel Bandwidth 3MHz**

<b>Channel 18615 (1851.50MHz)</b>	<b>QPSK</b>	<b>1 RB / 0 RB Offset</b>	<b>Channel 19185 (1908.50MHz)</b>	<b>QPSK</b>	<b>1 RB / 14 RB Offset</b>
---------------------------------------	-------------	---------------------------	---------------------------------------	-------------	----------------------------

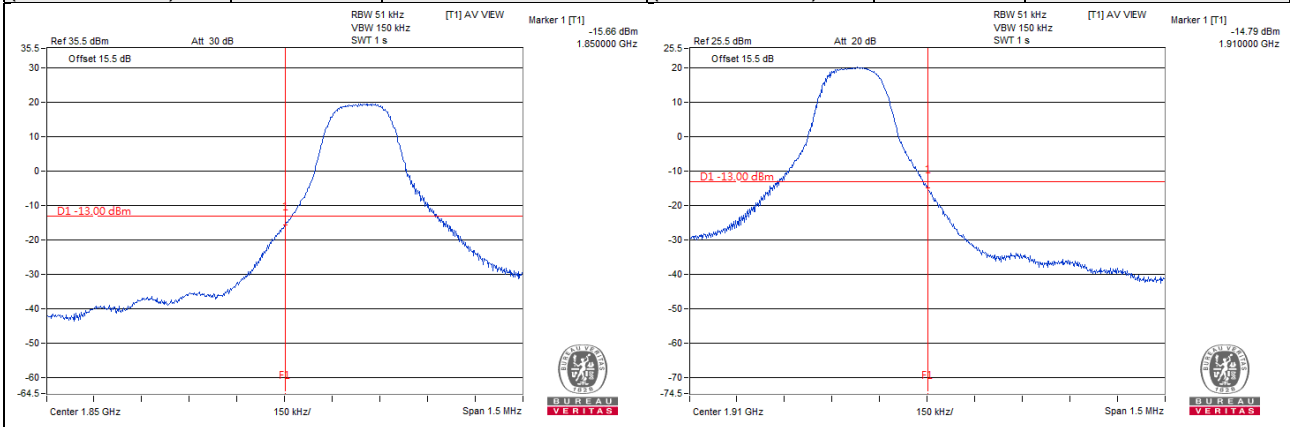

<b>Channel 18615 (1851.50MHz)</b>	<b>QPSK</b>	<b>15 RB / 0 RB Offset</b>	<b>Channel 19185 (1908.50MHz)</b>	<b>QPSK</b>	<b>15 RB / 0 RB Offset</b>
---------------------------------------	-------------	----------------------------	---------------------------------------	-------------	----------------------------

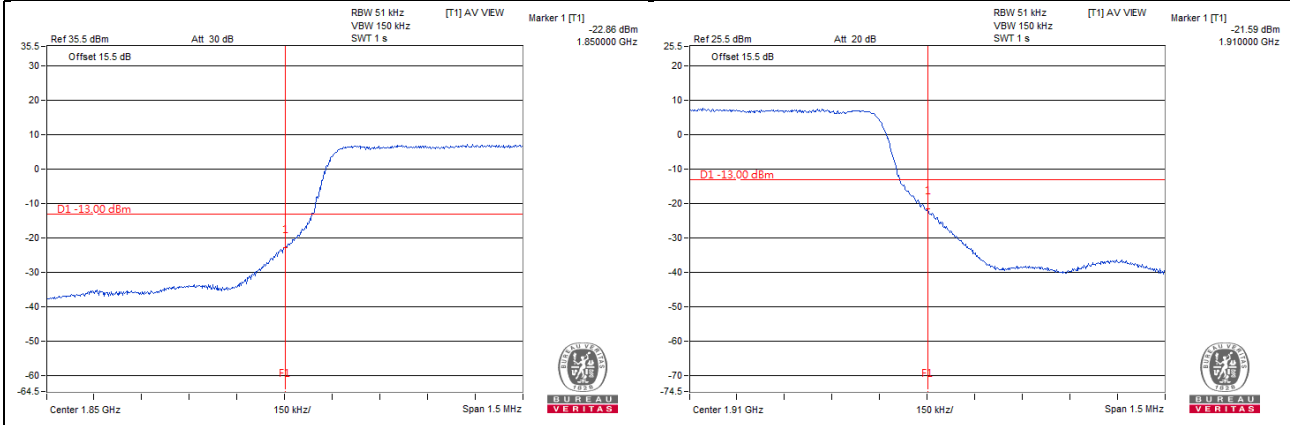

**LTE Band 2, Channel Bandwidth 5MHz**

<b>Channel 18625 (1852.50MHz)</b>	<b>QPSK</b>	<b>1 RB / 0 RB Offset</b>	<b>Channel 19175 (1907.50MHz)</b>	<b>QPSK</b>	<b>1 RB / 24 RB Offset</b>
---------------------------------------	-------------	---------------------------	---------------------------------------	-------------	----------------------------

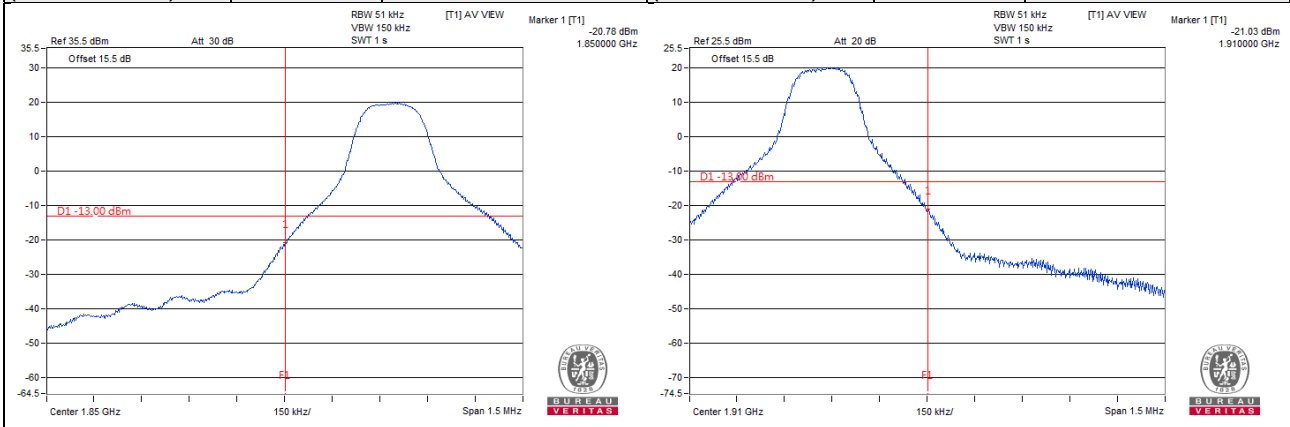

<b>Channel 18625 (1852.50MHz)</b>	<b>QPSK</b>	<b>25 RB / 0 RB Offset</b>	<b>Channel 19175 (1907.50MHz)</b>	<b>QPSK</b>	<b>25 RB / 0 RB Offset</b>
---------------------------------------	-------------	----------------------------	---------------------------------------	-------------	----------------------------

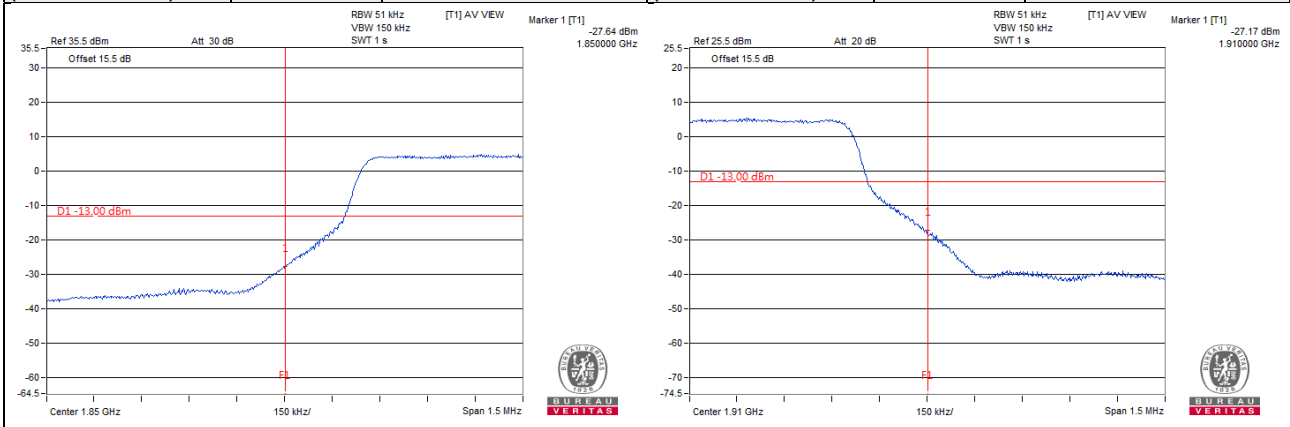

**LTE Band 2, Channel Bandwidth 10MHz**

<b>Channel 18650 (1855.00MHz)</b>	<b>QPSK</b>	<b>1 RB / 0 RB Offset</b>	<b>Channel 19150 (1905.00MHz)</b>	<b>QPSK</b>	<b>1 RB / 49 RB Offset</b>
---------------------------------------	-------------	---------------------------	---------------------------------------	-------------	----------------------------

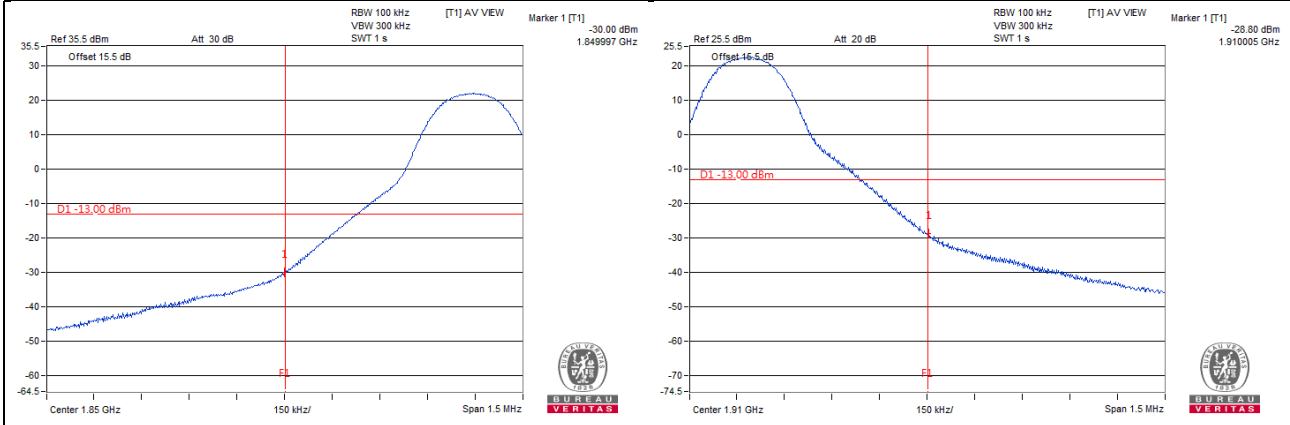

<b>Channel 18650 (1855.00MHz)</b>	<b>QPSK</b>	<b>50 RB / 0 RB Offset</b>	<b>Channel 19150 (1905.00MHz)</b>	<b>QPSK</b>	<b>50 RB / 0 RB Offset</b>
---------------------------------------	-------------	----------------------------	---------------------------------------	-------------	----------------------------

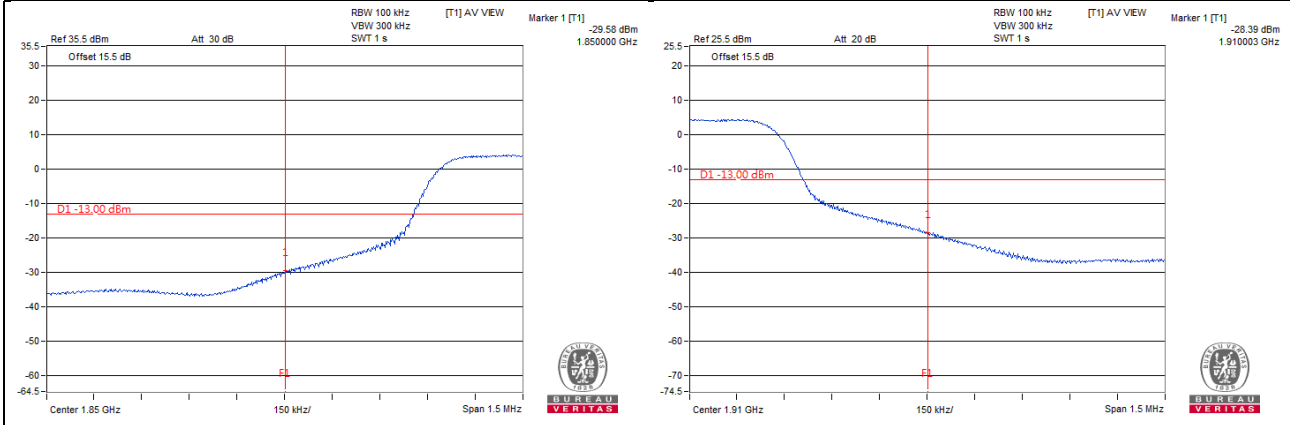

**LTE Band 2, Channel Bandwidth 15MHz**

<b>Channel 18675 (1857.50MHz)</b>	<b>QPSK</b>	<b>1 RB / 0 RB Offset</b>	<b>Channel 19125 (1902.50MHz)</b>	<b>QPSK</b>	<b>1 RB / 74 RB Offset</b>
---------------------------------------	-------------	---------------------------	---------------------------------------	-------------	----------------------------

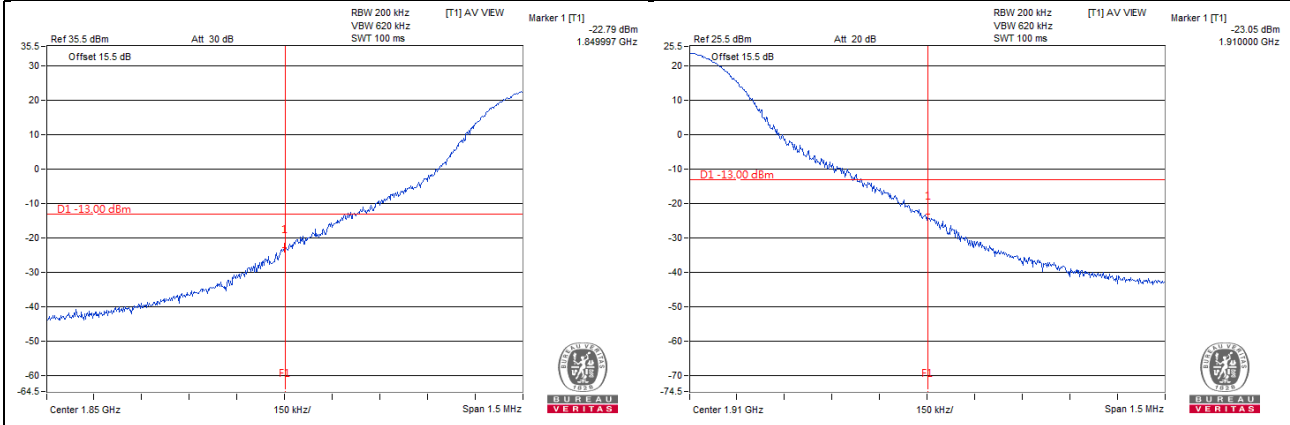

<b>Channel 18675 (1857.50MHz)</b>	<b>QPSK</b>	<b>75 RB / 0 RB Offset</b>	<b>Channel 19125 (1902.50MHz)</b>	<b>QPSK</b>	<b>75 RB / 0 RB Offset</b>
---------------------------------------	-------------	----------------------------	---------------------------------------	-------------	----------------------------

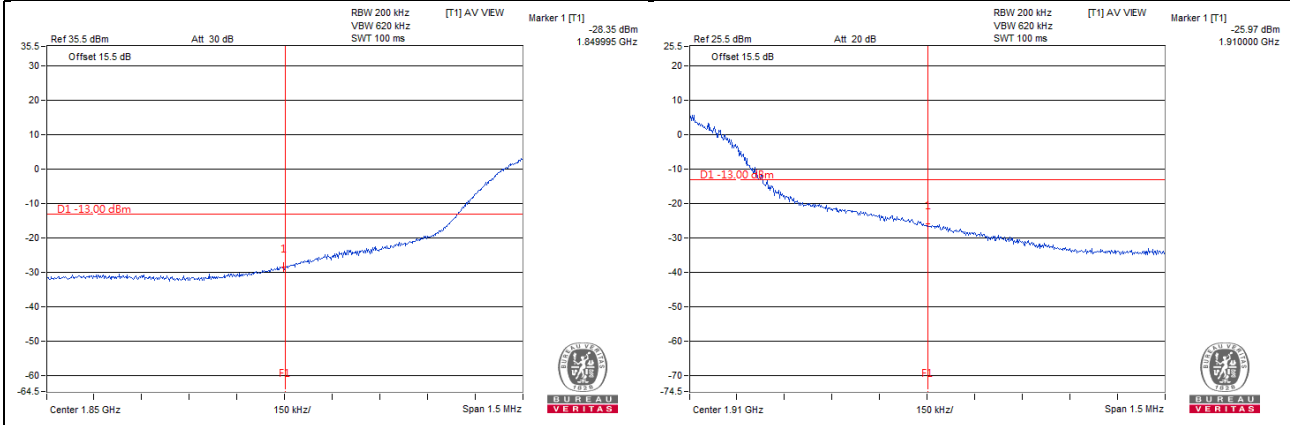

**LTE Band 2, Channel Bandwidth 20MHz**

<b>Channel 18700 (1860.00MHz)</b>	<b>QPSK</b>	<b>1 RB / 0 RB Offset</b>	<b>Channel 19100 (1900.00 MHz)</b>	<b>QPSK</b>	<b>1 RB / 99 RB Offset</b>
---------------------------------------	-------------	---------------------------	----------------------------------------	-------------	----------------------------

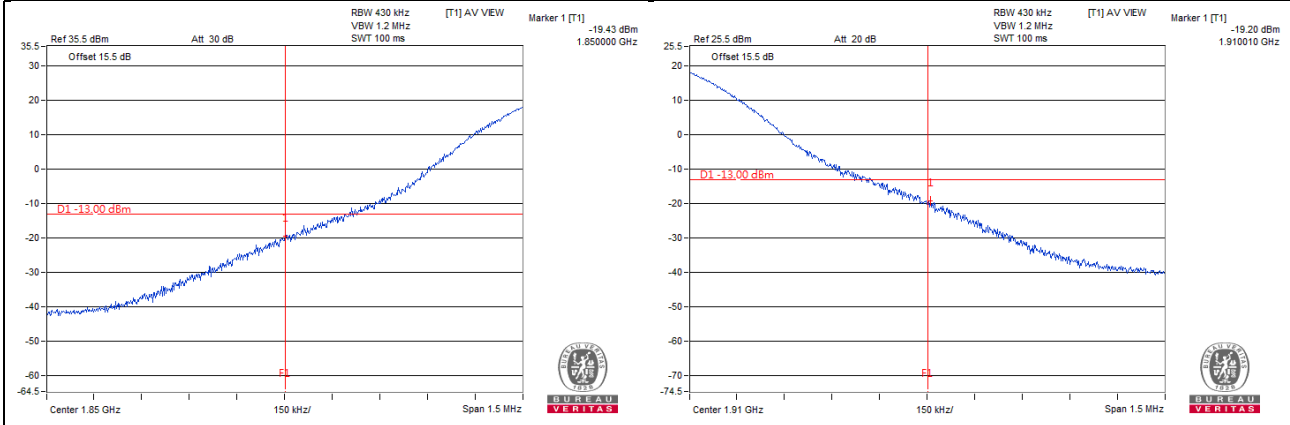

<b>Channel 18700 (1860.00MHz)</b>	<b>QPSK</b>	<b>100 RB / 0 RB Offset</b>	<b>Channel 19100 (1900.00 MHz)</b>	<b>QPSK</b>	<b>100 RB / 0 RB Offset</b>
---------------------------------------	-------------	-----------------------------	----------------------------------------	-------------	-----------------------------

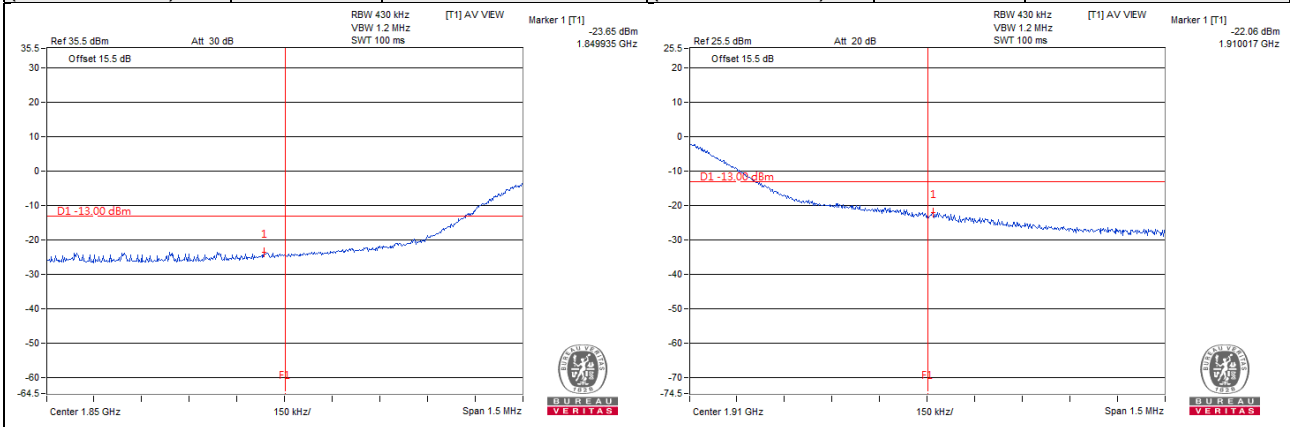



## 4.6 Peak to Average Ratio

### 4.6.1 Limits of Peak to Average Ratio Measurement

In measuring transmissions in this band using an average power technique, the peak to-average ratio (PAR) of the transmission may not exceed 13 dB

### 4.6.2 Test Setup

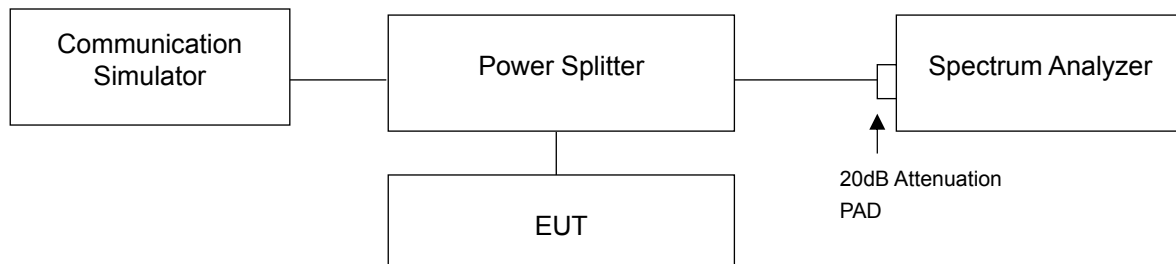

### 4.6.3 Test Procedures

- Set resolution/measurement bandwidth  $\geq$  signal's occupied bandwidth;
- Set the number of counts to a value that stabilizes the measured CCDF curve;
- Record the maximum PAPR level associated with a probability of 0.1%.

#### 4.6.4 Test Results

Channel	Frequency (MHz)	Peak To Average Ratio (dB)	
		PCS	EDGE
512	1850.2	2.70	2.78
661	1880.0	2.79	2.79
810	1909.8	2.80	2.80

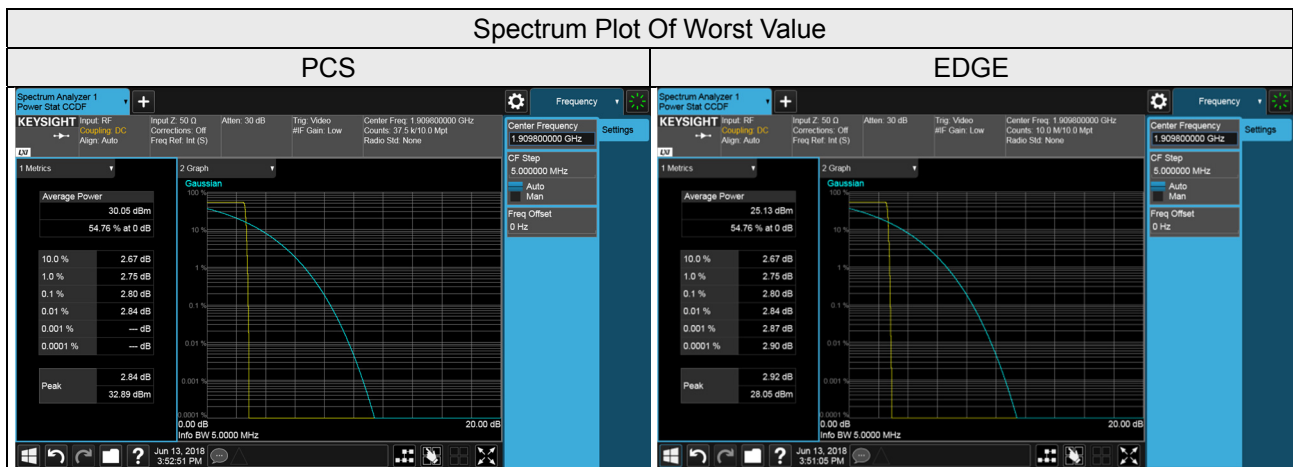

Channel	Frequency (MHz)	Peak To Average Ratio (dB)
		WCDMA
9262	1852.4	3.04
9400	1880.0	3.08
9538	1907.6	3.09



LTE Band 2, Channel Bandwidth 1.4MHz				
Channel	Frequency (MHz)	Peak To Average Ratio (dB)		
		QPSK	16QAM	64QAM
18607	1850.7	4.93	4.93	5.00
18900	1880.0	4.72	4.72	4.69
19193	1909.3	4.93	4.93	4.98

LTE Band 2, Channel Bandwidth 3MHz				
Channel	Frequency (MHz)	Peak To Average Ratio (dB)		
		QPSK	16QAM	64QAM
18615	1851.5	4.77	4.77	4.79
18900	1880.0	4.60	4.61	4.57
19185	1908.5	4.76	4.75	4.74

LTE Band 2, Channel Bandwidth 5MHz				
Channel	Frequency (MHz)	Peak To Average Ratio (dB)		
		QPSK	16QAM	64QAM
18625	1852.5	4.92	4.92	4.93
18900	1880.0	4.69	4.69	4.67
19175	1907.5	4.85	4.85	4.90

LTE Band 2, Channel Bandwidth 10MHz				
Channel	Frequency (MHz)	Peak To Average Ratio (dB)		
		QPSK	16QAM	64QAM
18650	1855.0	4.94	4.96	4.94
18900	1880.0	4.71	4.72	4.69
19150	1905.0	4.87	4.86	4.94

LTE Band 2, Channel Bandwidth 15MHz				
Channel	Frequency (MHz)	Peak To Average Ratio (dB)		
		QPSK	16QAM	64QAM
18675	1857.5	4.92	4.92	4.89
18900	1880.0	4.69	4.70	4.73
19125	1902.5	4.81	4.80	4.85

LTE Band 2, Channel Bandwidth 20MHz				
Channel	Frequency (MHz)	Peak To Average Ratio (dB)		
		QPSK	16QAM	64QAM
18700	1860.0	4.89	4.89	4.85
18900	1880.0	4.68	4.69	4.77
19100	1900.0	4.76	4.76	4.74

### Spectrum Plot Of Worst Value

#### 1.4MHz / 64QAM

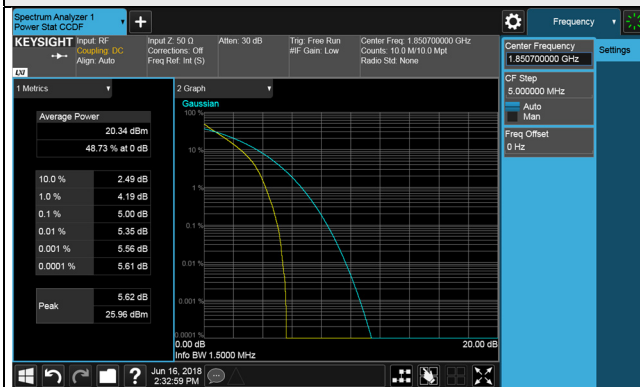

#### 3MHz / 64QAM

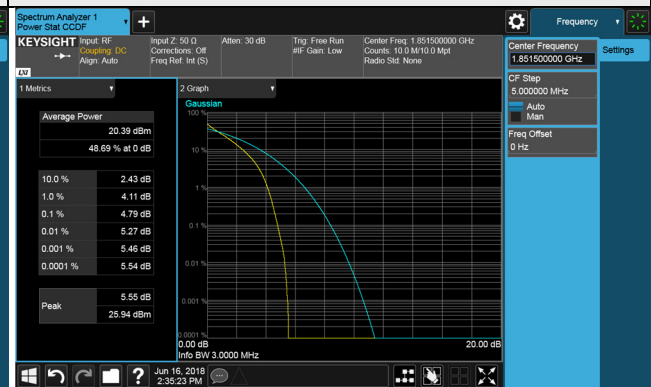

#### 5MHz / 64QAM

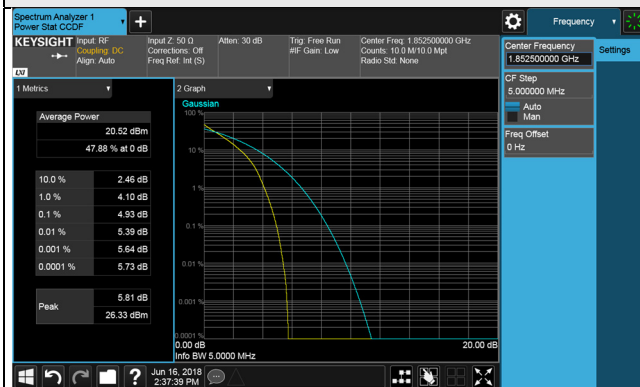

#### 10MHz / 16QAM

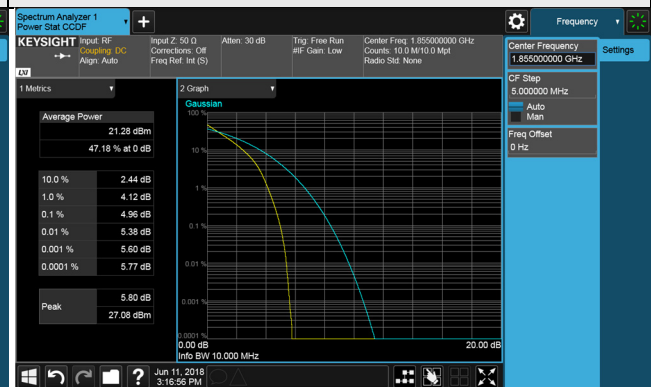

#### 15MHz / 16QAM

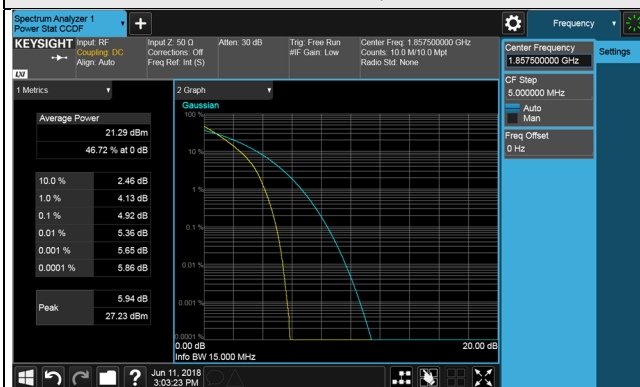

#### 20MHz / QPSK

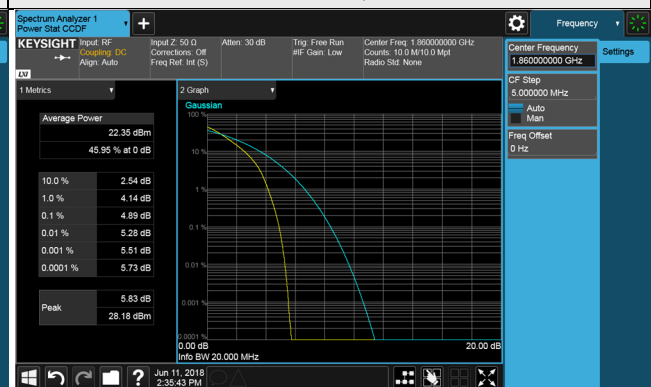

## 4.7 Conducted Spurious Emissions

### 4.7.1 Limits of Conducted Spurious Emissions Measurement

The power of any emission outside of the authorized operating frequency ranges must be attenuated below the transmitting power (P) by a factor of at least  $43 + 10 \log(P)$  dB. The emission limit equal to  $-13\text{dBm}$ .

### 4.7.2 Test Setup

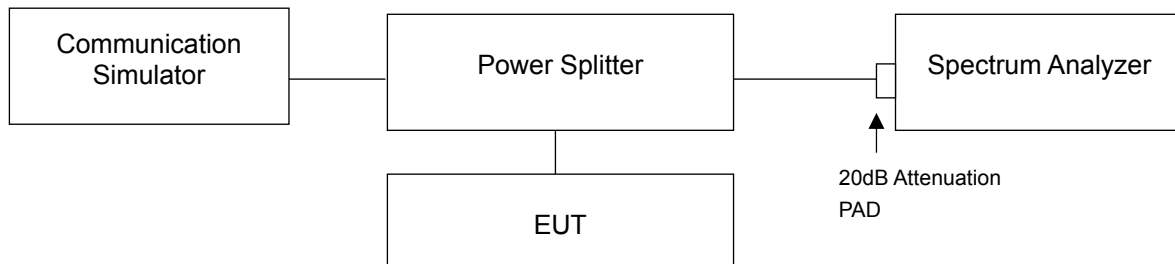

### 4.7.3 Test Procedure

- The EUT makes a phone call to the communication simulator. All measurements were done at low, middle and high operational frequency range.
- Measuring frequency range is from 9 kHz to 1GHz. 20dB attenuation pad is connected with spectrum. RBW=100kHz and VBW=300kHz is used for conducted emission measurement.
- Measuring frequency range is from 1GHz to 26.5GHz. 20dB attenuation pad is connected with spectrum. RBW=1MHz and VBW=3MHz is used for conducted emission measurement.

### 4.7.4 Test Results

PCS

Channel 512 (1850.2MHz)

Frequency Range : 9kHz~1GHz      Frequency Range : 1GHz~10GHz

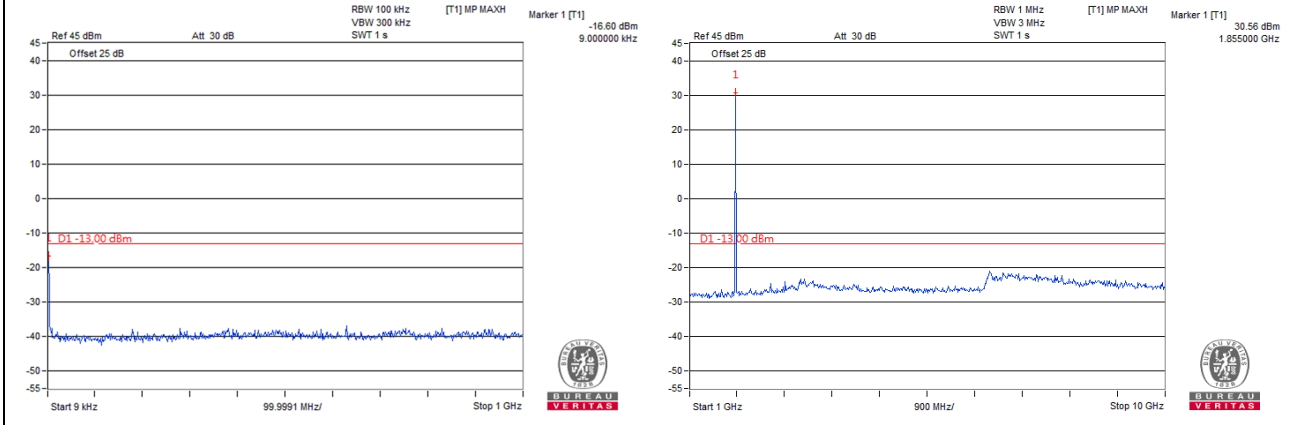

Frequency Range : 10GHz~26.5GHz

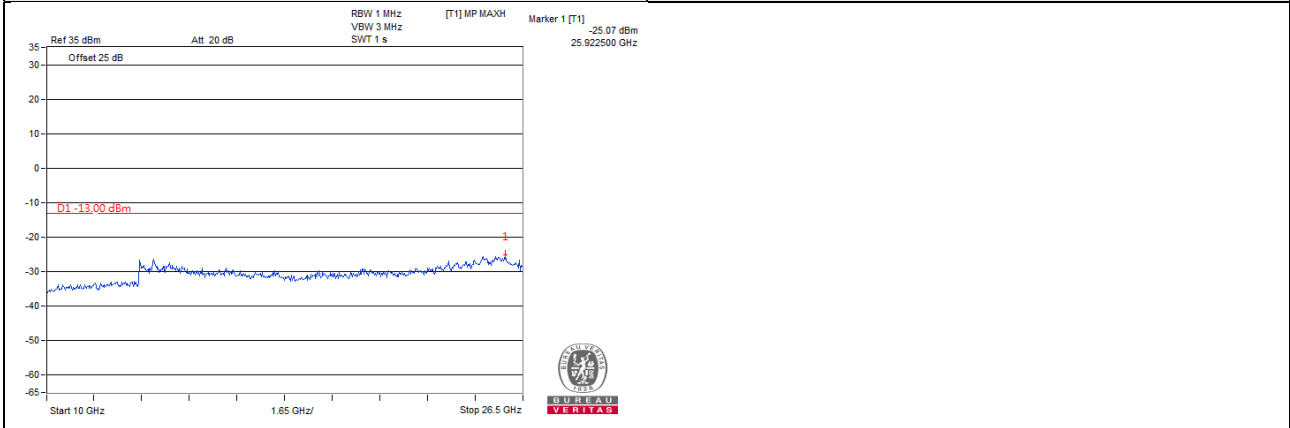

PCS

Channel 661 (1880.0MHz)

Frequency Range : 9kHz~1GHz

Frequency Range : 1GHz~10GHz

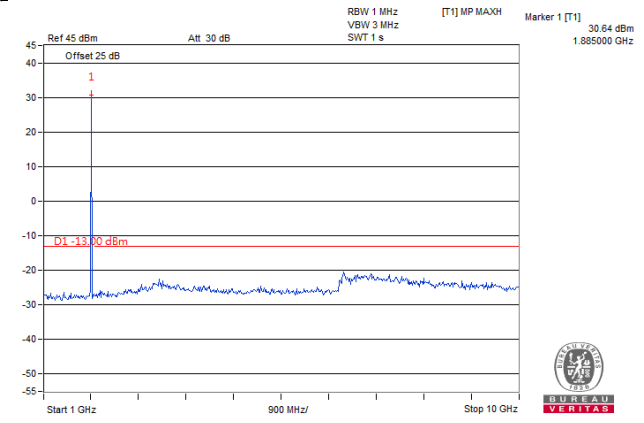
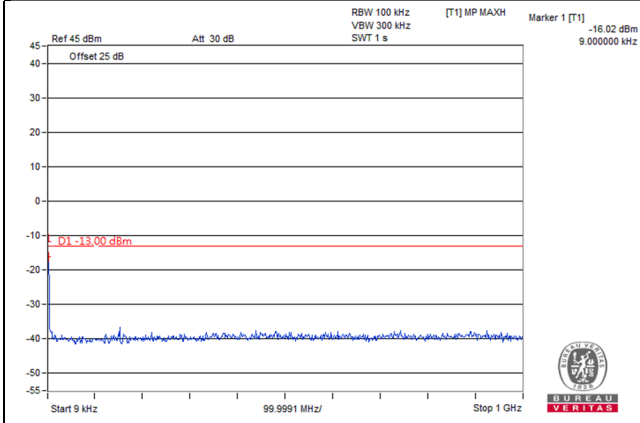

Frequency Range : 10GHz~26.5GHz

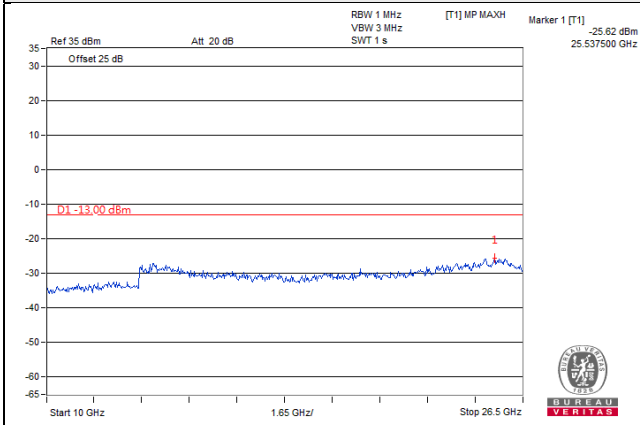



PCS

Channel 810 (1909.8MHz)

Frequency Range : 9kHz~1GHz

Frequency Range : 1GHz~10GHz

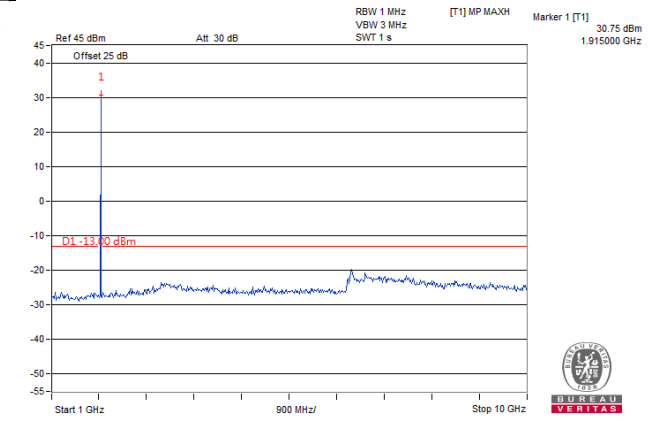
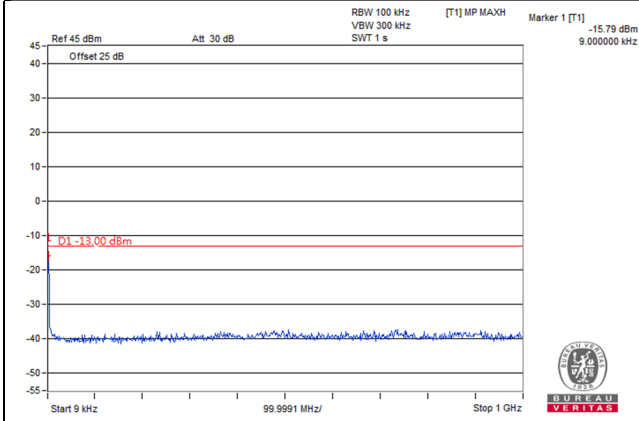

Frequency Range : 10GHz~26.5GHz

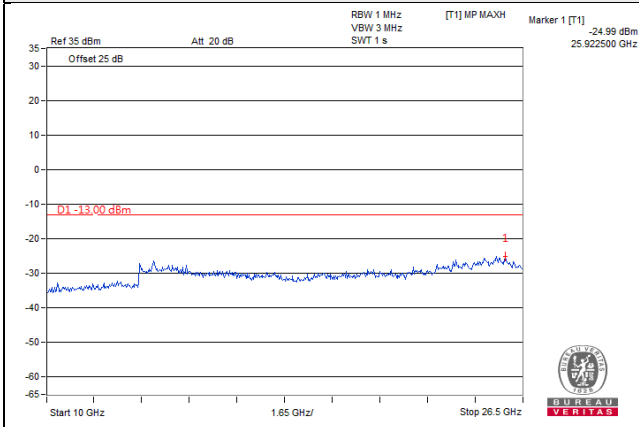

**EDGE**

**Channel 512 (1850.2MHz)**

**Frequency Range : 9kHz~1GHz**

**Frequency Range : 1GHz~10GHz**

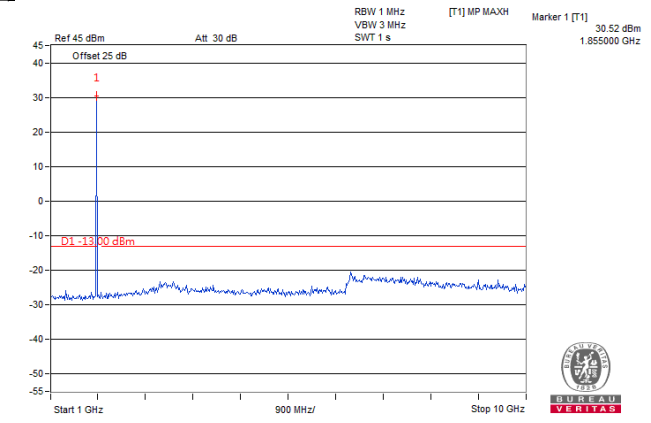
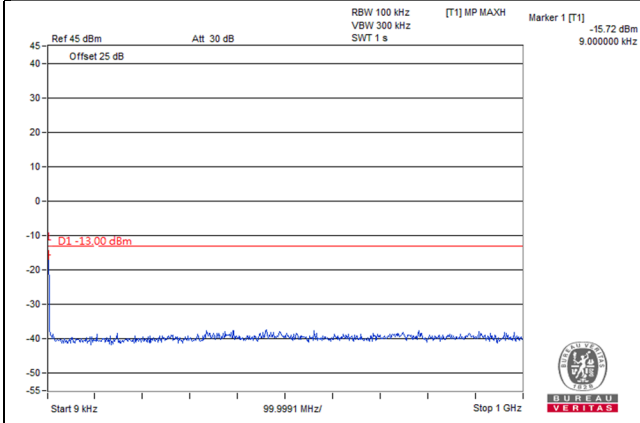

**Frequency Range : 10GHz~26.5GHz**

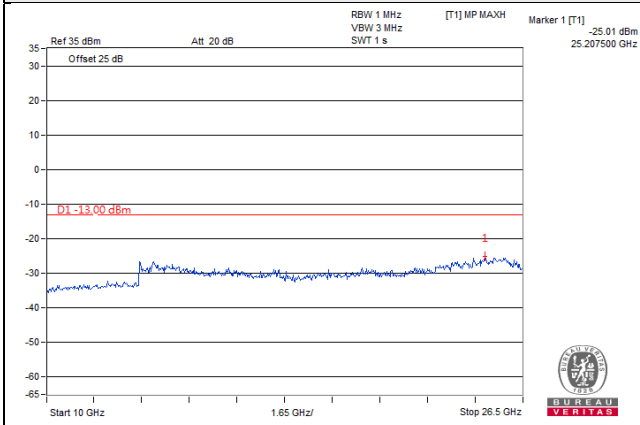

**EDGE**

Channel 661 (1880.0MHz)

Frequency Range : 9kHz~1GHz

Frequency Range : 1GHz~10GHz

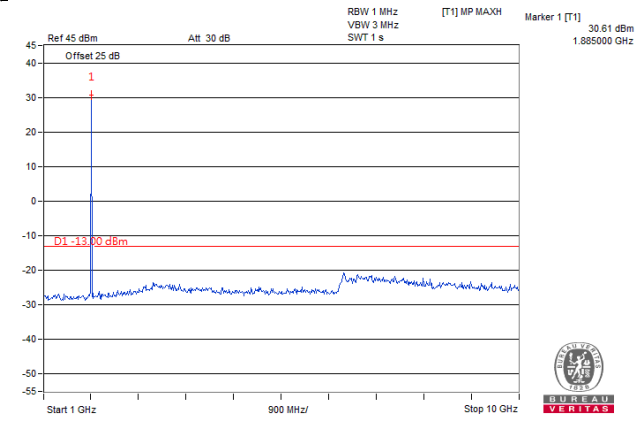
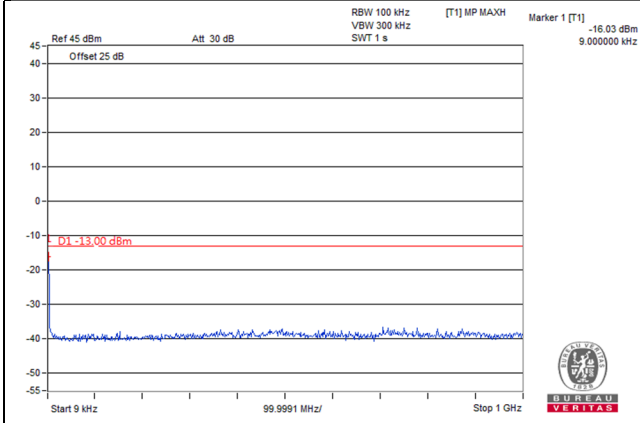

Frequency Range : 10GHz~26.5GHz

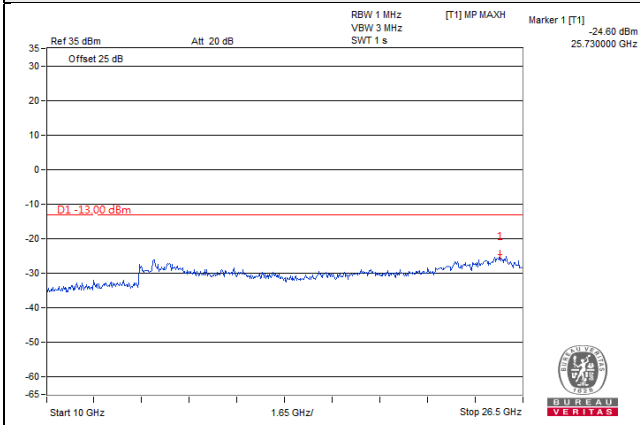

**EDGE**

**Channel 810 (1909.8MHz)**

**Frequency Range : 9kHz~1GHz**

**Frequency Range : 1GHz~10GHz**

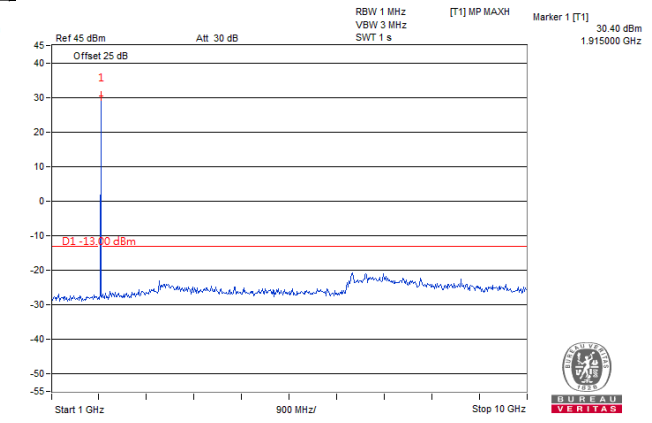
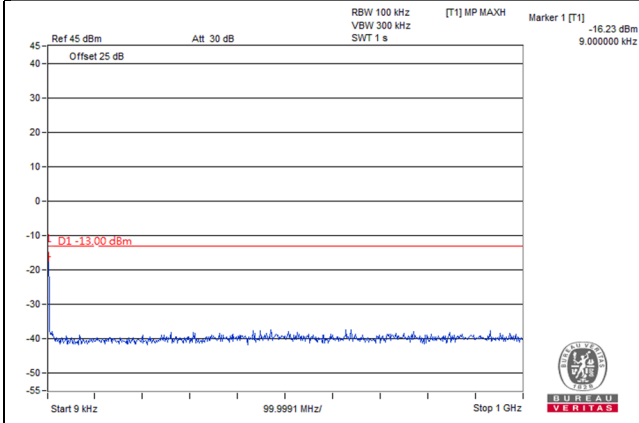

**Frequency Range : 10GHz~26.5GHz**

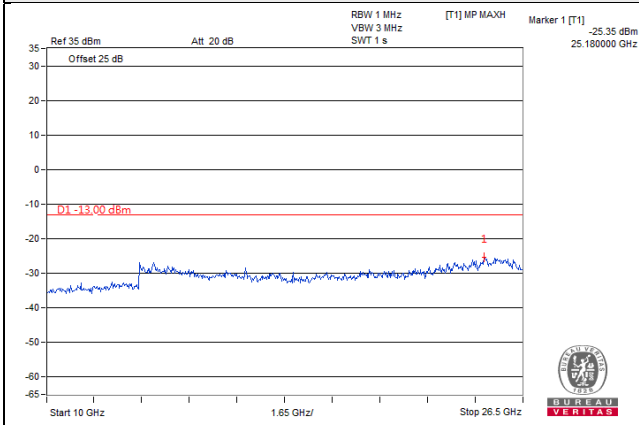

**WCDMA**

**Channel 9262 (1852.4MHz)**

**Frequency Range : 9kHz~1GHz**

**Frequency Range : 1GHz~10GHz**

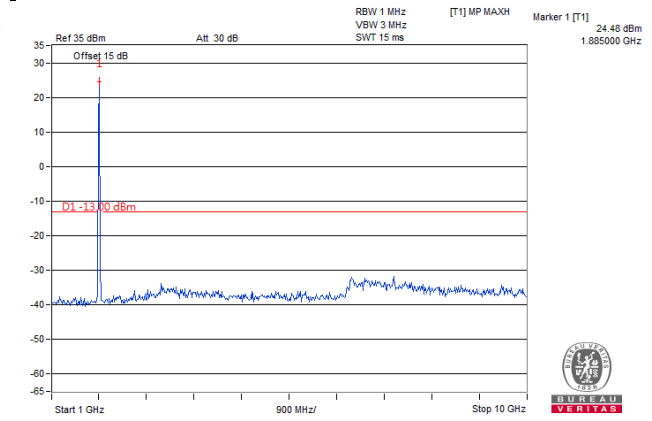
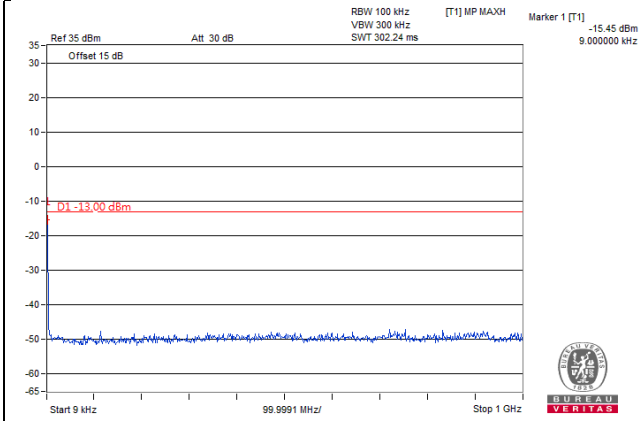

**Frequency Range : 10GHz~26.5GHz**

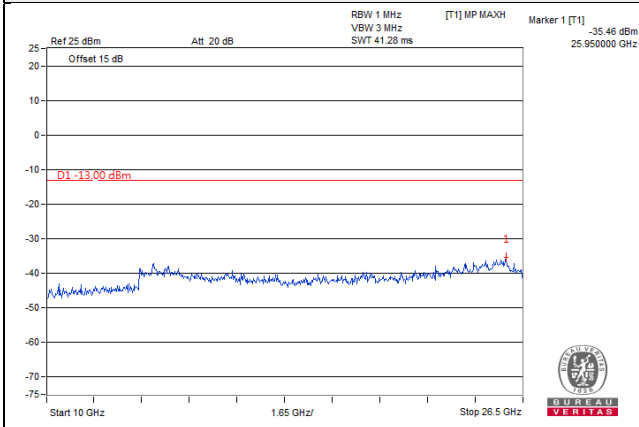

**WCDMA**

**Channel 9400 (1880.0MHz)**

**Frequency Range : 9kHz~1GHz**

**Frequency Range : 1GHz~10GHz**

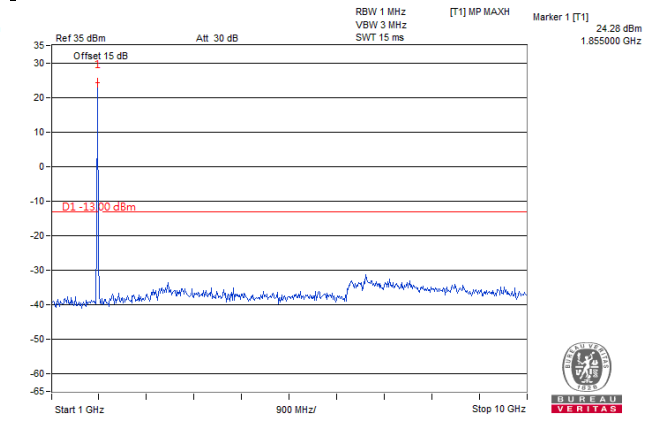
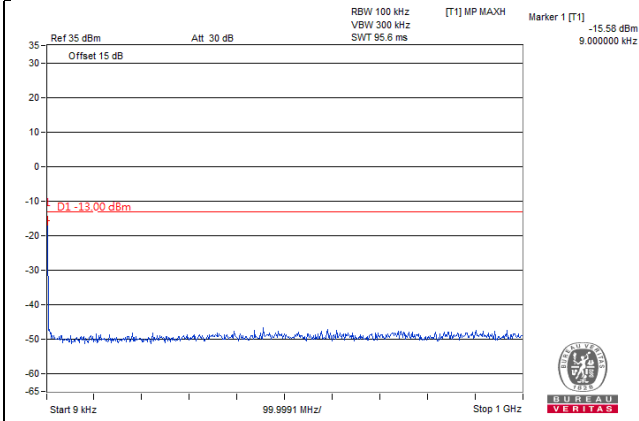

**Frequency Range : 10GHz~26.5GHz**

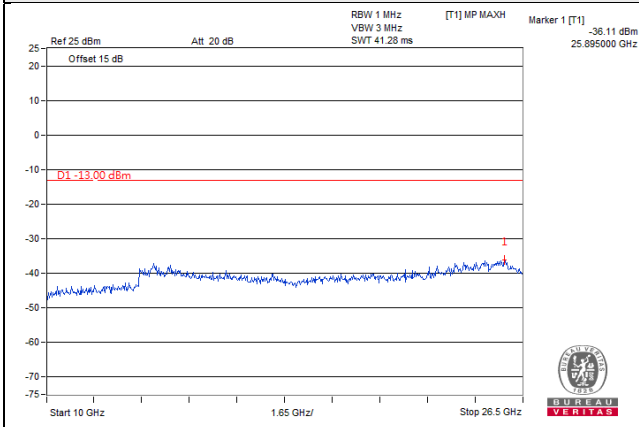

WCDMA

Channel 9538 (1907.6MHz)

Frequency Range : 9kHz~1GHz

Frequency Range : 1GHz~10GHz

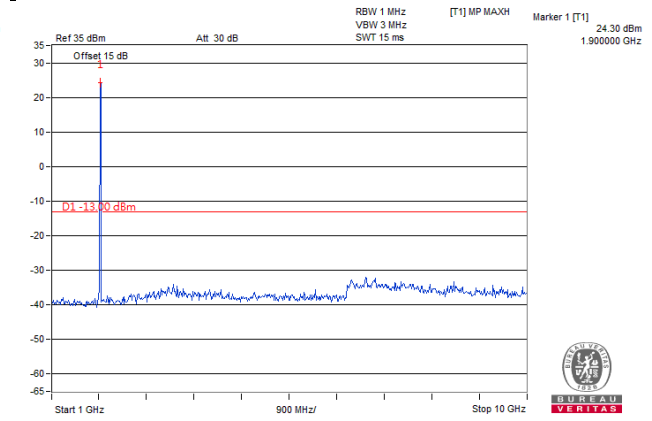
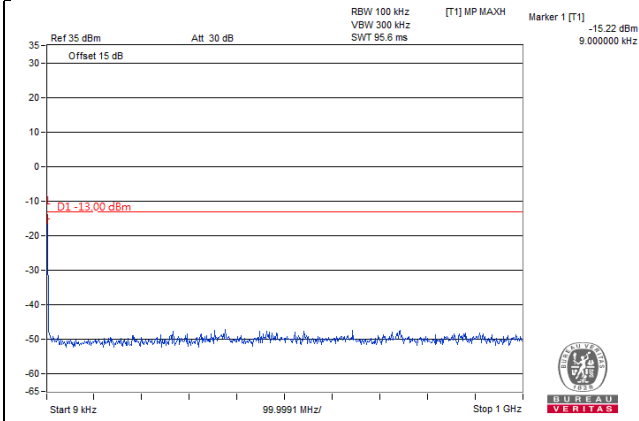

Frequency Range : 10GHz~26.5GHz

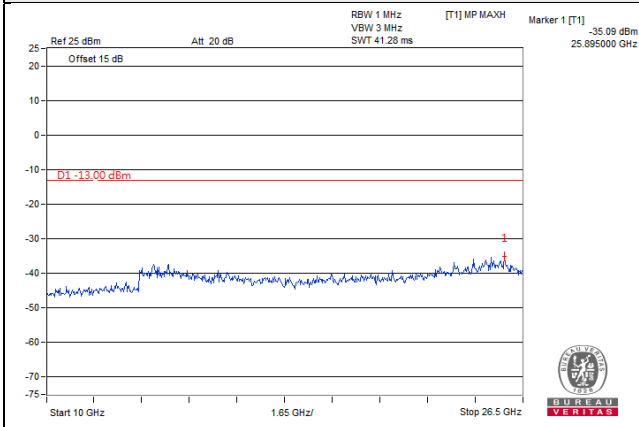

LTE Band 2, Channel Bandwidth 1.4MHz

Channel 18607 (1850.70MHz)

Frequency Range : 9kHz~1GHz

Frequency Range : 1GHz~10GHz

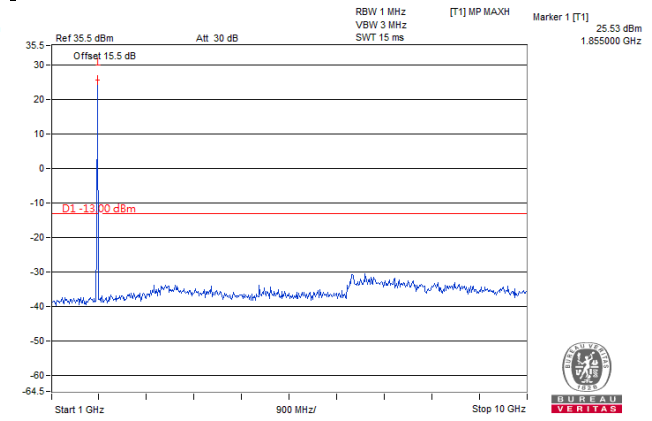
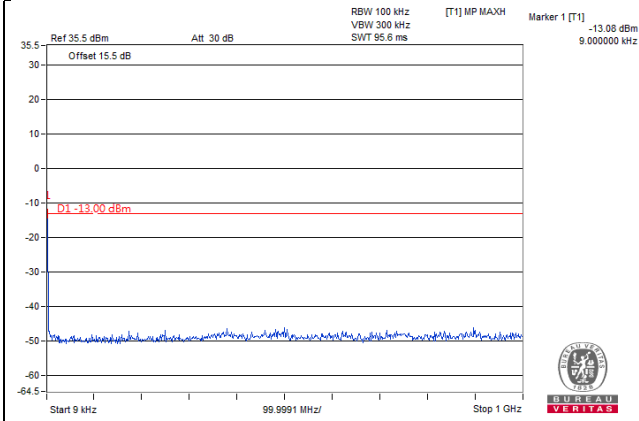

Frequency Range : 10GHz~26.5GHz

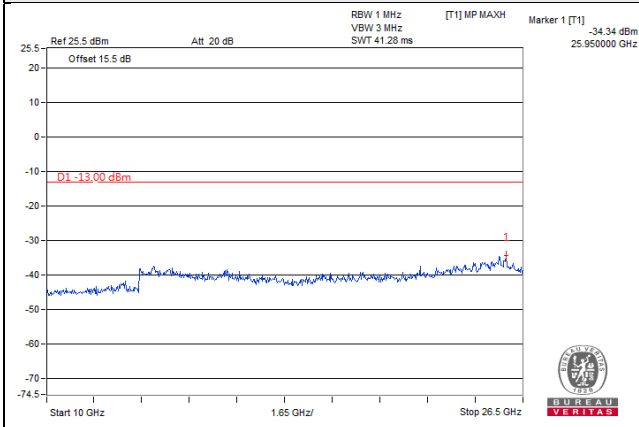



LTE Band 2, Channel Bandwidth 1.4MHz

Channel 18900 (1880.00MHz)

Frequency Range : 9kHz~1GHz

Frequency Range : 1GHz~10GHz

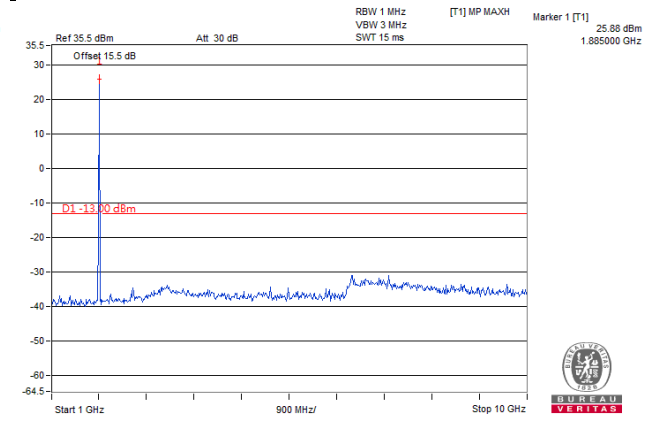
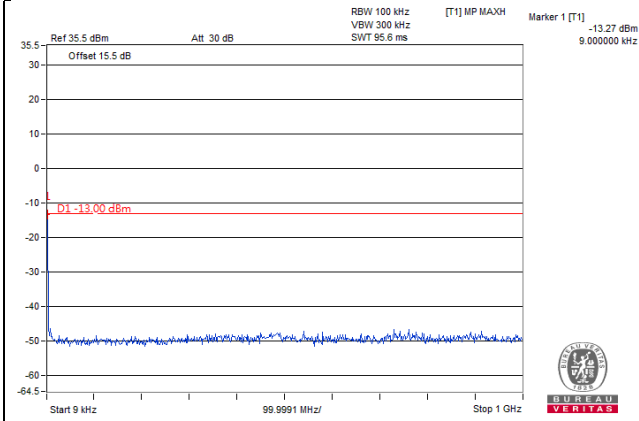

Frequency Range : 10GHz~26.5GHz

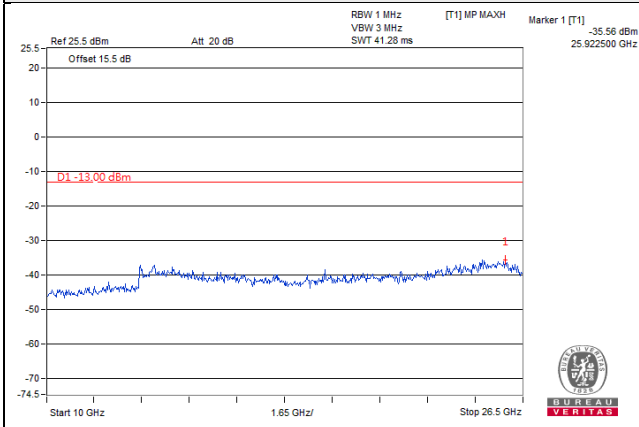

LTE Band 2, Channel Bandwidth 1.4MHz

Channel 19193 (1909.30MHz)

Frequency Range : 9kHz~1GHz

Frequency Range : 1GHz~10GHz

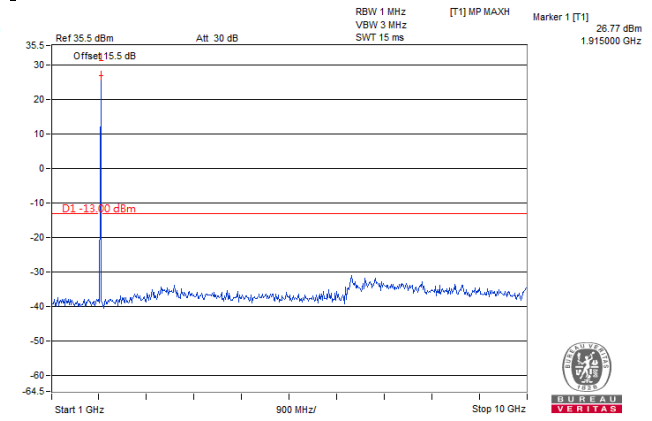
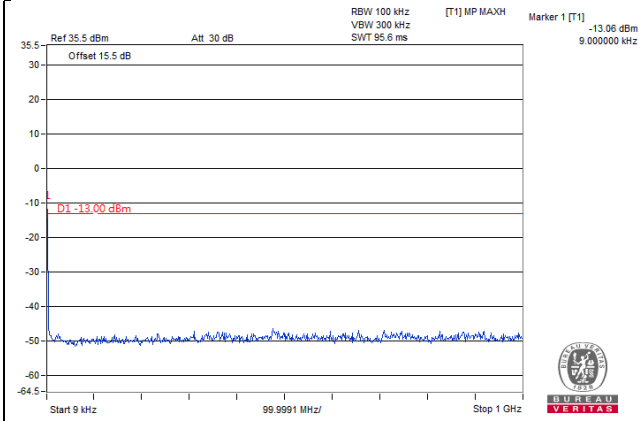

Frequency Range : 10GHz~26.5GHz

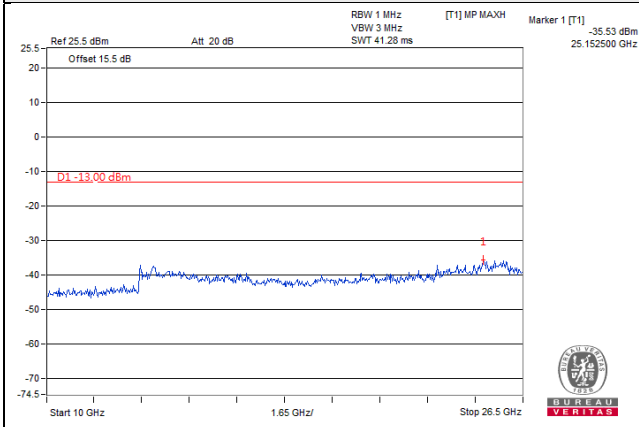

LTE Band 2, Channel Bandwidth 3MHz

Channel 18615 (1851.50MHz)

Frequency Range : 9kHz~1GHz

Frequency Range : 1GHz~10GHz

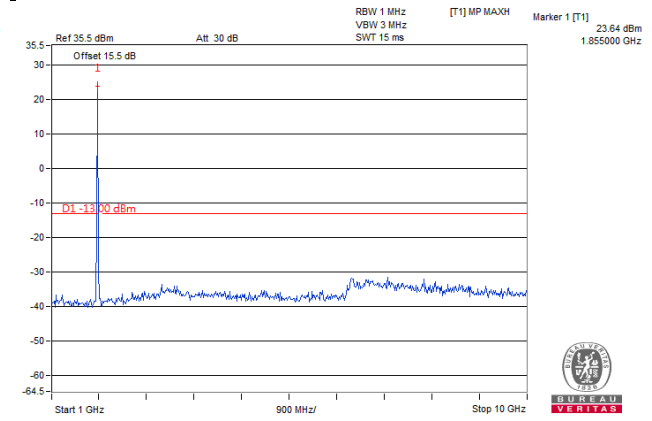
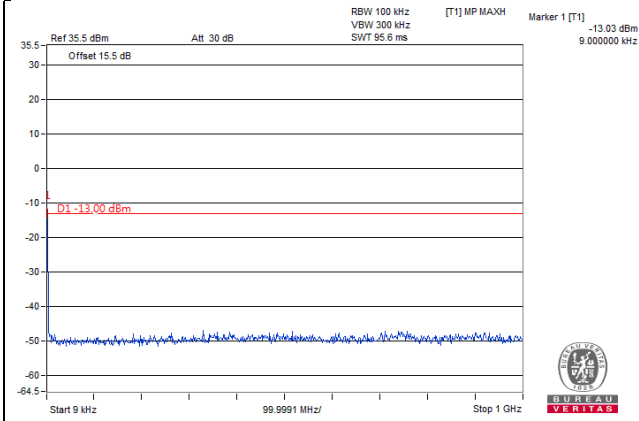

Frequency Range : 10GHz~26.5GHz

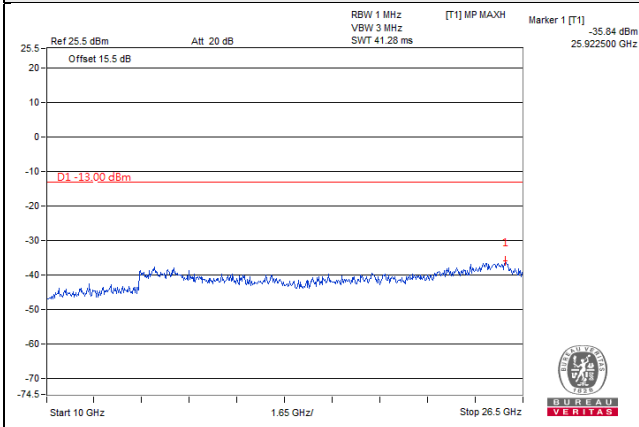

LTE Band 2, Channel Bandwidth 3MHz

Channel 18900 (1880.00MHz)

Frequency Range : 9kHz~1GHz

Frequency Range : 1GHz~10GHz

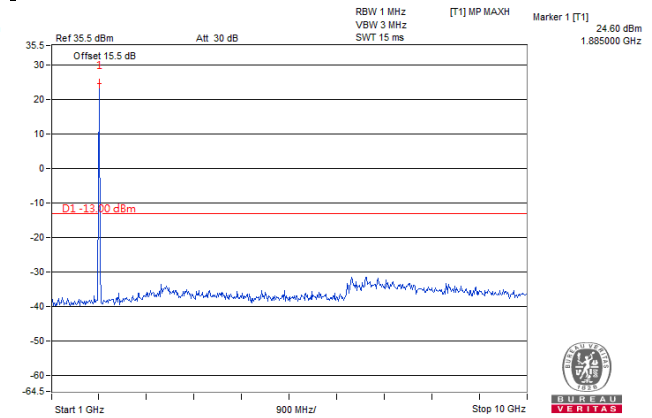
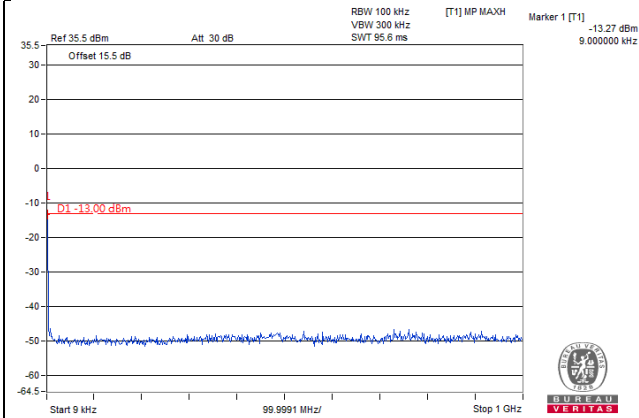

Frequency Range : 10GHz~26.5GHz

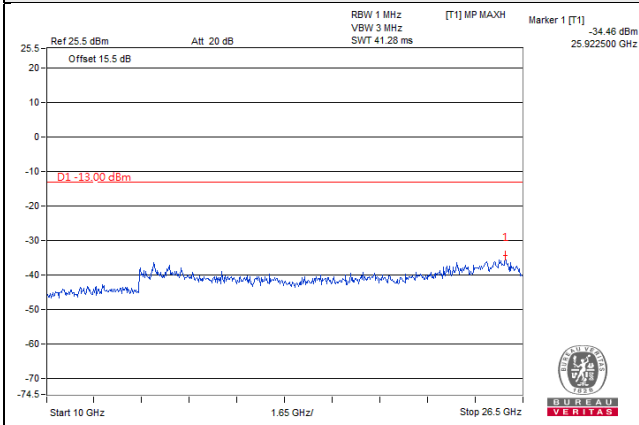

LTE Band 2, Channel Bandwidth 3MHz

Channel 19185 (1908.50MHz)

Frequency Range : 9kHz~1GHz

Frequency Range : 1GHz~10GHz

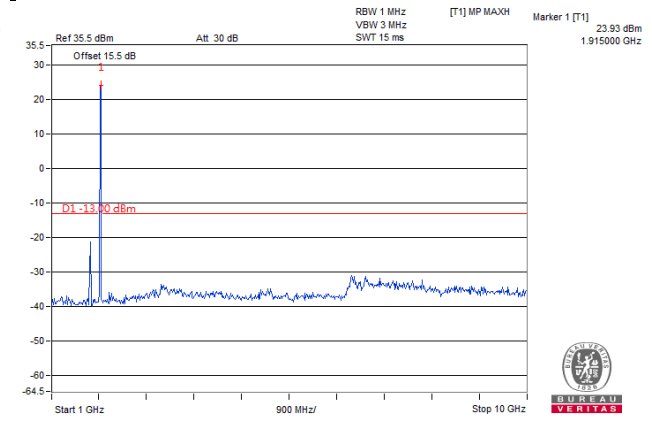
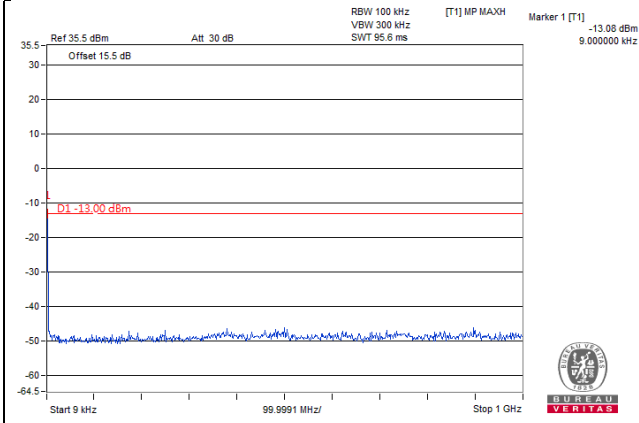

Frequency Range : 10GHz~26.5GHz

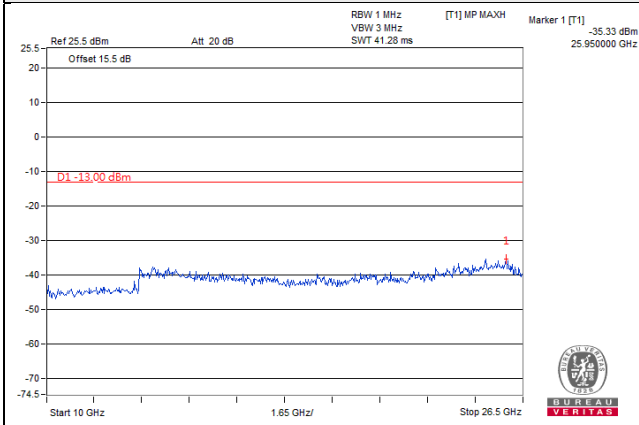

LTE Band 2, Channel Bandwidth 5MHz

Channel 18625 (1852.50MHz)

Frequency Range : 9kHz~1GHz

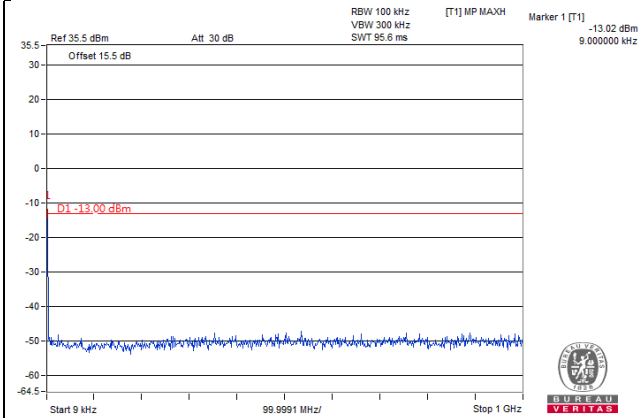

Frequency Range : 1GHz~10GHz

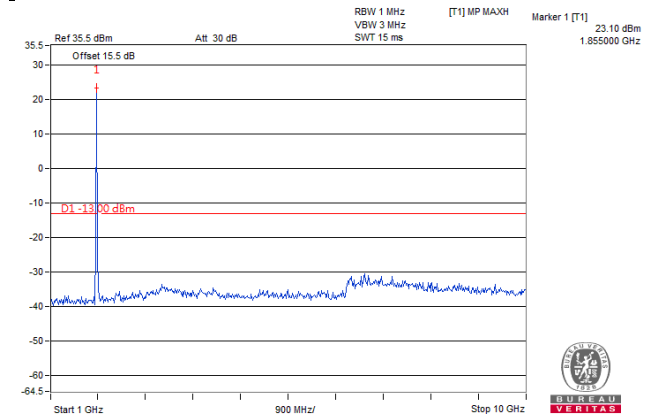

Frequency Range : 10GHz~26.5GHz

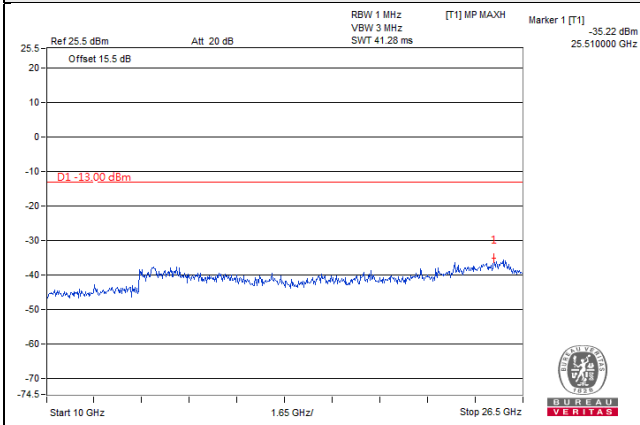

LTE Band 2, Channel Bandwidth 5MHz

Channel 18900 (1880.00MHz)

Frequency Range : 9kHz~1GHz

Frequency Range : 1GHz~10GHz

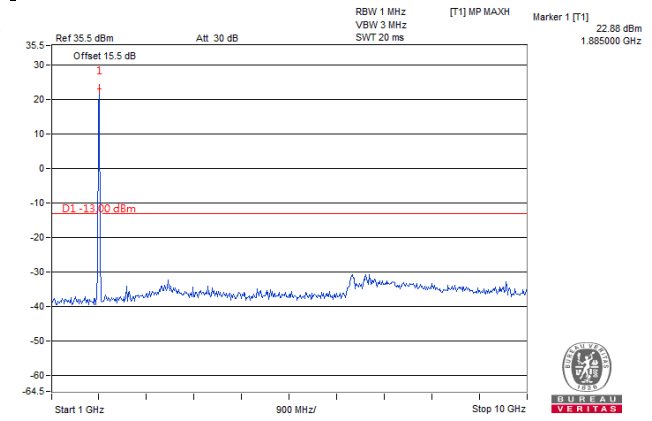
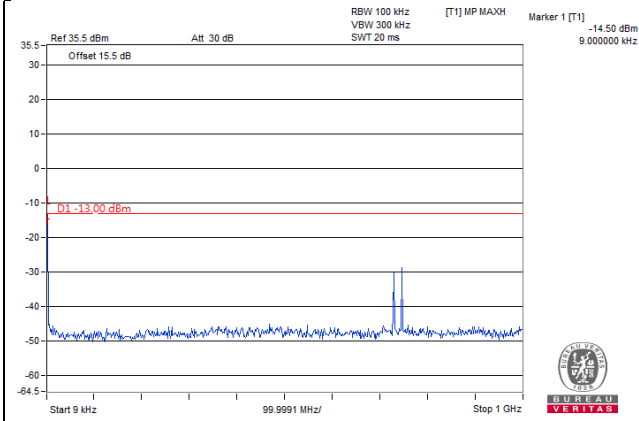

Frequency Range : 10GHz~26.5GHz

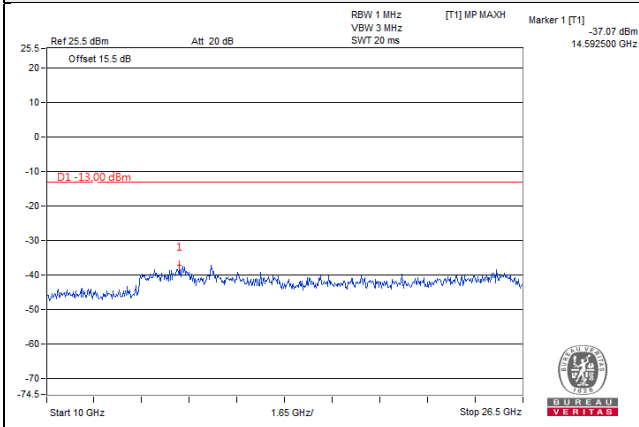

LTE Band 2, Channel Bandwidth 5MHz

Channel 19175 (1907.50MHz)

Frequency Range : 9kHz~1GHz

Frequency Range : 1GHz~10GHz

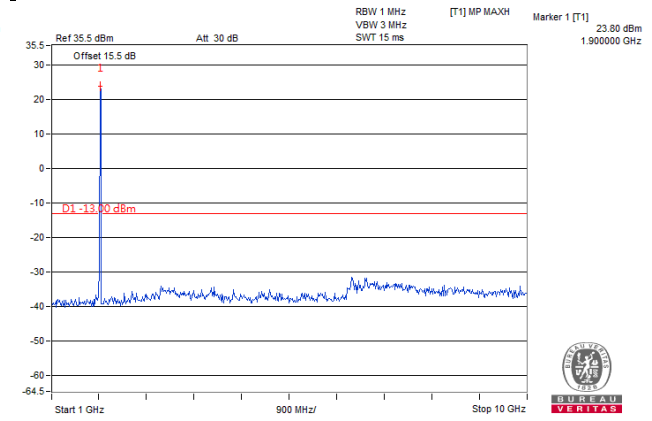
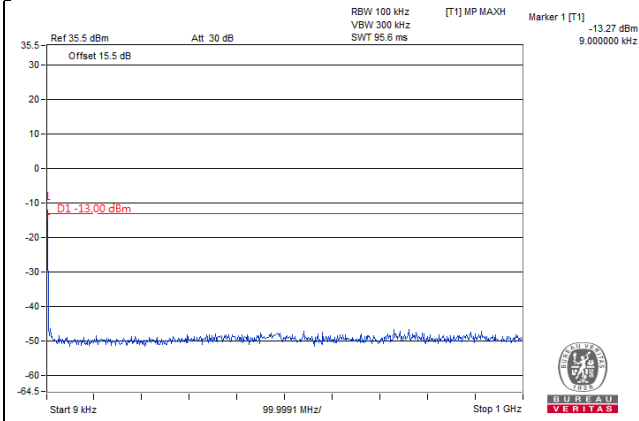

Frequency Range : 10GHz~26.5GHz

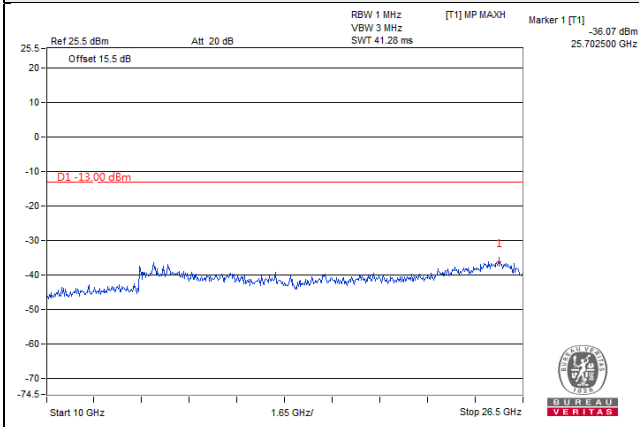



LTE Band 2, Channel Bandwidth 10MHz

Channel 18650 (1855.00MHz)

Frequency Range : 9kHz~1GHz

Frequency Range : 1GHz~10GHz

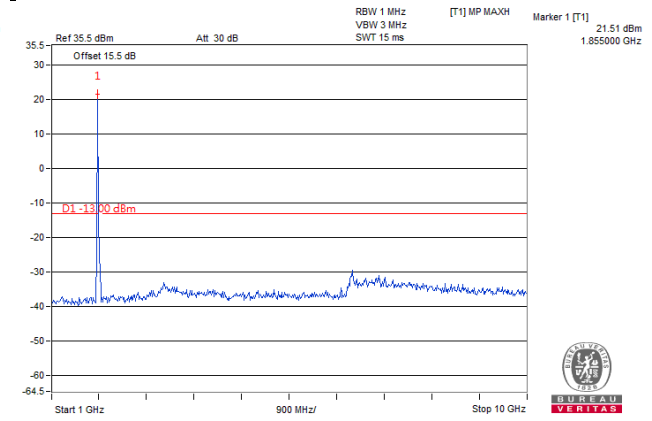
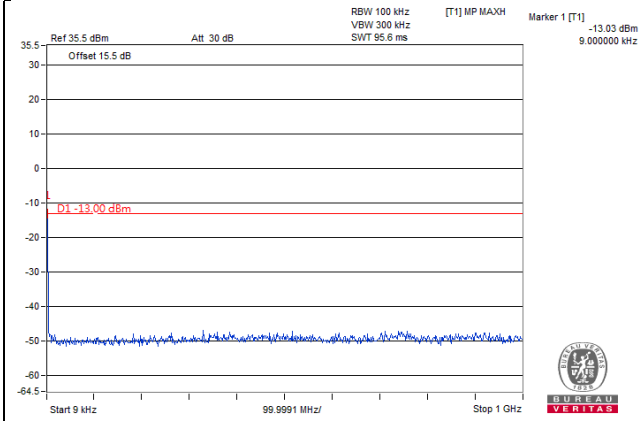

Frequency Range : 10GHz~26.5GHz

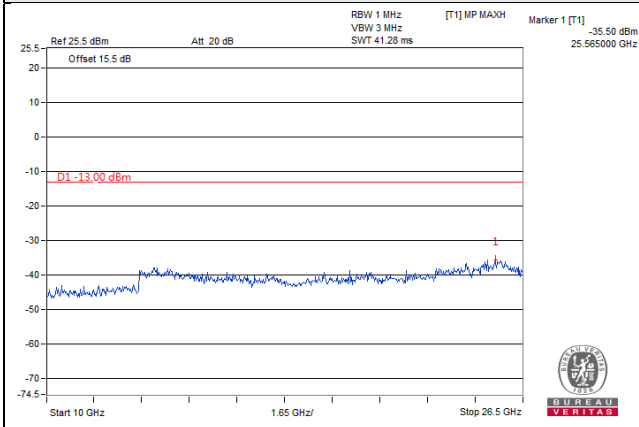

LTE Band 2, Channel Bandwidth 10MHz

Channel 18900 (1880.00MHz)

Frequency Range : 9kHz~1GHz

Frequency Range : 1GHz~10GHz

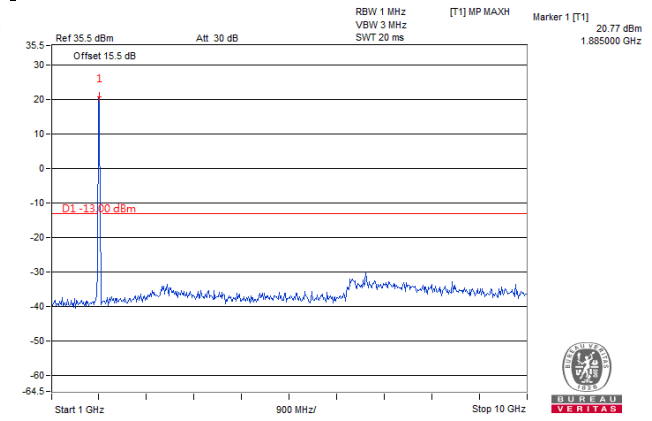
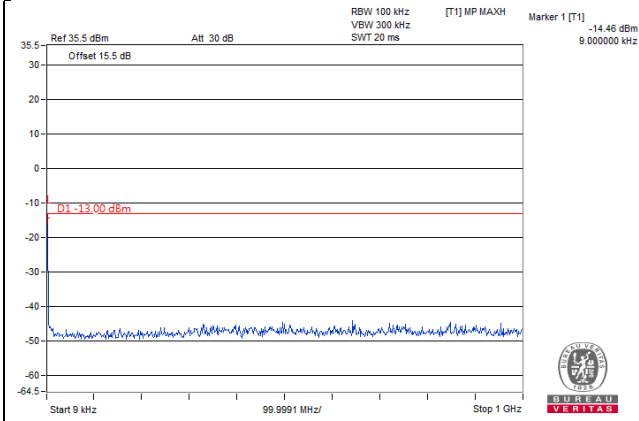

Frequency Range : 10GHz~26.5GHz

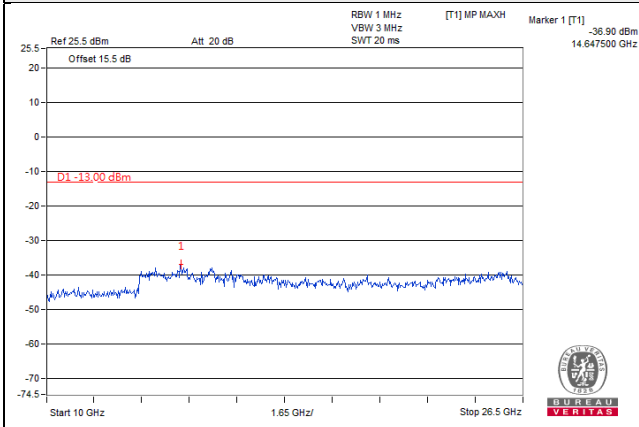

LTE Band 2, Channel Bandwidth 10MHz

Channel 19150 (1905.00MHz)

Frequency Range : 9kHz~1GHz

Frequency Range : 1GHz~10GHz

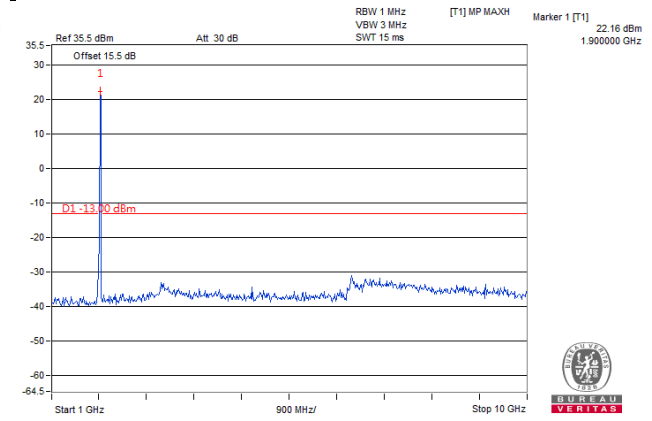
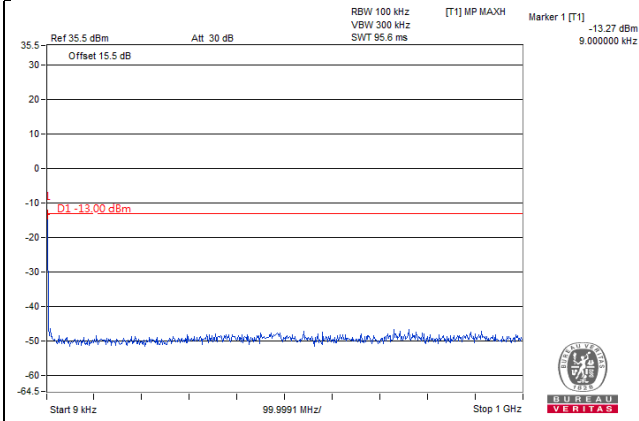

Frequency Range : 10GHz~26.5GHz

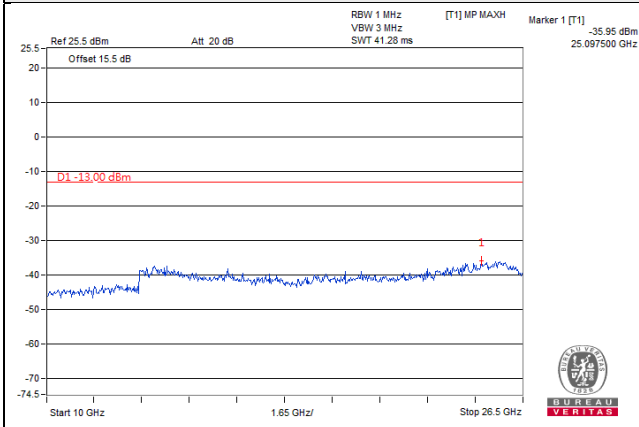

LTE Band 2, Channel Bandwidth 15MHz

Channel 18675 (1857.50MHz)

Frequency Range : 9kHz~1GHz

Frequency Range : 1GHz~10GHz

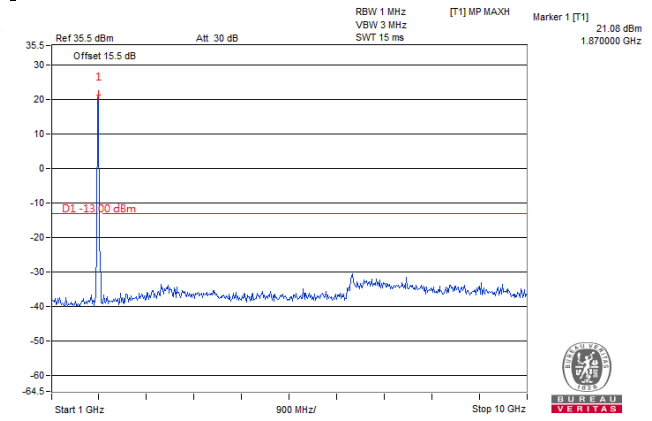
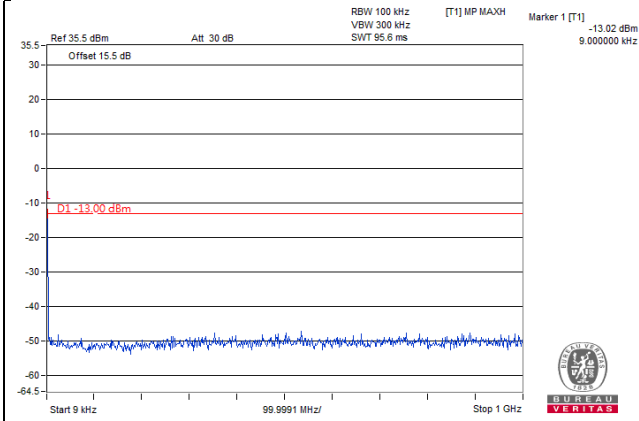

Frequency Range : 10GHz~26.5GHz

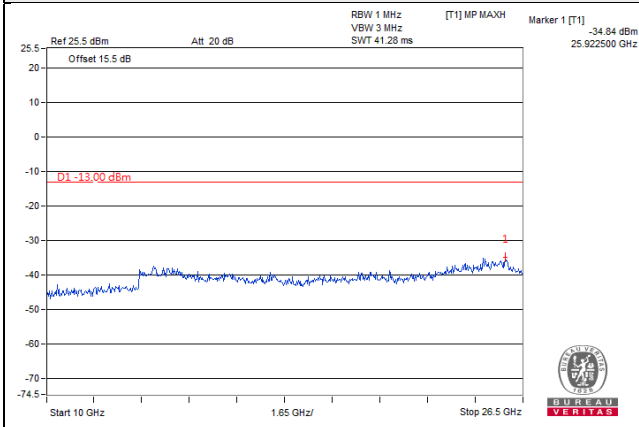

LTE Band 2, Channel Bandwidth 15MHz

Channel 18900 (1880.00MHz)

Frequency Range : 9kHz~1GHz

Frequency Range : 1GHz~10GHz

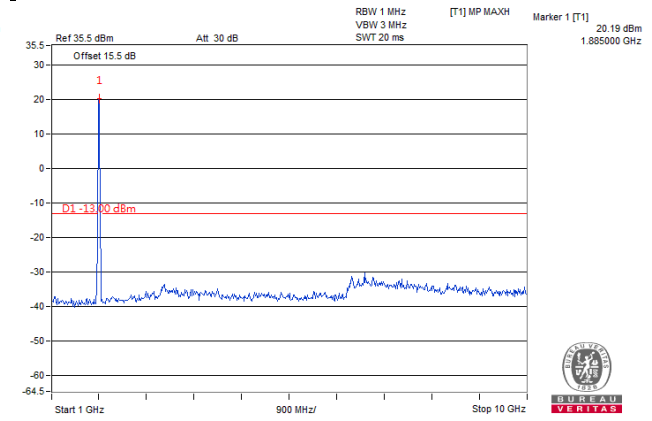
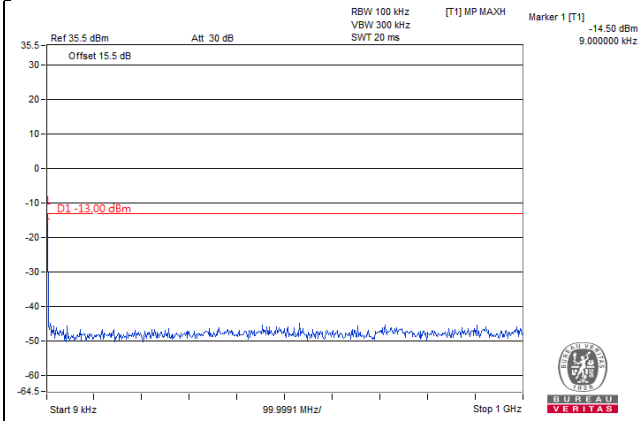

Frequency Range : 10GHz~26.5GHz

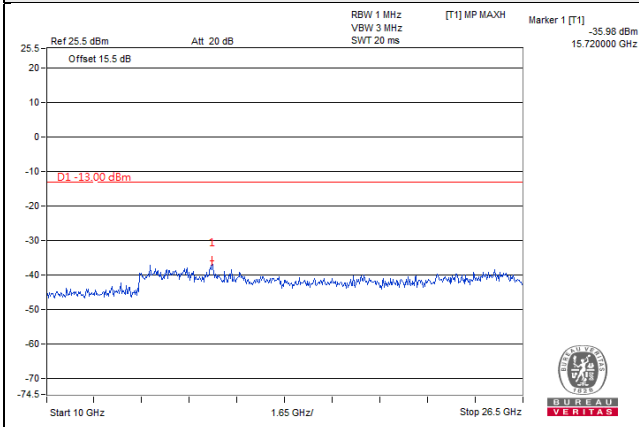

LTE Band 2, Channel Bandwidth 15MHz

Channel 19125 (1902.50MHz)

Frequency Range : 9kHz~1GHz

Frequency Range : 1GHz~10GHz

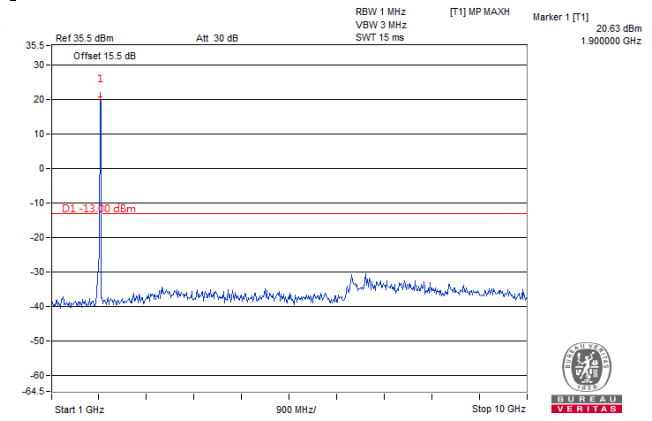
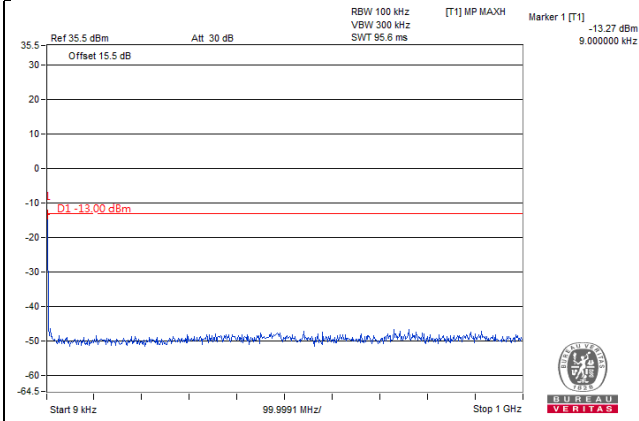

Frequency Range : 10GHz~26.5GHz

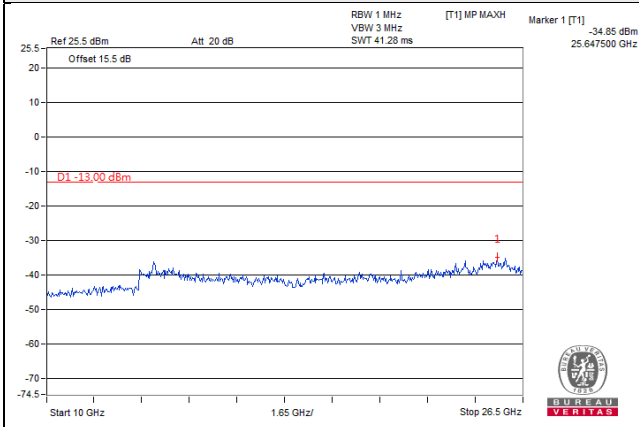

LTE Band 2, Channel Bandwidth 20MHz

Channel 18700 (1860.00MHz)

Frequency Range : 9kHz~1GHz

Frequency Range : 1GHz~10GHz

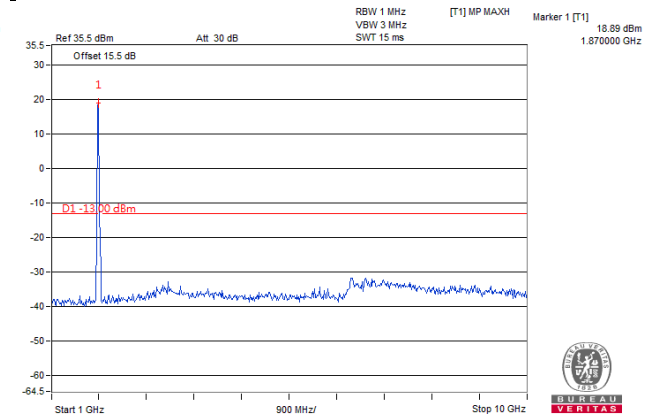
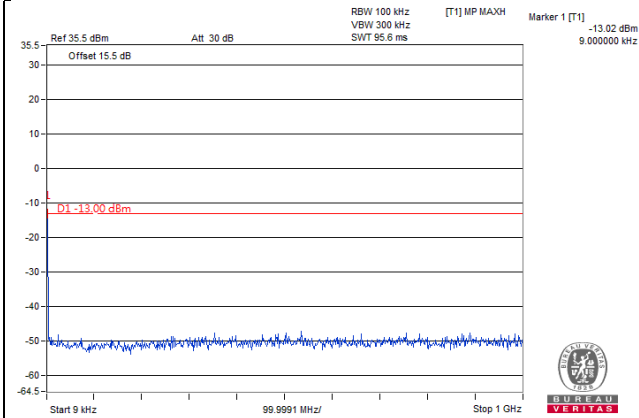

Frequency Range : 10GHz~26.5GHz

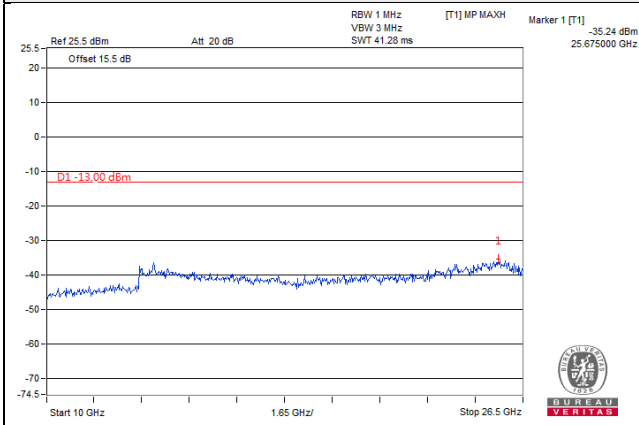

LTE Band 2, Channel Bandwidth 20MHz

Channel 18900 (1880.00MHz)

Frequency Range : 9kHz~1GHz

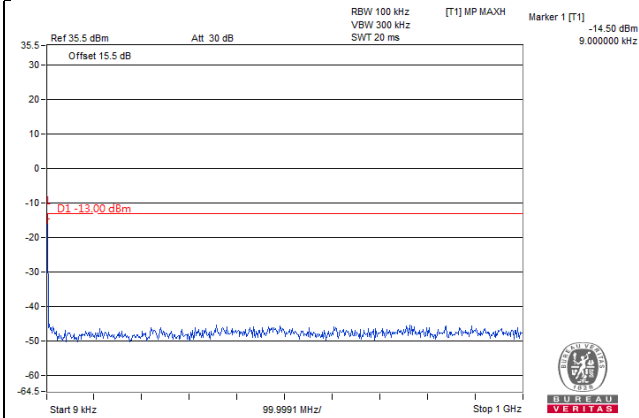

Frequency Range : 1GHz~10GHz

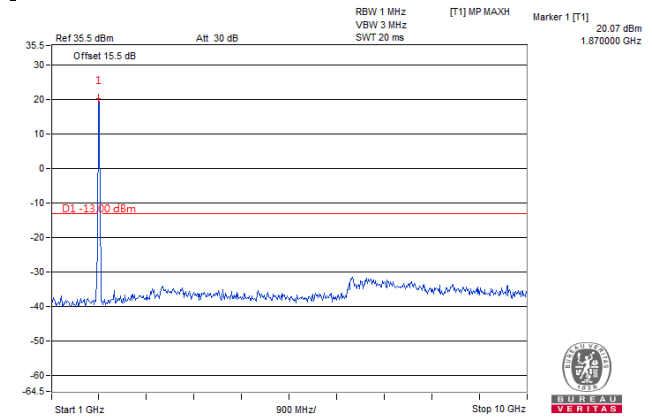

Frequency Range : 10GHz~26.5GHz

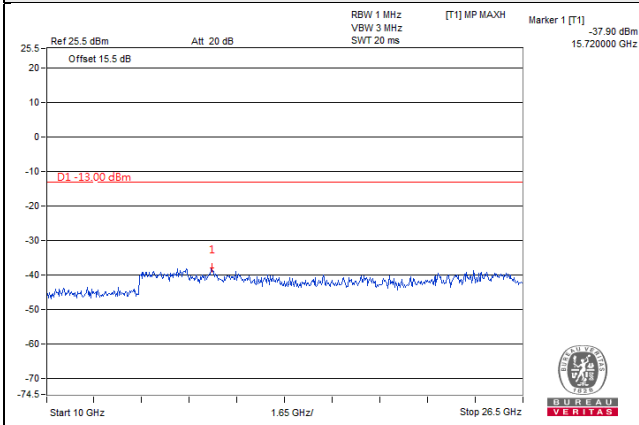



LTE Band 2, Channel Bandwidth 20MHz

Channel 19100 (1900.00MHz)

Frequency Range : 9kHz~1GHz

Frequency Range : 1GHz~10GHz

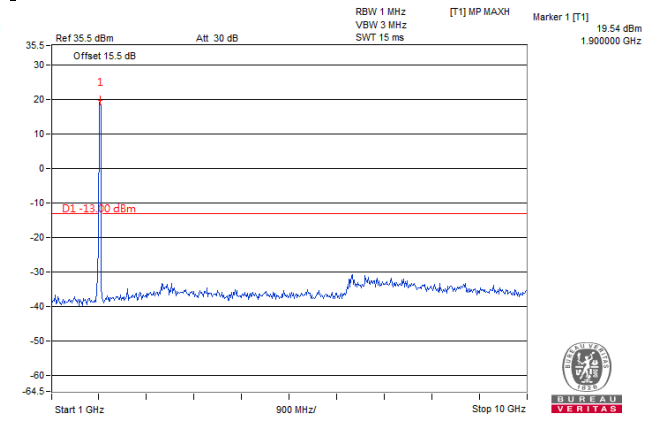
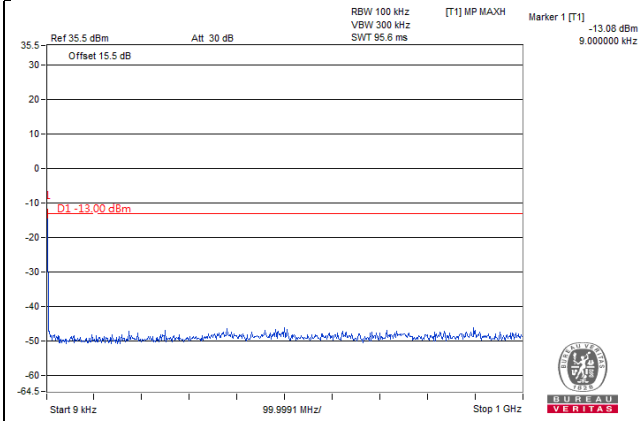

Frequency Range : 10GHz~26.5GHz

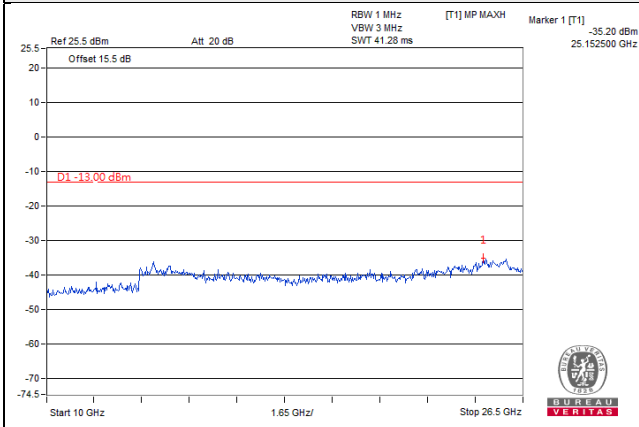

## 4.8 Radiated Emission Measurement

### 4.8.1 Limits of Radiated Emission Measurement

The power of any emission outside of the authorized operating frequency ranges must be attenuated below the transmitting power (P) by a factor of at least  $43 + 10 \log(P)$  dB. The emission limit equal to  $-13\text{dBm}$ .

### 4.8.2 Test Procedure

- a. Substitution method is used for E.I.R.P measurement. In the semi-anechoic chamber, EUT placed on the 0.8m height of Turn Table, rotated the table around 360 degrees to search the maximum radiation power and receiver antenna shall be rotated vertical and horizontal polarization and moved height from 1m to 4m to find the maximum polar radiated power. The "Read Value" is the spectrum reading the maximum power value.
- b. The substitution horn antenna is substituted for EUT at the same position and signals generator export the CW signal to the substitution antenna via a TX cable. Rotated the Turn Table and moved receiving antenna to find the maximum radiation power. Adjust output power level of S.G to get a Value of spectrum reading equal to "Read Value" of step a. Record the power level of S.G
- c.  $\text{EIRP} = \text{Output power level of S.G} - \text{TX cable loss} + \text{Antenna gain of substitution horn}$ .
- d. E.R.P power can be calculated form E.I.R.P power by subtracting the gain of dipole,  $\text{E.R.P power} = \text{E.I.R.P power} - 2.15\text{dBi}$ .

NOTE: The resolution bandwidth and video bandwidth of test receiver/spectrum analyzer is 1MHz/3MHz.

### 4.8.3 Deviation from Test Standard

No deviation.

#### 4.8.4 Test Setup

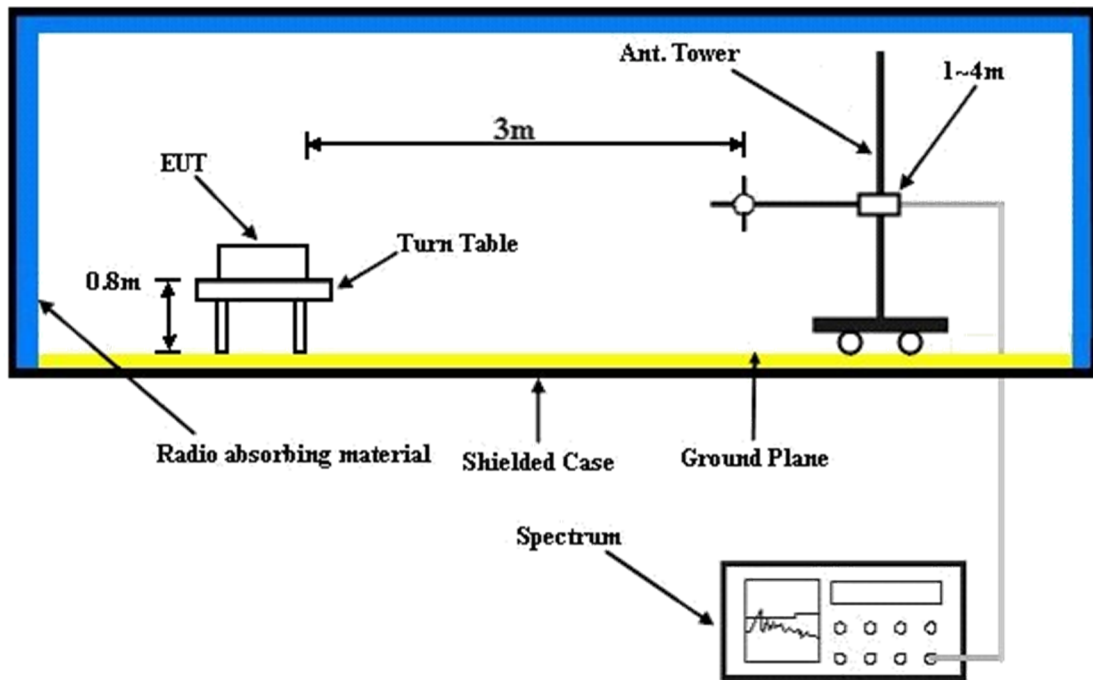

For the actual test configuration, please refer to the attached file (Test Setup Photo).

#### 4.8.5 Test Results

Below 1GHz  
PCS Mode

Mode	TX channel 512 (1850.2MHz)	Frequency Range	Below 1000 MHz
Environmental Conditions	22deg. C, 66%RH	Input Power	120Vac, 60Hz
Tested By	Han Wu		

Antenna Polarity & Test Distance: Horizontal at 3 M							
No.	Freq. (MHz)	Reading (dBm)	S.G Power Value (dBm)	Correction Factor (dB)	EIRP (dBm)	Limit (dBm)	Margin (dB)
1	70.74	-61.6	-67.4	-0.4	-67.8	-13.0	-54.8
2	108.57	-53.7	-59.2	-2.4	-61.6	-13.0	-48.6
3	235.64	-55.6	-61.3	-1.5	-62.8	-13.0	-49.8
4	401.51	-63.1	-67.1	3.3	-63.8	-13.0	-50.8
5	550.89	-64.7	-68.1	3.8	-64.3	-13.0	-51.3
6	674.08	-63.9	-64.8	3.6	-61.2	-13.0	-48.2
Antenna Polarity & Test Distance: Vertical at 3 M							
No.	Freq. (MHz)	Reading (dBm)	S.G Power Value (dBm)	Correction Factor (dB)	EIRP (dBm)	Limit (dBm)	Margin (dB)
1	34.85	-44.5	-38.2	-16.5	-54.7	-13.0	-41.7
2	91.11	-52.9	-59.1	-0.4	-59.5	-13.0	-46.5
3	145.43	-65.3	-64.2	-3.1	-67.3	-13.0	-54.3
4	267.65	-65.7	-62.6	-1.6	-64.2	-13.0	-51.2
5	389.87	-63.9	-67.9	3.4	-64.5	-13.0	-51.5
6	538.28	-65.6	-68.2	3.8	-64.4	-13.0	-51.4

Remarks:

- Output Power (dBm) = S.G Value (dBm) + Correction Factor (dB).
- Correction Factor (dB) = Substitution Antenna Gain (dB) + Cable Loss (dB).

EDGE Mode

Mode	TX channel 512 (1850.2MHz)	Frequency Range	Below 1000 MHz
Environmental Conditions	22deg. C, 66%RH	Input Power	120Vac, 60Hz
Tested By	Han Wu		

Antenna Polarity & Test Distance: Horizontal at 3 M							
No.	Freq. (MHz)	Reading (dBm)	S.G Power Value (dBm)	Correction Factor (dB)	EIRP (dBm)	Limit (dBm)	Margin (dB)
1	60.07	-62.9	-64.3	-3.4	-67.7	-13.0	-54.7
2	139.61	-53.1	-55.8	-3.1	-58.9	-13.0	-45.9
3	385.02	-60.7	-65.1	3.5	-61.6	-13.0	-48.6
4	736.16	-62.3	-61.9	3.7	-58.2	-13.0	-45.2
5	826.37	-66.9	-64.0	3.9	-60.1	-13.0	-47.1
6	945.68	-65.8	-61.3	3.8	-57.5	-13.0	-44.5
Antenna Polarity & Test Distance: Vertical at 3 M							
No.	Freq. (MHz)	Reading (dBm)	S.G Power Value (dBm)	Correction Factor (dB)	EIRP (dBm)	Limit (dBm)	Margin (dB)
1	60.07	-53.9	-57.3	-3.4	-60.7	-13.0	-47.7
2	112.45	-61.4	-66.3	-2.5	-68.8	-13.0	-55.8
3	199.75	-63.9	-62.6	-2.4	-65.0	-13.0	-52.0
4	316.15	-62.8	-66.8	4.0	-62.8	-13.0	-49.8
5	832.19	-60.8	-57.4	3.8	-53.6	-13.0	-40.6
6	932.10	-66.2	-61.1	3.7	-57.4	-13.0	-44.4

Remarks:

1. Output Power (dBm) = S.G Value (dBm) + Correction Factor (dB).
2. Correction Factor (dB) = Substitution Antenna Gain (dB) + Cable Loss (dB).

WCDMA Mode

Mode	TX channel 9262 (1852.4MHz)	Frequency Range	Below 1000 MHz
Environmental Conditions	22deg. C, 66%RH	Input Power	120Vac, 60Hz
Tested By	Han Wu		

Antenna Polarity & Test Distance: Horizontal at 3 M

No.	Freq. (MHz)	Reading (dBm)	S.G Power Value (dBm)	Correction Factor (dB)	EIRP (dBm)	Limit (dBm)	Margin (dB)
1	56.19	-65.9	-63.9	-5.1	-69.0	-13.0	-56.0
2	96.93	-49.7	-57.4	-1.2	-58.6	-13.0	-45.6
3	133.79	-56.1	-58.8	-3.3	-62.1	-13.0	-49.1
4	273.47	-59.2	-62.0	-1.6	-63.6	-13.0	-50.6
5	306.45	-55.7	-63.9	3.9	-60.0	-13.0	-47.0
6	426.73	-66.8	-70.7	3.5	-67.2	-13.0	-54.2

Antenna Polarity & Test Distance: Vertical at 3 M

No.	Freq. (MHz)	Reading (dBm)	S.G Power Value (dBm)	Correction Factor (dB)	EIRP (dBm)	Limit (dBm)	Margin (dB)
1	36.79	-50.6	-44.9	-15.2	-60.1	-13.0	-47.1
2	82.38	-46.8	-51.7	0.4	-51.3	-13.0	-38.3
3	152.22	-62.9	-62.0	-2.8	-64.8	-13.0	-51.8
4	255.04	-65.7	-63.9	-1.4	-65.3	-13.0	-52.3
5	410.24	-64.3	-68.1	3.3	-64.8	-13.0	-51.8
6	467.47	-66.0	-69.7	3.5	-66.2	-13.0	-53.2

Remarks:

1. Output Power (dBm) = S.G Value (dBm) + Correction Factor (dB).
2. Correction Factor (dB) = Substitution Antenna Gain (dB) + Cable Loss (dB).

LTE Band 2, Channel Bandwidth: 1.4MHz

Mode	TX channel 18607 (1850.70MHz)	Frequency Range	Below 1000 MHz
Environmental Conditions	25deg. C, 65%RH	Input Power	120Vac, 60Hz
Tested By	Greg Lin		

Antenna Polarity & Test Distance: Horizontal at 3 M

No.	Freq. (MHz)	Reading (dBm)	S.G Power Value (dBm)	Correction Factor (dB)	EIRP (dBm)	Limit (dBm)	Margin (dB)
1	30.00	-48.2	-24.8	-19.4	-44.2	-13.0	-31.2
2	80.44	-40.3	-45.7	0.5	-45.2	-13.0	-32.2
3	174.53	-49.0	-53.7	-2.8	-56.5	-13.0	-43.5
4	285.11	-53.3	-55.6	-1.6	-57.2	-13.0	-44.2
5	494.63	-59.2	-63.2	3.8	-59.4	-13.0	-46.4
6	722.58	-63.3	-63.5	3.6	-59.9	-13.0	-46.9

Antenna Polarity & Test Distance: Vertical at 3 M

No.	Freq. (MHz)	Reading (dBm)	S.G Power Value (dBm)	Correction Factor (dB)	EIRP (dBm)	Limit (dBm)	Margin (dB)
<b>1</b>	<b>31.94</b>	<b>-29.6</b>	<b>-21.8</b>	<b>-18.3</b>	<b>-40.1</b>	<b>-13.0</b>	<b>-27.1</b>
2	82.38	-40.4	-45.3	0.4	-44.9	-13.0	-31.9
3	164.83	-47.2	-47.5	-2.9	-50.4	-13.0	-37.4
4	296.75	-47.9	-46.3	-1.8	-48.1	-13.0	-35.1
5	655.65	-62.8	-60.9	3.6	-57.3	-13.0	-44.3
6	837.04	-65.8	-62.3	3.8	-58.5	-13.0	-45.5

Remarks:

1. Output Power (dBm) = S.G Value (dBm) + Correction Factor (dB).
2. Correction Factor (dB) = Substitution Antenna Gain (dB) + Cable Loss (dB).

LTE Band 2, Channel Bandwidth: 3MHz

Mode	TX channel 18615 (1851.50MHz)	Frequency Range	Below 1000 MHz
Environmental Conditions	25deg. C, 65%RH	Input Power	120Vac, 60Hz
Tested By	Greg Lin		

**Antenna Polarity & Test Distance: Horizontal at 3 M**

No.	Freq. (MHz)	Reading (dBm)	S.G Power Value (dBm)	Correction Factor (dB)	ERP (dBm)	Limit (dBm)	Margin (dB)
1	44.55	-44.5	-32.3	-10.9	-43.2	-13.0	-30.2
2	159.01	-48.1	-50.4	-2.8	-53.2	-13.0	-40.2
3	325.85	-52.9	-60.9	4.1	-56.8	-13.0	-43.8
4	409.27	-57.5	-61.0	3.2	-57.8	-13.0	-44.8
5	710.94	-61.9	-62.3	3.5	-58.8	-13.0	-45.8
6	978.66	-67.4	-62.1	3.5	-58.6	-13.0	-45.6

**Antenna Polarity & Test Distance: Vertical at 3 M**

No.	Freq. (MHz)	Reading (dBm)	S.G Power Value (dBm)	Correction Factor (dB)	ERP (dBm)	Limit (dBm)	Margin (dB)
1	42.61	-35.6	-32.5	-11.8	-44.3	-13.0	-31.3
2	87.23	-43.1	-49.2	-0.1	-49.3	-13.0	-36.3
3	187.14	-52.5	-52.2	-2.7	-54.9	-13.0	-41.9
4	295.78	-54.9	-53.1	-1.8	-54.9	-13.0	-41.9
5	494.63	-58.4	-62.3	3.8	-58.5	-13.0	-45.5
6	956.35	-68.6	-63.1	3.9	-59.2	-13.0	-46.2

Remarks:

1. Output Power (dBm) = S.G Value (dBm) + Correction Factor (dB).
2. Correction Factor (dB) = Substitution Antenna Gain (dB) + Cable Loss (dB).



LTE Band 2, Channel Bandwidth: 5MHz

Mode	TX channel 18625 (1852.50MHz)	Frequency Range	Below 1000 MHz
Environmental Conditions	25deg. C, 65%RH	Input Power	120Vac, 60Hz
Tested By	Greg Lin		

**Antenna Polarity & Test Distance: Horizontal at 3 M**

No.	Freq. (MHz)	Reading (dBm)	S.G Power Value (dBm)	Correction Factor (dB)	ERP (dBm)	Limit (dBm)	Margin (dB)
1	30.97	-48.0	-25.5	-18.8	-44.3	-13.0	-31.3
2	82.38	-38.5	-44.3	0.4	-43.9	-13.0	-30.9
3	162.89	-46.2	-49.1	-2.9	-52.0	-13.0	-39.0
4	296.75	-47.8	-48.8	-1.8	-50.6	-13.0	-37.6
5	705.12	-61.3	-61.8	3.5	-58.3	-13.0	-45.3
6	957.32	-66.1	-61.4	3.8	-57.6	-13.0	-44.6

**Antenna Polarity & Test Distance: Vertical at 3 M**

No.	Freq. (MHz)	Reading (dBm)	S.G Power Value (dBm)	Correction Factor (dB)	ERP (dBm)	Limit (dBm)	Margin (dB)
1	30.00	-35.2	-25.7	-19.4	-45.1	-13.0	-32.1
2	84.32	-40.7	-46.1	0.4	-45.7	-13.0	-32.7
3	296.75	-47.7	-46.1	-1.8	-47.9	-13.0	-34.9
4	654.68	-62.5	-60.5	3.6	-56.9	-13.0	-43.9
5	839.95	-66.5	-63.0	3.8	-59.2	-13.0	-46.2
6	956.35	-67.8	-62.3	3.9	-58.4	-13.0	-45.4

Remarks:

1. Output Power (dBm) = S.G Value (dBm) + Correction Factor (dB).
2. Correction Factor (dB) = Substitution Antenna Gain (dB) + Cable Loss (dB).

LTE Band 2, Channel Bandwidth: 10MHz

Mode	TX channel 18650 (1855.00MHz)	Frequency Range	Below 1000 MHz
Environmental Conditions	25deg. C, 65%RH	Input Power	120Vac, 60Hz
Tested By	Greg Lin		

Antenna Polarity & Test Distance: Horizontal at 3 M

No.	Freq. (MHz)	Reading (dBm)	S.G Power Value (dBm)	Correction Factor (dB)	ERP (dBm)	Limit (dBm)	Margin (dB)
1	30.00	-46.5	-23.1	-19.4	-42.5	-13.0	-29.5
2	84.32	-40.3	-46.7	0.4	-46.3	-13.0	-33.3
3	302.57	-51.6	-59.8	3.7	-56.1	-13.0	-43.1
4	450.01	-60.2	-63.7	3.4	-60.3	-13.0	-47.3
5	676.99	-61.9	-62.9	3.6	-59.3	-13.0	-46.3
6	922.40	-68.2	-63.7	3.6	-60.1	-13.0	-47.1

Antenna Polarity & Test Distance: Vertical at 3 M

No.	Freq. (MHz)	Reading (dBm)	S.G Power Value (dBm)	Correction Factor (dB)	ERP (dBm)	Limit (dBm)	Margin (dB)
1	81.41	-41.4	-46.5	0.5	-46.0	-13.0	-33.0
2	173.56	-49.7	-50.5	-2.8	-53.3	-13.0	-40.3
3	320.03	-57.3	-61.5	4.0	-57.5	-13.0	-44.5
4	679.90	-63.2	-61.1	3.5	-57.6	-13.0	-44.6
5	896.21	-66.5	-61.7	3.5	-58.2	-13.0	-45.2
6	994.18	-69.0	-62.3	3.4	-58.9	-13.0	-45.9

Remarks:

1. Output Power (dBm) = S.G Value (dBm) + Correction Factor (dB).
2. Correction Factor (dB) = Substitution Antenna Gain (dB) + Cable Loss (dB).

LTE Band 2, Channel Bandwidth: 15MHz

Mode	TX channel 18675 (1857.50MHz)	Frequency Range	Below 1000 MHz
Environmental Conditions	25deg. C, 65%RH	Input Power	120Vac, 60Hz
Tested By	Greg Lin		

Antenna Polarity & Test Distance: Horizontal at 3 M							
No.	Freq. (MHz)	Reading (dBm)	S.G Power Value (dBm)	Correction Factor (dB)	ERP (dBm)	Limit (dBm)	Margin (dB)
1	34.85	-52.5	-32.9	-16.5	-49.4	-13.0	-36.4
2	106.63	-47.3	-53.1	-2.2	-55.3	-13.0	-42.3
3	166.77	-45.5	-49.3	-2.9	-52.2	-13.0	-39.2
4	460.68	-58.8	-62.2	3.4	-58.8	-13.0	-45.8
5	709.00	-61.6	-62.0	3.5	-58.5	-13.0	-45.5
6	957.32	-66.3	-61.6	3.8	-57.8	-13.0	-44.8
Antenna Polarity & Test Distance: Vertical at 3 M							
No.	Freq. (MHz)	Reading (dBm)	S.G Power Value (dBm)	Correction Factor (dB)	ERP (dBm)	Limit (dBm)	Margin (dB)
1	30.00	-32.4	-22.9	-19.4	-42.3	-13.0	-29.3
2	81.41	-41.2	-46.3	0.5	-45.8	-13.0	-32.8
3	172.59	-48.5	-49.1	-2.9	-52.0	-13.0	-39.0
4	296.75	-47.6	-46.0	-1.8	-47.8	-13.0	-34.8
5	650.80	-61.9	-60.0	3.6	-56.4	-13.0	-43.4
6	990.30	-68.2	-61.8	3.4	-58.4	-13.0	-45.4

Remarks:

1. Output Power (dBm) = S.G Value (dBm) + Correction Factor (dB).
2. Correction Factor (dB) = Substitution Antenna Gain (dB) + Cable Loss (dB).

LTE Band 2, Channel Bandwidth: 20MHz

Mode	TX channel 18700 (1860.00MHz)	Frequency Range	Below 1000 MHz
Environmental Conditions	25deg. C, 65%RH	Input Power	120Vac, 60Hz
Tested By	Greg Lin		

Antenna Polarity & Test Distance: Horizontal at 3 M

No.	Freq. (MHz)	Reading (dBm)	S.G Power Value (dBm)	Correction Factor (dB)	ERP (dBm)	Limit (dBm)	Margin (dB)
1	30.97	-46.5	-24.0	-18.8	-42.8	-13.0	-29.8
2	81.41	-38.7	-44.3	0.5	-43.8	-13.0	-30.8
3	161.92	-45.9	-48.5	-2.9	-51.4	-13.0	-38.4
4	296.75	-47.9	-48.9	-1.8	-50.7	-13.0	-37.7
5	705.12	-61.5	-62.0	3.5	-58.5	-13.0	-45.5
6	1000.00	-67.0	-61.2	3.2	-58.0	-13.0	-45.0

Antenna Polarity & Test Distance: Vertical at 3 M

No.	Freq. (MHz)	Reading (dBm)	S.G Power Value (dBm)	Correction Factor (dB)	ERP (dBm)	Limit (dBm)	Margin (dB)
1	32.91	-36.2	-29.1	-17.7	-46.8	-13.0	-33.8
2	84.32	-42.0	-47.4	0.4	-47.0	-13.0	-34.0
3	161.92	-50.2	-50.2	-2.9	-53.1	-13.0	-40.1
4	362.71	-58.0	-62.3	3.9	-58.4	-13.0	-45.4
5	671.17	-62.9	-61.1	3.6	-57.5	-13.0	-44.5
6	957.32	-68.1	-62.6	3.8	-58.8	-13.0	-45.8

Remarks:

1. Output Power (dBm) = S.G Value (dBm) + Correction Factor (dB).
2. Correction Factor (dB) = Substitution Antenna Gain (dB) + Cable Loss (dB).

Above 1GHz  
PCS Mode

Mode	TX channel 512 (1850.2MHz)	Frequency Range	Above 1000MHz
Environmental Conditions	22deg. C, 66%RH	Input Power	120Vac, 60Hz
Tested By	Han Wu		

Antenna Polarity & Test Distance: Horizontal at 3 M							
No.	Freq. (MHz)	Reading (dBm)	S.G Power Value (dBm)	Correction Factor (dB)	EIRP (dBm)	Limit (dBm)	Margin (dB)
1	3700.40	-63.6	-55.1	1.4	-53.7	-13.0	-40.7
Antenna Polarity & Test Distance: Vertical at 3 M							
No.	Freq. (MHz)	Reading (dBm)	S.G Power Value (dBm)	Correction Factor (dB)	EIRP (dBm)	Limit (dBm)	Margin (dB)
1	3700.40	-63.5	-55.3	1.4	-53.9	-13.0	-40.9

Remarks:

1. Output Power (dBm) = S.G Value (dBm) + Correction Factor (dB).
2. Correction Factor (dB) = Substitution Antenna Gain (dB) + Cable Loss (dB).

Mode	TX channel 661 (1880.0MHz)	Frequency Range	Above 1000MHz
Environmental Conditions	22deg. C, 66%RH	Input Power	120Vac, 60Hz
Tested By	Han Wu		

Antenna Polarity & Test Distance: Horizontal at 3 M							
No.	Freq. (MHz)	Reading (dBm)	S.G Power Value (dBm)	Correction Factor (dB)	EIRP (dBm)	Limit (dBm)	Margin (dB)
1	3760.00	-63.3	-54.8	1.3	-53.5	-13.0	-40.5
Antenna Polarity & Test Distance: Vertical at 3 M							
No.	Freq. (MHz)	Reading (dBm)	S.G Power Value (dBm)	Correction Factor (dB)	EIRP (dBm)	Limit (dBm)	Margin (dB)
1	3760.00	-63.1	-54.8	1.3	-53.5	-13.0	-40.5

Remarks:

1. Output Power (dBm) = S.G Value (dBm) + Correction Factor (dB).
2. Correction Factor (dB) = Substitution Antenna Gain (dB) + Cable Loss (dB).

Mode	TX channel 810 (1909.8MHz)	Frequency Range	Above 1000MHz
Environmental Conditions	22deg. C, 66%RH	Input Power	120Vac, 60Hz
Tested By	Han Wu		

Antenna Polarity & Test Distance: Horizontal at 3 M							
No.	Freq. (MHz)	Reading (dBm)	S.G Power Value (dBm)	Correction Factor (dB)	EIRP (dBm)	Limit (dBm)	Margin (dB)
1	3819.60	-64.2	-55.9	1.4	-54.5	-13.0	-41.5
Antenna Polarity & Test Distance: Vertical at 3 M							
No.	Freq. (MHz)	Reading (dBm)	S.G Power Value (dBm)	Correction Factor (dB)	EIRP (dBm)	Limit (dBm)	Margin (dB)
1	3819.60	-62.5	-54.3	1.4	-52.9	-13.0	-39.9

Remarks:

1. Output Power (dBm) = S.G Value (dBm) + Correction Factor (dB).
2. Correction Factor (dB) = Substitution Antenna Gain (dB) + Cable Loss (dB).

EDGE Mode

Mode	TX channel 512 (1850.2MHz)	Frequency Range	Above 1000MHz
Environmental Conditions	22deg. C, 66%RH	Input Power	120Vac, 60Hz
Tested By	Greg Lin		

Antenna Polarity & Test Distance: Horizontal at 3 M							
No.	Freq. (MHz)	Reading (dBm)	S.G Power Value (dBm)	Correction Factor (dB)	EIRP (dBm)	Limit (dBm)	Margin (dB)
1	3700.40	-62.4	-53.9	1.4	-52.5	-13.0	-39.5
Antenna Polarity & Test Distance: Vertical at 3 M							
No.	Freq. (MHz)	Reading (dBm)	S.G Power Value (dBm)	Correction Factor (dB)	EIRP (dBm)	Limit (dBm)	Margin (dB)
1	3700.40	-63.4	-55.2	1.4	-53.8	-13.0	-40.8

Remarks:

1. Output Power (dBm) = S.G Value (dBm) + Correction Factor (dB).
2. Correction Factor (dB) = Substitution Antenna Gain (dB) + Cable Loss (dB).

Mode	TX channel 661 (1880.0MHz)	Frequency Range	Above 1000MHz
Environmental Conditions	22deg. C, 66%RH	Input Power	120Vac, 60Hz
Tested By	Greg Lin		

Antenna Polarity & Test Distance: Horizontal at 3 M							
No.	Freq. (MHz)	Reading (dBm)	S.G Power Value (dBm)	Correction Factor (dB)	EIRP (dBm)	Limit (dBm)	Margin (dB)
1	3760.00	-62.7	-54.2	1.3	-52.9	-13.0	-39.9
Antenna Polarity & Test Distance: Vertical at 3 M							
No.	Freq. (MHz)	Reading (dBm)	S.G Power Value (dBm)	Correction Factor (dB)	EIRP (dBm)	Limit (dBm)	Margin (dB)
1	3760.00	-63.5	-55.2	1.3	-53.9	-13.0	-40.9

Remarks:

1. Output Power (dBm) = S.G Value (dBm) + Correction Factor (dB).
2. Correction Factor (dB) = Substitution Antenna Gain (dB) + Cable Loss (dB).

Mode	TX channel 810 (1909.8MHz)	Frequency Range	Above 1000MHz
Environmental Conditions	22deg. C, 66%RH	Input Power	120Vac, 60Hz
Tested By	Greg Lin		

Antenna Polarity & Test Distance: Horizontal at 3 M							
No.	Freq. (MHz)	Reading (dBm)	S.G Power Value (dBm)	Correction Factor (dB)	EIRP (dBm)	Limit (dBm)	Margin (dB)
1	3819.60	-62.4	-54.1	1.4	-52.7	-13.0	-39.7
Antenna Polarity & Test Distance: Vertical at 3 M							
No.	Freq. (MHz)	Reading (dBm)	S.G Power Value (dBm)	Correction Factor (dB)	EIRP (dBm)	Limit (dBm)	Margin (dB)
1	3819.60	-63.3	-55.1	1.4	-53.7	-13.0	-40.7

Remarks:

1. Output Power (dBm) = S.G Value (dBm) + Correction Factor (dB).
2. Correction Factor (dB) = Substitution Antenna Gain (dB) + Cable Loss (dB).



WCDMA Mode

Mode	TX channel 9262 (1852.4MHz)	Frequency Range	Above 1000MHz
Environmental Conditions	22deg. C, 66%RH	Input Power	120Vac, 60Hz
Tested By	Han Wu		

Antenna Polarity & Test Distance: Horizontal at 3 M							
No.	Freq. (MHz)	Reading (dBm)	S.G Power Value (dBm)	Correction Factor (dB)	EIRP (dBm)	Limit (dBm)	Margin (dB)
1	3704.80	-63.4	-54.9	1.4	-53.5	-13.0	-40.5
Antenna Polarity & Test Distance: Vertical at 3 M							
No.	Freq. (MHz)	Reading (dBm)	S.G Power Value (dBm)	Correction Factor (dB)	EIRP (dBm)	Limit (dBm)	Margin (dB)
1	3704.80	-63.7	-55.5	1.4	-54.1	-13.0	-41.1

Remarks:

1. Output Power (dBm) = S.G Value (dBm) + Correction Factor (dB).
2. Correction Factor (dB) = Substitution Antenna Gain (dB) + Cable Loss (dB).

Mode	TX channel 9400 (1880.0MHz)	Frequency Range	Above 1000MHz
Environmental Conditions	22deg. C, 66%RH	Input Power	120Vac, 60Hz
Tested By	Han Wu		

Antenna Polarity & Test Distance: Horizontal at 3 M							
No.	Freq. (MHz)	Reading (dBm)	S.G Power Value (dBm)	Correction Factor (dB)	EIRP (dBm)	Limit (dBm)	Margin (dB)
1	3760.00	-63.5	-55.0	1.3	-53.7	-13.0	-40.7
Antenna Polarity & Test Distance: Vertical at 3 M							
No.	Freq. (MHz)	Reading (dBm)	S.G Power Value (dBm)	Correction Factor (dB)	EIRP (dBm)	Limit (dBm)	Margin (dB)
1	3760.00	-63.6	-55.3	1.3	-54.0	-13.0	-41.0

Remarks:

1. Output Power (dBm) = S.G Value (dBm) + Correction Factor (dB).
2. Correction Factor (dB) = Substitution Antenna Gain (dB) + Cable Loss (dB).

Mode	TX channel 9538 (1907.6MHz)	Frequency Range	Above 1000MHz
Environmental Conditions	22deg. C, 66%RH	Input Power	120Vac, 60Hz
Tested By	Han Wu		

Antenna Polarity & Test Distance: Horizontal at 3 M							
No.	Freq. (MHz)	Reading (dBm)	S.G Power Value (dBm)	Correction Factor (dB)	EIRP (dBm)	Limit (dBm)	Margin (dB)
1	3815.20	-64.2	-56.0	1.5	-54.5	-13.0	-41.5
Antenna Polarity & Test Distance: Vertical at 3 M							
No.	Freq. (MHz)	Reading (dBm)	S.G Power Value (dBm)	Correction Factor (dB)	EIRP (dBm)	Limit (dBm)	Margin (dB)
1	3815.20	-63.8	-56.2	1.5	-54.7	-13.0	-41.7

Remarks:

1. Output Power (dBm) = S.G Value (dBm) + Correction Factor (dB).
2. Correction Factor (dB) = Substitution Antenna Gain (dB) + Cable Loss (dB).

LTE Band 2, Channel Bandwidth: 1.4MHz

Mode	TX channel 18607 (1850.70MHz)	Frequency Range	Above 1000MHz
Environmental Conditions	25deg. C, 65%RH	Input Power	120Vac, 60Hz
Tested By	Greg Lin		

Antenna Polarity & Test Distance: Horizontal at 3 M							
No.	Freq. (MHz)	Reading (dBm)	S.G Power Value (dBm)	Correction Factor (dB)	EIRP (dBm)	Limit (dBm)	Margin (dB)
1	3701.40	-53.3	-44.8	1.4	-43.4	-13.0	-30.4
Antenna Polarity & Test Distance: Vertical at 3 M							
No.	Freq. (MHz)	Reading (dBm)	S.G Power Value (dBm)	Correction Factor (dB)	EIRP (dBm)	Limit (dBm)	Margin (dB)
1	3701.40	-53.8	-45.6	1.4	-44.2	-13.0	-31.2

Remarks:

1. Output Power (dBm) = S.G Value (dBm) + Correction Factor (dB).
2. Correction Factor (dB) = Substitution Antenna Gain (dB) + Cable Loss (dB).

Mode	TX channel 18900 (1880.00MHz)	Frequency Range	Above 1000MHz
Environmental Conditions	25deg. C, 65%RH	Input Power	120Vac, 60Hz
Tested By	Greg Lin		

Antenna Polarity & Test Distance: Horizontal at 3 M							
No.	Freq. (MHz)	Reading (dBm)	S.G Power Value (dBm)	Correction Factor (dB)	EIRP (dBm)	Limit (dBm)	Margin (dB)
1	3760.00	-52.9	-44.4	1.3	-43.1	-13.0	-30.1
Antenna Polarity & Test Distance: Vertical at 3 M							
No.	Freq. (MHz)	Reading (dBm)	S.G Power Value (dBm)	Correction Factor (dB)	EIRP (dBm)	Limit (dBm)	Margin (dB)
1	3760.00	-53.7	-45.4	1.3	-44.1	-13.0	-31.1

Remarks:

1. Output Power (dBm) = S.G Value (dBm) + Correction Factor (dB).
2. Correction Factor (dB) = Substitution Antenna Gain (dB) + Cable Loss (dB).

Mode	TX channel 19193 (1909.30MHz)	Frequency Range	Above 1000MHz
Environmental Conditions	25deg. C, 65%RH	Input Power	120Vac, 60Hz
Tested By	Greg Lin		

Antenna Polarity & Test Distance: Horizontal at 3 M							
No.	Freq. (MHz)	Reading (dBm)	S.G Power Value (dBm)	Correction Factor (dB)	EIRP (dBm)	Limit (dBm)	Margin (dB)
1	3818.60	-52.6	-44.3	1.4	-42.9	-13.0	-29.9
Antenna Polarity & Test Distance: Vertical at 3 M							
No.	Freq. (MHz)	Reading (dBm)	S.G Power Value (dBm)	Correction Factor (dB)	EIRP (dBm)	Limit (dBm)	Margin (dB)
1	3818.60	-53.5	-45.3	1.4	-43.9	-13.0	-30.9

Remarks:

1. Output Power (dBm) = S.G Value (dBm) + Correction Factor (dB).
2. Correction Factor (dB) = Substitution Antenna Gain (dB) + Cable Loss (dB).

LTE Band 2, Channel Bandwidth: 3MHz

Mode	TX channel 18615 (1851.50MHz)	Frequency Range	Above 1000MHz
Environmental Conditions	25deg. C, 65%RH	Input Power	120Vac, 60Hz
Tested By	Greg Lin		

Antenna Polarity & Test Distance: Horizontal at 3 M							
No.	Freq. (MHz)	Reading (dBm)	S.G Power Value (dBm)	Correction Factor (dB)	EIRP (dBm)	Limit (dBm)	Margin (dB)
1	3703.00	-52.6	-44.1	1.4	-42.7	-13.0	-29.7
Antenna Polarity & Test Distance: Vertical at 3 M							
No.	Freq. (MHz)	Reading (dBm)	S.G Power Value (dBm)	Correction Factor (dB)	EIRP (dBm)	Limit (dBm)	Margin (dB)
1	3703.00	-53.3	-45.1	1.4	-43.7	-13.0	-30.7

Remarks:

1. Output Power (dBm) = S.G Value (dBm) + Correction Factor (dB).
2. Correction Factor (dB) = Substitution Antenna Gain (dB) + Cable Loss (dB).

Mode	TX channel 18900 (1880.00MHz)	Frequency Range	Above 1000MHz
Environmental Conditions	25deg. C, 65%RH	Input Power	120Vac, 60Hz
Tested By	Greg Lin		

Antenna Polarity & Test Distance: Horizontal at 3 M							
No.	Freq. (MHz)	Reading (dBm)	S.G Power Value (dBm)	Correction Factor (dB)	EIRP (dBm)	Limit (dBm)	Margin (dB)
1	3760.00	-52.4	-43.9	1.3	-42.6	-13.0	-29.6
Antenna Polarity & Test Distance: Vertical at 3 M							
No.	Freq. (MHz)	Reading (dBm)	S.G Power Value (dBm)	Correction Factor (dB)	EIRP (dBm)	Limit (dBm)	Margin (dB)
1	3760.00	-53.2	-44.9	1.3	-43.6	-13.0	-30.6

Remarks:

1. Output Power (dBm) = S.G Value (dBm) + Correction Factor (dB).
2. Correction Factor (dB) = Substitution Antenna Gain (dB) + Cable Loss (dB).

Mode	TX channel 19185 (1908.50MHz)	Frequency Range	Above 1000MHz
Environmental Conditions	25deg. C, 65%RH	Input Power	120Vac, 60Hz
Tested By	Greg Lin		

Antenna Polarity & Test Distance: Horizontal at 3 M							
No.	Freq. (MHz)	Reading (dBm)	S.G Power Value (dBm)	Correction Factor (dB)	EIRP (dBm)	Limit (dBm)	Margin (dB)
1	3817.00	-52.5	-44.2	1.4	-42.8	-13.0	-29.8
Antenna Polarity & Test Distance: Vertical at 3 M							
No.	Freq. (MHz)	Reading (dBm)	S.G Power Value (dBm)	Correction Factor (dB)	EIRP (dBm)	Limit (dBm)	Margin (dB)
1	3817.00	-53.4	-45.2	1.4	-43.8	-13.0	-30.8

Remarks:

1. Output Power (dBm) = S.G Value (dBm) + Correction Factor (dB).
2. Correction Factor (dB) = Substitution Antenna Gain (dB) + Cable Loss (dB).

LTE Band 2, Channel Bandwidth: 5MHz

Mode	TX channel 18625 (1852.50MHz)	Frequency Range	Above 1000MHz
Environmental Conditions	25deg. C, 65%RH	Input Power	120Vac, 60Hz
Tested By	Greg Lin		

Antenna Polarity & Test Distance: Horizontal at 3 M							
No.	Freq. (MHz)	Reading (dBm)	S.G Power Value (dBm)	Correction Factor (dB)	EIRP (dBm)	Limit (dBm)	Margin (dB)
1	3705.00	-52.3	-43.8	1.4	-42.4	-13.0	-29.4
Antenna Polarity & Test Distance: Vertical at 3 M							
No.	Freq. (MHz)	Reading (dBm)	S.G Power Value (dBm)	Correction Factor (dB)	EIRP (dBm)	Limit (dBm)	Margin (dB)
1	3705.00	-53.3	-45.1	1.4	-43.7	-13.0	-30.7

Remarks:

1. Output Power (dBm) = S.G Value (dBm) + Correction Factor (dB).
2. Correction Factor (dB) = Substitution Antenna Gain (dB) + Cable Loss (dB).

Mode	TX channel 18900 (1880.00MHz)	Frequency Range	Above 1000MHz
Environmental Conditions	25deg. C, 65%RH	Input Power	120Vac, 60Hz
Tested By	Greg Lin		

Antenna Polarity & Test Distance: Horizontal at 3 M							
No.	Freq. (MHz)	Reading (dBm)	S.G Power Value (dBm)	Correction Factor (dB)	EIRP (dBm)	Limit (dBm)	Margin (dB)
1	3760.00	-52.4	-43.9	1.3	-42.6	-13.0	-29.6
Antenna Polarity & Test Distance: Vertical at 3 M							
No.	Freq. (MHz)	Reading (dBm)	S.G Power Value (dBm)	Correction Factor (dB)	EIRP (dBm)	Limit (dBm)	Margin (dB)
1	3760.00	-53.2	-44.9	1.3	-43.6	-13.0	-30.6

Remarks:

1. Output Power (dBm) = S.G Value (dBm) + Correction Factor (dB).
2. Correction Factor (dB) = Substitution Antenna Gain (dB) + Cable Loss (dB).

Mode	TX channel 19175 (1907.50MHz)	Frequency Range	Above 1000MHz
Environmental Conditions	25deg. C, 65%RH	Input Power	120Vac, 60Hz
Tested By	Greg Lin		

Antenna Polarity & Test Distance: Horizontal at 3 M							
No.	Freq. (MHz)	Reading (dBm)	S.G Power Value (dBm)	Correction Factor (dB)	EIRP (dBm)	Limit (dBm)	Margin (dB)
1	3815.00	-52.4	-44.1	1.4	-42.7	-13.0	-29.7
Antenna Polarity & Test Distance: Vertical at 3 M							
No.	Freq. (MHz)	Reading (dBm)	S.G Power Value (dBm)	Correction Factor (dB)	EIRP (dBm)	Limit (dBm)	Margin (dB)
1	3815.00	-53.5	-45.3	1.4	-43.9	-13.0	-30.9

Remarks:

1. Output Power (dBm) = S.G Value (dBm) + Correction Factor (dB).
2. Correction Factor (dB) = Substitution Antenna Gain (dB) + Cable Loss (dB).



LTE Band 2, Channel Bandwidth: 10MHz

Mode	TX channel 18650 (1855.00MHz)	Frequency Range	Above 1000MHz
Environmental Conditions	25deg. C, 65%RH	Input Power	120Vac, 60Hz
Tested By	Greg Lin		

Antenna Polarity & Test Distance: Horizontal at 3 M							
No.	Freq. (MHz)	Reading (dBm)	S.G Power Value (dBm)	Correction Factor (dB)	EIRP (dBm)	Limit (dBm)	Margin (dB)
1	3710.00	-52.5	-44.0	1.4	-42.6	-13.0	-29.6
Antenna Polarity & Test Distance: Vertical at 3 M							
No.	Freq. (MHz)	Reading (dBm)	S.G Power Value (dBm)	Correction Factor (dB)	EIRP (dBm)	Limit (dBm)	Margin (dB)
1	3710.00	-53.2	-45.0	1.4	-43.6	-13.0	-30.6

Remarks:

1. Output Power (dBm) = S.G Value (dBm) + Correction Factor (dB).
2. Correction Factor (dB) = Substitution Antenna Gain (dB) + Cable Loss (dB).

Mode	TX channel 18900 (1880.00MHz)	Frequency Range	Above 1000MHz
Environmental Conditions	25deg. C, 65%RH	Input Power	120Vac, 60Hz
Tested By	Greg Lin		

Antenna Polarity & Test Distance: Horizontal at 3 M							
No.	Freq. (MHz)	Reading (dBm)	S.G Power Value (dBm)	Correction Factor (dB)	EIRP (dBm)	Limit (dBm)	Margin (dB)
1	3760.00	-52.2	-43.7	1.3	-42.4	-13.0	-29.4
Antenna Polarity & Test Distance: Vertical at 3 M							
No.	Freq. (MHz)	Reading (dBm)	S.G Power Value (dBm)	Correction Factor (dB)	EIRP (dBm)	Limit (dBm)	Margin (dB)
1	3760.00	-53.6	-45.3	1.3	-44.0	-13.0	-31.0

Remarks:

1. Output Power (dBm) = S.G Value (dBm) + Correction Factor (dB).
2. Correction Factor (dB) = Substitution Antenna Gain (dB) + Cable Loss (dB).

Mode	TX channel 19150 (1905.00MHz)	Frequency Range	Above 1000MHz
Environmental Conditions	25deg. C, 65%RH	Input Power	120Vac, 60Hz
Tested By	Greg Lin		

Antenna Polarity & Test Distance: Horizontal at 3 M							
No.	Freq. (MHz)	Reading (dBm)	S.G Power Value (dBm)	Correction Factor (dB)	EIRP (dBm)	Limit (dBm)	Margin (dB)
1	3810.00	-52.8	-44.4	1.3	-43.1	-13.0	-30.1
Antenna Polarity & Test Distance: Vertical at 3 M							
No.	Freq. (MHz)	Reading (dBm)	S.G Power Value (dBm)	Correction Factor (dB)	EIRP (dBm)	Limit (dBm)	Margin (dB)
1	3810.00	-53.7	-45.4	1.3	-44.1	-13.0	-31.1

Remarks:

1. Output Power (dBm) = S.G Value (dBm) + Correction Factor (dB).
2. Correction Factor (dB) = Substitution Antenna Gain (dB) + Cable Loss (dB).

LTE Band 2, Channel Bandwidth: 15MHz

Mode	TX channel 18675 (1857.50MHz)	Frequency Range	Above 1000MHz
Environmental Conditions	25deg. C, 65%RH	Input Power	120Vac, 60Hz
Tested By	Greg Lin		

Antenna Polarity & Test Distance: Horizontal at 3 M

No.	Freq. (MHz)	Reading (dBm)	S.G Power Value (dBm)	Correction Factor (dB)	EIRP (dBm)	Limit (dBm)	Margin (dB)
1	3715.00	-52.6	-44.1	1.4	-42.7	-13.0	-29.7

Antenna Polarity & Test Distance: Vertical at 3 M

No.	Freq. (MHz)	Reading (dBm)	S.G Power Value (dBm)	Correction Factor (dB)	EIRP (dBm)	Limit (dBm)	Margin (dB)
1	3715.00	-53.6	-45.4	1.4	-44.0	-13.0	-31.0

Remarks:

1. Output Power (dBm) = S.G Value (dBm) + Correction Factor (dB).
2. Correction Factor (dB) = Substitution Antenna Gain (dB) + Cable Loss (dB).

Mode	TX channel 18900 (1880.00MHz)	Frequency Range	Above 1000MHz
Environmental Conditions	25deg. C, 65%RH	Input Power	120Vac, 60Hz
Tested By	Greg Lin		

Antenna Polarity & Test Distance: Horizontal at 3 M

No.	Freq. (MHz)	Reading (dBm)	S.G Power Value (dBm)	Correction Factor (dB)	EIRP (dBm)	Limit (dBm)	Margin (dB)
1	3760.00	-52.5	-44.0	1.3	-42.7	-13.0	-29.7

Antenna Polarity & Test Distance: Vertical at 3 M

No.	Freq. (MHz)	Reading (dBm)	S.G Power Value (dBm)	Correction Factor (dB)	EIRP (dBm)	Limit (dBm)	Margin (dB)
1	3760.00	-53.3	-45.0	1.3	-43.7	-13.0	-30.7

Remarks:

1. Output Power (dBm) = S.G Value (dBm) + Correction Factor (dB).
2. Correction Factor (dB) = Substitution Antenna Gain (dB) + Cable Loss (dB).

Mode	TX channel 19125 (1902.50MHz)	Frequency Range	Above 1000MHz
Environmental Conditions	25deg. C, 65%RH	Input Power	120Vac, 60Hz
Tested By	Greg Lin		

Antenna Polarity & Test Distance: Horizontal at 3 M							
No.	Freq. (MHz)	Reading (dBm)	S.G Power Value (dBm)	Correction Factor (dB)	EIRP (dBm)	Limit (dBm)	Margin (dB)
1	3805.00	-52.7	-44.3	1.3	-43.0	-13.0	-30.0
Antenna Polarity & Test Distance: Vertical at 3 M							
No.	Freq. (MHz)	Reading (dBm)	S.G Power Value (dBm)	Correction Factor (dB)	EIRP (dBm)	Limit (dBm)	Margin (dB)
1	3805.00	-53.7	-45.5	1.3	-44.2	-13.0	-31.2

Remarks:

1. Output Power (dBm) = S.G Value (dBm) + Correction Factor (dB).
2. Correction Factor (dB) = Substitution Antenna Gain (dB) + Cable Loss (dB).

LTE Band 2, Channel Bandwidth: 20MHz

Mode	TX channel 18700 (1860.00MHz)	Frequency Range	Above 1000MHz
Environmental Conditions	25deg. C, 65%RH	Input Power	120Vac, 60Hz
Tested By	Greg Lin		

Antenna Polarity & Test Distance: Horizontal at 3 M							
No.	Freq. (MHz)	Reading (dBm)	S.G Power Value (dBm)	Correction Factor (dB)	EIRP (dBm)	Limit (dBm)	Margin (dB)
1	3720.00	-52.3	-43.8	1.4	-42.4	-13.0	-29.4
Antenna Polarity & Test Distance: Vertical at 3 M							
No.	Freq. (MHz)	Reading (dBm)	S.G Power Value (dBm)	Correction Factor (dB)	EIRP (dBm)	Limit (dBm)	Margin (dB)
1	3720.00	-53.2	-45.0	1.4	-43.6	-13.0	-30.6

Remarks:

1. Output Power (dBm) = S.G Value (dBm) + Correction Factor (dB).
2. Correction Factor (dB) = Substitution Antenna Gain (dB) + Cable Loss (dB).

Mode	TX channel 18900 (1880.00MHz)	Frequency Range	Above 1000MHz
Environmental Conditions	25deg. C, 65%RH	Input Power	120Vac, 60Hz
Tested By	Greg Lin		

Antenna Polarity & Test Distance: Horizontal at 3 M							
No.	Freq. (MHz)	Reading (dBm)	S.G Power Value (dBm)	Correction Factor (dB)	EIRP (dBm)	Limit (dBm)	Margin (dB)
1	3760.00	-52.4	-43.9	1.3	-42.6	-13.0	-29.6
Antenna Polarity & Test Distance: Vertical at 3 M							
No.	Freq. (MHz)	Reading (dBm)	S.G Power Value (dBm)	Correction Factor (dB)	EIRP (dBm)	Limit (dBm)	Margin (dB)
1	3760.00	-53.2	-44.9	1.3	-43.6	-13.0	-30.6

Remarks:

1. Output Power (dBm) = S.G Value (dBm) + Correction Factor (dB).
2. Correction Factor (dB) = Substitution Antenna Gain (dB) + Cable Loss (dB).

Mode	TX channel 19100 (1900.00MHz)	Frequency Range	Above 1000MHz
Environmental Conditions	25deg. C, 65%RH	Input Power	120Vac, 60Hz
Tested By	Greg Lin		

Antenna Polarity & Test Distance: Horizontal at 3 M							
No.	Freq. (MHz)	Reading (dBm)	S.G Power Value (dBm)	Correction Factor (dB)	EIRP (dBm)	Limit (dBm)	Margin (dB)
1	3800.00	-52.5	-44.1	1.3	-42.8	-13.0	-29.8
Antenna Polarity & Test Distance: Vertical at 3 M							
No.	Freq. (MHz)	Reading (dBm)	S.G Power Value (dBm)	Correction Factor (dB)	EIRP (dBm)	Limit (dBm)	Margin (dB)
1	3800.00	-53.3	-45.1	1.3	-43.8	-13.0	-30.8

Remarks:

1. Output Power (dBm) = S.G Value (dBm) + Correction Factor (dB).
2. Correction Factor (dB) = Substitution Antenna Gain (dB) + Cable Loss (dB).

## 5 Pictures of Test Arrangements

Please refer to the attached file (Test Setup Photo).

## Appendix – Information on the Testing Laboratories

We, Bureau Veritas Consumer Products Services (H.K.) Ltd., Taoyuan Branch, were founded in 1988 to provide our best service in EMC, Radio, Telecom and Safety consultation. Our laboratories are FCC recognized accredited test firms and accredited and approved according to ISO/IEC 17025.

If you have any comments, please feel free to contact us at the following:

**Linko EMC/RF Lab**

Tel: 886-2-26052180

Fax: 886-2-26051924

**Hsin Chu EMC/RF/Telecom Lab**

Tel: 886-3-6668565

Fax: 886-3-6668323

**Hwa Ya EMC/RF/Safety Lab**

Tel: 886-3-3183232

Fax: 886-3-3270892

**Email:** [service.adt@tw.bureauveritas.com](mailto:service.adt@tw.bureauveritas.com)

**Web Site:** [www.bureauveritas-adt.com](http://www.bureauveritas-adt.com)

The address and road map of all our labs can be found in our web site also.

--- END ---