

FCC Test Report

(PART 22)

Report No.: RF180626C09

FCC ID: 2AJOTTA-1085

Test Model: TA-1085

Received Date: Jun. 26, 2018

Test Date: Jul. 05, 2018 ~ Jul. 20, 2018

Issued Date: Jul. 31, 2018

Applicant: HMD Global Oy

Address: Karaportti 2, 02610 Espoo, Finland

Issued By: Bureau Veritas Consumer Products Services (H.K.) Ltd., Taoyuan Branch

Lab Address: No. 47-2, 14th Ling, Chia Pau Vil., Lin Kou Dist., New Taipei City, Taiwan (R.O.C)

Test Location (1): No. 19, Hwa Ya 2nd Rd, Wen Hwa Vil, Kwei Shan Dist., Taoyuan City 33383, Taiwan (R.O.C)

Test Location (2): No.215, Sec. 3, Beixin Rd., Xindian Dist., New Taipei City 231, Taiwan, R.O.C

**FCC Registration /
Designation Number:** 427177 / TW0011



This report is for your exclusive use. Any copying or replication of this report to or for any other person or entity, or use of our name or trademark, is permitted only with our prior written permission. This report sets forth our findings solely with respect to the test samples identified herein. The results set forth in this report are not indicative or representative of the quality or characteristics of the lot from which a test sample was taken or any similar or identical product unless specifically and expressly noted. Our report includes all of the tests requested by you and the results thereof based upon the information that you provided to us. You have 60 days from date of issuance of this report to notify us of any material error or omission caused by our negligence, provided, however, that such notice shall be in writing and shall specifically address the issue you wish to raise. A failure to raise such issue within the prescribed time shall constitute your unqualified acceptance of the completeness of this report, the tests conducted and the correctness of the report contents. Unless specific mention, the uncertainty of measurement has been explicitly taken into account to declare the compliance or non-compliance to the specification. The report must not be used by the client to claim product certification, approval, or endorsement by TAF or any government agencies

Table of Contents

Release Control Record	4
1 Certificate of Conformity	5
2 Summary of Test Results	6
2.1 Measurement Uncertainty	6
2.2 Test Site and Instruments	7
3 General Information	9
3.1 General Description of EUT	9
3.2 Configuration of System under Test	10
3.2.1 Description of Support Units	10
3.3 Test Mode Applicability and Tested Channel Detail	11
3.4 EUT Operating Conditions	14
3.5 General Description of Applied Standards	14
4 Test Types and Results	15
4.1 Output Power Measurement	15
4.1.1 Limits of Output Power Measurement	15
4.1.2 Test Procedures	15
4.1.3 Test Setup	16
4.1.4 Test Results	17
4.2 Modulation Characteristics Measurement	23
4.2.1 Limits of Modulation Characteristics	23
4.2.2 Test Setup	23
4.2.3 Test Procedure	23
4.2.4 Test Results	24
4.3 Frequency Stability Measurement	25
4.3.1 Limits of Frequency Stability Measurement	25
4.3.2 Test Procedure	25
4.3.3 Test Setup	25
4.3.4 Test Results	26
4.4 Occupied Bandwidth Measurement	33
4.4.1 Test Procedure	33
4.4.2 Test Setup	33
4.4.3 Test Result	34
4.5 Band Edge Measurement	37
4.5.1 Limits of Band Edge Measurement	37
4.5.2 Test Setup	37
4.5.3 Test Procedures	37
4.5.4 Test Results	38
4.6 Peak to Average Ratio	43
4.6.1 Limits of Peak to Average Ratio Measurement	43
4.6.2 Test Setup	43
4.6.3 Test Procedures	43
4.6.4 Test Results	44
4.7 Conducted Spurious Emissions	47
4.7.1 Limits of Conducted Spurious Emissions Measurement	47
4.7.2 Test Setup	47
4.7.3 Test Procedure	47
4.7.4 Test Results	48
4.8 Radiated Emission Measurement	55
4.8.1 Limits of Radiated Emission Measurement	55
4.8.2 Test Procedure	55
4.8.3 Deviation from Test Standard	55
4.8.4 Test Setup	56
4.8.5 Test Results	57

5 Pictures of Test Arrangements.....	105
Appendix – Information on the Testing Laboratories	106

Release Control Record

Issue No.	Description	Date Issued
RF180626C09	Original Release	Jul. 31, 2018

1 Certificate of Conformity

Product: Smart Phone
Brand: NOKIA
Test Model: TA-1085
Sample Status: Engineering Sample
Applicant: HMD Global Oy
Test Date: Jul. 05, 2018 ~ Jul. 20, 2018
Standards: FCC Part 22, Subpart H

The above equipment has been tested by **Bureau Veritas Consumer Products Services (H.K.) Ltd., Taoyuan Branch**, and found compliance with the requirement of the above standards. The test record, data evaluation & Equipment Under Test (EUT) configurations represented herein are true and accurate accounts of the measurements of the sample's RF characteristics under the conditions specified in this report.

Prepared by : , **Date:** Jul. 31, 2018
Ivonne Wu / Supervisor

Approved by : , **Date:** Jul. 31, 2018
Dylan Chiou / Project Engineer

2 Summary of Test Results

Applied Standard: FCC Part 22 & Part 2			
FCC Clause	Test Item	Result	Remarks
2.1046 22.913 (a)	Effective Radiated Power	Pass	Meet the requirement of limit.
2.1047	Modulation Characteristics	Pass	Meet the requirement.
---	Peak to Average Ratio	Pass	Meet the requirement of limit.
2.1055 22.355	Frequency Stability	Pass	Meet the requirement of limit.
2.1049	Occupied Bandwidth	Pass	Meet the requirement of limit.
22.917	Band Edge Measurements	Pass	Meet the requirement of limit.
2.1051 22.917	Conducted Spurious Emissions	Pass	Meet the requirement of limit.
2.1053 22.917	Radiated Spurious Emissions	Pass	Meet the requirement of limit. Minimum passing margin is -24.90 dB at 2509.50 MHz.

2.1 Measurement Uncertainty

Where relevant, the following measurement uncertainty levels have been estimated for tests performed on the EUT as specified in CISPR 16-4-2:

Measurement	Frequency	Expanded Uncertainty (k=2) (±)
Radiated Emissions up to 1 GHz	30 MHz ~ 200 MHz	2.0153 dB
	200 MHz ~ 1000 MHz	2.0224 dB
Radiated Emissions above 1 GHz	1 GHz ~ 18 GHz	1.0121 dB
	18 GHz ~ 40 GHz	1.1508 dB

2.2 Test Site and Instruments

Description & Manufacturer	Model No.	Serial No.	Date of Calibration	Due Date of Calibration
Test Receiver Agilent Technologies	N9010A	MY52220314	Nov. 24, 2017	Nov. 23, 2018
Spectrum Analyzer ROHDE & SCHWARZ	FSU43	101261	Jan. 11, 2018	Jan. 10, 2019
Double Ridge Guide Horn Antenna EMCO	3115	5619	Nov. 30, 2017	Nov. 29, 2018
BILOG Antenna SCHWARZBECK	VULB 9168	9168-153	Dec. 06, 2017	Dec. 05, 2018
HORN Antenna Schwarzbeck	BBHA 9120D	9120D-969	Dec. 12, 2017	Dec. 11, 2018
Fixed Attenuator Woken	00801A1GGAM02Y	NA	May 17, 2018	May 16, 2019
MXG Vector signal generator Agilent	N5182B	MY53050430	Oct. 24, 2017	Oct. 23, 2018
Preamplifier Agilent	310N	187226	Jun. 19, 2018	Jun. 18, 2019
Preamplifier Agilent	83017A	MY39501357	Jun. 19, 2018	Jun. 18, 2019
RF signal cable ETS-LINDGREN	5D-FB	Cable-CH1-01(RF C-SMS-100-SMS- 120+RFC-SMS-1 00-SMS-400)	Jun. 19, 2018	Jun. 18, 2019
RF signal cable ETS-LINDGREN	8D-FB	Cable-CH1-02(RF C-SMS-100-SMS- 24)	Jun. 19, 2018	Jun. 18, 2019
Boresight Antenna Fixture	FBA-01	FBA-SIP01	NA	NA
Software BV ADT	E3 8.130425b	NA	NA	NA
Antenna Tower MF	NA	NA	NA	NA
Turn Table MF	NA	NA	NA	NA
Antenna Tower & Turn Table Controller MF	MF-7802	NA	NA	NA
Communications Tester-Wireless Agilent	8960 Series 10	MY53201073	Jun. 28, 2017	Jun. 27, 2019
Radio Communication Analyzer Anritsu	MT8820C	6201010284	Dec. 28, 2017	Dec. 27, 2018
Temperature & Humidity Chamber	GTH-120-40-CP-AR	MAA1306-019	Sep. 08, 2017	Sep. 07, 2018
DC Power Supply Topward	33010D	807748	Oct. 25, 2016	Oct. 24, 2018
Digital Multimeter Fluke	87-III	70360742	Jun. 29, 2018	Jun. 28, 2019

- Note:
1. The calibration interval of the above test instruments is 12 / 24 months and the calibrations are traceable to NML/ROC and NIST/USA.
 2. The test was performed in HsinTien Chamber 1.
 3. The horn antenna and preamplifier (model: 83017A) are used only for the measurement of emission frequency above 1 GHz if tested.
 4. The IC Site Registration No. is IC7450I-1.



3 General Information

3.1 General Description of EUT

Product	Smart Phone	
Brand	NOKIA	
Test Model	TA-1085	
Status of EUT	Engineering Sample	
Power Supply Rating	5.0 Vdc or 9 Vdc or 12 Vdc (adapter) 5.0 Vdc (host equipment) 3.85 Vdc (Li-ion battery)	
Modulation Type	GSM/GPRS	GMSK
	EDGE	GMSK, 8PSK
	WCDMA	QPSK
	LTE	QPSK, 16QAM
Frequency Range	GSM/GPRS/EDGE	824.2 ~ 848.8 MHz
	WCDMA	826.4 ~ 846.6 MHz
	LTE 5 (Channel Bandwidth: 1.4 MHz)	824.7 ~ 848.3 MHz
	LTE 5 (Channel Bandwidth: 3 MHz)	825.5 ~ 847.5 MHz
	LTE 5 (Channel Bandwidth: 5 MHz)	826.5 ~ 846.5 MHz
	LTE 5 (Channel Bandwidth: 10 MHz)	829 ~ 844 MHz
Max. ERP Power	GSM/GPRS	727.78 mW
	EDGE	145.21 mW
	WCDMA	81.47 mW
	LTE 5 (Channel Bandwidth: 1.4 MHz)	80.32 mW
	LTE 5 (Channel Bandwidth: 3 MHz)	80.87 mW
	LTE 5 (Channel Bandwidth: 5 MHz)	81.43 mW
	LTE 5 (Channel Bandwidth: 10 MHz)	82.19 mW
Emission Designator	GSM/GPRS	245KGXW
	EDGE	248KG7W
	WCDMA	4M16F9W
	LTE 5 (Channel Bandwidth: 1.4 MHz)	1M09W7D
	LTE 5 (Channel Bandwidth: 3 MHz)	2M70G7D
	LTE 5 (Channel Bandwidth: 5 MHz)	4M50W7D
	LTE 5 (Channel Bandwidth: 10 MHz)	8M98W7D
Antenna Type	PIFA Antenna with -2.05 dBi gain	
Accessory Device	Refer to Note as below	
Data Cable Supplied	Refer to Note as below	

Note:

- There're 2 configurations for the EUT listed as below.
 Main Sample: EUT + Battery 1
 2nd Sample: EUT + Battery 2
 ✧ Only the worst test data was presented in the report.
- The EUT's accessories list refers to Ext. Pho.
- The above EUT information is declared by manufacturer and for more detailed features description, please refers to the manufacturer's specifications or user's manual.

3.2 Configuration of System under Test

<Radiated Emission Test>

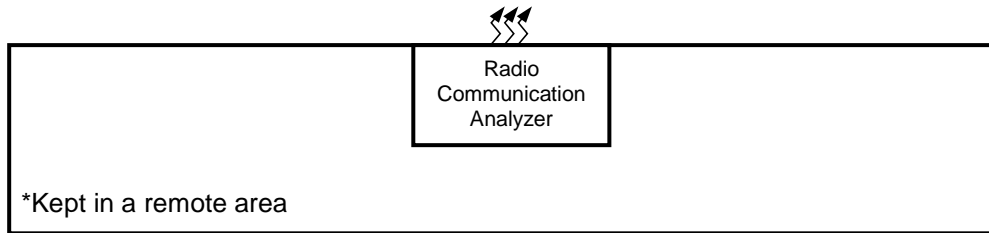
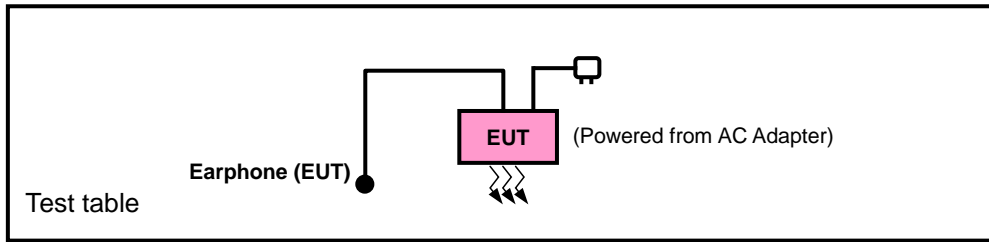

<E.R.P. Test>

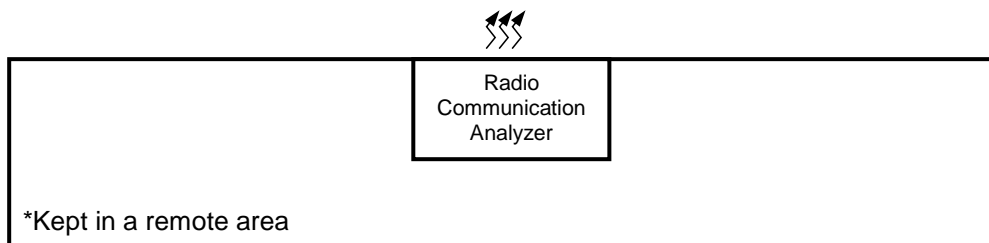
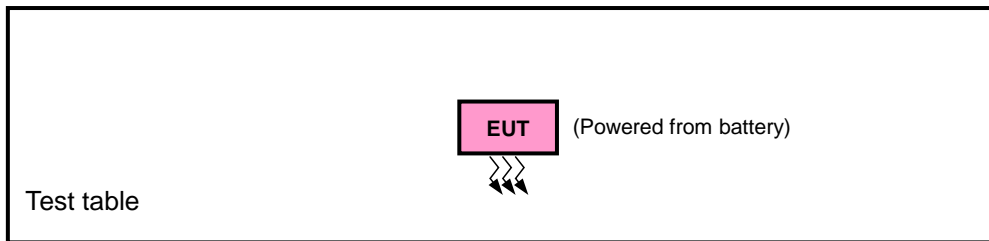

3.2.1 Description of Support Units

The EUT has been tested as an independent unit together with other necessary accessories or support units.

3.3 Test Mode Applicability and Tested Channel Detail

Pre-Scan has been conducted to determine the worst-case mode from all possible combinations between available modulations, data rates, XYZ axis, and antenna ports.

The worst case was found when positioned as the table below. Following channel(s) was (were) selected for the final test as listed below:

EUT Configure Mode	Description
A	Main Sample
B	2 nd Sample

SIM	Band	ERP	Radiated Emission
1	GSM	X-plane	X-axis
	EDGE	X-plane	X-axis
	WCDMA	X-plane	X-axis
	LTE Band 5	X-plane	Y-axis

GSM

EUT Configure Mode	Test Item	Available Channel	Tested Channel	Mode
A	ERP	128 to 251	128, 189, 251	GSM, EDGE
B		128 to 251	128, 189, 251	GSM
A	Modulation Characteristics	128 to 251	189	GSM, EDGE
A	Frequency Stability	128 to 251	128, 251	GSM, EDGE
A	Occupied Bandwidth	128 to 251	128, 189, 251	GSM, EDGE
A	Band Edge	128 to 251	128, 251	GSM, EDGE
A	Peak to Average Ratio	128 to 251	128, 189, 251	GSM, EDGE
A	Conducted Emission	128 to 251	128, 189, 251	GSM, EDGE
A	Radiated Emission	128 to 251	128, 189, 251	GSM, EDGE
B		128 to 251	128, 189, 251	GSM

WCDMA

EUT Configure Mode	Test Item	Available Channel	Tested Channel	Mode
A	ERP	4132 to 4233	4132, 4182, 4233	WCDMA
A	Modulation Characteristics	4132 to 4233	4182	WCDMA
A	Frequency Stability	4132 to 4233	4132, 4233	WCDMA
A	Occupied Bandwidth	4132 to 4233	4132, 4182, 4233	WCDMA
A	Band Edge	4132 to 4233	4132, 4233	WCDMA
A	Peak to Average Ratio	4132 to 4233	4132, 4182, 4233	WCDMA
A	Conducted Emission	4132 to 4233	4132, 4182, 4233	WCDMA
A	Radiated Emission	4132 to 4233	4132, 4182, 4233	WCDMA

LTE Band 5

EUT Configure Mode	Test Item	Available Channel	Tested Channel	Channel Bandwidth	Modulation	Mode		
A	ERP	20407 to 20643	20407, 20525, 20643	1.4 MHz	QPSK, 16QAM	1 RB / 0 RB Offset		
		20415 to 20635	20415, 20525, 20635	3 MHz	QPSK, 16QAM	1 RB / 0 RB Offset		
		20425 to 20625	20425, 20525, 20625	5 MHz	QPSK, 16QAM	1 RB / 0 RB Offset		
		20450 to 20600	20450, 20525, 20600	10 MHz	QPSK, 16QAM	1 RB / 0 RB Offset		
B		20450 to 20600	20450, 20525, 20600	10 MHz	QPSK, 16QAM	1 RB / 0 RB Offset		
A	Modulation Characteristics	20450 to 20600	20525	5 MHz	QPSK, 16QAM	25 RB / 0 RB Offset		
A	Frequency Stability	20407 to 20643	20407, 20643	1.4 MHz	QPSK	1 RB / 0 RB Offset		
		20415 to 20635	20415, 20635	3 MHz	QPSK	1 RB / 0 RB Offset		
		20425 to 20625	20425, 20625	5 MHz	QPSK	1 RB / 0 RB Offset		
		20450 to 20600	20450, 20600	10 MHz	QPSK	1 RB / 0 RB Offset		
A	Occupied Bandwidth	20407 to 20643	20407, 20525, 20643	1.4 MHz	QPSK, 16QAM	6 RB / 0 RB Offset		
		20415 to 20635	20415, 20525, 20635	3 MHz	QPSK, 16QAM	15 RB / 0 RB Offset		
		20425 to 20625	20425, 20525, 20625	5 MHz	QPSK, 16QAM	25 RB / 0 RB Offset		
		20450 to 20600	20450, 20525, 20600	10 MHz	QPSK, 16QAM	50 RB / 0 RB Offset		
A	Band Edge	20407 to 20643	20407	1.4MHz	QPSK	1 RB / 0 RB Offset 6 RB / 0 RB Offset		
			20643	1.4MHz	QPSK	1 RB / 5 RB Offset 6 RB / 0 RB Offset		
		20415 to 20635	20415	3 MHz	QPSK	1 RB / 0 RB Offset 15 RB / 0 RB Offset		
			20635	3 MHz	QPSK	1 RB / 14 RB Offset 15 RB / 0 RB Offset		
		20425 to 20625	20425	5 MHz	QPSK	1 RB / 0 RB Offset 25 RB / 0 RB Offset		
			20625	5 MHz	QPSK	1 RB / 24 RB Offset 25 RB / 0 RB Offset		
		20450 to 20600	20450	10 MHz	QPSK	1 RB / 0 RB Offset 50 RB / 0 RB Offset		
			20600	10 MHz	QPSK	1 RB / 49 RB Offset 50 RB / 0 RB Offset		
		A	Peak to Average Ratio	20407 to 20643	20407, 20525, 20643	1.4 MHz	QPSK, 16QAM	1 RB / 0 RB Offset
				20415 to 20635	20415, 20525, 20635	3 MHz	QPSK, 16QAM	1 RB / 0 RB Offset
				20425 to 20625	20425, 20525, 20625	5 MHz	QPSK, 16QAM	1 RB / 0 RB Offset
				20450 to 20600	20450, 20525, 20600	10 MHz	QPSK, 16QAM	1 RB / 0 RB Offset
A	Conducted Emission	20407 to 20643	20407, 20525, 20643	1.4 MHz	QPSK	1 RB / 0 RB Offset		
		20415 to 20635	20415, 20525, 20635	3 MHz	QPSK	1 RB / 0 RB Offset		
		20425 to 20625	20425, 20525, 20625	5 MHz	QPSK	1 RB / 0 RB Offset		
		20450 to 20600	20450, 20525, 20600	10 MHz	QPSK	1 RB / 0 RB Offset		
A	Radiated Emission	20407 to 20643	20407, 20525, 20643	1.4 MHz	QPSK	1 RB / 0 RB Offset		
		20425 to 20625	20425, 20525, 20625	5 MHz	QPSK	1 RB / 0 RB Offset		
		20450 to 20600	20450, 20525, 20600	10 MHz	QPSK	1 RB / 0 RB Offset		
B		20450 to 20600	20450, 20525, 20600	10 MHz	QPSK	1 RB / 0 RB Offset		

Note: This device was tested under all bandwidths, RB configurations and modulations. The worst case was found in QPSK modulation.

Test Condition:

Test Item	Environmental Conditions	Input Power	Tested By
ERP	25 deg. C, 65 % RH	3.85 Vdc	Charles Hsiao
Modulation Characteristics	25 deg. C, 65 % RH	3.85 Vdc	Wayne Lin
Frequency Stability	25 deg. C, 65 % RH	3.85 Vdc	Wayne Lin
Occupied Bandwidth	25 deg. C, 65 % RH	3.85 Vdc	Wayne Lin
Band Edge	25 deg. C, 65 % RH	3.85 Vdc	Wayne Lin
Peak to Average Ratio	25 deg. C, 65 % RH	3.85 Vdc	Wayne Lin
Conducted Emission	25 deg. C, 65 % RH	3.85 Vdc	Wayne Lin
Radiated Emission	25 deg. C, 65 % RH	120 Vac, 60 Hz	Charles Hsiao / Karl Lee

3.4 EUT Operating Conditions

The EUT makes a call to the communication simulator. The communication simulator station system controlled a EUT to export maximum output power under transmission mode and specific channel frequency.

3.5 General Description of Applied Standards

The EUT is a RF Product. According to the specifications of the manufacturer, it must comply with the requirements of the following standards:

FCC 47 CFR Part 2

FCC 47 CFR Part 22

KDB 971168 D01 Power Meas License Digital Systems v03r01

ANSI/TIA/EIA-603-E 2016

ANSI 63.26-2015

Note: All test items have been performed and recorded as per the above standards.

4 Test Types and Results

4.1 Output Power Measurement

4.1.1 Limits of Output Power Measurement

Mobile / Portable station are limited to 7 watts e.r.p.

4.1.2 Test Procedures

EIRP / ERP Measurement:

- a. All measurements were done at low, middle and high operational frequency range. RBW and VBW is 1 MHz for GSM, GPRS & EDGE, 5 MHz for WCDMA, and 10 MHz for LTE mode.
- b. Substitution method is used for E.I.R.P measurement. In the semi-anechoic chamber, EUT placed on the 0.8 m (below or equal 1 GHz) and/or 1.5 m (above 1 GHz) height of Turn Table, rotated the table around 360 degrees to search the maximum radiation power and receiver antenna shall be rotated vertical and horizontal polarization and moved height from 1 m to 4 m to find the maximum polar radiated power. The "Read Value" is the spectrum reading the maximum power value.
- c. The substitution horn antenna is substituted for EUT at the same position and signals generator export the CW signal to the substitution antenna via a tx cable. Rotated the Turn Table and moved receiving antenna to find the maximum radiation power. Adjust output power level of S.G to get a Value of spectrum reading equal to "Read Value" of step b. Record the power level of S.G.
- d. $EIRP = \text{Output power level of S.G} - \text{TX cable loss} + \text{Antenna gain of substitution horn}$. E.R.P power can be calculated form E.I.R.P power by subtracting the gain of dipole, $E.R.P \text{ power} = E.I.R.P \text{ power} - 2.15 \text{ dB}$.

Conducted Power Measurement:

The EUT was set up for the maximum power with GSM, GPRS, EDGE, WCDMA, and LTE link data modulation and link up with simulator. Set the EUT to transmit under low, middle and high channel and record the power level shown on simulator.

4.1.3 Test Setup

EIRP / ERP Measurement:

<Radiated Emission below or equal 1 GHz>

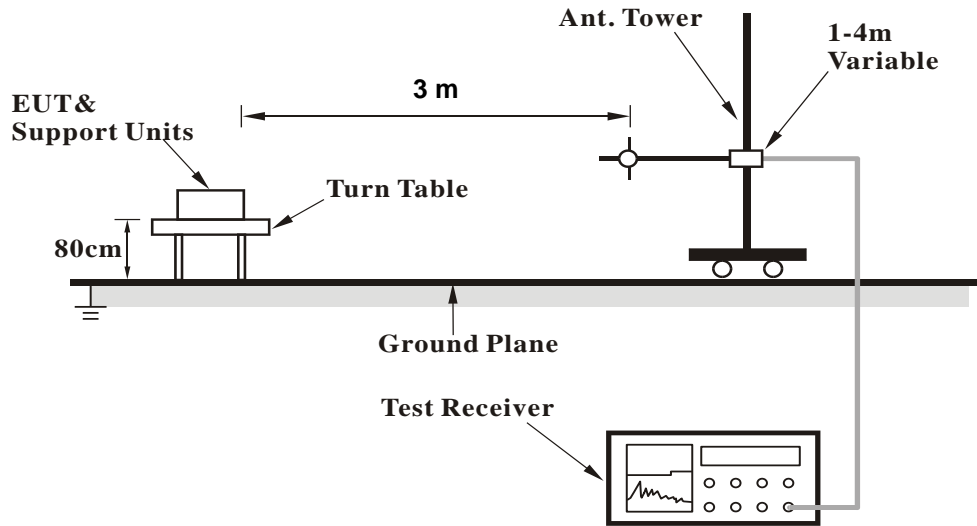

<Radiated Emission above 1 GHz>

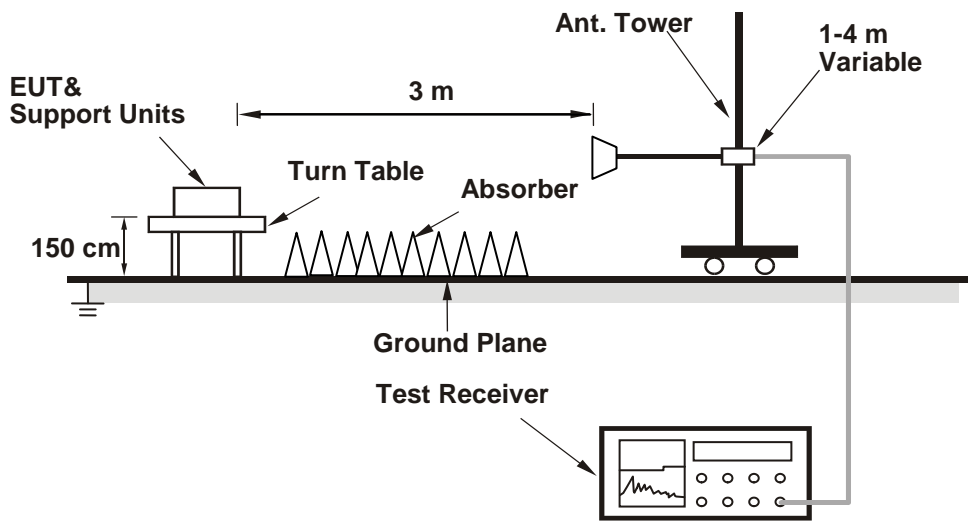

For the actual test configuration, please refer to the attached file (Test Setup Photo).

Conducted Power Measurement:

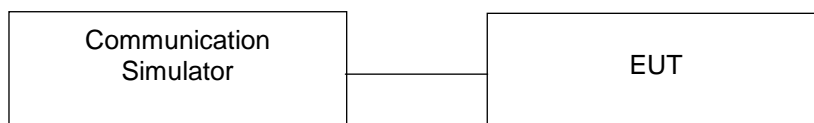

4.1.4 Test Results

Conducted Output Power (dBm)

Band	GSM850		
	128	189	251
Channel	824.2	836.4	848.8
Frequency (MHz)	824.2	836.4	848.8
GSM (GMSK, 1Tx-slot)	32.53	32.74	32.79
GPRS (GMSK, 1Tx-slot)	32.50	32.71	32.76
GPRS (GMSK, 2Tx-slot)	29.07	29.28	29.33
GPRS (GMSK, 3Tx-slot)	27.74	27.93	27.98
GPRS (GMSK, 4Tx-slot)	27.22	27.42	27.49
EDGE (8PSK, 1Tx-slot)	26.46	26.67	26.72
EDGE (8PSK, 2Tx-slot)	25.35	25.56	25.61
EDGE (8PSK, 3Tx-slot)	24.26	24.47	24.52
EDGE (8PSK, 4Tx-slot)	22.10	22.31	22.36

Band	WCDMA V		
	4132	4182	4233
Channel	826.4	836.4	846.6
Frequency (MHz)	826.4	836.4	846.6
RMC 12.2K	23.03	23.12	23.09
HSDPA Subtest-1	22.04	22.13	22.10
HSDPA Subtest-2	22.02	22.11	22.08
HSDPA Subtest-3	21.54	21.63	21.60
HSDPA Subtest-4	21.50	21.59	21.56
DC-HSDPA Subtest-1	21.93	22.02	21.99
DC-HSDPA Subtest-2	21.91	22.00	21.97
DC-HSDPA Subtest-3	21.43	21.52	21.49
DC-HSDPA Subtest-4	21.39	21.48	21.45
HSUPA Subtest-1	21.89	21.98	21.95
HSUPA Subtest-2	19.86	19.95	19.92
HSUPA Subtest-3	20.88	20.97	20.94
HSUPA Subtest-4	19.89	19.98	19.95
HSUPA Subtest-5	21.93	22.02	21.99

LTE Band 5															
BW	MCS Index	RB Size	RB Offset	Low	Mid	High	3GPP MPR (dB)	BW	MCS Index	RB Size	RB Offset	Low	Mid	High	3GPP MPR (dB)
				20450	20525	20600						20425	20525	20625	
				Channel Frequency (MHz)	829.0	836.5						844.0	Channel Frequency (MHz)	826.5	
10M	QPSK	1	0	23.08	23.16	23.09	0	5M	QPSK	1	0	22.96	23.04	22.97	0
		1	24	23.05	23.13	23.06	0			1	12	22.93	23.01	22.94	0
		1	49	23.02	23.10	23.03	0			1	24	22.90	22.98	22.91	0
		25	0	22.11	22.19	22.12	1			12	0	21.99	22.07	22.00	1
		25	12	22.09	22.17	22.10	1			12	6	21.97	22.05	21.98	1
		25	25	22.07	22.15	22.08	1			12	13	21.95	22.03	21.96	1
		50	0	22.08	22.16	22.09	1			25	0	21.96	22.04	21.97	1
	16QAM	1	0	22.04	22.12	22.05	1		16QAM	1	0	21.92	22.00	21.93	1
		1	24	22.01	22.09	22.02	1			1	12	21.89	21.97	21.90	1
		1	49	21.98	22.06	21.99	1			1	24	21.86	21.94	21.87	1
		25	0	21.07	21.15	21.08	2			12	0	20.95	21.03	20.96	2
		25	12	21.05	21.13	21.06	2			12	6	20.93	21.01	20.94	2
		25	25	21.03	21.11	21.04	2			12	13	20.91	20.99	20.92	2
		50	0	21.04	21.12	21.05	2			25	0	20.92	21.00	20.93	2
BW	MCS Index	RB Size	RB Offset	Low	Mid	High	3GPP MPR (dB)	BW	MCS Index	RB Size	RB Offset	Low	Mid	High	3GPP MPR (dB)
				20415	20525	20635						20407	20525	20643	
				Channel Frequency (MHz)	825.5	836.5						847.5	Channel Frequency (MHz)	824.7	
3M	QPSK	1	0	22.82	22.90	22.83	0	1.4M	QPSK	1	0	22.73	22.81	22.74	0
		1	7	22.79	22.87	22.80	0			1	2	22.70	22.78	22.71	0
		1	14	22.76	22.84	22.77	0			1	5	22.67	22.75	22.68	0
		8	0	21.85	21.93	21.86	1			3	0	22.59	22.67	22.60	0
		8	3	21.83	21.91	21.84	1			3	1	22.57	22.65	22.58	0
		8	7	21.81	21.89	21.82	1			3	3	22.55	22.63	22.56	0
		15	0	21.82	21.90	21.83	1			6	0	21.73	21.81	21.74	1
	16QAM	1	0	21.78	21.86	21.79	1		16QAM	1	0	21.69	21.77	21.70	1
		1	7	21.75	21.83	21.76	1			1	2	21.66	21.74	21.67	1
		1	14	21.72	21.80	21.73	1			1	5	21.63	21.71	21.64	1
		8	0	20.81	20.89	20.82	2			3	0	21.55	21.63	21.56	1
		8	3	20.79	20.87	20.80	2			3	1	21.53	21.61	21.54	1
		8	7	20.77	20.85	20.78	2			3	3	21.51	21.59	21.52	1
		15	0	20.78	20.86	20.79	2			6	0	20.69	20.77	20.70	2

ERP Power (dBm)

Mode A

GSM							
Plane	Channel	Frequency (MHz)	Reading (dBm)	Correction Factor (dB)	ERP (dBm)	ERP (mW)	Polarization (H/V)
X	128	824.2	-0.52	31.208	28.54	714.17	H
	189	836.4	-0.53	31.3	28.62	727.78	
	251	848.8	-0.55	31.222	28.52	711.54	
	128	824.2	-5.80	31.504	23.55	226.67	V
	189	836.4	-5.38	31.117	23.59	228.40	
	251	848.8	-6.27	31.922	23.50	223.98	

Note: ERP (dBm) = Reading (dBm) + Correction Factor (dB) – 2.15

EDGE							
Plane	Channel	Frequency (MHz)	Reading (dBm)	Correction Factor (dB)	ERP (dBm)	ERP (mW)	Polarization (H/V)
X	128	824.2	-7.50	31.208	21.56	143.15	H
	189	836.4	-7.53	31.3	21.62	145.21	
	251	848.8	-7.55	31.222	21.52	141.97	
	128	824.2	-12.81	31.504	16.54	45.12	V
	189	836.4	-12.40	31.117	16.57	45.36	
	251	848.8	-13.26	31.922	16.51	44.79	

Note: ERP (dBm) = Reading (dBm) + Correction Factor (dB) – 2.15

WCDMA							
Plane	Channel	Frequency (MHz)	Reading (dBm)	Correction Factor (dB)	ERP (dBm)	ERP (mW)	Polarization (H/V)
X	4132	826.4	-10.01	31.208	19.05	80.32	H
	4182	836.4	-10.04	31.3	19.11	81.47	
	4233	846.6	-10.06	31.222	19.01	79.65	
	4132	826.4	-14.31	31.504	15.04	31.94	V
	4182	836.4	-13.89	31.117	15.08	32.19	
	4233	846.6	-14.79	31.922	14.98	31.49	

Note: ERP (dBm) = Reading (dBm) + Correction Factor (dB) – 2.15

LTE Band 5							
Channel Bandwidth: 1.4 MHz / QPSK							
Plane	Channel	Frequency (MHz)	Reading (dBm)	Correction Factor (dB)	ERP (dBm)	ERP (mW)	Polarization (H/V)
X	20407	824.7	-10.01	31.208	19.05	80.32	H
	20525	836.5	-10.16	31.3	18.99	79.25	
	20643	848.3	-10.13	31.222	18.94	78.38	
	20407	824.7	-15.28	31.504	14.07	25.55	V
	20525	836.5	-14.92	31.117	14.05	25.39	
	20643	848.3	-15.79	31.922	13.98	25.01	
Channel Bandwidth: 1.4 MHz / 16QAM							
X	20407	824.7	-11.04	31.208	18.02	63.36	H
	20525	836.5	-11.19	31.3	17.96	62.52	
	20643	848.3	-11.16	31.222	17.91	61.83	
	20407	824.7	-16.30	31.504	13.05	20.20	V
	20525	836.5	-15.94	31.117	13.03	20.08	
	20643	848.3	-16.82	31.922	12.95	19.73	

Note: ERP (dBm) = Reading (dBm) + Correction Factor (dB) – 2.15

LTE Band 5							
Channel Bandwidth: 3 MHz / QPSK							
Plane	Channel	Frequency (MHz)	Reading (dBm)	Correction Factor (dB)	ERP (dBm)	ERP (mW)	Polarization (H/V)
X	20415	825.5	-9.98	31.208	19.08	80.87	H
	20525	836.5	-10.12	31.3	19.03	79.98	
	20635	847.5	-10.10	31.222	18.97	78.92	
	20415	825.5	-15.26	31.504	14.09	25.67	V
	20525	836.5	-14.90	31.117	14.07	25.51	
	20635	847.5	-15.76	31.922	14.01	25.19	
Channel Bandwidth: 3 MHz / 16QAM							
X	20415	825.5	-11.00	31.208	18.06	63.94	H
	20525	836.5	-11.14	31.3	18.01	63.24	
	20635	847.5	-11.13	31.222	17.94	62.26	
	20415	825.5	-16.27	31.504	13.08	20.34	V
	20525	836.5	-15.92	31.117	13.05	20.17	
	20635	847.5	-16.77	31.922	13.00	19.96	

Note: ERP (dBm) = Reading (dBm) + Correction Factor (dB) – 2.15

LTE Band 5							
Channel Bandwidth: 5 MHz / QPSK							
Plane	Channel	Frequency (MHz)	Reading (dBm)	Correction Factor (dB)	ERP (dBm)	ERP (mW)	Polarization (H/V)
X	20425	826.5	-9.95	31.208	19.11	81.43	H
	20525	836.5	-10.08	31.3	19.07	80.72	
	20625	846.5	-10.07	31.222	19.00	79.47	
	20425	826.5	-15.24	31.504	14.11	25.79	V
	20525	836.5	-14.87	31.117	14.10	25.69	
	20625	846.5	-15.73	31.922	14.04	25.36	
Channel Bandwidth: 5 MHz / 16QAM							
X	20425	826.5	-10.96	31.208	18.10	64.54	H
	20525	836.5	-11.08	31.3	18.07	64.12	
	20625	846.5	-11.09	31.222	17.98	62.83	
	20425	826.5	-16.25	31.504	13.10	20.44	V
	20525	836.5	-15.88	31.117	13.09	20.36	
	20625	846.5	-16.74	31.922	13.03	20.10	

Note: ERP (dBm) = Reading (dBm) + Correction Factor (dB) – 2.15

LTE Band 5							
Channel Bandwidth: 10 MHz / QPSK							
Plane	Channel	Frequency (MHz)	Reading (dBm)	Correction Factor (dB)	ERP (dBm)	ERP (mW)	Polarization (H/V)
X	20450	829.0	-9.91	31.208	19.15	82.19	H
	20525	836.5	-10.06	31.3	19.09	81.10	
	20600	844.0	-10.04	31.222	19.03	80.02	
	20450	829.0	-15.21	31.504	14.14	25.97	V
	20525	836.5	-14.85	31.117	14.12	25.80	
	20600	844.0	-15.70	31.922	14.07	25.54	
Channel Bandwidth: 10 MHz / 16QAM							
X	20425	826.5	-10.92	31.208	18.14	65.13	H
	20525	836.5	-11.07	31.3	18.08	64.27	
	20625	846.5	-11.06	31.222	18.01	63.27	
	20425	826.5	-16.22	31.504	13.13	20.58	V
	20525	836.5	-15.86	31.117	13.11	20.45	
	20625	846.5	-16.72	31.922	13.05	20.19	

Note: ERP (dBm) = Reading (dBm) + Correction Factor (dB) – 2.15

Mode B

GSM							
Plane	Channel	Frequency (MHz)	Reading (dBm)	Correction Factor (dB)	ERP (dBm)	ERP (mW)	Polarization (H/V)
X	128	824.2	-1.42	31.208	27.64	580.50	H
	189	836.4	-1.62	31.3	27.53	566.24	
	251	848.8	-1.25	31.222	27.82	605.62	
	128	824.2	-6.85	31.504	22.50	177.99	V
	189	836.4	-6.95	31.117	22.02	159.11	
	251	848.8	-6.88	31.922	22.89	194.63	

Note: ERP (dBm) = Reading (dBm) + Correction Factor (dB) – 2.15

LTE Band 5							
Channel Bandwidth: 10 MHz / QPSK							
Plane	Channel	Frequency (MHz)	Reading (dBm)	Correction Factor (dB)	ERP (dBm)	ERP (mW)	Polarization (H/V)
X	20450	829.0	-10.52	31.208	18.54	71.42	H
	20525	836.5	-10.84	31.3	18.31	67.76	
	20600	844.0	-10.76	31.222	18.31	67.80	
	20450	829.0	-15.86	31.504	13.49	22.36	V
	20525	836.5	-15.57	31.117	13.40	21.88	
	20600	844.0	-15.81	31.922	13.96	24.90	
Channel Bandwidth: 10 MHz / 16QAM							
X	20425	826.5	-11.87	31.208	17.19	52.34	H
	20525	836.5	-11.86	31.3	17.29	53.58	
	20625	846.5	-11.81	31.222	17.26	53.24	
	20425	826.5	-16.96	31.504	12.39	17.35	V
	20525	836.5	-16.75	31.117	12.22	16.66	
	20625	846.5	-16.88	31.922	12.89	19.46	

Note: ERP (dBm) = Reading (dBm) + Correction Factor (dB) – 2.15

4.2 Modulation Characteristics Measurement

4.2.1 Limits of Modulation Characteristics

N/A

4.2.2 Test Setup



4.2.3 Test Procedure

Connect the EUT to Communication Simulator via the antenna connector. The frequency band is set as EUT supported Modulation and Channels, the EUT output is matched with 50 ohm load, the waveform quality and constellation of the EUT was tested.

4.2.4 Test Results

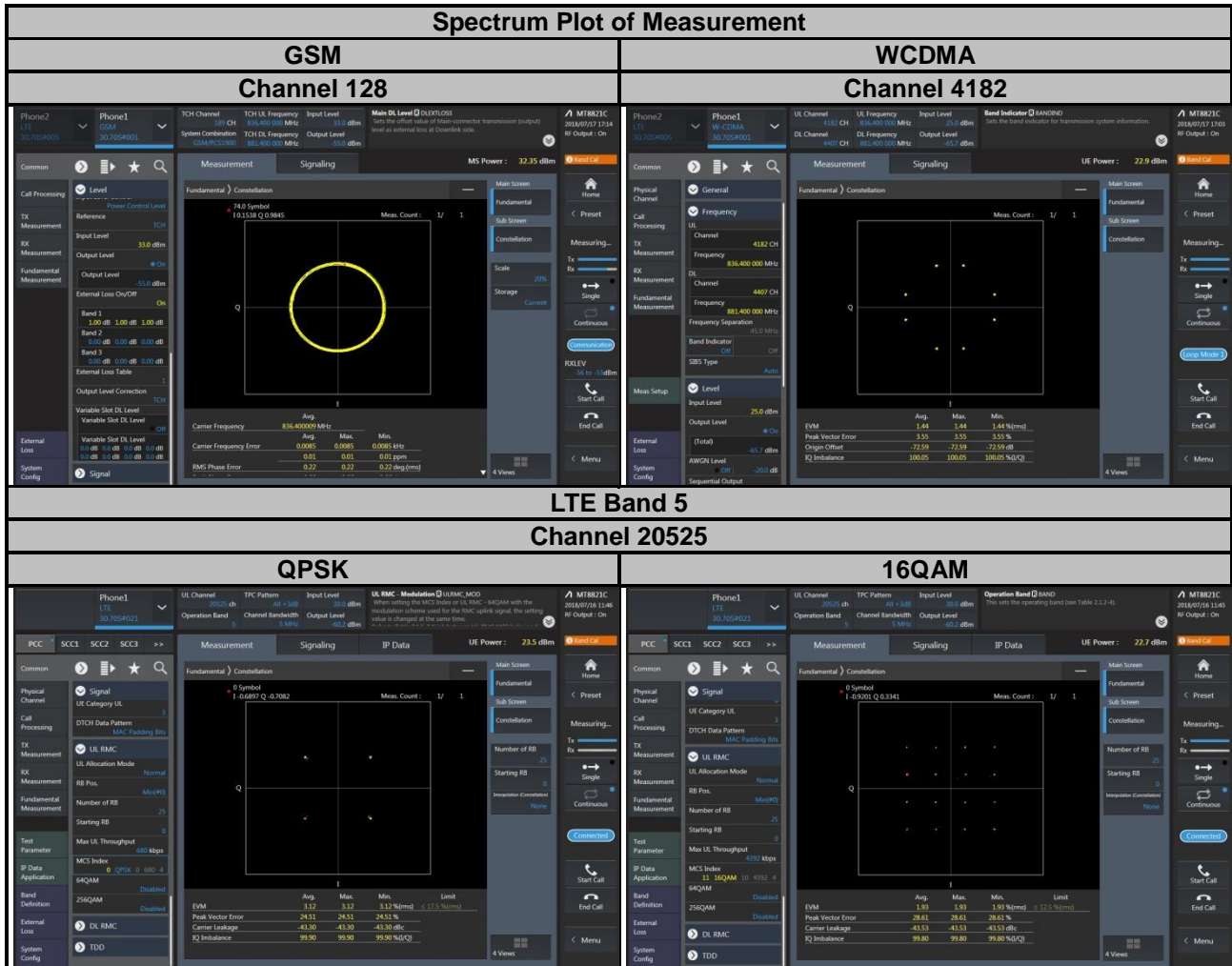

4.3 Frequency Stability Measurement

4.3.1 Limits of Frequency Stability Measurement

1.5 ppm is for base and fixed station. 2.5 ppm is for mobile station.

4.3.2 Test Procedure

- a. Device is placed at the oven room. The oven room could control the temperatures and humidity. Power warm up is at least 15 min and power applied should perform before recording frequency error.
- b. EUT is connected the external power supply to control the DC input power. The test voltage range is from minimum to maximum working voltage. Each step shall be record the frequency error rate.
- c. The temperature range step is 10 degrees in this test items. All temperature levels shall be hold the ± 0.5 °C during the measurement testing. The each temperature step shall be at least 0.5 hours, consider the EUT could be test under the stability condition.

NOTE: The frequency error was recorded frequency error from the communication simulator.

4.3.3 Test Setup

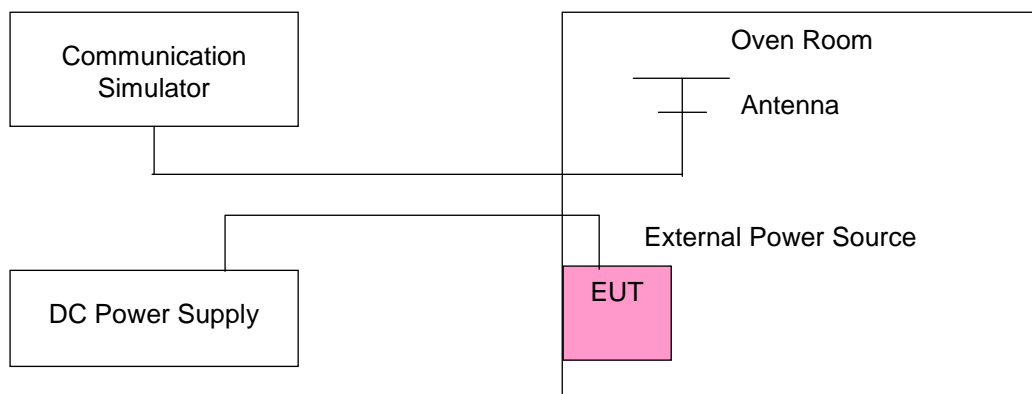

4.3.4 Test Results

Frequency Error vs. Voltage

Voltage (Volts)	GSM				Limit (ppm)
	Low Channel		High Channel		
	Frequency (MHz)	Frequency Error (ppm)	Frequency (MHz)	Frequency Error (ppm)	
3.85	824.200003	0.003	848.800003	0.003	2.5
3.27	824.200004	0.004	848.800001	0.001	2.5
4.42	824.200002	0.003	848.800001	0.002	2.5

Note: The applicant defined the normal working voltage of the battery is from 3.27 Vdc to 4.42 Vdc.

Frequency Error vs. Temperature

Temp. (°C)	GSM				Limit (ppm)
	Low Channel		High Channel		
	Frequency (MHz)	Frequency Error (ppm)	Frequency (MHz)	Frequency Error (ppm)	
-30	824.200003	0.004	848.800002	0.003	2.5
-20	824.200003	0.004	848.800003	0.004	2.5
-10	824.200004	0.004	848.800004	0.004	2.5
0	824.200004	0.005	848.800004	0.004	2.5
10	824.200003	0.004	848.800003	0.003	2.5
20	824.199996	-0.004	848.799999	-0.002	2.5
30	824.199996	-0.005	848.799997	-0.004	2.5
40	824.199999	-0.002	848.799997	-0.004	2.5
50	824.199998	-0.003	848.799997	-0.003	2.5
55	824.199998	-0.003	848.799998	-0.002	2.5

Frequency Error vs. Voltage

Voltage (Volts)	EDGE				Limit (ppm)
	Low Channel		High Channel		
	Frequency (MHz)	Frequency Error (ppm)	Frequency (MHz)	Frequency Error (ppm)	
3.85	824.200003	0.004	848.800004	0.004	2.5
3.27	824.200003	0.004	848.800002	0.002	2.5
4.42	824.200002	0.002	848.800004	0.004	2.5

Note: The applicant defined the normal working voltage of the battery is from 3.27 Vdc to 4.42 Vdc.

Frequency Error vs. Temperature

Temp. (°C)	EDGE				Limit (ppm)
	Low Channel		High Channel		
	Frequency (MHz)	Frequency Error (ppm)	Frequency (MHz)	Frequency Error (ppm)	
-30	824.200004	0.004	848.800002	0.002	2.5
-20	824.200001	0.002	848.800002	0.002	2.5
-10	824.200003	0.003	848.800003	0.003	2.5
0	824.200003	0.004	848.800004	0.005	2.5
10	824.200003	0.004	848.800001	0.001	2.5
20	824.199999	-0.002	848.799997	-0.003	2.5
30	824.199997	-0.004	848.799998	-0.003	2.5
40	824.199998	-0.003	848.799997	-0.003	2.5
50	824.199998	-0.003	848.799997	-0.004	2.5
55	824.199998	-0.002	848.799998	-0.003	2.5

Frequency Error vs. Voltage

Voltage (Volts)	WCDMA				Limit (ppm)
	Low Channel		High Channel		
	Frequency (MHz)	Frequency Error (ppm)	Frequency (MHz)	Frequency Error (ppm)	
3.85	826.400003	0.003	846.600003	0.004	2.5
3.27	826.400004	0.005	846.600004	0.005	2.5
4.42	826.400003	0.004	846.600002	0.002	2.5

Note: The applicant defined the normal working voltage of the battery is from 3.27 Vdc to 4.42 Vdc.

Frequency Error vs. Temperature

Temp. (°C)	WCDMA				Limit (ppm)
	Low Channel		High Channel		
	Frequency (MHz)	Frequency Error (ppm)	Frequency (MHz)	Frequency Error (ppm)	
-30	826.400002	0.003	846.600003	0.004	2.5
-20	826.400002	0.003	846.600002	0.002	2.5
-10	826.400003	0.004	846.600002	0.002	2.5
0	826.400001	0.001	846.600001	0.001	2.5
10	826.400002	0.003	846.600002	0.002	2.5
20	826.399997	-0.004	846.599999	-0.002	2.5
30	826.399998	-0.002	846.599998	-0.002	2.5
40	826.399999	-0.001	846.599996	-0.004	2.5
50	826.399997	-0.004	846.599998	-0.002	2.5
55	826.399997	-0.004	846.599998	-0.003	2.5

Frequency Error vs. Voltage

Voltage (Volts)	LTE Band 5				Limit (ppm)
	Channel Bandwidth: 1.4 MHz				
	Low Channel		High Channel		
	Frequency (MHz)	Frequency Error (ppm)	Frequency (MHz)	Frequency Error (ppm)	
3.85	824.700003	0.003	848.300001	0.001	2.5
3.27	824.700002	0.003	848.300004	0.004	2.5
4.42	824.700004	0.004	848.300003	0.003	2.5

Note: The applicant defined the normal working voltage of the battery is from 3.27 Vdc to 4.42 Vdc.

Frequency Error vs. Temperature

Temp. (°C)	LTE Band 5				Limit (ppm)
	Channel Bandwidth: 1.4 MHz				
	Low Channel		High Channel		
	Frequency (MHz)	Frequency Error (ppm)	Frequency (MHz)	Frequency Error (ppm)	
-30	824.700003	0.004	848.300002	0.002	2.5
-20	824.700004	0.005	848.300003	0.003	2.5
-10	824.700001	0.001	848.300004	0.005	2.5
0	824.700003	0.003	848.300003	0.004	2.5
10	824.700002	0.002	848.300003	0.004	2.5
20	824.699997	-0.003	848.299997	-0.003	2.5
30	824.699999	-0.002	848.299997	-0.004	2.5
40	824.699996	-0.004	848.299999	-0.002	2.5
50	824.699998	-0.002	848.299999	-0.002	2.5
55	824.699999	-0.001	848.299999	-0.002	2.5

Frequency Error vs. Voltage

Voltage (Volts)	LTE Band 5				Limit (ppm)
	Channel Bandwidth: 3 MHz				
	Low Channel		High Channel		
	Frequency (MHz)	Frequency Error (ppm)	Frequency (MHz)	Frequency Error (ppm)	
3.85	825.500002	0.002	847.500004	0.005	2.5
3.27	825.500004	0.004	847.500004	0.004	2.5
4.42	825.500004	0.005	847.500004	0.004	2.5

Note: The applicant defined the normal working voltage of the battery is from 3.27 Vdc to 4.42 Vdc.

Frequency Error vs. Temperature

Temp. (°C)	LTE Band 5				Limit (ppm)
	Channel Bandwidth: 3 MHz				
	Low Channel		High Channel		
	Frequency (MHz)	Frequency Error (ppm)	Frequency (MHz)	Frequency Error (ppm)	
-30	825.500002	0.003	847.500001	0.002	2.5
-20	825.500004	0.004	847.500004	0.004	2.5
-10	825.500003	0.003	847.500002	0.002	2.5
0	825.500002	0.002	847.500002	0.002	2.5
10	825.500002	0.003	847.500002	0.002	2.5
20	825.499998	-0.002	847.499996	-0.004	2.5
30	825.499999	-0.002	847.499999	-0.002	2.5
40	825.499998	-0.003	847.499999	-0.001	2.5
50	825.499998	-0.003	847.499998	-0.002	2.5
55	825.499998	-0.003	847.499999	-0.002	2.5

Frequency Error vs. Voltage

Voltage (Volts)	LTE Band 5				Limit (ppm)
	Channel Bandwidth: 5 MHz				
	Low Channel		High Channel		
	Frequency (MHz)	Frequency Error (ppm)	Frequency (MHz)	Frequency Error (ppm)	
3.85	826.500003	0.004	846.500002	0.002	2.5
3.27	826.500004	0.004	846.500002	0.003	2.5
4.42	826.500004	0.005	846.500003	0.004	2.5

Note: The applicant defined the normal working voltage of the battery is from 3.27 Vdc to 4.42 Vdc.

Frequency Error vs. Temperature

Temp. (°C)	LTE Band 5				Limit (ppm)
	Channel Bandwidth: 5 MHz				
	Low Channel		High Channel		
	Frequency (MHz)	Frequency Error (ppm)	Frequency (MHz)	Frequency Error (ppm)	
-30	826.500002	0.002	846.500003	0.004	2.5
-20	826.500004	0.004	846.500001	0.001	2.5
-10	826.500002	0.002	846.500002	0.002	2.5
0	826.500003	0.004	846.500001	0.002	2.5
10	826.500003	0.004	846.500004	0.005	2.5
20	826.499996	-0.005	846.499998	-0.002	2.5
30	826.499998	-0.003	846.499997	-0.003	2.5
40	826.499998	-0.002	846.499998	-0.003	2.5
50	826.499999	-0.001	846.499996	-0.004	2.5
55	826.499999	-0.001	846.499997	-0.004	2.5

Frequency Error vs. Voltage

Voltage (Volts)	LTE Band 5				Limit (ppm)
	Channel Bandwidth: 10 MHz				
	Low Channel		High Channel		
	Frequency (MHz)	Frequency Error (ppm)	Frequency (MHz)	Frequency Error (ppm)	
3.85	829.000002	0.003	844.000003	0.004	2.5
3.27	829.000003	0.004	844.000004	0.004	2.5
4.42	829.000003	0.004	844.000003	0.003	2.5

Note: The applicant defined the normal working voltage of the battery is from 3.27 Vdc to 4.42 Vdc.

Frequency Error vs. Temperature

Temp. (°C)	LTE Band 5				Limit (ppm)
	Channel Bandwidth: 10 MHz				
	Low Channel		High Channel		
	Frequency (MHz)	Frequency Error (ppm)	Frequency (MHz)	Frequency Error (ppm)	
-30	829.000001	0.002	844.000004	0.004	2.5
-20	829.000002	0.003	844.000003	0.004	2.5
-10	829.000003	0.003	844.000002	0.002	2.5
0	829.000001	0.001	844.000002	0.002	2.5
10	829.000001	0.001	844.000004	0.005	2.5
20	828.999998	-0.003	843.999998	-0.002	2.5
30	828.999998	-0.003	843.999998	-0.002	2.5
40	828.999996	-0.005	843.999998	-0.002	2.5
50	828.999998	-0.003	843.999998	-0.002	2.5
55	828.999998	-0.003	843.999997	-0.003	2.5

4.4 Occupied Bandwidth Measurement

4.4.1 Test Procedure

The EUT makes a call to the communication simulator. All measurements were done at low, middle and high operational frequency range. The communication simulator station system controlled a EUT to export maximum output power under transmission mode and specific channel frequency. Use OBW measurement function of Spectrum analyzer to measure 99 % occupied bandwidth.

4.4.2 Test Setup

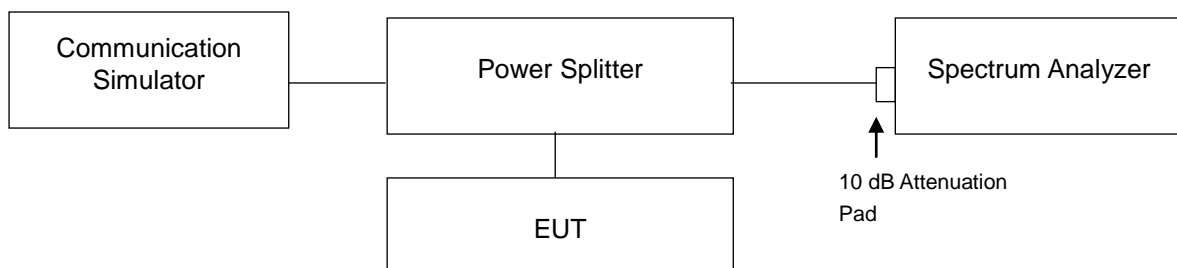

4.4.3 Test Result

Channel	Frequency (MHz)	99 % Occupied Bandwidth (kHz)		Channel	Frequency (MHz)	99 % Occupied Bandwidth (MHz)
		GSM	EDGE			WCDMA
128	824.2	242.50	246.28	4132	826.4	4.1503
189	836.4	244.86	244.25	4182	836.4	4.1527
251	848.8	243.84	247.77	4233	846.6	4.1571

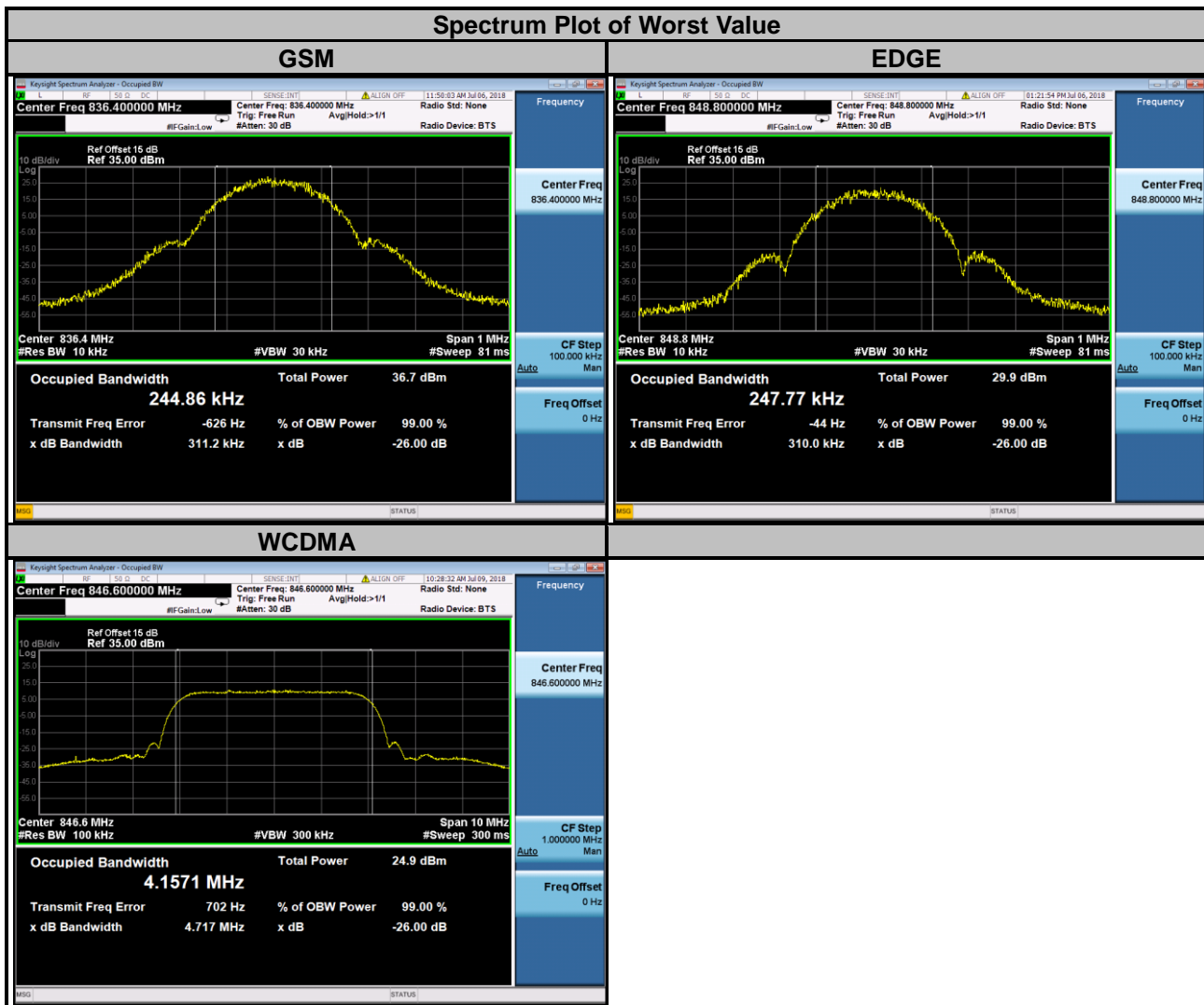

LTE Band 5							
Channel Bandwidth: 1.4 MHz				Channel Bandwidth: 3 MHz			
Channel	Frequency (MHz)	99 % Occupied Bandwidth (MHz)		Channel	Frequency (MHz)	99 % Occupied Bandwidth (MHz)	
		QPSK	16QAM			QPSK	16QAM
20407	824.7	1.0882	1.0901	20415	825.5	2.6994	2.6971
20525	836.5	1.0863	1.0899	20525	836.5	2.7000	2.6975
20643	848.3	1.0877	1.0889	20635	847.5	2.7028	2.6986

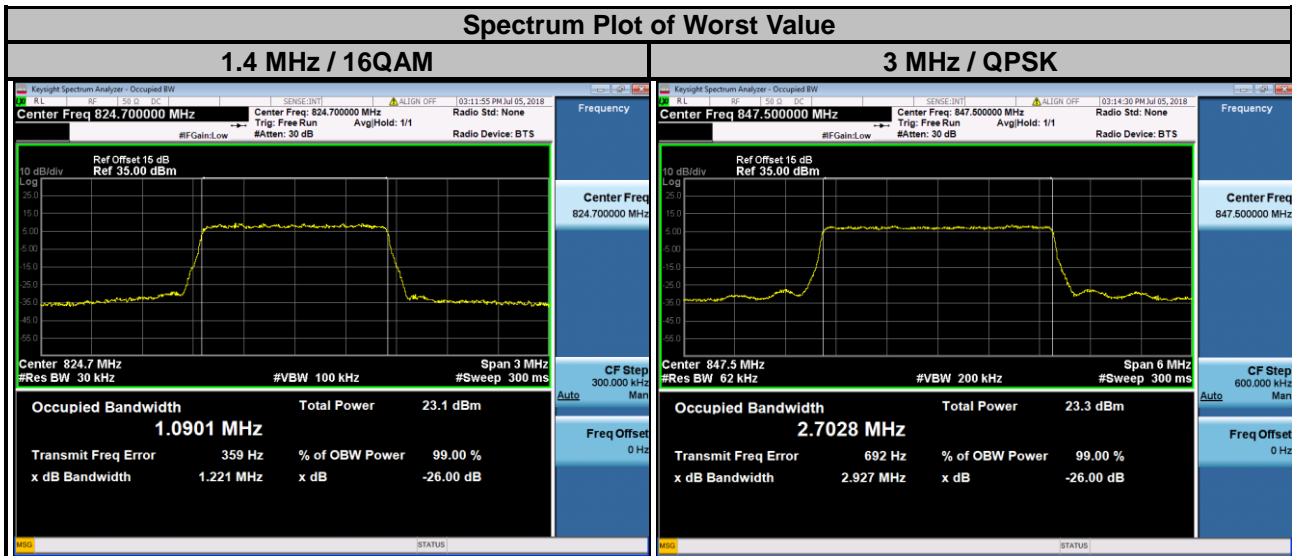

LTE Band 5							
Channel Bandwidth: 5 MHz				Channel Bandwidth: 10 MHz			
Channel	Frequency (MHz)	99 % Occupied Bandwidth (MHz)		Channel	Frequency (MHz)	99 % Occupied Bandwidth (MHz)	
		QPSK	16QAM			QPSK	16QAM
20425	826.5	4.4918	4.4954	20450	829.0	8.9758	8.9790
20525	836.5	4.4930	4.4948	20525	836.5	8.9655	8.9698
20625	846.5	4.4974	4.4982	20600	844.0	8.9728	8.9747

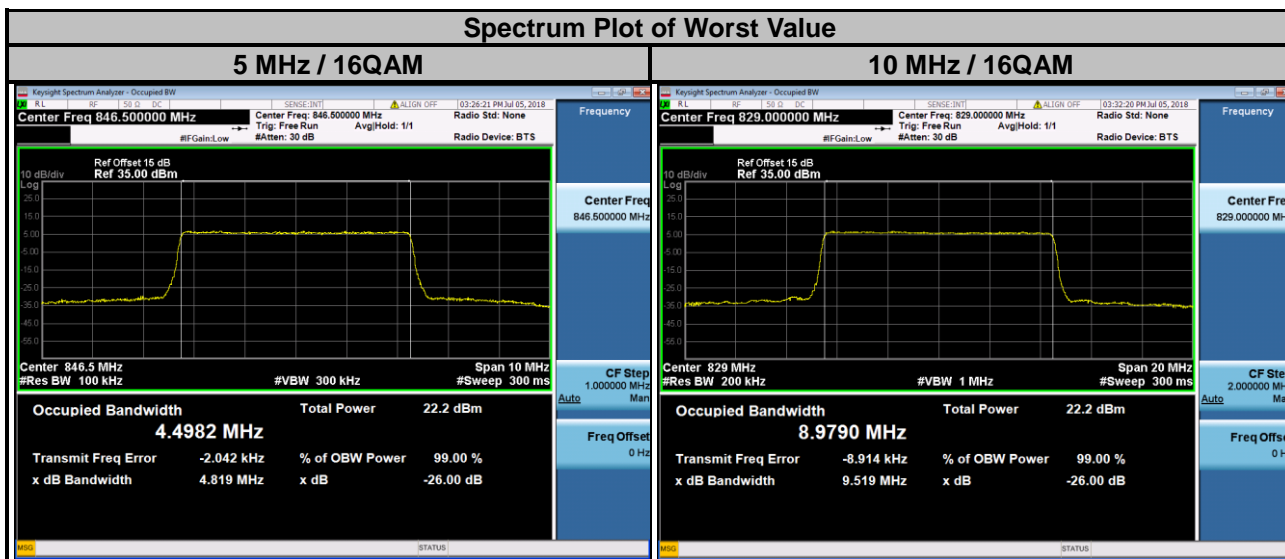

4.5 Band Edge Measurement

4.5.1 Limits of Band Edge Measurement

Power of any emission outside of the authorized operating frequency ranges must be attenuated below the transmitting power (P) by a factor of at least $43 + 10 \log(P)$ dB. In the 1 MHz bands immediately outside and adjacent to the frequency block a resolution bandwidth of at least one percent of the emission bandwidth of the fundamental emission of the transmitter may be employed.

4.5.2 Test Setup

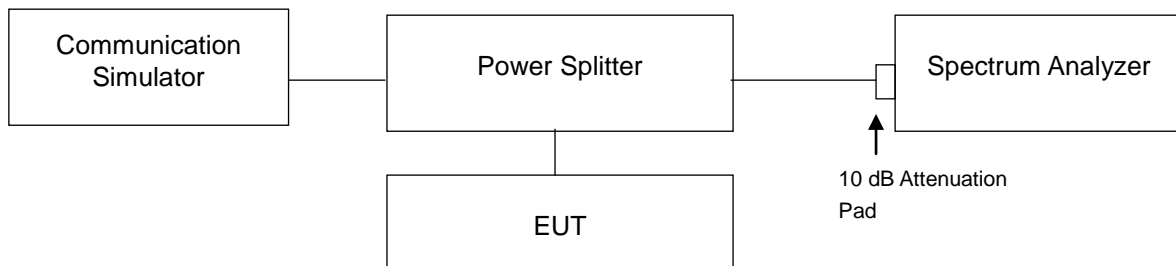

4.5.3 Test Procedures

- All measurements were done at low and high operational frequency range.
- The center frequency of spectrum is the band edge frequency and span is 1 MHz. RB of the spectrum is 10 kHz and VB of the spectrum is 30 kHz (GSM/GPRS/EDGE).
- The center frequency of spectrum is the band edge frequency and span is 5 MHz. RB of the spectrum is 100 kHz and VB of the spectrum is 300 kHz (WCDMA).
- The center frequency of spectrum is the band edge frequency and span is 1 MHz. RB of the spectrum is 30 kHz and VB of the spectrum is 100 kHz (LTE Bandwidth 1.4 MHz).
- The center frequency of spectrum is the band edge frequency and span is 1 MHz. RB of the spectrum is 62 kHz and VB of the spectrum is 200 kHz (LTE Bandwidth 3 MHz).
- The center frequency of spectrum is the band edge frequency and span is 1 MHz. RB of the spectrum is 100 kHz and VB of the spectrum is 300 kHz (LTE Bandwidth 5 MHz).
- The center frequency of spectrum is the band edge frequency and span is 1 MHz. RB of the spectrum is 200 kHz and VB of the spectrum is 1 MHz (LTE Bandwidth 10 MHz).
- Record the max trace plot into the test report.

4.5.4 Test Results

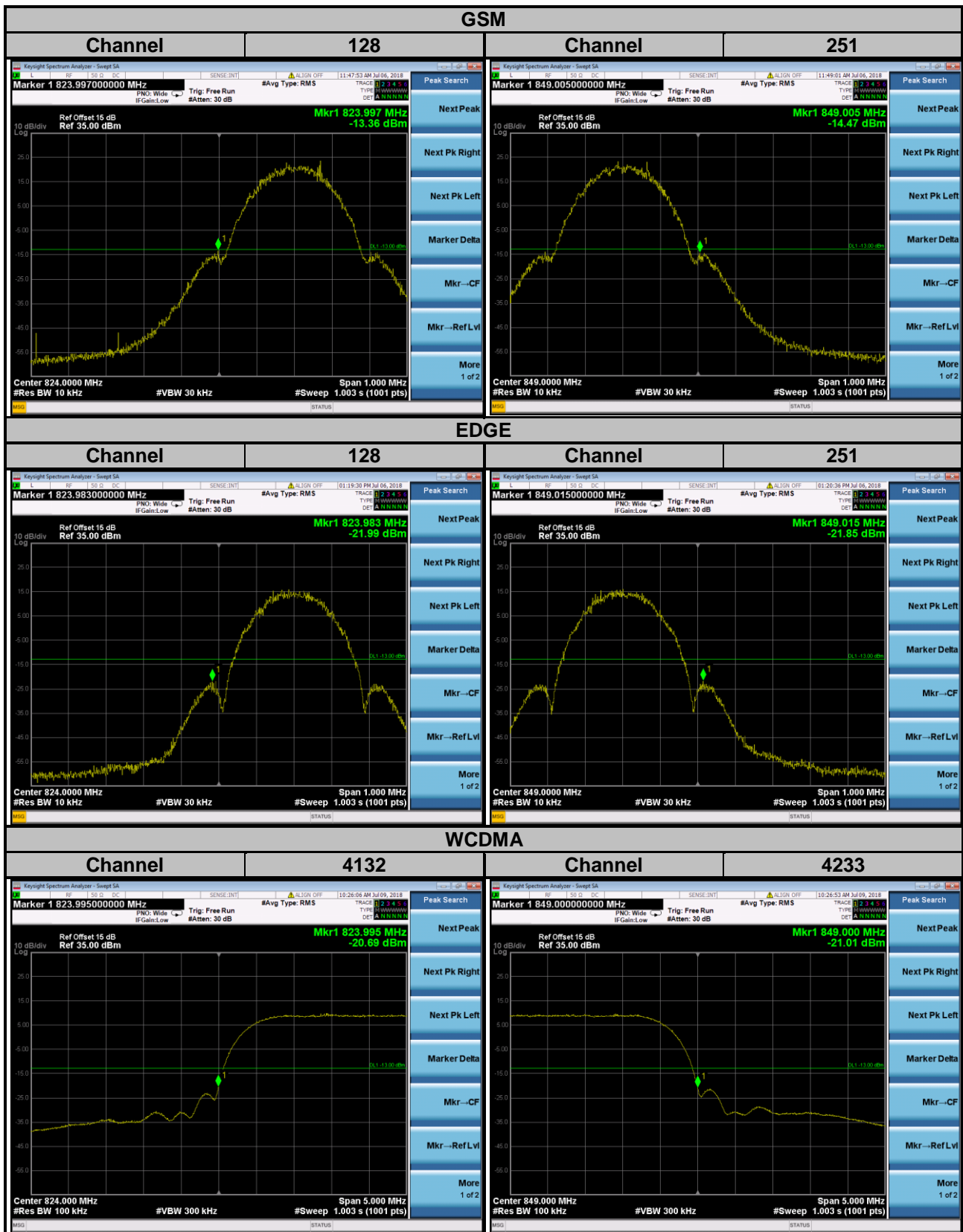

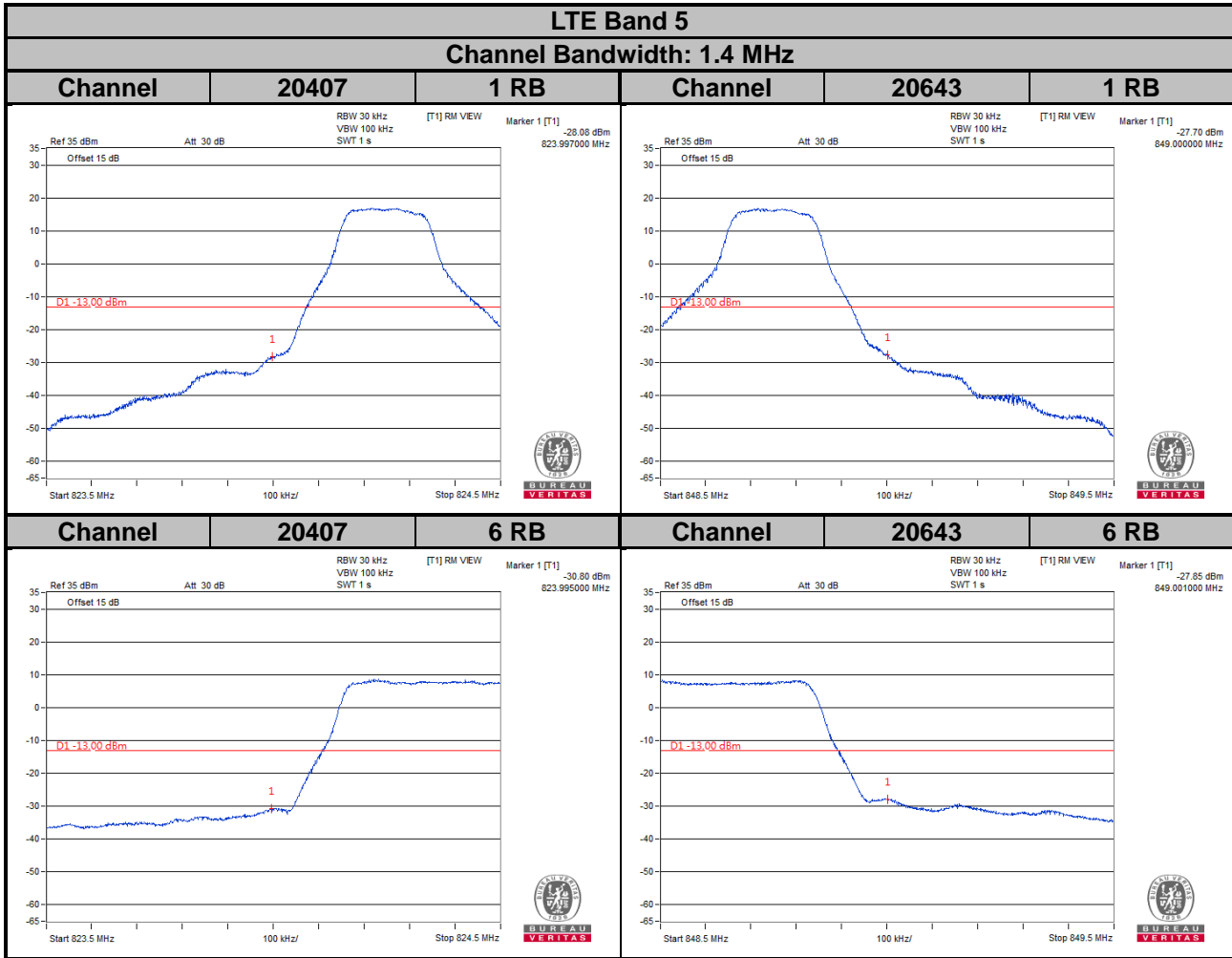

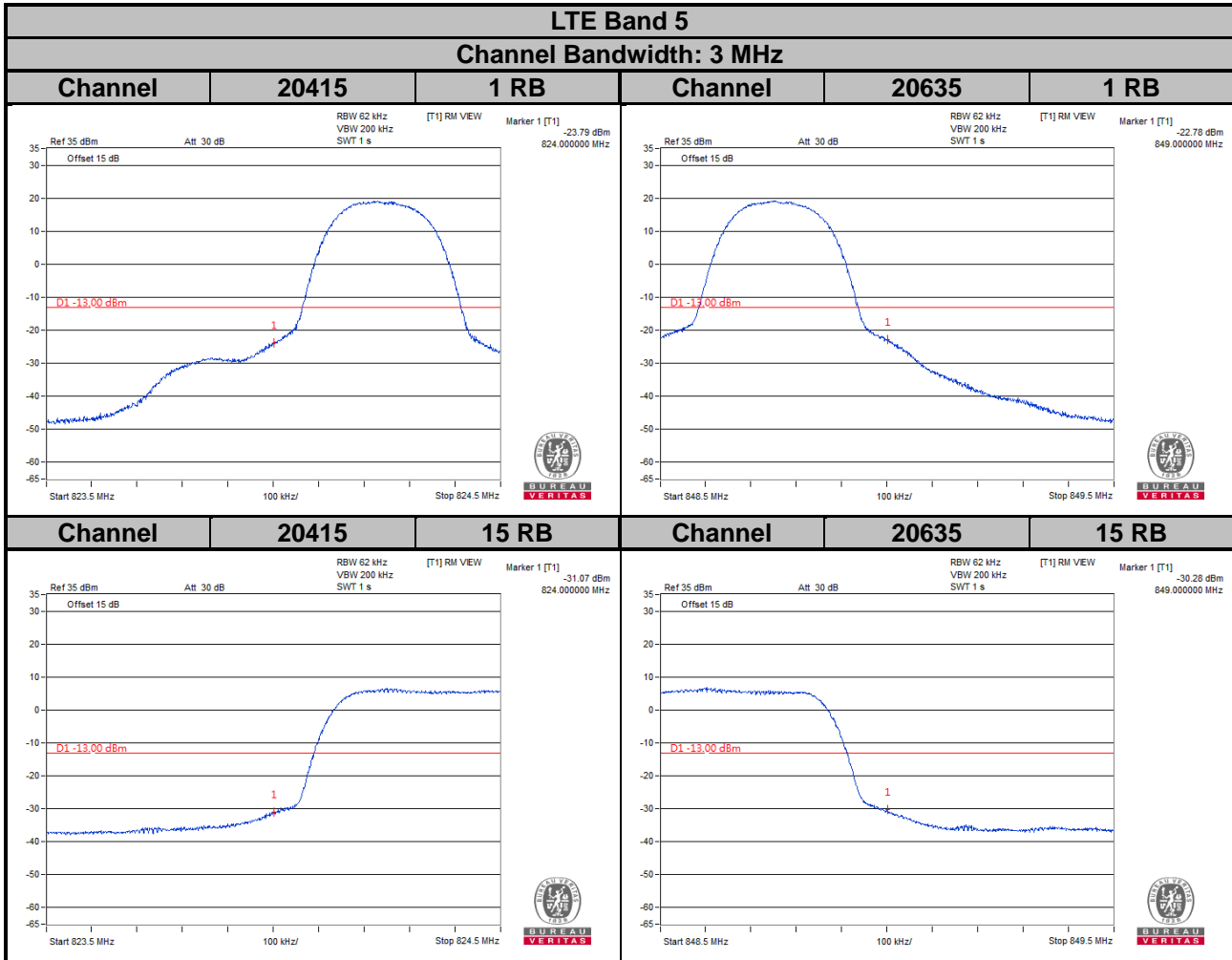

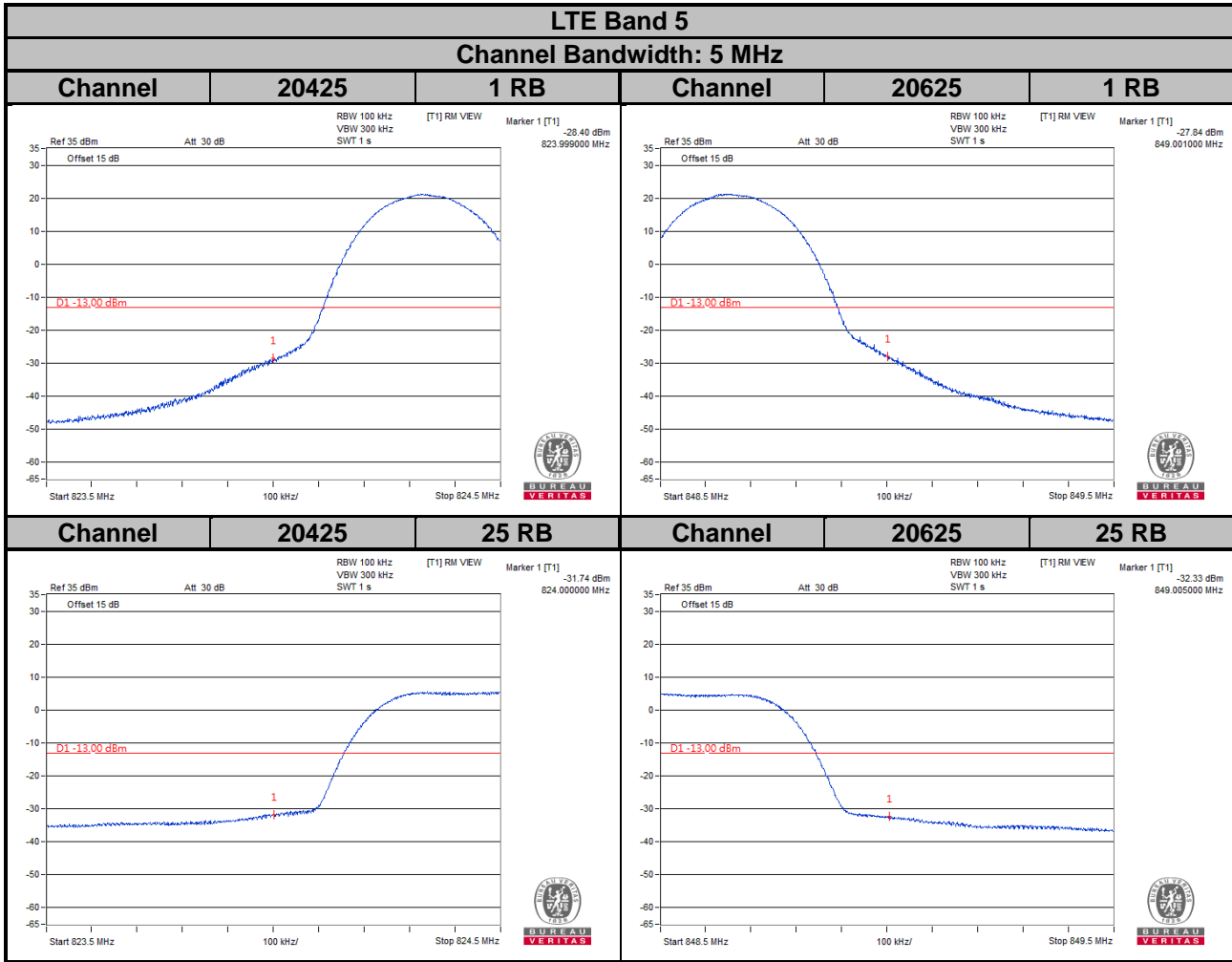

LTE Band 5
Channel Bandwidth: 10 MHz

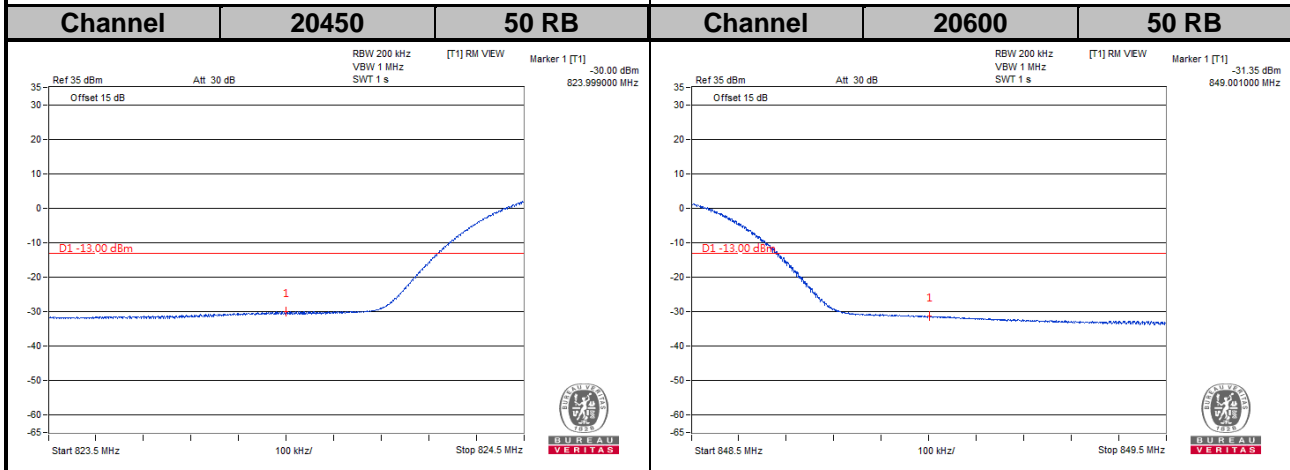
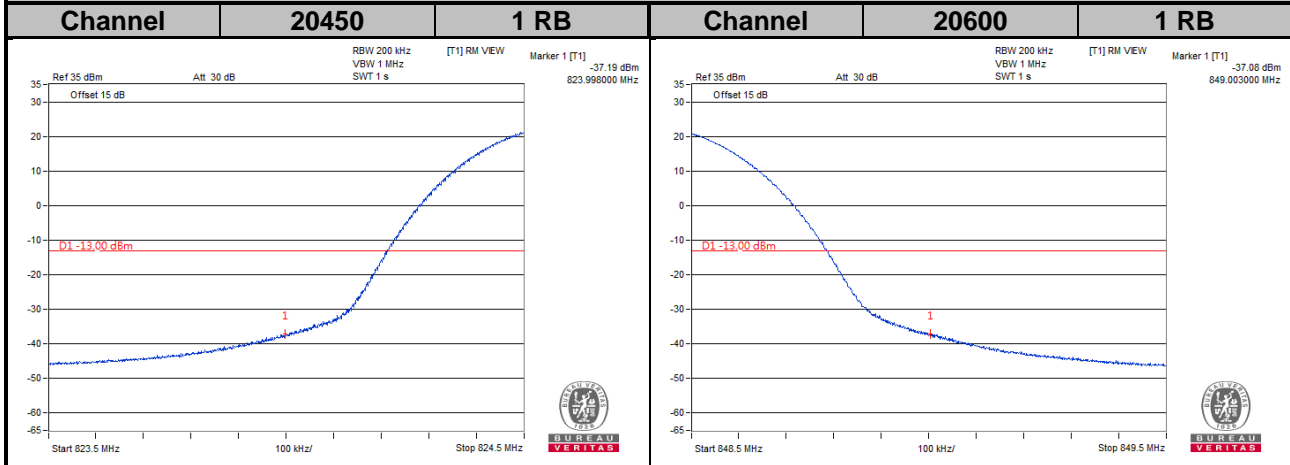

4.6 Peak to Average Ratio

4.6.1 Limits of Peak to Average Ratio Measurement

In measuring transmissions in this band using an average power technique, the peak to-average ratio (PAR) of the transmission may not exceed 13 dB.

4.6.2 Test Setup

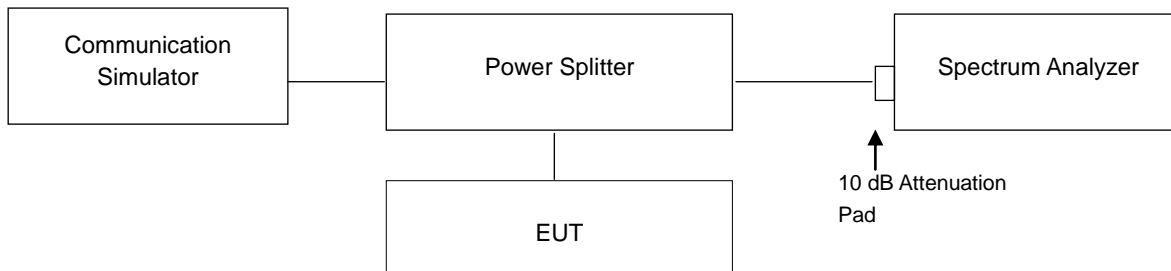

4.6.3 Test Procedures

1. Set resolution/measurement bandwidth \geq signal's occupied bandwidth;
2. Set the number of counts to a value that stabilizes the measured CCDF curve;
3. Record the maximum PAPR level associated with a probability of 0.1 %.

4.6.4 Test Results

Channel	Frequency (MHz)	Peak to Average Ratio (dB)		Channel	Frequency (MHz)	Peak to Average Ratio (dB)
		GSM	EDGE			
128	824.2	0.48	3.38	4132	826.4	3.16
189	836.4	0.50	3.35	4182	836.4	3.23
251	848.8	0.47	3.33	4233	846.6	3.25

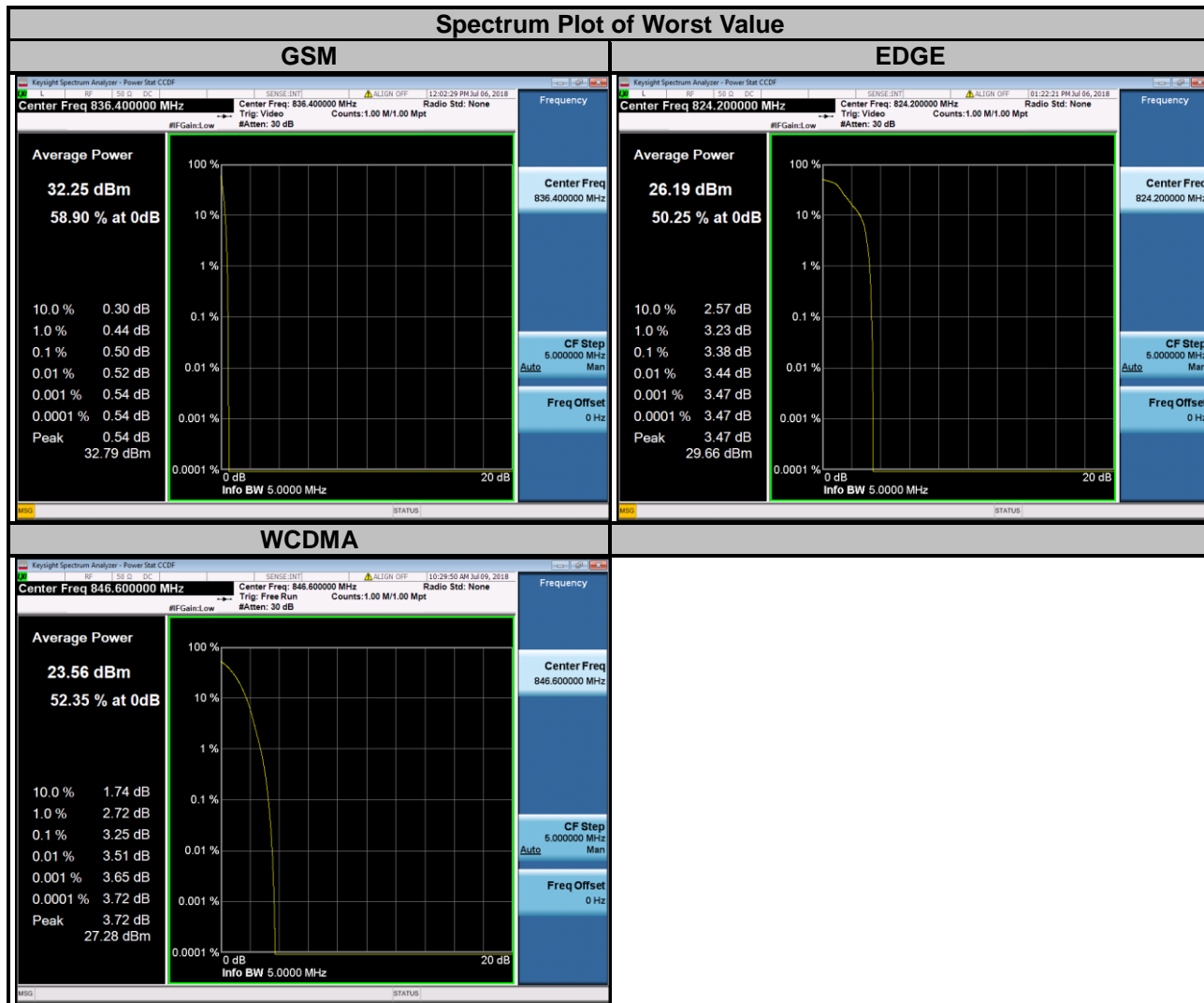

LTE Band 5

Channel Bandwidth: 1.4 MHz				Channel Bandwidth: 3 MHz			
Channel	Frequency (MHz)	Peak to Average Ratio (dB)		Channel	Frequency (MHz)	Peak to Average Ratio (dB)	
		QPSK	16QAM			QPSK	16QAM
20407	824.7	4.01	5.68	20415	825.5	3.81	5.53
20525	836.5	4.20	6.06	20525	836.5	3.95	5.86
20643	848.3	4.30	6.05	20635	847.5	4.03	5.74

Spectrum Plot of Worst Value

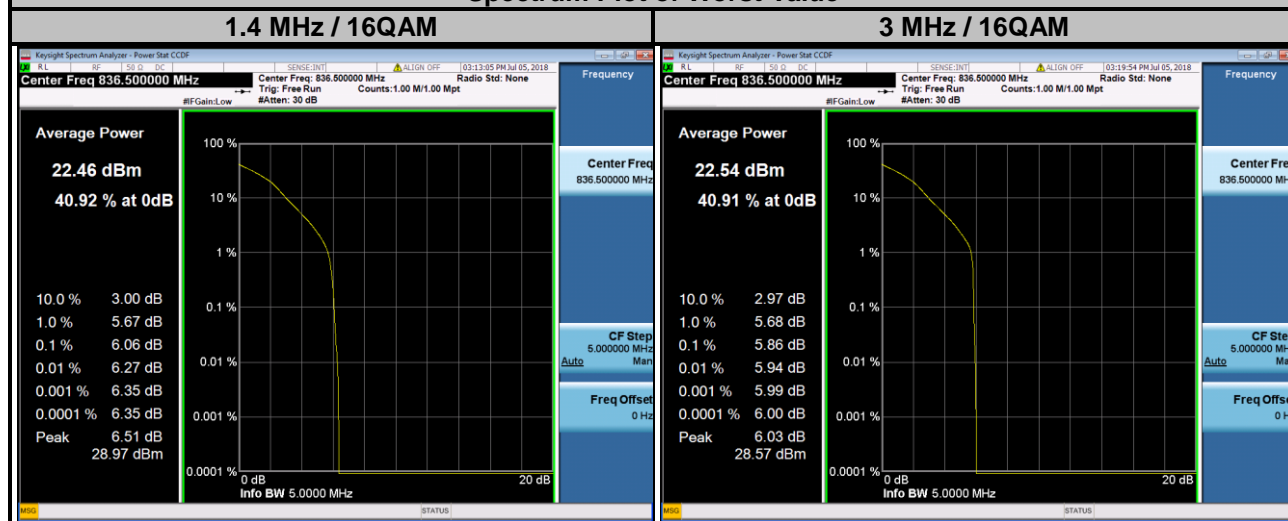

LTE Band 5							
Channel Bandwidth: 5 MHz				Channel Bandwidth: 10 MHz			
Channel	Frequency (MHz)	Peak to Average Ratio (dB)		Channel	Frequency (MHz)	Peak to Average Ratio (dB)	
		QPSK	16QAM			QPSK	16QAM
20425	826.5	3.81	5.48	20450	829.0	3.68	5.44
20525	836.5	3.97	5.87	20525	836.5	3.87	5.71
20625	846.5	3.84	5.54	20600	844.0	3.74	5.53

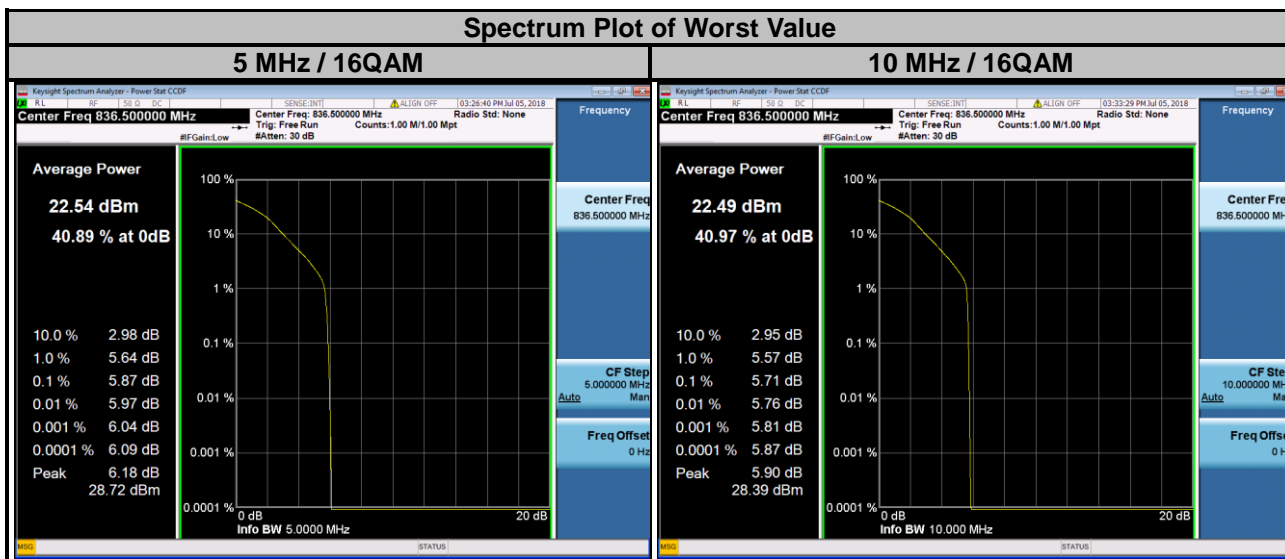

4.7 Conducted Spurious Emissions

4.7.1 Limits of Conducted Spurious Emissions Measurement

The power of any emission outside of the authorized operating frequency ranges must be attenuated below the transmitting power (P) by a factor of at least $43 + 10 \log(P)$ dB. The emission limit equal to -13 dBm.

4.7.2 Test Setup

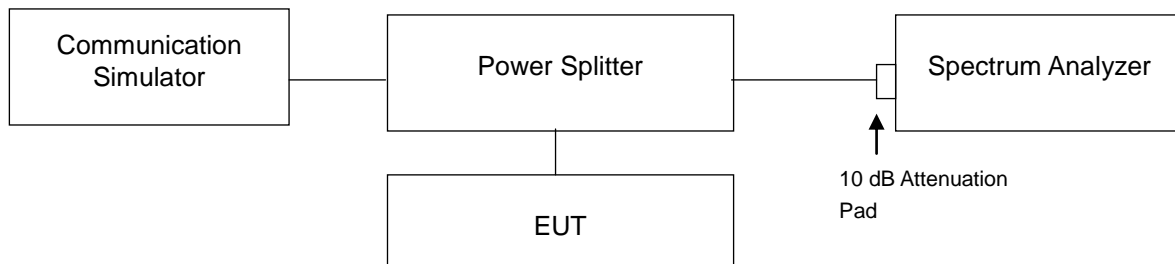

4.7.3 Test Procedure

- The EUT makes a phone call to the communication simulator. All measurements were done at low, middle and high operational frequency range.
- Measuring frequency range from 9 kHz to 1 GHz, 10 dB attenuation pad is connected with spectrum. RBW = 100 kHz and VBW = 300 kHz is used for conducted emission measurement.
- Measuring frequency range from 1 GHz to 10 GHz, 10 dB attenuation pad is connected with spectrum. RBW = 1 MHz and VBW = 3 MHz is used for conducted emission measurement.

4.7.4 Test Results

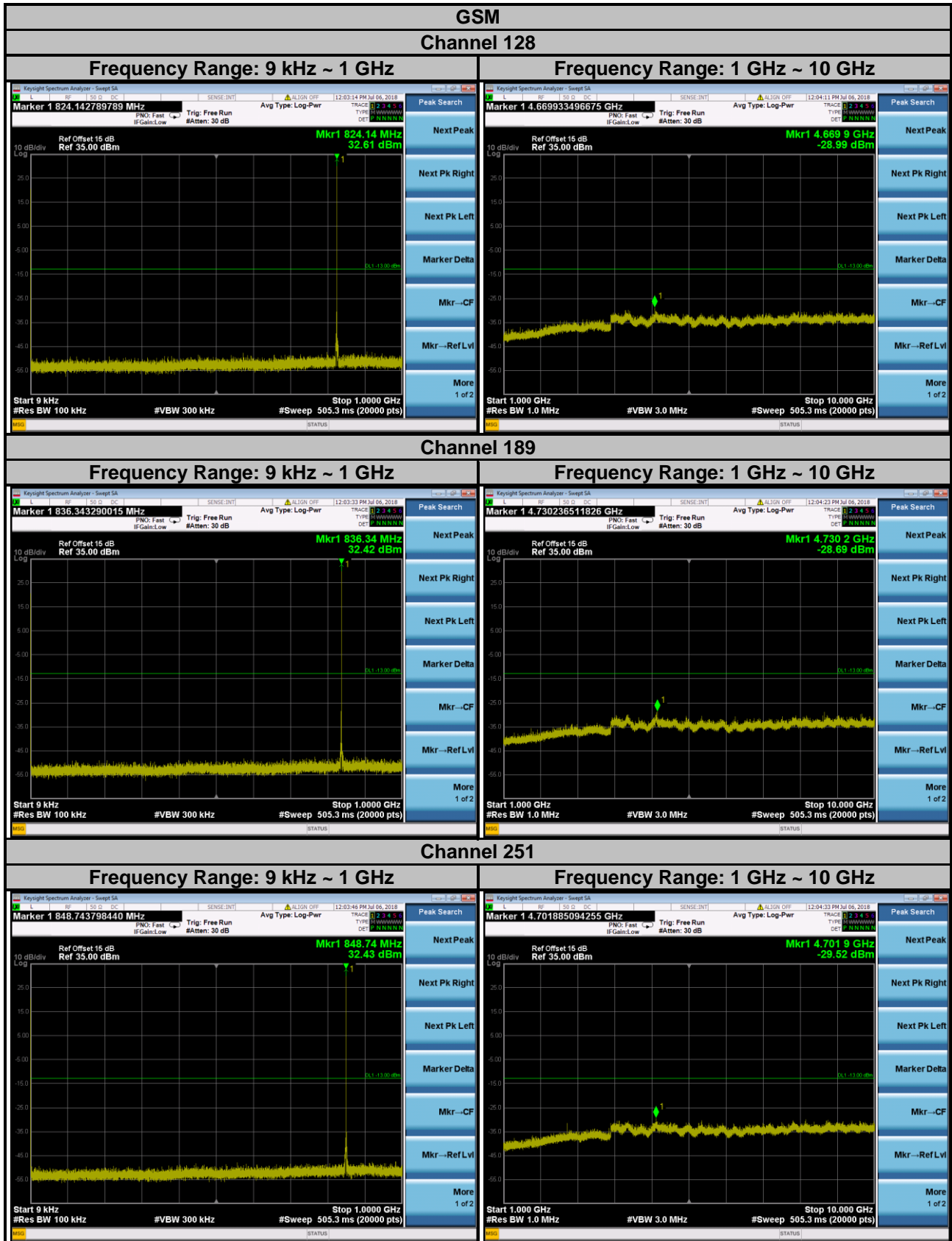

EDGE Channel 128

Frequency Range: 9 kHz ~ 1 GHz

Frequency Range: 1 GHz ~ 10 GHz

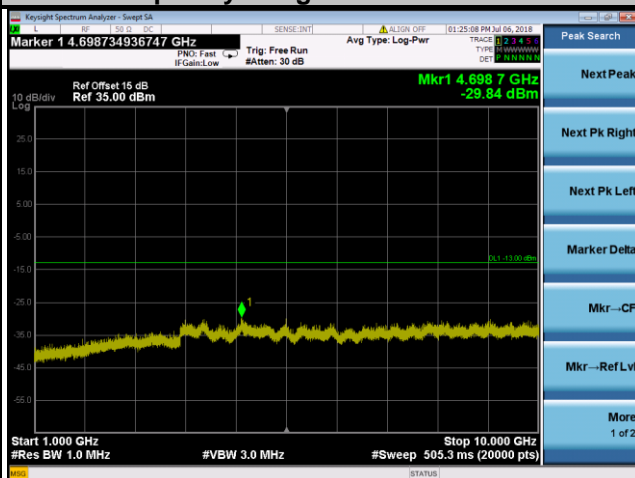
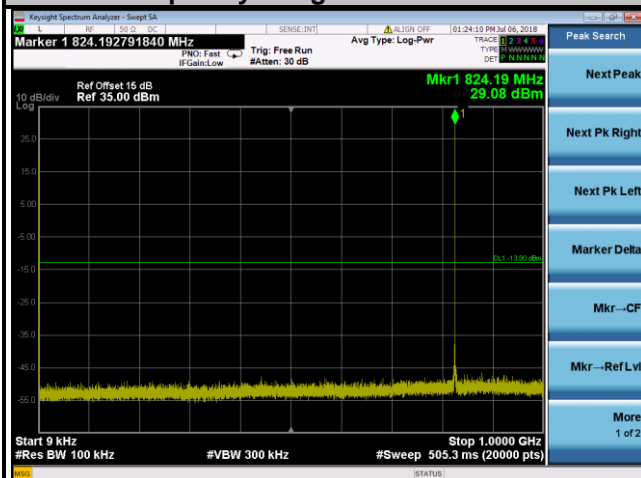

Channel 189

Frequency Range: 9 kHz ~ 1 GHz

Frequency Range: 1 GHz ~ 10 GHz

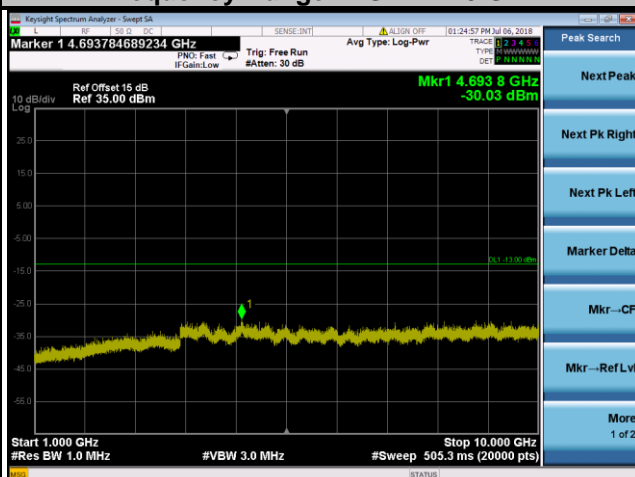
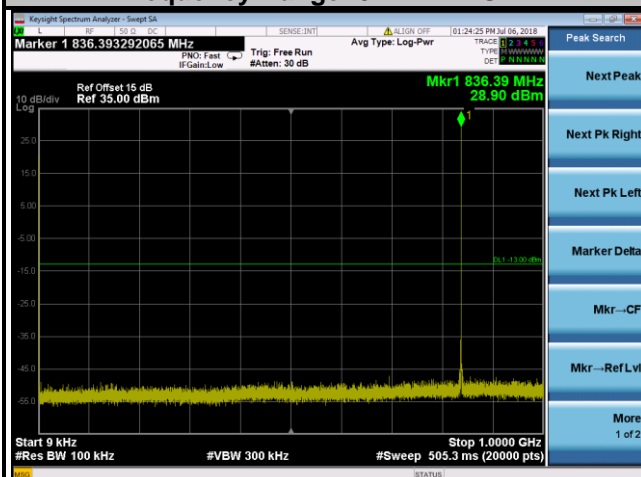

Channel 251

Frequency Range: 9 kHz ~ 1 GHz

Frequency Range: 1 GHz ~ 10 GHz

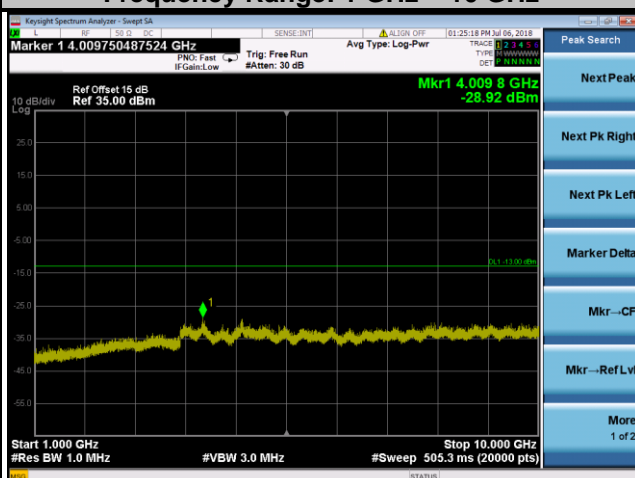
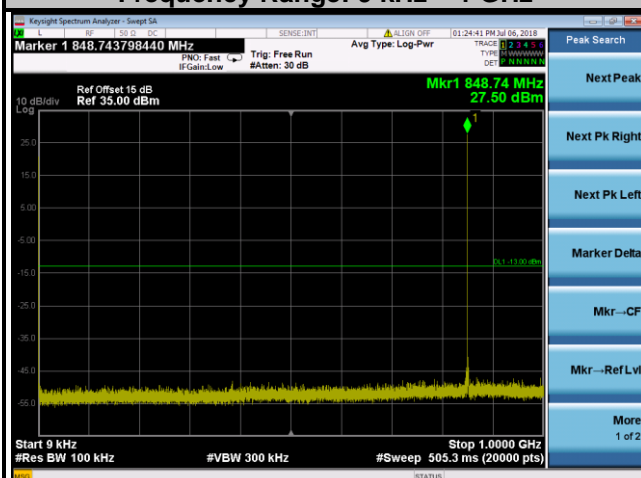

WCDMA Channel 4132

Frequency Range: 9 kHz ~ 1 GHz

Frequency Range: 1 GHz ~ 10 GHz

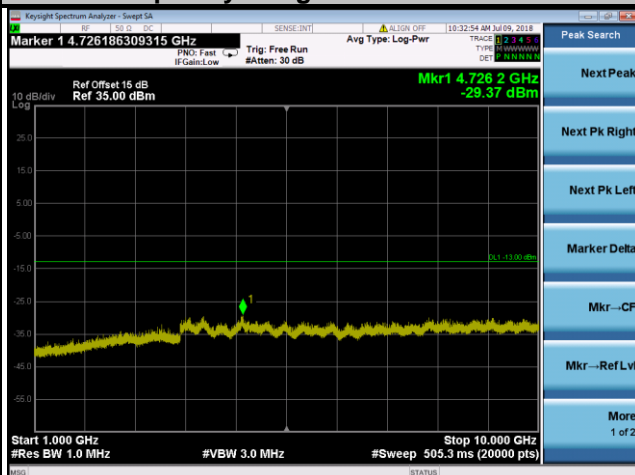
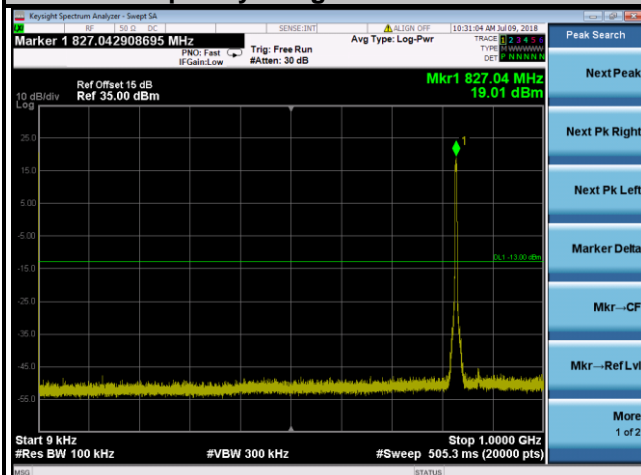

Channel 4182

Frequency Range: 9 kHz ~ 1 GHz

Frequency Range: 1 GHz ~ 10 GHz

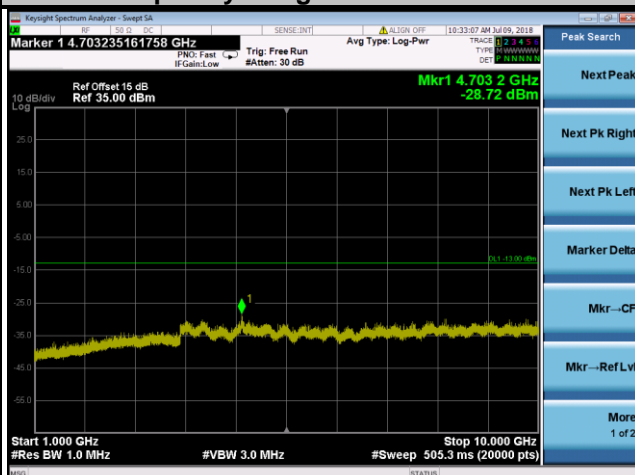
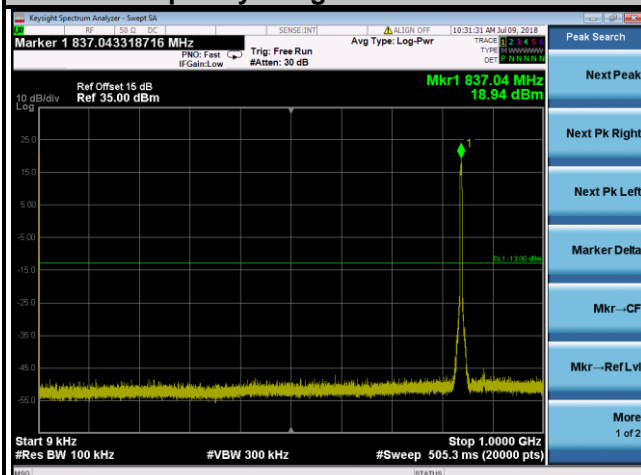

Channel 4233

Frequency Range: 9 kHz ~ 1 GHz

Frequency Range: 1 GHz ~ 10 GHz

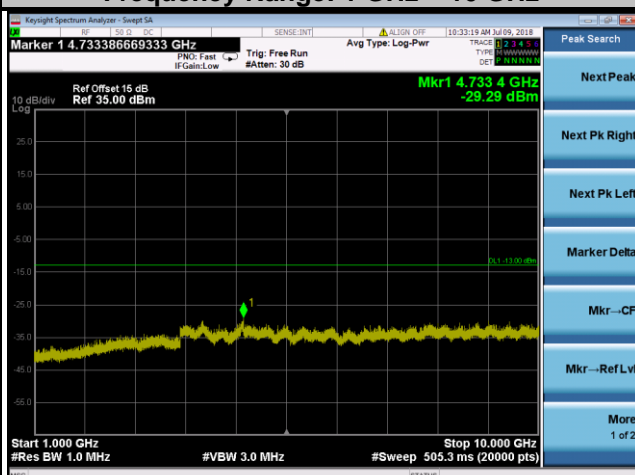
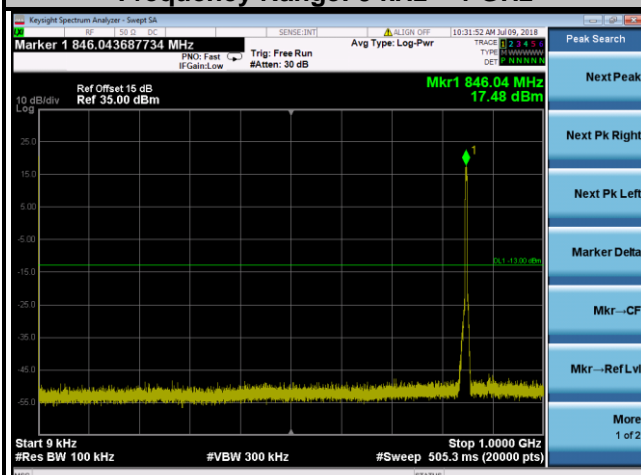

LTE Band 5
Channel Bandwidth: 1.4 MHz
Channel 20407

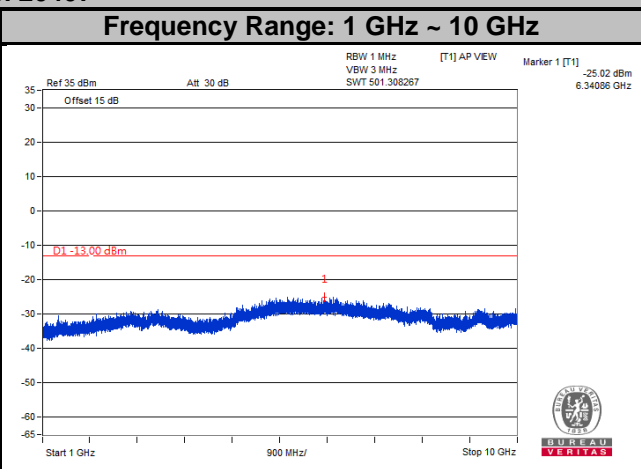
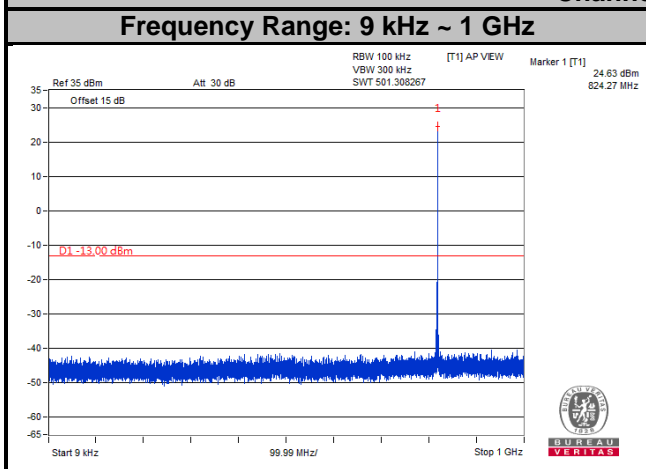

Channel 20525

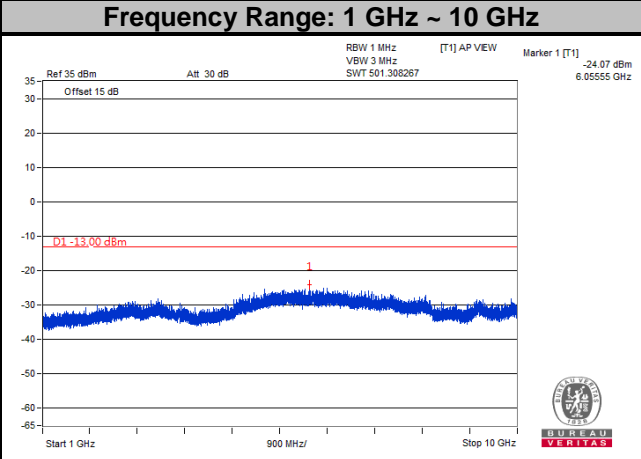
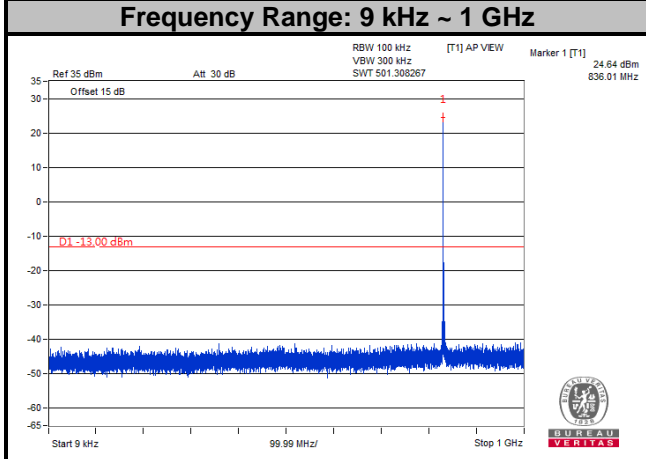

Channel 20643

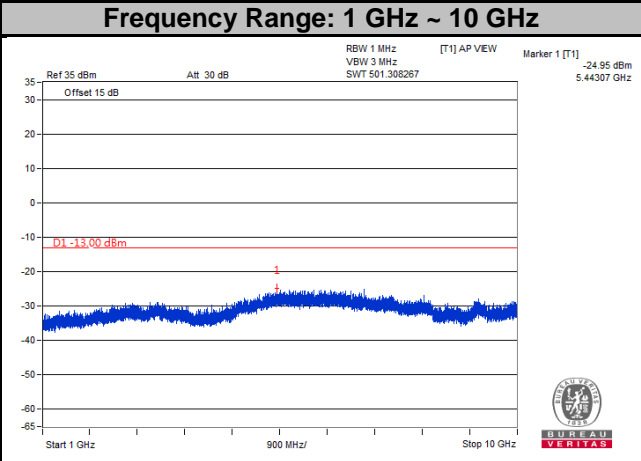
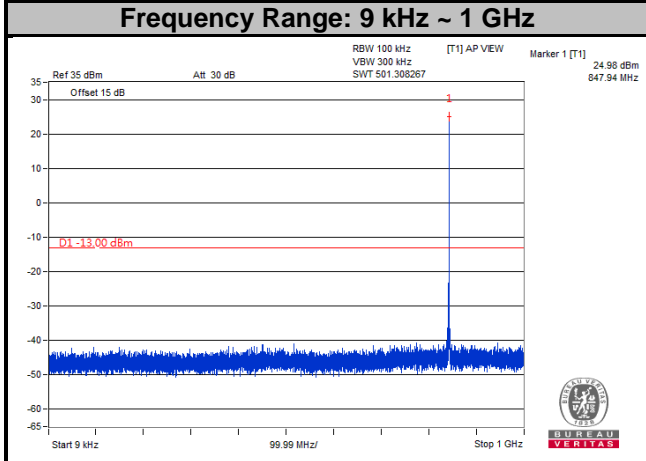

LTE Band 5
Channel Bandwidth: 3 MHz
Channel 20415

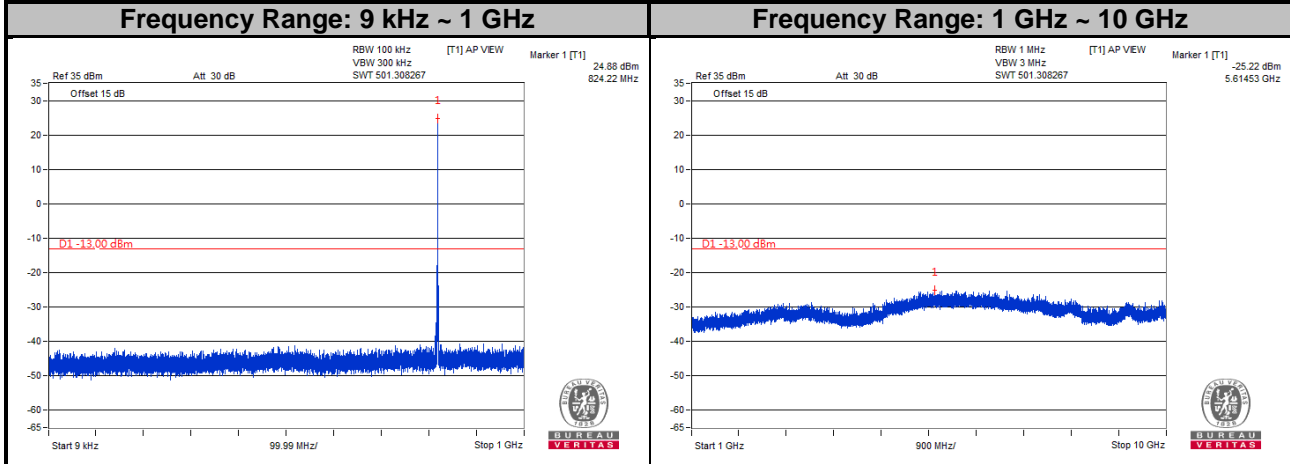

Channel 20525

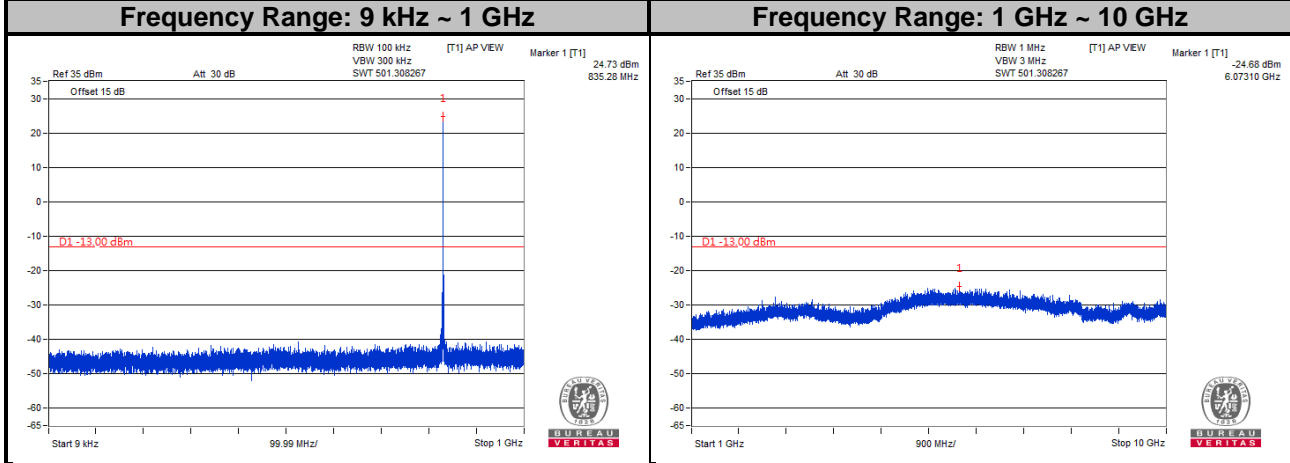

Channel 20635

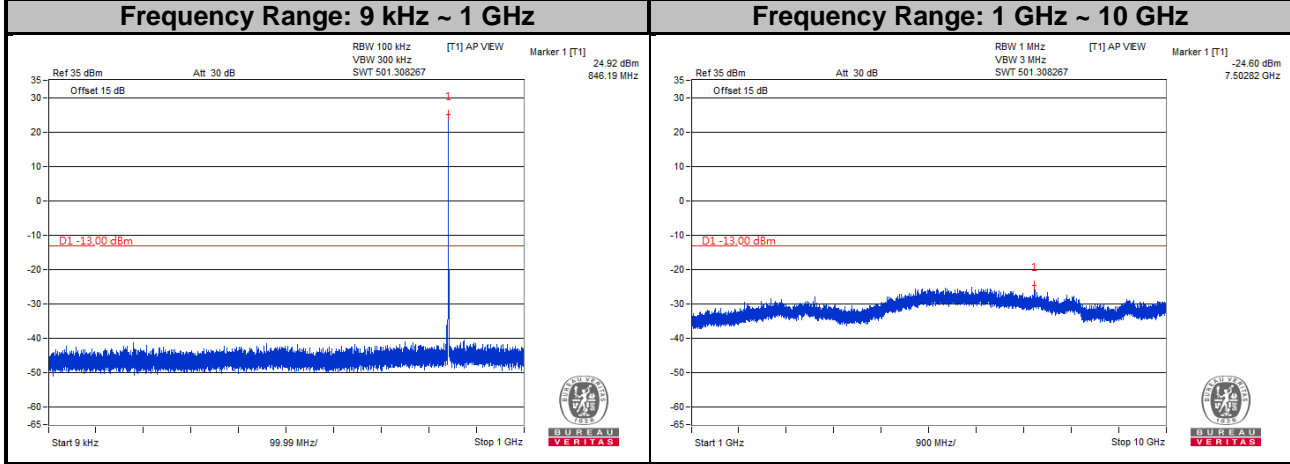

LTE Band 5
Channel Bandwidth: 5 MHz

Channel 20425

Frequency Range: 9 kHz ~ 1 GHz

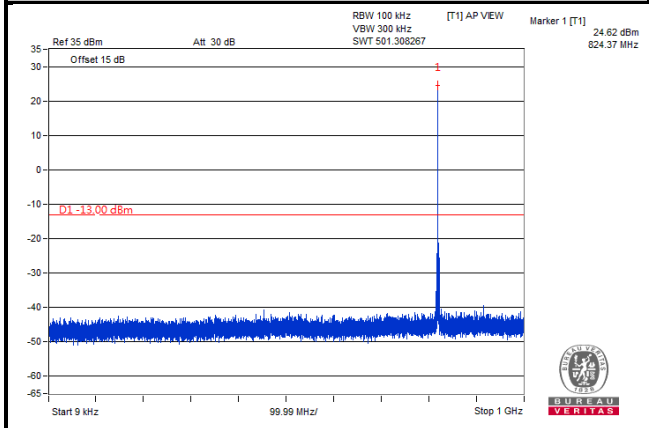

Frequency Range: 1 GHz ~ 10 GHz

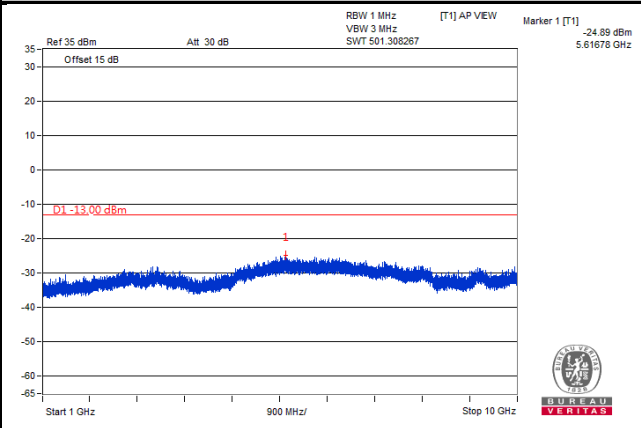

Channel 20525

Frequency Range: 9 kHz ~ 1 GHz

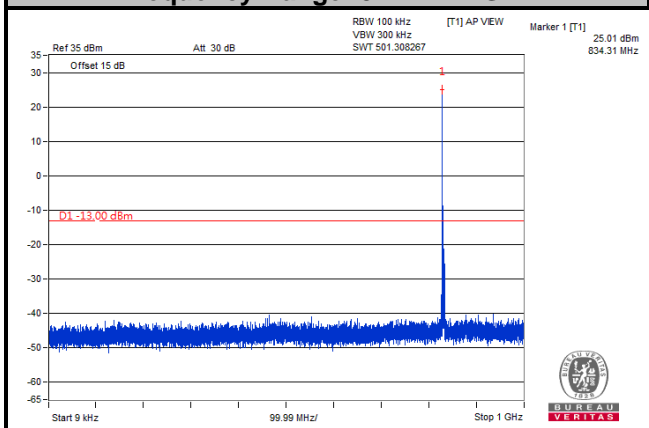

Frequency Range: 1 GHz ~ 10 GHz

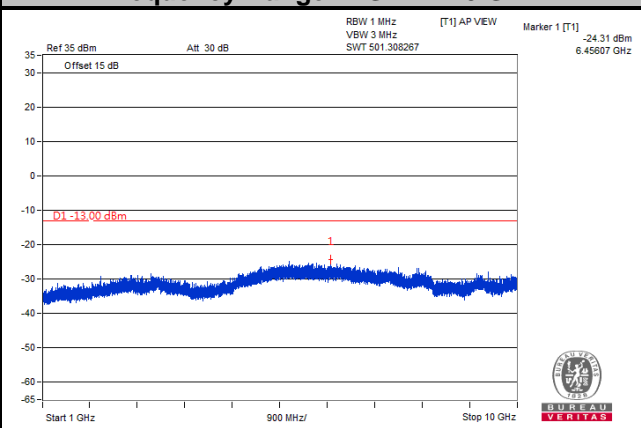

Channel 20625

Frequency Range: 9 kHz ~ 1 GHz

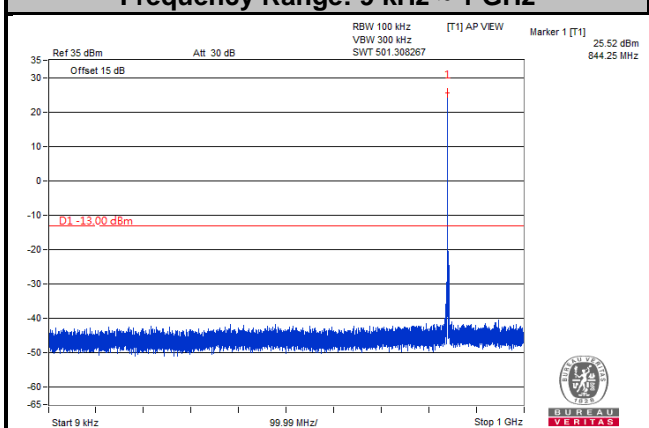

Frequency Range: 1 GHz ~ 10 GHz

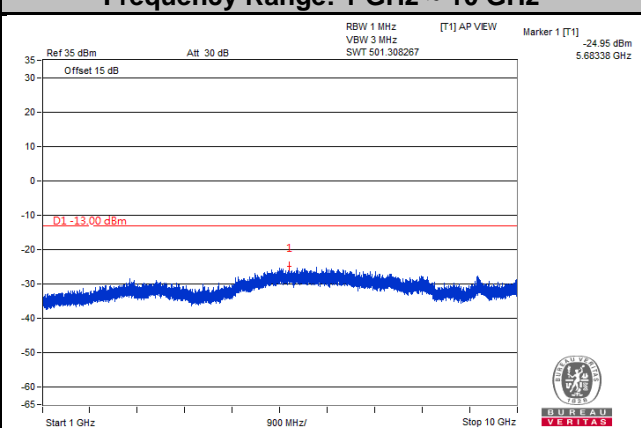

LTE Band 5
Channel Bandwidth: 10 MHz

Channel 20450

Frequency Range: 9 kHz ~ 1 GHz

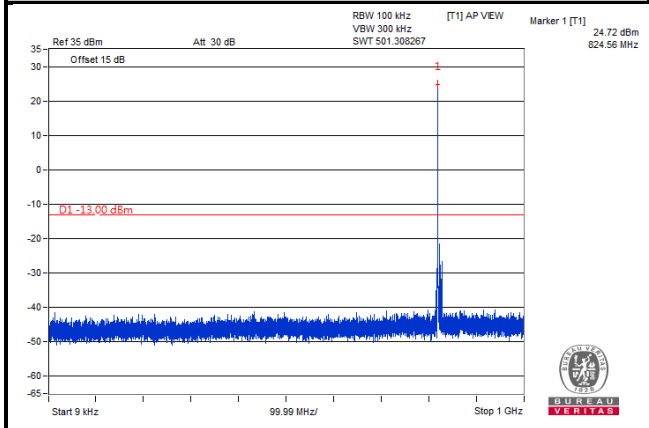

Frequency Range: 1 GHz ~ 10 GHz

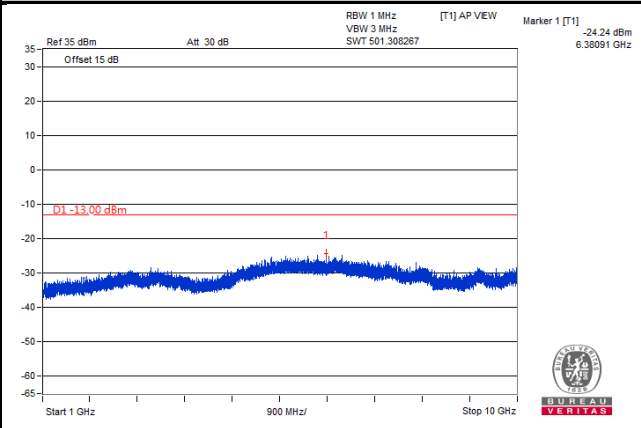

Channel 20525

Frequency Range: 9 kHz ~ 1 GHz

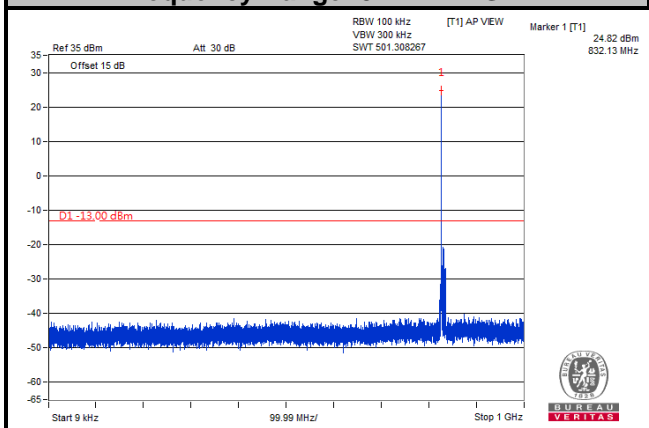

Frequency Range: 1 GHz ~ 10 GHz

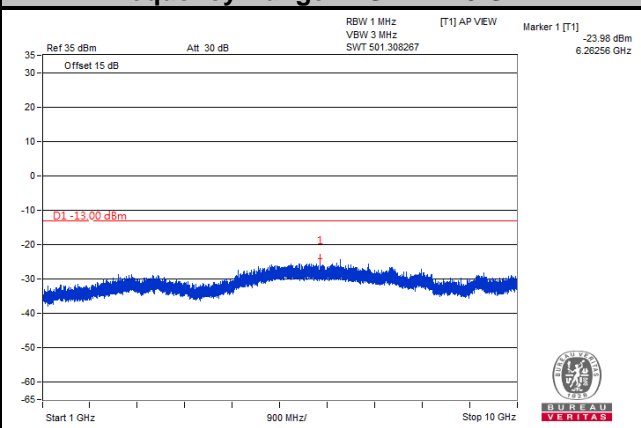

Channel 20600

Frequency Range: 9 kHz ~ 1 GHz

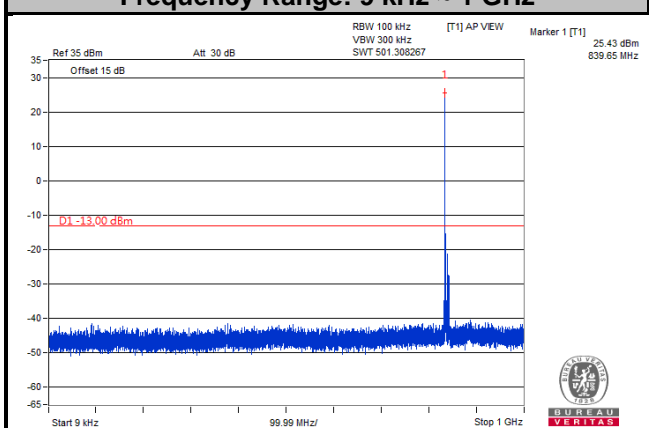

Frequency Range: 1 GHz ~ 10 GHz

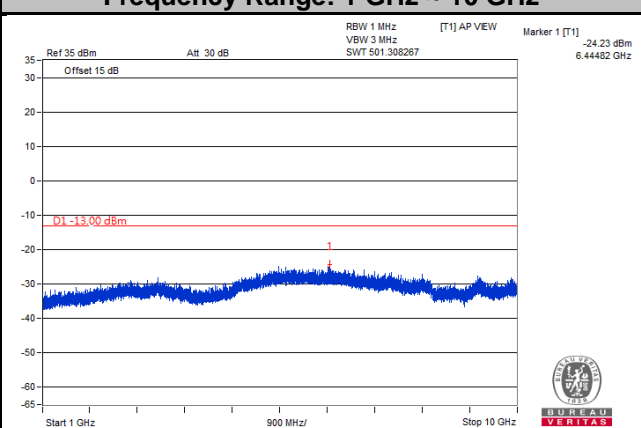

4.8 Radiated Emission Measurement

4.8.1 Limits of Radiated Emission Measurement

The power of any emission outside of the authorized operating frequency ranges must be attenuated below the transmitting power (P) by a factor of at least $43 + 10 \log(P)$ dB. The emission limit is equal to -13 dBm.

4.8.2 Test Procedure

- a. Substitution method is used for E.I.R.P measurement. In the semi-anechoic chamber, EUT placed on the 0.8 m (below or equal 1 GHz) and/or 1.5 m (above 1 GHz) height of Turn Table, rotated the table around 360 degrees to search the maximum radiation power and receiver antenna shall be rotated vertical and horizontal polarization and moved height from 1 m to 4 m to find the maximum polar radiated power. The "Read Value" is the spectrum reading the maximum power value.
- b. The substitution horn antenna is substituted for EUT at the same position and signals generator export the CW signal to the substitution antenna via a TX cable. Rotated the Turn Table and moved receiving antenna to find the maximum radiation power. Adjust output power level of S.G to get a Value of spectrum reading equal to "Read Value" of step a. Record the power level of S.G
- c. EIRP = Output power level of S.G – TX cable loss + Antenna gain of substitution horn.
- d. E.R.P power can be calculated form E.I.R.P power by subtracting the gain of dipole, E.R.P power = E.I.R.P power - 2.15 dB.

NOTE: The resolution bandwidth and video bandwidth of test receiver/spectrum analyzer is 1 MHz/3 MHz.

4.8.3 Deviation from Test Standard

No deviation.

4.8.4 Test Setup

<Radiated Emission below or equal 1 GHz>

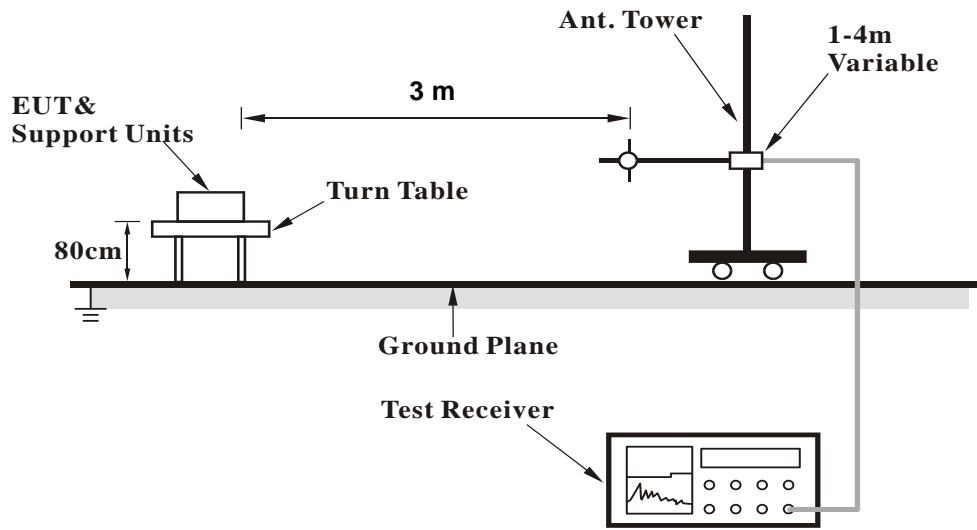

<Radiated Emission above 1 GHz>

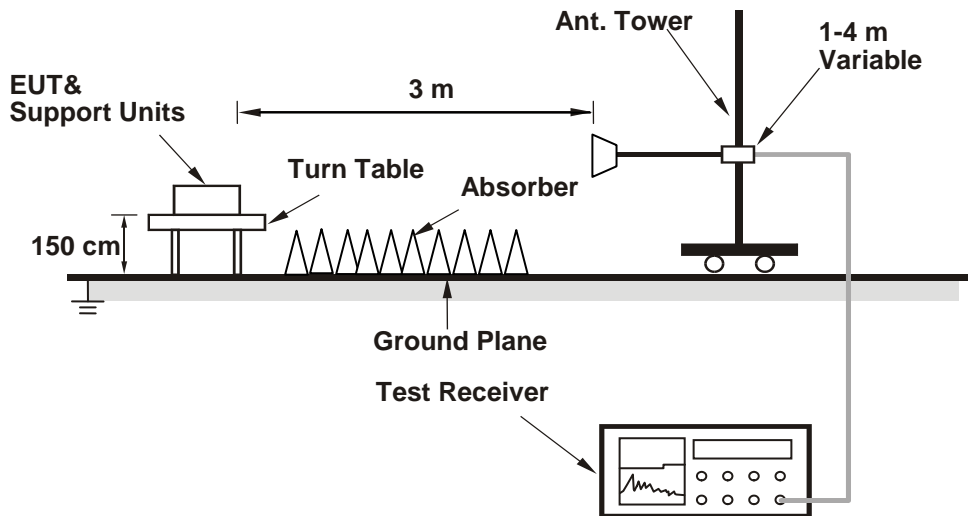

For the actual test configuration, please refer to the attached file (Test Setup Photo).

4.8.5 Test Results

Mode A

GSM:

Low Channel



Bureau Veritas Consumer Products Services Ltd., Taoyuan Branch

A D T

Data: 5

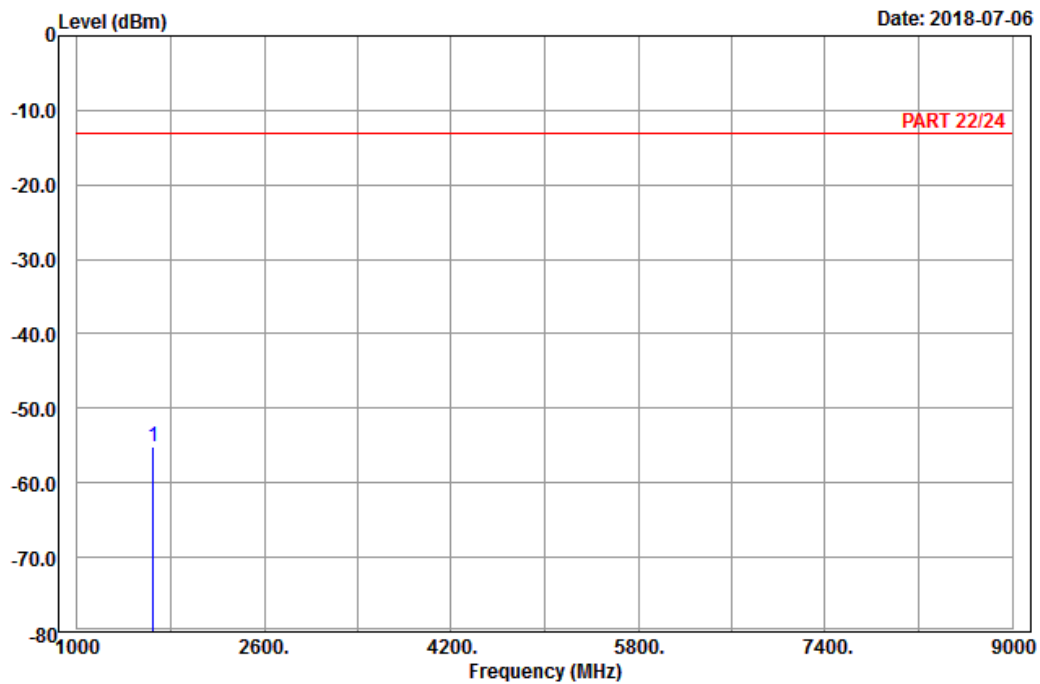

Site : 966 chamber 1
 Condition: PART 22/24 Horizontal
 Remark : GSM 850_Link_CH128
 Tested by: Charles Hsiao

Freq	Level	Read Level	Limit Level	Over Limit	Factor	Remark
MHz	dBm	dBm	dBm	dB	dB	
1 pp 1648.40	-55.07	-62.80	-13.00	-42.07	7.73	Peak



A D T

Data: 6

Date: 2018-07-06

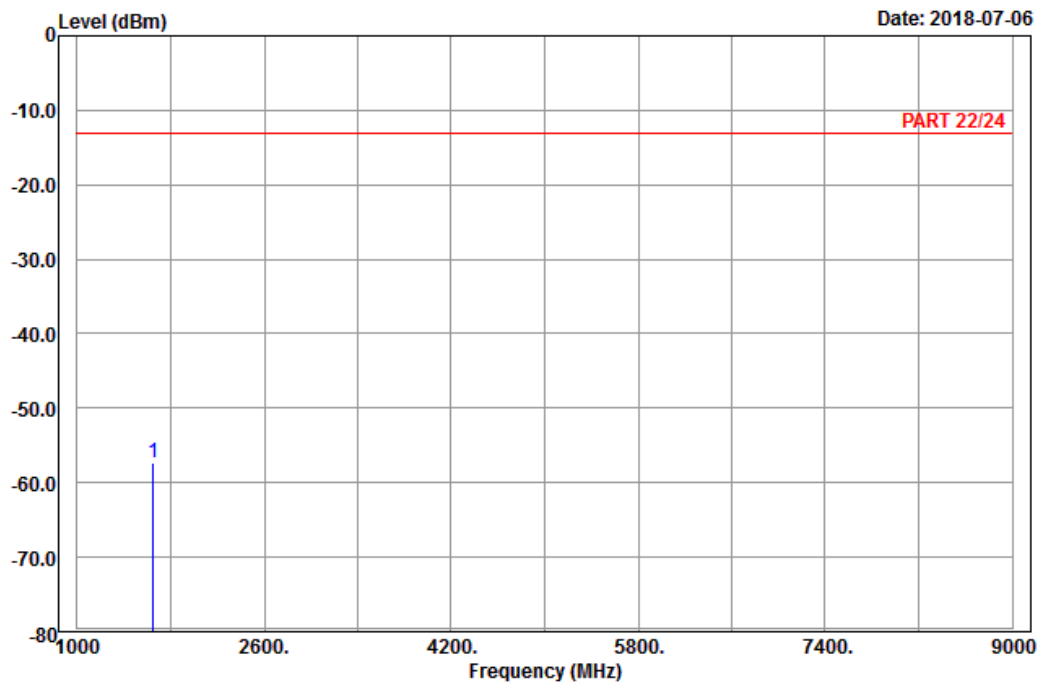

Site : 966 chamber 1
 Condition: PART 22/24 Vertical
 Remark : GSM 850_Link_CH128
 Tested by: Charles Hsiao

	Freq	Level	Read Level	Limit Line	Over Limit	Factor	Remark
	MHz	dBm	dBm	dBm	dB	dB	
1	pp 1648.40	-57.37	-65.10	-13.00	-44.37	7.73	Peak

Middle Channel



Bureau Veritas Consumer Products Services Ltd., Taoyuan Branch

A D T

Data: 9

Date: 2018-07-06

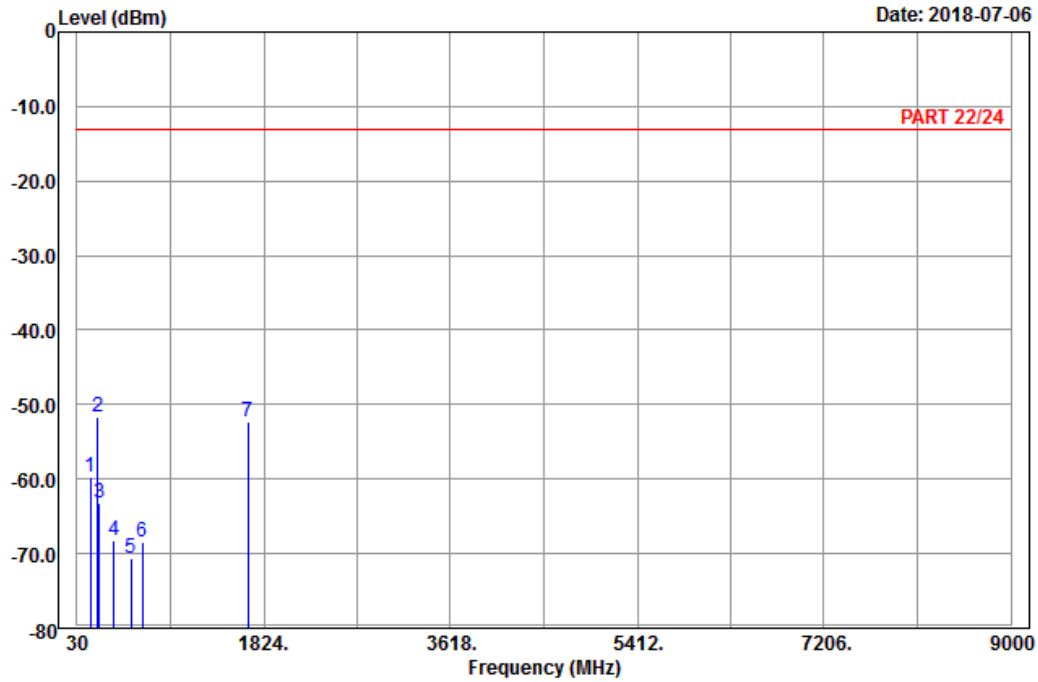

Site : 966 chamber 1
 Condition: PART 22/24 Horizontal
 Remark : GSM 850_Link_CH189
 Tested by: Charles Hsiao

	Read	Limit	Over				
Freq	Level	Level	Line	Limit	Factor	Remark	
MHz	dBm	dBm	dBm	dB	dB		
1	158.79	-59.63	-51.93	-13.00	-46.63	-7.70	Peak
2	pp 226.29	-51.76	-45.93	-13.00	-38.76	-5.83	Peak
3	247.35	-63.21	-57.66	-13.00	-50.21	-5.55	Peak
4	385.40	-68.27	-64.75	-13.00	-55.27	-3.52	Peak
5	548.50	-70.64	-68.91	-13.00	-57.64	-1.73	Peak
6	658.40	-68.44	-68.26	-13.00	-55.44	-0.18	Peak
7	1672.80	-52.33	-60.24	-13.00	-39.33	7.91	Peak



Bureau Veritas Consumer Products Services Ltd., Taoyuan Branch

A D T

Data: 10

Date: 2018-07-06

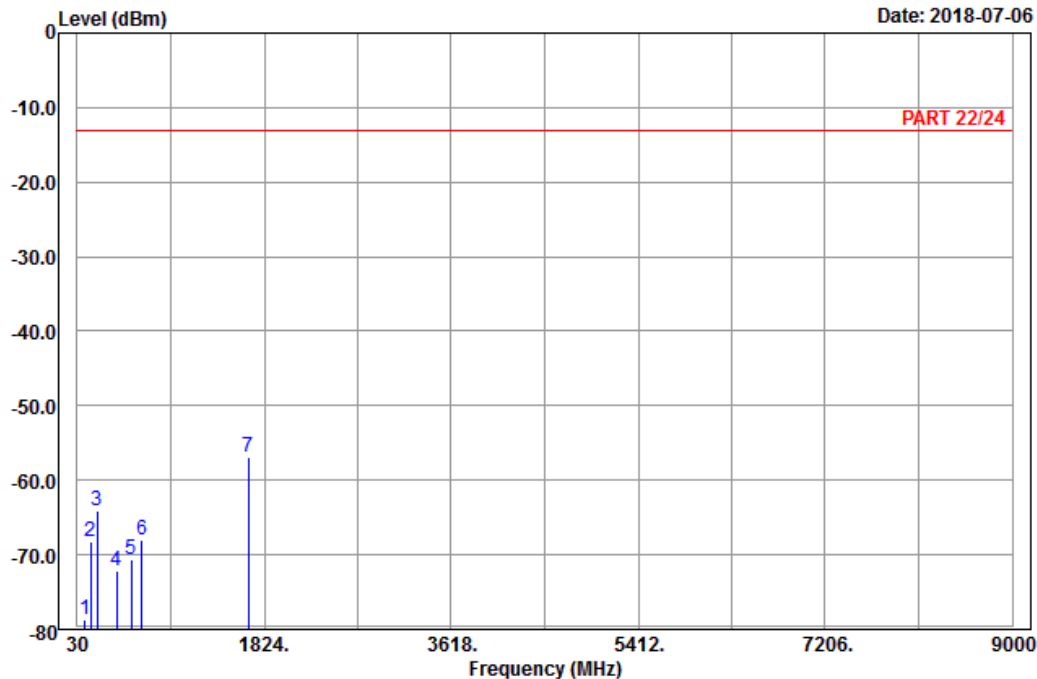

Site : 966 chamber 1
 Condition: PART 22/24 Vertical
 Remark : GSM 850_Link_CH189
 Tested by: Charles Hsiao

	Freq	Level	Read Level	Limit Line	Over Limit	Factor	Remark
	MHz	dBm	dBm	dBm	dB	dB	
1	106.68	-78.77	-69.47	-13.00	-65.77	-9.30	Peak
2	158.79	-68.14	-60.44	-13.00	-55.14	-7.70	Peak
3	224.13	-64.08	-58.22	-13.00	-51.08	-5.86	Peak
4	409.90	-72.12	-69.15	-13.00	-59.12	-2.97	Peak
5	548.50	-70.68	-68.95	-13.00	-57.68	-1.73	Peak
6	652.10	-68.10	-67.96	-13.00	-55.10	-0.14	Peak
7 pp	1672.80	-56.98	-64.89	-13.00	-43.98	7.91	Peak

High Channel



Bureau Veritas Consumer Products Services Ltd., Taoyuan Branch

A D T

Data: 5

Date: 2018-07-06

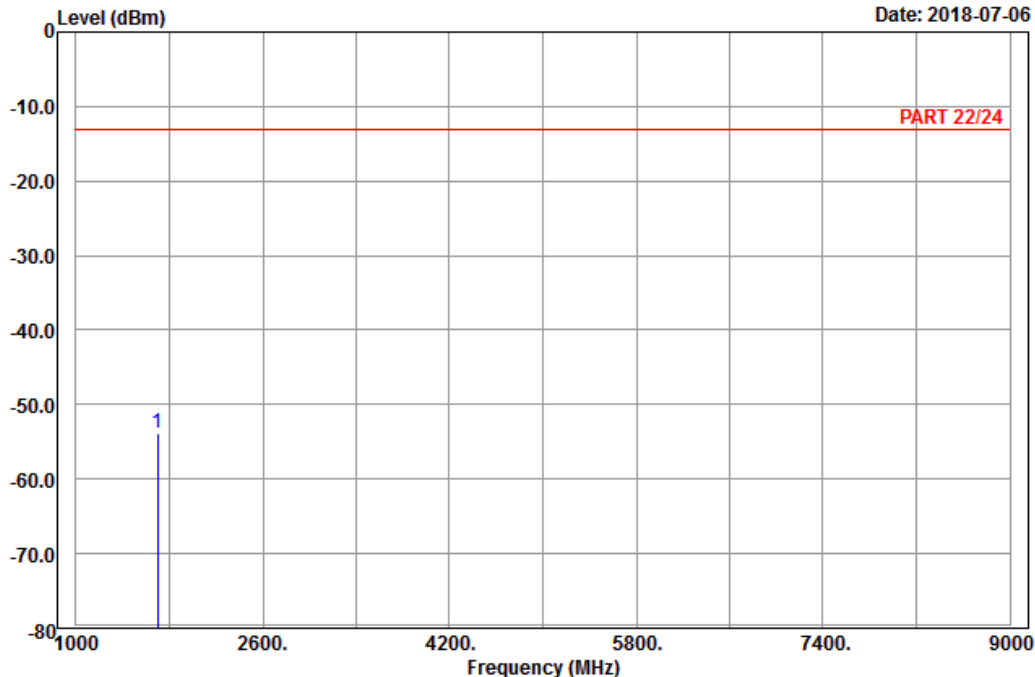

Site : 966 chamber 1
 Condition: PART 22/24 Horizontal
 Remark : GSM 850_Link_CH251
 Tested by: Charles Hsiao

Freq	Level	Read Level	Limit	Over	Factor	Remark
MHz	dBm	dBm	dBm	dB	dB	
1 pp 1697.60	-53.76	-61.90	-13.00	-40.76	8.14	Peak



Bureau Veritas Consumer Products Services Ltd., Taoyuan Branch

A D T

Data: 6

Date: 2018-07-06

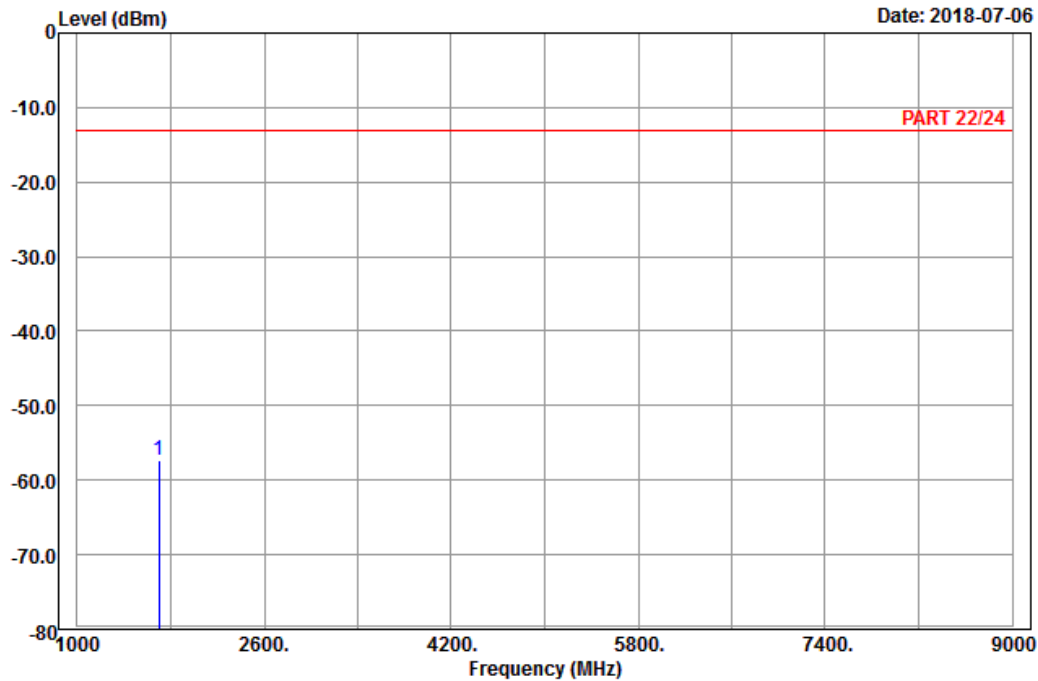

Site : 966 chamber 1
 Condition: PART 22/24 Vertical
 Remark : GSM 850_Link_CH251
 Tested by: Charles Hsiao

	Freq	Level	Read Level	Limit Line	Over Limit	Factor	Remark
	MHz	dBm	dBm	dBm	dB	dB	
1	pp 1697.60	-57.37	-65.51	-13.00	-44.37	8.14	Peak

EDGE:
Low Channel



Bureau Veritas Consumer Products Services Ltd., Taoyuan Branch

A D T

Data: 5

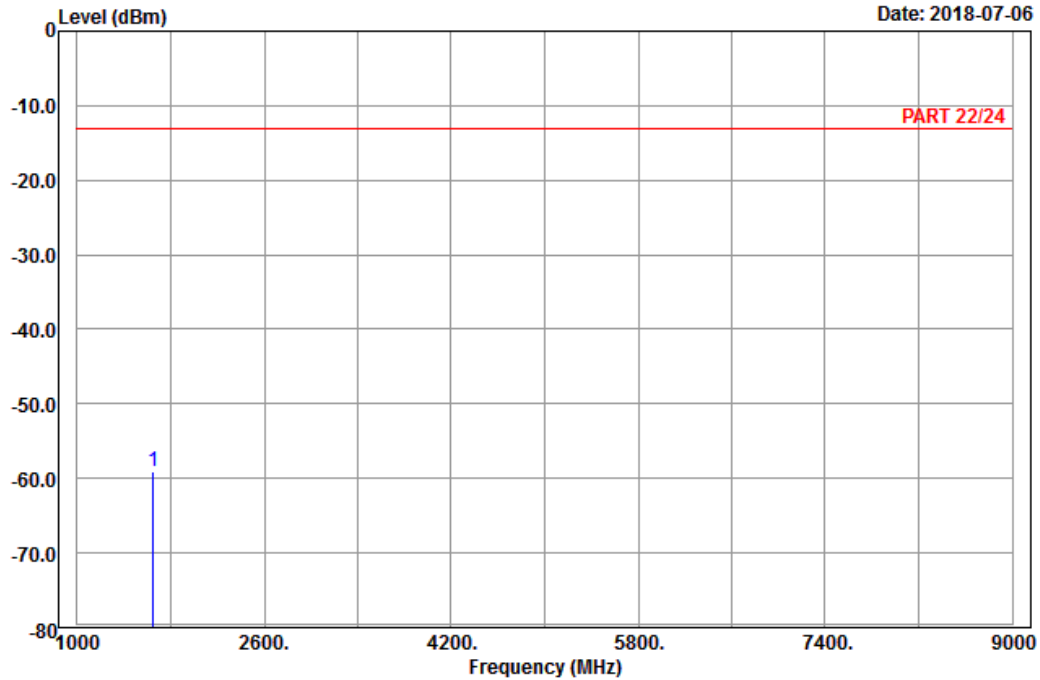

Site : 966 chamber 1
Condition: PART 22/24 Horizontal
Remark : EDGE 850_Link_CH128
Tested by: Charles Hsiao

	Read	Limit	Over			
Freq	Level	Level	Line	Limit	Factor	Remark
MHz	dBm	dBm	dBm	dB	dB	
1 pp 1648.40	-58.98	-66.71	-13.00	-45.98	7.73	Peak



Bureau Veritas Consumer Products Services Ltd., Taoyuan Branch

A D T

Data: 6

Date: 2018-07-06

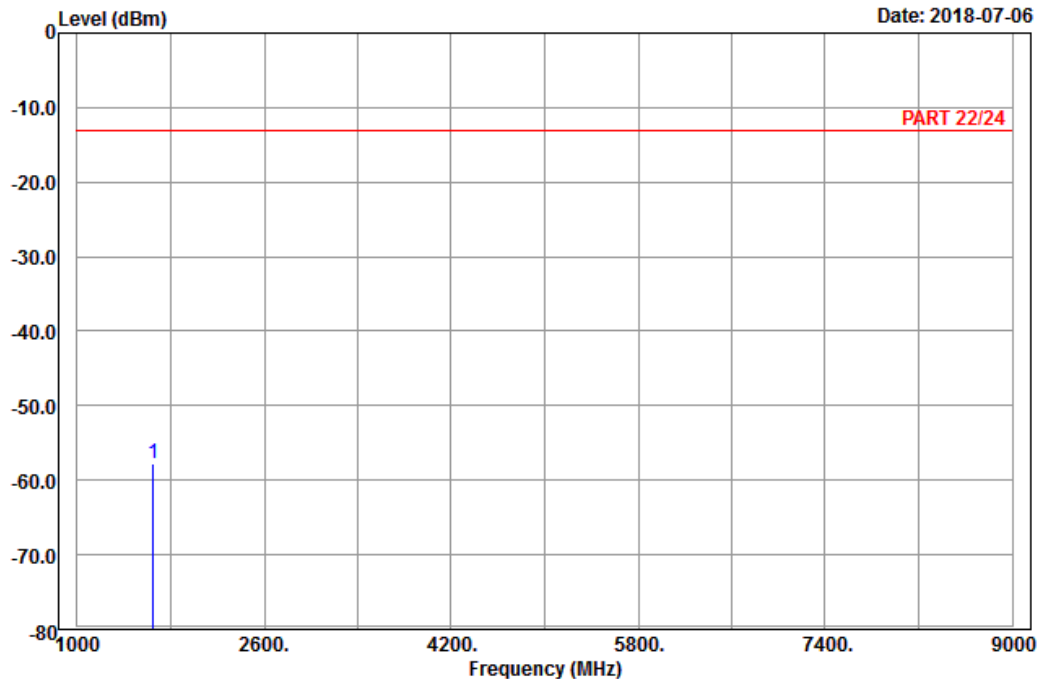

Site : 966 chamber 1
 Condition: PART 22/24 Vertical
 Remark : EDGE 850_Link_CH128
 Tested by: Charles Hsiao

	Freq	Level	Read Level	Limit Line	Over Limit	Factor	Remark
	MHz	dBm	dBm	dBm	dB	dB	
1	pp 1648.40	-57.87	-65.60	-13.00	-44.87	7.73	Peak

Middle Channel



Bureau Veritas Consumer Products Services Ltd., Taoyuan Branch

A D T

Data: 5

Date: 2018-07-06

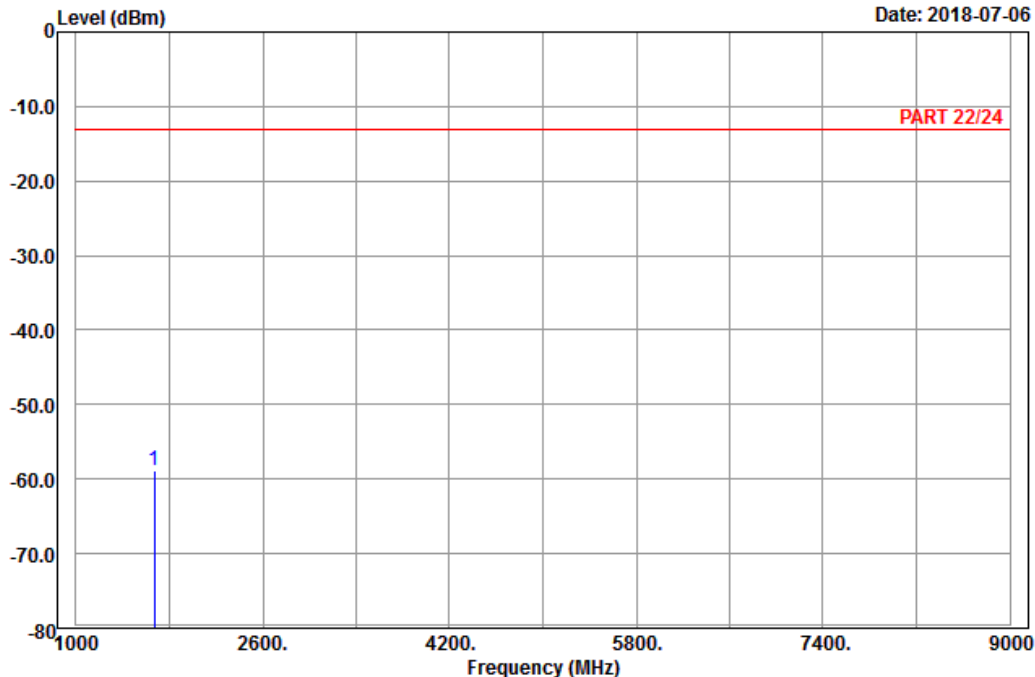

Site : 966 chamber 1
 Condition: PART 22/24 Horizontal
 Remark : EDGE 850_Link_CH189
 Tested by: Charles Hsiao

Freq	Level	Read Level	Limit	Over	Factor	Remark
MHz	dBm	dBm	dBm	dB	dB	
1 pp 1672.80	-58.82	-66.73	-13.00	-45.82	7.91	Peak



Bureau Veritas Consumer Products Services Ltd., Taoyuan Branch

A D T

Data: 6

Date: 2018-07-06

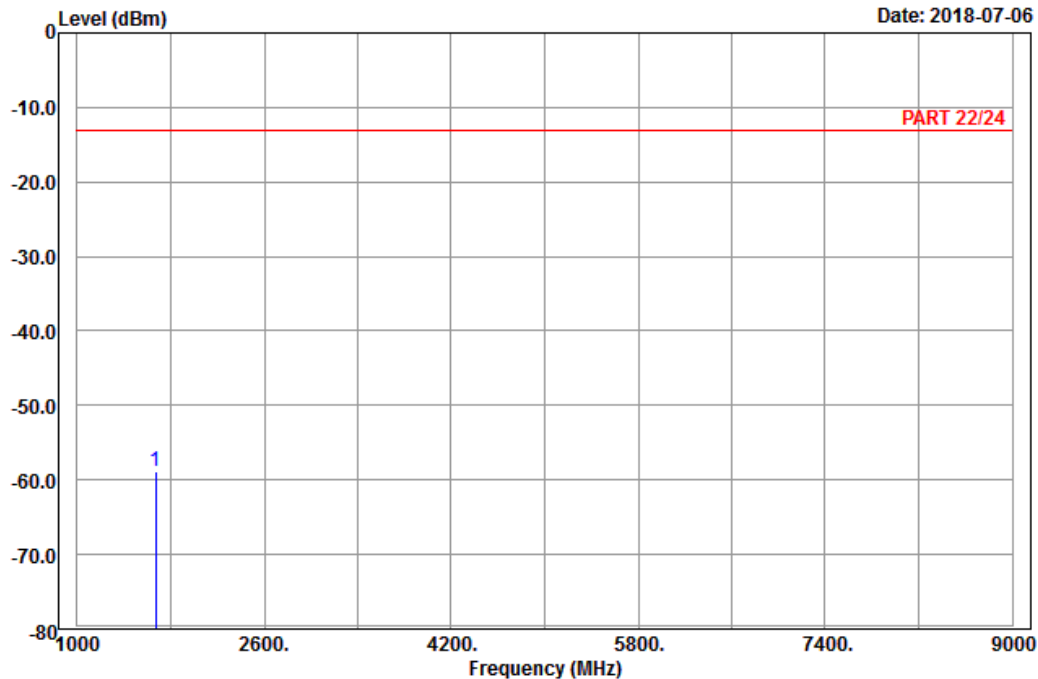

Site : 966 chamber 1
 Condition: PART 22/24 Vertical
 Remark : EDGE 850_Link_CH189
 Tested by: Charles Hsiao

	Freq	Level	Read Level	Limit Line	Over Limit	Factor	Remark
	MHz	dBm	dBm	dBm	dB	dB	
1	pp 1672.80	-58.83	-66.74	-13.00	-45.83	7.91	Peak

High Channel



Bureau Veritas Consumer Products Services Ltd., Taoyuan Branch

A D T

Data: 5

Date: 2018-07-06

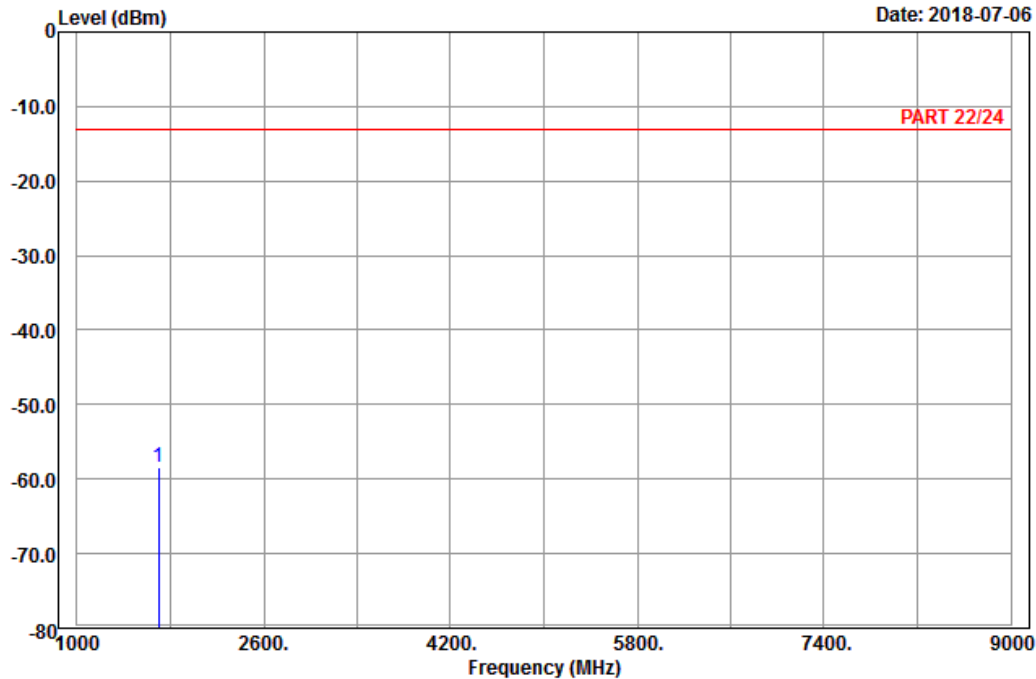

Site : 966 chamber 1
 Condition: PART 22/24 Horizontal
 Remark : EDGE 850_Link_CH251
 Tested by: Charles Hsiao

Freq	Level	Read Level	Limit Line	Over Limit	Factor	Remark
MHz	dBm	dBm	dBm	dB	dB	
1 pp 1697.60	-58.32	-66.46	-13.00	-45.32	8.14	Peak



Bureau Veritas Consumer Products Services Ltd., Taoyuan Branch

A D T

Data: 6

Date: 2018-07-06

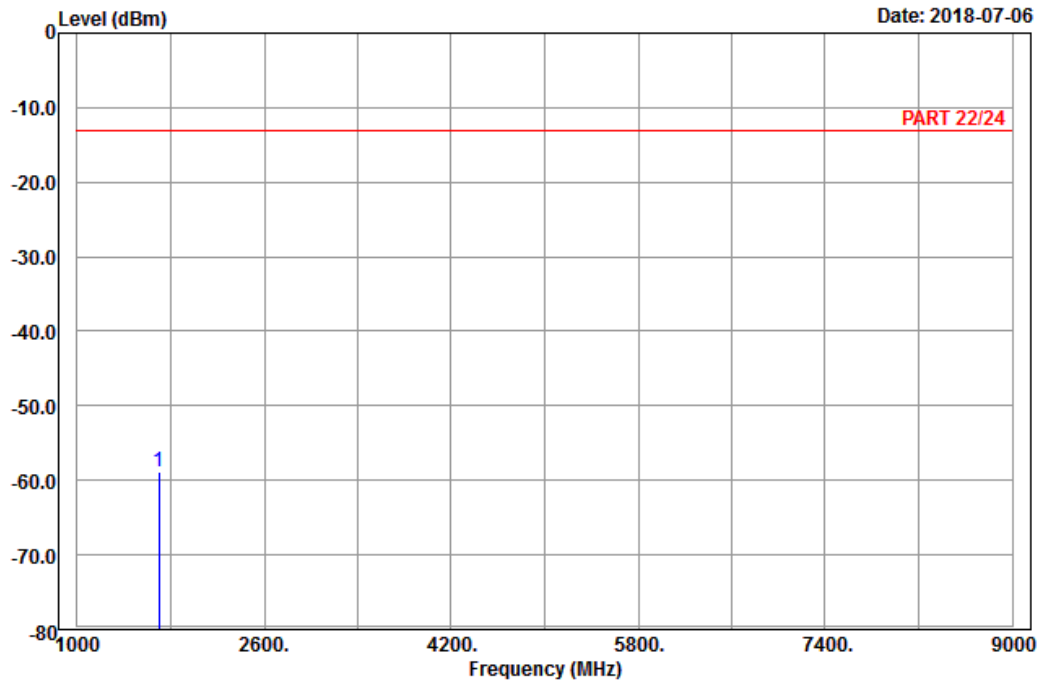

Site : 966 chamber 1
 Condition: PART 22/24 Vertical
 Remark : EDGE 850_Link_CH251
 Tested by: Charles Hsiao

	Read	Limit	Over			
Freq	Level	Level	Line	Limit	Factor	Remark
MHz	dBm	dBm	dBm	dB	dB	
1 pp 1697.60	-58.77	-66.91	-13.00	-45.77	8.14	Peak

WCDMA:
Low Channel



Bureau Veritas Consumer Products Services Ltd., Taoyuan Branch

A D T

Data: 5

Date: 2018-07-06

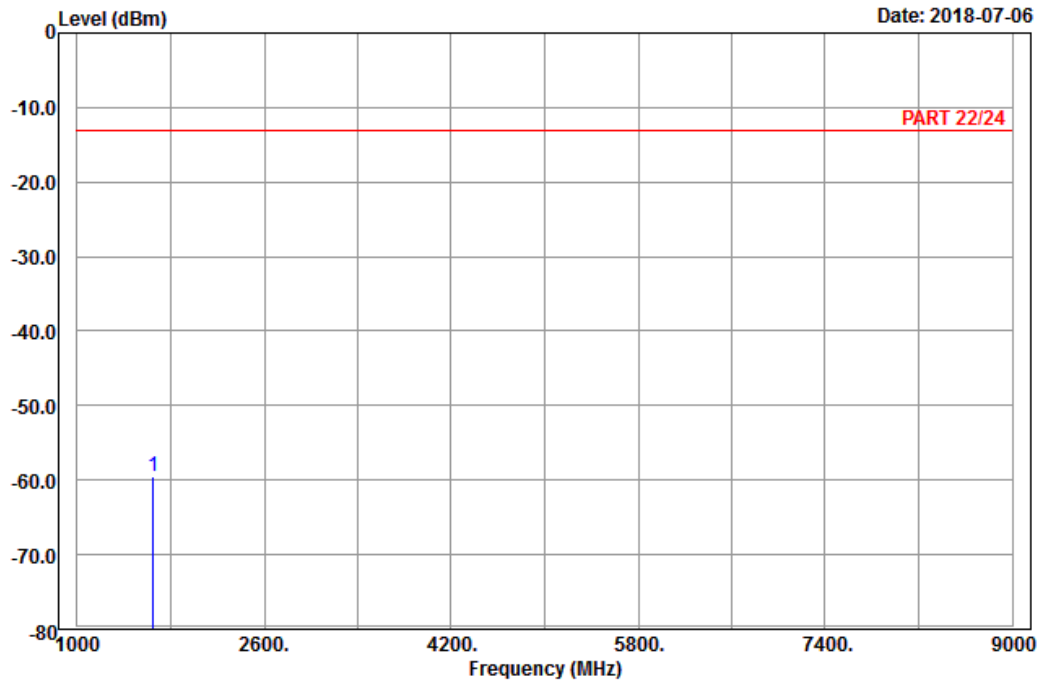

Site : 966 chamber 1
Condition: PART 22/24 Horizontal
Remark : Band V_Link_CH4132
Tested by: Charles Hsiao

	Freq	Level	Read Level	Limit Line	Over Limit	Factor	Remark
	MHz	dBm	dBm	dBm	dB	dB	
1	pp 1652.80	-59.47	-67.20	-13.00	-46.47	7.73	Peak



Bureau Veritas Consumer Products Services Ltd., Taoyuan Branch

A D T

Data: 6

Date: 2018-07-06

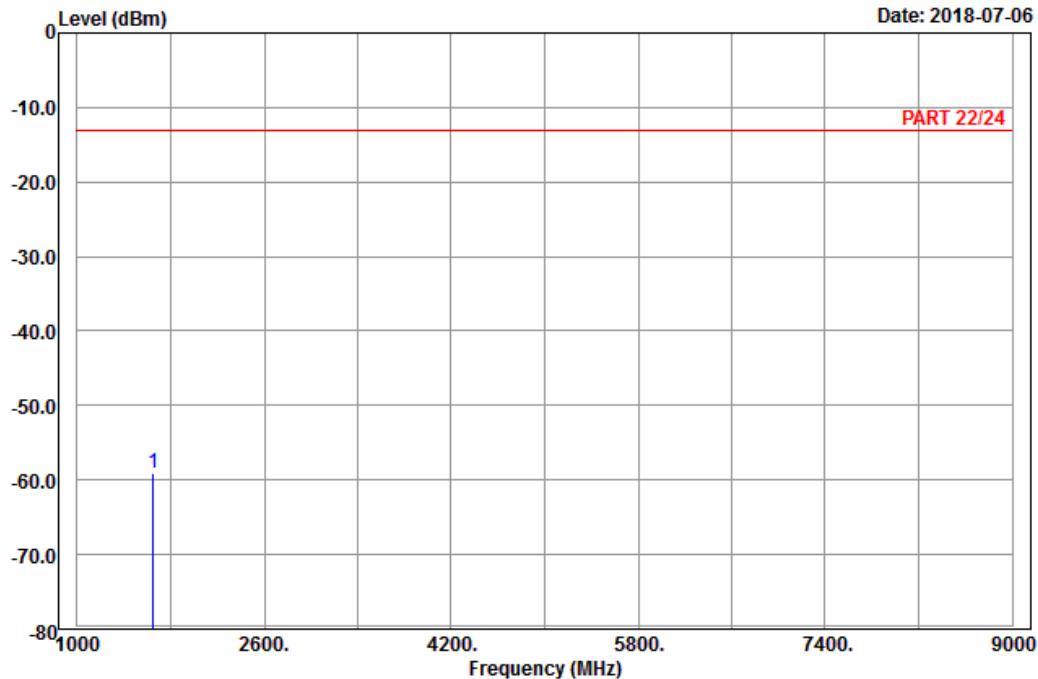

Site : 966 chamber 1
 Condition: PART 22/24 Vertical
 Remark : Band V_Link_CH4132
 Tested by: Charles Hsiao

	Freq	Level	Read Level	Limit Line	Over Limit	Factor	Remark
	MHz	dBm	dBm	dBm	dB	dB	
1	pp 1652.80	-58.98	-66.71	-13.00	-45.98	7.73	Peak

Middle Channel



Bureau Veritas Consumer Products Services Ltd., Taoyuan Branch

A D T

Data: 5

Date: 2018-07-06

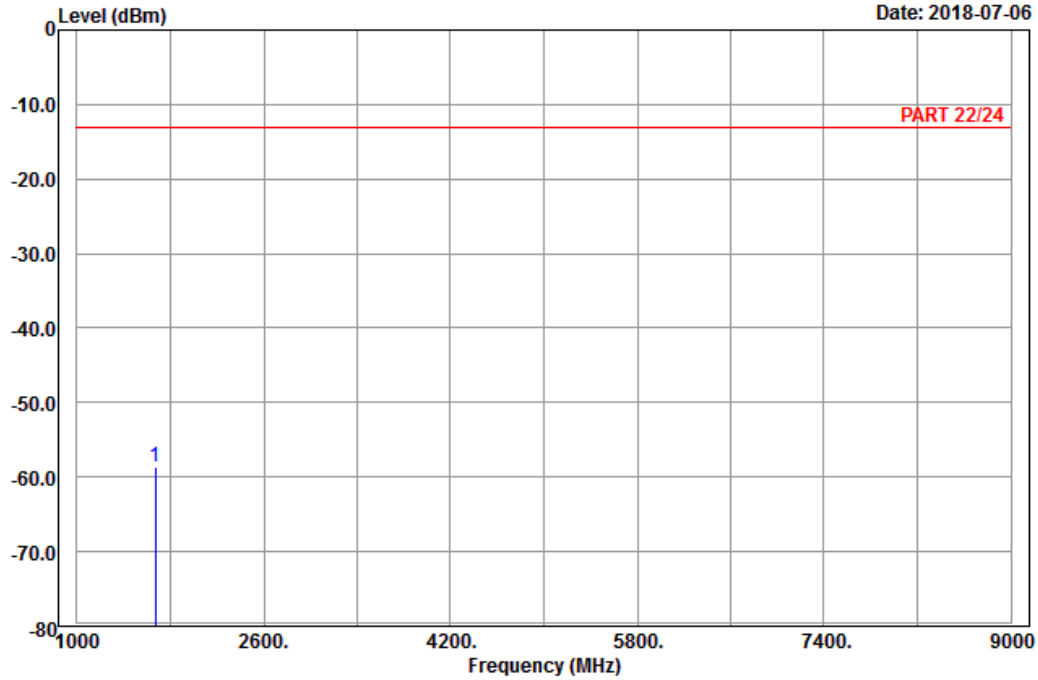

Site : 966 chamber 1
 Condition: PART 22/24 Horizontal
 Remark : Band V_Link_CH4182
 Tested by: Charles Hsiao

Freq	Level	Read Level	Limit	Over	Factor	Remark
MHz	dBm	dBm	dBm	dB	dB	
1 pp 1672.80	-58.74	-66.65	-13.00	-45.74	7.91	Peak



Bureau Veritas Consumer Products Services Ltd., Taoyuan Branch

A D T

Data: 6

Date: 2018-07-06

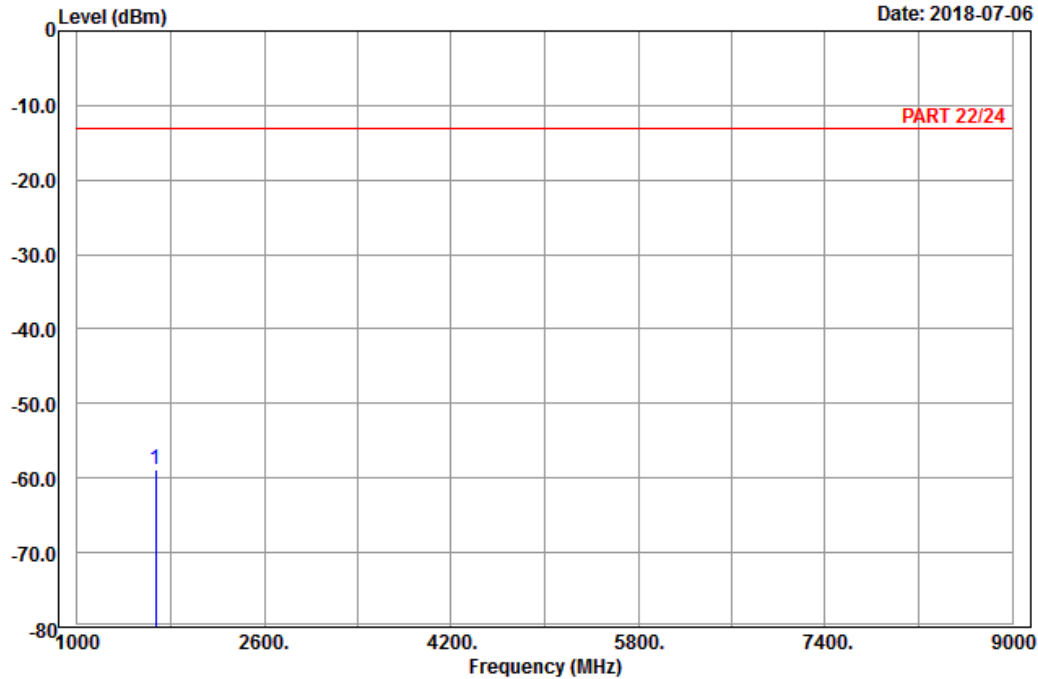

Site : 966 chamber 1
 Condition: PART 22/24 Vertical
 Remark : Band V_Link_CH4182
 Tested by: Charles Hsiao

	Freq	Level	Read Level	Limit Line	Over Limit	Factor	Remark
	MHz	dBm	dBm	dBm	dB	dB	
1	pp 1672.80	-58.77	-66.68	-13.00	-45.77	7.91	Peak

High Channel



Bureau Veritas Consumer Products Services Ltd., Taoyuan Branch

A D T

Data: 5

Date: 2018-07-06

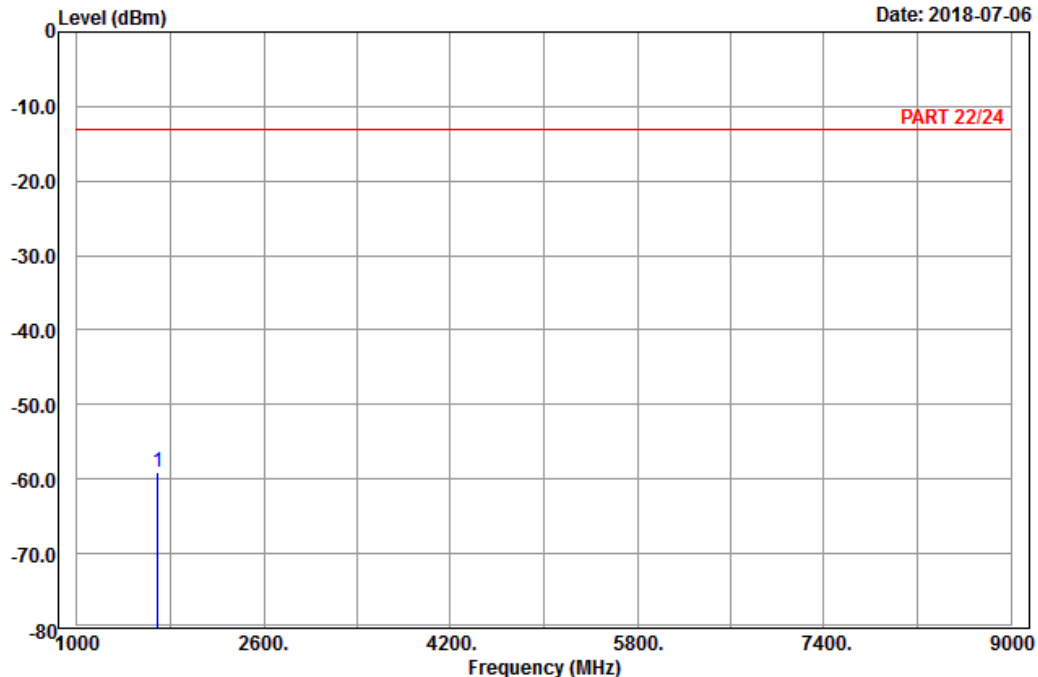

Site : 966 chamber 1
 Condition: PART 22/24 Horizontal
 Remark : Band V_Link_CH4233
 Tested by: Charles Hsiao

Freq	Level	Read Level	Limit Line	Over Limit	Factor	Remark
MHz	dBm	dBm	dBm	dB	dB	
1 pp 1693.20	-58.98	-67.12	-13.00	-45.98	8.14	Peak



Bureau Veritas Consumer Products Services Ltd., Taoyuan Branch

A D T

Data: 6

Date: 2018-07-06

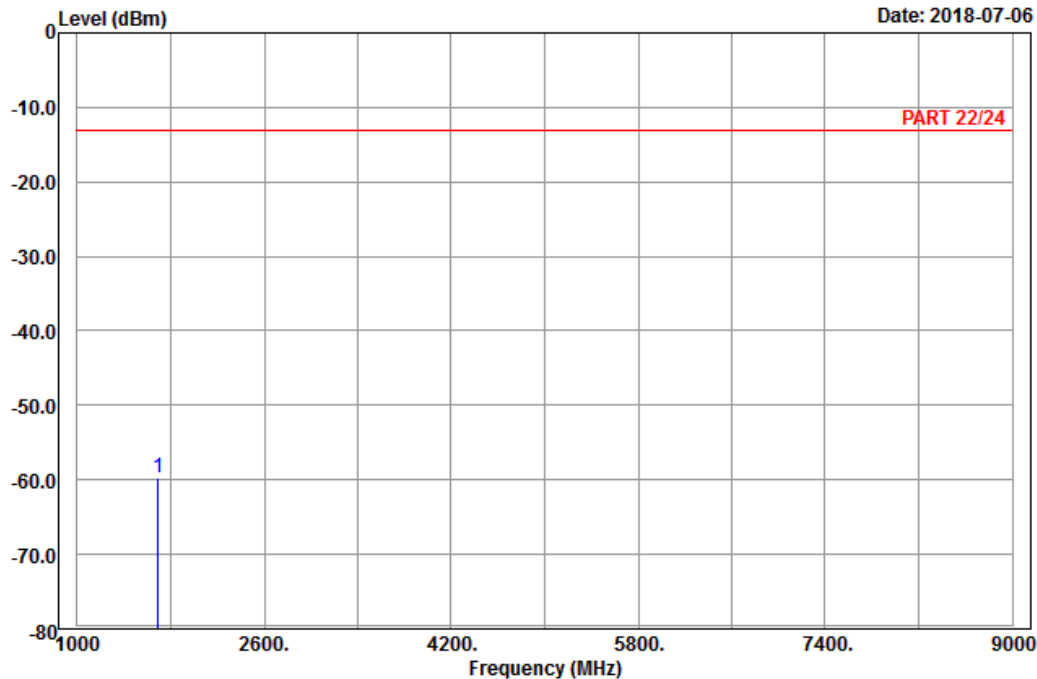

Site : 966 chamber 1
 Condition: PART 22/24 Vertical
 Remark : Band V_Link_CH4233
 Tested by: Charles Hsiao

	Freq	Level	Read Level	Limit Line	Over Limit	Factor	Remark
	MHz	dBm	dBm	dBm	dB	dB	
1	pp 1693.20	-59.78	-67.92	-13.00	-46.78	8.14	Peak

LTE Band 5
Channel Bandwidth: 1.4 MHz / QPSK
Low Channel



Bureau Veritas Consumer Products Services Ltd., Taoyuan Branch

A D T

Data: 5

Date: 2018-07-05

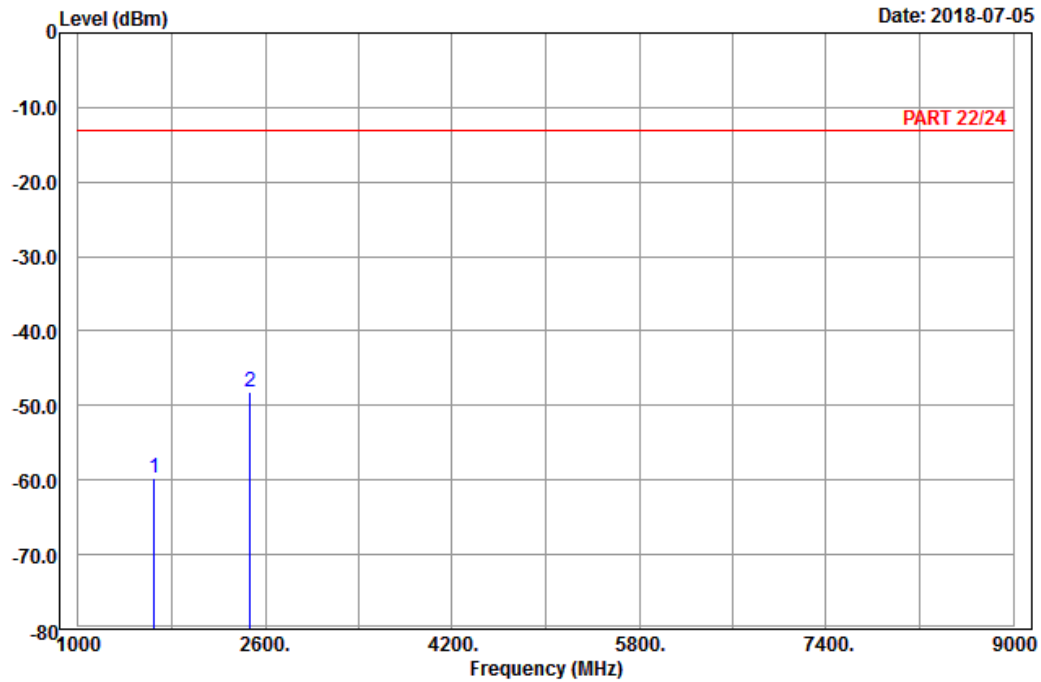

Site : 966 chamber 1
Condition: PART 22/24 Horizontal
Remark : LTE_Band 5_Link_CH20407
Tested by: Karl Lee

	Read	Limit	Over				
Freq	Level	Level	Line	Limit	Factor	Remark	
MHz	dBm	dBm	dBm	dB	dB		
1	1649.40	-59.77	-67.50	-13.00	-46.77	7.73	Peak
2 pp	2474.10	-48.12	-59.15	-13.00	-35.12	11.03	Peak



Bureau Veritas Consumer Products Services Ltd., Taoyuan Branch

A D T

Data: 6

Date: 2018-07-05

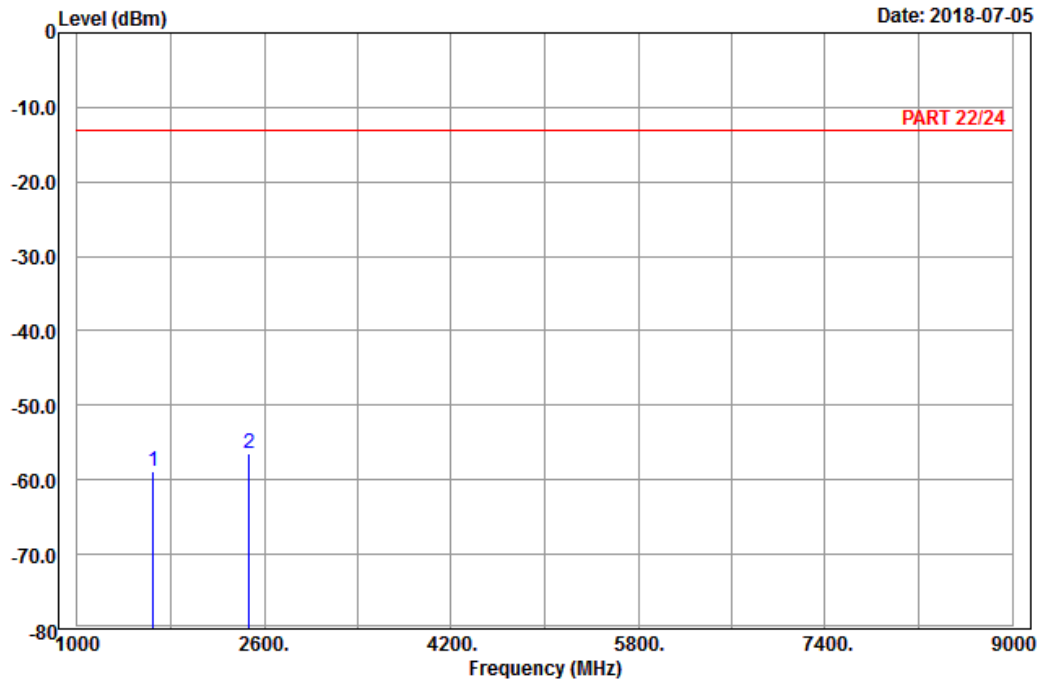

Site : 966 chamber 1
 Condition: PART 22/24 Vertical
 Remark : LTE_Band 5_Link_CH20407
 Tested by: Karl Lee

	Freq	Level	Read Level	Limit Line	Over Limit	Factor	Remark
	MHz	dBm	dBm	dBm	dB	dB	
1	1649.40	-58.78	-66.51	-13.00	-45.78	7.73	Peak
2 pp	2474.10	-56.36	-67.39	-13.00	-43.36	11.03	Peak

Middle Channel



Bureau Veritas Consumer Products Services Ltd., Taoyuan Branch

A D T

Data: 5

Date: 2018-07-05

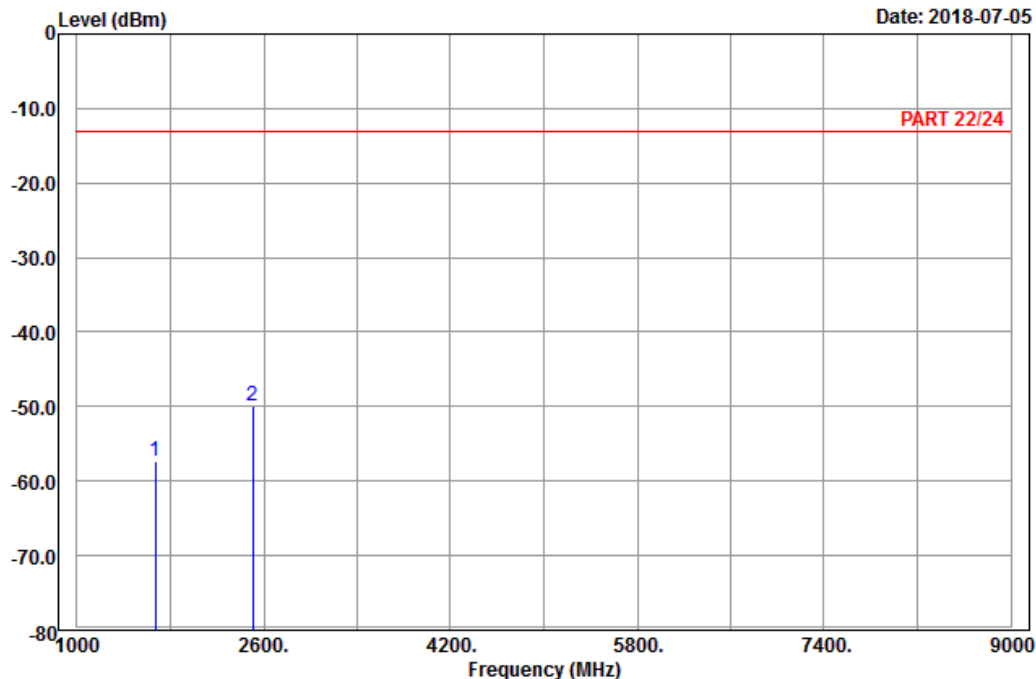

Site : 966 chamber 1
 Condition: PART 22/24 Horizontal
 Remark : LTE_Band 5_Link_CH20525
 Tested by: Karl Lee

	Freq	Level	Read Level	Limit Line	Over Limit	Factor	Remark
	MHz	dBm	dBm	dBm	dB	dB	
1	1673.00	-57.37	-65.28	-13.00	-44.37	7.91	Peak
2	2509.50	-49.99	-61.27	-13.00	-36.99	11.28	Peak



Bureau Veritas Consumer Products Services Ltd., Taoyuan Branch

A D T

Data: 6

Date: 2018-07-05

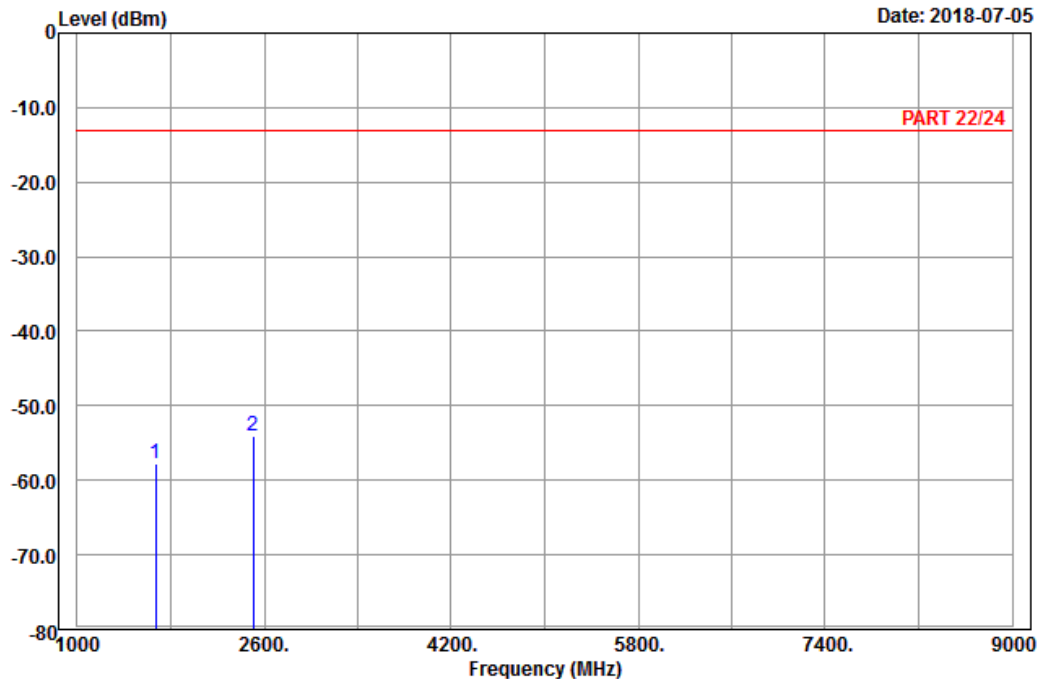

Site : 966 chamber 1
 Condition: PART 22/24 Vertical
 Remark : LTE_Band 5_Link_CH20525
 Tested by: Karl Lee

	Freq	Level	Read Level	Limit Line	Over Limit	Factor	Remark
	MHz	dBm	dBm	dBm	dB	dB	
1	1673.00	-57.82	-65.73	-13.00	-44.82	7.91	Peak
2 pp	2509.50	-54.07	-65.35	-13.00	-41.07	11.28	Peak

High Channel



Bureau Veritas Consumer Products Services Ltd., Taoyuan Branch

A D T

Data: 5

Date: 2018-07-05

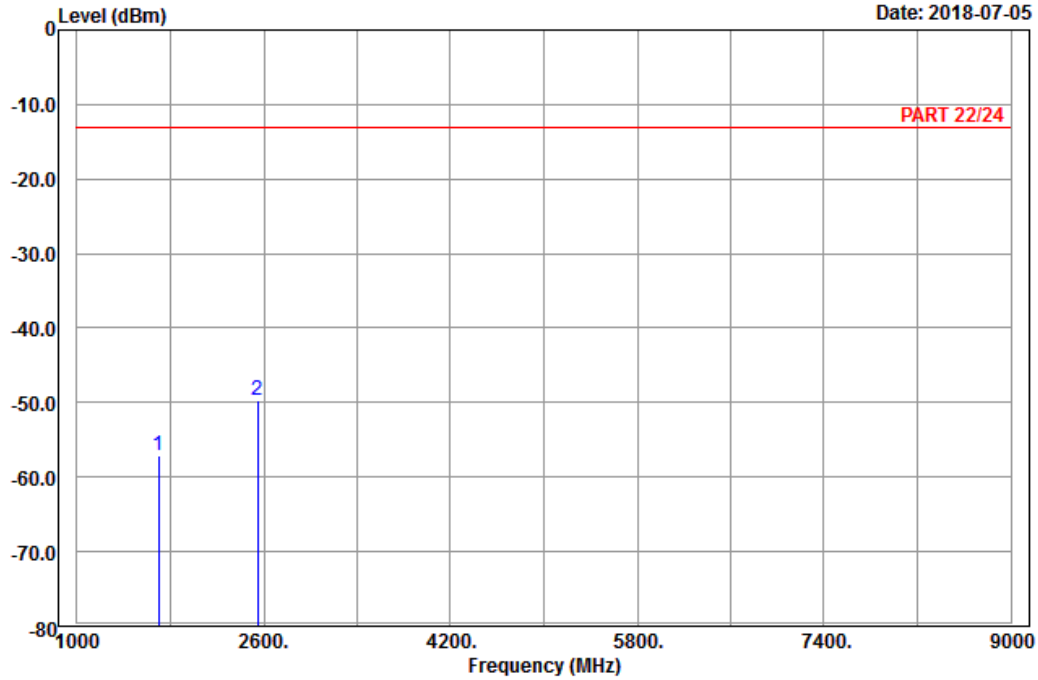

Site : 966 chamber 1
 Condition: PART 22/24 Horizontal
 Remark : LTE_Band 5_Link_CH20643
 Tested by: Karl Lee

	Read	Limit	Over			
Freq	Level	Level	Line	Limit	Factor	Remark
MHz	dBm	dBm	dBm	dB	dB	
1	1696.60	-57.04	-65.18	-13.00	-44.04	8.14 Peak
2 pp	2544.90	-49.68	-61.15	-13.00	-36.68	11.47 Peak



Bureau Veritas Consumer Products Services Ltd., Taoyuan Branch

A D T

Data: 6

Date: 2018-07-05

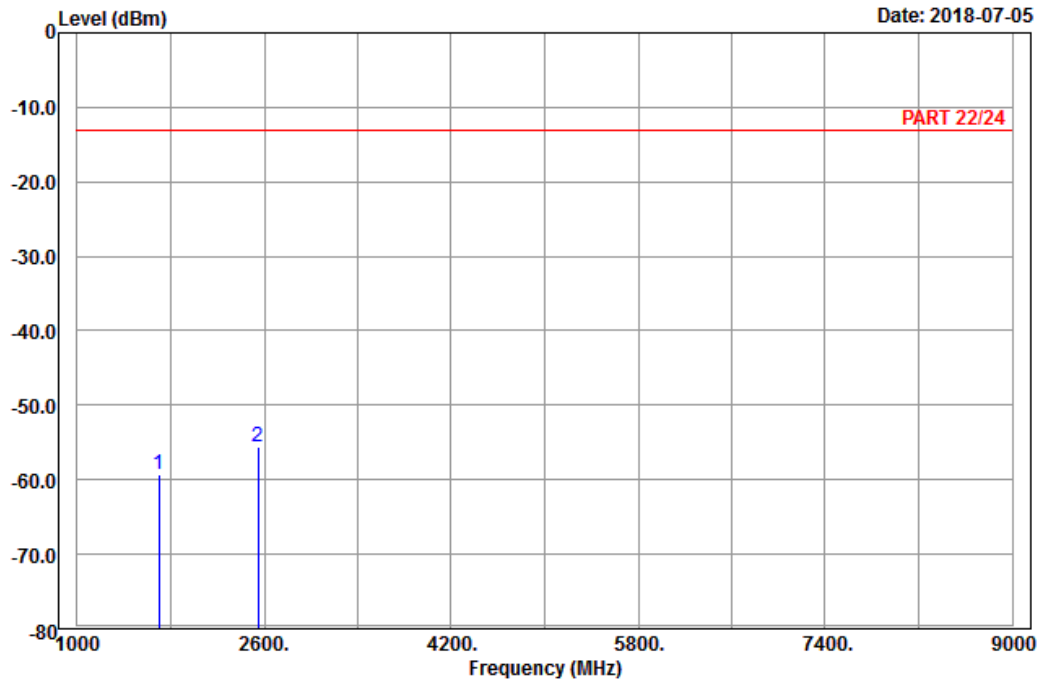

Site : 966 chamber 1
 Condition: PART 22/24 Vertical
 Remark : LTE_Band 5_Link_CH20643
 Tested by: Karl Lee

	Freq	Level	Read Level	Limit Line	Over Limit	Factor	Remark
	MHz	dBm	dBm	dBm	dB	dB	
1	1696.60	-59.22	-67.36	-13.00	-46.22	8.14	Peak
2 pp	2544.90	-55.60	-67.07	-13.00	-42.60	11.47	Peak

Channel Bandwidth: 5 MHz / QPSK
 Low Channel



Bureau Veritas Consumer Products Services Ltd., Taoyuan Branch

A D T

Data: 5

Date: 2018-07-05

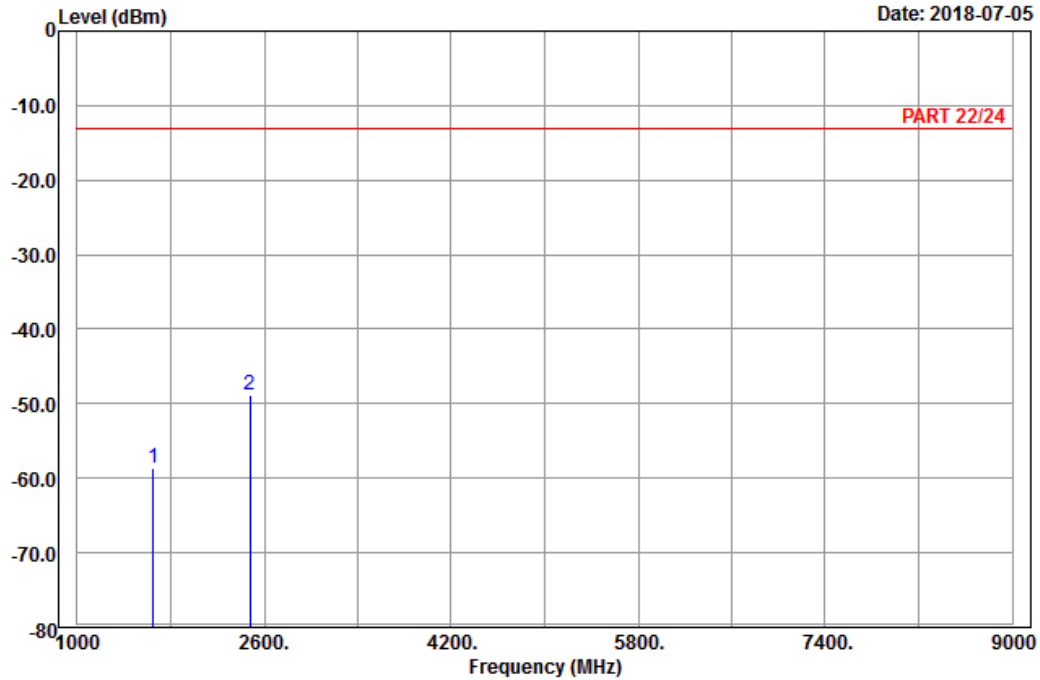

Site : 966 chamber 1
 Condition: PART 22/24 Horizontal
 Remark : LTE_Band 5_Link_CH20425
 Tested by: Karl Lee

	Freq	Level	Read Level	Limit Line	Over Limit	Factor	Remark
	MHz	dBm	dBm	dBm	dB	dB	
1	1653.00	-58.74	-66.47	-13.00	-45.74	7.73	Peak
2 pp	2479.50	-48.73	-59.76	-13.00	-35.73	11.03	Peak



A D T

Data: 6

Date: 2018-07-05

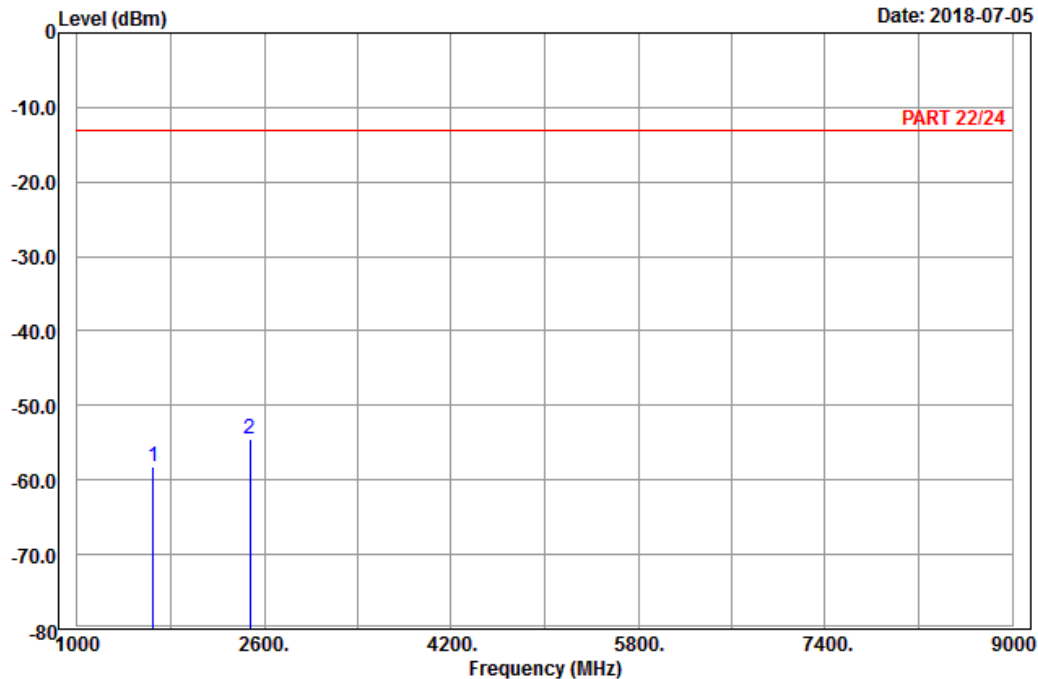

Site : 966 chamber 1
 Condition: PART 22/24 Vertical
 Remark : LTE_Band 5_Link_CH20425
 Tested by: Karl Lee

	Freq	Level	Read Level	Limit Line	Over Limit	Factor	Remark
	MHz	dBm	dBm	dBm	dB	dB	
1	1653.00	-58.22	-65.95	-13.00	-45.22	7.73	Peak
2 pp	2479.50	-54.42	-65.45	-13.00	-41.42	11.03	Peak

Middle Channel



Bureau Veritas Consumer Products Services Ltd., Taoyuan Branch

A D T

Data: 5

Date: 2018-07-05

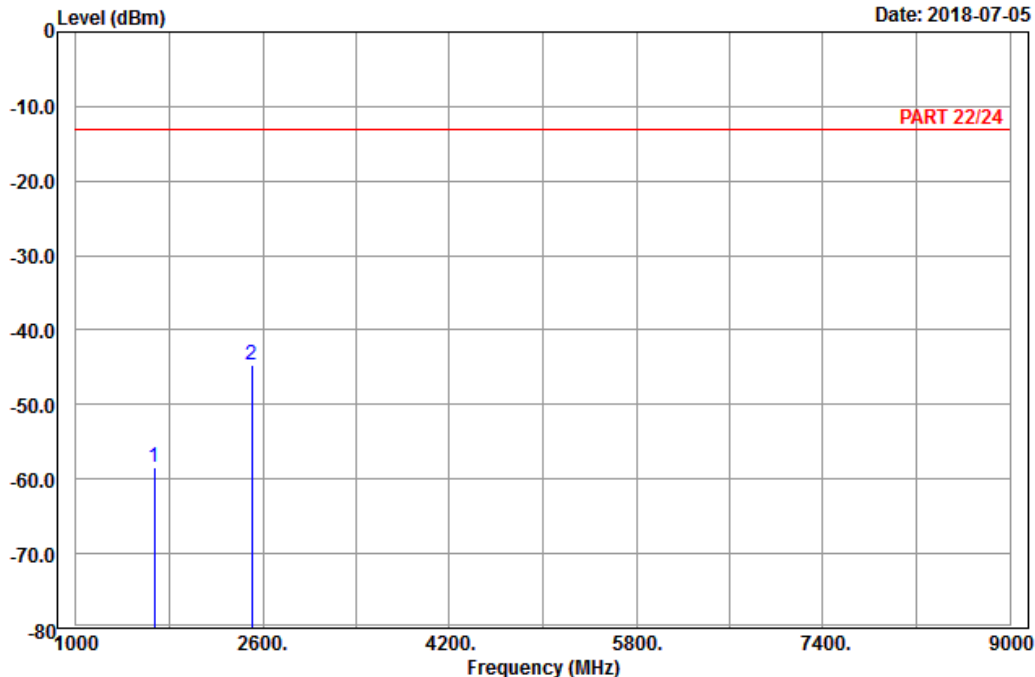

Site : 966 chamber 1
 Condition: PART 22/24 Horizontal
 Remark : LTE_Band 5_Link_CH20525
 Tested by: Karl Lee

	Freq	Level	Read Level	Limit Line	Over Limit	Factor	Remark
	MHz	dBm	dBm	dBm	dB	dB	
1	1673.00	-58.37	-66.28	-13.00	-45.37	7.91	Peak
2	2509.50	-44.69	-55.97	-13.00	-31.69	11.28	Peak



Bureau Veritas Consumer Products Services Ltd., Taoyuan Branch

A D T

Data: 6

Date: 2018-07-05

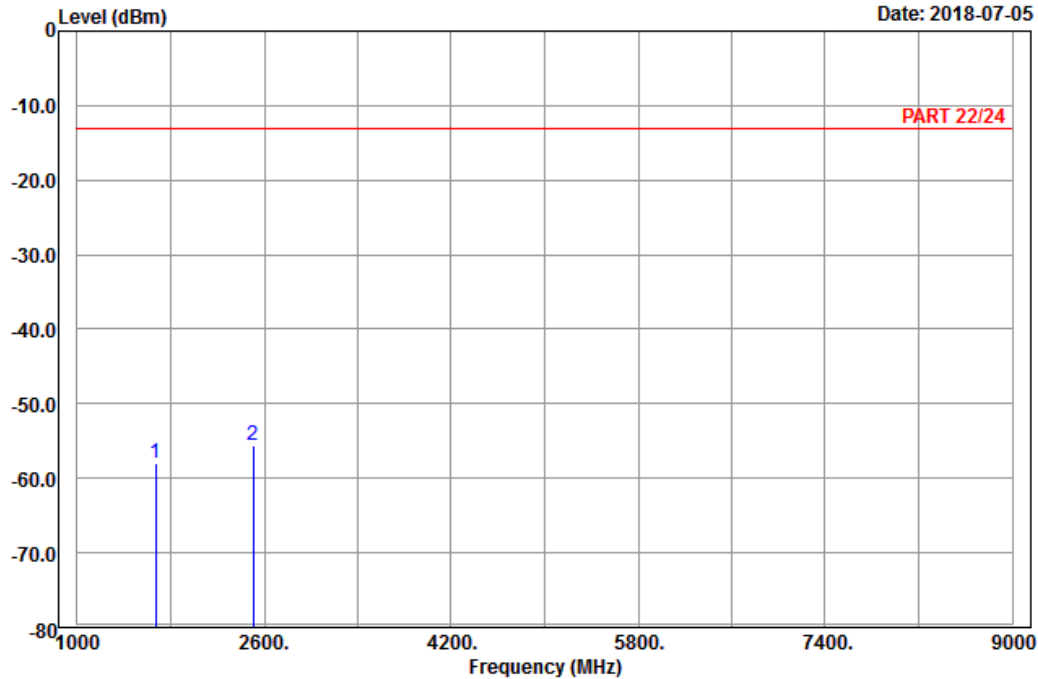

Site : 966 chamber 1
 Condition: PART 22/24 Vertical
 Remark : LTE_Band 5_Link_CH20525
 Tested by: Karl Lee

	Freq	Level	Read Level	Limit Line	Over Limit	Factor	Remark
	MHz	dBm	dBm	dBm	dB	dB	
1	1673.00	-57.88	-65.79	-13.00	-44.88	7.91	Peak
2 pp	2509.50	-55.57	-66.85	-13.00	-42.57	11.28	Peak

High Channel



Bureau Veritas Consumer Products Services Ltd., Taoyuan Branch

A D T

Data: 5

Date: 2018-07-05

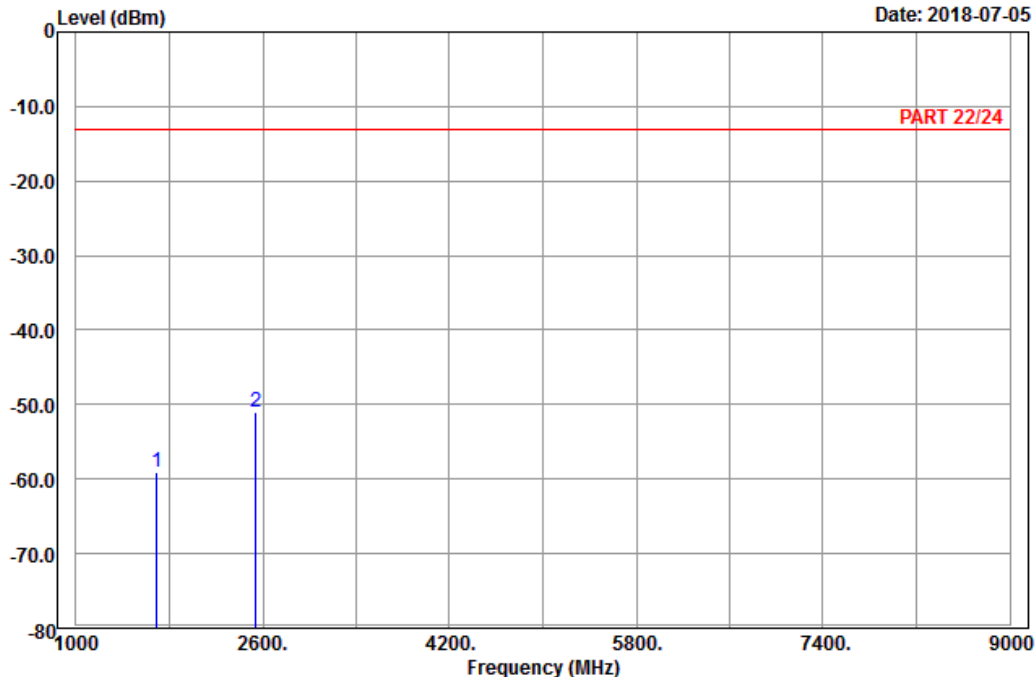

Site : 966 chamber 1
 Condition: PART 22/24 Horizontal
 Remark : LTE_Band 5_Link_CH20625
 Tested by: Karl Lee

	Freq	Level	Read Level	Limit Line	Over Limit	Factor	Remark
	MHz	dBm	dBm	dBm	dB	dB	
1	1693.00	-58.98	-67.00	-13.00	-45.98	8.02	Peak
2	2539.50	-51.01	-62.48	-13.00	-38.01	11.47	Peak



A D T

Data: 6

Date: 2018-07-05

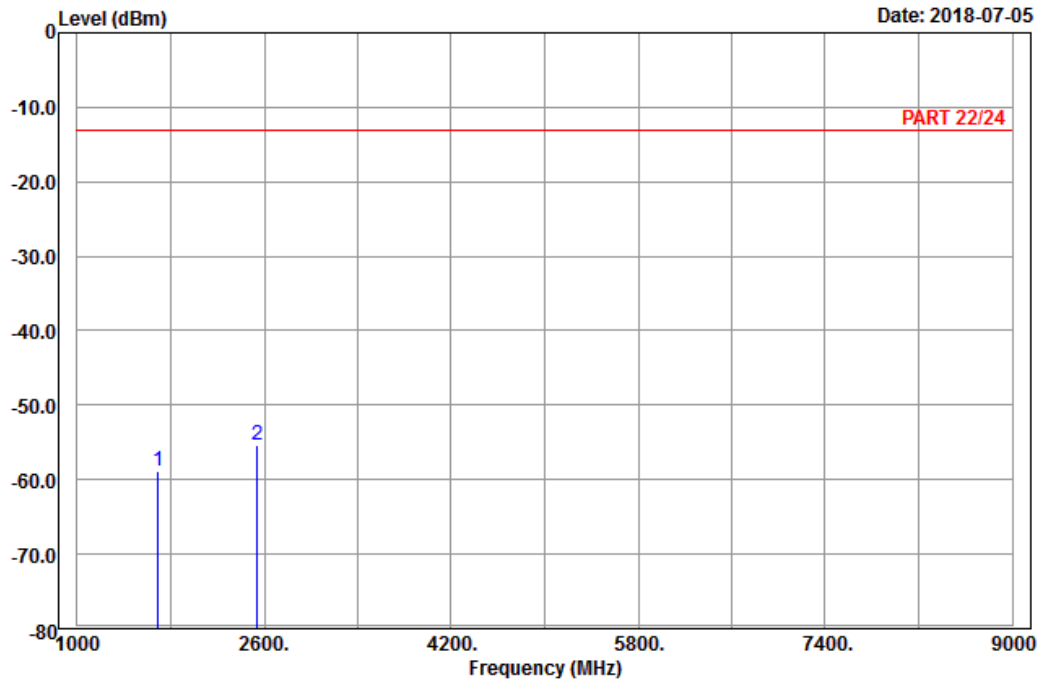

Site : 966 chamber 1
 Condition: PART 22/24 Vertical
 Remark : LTE_Band 5_Link_CH20625
 Tested by: Karl Lee

	Freq	Level	Read Level	Limit Line	Over Limit	Factor	Remark
	MHz	dBm	dBm	dBm	dB	dB	
1	1693.00	-58.82	-66.84	-13.00	-45.82	8.02	Peak
2 pp	2539.50	-55.33	-66.80	-13.00	-42.33	11.47	Peak

Channel Bandwidth: 10 MHz / QPSK
Low Channel



Bureau Veritas Consumer Products Services Ltd., Taoyuan Branch

A D T

Data: 5

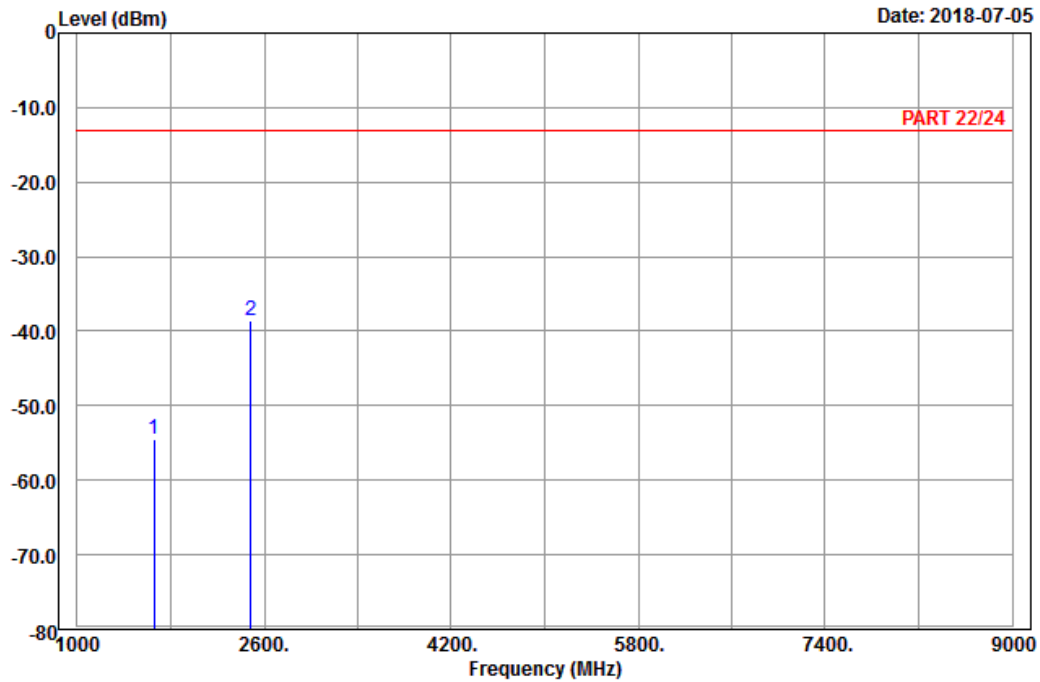

Site : 966 chamber 1
Condition: PART 22/24 Horizontal
Remark : LTE_Band 5_Link_CH20450
Tested by: Karl Lee

	Freq	Level	Read Level	Limit Line	Over Limit	Factor	Remark
	MHz	dBm	dBm	dBm	dB	dB	
1	1658.00	-54.42	-62.33	-13.00	-41.42	7.91	Peak
2 pp	2487.00	-38.57	-49.61	-13.00	-25.57	11.04	Peak



A D T

Data: 6

Date: 2018-07-05

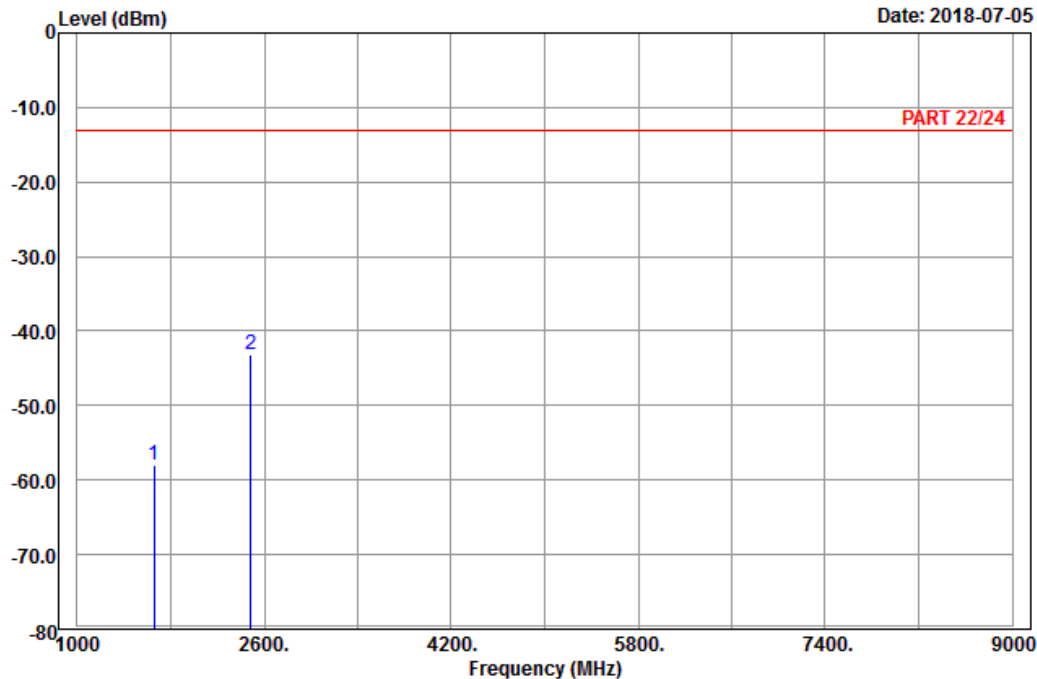

Site : 966 chamber 1
 Condition: PART 22/24 Vertical
 Remark : LTE_Band 5_Link_CH20450
 Tested by: Karl Lee

	Freq	Level	Read Level	Limit Line	Over Limit	Factor	Remark
	MHz	dBm	dBm	dBm	dB	dB	
1	1658.00	-58.07	-65.98	-13.00	-45.07	7.91	Peak
2 pp	2487.00	-43.10	-54.14	-13.00	-30.10	11.04	Peak

Middle Channel



Bureau Veritas Consumer Products Services Ltd., Taoyuan Branch

A D T

Data: 9

Date: 2018-07-05

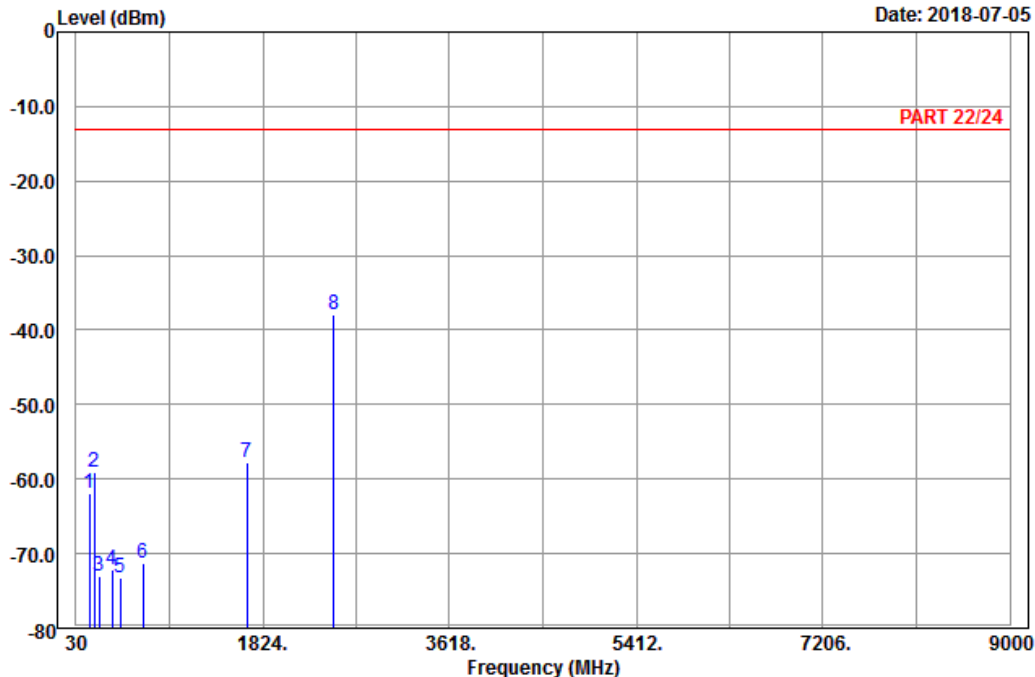

Site : 966 chamber 1
 Condition: PART 22/24 Horizontal
 Remark : LTE_Band 5_Link_CH20525
 Tested by: Karl Lee

	Freq	Level	Read Level	Limit Line	Over Limit	Factor	Remark
	MHz	dBm	dBm	dBm	dB	dB	
1	157.44	-61.82	-54.07	-13.00	-48.82	-7.75	Peak
2	205.23	-59.16	-53.05	-13.00	-46.16	-6.11	Peak
3	250.86	-72.97	-67.45	-13.00	-59.97	-5.52	Peak
4	374.90	-72.23	-68.20	-13.00	-59.23	-4.03	Peak
5	451.90	-73.25	-69.35	-13.00	-60.25	-3.90	Peak
6	671.00	-71.31	-71.07	-13.00	-58.31	-0.24	Peak
7	1673.00	-57.71	-65.62	-13.00	-44.71	7.91	Peak
8 pp	2509.50	-37.90	-49.18	-13.00	-24.90	11.28	Peak



Bureau Veritas Consumer Products Services Ltd., Taoyuan Branch

A D T

Data: 10

Date: 2018-07-05

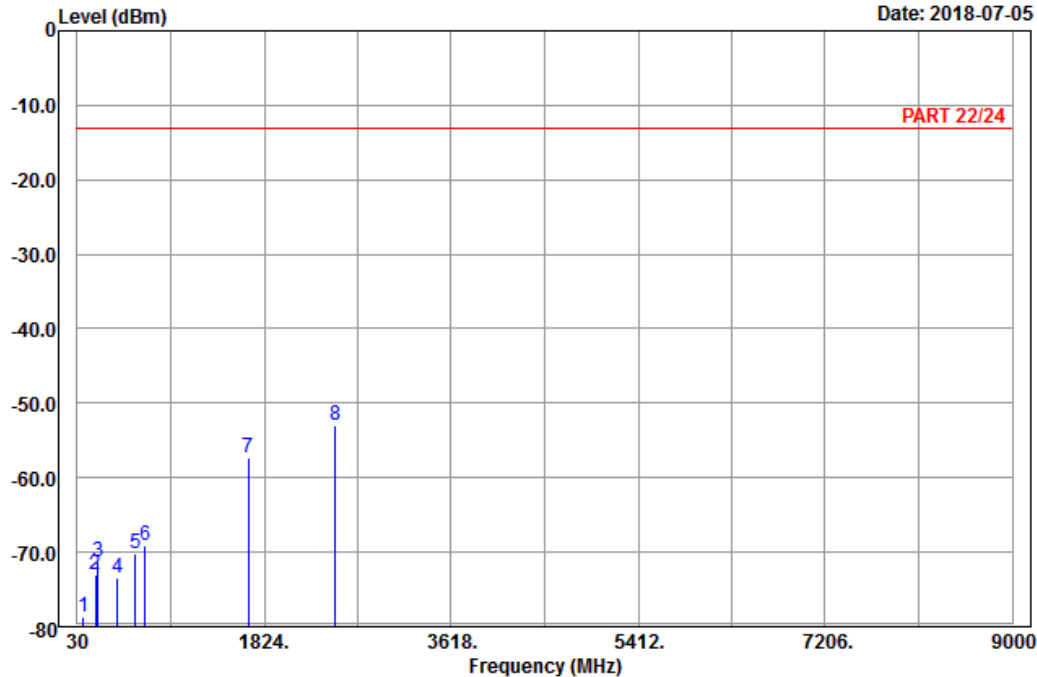

Site : 966 chamber 1
 Condition: PART 22/24 Vertical
 Remark : LTE_Band 5_Link_CH20525
 Tested by: Karl Lee

	Freq	Level	Read Level	Limit Line	Over Limit	Factor	Remark
	MHz	dBm	dBm	dBm	dB	dB	
1	87.78	-78.63	-67.74	-13.00	-65.63	-10.89	Peak
2	208.20	-73.10	-67.03	-13.00	-60.10	-6.07	Peak
3	231.42	-71.27	-65.52	-13.00	-58.27	-5.75	Peak
4	414.10	-73.43	-70.37	-13.00	-60.43	-3.06	Peak
5	589.80	-70.14	-70.13	-13.00	-57.14	-0.01	Peak
6	680.10	-69.01	-68.73	-13.00	-56.01	-0.28	Peak
7	1673.00	-57.23	-65.14	-13.00	-44.23	7.91	Peak
8 pp	2509.50	-52.92	-64.20	-13.00	-39.92	11.28	Peak

High Channel



Bureau Veritas Consumer Products Services Ltd., Taoyuan Branch

A D T

Data: 5

Date: 2018-07-05

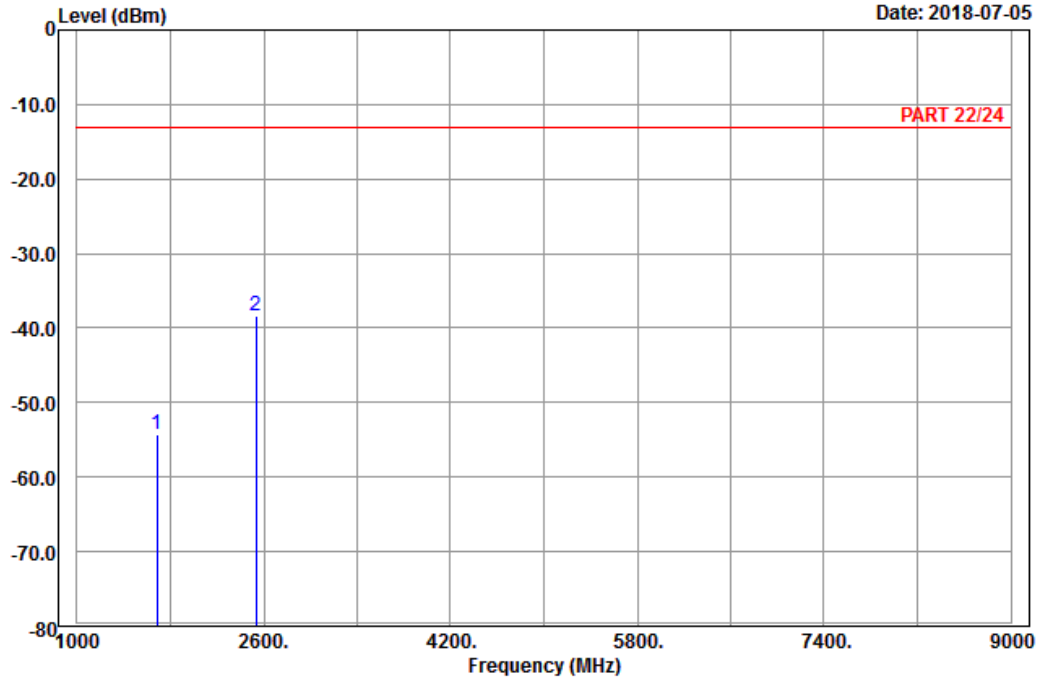

Site : 966 chamber 1
 Condition: PART 22/24 Horizontal
 Remark : LTE_Band 5_Link_CH20600
 Tested by: Karl Lee

	Freq	Level	Read Level	Limit Line	Over Limit	Factor	Remark
	MHz	dBm	dBm	dBm	dB	dB	
1	1688.00	-54.32	-62.34	-13.00	-41.32	8.02	Peak
2	2532.00	-38.33	-49.71	-13.00	-25.33	11.38	Peak



A D T

Data: 6

Date: 2018-07-05

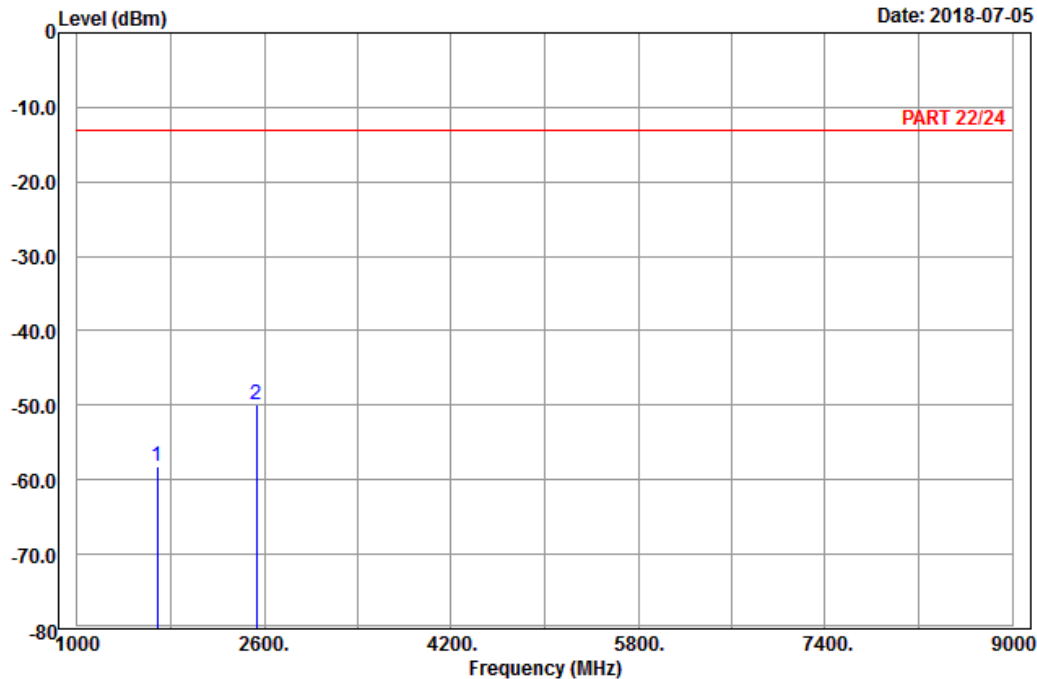

Site : 966 chamber 1
 Condition: PART 22/24 Vertical
 Remark : LTE_Band 5_Link_CH20600
 Tested by: Karl Lee

	Freq	Level	Read Level	Limit Line	Over Limit	Factor	Remark
	MHz	dBm	dBm	dBm	dB	dB	
1	1688.00	-58.27	-66.29	-13.00	-45.27	8.02	Peak
2 pp	2532.00	-49.83	-61.21	-13.00	-36.83	11.38	Peak

Mode B
GSM:
Low Channel



Bureau Veritas Consumer Products Services Ltd., Taoyuan Branch

A D T

Data: 5

Date: 2018-07-20

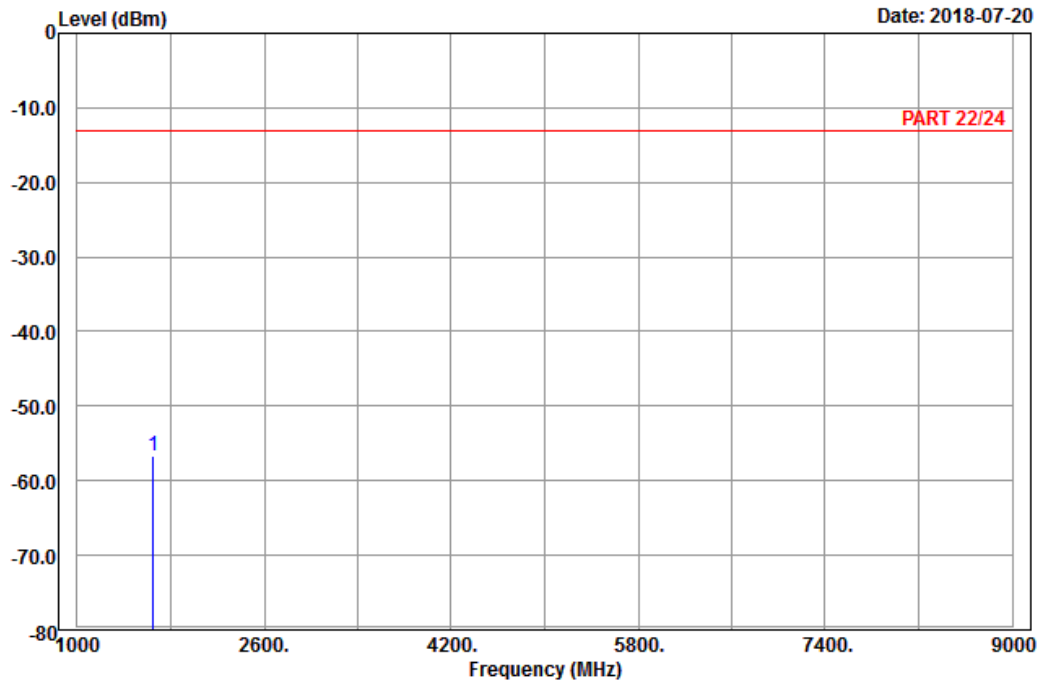

Site : 966 chamber 1
Condition: PART 22/24 Horizontal
Remark : GSM 850_Link_CH128
Tested by: Charles Hsiao

	Read	Limit	Over		
Freq	Level	Level	Line	Limit	Factor Remark
MHz	dBm	dBm	dBm	dB	dB
1 pp 1648.40	-56.64	-64.37	-13.00	-43.64	7.73 Peak



Bureau Veritas Consumer Products Services Ltd., Taoyuan Branch

A D T

Data: 6

Date: 2018-07-20

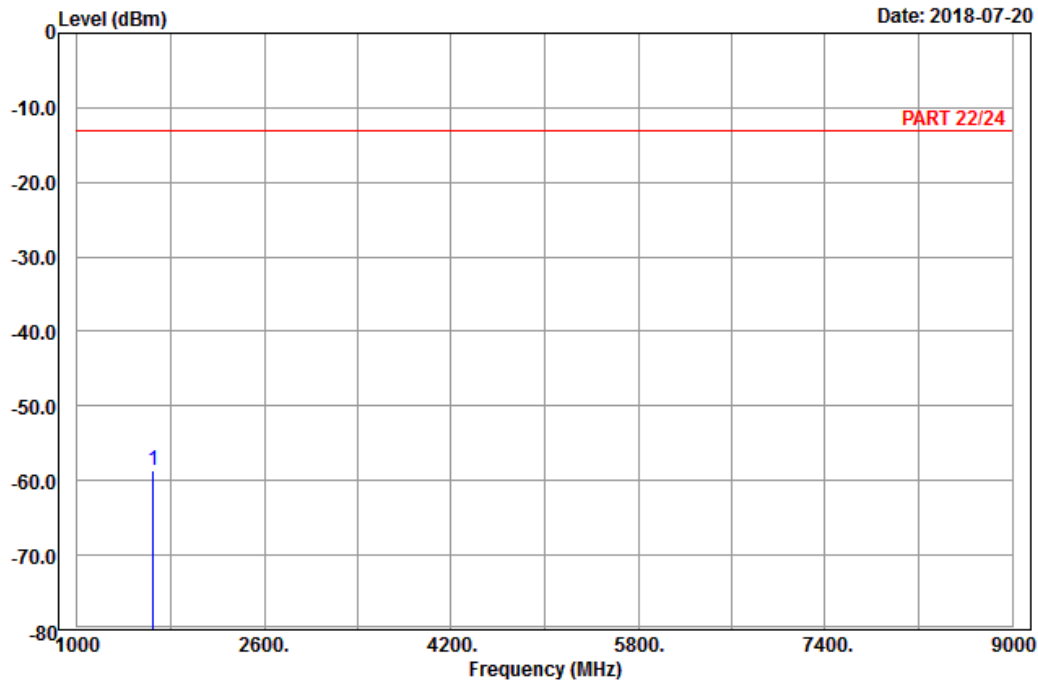

Site : 966 chamber 1
 Condition: PART 22/24 Vertical
 Remark : GSM 850_Link_CH128
 Tested by: Charles Hsiao

	Read	Limit	Over			
Freq	Level	Level	Line	Limit	Factor	Remark
MHz	dBm	dBm	dBm	dB	dB	
1 pp 1648.40	-58.74	-66.47	-13.00	-45.74	7.73	Peak

Middle Channel



Bureau Veritas Consumer Products Services Ltd., Taoyuan Branch

A D T

Data: 9

Date: 2018-07-20

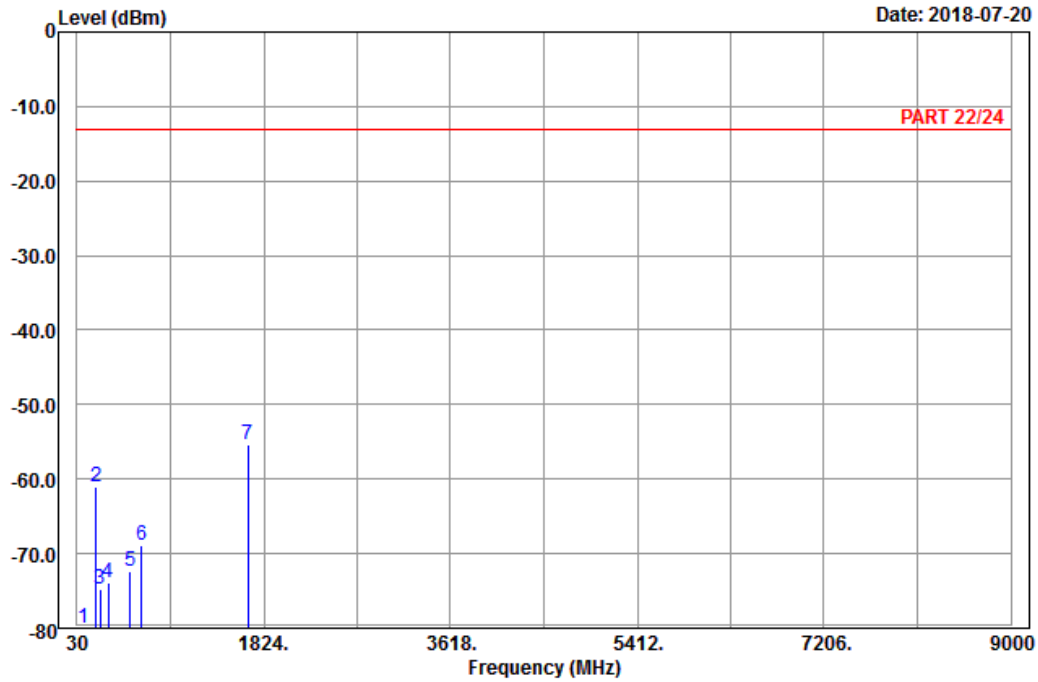

Site : 966 chamber 1
 Condition: PART 22/24 Horizontal
 Remark : GSM 850_Link_CH189
 Tested by: Charles Hsiao

	Freq	Level	Read Level	Limit Line	Over Limit	Factor	Remark
	MHz	dBm	dBm	dBm	dB	dB	
1	98.31	-80.08	-69.85	-13.00	-67.08	-10.23	Peak
2	210.63	-60.99	-54.95	-13.00	-47.99	-6.04	Peak
3	254.37	-74.81	-69.27	-13.00	-61.81	-5.54	Peak
4	327.30	-73.83	-68.18	-13.00	-60.83	-5.65	Peak
5	542.90	-72.36	-70.20	-13.00	-59.36	-2.16	Peak
6	650.00	-68.80	-68.67	-13.00	-55.80	-0.13	Peak
7 pp	1672.80	-55.38	-63.29	-13.00	-42.38	7.91	Peak



Bureau Veritas Consumer Products Services Ltd., Taoyuan Branch

A D T

Data: 10

Date: 2018-07-20

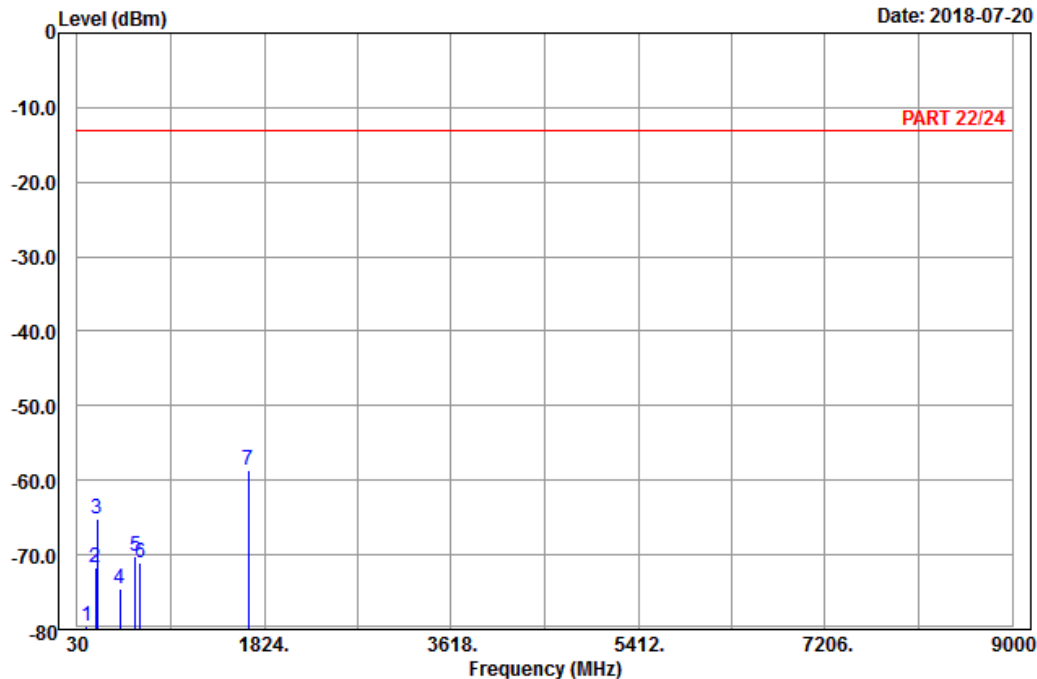

Site : 966 chamber 1
 Condition: PART 22/24 Vertical
 Remark : GSM 850_Link_CH189
 Tested by: Charles Hsiao

	Freq	Level	Read Level	Limit Line	Over Limit	Factor	Remark
	MHz	dBm	dBm	dBm	dB	dB	
1	122.34	-79.51	-71.38	-13.00	-66.51	-8.13	Peak
2	205.77	-71.74	-65.63	-13.00	-58.74	-6.11	Peak
3	220.35	-65.27	-59.36	-13.00	-52.27	-5.91	Peak
4	440.70	-74.60	-70.97	-13.00	-61.60	-3.63	Peak
5	586.30	-70.12	-69.98	-13.00	-57.12	-0.14	Peak
6	632.50	-71.15	-71.21	-13.00	-58.15	0.06	Peak
7 pp	1672.80	-58.71	-66.62	-13.00	-45.71	7.91	Peak

High Channel



Bureau Veritas Consumer Products Services Ltd., Taoyuan Branch

A D T

Data: 5

Date: 2018-07-20

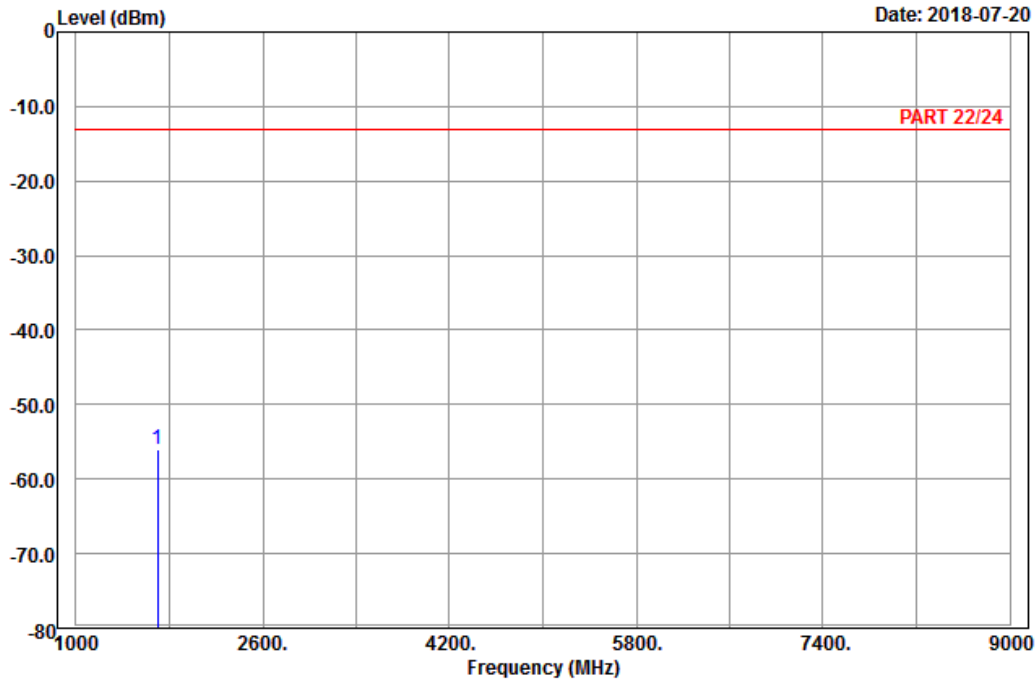

Site : 966 chamber 1
 Condition: PART 22/24 Horizontal
 Remark : GSM 850_Link_CH251
 Tested by: Charles Hsiao

Freq	Level	Read Level	Limit	Over	Factor	Remark
MHz	dBm	dBm	dBm	dB	dB	
1 pp 1697.60	-56.04	-64.18	-13.00	-43.04	8.14	Peak



Bureau Veritas Consumer Products Services Ltd., Taoyuan Branch

A D T

Data: 6

Date: 2018-07-20

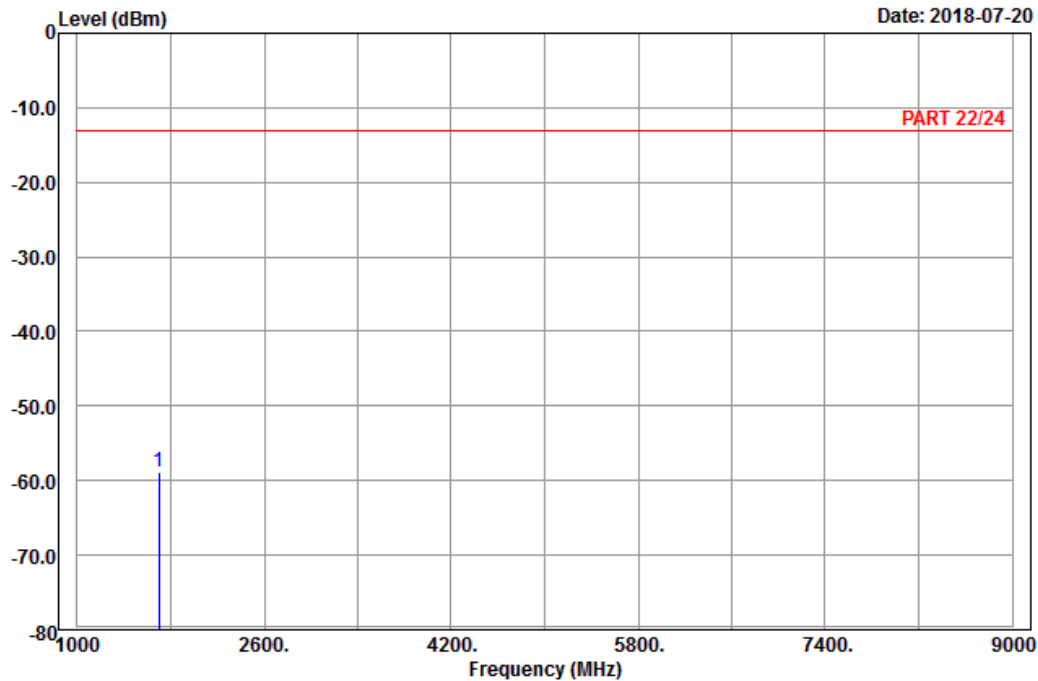

Site : 966 chamber 1
 Condition: PART 22/24 Vertical
 Remark : GSM 850_Link_CH251
 Tested by: Charles Hsiao

	Read	Limit	Over			
Freq	Level	Level	Line	Limit	Factor	Remark
MHz	dBm	dBm	dBm	dB	dB	
1 pp 1697.60	-58.90	-67.04	-13.00	-45.90	8.14	Peak

LTE Band 5
 Channel Bandwidth: 10 MHz / QPSK
 Low Channel



Bureau Veritas Consumer Products Services Ltd., Taoyuan Branch

A D T

Data: 5

Date: 2018-07-20

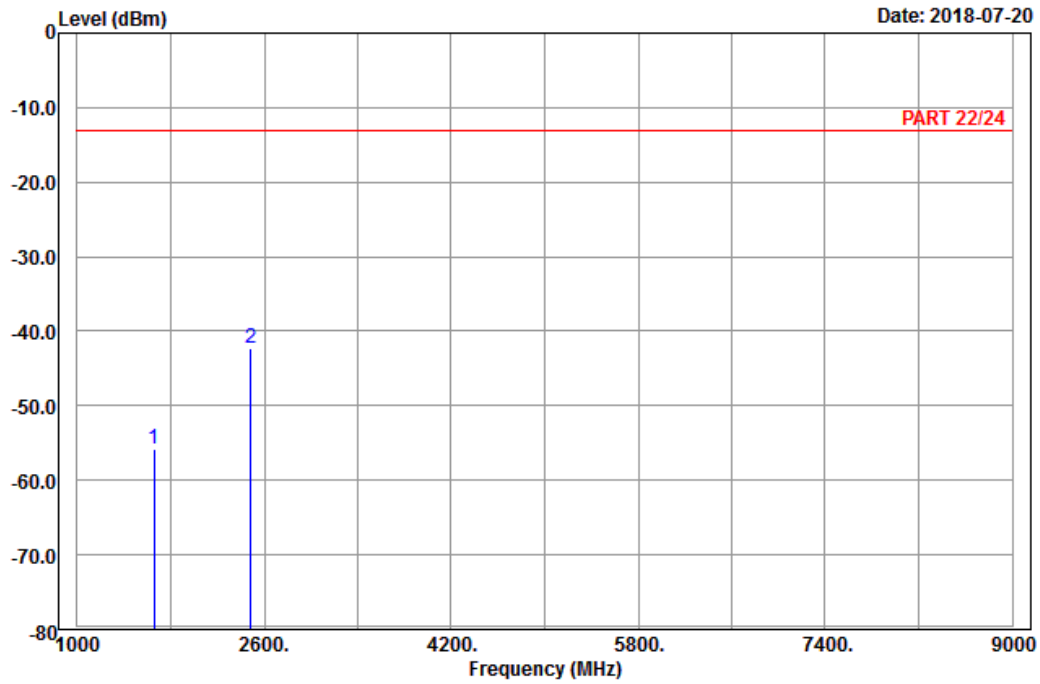

Site : 966 chamber 1
 Condition: PART 22/24 Horizontal
 Remark : LTE_Band 5_Link_CH20450
 Tested by: Karl Lee

	Read	Limit	Over				
Freq	Level	Level	Line	Limit	Factor	Remark	
MHz	dBm	dBm	dBm	dB	dB		
1	1658.00	-55.77	-63.68	-13.00	-42.77	7.91	Peak
2 pp	2487.00	-42.27	-53.31	-13.00	-29.27	11.04	Peak



Bureau Veritas Consumer Products Services Ltd., Taoyuan Branch

A D T

Data: 6

Date: 2018-07-20

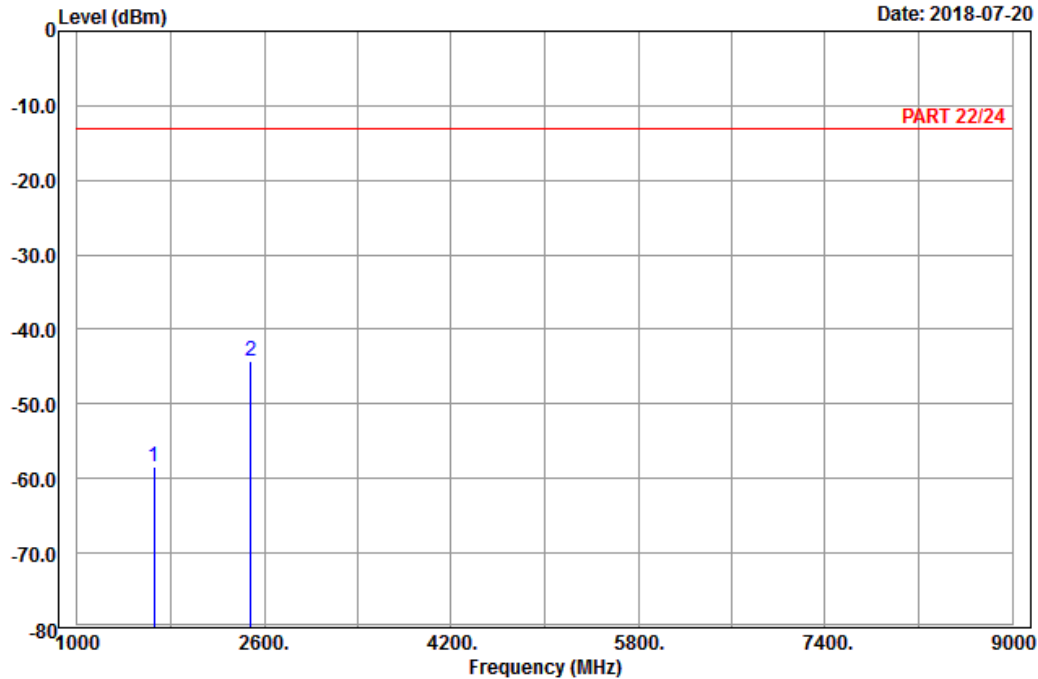

Site : 966 chamber 1
 Condition: PART 22/24 Vertical
 Remark : LTE_Band 5_Link_CH20450
 Tested by: Karl Lee

	Freq	Level	Read Level	Limit Line	Over Limit	Factor	Remark
	MHz	dBm	dBm	dBm	dB	dB	
1	1658.00	-58.45	-66.36	-13.00	-45.45	7.91	Peak
2 pp	2487.00	-44.20	-55.24	-13.00	-31.20	11.04	Peak

Middle Channel



Bureau Veritas Consumer Products Services Ltd., Taoyuan Branch

A D T

Data: 9

Date: 2018-07-20

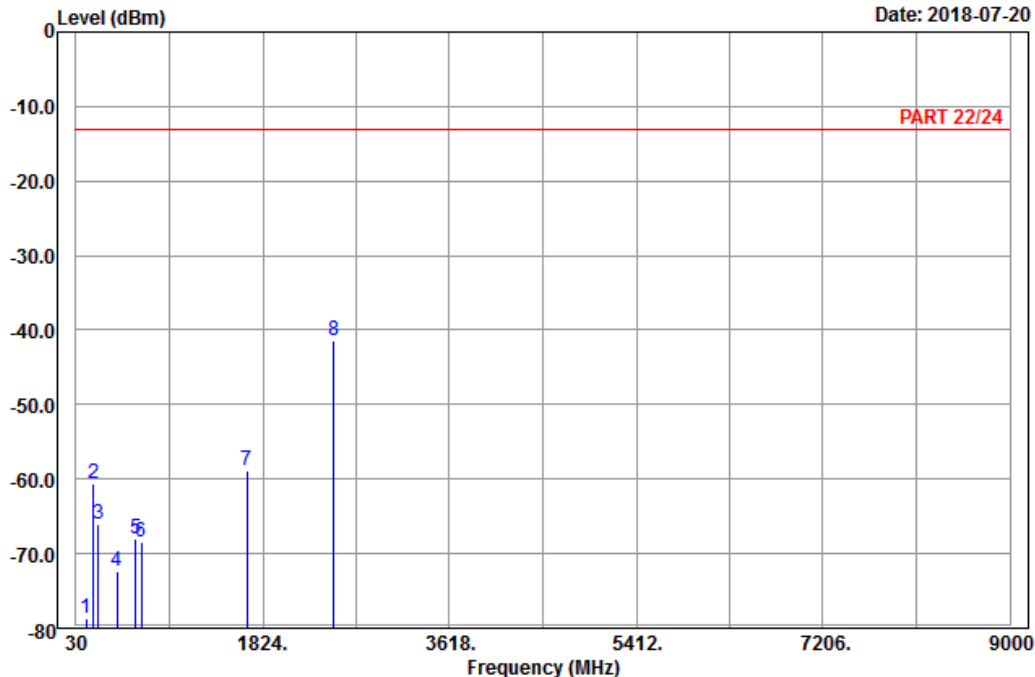

Site : 966 chamber 1
 Condition: PART 22/24 Horizontal
 Remark : LTE_Band 5_Link_CH20525
 Tested by: Karl Lee

	Freq	Level	Read Level	Limit Line	Over Limit	Factor	Remark
	MHz	dBm	dBm	dBm	dB	dB	
1	126.66	-78.64	-70.81	-13.00	-65.64	-7.83	Peak
2	196.32	-60.53	-54.53	-13.00	-47.53	-6.00	Peak
3	240.87	-66.15	-60.51	-13.00	-53.15	-5.64	Peak
4	424.60	-72.41	-69.12	-13.00	-59.41	-3.29	Peak
5	601.00	-68.04	-68.46	-13.00	-55.04	0.42	Peak
6	658.40	-68.44	-68.26	-13.00	-55.44	-0.18	Peak
7	1673.00	-58.84	-66.75	-13.00	-45.84	7.91	Peak
8 pp	2509.50	-41.50	-52.78	-13.00	-28.50	11.28	Peak



Bureau Veritas Consumer Products Services Ltd., Taoyuan Branch

A D T

Data: 10

Date: 2018-07-20

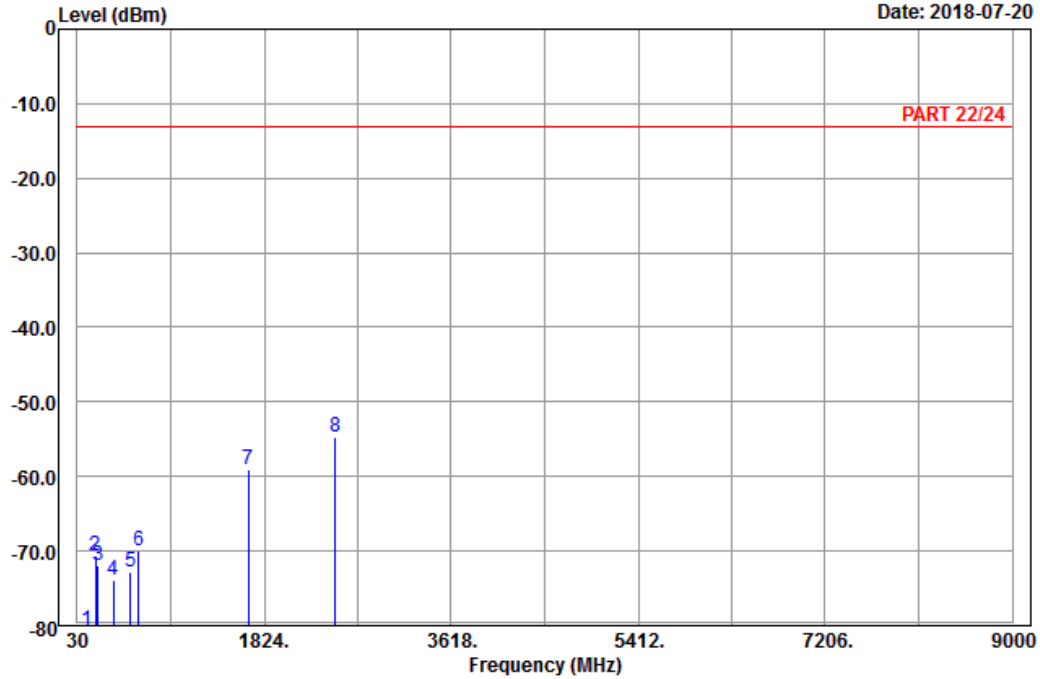

Site : 966 chamber 1
 Condition: PART 22/24 Vertical
 Remark : LTE_Band 5_Link_CH20525
 Tested by: Karl Lee

	Freq	Level	Read Level	Limit Line	Over Limit	Factor	Remark
	MHz	dBm	dBm	dBm	dB	dB	
1	123.69	-80.69	-72.68	-13.00	-67.69	-8.01	Peak
2	204.15	-70.56	-64.44	-13.00	-57.56	-6.12	Peak
3	229.53	-71.95	-66.17	-13.00	-58.95	-5.78	Peak
4	379.10	-73.82	-69.99	-13.00	-60.82	-3.83	Peak
5	538.00	-72.87	-70.36	-13.00	-59.87	-2.51	Peak
6	618.50	-70.08	-70.30	-13.00	-57.08	0.22	Peak
7	1673.00	-59.17	-67.08	-13.00	-46.17	7.91	Peak
8 pp	2509.50	-54.65	-65.93	-13.00	-41.65	11.28	Peak

High Channel



Bureau Veritas Consumer Products Services Ltd., Taoyuan Branch

A D T

Data: 5

Date: 2018-07-20

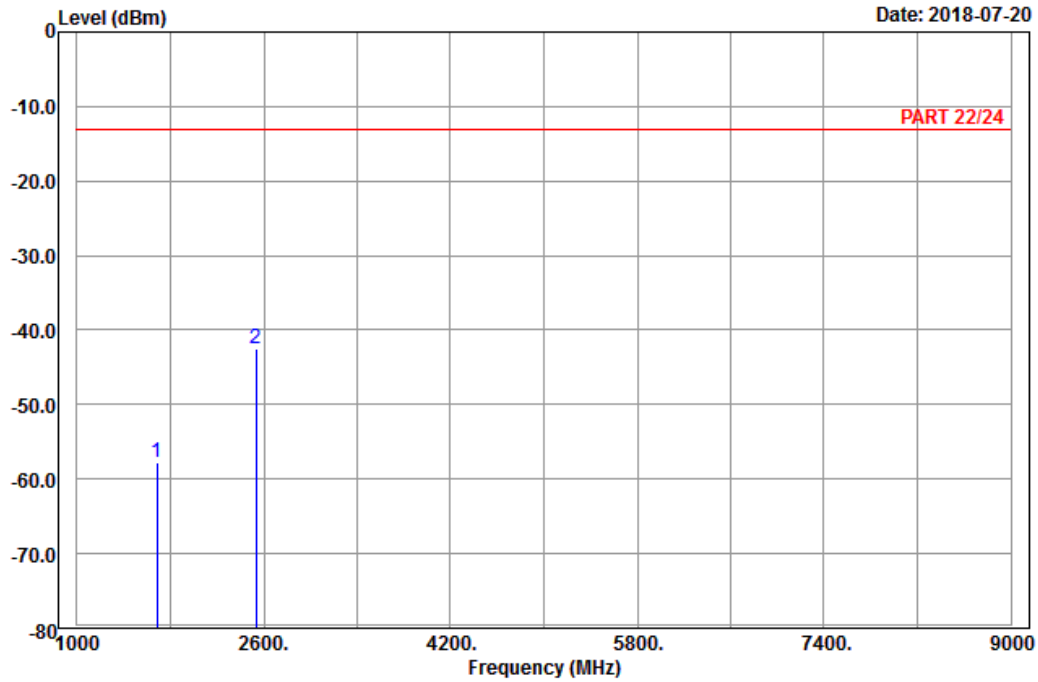

Site : 966 chamber 1
 Condition: PART 22/24 Horizontal
 Remark : LTE_Band 5_Link_CH20600
 Tested by: Karl Lee

	Freq	Level	Read Level	Limit Line	Over Limit	Factor	Remark
	MHz	dBm	dBm	dBm	dB	dB	
1	1688.00	-57.84	-65.86	-13.00	-44.84	8.02	Peak
2	2532.00	-42.41	-53.79	-13.00	-29.41	11.38	Peak



A D T

Data: 6

Date: 2018-07-20

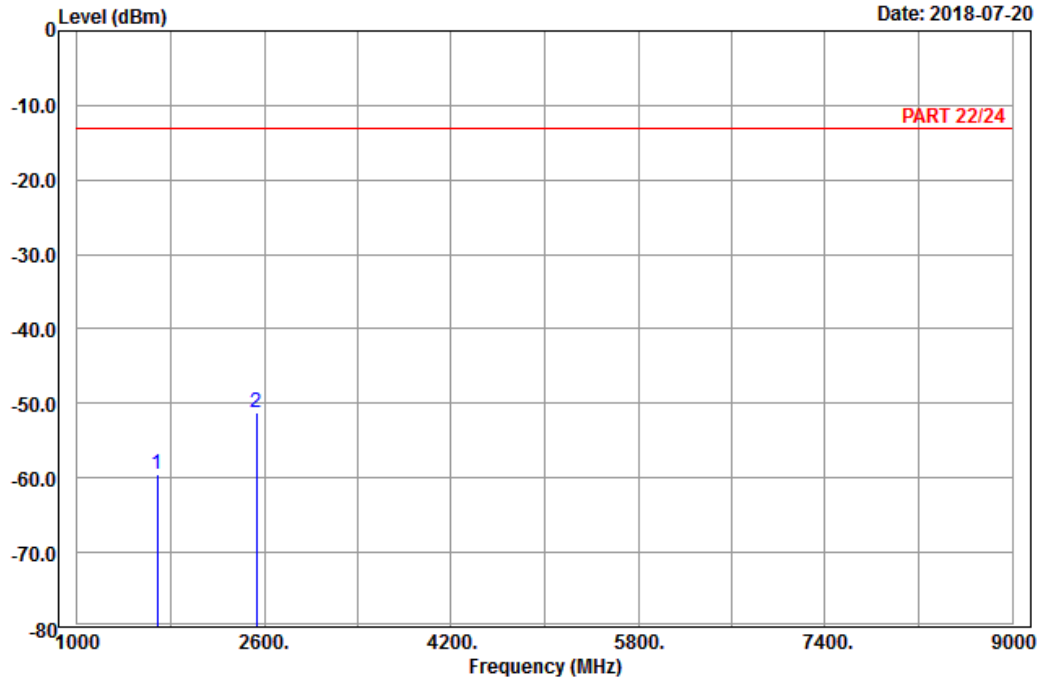

Site : 966 chamber 1
 Condition: PART 22/24 Vertical
 Remark : LTE_Band 5_Link_CH20600
 Tested by: Karl Lee

	Freq	Level	Read Level	Limit Line	Over Limit	Factor	Remark
	MHz	dBm	dBm	dBm	dB	dB	
1	1688.00	-59.50	-67.52	-13.00	-46.50	8.02	Peak
2 pp	2532.00	-51.12	-62.50	-13.00	-38.12	11.38	Peak

5 Pictures of Test Arrangements

Please refer to the attached file (Test Setup Photo).

Appendix – Information on the Testing Laboratories

We, Bureau Veritas Consumer Products Services (H.K.) Ltd., Taoyuan Branch, were founded in 1988 to provide our best service in EMC, Radio, Telecom and Safety consultation. Our laboratories are FCC recognized accredited test firms and accredited according to ISO/IEC 17025.

If you have any comments, please feel free to contact us at the following:

Linko EMC/RF Lab

Tel: 886-2-26052180

Fax: 886-2-26051924

Hsin Chu EMC/RF/Telecom Lab

Tel: 886-3-6668565

Fax: 886-3-6668323

Hwa Ya EMC/RF/Safety

Tel: 886-3-3183232

Fax: 886-3-3270892

Email: service.adt@tw.bureauveritas.com

Web Site: www.bureauveritas-adt.com

The address and road map of all our labs can be found in our web site also.

--- END ---