

FCC Test Report

Report No.: RF180626C09-7

FCC ID: 2AJOTTA-1085

Test Model: TA-1085

Received Date: Jun. 26, 2018

Test Date: Jul. 04 ~ Jul. 26, 2018

Issued Date: Jul. 30, 2018

Applicant: HMD Global Oy

Address: Karaportti 2, 02610 Espoo, Finland

Issued By: Bureau Veritas Consumer Products Services (H.K.) Ltd., Taoyuan Branch

Lab Address: No. 47-2, 14th Ling, Chia Pau Vil., Lin Kou Dist., New Taipei City, Taiwan (R.O.C.)

Test Location: No. 19, Hwa Ya 2nd Rd., Wen Hwa Vil., Kwei Shan Dist., Taoyuan City 33383, TAIWAN (R.O.C.)

**FCC Registration/
Designation Number:** 788550 / TW0003



This report is for your exclusive use. Any copying or replication of this report to or for any other person or entity, or use of our name or trademark, is permitted only with our prior written permission. This report sets forth our findings solely with respect to the test samples identified herein. The results set forth in this report are not indicative or representative of the quality or characteristics of the lot from which a test sample was taken or any similar or identical product unless specifically and expressly noted. Our report includes all of the tests requested by you and the results thereof based upon the information that you provided to us. You have 60 days from date of issuance of this report to notify us of any material error or omission caused by our negligence, provided, however, that such notice shall be in writing and shall specifically address the issue you wish to raise. A failure to raise such issue within the prescribed time shall constitute your unqualified acceptance of the completeness of this report, the tests conducted and the correctness of the report contents. Unless specifically mentioned, the uncertainty of measurement has been explicitly taken into account to declare the compliance or non-compliance to the specification. The report must not be used by the client to claim product certification, approval, or endorsement by TAF or any government agencies.

Table of Contents

Release Control Record	4
1 Certificate of Conformity	5
2 Summary of Test Results	6
2.1 Measurement Uncertainty	6
2.2 Modification Record	6
3 General Information	7
3.1 General Description of EUT	7
3.2 Description of Test Modes	9
3.2.1 Test Mode Applicability and Tested Channel Detail	11
3.3 Duty Cycle of Test Signal	13
3.4 Description of Support Units	14
3.4.1 Configuration of System under Test	14
3.5 General Description of Applied Standards	14
4 Test Types and Results	15
4.1 Radiated Emission and Bandedge Measurement.....	15
4.1.1 Limits of Radiated Emission and Bandedge Measurement	15
4.1.2 Test Instruments	16
4.1.3 Test Procedures.....	17
4.1.4 Deviation from Test Standard	17
4.1.5 Test Set Up	18
4.1.6 EUT Operating Conditions.....	19
4.1.7 Test Results	20
4.2 Conducted Emission Measurement	66
4.2.1 Limits of Conducted Emission Measurement	66
4.2.2 Test Instruments	66
4.2.3 Test Procedures.....	67
4.2.4 Deviation from Test Standard	67
4.2.5 Test Setup.....	67
4.2.6 EUT Operating Conditions.....	67
4.2.7 Test Results	68
4.3 Transmit Power Measurement	70
4.3.1 Limits of Transmit Power Measurement	70
4.3.2 Test Setup.....	70
4.3.3 Test Instruments	71
4.3.4 Test Procedure	71
4.3.5 Deviation from Test Standard	71
4.3.6 EUT Operating Conditions.....	71
4.3.7 Test Result.....	72
4.4 Occupied Bandwidth Measurement	80
4.4.1 Test Setup.....	80
4.4.2 Test Instruments	80
4.4.3 Test Procedure	80
4.4.4 Test Result.....	81
4.5 Peak Power Spectral Density Measurement	84
4.5.1 Limits of Peak Power Spectral Density Measurement	84
4.5.2 Test Setup.....	84
4.5.3 Test Instruments	84
4.5.4 Test Procedures.....	85
4.5.5 Deviation from Test Standard	85
4.5.6 EUT Operating Conditions.....	85
4.5.7 Test Results	86
4.6 Frequency Stability.....	91
4.6.1 Limits of Frequency Stability Measurement	91

4.6.2	Test Setup.....	91
4.6.3	Test Instruments	91
4.6.4	Test Procedure	91
4.6.5	Deviation from Test Standard	91
4.6.6	EUT Operating Condition	92
4.6.7	Test Results	93
4.7	6dB Bandwidth Measurement.....	94
4.7.1	Limits of 6dB Bandwidth Measurement.....	94
4.7.2	Test Setup.....	94
4.7.3	Test Instruments	94
4.7.4	Test Procedure	94
4.7.5	Deviation from Test Standard	94
4.7.6	EUT Operating Condition	94
4.7.7	Test Results	95
5	Pictures of Test Arrangements.....	97
	Annex A- Radiated Out of Band Emission (OOBE) Measurement (For U-NII-3 band).....	98
	Appendix – Information on the Testing Laboratories	101

Release Control Record

Issue No.	Description	Date Issued
RF180626C09-7	Original release	Jul. 30, 2018

1 Certificate of Conformity

Product: Smart Phone

Brand: NOKIA

Model: TA-1085

Sample Status: Engineering sample

Applicant: HMD Global Oy

Test Date: Jul. 04 ~ Jul. 26, 2018

Standards: 47 CFR FCC Part 15, Subpart E (Section 15.407)
ANSI C63.10:2013

The above equipment has been tested by **Bureau Veritas Consumer Products Services (H.K.) Ltd., Taoyuan Branch**, and found compliance with the requirement of the above standards. The test record, data evaluation & Equipment Under Test (EUT) configurations represented herein are true and accurate accounts of the measurements of the sample's RF characteristics under the conditions specified in this report.

Prepared by :

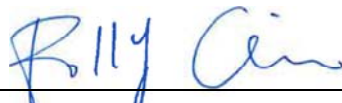
Polly Chien / Specialist

Date: Jul. 30, 2018

Approved by :

Bruce Chen / Project Engineer

Date: Jul. 30, 2018

2 Summary of Test Results

47 CFR FCC Part 15, Subpart E (Section 15.407)			
FCC Clause	Test Item	Result	Remarks
15.407(b)(6)	AC Power Conducted Emissions	Pass	Meet the requirement of limit. Minimum passing margin is -17.66dB at 0.16350MHz.
15.407(b) (1/2/3/4(i/ii)/6)	Radiated Emissions & Band Edge Measurement	Pass	Meet the requirement of limit. Minimum passing margin is -4.1dB at 84.34MHz.
15.407(a)(1/2/3)	Max Average Transmit Power	Pass	Meet the requirement of limit.
---	Occupied Bandwidth Measurement	Pass	Meet the requirement of limit.
15.407(a)(1/2/3)	Peak Power Spectral Density	Pass	Meet the requirement of limit. (U-NII-3 Band only)
15.407(e)	6dB bandwidth	Pass	Meet the requirement of limit.
15.407(g)	Frequency Stability	Pass	Meet the requirement of limit.
15.203	Antenna Requirement	Pass	No antenna connector is used.

*For U-NII-3 band compliance with rule part 15.407(b)(4)(i), the OOB test plots were recorded in Annex A.

2.1 Measurement Uncertainty

Where relevant, the following measurement uncertainty levels have been estimated for tests performed on the EUT as specified in CISPR 16-4-2:

Measurement	Frequency	Expanded Uncertainty (k=2) (\pm)
Conducted Emissions at mains ports	150kHz ~ 30MHz	2.94 dB
Radiated Emissions	30MHz ~ 200MHz	3.86 dB
	200MHz ~ 1000MHz	3.87 dB
	1GHz ~ 18GHz	2.29 dB
	18GHz ~ 40GHz	2.29 dB

2.2 Modification Record

There were no modifications required for compliance.

3 General Information

3.1 General Description of EUT

Product	Smart Phone
Brand	NOKIA
Model	TA-1085
Model Difference	Refer to Note
Sample Status	Engineering sample
Power Supply Rating	5.0 Vdc or 9 Vdc or 12 Vdc (adapter) 5.0 Vdc (host equipment) 3.85 Vdc (Li-ion battery)
Modulation Type	256QAM, 64QAM, 16QAM, QPSK, BPSK
Modulation Technology	OFDM
Transfer Rate	802.11a: 54/48/36/24/18/12/9/6Mbps 802.11n: up to 150Mbps 802.11ac: up to 433.4Mbps
Operating Frequency	5180~5240MHz, 5260~5320MHz, 5500~5720MHz, 5745~5825MHz
Number of Channel	5180~5240MHz: 802.11a, 802.11n (HT20), 802.11ac (VHT20): 4 802.11n (HT40), 802.11ac (VHT40): 2 802.11ac (VHT80): 1 5260~5320MHz: 802.11a, 802.11n (HT20), 802.11ac (VHT20): 4 802.11n (HT40), 802.11ac (VHT40): 2 802.11ac (VHT80): 1 5500~5720MHz: 802.11a, 802.11n (HT20), 802.11ac (VHT20): 12 802.11n (HT40), 802.11ac (VHT40): 6 802.11ac (VHT80): 3 5745~5825MHz: 802.11a, 802.11n (HT20), 802.11ac (VHT20): 5 802.11n (HT40), 802.11ac (VHT40): 2 802.11ac (VHT80): 1
Output Power	5180~5240MHz: 22.699mW 5260~5320MHz: 23.174mW 5500~5720MHz: 22.699mW 5745~5825MHz: 23.823mW
Antenna Type	Refer to note
Antenna Connector	Refer to note
Accessory Device	Refer to Note as below
Cable Supplied	Refer to Note as below

Note:

1. The EUT provides 1 completed transmitter and 1 receiver.

Modulation Mode	TX Function
802.11a	1TX
802.11n (HT20)	1TX
802.11n (HT40)	1TX
802.11ac (VHT20)	1TX
802.11ac (VHT40)	1TX
802.11ac (VHT80)	1TX

* The modulation and bandwidth are similar for 802.11n mode for 20MHz/40MHz and 802.11ac mode for 20MHz/40MHz, therefore investigated worst case to representative mode in test report. (Final test mode refer section 3.2.1)

2. The EUT uses following antenna.

Type	Loop			
Connector	NA			
Gain (dBi)				
Frequency (MHz)	5180 ~ 5240MHz	5260 ~ 5320MHz	5500~5720MHz	5745~5825MHz
	-5.14	-2.27	0.72	-0.56

*The maximum antenna gain is chosen for final test.

3. The EUT's accessories list refers to Ext. Pho.
4. The above EUT information is declared by manufacturer and for more detailed features description, please refers to the manufacturer's specifications or user's manual.

3.2 Description of Test Modes

5180~5240MHz:

4 channels are provided for 802.11a, 802.11n (HT20), 802.11ac (VHT20):

Channel	Frequency	Channel	Frequency
36	5180 MHz	44	5220 MHz
40	5200 MHz	48	5240 MHz

2 channels are provided for 802.11n (HT40), 802.11ac (VHT40):

Channel	Frequency	Channel	Frequency
38	5190 MHz	46	5230 MHz

1 channel is provided for 802.11ac (VHT80):

Channel	Frequency
42	5210 MHz

5260~5320MHz:

4 channels are provided for 802.11a, 802.11n (HT20), 802.11ac (VHT20):

Channel	Frequency	Channel	Frequency
52	5260 MHz	60	5300 MHz
56	5280 MHz	64	5320 MHz

2 channels are provided for 802.11n (HT40), 802.11ac (VHT40):

Channel	Frequency	Channel	Frequency
54	5270 MHz	62	5310 MHz

1 channel is provided for 802.11ac (VHT80):

Channel	Frequency
58	5290 MHz

5500~5720MHz:

12 channels are provided for 802.11a, 802.11n (HT20), 802.11ac (VHT20):

Channel	Frequency	Channel	Frequency
100	5500 MHz	124	5620 MHz
104	5520 MHz	128	5640 MHz
108	5540 MHz	132	5660 MHz
112	5560 MHz	136	5680 MHz
116	5580 MHz	140	5700 MHz
120	5600 MHz	144	5720 MHz

6 channels are provided for 802.11n (HT40), 802.11ac (VHT40):

Channel	Frequency	Channel	Frequency
102	5510 MHz	126	5630 MHz
110	5550 MHz	134	5670 MHz
118	5590 MHz	142	5710 MHz

3 channels are provided for 802.11ac (VHT80):

Channel	Frequency	Channel	Frequency
106	5530 MHz	122	5610 MHz
138	5690 MHz		

5745~5825MHz:

5 channels are provided for 802.11a, 802.11n (HT20), 802.11ac (VHT20):

Channel	Frequency	Channel	Frequency
149	5745 MHz	161	5805 MHz
153	5765 MHz	165	5825 MHz
157	5785 MHz		

2 channels are provided for 802.11n (HT40), 802.11ac (VHT40):

Channel	Frequency	Channel	Frequency
151	5755 MHz	159	5795 MHz

1 channel is provided for 802.11ac (VHT80):

Channel	Frequency
155	5775 MHz

3.2.1 Test Mode Applicability and Tested Channel Detail

EUT Configure Mode	Applicable to				Description
	RE \geq 1G	RE<1G	PLC	APCM	
A	√	√	√	√	EUT + Battery 1
B	-	√	-	-	EUT + Battery 2

Where RE \geq 1G: Radiated Emission above 1GHz & Bandedge Measurement
 RE<1G: Radiated Emission below 1GHz
 PLC: Power Line Conducted Emission
 APCM: Antenna Port Conducted Measurement

Note:

1. The EUT had been pre-tested on the positioned of each 3 axis. The worst case was found when positioned on Y-plane.
2. "-" means no effect.

Radiated Emission Test (Above 1GHz):

- Pre-Scan has been conducted to determine the worst-case mode from all possible combinations between available modulations, data rates and antenna ports (if EUT with antenna diversity architecture).
- Following channel(s) was (were) selected for the final test as listed below.

EUT Configure Mode	Mode	Frequency Band (MHz)	Available Channel	Tested Channel	Modulation Technology	Data Rate (Mbps)
A	802.11a	5180-5240	36 to 48	36, 40, 48	OFDM	6.0
	802.11n (HT20)		36 to 48	36, 40, 48	OFDM	6.5
	802.11n (HT40)		38 to 46	38, 46	OFDM	13.5
	802.11ac (VHT80)		42	42	OFDM	29.3
A	802.11a	5260-5320	52 to 64	52, 60, 64	OFDM	6.0
	802.11n (HT20)		52 to 64	52, 60, 64	OFDM	6.5
	802.11n (HT40)		54 to 62	54, 62	OFDM	13.5
	802.11ac (VHT80)		58	58	OFDM	29.3
A	802.11a	5500-5720	100 to 144	100, 116, 140, 144	OFDM	6.0
	802.11n (HT20)		100 to 144	100, 116, 140, 144	OFDM	6.5
	802.11n (HT40)		102 to 142	102, 110, 134, 142	OFDM	13.5
	802.11ac (VHT80)		106 to 138	106, 122, 138	OFDM	29.3
A	802.11a	5745-5825	149 to 165	149, 157, 165	OFDM	6.0
	802.11n (HT20)		149 to 165	149, 157, 165	OFDM	6.5
	802.11n (HT40)		151 to 159	151, 159	OFDM	13.5
	802.11ac (VHT80)		155	155	OFDM	29.3

Radiated Emission Test (Below 1GHz):

- Pre-Scan has been conducted to determine the worst-case mode from all possible combinations between available modulations, data rates and antenna ports (if EUT with antenna diversity architecture).
- Following channel(s) was (were) selected for the final test as listed below.

EUT Configure Mode	Mode	Frequency Band (MHz)	Available Channel	Tested Channel	Modulation Technology	Data Rate (Mbps)
A, B	802.11a	5180-5240	36 to 48	149	OFDM	6.0
		5260-5320	52 to 64		OFDM	6.0
		5500-5720	100 to 144		OFDM	6.0
		5745-5825	149 to 165		OFDM	6.0

Power Line Conducted Emission Test:

- Pre-Scan has been conducted to determine the worst-case mode from all possible combinations between available modulations, data rates and antenna ports (if EUT with antenna diversity architecture).
- Following channel(s) was (were) selected for the final test as listed below.

EUT Configure Mode	Mode	Frequency Band (MHz)	Available Channel	Tested Channel	Modulation Technology	Data Rate (Mbps)
A	802.11a	5180-5240	36 to 48	149	OFDM	6.0
		5260-5320	52 to 64		OFDM	6.0
		5500-5720	100 to 144		OFDM	6.0
		5745-5825	149 to 165		OFDM	6.0

Antenna Port Conducted Measurement:

- This item includes all test value of each mode, but only includes spectrum plot of worst value of each mode.
- Pre-Scan has been conducted to determine the worst-case mode from all possible combinations between available modulations, data rates and antenna ports (if EUT with antenna diversity architecture).
- Following channel(s) was (were) selected for the final test as listed below.

EUT Configure Mode	Mode	Frequency Band (MHz)	Available Channel	Tested Channel	Modulation Technology	Data Rate (Mbps)
A	802.11a	5180-5240	36 to 48	36, 40, 48	OFDM	6.0
	802.11n (HT20)		36 to 48	36, 40, 48	OFDM	6.5
	802.11n (HT40)		38 to 46	38, 46	OFDM	13.5
	802.11ac (VHT80)		42	42	OFDM	29.3
A	802.11a	5260-5320	52 to 64	52, 60, 64	OFDM	6.0
	802.11n (HT20)		52 to 64	52, 60, 64	OFDM	6.5
	802.11n (HT40)		54 to 62	54, 62	OFDM	13.5
	802.11ac (VHT80)		58	58	OFDM	29.3
A	802.11a	5500-5720	100 to 144	100, 116, 140, 144	OFDM	6.0
	802.11n (HT20)		100 to 144	100, 116, 140, 144	OFDM	6.5
	802.11n (HT40)		102 to 142	102, 110, 134, 142	OFDM	13.5
	802.11ac (VHT80)		106 to 138	106, 122, 138	OFDM	29.3
A	802.11a	5745-5825	149 to 165	149, 157, 165	OFDM	6.0
	802.11n (HT20)		149 to 165	149, 157, 165	OFDM	6.5
	802.11n (HT40)		151 to 159	151, 159	OFDM	13.5
	802.11ac (VHT80)		155	155	OFDM	29.3

Test Condition:

Applicable to	Environmental Conditions	Input Power	Tested by
RE \geq 1G	23deg. C, 66%RH	120Vac, 60Hz	Adair Peng
RE<1G	23deg. C, 69%RH 21deg. C, 67%RH	120Vac, 60Hz	Willy Cheng, Adair Peng
PLC	23deg. C, 69%RH	120Vac, 60Hz	Willy Cheng
APCM	25deg. C, 60%RH	120Vac, 60Hz	Frank Liu

3.3 Duty Cycle of Test Signal

Duty cycle of test signal is < 98%, duty factor shall be considered.

802.11a: Duty cycle = 2.053/2.195 = 0.935, Duty factor = $10 \cdot \log(1/0.935) = 0.29$

802.11n (HT20): Duty cycle = 1.913/2.053 = 0.932, Duty factor = $10 \cdot \log(1/0.932) = 0.31$

802.11n (HT40): Duty cycle = 0.944/1.062 = 0.889, Duty factor = $10 \cdot \log(1/0.889) = 0.51$

802.11ac (VHT80): Duty cycle = 0.462/0.567 = 0.815, Duty factor = $10 \cdot \log(1/0.815) = 0.89$

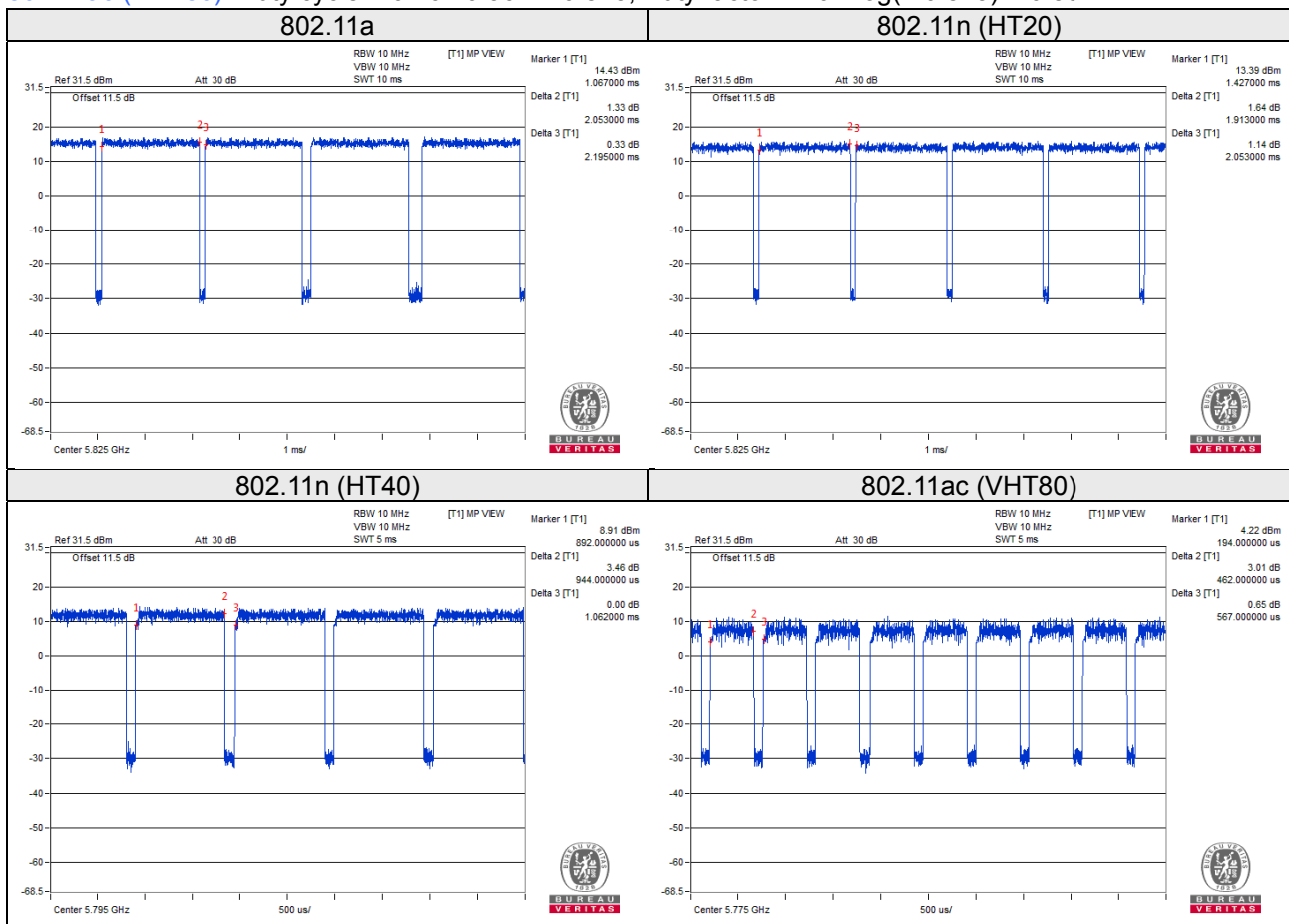

3.4 Description of Support Units

The EUT has been tested as an independent unit together with other necessary accessories or support units.

3.4.1 Configuration of System under Test

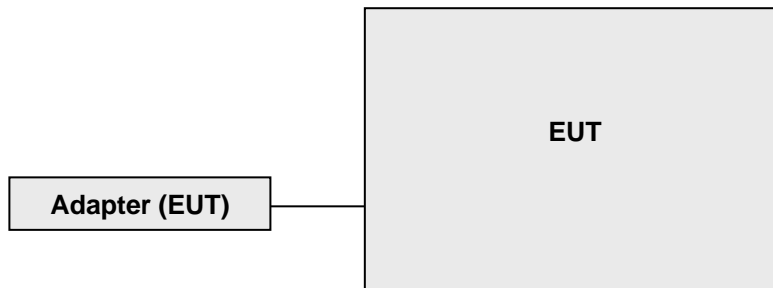

3.5 General Description of Applied Standards

The EUT is a RF Product. According to the specifications of the manufacturer, it must comply with the requirements of the following standards:

FCC Part 15, Subpart E (15.407)

KDB 789033 D02 General UNII Test Procedure New Rules v02r01

ANSI C63.10:2013

All test items have been performed and recorded as per the above standards.

4 Test Types and Results

4.1 Radiated Emission and Bandedge Measurement

4.1.1 Limits of Radiated Emission and Bandedge Measurement

Radiated emissions which fall in the restricted bands must comply with the radiated emission limits specified as below table.

Frequencies (MHz)	Field Strength (microvolts/meter)	Measurement Distance (meters)
0.009 ~ 0.490	2400/F(kHz)	300
0.490 ~ 1.705	24000/F(kHz)	30
1.705 ~ 30.0	30	30
30 ~ 88	100	3
88 ~ 216	150	3
216 ~ 960	200	3
Above 960	500	3

NOTE:

- The lower limit shall apply at the transition frequencies.
- Emission level (dBuV/m) = 20 log Emission level (uV/m).
- For frequencies above 1000MHz, the field strength limits are based on average detector, however, the peak field strength of any emission shall not exceed the maximum permitted average limits, specified above by more than 20dB under any condition of modulation.

Limits of unwanted emission out of the restricted bands

Applicable To		Limit	
789033 D02 General UNII Test Procedure New Rules v02r01		Field Strength at 3m	
		PK: 74 (dBµV/m)	AV: 54 (dBµV/m)
Frequency Band	Applicable To	EIRP Limit	Equivalent Field Strength at 3m
5150~5250 MHz	15.407(b)(1)	PK: -27 (dBm/MHz)	PK: 68.2(dBµV/m)
5250~5350 MHz	15.407(b)(2)		
5470~5725 MHz	15.407(b)(3)		
5725~5850 MHz	<input checked="" type="checkbox"/> 15.407(b)(4)(i)	PK: -27 (dBm/MHz) ^{*1} PK: 10 (dBm/MHz) ^{*2} PK: 15.6 (dBm/MHz) ^{*3} PK: 27 (dBm/MHz) ^{*4}	PK: 68.2(dBµV/m) ^{*1} PK: 105.2 (dBµV/m) ^{*2} PK: 110.8(dBµV/m) ^{*3} PK: 122.2 (dBµV/m) ^{*4}
	<input type="checkbox"/> 15.407(b)(4)(ii)	Emission limits in section 15.247(d)	
^{*1} beyond 75 MHz or more above of the band edge.		^{*2} below the band edge increasing linearly to 10 dBm/MHz at 25 MHz above.	
^{*3} below the band edge increasing linearly to a level of 15.6 dBm/MHz at 5 MHz above.		^{*4} from 5 MHz above or below the band edge increasing linearly to a level of 27 dBm/MHz at the band edge.	

Note: The following formula is used to convert the equipment isotropic radiated power (eirp) to field strength:

$$E = \frac{1000000 \sqrt{30P}}{3} \mu\text{V/m, where P is the eirp (Watts).}$$

4.1.2 Test Instruments

Description & Manufacturer	Model No.	Serial No.	Cal. Date	Cal. Due
Test Receiver ROHDE & SCHWARZ	ESIB7	100187	May 29, 2018	May 28, 2019
Spectrum Analyzer ROHDE & SCHWARZ	FSP40	100041	Dec. 12, 2017	Dec. 11, 2018
BILOG Antenna SCHWARZBECK	VULB9168	9168-171	Dec. 11, 2017	Dec. 10, 2018
HORN Antenna SCHWARZBECK	9120D	209	Dec. 13, 2017	Dec. 12, 2018
HORN Antenna SCHWARZBECK	BBHA 9170	BBHA9170241	Dec. 01, 2017	Nov. 30, 2018
Loop Antenna EMCI	EM-6879	269	Aug. 11, 2017	Aug. 10, 2018
Preamplifier Agilent (Below 1GHz)	8447D	2944A10738	Aug. 21, 2017	Aug. 20, 2018
Preamplifier Agilent (Above 1GHz)	8449B	3008A02465	Apr. 03, 2018	Apr. 02, 2019
RF signal cable HUBER+SUHNER	SUCOFLEX 104	Cable-CH3-03 (223653/4)	Aug. 21, 2017	Aug. 20, 2018
RF signal cable HUBER+SUHNER& EMCI	SUCOFLEX 104&EMC104-SM-SM-8 000	Cable-CH3-03 (309224+170907)	Sep.11, 2017	Sep. 10, 2018
Software BV ADT	ADT_Radiated_ V7.6.15.9.5	NA	NA	NA
Antenna Tower inn-co GmbH	MA 4000	013303	NA	NA
Antenna Tower Controller BV ADT	AT100	AT93021702	NA	NA
Turn Table BV ADT	TT100	TT93021702	NA	NA
Turn Table Controller BV ADT	SC100	SC93021702	NA	NA
Boresight Antenna Fixture	FBA-01	FBA-SIP01	NA	NA
26GHz ~ 40GHz Amplifier Agilent	8449B	3008A1960	Aug. 08, 2017	Aug. 07, 2018
High Speed Peak Power Meter	ML2495A	0824012	Aug. 18, 2017	Aug. 17, 2018
Power Sensor	MA2411B	0738171	Aug. 18, 2017	Aug. 17, 2018

- Note:
1. The calibration interval of the above test instruments is 12 months and the calibrations are traceable to NML/ROC and NIST/USA.
 2. The test was performed in HwaYa Chamber 3.
 3. The horn antenna and preamplifier (model: 8449B) are used only for the measurement of emission frequency above 1GHz if tested.
 4. The FCC Designation Number is TW0003. The number will be varied with the Lab location and scope as attached.
 5. The IC Site Registration No. is IC 7450F-3.

4.1.3 Test Procedures

For Radiated emission below 30MHz

- a. The EUT was placed on the top of a rotating table 0.8 meters above the ground at a 3 meter chamber room. The table was rotated 360 degrees to determine the position of the highest radiation.
- b. The EUT was set 3 meters away from the interference-receiving antenna, which was mounted on the top of a variable-height antenna tower.
- c. Parallel, perpendicular, and ground-parallel orientations of the antenna are set to make the measurement.
- d. For each suspected emission, the EUT was arranged to its worst case and the rotatable table was turned from 0 degrees to 360 degrees to find the maximum reading.
- e. The test-receiver system was set to Quasi-Peak Detect Function and Specified Bandwidth with Maximum Hold Mode.

Note:

1. The resolution bandwidth and video bandwidth of test receiver/spectrum analyzer is 9kHz at frequency below 30MHz.

For Radiated emission above 30MHz

- a. The EUT was placed on the top of a rotating table 0.8 meters (for 30MHz ~ 1GHz) / 1.5 meters (for above 1GHz) above the ground at 3 meter chamber room for test. The table was rotated 360 degrees to determine the position of the highest radiation.
- b. The EUT was set 3 meters away from the interference-receiving antenna, which was mounted on the top of a variable-height antenna tower.
- c. The height of antenna is varied from one meter to four meters above the ground to determine the maximum value of the field strength. Both horizontal and vertical polarizations of the antenna are set to make the measurement.
- d. For each suspected emission, the EUT was arranged to its worst case and then the antenna was tuned to heights from 1 meter to 4 meters and the rotatable table was turned from 0 degrees to 360 degrees to find the maximum reading.
- e. The test-receiver system was set to quasi-peak detect function and specified bandwidth with maximum hold mode when the test frequency is below 1 GHz.
- f. The test-receiver system was set to peak and average detect function and specified bandwidth with maximum hold mode when the test frequency is above 1 GHz. If the peak reading value also meets average limit, measurement with the average detector is unnecessary.

Note:

1. The resolution bandwidth and video bandwidth of test receiver/spectrum analyzer is 120kHz for Quasi-peak detection (QP) at frequency below 1GHz.
2. The resolution bandwidth of test receiver/spectrum analyzer is 1 MHz and the video bandwidth is 3 MHz for Peak detection (PK) at frequency above 1GHz.
3. The resolution bandwidth of test receiver/spectrum analyzer is 1MHz and the video bandwidth is $\geq 1/T$ (Duty cycle < 98%) or 10Hz (Duty cycle $\geq 98\%$) for Average detection (AV) at frequency above 1GHz.
4. All modes of operation were investigated and the worst-case emissions are reported.

4.1.4 Deviation from Test Standard

No deviation.

4.1.5 Test Set Up

For Radiated emission below 30MHz

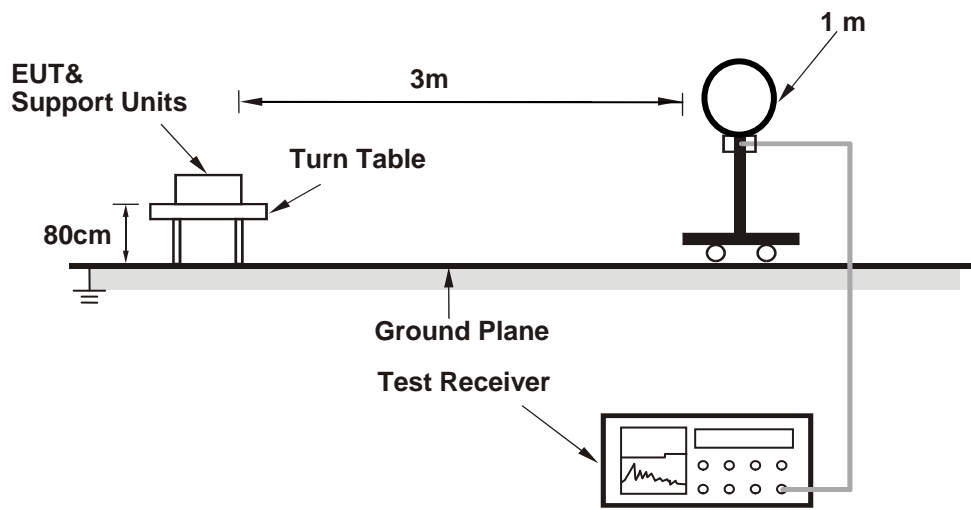

For Radiated emission 30MHz to 1GHz

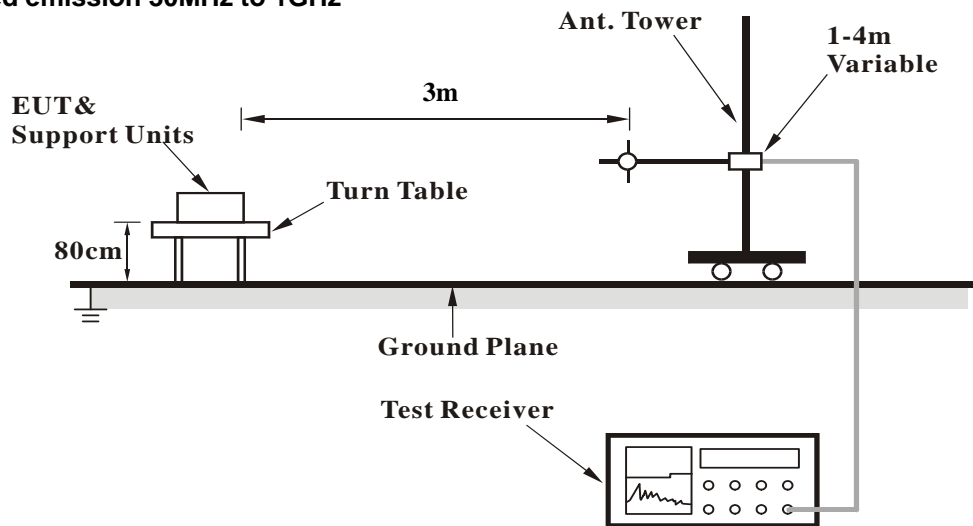

For Radiated emission above 1GHz

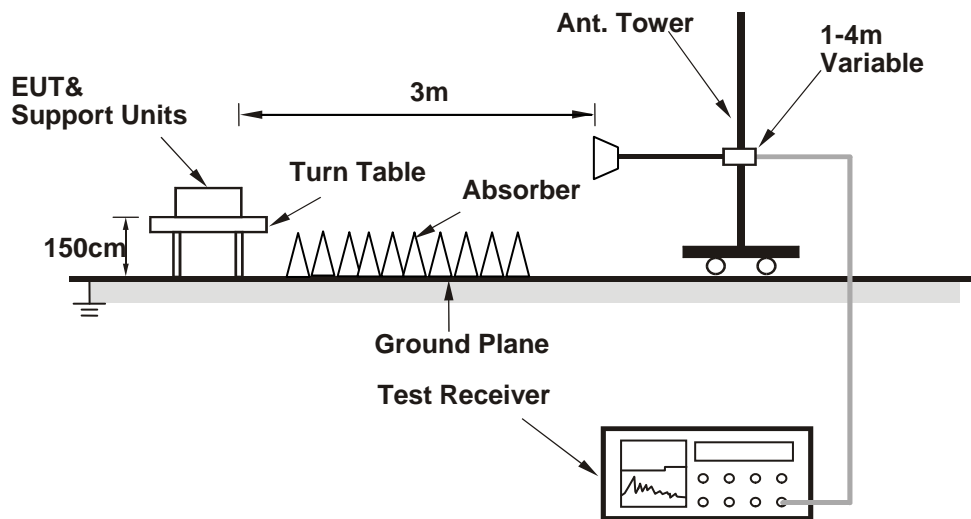

For the actual test configuration, please refer to the attached file (Test Setup Photo).

4.1.6 EUT Operating Conditions

- a. Placed the EUT on the testing table.
- b. Set the EUT under transmission condition continuously at specific channel frequency.

4.1.7 Test Results

Above 1GHz data:

802.11a

CHANNEL	TX Channel 36	DETECTOR FUNCTION	Peak (PK)
FREQUENCY RANGE	1GHz ~ 40GHz		Average (AV)

ANTENNA POLARITY & TEST DISTANCE: HORIZONTAL AT 3 M

NO.	FREQ. (MHz)	EMISSION LEVEL (dBuV/m)	LIMIT (dBuV/m)	MARGIN (dB)	ANTENNA HEIGHT (m)	TABLE ANGLE (Degree)	RAW VALUE (dBuV)	CORRECTION FACTOR (dB/m)
1	5150.00	53.6 PK	68.2	-14.6	1.90 H	181	49.70	3.90
2	*5180.00	93.5 PK			1.89 H	187	53.90	39.60
3	#10360.00	53.4 PK	68.2	-14.8	2.31 H	261	37.60	15.80

ANTENNA POLARITY & TEST DISTANCE: VERTICAL AT 3 M

NO.	FREQ. (MHz)	EMISSION LEVEL (dBuV/m)	LIMIT (dBuV/m)	MARGIN (dB)	ANTENNA HEIGHT (m)	TABLE ANGLE (Degree)	RAW VALUE (dBuV)	CORRECTION FACTOR (dB/m)
1	5150.00	54.2 PK	68.2	-14.0	1.44 V	177	50.30	3.90
2	*5180.00	97.7 PK			1.26 V	183	58.10	39.60
3	#10360.00	53.4 PK	68.2	-14.8	1.91 V	215	37.60	15.80

Remarks:

1. Emission Level(dBuV/m) = Raw Value(dBuV) + Correction Factor(dB/m)
2. Correction Factor(dB/m) = Antenna Factor(dB/m) + Cable Factor(dB) – Pre-Amplifier Factor(dB)
3. The other emission levels were very low against the limit.
4. Margin value = Emission Level – Limit value
5. " * ": Fundamental frequency.
6. " # ": The radiated frequency is out of the restricted band.

CHANNEL	TX Channel 40	DETECTOR FUNCTION	Peak (PK)
FREQUENCY RANGE	1GHz ~ 40GHz		Average (AV)

ANTENNA POLARITY & TEST DISTANCE: HORIZONTAL AT 3 M								
NO.	FREQ. (MHz)	EMISSION LEVEL (dBuV/m)	LIMIT (dBuV/m)	MARGIN (dB)	ANTENNA HEIGHT (m)	TABLE ANGLE (Degree)	RAW VALUE (dBuV)	CORRECTION FACTOR (dB/m)
1	*5200.00	96.2 PK			1.40 H	170	56.60	39.60
2	#10400.00	53.1 PK	68.2	-15.1	2.19 H	263	37.20	15.90
ANTENNA POLARITY & TEST DISTANCE: VERTICAL AT 3 M								
NO.	FREQ. (MHz)	EMISSION LEVEL (dBuV/m)	LIMIT (dBuV/m)	MARGIN (dB)	ANTENNA HEIGHT (m)	TABLE ANGLE (Degree)	RAW VALUE (dBuV)	CORRECTION FACTOR (dB/m)
1	*5200.00	99.4 PK			1.67 V	168	59.80	39.60
2	#10400.00	53.2 PK	68.2	-15.0	2.14 V	220	37.30	15.90

Remarks:

1. Emission Level(dBuV/m) = Raw Value(dBuV) + Correction Factor(dB/m)
2. Correction Factor(dB/m) = Antenna Factor(dB/m) + Cable Factor(dB) – Pre-Amplifier Factor(dB)
3. The other emission levels were very low against the limit.
4. Margin value = Emission Level – Limit value
5. " * ": Fundamental frequency.
6. " # ": The radiated frequency is out of the restricted band.

CHANNEL	TX Channel 48	DETECTOR FUNCTION	Peak (PK)
FREQUENCY RANGE	1GHz ~ 40GHz		Average (AV)

ANTENNA POLARITY & TEST DISTANCE: HORIZONTAL AT 3 M

NO.	FREQ. (MHz)	EMISSION LEVEL (dBuV/m)	LIMIT (dBuV/m)	MARGIN (dB)	ANTENNA HEIGHT (m)	TABLE ANGLE (Degree)	RAW VALUE (dBuV)	CORRECTION FACTOR (dB/m)
1	*5240.00	96.7 PK			1.90 H	170	57.30	39.40
2	5350.00	55.1 PK	68.2	-13.1	1.85 H	166	51.10	4.00
3	#10480.00	53.8 PK	68.2	-14.4	2.02 H	233	37.10	16.70

ANTENNA POLARITY & TEST DISTANCE: VERTICAL AT 3 M

NO.	FREQ. (MHz)	EMISSION LEVEL (dBuV/m)	LIMIT (dBuV/m)	MARGIN (dB)	ANTENNA HEIGHT (m)	TABLE ANGLE (Degree)	RAW VALUE (dBuV)	CORRECTION FACTOR (dB/m)
1	*5240.00	98.1 PK			1.53 V	168	58.70	39.40
2	5350.00	55.3 PK	68.2	-12.9	1.60 V	169	51.30	4.00
3	#10480.00	54.0 PK	68.2	-14.2	1.99 V	240	37.30	16.70

Remarks:

1. Emission Level(dBuV/m) = Raw Value(dBuV) + Correction Factor(dB/m)
2. Correction Factor(dB/m) = Antenna Factor(dB/m) + Cable Factor(dB) – Pre-Amplifier Factor(dB)
3. The other emission levels were very low against the limit.
4. Margin value = Emission Level – Limit value
5. " * ": Fundamental frequency.
6. " # ": The radiated frequency is out of the restricted band.

CHANNEL	TX Channel 52	DETECTOR FUNCTION	Peak (PK)
FREQUENCY RANGE	1GHz ~ 40GHz		Average (AV)

ANTENNA POLARITY & TEST DISTANCE: HORIZONTAL AT 3 M

NO.	FREQ. (MHz)	EMISSION LEVEL (dBuV/m)	LIMIT (dBuV/m)	MARGIN (dB)	ANTENNA HEIGHT (m)	TABLE ANGLE (Degree)	RAW VALUE (dBuV)	CORRECTION FACTOR (dB/m)
1	5150.00	54.1 PK	68.2	-14.1	1.50 H	185	50.20	3.90
2	*5260.00	96.8 PK			1.44 H	191	57.40	39.40
3	#10520.00	55.3 PK	68.2	-12.9	2.51 H	261	38.50	16.80

ANTENNA POLARITY & TEST DISTANCE: VERTICAL AT 3 M

NO.	FREQ. (MHz)	EMISSION LEVEL (dBuV/m)	LIMIT (dBuV/m)	MARGIN (dB)	ANTENNA HEIGHT (m)	TABLE ANGLE (Degree)	RAW VALUE (dBuV)	CORRECTION FACTOR (dB/m)
1	5150.00	54.4 PK	68.2	-13.8	1.70 V	171	50.50	3.90
2	*5260.00	97.4 PK			1.62 V	169	58.00	39.40
3	#10520.00	55.3 PK	68.2	-12.9	2.00 V	211	38.50	16.80

Remarks:

1. Emission Level(dBuV/m) = Raw Value(dBuV) + Correction Factor(dB/m)
2. Correction Factor(dB/m) = Antenna Factor(dB/m) + Cable Factor(dB) – Pre-Amplifier Factor(dB)
3. The other emission levels were very low against the limit.
4. Margin value = Emission Level – Limit value
5. " * ": Fundamental frequency.
6. " # ": The radiated frequency is out of the restricted band.

CHANNEL	TX Channel 60	DETECTOR FUNCTION	Peak (PK)
FREQUENCY RANGE	1GHz ~ 40GHz		Average (AV)

ANTENNA POLARITY & TEST DISTANCE: HORIZONTAL AT 3 M

NO.	FREQ. (MHz)	EMISSION LEVEL (dBuV/m)	LIMIT (dBuV/m)	MARGIN (dB)	ANTENNA HEIGHT (m)	TABLE ANGLE (Degree)	RAW VALUE (dBuV)	CORRECTION FACTOR (dB/m)
1	*5300.00	97.9 PK			1.48 H	172	58.50	39.40
2	10600.00	54.5 PK	68.2	-13.7	2.49 H	261	37.50	17.00

ANTENNA POLARITY & TEST DISTANCE: VERTICAL AT 3 M

NO.	FREQ. (MHz)	EMISSION LEVEL (dBuV/m)	LIMIT (dBuV/m)	MARGIN (dB)	ANTENNA HEIGHT (m)	TABLE ANGLE (Degree)	RAW VALUE (dBuV)	CORRECTION FACTOR (dB/m)
1	*5300.00	98.6 PK			1.16 V	184	59.20	39.40
2	10600.00	54.8 PK	68.2	-13.4	2.23 V	230	37.80	17.00

Remarks:

1. Emission Level(dBuV/m) = Raw Value(dBuV) + Correction Factor(dB/m)
2. Correction Factor(dB/m) = Antenna Factor(dB/m) + Cable Factor(dB) – Pre-Amplifier Factor(dB)
3. The other emission levels were very low against the limit.
4. Margin value = Emission Level – Limit value
5. " * ": Fundamental frequency.
6. " # ": The radiated frequency is out of the restricted band.

CHANNEL	TX Channel 64	DETECTOR FUNCTION	Peak (PK)
FREQUENCY RANGE	1GHz ~ 40GHz		Average (AV)

ANTENNA POLARITY & TEST DISTANCE: HORIZONTAL AT 3 M

NO.	FREQ. (MHz)	EMISSION LEVEL (dBuV/m)	LIMIT (dBuV/m)	MARGIN (dB)	ANTENNA HEIGHT (m)	TABLE ANGLE (Degree)	RAW VALUE (dBuV)	CORRECTION FACTOR (dB/m)
1	*5320.00	98.7 PK			1.44 H	170	59.20	39.50
2	5350.00	56.0 PK	68.2	-12.2	1.50 H	166	52.00	4.00
3	10640.00	55.7 PK	68.2	-12.5	2.41 H	255	38.70	17.00

ANTENNA POLARITY & TEST DISTANCE: VERTICAL AT 3 M

NO.	FREQ. (MHz)	EMISSION LEVEL (dBuV/m)	LIMIT (dBuV/m)	MARGIN (dB)	ANTENNA HEIGHT (m)	TABLE ANGLE (Degree)	RAW VALUE (dBuV)	CORRECTION FACTOR (dB/m)
1	*5320.00	98.7 PK			1.20 V	170	59.20	39.50
2	5350.00	56.7 PK	68.2	-11.5	1.25 V	166	52.70	4.00
3	10640.00	55.9 PK	68.2	-12.3	2.05 V	222	38.90	17.00

Remarks:

1. Emission Level(dBuV/m) = Raw Value(dBuV) + Correction Factor(dB/m)
2. Correction Factor(dB/m) = Antenna Factor(dB/m) + Cable Factor(dB) – Pre-Amplifier Factor(dB)
3. The other emission levels were very low against the limit.
4. Margin value = Emission Level – Limit value
5. " * ": Fundamental frequency.
6. " # ": The radiated frequency is out of the restricted band.

CHANNEL	TX Channel 100	DETECTOR FUNCTION	Peak (PK)
FREQUENCY RANGE	1GHz ~ 40GHz		Average (AV)

ANTENNA POLARITY & TEST DISTANCE: HORIZONTAL AT 3 M

NO.	FREQ. (MHz)	EMISSION LEVEL (dBuV/m)	LIMIT (dBuV/m)	MARGIN (dB)	ANTENNA HEIGHT (m)	TABLE ANGLE (Degree)	RAW VALUE (dBuV)	CORRECTION FACTOR (dB/m)
1	5460.00	56.5 PK	68.2	-11.7	1.39 H	169	52.10	4.40
2	#5470.00	59.4 PK	68.2	-8.8	1.41 H	170	55.00	4.40
3	*5500.00	103.0 PK			1.32 H	172	62.90	40.10
4	11000.00	58.0 PK	68.2	-10.2	2.61 H	244	39.30	18.70

ANTENNA POLARITY & TEST DISTANCE: VERTICAL AT 3 M

NO.	FREQ. (MHz)	EMISSION LEVEL (dBuV/m)	LIMIT (dBuV/m)	MARGIN (dB)	ANTENNA HEIGHT (m)	TABLE ANGLE (Degree)	RAW VALUE (dBuV)	CORRECTION FACTOR (dB/m)
1	5460.00	56.2 PK	68.2	-12.0	1.59 V	170	51.80	4.40
2	#5470.00	57.9 PK	68.2	-10.3	1.60 V	166	53.50	4.40
3	*5500.00	97.3 PK			1.53 V	175	57.20	40.10
4	11000.00	57.6 PK	68.2	-10.6	2.31 V	210	38.90	18.70

Remarks:

1. Emission Level(dBuV/m) = Raw Value(dBuV) + Correction Factor(dB/m)
2. Correction Factor(dB/m) = Antenna Factor(dB/m) + Cable Factor(dB) – Pre-Amplifier Factor(dB)
3. The other emission levels were very low against the limit.
4. Margin value = Emission Level – Limit value
5. " * ": Fundamental frequency.
6. " # ": The radiated frequency is out of the restricted band.

CHANNEL	TX Channel 116	DETECTOR FUNCTION	Peak (PK)
FREQUENCY RANGE	1GHz ~ 40GHz		Average (AV)

ANTENNA POLARITY & TEST DISTANCE: HORIZONTAL AT 3 M								
NO.	FREQ. (MHz)	EMISSION LEVEL (dBuV/m)	LIMIT (dBuV/m)	MARGIN (dB)	ANTENNA HEIGHT (m)	TABLE ANGLE (Degree)	RAW VALUE (dBuV)	CORRECTION FACTOR (dB/m)
1	*5580.00	101.2 PK			1.41 H	172	61.20	40.00
2	11160.00	56.8 PK	68.2	-11.4	2.49 H	229	39.30	17.50
ANTENNA POLARITY & TEST DISTANCE: VERTICAL AT 3 M								
NO.	FREQ. (MHz)	EMISSION LEVEL (dBuV/m)	LIMIT (dBuV/m)	MARGIN (dB)	ANTENNA HEIGHT (m)	TABLE ANGLE (Degree)	RAW VALUE (dBuV)	CORRECTION FACTOR (dB/m)
1	*5580.00	97.4 PK			1.30 V	182	57.40	40.00
2	11160.00	56.4 PK	68.2	-11.8	2.30 V	233	38.90	17.50

Remarks:

1. Emission Level(dBuV/m) = Raw Value(dBuV) + Correction Factor(dB/m)
2. Correction Factor(dB/m) = Antenna Factor(dB/m) + Cable Factor(dB) – Pre-Amplifier Factor(dB)
3. The other emission levels were very low against the limit.
4. Margin value = Emission Level – Limit value
5. " * ": Fundamental frequency.
6. " # ": The radiated frequency is out of the restricted band.

CHANNEL	TX Channel 140	DETECTOR FUNCTION	Peak (PK)
FREQUENCY RANGE	1GHz ~ 40GHz		Average (AV)

ANTENNA POLARITY & TEST DISTANCE: HORIZONTAL AT 3 M

NO.	FREQ. (MHz)	EMISSION LEVEL (dBuV/m)	LIMIT (dBuV/m)	MARGIN (dB)	ANTENNA HEIGHT (m)	TABLE ANGLE (Degree)	RAW VALUE (dBuV)	CORRECTION FACTOR (dB/m)
1	*5700.00	99.2 PK			1.42 H	171	59.20	40.00
2	#5725.00	57.9 PK	68.2	-10.3	1.49 H	170	53.50	4.40
3	11400.00	56.6 PK	68.2	-11.6	2.51 H	261	39.20	17.40

ANTENNA POLARITY & TEST DISTANCE: VERTICAL AT 3 M

NO.	FREQ. (MHz)	EMISSION LEVEL (dBuV/m)	LIMIT (dBuV/m)	MARGIN (dB)	ANTENNA HEIGHT (m)	TABLE ANGLE (Degree)	RAW VALUE (dBuV)	CORRECTION FACTOR (dB/m)
1	*5700.00	97.8 PK			1.54 V	186	57.80	40.00
2	#5725.00	56.5 PK	68.2	-11.7	1.60 V	180	52.10	4.40
3	11400.00	56.0 PK	68.2	-12.2	2.26 V	203	38.60	17.40

Remarks:

1. Emission Level(dBuV/m) = Raw Value(dBuV) + Correction Factor(dB/m)
2. Correction Factor(dB/m) = Antenna Factor(dB/m) + Cable Factor(dB) – Pre-Amplifier Factor(dB)
3. The other emission levels were very low against the limit.
4. Margin value = Emission Level – Limit value
5. " * ": Fundamental frequency.
6. " # ": The radiated frequency is out of the restricted band.

CHANNEL	TX Channel 144	DETECTOR FUNCTION	Peak (PK)
FREQUENCY RANGE	1GHz ~ 40GHz		Average (AV)

ANTENNA POLARITY & TEST DISTANCE: HORIZONTAL AT 3 M								
NO.	FREQ. (MHz)	EMISSION LEVEL (dBuV/m)	LIMIT (dBuV/m)	MARGIN (dB)	ANTENNA HEIGHT (m)	TABLE ANGLE (Degree)	RAW VALUE (dBuV)	CORRECTION FACTOR (dB/m)
1	#5470.00	56.4 PK	68.2	-11.8	1.22 H	169	52.00	4.40
2	*5720.00	94.2 PK			1.08 H	127	54.20	40.00
3	#5825.00	56.4 PK	68.2	-11.8	1.18 H	97	51.60	4.80
4	11440.00	52.7 PK	68.2	-15.5	1.89 H	236	35.10	17.60

ANTENNA POLARITY & TEST DISTANCE: VERTICAL AT 3 M								
NO.	FREQ. (MHz)	EMISSION LEVEL (dBuV/m)	LIMIT (dBuV/m)	MARGIN (dB)	ANTENNA HEIGHT (m)	TABLE ANGLE (Degree)	RAW VALUE (dBuV)	CORRECTION FACTOR (dB/m)
1	#5470.00	56.7 PK	68.2	-11.5	1.76 V	312	52.30	4.40
2	*5720.00	93.2 PK			1.44 V	178	53.20	40.00
3	#5825.00	56.5 PK	68.2	-11.7	1.86 V	239	51.70	4.80
4	11440.00	52.9 PK	68.2	-15.3	2.69 V	236	35.30	17.60

REMARKS:

1. Emission Level(dBuV/m) = Raw Value(dBuV) + Correction Factor(dB/m)
2. Correction Factor(dB/m) = Antenna Factor(dB/m) + Cable Factor(dB) – Pre-Amplifier Factor(dB)
3. The other emission levels were very low against the limit.
4. Margin value = Emission Level – Limit value
5. " * ": Fundamental frequency.
6. " # ": The radiated frequency is out of the restricted band.

CHANNEL	TX Channel 149	DETECTOR FUNCTION	Peak (PK)
FREQUENCY RANGE	1GHz ~ 40GHz		Average (AV)

ANTENNA POLARITY & TEST DISTANCE: HORIZONTAL AT 3 M

NO.	FREQ. (MHz)	EMISSION LEVEL (dBuV/m)	LIMIT (dBuV/m)	MARGIN (dB)	ANTENNA HEIGHT (m)	TABLE ANGLE (Degree)	RAW VALUE (dBuV)	CORRECTION FACTOR (dB/m)
1	#5618.59	54.5 PK	68.2	-13.7	1.05 H	155	50.00	4.50
2	*5745.00	101.4 PK			1.05 H	155	61.30	40.10
3	#5930.13	56.9 PK	68.2	-11.3	1.05 H	155	51.70	5.20
4	11490.00	55.8 PK	68.2	-12.4	2.55 H	213	38.20	17.60

ANTENNA POLARITY & TEST DISTANCE: VERTICAL AT 3 M

NO.	FREQ. (MHz)	EMISSION LEVEL (dBuV/m)	LIMIT (dBuV/m)	MARGIN (dB)	ANTENNA HEIGHT (m)	TABLE ANGLE (Degree)	RAW VALUE (dBuV)	CORRECTION FACTOR (dB/m)
1	#5604.49	58.0 PK	68.2	-10.2	1.01 V	177	53.50	4.50
2	*5745.00	99.7 PK			1.01 V	177	59.60	40.10
3	#5967.95	59.4 PK	68.2	-8.8	1.01 V	177	54.10	5.30
4	11490.00	54.2 PK	68.2	-14.0	2.29 V	233	36.60	17.60

Remarks:

1. Emission Level(dBuV/m) = Raw Value(dBuV) + Correction Factor(dB/m)
2. Correction Factor(dB/m) = Antenna Factor(dB/m) + Cable Factor(dB) – Pre-Amplifier Factor(dB)
3. The other emission levels were very low against the limit.
4. Margin value = Emission Level – Limit value
5. " * ": Fundamental frequency.
6. " # ": The radiated frequency is out of the restricted band.

CHANNEL	TX Channel 157	DETECTOR FUNCTION	Peak (PK)
FREQUENCY RANGE	1GHz ~ 40GHz		Average (AV)

ANTENNA POLARITY & TEST DISTANCE: HORIZONTAL AT 3 M

NO.	FREQ. (MHz)	EMISSION LEVEL (dBuV/m)	LIMIT (dBuV/m)	MARGIN (dB)	ANTENNA HEIGHT (m)	TABLE ANGLE (Degree)	RAW VALUE (dBuV)	CORRECTION FACTOR (dB/m)
1	#5618.59	58.9 PK	68.2	-9.3	1.00 H	153	54.40	4.50
2	*5785.00	101.4 PK			1.00 H	155	61.10	40.30
3	#5966.03	60.4 PK	68.2	-7.8	1.00 H	153	55.20	5.20
4	11570.00	56.6 PK	68.2	-11.6	2.66 H	251	38.70	17.90

ANTENNA POLARITY & TEST DISTANCE: VERTICAL AT 3 M

NO.	FREQ. (MHz)	EMISSION LEVEL (dBuV/m)	LIMIT (dBuV/m)	MARGIN (dB)	ANTENNA HEIGHT (m)	TABLE ANGLE (Degree)	RAW VALUE (dBuV)	CORRECTION FACTOR (dB/m)
1	#5626.28	57.4 PK	68.2	-10.8	1.22 V	165	52.90	4.50
2	*5785.00	100.8 PK			1.22 V	165	60.50	40.30
3	#5930.13	58.9 PK	68.2	-9.3	1.22 V	165	53.70	5.20
4	11570.00	55.0 PK	68.2	-13.2	2.39 V	229	37.10	17.90

Remarks:

1. Emission Level(dBuV/m) = Raw Value(dBuV) + Correction Factor(dB/m)
2. Correction Factor(dB/m) = Antenna Factor(dB/m) + Cable Factor(dB) – Pre-Amplifier Factor(dB)
3. The other emission levels were very low against the limit.
4. Margin value = Emission Level – Limit value
5. " * ": Fundamental frequency.
6. " # ": The radiated frequency is out of the restricted band.

CHANNEL	TX Channel 165	DETECTOR FUNCTION	Peak (PK)
FREQUENCY RANGE	1GHz ~ 40GHz		Average (AV)

ANTENNA POLARITY & TEST DISTANCE: HORIZONTAL AT 3 M

NO.	FREQ. (MHz)	EMISSION LEVEL (dBuV/m)	LIMIT (dBuV/m)	MARGIN (dB)	ANTENNA HEIGHT (m)	TABLE ANGLE (Degree)	RAW VALUE (dBuV)	CORRECTION FACTOR (dB/m)
1	#5648.72	58.4 PK	68.2	-9.8	1.08 H	154	53.80	4.60
2	*5825.00	100.8 PK			1.08 H	154	60.30	40.50
3	#5935.90	59.6 PK	68.2	-8.6	1.08 H	154	54.50	5.10
4	11650.00	56.1 PK	68.2	-12.1	2.53 H	233	38.60	17.50

ANTENNA POLARITY & TEST DISTANCE: VERTICAL AT 3 M

NO.	FREQ. (MHz)	EMISSION LEVEL (dBuV/m)	LIMIT (dBuV/m)	MARGIN (dB)	ANTENNA HEIGHT (m)	TABLE ANGLE (Degree)	RAW VALUE (dBuV)	CORRECTION FACTOR (dB/m)
1	#5649.36	58.0 PK	68.2	-10.2	1.06 V	165	53.40	4.60
2	*5825.00	101.2 PK			1.06 V	165	60.70	40.50
3	#5926.28	59.6 PK	68.2	-8.6	1.06 V	165	54.40	5.20
4	11650.00	54.7 PK	68.2	-13.5	2.43 V	210	37.20	17.50

Remarks:

1. Emission Level(dBuV/m) = Raw Value(dBuV) + Correction Factor(dB/m)
2. Correction Factor(dB/m) = Antenna Factor(dB/m) + Cable Factor(dB) – Pre-Amplifier Factor(dB)
3. The other emission levels were very low against the limit.
4. Margin value = Emission Level – Limit value
5. " * ": Fundamental frequency.
6. " # ": The radiated frequency is out of the restricted band.

802.11n (HT20)

CHANNEL	TX Channel 36	DETECTOR FUNCTION	Peak (PK)
FREQUENCY RANGE	1GHz ~ 40GHz		Average (AV)

ANTENNA POLARITY & TEST DISTANCE: HORIZONTAL AT 3 M								
NO.	FREQ. (MHz)	EMISSION LEVEL (dBuV/m)	LIMIT (dBuV/m)	MARGIN (dB)	ANTENNA HEIGHT (m)	TABLE ANGLE (Degree)	RAW VALUE (dBuV)	CORRECTION FACTOR (dB/m)
1	5150.00	53.7 PK	68.2	-14.5	1.83 H	191	49.80	3.90
2	*5180.00	92.4 PK			1.90 H	185	52.80	39.60
3	#10360.00	53.6 PK	68.2	-14.6	2.41 H	263	37.80	15.80
ANTENNA POLARITY & TEST DISTANCE: VERTICAL AT 3 M								
NO.	FREQ. (MHz)	EMISSION LEVEL (dBuV/m)	LIMIT (dBuV/m)	MARGIN (dB)	ANTENNA HEIGHT (m)	TABLE ANGLE (Degree)	RAW VALUE (dBuV)	CORRECTION FACTOR (dB/m)
1	5150.00	53.7 PK	68.2	-14.5	1.55 V	160	49.80	3.90
2	*5180.00	95.8 PK			1.52 V	151	56.20	39.60
3	#10360.00	53.8 PK	68.2	-14.4	1.89 V	205	38.00	15.80

Remarks:

1. Emission Level(dBuV/m) = Raw Value(dBuV) + Correction Factor(dB/m)
2. Correction Factor(dB/m) = Antenna Factor(dB/m) + Cable Factor(dB) – Pre-Amplifier Factor(dB)
3. The other emission levels were very low against the limit.
4. Margin value = Emission Level – Limit value
5. " * ": Fundamental frequency.
6. " # ": The radiated frequency is out of the restricted band.

CHANNEL	TX Channel 40	DETECTOR FUNCTION	Peak (PK)
FREQUENCY RANGE	1GHz ~ 40GHz		Average (AV)

ANTENNA POLARITY & TEST DISTANCE: HORIZONTAL AT 3 M								
NO.	FREQ. (MHz)	EMISSION LEVEL (dBuV/m)	LIMIT (dBuV/m)	MARGIN (dB)	ANTENNA HEIGHT (m)	TABLE ANGLE (Degree)	RAW VALUE (dBuV)	CORRECTION FACTOR (dB/m)
1	*5200.00	95.1 PK			1.42 H	171	55.50	39.60
2	#10400.00	53.5 PK	68.2	-14.7	2.35 H	263	37.60	15.90
ANTENNA POLARITY & TEST DISTANCE: VERTICAL AT 3 M								
NO.	FREQ. (MHz)	EMISSION LEVEL (dBuV/m)	LIMIT (dBuV/m)	MARGIN (dB)	ANTENNA HEIGHT (m)	TABLE ANGLE (Degree)	RAW VALUE (dBuV)	CORRECTION FACTOR (dB/m)
1	*5200.00	98.2 PK			1.66 V	169	58.60	39.60
2	#10400.00	53.7 PK	68.2	-14.5	1.98 V	231	37.80	15.90

Remarks:

1. Emission Level(dBuV/m) = Raw Value(dBuV) + Correction Factor(dB/m)
2. Correction Factor(dB/m) = Antenna Factor(dB/m) + Cable Factor(dB) – Pre-Amplifier Factor(dB)
3. The other emission levels were very low against the limit.
4. Margin value = Emission Level – Limit value
5. " * ": Fundamental frequency.
6. " # ": The radiated frequency is out of the restricted band.

CHANNEL	TX Channel 48	DETECTOR FUNCTION	Peak (PK)
FREQUENCY RANGE	1GHz ~ 40GHz		Average (AV)

ANTENNA POLARITY & TEST DISTANCE: HORIZONTAL AT 3 M

NO.	FREQ. (MHz)	EMISSION LEVEL (dBuV/m)	LIMIT (dBuV/m)	MARGIN (dB)	ANTENNA HEIGHT (m)	TABLE ANGLE (Degree)	RAW VALUE (dBuV)	CORRECTION FACTOR (dB/m)
1	*5240.00	95.1 PK			2.01 H	169	55.70	39.40
2	5350.00	55.7 PK	68.2	-12.5	1.88 H	170	51.70	4.00
3	#10480.00	53.7 PK	68.2	-14.5	2.14 H	261	37.00	16.70

ANTENNA POLARITY & TEST DISTANCE: VERTICAL AT 3 M

NO.	FREQ. (MHz)	EMISSION LEVEL (dBuV/m)	LIMIT (dBuV/m)	MARGIN (dB)	ANTENNA HEIGHT (m)	TABLE ANGLE (Degree)	RAW VALUE (dBuV)	CORRECTION FACTOR (dB/m)
1	*5240.00	97.3 PK			1.35 V	171	57.90	39.40
2	5350.00	56.3 PK	68.2	-11.9	1.40 V	177	52.30	4.00
3	#10480.00	54.0 PK	68.2	-14.2	2.10 V	202	37.30	16.70

Remarks:

1. Emission Level(dBuV/m) = Raw Value(dBuV) + Correction Factor(dB/m)
2. Correction Factor(dB/m) = Antenna Factor(dB/m) + Cable Factor(dB) – Pre-Amplifier Factor(dB)
3. The other emission levels were very low against the limit.
4. Margin value = Emission Level – Limit value
5. " * ": Fundamental frequency.
6. " # ": The radiated frequency is out of the restricted band.

CHANNEL	TX Channel 52	DETECTOR	Peak (PK)
FREQUENCY RANGE	1GHz ~ 40GHz	FUNCTION	Average (AV)

ANTENNA POLARITY & TEST DISTANCE: HORIZONTAL AT 3 M

NO.	FREQ. (MHz)	EMISSION LEVEL (dBuV/m)	LIMIT (dBuV/m)	MARGIN (dB)	ANTENNA HEIGHT (m)	TABLE ANGLE (Degree)	RAW VALUE (dBuV)	CORRECTION FACTOR (dB/m)
1	5150.00	55.2 PK	68.2	-13.0	1.40 H	172	51.30	3.90
2	*5260.00	96.4 PK			1.34 H	169	57.00	39.40
3	#10520.00	56.3 PK	68.2	-11.9	2.44 H	223	39.50	16.80

ANTENNA POLARITY & TEST DISTANCE: VERTICAL AT 3 M

NO.	FREQ. (MHz)	EMISSION LEVEL (dBuV/m)	LIMIT (dBuV/m)	MARGIN (dB)	ANTENNA HEIGHT (m)	TABLE ANGLE (Degree)	RAW VALUE (dBuV)	CORRECTION FACTOR (dB/m)
1	5150.00	54.9 PK	68.2	-13.3	1.66 V	165	51.00	3.90
2	*5260.00	96.0 PK			1.58 V	161	56.60	39.40
3	#10520.00	56.0 PK	68.2	-12.2	2.22 V	199	39.20	16.80

Remarks:

1. Emission Level(dBuV/m) = Raw Value(dBuV) + Correction Factor(dB/m)
2. Correction Factor(dB/m) = Antenna Factor(dB/m) + Cable Factor(dB) – Pre-Amplifier Factor(dB)
3. The other emission levels were very low against the limit.
4. Margin value = Emission Level – Limit value
5. " * ": Fundamental frequency.
6. " # ": The radiated frequency is out of the restricted band.

CHANNEL	TX Channel 60	DETECTOR FUNCTION	Peak (PK)
FREQUENCY RANGE	1GHz ~ 40GHz		Average (AV)

ANTENNA POLARITY & TEST DISTANCE: HORIZONTAL AT 3 M								
NO.	FREQ. (MHz)	EMISSION LEVEL (dBuV/m)	LIMIT (dBuV/m)	MARGIN (dB)	ANTENNA HEIGHT (m)	TABLE ANGLE (Degree)	RAW VALUE (dBuV)	CORRECTION FACTOR (dB/m)
1	*5300.00	97.9 PK			1.39 H	171	58.50	39.40
2	10600.00	55.7 PK	68.2	-12.5	2.54 H	233	38.70	17.00
ANTENNA POLARITY & TEST DISTANCE: VERTICAL AT 3 M								
NO.	FREQ. (MHz)	EMISSION LEVEL (dBuV/m)	LIMIT (dBuV/m)	MARGIN (dB)	ANTENNA HEIGHT (m)	TABLE ANGLE (Degree)	RAW VALUE (dBuV)	CORRECTION FACTOR (dB/m)
1	*5300.00	97.7 PK			1.54 V	195	58.30	39.40
2	10600.00	55.5 PK	68.2	-12.7	2.41 V	210	38.50	17.00

Remarks:

1. Emission Level(dBuV/m) = Raw Value(dBuV) + Correction Factor(dB/m)
2. Correction Factor(dB/m) = Antenna Factor(dB/m) + Cable Factor(dB) – Pre-Amplifier Factor(dB)
3. The other emission levels were very low against the limit.
4. Margin value = Emission Level – Limit value
5. " * ": Fundamental frequency.
6. " # ": The radiated frequency is out of the restricted band.

CHANNEL	TX Channel 64	DETECTOR FUNCTION	Peak (PK)
FREQUENCY RANGE	1GHz ~ 40GHz		Average (AV)

ANTENNA POLARITY & TEST DISTANCE: HORIZONTAL AT 3 M

NO.	FREQ. (MHz)	EMISSION LEVEL (dBuV/m)	LIMIT (dBuV/m)	MARGIN (dB)	ANTENNA HEIGHT (m)	TABLE ANGLE (Degree)	RAW VALUE (dBuV)	CORRECTION FACTOR (dB/m)
1	*5320.00	99.5 PK			1.30 H	171	60.00	39.50
2	5350.00	57.0 PK	68.2	-11.2	1.33 H	169	53.00	4.00
3	10640.00	57.3 PK	68.2	-10.9	2.43 H	261	40.30	17.00

ANTENNA POLARITY & TEST DISTANCE: VERTICAL AT 3 M

NO.	FREQ. (MHz)	EMISSION LEVEL (dBuV/m)	LIMIT (dBuV/m)	MARGIN (dB)	ANTENNA HEIGHT (m)	TABLE ANGLE (Degree)	RAW VALUE (dBuV)	CORRECTION FACTOR (dB/m)
1	*5320.00	99.0 PK			1.70 V	173	59.50	39.50
2	5350.00	56.3 PK	68.2	-11.9	1.65 V	169	52.30	4.00
3	10640.00	57.2 PK	68.2	-11.0	2.18 V	205	40.20	17.00

Remarks:

1. Emission Level(dBuV/m) = Raw Value(dBuV) + Correction Factor(dB/m)
2. Correction Factor(dB/m) = Antenna Factor(dB/m) + Cable Factor(dB) – Pre-Amplifier Factor(dB)
3. The other emission levels were very low against the limit.
4. Margin value = Emission Level – Limit value
5. " * ": Fundamental frequency.
6. " # ": The radiated frequency is out of the restricted band.

CHANNEL	TX Channel 100	DETECTOR FUNCTION	Peak (PK)
FREQUENCY RANGE	1GHz ~ 40GHz		Average (AV)

ANTENNA POLARITY & TEST DISTANCE: HORIZONTAL AT 3 M

NO.	FREQ. (MHz)	EMISSION LEVEL (dBuV/m)	LIMIT (dBuV/m)	MARGIN (dB)	ANTENNA HEIGHT (m)	TABLE ANGLE (Degree)	RAW VALUE (dBuV)	CORRECTION FACTOR (dB/m)
1	5460.00	56.7 PK	68.2	-11.5	1.15 H	171	52.30	4.40
2	#5470.00	59.6 PK	68.2	-8.6	1.21 H	170	55.20	4.40
3	*5500.00	101.4 PK			1.10 H	173	61.30	40.10
4	11000.00	58.5 PK	68.2	-9.7	2.59 H	251	39.80	18.70

ANTENNA POLARITY & TEST DISTANCE: VERTICAL AT 3 M

NO.	FREQ. (MHz)	EMISSION LEVEL (dBuV/m)	LIMIT (dBuV/m)	MARGIN (dB)	ANTENNA HEIGHT (m)	TABLE ANGLE (Degree)	RAW VALUE (dBuV)	CORRECTION FACTOR (dB/m)
1	5460.00	55.9 PK	68.2	-12.3	1.60 V	170	51.50	4.40
2	#5470.00	57.7 PK	68.2	-10.5	1.59 V	170	53.30	4.40
3	*5500.00	96.7 PK			1.52 V	174	56.60	40.10
4	11000.00	57.8 PK	68.2	-10.4	2.11 V	230	39.10	18.70

Remarks:

1. Emission Level(dBuV/m) = Raw Value(dBuV) + Correction Factor(dB/m)
2. Correction Factor(dB/m) = Antenna Factor(dB/m) + Cable Factor(dB) – Pre-Amplifier Factor(dB)
3. The other emission levels were very low against the limit.
4. Margin value = Emission Level – Limit value
5. " * ": Fundamental frequency.
6. " # ": The radiated frequency is out of the restricted band.

CHANNEL	TX Channel 116	DETECTOR FUNCTION	Peak (PK)
FREQUENCY RANGE	1GHz ~ 40GHz		Average (AV)

ANTENNA POLARITY & TEST DISTANCE: HORIZONTAL AT 3 M								
NO.	FREQ. (MHz)	EMISSION LEVEL (dBuV/m)	LIMIT (dBuV/m)	MARGIN (dB)	ANTENNA HEIGHT (m)	TABLE ANGLE (Degree)	RAW VALUE (dBuV)	CORRECTION FACTOR (dB/m)
1	*5580.00	101.4 PK			1.29 H	172	61.40	40.00
2	11160.00	57.6 PK	68.2	-10.6	2.31 H	222	40.10	17.50
ANTENNA POLARITY & TEST DISTANCE: VERTICAL AT 3 M								
NO.	FREQ. (MHz)	EMISSION LEVEL (dBuV/m)	LIMIT (dBuV/m)	MARGIN (dB)	ANTENNA HEIGHT (m)	TABLE ANGLE (Degree)	RAW VALUE (dBuV)	CORRECTION FACTOR (dB/m)
1	*5580.00	96.7 PK			1.20 V	173	56.70	40.00
2	11160.00	57.0 PK	68.2	-11.2	2.31 V	202	39.50	17.50

Remarks:

1. Emission Level(dBuV/m) = Raw Value(dBuV) + Correction Factor(dB/m)
2. Correction Factor(dB/m) = Antenna Factor(dB/m) + Cable Factor(dB) – Pre-Amplifier Factor(dB)
3. The other emission levels were very low against the limit.
4. Margin value = Emission Level – Limit value
5. " * ": Fundamental frequency.
6. " # ": The radiated frequency is out of the restricted band.

CHANNEL	TX Channel 140	DETECTOR FUNCTION	Peak (PK)
FREQUENCY RANGE	1GHz ~ 40GHz		Average (AV)

ANTENNA POLARITY & TEST DISTANCE: HORIZONTAL AT 3 M

NO.	FREQ. (MHz)	EMISSION LEVEL (dBuV/m)	LIMIT (dBuV/m)	MARGIN (dB)	ANTENNA HEIGHT (m)	TABLE ANGLE (Degree)	RAW VALUE (dBuV)	CORRECTION FACTOR (dB/m)
1	*5700.00	99.4 PK			1.25 H	172	59.40	40.00
2	#5725.00	57.9 PK	68.2	-10.3	1.31 H	169	53.50	4.40
3	11400.00	56.9 PK	68.2	-11.3	2.58 H	244	39.50	17.40

ANTENNA POLARITY & TEST DISTANCE: VERTICAL AT 3 M

NO.	FREQ. (MHz)	EMISSION LEVEL (dBuV/m)	LIMIT (dBuV/m)	MARGIN (dB)	ANTENNA HEIGHT (m)	TABLE ANGLE (Degree)	RAW VALUE (dBuV)	CORRECTION FACTOR (dB/m)
1	*5700.00	98.0 PK			1.52 V	184	58.00	40.00
2	#5725.00	56.4 PK	68.2	-11.8	1.60 V	177	52.00	4.40
3	11400.00	56.3 PK	68.2	-11.9	1.99 V	205	38.90	17.40

Remarks:

1. Emission Level(dBuV/m) = Raw Value(dBuV) + Correction Factor(dB/m)
2. Correction Factor(dB/m) = Antenna Factor(dB/m) + Cable Factor(dB) – Pre-Amplifier Factor(dB)
3. The other emission levels were very low against the limit.
4. Margin value = Emission Level – Limit value
5. " * ": Fundamental frequency.
6. " # ": The radiated frequency is out of the restricted band.

CHANNEL	TX Channel 144	DETECTOR	Peak (PK)
FREQUENCY RANGE	1GHz ~ 40GHz	FUNCTION	Average (AV)

ANTENNA POLARITY & TEST DISTANCE: HORIZONTAL AT 3 M

NO.	FREQ. (MHz)	EMISSION LEVEL (dBuV/m)	LIMIT (dBuV/m)	MARGIN (dB)	ANTENNA HEIGHT (m)	TABLE ANGLE (Degree)	RAW VALUE (dBuV)	CORRECTION FACTOR (dB/m)
1	#5470.00	56.4 PK	68.2	-11.8	1.62 H	181	52.00	4.40
2	*5720.00	98.2 PK			1.40 H	169	58.20	40.00
3	#5825.00	56.1 PK	68.2	-12.1	1.69 H	192	51.30	4.80
4	11440.00	52.8 PK	68.2	-15.4	2.56 H	234	35.20	17.60

ANTENNA POLARITY & TEST DISTANCE: VERTICAL AT 3 M

NO.	FREQ. (MHz)	EMISSION LEVEL (dBuV/m)	LIMIT (dBuV/m)	MARGIN (dB)	ANTENNA HEIGHT (m)	TABLE ANGLE (Degree)	RAW VALUE (dBuV)	CORRECTION FACTOR (dB/m)
1	#5470.00	56.7 PK	68.2	-11.5	1.96 V	203	52.30	4.40
2	*5720.00	98.0 PK			1.25 V	163	58.00	40.00
3	#5825.00	56.0 PK	68.2	-12.2	1.44 V	183	51.20	4.80
4	11440.00	53.1 PK	68.2	-15.1	2.56 V	288	35.50	17.60

REMARKS:

1. Emission Level(dBuV/m) = Raw Value(dBuV) + Correction Factor(dB/m)
2. Correction Factor(dB/m) = Antenna Factor(dB/m) + Cable Factor(dB) – Pre-Amplifier Factor(dB)
3. The other emission levels were very low against the limit.
4. Margin value = Emission Level – Limit value
5. " * ": Fundamental frequency.
6. " # ": The radiated frequency is out of the restricted band.

CHANNEL	TX Channel 149	DETECTOR	Peak (PK)
FREQUENCY RANGE	1GHz ~ 40GHz	FUNCTION	Average (AV)

ANTENNA POLARITY & TEST DISTANCE: HORIZONTAL AT 3 M

NO.	FREQ. (MHz)	EMISSION LEVEL (dBuV/m)	LIMIT (dBuV/m)	MARGIN (dB)	ANTENNA HEIGHT (m)	TABLE ANGLE (Degree)	RAW VALUE (dBuV)	CORRECTION FACTOR (dB/m)
1	#5607.05	58.0 PK	68.2	-10.2	1.04 H	155	53.50	4.50
2	*5745.00	99.9 PK			1.04 H	155	59.80	40.10
3	#5957.05	59.3 PK	68.2	-8.9	1.04 H	155	54.10	5.20
4	11490.00	55.4 PK	68.2	-12.8	2.36 H	261	37.80	17.60

ANTENNA POLARITY & TEST DISTANCE: VERTICAL AT 3 M

NO.	FREQ. (MHz)	EMISSION LEVEL (dBuV/m)	LIMIT (dBuV/m)	MARGIN (dB)	ANTENNA HEIGHT (m)	TABLE ANGLE (Degree)	RAW VALUE (dBuV)	CORRECTION FACTOR (dB/m)
1	#5614.74	57.7 PK	68.2	-10.5	1.17 V	188	53.20	4.50
2	*5745.00	98.2 PK			1.17 V	188	58.10	40.10
3	#5952.56	59.0 PK	68.2	-9.2	1.17 V	188	53.80	5.20
4	11490.00	54.7 PK	68.2	-13.5	2.41 V	233	37.10	17.60

Remarks:

1. Emission Level(dBuV/m) = Raw Value(dBuV) + Correction Factor(dB/m)
2. Correction Factor(dB/m) = Antenna Factor(dB/m) + Cable Factor(dB) – Pre-Amplifier Factor(dB)
3. The other emission levels were very low against the limit.
4. Margin value = Emission Level – Limit value
5. " * ": Fundamental frequency.
6. " # ": The radiated frequency is out of the restricted band.

CHANNEL	TX Channel 157	DETECTOR	Peak (PK)
FREQUENCY RANGE	1GHz ~ 40GHz	FUNCTION	Average (AV)

ANTENNA POLARITY & TEST DISTANCE: HORIZONTAL AT 3 M

NO.	FREQ. (MHz)	EMISSION LEVEL (dBuV/m)	LIMIT (dBuV/m)	MARGIN (dB)	ANTENNA HEIGHT (m)	TABLE ANGLE (Degree)	RAW VALUE (dBuV)	CORRECTION FACTOR (dB/m)
1	#5648.08	57.5 PK	68.2	-10.7	1.10 H	155	52.90	4.60
2	*5785.00	100.0 PK			1.10 H	155	59.70	40.30
3	#5940.38	59.2 PK	68.2	-9.0	1.10 H	155	54.10	5.10
4	11570.00	55.8 PK	68.2	-12.4	2.51 H	239	37.90	17.90

ANTENNA POLARITY & TEST DISTANCE: VERTICAL AT 3 M

NO.	FREQ. (MHz)	EMISSION LEVEL (dBuV/m)	LIMIT (dBuV/m)	MARGIN (dB)	ANTENNA HEIGHT (m)	TABLE ANGLE (Degree)	RAW VALUE (dBuV)	CORRECTION FACTOR (dB/m)
1	#5648.08	58.2 PK	68.2	-10.0	1.23 V	155	53.60	4.60
2	*5785.00	100.3 PK			1.23 V	155	60.00	40.30
3	#5935.26	59.4 PK	68.2	-8.8	1.23 V	155	54.30	5.10
4	11570.00	55.0 PK	68.2	-13.2	2.30 V	229	37.10	17.90

Remarks:

1. Emission Level(dBuV/m) = Raw Value(dBuV) + Correction Factor(dB/m)
2. Correction Factor(dB/m) = Antenna Factor(dB/m) + Cable Factor(dB) – Pre-Amplifier Factor(dB)
3. The other emission levels were very low against the limit.
4. Margin value = Emission Level – Limit value
5. " * ": Fundamental frequency.
6. " # ": The radiated frequency is out of the restricted band.

CHANNEL	TX Channel 165	DETECTOR FUNCTION	Peak (PK)
FREQUENCY RANGE	1GHz ~ 40GHz		Average (AV)

ANTENNA POLARITY & TEST DISTANCE: HORIZONTAL AT 3 M

NO.	FREQ. (MHz)	EMISSION LEVEL (dBuV/m)	LIMIT (dBuV/m)	MARGIN (dB)	ANTENNA HEIGHT (m)	TABLE ANGLE (Degree)	RAW VALUE (dBuV)	CORRECTION FACTOR (dB/m)
1	#5633.97	57.7 PK	68.2	-10.5	1.05 H	154	53.20	4.50
2	*5825.00	99.5 PK			1.05 H	154	59.00	40.50
3	#5975.64	59.4 PK	68.2	-8.8	1.05 H	154	54.10	5.30
4	11650.00	56.3 PK	68.2	-11.9	2.44 H	229	38.80	17.50

ANTENNA POLARITY & TEST DISTANCE: VERTICAL AT 3 M

NO.	FREQ. (MHz)	EMISSION LEVEL (dBuV/m)	LIMIT (dBuV/m)	MARGIN (dB)	ANTENNA HEIGHT (m)	TABLE ANGLE (Degree)	RAW VALUE (dBuV)	CORRECTION FACTOR (dB/m)
1	#5632.05	58.0 PK	68.2	-10.2	1.36 V	177	53.50	4.50
2	*5825.00	100.3 PK			1.36 V	177	59.80	40.50
3	#5973.08	59.9 PK	68.2	-8.3	1.36 V	177	54.60	5.30
4	11650.00	55.0 PK	68.2	-13.2	2.12 V	244	37.50	17.50

Remarks:

1. Emission Level(dBuV/m) = Raw Value(dBuV) + Correction Factor(dB/m)
2. Correction Factor(dB/m) = Antenna Factor(dB/m) + Cable Factor(dB) – Pre-Amplifier Factor(dB)
3. The other emission levels were very low against the limit.
4. Margin value = Emission Level – Limit value
5. " * ": Fundamental frequency.
6. " # ": The radiated frequency is out of the restricted band.

802.11n (HT40)

CHANNEL	TX Channel 38	DETECTOR	Peak (PK)
FREQUENCY RANGE	1GHz ~ 40GHz	FUNCTION	Average (AV)

ANTENNA POLARITY & TEST DISTANCE: HORIZONTAL AT 3 M

NO.	FREQ. (MHz)	EMISSION LEVEL (dBuV/m)	LIMIT (dBuV/m)	MARGIN (dB)	ANTENNA HEIGHT (m)	TABLE ANGLE (Degree)	RAW VALUE (dBuV)	CORRECTION FACTOR (dB/m)
1	5150.00	53.9 PK	68.2	-14.3	1.55 H	170	50.00	3.90
2	*5190.00	91.2 PK			1.44 H	169	51.60	39.60
3	#10380.00	53.8 PK	68.2	-14.4	2.39 H	229	37.90	15.90

ANTENNA POLARITY & TEST DISTANCE: VERTICAL AT 3 M

NO.	FREQ. (MHz)	EMISSION LEVEL (dBuV/m)	LIMIT (dBuV/m)	MARGIN (dB)	ANTENNA HEIGHT (m)	TABLE ANGLE (Degree)	RAW VALUE (dBuV)	CORRECTION FACTOR (dB/m)
1	5150.00	54.3 PK	68.2	-13.9	1.56 V	171	50.40	3.90
2	*5190.00	94.8 PK			1.38 V	169	55.20	39.60
3	#10380.00	54.3 PK	68.2	-13.9	2.21 V	231	38.40	15.90

Remarks:

1. Emission Level(dBuV/m) = Raw Value(dBuV) + Correction Factor(dB/m)
2. Correction Factor(dB/m) = Antenna Factor(dB/m) + Cable Factor(dB) – Pre-Amplifier Factor(dB)
3. The other emission levels were very low against the limit.
4. Margin value = Emission Level – Limit value
5. " * ": Fundamental frequency.
6. " # ": The radiated frequency is out of the restricted band.

CHANNEL	TX Channel 46	DETECTOR FUNCTION	Peak (PK)
FREQUENCY RANGE	1GHz ~ 40GHz		Average (AV)

ANTENNA POLARITY & TEST DISTANCE: HORIZONTAL AT 3 M

NO.	FREQ. (MHz)	EMISSION LEVEL (dBuV/m)	LIMIT (dBuV/m)	MARGIN (dB)	ANTENNA HEIGHT (m)	TABLE ANGLE (Degree)	RAW VALUE (dBuV)	CORRECTION FACTOR (dB/m)
1	*5230.00	92.1 PK			1.62 H	169	52.70	39.40
2	5350.00	55.4 PK	68.2	-12.8	1.69 H	169	51.40	4.00
3	#10460.00	53.4 PK	68.2	-14.8	2.41 H	244	37.00	16.40

ANTENNA POLARITY & TEST DISTANCE: VERTICAL AT 3 M

NO.	FREQ. (MHz)	EMISSION LEVEL (dBuV/m)	LIMIT (dBuV/m)	MARGIN (dB)	ANTENNA HEIGHT (m)	TABLE ANGLE (Degree)	RAW VALUE (dBuV)	CORRECTION FACTOR (dB/m)
1	*5230.00	94.6 PK			1.33 V	164	55.20	39.40
2	5350.00	55.9 PK	68.2	-12.3	1.40 V	165	51.90	4.00
3	#10460.00	53.6 PK	68.2	-14.6	2.05 V	199	37.20	16.40

Remarks:

1. Emission Level(dBuV/m) = Raw Value(dBuV) + Correction Factor(dB/m)
2. Correction Factor(dB/m) = Antenna Factor(dB/m) + Cable Factor(dB) – Pre-Amplifier Factor(dB)
3. The other emission levels were very low against the limit.
4. Margin value = Emission Level – Limit value
5. " * ": Fundamental frequency.
6. " # ": The radiated frequency is out of the restricted band.

CHANNEL	TX Channel 54	DETECTOR FUNCTION	Peak (PK)
FREQUENCY RANGE	1GHz ~ 40GHz		Average (AV)

ANTENNA POLARITY & TEST DISTANCE: HORIZONTAL AT 3 M

NO.	FREQ. (MHz)	EMISSION LEVEL (dBuV/m)	LIMIT (dBuV/m)	MARGIN (dB)	ANTENNA HEIGHT (m)	TABLE ANGLE (Degree)	RAW VALUE (dBuV)	CORRECTION FACTOR (dB/m)
1	5150.00	55.8 PK	68.2	-12.4	1.39 H	166	51.90	3.90
2	*5270.00	94.4 PK			1.31 H	171	55.00	39.40
3	#10540.00	56.8 PK	68.2	-11.4	2.54 H	223	39.90	16.90

ANTENNA POLARITY & TEST DISTANCE: VERTICAL AT 3 M

NO.	FREQ. (MHz)	EMISSION LEVEL (dBuV/m)	LIMIT (dBuV/m)	MARGIN (dB)	ANTENNA HEIGHT (m)	TABLE ANGLE (Degree)	RAW VALUE (dBuV)	CORRECTION FACTOR (dB/m)
1	5150.00	55.0 PK	68.2	-13.2	1.65 V	169	51.10	3.90
2	*5270.00	93.3 PK			1.71 V	165	53.90	39.40
3	#10540.00	56.6 PK	68.2	-11.6	2.29 V	196	39.70	16.90

Remarks:

1. Emission Level(dBuV/m) = Raw Value(dBuV) + Correction Factor(dB/m)
2. Correction Factor(dB/m) = Antenna Factor(dB/m) + Cable Factor(dB) – Pre-Amplifier Factor(dB)
3. The other emission levels were very low against the limit.
4. Margin value = Emission Level – Limit value
5. " * ": Fundamental frequency.
6. " # ": The radiated frequency is out of the restricted band.

CHANNEL	TX Channel 62	DETECTOR FUNCTION	Peak (PK)
FREQUENCY RANGE	1GHz ~ 40GHz		Average (AV)

ANTENNA POLARITY & TEST DISTANCE: HORIZONTAL AT 3 M

NO.	FREQ. (MHz)	EMISSION LEVEL (dBuV/m)	LIMIT (dBuV/m)	MARGIN (dB)	ANTENNA HEIGHT (m)	TABLE ANGLE (Degree)	RAW VALUE (dBuV)	CORRECTION FACTOR (dB/m)
1	*5310.00	96.4 PK			1.64 H	170	57.00	39.40
2	5350.00	59.3 PK	68.2	-8.9	1.59 H	171	55.30	4.00
3	10620.00	57.2 PK	68.2	-11.0	2.61 H	233	40.10	17.10

ANTENNA POLARITY & TEST DISTANCE: VERTICAL AT 3 M

NO.	FREQ. (MHz)	EMISSION LEVEL (dBuV/m)	LIMIT (dBuV/m)	MARGIN (dB)	ANTENNA HEIGHT (m)	TABLE ANGLE (Degree)	RAW VALUE (dBuV)	CORRECTION FACTOR (dB/m)
1	*5310.00	94.5 PK			1.53 V	172	55.10	39.40
2	5350.00	56.2 PK	68.2	-12.0	1.60 V	169	52.20	4.00
3	10620.00	57.0 PK	68.2	-11.2	1.99 V	205	39.90	17.10

Remarks:

1. Emission Level(dBuV/m) = Raw Value(dBuV) + Correction Factor(dB/m)
2. Correction Factor(dB/m) = Antenna Factor(dB/m) + Cable Factor(dB) – Pre-Amplifier Factor(dB)
3. The other emission levels were very low against the limit.
4. Margin value = Emission Level – Limit value
5. " * ": Fundamental frequency.
6. " # ": The radiated frequency is out of the restricted band.

CHANNEL	TX Channel 102	DETECTOR FUNCTION	Peak (PK)
FREQUENCY RANGE	1GHz ~ 40GHz		Average (AV)

ANTENNA POLARITY & TEST DISTANCE: HORIZONTAL AT 3 M

NO.	FREQ. (MHz)	EMISSION LEVEL (dBuV/m)	LIMIT (dBuV/m)	MARGIN (dB)	ANTENNA HEIGHT (m)	TABLE ANGLE (Degree)	RAW VALUE (dBuV)	CORRECTION FACTOR (dB/m)
1	5460.00	56.4 PK	68.2	-11.8	1.21 H	170	52.00	4.40
2	#5470.00	57.9 PK	68.2	-10.3	1.20 H	170	53.50	4.40
3	*5510.00	99.0 PK			1.10 H	173	58.90	40.10
4	11020.00	57.5 PK	68.2	-10.7	2.54 H	240	39.10	18.40

ANTENNA POLARITY & TEST DISTANCE: VERTICAL AT 3 M

NO.	FREQ. (MHz)	EMISSION LEVEL (dBuV/m)	LIMIT (dBuV/m)	MARGIN (dB)	ANTENNA HEIGHT (m)	TABLE ANGLE (Degree)	RAW VALUE (dBuV)	CORRECTION FACTOR (dB/m)
1	5460.00	56.2 PK	68.2	-12.0	1.09 V	175	51.80	4.40
2	#5470.00	57.5 PK	68.2	-10.7	1.11 V	170	53.10	4.40
3	*5510.00	94.9 PK			1.04 V	179	54.80	40.10
4	11020.00	57.2 PK	68.2	-11.0	2.19 V	209	38.80	18.40

Remarks:

1. Emission Level(dBuV/m) = Raw Value(dBuV) + Correction Factor(dB/m)
2. Correction Factor(dB/m) = Antenna Factor(dB/m) + Cable Factor(dB) – Pre-Amplifier Factor(dB)
3. The other emission levels were very low against the limit.
4. Margin value = Emission Level – Limit value
5. " * ": Fundamental frequency.
6. " # ": The radiated frequency is out of the restricted band.

CHANNEL	TX Channel 110	DETECTOR FUNCTION	Peak (PK)
FREQUENCY RANGE	1GHz ~ 40GHz		Average (AV)

ANTENNA POLARITY & TEST DISTANCE: HORIZONTAL AT 3 M								
NO.	FREQ. (MHz)	EMISSION LEVEL (dBuV/m)	LIMIT (dBuV/m)	MARGIN (dB)	ANTENNA HEIGHT (m)	TABLE ANGLE (Degree)	RAW VALUE (dBuV)	CORRECTION FACTOR (dB/m)
1	*5550.00	98.4 PK			1.35 H	173	58.40	40.00
2	11100.00	58.0 PK	68.2	-10.2	2.63 H	239	40.50	17.50
ANTENNA POLARITY & TEST DISTANCE: VERTICAL AT 3 M								
NO.	FREQ. (MHz)	EMISSION LEVEL (dBuV/m)	LIMIT (dBuV/m)	MARGIN (dB)	ANTENNA HEIGHT (m)	TABLE ANGLE (Degree)	RAW VALUE (dBuV)	CORRECTION FACTOR (dB/m)
1	*5550.00	94.0 PK			1.21 V	197	54.00	40.00
2	11100.00	57.9 PK	68.2	-10.3	1.89 V	199	40.40	17.50

Remarks:

1. Emission Level(dBuV/m) = Raw Value(dBuV) + Correction Factor(dB/m)
2. Correction Factor(dB/m) = Antenna Factor(dB/m) + Cable Factor(dB) – Pre-Amplifier Factor(dB)
3. The other emission levels were very low against the limit.
4. Margin value = Emission Level – Limit value
5. " * ": Fundamental frequency.
6. " # ": The radiated frequency is out of the restricted band.

CHANNEL	TX Channel 134	DETECTOR FUNCTION	Peak (PK)
FREQUENCY RANGE	1GHz ~ 40GHz		Average (AV)

ANTENNA POLARITY & TEST DISTANCE: HORIZONTAL AT 3 M

NO.	FREQ. (MHz)	EMISSION LEVEL (dBuV/m)	LIMIT (dBuV/m)	MARGIN (dB)	ANTENNA HEIGHT (m)	TABLE ANGLE (Degree)	RAW VALUE (dBuV)	CORRECTION FACTOR (dB/m)
1	*5670.00	96.6 PK			1.71 H	172	56.50	40.10
2	#5725.00	56.5 PK	68.2	-11.7	1.41 H	170	52.10	4.40
3	11340.00	57.6 PK	68.2	-10.6	2.55 H	229	39.80	17.80

ANTENNA POLARITY & TEST DISTANCE: VERTICAL AT 3 M

NO.	FREQ. (MHz)	EMISSION LEVEL (dBuV/m)	LIMIT (dBuV/m)	MARGIN (dB)	ANTENNA HEIGHT (m)	TABLE ANGLE (Degree)	RAW VALUE (dBuV)	CORRECTION FACTOR (dB/m)
1	*5670.00	94.8 PK			1.26 V	164	54.70	40.10
2	#5725.00	55.9 PK	68.2	-12.3	1.33 V	169	51.50	4.40
3	11340.00	57.1 PK	68.2	-11.1	2.29 V	205	39.30	17.80

Remarks:

1. Emission Level(dBuV/m) = Raw Value(dBuV) + Correction Factor(dB/m)
2. Correction Factor(dB/m) = Antenna Factor(dB/m) + Cable Factor(dB) – Pre-Amplifier Factor(dB)
3. The other emission levels were very low against the limit.
4. Margin value = Emission Level – Limit value
5. " * ": Fundamental frequency.
6. " # ": The radiated frequency is out of the restricted band.

CHANNEL	TX Channel 142	DETECTOR FUNCTION	Peak (PK)
FREQUENCY RANGE	1GHz ~ 40GHz		Average (AV)

ANTENNA POLARITY & TEST DISTANCE: HORIZONTAL AT 3 M

NO.	FREQ. (MHz)	EMISSION LEVEL (dBuV/m)	LIMIT (dBuV/m)	MARGIN (dB)	ANTENNA HEIGHT (m)	TABLE ANGLE (Degree)	RAW VALUE (dBuV)	CORRECTION FACTOR (dB/m)
1	#5470.00	56.0 PK	68.2	-12.2	1.44 H	183	51.60	4.40
2	*5710.00	94.9 PK			1.03 H	154	54.90	40.00
3	#5825.00	56.1 PK	68.2	-12.1	1.27 H	126	51.30	4.80
4	11420.00	54.7 PK	68.2	-13.5	1.93 H	254	37.20	17.50

ANTENNA POLARITY & TEST DISTANCE: VERTICAL AT 3 M

NO.	FREQ. (MHz)	EMISSION LEVEL (dBuV/m)	LIMIT (dBuV/m)	MARGIN (dB)	ANTENNA HEIGHT (m)	TABLE ANGLE (Degree)	RAW VALUE (dBuV)	CORRECTION FACTOR (dB/m)
1	#5470.00	56.5 PK	68.2	-11.7	2.32 V	186	52.10	4.40
2	*5710.00	94.2 PK			1.51 V	164	54.20	40.00
3	#5825.00	57.3 PK	68.2	-10.9	2.35 V	156	52.50	4.80
4	11420.00	53.9 PK	68.2	-14.3	2.38 V	184	36.40	17.50

REMARKS:

1. Emission Level(dBuV/m) = Raw Value(dBuV) + Correction Factor(dB/m)
2. Correction Factor(dB/m) = Antenna Factor(dB/m) + Cable Factor(dB) – Pre-Amplifier Factor(dB)
3. The other emission levels were very low against the limit.
4. Margin value = Emission Level – Limit value
5. " * ": Fundamental frequency.
6. " # ": The radiated frequency is out of the restricted band.

CHANNEL	TX Channel 151	DETECTOR FUNCTION	Peak (PK)
FREQUENCY RANGE	1GHz ~ 40GHz		Average (AV)

ANTENNA POLARITY & TEST DISTANCE: HORIZONTAL AT 3 M

NO.	FREQ. (MHz)	EMISSION LEVEL (dBuV/m)	LIMIT (dBuV/m)	MARGIN (dB)	ANTENNA HEIGHT (m)	TABLE ANGLE (Degree)	RAW VALUE (dBuV)	CORRECTION FACTOR (dB/m)
1	#5601.28	57.4 PK	68.2	-10.8	1.14 H	153	52.90	4.50
2	*5755.00	96.3 PK			1.14 H	153	56.20	40.10
3	#5973.08	59.2 PK	68.2	-9.0	1.14 H	153	53.90	5.30
4	11510.00	54.6 PK	68.2	-13.6	2.29 H	243	37.00	17.60

ANTENNA POLARITY & TEST DISTANCE: VERTICAL AT 3 M

NO.	FREQ. (MHz)	EMISSION LEVEL (dBuV/m)	LIMIT (dBuV/m)	MARGIN (dB)	ANTENNA HEIGHT (m)	TABLE ANGLE (Degree)	RAW VALUE (dBuV)	CORRECTION FACTOR (dB/m)
1	#5618.59	57.7 PK	68.2	-10.5	1.40 V	164	53.20	4.50
2	*5755.00	95.7 PK			1.40 V	164	55.60	40.10
3	#5977.56	58.8 PK	68.2	-9.4	1.40 V	164	53.50	5.30
4	11510.00	54.1 PK	68.2	-14.1	2.19 V	241	36.50	17.60

Remarks:

1. Emission Level(dBuV/m) = Raw Value(dBuV) + Correction Factor(dB/m)
2. Correction Factor(dB/m) = Antenna Factor(dB/m) + Cable Factor(dB) – Pre-Amplifier Factor(dB)
3. The other emission levels were very low against the limit.
4. Margin value = Emission Level – Limit value
5. " * ": Fundamental frequency.
6. " # ": The radiated frequency is out of the restricted band.

CHANNEL	TX Channel 159	DETECTOR	Peak (PK)
FREQUENCY RANGE	1GHz ~ 40GHz	FUNCTION	Average (AV)

ANTENNA POLARITY & TEST DISTANCE: HORIZONTAL AT 3 M

NO.	FREQ. (MHz)	EMISSION LEVEL (dBuV/m)	LIMIT (dBuV/m)	MARGIN (dB)	ANTENNA HEIGHT (m)	TABLE ANGLE (Degree)	RAW VALUE (dBuV)	CORRECTION FACTOR (dB/m)
1	#5632.05	58.0 PK	68.2	-10.2	1.02 H	153	53.50	4.50
2	*5795.00	97.3 PK			1.02 H	153	57.00	40.30
3	#5983.33	59.6 PK	68.2	-8.6	1.02 H	153	54.30	5.30
4	11590.00	55.2 PK	68.2	-13.0	2.51 H	233	37.30	17.90

ANTENNA POLARITY & TEST DISTANCE: VERTICAL AT 3 M

NO.	FREQ. (MHz)	EMISSION LEVEL (dBuV/m)	LIMIT (dBuV/m)	MARGIN (dB)	ANTENNA HEIGHT (m)	TABLE ANGLE (Degree)	RAW VALUE (dBuV)	CORRECTION FACTOR (dB/m)
1	#5639.74	58.0 PK	68.2	-10.2	1.18 V	166	53.50	4.50
2	*5795.00	97.5 PK			1.18 V	166	57.20	40.30
3	#5937.82	59.5 PK	68.2	-8.7	1.18 V	166	54.40	5.10
4	11590.00	55.4 PK	68.2	-12.8	2.29 V	239	37.50	17.90

Remarks:

1. Emission Level(dBuV/m) = Raw Value(dBuV) + Correction Factor(dB/m)
2. Correction Factor(dB/m) = Antenna Factor(dB/m) + Cable Factor(dB) – Pre-Amplifier Factor(dB)
3. The other emission levels were very low against the limit.
4. Margin value = Emission Level – Limit value
5. " * ": Fundamental frequency.
6. " # ": The radiated frequency is out of the restricted band.

802.11ac (VHT80)

CHANNEL	TX Channel 42	DETECTOR FUNCTION	Peak (PK)
FREQUENCY RANGE	1GHz ~ 40GHz		Average (AV)

ANTENNA POLARITY & TEST DISTANCE: HORIZONTAL AT 3 M								
NO.	FREQ. (MHz)	EMISSION LEVEL (dBuV/m)	LIMIT (dBuV/m)	MARGIN (dB)	ANTENNA HEIGHT (m)	TABLE ANGLE (Degree)	RAW VALUE (dBuV)	CORRECTION FACTOR (dB/m)
1	5150.00	54.3 PK	68.2	-13.9	1.70 H	172	50.40	3.90
2	*5210.00	88.0 PK			1.67 H	169	48.50	39.50
3	5350.00	56.7 PK	68.2	-11.5	1.63 H	165	52.70	4.00
4	#10420.00	53.0 PK	68.2	-15.2	2.29 H	254	37.00	16.00
ANTENNA POLARITY & TEST DISTANCE: VERTICAL AT 3 M								
NO.	FREQ. (MHz)	EMISSION LEVEL (dBuV/m)	LIMIT (dBuV/m)	MARGIN (dB)	ANTENNA HEIGHT (m)	TABLE ANGLE (Degree)	RAW VALUE (dBuV)	CORRECTION FACTOR (dB/m)
1	5150.00	54.3 PK	68.2	-13.9	1.71 V	177	50.40	3.90
2	*5210.00	89.7 PK			1.67 V	182	50.20	39.50
3	5350.00	56.0 PK	68.2	-12.2	1.65 V	188	52.00	4.00
4	#10420.00	53.0 PK	68.2	-15.2	2.09 V	229	37.00	16.00

Remarks:

1. Emission Level(dBuV/m) = Raw Value(dBuV) + Correction Factor(dB/m)
2. Correction Factor(dB/m) = Antenna Factor(dB/m) + Cable Factor(dB) – Pre-Amplifier Factor(dB)
3. The other emission levels were very low against the limit.
4. Margin value = Emission Level – Limit value
5. " * ": Fundamental frequency.
6. " # ": The radiated frequency is out of the restricted band.

CHANNEL	TX Channel 58	DETECTOR FUNCTION	Peak (PK)
FREQUENCY RANGE	1GHz ~ 40GHz		Average (AV)

ANTENNA POLARITY & TEST DISTANCE: HORIZONTAL AT 3 M

NO.	FREQ. (MHz)	EMISSION LEVEL (dBuV/m)	LIMIT (dBuV/m)	MARGIN (dB)	ANTENNA HEIGHT (m)	TABLE ANGLE (Degree)	RAW VALUE (dBuV)	CORRECTION FACTOR (dB/m)
1	5150.00	54.6 PK	68.2	-13.6	1.44 H	170	50.70	3.90
2	*5290.00	90.0 PK			1.40 H	168	50.60	39.40
3	5350.00	57.9 PK	68.2	-10.3	1.49 H	169	53.90	4.00
4	#10580.00	55.9 PK	68.2	-12.3	2.66 H	239	38.80	17.10

ANTENNA POLARITY & TEST DISTANCE: VERTICAL AT 3 M

NO.	FREQ. (MHz)	EMISSION LEVEL (dBuV/m)	LIMIT (dBuV/m)	MARGIN (dB)	ANTENNA HEIGHT (m)	TABLE ANGLE (Degree)	RAW VALUE (dBuV)	CORRECTION FACTOR (dB/m)
1	5150.00	54.3 PK	68.2	-13.9	1.60 V	188	50.40	3.90
2	*5290.00	88.9 PK			1.54 V	195	49.50	39.40
3	5350.00	56.5 PK	68.2	-11.7	1.59 V	190	52.50	4.00
4	#10580.00	55.4 PK	68.2	-12.8	2.13 V	211	38.30	17.10

Remarks:

1. Emission Level(dBuV/m) = Raw Value(dBuV) + Correction Factor(dB/m)
2. Correction Factor(dB/m) = Antenna Factor(dB/m) + Cable Factor(dB) – Pre-Amplifier Factor(dB)
3. The other emission levels were very low against the limit.
4. Margin value = Emission Level – Limit value
5. " * ": Fundamental frequency.
6. " # ": The radiated frequency is out of the restricted band.

CHANNEL	TX Channel 106	DETECTOR FUNCTION	Peak (PK)
FREQUENCY RANGE	1GHz ~ 40GHz		Average (AV)

ANTENNA POLARITY & TEST DISTANCE: HORIZONTAL AT 3 M

NO.	FREQ. (MHz)	EMISSION LEVEL (dBuV/m)	LIMIT (dBuV/m)	MARGIN (dB)	ANTENNA HEIGHT (m)	TABLE ANGLE (Degree)	RAW VALUE (dBuV)	CORRECTION FACTOR (dB/m)
1	5460.00	56.4 PK	68.2	-11.8	1.59 H	170	52.00	4.40
2	#5470.00	57.6 PK	68.2	-10.6	1.55 H	166	53.20	4.40
3	*5530.00	93.1 PK			1.51 H	171	53.00	40.10
4	#5725.00	56.5 PK	68.2	-11.7	1.61 H	170	52.10	4.40
5	11060.00	58.9 PK	68.2	-9.3	2.57 H	244	41.00	17.90

ANTENNA POLARITY & TEST DISTANCE: VERTICAL AT 3 M

NO.	FREQ. (MHz)	EMISSION LEVEL (dBuV/m)	LIMIT (dBuV/m)	MARGIN (dB)	ANTENNA HEIGHT (m)	TABLE ANGLE (Degree)	RAW VALUE (dBuV)	CORRECTION FACTOR (dB/m)
1	5460.00	56.0 PK	68.2	-12.2	1.29 V	174	51.60	4.40
2	#5470.00	57.3 PK	68.2	-10.9	1.30 V	170	52.90	4.40
3	*5530.00	89.1 PK			1.23 V	174	49.00	40.10
4	#5725.00	56.1 PK	68.2	-12.1	1.30 V	177	51.70	4.40
5	11060.00	57.9 PK	68.2	-10.3	1.99 V	210	40.00	17.90

Remarks:

1. Emission Level(dBuV/m) = Raw Value(dBuV) + Correction Factor(dB/m)
2. Correction Factor(dB/m) = Antenna Factor(dB/m) + Cable Factor(dB) – Pre-Amplifier Factor(dB)
3. The other emission levels were very low against the limit.
4. Margin value = Emission Level – Limit value
5. " * ": Fundamental frequency.
6. " # ": The radiated frequency is out of the restricted band.

CHANNEL	TX Channel 122	DETECTOR FUNCTION	Peak (PK)
FREQUENCY RANGE	1GHz ~ 40GHz		Average (AV)

ANTENNA POLARITY & TEST DISTANCE: HORIZONTAL AT 3 M								
NO.	FREQ. (MHz)	EMISSION LEVEL (dBuV/m)	LIMIT (dBuV/m)	MARGIN (dB)	ANTENNA HEIGHT (m)	TABLE ANGLE (Degree)	RAW VALUE (dBuV)	CORRECTION FACTOR (dB/m)
1	5460.00	56.2 PK	68.2	-12.0	1.51 H	166	51.80	4.40
2	#5470.00	57.7 PK	68.2	-10.5	1.55 H	170	53.30	4.40
3	*5610.00	94.5 PK			1.49 H	171	54.40	40.10
4	#5725.00	55.9 PK	68.2	-12.3	1.50 H	165	51.50	4.40
5	11220.00	57.5 PK	68.2	-10.7	2.63 H	259	39.80	17.70

ANTENNA POLARITY & TEST DISTANCE: VERTICAL AT 3 M								
NO.	FREQ. (MHz)	EMISSION LEVEL (dBuV/m)	LIMIT (dBuV/m)	MARGIN (dB)	ANTENNA HEIGHT (m)	TABLE ANGLE (Degree)	RAW VALUE (dBuV)	CORRECTION FACTOR (dB/m)
1	5460.00	55.8 PK	68.2	-12.4	1.29 V	170	51.40	4.40
2	#5470.00	57.6 PK	68.2	-10.6	1.33 V	169	53.20	4.40
3	*5610.00	90.5 PK			1.20 V	179	50.40	40.10
4	#5725.00	55.8 PK	68.2	-12.4	1.25 V	170	51.40	4.40
5	11220.00	57.0 PK	68.2	-11.2	2.25 V	223	39.30	17.70

Remarks:

1. Emission Level(dBuV/m) = Raw Value(dBuV) + Correction Factor(dB/m)
2. Correction Factor(dB/m) = Antenna Factor(dB/m) + Cable Factor(dB) – Pre-Amplifier Factor(dB)
3. The other emission levels were very low against the limit.
4. Margin value = Emission Level – Limit value
5. " * ": Fundamental frequency.
6. " # ": The radiated frequency is out of the restricted band.

CHANNEL	TX Channel 138	DETECTOR FUNCTION	Peak (PK)
FREQUENCY RANGE	1GHz ~ 40GHz		Average (AV)

ANTENNA POLARITY & TEST DISTANCE: HORIZONTAL AT 3 M

NO.	FREQ. (MHz)	EMISSION LEVEL (dBuV/m)	LIMIT (dBuV/m)	MARGIN (dB)	ANTENNA HEIGHT (m)	TABLE ANGLE (Degree)	RAW VALUE (dBuV)	CORRECTION FACTOR (dB/m)
1	#5470.00	55.7 PK	68.2	-12.5	1.73 H	186	51.30	4.40
2	*5690.00	93.2 PK			1.50 H	177	53.20	40.00
3	#5825.00	55.8 PK	68.2	-12.4	1.82 H	203	51.00	4.80
4	11380.00	54.1 PK	68.2	-14.1	2.20 H	47	36.60	17.50

ANTENNA POLARITY & TEST DISTANCE: VERTICAL AT 3 M

NO.	FREQ. (MHz)	EMISSION LEVEL (dBuV/m)	LIMIT (dBuV/m)	MARGIN (dB)	ANTENNA HEIGHT (m)	TABLE ANGLE (Degree)	RAW VALUE (dBuV)	CORRECTION FACTOR (dB/m)
1	#5470.00	57.3 PK	68.2	-10.9	1.72 V	196	52.90	4.40
2	*5690.00	91.6 PK			1.08 V	164	51.60	40.00
3	#5825.00	56.0 PK	68.2	-12.2	2.39 V	177	51.20	4.80
4	11380.00	54.0 PK	68.2	-14.2	2.56 V	284	36.50	17.50

REMARKS:

1. Emission Level(dBuV/m) = Raw Value(dBuV) + Correction Factor(dB/m)
2. Correction Factor(dB/m) = Antenna Factor(dB/m) + Cable Factor(dB) – Pre-Amplifier Factor(dB)
3. The other emission levels were very low against the limit.
4. Margin value = Emission Level – Limit value
5. " * ": Fundamental frequency.
6. " # ": The radiated frequency is out of the restricted band.

CHANNEL	TX Channel 155	DETECTOR FUNCTION	Peak (PK)
FREQUENCY RANGE	1GHz ~ 40GHz		Average (AV)

ANTENNA POLARITY & TEST DISTANCE: HORIZONTAL AT 3 M								
NO.	FREQ. (MHz)	EMISSION LEVEL (dBuV/m)	LIMIT (dBuV/m)	MARGIN (dB)	ANTENNA HEIGHT (m)	TABLE ANGLE (Degree)	RAW VALUE (dBuV)	CORRECTION FACTOR (dB/m)
1	#5609.62	57.7 PK	68.2	-10.5	1.01 H	154	53.20	4.50
2	#5650.00	55.0 PK	68.2	-13.2	1.11 H	150	50.40	4.60
3	*5775.00	92.8 PK			1.01 H	154	52.60	40.20
4	#5925.00	57.3 PK	68.2	-10.9	1.09 H	153	52.10	5.20
5	#5953.21	58.8 PK	68.2	-9.4	1.01 H	154	53.60	5.20
6	11550.00	55.4 PK	68.2	-12.8	2.51 H	259	37.60	17.80

ANTENNA POLARITY & TEST DISTANCE: VERTICAL AT 3 M								
NO.	FREQ. (MHz)	EMISSION LEVEL (dBuV/m)	LIMIT (dBuV/m)	MARGIN (dB)	ANTENNA HEIGHT (m)	TABLE ANGLE (Degree)	RAW VALUE (dBuV)	CORRECTION FACTOR (dB/m)
1	#5602.56	57.8 PK	68.2	-10.4	1.21 V	177	53.30	4.50
2	#5650.00	54.9 PK	68.2	-13.3	1.19 V	170	50.30	4.60
3	*5775.00	92.4 PK			1.21 V	177	52.20	40.20
4	#5925.00	57.2 PK	68.2	-11.0	1.20 V	175	52.00	5.20
5	#5982.69	59.0 PK	68.2	-9.2	1.21 V	177	53.70	5.30
6	11550.00	55.0 PK	68.2	-13.2	2.29 V	243	37.20	17.80

Remarks:

1. Emission Level(dBuV/m) = Raw Value(dBuV) + Correction Factor(dB/m)
2. Correction Factor(dB/m) = Antenna Factor(dB/m) + Cable Factor(dB) – Pre-Amplifier Factor(dB)
3. The other emission levels were very low against the limit.
4. Margin value = Emission Level – Limit value
5. " * ": Fundamental frequency.
6. " # ": The radiated frequency is out of the restricted band.

Below 1GHz Worst-Case Data: 802.11a

CHANNEL	TX Channel 149	DETECTOR FUNCTION	Quasi-Peak (QP)
FREQUENCY RANGE	9kHz ~ 1GHz	TEST MODE	A

ANTENNA POLARITY & TEST DISTANCE: HORIZONTAL AT 3 M								
NO.	FREQ. (MHz)	EMISSION LEVEL (dBuV/m)	LIMIT (dBuV/m)	MARGIN (dB)	ANTENNA HEIGHT (m)	TABLE ANGLE (Degree)	RAW VALUE (dBuV)	CORRECTION FACTOR (dB/m)
1	86.53	33.3 QP	40.0	-6.7	2.00 H	130	47.80	-14.50
2	136.84	29.3 QP	43.5	-14.2	2.00 H	96	39.10	-9.80
3	181.55	31.0 QP	43.5	-12.5	1.50 H	77	41.20	-10.20
4	247.66	26.6 QP	46.0	-19.4	1.00 H	139	35.80	-9.20
5	362.37	23.5 QP	46.0	-22.5	2.00 H	220	29.40	-5.90
6	619.02	30.3 QP	46.0	-15.7	1.00 H	188	30.40	-0.10

Remarks:

1. Emission Level(dBuV/m) = Raw Value(dBuV) + Correction Factor(dB/m)
2. Correction Factor(dB/m) = Antenna Factor(dB/m) + Cable Factor(dB) – Pre-Amplifier Factor(dB)
3. The other emission levels were very low against the limit.
4. Margin value = Emission Level – Limit value

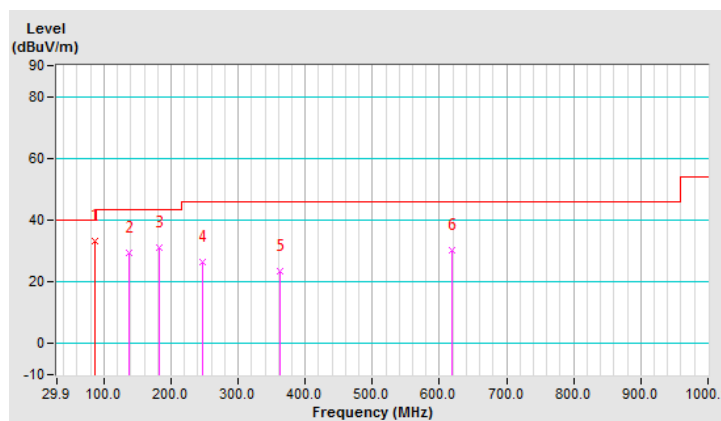

CHANNEL	TX Channel 149	DETECTOR FUNCTION	Quasi-Peak (QP)
FREQUENCY RANGE	9kHz ~ 1GHz	TEST MODE	A

ANTENNA POLARITY & TEST DISTANCE: VERTICAL AT 3 M

NO.	FREQ. (MHz)	EMISSION LEVEL (dBuV/m)	LIMIT (dBuV/m)	MARGIN (dB)	ANTENNA HEIGHT (m)	TABLE ANGLE (Degree)	RAW VALUE (dBuV)	CORRECTION FACTOR (dB/m)
1	85.91	33.4 QP	40.0	-6.6	1.00 V	136	47.90	-14.50
2	136.84	26.7 QP	43.5	-16.8	1.00 V	215	36.50	-9.80
3	160.17	26.9 QP	43.5	-16.6	1.00 V	160	35.60	-8.70
4	253.49	24.5 QP	46.0	-21.5	1.00 V	15	33.40	-8.90
5	315.71	25.0 QP	46.0	-21.0	1.49 V	187	31.70	-6.70
6	578.19	31.0 QP	46.0	-15.0	1.00 V	240	32.10	-1.10

Remarks:

1. Emission Level(dBuV/m) = Raw Value(dBuV) + Correction Factor(dB/m)
2. Correction Factor(dB/m) = Antenna Factor(dB/m) + Cable Factor(dB) – Pre-Amplifier Factor(dB)
3. The other emission levels were very low against the limit.
4. Margin value = Emission Level – Limit value

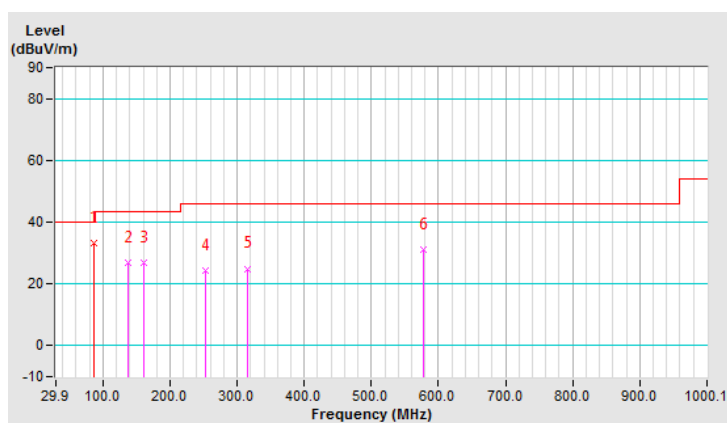

CHANNEL	TX Channel 149	DETECTOR FUNCTION	Quasi-Peak (QP)
FREQUENCY RANGE	9kHz ~ 1GHz	TEST MODE	B

ANTENNA POLARITY & TEST DISTANCE: HORIZONTAL AT 3 M								
NO.	FREQ. (MHz)	EMISSION LEVEL (dBuV/m)	LIMIT (dBuV/m)	MARGIN (dB)	ANTENNA HEIGHT (m)	TABLE ANGLE (Degree)	RAW VALUE (dBuV)	CORRECTION FACTOR (dB/m)
1	84.34	35.9 QP	40.0	-4.1	2.00 H	156	50.10	-14.20
2	136.84	30.1 QP	43.5	-13.4	2.00 H	72	39.90	-9.80
3	247.66	26.0 QP	46.0	-20.0	1.00 H	272	35.20	-9.20
4	375.98	24.3 QP	46.0	-21.7	2.00 H	197	29.80	-5.50
5	508.19	26.6 QP	46.0	-19.4	1.00 H	21	29.30	-2.70
6	654.02	29.6 QP	46.0	-16.4	1.00 H	163	29.30	0.30

Remarks:

1. Emission Level(dBuV/m) = Raw Value(dBuV) + Correction Factor(dB/m)
2. Correction Factor(dB/m) = Antenna Factor(dB/m) + Cable Factor(dB) – Pre-Amplifier Factor(dB)
3. The other emission levels were very low against the limit.
4. Margin value = Emission Level – Limit value

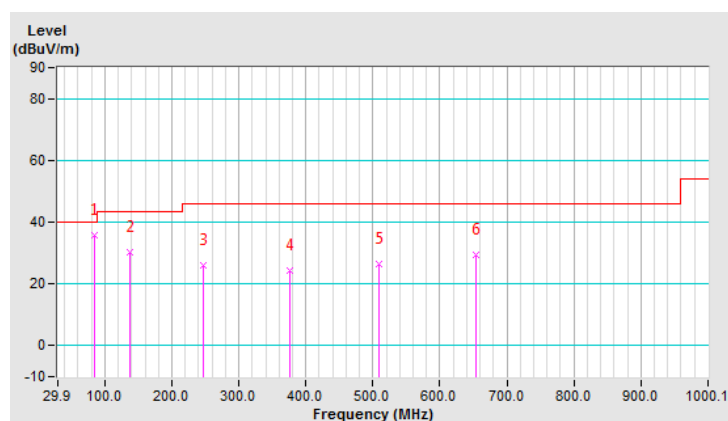

ANTENNA POLARITY & TEST DISTANCE: VERTICAL AT 3 M

NO.	FREQ. (MHz)	EMISSION LEVEL (dBuV/m)	LIMIT (dBuV/m)	MARGIN (dB)	ANTENNA HEIGHT (m)	TABLE ANGLE (Degree)	RAW VALUE (dBuV)	CORRECTION FACTOR (dB/m)
1	66.84	29.9 QP	40.0	-10.1	1.00 V	22	40.30	-10.40
2	90.17	30.2 QP	43.5	-13.3	1.00 V	135	44.90	-14.70
3	158.22	27.4 QP	43.5	-16.1	1.00 V	163	36.10	-8.70
4	251.55	24.4 QP	46.0	-21.6	1.50 V	16	33.40	-9.00
5	399.31	25.1 QP	46.0	-20.9	1.00 V	202	30.30	-5.20
6	615.13	30.0 QP	46.0	-16.0	1.00 V	82	30.30	-0.30

Remarks:

1. Emission Level(dBuV/m) = Raw Value(dBuV) + Correction Factor(dB/m)
2. Correction Factor(dB/m) = Antenna Factor(dB/m) + Cable Factor(dB) – Pre-Amplifier Factor(dB)
3. The other emission levels were very low against the limit.
4. Margin value = Emission Level – Limit value

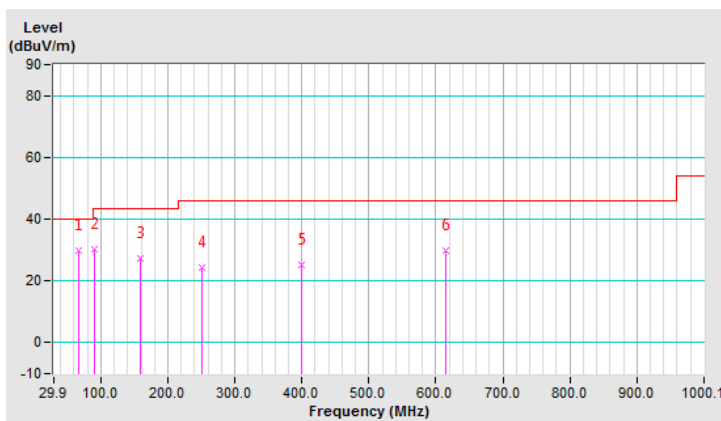

4.2 Conducted Emission Measurement

4.2.1 Limits of Conducted Emission Measurement

Frequency (MHz)	Conducted Limit (dBuV)	
	Quasi-peak	Average
0.15 - 0.5	66 - 56	56 - 46
0.50 - 5.0	56	46
5.0 - 30.0	60	50

Note: 1. The lower limit shall apply at the transition frequencies.

2. The limit decreases in line with the logarithm of the frequency in the range of 0.15 to 0.50MHz.

4.2.2 Test Instruments

Description & Manufacturer	Model No.	Serial No.	Cal. Date	Cal. Due
Test Receiver ROHDE & SCHWARZ	ESR3	102412	Feb. 08, 2018	Feb. 07, 2019
RF signal cable (with 10dB PAD) Woken	5D-FB	Cable-cond2-01	Sep. 08, 2017	Sep. 07, 2018
LISN ROHDE & SCHWARZ (EUT)	ESH2-Z5	100100	Feb. 05, 2018	Feb. 04, 2019
LISN ROHDE & SCHWARZ (Peripheral)	ESH3-Z5	100312	Aug. 02, 2017	Aug. 01, 2018
Software ADT	BV ADT_Cond_ V7.3.7.4	NA	NA	NA

Note: 1. The calibration interval of the above test instruments is 12 months and the calibrations are traceable to NML/ROC and NIST/USA.

2. The test was performed in HwaYa Shielded Room 2.

3. The VCCI Site Registration No. is C-2047.

4.2.3 Test Procedures

- The EUT was placed 0.4 meters from the conducting wall of the shielded room with EUT being connected to the power mains through a line impedance stabilization network (LISN). Other support units were connected to the power mains through another LISN. The two LISNs provide 50 ohm/ 50uH of coupling impedance for the measuring instrument.
- Both lines of the power mains connected to the EUT were checked for maximum conducted interference.
- The frequency range from 150kHz to 30MHz was searched. Emission levels under (Limit - 20dB) was not recorded.

NOTE: The resolution bandwidth and video bandwidth of test receiver is 9kHz for quasi-peak detection (QP) and average detection (AV) at frequency 0.15MHz-30MHz.

4.2.4 Deviation from Test Standard

No deviation.

4.2.5 Test Setup

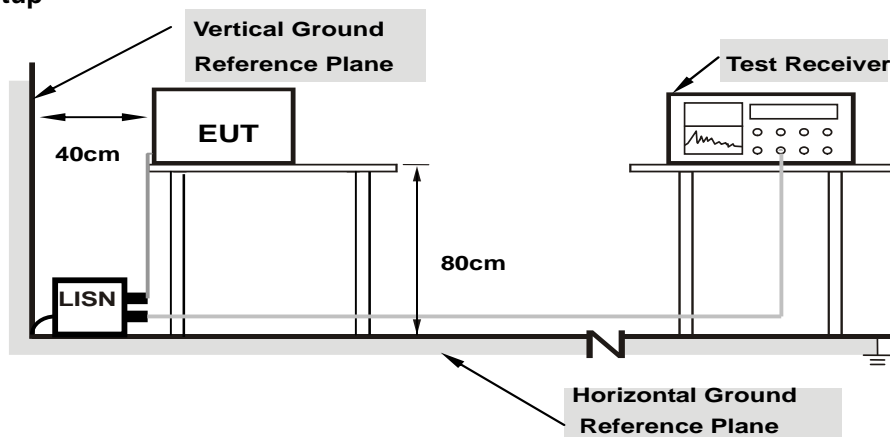

Note: 1.Support units were connected to second LISN.

For the actual test configuration, please refer to the attached file (Test Setup Photo).

4.2.6 EUT Operating Conditions

Same as 4.1.6.

4.2.7 Test Results

Phase	Line (L)	Detector Function	Quasi-Peak (QP) / Average (AV)
-------	----------	-------------------	--------------------------------

No	Freq. [MHz]	Corr. Factor (dB)	Reading Value [dB (uV)]		Emission Level [dB (uV)]		Limit [dB (uV)]		Margin (dB)	
			Q.P.	AV.	Q.P.	AV.	Q.P.	AV.	Q.P.	AV.
			1	0.16567	10.29	36.18	20.82	46.47	31.11	65.17
2	0.26925	10.32	27.10	13.76	37.42	24.08	61.14	51.14	-23.72	-27.06
3	0.52575	10.36	26.99	17.03	37.35	27.39	56.00	46.00	-18.65	-18.61
4	1.63275	10.42	24.50	13.51	34.92	23.93	56.00	46.00	-21.08	-22.07
5	5.23725	10.55	20.94	9.18	31.49	19.73	60.00	50.00	-28.51	-30.27
6	13.89750	10.73	24.59	14.74	35.32	25.47	60.00	50.00	-24.68	-24.53

REMARKS:

1. Q.P. and AV. are abbreviations of quasi-peak and average individually.
2. The emission levels of other frequencies were very low against the limit.
3. Margin value = Emission level - Limit value
4. Correction factor = Insertion loss + Cable loss
5. Emission Level = Correction Factor + Reading Value.

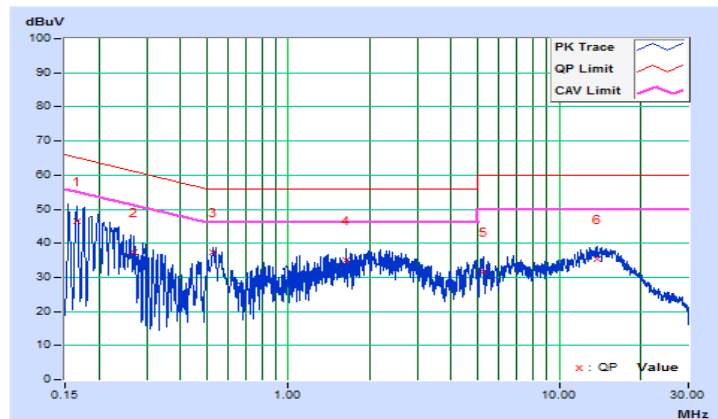

Phase	Neutral (N)	Detector Function	Quasi-Peak (QP) / Average (AV)
-------	-------------	-------------------	--------------------------------

No	Freq. [MHz]	Corr. Factor (dB)	Reading Value [dB (uV)]		Emission Level [dB (uV)]		Limit [dB (uV)]		Margin (dB)	
			Q.P.	AV.	Q.P.	AV.	Q.P.	AV.	Q.P.	AV.
	1	0.16350	10.33	37.29	21.06	47.62	31.39	65.28	55.28	-17.66
2	0.23325	10.31	33.69	18.73	44.00	29.04	62.33	52.33	-18.33	-23.29
3	0.53700	10.34	23.21	12.07	33.55	22.41	56.00	46.00	-22.45	-23.59
4	2.41125	10.50	17.43	7.23	27.93	17.73	56.00	46.00	-28.07	-28.27
5	4.77825	10.58	16.92	7.43	27.50	18.01	56.00	46.00	-28.50	-27.99
6	14.83350	10.86	19.51	11.12	30.37	21.98	60.00	50.00	-29.63	-28.02

REMARKS:

1. Q.P. and AV. are abbreviations of quasi-peak and average individually.
2. The emission levels of other frequencies were very low against the limit.
3. Margin value = Emission level - Limit value
4. Correction factor = Insertion loss + Cable loss
5. Emission Level = Correction Factor + Reading Value.

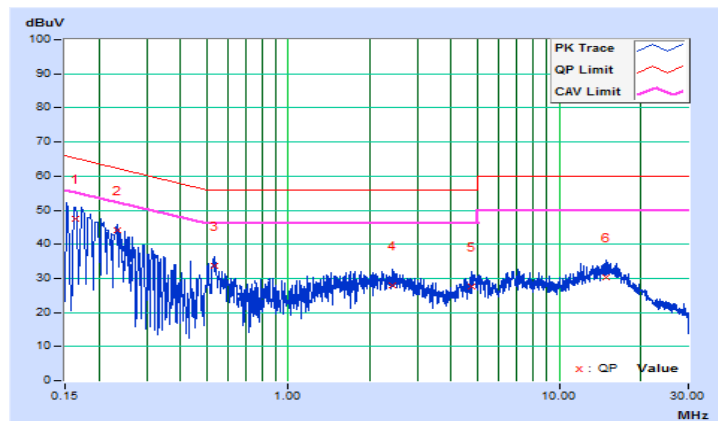

4.3 Transmit Power Measurement

4.3.1 Limits of Transmit Power Measurement

Operation Band	EUT Category		LIMIT
U-NII-1		Outdoor Access Point	1 Watt (30 dBm) (Max. e.i.r.p \leq 125mW(21 dBm) at any elevation angle above 30 degrees as measured from the horizon)
		Fixed point-to-point Access Point	1 Watt (30 dBm)
		Indoor Access Point	1 Watt (30 dBm)
	√	Mobile and Portable client device	250mW (24 dBm)
U-NII-2A		√	250mW (24 dBm) or 11 dBm+10 log B*
U-NII-2C		√	250mW (24 dBm) or 11 dBm+10 log B*
U-NII-3		√	1 Watt (30 dBm)

*B is the 26 dB emission bandwidth in megahertz

4.3.2 Test Setup

For Power Output
 802.11a, 802.11n (HT20), 802.11n (HT40)

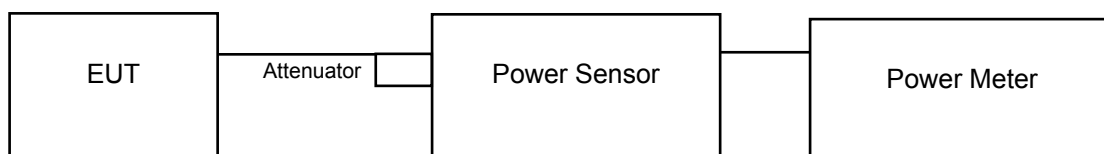

802.11ac (VHT80)

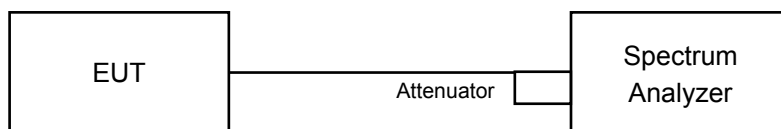

For 26dB and Occupied Bandwidth

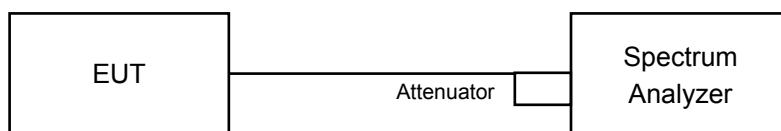

4.3.3 Test Instruments

Refer to section 4.1.2 to get information of above instrument.

4.3.4 Test Procedure

For Average Power Measurement

For 802.11a, 802.11n (HT20), 802.11n (HT40)

Method PM is used to perform output power measurement, trigger and gating function of wide band power meter is enabled to measure max output power of TX on burst and set the detector to AVERAGE. Duty factor is not added to measured value.

For 802.11ac (VHT80)

- 1) Set span to encompass the entire 26 dB EBW (or, alternatively, the entire 99% occupied bandwidth) of the signal.
- 2) Set sweep trigger to "free run".
- 3) Set RBW = 1 MHz.
- 4) Set VBW \geq 3 MHz
- 5) Number of points in sweep \geq 2 Span / RBW.
- 6) Sweep time \leq (number of points in sweep) * T
- 7) Using emission bandwidth to determine the frequency span for integration the channel bandwidth.
- 8) Detector = RMS.
- 9) Trace mode = max hold.
- 10) Allow max hold to run for at least 60 seconds, or longer as needed to allow the trace to stabilize.

For 26dB Bandwidth

- a. Set RBW = approximately 1% of the emission bandwidth.
- b. Set the VBW > RBW.
- c. Detector = Peak.
- d. Trace mode = max hold.
- e. Measure the maximum width of the emission that is 26 dB down from the peak of the emission. Compare this with the RBW setting of the analyzer. Readjust RBW and repeat measurement as needed until the RBW/EBW ratio is approximately 1%.

For Occupied Bandwidth

The transmitter output was connected to the spectrum analyzer through an attenuator. The bandwidth of the fundamental frequency was measured by spectrum analyzer with resolution bandwidth in the range of 1% to 5% of the anticipated emission bandwidth, and a video bandwidth at least 3x the resolution bandwidth and set the detector to Sampling. The width of a frequency band such that, below the lower and above the upper frequency limits, the mean powers emitted are each equal to a specified percentage 0.5 %of the total mean power of a given emission.

4.3.5 Deviation from Test Standard

No deviation.

4.3.6 EUT Operating Conditions

The software provided by client to enable the EUT under transmission condition continuously at lowest, middle and highest channel frequencies individually.

4.3.7 Test Result

Power Output:

802.11a

Chan.	Freq. (MHz)	Maximum Conducted Power (mW)	Maximum Conducted Power (dBm)	Power Limit (dBm)	Pass / Fail
36	5180	22.699	13.56	24.00	Pass
40	5200	22.491	13.52	24.00	Pass
48	5240	22.542	13.53	24.00	Pass
52	5260	22.699	13.56	24.00	Pass
60	5300	23.174	13.65	24.00	Pass
64	5320	22.439	13.51	24.00	Pass
100	5500	22.646	13.55	24.00	Pass
116	5580	22.699	13.56	24.00	Pass
140	5700	22.646	13.55	24.00	Pass
144	5720 For U-NII-2C	7.431	8.71	23.11	Pass
144	5720 For U-NII-3	2.494	3.97	30.00	Pass
149	5745	23.823	13.77	30.00	Pass
157	5785	22.646	13.55	30.00	Pass
165	5825	22.856	13.59	30.00	Pass

Note:

For U-NII-2A, U-NII-2C Band:

Chain 0

1. $11\text{dBm} + 10\log(23.14) = 24.64\text{ dBm} > 24\text{dBm}$
2. $11\text{dBm} + 10\log(22.21) = 24.47\text{ dBm} > 24\text{dBm}$
3. $11\text{dBm} + 10\log(22.82) = 24.58\text{ dBm} > 24\text{dBm}$
4. $11\text{dBm} + 10\log(22.41) = 24.50\text{ dBm} > 24\text{dBm}$
5. $11\text{dBm} + 10\log(22.79) = 24.58\text{ dBm} > 24\text{dBm}$
6. $11\text{dBm} + 10\log(22.79) = 24.58\text{ dBm} > 24\text{dBm}$
7. $11\text{dBm} + 10\log(5725.00 - 5708.74) = 23.11\text{ dBm} < 24\text{dBm}$.

802.11n (HT20)

Chan.	Freq. (MHz)	Maximum Conducted Power (mW)	Maximum Conducted Power (dBm)	Power Limit (dBm)	Pass / Fail
36	5180	17.906	12.53	24.00	Pass
40	5200	17.989	12.55	24.00	Pass
48	5240	17.824	12.51	24.00	Pass
52	5260	18.113	12.58	24.00	Pass
60	5300	17.865	12.52	24.00	Pass
64	5320	19.187	12.83	24.00	Pass
100	5500	17.783	12.50	24.00	Pass
116	5580	19.320	12.86	24.00	Pass
140	5700	18.621	12.70	24.00	Pass
144	5720 For U-NII-2C	7.846	8.95	23.23	Pass
144	5720 For U-NII-3	1.741	2.41	30.00	Pass
149	5745	18.323	12.63	30.00	Pass
157	5785	18.113	12.58	30.00	Pass
165	5825	17.824	12.51	30.00	Pass

Note:

For U-NII-2A, U-NII-2C Band:

1. $11\text{dBm} + 10\log(23.34) = 24.68\text{ dBm} > 24\text{dBm}$
2. $11\text{dBm} + 10\log(23.60) = 24.73\text{ dBm} > 24\text{dBm}$
3. $11\text{dBm} + 10\log(23.86) = 24.78\text{ dBm} > 24\text{dBm}$
4. $11\text{dBm} + 10\log(23.61) = 24.73\text{ dBm} > 24\text{dBm}$
5. $11\text{dBm} + 10\log(23.74) = 24.75\text{ dBm} > 24\text{dBm}$
6. $11\text{dBm} + 10\log(23.85) = 24.77\text{ dBm} > 24\text{dBm}$
7. $11\text{dBm} + 10\log(5725.00 - 5708.26) = 23.23\text{ dBm} < 24\text{dBm}$.

802.11n (HT40)

Chan.	Freq. (MHz)	Maximum Conducted Power (mW)	Maximum Conducted Power (dBm)	Power Limit (dBm)	Pass / Fail
38	5190	18.923	12.77	24.00	Pass
46	5230	18.75	12.73	24.00	Pass
54	5270	18.197	12.60	24.00	Pass
62	5310	18.493	12.67	24.00	Pass
102	5510	18.664	12.71	24.00	Pass
110	5550	18.493	12.67	24.00	Pass
134	5670	17.783	12.50	24.00	Pass
142	5710 For U-NII-2C	4.854	6.86	24.00	Pass
142	5710 For U-NII-3	0.4733	-3.25	30.00	Pass
151	5755	17.989	12.55	30.00	Pass
159	5795	19.275	12.85	30.00	Pass

Note:

For U-NII-2A, U-NII-2C Band:

1. $11\text{dBm} + 10\log(42.25) = 27.26\text{ dBm} > 24\text{dBm}$
2. $11\text{dBm} + 10\log(42.06) = 27.24\text{ dBm} > 24\text{dBm}$
3. $11\text{dBm} + 10\log(41.95) = 27.23\text{ dBm} > 24\text{dBm}$
4. $11\text{dBm} + 10\log(42.20) = 27.25\text{ dBm} > 24\text{dBm}$
5. $11\text{dBm} + 10\log(42.19) = 27.25\text{ dBm} > 24\text{dBm}$
6. $11\text{dBm} + 10\log(5725.00 - 5689.00) = 26.56\text{ dBm} > 24\text{dBm}$.

802.11ac (VHT80)

Chan.	Freq. (MHz)	Maximum Conducted Power (mW)	Maximum Conducted Power (dBm)	Power Limit (dBm)	Pass / Fail
42	5210	11.455	10.59	24.00	Pass
58	5290	11.220	10.50	24.00	Pass
106	5530	11.272	10.52	24.00	Pass
122	5610	11.246	10.51	24.00	Pass
138	5690 For U-NII-2C	2.964	4.72	24.00	Pass
138	5690 For U-NII-3	0.1964	-7.07	30.00	Pass
155	5775	12.274	10.89	30.00	Pass

Note:

Chain 0

1. $11\text{dBm} + 10\log(84.31) = 30.26\text{ dBm} > 24\text{dBm}$
2. $11\text{dBm} + 10\log(84.71) = 30.28\text{ dBm} > 24\text{dBm}$
3. $11\text{dBm} + 10\log(84.49) = 30.27\text{ dBm} > 24\text{dBm}$
4. $11\text{dBm} + 10\log(5725.00 - 5647.73) = 29.88\text{ dBm} > 24\text{dBm}$.

26dB Bandwidth:

802.11a

Chan.	Freq. (MHz)	26dBc Bandwidth (MHz)
36	5180	22.84
40	5200	23.06
48	5240	23.23
52	5260	23.14
60	5300	22.21
64	5320	22.82
100	5500	22.41
116	5580	22.79
140	5700	22.79
144	5720 For U-NII-2C	16.26

802.11n (HT20)

Chan.	Freq. (MHz)	26dBc Bandwidth (MHz)
36	5180	23.60
40	5200	23.36
48	5240	23.34
52	5260	23.34
60	5300	23.60
64	5320	23.86
100	5500	23.61
116	5580	23.74
140	5700	23.85
144	5720 For U-NII-2C	16.74

802.11n (HT40)

Chan.	Freq. (MHz)	26dBc Bandwidth (MHz)
38	5190	42.07
46	5230	42.27
54	5270	42.25
62	5310	42.06
102	5510	41.95
110	5550	42.20
134	5670	42.19
142	5710 For U-NII-2C	36.00

802.11ac (VHT80)

Chan.	Freq. (MHz)	26dBc Bandwidth (MHz)
42	5210	84.44
58	5290	84.31
106	5530	84.71
122	5610	84.49
138	5690 For U-NII-2C	77.27

Spectrum Plot of Worst Value

802.11a

802.11n (HT20)

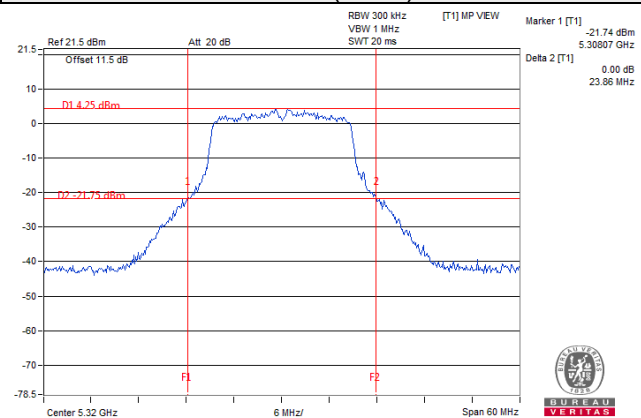
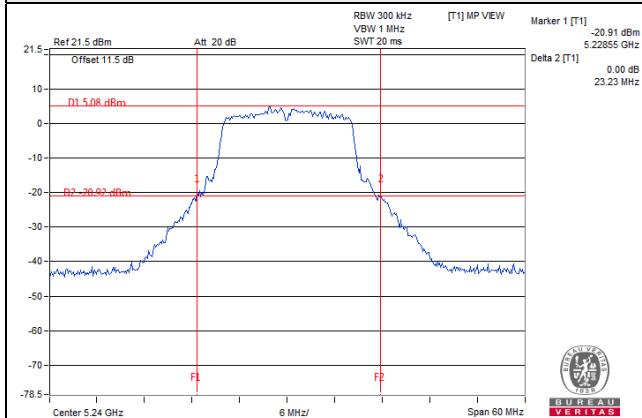

802.11n (HT40)

802.11ac (VHT80)

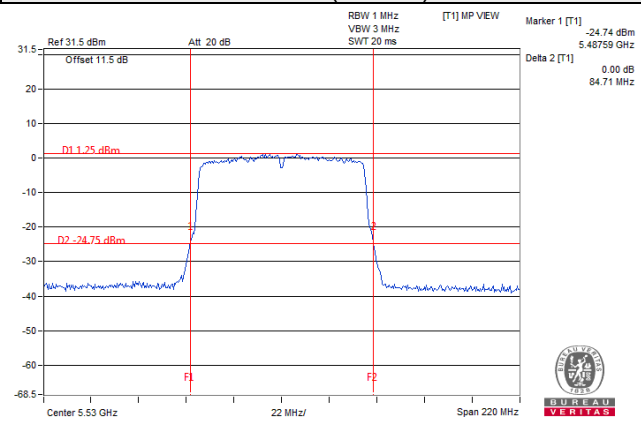
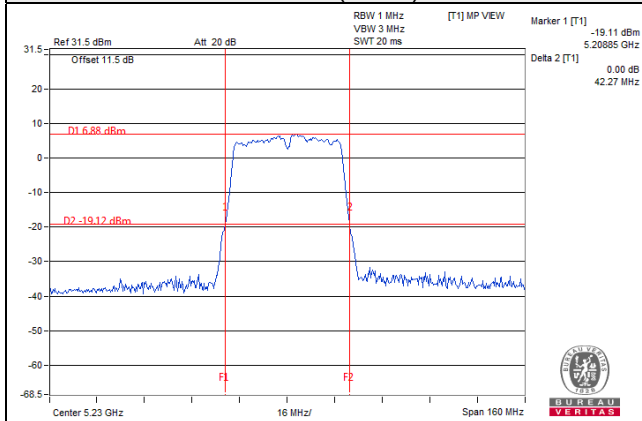

EUT Maximum Conducted Power

802.11a

Frequency Band (MHz)	Max. Power	
	Output Power (mW)	Output Power (dBm)
5250~5350	23.174	13.65
5470~5725	22.699	13.56

802.11n (HT20)

Frequency Band (MHz)	Max. Power	
	Output Power (mW)	Output Power (dBm)
5250~5350	19.187	12.83
5470~5725	19.320	12.86

802.11n (HT40)

Frequency Band (MHz)	Max. Power	
	Output Power (mW)	Output Power (dBm)
5250~5350	18.493	12.67
5470~5725	18.664	12.71

802.11ac (VHT80)

Frequency Band (MHz)	Max. Power	
	Output Power (mW)	Output Power (dBm)
5250~5350	11.220	10.50
5470~5725	11.272	10.52

4.4 Occupied Bandwidth Measurement

4.4.1 Test Setup

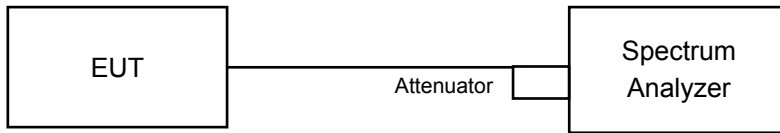

4.4.2 Test Instruments

Refer to section 4.1.2 to get information of above instrument.

4.4.3 Test Procedure

The transmitter output was connected to the spectrum analyzer through an attenuator. The bandwidth of the fundamental frequency was measured by spectrum analyzer with resolution bandwidth in the range of 1% to 5% of the anticipated emission bandwidth, and a video bandwidth at least 3x the resolution bandwidth and set the detector to sampling. The width of a frequency band such that, below the lower and above the upper frequency limits, the mean powers emitted are each equal to a specified percentage 0.5 %of the total mean power of a given emission.

4.4.4 Test Result

802.11a

Channel	Frequency (MHz)	Occupied Bandwidth (MHz)
36	5180	16.68
40	5200	16.80
48	5240	16.80
52	5260	16.68
60	5300	16.80
64	5320	16.68
100	5500	16.68
116	5580	16.68
140	5700	16.68
144	5720 For U-NII-2C	13.28
144	5720 For U-NII-3	3.16
149	5745	16.68
157	5785	16.68
165	5825	16.68

802.11n (HT20)

Channel	Frequency (MHz)	Occupied Bandwidth (MHz)
36	5180	17.88
40	5200	18.00
48	5240	17.76
52	5260	17.88
60	5300	18.00
64	5320	18.00
100	5500	17.88
116	5580	17.88
140	5700	17.88
144	5720 For U-NII-2C	13.88
144	5720 For U-NII-3	3.76
149	5745	17.88
157	5785	17.88
165	5825	17.88

802.11n (HT40)

Channel	Frequency (MHz)	Occupied Bandwidth (MHz)
38	5190	36.60
46	5230	36.60
54	5270	36.60
62	5310	36.60
102	5510	36.60
110	5550	36.60
134	5670	36.72
142	5710 For U-NII-2C	33.24
142	5710 For U-NII-3	3.36
151	5755	36.60
159	5795	36.72

802.11ac (VHT80)

Channel	Frequency (MHz)	Occupied Bandwidth (MHz)
42	5210	75.84
58	5290	75.84
106	5530	75.84
122	5610	75.84
138	5690 For U-NII-2C	72.92
138	5690 For U-NII-3	2.92
155	5775	75.84

Spectrum Plot of Worst Value

802.11a

802.11n (HT20)

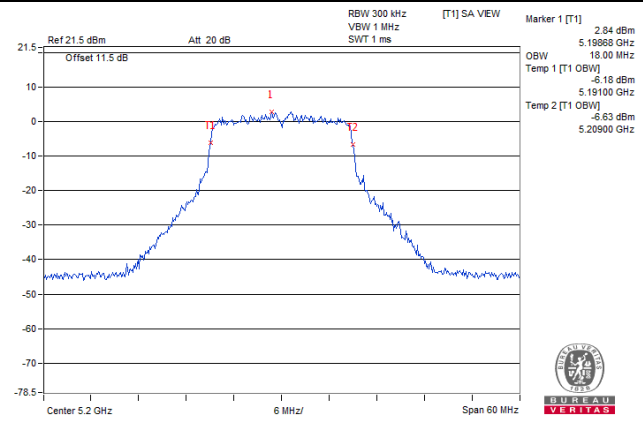
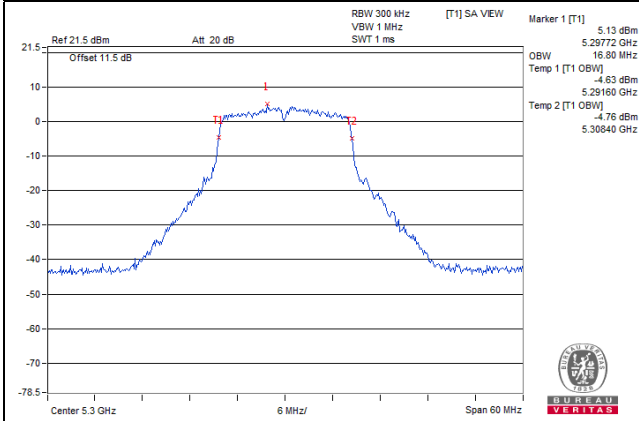

802.11n (HT40)

802.11ac (VHT80)

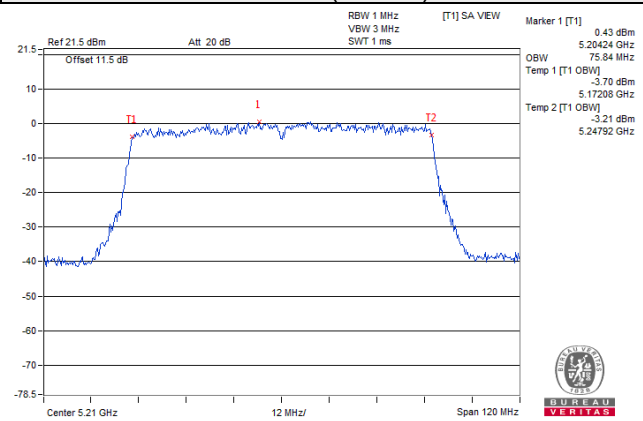
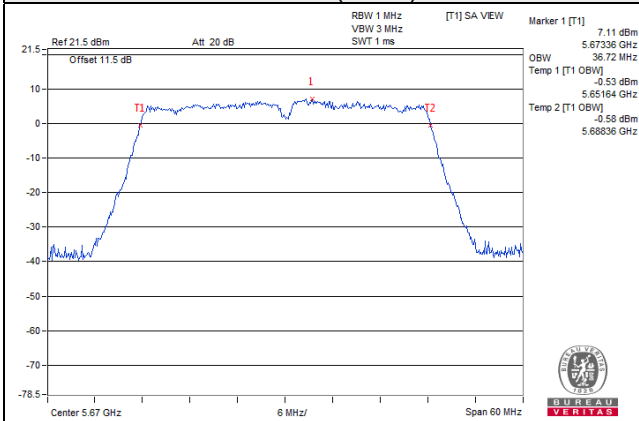

4.5 Peak Power Spectral Density Measurement

4.5.1 Limits of Peak Power Spectral Density Measurement

Operation Band	EUT Category		LIMIT
U-NII-1		Outdoor Access Point	17dBm/ MHz
		Fixed point-to-point Access Point	
		Indoor Access Point	
	√	Mobile and Portable client device	11dBm/ MHz
U-NII-2A		√	11dBm/ MHz
U-NII-2C		√	11dBm/ MHz
U-NII-3		√	30dBm/ 500kHz

4.5.2 Test Setup

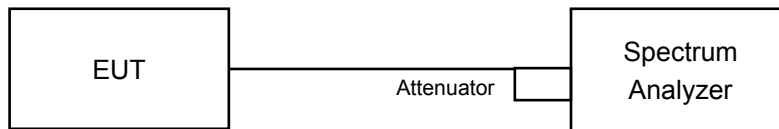

4.5.3 Test Instruments

Refer to section 4.1.2 to get information of above instrument.

4.5.4 Test Procedures

For U-NII-1, U-NII-2A, U-NII-2C band:

Duty cycle of test signal is < 98%

Using method SA-2

- 1) Set span to encompass the entire emission bandwidth (EBW) of the signal.
- 2) Set RBW = 1MHz, Set VBW \geq 3 MHz, Detector = RMS
- 3) Set Channel power measure = 1MHz
- 4) Sweep time = auto, trigger set to "free run".
- 5) Trace average at least 100 traces in power averaging mode.
- 6) Record the max value and add $10 \log (1/\text{duty cycle})$

For U-NII-3 band:

Duty cycle of test signal is < 98%

- 1) Set span to encompass the entire emission bandwidth (EBW) of the signal.
- 2) Set RBW = 300 kHz, Set VBW \geq 1 MHz, Detector = RMS
- 3) Use the peak marker function to determine the maximum power level in any 300 kHz band segment within the fundamental EBW.
- 4) Scale the observed power level to an equivalent value in 500 kHz by adjusting (reducing) the measured power by a bandwidth correction factor (BWCF) where $BWCF = 10\log(500 \text{ kHz} / 300 \text{ kHz})$
- 5) Sweep time = auto, trigger set to "free run".
- 6) Trace average at least 100 traces in power averaging mode.
- 7) Record the max value and add $10 \log (1/\text{duty cycle})$

4.5.5 Deviation from Test Standard

No deviation.

4.5.6 EUT Operating Conditions

Same as 4.3.6.

4.5.7 Test Results

For U-NII-1, U-NII-2A, U-NII-2C band

802.11a

Chan.	Freq. (MHz)	PSD w/o Duty Factor (dBm/MHz)	Duty Factor (dB)	PSD With Duty Factor (dBm/MHz)	MAX. Limit (dBm/MHz)	Pass / Fail
36	5180	0.30	0.29	0.59	11	Pass
40	5200	0.17	0.29	0.46	11	Pass
48	5240	0.21	0.29	0.50	11	Pass
52	5260	0.38	0.29	0.67	11	Pass
60	5300	0.36	0.29	0.65	11	Pass
64	5320	1.02	0.29	1.31	11	Pass
100	5500	0.09	0.29	0.38	11	Pass
116	5580	-0.15	0.29	0.14	11	Pass
140	5700	0.97	0.29	1.26	11	Pass
144	5720 For U-NII-2C	0.48	0.29	0.77	11	Pass

Note: Refer to section 3.3 for duty cycle spectrum plot.

802.11n (HT20)

Chan.	Freq. (MHz)	PSD w/o Duty Factor (dBm/MHz)	Duty Factor (dB)	PSD With Duty Factor (dBm/MHz)	MAX. Limit (dBm/MHz)	Pass / Fail
36	5180	-1.31	0.31	-1.00	11	Pass
40	5200	-1.25	0.31	-0.94	11	Pass
48	5240	-1.20	0.31	-0.89	11	Pass
52	5260	-1.29	0.31	-0.98	11	Pass
60	5300	-1.23	0.31	-0.92	11	Pass
64	5320	-0.57	0.31	-0.26	11	Pass
100	5500	-1.43	0.31	-1.12	11	Pass
116	5580	-1.59	0.31	-1.28	11	Pass
140	5700	-0.69	0.31	-0.38	11	Pass
144	5720 For U-NII-2C	-0.09	0.31	0.22	11	Pass

Note: Refer to section 3.3 for duty cycle spectrum plot.

802.11n (HT40)

Chan.	Freq. (MHz)	PSD w/o Duty Factor (dBm/MHz)	Duty Factor (dB)	PSD With Duty Factor (dBm/MHz)	MAX. Limit (dBm/MHz)	Pass / Fail
38	5190	-4.08	0.51	-3.57	11	Pass
46	5230	-4.06	0.51	-3.55	11	Pass
54	5270	-4.06	0.51	-3.55	11	Pass
62	5310	-4.04	0.51	-3.53	11	Pass
102	5510	-4.27	0.51	-3.76	11	Pass
110	5550	-4.37	0.51	-3.86	11	Pass
134	5670	-3.44	0.51	-2.93	11	Pass
142	5710 For U-NII-2C	-3.86	0.51	-3.35	11	Pass

Note: Refer to section 3.3 for duty cycle spectrum plot.

802.11ac (VHT80)

Chan.	Freq. (MHz)	PSD w/o Duty Factor (dBm/MHz)	Duty Factor (dB)	PSD With Duty Factor (dBm/MHz)	MAX. Limit (dBm/MHz)	Pass / Fail
42	5210	-9.62	0.89	-8.73	11	Pass
58	5290	-9.55	0.89	-8.66	11	Pass
106	5530	-9.79	0.89	-8.90	11	Pass
122	5610	-9.78	0.89	-8.89	11	Pass
138	5690 For U-NII-2C	-7.42	0.89	-6.53	11	Pass

Note: Refer to section 3.3 for duty cycle spectrum plot.

Spectrum Plot of Worst Value

802.11a / CH 64

802.11n (HT20) / CH 144

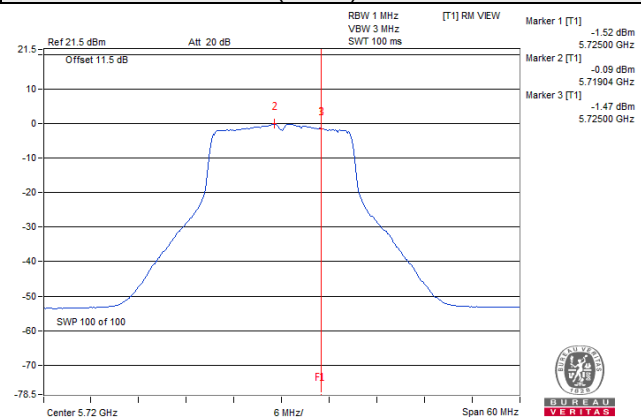
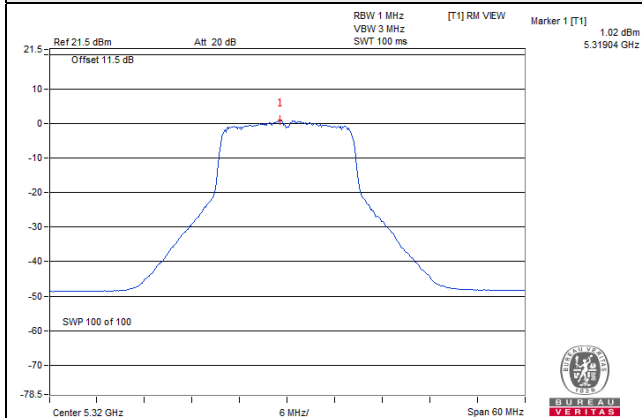

802.11n (HT40) / CH 134

802.11ac (VHT80) / CH 138

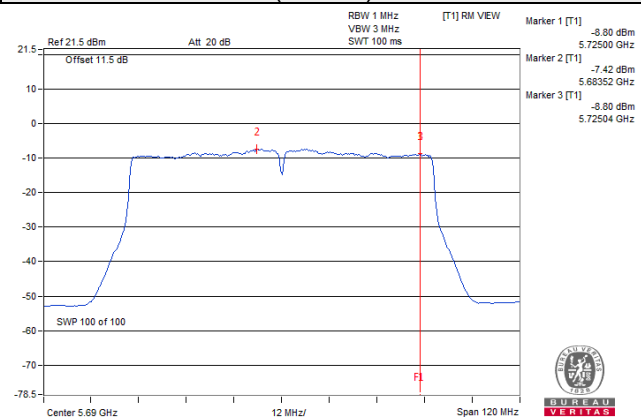
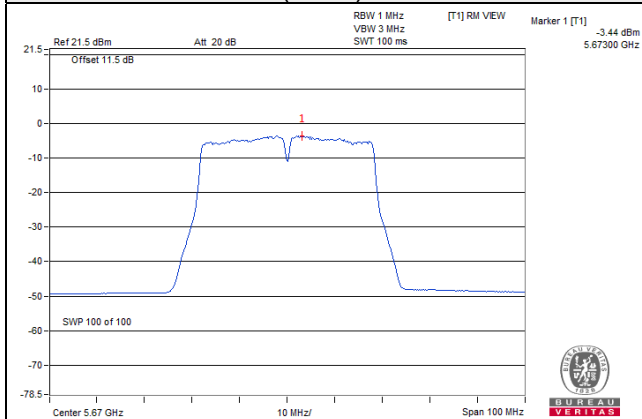

For U-NII-3 band:

802.11a

Chan.	Freq. (MHz)	PSD w/o Duty Factor		Duty Factor (dB)	PSD with Duty Factor (dBm/500kHz)	Limit (dBm/500kHz)	Pass / Fail
		(dBm/300kHz)	(dBm/500kHz)				
144	5720 (For U-NII-3)	-9.42	-7.20	0.29	-6.91	30	Pass
149	5745	-7.46	-5.24	0.29	-4.95	30	Pass
157	5785	-7.88	-5.66	0.29	-5.37	30	Pass
165	5825	-7.96	-5.74	0.29	-5.45	30	Pass

Note: Refer to section 3.3 for duty cycle spectrum plot.

802.11n (HT20)

Chan.	Freq. (MHz)	PSD w/o Duty Factor		Duty Factor (dB)	PSD with Duty Factor (dBm/500kHz)	Limit (dBm/500kHz)	Pass / Fail
		(dBm/300kHz)	(dBm/500kHz)				
144	5720 (For U-NII-3)	-10.08	-7.86	0.31	-7.55	30	Pass
149	5745	-9.20	-6.98	0.31	-6.67	30	Pass
157	5785	-9.43	-7.21	0.31	-6.90	30	Pass
165	5825	-9.58	-7.36	0.31	-7.05	30	Pass

Note: Refer to section 3.3 for duty cycle spectrum plot.

802.11n (HT40)

Chan.	Freq. (MHz)	PSD w/o Duty Factor		Duty Factor (dB)	PSD with Duty Factor (dBm/500kHz)	Limit (dBm/500kHz)	Pass / Fail
		(dBm/300kHz)	(dBm/500kHz)				
142	5710 (For U-NII-3)	-14.12	-11.90	0.51	-11.39	30	Pass
151	5755	-12.50	-10.28	0.51	-9.77	30	Pass
159	5795	-12.78	-10.56	0.51	-10.05	30	Pass

Note: Refer to section 3.3 for duty cycle spectrum plot.

802.11ac (VHT80)

Chan.	Freq. (MHz)	PSD w/o Duty Factor		Duty Factor (dB)	PSD with Duty Factor (dBm/500kHz)	Limit (dBm/500kHz)	Pass / Fail
		(dBm/300kHz)	(dBm/500kHz)				
138	5690 (For U-NII-3)	-17.41	-15.19	0.89	-14.30	30	Pass
155	5775	-18.05	-15.83	0.89	-14.94	30	Pass

Note: Refer to section 3.3 for duty cycle spectrum plot.

Spectrum Plot of Worst Value

802.11a

802.11n (HT20)

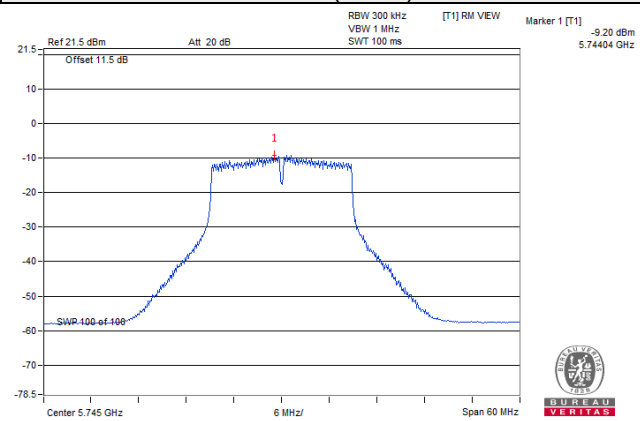
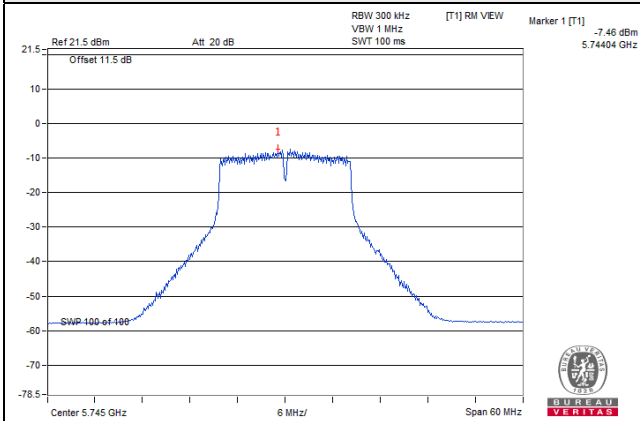

802.11n (HT40)

802.11ac (VHT80)

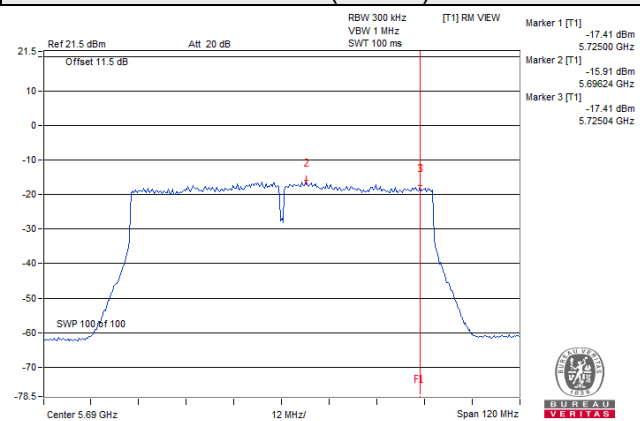
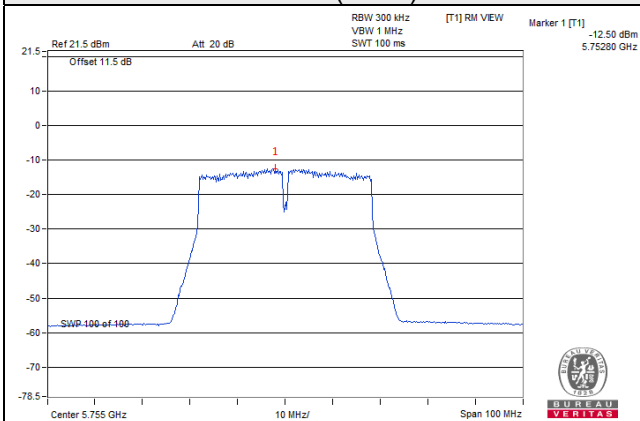

4.6 Frequency Stability

4.6.1 Limits of Frequency Stability Measurement

The frequency of the carrier signal shall be maintained within band of operation

4.6.2 Test Setup

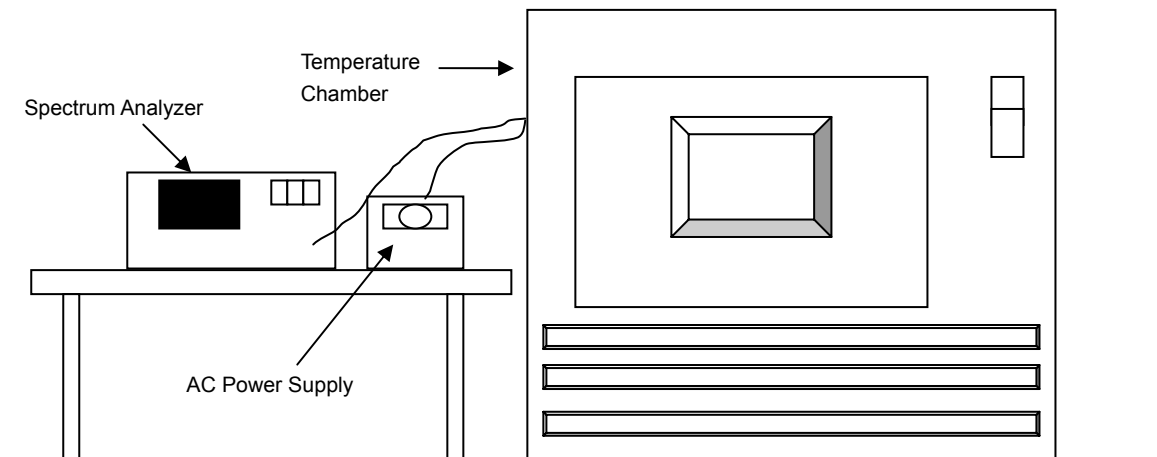

4.6.3 Test Instruments

Description & Manufacturer	Model No.	Serial No.	Cal. Date	Cal. Due
Spectrum Analyzer ROHDE & SCHWARZ	FSP40	100040	Aug. 18, 2017	Aug. 17, 2018
WIT Standard Temperature And Humidity Chamber	TH-4S-C	W981030	Jun. 04, 2018	Jun. 03, 2019
Digital Multimeter Fluke	87-III	70360742	Jun. 29, 2018	Jun. 28, 2019
AC Power Supply Exttech	CFW-105	E000603	NA	NA

4.6.4 Test Procedure

- The EUT was placed inside the environmental test chamber and powered by nominal AC voltage.
- Turn the EUT on and couple its output to a spectrum analyzer.
- Turn the EUT off and set the chamber to the highest temperature specified.
- Allow sufficient time (approximately 30 min) for the temperature of the chamber to stabilize, turn the EUT on and measure the operating frequency after 2, 5, and 10 minutes.
- Repeat step 2 and 3 with the temperature chamber set to the lowest temperature.
- The test chamber was allowed to stabilize at +20 degree C for a minimum of 30 minutes. The supply voltage was then adjusted on the EUT from 85% to 115% and the frequency record.

4.6.5 Deviation from Test Standard

No deviation.

4.6.6 EUT Operating Condition

Set the EUT transmit at un-modulation mode to test frequency stability.

4.6.7 Test Results

Frequency Stability Versus Temp.									
Operating Frequency: 5180MHz									
Temp. (°C)	Power Supply (Vac)	0 Minute		2 Minute		5 Minute		10 Minute	
		Measured Frequency (MHz)	Result	Measured Frequency (MHz)	Result	Measured Frequency (MHz)	Result	Measured Frequency (MHz)	Result
55	120	5179.9838	PASS	5179.9842	PASS	5179.9833	PASS	5179.9836	PASS
50	120	5180.005	PASS	5180.0057	PASS	5180.0075	PASS	5180.0061	PASS
40	120	5179.9791	PASS	5179.9805	PASS	5179.9813	PASS	5179.9806	PASS
30	120	5180.0055	PASS	5180.0037	PASS	5180.0059	PASS	5180.0058	PASS
20	120	5180.0197	PASS	5180.0211	PASS	5180.02	PASS	5180.0179	PASS
10	120	5179.9955	PASS	5179.9965	PASS	5179.9994	PASS	5179.9987	PASS
0	120	5180.0094	PASS	5180.0093	PASS	5180.0064	PASS	5180.0102	PASS
-10	120	5180.0229	PASS	5180.0235	PASS	5180.022	PASS	5180.0227	PASS

Frequency Stability Versus Voltage									
Operating Frequency: 5180MHz									
Temp. (°C)	Power Supply (Vac)	0 Minute		2 Minute		5 Minute		10 Minute	
		Measured Frequency (MHz)	Result	Measured Frequency (MHz)	Result	Measured Frequency (MHz)	Result	Measured Frequency (MHz)	Result
20	138	5180.0189	PASS	5180.0214	PASS	5180.0202	PASS	5180.018	PASS
	120	5180.0197	PASS	5180.0211	PASS	5180.02	PASS	5180.0179	PASS
	102	5180.0207	PASS	5180.0205	PASS	5180.0197	PASS	5180.0185	PASS

4.7 6dB Bandwidth Measurement

4.7.1 Limits of 6dB Bandwidth Measurement

The minimum of 6dB Bandwidth Measurement is 0.5MHz.

4.7.2 Test Setup

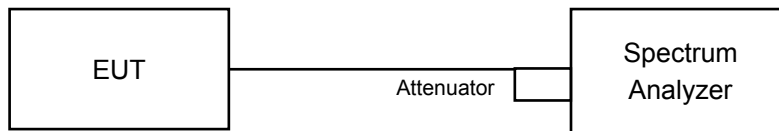

4.7.3 Test Instruments

Refer to section 4.1.2 to get information of above instrument.

4.7.4 Test Procedure

Measurement Procedure REF

- Set resolution bandwidth (RBW) = 100kHz
- Set the video bandwidth (VBW) $\geq 3 \times$ RBW, Detector = Peak.
- Trace mode = max hold.
- Sweep = auto couple.
- Measure the maximum width of the emission that is constrained by the frequencies associated with the two amplitude points (upper and lower) that are attenuated by 6 dB relative to the maximum level measured in the fundamental emission

4.7.5 Deviation from Test Standard

No deviation.

4.7.6 EUT Operating Condition

The software provided by client to enable the EUT under transmission condition continuously at lowest, middle and highest channel frequencies individually.

4.7.7 Test Results

802.11a

Channel	Frequency (MHz)	6dB Bandwidth (MHz)	Minimum Limit (MHz)	Pass / Fail
144 (For U-NII-3)	5720	2.78	0.5	Pass
149	5745	15.58	0.5	Pass
157	5785	15.58	0.5	Pass
165	5825	15.58	0.5	Pass

802.11n (HT20)

Channel	Frequency (MHz)	6dB Bandwidth (MHz)	Minimum Limit (MHz)	Pass / Fail
144 (For U-NII-3)	5720	2.58	0.5	Pass
149	5745	16.18	0.5	Pass
157	5785	15.21	0.5	Pass
165	5825	15.49	0.5	Pass

802.11n (HT40)

Channel	Frequency (MHz)	6dB Bandwidth (MHz)	Minimum Limit (MHz)	Pass / Fail
142 (For U-NII-3)	5710	2.67	0.5	Pass
151	5755	35.31	0.5	Pass
159	5795	35.52	0.5	Pass

802.11ac (VHT80)

Channel	Frequency (MHz)	6dB Bandwidth (MHz)	Minimum Limit (MHz)	Pass / Fail
138 (For U-NII-3)	5690	2.74	0.5	Pass
155	5775	75.48	0.5	Pass

Spectrum Plot of Worst Value

802.11a

802.11n (HT20)

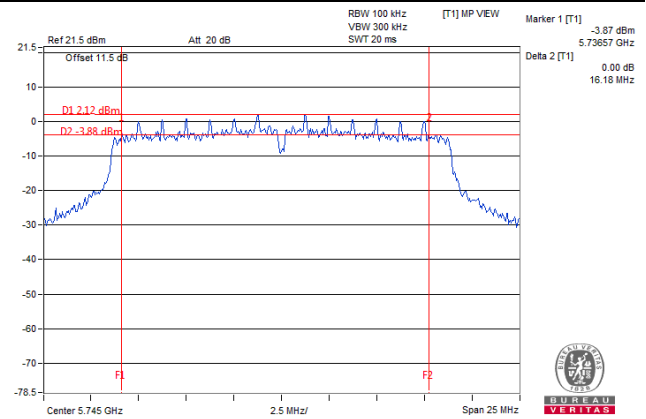
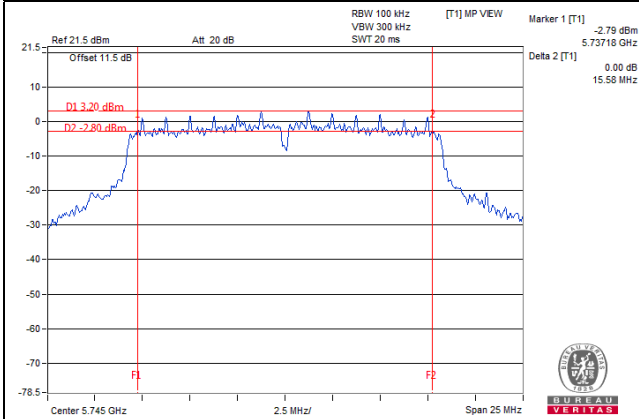

802.11n (HT40)

802.11ac (VHT80)

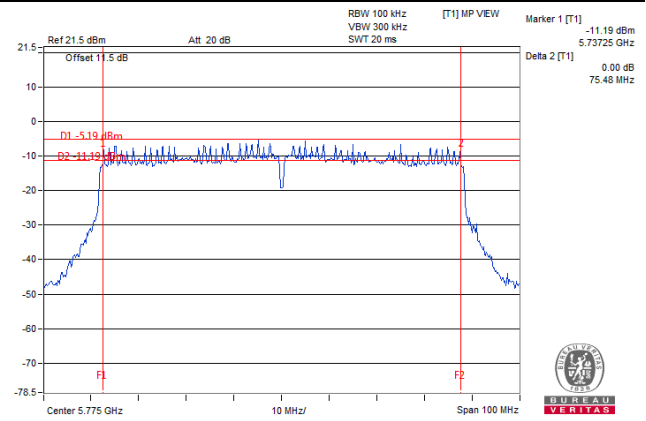
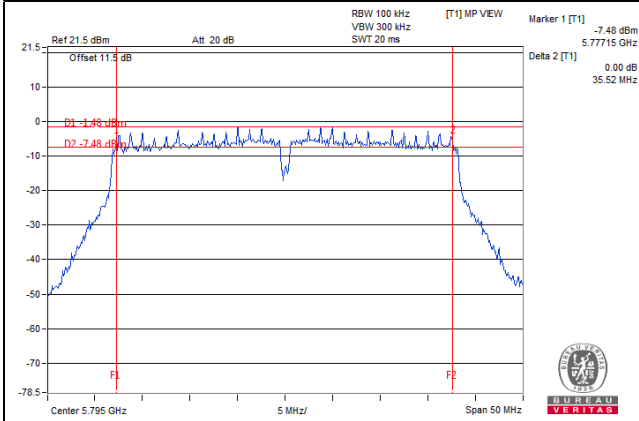

5 Pictures of Test Arrangements

Please refer to the attached file (Test Setup Photo).

Annex A- Radiated Out of Band Emission (OOBE) Measurement (For U-NII-3 band)

802.11a

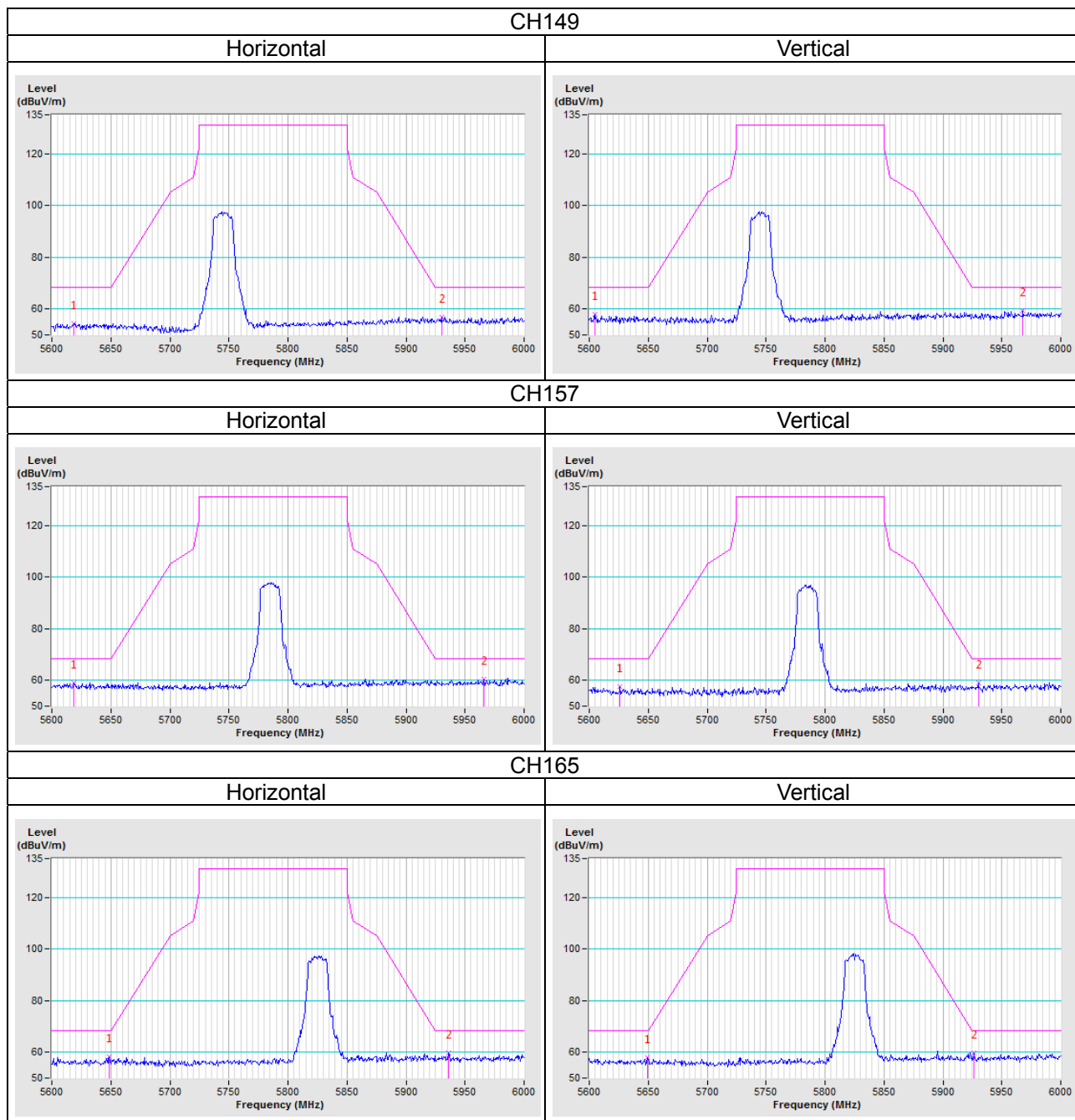

802.11n (HT20)

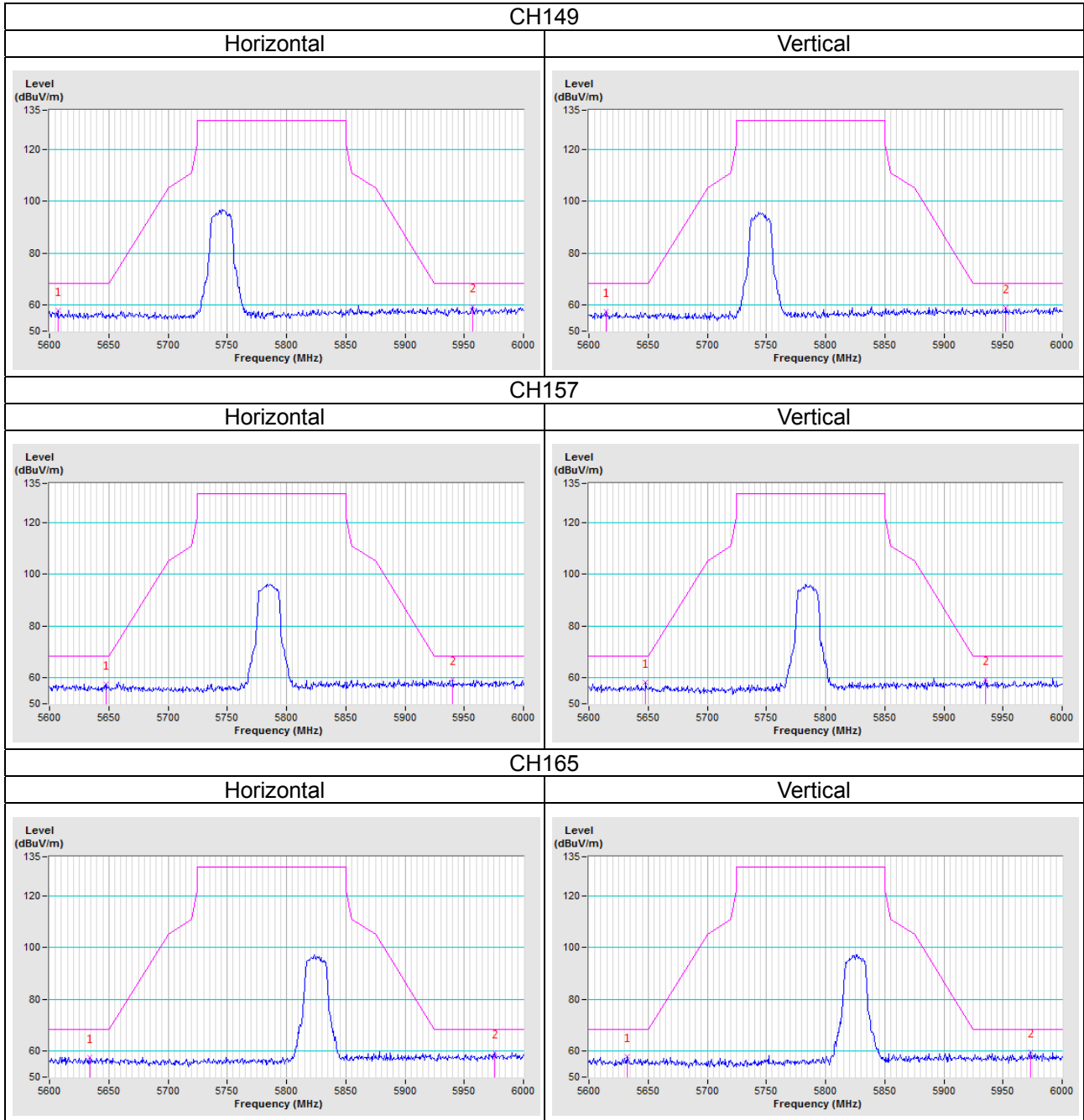

802.11n (HT40)

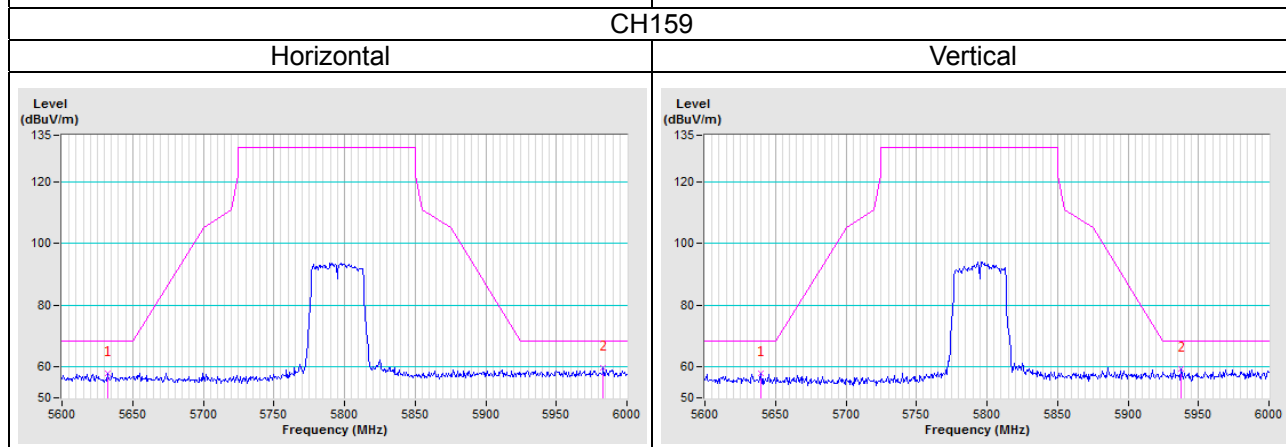
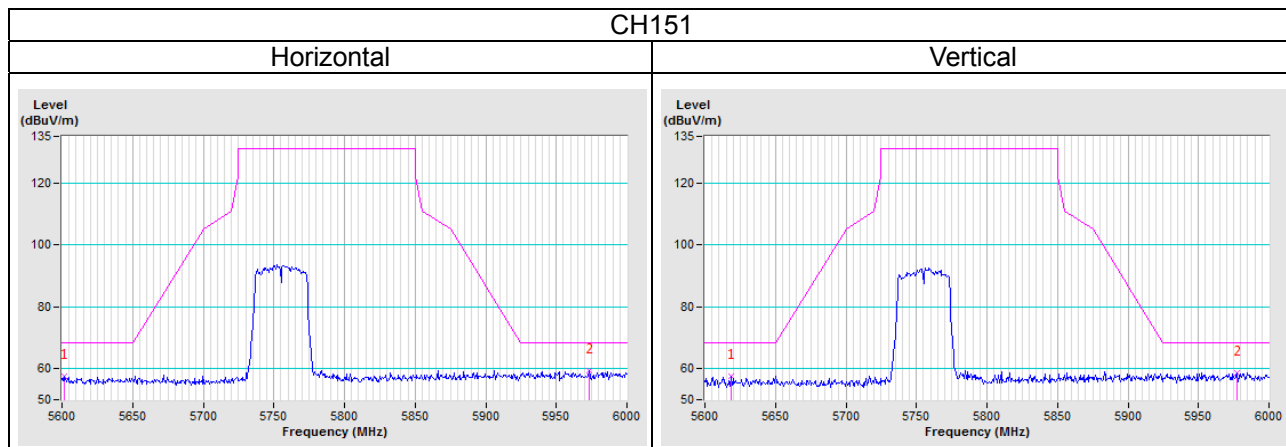

802.11ac (VHT80)

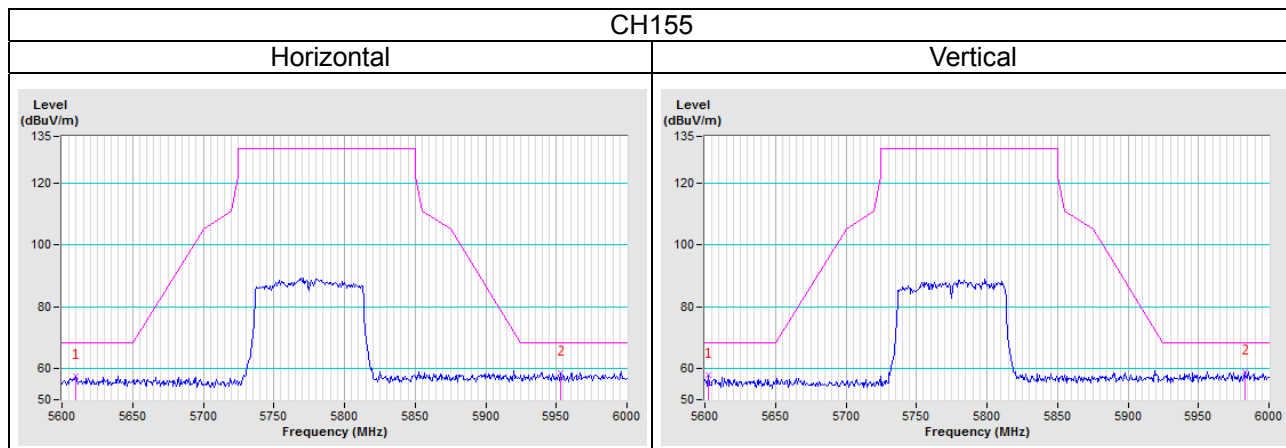

Appendix – Information on the Testing Laboratories

We, Bureau Veritas Consumer Products Services (H.K.) Ltd., Taoyuan Branch, were founded in 1988 to provide our best service in EMC, Radio, Telecom and Safety consultation. Our laboratories are accredited and approved according to ISO/IEC 17025.

If you have any comments, please feel free to contact us at the following:

Linko EMC/RF Lab

Tel: 886-2-26052180

Fax: 886-2-26051924

Hsin Chu EMC/RF/Telecom Lab

Tel: 886-3-6668565

Fax: 886-3-6668323

Hwa Ya EMC/RF/Safety

Tel: 886-3-3183232

Fax: 886-3-3270892

Email: service.adt@tw.bureauveritas.com

Web Site: www.bureauveritas-adt.com

The address and road map of all our labs can be found in our web site also.

--- END ---