

FCC Test Report (Part 22)

Report No.: RF180523C10 R1

FCC ID: 2AJOTTA-1082

Test Model: TA-1082

Received Date: May 23, 2018

Test Date: Jun. 20 ~ Jun. 29, 2018

Issued Date: Oct. 24, 2018

Applicant: HMD Global Oy

Address: Bertel Jungin aukio 9, 02600 Espoo, Finland

Issued By: Bureau Veritas Consumer Products Services (H.K.) Ltd., Taoyuan Branch

Lab Address: No. 47-2, 14th Ling, Chia Pau Vil., Lin Kou Dist., New Taipei City, Taiwan (R.O.C.)

Test Location: No. 19, Hwa Ya 2nd Rd., Wen Hwa Vil., Kwei Shan Dist., Taoyuan City 33383, TAIWAN (R.O.C.)



This report is for your exclusive use. Any copying or replication of this report to or for any other person or entity, or use of our name or trademark, is permitted only with our prior written permission. This report sets forth our findings solely with respect to the test samples identified herein. The results set forth in this report are not indicative or representative of the quality or characteristics of the lot from which a test sample was taken or any similar or identical product unless specifically and expressly noted. Our report includes all of the tests requested by you and the results thereof based upon the information that you provided to us. You have 60 days from date of issuance of this report to notify us of any material error or omission caused by our negligence, provided, however, that such notice shall be in writing and shall specifically address the issue you wish to raise. A failure to raise such issue within the prescribed time shall constitute your unqualified acceptance of the completeness of this report, the tests conducted and the correctness of the report contents. Unless specifically mentioned, the uncertainty of measurement has been explicitly taken into account to declare the compliance or non-compliance to the specification. The report must not be used by the client to claim product certification, approval, or endorsement by TAF or any government agencies

Table of Contents

Release Control Record	3
1 Certificate of Conformity	4
2 Summary of Test Results	5
2.1 Measurement Uncertainty.....	5
2.2 Test Site and Instruments.....	6
3 General Information	7
3.1 General Description of EUT.....	7
3.2 Configuration of System under Test.....	8
3.2.1 Description of Support Units.....	8
3.3 Test Mode Applicability and Tested Channel Detail.....	9
3.4 EUT Operating Conditions.....	9
3.5 General Description of Applied Standards.....	9
4 Test Types and Results	10
4.1 Radiated Emission Measurement.....	10
4.1.1 Limits of Radiated Emission Measurement.....	10
4.1.2 Test Procedure.....	10
4.1.3 Deviation from Test Standard.....	10
4.1.4 Test Setup.....	11
4.1.5 Test Results.....	12
5 Pictures of Test Arrangements	13
Appendix – Information on the Testing Laboratories	14
Annex A – Test Report for TA-1087 (Dual SIM)	15

Release Control Record

Issue No.	Description	Date Issued
RF180523C10	Original release	Jul. 02, 2018
RF180523C10 R1	Revised applicant's address	Oct. 24, 2018

1 Certificate of Conformity

Product: Smart Phone
Brand: NOKIA
Test Model: TA-1082
Sample Status: Production Unit
Applicant: HMD Global Oy
Test Date: Jun. 20 ~ Jun. 29, 2018
Standards: FCC Part 22, Subpart H

This report is issued as a supplementary report to BV CPS report no.: RF180523C09. This report shall be used by combining with its original report.

Prepared by : Pettie Chen , **Date:** Oct. 24, 2018
Pettie Chen / Senior Specialist

Approved by : Bruce Chen , **Date:** Oct. 24, 2018
Bruce Chen / Project Engineer

2 Summary of Test Results

Applied Standard: FCC Part 22 & Part 2			
FCC Clause	Test Item	Result	Remarks
2.1046 22.913 (a)	Effective radiated power	N/A	Refer to Note
2.1047	Modulation characteristics	N/A	Refer to Note
---	Peak To Average Ratio	N/A	Refer to Note
2.1055 22.355	Frequency Stability	N/A	Refer to Note
2.1049	Occupied Bandwidth	N/A	Refer to Note
22.917	Band Edge Measurements	N/A	Refer to Note
2.1051 22.917	Conducted Spurious Emissions	N/A	Refer to Note
2.1053 22.917	Radiated Spurious Emissions	Pass	Meet the requirement of limit. Minimum passing margin is -32.9dB at 1672.80MHz.

Note: Only Radiated Spurious Emissions test had been performed for the addendum. Refer to original report for other test data.

2.1 Measurement Uncertainty

Where relevant, the following measurement uncertainty levels have been estimated for tests performed on the EUT as specified in CISPR 16-4-2:

Measurement	Frequency	Expanded Uncertainty (k=2) (\pm)
Radiated Emissions up to 1 GHz	30MHz ~ 200MHz	3.59 dB
	200MHz ~1000MHz	3.60 dB
Radiated Emissions above 1 GHz	1GHz ~ 18GHz	2.29 dB
	18GHz ~ 40GHz	2.29 dB

2.2 Test Site and Instruments

Description & Manufacturer	Model No.	Serial No.	Cal. Date	Cal. Due
Test Receiver KEYSIGHT	N9038A	MY55420137	Apr. 11, 2018	Apr. 10, 2019
Spectrum Analyzer ROHDE & SCHWARZ	FSP40	100269	May 29, 2018	May 28, 2019
BILOG Antenna SCHWARZBECK	VULB9168	9168-148	Dec. 11, 2017	Dec. 10, 2018
HORN Antenna SCHWARZBECK	BBHA 9120 D	9120D-1169	Dec. 12, 2017	Dec. 11, 2018
HORN Antenna SCHWARZBECK	BBHA 9170	BBHA9170241	Dec. 01, 2017	Nov. 30, 2018
Loop Antenna EMCI	EM-6879	269	Aug. 11, 2017	Aug. 10, 2018
Preamplifier Agilent (Below 1GHz)	8447D	2944A10638	Aug. 08, 2017	Aug. 07, 2018
Preamplifier Agilent (Above 1GHz)	8449B	3008A01638	Feb. 22, 2018	Feb. 21, 2019
RF signal cable HUBER+SUHNER&EMCI	SUCOFLEX 104 & EMC104-SM-SM8000	CABLE-CH9-02 (248780+171006)	Jan. 15, 2018	Jan. 14, 2019
RF signal cable HUBER+SUHNER	SUCOFLEX 104	CABLE-CH9-(250795/4)	Aug. 08, 2017	Aug. 07, 2018
RF signal cable Woken	8D-FB	Cable-CH9-01	Aug. 01, 2017	Jul. 31, 2018
Software BV ADT	ADT_Radiated_ V7.6.15.9.5	NA	NA	NA
Antenna Tower EMCO	2070/2080	512.835.4684	NA	NA
Turn Table EMCO	2087-2.03	NA	NA	NA
Antenna Tower & Turn BV ADT	AT100	AT93021705	NA	NA
Turn Table BV ADT	TT100	TT93021705	NA	NA
Turn Table Controller BV ADT	SC100	SC93021705	NA	NA
Boresight Antenna Fixture	FBA-01	FBA-SIP01	NA	NA
Turn Table Controller BV ADT	SC100	SC93021702	NA	NA
Temperature And Humidity Chamber TERCHY	HRM-120RF	931022	Nov. 20, 2017	Nov. 19, 2018
JFW 20dB attenuation	50HF-020-SMA	NA	NA	NA
Radio Communication Analyzer	MT8821C	6261786083	Dec. 21, 2017	Dec. 20, 2018

- Note: 1. The calibration interval of the above test instruments is 12 months and the calibrations are traceable to NML/ROC and NIST/USA.
2. The test was performed in HwaYa Chamber 9.
3. The FCC Designation Number is TW0003. The number will be varied with the Lab location and scope as attached.
4. The IC Site Registration No. is IC 7450F-9.

3 General Information

3.1 General Description of EUT

Product	SmartPhone			
Brand	NOKIA			
Test Model	TA-1082			
Sample Status	Production Unit			
Power Supply Rating	5.0 Vdc or 9 Vdc or 12 Vdc (adapter) 5.0 Vdc (host equipment) 3.85 Vdc (Li-ion battery)			
Modulation Type	GSM, GPRS: GMSK EDGE: 8PSK WCDMA: BPSK, QPSK HSDPA: BPSK HSUPA: QPSK LTE: QPSK, 16QAM, 64QAM			
Operating Frequency	GSM/GPRS/EDGE	824.2MHz ~ 848.8MHz		
	WCDMA	826.4MHz ~ 846.6MHz		
	LTE Band 5 (Channel Bandwidth 1.4MHz)	824.7MHz ~ 848.3MHz		
	LTE Band 5 (Channel Bandwidth 3MHz)	825.5MHz ~ 847.5MHz		
	LTE Band 5 (Channel Bandwidth 5MHz)	826.5MHz ~ 846.5MHz		
	LTE Band 5 (Channel Bandwidth 10MHz)	829.0MHz ~ 844.0MHz		
Max. ERP Power	GSM/GPRS	1148.154mW (30.6dBm)		
	EDGE	407.380mW (26.1dBm)		
	WCDMA	181.970mW (22.6dBm)		
		QPSK	16QAM	64QAM
	LTE Band 5 (Channel Bandwidth 1.4MHz)	162.181mW (22.1dBm)	131.826mW (21.2dBm)	125.893mW (21.0dBm)
	LTE Band 5 (Channel Bandwidth 3MHz)	169.824mW (22.3dBm)	131.826mW (21.2dBm)	117.490mW (20.7dBm)
	LTE Band 5 (Channel Bandwidth 5MHz)	169.824mW (22.3dBm)	131.826mW (21.2dBm)	114.815mW (20.6dBm)
	LTE Band 5 (Channel Bandwidth 10MHz)	165.959mW (22.2dBm)	134.896mW (21.3dBm)	128.825mW (21.1dBm)
Emission Designator	GSM/GPRS	260KGXW		
	EDGE	250KGXW		
	WCDMA	4M15F9W		
		QPSK	16QAM	64QAM
	LTE Band 5 (Channel Bandwidth 1.4MHz)	1M09G7D	1M09W7D	1M09W7D
	LTE Band 5 (Channel Bandwidth 3MHz)	2M68G7D	2M69W7D	2M68W7D
	LTE Band 5 (Channel Bandwidth 5MHz)	4M48G7D	4M48W7D	4M48W7D
	LTE Band 5 (Channel Bandwidth 10MHz)	8M96G7D	8M93W7D	8M93W7D
Antenna Connector	Main Ant.: Fixed Internal antenna with -4dBi gain Aux. Ant.: Fixed Internal antenna with -2.5dBi gain (Brand: TongDa Electrics, Model: MEAOP61010A)			
Antenna Connector	NA			
Accessory Device	Refer to Note as below			
Data Cable Supplied	Refer to Note as below			

Note:

1. This report is issued as a supplementary to BV CPS report no.: RF180523C09. The difference is listed as below. Only Effective radiated power & radiated emissions test was verified for this report.

Report No.	FCC ID	Model	Difference
RF180523C09	2AJOTTA-1087	TA-1087	Dual SIM
RF180523C10	2AJOTTA-1082	TA-1082	Single SIM

* The models have the same layout, circuit, and components, but different SIM tray.

2. The EUT's accessories list refers to Ext. Pho.

3.2 Configuration of System under Test

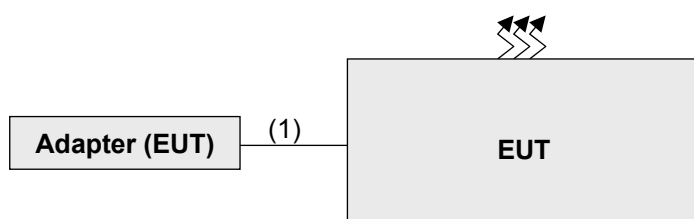

3.2.1 Description of Support Units

The EUT has been tested as an independent unit together with other necessary accessories or support units. The following support units or accessories were used to form a representative test configuration during the tests.

ID	Descriptions	Qty.	Length (m)	Shielding (Yes/No)	Cores (Qty.)	Remarks
1.	USB cable	1	1.0	N	0	Accessory Device

3.3 Test Mode Applicability and Tested Channel Detail

Pre-Scan has been conducted to determine the worst-case mode from all possible combinations between available modulations, data rates, XYZ axis and antenna ports. The worst case was found when positioned on Z-plane (For Radiated Emission Below 1GHz) and X-plane (For Radiated Emission Above 1GHz). Following channel(s) was (were) selected for the final test as listed below:

GSM Mode

EUT Configure Mode	Test Item	Available Channel	Tested Channel	Mode
-	Radiated Emission Below 1GHz	128 to 251	189(836.4MHz)	GSM
-	Radiated Emission Above 1GHz	128 to 251	189(836.4MHz)	GSM

Test Condition:

Test Item	Environmental Conditions	Input Power	Tested By
Radiated Emission	22deg. C, 66%RH	120Vac, 60Hz	Han Wu

3.4 EUT Operating Conditions

The EUT makes a call to the communication simulator. The communication simulator station system controlled a EUT to export maximum output power under transmission mode and specific channel frequency

3.5 General Description of Applied Standards

The EUT is a RF Product. According to the specifications of the manufacturer, it must comply with the requirements of the following standards:

FCC 47 CFR Part 2

FCC 47 CFR Part 22

KDB 971168 D01 Power Meas License Digital Systems v03r01

ANSI/TIA/EIA-603-E 2016

ANSI 63.26-2015

All test items have been performed and recorded as per the above standards.

4 Test Types and Results

4.1 Radiated Emission Measurement

4.1.1 Limits of Radiated Emission Measurement

The power of any emission outside of the authorized operating frequency ranges must be attenuated below the transmitting power (P) by a factor of at least $43 + 10 \log(P)$ dB. The emission limit equal to -13dBm .

4.1.2 Test Procedure

- a. Substitution method is used for E.I.R.P measurement. In the semi-anechoic chamber, EUT placed on the 0.8m height of Turn Table, rotated the table around 360 degrees to search the maximum radiation power and receiver antenna shall be rotated vertical and horizontal polarization and moved height from 1m to 4m to find the maximum polar radiated power. The "Read Value" is the spectrum reading the maximum power value.
- b. The substitution horn antenna is substituted for EUT at the same position and signals generator export the CW signal to the substitution antenna via a TX cable. Rotated the Turn Table and moved receiving antenna to find the maximum radiation power. Adjust output power level of S.G to get a Value of spectrum reading equal to "Read Value" of step a. Record the power level of S.G
- c. $\text{EIRP} = \text{Output power level of S.G} - \text{TX cable loss} + \text{Antenna gain of substitution horn}$.
- d. E.R.P power can be calculated form E.I.R.P power by subtracting the gain of dipole, $\text{E.R.P power} = \text{E.I.R.P power} - 2.15\text{dBi}$.

NOTE: The resolution bandwidth and video bandwidth of test receiver/spectrum analyzer is 1MHz/3MHz.

4.1.3 Deviation from Test Standard

No deviation.

4.1.4 Test Setup

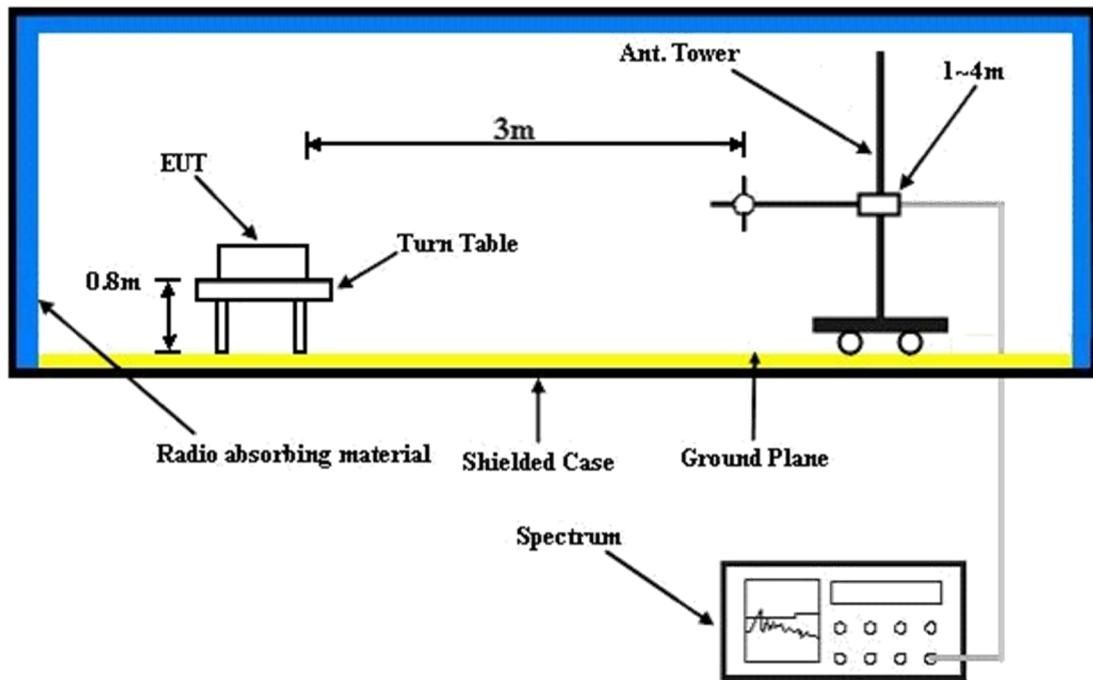

For the actual test configuration, please refer to the attached file (Test Setup Photo).

4.1.5 Test Results

Below 1GHz
GSM Mode

Mode	TX channel 189 (836.4MHz)	Frequency Range	Below 1000 MHz
Environmental Conditions	22deg. C, 66%RH	Input Power	120Vac, 60Hz
Tested By	Han Wu		

Antenna Polarity & Test Distance: Horizontal at 3 M							
No.	Freq. (MHz)	Reading (dBm)	S.G Power Value (dBm)	Correction Factor (dB)	ERP (dBm)	Limit (dBm)	Margin (dB)
1	37.76	-59.4	-43.6	-14.7	-58.3	-13.0	-45.3
2	45.52	-59.4	-50.4	-10.4	-60.8	-13.0	-47.8
3	88.20	-43.5	-53.0	-0.2	-53.2	-13.0	-40.2
4	109.54	-52.2	-59.7	-2.5	-62.2	-13.0	-49.2
5	165.80	-49.5	-55.3	-3.0	-58.3	-13.0	-45.3
6	327.79	-57.0	-67.2	4.2	-63.0	-13.0	-50.0
Antenna Polarity & Test Distance: Vertical at 3 M							
No.	Freq. (MHz)	Reading (dBm)	S.G Power Value (dBm)	Correction Factor (dB)	ERP (dBm)	Limit (dBm)	Margin (dB)
1	41.64	-43.5	-42.3	-12.3	-54.6	-13.0	-41.6
2	54.25	-52.7	-55.9	-5.7	-61.6	-13.0	-48.6
3	84.32	-45.2	-52.8	0.4	-52.4	-13.0	-39.4
4	158.04	-57.4	-59.7	-2.7	-62.4	-13.0	-49.4
5	303.54	-59.6	-65.3	3.7	-61.6	-13.0	-48.6
6	587.75	-60.7	-64.0	3.8	-60.2	-13.0	-47.2

Remarks:

- Output Power (dBm) = S.G Value (dBm) + Correction Factor (dB).
- Correction Factor (dB) = Substitution Antenna Gain (dB) + Cable Loss (dB).

Above 1GHz
GSM Mode

Mode	TX channel 189 (836.4MHz)	Frequency Range	Above 1000MHz
Environmental Conditions	22deg. C, 66%RH	Input Power	120Vac, 60Hz
Tested By	Han Wu		

Antenna Polarity & Test Distance: Horizontal at 3 M							
No.	Freq. (MHz)	Reading (dBm)	S.G Power Value (dBm)	Correction Factor (dB)	ERP (dBm)	Limit (dBm)	Margin (dB)
1	1672.80	-54.3	-46.7	0.8	-45.9	-13.0	-32.9
Antenna Polarity & Test Distance: Vertical at 3 M							
No.	Freq. (MHz)	Reading (dBm)	S.G Power Value (dBm)	Correction Factor (dB)	ERP (dBm)	Limit (dBm)	Margin (dB)
1	1672.80	-59.5	-52.2	0.8	-51.4	-13.0	-38.4

Remarks:

- Output Power (dBm) = S.G Value (dBm) + Correction Factor (dB).
- Correction Factor (dB) = Substitution Antenna Gain (dB) + Cable Loss (dB).

5 Pictures of Test Arrangements

Please refer to the attached file (Test Setup Photo).

Appendix – Information on the Testing Laboratories

We, Bureau Veritas Consumer Products Services (H.K.) Ltd., Taoyuan Branch, were founded in 1988 to provide our best service in EMC, Radio, Telecom and Safety consultation. Our laboratories are FCC recognized accredited test firms and accredited and approved according to ISO/IEC 17025.

If you have any comments, please feel free to contact us at the following:

Linko EMC/RF Lab

Tel: 886-2-26052180

Fax: 886-2-26051924

Hsin Chu EMC/RF/Telecom Lab

Tel: 886-3-6668565

Fax: 886-3-6668323

Hwa Ya EMC/RF/Safety Lab

Tel: 886-3-3183232

Fax: 886-3-3270892

Email: service.adt@tw.bureauveritas.com

Web Site: www.bureauveritas-adt.com

The address and road map of all our labs can be found in our web site also.

--- END ---

Annex A – Test Report for TA-1087 (Dual SIM)

FCC Test Report (Part 22)

Report No.: RF180523C09 R1

FCC ID: 2AJOTTA-1087

Test Model: TA-1087

Received Date: May 23, 2018

Test Date: Jun. 07 ~ Jun. 15, 2018

Issued Date: Oct. 24, 2018

Applicant: HMD Global Oy

Address: Bertel Jungin aukio 9, 02600 Espoo, Finland

Issued By: Bureau Veritas Consumer Products Services (H.K.) Ltd., Taoyuan Branch

Lab Address: No. 47-2, 14th Ling, Chia Pau Vil., Lin Kou Dist., New Taipei City, Taiwan (R.O.C.)

Test Location: No. 19, Hwa Ya 2nd Rd., Wen Hwa Vil., Kwei Shan Dist., Taoyuan City 33383, TAIWAN (R.O.C.)



This report is for your exclusive use. Any copying or replication of this report to or for any other person or entity, or use of our name or trademark, is permitted only with our prior written permission. This report sets forth our findings solely with respect to the test samples identified herein. The results set forth in this report are not indicative or representative of the quality or characteristics of the lot from which a test sample was taken or any similar or identical product unless specifically and expressly noted. Our report includes all of the tests requested by you and the results thereof based upon the information that you provided to us. You have 60 days from date of issuance of this report to notify us of any material error or omission caused by our negligence, provided, however, that such notice shall be in writing and shall specifically address the issue you wish to raise. A failure to raise such issue within the prescribed time shall constitute your unqualified acceptance of the completeness of this report, the tests conducted and the correctness of the report contents. Unless specifically mentioned, the uncertainty of measurement has been explicitly taken into account to declare the compliance or non-compliance to the specification. The report must not be used by the client to claim product certification, approval, or endorsement by TAF or any government agencies

Table of Contents

Release Control Record	4
1 Certificate of Conformity	5
2 Summary of Test Results	6
2.1 Measurement Uncertainty.....	6
2.2 Test Site and Instruments.....	7
3 General Information	8
3.1 General Description of EUT.....	8
3.2 Configuration of System under Test.....	9
3.2.1 Description of Support Units.....	9
3.3 Test Mode Applicability and Tested Channel Detail.....	10
3.4 EUT Operating Conditions.....	14
3.5 General Description of Applied Standards.....	14
4 Test Types and Results	15
4.1 Output Power Measurement.....	15
4.1.1 Limits of Output Power Measurement.....	15
4.1.2 Test Procedures.....	15
4.1.3 Test Setup.....	16
4.1.4 Test Results.....	17
4.2 Modulation Characteristics Measurement.....	37
4.2.1 Limits of Modulation Characteristics.....	37
4.2.2 Test Procedure.....	37
4.2.3 Test Setup.....	37
4.2.4 Test Results.....	38
4.3 Frequency Stability Measurement.....	40
4.3.1 Limits of Frequency Stability Measurement.....	40
4.3.2 Test Procedure.....	40
4.3.3 Test Setup.....	40
4.3.4 Test Results.....	41
4.4 Occupied Bandwidth Measurement.....	42
4.4.1 Test Procedure.....	42
4.4.2 Test Setup.....	42
4.4.3 Test Result.....	43
4.5 Band Edge Measurement.....	49
4.5.1 Limits of Band Edge Measurement.....	49
4.5.2 Test Setup.....	49
4.5.3 Test Procedures.....	49
4.5.4 Test Results.....	50
4.6 Peak to Average Ratio.....	55
4.6.1 Limits of Peak to Average Ratio Measurement.....	55
4.6.2 Test Setup.....	55
4.6.3 Test Procedures.....	55
4.6.4 Test Results.....	56
4.7 Conducted Spurious Emissions.....	59
4.7.1 Limits of Conducted Spurious Emissions Measurement.....	59
4.7.2 Test Setup.....	59
4.7.3 Test Procedure.....	59
4.7.4 Test Results.....	60
4.8 Radiated Emission Measurement.....	81
4.8.1 Limits of Radiated Emission Measurement.....	81
4.8.2 Test Procedure.....	81
4.8.3 Deviation from Test Standard.....	81
4.8.4 Test Setup.....	82
4.8.5 Test Results.....	83

5	Pictures of Test Arrangements.....	104
	Appendix – Information on the Testing Laboratories	105

Release Control Record

Issue No.	Description	Date Issued
RF180523C09	Original release	Jun. 20, 2018
RF180523C09 R1	Revised applicant's address	Oct. 24, 2018

1 Certificate of Conformity

Product: Smart Phone
Brand: NOKIA
Test Model: TA-1087
Sample Status: Production Unit
Applicant: HMD Global Oy
Test Date: Jun. 07 ~ Jun. 15, 2018
Standards: FCC Part 22, Subpart H

The above equipment has been tested by **Bureau Veritas Consumer Products Services (H.K.) Ltd., Taoyuan Branch**, and found compliance with the requirement of the above standards. The test record, data evaluation & Equipment Under Test (EUT) configurations represented herein are true and accurate accounts of the measurements of the sample's RF characteristics under the conditions specified in this report.

Prepared by : Pettie Chen , **Date:** Oct. 24, 2018
Pettie Chen / Senior Specialist

Approved by : Bruce Chen , **Date:** Oct. 24, 2018
Bruce Chen / Project Engineer

2 Summary of Test Results

Applied Standard: FCC Part 22 & Part 2			
FCC Clause	Test Item	Result	Remarks
2.1046 22.913 (a)	Effective radiated power	Pass	Meet the requirement of limit.
2.1047	Modulation characteristics	Pass	Meet the requirement
---	Peak To Average Ratio	Pass	Meet the requirement of limit.
2.1055 22.355	Frequency Stability	Pass	Meet the requirement of limit.
2.1049	Occupied Bandwidth	Pass	Meet the requirement of limit.
22.917	Band Edge Measurements	Pass	Meet the requirement of limit.
2.1051 22.917	Conducted Spurious Emissions	Pass	Meet the requirement of limit.
2.1053 22.917	Radiated Spurious Emissions	Pass	Meet the requirement of limit. Minimum passing margin is -32.5dB at 30.00MHz.

2.1 Measurement Uncertainty

Where relevant, the following measurement uncertainty levels have been estimated for tests performed on the EUT as specified in CISPR 16-4-2:

Measurement	Frequency	Expanded Uncertainty (k=2) (±)
Radiated Emissions up to 1 GHz	30MHz ~ 200MHz	3.59 dB
	200MHz ~1000MHz	3.60 dB
Radiated Emissions above 1 GHz	1GHz ~ 18GHz	2.29 dB
	18GHz ~ 40GHz	2.29 dB

2.2 Test Site and Instruments

Description & Manufacturer	Model No.	Serial No.	Cal. Date	Cal. Due
Test Receiver KEYSIGHT	N9038A	MY55420137	Apr. 11, 2018	Apr. 10, 2019
Spectrum Analyzer ROHDE & SCHWARZ	FSP40	100269	May 29, 2018	May 28, 2019
BILOG Antenna SCHWARZBECK	VULB9168	9168-148	Dec. 11, 2017	Dec. 10, 2018
HORN Antenna SCHWARZBECK	BBHA 9120 D	9120D-1169	Dec. 12, 2017	Dec. 11, 2018
HORN Antenna SCHWARZBECK	BBHA 9170	BBHA9170241	Dec. 01, 2017	Nov. 30, 2018
Loop Antenna EMCI	EM-6879	269	Aug. 11, 2017	Aug. 10, 2018
Preamplifier Agilent (Below 1GHz)	8447D	2944A10638	Aug. 08, 2017	Aug. 07, 2018
Preamplifier Agilent (Above 1GHz)	8449B	3008A01638	Feb. 22, 2018	Feb. 21, 2019
RF signal cable HUBER+SUHNER&EMCI	SUCOFLEX 104 & EMC104-SM-SM8000	CABLE-CH9-02 (248780+171006)	Jan. 15, 2018	Jan. 14, 2019
RF signal cable HUBER+SUHNER	SUCOFLEX 104	CABLE-CH9-(250795/4)	Aug. 08, 2017	Aug. 07, 2018
RF signal cable Woken	8D-FB	Cable-CH9-01	Aug. 01, 2017	Jul. 31, 2018
Software BV ADT	ADT_Radiated_ V7.6.15.9.5	NA	NA	NA
Antenna Tower EMCO	2070/2080	512.835.4684	NA	NA
Turn Table EMCO	2087-2.03	NA	NA	NA
Antenna Tower & Turn BV ADT	AT100	AT93021705	NA	NA
Turn Table BV ADT	TT100	TT93021705	NA	NA
Turn Table Controller BV ADT	SC100	SC93021705	NA	NA
Boresight Antenna Fixture	FBA-01	FBA-SIP01	NA	NA
Turn Table Controller BV ADT	SC100	SC93021702	NA	NA
Temperature And Humidity Chamber TERCHY	HRM-120RF	931022	Nov. 20, 2017	Nov. 19, 2018
JFW 20dB attenuation	50HF-020-SMA	NA	NA	NA
Radio Communication Analyzer	MT8821C	6261786083	Dec. 21, 2017	Dec. 20, 2018

- Note: 1. The calibration interval of the above test instruments is 12 months and the calibrations are traceable to NML/ROC and NIST/USA.
2. The test was performed in HwaYa Chamber 9.
3. The FCC Designation Number is TW0003. The number will be varied with the Lab location and scope as attached.
4. The IC Site Registration No. is IC 7450F-9.

3 General Information

3.1 General Description of EUT

Product	SmartPhone			
Brand	NOKIA			
Test Model	TA-1087			
Sample Status	Production Unit			
Power Supply Rating	5.0 Vdc or 9 Vdc or 12 Vdc (adapter) 5.0 Vdc (host equipment) 3.85 Vdc (Li-ion battery)			
Modulation Type	GSM, GPRS: GMSK EDGE: 8PSK WCDMA: BPSK, QPSK HSDPA: BPSK HSUPA: QPSK LTE: QPSK, 16QAM, 64QAM			
Operating Frequency	GSM/GPRS/EDGE	824.2MHz ~ 848.8MHz		
	WCDMA	826.4MHz ~ 846.6MHz		
	LTE Band 5 (Channel Bandwidth 1.4MHz)	824.7MHz ~ 848.3MHz		
	LTE Band 5 (Channel Bandwidth 3MHz)	825.5MHz ~ 847.5MHz		
	LTE Band 5 (Channel Bandwidth 5MHz)	826.5MHz ~ 846.5MHz		
	LTE Band 5 (Channel Bandwidth 10MHz)	829.0MHz ~ 844.0MHz		
Max. ERP Power	GSM/GPRS	1148.154mW (30.6dBm)		
	EDGE	407.380mW (26.1dBm)		
	WCDMA	181.970mW (22.6dBm)		
		QPSK	16QAM	64QAM
	LTE Band 5 (Channel Bandwidth 1.4MHz)	162.181mW (22.1dBm)	131.826mW (21.2dBm)	125.893mW (21.0dBm)
	LTE Band 5 (Channel Bandwidth 3MHz)	169.824mW (22.3dBm)	131.826mW (21.2dBm)	117.490mW (20.7dBm)
	LTE Band 5 (Channel Bandwidth 5MHz)	169.824mW (22.3dBm)	131.826mW (21.2dBm)	114.815mW (20.6dBm)
	LTE Band 5 (Channel Bandwidth 10MHz)	165.959mW (22.2dBm)	134.896mW (21.3dBm)	128.825mW (21.1dBm)
Emission Designator	GSM/GPRS	260KGXW		
	EDGE	250KGXW		
	WCDMA	4M15F9W		
		QPSK	16QAM	64QAM
	LTE Band 5 (Channel Bandwidth 1.4MHz)	1M09G7D	1M09W7D	1M09W7D
	LTE Band 5 (Channel Bandwidth 3MHz)	2M68G7D	2M69W7D	2M68W7D
	LTE Band 5 (Channel Bandwidth 5MHz)	4M48G7D	4M48W7D	4M48W7D
	LTE Band 5 (Channel Bandwidth 10MHz)	8M96G7D	8M93W7D	8M93W7D
Antenna Connector	Main Ant.: Fixed Internal antenna with -4dBi gain Aux. Ant.: Fixed Internal antenna with -2.5dBi gain (Brand: TongDa Electrics, Model: MEAOP61010A)			
Antenna Connector	NA			
Accessory Device	Refer to Note as below			
Data Cable Supplied	Refer to Note as below			

Note: The EUT's accessories list refers to Ext. Pho.

3.2 Configuration of System under Test

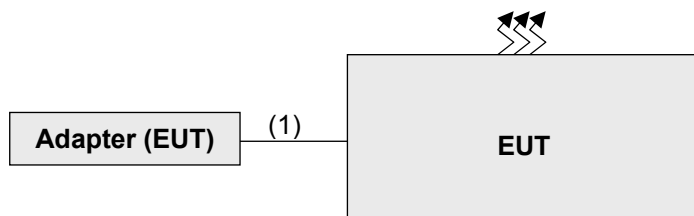

3.2.1 Description of Support Units

The EUT has been tested as an independent unit together with other necessary accessories or support units. The following support units or accessories were used to form a representative test configuration during the tests.

ID	Descriptions	Qty.	Length (m)	Shielding (Yes/No)	Cores (Qty.)	Remarks
1.	USB cable	1	1.0	N	0	Accessory Device

3.3 Test Mode Applicability and Tested Channel Detail

Pre-Scan has been conducted to determine the worst-case mode from all possible combinations between available modulations, data rates, XYZ axis and antenna ports. The worst case was found when positioned on Z-plane (For all tests except Radiated Emission Above 1GHz) and X-plane (For Radiated Emission Above 1GHz). Following channel(s) was (were) selected for the final test as listed below:

GSM Mode

EUT Configure Mode	Test Item	Available Channel	Tested Channel	Mode
-	ERP	128 to 251	128(824.2MHz), 189(836.4MHz), 251(848.8MHz)	GSM, EDGE
-	Modulation Characteristics	128 to 251	128(824.2MHz)	GSM, EDGE
-	Frequency Stability	128 to 251	189(836.4MHz)	GSM
-	Occupied Bandwidth	128 to 251	128(824.2MHz), 189(836.4MHz), 251(848.8MHz)	GSM, EDGE
-	Band Edge	128 to 251	128(824.2MHz), 251(848.8MHz)	GSM, EDGE
-	Peak To Average Ratio	128 to 251	128(824.2MHz), 189(836.4MHz), 251(848.8MHz)	GSM, EDGE
-	Conducted Emission	128 to 251	128(824.2MHz), 189(836.4MHz), 251(848.8MHz)	GSM, EDGE
-	Radiated Emission Below 1GHz	128 to 251	128(824.2MHz)	GSM, EDGE
-	Radiated Emission Above 1GHz	128 to 251	128(824.2MHz), 189(836.4MHz), 251(848.8MHz)	GSM, EDGE

WCDMA Mode

EUT Configure Mode	Test Item	Available Channel	Tested Channel	Mode
-	ERP	4132 to 4233	4132(826.4MHz), 4182(836.6MHz), 4233(846.6MHz)	WCDMA
-	Modulation Characteristics	4132 to 4233	4132(826.4MHz)	WCDMA
-	Frequency Stability	4132 to 4233	4182(836.6MHz)	WCDMA
-	Occupied Bandwidth	4132 to 4233	4132(826.4MHz), 4182(836.6MHz), 4233(846.6MHz)	WCDMA
-	Band Edge	4132 to 4233	4132(826.4MHz) 4233(846.6MHz)	WCDMA
-	Peak To Average Ratio	4132 to 4233	4132(826.4MHz), 4182(836.6MHz), 4233(846.6MHz)	WCDMA
-	Conducted Emission	4132 to 4233	4132(826.4MHz), 4182(836.6MHz), 4233(846.6MHz)	WCDMA
-	Radiated Emission Below 1GHz	4132 to 4233	4132(826.4MHz)	WCDMA
-	Radiated Emission Above 1GHz	4132 to 4233	4132(826.4MHz), 4182(836.6MHz), 4233(846.6MHz)	WCDMA

LTE Band 5

EUT Configure Mode	Test item	Available channel	Tested channel	Channel Bandwidth	Modulation	Mode
-	ERP	20407 to 20643	20407(824.7MHz), 20525(836.5MHz), 20643(848.3MHz)	1.4MHz	QPSK / 16QAM / 64QAM	1 RB / 5 RB Offset
		20415 to 20635	20415(825.5MHz), 20525(836.5MHz), 20635(847.5MHz)	3MHz	QPSK / 16QAM / 64QAM	1 RB / 14 RB Offset
		20425 to 20625	20425(826.5MHz), 20525(836.5MHz), 20625(846.5MHz)	5MHz	QPSK / 16QAM / 64QAM	1 RB / 24 RB Offset
		20450 to 20600	20450(829.0MHz), 20525(836.5MHz), 20600(844.0MHz)	10MHz	QPSK / 16QAM / 64QAM	1 RB / 49 RB Offset
-	Modulation characteristics	20407 to 20643	20525(836.5MHz)	1.4MHz	QPSK / 16QAM	1 RB / 5 RB Offset
		20450 to 20600	20525(836.5MHz)	10MHz	QPSK / 16QAM	1 RB / 49 RB Offset
-	Frequency Stability	20407 to 20643	20525(836.5MHz)	1.4MHz	QPSK	1 RB / 5 RB Offset
-	Occupied Bandwidth	20407 to 20643	20407(824.7MHz), 20525(836.5MHz), 20643(848.3MHz)	1.4MHz	QPSK / 16QAM / 64QAM	5 RB / 0RB Offset
		20415 to 20635	20415(825.5MHz), 20525(836.5MHz), 20635(847.5MHz)	3MHz	QPSK / 16QAM / 64QAM	14 RB / 0RB Offset
		20425 to 20625	20425(826.5MHz), 20525(836.5MHz), 20625(846.5MHz)	5MHz	QPSK / 16QAM / 64QAM	24RB / 0RB Offset
		20450 to 20600	20450(829.0MHz), 20525(836.5MHz), 20600(844.0MHz)	10MHz	QPSK / 16QAM / 64QAM	49RB / 0RB Offset
-	Band Edge	20407 to 20643	20407(824.7MHz), 20643(848.3MHz)	1.4MHz	QPSK	1 RB / 0 RB Offset 1 RB / 5 RB Offset 6 RB / 0 RB Offset
		20415 to 20635	20415(825.5MHz), 20635(847.5MHz)	3MHz	QPSK	1 RB / 0 RB Offset 1 RB / 14 RB Offset 15 RB / 0 RB Offset
		20425 to 20625	20425(826.5MHz), 20625(846.5MHz)	5MHz	QPSK	1 RB / 0 RB Offset 1 RB / 24 RB Offset 25 RB / 0 RB Offset
		20450 to 20600	20450(829.0MHz), 20600(844.0MHz)	10MHz	QPSK	1 RB / 0 RB Offset 1 RB / 49 RB Offset 50 RB / 0 RB Offset
-	Peak to Average Ratio	20407 to 20643	20407(824.7MHz), 20525(836.5MHz), 20643(848.3MHz)	1.4MHz	QPSK / 16QAM / 64QAM	1 RB / 5 RB Offset
		20415 to 20635	20415(825.5MHz), 20525(836.5MHz), 20635(847.5MHz)	3MHz	QPSK / 16QAM / 64QAM	1 RB / 14 RB Offset
		20425 to 20625	20425(826.5MHz), 20525(836.5MHz), 20625(846.5MHz)	5MHz	QPSK / 16QAM / 64QAM	1 RB / 24 RB Offset
		20450 to 20600	20450(829.0MHz), 20525(836.5MHz), 20600(844.0MHz)	10MHz	QPSK / 16QAM / 64QAM	1 RB / 49 RB Offset

EUT Configure Mode	Test item	Available channel	Tested channel	Channel Bandwidth	Modulation	Mode
-	Conducted Emission	20407 to 20643	20407(824.7MHz), 20525(836.5MHz), 20643(848.3MHz)	1.4MHz	QPSK	1 RB / 5 RB Offset
		20415 to 20635	20415(825.5MHz), 20525(836.5MHz), 20635(847.5MHz)	3MHz	QPSK	1 RB / 14 RB Offset
		20425 to 20625	20425(826.5MHz), 20525(836.5MHz), 20625(846.5MHz)	5MHz	QPSK	1 RB / 24 RB Offset
		20450 to 20600	20450(829.0MHz), 20525(836.5MHz), 20600(844.0MHz)	10MHz	QPSK	1 RB / 49 RB Offset
-	Radiated Emission Below 1GHz	20407 to 20643	20407(824.7MHz)	1.4MHz	QPSK	1 RB / 5 RB Offset
-		20415 to 20635	20415(825.5MHz)	3MHz	QPSK	1 RB / 14 RB Offset
-		20425 to 20625	20425(826.5MHz)	5MHz	QPSK	1 RB / 24 RB Offset
-		20450 to 20600	20450(829.0MHz)	10MHz	QPSK	1 RB / 49 RB Offset
-	Radiated Emission Above 1GHz	20407 to 20643	20407(824.7MHz), 20525(836.5MHz), 20643(848.3MHz)	1.4MHz	QPSK	1 RB / 5 RB Offset
		20415 to 20635	20415(825.5MHz), 20525(836.5MHz), 20635(847.5MHz)	3MHz	QPSK	1 RB / 14 RB Offset
		20425 to 20625	20425(826.5MHz), 20525(836.5MHz), 20625(846.5MHz)	5MHz	QPSK	1 RB / 24 RB Offset
		20450 to 20600	20450(829.0MHz), 20525(836.5MHz), 20600(844.0MHz)	10MHz	QPSK	1 RB / 49 RB Offset

Note:

1. For radiated emission below 1GHz, low, mid and high channels were pre-tested in chamber with 1.4MHz mode. Low channel on mode A was found to be the worst case and therefore had been chosen for all final tests.
2. The conducted output power for QPSK, 16QAM and 64QAM, measured value of QPSK is higher than 16QAM and 64QAM mode. Therefore, only occupied bandwidth and Peak to average ratio items had been tested under QPSK, 16QAM and 64QAM modes, the other test items were performed under QPSK mode only.

Test Condition:

Test Item	Environmental Conditions	Input Power	Tested By
ERP	22deg. C, 66%RH	120Vac, 60Hz	Han Wu
Modulation characteristics	24deg. C, 64%RH	120Vac, 60Hz	James Yang
Frequency Stability	24deg. C, 64%RH	120Vac, 60Hz	James Yang
Occupied Bandwidth	24deg. C, 64%RH	120Vac, 60Hz	James Yang
Band Edge	24deg. C, 64%RH	120Vac, 60Hz	James Yang
Peak To Average Ratio	24deg. C, 64%RH	120Vac, 60Hz	James Yang
Conducted Emission	24deg. C, 64%RH	120Vac, 60Hz	James Yang
Radiated Emission	22deg. C, 66%RH 25deg. C, 65%RH	120Vac, 60Hz	Han Wu Greg Lin

3.4 EUT Operating Conditions

The EUT makes a call to the communication simulator. The communication simulator station system controlled a EUT to export maximum output power under transmission mode and specific channel frequency

3.5 General Description of Applied Standards

The EUT is a RF Product. According to the specifications of the manufacturer, it must comply with the requirements of the following standards:

FCC 47 CFR Part 2

FCC 47 CFR Part 22

KDB 971168 D01 Power Meas License Digital Systems v03r01

ANSI/TIA/EIA-603-E 2016

ANSI 63.26-2015

All test items have been performed and recorded as per the above standards.

4 Test Types and Results

4.1 Output Power Measurement

4.1.1 Limits of Output Power Measurement

Mobile / Portable station are limited to 7 watts e.r.p.

4.1.2 Test Procedures

EIRP / ERP Measurement:

- All measurements were done at low, middle and high operational frequency range. RBW and VBW is 1MHz for GSM, 5MHz for WCDMA mode, 10MHz for LTE mode.
- Substitution method is used for E.I.R.P measurement. In the semi-anechoic chamber, EUT placed on the 0.8m(below or equal 1GHz) and/or 1.5m(above 1GHz) height of Turn Table, rotated the table around 360 degrees to search the maximum radiation power and receiver antenna shall be rotated vertical and horizontal polarization and moved height from 1m to 4m to find the maximum polar radiated power. The "Read Value" is the spectrum reading the maximum power value.
- The substitution horn antenna is substituted for EUT at the same position and signals generator export the CW signal to the substitution antenna via a TX cable. Rotated the Turn Table and moved receiving antenna to find the maximum radiation power. Adjust output power level of S.G to get a Value of spectrum reading equal to "Read Value" of step b. Record the power level of S.G
- EIRP = Output power level of S.G – TX cable loss + Antenna gain of substitution horn. E.R.P power can be calculated form E.I.R.P power by subtracting the gain of dipole, E.R.P power = E.I.R.P power - 2.15dB.

Where:

$$ERP/EIRP = P_{Meas} + G_T - L_C$$

P_{Meas} : Measure transmitter output power.

G_T : Gain of the transmitting antenna.

L_C : signal attenuation in the connecting cable between the transmitter and antenna.

Conducted Power Measurement:

The EUT was set up for the maximum power with GSM, WCDMA, LTE link data modulation and link up with simulator. Set the EUT to transmit under low, middle and high channel and record the power level shown on simulator.

4.1.3 Test Setup

EIRP / ERP Measurement:

For Radiated Emission below or equal 1GHz

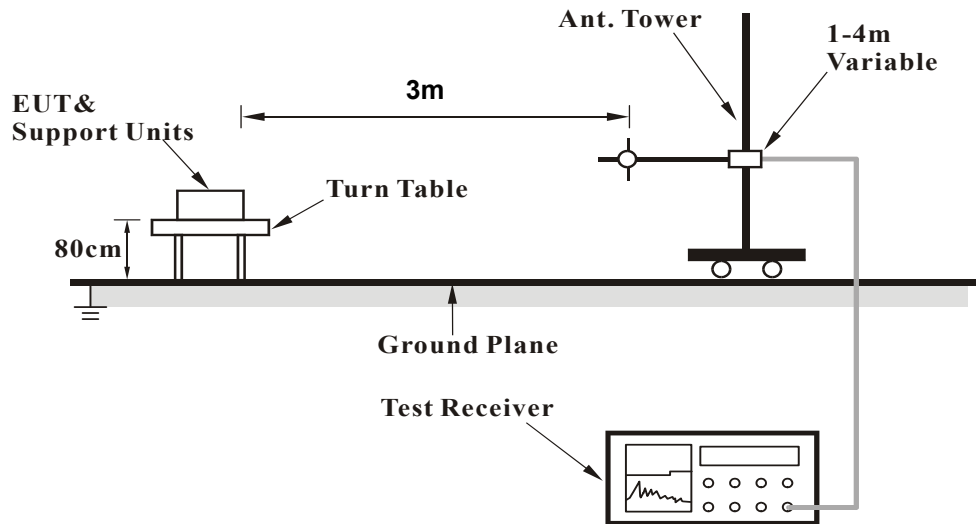

For Radiated Emission above 1GHz

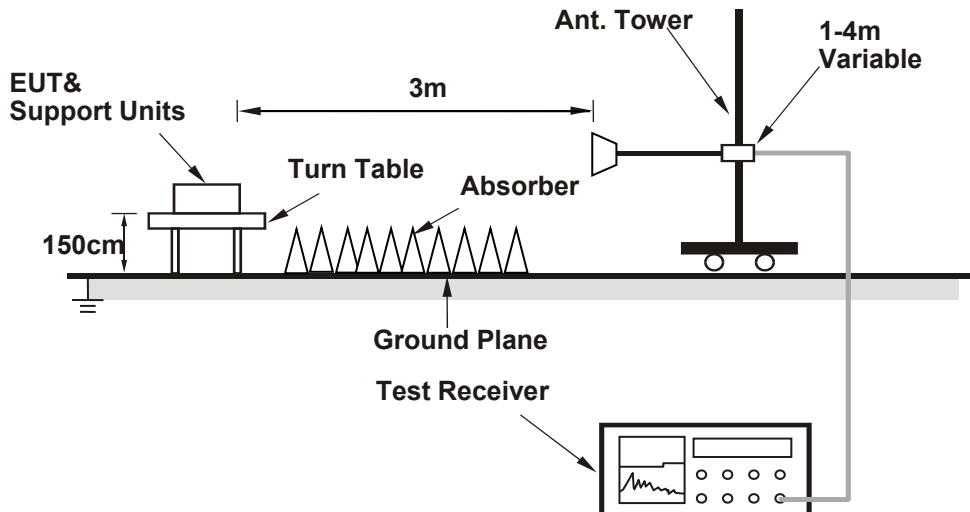

For the actual test configuration, please refer to the attached file (Test Setup Photo).

Conducted Power Measurement:



For the actual test configuration, please refer to the attached file (Test Setup Photo).

4.1.4 Test Results

Conducted Output Power (dBm)

Band	GSM850		
Channel	128	189	251
Frequency (MHz)	824.2	836.4	848.8
GSM	32.28	32.44	32.34
GPRS 1Tx Slot	32.01	32.17	32.07
GPRS 2Tx Slot	29.81	29.97	29.87
GPRS 3Tx Slot	28.42	28.49	28.48
GPRS 4Tx Slot	26.96	26.99	26.97
EDGE 1Tx Slot (MCS9)	26.05	26.21	26.11
EDGE 2Tx Slot (MCS9)	23.41	23.57	23.47
EDGE 3Tx Slot (MCS9)	22.20	22.36	22.26
EDGE 4Tx Slot (MCS9)	21.06	21.22	21.12

Band	WCDMA Band V		
Channel	4132	4182	4233
Frequency (MHz)	826.4	836.4	846.6
RMC 12.2K	23.00	23.18	22.97
HSDPA Subtest-1	21.80	21.98	21.77
HSDPA Subtest-2	21.77	21.95	21.74
HSDPA Subtest-3	21.33	21.51	21.30
HSDPA Subtest-4	21.31	21.49	21.28
DC-HSDPA Subtest-1	21.76	21.96	21.74
DC-HSDPA Subtest-2	21.75	21.87	21.69
DC-HSDPA Subtest-3	21.29	21.45	21.28
DC-HSDPA Subtest-4	21.29	21.43	21.24
HSUPA Subtest-1	21.88	22.06	21.85
HSUPA Subtest-2	19.87	20.05	19.84
HSUPA Subtest-3	20.88	21.06	20.85
HSUPA Subtest-4	19.88	20.06	19.85
HSUPA Subtest-5	21.82	22.00	21.79

Conducted Output Power (dBm)

LTE Band 5						
BW	MCS Index	RB Size	RB Offset	Low	Mid	High
		Channel		20450	20525	20600
		Frequency (MHz)		829	836.5	844
10M	QPSK	1	0	22.57	22.75	22.61
		1	24	22.38	22.56	22.42
		1	49	22.45	22.63	22.49
		25	0	21.44	21.62	21.48
		25	12	21.41	21.59	21.45
		25	25	21.38	21.56	21.42
		50	0	21.43	21.61	21.47
	16QAM	1	0	21.54	21.67	21.53
		1	24	21.34	21.46	21.32
		1	49	21.45	21.56	21.43
		25	0	20.39	20.60	20.42
		25	12	20.32	20.49	20.36
		25	25	20.37	20.55	20.41
		50	0	20.34	20.55	20.39
	64QAM	1	0	20.48	20.49	20.57
		1	24	20.24	20.17	20.12
		1	49	20.03	20.14	20.09
		25	0	19.43	19.41	19.41
		25	12	19.28	19.34	19.21
		25	25	19.16	19.27	19.29
		50	0	19.22	19.29	19.28

LTE Band 5						
BW	MCS Index	RB Size	RB Offset	Low	Mid	High
		Channel		20425	20525	20625
		Frequency (MHz)		826.5	836.5	846.5
5M	QPSK	1	0	22.54	22.73	22.54
		1	12	22.36	22.55	22.33
		1	24	22.43	22.54	22.44
		12	0	21.44	21.58	21.44
		12	6	21.32	21.51	21.44
		12	13	21.36	21.50	21.42
		25	0	21.37	21.52	21.45
	16QAM	1	0	21.43	21.72	21.46
		1	12	21.30	21.47	21.34
		1	24	21.37	21.50	21.41
		12	0	20.25	20.52	20.33
		12	6	20.29	20.57	20.28
		12	13	20.21	20.46	20.35
		25	0	20.32	20.42	20.41
	64QAM	1	0	20.45	20.41	20.42
		1	12	20.24	20.33	20.21
		1	24	20.16	20.16	20.05
		12	0	19.28	19.35	19.23
		12	6	19.27	19.32	19.08
		12	13	19.19	19.18	19.09
		25	0	19.33	19.20	19.26

LTE Band 5						
BW	MCSIndex	RB Size	RB Offset	Low	Mid	High
		Channel		20415	20525	20635
		Frequency (MHz)		825.5	836.5	847.5
3M	QPSK	1	0	22.44	22.57	22.49
		1	7	22.29	22.51	22.27
		1	14	22.36	22.48	22.36
		8	0	21.34	21.51	21.25
		8	3	21.22	21.58	21.26
		8	7	21.33	21.36	21.32
		15	0	21.29	21.49	21.40
	16QAM	1	0	21.38	21.57	21.35
		1	7	21.22	21.46	21.31
		1	14	21.22	21.46	21.15
		8	0	20.14	20.49	20.28
		8	3	20.19	20.46	20.39
		8	7	20.26	20.41	20.24
		15	0	20.15	20.32	20.43
	64QAM	1	0	20.44	20.54	20.36
		1	7	20.19	20.14	20.18
		1	14	20.17	20.31	20.17
		8	0	19.38	19.28	19.32
		8	3	19.33	19.29	19.16
		8	7	19.17	19.15	19.14
		15	0	19.32	19.26	19.17

LTE Band 5						
BW	MCS Index	RB Size	RB Offset	Low	Mid	High
		Channel		20407	20525	20643
		Frequency (MHz)		824.7	836.5	848.3
1.4M	QPSK	1	0	22.50	22.60	22.48
		1	2	22.20	22.35	22.22
		1	5	22.32	22.48	22.42
		3	0	22.37	22.51	22.42
		3	1	22.30	22.56	22.23
		3	3	22.18	22.55	22.26
		6	0	21.25	21.47	21.37
	16QAM	1	0	21.46	21.50	21.36
		1	2	21.11	21.42	21.23
		1	5	21.36	21.43	21.31
		3	0	21.25	21.59	21.34
		3	1	21.19	21.44	21.23
		3	3	21.16	21.30	21.31
		6	0	20.30	20.44	20.30
	64QAM	1	0	20.45	20.59	20.43
		1	2	20.19	20.28	20.20
		1	5	20.14	20.16	20.07
		3	0	20.29	20.31	20.26
		3	1	20.28	20.21	20.25
		3	3	20.09	20.36	20.19
		6	0	19.22	19.27	19.10

ERP Power
GSM Mode

MODE		TX channel 128					
Antenna Polarity & Test Distance: Horizontal at 3 M							
No.	Freq. (MHz)	Reading (dBm)	S.G Power Value (dBm)	Correction Factor (dB)	ERP (dBm)	Limit (dBm)	Margin (dB)
1	824.20	-7.6	20.0	3.9	23.9	38.5	-14.6
Antenna Polarity & Test Distance: Vertical at 3 M							
No.	Freq. (MHz)	Reading (dBm)	S.G Power Value (dBm)	Correction Factor (dB)	ERP (dBm)	Limit (dBm)	Margin (dB)
1	824.20	-3.1	25.2	3.9	29.1	38.5	-9.4

MODE		TX channel 189					
Antenna Polarity & Test Distance: Horizontal at 3 M							
No.	Freq. (MHz)	Reading (dBm)	S.G Power Value (dBm)	Correction Factor (dB)	ERP (dBm)	Limit (dBm)	Margin (dB)
1	836.40	-7.1	20.4	3.8	24.2	38.5	-14.3
Antenna Polarity & Test Distance: Vertical at 3 M							
No.	Freq. (MHz)	Reading (dBm)	S.G Power Value (dBm)	Correction Factor (dB)	ERP (dBm)	Limit (dBm)	Margin (dB)
1	836.40	-1.2	26.8	3.8	30.6	38.5	-7.9

MODE		TX channel 251					
Antenna Polarity & Test Distance: Horizontal at 3 M							
No.	Freq. (MHz)	Reading (dBm)	S.G Power Value (dBm)	Correction Factor (dB)	ERP (dBm)	Limit (dBm)	Margin (dB)
1	848.80	-6.6	21.1	3.4	24.5	38.5	-14.0
Antenna Polarity & Test Distance: Vertical at 3 M							
No.	Freq. (MHz)	Reading (dBm)	S.G Power Value (dBm)	Correction Factor (dB)	ERP (dBm)	Limit (dBm)	Margin (dB)
1	848.80	-0.9	27.2	3.4	30.6	38.5	-7.9

Note: ERP (dBm) = S.G Power Value (dBm) + Correction Factor (dB).

EDGE Mode

MODE		TX channel 128					
Antenna Polarity & Test Distance: Horizontal at 3 M							
No.	Freq. (MHz)	Reading (dBm)	S.G Power Value (dBm)	Correction Factor (dB)	ERP (dBm)	Limit (dBm)	Margin (dB)
1	824.20	-10.5	17.1	3.9	21.0	38.5	-17.5
Antenna Polarity & Test Distance: Vertical at 3 M							
No.	Freq. (MHz)	Reading (dBm)	S.G Power Value (dBm)	Correction Factor (dB)	ERP (dBm)	Limit (dBm)	Margin (dB)
1	824.20	-6.1	22.2	3.9	26.1	38.5	-12.4

MODE		TX channel 189					
Antenna Polarity & Test Distance: Horizontal at 3 M							
No.	Freq. (MHz)	Reading (dBm)	S.G Power Value (dBm)	Correction Factor (dB)	ERP (dBm)	Limit (dBm)	Margin (dB)
1	836.40	-10.1	17.3	3.8	21.1	38.5	-17.4
Antenna Polarity & Test Distance: Vertical at 3 M							
No.	Freq. (MHz)	Reading (dBm)	S.G Power Value (dBm)	Correction Factor (dB)	ERP (dBm)	Limit (dBm)	Margin (dB)
1	836.40	-6.2	21.9	3.8	25.7	38.5	-12.8

MODE		TX channel 251					
Antenna Polarity & Test Distance: Horizontal at 3 M							
No.	Freq. (MHz)	Reading (dBm)	S.G Power Value (dBm)	Correction Factor (dB)	ERP (dBm)	Limit (dBm)	Margin (dB)
1	848.80	-9.7	18.0	3.4	21.4	38.5	-17.1
Antenna Polarity & Test Distance: Vertical at 3 M							
No.	Freq. (MHz)	Reading (dBm)	S.G Power Value (dBm)	Correction Factor (dB)	ERP (dBm)	Limit (dBm)	Margin (dB)
1	848.80	-6.0	22.1	3.4	25.5	38.5	-13.0

Note: ERP (dBm) = S.G Power Value (dBm) + Correction Factor (dB).

WCDMA Mode

MODE		TX channel 4132					
Antenna Polarity & Test Distance: Horizontal at 3 M							
No.	Freq. (MHz)	Reading (dBm)	S.G Power Value (dBm)	Correction Factor (dB)	ERP (dBm)	Limit (dBm)	Margin (dB)
1	826.40	-15.8	11.8	3.9	15.7	38.5	-22.8
Antenna Polarity & Test Distance: Vertical at 3 M							
No.	Freq. (MHz)	Reading (dBm)	S.G Power Value (dBm)	Correction Factor (dB)	ERP (dBm)	Limit (dBm)	Margin (dB)
1	826.40	-9.6	18.7	3.9	22.6	38.5	-15.9

MODE		TX channel 4182					
Antenna Polarity & Test Distance: Horizontal at 3 M							
No.	Freq. (MHz)	Reading (dBm)	S.G Power Value (dBm)	Correction Factor (dB)	ERP (dBm)	Limit (dBm)	Margin (dB)
1	836.40	-15.4	12.0	3.8	15.8	38.5	-22.7
Antenna Polarity & Test Distance: Vertical at 3 M							
No.	Freq. (MHz)	Reading (dBm)	S.G Power Value (dBm)	Correction Factor (dB)	ERP (dBm)	Limit (dBm)	Margin (dB)
1	836.40	-9.7	18.4	3.8	22.2	38.5	-16.3

MODE		TX channel 4233					
Antenna Polarity & Test Distance: Horizontal at 3 M							
No.	Freq. (MHz)	Reading (dBm)	S.G Power Value (dBm)	Correction Factor (dB)	ERP (dBm)	Limit (dBm)	Margin (dB)
1	846.60	-15.4	12.2	3.4	15.6	38.5	-22.9
Antenna Polarity & Test Distance: Vertical at 3 M							
No.	Freq. (MHz)	Reading (dBm)	S.G Power Value (dBm)	Correction Factor (dB)	ERP (dBm)	Limit (dBm)	Margin (dB)
1	846.60	-9.6	18.6	3.4	22.0	38.5	-16.5

Note: ERP (dBm) = S.G Power Value (dBm) + Correction Factor (dB).

Modulation Type: QPSK

LTE Band 5, Channel Bandwidth: 1.4MHz

MODE		TX channel 20407					
Antenna Polarity & Test Distance: Horizontal at 3 M							
No.	Freq. (MHz)	Reading (dBm)	S.G Power Value (dBm)	Correction Factor (dB)	ERP (dBm)	Limit (dBm)	Margin (dB)
1	824.70	-18.1	9.5	3.9	13.4	38.5	-25.1
Antenna Polarity & Test Distance: Vertical at 3 M							
No.	Freq. (MHz)	Reading (dBm)	S.G Power Value (dBm)	Correction Factor (dB)	ERP (dBm)	Limit (dBm)	Margin (dB)
1	824.70	-10.6	17.7	3.9	21.6	38.5	-16.9

MODE		TX channel 20525					
Antenna Polarity & Test Distance: Horizontal at 3 M							
No.	Freq. (MHz)	Reading (dBm)	S.G Power Value (dBm)	Correction Factor (dB)	ERP (dBm)	Limit (dBm)	Margin (dB)
1	836.50	-17.4	10.1	3.8	13.9	38.5	-24.6
Antenna Polarity & Test Distance: Vertical at 3 M							
No.	Freq. (MHz)	Reading (dBm)	S.G Power Value (dBm)	Correction Factor (dB)	ERP (dBm)	Limit (dBm)	Margin (dB)
1	836.50	-9.8	18.3	3.8	22.1	38.5	-16.4

MODE		TX channel 20643					
Antenna Polarity & Test Distance: Horizontal at 3 M							
No.	Freq. (MHz)	Reading (dBm)	S.G Power Value (dBm)	Correction Factor (dB)	ERP (dBm)	Limit (dBm)	Margin (dB)
1	848.30	-17.1	10.6	3.4	14.0	38.5	-24.5
Antenna Polarity & Test Distance: Vertical at 3 M							
No.	Freq. (MHz)	Reading (dBm)	S.G Power Value (dBm)	Correction Factor (dB)	ERP (dBm)	Limit (dBm)	Margin (dB)
1	848.30	-9.7	18.4	3.4	21.8	38.5	-16.7

Note: ERP (dBm) = S.G Power Value (dBm) + Correction Factor (dB).

LTE Band 5, Channel Bandwidth: 3MHz

MODE		TX channel 20415					
Antenna Polarity & Test Distance: Horizontal at 3 M							
No.	Freq. (MHz)	Reading (dBm)	S.G Power Value (dBm)	Correction Factor (dB)	ERP (dBm)	Limit (dBm)	Margin (dB)
1	825.50	-17.9	9.7	3.9	13.6	38.5	-24.9
Antenna Polarity & Test Distance: Vertical at 3 M							
No.	Freq. (MHz)	Reading (dBm)	S.G Power Value (dBm)	Correction Factor (dB)	ERP (dBm)	Limit (dBm)	Margin (dB)
1	825.50	-10.4	18.0	3.9	21.9	38.5	-16.6

MODE		TX channel 20525					
Antenna Polarity & Test Distance: Horizontal at 3 M							
No.	Freq. (MHz)	Reading (dBm)	S.G Power Value (dBm)	Correction Factor (dB)	ERP (dBm)	Limit (dBm)	Margin (dB)
1	836.50	-17.1	10.3	3.8	14.1	38.5	-24.4
Antenna Polarity & Test Distance: Vertical at 3 M							
No.	Freq. (MHz)	Reading (dBm)	S.G Power Value (dBm)	Correction Factor (dB)	ERP (dBm)	Limit (dBm)	Margin (dB)
1	836.50	-9.6	18.5	3.8	22.3	38.5	-16.2

MODE		TX channel 20635					
Antenna Polarity & Test Distance: Horizontal at 3 M							
No.	Freq. (MHz)	Reading (dBm)	S.G Power Value (dBm)	Correction Factor (dB)	ERP (dBm)	Limit (dBm)	Margin (dB)
1	847.50	-17.2	10.4	3.4	13.8	38.5	-24.7
Antenna Polarity & Test Distance: Vertical at 3 M							
No.	Freq. (MHz)	Reading (dBm)	S.G Power Value (dBm)	Correction Factor (dB)	ERP (dBm)	Limit (dBm)	Margin (dB)
1	847.50	-9.8	18.4	3.4	21.8	38.5	-16.7

Note: ERP (dBm) = S.G Power Value (dBm) + Correction Factor (dB).

LTE Band 5, Channel Bandwidth: 5MHz

MODE		TX channel 20425					
Antenna Polarity & Test Distance: Horizontal at 3 M							
No.	Freq. (MHz)	Reading (dBm)	S.G Power Value (dBm)	Correction Factor (dB)	ERP (dBm)	Limit (dBm)	Margin (dB)
1	826.50	-17.7	9.9	3.9	13.8	38.5	-24.7
Antenna Polarity & Test Distance: Vertical at 3 M							
No.	Freq. (MHz)	Reading (dBm)	S.G Power Value (dBm)	Correction Factor (dB)	ERP (dBm)	Limit (dBm)	Margin (dB)
1	826.50	-10.4	17.9	3.9	21.8	38.5	-16.7

MODE		TX channel 20525					
Antenna Polarity & Test Distance: Horizontal at 3 M							
No.	Freq. (MHz)	Reading (dBm)	S.G Power Value (dBm)	Correction Factor (dB)	ERP (dBm)	Limit (dBm)	Margin (dB)
1	836.50	-17.1	10.3	3.8	14.1	38.5	-24.4
Antenna Polarity & Test Distance: Vertical at 3 M							
No.	Freq. (MHz)	Reading (dBm)	S.G Power Value (dBm)	Correction Factor (dB)	ERP (dBm)	Limit (dBm)	Margin (dB)
1	836.50	-9.6	18.5	3.8	22.3	38.5	-16.2

MODE		TX channel 20625					
Antenna Polarity & Test Distance: Horizontal at 3 M							
No.	Freq. (MHz)	Reading (dBm)	S.G Power Value (dBm)	Correction Factor (dB)	ERP (dBm)	Limit (dBm)	Margin (dB)
1	846.50	-17.0	10.6	3.4	14.0	38.5	-24.5
Antenna Polarity & Test Distance: Vertical at 3 M							
No.	Freq. (MHz)	Reading (dBm)	S.G Power Value (dBm)	Correction Factor (dB)	ERP (dBm)	Limit (dBm)	Margin (dB)
1	846.50	-9.6	18.6	3.4	22.0	38.5	-16.5

Note: ERP (dBm) = S.G Power Value (dBm) + Correction Factor (dB).

LTE Band 5, Channel Bandwidth: 10MHz

MODE		TX channel 20450					
Antenna Polarity & Test Distance: Horizontal at 3 M							
No.	Freq. (MHz)	Reading (dBm)	S.G Power Value (dBm)	Correction Factor (dB)	ERP (dBm)	Limit (dBm)	Margin (dB)
1	829.00	-17.8	9.9	3.9	13.8	38.5	-24.7
Antenna Polarity & Test Distance: Vertical at 3 M							
No.	Freq. (MHz)	Reading (dBm)	S.G Power Value (dBm)	Correction Factor (dB)	ERP (dBm)	Limit (dBm)	Margin (dB)
1	829.00	-10.3	17.9	3.9	21.8	38.5	-16.7

MODE		TX channel 20525					
Antenna Polarity & Test Distance: Horizontal at 3 M							
No.	Freq. (MHz)	Reading (dBm)	S.G Power Value (dBm)	Correction Factor (dB)	ERP (dBm)	Limit (dBm)	Margin (dB)
1	836.50	-17.1	10.3	3.8	14.1	38.5	-24.4
Antenna Polarity & Test Distance: Vertical at 3 M							
No.	Freq. (MHz)	Reading (dBm)	S.G Power Value (dBm)	Correction Factor (dB)	ERP (dBm)	Limit (dBm)	Margin (dB)
1	836.50	-9.7	18.4	3.8	22.2	38.5	-16.3

MODE		TX channel 20600					
Antenna Polarity & Test Distance: Horizontal at 3 M							
No.	Freq. (MHz)	Reading (dBm)	S.G Power Value (dBm)	Correction Factor (dB)	ERP (dBm)	Limit (dBm)	Margin (dB)
1	844.00	-17.4	10.2	3.7	13.9	38.5	-24.6
Antenna Polarity & Test Distance: Vertical at 3 M							
No.	Freq. (MHz)	Reading (dBm)	S.G Power Value (dBm)	Correction Factor (dB)	ERP (dBm)	Limit (dBm)	Margin (dB)
1	844.00	-9.9	18.5	3.7	22.2	38.5	-16.3

Note: ERP (dBm) = S.G Power Value (dBm) + Correction Factor (dB).

Modulation Type: 16QAM

LTE Band 5, Channel Bandwidth: 1.4MHz

MODE		TX channel 20407					
Antenna Polarity & Test Distance: Horizontal at 3 M							
No.	Freq. (MHz)	Reading (dBm)	S.G Power Value (dBm)	Correction Factor (dB)	ERP (dBm)	Limit (dBm)	Margin (dB)
1	824.70	-18.9	8.7	3.9	12.6	38.5	-25.9
Antenna Polarity & Test Distance: Vertical at 3 M							
No.	Freq. (MHz)	Reading (dBm)	S.G Power Value (dBm)	Correction Factor (dB)	ERP (dBm)	Limit (dBm)	Margin (dB)
1	824.70	-11.4	17.0	3.9	20.9	38.5	-17.6

MODE		TX channel 20525					
Antenna Polarity & Test Distance: Horizontal at 3 M							
No.	Freq. (MHz)	Reading (dBm)	S.G Power Value (dBm)	Correction Factor (dB)	ERP (dBm)	Limit (dBm)	Margin (dB)
1	836.50	-18.4	9.1	3.8	12.9	38.5	-25.6
Antenna Polarity & Test Distance: Vertical at 3 M							
No.	Freq. (MHz)	Reading (dBm)	S.G Power Value (dBm)	Correction Factor (dB)	ERP (dBm)	Limit (dBm)	Margin (dB)
1	836.50	-10.7	17.4	3.8	21.2	38.5	-17.3

MODE		TX channel 20643					
Antenna Polarity & Test Distance: Horizontal at 3 M							
No.	Freq. (MHz)	Reading (dBm)	S.G Power Value (dBm)	Correction Factor (dB)	ERP (dBm)	Limit (dBm)	Margin (dB)
1	848.30	-18.2	9.5	3.4	12.9	38.5	-25.6
Antenna Polarity & Test Distance: Vertical at 3 M							
No.	Freq. (MHz)	Reading (dBm)	S.G Power Value (dBm)	Correction Factor (dB)	ERP (dBm)	Limit (dBm)	Margin (dB)
1	848.30	-10.8	17.3	3.4	20.7	38.5	-17.8

Note: ERP (dBm) = S.G Power Value (dBm) + Correction Factor (dB).

LTE Band 5, Channel Bandwidth: 3MHz

MODE		TX channel 20415					
Antenna Polarity & Test Distance: Horizontal at 3 M							
No.	Freq. (MHz)	Reading (dBm)	S.G Power Value (dBm)	Correction Factor (dB)	ERP (dBm)	Limit (dBm)	Margin (dB)
1	825.50	-18.9	8.7	3.9	12.6	38.5	-25.9
Antenna Polarity & Test Distance: Vertical at 3 M							
No.	Freq. (MHz)	Reading (dBm)	S.G Power Value (dBm)	Correction Factor (dB)	ERP (dBm)	Limit (dBm)	Margin (dB)
1	825.50	-11.4	17.0	3.9	20.9	38.5	-17.6

MODE		TX channel 20525					
Antenna Polarity & Test Distance: Horizontal at 3 M							
No.	Freq. (MHz)	Reading (dBm)	S.G Power Value (dBm)	Correction Factor (dB)	ERP (dBm)	Limit (dBm)	Margin (dB)
1	836.50	-18.1	9.4	3.8	13.2	38.5	-25.3
Antenna Polarity & Test Distance: Vertical at 3 M							
No.	Freq. (MHz)	Reading (dBm)	S.G Power Value (dBm)	Correction Factor (dB)	ERP (dBm)	Limit (dBm)	Margin (dB)
1	836.50	-10.7	17.4	3.8	21.2	38.5	-17.3

MODE		TX channel 20635					
Antenna Polarity & Test Distance: Horizontal at 3 M							
No.	Freq. (MHz)	Reading (dBm)	S.G Power Value (dBm)	Correction Factor (dB)	ERP (dBm)	Limit (dBm)	Margin (dB)
1	847.50	-18.2	9.4	3.4	12.8	38.5	-25.7
Antenna Polarity & Test Distance: Vertical at 3 M							
No.	Freq. (MHz)	Reading (dBm)	S.G Power Value (dBm)	Correction Factor (dB)	ERP (dBm)	Limit (dBm)	Margin (dB)
1	847.50	-10.8	17.4	3.4	20.8	38.5	-17.7

Note: ERP (dBm) = S.G Power Value (dBm) + Correction Factor (dB).

LTE Band 5, Channel Bandwidth: 5MHz

MODE		TX channel 20425					
Antenna Polarity & Test Distance: Horizontal at 3 M							
No.	Freq. (MHz)	Reading (dBm)	S.G Power Value (dBm)	Correction Factor (dB)	ERP (dBm)	Limit (dBm)	Margin (dB)
1	826.50	-18.6	9.0	3.9	12.9	38.5	-25.6
Antenna Polarity & Test Distance: Vertical at 3 M							
No.	Freq. (MHz)	Reading (dBm)	S.G Power Value (dBm)	Correction Factor (dB)	ERP (dBm)	Limit (dBm)	Margin (dB)
1	826.50	-11.4	17.0	3.9	20.9	38.5	-17.6

MODE		TX channel 20525					
Antenna Polarity & Test Distance: Horizontal at 3 M							
No.	Freq. (MHz)	Reading (dBm)	S.G Power Value (dBm)	Correction Factor (dB)	ERP (dBm)	Limit (dBm)	Margin (dB)
1	836.50	-18.1	9.4	3.8	13.2	38.5	-25.3
Antenna Polarity & Test Distance: Vertical at 3 M							
No.	Freq. (MHz)	Reading (dBm)	S.G Power Value (dBm)	Correction Factor (dB)	ERP (dBm)	Limit (dBm)	Margin (dB)
1	836.50	-10.7	17.4	3.8	21.2	38.5	-17.3

MODE		TX channel 20625					
Antenna Polarity & Test Distance: Horizontal at 3 M							
No.	Freq. (MHz)	Reading (dBm)	S.G Power Value (dBm)	Correction Factor (dB)	ERP (dBm)	Limit (dBm)	Margin (dB)
1	846.50	-17.8	9.8	3.4	13.2	38.5	-25.3
Antenna Polarity & Test Distance: Vertical at 3 M							
No.	Freq. (MHz)	Reading (dBm)	S.G Power Value (dBm)	Correction Factor (dB)	ERP (dBm)	Limit (dBm)	Margin (dB)
1	846.50	-10.4	17.8	3.4	21.2	38.5	-17.3

Note: ERP (dBm) = S.G Power Value (dBm) + Correction Factor (dB).

LTE Band 5, Channel Bandwidth: 10MHz

MODE		TX channel 20450					
Antenna Polarity & Test Distance: Horizontal at 3 M							
No.	Freq. (MHz)	Reading (dBm)	S.G Power Value (dBm)	Correction Factor (dB)	ERP (dBm)	Limit (dBm)	Margin (dB)
1	829.00	-18.7	9.0	3.9	12.9	38.5	-25.6
Antenna Polarity & Test Distance: Vertical at 3 M							
No.	Freq. (MHz)	Reading (dBm)	S.G Power Value (dBm)	Correction Factor (dB)	ERP (dBm)	Limit (dBm)	Margin (dB)
1	829.00	-11.2	17.0	3.9	20.9	38.5	-17.6

MODE		TX channel 20525					
Antenna Polarity & Test Distance: Horizontal at 3 M							
No.	Freq. (MHz)	Reading (dBm)	S.G Power Value (dBm)	Correction Factor (dB)	ERP (dBm)	Limit (dBm)	Margin (dB)
1	836.50	-18.1	9.3	3.8	13.1	38.5	-25.4
Antenna Polarity & Test Distance: Vertical at 3 M							
No.	Freq. (MHz)	Reading (dBm)	S.G Power Value (dBm)	Correction Factor (dB)	ERP (dBm)	Limit (dBm)	Margin (dB)
1	836.50	-10.7	17.4	3.8	21.2	38.5	-17.3

MODE		TX channel 20600					
Antenna Polarity & Test Distance: Horizontal at 3 M							
No.	Freq. (MHz)	Reading (dBm)	S.G Power Value (dBm)	Correction Factor (dB)	ERP (dBm)	Limit (dBm)	Margin (dB)
1	844.00	-18.4	9.2	3.7	12.9	38.5	-25.6
Antenna Polarity & Test Distance: Vertical at 3 M							
No.	Freq. (MHz)	Reading (dBm)	S.G Power Value (dBm)	Correction Factor (dB)	ERP (dBm)	Limit (dBm)	Margin (dB)
1	844.00	-10.8	17.6	3.7	21.3	38.5	-17.2

Note: ERP (dBm) = S.G Power Value (dBm) + Correction Factor (dB).

Modulation Type: 64QAM

LTE Band 5, Channel Bandwidth: 1.4MHz

MODE		TX channel 20407					
Antenna Polarity & Test Distance: Horizontal at 3 M							
No.	Freq. (MHz)	Reading (dBm)	S.G Power Value (dBm)	Correction Factor (dB)	ERP (dBm)	Limit (dBm)	Margin (dB)
1	824.70	-19.1	8.5	3.9	12.4	38.5	-26.1
Antenna Polarity & Test Distance: Vertical at 3 M							
No.	Freq. (MHz)	Reading (dBm)	S.G Power Value (dBm)	Correction Factor (dB)	ERP (dBm)	Limit (dBm)	Margin (dB)
1	824.70	-11.6	16.7	3.9	20.6	38.5	-17.9

MODE		TX channel 20525					
Antenna Polarity & Test Distance: Horizontal at 3 M							
No.	Freq. (MHz)	Reading (dBm)	S.G Power Value (dBm)	Correction Factor (dB)	ERP (dBm)	Limit (dBm)	Margin (dB)
1	836.50	-18.8	8.7	3.8	12.5	38.5	-26.0
Antenna Polarity & Test Distance: Vertical at 3 M							
No.	Freq. (MHz)	Reading (dBm)	S.G Power Value (dBm)	Correction Factor (dB)	ERP (dBm)	Limit (dBm)	Margin (dB)
1	836.50	-10.9	17.2	3.8	21.0	38.5	-17.5

MODE		TX channel 20643					
Antenna Polarity & Test Distance: Horizontal at 3 M							
No.	Freq. (MHz)	Reading (dBm)	S.G Power Value (dBm)	Correction Factor (dB)	ERP (dBm)	Limit (dBm)	Margin (dB)
1	848.30	-18.9	8.8	3.4	12.2	38.5	-26.3
Antenna Polarity & Test Distance: Vertical at 3 M							
No.	Freq. (MHz)	Reading (dBm)	S.G Power Value (dBm)	Correction Factor (dB)	ERP (dBm)	Limit (dBm)	Margin (dB)
1	848.30	-11.1	17.0	3.4	20.4	38.5	-18.1

Note: ERP (dBm) = S.G Power Value (dBm) + Correction Factor (dB).

LTE Band 5, Channel Bandwidth: 3MHz

MODE		TX channel 20415					
Antenna Polarity & Test Distance: Horizontal at 3 M							
No.	Freq. (MHz)	Reading (dBm)	S.G Power Value (dBm)	Correction Factor (dB)	ERP (dBm)	Limit (dBm)	Margin (dB)
1	825.50	-19.1	8.5	3.9	12.4	38.5	-26.1
Antenna Polarity & Test Distance: Vertical at 3 M							
No.	Freq. (MHz)	Reading (dBm)	S.G Power Value (dBm)	Correction Factor (dB)	ERP (dBm)	Limit (dBm)	Margin (dB)
1	825.50	-11.6	16.8	3.9	20.7	38.5	-17.8

MODE		TX channel 20525					
Antenna Polarity & Test Distance: Horizontal at 3 M							
No.	Freq. (MHz)	Reading (dBm)	S.G Power Value (dBm)	Correction Factor (dB)	ERP (dBm)	Limit (dBm)	Margin (dB)
1	836.50	-18.2	9.2	3.8	13.0	38.5	-25.5
Antenna Polarity & Test Distance: Vertical at 3 M							
No.	Freq. (MHz)	Reading (dBm)	S.G Power Value (dBm)	Correction Factor (dB)	ERP (dBm)	Limit (dBm)	Margin (dB)
1	836.50	-12.0	16.1	3.8	19.9	38.5	-18.6

MODE		TX channel 20635					
Antenna Polarity & Test Distance: Horizontal at 3 M							
No.	Freq. (MHz)	Reading (dBm)	S.G Power Value (dBm)	Correction Factor (dB)	ERP (dBm)	Limit (dBm)	Margin (dB)
1	847.50	-18.6	9.0	3.4	12.4	38.5	-26.1
Antenna Polarity & Test Distance: Vertical at 3 M							
No.	Freq. (MHz)	Reading (dBm)	S.G Power Value (dBm)	Correction Factor (dB)	ERP (dBm)	Limit (dBm)	Margin (dB)
1	847.50	-11.1	17.1	3.4	20.5	38.5	-18.0

Note: ERP (dBm) = S.G Power Value (dBm) + Correction Factor (dB).

LTE Band 5, Channel Bandwidth: 5MHz

MODE		TX channel 20425					
Antenna Polarity & Test Distance: Horizontal at 3 M							
No.	Freq. (MHz)	Reading (dBm)	S.G Power Value (dBm)	Correction Factor (dB)	ERP (dBm)	Limit (dBm)	Margin (dB)
1	826.50	-19.0	8.6	3.9	12.5	38.5	-26.0
Antenna Polarity & Test Distance: Vertical at 3 M							
No.	Freq. (MHz)	Reading (dBm)	S.G Power Value (dBm)	Correction Factor (dB)	ERP (dBm)	Limit (dBm)	Margin (dB)
1	826.50	-11.6	16.7	3.9	20.6	38.5	-17.9

MODE		TX channel 20525					
Antenna Polarity & Test Distance: Horizontal at 3 M							
No.	Freq. (MHz)	Reading (dBm)	S.G Power Value (dBm)	Correction Factor (dB)	ERP (dBm)	Limit (dBm)	Margin (dB)
1	836.50	-18.4	9.1	3.8	12.9	38.5	-25.6
Antenna Polarity & Test Distance: Vertical at 3 M							
No.	Freq. (MHz)	Reading (dBm)	S.G Power Value (dBm)	Correction Factor (dB)	ERP (dBm)	Limit (dBm)	Margin (dB)
1	836.50	-12.0	16.1	3.8	19.9	38.5	-18.6

MODE		TX channel 20625					
Antenna Polarity & Test Distance: Horizontal at 3 M							
No.	Freq. (MHz)	Reading (dBm)	S.G Power Value (dBm)	Correction Factor (dB)	ERP (dBm)	Limit (dBm)	Margin (dB)
1	846.50	-18.0	9.6	3.4	13.0	38.5	-25.5
Antenna Polarity & Test Distance: Vertical at 3 M							
No.	Freq. (MHz)	Reading (dBm)	S.G Power Value (dBm)	Correction Factor (dB)	ERP (dBm)	Limit (dBm)	Margin (dB)
1	846.50	-11.8	16.4	3.4	19.8	38.5	-18.7

Note: ERP (dBm) = S.G Power Value (dBm) + Correction Factor (dB).

LTE Band 5, Channel Bandwidth: 10MHz

MODE		TX channel 20450					
Antenna Polarity & Test Distance: Horizontal at 3 M							
No.	Freq. (MHz)	Reading (dBm)	S.G Power Value (dBm)	Correction Factor (dB)	ERP (dBm)	Limit (dBm)	Margin (dB)
1	829.00	-19.0	8.7	3.9	12.6	38.5	-25.9
Antenna Polarity & Test Distance: Vertical at 3 M							
No.	Freq. (MHz)	Reading (dBm)	S.G Power Value (dBm)	Correction Factor (dB)	ERP (dBm)	Limit (dBm)	Margin (dB)
1	829.00	-11.5	16.7	3.9	20.6	38.5	-17.9

MODE		TX channel 20525					
Antenna Polarity & Test Distance: Horizontal at 3 M							
No.	Freq. (MHz)	Reading (dBm)	S.G Power Value (dBm)	Correction Factor (dB)	ERP (dBm)	Limit (dBm)	Margin (dB)
1	836.50	-18.4	9.0	3.8	12.8	38.5	-25.7
Antenna Polarity & Test Distance: Vertical at 3 M							
No.	Freq. (MHz)	Reading (dBm)	S.G Power Value (dBm)	Correction Factor (dB)	ERP (dBm)	Limit (dBm)	Margin (dB)
1	836.50	-10.9	17.2	3.8	21.0	38.5	-17.5

MODE		TX channel 20600					
Antenna Polarity & Test Distance: Horizontal at 3 M							
No.	Freq. (MHz)	Reading (dBm)	S.G Power Value (dBm)	Correction Factor (dB)	ERP (dBm)	Limit (dBm)	Margin (dB)
1	844.00	-18.6	8.9	3.7	12.6	38.5	-25.9
Antenna Polarity & Test Distance: Vertical at 3 M							
No.	Freq. (MHz)	Reading (dBm)	S.G Power Value (dBm)	Correction Factor (dB)	ERP (dBm)	Limit (dBm)	Margin (dB)
1	844.00	-11.0	17.4	3.7	21.1	38.5	-17.4

Note: ERP (dBm) = S.G Power Value (dBm) + Correction Factor (dB).

4.2 Modulation Characteristics Measurement

4.2.1 Limits of Modulation Characteristics

N/A

4.2.2 Test Procedure

Connect the EUT to Communication Simulator via the antenna connector, The frequency band is set as EUT supported Modulation and Channels, the EUT output is matched with 50 ohm load, the waveform quality and constellation of the EUT was tested.

4.2.3 Test Setup



4.2.4 Test Results

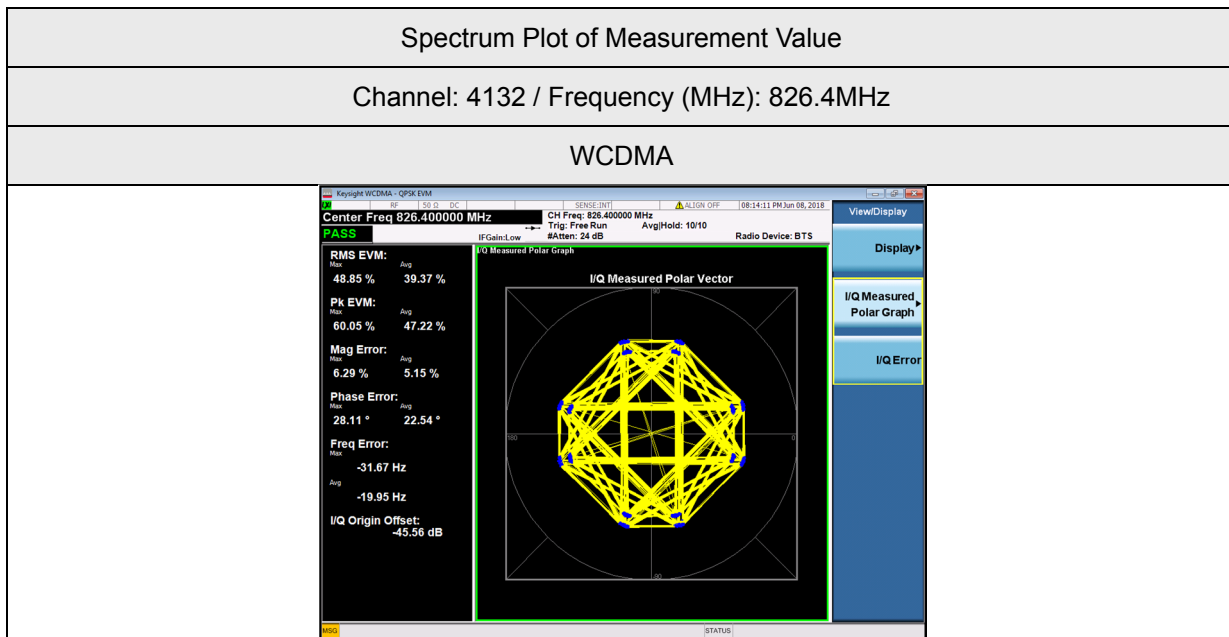
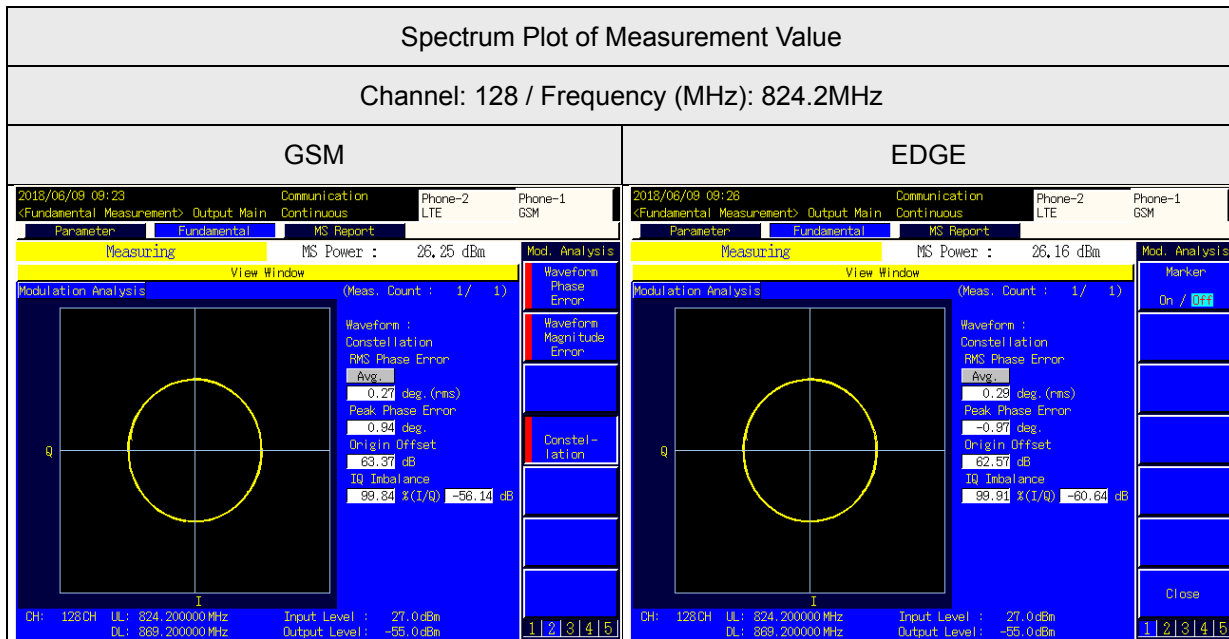

LTE Band 5

Spectrum Plot of Measurement Value

Channel: 20525 / Frequency (MHz): 836.5MHz

Channel Bandwidth: 1.4MHz / QPSK

Channel Bandwidth: 1.4MHz / 16QAM

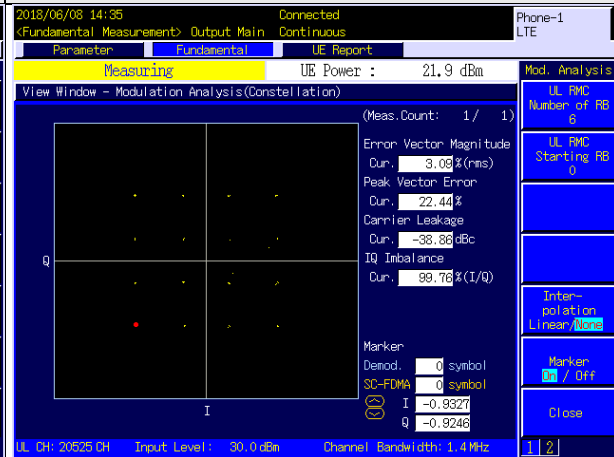
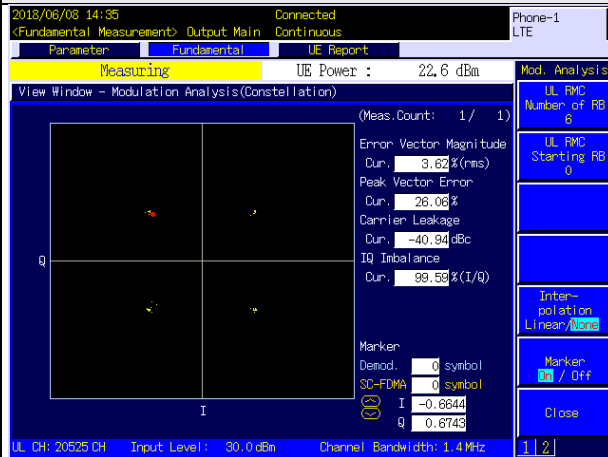

Channel Bandwidth: 10MHz / QPSK

Channel Bandwidth: 10MHz / 16QAM

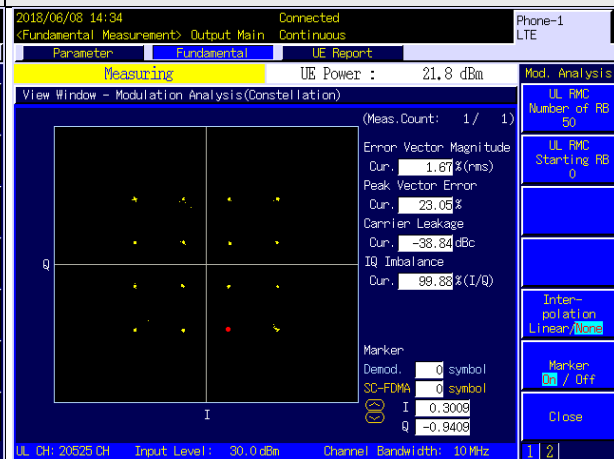
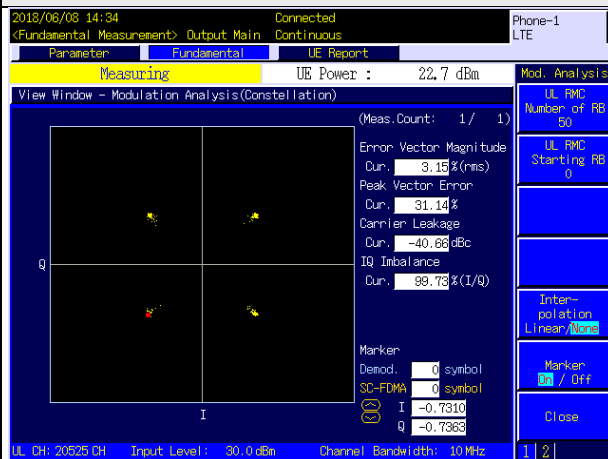

4.3 Frequency Stability Measurement

4.3.1 Limits of Frequency Stability Measurement

1.5 ppm is for base and fixed station. 2.5 ppm is for mobile station.

4.3.2 Test Procedure

- a. Device is placed at the oven room. The oven room could control the temperatures and humidity. Power warm up is at least 15 min and power applied should perform before recording frequency error.
- b. EUT is connected the external power supply to control the DC input power. The test voltage range is from minimum to maximum working voltage. Each step shall be record the frequency error rate.
- c. The temperature range step is 10 degrees in this test items. All temperature levels shall be hold the ± 0.5 °C during the measurement testing. The each temperature step shall be at least 0.5 hours, consider the EUT could be test under the stability condition.

NOTE: The frequency error was recorded frequency error from the communication simulator.

4.3.3 Test Setup

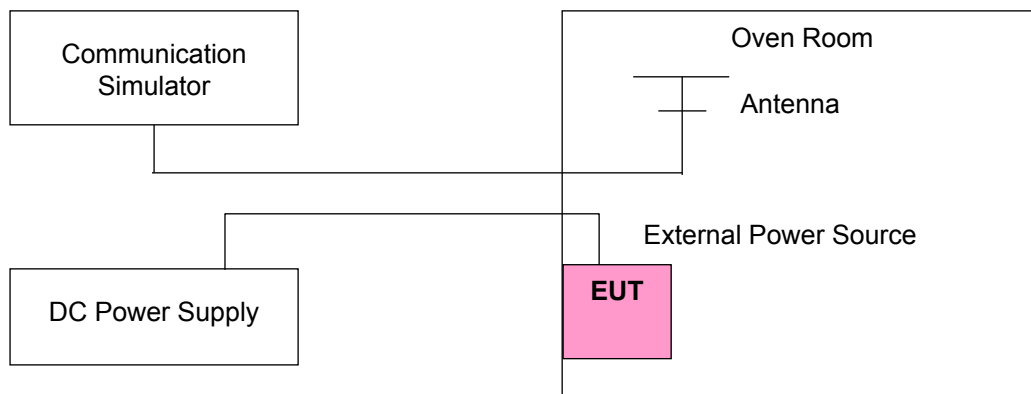

4.3.4 Test Results

Frequency Error vs. Voltage

Voltage (Volts)	Frequency Error (ppm)			Limit (ppm)
	GSM	WCDMA	LTE Band 5	
4.3	0.04418	0.03821	0.01802	2.5
3.8	0.04505	0.06609	0.02603	2.5
3.4	0.04419	0.01322	0.04710	2.5

Note: The applicant defined the normal working voltage is from 3.4Vdc to 4.3Vdc.

Frequency Error vs. Temperature.

Temp. (°C)	Frequency Error (ppm)			Limit (ppm)
	GSM	WCDMA	LTE Band 5	
50	0.00029	0.06102	0.01183	2.5
40	0.03203	0.06642	0.05965	2.5
30	0.05792	0.00204	0.00856	2.5
20	0.07494	0.07468	0.02603	2.5
10	0.07830	0.06544	0.03121	2.5
0	0.05319	0.05772	0.03380	2.5
-10	0.03026	0.02213	0.05476	2.5
-20	0.01294	0.06086	0.07523	2.5
-30	0.04792	0.02253	0.03519	2.5

4.4 Occupied Bandwidth Measurement

4.4.1 Test Procedure

The EUT makes a call to the communication simulator. All measurements were done at low, middle and high operational frequency range. The communication simulator station system controlled a EUT to export maximum output power under transmission mode and specific channel frequency. Use OBW measurement function of Spectrum analyzer to measure 99 % occupied bandwidth.

4.4.2 Test Setup

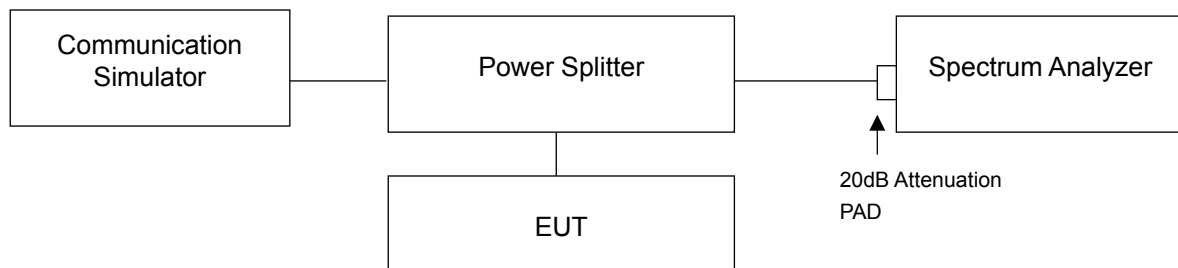

4.4.3 Test Result

Channel	Frequency (MHz)	99% Occupied Bandwidth (kHz)	
		GSM	EDGE
128	824.2	250	250
189	836.4	260	250
251	848.8	260	250

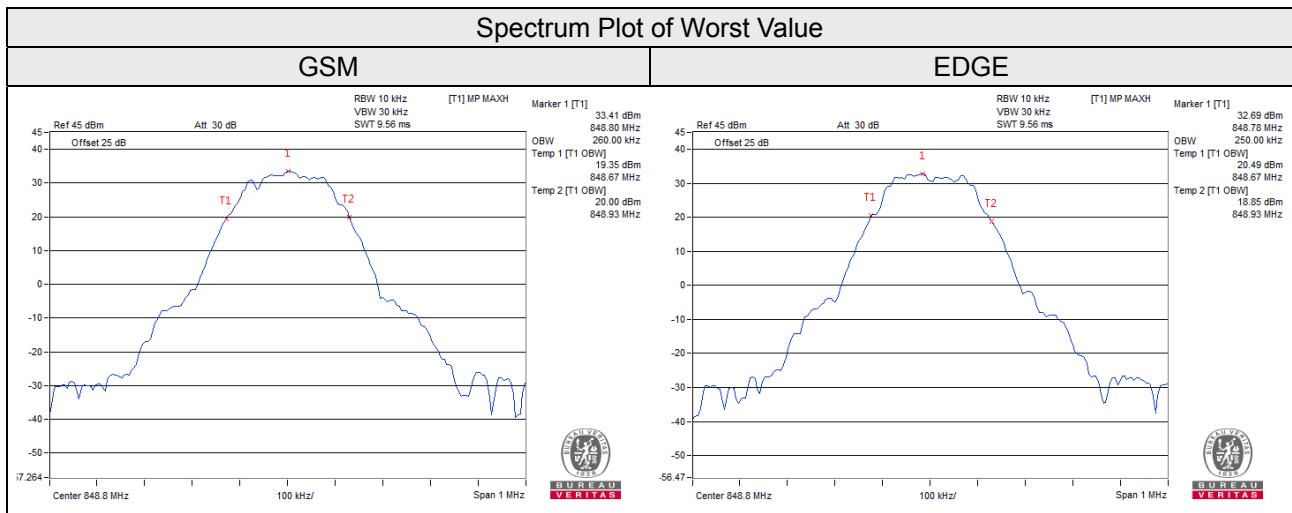

Channel	Frequency (MHz)	99% Occupied Bandwidth (MHz)
		WCDMA
4132	826.4	4.11
4182	836.6	4.15
4233	846.6	4.13

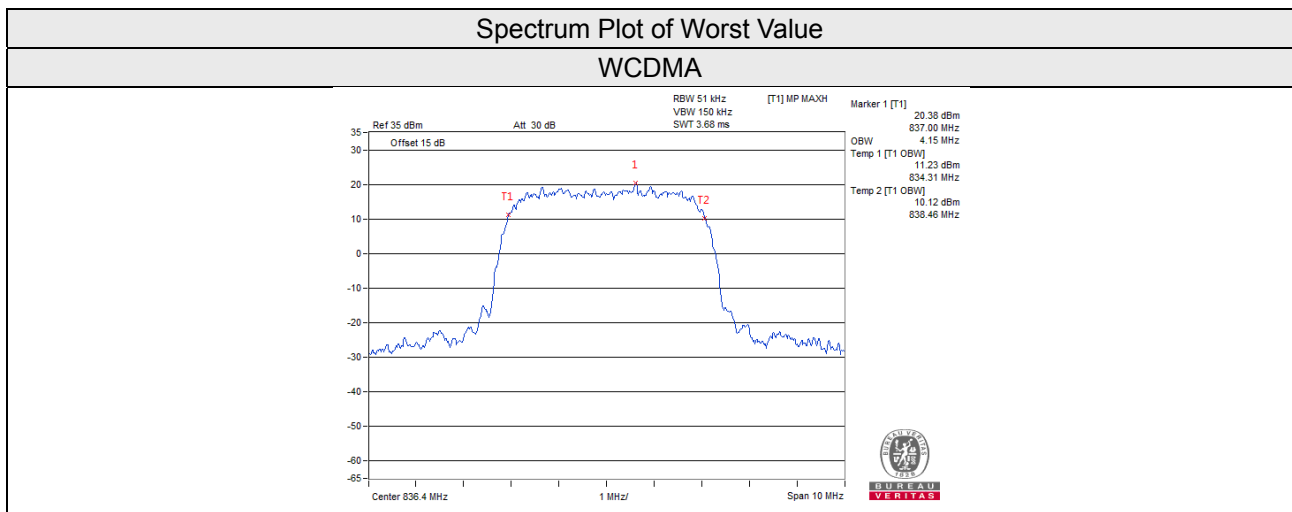

26dB Bandwidth

Channel	Frequency (MHz)	26dB Bandwidth (kHz)	
		GSM	EDGE
128	824.2	315.638	315.721
189	836.4	314.369	312.175
251	848.8	314.155	309.932

Spectrum Plot of Worst Value

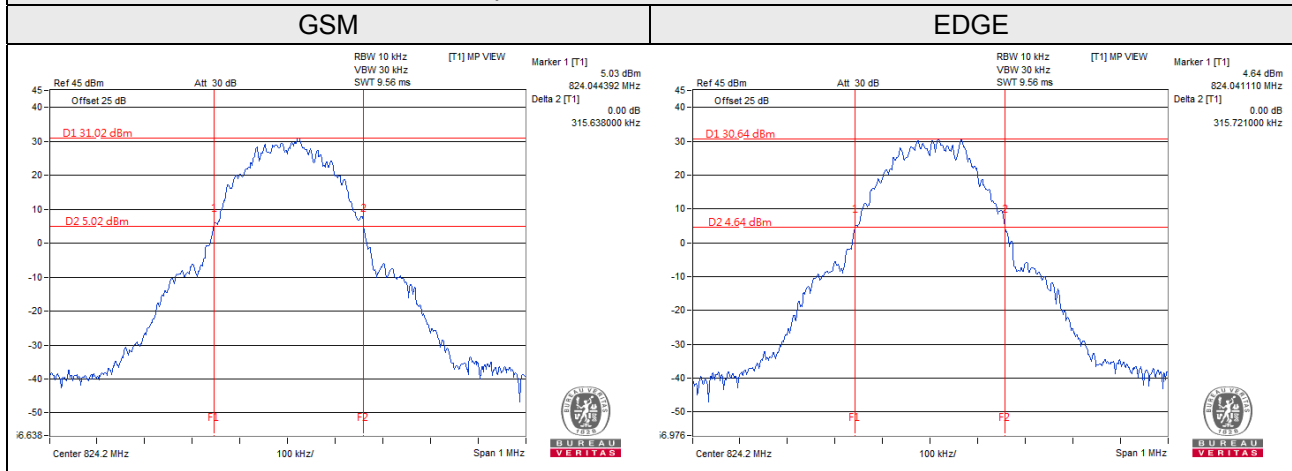

Channel	Frequency (MHz)	26dB Bandwidth (MHz)
		WCDMA
4132	826.4	4.666
4182	836.6	4.698
4233	846.6	4.690

Spectrum Plot of Worst Value

WCDMA

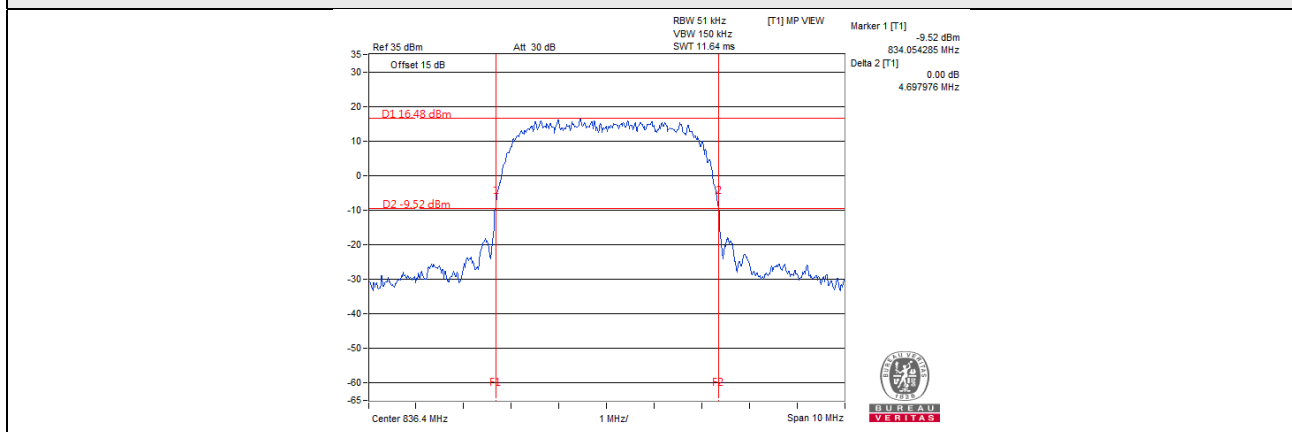

LTE Band 5, Channel Bandwidth 1.4MHz				
Channel	Frequency (MHz)	26dB Bandwidth (MHz)		
		QPSK	16QAM	64QAM
20407	824.7	1.242	1.236	1.232
20525	836.5	1.239	1.233	1.225
20643	848.3	1.239	1.241	1.234

LTE Band 5, Channel Bandwidth 3MHz				
Channel	Frequency (MHz)	26dB Bandwidth (MHz)		
		QPSK	16QAM	64QAM
20415	825.5	2.983	2.945	2.961
20525	836.5	2.957	2.953	2.960
20635	847.5	2.955	2.952	2.971

LTE Band 5, Channel Bandwidth 5MHz				
Channel	Frequency (MHz)	26dB Bandwidth (MHz)		
		QPSK	16QAM	64QAM
20425	826.5	4.889	4.887	4.851
20525	836.5	4.907	4.911	4.876
20625	846.5	4.872	4.878	4.885

LTE Band 5, Channel Bandwidth 10MHz				
Channel	Frequency (MHz)	26dB Bandwidth (MHz)		
		QPSK	16QAM	64QAM
20450	829.0	9.626	9.613	9.573
20525	836.5	9.604	9.580	9.622
20600	844.0	9.550	9.584	9.550

Spectrum Plot of Worst Value

1.4MHz / QPSK

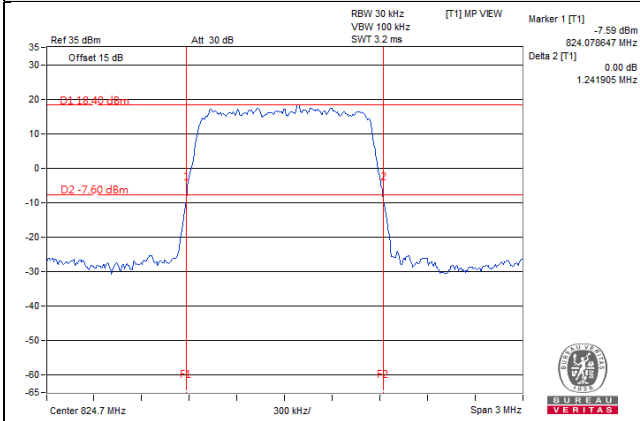

3MHz / QPSK

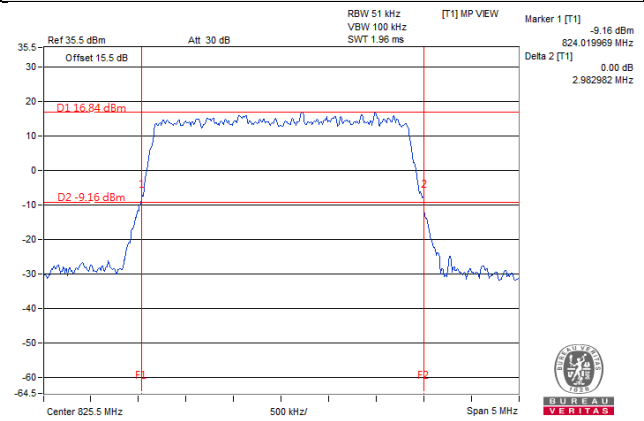

5MHz / 16QAM

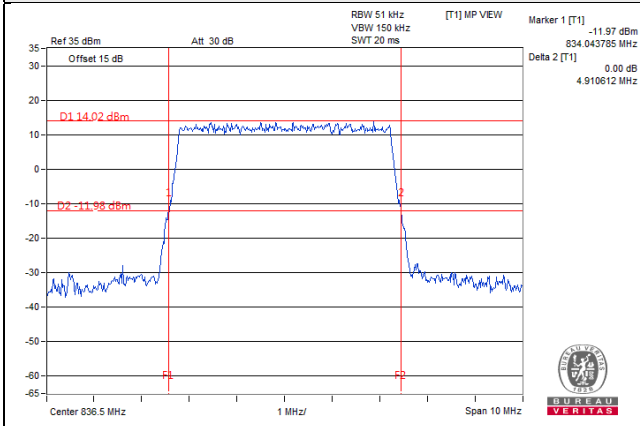

10MHz / QPSK

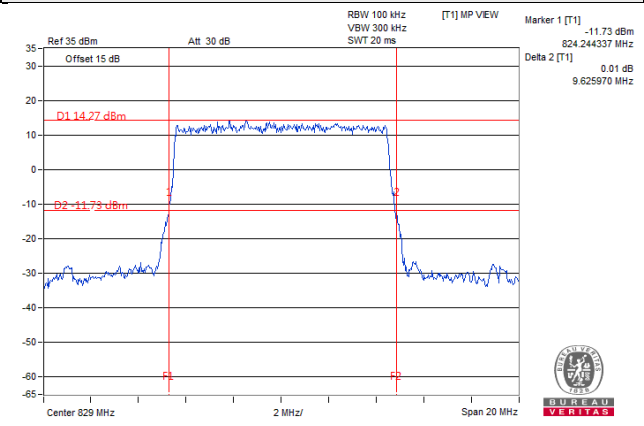

Occupied Bandwidth

LTE Band 5, Channel Bandwidth 1.4MHz				
Channel	Frequency (MHz)	99% Occupied Bandwidth (MHz)		
		QPSK	16QAM	64QAM
20407	824.7	1.09	1.09	1.09
20525	836.5	1.09	1.09	1.09
20643	848.3	1.09	1.09	1.08

LTE Band 5, Channel Bandwidth 3MHz				
Channel	Frequency (MHz)	99% Occupied Bandwidth (MHz)		
		QPSK	16QAM	64QAM
20415	825.5	2.68	2.68	2.68
20525	836.5	2.68	2.68	2.68
20635	847.5	2.68	2.69	2.68

LTE Band 5, Channel Bandwidth 5MHz				
Channel	Frequency (MHz)	99% Occupied Bandwidth (MHz)		
		QPSK	16QAM	64QAM
20425	826.5	4.48	4.48	4.48
20525	836.5	4.48	4.48	4.48
20625	846.5	4.46	4.48	4.48

LTE Band 5, Channel Bandwidth 10MHz				
Channel	Frequency (MHz)	99% Occupied Bandwidth (MHz)		
		QPSK	16QAM	64QAM
20450	829.0	8.96	8.93	8.90
20525	836.5	8.93	8.93	8.90
20600	844.0	8.93	8.93	8.93

Spectrum Plot of Worst Value

1.4MHz / QPSK

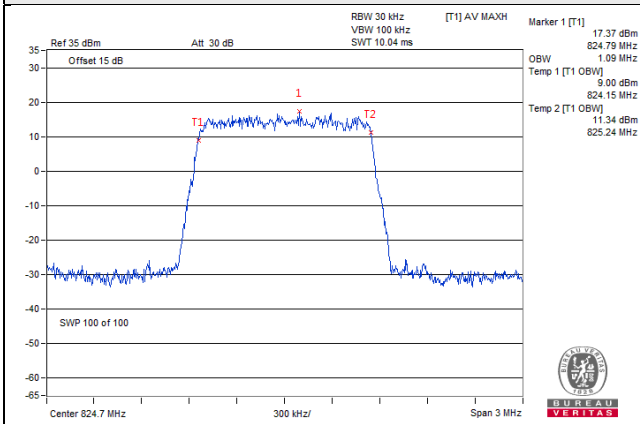

3MHz / 16QAM

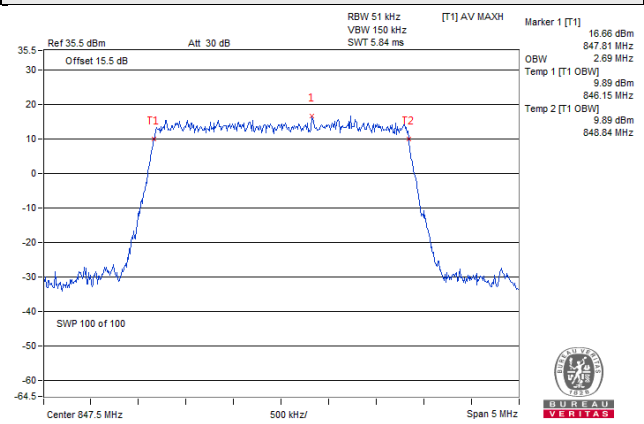

5MHz / QPSK

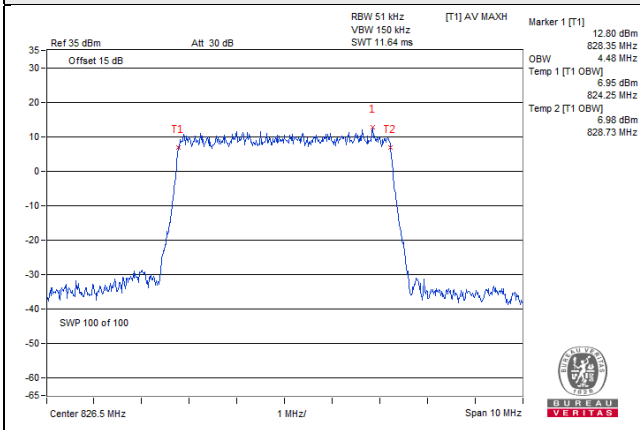

10MHz / QPSK

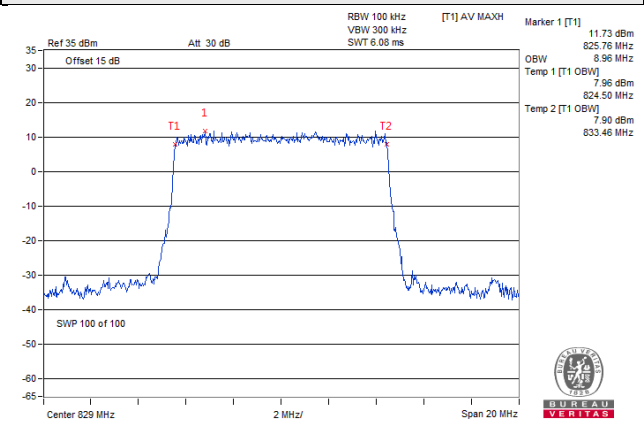

4.5 Band Edge Measurement

4.5.1 Limits of Band Edge Measurement

Power of any emission outside of the authorized operating frequency ranges must be attenuated below the transmitting power (P) by a factor of at least $43 + 10 \log(P)$ dB. In the 1 MHz bands immediately outside and adjacent to the frequency block a resolution bandwidth of at least one percent of the emission bandwidth of the fundamental emission of the transmitter may be employed.

4.5.2 Test Setup

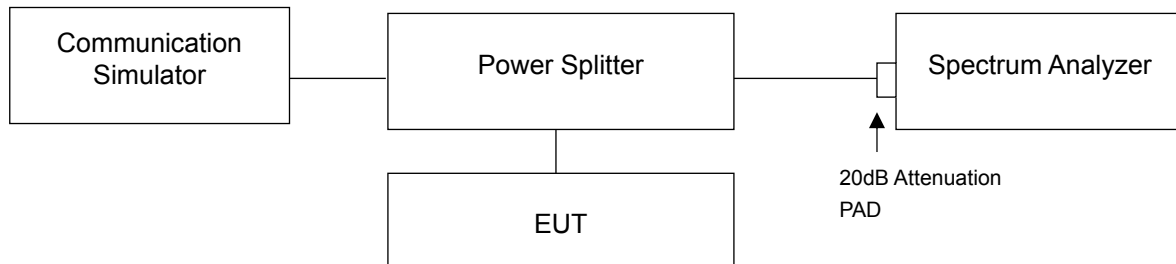

4.5.3 Test Procedures

- All measurements were done at low and high operational frequency range.
- The center frequency of spectrum is the band edge frequency and span is 1.5MHz. RB of the spectrum is 10kHz and VB of the spectrum is 30kHz (GSM / EDGE).
- The center frequency of spectrum is the band edge frequency and span is 10MHz. RB of the spectrum is 51kHz and VB of the spectrum is 150kHz (WCDMA).
- The center frequency of spectrum is the band edge frequency and span is 1.5MHz. RB of the spectrum is 30kHz and VB of the spectrum is 100kHz (LTE Channel Bandwidth 1.4MHz).
- The center frequency of spectrum is the band edge frequency and span is 1.5MHz. RB of the spectrum is 51kHz and VB of the spectrum is 150kHz (LTE Channel Bandwidth 3MHz and 5MHz).
- The center frequency of spectrum is the band edge frequency and span is 1.5MHz. RB of the spectrum is 100kHz and VB of the spectrum is 300kHz (LTE Channel Bandwidth 10MHz).
- Record the max trace plot into the test report.

4.5.4 Test Results

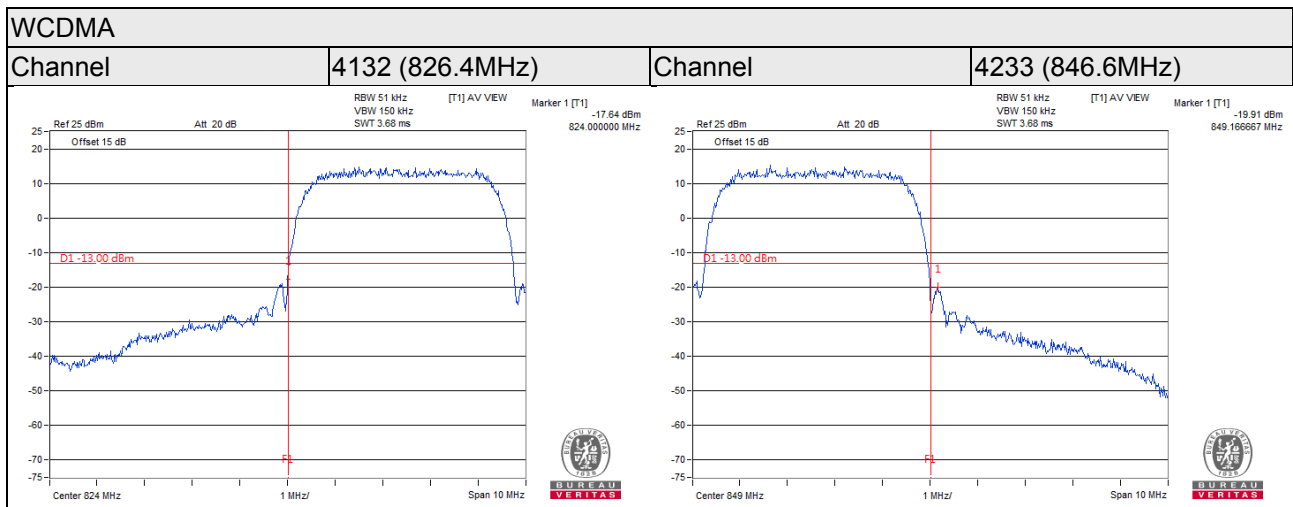
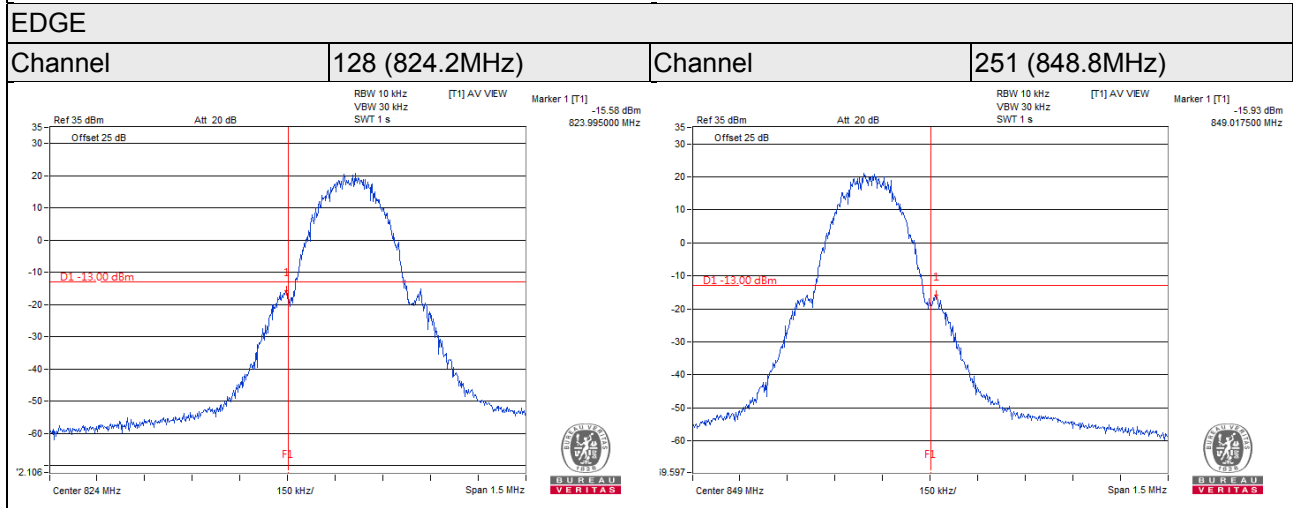
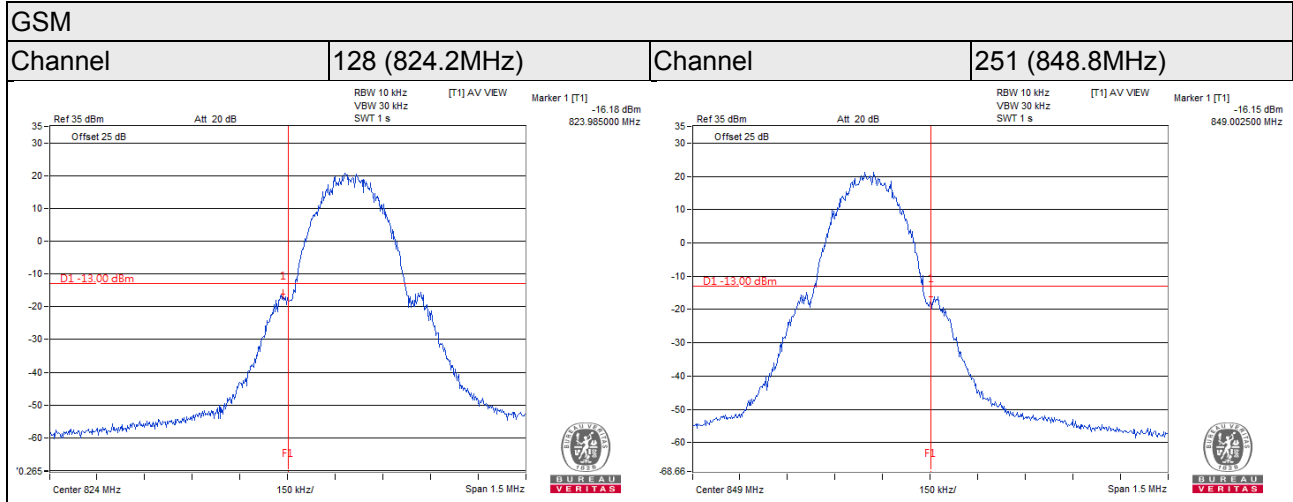

LTE Band 5, Channel Bandwidth 1.4MHz

Channel 20407 (824.7MHz)	QPSK	1 RB / 0 RB Offset	Channel 20643 (848.3MHz)	QPSK	1 RB / 5 RB Offset
-------------------------------------	-------------	---------------------------	-------------------------------------	-------------	---------------------------

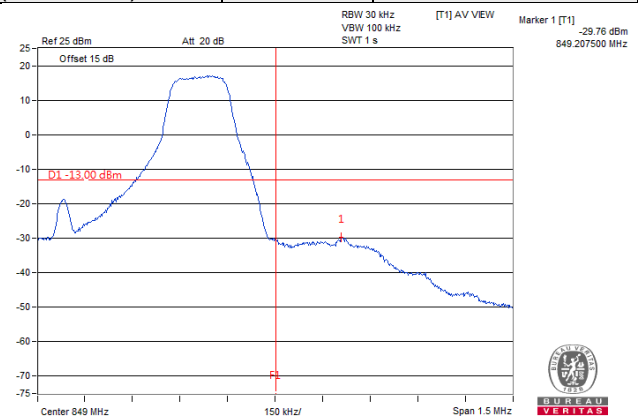
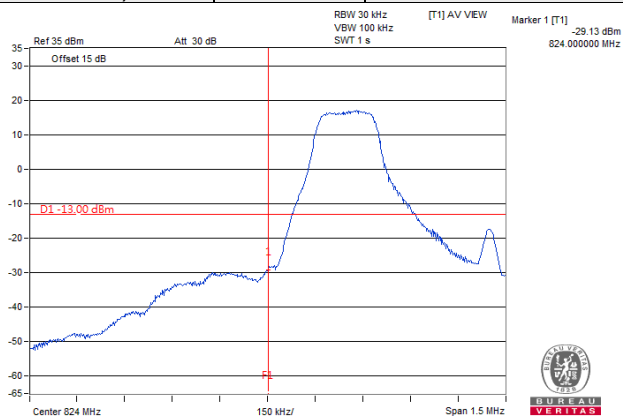

Channel 20407 (824.7MHz)	QPSK	6 RB / 0 RB Offset	Channel 20643 (848.3MHz)	QPSK	6 RB / 0 RB Offset
-------------------------------------	-------------	---------------------------	-------------------------------------	-------------	---------------------------

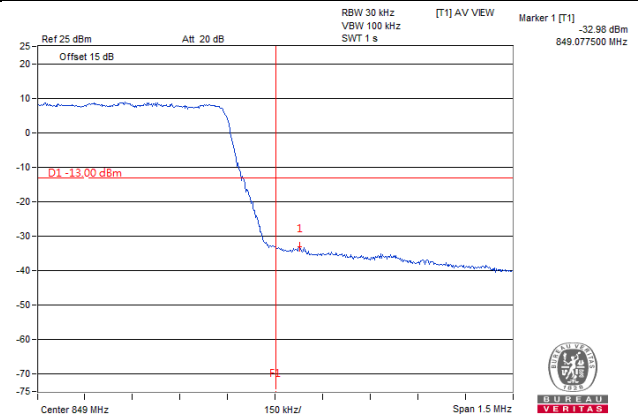
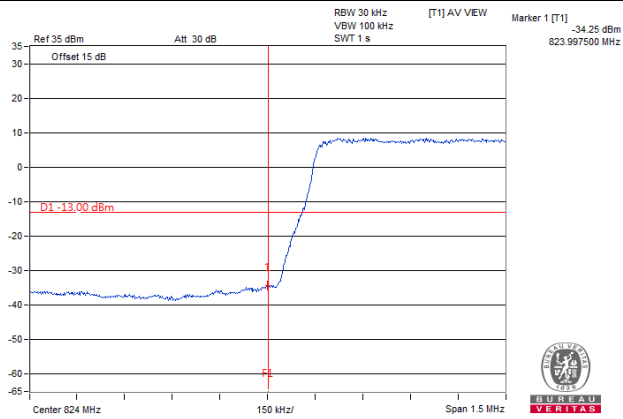

LTE Band 5, Channel Bandwidth 3MHz

Channel 20415 (825.5MHz)	QPSK	1 RB / 0 RB Offset	Channel 20635 (847.5MHz)	QPSK	1 RB / 14 RB Offset
-------------------------------------	-------------	---------------------------	-------------------------------------	-------------	----------------------------

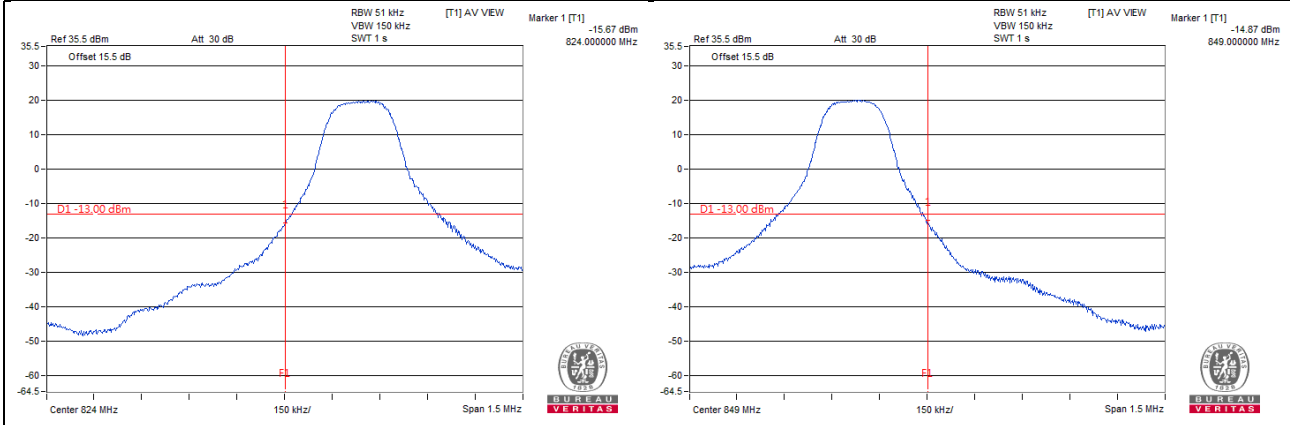

Channel 20415 (825.5MHz)	QPSK	15 RB / 0 RB Offset	Channel 20635 (847.5MHz)	QPSK	15 RB / 0 RB Offset
-------------------------------------	-------------	----------------------------	-------------------------------------	-------------	----------------------------

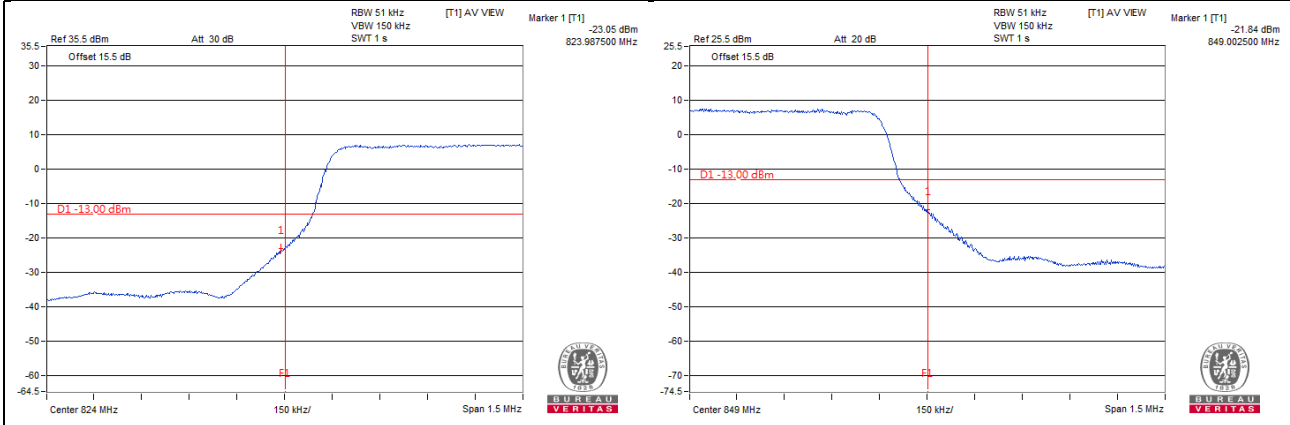

LTE Band 5, Channel Bandwidth 5MHz

Channel 20425 (826.5MHz)	QPSK	1 RB / 0 RB Offset	Channel 20625 (846.5MHz)	QPSK	1 RB / 24 RB Offset
-------------------------------------	-------------	---------------------------	-------------------------------------	-------------	----------------------------

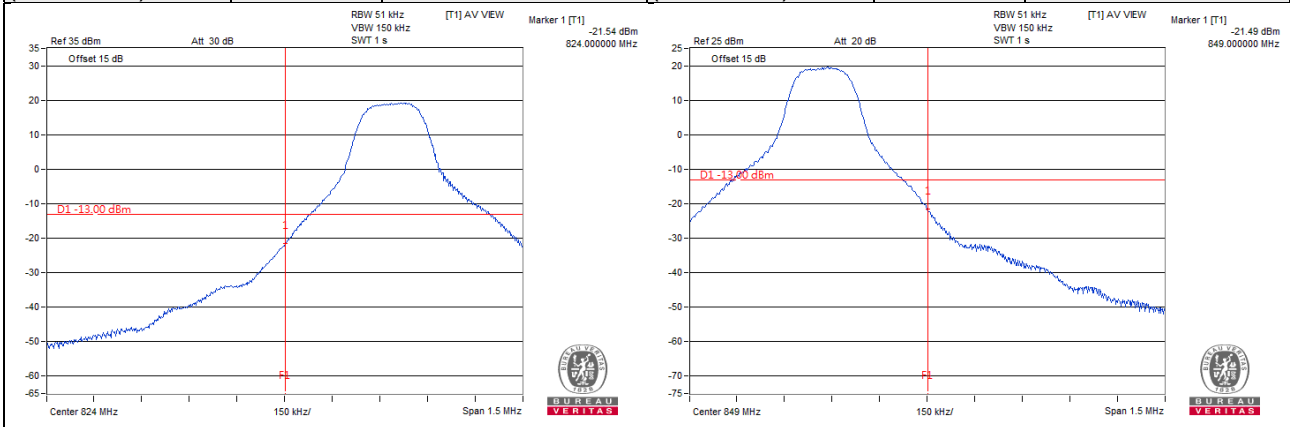

Channel 20425 (826.5MHz)	QPSK	25 RB / 0 RB Offset	Channel 20625 (846.5MHz)	QPSK	25 RB / 0 RB Offset
-------------------------------------	-------------	----------------------------	-------------------------------------	-------------	----------------------------

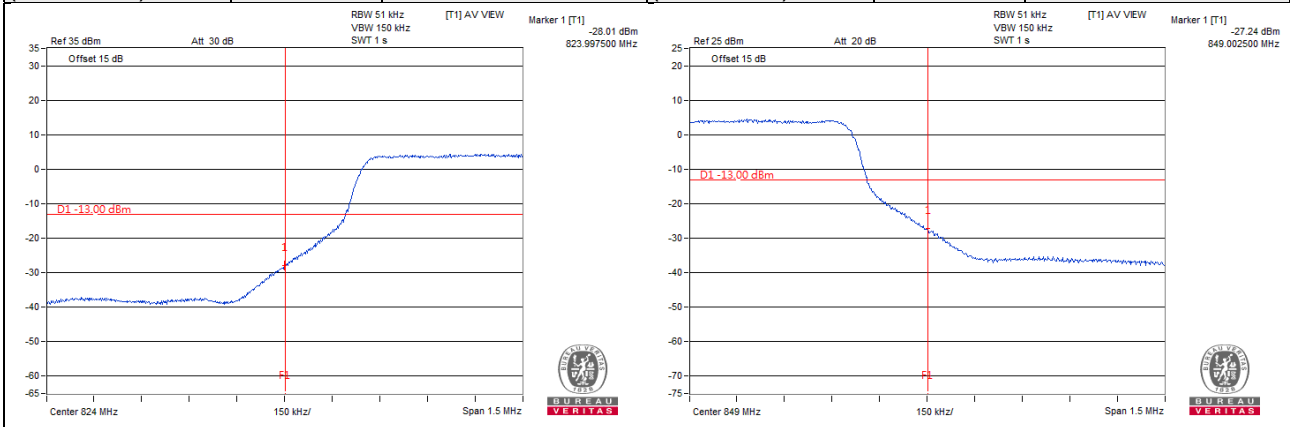

LTE Band 5, Channel Bandwidth 10MHz

Channel 20450 (829.0MHz)	QPSK	1 RB / 0 RB Offset	Channel 20600 (844.0MHz)	QPSK	1 RB / 49 RB Offset
-----------------------------	------	--------------------	-----------------------------	------	---------------------

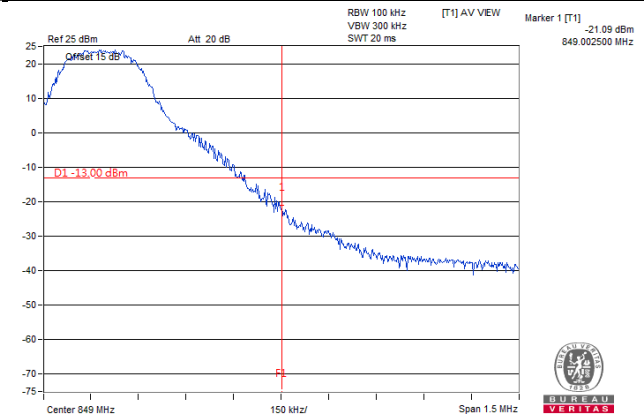
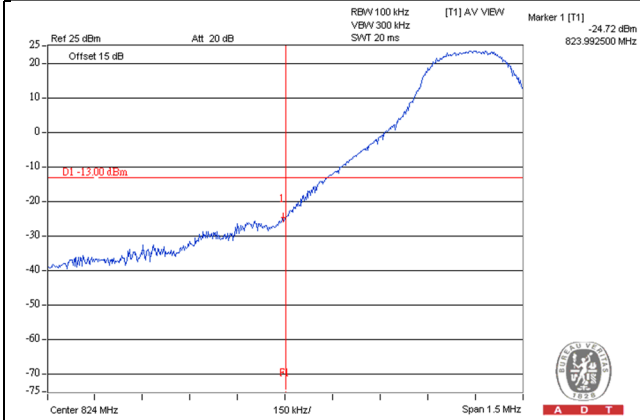

Channel 20450 (829.0MHz)	QPSK	50 RB / 0 RB Offset	Channel 20600 (844.0MHz)	QPSK	50 RB / 0 RB Offset
-----------------------------	------	---------------------	-----------------------------	------	---------------------

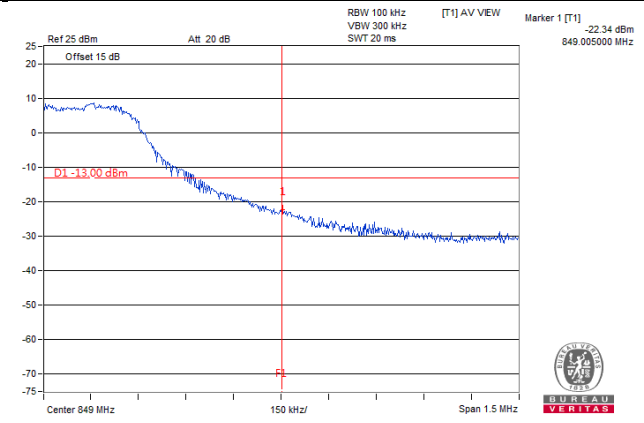
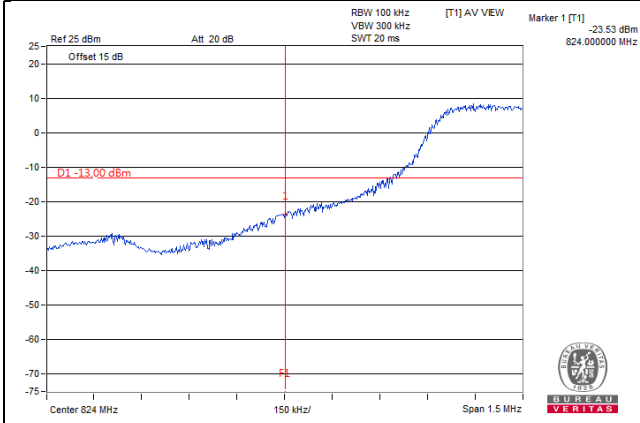

4.6 Peak to Average Ratio

4.6.1 Limits of Peak to Average Ratio Measurement

In measuring transmissions in this band using an average power technique, the peak to-average ratio (PAR) of the transmission may not exceed 13 dB

4.6.2 Test Setup

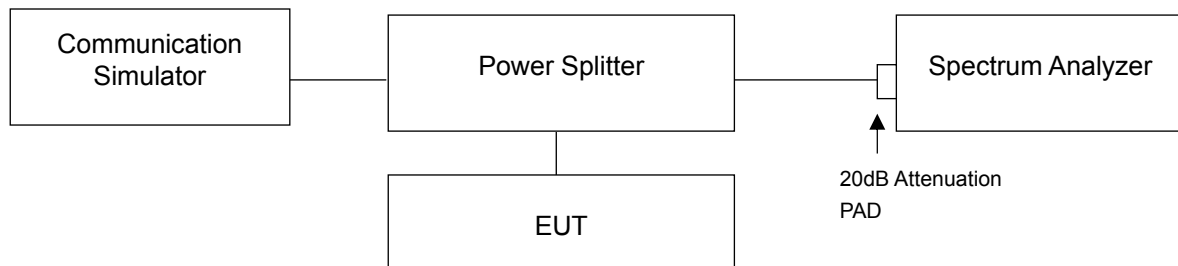

4.6.3 Test Procedures

- Set resolution/measurement bandwidth \geq signal's occupied bandwidth;
- Set the number of counts to a value that stabilizes the measured CCDF curve;
- Record the maximum PAPR level associated with a probability of 0.1%.

4.6.4 Test Results

Channel	Frequency (MHz)	Peak To Average Ratio (dB)	
		GSM	EDGE
128	824.2	2.73	2.73
189	836.4	2.72	2.72
251	848.8	2.74	2.72

Spectrum Plot of Worst Value

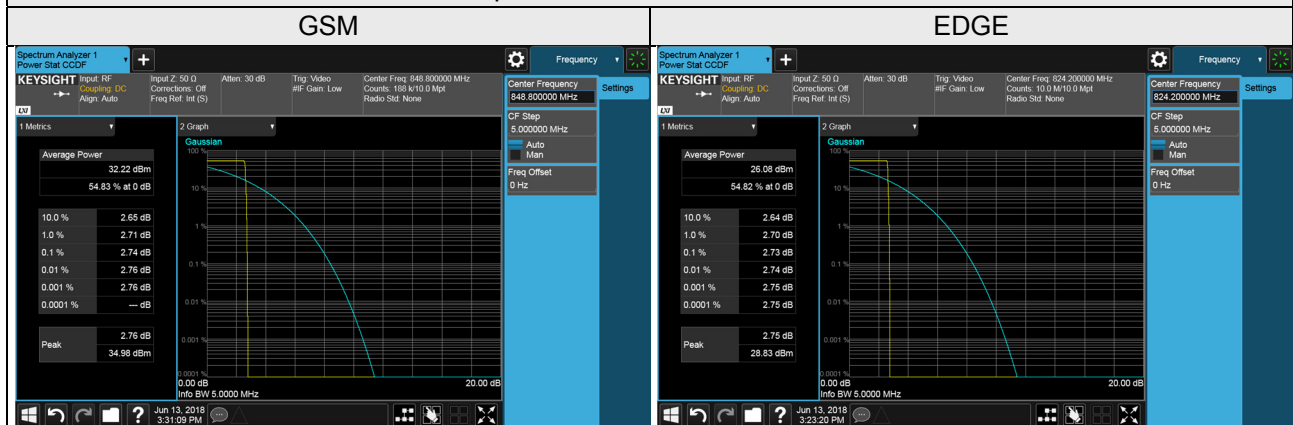

Channel	Frequency (MHz)	Peak To Average Ratio (dB)
		WCDMA
4132	826.4	2.96
4182	836.6	2.96
4233	846.6	3.08

Spectrum Plot of Worst Value

WCDMA

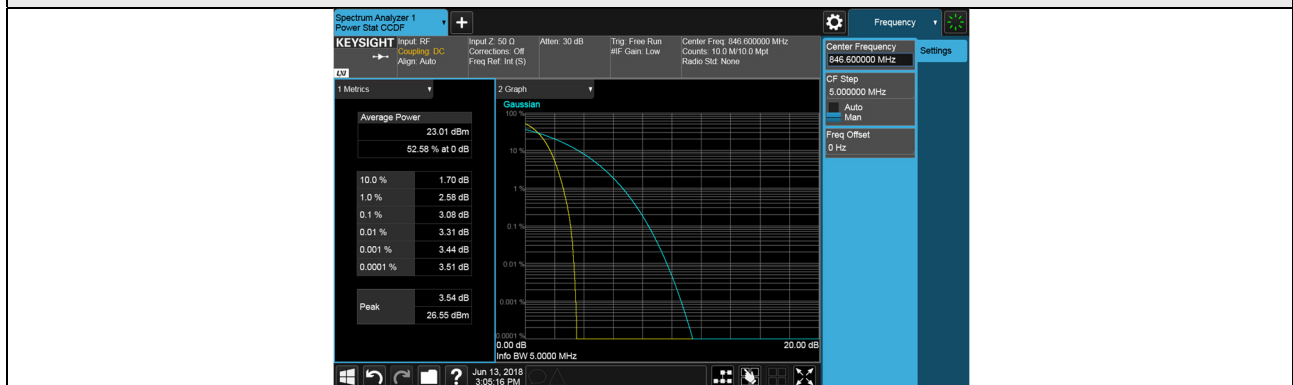

LTE Band 5, Channel Bandwidth 1.4MHz				
Channel	Frequency (MHz)	Peak To Average Ratio (dB)		
		QPSK	16QAM	64QAM
20407	824.7	4.73	4.73	5.04
20525	836.5	4.97	4.99	5.02
20643	848.3	5.02	5.03	5.02

LTE Band 5, Channel Bandwidth 3MHz				
Channel	Frequency (MHz)	Peak To Average Ratio (dB)		
		QPSK	16QAM	64QAM
20415	825.5	4.74	4.78	4.79
20525	836.5	4.79	4.81	4.79
20635	847.5	4.80	4.79	4.80

LTE Band 5, Channel Bandwidth 5MHz				
Channel	Frequency (MHz)	Peak To Average Ratio (dB)		
		QPSK	16QAM	64QAM
20425	826.5	4.92	4.92	4.92
20525	836.5	4.95	4.94	4.93
20625	846.5	4.94	4.95	4.93

LTE Band 5, Channel Bandwidth 10MHz				
Channel	Frequency (MHz)	Peak To Average Ratio (dB)		
		QPSK	16QAM	64QAM
20450	829.0	4.94	4.95	4.92
20525	836.5	4.95	4.96	4.96
20600	844.0	4.98	4.98	4.94

Spectrum Plot of Worst Value

1.4MHz / 64QAM

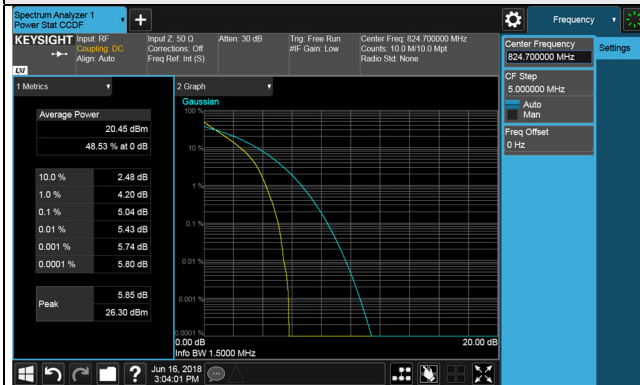

3MHz / 16QAM

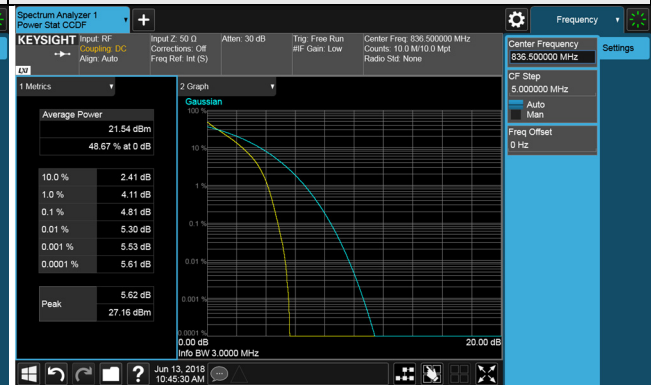

5MHz / QPSK

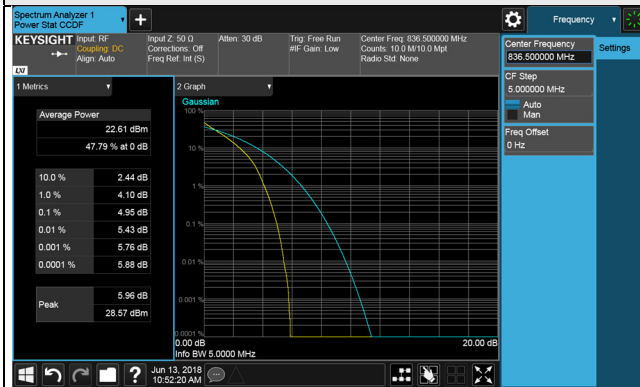

10MHz / QPSK

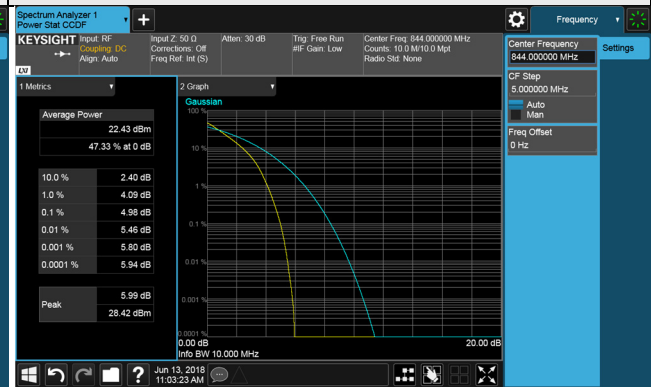

4.7 Conducted Spurious Emissions

4.7.1 Limits of Conducted Spurious Emissions Measurement

The power of any emission outside of the authorized operating frequency ranges must be attenuated below the transmitting power (P) by a factor of at least $43 + 10 \log(P)$ dB. The emission limit equal to -13dBm .

4.7.2 Test Setup

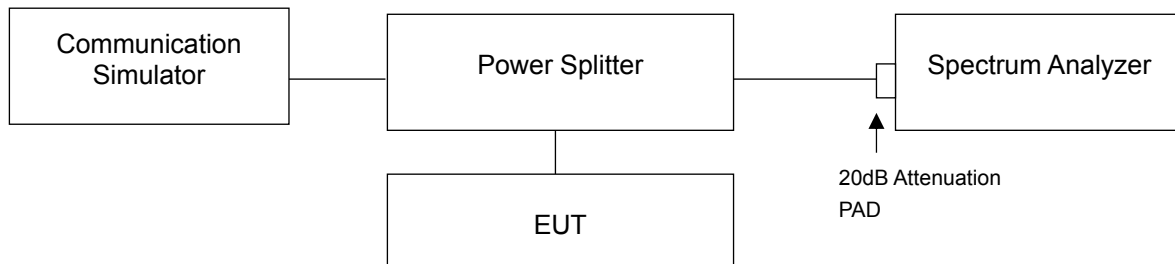

4.7.3 Test Procedure

- The EUT makes a phone call to the communication simulator. All measurements were done at low, middle and high operational frequency range.
- Measuring frequency range is from 9 kHz to 1GHz. 20dB attenuation pad is connected with spectrum. RBW=100kHz and VBW=300kHz is used for conducted emission measurement.
- Measuring frequency range is from 1GHz to 26.5GHz. 20dB attenuation pad is connected with spectrum. RBW=1MHz and VBW=3MHz is used for conducted emission measurement.

4.7.4 Test Results

GSM

Channel 128 (824.2MHz)

Frequency Range : 9kHz~1GHz Frequency Range : 1GHz~10GHz

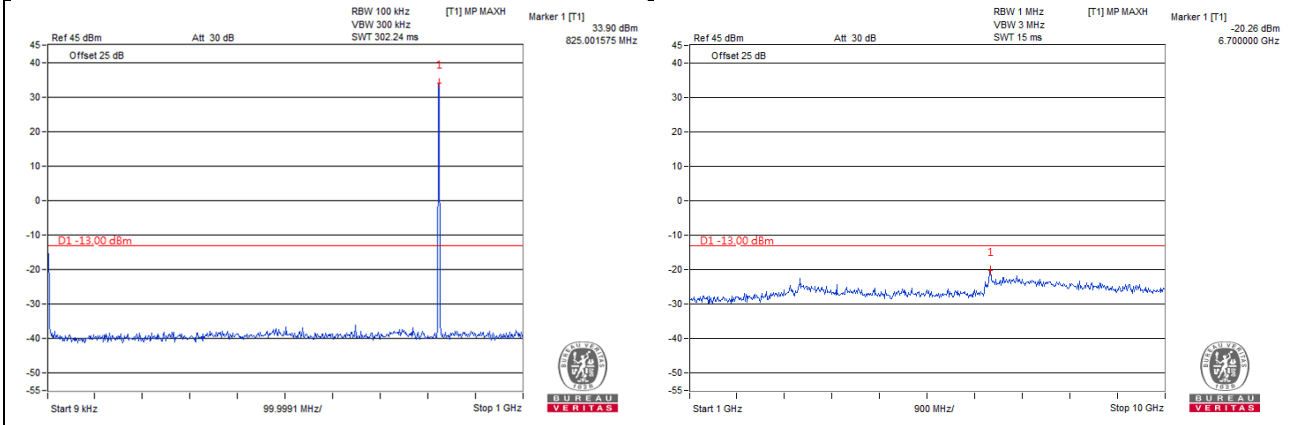

Frequency Range : 10GHz~26.5GHz

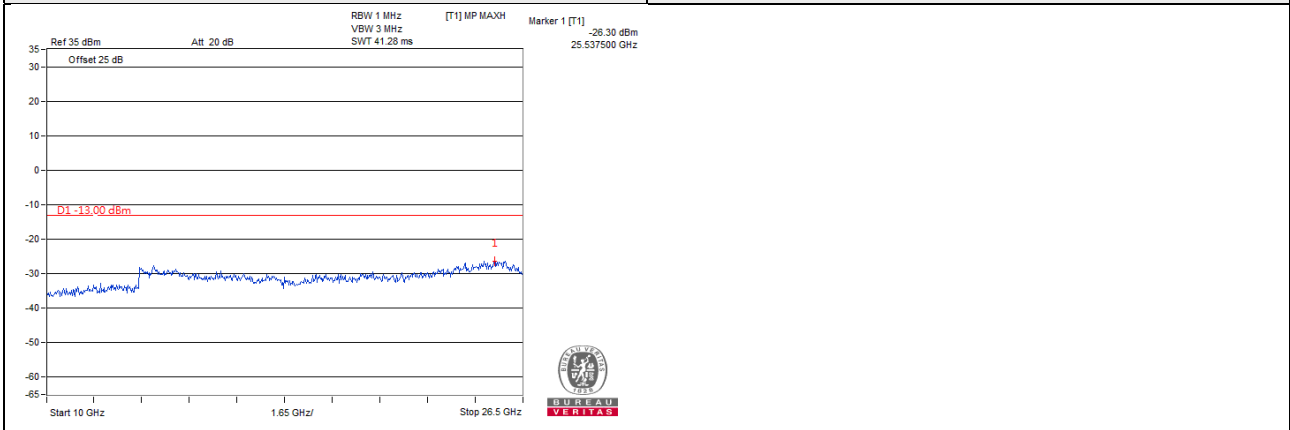

GSM

Channel 189 (836.4MHz)

Frequency Range : 9kHz~1GHz

Frequency Range : 1GHz~10GHz

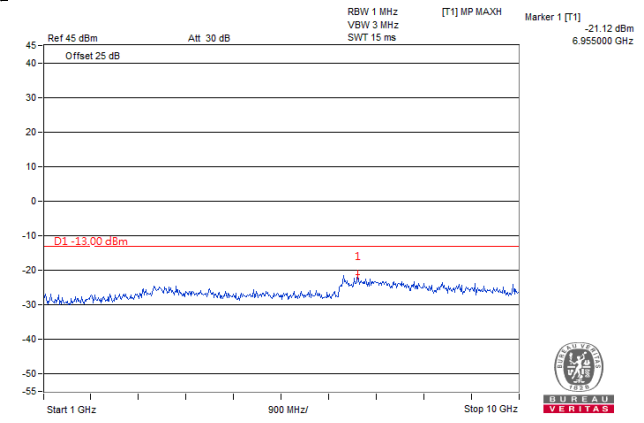
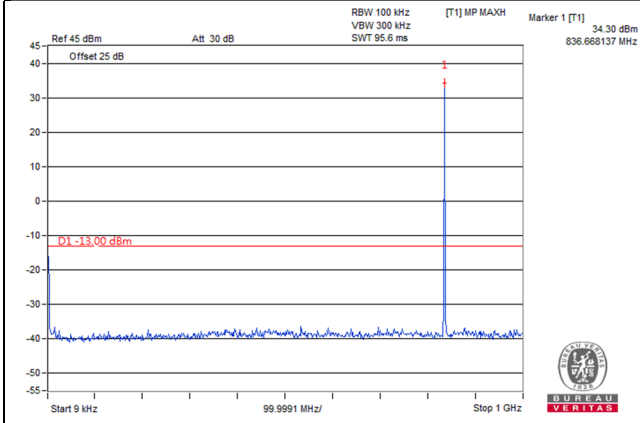

Frequency Range : 10GHz~26.5GHz

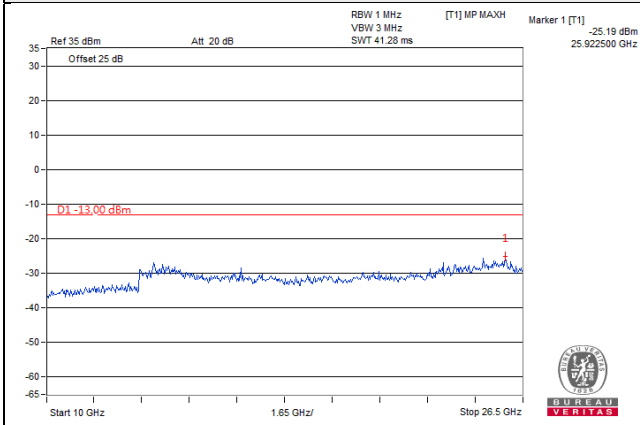

GSM

Channel 251 (848.8MHz)

Frequency Range : 9kHz~1GHz

Frequency Range : 1GHz~10GHz

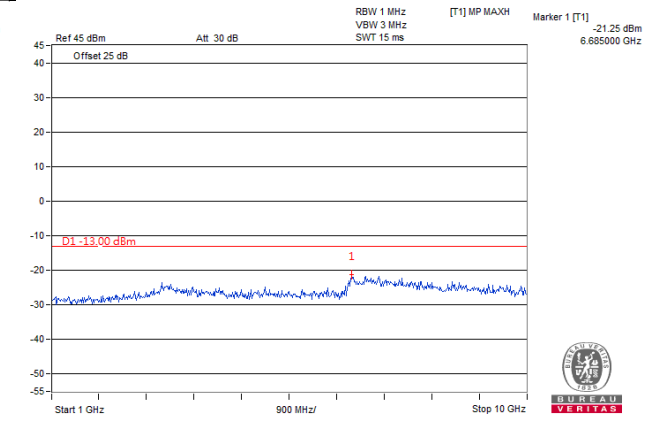
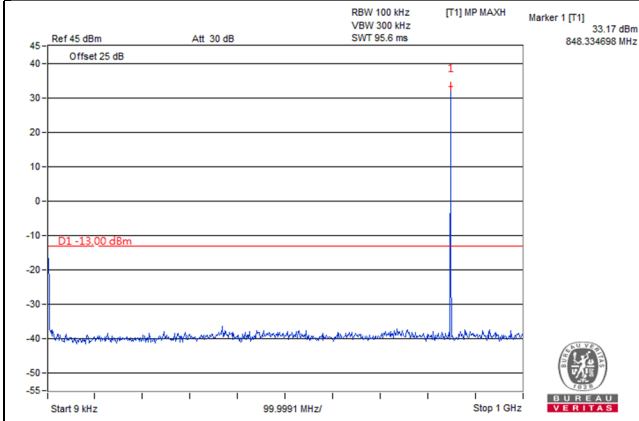

Frequency Range : 10GHz~26.5GHz

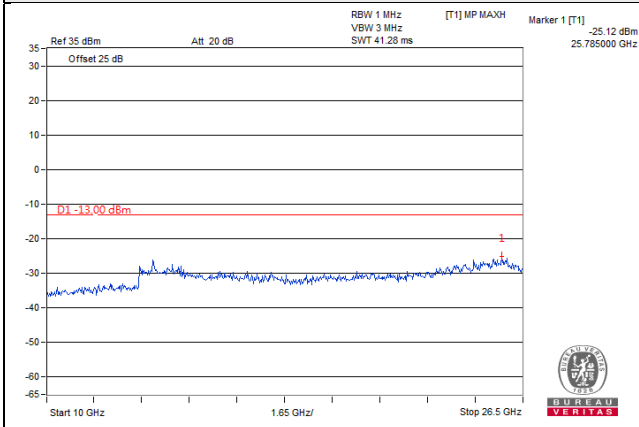

EDGE

Channel 128 (824.2MHz)

Frequency Range : 9kHz~1GHz

Frequency Range : 1GHz~10GHz

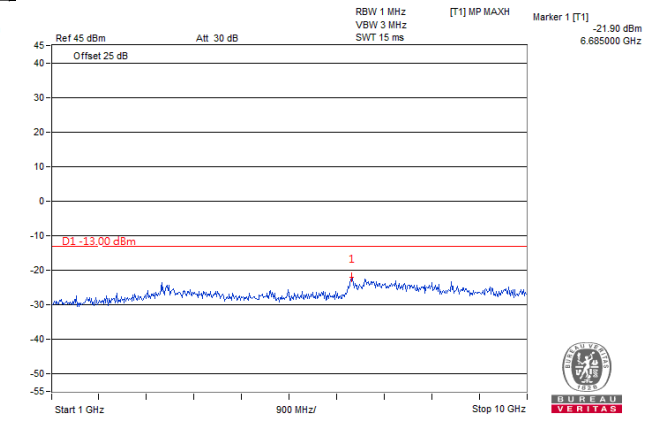
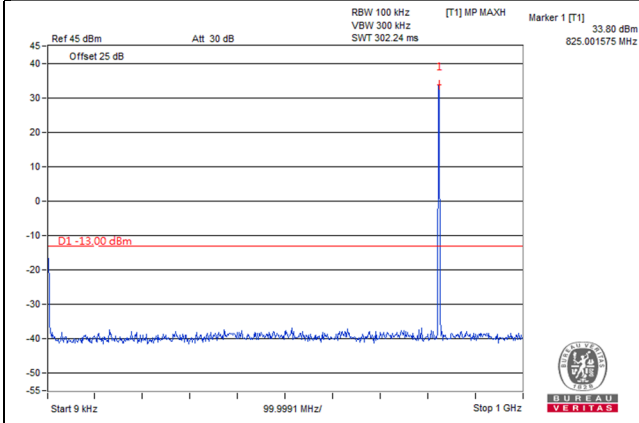

Frequency Range : 10GHz~26.5GHz

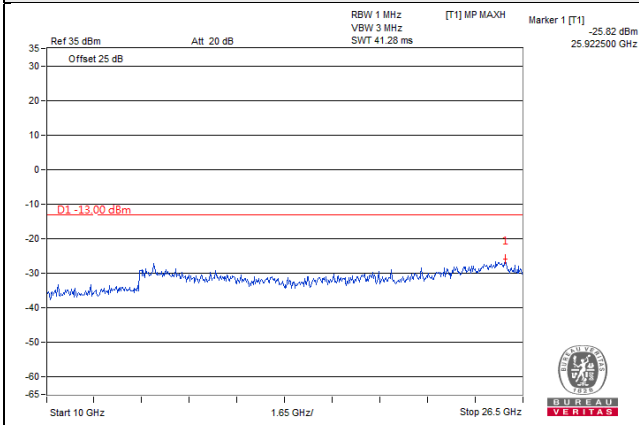

EDGE

Channel 189 (836.4MHz)

Frequency Range : 9kHz~1GHz

Frequency Range : 1GHz~10GHz

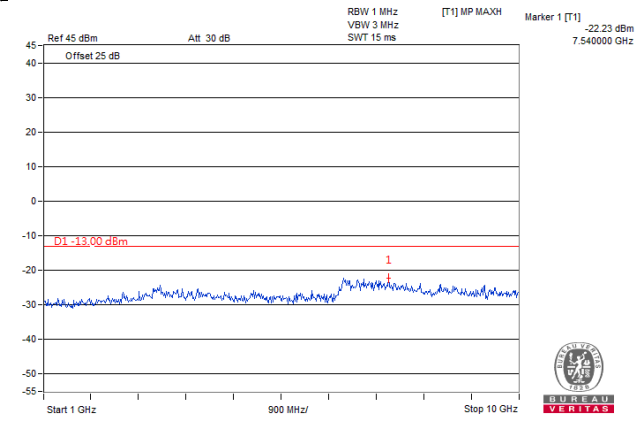
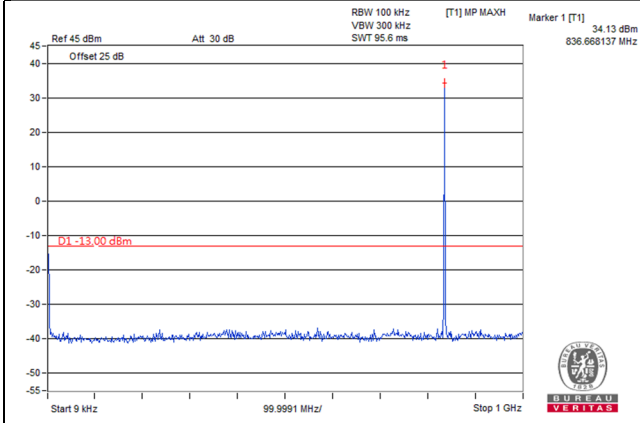

Frequency Range : 10GHz~26.5GHz

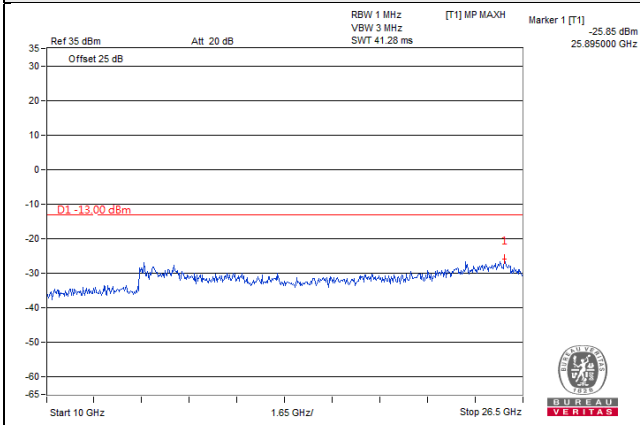

EDGE

Channel 251 (848.8MHz)

Frequency Range : 9kHz~1GHz

Frequency Range : 1GHz~10GHz

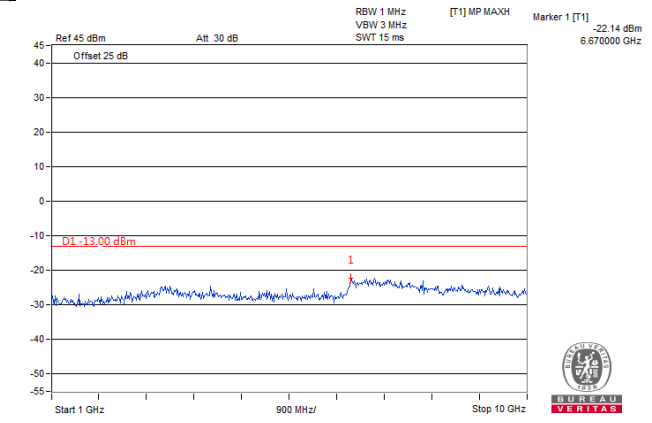
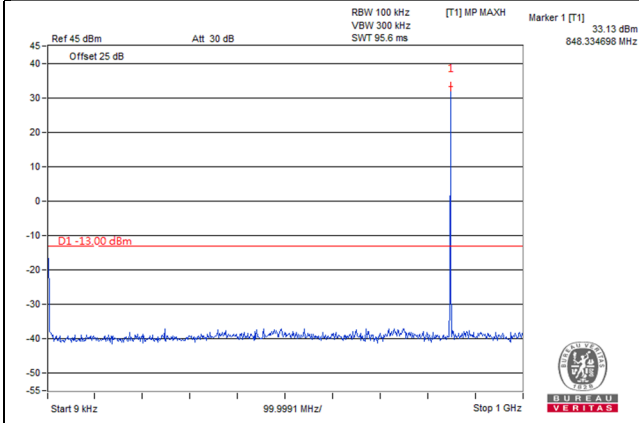

Frequency Range : 10GHz~26.5GHz

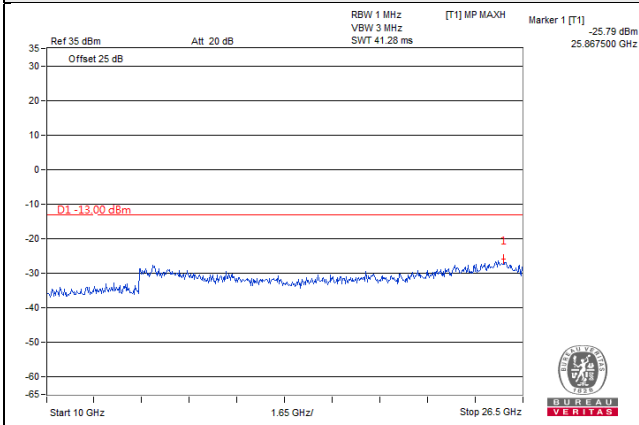

WCDMA

Channel 4132 (826.4MHz)

Frequency Range : 9kHz~1GHz

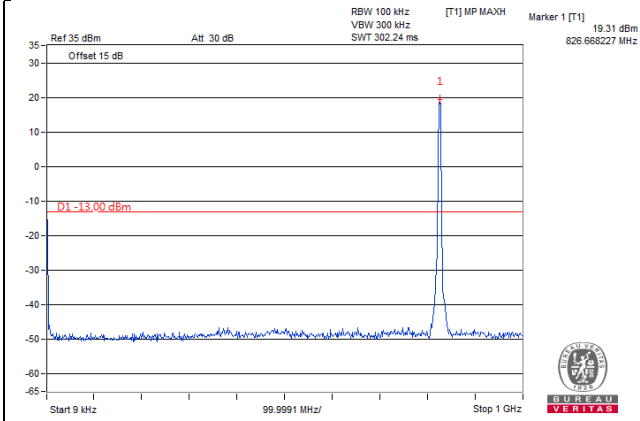

Frequency Range : 1GHz~10GHz

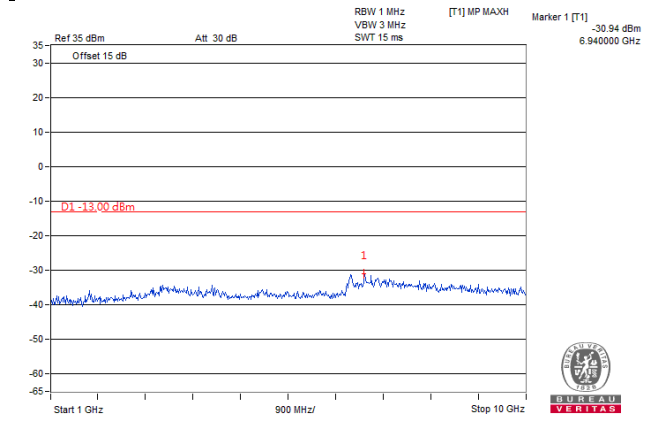

Frequency Range : 10GHz~26.5GHz

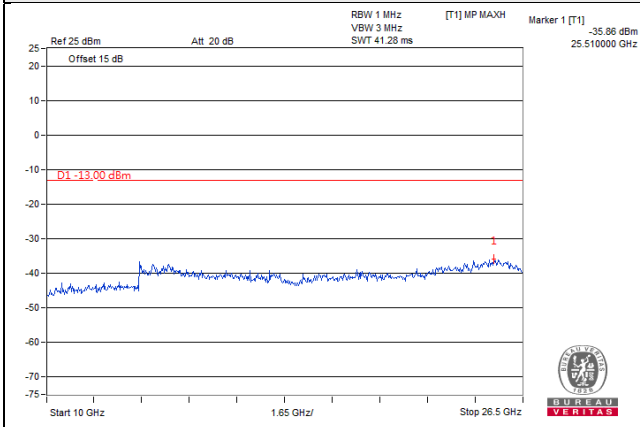

WCDMA

Channel 4182 (836.6MHz)

Frequency Range : 9kHz~1GHz

Frequency Range : 1GHz~10GHz

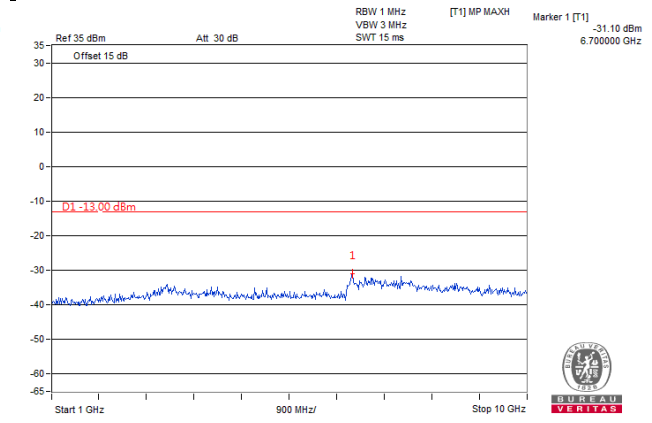
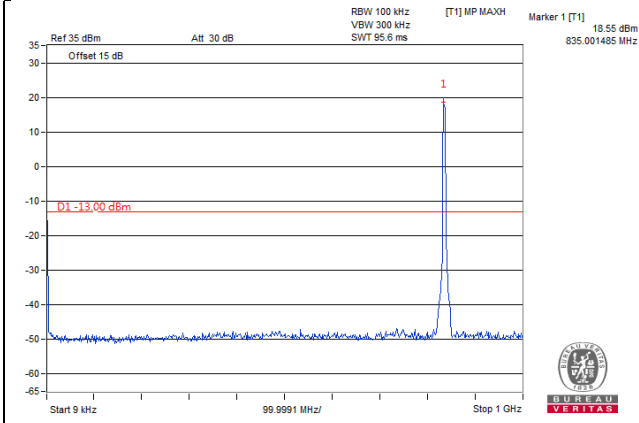

Frequency Range : 10GHz~26.5GHz

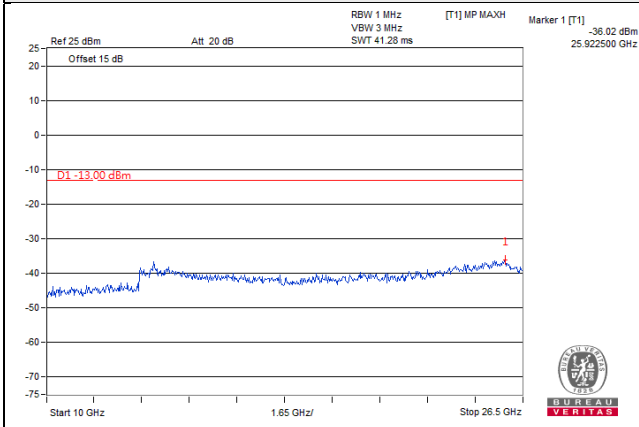

WCDMA

Channel 4233 (846.6MHz)

Frequency Range : 9kHz~1GHz

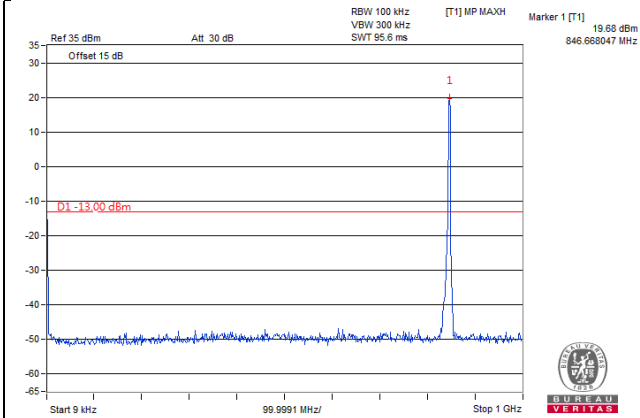

Frequency Range : 1GHz~10GHz

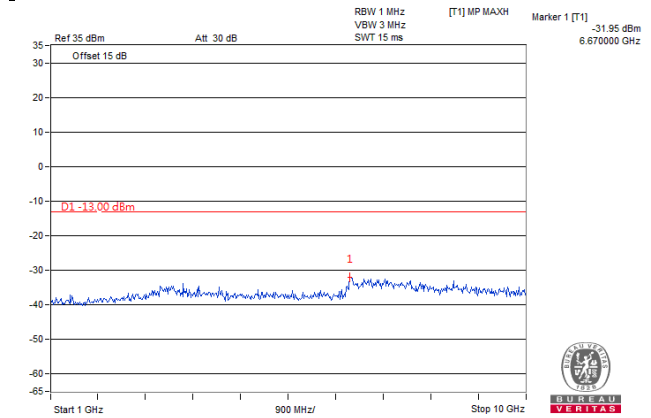

Frequency Range : 10GHz~26.5GHz

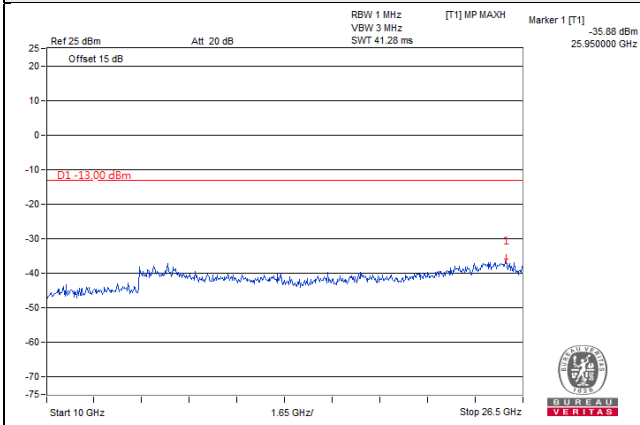

LTE Band 5, Channel Bandwidth 1.4MHz

Channel 20407 (824.7MHz)

Frequency Range : 9kHz~1GHz

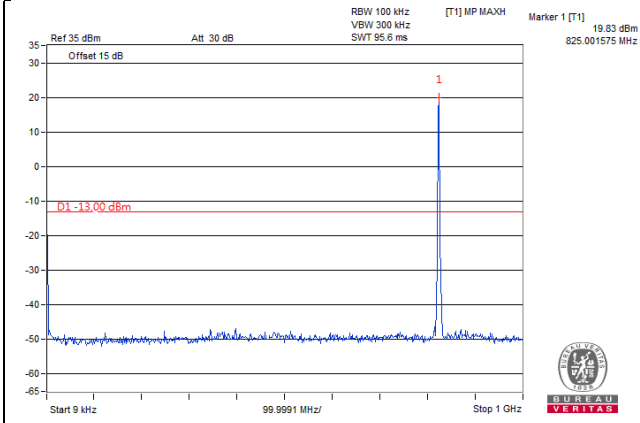

Frequency Range : 1GHz~10GHz

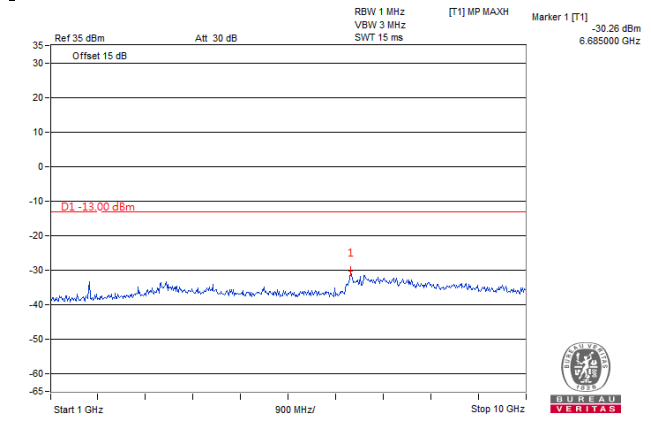

Frequency Range : 10GHz~26.5GHz

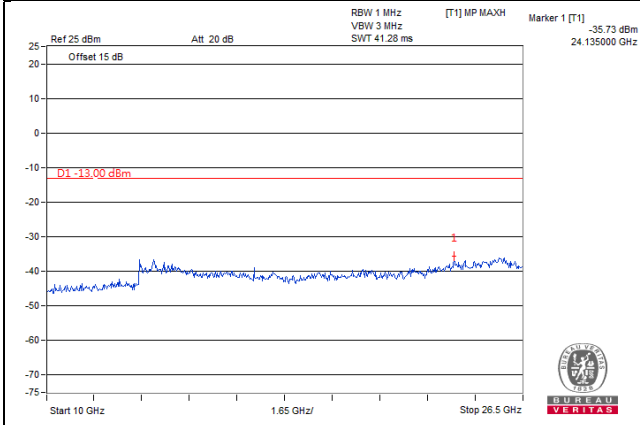

LTE Band 5, Channel Bandwidth 1.4MHz

Channel 20525 (836.5MHz)

Frequency Range : 9kHz~1GHz

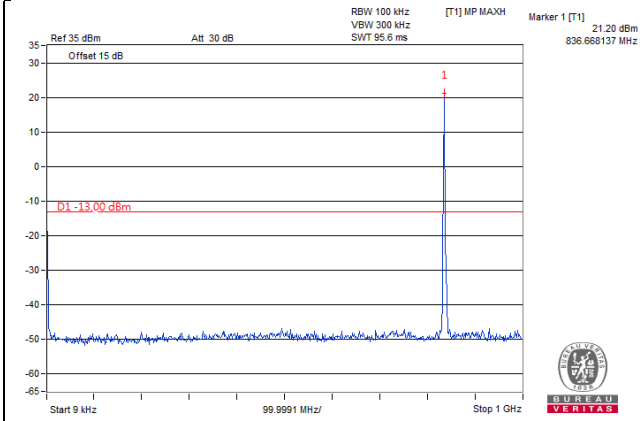

Frequency Range : 1GHz~10GHz

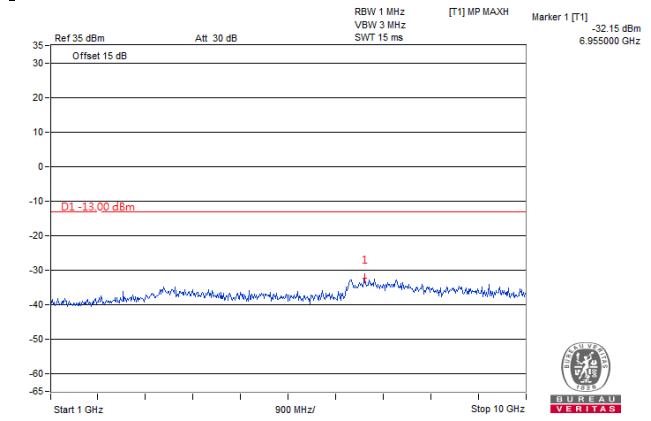

Frequency Range : 10GHz~26.5GHz

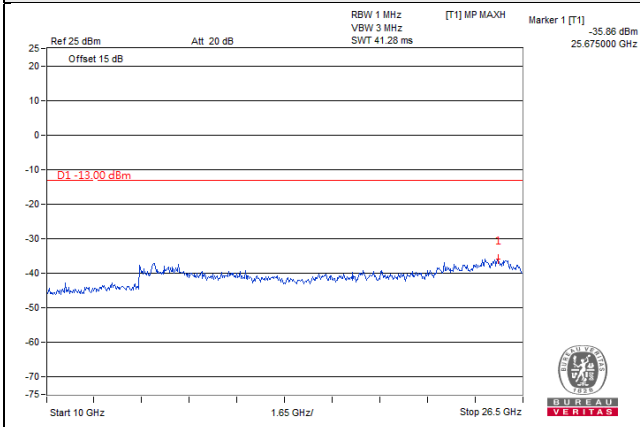

LTE Band 5, Channel Bandwidth 1.4MHz

Channel 20643 (848.3MHz)

Frequency Range : 9kHz~1GHz

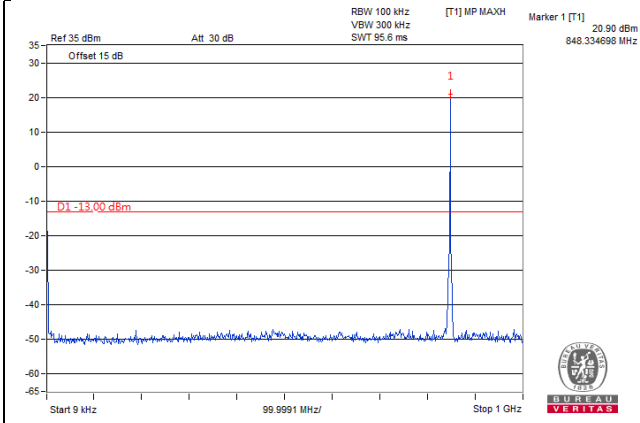

Frequency Range : 1GHz~10GHz

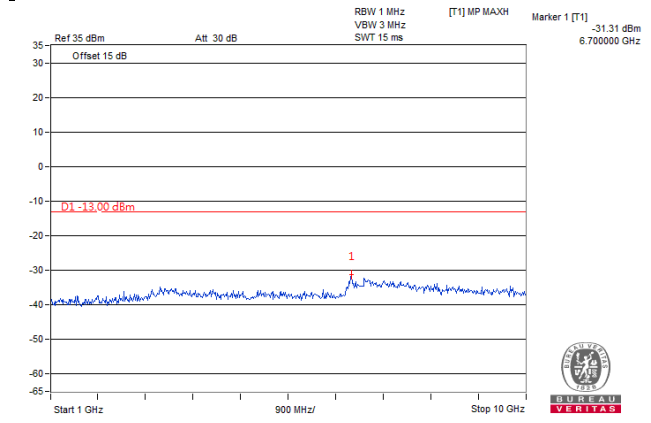

Frequency Range : 10GHz~26.5GHz

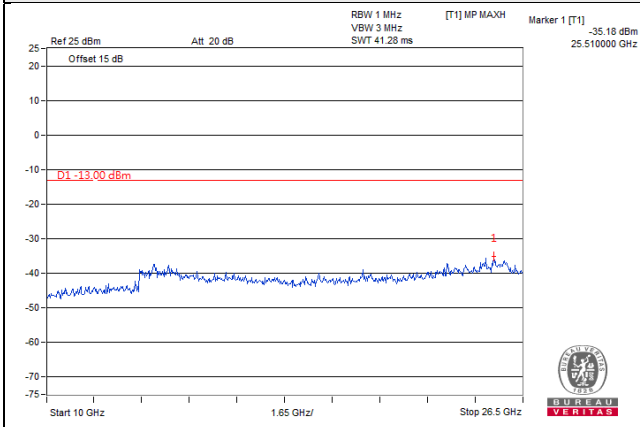

LTE Band 5, Channel Bandwidth 3MHz

Channel 20415 (825.5MHz)

Frequency Range : 9kHz~1GHz

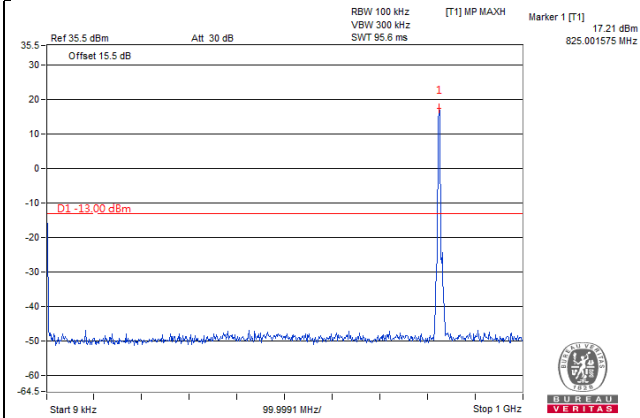

Frequency Range : 1GHz~10GHz

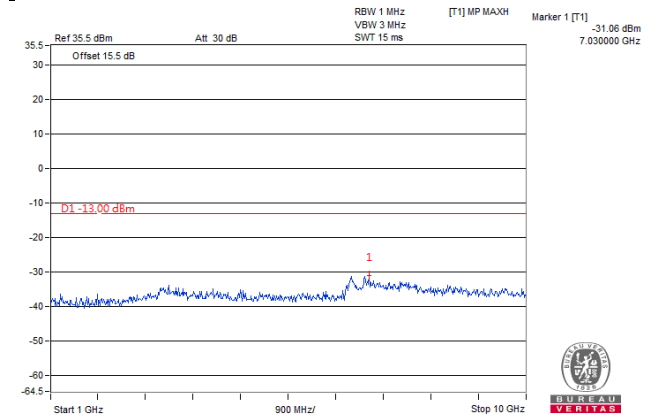

Frequency Range : 10GHz~26.5GHz

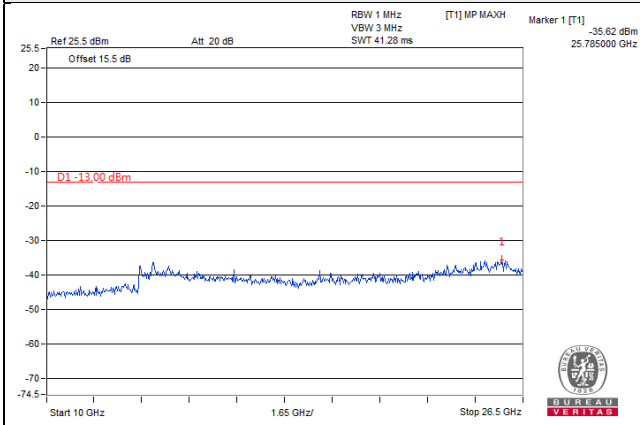

LTE Band 5, Channel Bandwidth 3MHz

Channel 20525 (836.5MHz)

Frequency Range : 9kHz~1GHz

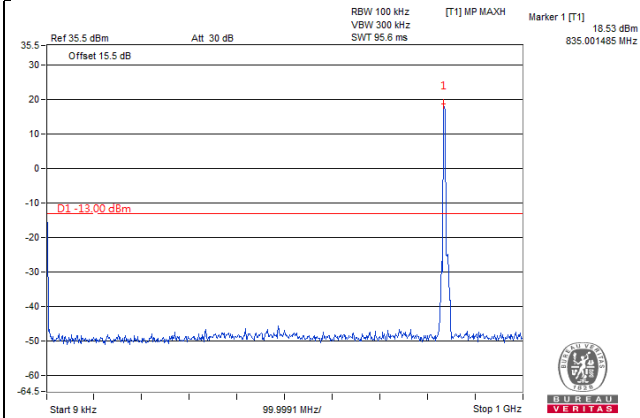

Frequency Range : 1GHz~10GHz

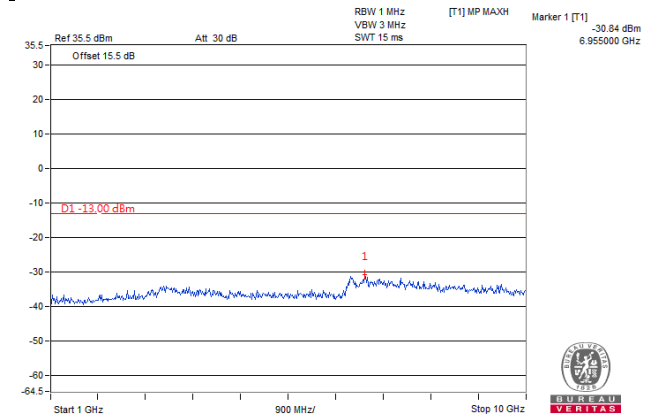

Frequency Range : 10GHz~26.5GHz

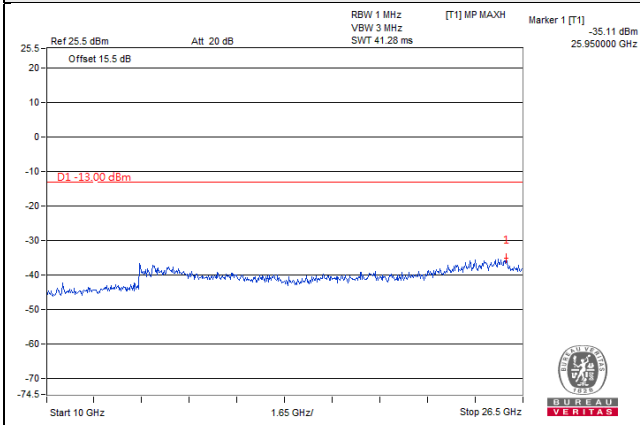

LTE Band 5, Channel Bandwidth 3MHz

Channel 20635 (847.5MHz)

Frequency Range : 9kHz~1GHz

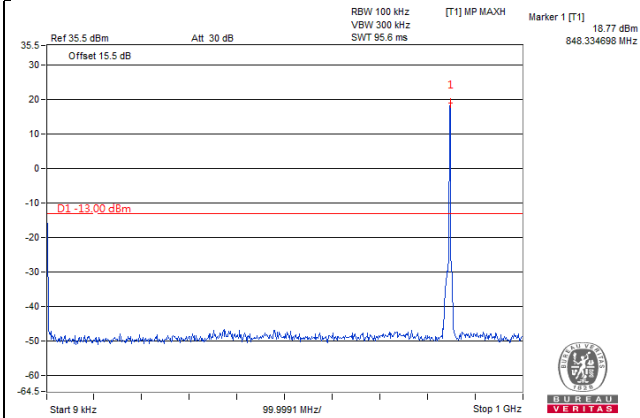

Frequency Range : 1GHz~10GHz

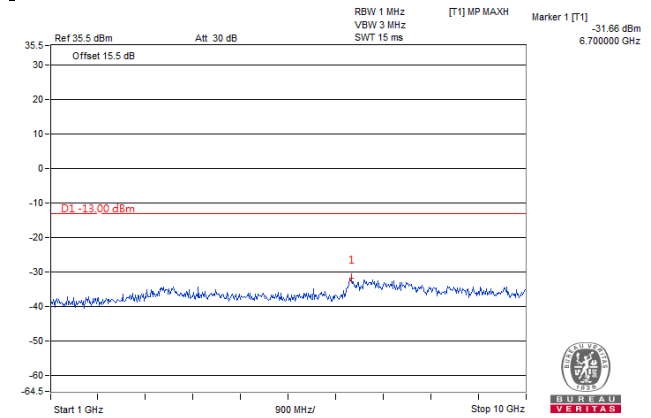

Frequency Range : 10GHz~26.5GHz

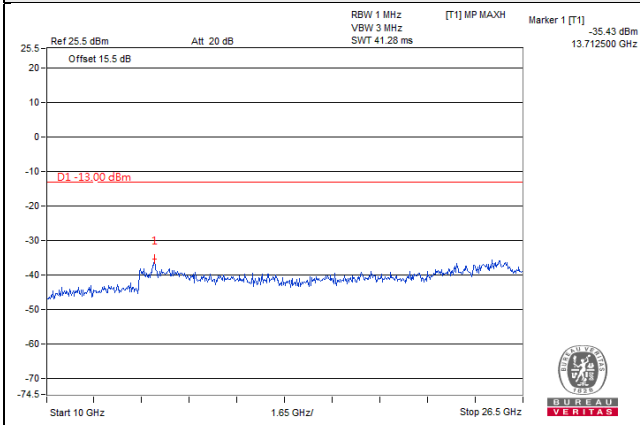

LTE Band 5, Channel Bandwidth 5MHz

Channel 20425 (826.5MHz)

Frequency Range : 9kHz~1GHz

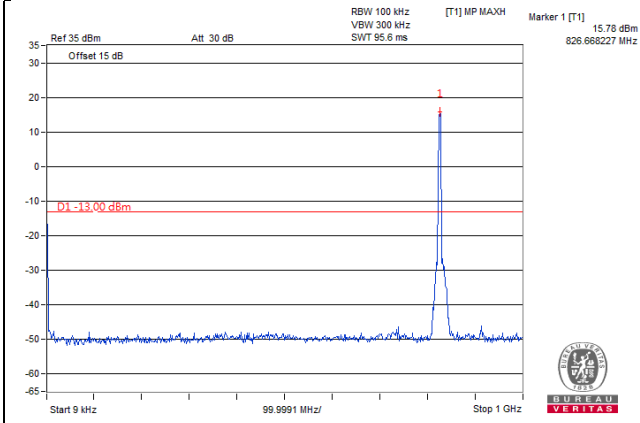

Frequency Range : 1GHz~10GHz

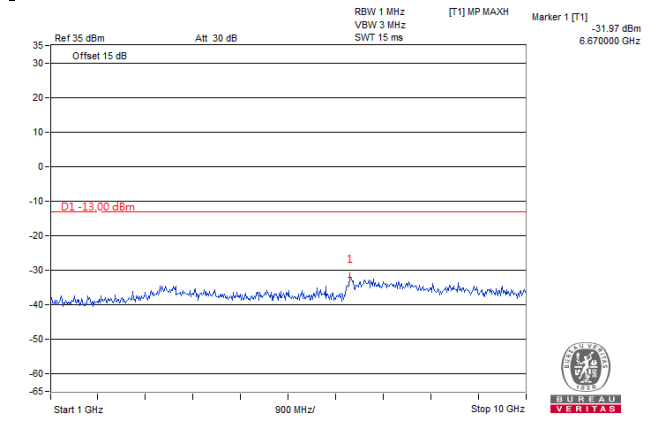

Frequency Range : 10GHz~26.5GHz

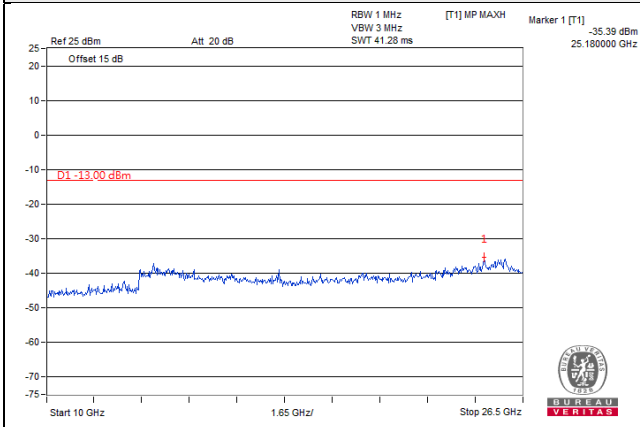

LTE Band 5, Channel Bandwidth 5MHz

Channel 20525 (836.5MHz)

Frequency Range : 9kHz~1GHz

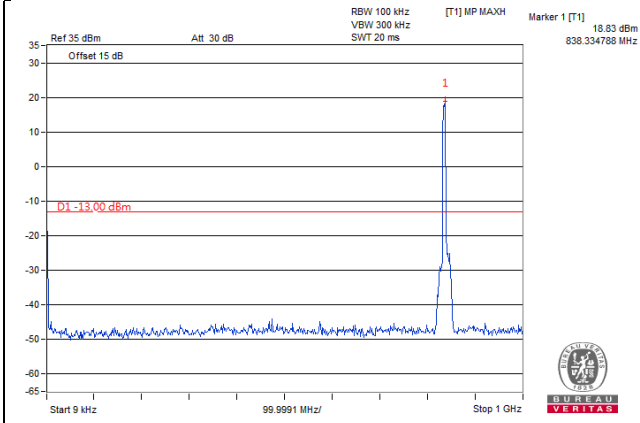

Frequency Range : 1GHz~10GHz

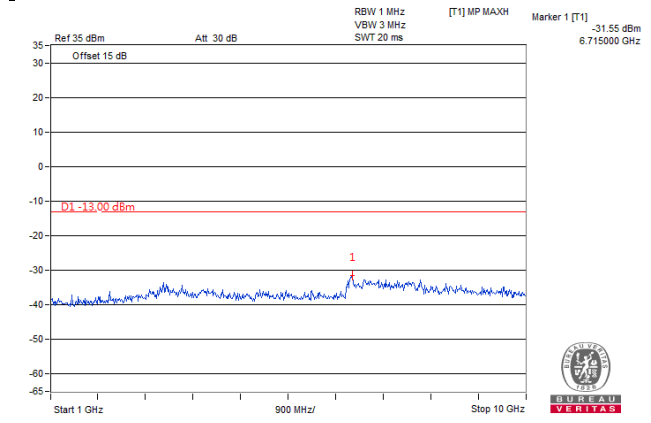

Frequency Range : 10GHz~26.5GHz

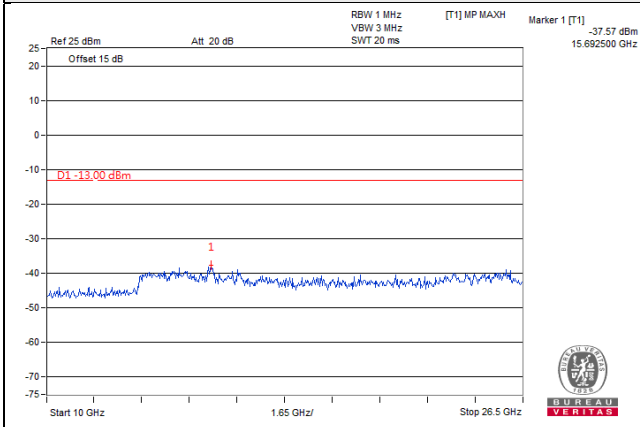

LTE Band 5, Channel Bandwidth 5MHz

Channel 20625 (846.5MHz)

Frequency Range : 9kHz~1GHz

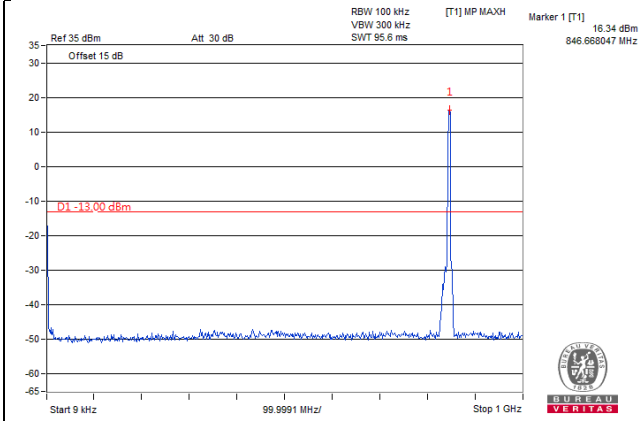

Frequency Range : 1GHz~10GHz

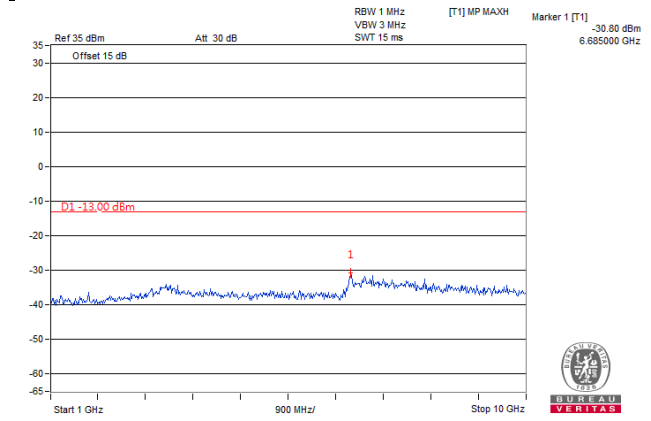

Frequency Range : 10GHz~26.5GHz

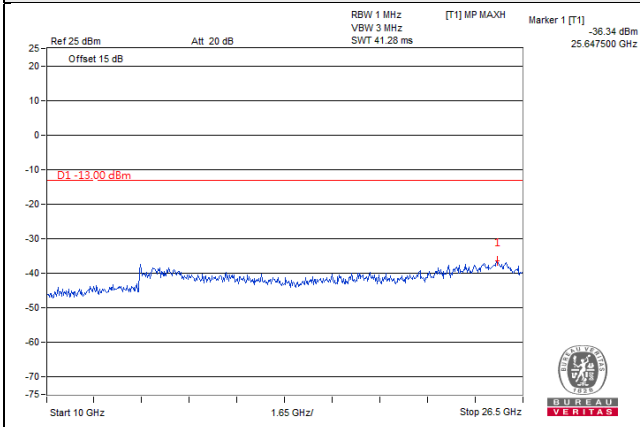

LTE Band 5, Channel Bandwidth 10MHz

Channel 20450 (829.0MHz)

Frequency Range : 9kHz~1GHz

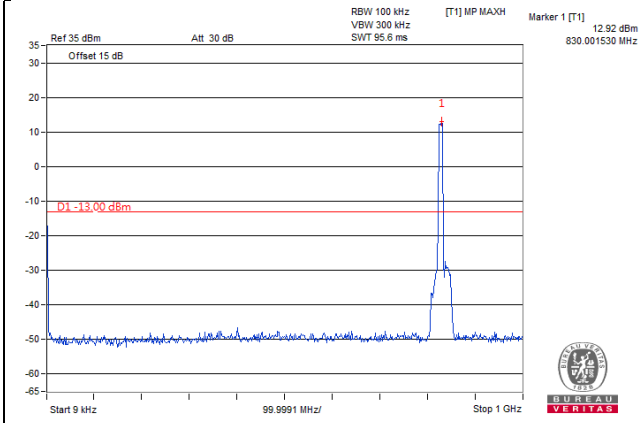

Frequency Range : 1GHz~10GHz

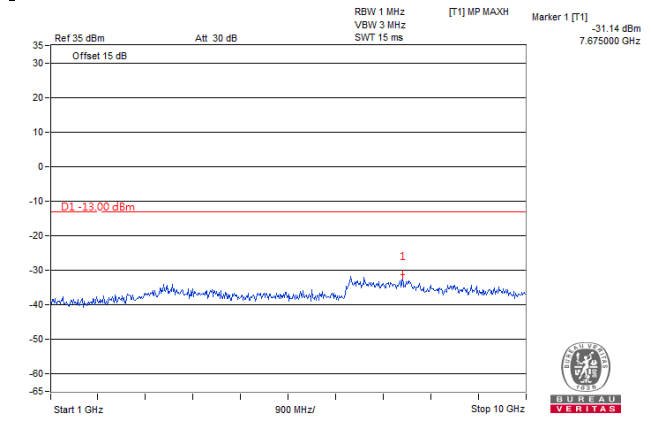

Frequency Range : 10GHz~26.5GHz

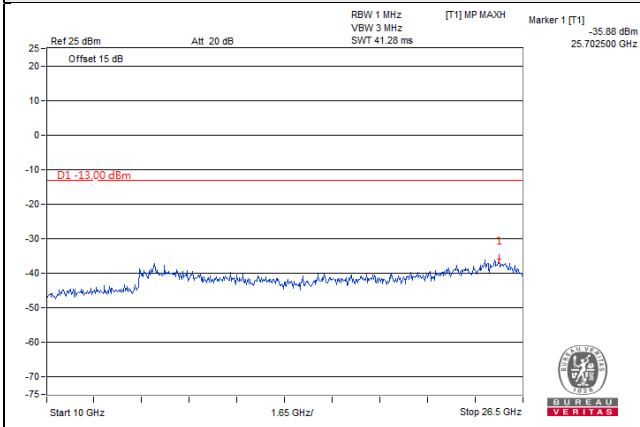

LTE Band 5, Channel Bandwidth 10MHz

Channel 20525 (836.5MHz)

Frequency Range : 9kHz~1GHz

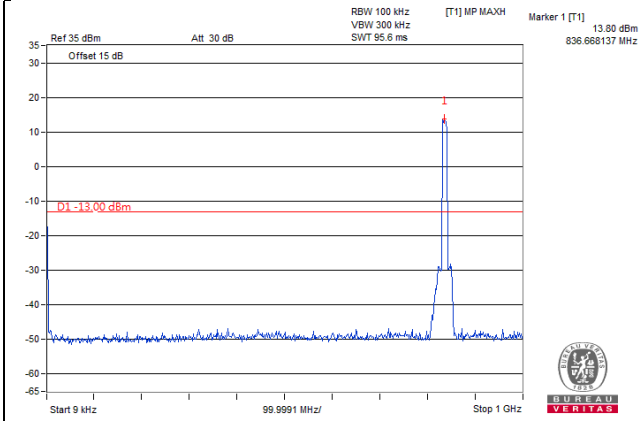

Frequency Range : 1GHz~10GHz

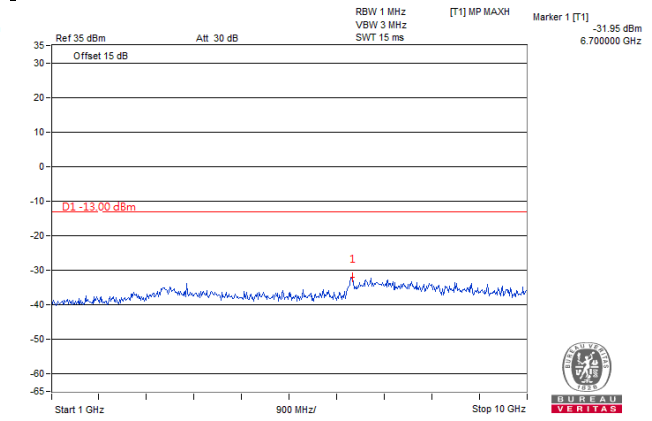

Frequency Range : 10GHz~26.5GHz

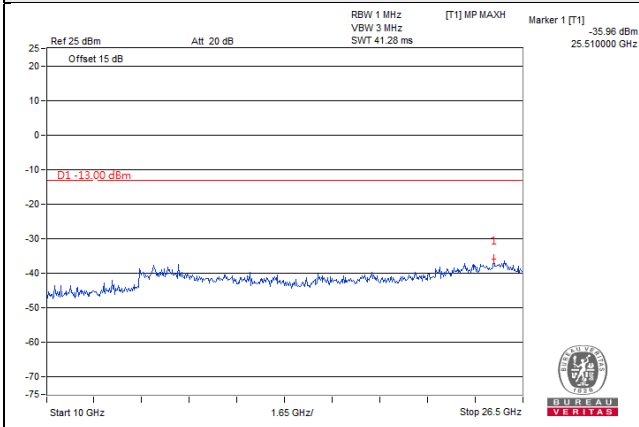

LTE Band 5, Channel Bandwidth 10MHz

Channel 20600 (844.0MHz)

Frequency Range : 9kHz~1GHz

Frequency Range : 1GHz~10GHz

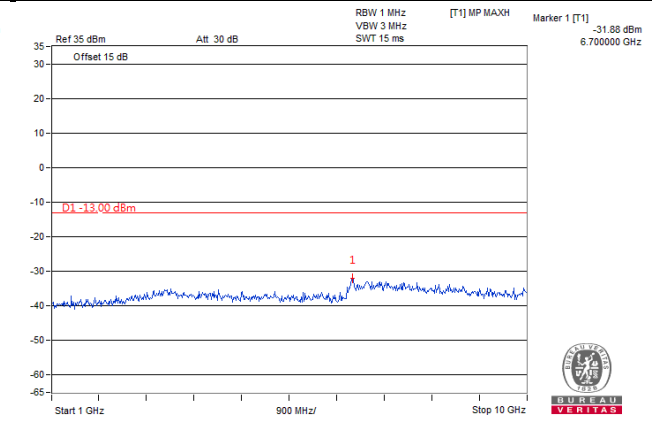
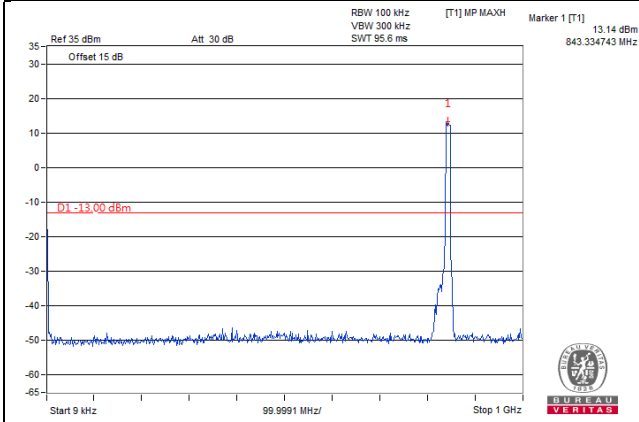

Frequency Range : 10GHz~26.5GHz

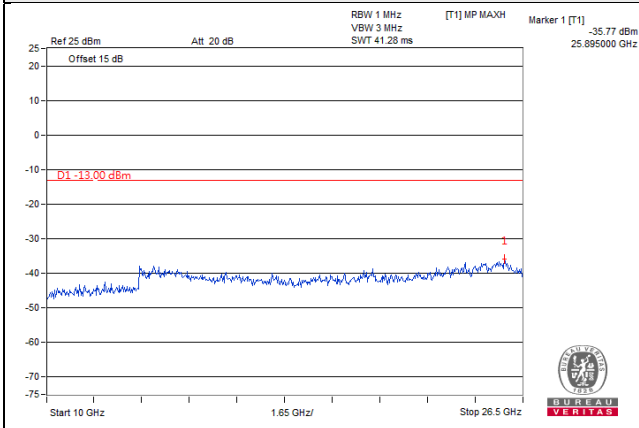

4.8 Radiated Emission Measurement

4.8.1 Limits of Radiated Emission Measurement

The power of any emission outside of the authorized operating frequency ranges must be attenuated below the transmitting power (P) by a factor of at least $43 + 10 \log(P)$ dB. The emission limit equal to -13dBm .

4.8.2 Test Procedure

- a. Substitution method is used for E.I.R.P measurement. In the semi-anechoic chamber, EUT placed on the 0.8m height of Turn Table, rotated the table around 360 degrees to search the maximum radiation power and receiver antenna shall be rotated vertical and horizontal polarization and moved height from 1m to 4m to find the maximum polar radiated power. The "Read Value" is the spectrum reading the maximum power value.
- b. The substitution horn antenna is substituted for EUT at the same position and signals generator export the CW signal to the substitution antenna via a TX cable. Rotated the Turn Table and moved receiving antenna to find the maximum radiation power. Adjust output power level of S.G to get a Value of spectrum reading equal to "Read Value" of step a. Record the power level of S.G
- c. $\text{EIRP} = \text{Output power level of S.G} - \text{TX cable loss} + \text{Antenna gain of substitution horn}$.
- d. E.R.P power can be calculated form E.I.R.P power by subtracting the gain of dipole, $\text{E.R.P power} = \text{E.I.R.P power} - 2.15\text{dBi}$.

NOTE: The resolution bandwidth and video bandwidth of test receiver/spectrum analyzer is 1MHz/3MHz.

4.8.3 Deviation from Test Standard

No deviation.

4.8.4 Test Setup

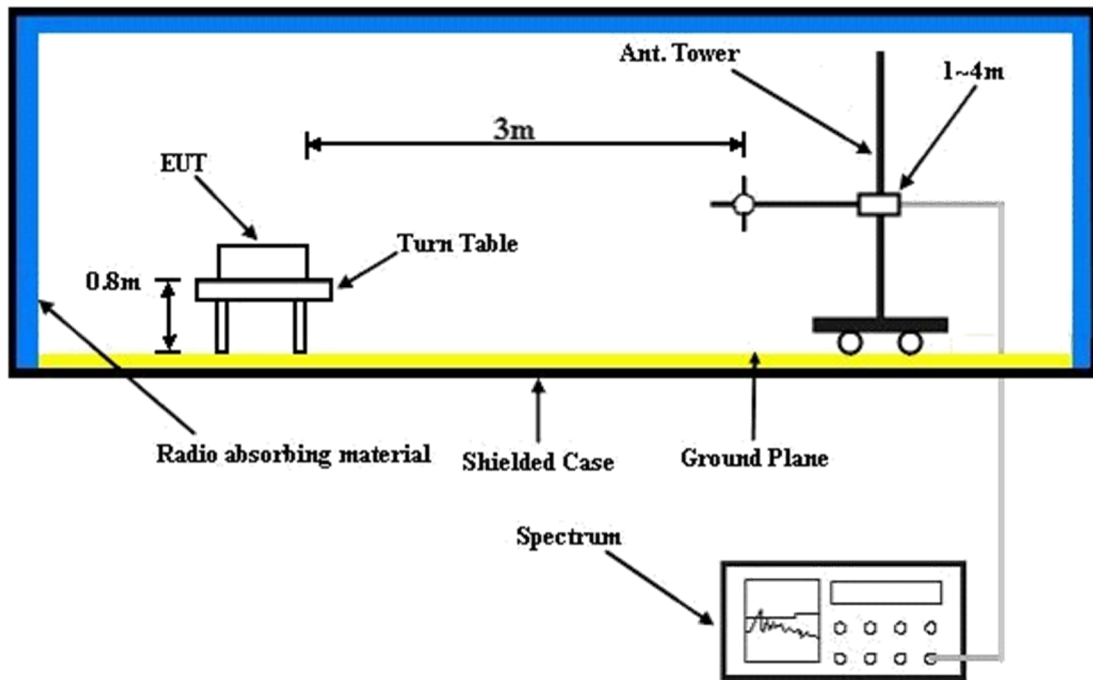

For the actual test configuration, please refer to the attached file (Test Setup Photo).

4.8.5 Test Results

Below 1GHz
GSM Mode

Mode	TX channel 128 (824.2MHz)	Frequency Range	Below 1000 MHz
Environmental Conditions	22deg. C, 66%RH	Input Power	120Vac, 60Hz
Tested By	Luis Lee		

Antenna Polarity & Test Distance: Horizontal at 3 M							
No.	Freq. (MHz)	Reading (dBm)	S.G Power Value (dBm)	Correction Factor (dB)	ERP (dBm)	Limit (dBm)	Margin (dB)
1	36.79	-58.5	-42.0	-15.2	-57.2	-13.0	-44.2
2	65.89	-61.0	-68.3	-1.9	-70.2	-13.0	-57.2
3	93.05	-47.6	-57.7	-0.7	-58.4	-13.0	-45.4
4	256.98	-58.9	-64.8	-1.5	-66.3	-13.0	-53.3
5	434.49	-61.8	-67.9	3.6	-64.3	-13.0	-51.3
6	588.72	-62.0	-66.8	3.8	-63.0	-13.0	-50.0

Antenna Polarity & Test Distance: Vertical at 3 M							
No.	Freq. (MHz)	Reading (dBm)	S.G Power Value (dBm)	Correction Factor (dB)	ERP (dBm)	Limit (dBm)	Margin (dB)
1	33.88	-42.9	-38.5	-17.1	-55.6	-13.0	-42.6
2	66.86	-54.0	-61.9	-1.5	-63.4	-13.0	-50.4
3	93.05	-53.2	-61.8	-0.7	-62.5	-13.0	-49.5
4	306.45	-61.0	-66.9	3.9	-63.0	-13.0	-50.0
5	455.83	-61.6	-67.5	3.5	-64.0	-13.0	-51.0
6	543.13	-61.9	-66.5	3.9	-62.6	-13.0	-49.6

Remarks:

1. Output Power (dBm) = S.G Value (dBm) + Correction Factor (dB).
2. Correction Factor (dB) = Substitution Antenna Gain (dB) + Cable Loss (dB).

EDGE Mode

Mode	TX channel 128 (824.2MHz)	Frequency Range	Below 1000 MHz
Environmental Conditions	22deg. C, 66%RH	Input Power	120Vac, 60Hz
Tested By	Han Wu		

Antenna Polarity & Test Distance: Horizontal at 3 M							
No.	Freq. (MHz)	Reading (dBm)	S.G Power Value (dBm)	Correction Factor (dB)	ERP (dBm)	Limit (dBm)	Margin (dB)
1	45.52	-59.4	-50.4	-10.4	-60.8	-13.0	-47.8
2	175.50	-51.2	-58.2	-2.8	-61.0	-13.0	-48.0
3	340.40	-58.8	-68.4	4.0	-64.4	-13.0	-51.4
4	474.26	-60.9	-66.7	3.5	-63.2	-13.0	-50.2
5	693.48	-60.6	-63.5	3.5	-60.0	-13.0	-47.0
6	828.31	-60.5	-59.6	3.9	-55.7	-13.0	-42.7
Antenna Polarity & Test Distance: Vertical at 3 M							
No.	Freq. (MHz)	Reading (dBm)	S.G Power Value (dBm)	Correction Factor (dB)	ERP (dBm)	Limit (dBm)	Margin (dB)
1	41.64	-43.5	-42.3	-12.3	-54.6	-13.0	-41.6
2	54.25	-52.7	-55.9	-5.7	-61.6	-13.0	-48.6
3	158.04	-57.4	-59.7	-2.7	-62.4	-13.0	-49.4
4	414.12	-60.0	-65.9	3.4	-62.5	-13.0	-49.5
5	587.75	-60.7	-64.0	3.8	-60.2	-13.0	-47.2
6	831.22	-59.8	-58.5	3.9	-54.6	-13.0	-41.6

Remarks:

1. Output Power (dBm) = S.G Value (dBm) + Correction Factor (dB).
2. Correction Factor (dB) = Substitution Antenna Gain (dB) + Cable Loss (dB).

WCDMA Mode

Mode	TX channel 4132 (826.4MHz)	Frequency Range	Below 1000 MHz
Environmental Conditions	20deg. C, 66%RH	Input Power	120Vac, 60Hz
Tested By	Luis Lee		

Antenna Polarity & Test Distance: Horizontal at 3 M							
No.	Freq. (MHz)	Reading (dBm)	S.G Power Value (dBm)	Correction Factor (dB)	ERP (dBm)	Limit (dBm)	Margin (dB)
1	48.43	-62.4	-55.9	-8.7	-64.6	-13.0	-51.6
2	111.48	-53.1	-60.5	-2.5	-63.0	-13.0	-50.0
3	224.00	-61.2	-69.5	-2.1	-71.6	-13.0	-58.6
4	366.59	-60.7	-69.0	3.8	-65.2	-13.0	-52.2
5	500.45	-61.2	-67.3	3.8	-63.5	-13.0	-50.5
6	553.80	-62.5	-68.0	3.7	-64.3	-13.0	-51.3
Antenna Polarity & Test Distance: Vertical at 3 M							
No.	Freq. (MHz)	Reading (dBm)	S.G Power Value (dBm)	Correction Factor (dB)	ERP (dBm)	Limit (dBm)	Margin (dB)
1	31.94	-42.1	-36.5	-18.3	-54.8	-13.0	-41.8
2	66.86	-54.0	-61.9	-1.5	-63.4	-13.0	-50.4
3	127.00	-61.1	-65.6	-3.3	-68.9	-13.0	-55.9
4	222.06	-61.6	-65.8	-1.9	-67.7	-13.0	-54.7
5	335.55	-62.5	-69.2	4.0	-65.2	-13.0	-52.2
6	449.04	-61.8	-67.7	3.4	-64.3	-13.0	-51.3

Remarks:

1. Output Power (dBm) = S.G Value (dBm) + Correction Factor (dB).
2. Correction Factor (dB) = Substitution Antenna Gain (dB) + Cable Loss (dB).

LTE Band 5, Channel Bandwidth: 1.4MHz

Mode	TX channel 20407 (824.7MHz)	Frequency Range	Below 1000 MHz
Environmental Conditions	25deg. C, 65%RH	Input Power	120Vac, 60Hz
Tested By	Greg Lin		

Antenna Polarity & Test Distance: Horizontal at 3 M

No.	Freq. (MHz)	Reading (dBm)	S.G Power Value (dBm)	Correction Factor (dB)	ERP (dBm)	Limit (dBm)	Margin (dB)
1	30.97	-49.4	-29.1	-18.8	-47.9	-13.0	-34.9
2	82.38	-40.2	-48.2	0.4	-47.8	-13.0	-34.8
3	187.14	-47.9	-55.6	-2.7	-58.3	-13.0	-45.3
4	406.36	-56.1	-62.0	3.3	-58.7	-13.0	-45.7
5	779.81	-61.5	-62.5	4.0	-58.5	-13.0	-45.5
6	966.05	-61.1	-58.6	3.6	-55.0	-13.0	-42.0

Antenna Polarity & Test Distance: Vertical at 3 M

No.	Freq. (MHz)	Reading (dBm)	S.G Power Value (dBm)	Correction Factor (dB)	ERP (dBm)	Limit (dBm)	Margin (dB)
1	78.50	-43.1	-51.1	0.6	-50.5	-13.0	-37.5
2	205.57	-58.5	-60.9	-2.0	-62.9	-13.0	-49.9
3	340.40	-57.1	-63.9	4.0	-59.9	-13.0	-46.9
4	537.31	-60.1	-64.9	3.8	-61.1	-13.0	-48.1
5	780.78	-61.3	-60.4	4.0	-56.4	-13.0	-43.4
6	954.41	-61.4	-57.9	3.8	-54.1	-13.0	-41.1

Remarks:

1. Output Power (dBm) = S.G Value (dBm) + Correction Factor (dB).
2. Correction Factor (dB) = Substitution Antenna Gain (dB) + Cable Loss (dB).

LTE Band 5, Channel Bandwidth: 3MHz

Mode	TX channel 20415 (825.5MHz)	Frequency Range	Below 1000 MHz
Environmental Conditions	25deg. C, 65%RH	Input Power	120Vac, 60Hz
Tested By	Greg Lin		

Antenna Polarity & Test Distance: Horizontal at 3 M							
No.	Freq. (MHz)	Reading (dBm)	S.G Power Value (dBm)	Correction Factor (dB)	ERP (dBm)	Limit (dBm)	Margin (dB)
1	33.88	-50.9	-33.0	-17.1	-50.1	-13.0	-37.1
2	84.32	-41.0	-49.5	0.4	-49.1	-13.0	-36.1
3	157.07	-50.5	-54.6	-2.8	-57.4	-13.0	-44.4
4	321.00	-54.1	-64.3	4.0	-60.3	-13.0	-47.3
5	593.57	-59.9	-64.4	3.7	-60.7	-13.0	-47.7
6	771.08	-61.3	-62.7	3.9	-58.8	-13.0	-45.8
Antenna Polarity & Test Distance: Vertical at 3 M							
No.	Freq. (MHz)	Reading (dBm)	S.G Power Value (dBm)	Correction Factor (dB)	ERP (dBm)	Limit (dBm)	Margin (dB)
1	55.22	-41.3	-45.0	-5.4	-50.4	-13.0	-37.4
2	164.83	-51.4	-53.8	-2.9	-56.7	-13.0	-43.7
3	287.05	-58.2	-56.9	-1.7	-58.6	-13.0	-45.6
4	551.86	-60.1	-64.4	3.8	-60.6	-13.0	-47.6
5	748.77	-61.2	-60.2	3.7	-56.5	-13.0	-43.5
6	986.42	-60.9	-57.0	3.5	-53.5	-13.0	-40.5

Remarks:

1. Output Power (dBm) = S.G Value (dBm) + Correction Factor (dB).
2. Correction Factor (dB) = Substitution Antenna Gain (dB) + Cable Loss (dB).

LTE Band 5, Channel Bandwidth: 5MHz

Mode	TX channel 20425 (826.5MHz)	Frequency Range	Below 1000 MHz
Environmental Conditions	25deg. C, 65%RH	Input Power	120Vac, 60Hz
Tested By	Greg Lin		

Antenna Polarity & Test Distance: Horizontal at 3 M

No.	Freq. (MHz)	Reading (dBm)	S.G Power Value (dBm)	Correction Factor (dB)	ERP (dBm)	Limit (dBm)	Margin (dB)
1	42.61	-51.0	-39.5	-11.8	-51.3	-13.0	-38.3
2	187.14	-47.9	-55.6	-2.7	-58.3	-13.0	-45.3
3	385.99	-56.8	-63.2	3.5	-59.7	-13.0	-46.7
4	566.41	-60.2	-65.4	3.8	-61.6	-13.0	-48.6
5	826.37	-61.8	-61.0	3.9	-57.1	-13.0	-44.1
6	924.34	-61.2	-58.8	3.6	-55.2	-13.0	-42.2

Antenna Polarity & Test Distance: Vertical at 3 M

No.	Freq. (MHz)	Reading (dBm)	S.G Power Value (dBm)	Correction Factor (dB)	ERP (dBm)	Limit (dBm)	Margin (dB)
1	33.88	-42.1	-37.8	-17.1	-54.9	-13.0	-41.9
2	84.32	-42.5	-50.0	0.4	-49.6	-13.0	-36.6
3	191.99	-55.8	-56.9	-2.6	-59.5	-13.0	-46.5
4	412.18	-58.2	-64.1	3.3	-60.8	-13.0	-47.8
5	705.12	-60.4	-60.0	3.5	-56.5	-13.0	-43.5
6	900.09	-60.2	-57.6	3.5	-54.1	-13.0	-41.1

Remarks:

1. Output Power (dBm) = S.G Value (dBm) + Correction Factor (dB).
2. Correction Factor (dB) = Substitution Antenna Gain (dB) + Cable Loss (dB).

LTE Band 5, Channel Bandwidth: 10MHz

Mode	TX channel 20450 (829.0MHz)	Frequency Range	Below 1000 MHz
Environmental Conditions	25deg. C, 65%RH	Input Power	120Vac, 60Hz
Tested By	Greg Lin		

Antenna Polarity & Test Distance: Horizontal at 3 M							
No.	Freq. (MHz)	Reading (dBm)	S.G Power Value (dBm)	Correction Factor (dB)	ERP (dBm)	Limit (dBm)	Margin (dB)
1	30.00	-47.4	-26.1	-19.4	-45.5	-13.0	-32.5
2	78.50	-44.6	-52.5	0.6	-51.9	-13.0	-38.9
3	152.22	-51.6	-55.2	-2.8	-58.0	-13.0	-45.0
4	411.21	-58.1	-63.8	3.3	-60.5	-13.0	-47.5
5	566.41	-60.2	-65.4	3.8	-61.6	-13.0	-48.6
6	872.93	-60.6	-58.9	3.5	-55.4	-13.0	-42.4
Antenna Polarity & Test Distance: Vertical at 3 M							
No.	Freq. (MHz)	Reading (dBm)	S.G Power Value (dBm)	Correction Factor (dB)	ERP (dBm)	Limit (dBm)	Margin (dB)
1	31.94	-40.5	-34.8	-18.3	-53.1	-13.0	-40.1
2	81.41	-40.5	-47.7	0.5	-47.2	-13.0	-34.2
3	281.23	-59.4	-56.8	-1.7	-58.5	-13.0	-45.5
4	644.01	-61.5	-62.1	3.7	-58.4	-13.0	-45.4
5	774.96	-61.3	-60.4	4.0	-56.4	-13.0	-43.4
6	959.26	-61.4	-58.1	3.8	-54.3	-13.0	-41.3

Remarks:

1. Output Power (dBm) = S.G Value (dBm) + Correction Factor (dB).
2. Correction Factor (dB) = Substitution Antenna Gain (dB) + Cable Loss (dB).

Above 1GHz
GSM Mode

Mode	TX channel 128 (824.2MHz)	Frequency Range	Above 1000MHz
Environmental Conditions	22deg. C, 66%RH	Input Power	120Vac, 60Hz
Tested By	Han Wu		

Antenna Polarity & Test Distance: Horizontal at 3 M							
No.	Freq. (MHz)	Reading (dBm)	S.G Power Value (dBm)	Correction Factor (dB)	ERP (dBm)	Limit (dBm)	Margin (dB)
1	1648.40	-55.4	-47.7	0.9	-46.8	-13.0	-33.8
Antenna Polarity & Test Distance: Vertical at 3 M							
No.	Freq. (MHz)	Reading (dBm)	S.G Power Value (dBm)	Correction Factor (dB)	ERP (dBm)	Limit (dBm)	Margin (dB)
1	1648.40	-60.0	-52.7	0.9	-51.8	-13.0	-38.8

Remarks:

1. Output Power (dBm) = S.G Value (dBm) + Correction Factor (dB).
2. Correction Factor (dB) = Substitution Antenna Gain (dB) + Cable Loss (dB).

Mode	TX channel 189 (836.4MHz)	Frequency Range	Above 1000MHz
Environmental Conditions	22deg. C, 66%RH	Input Power	120Vac, 60Hz
Tested By	Han Wu		

Antenna Polarity & Test Distance: Horizontal at 3 M							
No.	Freq. (MHz)	Reading (dBm)	S.G Power Value (dBm)	Correction Factor (dB)	ERP (dBm)	Limit (dBm)	Margin (dB)
1	1672.80	-54.0	-46.4	0.8	-45.6	-13.0	-32.6
Antenna Polarity & Test Distance: Vertical at 3 M							
No.	Freq. (MHz)	Reading (dBm)	S.G Power Value (dBm)	Correction Factor (dB)	ERP (dBm)	Limit (dBm)	Margin (dB)
1	1672.80	-59.4	-52.0	0.8	-51.2	-13.0	-38.2

Remarks:

1. Output Power (dBm) = S.G Value (dBm) + Correction Factor (dB).
2. Correction Factor (dB) = Substitution Antenna Gain (dB) + Cable Loss (dB).

Mode	TX channel 251 (848.8MHz)	Frequency Range	Above 1000MHz
Environmental Conditions	22deg. C, 66%RH	Input Power	120Vac, 60Hz
Tested By	Han Wu		

Antenna Polarity & Test Distance: Horizontal at 3 M							
No.	Freq. (MHz)	Reading (dBm)	S.G Power Value (dBm)	Correction Factor (dB)	ERP (dBm)	Limit (dBm)	Margin (dB)
1	1697.60	-54.1	-46.6	0.7	-45.9	-13.0	-32.9
Antenna Polarity & Test Distance: Vertical at 3 M							
No.	Freq. (MHz)	Reading (dBm)	S.G Power Value (dBm)	Correction Factor (dB)	ERP (dBm)	Limit (dBm)	Margin (dB)
1	1697.60	-58.6	-51.3	0.7	-50.6	-13.0	-37.6

Remarks:

1. Output Power (dBm) = S.G Value (dBm) + Correction Factor (dB).
2. Correction Factor (dB) = Substitution Antenna Gain (dB) + Cable Loss (dB).

EDGE Mode

Mode	TX channel 128 (824.2MHz)	Frequency Range	Above 1000MHz
Environmental Conditions	22deg. C, 66%RH	Input Power	120Vac, 60Hz
Tested By	Greg Lin		

Antenna Polarity & Test Distance: Horizontal at 3 M							
No.	Freq. (MHz)	Reading (dBm)	S.G Power Value (dBm)	Correction Factor (dB)	ERP (dBm)	Limit (dBm)	Margin (dB)
1	1648.40	-55.1	-47.4	0.9	-46.5	-13.0	-33.5
Antenna Polarity & Test Distance: Vertical at 3 M							
No.	Freq. (MHz)	Reading (dBm)	S.G Power Value (dBm)	Correction Factor (dB)	ERP (dBm)	Limit (dBm)	Margin (dB)
1	1648.40	-59.8	-52.4	0.9	-51.5	-13.0	-38.5

Remarks:

1. Output Power (dBm) = S.G Value (dBm) + Correction Factor (dB).
2. Correction Factor (dB) = Substitution Antenna Gain (dB) + Cable Loss (dB).

Mode	TX channel 189 (836.4MHz)	Frequency Range	Above 1000MHz
Environmental Conditions	22deg. C, 66%RH	Input Power	120Vac, 60Hz
Tested By	Greg Lin		

Antenna Polarity & Test Distance: Horizontal at 3 M							
No.	Freq. (MHz)	Reading (dBm)	S.G Power Value (dBm)	Correction Factor (dB)	ERP (dBm)	Limit (dBm)	Margin (dB)
1	1672.80	-54.3	-46.7	0.8	-45.9	-13.0	-32.9
Antenna Polarity & Test Distance: Vertical at 3 M							
No.	Freq. (MHz)	Reading (dBm)	S.G Power Value (dBm)	Correction Factor (dB)	ERP (dBm)	Limit (dBm)	Margin (dB)
1	1672.80	-59.8	-52.4	0.8	-51.6	-13.0	-38.6

Remarks:

1. Output Power (dBm) = S.G Value (dBm) + Correction Factor (dB).
2. Correction Factor (dB) = Substitution Antenna Gain (dB) + Cable Loss (dB).

Mode	TX channel 251 (848.8MHz)	Frequency Range	Above 1000MHz
Environmental Conditions	22deg. C, 66%RH	Input Power	120Vac, 60Hz
Tested By	Greg Lin		

Antenna Polarity & Test Distance: Horizontal at 3 M							
No.	Freq. (MHz)	Reading (dBm)	S.G Power Value (dBm)	Correction Factor (dB)	ERP (dBm)	Limit (dBm)	Margin (dB)
1	1697.60	-54.5	-46.9	0.7	-46.2	-13.0	-33.2
Antenna Polarity & Test Distance: Vertical at 3 M							
No.	Freq. (MHz)	Reading (dBm)	S.G Power Value (dBm)	Correction Factor (dB)	ERP (dBm)	Limit (dBm)	Margin (dB)
1	1697.60	-58.9	-51.6	0.7	-50.9	-13.0	-37.9

Remarks:

1. Output Power (dBm) = S.G Value (dBm) + Correction Factor (dB).
2. Correction Factor (dB) = Substitution Antenna Gain (dB) + Cable Loss (dB).

WCDMA Mode

Mode	TX channel 4132 (826.4MHz)	Frequency Range	Above 1000MHz
Environmental Conditions	22deg. C, 66%RH	Input Power	120Vac, 60Hz
Tested By	Han Wu		

Antenna Polarity & Test Distance: Horizontal at 3 M							
No.	Freq. (MHz)	Reading (dBm)	S.G Power Value (dBm)	Correction Factor (dB)	ERP (dBm)	Limit (dBm)	Margin (dB)
1	1652.80	-64.4	-56.6	0.9	-55.7	-13.0	-42.7
Antenna Polarity & Test Distance: Vertical at 3 M							
No.	Freq. (MHz)	Reading (dBm)	S.G Power Value (dBm)	Correction Factor (dB)	ERP (dBm)	Limit (dBm)	Margin (dB)
1	1652.80	-63.6	-56.4	0.9	-55.5	-13.0	-42.5

Remarks:

1. Output Power (dBm) = S.G Value (dBm) + Correction Factor (dB).
2. Correction Factor (dB) = Substitution Antenna Gain (dB) + Cable Loss (dB).

Mode	TX channel 4182 (836.6MHz)	Frequency Range	Above 1000MHz
Environmental Conditions	22deg. C, 66%RH	Input Power	120Vac, 60Hz
Tested By	Han Wu		

Antenna Polarity & Test Distance: Horizontal at 3 M							
No.	Freq. (MHz)	Reading (dBm)	S.G Power Value (dBm)	Correction Factor (dB)	ERP (dBm)	Limit (dBm)	Margin (dB)
1	1672.80	-62.3	-54.7	0.8	-53.9	-13.0	-40.9
Antenna Polarity & Test Distance: Vertical at 3 M							
No.	Freq. (MHz)	Reading (dBm)	S.G Power Value (dBm)	Correction Factor (dB)	ERP (dBm)	Limit (dBm)	Margin (dB)
1	1672.80	-61.2	-53.9	0.8	-53.1	-13.0	-40.1

Remarks:

1. Output Power (dBm) = S.G Value (dBm) + Correction Factor (dB).
2. Correction Factor (dB) = Substitution Antenna Gain (dB) + Cable Loss (dB).

Mode	TX channel 4233 (846.6MHz)	Frequency Range	Above 1000MHz
Environmental Conditions	22deg. C, 66%RH	Input Power	120Vac, 60Hz
Tested By	Han Wu		

Antenna Polarity & Test Distance: Horizontal at 3 M							
No.	Freq. (MHz)	Reading (dBm)	S.G Power Value (dBm)	Correction Factor (dB)	ERP (dBm)	Limit (dBm)	Margin (dB)
1	1693.20	-62.5	-54.9	0.7	-54.2	-13.0	-41.2
Antenna Polarity & Test Distance: Vertical at 3 M							
No.	Freq. (MHz)	Reading (dBm)	S.G Power Value (dBm)	Correction Factor (dB)	ERP (dBm)	Limit (dBm)	Margin (dB)
1	1693.20	-62.8	-55.5	0.7	-54.8	-13.0	-41.8

Remarks:

1. Output Power (dBm) = S.G Value (dBm) + Correction Factor (dB).
2. Correction Factor (dB) = Substitution Antenna Gain (dB) + Cable Loss (dB).

LTE Band 5, Channel Bandwidth: 1.4MHz

Mode	TX channel 20407 (824.7MHz)	Frequency Range	Above 1000MHz
Environmental Conditions	25deg. C, 65%RH	Input Power	120Vac, 60Hz
Tested By	Greg Lin		

Antenna Polarity & Test Distance: Horizontal at 3 M							
No.	Freq. (MHz)	Reading (dBm)	S.G Power Value (dBm)	Correction Factor (dB)	ERP (dBm)	Limit (dBm)	Margin (dB)
1	1649.40	-67.7	-59.9	0.9	-59.0	-13.0	-46.0
Antenna Polarity & Test Distance: Vertical at 3 M							
No.	Freq. (MHz)	Reading (dBm)	S.G Power Value (dBm)	Correction Factor (dB)	ERP (dBm)	Limit (dBm)	Margin (dB)
1	1649.40	-64.0	-56.8	0.9	-55.9	-13.0	-42.9

Remarks:

1. Output Power (dBm) = S.G Value (dBm) + Correction Factor (dB).
2. Correction Factor (dB) = Substitution Antenna Gain (dB) + Cable Loss (dB).

Mode	TX channel 20525 (836.5MHz)	Frequency Range	Above 1000MHz
Environmental Conditions	25deg. C, 65%RH	Input Power	120Vac, 60Hz
Tested By	Greg Lin		

Antenna Polarity & Test Distance: Horizontal at 3 M							
No.	Freq. (MHz)	Reading (dBm)	S.G Power Value (dBm)	Correction Factor (dB)	ERP (dBm)	Limit (dBm)	Margin (dB)
1	1673.00	-65.7	-58.0	0.8	-57.2	-13.0	-44.2
Antenna Polarity & Test Distance: Vertical at 3 M							
No.	Freq. (MHz)	Reading (dBm)	S.G Power Value (dBm)	Correction Factor (dB)	ERP (dBm)	Limit (dBm)	Margin (dB)
1	1673.00	-63.4	-56.0	0.8	-55.2	-13.0	-42.2

Remarks:

1. Output Power (dBm) = S.G Value (dBm) + Correction Factor (dB).
2. Correction Factor (dB) = Substitution Antenna Gain (dB) + Cable Loss (dB).

Mode	TX channel 20643 (848.3MHz)	Frequency Range	Above 1000MHz
Environmental Conditions	25deg. C, 65%RH	Input Power	120Vac, 60Hz
Tested By	Greg Lin		

Antenna Polarity & Test Distance: Horizontal at 3 M							
No.	Freq. (MHz)	Reading (dBm)	S.G Power Value (dBm)	Correction Factor (dB)	ERP (dBm)	Limit (dBm)	Margin (dB)
1	1696.60	-67.2	-59.7	0.7	-59.0	-13.0	-46.0
Antenna Polarity & Test Distance: Vertical at 3 M							
No.	Freq. (MHz)	Reading (dBm)	S.G Power Value (dBm)	Correction Factor (dB)	ERP (dBm)	Limit (dBm)	Margin (dB)
1	1696.60	-63.2	-55.9	0.7	-55.2	-13.0	-42.2

Remarks:

1. Output Power (dBm) = S.G Value (dBm) + Correction Factor (dB).
2. Correction Factor (dB) = Substitution Antenna Gain (dB) + Cable Loss (dB).

LTE Band 5, Channel Bandwidth: 3MHz

Mode	TX channel 20415 (825.5MHz)	Frequency Range	Above 1000MHz
Environmental Conditions	25deg. C, 65%RH	Input Power	120Vac, 60Hz
Tested By	Greg Lin		

Antenna Polarity & Test Distance: Horizontal at 3 M							
No.	Freq. (MHz)	Reading (dBm)	S.G Power Value (dBm)	Correction Factor (dB)	ERP (dBm)	Limit (dBm)	Margin (dB)
1	1651.00	-67.4	-59.6	0.9	-58.7	-13.0	-45.7
Antenna Polarity & Test Distance: Vertical at 3 M							
No.	Freq. (MHz)	Reading (dBm)	S.G Power Value (dBm)	Correction Factor (dB)	ERP (dBm)	Limit (dBm)	Margin (dB)
1	1651.00	-63.9	-56.7	0.9	-55.8	-13.0	-42.8

Remarks:

1. Output Power (dBm) = S.G Value (dBm) + Correction Factor (dB).
2. Correction Factor (dB) = Substitution Antenna Gain (dB) + Cable Loss (dB).

Mode	TX channel 20525 (836.5MHz)	Frequency Range	Above 1000MHz
Environmental Conditions	25deg. C, 65%RH	Input Power	120Vac, 60Hz
Tested By	Greg Lin		

Antenna Polarity & Test Distance: Horizontal at 3 M							
No.	Freq. (MHz)	Reading (dBm)	S.G Power Value (dBm)	Correction Factor (dB)	ERP (dBm)	Limit (dBm)	Margin (dB)
1	1673.00	-66.8	-59.2	0.8	-58.4	-13.0	-45.4
Antenna Polarity & Test Distance: Vertical at 3 M							
No.	Freq. (MHz)	Reading (dBm)	S.G Power Value (dBm)	Correction Factor (dB)	ERP (dBm)	Limit (dBm)	Margin (dB)
1	1673.00	-63.1	-55.8	0.8	-55.0	-13.0	-42.0

Remarks:

1. Output Power (dBm) = S.G Value (dBm) + Correction Factor (dB).
2. Correction Factor (dB) = Substitution Antenna Gain (dB) + Cable Loss (dB).

Mode	TX channel 20635 (847.5MHz)	Frequency Range	Above 1000MHz
Environmental Conditions	25deg. C, 65%RH	Input Power	120Vac, 60Hz
Tested By	Greg Lin		

Antenna Polarity & Test Distance: Horizontal at 3 M							
No.	Freq. (MHz)	Reading (dBm)	S.G Power Value (dBm)	Correction Factor (dB)	ERP (dBm)	Limit (dBm)	Margin (dB)
1	1695.00	-66.8	-59.2	0.7	-58.5	-13.0	-45.5
Antenna Polarity & Test Distance: Vertical at 3 M							
No.	Freq. (MHz)	Reading (dBm)	S.G Power Value (dBm)	Correction Factor (dB)	ERP (dBm)	Limit (dBm)	Margin (dB)
1	1695.00	-63.2	-55.9	0.7	-55.2	-13.0	-42.2

Remarks:

1. Output Power (dBm) = S.G Value (dBm) + Correction Factor (dB).
2. Correction Factor (dB) = Substitution Antenna Gain (dB) + Cable Loss (dB).

LTE Band 5, Channel Bandwidth: 5MHz

Mode	TX channel 20425 (826.5MHz)	Frequency Range	Above 1000MHz
Environmental Conditions	25deg. C, 65%RH	Input Power	120Vac, 60Hz
Tested By	Greg Lin		

Antenna Polarity & Test Distance: Horizontal at 3 M							
No.	Freq. (MHz)	Reading (dBm)	S.G Power Value (dBm)	Correction Factor (dB)	ERP (dBm)	Limit (dBm)	Margin (dB)
1	1653.00	-66.9	-59.1	0.9	-58.2	-13.0	-45.2
Antenna Polarity & Test Distance: Vertical at 3 M							
No.	Freq. (MHz)	Reading (dBm)	S.G Power Value (dBm)	Correction Factor (dB)	ERP (dBm)	Limit (dBm)	Margin (dB)
1	1653.00	-63.4	-56.1	0.9	-55.2	-13.0	-42.2

Remarks:

1. Output Power (dBm) = S.G Value (dBm) + Correction Factor (dB).
2. Correction Factor (dB) = Substitution Antenna Gain (dB) + Cable Loss (dB).

Mode	TX channel 20525 (836.5MHz)	Frequency Range	Above 1000MHz
Environmental Conditions	25deg. C, 65%RH	Input Power	120Vac, 60Hz
Tested By	Greg Lin		

Antenna Polarity & Test Distance: Horizontal at 3 M							
No.	Freq. (MHz)	Reading (dBm)	S.G Power Value (dBm)	Correction Factor (dB)	ERP (dBm)	Limit (dBm)	Margin (dB)
1	1673.00	-67.2	-59.6	0.8	-58.8	-13.0	-45.8
Antenna Polarity & Test Distance: Vertical at 3 M							
No.	Freq. (MHz)	Reading (dBm)	S.G Power Value (dBm)	Correction Factor (dB)	ERP (dBm)	Limit (dBm)	Margin (dB)
1	1673.00	-64.0	-56.7	0.8	-55.9	-13.0	-42.9

Remarks:

1. Output Power (dBm) = S.G Value (dBm) + Correction Factor (dB).
2. Correction Factor (dB) = Substitution Antenna Gain (dB) + Cable Loss (dB).

Mode	TX channel 20625 (846.5MHz)	Frequency Range	Above 1000MHz
Environmental Conditions	25deg. C, 65%RH	Input Power	120Vac, 60Hz
Tested By	Greg Lin		

Antenna Polarity & Test Distance: Horizontal at 3 M							
No.	Freq. (MHz)	Reading (dBm)	S.G Power Value (dBm)	Correction Factor (dB)	ERP (dBm)	Limit (dBm)	Margin (dB)
1	1693.00	-66.5	-58.9	0.7	-58.2	-13.0	-45.2
Antenna Polarity & Test Distance: Vertical at 3 M							
No.	Freq. (MHz)	Reading (dBm)	S.G Power Value (dBm)	Correction Factor (dB)	ERP (dBm)	Limit (dBm)	Margin (dB)
1	1693.00	-62.6	-55.3	0.7	-54.6	-13.0	-41.6

Remarks:

1. Output Power (dBm) = S.G Value (dBm) + Correction Factor (dB).
2. Correction Factor (dB) = Substitution Antenna Gain (dB) + Cable Loss (dB).

LTE Band 5, Channel Bandwidth: 10MHz

Mode	TX channel 20450 (829.0MHz)	Frequency Range	Above 1000MHz
Environmental Conditions	25deg. C, 65%RH	Input Power	120Vac, 60Hz
Tested By	Greg Lin		

Antenna Polarity & Test Distance: Horizontal at 3 M							
No.	Freq. (MHz)	Reading (dBm)	S.G Power Value (dBm)	Correction Factor (dB)	ERP (dBm)	Limit (dBm)	Margin (dB)
1	1658.00	-66.5	-58.9	0.9	-58.0	-13.0	-45.0
Antenna Polarity & Test Distance: Vertical at 3 M							
No.	Freq. (MHz)	Reading (dBm)	S.G Power Value (dBm)	Correction Factor (dB)	ERP (dBm)	Limit (dBm)	Margin (dB)
1	1658.00	-63.2	-56.0	0.9	-55.1	-13.0	-42.1

Remarks:

1. Output Power (dBm) = S.G Value (dBm) + Correction Factor (dB).
2. Correction Factor (dB) = Substitution Antenna Gain (dB) + Cable Loss (dB).

Mode	TX channel 20525 (836.5MHz)	Frequency Range	Above 1000MHz
Environmental Conditions	25deg. C, 65%RH	Input Power	120Vac, 60Hz
Tested By	Greg Lin		

Antenna Polarity & Test Distance: Horizontal at 3 M							
No.	Freq. (MHz)	Reading (dBm)	S.G Power Value (dBm)	Correction Factor (dB)	ERP (dBm)	Limit (dBm)	Margin (dB)
1	1673.00	-66.8	-59.1	0.8	-58.3	-13.0	-45.3
Antenna Polarity & Test Distance: Vertical at 3 M							
No.	Freq. (MHz)	Reading (dBm)	S.G Power Value (dBm)	Correction Factor (dB)	ERP (dBm)	Limit (dBm)	Margin (dB)
1	1673.00	-62.8	-55.4	0.8	-54.6	-13.0	-41.6

Remarks:

1. Output Power (dBm) = S.G Value (dBm) + Correction Factor (dB).
2. Correction Factor (dB) = Substitution Antenna Gain (dB) + Cable Loss (dB).

Mode	TX channel 20600 (844.0MHz)	Frequency Range	Above 1000MHz
Environmental Conditions	25deg. C, 65%RH	Input Power	120Vac, 60Hz
Tested By	Greg Lin		

Antenna Polarity & Test Distance: Horizontal at 3 M							
No.	Freq. (MHz)	Reading (dBm)	S.G Power Value (dBm)	Correction Factor (dB)	ERP (dBm)	Limit (dBm)	Margin (dB)
1	1688.00	-67.5	-59.8	0.7	-59.1	-13.0	-46.1
Antenna Polarity & Test Distance: Vertical at 3 M							
No.	Freq. (MHz)	Reading (dBm)	S.G Power Value (dBm)	Correction Factor (dB)	ERP (dBm)	Limit (dBm)	Margin (dB)
1	1688.00	-64.0	-56.7	0.7	-56.0	-13.0	-43.0

Remarks:

1. Output Power (dBm) = S.G Value (dBm) + Correction Factor (dB).
2. Correction Factor (dB) = Substitution Antenna Gain (dB) + Cable Loss (dB).

5 Pictures of Test Arrangements

Please refer to the attached file (Test Setup Photo).

Appendix – Information on the Testing Laboratories

We, Bureau Veritas Consumer Products Services (H.K.) Ltd., Taoyuan Branch, were founded in 1988 to provide our best service in EMC, Radio, Telecom and Safety consultation. Our laboratories are FCC recognized accredited test firms and accredited and approved according to ISO/IEC 17025.

If you have any comments, please feel free to contact us at the following:

Linko EMC/RF Lab

Tel: 886-2-26052180

Fax: 886-2-26051924

Hsin Chu EMC/RF/Telecom Lab

Tel: 886-3-6668565

Fax: 886-3-6668323

Hwa Ya EMC/RF/Safety Lab

Tel: 886-3-3183232

Fax: 886-3-3270892

Email: service.adt@tw.bureauveritas.com

Web Site: www.bureauveritas-adt.com

The address and road map of all our labs can be found in our web site also.

--- END ---