

FCC Test Report

Report No.: RF180523C10-7 R1

FCC ID: 2AJOTTA-1082

Test Model: TA-1082

Received Date: May 23, 2018

Test Date: Jun. 29, 2018

Issued Date: Oct. 24, 2018

Applicant: HMD Global Oy

Address: Bertel Jungin aukio 9, 02600 Espoo, Finland

Issued By: Bureau Veritas Consumer Products Services (H.K.) Ltd., Taoyuan Branch

Lab Address: No. 47-2, 14th Ling, Chia Pau Vil., Lin Kou Dist., New Taipei City, Taiwan (R.O.C)

Test Location (1): No. 19, Hwa Ya 2nd Rd, Wen Hwa Tsuen, Kwei Shan Hsiang, Taoyuan Hsien 333, Taiwan, R.O.C.

Test Location (2): No.215, Sec. 3, Beixin Rd., Xindian Dist., New Taipei City 231, Taiwan, R.O.C

**FCC Registration /
Designation Number:** 427177 / TW0011



This report is for your exclusive use. Any copying or replication of this report to or for any other person or entity, or use of our name or trademark, is permitted only with our prior written permission. This report sets forth our findings solely with respect to the test samples identified herein. The results set forth in this report are not indicative or representative of the quality or characteristics of the lot from which a test sample was taken or any similar or identical product unless specifically and expressly noted. Our report includes all of the tests requested by you and the results thereof based upon the information that you provided to us. You have 60 days from date of issuance of this report to notify us of any material error or omission caused by our negligence, provided, however, that such notice shall be in writing and shall specifically address the issue you wish to raise. A failure to raise such issue within the prescribed time shall constitute your unqualified acceptance of the completeness of this report, the tests conducted and the correctness of the report contents. Unless specific mention, the uncertainty of measurement has been explicitly taken into account to declare the compliance or non-compliance to the specification. The report must not be used by the client to claim product certification, approval, or endorsement by TAF or any government agencies.

Table of Contents

Release Control Record	3
1 Certificate of Conformity	4
2 Summary of Test Results.....	5
2.1 Measurement Uncertainty.....	5
2.2 Modification Record	5
3 General Information	6
3.1 General Description of EUT	6
3.2 Description of Test Modes.....	8
3.2.1 Test Mode Applicability and Tested Channel Detail.....	10
3.3 Description of Support Units	11
3.3.1 Configuration of System under Test	11
3.4 General Description of Applied Standards.....	11
4 Test Types and Results	12
4.1 Radiated Emission and Bandedge Measurement	12
4.1.1 Limits of Radiated Emission and Bandedge Measurement	12
4.1.2 Limits of Unwanted Emission Out of the Restricted Bands.....	13
4.1.3 Test Instruments	14
4.1.4 Test Procedures.....	15
4.1.5 Deviation from Test Standard	16
4.1.6 Test Setup.....	16
4.1.7 EUT Operating Conditions.....	17
4.1.8 Test Results	18
5 Pictures of Test Arrangements.....	23
Appendix – Information on the Testing Laboratories	25
Annex A – Test Report for TA-1087 (Dual SIM)	26

Release Control Record

Issue No.	Description	Date Issued
RF180523C10-7	Original Release	Jul. 05, 2018
RF180523C10-7 R1	Revise applicant's address	Oct. 24, 2018

1 Certificate of Conformity

Product: Smart Phone

Brand: NOKIA

Test Model: TA-1082

Sample Status: Production Unit

Applicant: HMD Global Oy

Test Date: Jun. 29, 2018

Standards: 47 CFR FCC Part 15, Subpart E (Section 15.407)
ANSI C63.10:2013

This report is issued as a supplementary report to BV CPS report no.: RF180523C09-7. This report shall be used by combining with its original report.

Prepared by :  , **Date:** Oct. 24, 2018
Ivonne Wu / Supervisor

Approved by :  , **Date:** Oct. 24, 2018
Dylan Chiou / Project Engineer

2 Summary of Test Results

47 CFR FCC Part 15, Subpart E (Section 15.407)			
FCC Clause	Test Item	Result	Remarks
15.407(b)(6)	AC Power Conducted Emissions	N/A	Refer to Note
15.407(b) (1/2/3/4(i/ii)/6)	Radiated Emissions & Band Edge Measurement	Pass	Meet the requirement of limit. Minimum passing margin is -2.15 dB at 5350 MHz.
15.407(a)(1/2/3)	Max Average Transmit Power	N/A	Refer to Note
---	Occupied Bandwidth Measurement	N/A	Refer to Note
15.407(a)(1/2/3)	Peak Power Spectral Density	N/A	Refer to Note
15.407(e)	6 dB Bandwidth	N/A	Refer to Note
15.407(g)	Frequency Stability	N/A	Refer to Note
15.203	Antenna Requirement	Pass	No antenna connector is used.

Note: Only radiated emissions test had been performed for the addendum. Refer to original report for other test data.

2.1 Measurement Uncertainty

Where relevant, the following measurement uncertainty levels have been estimated for tests performed on the EUT as specified in CISPR 16-4-2:

Measurement	Frequency	Expanded Uncertainty (k=2) (±)
Radiated Emissions up to 1 GHz	30 MHz ~ 200 MHz	2.0153 dB
	200 MHz ~ 1000 MHz	2.0224 dB
Radiated Emissions above 1 GHz	1 GHz ~ 18 GHz	1.0121 dB
	18 GHz ~ 40 GHz	1.1508 dB

2.2 Modification Record

There were no modifications required for compliance.

3 General Information

3.1 General Description of EUT

Product	Smart Phone
Brand	NOKIA
Test Model	TA-1082
Status of EUT	Production Unit
Power Supply Rating	5.0 Vdc or 9 Vdc or 12 Vdc (adapter) 5.0 Vdc (host equipment) 3.85 Vdc (Li-ion battery)
Modulation Type	256QAM, 64QAM, 16QAM, QPSK, BPSK
Modulation Technology	OFDM
Transfer Rate	802.11a: 54.0/ 48.0/ 36.0/ 24.0/ 18.0/ 12.0/ 9.0/ 6.0 Mbps 802.11n: up to 300 Mbps 802.11ac: up to 866.7 Mbps
Operating Frequency	5180 ~ 5240 MHz, 5260 ~ 5320 MHz, 5500 ~ 5720 MHz, 5745 ~ 5825 MHz
Number of Channel	5180 ~ 5240 MHz: 4 for 802.11a, 802.11n (HT20) 2 for 802.11n (HT40) 1 for 802.11ac (VHT80) 5260 ~ 5320 MHz: 4 for 802.11a, 802.11n (HT20) 2 for 802.11n (HT40) 1 for 802.11ac (VHT80) 5500 ~ 5720 MHz: 12 for 802.11a, 802.11n (HT20) 6 for 802.11n (HT40) 3 for 802.11ac (VHT80) 5745 ~ 5825 MHz: 5 for 802.11a, 802.11n (HT20) 2 for 802.11n (HT40) 1 for 802.11ac (VHT80)
Antenna Type	PIFA antenna with -2 dBi (Main) / -4 dBi gain (Aux.) (5180 ~ 5240 MHz) PIFA antenna with -0.78 dBi (Main) / -5.6 dBi gain (Aux.) (5260 ~ 5320 MHz) PIFA antenna with 1.3 dBi (Main) / -2.2 dBi gain (Aux.) (5500 ~ 5720 MHz) PIFA antenna with 0.9 dBi (Main) / -4.5 dBi gain (Aux.) (5745 ~ 5825 MHz)
Antenna Connector	N/A
Accessory Device	Refer to Note as below
Data Cable Supplied	Refer to Note as below

Note:

1. This report is issued as a supplementary report to BV CPS report no.: RF180523C09-7. The difference is listed as below. Only radiated emission test was verified in this report.

Report No.	FCC ID	Model	Difference
RF180523C09-7	2AJOTTA-1087	TA-1087	Dual SIM
RF180523C10-7	2AJOTTA-1082	TA-1082	Single SIM

* The models have the same layout, circuit, and components, but different SIM tray.

2. The EUT incorporates a MIMO function. Physically, the EUT provides two completed transmitters and two receivers.

Modulation Mode	Tx Function
802.11a	1TX
802.11n (HT20)	2TX
802.11n (HT40)	2TX
802.11ac (VHT20)	2TX
802.11ac (VHT40)	2TX
802.11ac (VHT80)	2TX

* The modulation and bandwidth are similar for 802.11n mode for HT20 / HT40 and 802.11ac mode for VHT20 / VHT40, therefore investigated worst case to representative mode in test report. (Final test mode refer section 3.2.1)

3. The EUT's accessories list refers to Ext. Pho.
4. The above EUT information is declared by manufacturer and for more detailed features description, please refers to the manufacturer's specifications or user's manual.

3.2 Description of Test Modes

For 5180 ~ 5240 MHz

4 channels are provided for 802.11a, 802.11n (HT20):

Channel	Frequency (MHz)	Channel	Frequency (MHz)
36	5180	44	5220
40	5200	48	5240

2 channels are provided for 802.11n (HT40):

Channel	Frequency (MHz)	Channel	Frequency (MHz)
38	5190	46	5230

1 channel is provided for 802.11ac (VHT80):

Channel	Frequency (MHz)
42	5210

For 5260 ~ 5320 MHz

4 channels are provided for 802.11a, 802.11n (HT20):

Channel	Frequency (MHz)	Channel	Frequency (MHz)
52	5260	60	5300
56	5280	64	5320

2 channels are provided for 802.11n (HT40):

Channel	Frequency (MHz)	Channel	Frequency (MHz)
54	5270	62	5310

1 channel is provided for 802.11ac (VHT80):

Channel	Frequency (MHz)
58	5290

For 5500 ~ 5700 MHz

12 channels are provided for 802.11a, 802.11n (HT20):

Channel	Frequency (MHz)	Channel	Frequency (MHz)
100	5500	124	5620
104	5520	128	5640
108	5540	132	5660
112	5560	136	5680
116	5580	140	5700
120	5600	144	5720

6 channels are provided for 802.11n (HT40):

Channel	Frequency (MHz)	Channel	Frequency (MHz)
102	5510	126	5630
110	5550	134	5670
118	5590	142	5710

3 channels are provided for 802.11ac (VHT80):

Channel	Frequency (MHz)	Channel	Frequency (MHz)
106	5530	138	5690
122	5610		

For 5745 ~ 5825 MHz:

5 channels are provided for 802.11a, 802.11n (HT20):

Channel	Frequency (MHz)	Channel	Frequency (MHz)
149	5745	161	5805
153	5765	165	5825
157	5785		

2 channels are provided for 802.11n (HT40):

Channel	Frequency (MHz)	Channel	Frequency (MHz)
151	5755	159	5795

1 channel is provided for 802.11ac (VHT80):

Channel	Frequency (MHz)
155	5775

3.2.1 Test Mode Applicability and Tested Channel Detail

EUT Configure Mode	Applicable To		Description
	RE \geq 1G	RE<1G	
-	√	√	-

Where **RE \geq 1G**: Radiated Emission above 1 GHz **RE<1G**: Radiated Emission below 1 GHz

Note:

- The EUT had been pre-tested on the positioned of each 3 axis. The worst case was found when positioned on **Y-plane** for 1TX 5180-5240MHz & 5260-5320MHz and 2TX, and **X-plane** for 1TX 5500-5720MHz & 5745-5825MHz.
- "-" means no effect.

Radiated Emission Test (Above 1 GHz):

- Pre-Scan has been conducted to determine the worst-case mode from all possible combinations between available modulations, data rates and antenna ports (if EUT with antenna diversity architecture).
- Following channel(s) was (were) selected for the final test as listed below.

EUT Configure Mode	Frequency Band (MHz)	Mode	Available Channel	Tested Channel	Modulation Technology	Modulation Type	Data Rate (Mbps)
-	5180-5240	802.11ac (VHT80)	42	42	OFDM	BPSK	29.3
-	5260-5320	802.11n (HT40)	54 to 62	62	OFDM	BPSK	13.5
-	5500-5720	802.11ac (VHT80)	106 to 138	106	OFDM	BPSK	29.3
-	5745-5825	802.11a	149 to 165	157	OFDM	BPSK	6.0

Radiated Emission Test (Below 1 GHz):

- Pre-Scan has been conducted to determine the worst-case mode from all possible combinations between available modulations, data rates and antenna ports (if EUT with antenna diversity architecture).
- Following channel(s) was (were) selected for the final test as listed below.

EUT Configure Mode	Frequency Band (MHz)	Mode	Available Channel	Tested Channel	Modulation Technology	Modulation Type	Data Rate (Mbps)
-	5260-5320	802.11n (HT40)	54 to 62	62	OFDM	BPSK	13.5

Test Condition:

Applicable To	Environmental Conditions	Input Power	Tested by
RE \geq 1G	25 deg. C, 65 % RH	120 Vac, 60 Hz	Charles Hsiao
RE<1G	25 deg. C, 65 % RH	120 Vac, 60 Hz	Charles Hsiao

3.3 Description of Support Units

The EUT has been tested as an independent unit together with other necessary accessories or support units.

3.3.1 Configuration of System under Test

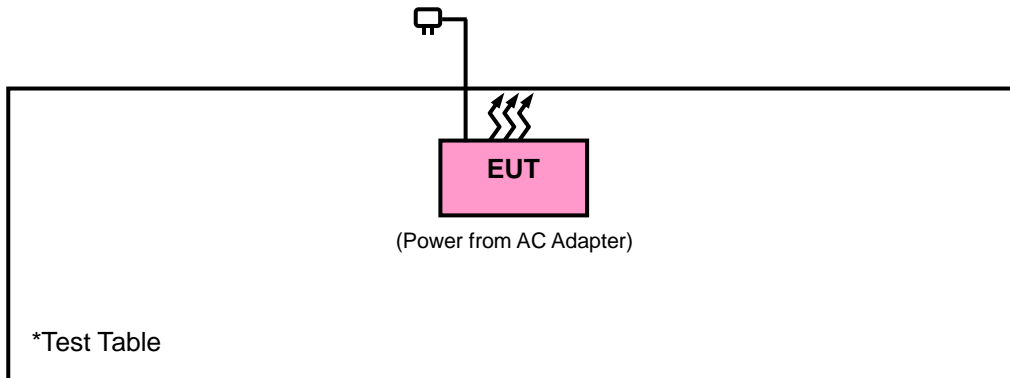

3.4 General Description of Applied Standards

The EUT is a RF Product. According to the specifications of the manufacturer, it must comply with the requirements of the following standards:

FCC Part 15, Subpart E (15.407)

KDB 789033 D02 General UNII Test Procedures New Rules v02r01

KDB 644545 D01 Guidance for IEEE 802 11ac v01r02

KDB 662911 D01 Multiple Transmitter Output v02r01

ANSI C63.10-2013

All test items have been performed and recorded as per the above standards.

4 Test Types and Results

4.1 Radiated Emission and Bandedge Measurement

4.1.1 Limits of Radiated Emission and Bandedge Measurement

Radiated emissions which fall in the restricted bands must comply with the radiated emission limits specified as below table. Other emissions shall be at least 20 dB below the highest level of the desired power:

Frequencies (MHz)	Field Strength (microvolts/meter)	Measurement Distance (meters)
0.009 ~ 0.490	2400/F (kHz)	300
0.490 ~ 1.705	24000/F (kHz)	30
1.705 ~ 30.0	30	30
30 ~ 88	100	3
88 ~ 216	150	3
216 ~ 960	200	3
Above 960	500	3

Note:

1. The lower limit shall apply at the transition frequencies.
2. Emission level (dBuV/m) = 20 log Emission level (uV/m).
3. For frequencies above 1000 MHz, the field strength limits are based on average detector, however, the peak field strength of any emission shall not exceed the maximum permitted average limits, specified above by more than 20 dB under any condition of modulation.

4.1.2 Limits of Unwanted Emission Out of the Restricted Bands

Applicable To		Limit	
789033 D02 General UNII Test Procedures New Rules v02r01		Field Strength at 3 m	
		PK: 74 (dBµV/m)	AV: 54 (dBµV/m)
Frequency Band	Applicable To	EIRP Limit	Equivalent Field Strength at 3 m
5150~5250 MHz	15.407(b)(1)	PK: -27 (dBm/MHz)	PK: 68.2 (dBµV/m)
5250~5350 MHz	15.407(b)(2)		
5470~5725 MHz	15.407(b)(3)		
5725~5850 MHz	15.407(b)(4)(i)	PK:-27 (dBm/MHz) ^{*1} PK:10 (dBm/MHz) ^{*2} PK:15.6 (dBm/MHz) ^{*3} PK:27 (dBm/MHz) ^{*4}	PK: 68.2 (dBµV/m) ^{*1} PK:105.2 (dBµV/m) ^{*2} PK: 110.8 (dBµV/m) ^{*3} PK:122.2 (dBµV/m) ^{*4}
	15.407(b)(4)(ii)	Emission limits in section 15.247(d)	
^{*1} beyond 75 MHz or more above of the band edge. ^{*2} below the band edge increasing linearly to 10 dBm/MHz at 25 MHz above. ^{*3} below the band edge increasing linearly to a level of 15.6 dBm/MHz at 5 MHz above. ^{*4} from 5 MHz above or below the band edge increasing linearly to a level of 27 dBm/MHz at the band edge.			

Note:

The following formula is used to convert the equipment isotropic radiated power (eirp) to field strength:

$$E = \frac{1000000\sqrt{30P}}{3} \mu\text{V/m, where P is the eirp (Watts).$$

4.1.3 Test Instruments

Description & Manufacturer	Model No.	Serial No.	Date of Calibration	Due Date of Calibration
Test Receiver Agilent Technologies	N9038A	MY52260177	Jul. 05, 2017	Jul. 04, 2018
Spectrum Analyzer ROHDE & SCHWARZ	FSU43	101261	Jan. 11, 2018	Jan. 10, 2019
Double Ridge Guide Horn Antenna EMCO	3115	5619	Nov. 30, 2017	Nov. 29, 2018
BILOG Antenna SCHWARZBECK	VULB 9168	9168-153	Dec. 06, 2017	Dec. 05, 2018
Fixed Attenuator Mini-Circuits	BW-N10W5+	NA	Jul. 07, 2017	Jul. 06, 2018
Loop Antenna	EM-6879	269	Aug. 11, 2017	Aug. 10, 2018
Preamplifier Agilent	8447D	2944A10628	Oct. 13, 2018	Oct. 12, 2019
Preamplifier Agilent	8449B	3008A01962	Oct. 13, 2018	Oct. 12, 2019
RF signal cable ETS-LINDGREN	5D-FB	Cable-RF1-01(RFC -SMS-100-SMS-12 0+MY13379/4)	Jun. 20, 2018	Jun. 19, 2019
RF signal cable ETS-LINDGREN	8D-FB	Cable-RF1-02(RFC -SMS-100-NMS-12 0+8120_5140_2911)	Jun. 20, 2018	Jun. 19, 2019
Boresight Antenna Fixture	FBA-01	FBA-SIP01	NA	NA
Software BV ADT	E3 8.130425b	NA	NA	NA
Antenna Tower MF	NA	NA	NA	NA
Turn Table MF	NA	NA	NA	NA
Antenna Tower & Turn Table Controller MF	MF-7802	NA	NA	NA

- Note: 1. The calibration interval of the above test instruments is 12 / 24 months and the calibrations are traceable to NML/ROC and NIST/USA.
2. The test was performed in HsinTien Chamber 1.
3. The horn antenna and preamplifier (model: 83017A) are used only for the measurement of emission frequency above 1 GHz if tested.
4. The IC Site Registration No. is IC7450I-1.

4.1.4 Test Procedures

For Radiated Emission below 30 MHz

- a. The EUT was placed on the top of a rotating table 0.8 meters above the ground at a 3 meter chamber room. The table was rotated 360 degrees to determine the position of the highest radiation.
- b. The EUT was set 3 meters away from the interference-receiving antenna, which was mounted on the top of a variable-height antenna tower.
- c. Both Parallel, perpendicular, and ground-parallel orientations of the antenna are set to make the measurement.
- d. For each suspected emission, the EUT was arranged to its worst case and the rotatable table was turned from 0 degrees to 360 degrees to find the maximum reading.
- e. The test-receiver system was set to Quasi-Peak Detect Function and Specified Bandwidth with Maximum Hold Mode.

Note:

1. The resolution bandwidth and video bandwidth of test receiver/spectrum analyzer is 9 kHz at frequency below 30 MHz.

For Radiated Emission above 30 MHz

- a. The EUT was placed on the top of a rotating table 0.8 meters (for 30 MHz ~ 1 GHz) / 1.5 meters (for above 1 GHz) above the ground at 3 meter chamber room for test. The table was rotated 360 degrees to determine the position of the highest radiation.
- b. The EUT was set 3 meters away from the interference-receiving antenna, which was mounted on the top of a variable-height antenna tower.
- c. The height of antenna is varied from one meter to four meters above the ground to determine the maximum value of the field strength. Both horizontal and vertical polarizations of the antenna are set to make the measurement.
- d. For each suspected emission, the EUT was arranged to its worst case and then the antenna was tuned to heights from 1 meter to 4 meters and the rotatable table was turned from 0 degrees to 360 degrees to find the maximum reading.
- e. The test-receiver system was set to quasi-peak detect function and specified bandwidth with maximum hold mode when the test frequency is below 1 GHz.
- f. The test-receiver system was set to peak and average detected function and specified bandwidth with maximum hold mode when the test frequency is above 1 GHz. If the peak reading value also meets average limit, measurement with the average detector is unnecessary.

Note:

1. The resolution bandwidth and video bandwidth of test receiver/spectrum analyzer is 120 kHz for Quasi-peak detection (QP) at frequency below 1 GHz.
2. The resolution bandwidth of test receiver/spectrum analyzer is 1 MHz and the video bandwidth is 3 MHz for Peak detection (PK) at frequency above 1 GHz.
3. The resolution bandwidth of test receiver/spectrum analyzer is 1 MHz and the video bandwidth is $\geq 1/T$ (Duty cycle < 98 %) or 10 Hz (Duty cycle ≥ 98 %) for Average detection (AV) at frequency above 1 GHz.
(11a: RBW = 1 MHz, VBW = 1 kHz ; 11n (HT20): RBW = 1 MHz, VBW = 1 kHz ;
11n (HT40): RBW = 1 MHz, VBW = 3 kHz ; 11ac (VHT80): RBW = 1 MHz, VBW = 10 kHz)
4. All modes of operation were investigated and the worst-case emissions are reported.

4.1.5 Deviation from Test Standard

No deviation.

4.1.6 Test Setup

<Radiated Emission below 30 MHz>

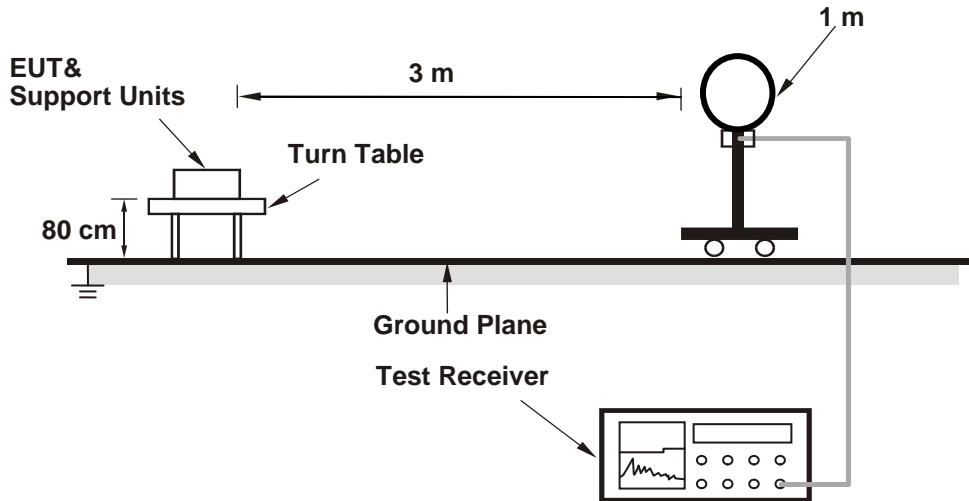

<Radiated Emission 30 MHz to 1 GHz>

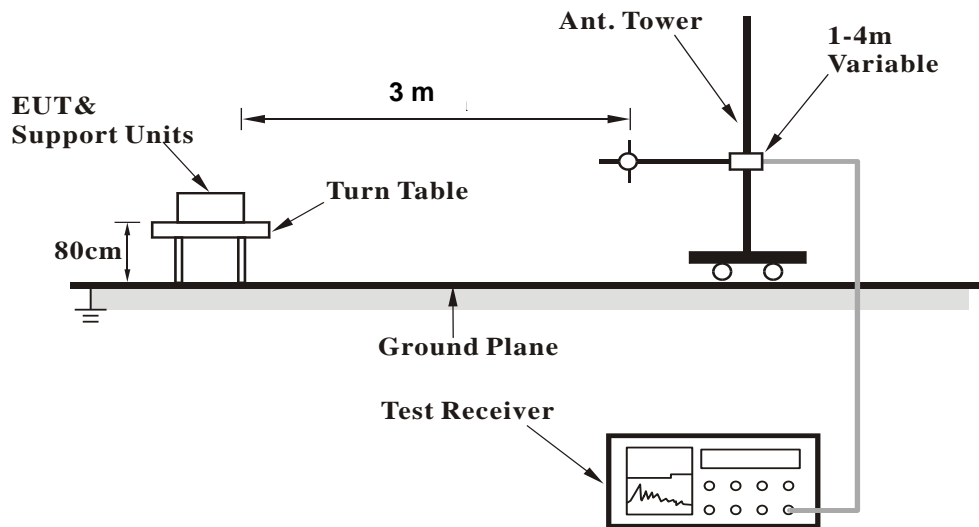

<Radiated Emission above 1 GHz>

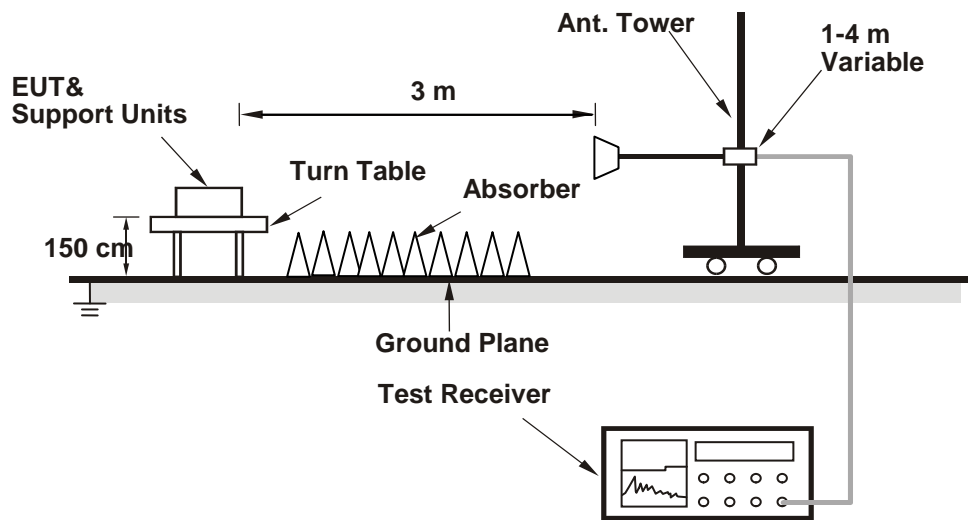

For the actual test configuration, please refer to the attached file (Test Setup Photo).

4.1.7 EUT Operating Conditions

- Placed the EUT on a testing table.
- Use the software to control the EUT under transmission condition continuously at specific channel frequency.

4.1.8 Test Results
 Above 1 GHz Data :
 <2TX>
 802.11ac (VHT80)

EUT Test Condition		Measurement Detail	
Channel	Channel 42	Frequency Range	1 GHz ~ 40 GHz
Input Power	120 Vac, 60 Hz	Detector Function	Peak (PK) Average (AV)
Environmental Conditions	25 deg. C, 65 % RH	Tested By	Charles Hsiao

Antenna Polarity & Test Distance: Horizontal at 3 m										
Frequency (MHz)	Emission Level (dBuV/m)	Read Level (dBuV)	Limit (dBuV/m)	Margin (dB)	Antenna Factor (dB/m)	Cable Loss (dB)	Preamp Factor (dB)	Antenna Height (cm)	Table Angle (Degree)	Remark
5150	51.7	43.45	54	-2.3	34.12	8.13	34	111	222	Average
5150	59.55	51.3	74	-14.45	34.12	8.13	34	111	222	Peak
5210	92.75	84.39			34.17	8.19	34	120	220	Average
5210	98.88	90.52			34.17	8.19	34	120	220	Peak
5350	43.21	34.58	54	-10.79	34.28	8.38	34.03	111	222	Average
5350	53.65	45.02	74	-20.35	34.28	8.38	34.03	111	222	Peak
*10420	55.18	40.77	68.2	-13.02	37.15	12.42	35.16	115	217	Peak

Antenna Polarity & Test Distance: Vertical at 3 m										
Frequency (MHz)	Emission Level (dBuV/m)	Read Level (dBuV)	Limit (dBuV/m)	Margin (dB)	Antenna Factor (dB/m)	Cable Loss (dB)	Preamp Factor (dB)	Antenna Height (cm)	Table Angle (Degree)	Remark
5149	46.57	38.32	54	-7.43	34.12	8.13	34	125	295	Average
5149	55.36	47.11	74	-18.64	34.12	8.13	34	125	295	Peak
5210	87.49	79.13			34.17	8.19	34	125	295	Average
5210	94.24	85.88			34.17	8.19	34	125	295	Peak
5450	43.24	34.42	54	-10.76	34.36	8.51	34.05	125	295	Average
5450	53	44.18	74	-21	34.36	8.51	34.05	125	295	Peak
*10420	55.02	40.61	68.2	-13.18	37.15	12.42	35.16	117	14	Peak

Remarks:

- Emission Level = Read Level + Antenna Factor + Cable Loss - Preamp Factor
 Margin value = Emission level – Limit value
- 5210 MHz: Fundamental Frequency
- *: Out of Restricted Band
- The emission levels of other frequencies were very low against the limit

<2TX>

802.11n (HT40)

EUT Test Condition		Measurement Detail	
Channel	Channel 62	Frequency Range	1 GHz ~ 40 GHz
Input Power	120 Vac, 60 Hz	Detector Function	Peak (PK) Average (AV)
Environmental Conditions	25 deg. C, 65 % RH	Tested By	Charles Hsiao

Antenna Polarity & Test Distance: Horizontal at 3 m										
Frequency (MHz)	Emission Level (dBuV/m)	Read Level (dBuV)	Limit (dBuV/m)	Margin (dB)	Antenna Factor (dB/m)	Cable Loss (dB)	Preamp Factor (dB)	Antenna Height (cm)	Table Angle (Degree)	Remark
5140	41.96	33.7	54	-12.04	34.12	8.13	33.99	120	235	Average
5140	52.84	44.58	74	-21.16	34.12	8.13	33.99	120	235	Peak
5310	93.77	85.22			34.25	8.32	34.02	103	235	Average
5310	100.77	92.22			34.25	8.32	34.02	103	235	Peak
5350	51.85	43.22	54	-2.15	34.28	8.38	34.03	120	235	Average
5350	61	52.37	74	-13	34.28	8.38	34.03	120	235	Peak
10620	45	30.29	54	-9	37.3	12.69	35.28	200	200	Average
10620	55.35	40.64	74	-18.65	37.3	12.69	35.28	200	200	Peak

Antenna Polarity & Test Distance: Vertical at 3 m										
Frequency (MHz)	Emission Level (dBuV/m)	Read Level (dBuV)	Limit (dBuV/m)	Margin (dB)	Antenna Factor (dB/m)	Cable Loss (dB)	Preamp Factor (dB)	Antenna Height (cm)	Table Angle (Degree)	Remark
5088.44	41.74	33.58	54	-12.26	34.07	8.07	33.98	130	270	Average
5088.44	52.9	44.74	74	-21.1	34.07	8.07	33.98	130	270	Peak
5310	89.85	81.3			34.25	8.32	34.02	135	280	Average
5310	96.6	88.05			34.25	8.32	34.02	135	280	Peak
5350	47.4	38.77	54	-6.6	34.28	8.38	34.03	130	270	Average
5350	56.36	47.73	74	-17.64	34.28	8.38	34.03	130	270	Peak
10620	44.32	29.61	54	-9.68	37.3	12.69	35.28	105	28	Average
10620	54	39.29	74	-20	37.3	12.69	35.28	105	28	Peak

Remarks:

- Emission Level = Read Level + Antenna Factor + Cable Loss - Preamp Factor
Margin value = Emission level – Limit value
- 5310 MHz: Fundamental Frequency
- The emission levels of other frequencies were very low against the limit

<2TX>

802.11ac (VHT80)

EUT Test Condition		Measurement Detail	
Channel	Channel 106	Frequency Range	1 GHz ~ 40 GHz
Input Power	120 Vac, 60 Hz	Detector Function	Peak (PK) Average (AV)
Environmental Conditions	25 deg. C, 65 % RH	Tested By	Charles Hsiao

Antenna Polarity & Test Distance: Horizontal at 3 m										
Frequency (MHz)	Emission Level (dBuV/m)	Read Level (dBuV)	Limit (dBuV/m)	Margin (dB)	Antenna Factor (dB/m)	Cable Loss (dB)	Preamp Factor (dB)	Antenna Height (cm)	Table Angle (Degree)	Remark
5460	51.76	42.94	54	-2.24	34.36	8.51	34.05	105	244	Average
5460	62	53.18	74	-12	34.36	8.51	34.05	105	244	Peak
*5470	63.35	54.52	68.2	-4.85	34.37	8.51	34.05	105	244	Peak
5530	91.74	82.81			34.42	8.58	34.07	100	248	Average
5530	99.62	90.69			34.42	8.58	34.07	100	248	Peak
*5726	51.95	42.79	68.2	-16.25	34.62	8.65	34.11	100	248	Peak
11060	45.29	30.21	54	-8.71	37.64	12.91	35.47	135	322	Average
11060	55.36	40.28	74	-18.64	37.64	12.91	35.47	135	322	Peak
Antenna Polarity & Test Distance: Vertical at 3 m										
Frequency (MHz)	Emission Level (dBuV/m)	Read Level (dBuV)	Limit (dBuV/m)	Margin (dB)	Antenna Factor (dB/m)	Cable Loss (dB)	Preamp Factor (dB)	Antenna Height (cm)	Table Angle (Degree)	Remark
5460	47.99	39.17	54	-6.01	34.36	8.51	34.05	125	264	Average
5460	56.25	47.43	74	-17.75	34.36	8.51	34.05	125	264	Peak
*5470	58.88	50.05	68.2	-9.32	34.37	8.51	34.05	125	264	Peak
5530	87.25	78.32			34.42	8.58	34.07	112	280	Average
5530	95.28	86.35			34.42	8.58	34.07	112	280	Peak
*5724.44	52.22	43.06	68.2	-15.98	34.62	8.65	34.11	112	280	Peak
11060	45.2	30.12	54	-8.8	37.64	12.91	35.47	186	2	Average
11060	55	39.92	74	-19	37.64	12.91	35.47	186	2	Peak

Remarks:

- Emission Level = Read Level + Antenna Factor + Cable Loss - Preamp Factor
Margin value = Emission level – Limit value
- 5530 MHz: Fundamental Frequency
- *: Out of Restricted Band
- The emission levels of other frequencies were very low against the limit

<1TX>
802.11a

EUT Test Condition		Measurement Detail	
Channel	Channel 157	Frequency Range	1 GHz ~ 40 GHz
Input Power	120 Vac, 60 Hz	Detector Function	Peak (PK) Average (AV)
Environmental Conditions	25 deg. C, 65 % RH	Tested By	Charles Hsiao

<Spurious Emission>

Antenna Polarity & Test Distance: Horizontal at 3 m										
Frequency (MHz)	Emission Level (dBuV/m)	Read Level (dBuV)	Limit (dBuV/m)	Margin (dB)	Antenna Factor (dB/m)	Cable Loss (dB)	Preamp Factor (dB)	Antenna Height (cm)	Table Angle (Degree)	Remark
5785	97.12	87.89			34.68	8.68	34.13	112	141	Average
5785	104.21	94.98			34.68	8.68	34.13	112	141	Peak
11570	45.22	29.91	54	-8.78	38	12.68	35.37	125	184	Average
11570	55.21	39.9	74	-18.79	38	12.68	35.37	125	184	Peak
Antenna Polarity & Test Distance: Vertical at 3 m										
Frequency (MHz)	Emission Level (dBuV/m)	Read Level (dBuV)	Limit (dBuV/m)	Margin (dB)	Antenna Factor (dB/m)	Cable Loss (dB)	Preamp Factor (dB)	Antenna Height (cm)	Table Angle (Degree)	Remark
5785	95.2	85.97			34.68	8.68	34.13	112	165	Average
5785	102.51	93.28			34.68	8.68	34.13	112	165	Peak
11570	45.12	29.81	54	-8.88	38	12.68	35.37	115	142	Average
11570	55.21	39.9	74	-18.79	38	12.68	35.37	115	142	Peak

<Out of Band Emission (OOBE)>

Antenna Polarity & Test Distance: Horizontal at 3 m										
Frequency (MHz)	Emission Level (dBuV/m)	Read Level (dBuV)	Limit (dBuV/m)	Margin (dB)	Antenna Factor (dB/m)	Cable Loss (dB)	Preamp Factor (dB)	Antenna Height (cm)	Table Angle (Degree)	Remark
*5576.12	47.13	38.13	68.2	-21.07	34.47	8.6	34.07	123	20	Peak
5653.21	47.12	38.02	70.58	-23.46	34.56	8.63	34.09	123	20	Peak
5922.12	47.55	38.15	70.33	-22.78	34.83	8.73	34.16	123	20	Peak
*5985.2	49.13	39.67	68.2	-19.07	34.88	8.75	34.17	123	20	Peak
Antenna Polarity & Test Distance: Vertical at 3 m										
Frequency (MHz)	Emission Level (dBuV/m)	Read Level (dBuV)	Limit (dBuV/m)	Margin (dB)	Antenna Factor (dB/m)	Cable Loss (dB)	Preamp Factor (dB)	Antenna Height (cm)	Table Angle (Degree)	Remark
*5595.21	49.13	40.12	68.2	-19.07	34.49	8.6	34.08	111	201	Peak
5652.56	47.25	38.15	70.09	-22.84	34.56	8.63	34.09	111	201	Peak
5922.58	48.12	38.72	69.99	-21.87	34.83	8.73	34.16	111	201	Peak
*5953.25	49.21	39.78	68.2	-18.99	34.85	8.74	34.16	111	201	Peak

Remarks:

- Emission Level = Read Level + Antenna Factor + Cable Loss - Preamp Factor
Margin value = Emission level – Limit value
- 5785 MHz: Fundamental Frequency
- *: Out of Restricted Band
- The emission levels of other frequencies were very low against the limit

9 kHz ~ 30 MHz Data:

The amplitude of spurious emissions attenuated more than 20 dB below the permissible value is not required to be report.

30 MHz ~ 1 GHz Worst-Case Data:

<2TX>

802.11n (HT40)

EUT Test Condition		Measurement Detail	
Channel	Channel 62	Frequency Range	30 MHz ~ 1 GHz
Input Power	120 Vac, 60 Hz	Detector Function	Peak (PK) Quasi-peak (QP)
Environmental Conditions	25 deg. C, 65 % RH	Tested By	Charles Hsiao

Antenna Polarity & Test Distance: Horizontal at 3 m										
Frequency (MHz)	Emission Level (dBuV/m)	Read Level (dBuV)	Limit (dBuV/m)	Margin (dB)	Antenna Factor (dB/m)	Cable Loss (dB)	Preamp Factor (dB)	Antenna Height (cm)	Table Angle (Degree)	Remark
91.02	16	35.97	43.5	-27.5	10.69	1.11	31.77	185	326	Peak
162.03	19.79	41.71	43.5	-23.71	8.82	1.52	32.26	106	2	Peak
268.41	18.11	35.66	46	-27.89	12.62	1.94	32.11	200	121	Peak
381.2	20.04	35.26	46	-25.96	14.61	2.34	32.17	139	9	Peak
712.3	20.06	29.65	46	-25.94	19.4	3.11	32.1	194	265	Peak
892.2	22.92	29.55	46	-23.08	21.41	3.49	31.53	105	141	Peak

Antenna Polarity & Test Distance: Vertical at 3 m										
Frequency (MHz)	Emission Level (dBuV/m)	Read Level (dBuV)	Limit (dBuV/m)	Margin (dB)	Antenna Factor (dB/m)	Cable Loss (dB)	Preamp Factor (dB)	Antenna Height (cm)	Table Angle (Degree)	Remark
50.52	17.25	34.03	40	-22.75	14.54	0.9	32.22	180	14	Peak
89.4	13.81	34.25	43.5	-29.69	10.21	1.11	31.76	138	255	Peak
166.35	10.28	32.02	43.5	-33.22	8.99	1.52	32.25	127	217	Peak
514.2	15.62	28.51	46	-30.38	16.53	2.7	32.12	165	296	Peak
704.6	19.36	29.05	46	-26.64	19.29	3.11	32.09	170	14	Peak
791.4	20.04	28.6	46	-25.96	20.24	3.27	32.07	199	200	Peak

Remarks:

- Emission Level = Read Level + Antenna Factor + Cable Loss - Preamp Factor
Margin value = Emission level – Limit value
- The emission levels of other frequencies were very low against the limit

5 Pictures of Test Arrangements

Please refer to the attached file (Test Setup Photo).

Appendix – Information on the Testing Laboratories

We, Bureau Veritas Consumer Products Services (H.K.) Ltd., Taoyuan Branch, were founded in 1988 to provide our best service in EMC, Radio, Telecom and Safety consultation. Our laboratories are FCC recognized accredited test firms and accredited according to ISO/IEC 17025.

If you have any comments, please feel free to contact us at the following:

Linko EMC/RF Lab

Tel: 886-2-26052180

Fax: 886-2-26051924

Hsin Chu EMC/RF/Telecom Lab

Tel: 886-3-6668565

Fax: 886-3-6668323

Hwa Ya EMC/RF/Safety

Tel: 886-3-3183232

Fax: 886-3-3270892

Email: service.adt@tw.bureauveritas.com

Web Site: www.bureauveritas-adt.com

The address and road map of all our labs can be found in our web site also.

--- END ---

Annex A – Test Report for TA-1087 (Dual SIM)

FCC Test Report

Report No.: RF180523C09-7 R1

FCC ID: 2AJOTTA-1087

Test Model: TA-1087

Received Date: May 23, 2018

Test Date: Jun. 05, 2018 ~ Jun. 14, 2018

Issued Date: Oct. 24, 2018

Applicant: HMD Global Oy

Address: Bertel Jungin aukio 9, 02600 Espoo, Finland

Issued By: Bureau Veritas Consumer Products Services (H.K.) Ltd., Taoyuan Branch

Lab Address: No. 47-2, 14th Ling, Chia Pau Vil., Lin Kou Dist., New Taipei City, Taiwan (R.O.C)

Test Location (1): No. 19, Hwa Ya 2nd Rd, Wen Hwa Tsuen, Kwei Shan Hsiang, Taoyuan Hsien 333, Taiwan, R.O.C.

Test Location (2): No.215, Sec. 3, Beixin Rd., Xindian Dist., New Taipei City 231, Taiwan, R.O.C

**FCC Registration /
Designation Number:** 427177 / TW0011



This report is for your exclusive use. Any copying or replication of this report to or for any other person or entity, or use of our name or trademark, is permitted only with our prior written permission. This report sets forth our findings solely with respect to the test samples identified herein. The results set forth in this report are not indicative or representative of the quality or characteristics of the lot from which a test sample was taken or any similar or identical product unless specifically and expressly noted. Our report includes all of the tests requested by you and the results thereof based upon the information that you provided to us. You have 60 days from date of issuance of this report to notify us of any material error or omission caused by our negligence, provided, however, that such notice shall be in writing and shall specifically address the issue you wish to raise. A failure to raise such issue within the prescribed time shall constitute your unqualified acceptance of the completeness of this report, the tests conducted and the correctness of the report contents. Unless specific mention, the uncertainty of measurement has been explicitly taken into account to declare the compliance or non-compliance to the specification. The report must not be used by the client to claim product certification, approval, or endorsement by TAF or any government agencies.

Table of Contents

Release Control Record	4
1 Certificate of Conformity	5
2 Summary of Test Results	6
2.1 Measurement Uncertainty.....	6
2.2 Modification Record	6
3 General Information	7
3.1 General Description of EUT	7
3.2 Description of Test Modes.....	9
3.2.1 Test Mode Applicability and Tested Channel Detail.....	11
3.3 Duty Cycle of Test Signal	13
3.4 Description of Support Units	14
3.4.1 Configuration of System under Test	14
3.5 General Description of Applied Standards.....	14
4 Test Types and Results	15
4.1 Radiated Emission and Bandedge Measurement	15
4.1.1 Limits of Radiated Emission and Bandedge Measurement	15
4.1.2 Limits of Unwanted Emission Out of the Restricted Bands	16
4.1.3 Test Instruments	17
4.1.4 Test Procedures.....	18
4.1.5 Deviation from Test Standard	19
4.1.6 Test Set Up	19
4.1.7 EUT Operating Conditions.....	20
4.1.8 Test Results	21
4.2 Conducted Emission Measurement.....	64
4.2.1 Limits of Conducted Emission Measurement	64
4.2.2 Test Instruments	64
4.2.3 Test Procedures.....	65
4.2.4 Deviation from Test Standard	65
4.2.5 Test Setup.....	65
4.2.6 EUT Operating Conditions.....	65
4.2.7 Test Results	66
4.3 Transmit Power Measurement.....	68
4.3.1 Limits of Transmit Power Measurement	68
4.3.2 Test Setup.....	68
4.3.3 Test Instruments	69
4.3.4 Test Procedure	69
4.3.5 Deviation from Test Standard	69
4.3.6 EUT Operating Conditions.....	69
4.3.7 Test Result	70
4.4 Occupied Bandwidth Measurement.....	77
4.4.1 Test Setup.....	77
4.4.2 Test Instruments	77
4.4.3 Test Procedure	77
4.4.4 Test Results	78
4.5 Peak Power Spectral Density Measurement	81
4.5.1 Limits of Peak Power Spectral Density Measurement	81
4.5.2 Test Setup.....	81
4.5.3 Test Instruments	81
4.5.4 Test Procedures.....	81
4.5.5 Deviation from Test Standard	82
4.5.6 EUT Operating Conditions.....	82
4.5.7 Test Results	83
4.6 Frequency Stability	89

4.6.1	Limit of Frequency Stability Measurement	89
4.6.2	Test Setup	89
4.6.3	Test Instruments	89
4.6.4	Test Procedure	89
4.6.5	Deviation from Test Standard	89
4.6.6	EUT Operating Condition	89
4.6.7	Test Results	90
4.7	6 dB Bandwidth Measurement.....	91
4.7.1	Limits of 6 dB Bandwidth Measurement.....	91
4.7.2	Test Setup.....	91
4.7.3	Test Instruments	91
4.7.4	Test Procedure	91
4.7.5	Deviation from Test Standard	91
4.7.6	EUT Operating Condition	91
4.7.7	Test Results	92
5	Pictures of Test Arrangements.....	94
	Annex A- Radiated Out of Band Emisison (OOBE) Measurement (For U-NII-3 band)	95
	Appendix – Information on the Testing Laboratories	98

Release Control Record

Issue No.	Description	Date Issued
RF180523C09-7	Original Release	Jun. 28, 2018
RF180523C09-7 R1	Revise applicant's address	Oct. 24, 2018

1 Certificate of Conformity

Product: Smart Phone
Brand: NOKIA
Test Model: TA-1087
Sample Status: Production Unit
Applicant: HMD Global Oy
Test Date: Jun. 05, 2018 ~ Jun. 14, 2018
Standards: 47 CFR FCC Part 15, Subpart E (Section 15.407)
ANSI C63.10:2013

The above equipment has been tested by **Bureau Veritas Consumer Products Services (H.K.) Ltd., Taoyuan Branch**, and found compliance with the requirement of the above standards. The test record, data evaluation & Equipment Under Test (EUT) configurations represented herein are true and accurate accounts of the measurements of the sample's RF characteristics under the conditions specified in this report.

Prepared by :  , **Date:** Oct. 24, 2018
Ivonne Wu / Supervisor

Approved by :  , **Date:** Oct. 24, 2018
Dylan Chiou / Project Engineer

2 Summary of Test Results

47 CFR FCC Part 15, Subpart E (Section 15.407)			
FCC Clause	Test Item	Result	Remarks
15.407(b)(6)	AC Power Conducted Emissions	Pass	Meet the requirement of limit. Minimum passing margin is -14.32 dB at 0.54375 MHz.
15.407(b) (1/2/3/4(i/ii)/6)	Radiated Emissions & Band Edge Measurement	Pass	Meet the requirement of limit. Minimum passing margin is -1.55 dB at 5350 MHz.
15.407(a)(1/2/3)	Max Average Transmit Power	Pass	Meet the requirement of limit.
---	Occupied Bandwidth Measurement	-	Reference only
15.407(a)(1/2/3)	Peak Power Spectral Density	Pass	Meet the requirement of limit.
15.407(e)	6 dB Bandwidth	Pass	Meet the requirement of limit. (U-NII-3 Band only)
15.407(g)	Frequency Stability	Pass	Meet the requirement of limit.
15.203	Antenna Requirement	Pass	No antenna connector is used.

*For U-NII-3 band compliance with rule part 15.407(b)(4)(i), the OOBE test plots were recorded in Annex A.

2.1 Measurement Uncertainty

Where relevant, the following measurement uncertainty levels have been estimated for tests performed on the EUT as specified in CISPR 16-4-2:

Measurement	Frequency	Expanded Uncertainty (k=2) (\pm)
Conducted Emissions at mains ports	150 kHz ~ 30 MHz	2.44 dB
Radiated Emissions up to 1 GHz	30 MHz ~ 200 MHz	2.0153 dB
	200 MHz ~ 1000 MHz	2.0224 dB
Radiated Emissions above 1 GHz	1 GHz ~ 18 GHz	1.0121 dB
	18 GHz ~ 40 GHz	1.1508 dB

2.2 Modification Record

There were no modifications required for compliance.

3 General Information

3.1 General Description of EUT

Product	Smart Phone
Brand	NOKIA
Test Model	TA-1087
Status of EUT	Production Unit
Power Supply Rating	5.0 Vdc or 9 Vdc or 12 Vdc (adapter) 5.0 Vdc (host equipment) 3.85 Vdc (Li-ion battery)
Modulation Type	256QAM, 64QAM, 16QAM, QPSK, BPSK
Modulation Technology	OFDM
Transfer Rate	802.11a: 54.0/ 48.0/ 36.0/ 24.0/ 18.0/ 12.0/ 9.0/ 6.0 Mbps 802.11n: up to 300 Mbps 802.11ac: up to 866.7 Mbps
Operating Frequency	5180 ~ 5240 MHz, 5260 ~ 5320 MHz, 5500 ~ 5720 MHz, 5745 ~ 5825 MHz
Number of Channel	5180 ~ 5240 MHz: 4 for 802.11a, 802.11n (HT20) 2 for 802.11n (HT40) 1 for 802.11ac (VHT80) 5260 ~ 5320 MHz: 4 for 802.11a, 802.11n (HT20) 2 for 802.11n (HT40) 1 for 802.11ac (VHT80) 5500 ~ 5720 MHz: 12 for 802.11a, 802.11n (HT20) 6 for 802.11n (HT40) 3 for 802.11ac (VHT80) 5745 ~ 5825 MHz: 5 for 802.11a, 802.11n (HT20) 2 for 802.11n (HT40) 1 for 802.11ac (VHT80)
Output Power	157.592 mW for 5180 ~ 5240 MHz 155.976 mW for 5260 ~ 5320 MHz 157.592 mW for 5500 ~ 5720 MHz 155.079 mW for 5745 ~ 5825 MHz
Antenna Type	PIFA antenna with -2 dBi (Main) / -4 dBi gain (Aux.) (5180 ~ 5240 MHz) PIFA antenna with -0.78 dBi (Main) / -5.6 dBi gain (Aux.) (5260 ~ 5320 MHz) PIFA antenna with 1.3 dBi (Main) / -2.2 dBi gain (Aux.) (5500 ~ 5720 MHz) PIFA antenna with 0.9 dBi (Main) / -4.5 dBi gain (Aux.) (5745 ~ 5825 MHz)
Antenna Connector	N/A
Accessory Device	Refer to Note as below
Data Cable Supplied	Refer to Note as below

Note:

1. The EUT incorporates a MIMO function. Physically, the EUT provides two completed transmitters and two receivers.

Modulation Mode	Tx Function
802.11a	1TX
802.11n (HT20)	2TX
802.11n (HT40)	2TX
802.11ac (VHT20)	2TX
802.11ac (VHT40)	2TX
802.11ac (VHT80)	2TX

* The modulation and bandwidth are similar for 802.11n mode for HT20 / HT40 and 802.11ac mode for VHT20 / VHT40, therefore investigated worst case to representative mode in test report. (Final test mode refer section 3.2.1)

2. The EUT's accessories list refers to Ext. Pho.
3. The above EUT information is declared by manufacturer and for more detailed features description, please refers to the manufacturer's specifications or user's manual.

3.2 Description of Test Modes

For 5180 ~ 5240 MHz

4 channels are provided for 802.11a, 802.11n (HT20):

Channel	Frequency (MHz)	Channel	Frequency (MHz)
36	5180	44	5220
40	5200	48	5240

2 channels are provided for 802.11n (HT40):

Channel	Frequency (MHz)	Channel	Frequency (MHz)
38	5190	46	5230

1 channel is provided for 802.11ac (VHT80):

Channel	Frequency (MHz)
42	5210

For 5260 ~ 5320 MHz

4 channels are provided for 802.11a, 802.11n (HT20):

Channel	Frequency (MHz)	Channel	Frequency (MHz)
52	5260	60	5300
56	5280	64	5320

2 channels are provided for 802.11n (HT40):

Channel	Frequency (MHz)	Channel	Frequency (MHz)
54	5270	62	5310

1 channel is provided for 802.11ac (VHT80):

Channel	Frequency (MHz)
58	5290

For 5500 ~ 5700 MHz

12 channels are provided for 802.11a, 802.11n (HT20):

Channel	Frequency (MHz)	Channel	Frequency (MHz)
100	5500	124	5620
104	5520	128	5640
108	5540	132	5660
112	5560	136	5680
116	5580	140	5700
120	5600	144	5720

6 channels are provided for 802.11n (HT40):

Channel	Frequency (MHz)	Channel	Frequency (MHz)
102	5510	126	5630
110	5550	134	5670
118	5590	142	5710

3 channels are provided for 802.11ac (VHT80):

Channel	Frequency (MHz)	Channel	Frequency (MHz)
106	5530	138	5690
122	5610		

For 5745 ~ 5825 MHz:

5 channels are provided for 802.11a, 802.11n (HT20):

Channel	Frequency (MHz)	Channel	Frequency (MHz)
149	5745	161	5805
153	5765	165	5825
157	5785		

2 channels are provided for 802.11n (HT40):

Channel	Frequency (MHz)	Channel	Frequency (MHz)
151	5755	159	5795

1 channel is provided for 802.11ac (VHT80):

Channel	Frequency (MHz)
155	5775

3.2.1 Test Mode Applicability and Tested Channel Detail

EUT Configure Mode	Applicable To				Description
	RE \geq 1G	RE $<$ 1G	PLC	APCM	
-	√	√	√	√	-

Where **RE \geq 1G**: Radiated Emission above 1 GHz **RE $<$ 1G**: Radiated Emission below 1 GHz
PLC: Power Line Conducted Emission **APCM**: Antenna Port Conducted Measurement

Note:

- The EUT had been pre-tested on the positioned of each 3 axis. The worst case was found when positioned on **Y-plane** for 1TX 5180-5240MHz & 5260-5320MHz and 2TX, and **X-plane** for 1TX 5500-5720MHz & 5745-5825MHz.
- "-" means no effect.

Radiated Emission Test (Above 1 GHz):

- Pre-Scan has been conducted to determine the worst-case mode from all possible combinations between available modulations, data rates and antenna ports (if EUT with antenna diversity architecture).
- Following channel(s) was (were) selected for the final test as listed below.

EUT Configure Mode	Frequency Band (MHz)	Mode	Available Channel	Tested Channel	Modulation Technology	Modulation Type	Data Rate (Mbps)
-	5180-5240	802.11a	36 to 48	36, 44, 48	OFDM	BPSK	6.0
-		802.11n (HT20)	36 to 48	36, 44, 48	OFDM	BPSK	6.5
-		802.11n (HT40)	38 to 46	38, 46	OFDM	BPSK	13.5
-		802.11ac (VHT80)	42	42	OFDM	BPSK	29.3
-	5260-5320	802.11a	52 to 64	52, 60, 64	OFDM	BPSK	6.0
-		802.11n (HT20)	52 to 64	52, 60, 64	OFDM	BPSK	6.5
-		802.11n (HT40)	54 to 62	54, 62	OFDM	BPSK	13.5
-		802.11ac (VHT80)	58	58	OFDM	BPSK	29.3
-	5500-5720	802.11a	100 to 144	100, 116, 140, 144	OFDM	BPSK	6.0
-		802.11n (HT20)	100 to 144	100, 116, 140, 144	OFDM	BPSK	6.5
-		802.11n (HT40)	102 to 142	102, 110, 134, 142	OFDM	BPSK	13.5
-		802.11ac (VHT80)	106 to 138	106, 122, 138	OFDM	BPSK	29.3
-	5745-5825	802.11a	149 to 165	149, 157, 165	OFDM	BPSK	6.0
-		802.11n (HT20)	149 to 165	149, 157, 165	OFDM	BPSK	6.5
-		802.11n (HT40)	151 to 159	151, 159	OFDM	BPSK	13.5
-		802.11ac (VHT80)	155	155	OFDM	BPSK	29.3

Radiated Emission Test (Below 1 GHz):

- Pre-Scan has been conducted to determine the worst-case mode from all possible combinations between available modulations, data rates and antenna ports (if EUT with antenna diversity architecture).
- Following channel(s) was (were) selected for the final test as listed below.

EUT Configure Mode	Frequency Band (MHz)	Mode	Available Channel	Tested Channel	Modulation Technology	Modulation Type	Data Rate (Mbps)
-	5260-5320	802.11n (HT40)	54 to 62	62	OFDM	BPSK	13.5

Power Line Conducted Emission Test:

- Pre-Scan has been conducted to determine the worst-case mode from all possible combinations between available modulations, data rates and antenna ports (if EUT with antenna diversity architecture).
- Following channel(s) was (were) selected for the final test as listed below.

EUT Configure Mode	Frequency Band (MHz)	Mode	Available Channel	Tested Channel	Modulation Technology	Modulation Type	Data Rate (Mbps)
-	5180-5320	802.11a	36 to 64	62	OFDM	BPSK	6.0

Antenna Port Conducted Measurement:

- This item includes all test value of each mode, but only includes spectrum plot of worst value of each mode.
- Pre-Scan has been conducted to determine the worst-case mode from all possible combinations between available modulations, data rates and antenna ports (if EUT with antenna diversity architecture).
- Following channel(s) was (were) selected for the final test as listed below.

EUT Configure Mode	Frequency Band (MHz)	Mode	Available Channel	Tested Channel	Modulation Technology	Modulation Type	Data Rate (Mbps)
-	5180-5240	802.11a	36 to 48	36, 44, 48	OFDM	BPSK	6.0
-		802.11n (HT20)	36 to 48	36, 44, 48	OFDM	BPSK	6.5
-		802.11n (HT40)	38 to 46	38, 46	OFDM	BPSK	13.5
-		802.11ac (VHT80)	42	42	OFDM	BPSK	29.3
-	5260-5320	802.11a	52 to 64	52, 60, 64	OFDM	BPSK	6.0
-		802.11n (HT20)	52 to 64	52, 60, 64	OFDM	BPSK	6.5
-		802.11n (HT40)	54 to 62	54, 62	OFDM	BPSK	13.5
-		802.11ac (VHT80)	58	58	OFDM	BPSK	29.3
-	5500-5720	802.11a	100 to 144	100, 116, 140, 144	OFDM	BPSK	6.0
-		802.11n (HT20)	100 to 144	100, 116, 140, 144	OFDM	BPSK	6.5
-		802.11n (HT40)	102 to 142	102, 110, 134, 142	OFDM	BPSK	13.5
-		802.11ac (VHT80)	106 to 138	106, 122, 138	OFDM	BPSK	29.3
-	5745-5825	802.11a	149 to 165	149, 157, 165	OFDM	BPSK	6.0
-		802.11n (HT20)	149 to 165	149, 157, 165	OFDM	BPSK	6.5
-		802.11n (HT40)	151 to 159	151, 159	OFDM	BPSK	13.5
-		802.11ac (VHT80)	155	155	OFDM	BPSK	29.3

Test Condition:

Applicable To	Environmental Conditions	Input Power	Tested by
RE≥1G	25 deg. C, 65 % RH	120 Vac, 60 Hz	Karl Lee
RE<1G	25 deg. C, 65 % RH	120 Vac, 60 Hz	Karl Lee
PLC	25 deg. C, 65 % RH	120 Vac, 60 Hz	Jisyong Wang
APCM	25 deg. C, 65 % RH	3.85 Vdc	Carlos Chen

3.3 Duty Cycle of Test Signal

MODULATION TYPE: BPSK

Duty cycle of test signal is $\geq 98\%$, duty factor is not required.

Duty cycle of test signal is $< 98\%$, duty factor is required.

802.11a: Duty cycle = $2.063/2.103 = 0.981$

802.11n (HT20): Duty cycle = $1.922/1.961 = 0.98$

802.11n (HT40): Duty cycle = $944/1003 = 0.941$, Duty factor = $10 * \log(1/0.941) = 0.26$

802.11ac (VHT80): Duty cycle = $253/307 = 0.824$, Duty factor = $10 * \log(1/0.824) = 0.84$

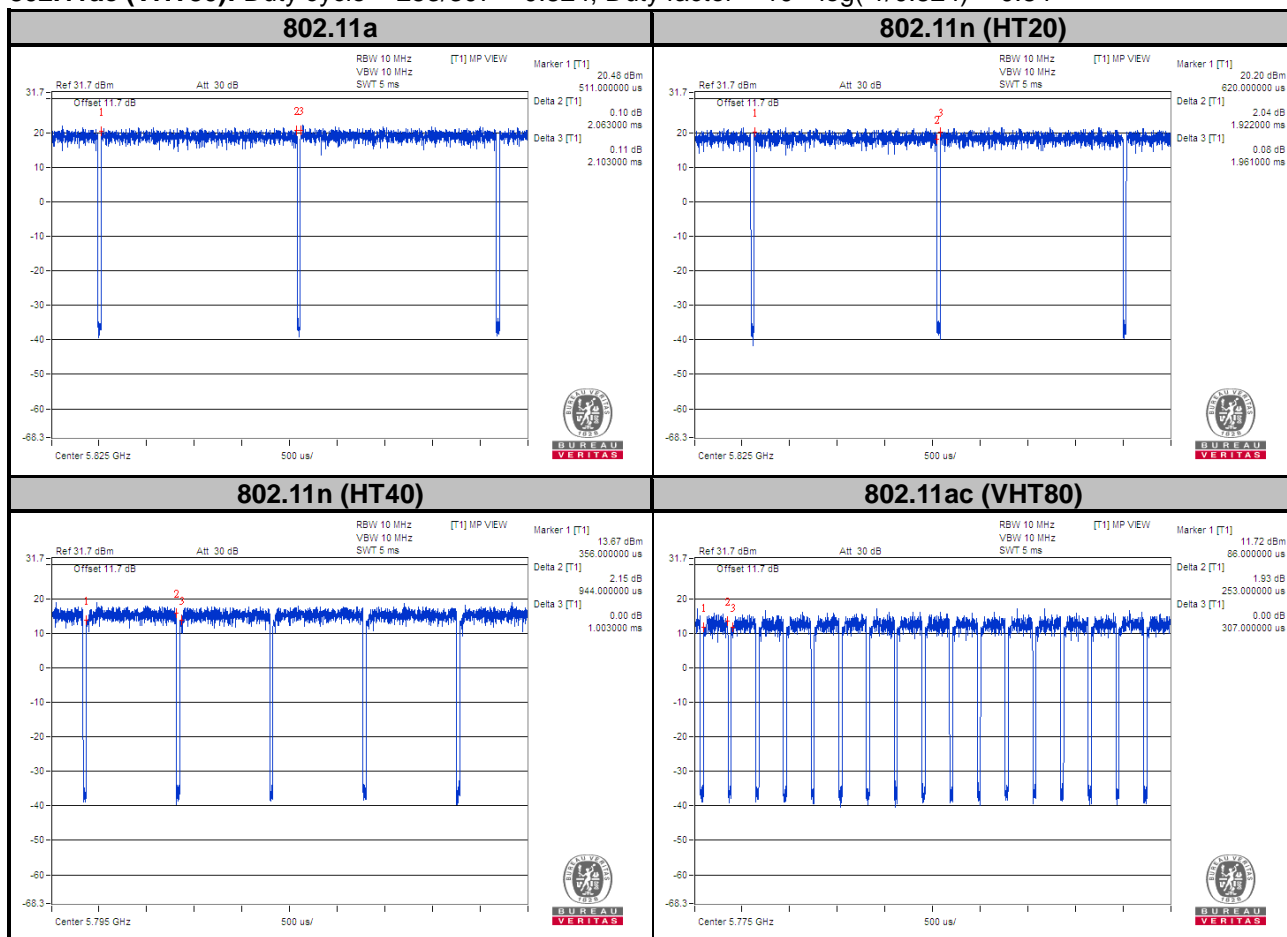

3.4 Description of Support Units

The EUT has been tested as an independent unit together with other necessary accessories or support units.

3.4.1 Configuration of System under Test

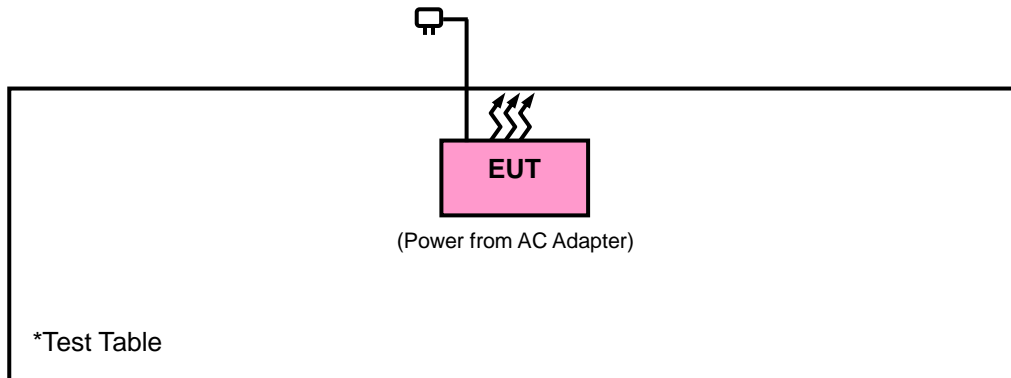

3.5 General Description of Applied Standards

The EUT is a RF Product. According to the specifications of the manufacturer, it must comply with the requirements of the following standards:

FCC Part 15, Subpart E (15.407)

KDB 789033 D02 General UNII Test Procedures New Rules v02r01

KDB 644545 D01 Guidance for IEEE 802 11ac v01r02

KDB 662911 D01 Multiple Transmitter Output v02r01

ANSI C63.10-2013

All test items have been performed and recorded as per the above standards.

4 Test Types and Results

4.1 Radiated Emission and Bandedge Measurement

4.1.1 Limits of Radiated Emission and Bandedge Measurement

Radiated emissions which fall in the restricted bands must comply with the radiated emission limits specified as below table. Other emissions shall be at least 20 dB below the highest level of the desired power:

Frequencies (MHz)	Field Strength (microvolts/meter)	Measurement Distance (meters)
0.009 ~ 0.490	2400/F (kHz)	300
0.490 ~ 1.705	24000/F (kHz)	30
1.705 ~ 30.0	30	30
30 ~ 88	100	3
88 ~ 216	150	3
216 ~ 960	200	3
Above 960	500	3

Note:

1. The lower limit shall apply at the transition frequencies.
2. Emission level (dBuV/m) = 20 log Emission level (uV/m).
3. For frequencies above 1000 MHz, the field strength limits are based on average detector, however, the peak field strength of any emission shall not exceed the maximum permitted average limits, specified above by more than 20 dB under any condition of modulation.

4.1.2 Limits of Unwanted Emission Out of the Restricted Bands

Applicable To		Limit	
789033 D02 General UNII Test Procedures New Rules v02r01		Field Strength at 3 m	
		PK: 74 (dBµV/m)	AV: 54 (dBµV/m)
Frequency Band	Applicable To	EIRP Limit	Equivalent Field Strength at 3 m
5150~5250 MHz	15.407(b)(1)	PK: -27 (dBm/MHz)	PK: 68.2 (dBµV/m)
5250~5350 MHz	15.407(b)(2)		
5470~5725 MHz	15.407(b)(3)		
5725~5850 MHz	15.407(b)(4)(i)	PK:-27 (dBm/MHz) ^{*1} PK:10 (dBm/MHz) ^{*2} PK:15.6 (dBm/MHz) ^{*3} PK:27 (dBm/MHz) ^{*4}	PK: 68.2 (dBµV/m) ^{*1} PK:105.2 (dBµV/m) ^{*2} PK: 110.8 (dBµV/m) ^{*3} PK:122.2 (dBµV/m) ^{*4}
	15.407(b)(4)(ii)	Emission limits in section 15.247(d)	
^{*1} beyond 75 MHz or more above of the band edge. ^{*2} below the band edge increasing linearly to 10 dBm/MHz at 25 MHz above. ^{*3} below the band edge increasing linearly to a level of 15.6 dBm/MHz at 5 MHz above. ^{*4} from 5 MHz above or below the band edge increasing linearly to a level of 27 dBm/MHz at the band edge.			

Note:

The following formula is used to convert the equipment isotropic radiated power (eirp) to field strength:

$$E = \frac{1000000\sqrt{30P}}{3} \mu\text{V/m, where P is the eirp (Watts).}$$

4.1.3 Test Instruments

Description & Manufacturer	Model No.	Serial No.	Date of Calibration	Due Date of Calibration
Test Receiver Agilent Technologies	N9038A	MY52260177	Jul. 05, 2017	Jul. 04, 2018
Spectrum Analyzer ROHDE & SCHWARZ	FSU43	101261	Jan. 11, 2018	Jan. 10, 2019
Double Ridge Guide Horn Antenna EMCO	3115	5619	Nov. 30, 2017	Nov. 29, 2018
BILOG Antenna SCHWARZBECK	VULB 9168	9168-153	Dec. 06, 2017	Dec. 05, 2018
Fixed Attenuator Mini-Circuits	BW-N10W5+	NA	Jul. 07, 2017	Jul. 06, 2018
Loop Antenna	EM-6879	269	Aug. 11, 2017	Aug. 10, 2018
Preamplifier Agilent	310N	187226	Jun. 23, 2017	Jun. 22, 2018
Preamplifier Agilent	83017A	MY39501357	Jun. 23, 2017	Jun. 22, 2018
Power Meter Anritsu	ML2495A	1012010	Aug. 15, 2017	Aug. 14, 2018
Power Sensor Anritsu	MA2411B	1315050	Aug. 15, 2017	Aug. 14, 2018
RF signal cable ETS-LINDGREN	5D-FB	Cable-CH1-01(RFC -SMS-100-SMS-12 0+RFC-SMS-100-S MS-400)	Jun. 26, 2017	Jun. 25, 2018
RF signal cable ETS-LINDGREN	8D-FB	Cable-CH1-02(RFC -SMS-100-SMS-24)	Jun. 26, 2017	Jun. 25, 2018
Boresight Antenna Fixture	FBA-01	FBA-SIP01	NA	NA
Software BV ADT	E3 8.130425b	NA	NA	NA
Antenna Tower MF	NA	NA	NA	NA
Turn Table MF	NA	NA	NA	NA
Antenna Tower & Turn Table Controller MF	MF-7802	NA	NA	NA
Temperature & Humidity Chamber	GTH-120-40-CP-A R	MAA1306-019	Sep. 08, 2017	Sep. 07, 2018
DC Power Supply Topward	33010D	807748	Oct. 25, 2016	Oct. 24, 2018
Digital Multimeter Fluke	87-III	70360742	Jun. 30, 2017	Jun. 29, 2018

- Note: 1. The calibration interval of the above test instruments is 12 / 24 months and the calibrations are traceable to NML/ROC and NIST/USA.
2. The test was performed in HsinTien Chamber 1.
3. The horn antenna and preamplifier (model: 83017A) are used only for the measurement of emission frequency above 1 GHz if tested.
4. The IC Site Registration No. is IC7450I-1.

4.1.4 Test Procedures

For Radiated Emission below 30 MHz

- a. The EUT was placed on the top of a rotating table 0.8 meters above the ground at a 3 meter chamber room. The table was rotated 360 degrees to determine the position of the highest radiation.
- b. The EUT was set 3 meters away from the interference-receiving antenna, which was mounted on the top of a variable-height antenna tower.
- c. Both Parallel, perpendicular, and ground-parallel orientations of the antenna are set to make the measurement.
- d. For each suspected emission, the EUT was arranged to its worst case and the rotatable table was turned from 0 degrees to 360 degrees to find the maximum reading.
- e. The test-receiver system was set to Quasi-Peak Detect Function and Specified Bandwidth with Maximum Hold Mode.

Note:

1. The resolution bandwidth and video bandwidth of test receiver/spectrum analyzer is 9 kHz at frequency below 30 MHz.

For Radiated Emission above 30 MHz

- a. The EUT was placed on the top of a rotating table 0.8 meters (for 30 MHz ~ 1 GHz) / 1.5 meters (for above 1 GHz) above the ground at 3 meter chamber room for test. The table was rotated 360 degrees to determine the position of the highest radiation.
- b. The EUT was set 3 meters away from the interference-receiving antenna, which was mounted on the top of a variable-height antenna tower.
- c. The height of antenna is varied from one meter to four meters above the ground to determine the maximum value of the field strength. Both horizontal and vertical polarizations of the antenna are set to make the measurement.
- d. For each suspected emission, the EUT was arranged to its worst case and then the antenna was tuned to heights from 1 meter to 4 meters and the rotatable table was turned from 0 degrees to 360 degrees to find the maximum reading.
- e. The test-receiver system was set to quasi-peak detect function and specified bandwidth with maximum hold mode when the test frequency is below 1 GHz.
- f. The test-receiver system was set to peak and average detected function and specified bandwidth with maximum hold mode when the test frequency is above 1 GHz. If the peak reading value also meets average limit, measurement with the average detector is unnecessary.

Note:

1. The resolution bandwidth and video bandwidth of test receiver/spectrum analyzer is 120 kHz for Quasi-peak detection (QP) at frequency below 1 GHz.
2. The resolution bandwidth of test receiver/spectrum analyzer is 1 MHz and the video bandwidth is 3 MHz for Peak detection (PK) at frequency above 1 GHz.
3. The resolution bandwidth of test receiver/spectrum analyzer is 1 MHz and the video bandwidth is $\geq 1/T$ (Duty cycle < 98 %) or 10 Hz (Duty cycle ≥ 98 %) for Average detection (AV) at frequency above 1 GHz.
(11a: RBW = 1 MHz, VBW = 1 kHz ; 11n (HT20): RBW = 1 MHz, VBW = 1 kHz ;
11n (HT40): RBW = 1 MHz, VBW = 3 kHz ; 11ac (VHT80): RBW = 1 MHz, VBW = 10 kHz)
4. All modes of operation were investigated and the worst-case emissions are reported.

4.1.5 Deviation from Test Standard

No deviation.

4.1.6 Test Setup

<Radiated Emission below 30 MHz>

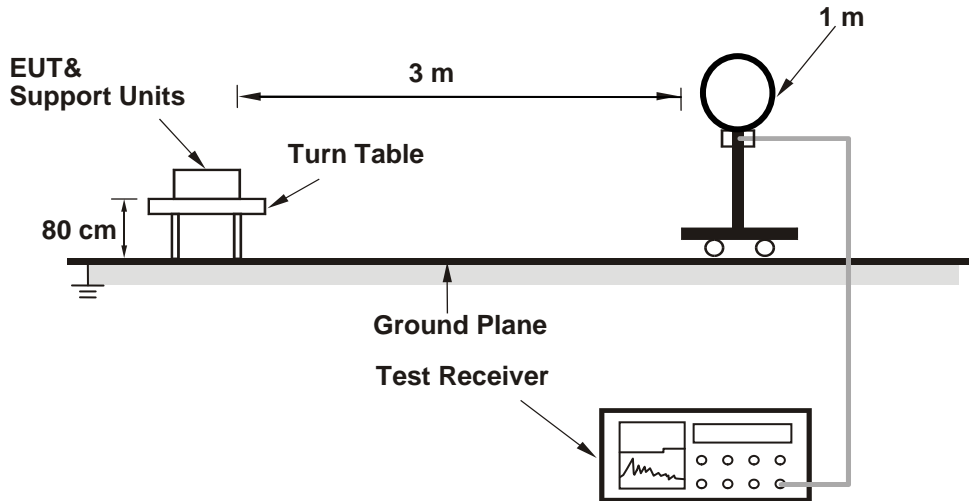

<Radiated Emission 30 MHz to 1 GHz>

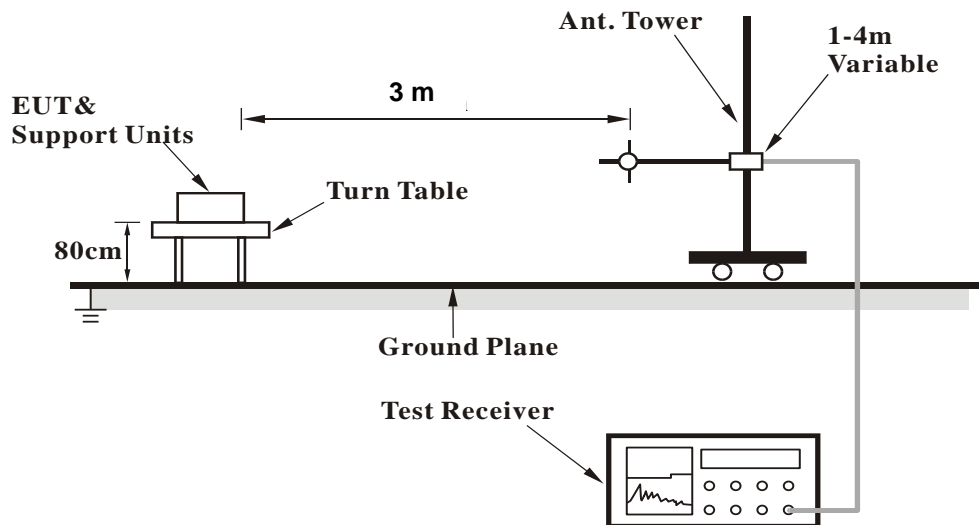

<Radiated Emission above 1 GHz>

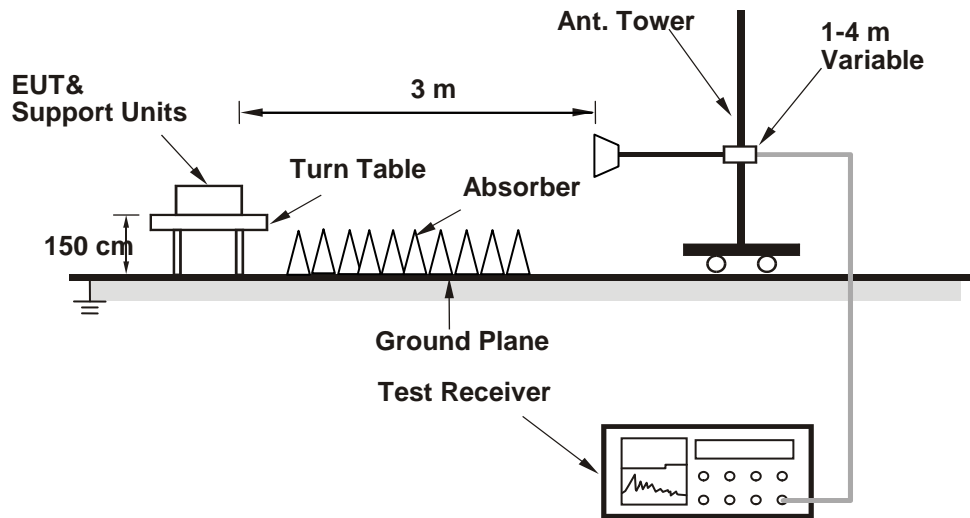

For the actual test configuration, please refer to the attached file (Test Setup Photo).

4.1.7 EUT Operating Conditions

- a. Placed the EUT on a testing table.
- b. Use the software to control the EUT under transmission condition continuously at specific channel frequency.

4.1.8 Test Results
 Above 1 GHz Data :
 <1TX>
 802.11a

EUT Test Condition		Measurement Detail	
Channel	Channel 36	Frequency Range	1 GHz ~ 40 GHz
Input Power	120 Vac, 60 Hz	Detector Function	Peak (PK) Average (AV)
Environmental Conditions	25 deg. C, 65 % RH	Tested By	Karl Lee

Antenna Polarity & Test Distance: Horizontal at 3 m										
Frequency (MHz)	Emission Level (dBuV/m)	Read Level (dBuV)	Limit (dBuV/m)	Margin (dB)	Antenna Factor (dB/m)	Cable Loss (dB)	Preamp Factor (dB)	Antenna Height (cm)	Table Angle (Degree)	Remark
5148.8	45.97	37.72	54	-8.03	34.12	8.13	34	100	246	Average
5148.8	56.47	48.22	74	-17.53	34.12	8.13	34	100	246	Peak
5180	100.62	92.31			34.15	8.16	34	100	246	Average
5180	107.6	99.29			34.15	8.16	34	100	246	Peak
*10360	54.68	40.38	68.2	-13.52	37.12	12.3	35.12	103	248	Peak

Antenna Polarity & Test Distance: Vertical at 3 m										
Frequency (MHz)	Emission Level (dBuV/m)	Read Level (dBuV)	Limit (dBuV/m)	Margin (dB)	Antenna Factor (dB/m)	Cable Loss (dB)	Preamp Factor (dB)	Antenna Height (cm)	Table Angle (Degree)	Remark
5148.2	43.26	35.01	54	-10.74	34.12	8.13	34	102	246	Average
5148.2	53.71	45.46	74	-20.29	34.12	8.13	34	102	246	Peak
5180	93.65	85.34			34.15	8.16	34	102	246	Average
5180	100.9	92.59			34.15	8.16	34	102	246	Peak
*10360	54.55	40.25	68.2	-13.65	37.12	12.3	35.12	121	158	Peak

Remarks:

- Emission Level = Read Level + Antenna Factor + Cable Loss - Preamp Factor
Margin value = Emission level – Limit value
- 5180 MHz: Fundamental Frequency
- *: Out of Restricted Band
- The emission levels of other frequencies were very low against the limit

EUT Test Condition		Measurement Detail	
Channel	Channel 44	Frequency Range	1 GHz ~ 40 GHz
Input Power	120 Vac, 60 Hz	Detector Function	Peak (PK) Average (AV)
Environmental Conditions	25 deg. C, 65 % RH	Tested By	Karl Lee

Antenna Polarity & Test Distance: Horizontal at 3 m										
Frequency (MHz)	Emission Level (dBuV/m)	Read Level (dBuV)	Limit (dBuV/m)	Margin (dB)	Antenna Factor (dB/m)	Cable Loss (dB)	Preamp Factor (dB)	Antenna Height (cm)	Table Angle (Degree)	Remark
5149.85	43.22	34.97	54	-10.78	34.12	8.13	34	100	246	Average
5149.85	53.63	45.38	74	-20.37	34.12	8.13	34	100	246	Peak
5220	100.74	92.35			34.17	8.22	34	100	246	Average
5220	107.05	98.66			34.17	8.22	34	100	246	Peak
5453.07	43.02	34.2	54	-10.98	34.36	8.51	34.05	100	246	Average
5453.07	53.26	44.44	74	-20.74	34.36	8.51	34.05	100	246	Peak
*10440	54.88	40.42	68.2	-13.32	37.16	12.47	35.17	168	322	Peak
Antenna Polarity & Test Distance: Vertical at 3 m										
Frequency (MHz)	Emission Level (dBuV/m)	Read Level (dBuV)	Limit (dBuV/m)	Margin (dB)	Antenna Factor (dB/m)	Cable Loss (dB)	Preamp Factor (dB)	Antenna Height (cm)	Table Angle (Degree)	Remark
5125.4	42.64	34.42	54	-11.36	34.11	8.1	33.99	102	246	Average
5125.4	53.96	45.74	74	-20.04	34.11	8.1	33.99	102	246	Peak
5220	93.65	85.26			34.17	8.22	34	102	246	Average
5220	100.63	92.24			34.17	8.22	34	102	246	Peak
5363.42	42.69	34.05	54	-11.31	34.29	8.38	34.03	102	246	Average
5363.42	53.39	44.75	74	-20.61	34.29	8.38	34.03	102	246	Peak
*10440	54.63	40.17	68.2	-13.57	37.16	12.47	35.17	139	216	Peak

Remarks:

- Emission Level = Read Level + Antenna Factor + Cable Loss - Preamp Factor
Margin value = Emission level – Limit value
- 5220 MHz: Fundamental Frequency
- *: Out of Restricted Band
- The emission levels of other frequencies were very low against the limit

EUT Test Condition		Measurement Detail	
Channel	Channel 48	Frequency Range	1 GHz ~ 40 GHz
Input Power	120 Vac, 60 Hz	Detector Function	Peak (PK) Average (AV)
Environmental Conditions	25 deg. C, 65 % RH	Tested By	Karl Lee

Antenna Polarity & Test Distance: Horizontal at 3 m										
Frequency (MHz)	Emission Level (dBuV/m)	Read Level (dBuV)	Limit (dBuV/m)	Margin (dB)	Antenna Factor (dB/m)	Cable Loss (dB)	Preamp Factor (dB)	Antenna Height (cm)	Table Angle (Degree)	Remark
5240	100.47	92.03			34.19	8.26	34.01	100	246	Average
5240	107.42	98.98			34.19	8.26	34.01	100	246	Peak
5351.43	43.06	34.43	54	-10.94	34.28	8.38	34.03	100	246	Average
5351.43	53.49	44.86	74	-20.51	34.28	8.38	34.03	100	246	Peak
*10480	56.03	41.52	68.2	-12.17	37.19	12.53	35.21	125	156	Peak

Antenna Polarity & Test Distance: Vertical at 3 m										
Frequency (MHz)	Emission Level (dBuV/m)	Read Level (dBuV)	Limit (dBuV/m)	Margin (dB)	Antenna Factor (dB/m)	Cable Loss (dB)	Preamp Factor (dB)	Antenna Height (cm)	Table Angle (Degree)	Remark
5240	93.49	85.05			34.19	8.26	34.01	102	246	Average
5240	100.41	91.97			34.19	8.26	34.01	102	246	Peak
5459.23	42.78	33.96	54	-11.22	34.36	8.51	34.05	102	246	Average
5459.23	53.13	44.31	74	-20.87	34.36	8.51	34.05	102	246	Peak
*10480	55.11	40.6	68.2	-13.09	37.19	12.53	35.21	148	107	Peak

Remarks:

- Emission Level = Read Level + Antenna Factor + Cable Loss - Preamp Factor
Margin value = Emission level – Limit value
- 5240 MHz: Fundamental Frequency
- *: Out of Restricted Band
- The emission levels of other frequencies were very low against the limit

EUT Test Condition		Measurement Detail	
Channel	Channel 52	Frequency Range	1 GHz ~ 40 GHz
Input Power	120 Vac, 60 Hz	Detector Function	Peak (PK) Average (AV)
Environmental Conditions	25 deg. C, 65 % RH	Tested By	Karl Lee

Antenna Polarity & Test Distance: Horizontal at 3 m										
Frequency (MHz)	Emission Level (dBuV/m)	Read Level (dBuV)	Limit (dBuV/m)	Margin (dB)	Antenna Factor (dB/m)	Cable Loss (dB)	Preamp Factor (dB)	Antenna Height (cm)	Table Angle (Degree)	Remark
5129	42.5	34.28	54	-11.5	34.11	8.1	33.99	100	246	Average
5129	53.26	45.04	74	-20.74	34.11	8.1	33.99	100	246	Peak
5260	100.47	92.01			34.21	8.26	34.01	100	246	Average
5260	107.05	98.59			34.21	8.26	34.01	100	246	Peak
*10520	54.88	40.29	68.2	-13.32	37.21	12.61	35.23	186	213	Peak

Antenna Polarity & Test Distance: Vertical at 3 m										
Frequency (MHz)	Emission Level (dBuV/m)	Read Level (dBuV)	Limit (dBuV/m)	Margin (dB)	Antenna Factor (dB/m)	Cable Loss (dB)	Preamp Factor (dB)	Antenna Height (cm)	Table Angle (Degree)	Remark
5123.75	42.69	34.47	54	-11.31	34.11	8.1	33.99	102	246	Average
5123.75	53.12	44.9	74	-20.88	34.11	8.1	33.99	102	246	Peak
5260	93.35	84.89			34.21	8.26	34.01	102	246	Average
5260	100.82	92.36			34.21	8.26	34.01	102	246	Peak
*10520	55.52	40.93	68.2	-12.68	37.21	12.61	35.23	123	316	Peak

Remarks:

- Emission Level = Read Level + Antenna Factor + Cable Loss - Preamp Factor
Margin value = Emission level – Limit value
- 5260 MHz: Fundamental Frequency
- *: Out of Restricted Band
- The emission levels of other frequencies were very low against the limit

EUT Test Condition		Measurement Detail	
Channel	Channel 60	Frequency Range	1 GHz ~ 40 GHz
Input Power	120 Vac, 60 Hz	Detector Function	Peak (PK) Average (AV)
Environmental Conditions	25 deg. C, 65 % RH	Tested By	Karl Lee

Antenna Polarity & Test Distance: Horizontal at 3 m										
Frequency (MHz)	Emission Level (dBuV/m)	Read Level (dBuV)	Limit (dBuV/m)	Margin (dB)	Antenna Factor (dB/m)	Cable Loss (dB)	Preamp Factor (dB)	Antenna Height (cm)	Table Angle (Degree)	Remark
5129	42.65	34.43	54	-11.35	34.11	8.1	33.99	100	246	Average
5129	53.11	44.89	74	-20.89	34.11	8.1	33.99	100	246	Peak
5300	100.74	92.2			34.24	8.32	34.02	100	246	Average
5300	107.47	98.93			34.24	8.32	34.02	100	246	Peak
5351.1	44.33	35.7	54	-9.67	34.28	8.38	34.03	100	246	Average
5351.1	54.5	45.87	74	-19.5	34.28	8.38	34.03	100	246	Peak
10600	45.82	31.14	54	-8.18	37.28	12.67	35.27	146	182	Average
10600	55.91	41.23	74	-18.09	37.28	12.67	35.27	146	182	Peak

Antenna Polarity & Test Distance: Vertical at 3 m										
Frequency (MHz)	Emission Level (dBuV/m)	Read Level (dBuV)	Limit (dBuV/m)	Margin (dB)	Antenna Factor (dB/m)	Cable Loss (dB)	Preamp Factor (dB)	Antenna Height (cm)	Table Angle (Degree)	Remark
5108	42.54	34.34	54	-11.46	34.09	8.1	33.99	102	246	Average
5108	52.82	44.62	74	-21.18	34.09	8.1	33.99	102	246	Peak
5300	93.65	85.11			34.24	8.32	34.02	102	246	Average
5300	100.03	91.49			34.24	8.32	34.02	102	246	Peak
5355.39	42.94	34.31	54	-11.06	34.28	8.38	34.03	102	246	Average
5355.39	53.76	45.13	74	-20.24	34.28	8.38	34.03	102	246	Peak
10600	45.06	30.38	54	-8.94	37.28	12.67	35.27	149	127	Average
10600	54.84	40.16	74	-19.16	37.28	12.67	35.27	149	127	Peak

Remarks:

- Emission Level = Read Level + Antenna Factor + Cable Loss - Preamp Factor
Margin value = Emission level – Limit value
- 5300 MHz: Fundamental Frequency
- The emission levels of other frequencies were very low against the limit

EUT Test Condition		Measurement Detail	
Channel	Channel 64	Frequency Range	1 GHz ~ 40 GHz
Input Power	120 Vac, 60 Hz	Detector Function	Peak (PK) Average (AV)
Environmental Conditions	25 deg. C, 65 % RH	Tested By	Karl Lee

Antenna Polarity & Test Distance: Horizontal at 3 m										
Frequency (MHz)	Emission Level (dBuV/m)	Read Level (dBuV)	Limit (dBuV/m)	Margin (dB)	Antenna Factor (dB/m)	Cable Loss (dB)	Preamp Factor (dB)	Antenna Height (cm)	Table Angle (Degree)	Remark
5320	100.41	91.83			34.25	8.35	34.02	100	246	Average
5320	107.14	98.56			34.25	8.35	34.02	100	246	Peak
5350.22	46.59	37.96	54	-7.41	34.28	8.38	34.03	100	246	Average
5350.22	57.61	48.98	74	-16.39	34.28	8.38	34.03	100	246	Peak
10640	45.89	31.16	54	-8.11	37.31	12.71	35.29	152	118	Average
10640	55.85	41.12	74	-18.15	37.31	12.71	35.29	152	118	Peak

Antenna Polarity & Test Distance: Vertical at 3 m										
Frequency (MHz)	Emission Level (dBuV/m)	Read Level (dBuV)	Limit (dBuV/m)	Margin (dB)	Antenna Factor (dB/m)	Cable Loss (dB)	Preamp Factor (dB)	Antenna Height (cm)	Table Angle (Degree)	Remark
5320	93.66	85.08			34.25	8.35	34.02	102	246	Average
5320	100.79	92.21			34.25	8.35	34.02	102	246	Peak
5350.22	43.62	34.99	54	-10.38	34.28	8.38	34.03	102	246	Average
5350.22	53.69	45.06	74	-20.31	34.28	8.38	34.03	102	246	Peak
10640	45.39	30.66	54	-8.61	37.31	12.71	35.29	135	274	Average
10640	55.2	40.47	74	-18.8	37.31	12.71	35.29	135	274	Peak

Remarks:

- Emission Level = Read Level + Antenna Factor + Cable Loss - Preamp Factor
Margin value = Emission level – Limit value
- 5320 MHz: Fundamental Frequency
- The emission levels of other frequencies were very low against the limit

EUT Test Condition		Measurement Detail	
Channel	Channel 100	Frequency Range	1 GHz ~ 40 GHz
Input Power	120 Vac, 60 Hz	Detector Function	Peak (PK) Average (AV)
Environmental Conditions	25 deg. C, 65 % RH	Tested By	Karl Lee

Antenna Polarity & Test Distance: Horizontal at 3 m										
Frequency (MHz)	Emission Level (dBuV/m)	Read Level (dBuV)	Limit (dBuV/m)	Margin (dB)	Antenna Factor (dB/m)	Cable Loss (dB)	Preamp Factor (dB)	Antenna Height (cm)	Table Angle (Degree)	Remark
5459.12	44	35.18	54	-10	34.36	8.51	34.05	200	37	Average
5459.12	53.83	45.01	74	-20.17	34.36	8.51	34.05	200	37	Peak
*5468.24	55.12	46.29	68.2	-13.08	34.37	8.51	34.05	200	37	Peak
5500	99.75	90.83			34.4	8.57	34.05	200	37	Average
5500	106.95	98.03			34.4	8.57	34.05	200	37	Peak
11000	45.71	30.63	54	-8.29	37.6	12.96	35.48	149	328	Average
11000	55.66	40.58	74	-18.34	37.6	12.96	35.48	149	328	Peak
Antenna Polarity & Test Distance: Vertical at 3 m										
Frequency (MHz)	Emission Level (dBuV/m)	Read Level (dBuV)	Limit (dBuV/m)	Margin (dB)	Antenna Factor (dB/m)	Cable Loss (dB)	Preamp Factor (dB)	Antenna Height (cm)	Table Angle (Degree)	Remark
5459.92	43.98	35.16	54	-10.02	34.36	8.51	34.05	100	348	Average
5459.92	54.24	45.42	74	-19.76	34.36	8.51	34.05	100	348	Peak
*5469.36	54.94	46.11	68.2	-13.26	34.37	8.51	34.05	100	348	Peak
5500	97.77	88.85			34.4	8.57	34.05	100	348	Average
5500	104.97	96.05			34.4	8.57	34.05	100	348	Peak
11000	45.73	30.65	54	-8.27	37.6	12.96	35.48	105	293	Average
11000	55.86	40.78	74	-18.14	37.6	12.96	35.48	105	293	Peak

Remarks:

- Emission Level = Read Level + Antenna Factor + Cable Loss - Preamp Factor
Margin value = Emission level – Limit value
- 5500 MHz: Fundamental Frequency
- *: Out of Restricted Band
- The emission levels of other frequencies were very low against the limit

EUT Test Condition		Measurement Detail	
Channel	Channel 116	Frequency Range	1 GHz ~ 40 GHz
Input Power	120 Vac, 60 Hz	Detector Function	Peak (PK) Average (AV)
Environmental Conditions	25 deg. C, 65 % RH	Tested By	Karl Lee

Antenna Polarity & Test Distance: Horizontal at 3 m										
Frequency (MHz)	Emission Level (dBuV/m)	Read Level (dBuV)	Limit (dBuV/m)	Margin (dB)	Antenna Factor (dB/m)	Cable Loss (dB)	Preamp Factor (dB)	Antenna Height (cm)	Table Angle (Degree)	Remark
5455.12	42.65	33.83	54	-11.35	34.36	8.51	34.05	200	37	Average
5455.12	53.42	44.6	74	-20.58	34.36	8.51	34.05	200	37	Peak
*5468.24	52.73	43.9	68.2	-15.47	34.37	8.51	34.05	200	37	Peak
5580	99.65	90.66			34.47	8.6	34.08	200	37	Average
5580	106.25	97.26			34.47	8.6	34.08	200	37	Peak
*5725.16	51.76	42.6	68.2	-16.44	34.62	8.65	34.11	200	37	Peak
11160	46.83	31.75	54	-7.17	37.7	12.83	35.45	143	62	Average
11160	56.91	41.83	74	-17.09	37.7	12.83	35.45	143	62	Peak

Antenna Polarity & Test Distance: Vertical at 3 m										
Frequency (MHz)	Emission Level (dBuV/m)	Read Level (dBuV)	Limit (dBuV/m)	Margin (dB)	Antenna Factor (dB/m)	Cable Loss (dB)	Preamp Factor (dB)	Antenna Height (cm)	Table Angle (Degree)	Remark
5459.76	42.6	33.78	54	-11.4	34.36	8.51	34.05	100	348	Average
5459.76	53.49	44.67	74	-20.51	34.36	8.51	34.05	100	348	Peak
*5468.56	52.36	43.53	68.2	-15.84	34.37	8.51	34.05	100	348	Peak
5580	97.88	88.89			34.47	8.6	34.08	100	348	Average
5580	104.92	95.93			34.47	8.6	34.08	100	348	Peak
*5726.04	52.95	43.79	68.2	-15.25	34.62	8.65	34.11	100	348	Peak
11160	46.39	31.31	54	-7.61	37.7	12.83	35.45	137	144	Average
11160	56.57	41.49	74	-17.43	37.7	12.83	35.45	137	144	Peak

Remarks:

- Emission Level = Read Level + Antenna Factor + Cable Loss - Preamp Factor
Margin value = Emission level – Limit value
- 5580 MHz: Fundamental Frequency
- *: Out of Restricted Band
- The emission levels of other frequencies were very low against the limit

EUT Test Condition		Measurement Detail	
Channel	Channel 140	Frequency Range	1 GHz ~ 40 GHz
Input Power	120 Vac, 60 Hz	Detector Function	Peak (PK) Average (AV)
Environmental Conditions	25 deg. C, 65 % RH	Tested By	Karl Lee

Antenna Polarity & Test Distance: Horizontal at 3 m										
Frequency (MHz)	Emission Level (dBuV/m)	Read Level (dBuV)	Limit (dBuV/m)	Margin (dB)	Antenna Factor (dB/m)	Cable Loss (dB)	Preamp Factor (dB)	Antenna Height (cm)	Table Angle (Degree)	Remark
5700	98.65	89.52			34.59	8.64	34.1	200	37	Average
5700	105.77	96.64			34.59	8.64	34.1	200	37	Peak
*5724.12	56.52	47.36	68.2	-11.68	34.62	8.65	34.11	200	37	Peak
11400	46.27	31.17	54	-7.73	37.84	12.67	35.41	163	309	Average
11400	56.16	41.06	74	-17.84	37.84	12.67	35.41	163	309	Peak

Antenna Polarity & Test Distance: Vertical at 3 m										
Frequency (MHz)	Emission Level (dBuV/m)	Read Level (dBuV)	Limit (dBuV/m)	Margin (dB)	Antenna Factor (dB/m)	Cable Loss (dB)	Preamp Factor (dB)	Antenna Height (cm)	Table Angle (Degree)	Remark
5700	96.65	87.52			34.59	8.64	34.1	100	348	Average
5700	103.81	94.68			34.59	8.64	34.1	100	348	Peak
*5724.12	57.28	48.12	68.2	-10.92	34.62	8.65	34.11	100	348	Peak
11400	46.28	31.18	54	-7.72	37.84	12.67	35.41	135	218	Average
11400	56.14	41.04	74	-17.86	37.84	12.67	35.41	135	218	Peak

Remarks:

- Emission Level = Read Level + Antenna Factor + Cable Loss - Preamp Factor
Margin value = Emission level – Limit value
- 5700 MHz: Fundamental Frequency
- *: Out of Restricted Band
- The emission levels of other frequencies were very low against the limit

EUT Test Condition		Measurement Detail	
Channel	Channel 144	Frequency Range	1 GHz ~ 40 GHz
Input Power	120 Vac, 60 Hz	Detector Function	Peak (PK) Average (AV)
Environmental Conditions	25 deg. C, 65 % RH	Tested By	Karl Lee

Antenna Polarity & Test Distance: Horizontal at 3 m										
Frequency (MHz)	Emission Level (dBuV/m)	Read Level (dBuV)	Limit (dBuV/m)	Margin (dB)	Antenna Factor (dB/m)	Cable Loss (dB)	Preamp Factor (dB)	Antenna Height (cm)	Table Angle (Degree)	Remark
5448.4	42.67	33.84	54	-11.33	34.36	8.51	34.04	200	37	Average
5448.4	54.07	45.24	74	-19.93	34.36	8.51	34.04	200	37	Peak
*5470.8	51.72	42.86	68.2	-16.48	34.37	8.54	34.05	200	37	Peak
5720	98.74	89.58			34.62	8.65	34.11	200	37	Average
5720	105.59	96.43			34.62	8.65	34.11	200	37	Peak
11440	47.07	31.96	54	-6.93	37.86	12.65	35.4	159	114	Average
11440	55.98	40.87	74	-18.02	37.86	12.65	35.4	159	114	Peak

Antenna Polarity & Test Distance: Vertical at 3 m										
Frequency (MHz)	Emission Level (dBuV/m)	Read Level (dBuV)	Limit (dBuV/m)	Margin (dB)	Antenna Factor (dB/m)	Cable Loss (dB)	Preamp Factor (dB)	Antenna Height (cm)	Table Angle (Degree)	Remark
5443.12	42.7	33.91	54	-11.3	34.35	8.48	34.04	100	348	Average
5443.12	53.05	44.26	74	-20.95	34.35	8.48	34.04	100	348	Peak
*5470	53.18	44.35	68.2	-15.02	34.37	8.51	34.05	100	348	Peak
5720	96.25	87.09			34.62	8.65	34.11	100	348	Average
5720	103	93.84			34.62	8.65	34.11	100	348	Peak
11440	47.11	32	54	-6.89	37.86	12.65	35.4	134	195	Average
11440	55.48	40.37	74	-18.52	37.86	12.65	35.4	134	195	Peak

Remarks:

- Emission Level = Read Level + Antenna Factor + Cable Loss - Preamp Factor
Margin value = Emission level – Limit value
- 5720 MHz: Fundamental Frequency
- *: Out of Restricted Band
- The emission levels of other frequencies were very low against the limit

EUT Test Condition		Measurement Detail	
Channel	Channel 149	Frequency Range	1 GHz ~ 40 GHz
Input Power	120 Vac, 60 Hz	Detector Function	Peak (PK) Average (AV)
Environmental Conditions	25 deg. C, 65 % RH	Tested By	Karl Lee

<Spurious Emission>

Antenna Polarity & Test Distance: Horizontal at 3 m										
Frequency (MHz)	Emission Level (dBuV/m)	Read Level (dBuV)	Limit (dBuV/m)	Margin (dB)	Antenna Factor (dB/m)	Cable Loss (dB)	Preamp Factor (dB)	Antenna Height (cm)	Table Angle (Degree)	Remark
5745	98.78	89.59			34.64	8.66	34.11	200	37	Average
5745	105.07	95.88			34.64	8.66	34.11	200	37	Peak
11490	46.23	31.11	54	-7.77	37.89	12.62	35.39	135	211	Average
11490	56.11	40.99	74	-17.89	37.89	12.62	35.39	135	211	Peak
Antenna Polarity & Test Distance: Vertical at 3 m										
Frequency (MHz)	Emission Level (dBuV/m)	Read Level (dBuV)	Limit (dBuV/m)	Margin (dB)	Antenna Factor (dB/m)	Cable Loss (dB)	Preamp Factor (dB)	Antenna Height (cm)	Table Angle (Degree)	Remark
5745	96.74	87.55			34.64	8.66	34.11	100	348	Average
5745	103.09	93.9			34.64	8.66	34.11	100	348	Peak
11490	46.51	31.39	54	-7.49	37.89	12.62	35.39	127	234	Average
11490	56.4	41.28	74	-17.6	37.89	12.62	35.39	127	234	Peak

<Out of Band Emission (OOBE)>

Antenna Polarity & Test Distance: Horizontal at 3 m										
Frequency (MHz)	Emission Level (dBuV/m)	Read Level (dBuV)	Limit (dBuV/m)	Margin (dB)	Antenna Factor (dB/m)	Cable Loss (dB)	Preamp Factor (dB)	Antenna Height (cm)	Table Angle (Degree)	Remark
*5542	53.35	44.41	68.2	-14.85	34.43	8.58	34.07	200	37	Peak
5653.3	52.24	43.14	70.64	-18.4	34.56	8.63	34.09	200	37	Peak
5918.95	52.43	43.05	72.68	-20.25	34.81	8.73	34.16	200	37	Peak
*6022.375	53.11	43.6	68.2	-15.09	34.92	8.77	34.18	200	37	Peak
Antenna Polarity & Test Distance: Vertical at 3 m										
Frequency (MHz)	Emission Level (dBuV/m)	Read Level (dBuV)	Limit (dBuV/m)	Margin (dB)	Antenna Factor (dB/m)	Cable Loss (dB)	Preamp Factor (dB)	Antenna Height (cm)	Table Angle (Degree)	Remark
*5639.65	53.61	44.54	68.2	-14.59	34.54	8.62	34.09	100	348	Peak
5657.5	51.49	42.4	73.75	-22.26	34.56	8.63	34.1	100	348	Peak
5921.575	52.25	42.85	70.73	-18.48	34.83	8.73	34.16	100	348	Peak
*5932.6	53.43	44.03	68.2	-14.77	34.83	8.73	34.16	100	348	Peak

Remarks:

- Emission Level = Read Level + Antenna Factor + Cable Loss - Preamp Factor
Margin value = Emission level – Limit value
- 5745 MHz: Fundamental Frequency
- *: Out of Restricted Band
- The emission levels of other frequencies were very low against the limit

EUT Test Condition		Measurement Detail	
Channel	Channel 157	Frequency Range	1 GHz ~ 40 GHz
Input Power	120 Vac, 60 Hz	Detector Function	Peak (PK) Average (AV)
Environmental Conditions	25 deg. C, 65 % RH	Tested By	Karl Lee

<Spurious Emission>

Antenna Polarity & Test Distance: Horizontal at 3 m										
Frequency (MHz)	Emission Level (dBuV/m)	Read Level (dBuV)	Limit (dBuV/m)	Margin (dB)	Antenna Factor (dB/m)	Cable Loss (dB)	Preamp Factor (dB)	Antenna Height (cm)	Table Angle (Degree)	Remark
5785	98.36	89.13			34.68	8.68	34.13	200	37	Average
5785	105.78	96.55			34.68	8.68	34.13	200	37	Peak
11570	46.83	31.52	54	-7.17	38	12.68	35.37	139	247	Average
11570	56.75	41.44	74	-17.25	38	12.68	35.37	139	247	Peak
Antenna Polarity & Test Distance: Vertical at 3 m										
Frequency (MHz)	Emission Level (dBuV/m)	Read Level (dBuV)	Limit (dBuV/m)	Margin (dB)	Antenna Factor (dB/m)	Cable Loss (dB)	Preamp Factor (dB)	Antenna Height (cm)	Table Angle (Degree)	Remark
5785	96.55	87.32			34.68	8.68	34.13	100	348	Average
5785	103.58	94.35			34.68	8.68	34.13	100	348	Peak
11570	46.59	31.28	54	-7.41	38	12.68	35.37	121	156	Average
11570	56.73	41.42	74	-17.27	38	12.68	35.37	121	156	Peak

<Out of Band Emission (OOBE)>

Antenna Polarity & Test Distance: Horizontal at 3 m										
Frequency (MHz)	Emission Level (dBuV/m)	Read Level (dBuV)	Limit (dBuV/m)	Margin (dB)	Antenna Factor (dB/m)	Cable Loss (dB)	Preamp Factor (dB)	Antenna Height (cm)	Table Angle (Degree)	Remark
*5639.125	53.16	44.09	68.2	-15.04	34.54	8.62	34.09	200	37	Peak
5658.55	51.64	42.55	74.53	-22.89	34.56	8.63	34.1	200	37	Peak
5924.2	54.56	45.16	68.79	-14.23	34.83	8.73	34.16	200	37	Peak
*5950.45	53.53	44.1	68.2	-14.67	34.85	8.74	34.16	200	37	Peak
Antenna Polarity & Test Distance: Vertical at 3 m										
Frequency (MHz)	Emission Level (dBuV/m)	Read Level (dBuV)	Limit (dBuV/m)	Margin (dB)	Antenna Factor (dB/m)	Cable Loss (dB)	Preamp Factor (dB)	Antenna Height (cm)	Table Angle (Degree)	Remark
*5648.575	53.32	44.25	68.2	-14.88	34.54	8.62	34.09	100	348	Peak
5659.6	52.92	43.83	75.3	-22.38	34.56	8.63	34.1	100	348	Peak
5917.9	51.31	41.93	73.45	-22.14	34.81	8.73	34.16	100	348	Peak
*5964.625	53.26	43.81	68.2	-14.94	34.87	8.75	34.17	100	348	Peak

Remarks:

- Emission Level = Read Level + Antenna Factor + Cable Loss - Preamp Factor
Margin value = Emission level – Limit value
- 5785 MHz: Fundamental Frequency
- *: Out of Restricted Band
- The emission levels of other frequencies were very low against the limit

EUT Test Condition		Measurement Detail	
Channel	Channel 165	Frequency Range	1 GHz ~ 40 GHz
Input Power	120 Vac, 60 Hz	Detector Function	Peak (PK) Average (AV)
Environmental Conditions	25 deg. C, 65 % RH	Tested By	Karl Lee

<Spurious Emission>

Antenna Polarity & Test Distance: Horizontal at 3 m										
Frequency (MHz)	Emission Level (dBuV/m)	Read Level (dBuV)	Limit (dBuV/m)	Margin (dB)	Antenna Factor (dB/m)	Cable Loss (dB)	Preamp Factor (dB)	Antenna Height (cm)	Table Angle (Degree)	Remark
5825	98.52	89.23			34.73	8.69	34.13	200	37	Average
5825	105.14	95.85			34.73	8.69	34.13	200	37	Peak
11650	46.02	30.49	54	-7.98	38.09	12.8	35.36	189	216	Average
11650	55.99	40.46	74	-18.01	38.09	12.8	35.36	189	216	Peak
Antenna Polarity & Test Distance: Vertical at 3 m										
Frequency (MHz)	Emission Level (dBuV/m)	Read Level (dBuV)	Limit (dBuV/m)	Margin (dB)	Antenna Factor (dB/m)	Cable Loss (dB)	Preamp Factor (dB)	Antenna Height (cm)	Table Angle (Degree)	Remark
5825	96.17	86.88			34.73	8.69	34.13	100	348	Average
5825	103.63	94.34			34.73	8.69	34.13	100	348	Peak
11650	46.53	31	54	-7.47	38.09	12.8	35.36	147	128	Average
11650	56.47	40.94	74	-17.53	38.09	12.8	35.36	147	128	Peak

<Out of Band Emission (OOBE)>

Antenna Polarity & Test Distance: Horizontal at 3 m										
Frequency (MHz)	Emission Level (dBuV/m)	Read Level (dBuV)	Limit (dBuV/m)	Margin (dB)	Antenna Factor (dB/m)	Cable Loss (dB)	Preamp Factor (dB)	Antenna Height (cm)	Table Angle (Degree)	Remark
*5644.9	53.12	44.05	68.2	-15.08	34.54	8.62	34.09	200	37	Peak
5656.45	51.03	41.94	72.97	-21.94	34.56	8.63	34.1	200	37	Peak
5922.1	52.12	42.72	70.35	-18.23	34.83	8.73	34.16	200	37	Peak
*5946.775	53.47	44.04	68.2	-14.73	34.85	8.74	34.16	200	37	Peak
Antenna Polarity & Test Distance: Vertical at 3 m										
Frequency (MHz)	Emission Level (dBuV/m)	Read Level (dBuV)	Limit (dBuV/m)	Margin (dB)	Antenna Factor (dB/m)	Cable Loss (dB)	Preamp Factor (dB)	Antenna Height (cm)	Table Angle (Degree)	Remark
*5607.625	54.04	45.01	68.2	-14.16	34.5	8.61	34.08	100	348	Peak
5657.5	52.31	43.22	73.75	-21.44	34.56	8.63	34.1	100	348	Peak
5922.1	52.11	42.71	70.35	-18.24	34.83	8.73	34.16	100	348	Peak
*5938.9	53.37	43.94	68.2	-14.83	34.85	8.74	34.16	100	348	Peak

Remarks:

- Emission Level = Read Level + Antenna Factor + Cable Loss - Preamp Factor
Margin value = Emission level – Limit value
- 5825 MHz: Fundamental Frequency
- *: Out of Restricted Band
- The emission levels of other frequencies were very low against the limit

<2TX>

802.11n (HT20)

EUT Test Condition		Measurement Detail	
Channel	Channel 36	Frequency Range	1 GHz ~ 40 GHz
Input Power	120 Vac, 60 Hz	Detector Function	Peak (PK) Average (AV)
Environmental Conditions	25 deg. C, 65 % RH	Tested By	Karl Lee

Antenna Polarity & Test Distance: Horizontal at 3 m										
Frequency (MHz)	Emission Level (dBuV/m)	Read Level (dBuV)	Limit (dBuV/m)	Margin (dB)	Antenna Factor (dB/m)	Cable Loss (dB)	Preamp Factor (dB)	Antenna Height (cm)	Table Angle (Degree)	Remark
5149.85	46.8	38.55	54	-7.2	34.12	8.13	34	100	246	Average
5149.85	56.34	48.09	74	-17.66	34.12	8.13	34	100	246	Peak
5180	100.11	91.8			34.15	8.16	34	230	246	Average
5180	107.34	99.03			34.15	8.16	34	230	246	Peak
*10360	54.91	40.61	68.2	-13.29	37.12	12.3	35.12	196	115	Peak

Antenna Polarity & Test Distance: Vertical at 3 m										
Frequency (MHz)	Emission Level (dBuV/m)	Read Level (dBuV)	Limit (dBuV/m)	Margin (dB)	Antenna Factor (dB/m)	Cable Loss (dB)	Preamp Factor (dB)	Antenna Height (cm)	Table Angle (Degree)	Remark
5148.35	43.67	35.42	54	-10.33	34.12	8.13	34	108	292	Average
5148.35	53.9	45.65	74	-20.1	34.12	8.13	34	108	292	Peak
5180	95.56	87.25			34.15	8.16	34	111	280	Average
5180	103.34	95.03			34.15	8.16	34	111	280	Peak
*10360	53.92	39.62	68.2	-14.28	37.12	12.3	35.12	149	121	Peak

Remarks:

- Emission Level = Read Level + Antenna Factor + Cable Loss - Preamp Factor
Margin value = Emission level – Limit value
- 5180 MHz: Fundamental Frequency
- *: Out of Restricted Band
- The emission levels of other frequencies were very low against the limit

EUT Test Condition		Measurement Detail	
Channel	Channel 44	Frequency Range	1 GHz ~ 40 GHz
Input Power	120 Vac, 60 Hz	Detector Function	Peak (PK) Average (AV)
Environmental Conditions	25 deg. C, 65 % RH	Tested By	Karl Lee

Antenna Polarity & Test Distance: Horizontal at 3 m										
Frequency (MHz)	Emission Level (dBuV/m)	Read Level (dBuV)	Limit (dBuV/m)	Margin (dB)	Antenna Factor (dB/m)	Cable Loss (dB)	Preamp Factor (dB)	Antenna Height (cm)	Table Angle (Degree)	Remark
5149.25	42.59	34.34	54	-11.41	34.12	8.13	34	230	246	Average
5149.25	52.95	44.7	74	-21.05	34.12	8.13	34	230	246	Peak
5220	99.16	90.77			34.17	8.22	34	230	246	Average
5220	107.26	98.87			34.17	8.22	34	230	246	Peak
5451.86	42.88	34.06	54	-11.12	34.36	8.51	34.05	230	246	Average
5451.86	52.95	44.13	74	-21.05	34.36	8.51	34.05	230	246	Peak
*10440	54.74	40.28	68.2	-13.46	37.16	12.47	35.17	195	131	Peak

Antenna Polarity & Test Distance: Vertical at 3 m										
Frequency (MHz)	Emission Level (dBuV/m)	Read Level (dBuV)	Limit (dBuV/m)	Margin (dB)	Antenna Factor (dB/m)	Cable Loss (dB)	Preamp Factor (dB)	Antenna Height (cm)	Table Angle (Degree)	Remark
5144	42.58	34.33	54	-11.42	34.12	8.13	34	111	280	Average
5144	53.41	45.16	74	-20.59	34.12	8.13	34	111	280	Peak
5220	95.66	87.27			34.17	8.22	34	111	280	Average
5220	103.55	95.16			34.17	8.22	34	111	280	Peak
5383.99	42.55	33.87	54	-11.45	34.31	8.41	34.04	111	280	Average
5383.99	53.49	44.81	74	-20.51	34.31	8.41	34.04	111	280	Peak
*10440	54.45	39.99	68.2	-13.75	37.16	12.47	35.17	163	124	Peak

Remarks:

- Emission Level = Read Level + Antenna Factor + Cable Loss - Preamp Factor
Margin value = Emission level – Limit value
- 5220 MHz: Fundamental Frequency
- *: Out of Restricted Band
- The emission levels of other frequencies were very low against the limit

EUT Test Condition		Measurement Detail	
Channel	Channel 48	Frequency Range	1 GHz ~ 40 GHz
Input Power	120 Vac, 60 Hz	Detector Function	Peak (PK) Average (AV)
Environmental Conditions	25 deg. C, 65 % RH	Tested By	Karl Lee

Antenna Polarity & Test Distance: Horizontal at 3 m										
Frequency (MHz)	Emission Level (dBuV/m)	Read Level (dBuV)	Limit (dBuV/m)	Margin (dB)	Antenna Factor (dB/m)	Cable Loss (dB)	Preamp Factor (dB)	Antenna Height (cm)	Table Angle (Degree)	Remark
5240	100.56	92.12			34.19	8.26	34.01	230	246	Average
5240	107.77	99.33			34.19	8.26	34.01	230	246	Peak
5359.02	42.68	34.05	54	-11.32	34.28	8.38	34.03	230	246	Average
5359.02	53.2	44.57	74	-20.8	34.28	8.38	34.03	230	246	Peak
*10480	55.27	40.76	68.2	-12.93	37.19	12.53	35.21	126	118	Peak

Antenna Polarity & Test Distance: Vertical at 3 m										
Frequency (MHz)	Emission Level (dBuV/m)	Read Level (dBuV)	Limit (dBuV/m)	Margin (dB)	Antenna Factor (dB/m)	Cable Loss (dB)	Preamp Factor (dB)	Antenna Height (cm)	Table Angle (Degree)	Remark
5240	95.98	87.54			34.19	8.26	34.01	111	280	Average
5240	103.84	95.4			34.19	8.26	34.01	111	280	Peak
5381.57	42.69	34.01	54	-11.31	34.31	8.41	34.04	111	280	Average
5381.57	53.4	44.72	74	-20.6	34.31	8.41	34.04	111	280	Peak
*10480	55.62	41.11	68.2	-12.58	37.19	12.53	35.21	151	177	Peak

Remarks:

- Emission Level = Read Level + Antenna Factor + Cable Loss - Preamp Factor
Margin value = Emission level – Limit value
- 5240 MHz: Fundamental Frequency
- *: Out of Restricted Band
- The emission levels of other frequencies were very low against the limit

EUT Test Condition		Measurement Detail	
Channel	Channel 52	Frequency Range	1 GHz ~ 40 GHz
Input Power	120 Vac, 60 Hz	Detector Function	Peak (PK) Average (AV)
Environmental Conditions	25 deg. C, 65 % RH	Tested By	Karl Lee

Antenna Polarity & Test Distance: Horizontal at 3 m										
Frequency (MHz)	Emission Level (dBuV/m)	Read Level (dBuV)	Limit (dBuV/m)	Margin (dB)	Antenna Factor (dB/m)	Cable Loss (dB)	Preamp Factor (dB)	Antenna Height (cm)	Table Angle (Degree)	Remark
5146.1	42.31	34.06	54	-11.69	34.12	8.13	34	100	171	Average
5146.1	53.13	44.88	74	-20.87	34.12	8.13	34	100	171	Peak
5260	99.61	91.15			34.21	8.26	34.01	100	171	Average
5260	107.26	98.8			34.21	8.26	34.01	100	171	Peak
*10520	55.02	40.43	68.2	-13.18	37.21	12.61	35.23	133	269	Peak

Antenna Polarity & Test Distance: Vertical at 3 m										
Frequency (MHz)	Emission Level (dBuV/m)	Read Level (dBuV)	Limit (dBuV/m)	Margin (dB)	Antenna Factor (dB/m)	Cable Loss (dB)	Preamp Factor (dB)	Antenna Height (cm)	Table Angle (Degree)	Remark
5109.5	42.33	34.13	54	-11.67	34.09	8.1	33.99	107	283	Average
5109.5	53.56	45.36	74	-20.44	34.09	8.1	33.99	107	283	Peak
5260	96.28	87.82			34.21	8.26	34.01	107	283	Average
5260	103.03	94.57			34.21	8.26	34.01	107	283	Peak
*10520	55.24	40.65	68.2	-12.96	37.21	12.61	35.23	114	129	Peak

Remarks:

- Emission Level = Read Level + Antenna Factor + Cable Loss - Preamp Factor
Margin value = Emission level – Limit value
- 5260 MHz: Fundamental Frequency
- *: Out of Restricted Band
- The emission levels of other frequencies were very low against the limit

EUT Test Condition		Measurement Detail	
Channel	Channel 60	Frequency Range	1 GHz ~ 40 GHz
Input Power	120 Vac, 60 Hz	Detector Function	Peak (PK) Average (AV)
Environmental Conditions	25 deg. C, 65 % RH	Tested By	Karl Lee

Antenna Polarity & Test Distance: Horizontal at 3 m										
Frequency (MHz)	Emission Level (dBuV/m)	Read Level (dBuV)	Limit (dBuV/m)	Margin (dB)	Antenna Factor (dB/m)	Cable Loss (dB)	Preamp Factor (dB)	Antenna Height (cm)	Table Angle (Degree)	Remark
5118.8	42.43	34.23	54	-11.57	34.09	8.1	33.99	100	171	Average
5118.8	52.83	44.63	74	-21.17	34.09	8.1	33.99	100	171	Peak
5300	100.18	91.64			34.24	8.32	34.02	100	171	Average
5300	107.36	98.82			34.24	8.32	34.02	100	171	Peak
5352.09	43.77	35.14	54	-10.23	34.28	8.38	34.03	100	171	Average
5352.09	53.47	44.84	74	-20.53	34.28	8.38	34.03	100	171	Peak
10600	45.71	31.03	54	-8.29	37.28	12.67	35.27	139	241	Average
10600	55.72	41.04	74	-18.28	37.28	12.67	35.27	139	241	Peak

Antenna Polarity & Test Distance: Vertical at 3 m										
Frequency (MHz)	Emission Level (dBuV/m)	Read Level (dBuV)	Limit (dBuV/m)	Margin (dB)	Antenna Factor (dB/m)	Cable Loss (dB)	Preamp Factor (dB)	Antenna Height (cm)	Table Angle (Degree)	Remark
5108	42.41	34.21	54	-11.59	34.09	8.1	33.99	107	283	Average
5108	53.02	44.82	74	-20.98	34.09	8.1	33.99	107	283	Peak
5300	95.8	87.26			34.24	8.32	34.02	107	283	Average
5300	103.31	94.77			34.24	8.32	34.02	107	283	Peak
5356.38	43.09	34.46	54	-10.91	34.28	8.38	34.03	107	283	Average
5356.38	54.1	45.47	74	-19.9	34.28	8.38	34.03	107	283	Peak
10600	45.02	30.34	54	-8.98	37.28	12.67	35.27	145	227	Average
10600	54.92	40.24	74	-19.08	37.28	12.67	35.27	145	227	Peak

Remarks:

- Emission Level = Read Level + Antenna Factor + Cable Loss - Preamp Factor
Margin value = Emission level – Limit value
- 5300 MHz: Fundamental Frequency
- The emission levels of other frequencies were very low against the limit

EUT Test Condition		Measurement Detail	
Channel	Channel 64	Frequency Range	1 GHz ~ 40 GHz
Input Power	120 Vac, 60 Hz	Detector Function	Peak (PK) Average (AV)
Environmental Conditions	25 deg. C, 65 % RH	Tested By	Karl Lee

Antenna Polarity & Test Distance: Horizontal at 3 m										
Frequency (MHz)	Emission Level (dBuV/m)	Read Level (dBuV)	Limit (dBuV/m)	Margin (dB)	Antenna Factor (dB/m)	Cable Loss (dB)	Preamp Factor (dB)	Antenna Height (cm)	Table Angle (Degree)	Remark
5320	100.06	91.48			34.25	8.35	34.02	100	171	Average
5320	107.31	98.73			34.25	8.35	34.02	100	171	Peak
5350	49.48	40.85	54	-4.52	34.28	8.38	34.03	115	245	Average
5350	59.6	50.97	74	-14.4	34.28	8.38	34.03	115	245	Peak
10640	44.86	30.13	54	-9.14	37.31	12.71	35.29	126	305	Average
10640	54.74	40.01	74	-19.26	37.31	12.71	35.29	126	305	Peak

Antenna Polarity & Test Distance: Vertical at 3 m										
Frequency (MHz)	Emission Level (dBuV/m)	Read Level (dBuV)	Limit (dBuV/m)	Margin (dB)	Antenna Factor (dB/m)	Cable Loss (dB)	Preamp Factor (dB)	Antenna Height (cm)	Table Angle (Degree)	Remark
5320	95.87	87.29			34.25	8.35	34.02	107	283	Average
5320	103.45	94.87			34.25	8.35	34.02	107	283	Peak
5350.33	45.48	36.85	54	-8.52	34.28	8.38	34.03	107	283	Average
5350.33	55.39	46.76	74	-18.61	34.28	8.38	34.03	107	283	Peak
10640	45.31	30.58	54	-8.69	37.31	12.71	35.29	158	227	Average
10640	55.44	40.71	74	-18.56	37.31	12.71	35.29	158	227	Peak

Remarks:

- Emission Level = Read Level + Antenna Factor + Cable Loss - Preamp Factor
Margin value = Emission level – Limit value
- 5320 MHz: Fundamental Frequency
- The emission levels of other frequencies were very low against the limit

EUT Test Condition		Measurement Detail	
Channel	Channel 100	Frequency Range	1 GHz ~ 40 GHz
Input Power	120 Vac, 60 Hz	Detector Function	Peak (PK) Average (AV)
Environmental Conditions	25 deg. C, 65 % RH	Tested By	Karl Lee

Antenna Polarity & Test Distance: Horizontal at 3 m										
Frequency (MHz)	Emission Level (dBuV/m)	Read Level (dBuV)	Limit (dBuV/m)	Margin (dB)	Antenna Factor (dB/m)	Cable Loss (dB)	Preamp Factor (dB)	Antenna Height (cm)	Table Angle (Degree)	Remark
5458.8	45.92	37.1	54	-8.08	34.36	8.51	34.05	106	243	Average
5458.8	56.72	47.9	74	-17.28	34.36	8.51	34.05	106	243	Peak
*5468.72	58.84	50.01	68.2	-9.36	34.37	8.51	34.05	106	243	Peak
5500	101.17	92.25			34.4	8.57	34.05	103	243	Average
5500	108.79	99.87			34.4	8.57	34.05	103	243	Peak
11000	46.39	31.31	54	-7.61	37.6	12.96	35.48	125	80	Average
11000	56.54	41.46	74	-17.46	37.6	12.96	35.48	125	80	Peak
Antenna Polarity & Test Distance: Vertical at 3 m										
Frequency (MHz)	Emission Level (dBuV/m)	Read Level (dBuV)	Limit (dBuV/m)	Margin (dB)	Antenna Factor (dB/m)	Cable Loss (dB)	Preamp Factor (dB)	Antenna Height (cm)	Table Angle (Degree)	Remark
5456.24	43.96	35.14	54	-10.04	34.36	8.51	34.05	120	280	Average
5456.24	54.15	45.33	74	-19.85	34.36	8.51	34.05	120	280	Peak
*5470	55.04	46.21	68.2	-13.16	34.37	8.51	34.05	120	280	Peak
5500	97.58	88.66			34.4	8.57	34.05	120	280	Average
5500	104.67	95.75			34.4	8.57	34.05	120	280	Peak
11000	46.18	31.1	54	-7.82	37.6	12.96	35.48	183	155	Average
11000	56.21	41.13	74	-17.79	37.6	12.96	35.48	183	155	Peak

Remarks:

- Emission Level = Read Level + Antenna Factor + Cable Loss - Preamp Factor
Margin value = Emission level – Limit value
- 5500 MHz: Fundamental Frequency
- *: Out of Restricted Band
- The emission levels of other frequencies were very low against the limit

EUT Test Condition		Measurement Detail	
Channel	Channel 116	Frequency Range	1 GHz ~ 40 GHz
Input Power	120 Vac, 60 Hz	Detector Function	Peak (PK) Average (AV)
Environmental Conditions	25 deg. C, 65 % RH	Tested By	Karl Lee

Antenna Polarity & Test Distance: Horizontal at 3 m										
Frequency (MHz)	Emission Level (dBuV/m)	Read Level (dBuV)	Limit (dBuV/m)	Margin (dB)	Antenna Factor (dB/m)	Cable Loss (dB)	Preamp Factor (dB)	Antenna Height (cm)	Table Angle (Degree)	Remark
5453.04	42.86	34.04	54	-11.14	34.36	8.51	34.05	105	243	Average
5453.04	54.15	45.33	74	-19.85	34.36	8.51	34.05	105	243	Peak
*5469.36	52.65	43.82	68.2	-15.55	34.37	8.51	34.05	105	243	Peak
5580	100.39	91.4			34.47	8.6	34.08	105	243	Average
5580	108.28	99.29			34.47	8.6	34.08	105	243	Peak
*5724.68	51.57	42.41	68.2	-16.63	34.62	8.65	34.11	105	243	Peak
11160	46.93	31.85	54	-7.07	37.7	12.83	35.45	158	207	Average
11160	57.17	42.09	74	-16.83	37.7	12.83	35.45	158	207	Peak

Antenna Polarity & Test Distance: Vertical at 3 m										
Frequency (MHz)	Emission Level (dBuV/m)	Read Level (dBuV)	Limit (dBuV/m)	Margin (dB)	Antenna Factor (dB/m)	Cable Loss (dB)	Preamp Factor (dB)	Antenna Height (cm)	Table Angle (Degree)	Remark
5445.2	42.6	33.78	54	-11.4	34.35	8.51	34.04	120	279	Average
5445.2	53.77	44.95	74	-20.23	34.35	8.51	34.04	120	279	Peak
*5468.4	51.98	43.15	68.2	-16.22	34.37	8.51	34.05	120	279	Peak
5580	96.89	87.9			34.47	8.6	34.08	120	279	Average
5580	104.34	95.35			34.47	8.6	34.08	120	279	Peak
*5725.32	52.24	43.08	68.2	-15.96	34.62	8.65	34.11	120	279	Peak
11160	46.21	31.13	54	-7.79	37.7	12.83	35.45	124	196	Average
11160	56.03	40.95	74	-17.97	37.7	12.83	35.45	124	196	Peak

Remarks:

- Emission Level = Read Level + Antenna Factor + Cable Loss - Preamp Factor
Margin value = Emission level – Limit value
- 5580 MHz: Fundamental Frequency
- *: Out of Restricted Band
- The emission levels of other frequencies were very low against the limit

EUT Test Condition		Measurement Detail	
Channel	Channel 140	Frequency Range	1 GHz ~ 40 GHz
Input Power	120 Vac, 60 Hz	Detector Function	Peak (PK) Average (AV)
Environmental Conditions	25 deg. C, 65 % RH	Tested By	Karl Lee

Antenna Polarity & Test Distance: Horizontal at 3 m										
Frequency (MHz)	Emission Level (dBuV/m)	Read Level (dBuV)	Limit (dBuV/m)	Margin (dB)	Antenna Factor (dB/m)	Cable Loss (dB)	Preamp Factor (dB)	Antenna Height (cm)	Table Angle (Degree)	Remark
5700	99.47	90.34			34.59	8.64	34.1	190	115	Average
5700	106.08	96.95			34.59	8.64	34.1	190	115	Peak
*5724.12	66.14	56.98	68.2	-2.06	34.62	8.65	34.11	190	176	Peak
11400	46.11	31.01	54	-7.89	37.84	12.67	35.41	196	320	Average
11400	56	40.9	74	-18	37.84	12.67	35.41	196	320	Peak

Antenna Polarity & Test Distance: Vertical at 3 m										
Frequency (MHz)	Emission Level (dBuV/m)	Read Level (dBuV)	Limit (dBuV/m)	Margin (dB)	Antenna Factor (dB/m)	Cable Loss (dB)	Preamp Factor (dB)	Antenna Height (cm)	Table Angle (Degree)	Remark
5700	95.63	86.5			34.59	8.64	34.1	120	119	Average
5700	102.17	93.04			34.59	8.64	34.1	120	119	Peak
*5723.96	62.26	53.1	68.2	-5.94	34.62	8.65	34.11	120	119	Peak
11400	47.23	32.13	54	-6.77	37.84	12.67	35.41	159	224	Average
11400	57.11	42.01	74	-16.89	37.84	12.67	35.41	159	224	Peak

Remarks:

- Emission Level = Read Level + Antenna Factor + Cable Loss - Preamp Factor
Margin value = Emission level – Limit value
- 5700 MHz: Fundamental Frequency
- *: Out of Restricted Band
- The emission levels of other frequencies were very low against the limit

EUT Test Condition		Measurement Detail	
Channel	Channel 144	Frequency Range	1 GHz ~ 40 GHz
Input Power	120 Vac, 60 Hz	Detector Function	Peak (PK) Average (AV)
Environmental Conditions	25 deg. C, 65 % RH	Tested By	Karl Lee

Antenna Polarity & Test Distance: Horizontal at 3 m										
Frequency (MHz)	Emission Level (dBuV/m)	Read Level (dBuV)	Limit (dBuV/m)	Margin (dB)	Antenna Factor (dB/m)	Cable Loss (dB)	Preamp Factor (dB)	Antenna Height (cm)	Table Angle (Degree)	Remark
5458.8	42.73	33.91	54	-11.27	34.36	8.51	34.05	190	115	Average
5458.8	53.01	44.19	74	-20.99	34.36	8.51	34.05	190	115	Peak
*5470.48	51.62	42.79	68.2	-16.58	34.37	8.51	34.05	190	115	Peak
5720	100.95	91.79			34.62	8.65	34.11	190	115	Average
5720	107.28	98.12			34.62	8.65	34.11	190	115	Peak
11440	47.51	32.4	54	-6.49	37.86	12.65	35.4	154	355	Average
11440	55.4	40.29	74	-18.6	37.86	12.65	35.4	154	355	Peak
Antenna Polarity & Test Distance: Vertical at 3 m										
Frequency (MHz)	Emission Level (dBuV/m)	Read Level (dBuV)	Limit (dBuV/m)	Margin (dB)	Antenna Factor (dB/m)	Cable Loss (dB)	Preamp Factor (dB)	Antenna Height (cm)	Table Angle (Degree)	Remark
5446.32	42.65	33.82	54	-11.35	34.36	8.51	34.04	120	119	Average
5446.32	53.25	44.42	74	-20.75	34.36	8.51	34.04	120	119	Peak
*5469.68	52.06	43.23	68.2	-16.14	34.37	8.51	34.05	120	119	Peak
5720	96.54	87.38			34.62	8.65	34.11	120	119	Average
5720	103.86	94.7			34.62	8.65	34.11	120	119	Peak
11440	47.25	32.14	54	-6.75	37.86	12.65	35.4	151	290	Average
11440	55.5	40.39	74	-18.5	37.86	12.65	35.4	151	290	Peak

Remarks:

- Emission Level = Read Level + Antenna Factor + Cable Loss - Preamp Factor
Margin value = Emission level – Limit value
- 5720 MHz: Fundamental Frequency
- *: Out of Restricted Band
- The emission levels of other frequencies were very low against the limit

EUT Test Condition		Measurement Detail	
Channel	Channel 149	Frequency Range	1 GHz ~ 40 GHz
Input Power	120 Vac, 60 Hz	Detector Function	Peak (PK) Average (AV)
Environmental Conditions	25 deg. C, 65 % RH	Tested By	Karl Lee

<Spurious Emission>

Antenna Polarity & Test Distance: Horizontal at 3 m										
Frequency (MHz)	Emission Level (dBuV/m)	Read Level (dBuV)	Limit (dBuV/m)	Margin (dB)	Antenna Factor (dB/m)	Cable Loss (dB)	Preamp Factor (dB)	Antenna Height (cm)	Table Angle (Degree)	Remark
5745	100.44	91.25			34.64	8.66	34.11	125	200	Average
5745	107.45	98.26			34.64	8.66	34.11	125	200	Peak
11490	46.31	31.19	54	-7.69	37.89	12.62	35.39	145	223	Average
11490	56.42	41.3	74	-17.58	37.89	12.62	35.39	145	223	Peak
Antenna Polarity & Test Distance: Vertical at 3 m										
Frequency (MHz)	Emission Level (dBuV/m)	Read Level (dBuV)	Limit (dBuV/m)	Margin (dB)	Antenna Factor (dB/m)	Cable Loss (dB)	Preamp Factor (dB)	Antenna Height (cm)	Table Angle (Degree)	Remark
5745	99.62	90.43			34.64	8.66	34.11	200	145	Average
5745	106.77	97.58			34.64	8.66	34.11	200	145	Peak
11490	46.39	31.27	54	-7.61	37.89	12.62	35.39	106	311	Average
11490	56.21	41.09	74	-17.79	37.89	12.62	35.39	106	311	Peak

<Out of Band Emission (OOBE)>

Antenna Polarity & Test Distance: Horizontal at 3 m										
Frequency (MHz)	Emission Level (dBuV/m)	Read Level (dBuV)	Limit (dBuV/m)	Margin (dB)	Antenna Factor (dB/m)	Cable Loss (dB)	Preamp Factor (dB)	Antenna Height (cm)	Table Angle (Degree)	Remark
*5563.525	53.69	44.72	68.2	-14.51	34.45	8.59	34.07	125	200	Peak
5658.55	51.98	42.89	74.53	-22.55	34.56	8.63	34.1	125	200	Peak
5916.325	51.32	41.94	74.62	-23.3	34.81	8.73	34.16	125	200	Peak
*6016.075	53.2	43.7	68.2	-15	34.92	8.76	34.18	125	200	Peak
Antenna Polarity & Test Distance: Vertical at 3 m										
Frequency (MHz)	Emission Level (dBuV/m)	Read Level (dBuV)	Limit (dBuV/m)	Margin (dB)	Antenna Factor (dB/m)	Cable Loss (dB)	Preamp Factor (dB)	Antenna Height (cm)	Table Angle (Degree)	Remark
*5564.05	54.67	45.7	68.2	-13.53	34.45	8.59	34.07	200	145	Peak
5653.3	50.46	41.36	70.64	-20.18	34.56	8.63	34.09	200	145	Peak
5921.575	52.43	43.03	70.73	-18.3	34.83	8.73	34.16	200	145	Peak
*6011.875	53.37	43.87	68.2	-14.83	34.92	8.76	34.18	200	145	Peak

Remarks:

- Emission Level = Read Level + Antenna Factor + Cable Loss - Preamp Factor
Margin value = Emission level – Limit value
- 5745 MHz: Fundamental Frequency
- *: Out of Restricted Band
- The emission levels of other frequencies were very low against the limit

EUT Test Condition		Measurement Detail	
Channel	Channel 157	Frequency Range	1 GHz ~ 40 GHz
Input Power	120 Vac, 60 Hz	Detector Function	Peak (PK) Average (AV)
Environmental Conditions	25 deg. C, 65 % RH	Tested By	Karl Lee

<Spurious Emission>

Antenna Polarity & Test Distance: Horizontal at 3 m										
Frequency (MHz)	Emission Level (dBuV/m)	Read Level (dBuV)	Limit (dBuV/m)	Margin (dB)	Antenna Factor (dB/m)	Cable Loss (dB)	Preamp Factor (dB)	Antenna Height (cm)	Table Angle (Degree)	Remark
5785	100	90.77			34.68	8.68	34.13	125	200	Average
5785	107.08	97.85			34.68	8.68	34.13	125	200	Peak
11570	46.1	30.79	54	-7.9	38	12.68	35.37	148	221	Average
11570	55.99	40.68	74	-18.01	38	12.68	35.37	148	221	Peak
Antenna Polarity & Test Distance: Vertical at 3 m										
Frequency (MHz)	Emission Level (dBuV/m)	Read Level (dBuV)	Limit (dBuV/m)	Margin (dB)	Antenna Factor (dB/m)	Cable Loss (dB)	Preamp Factor (dB)	Antenna Height (cm)	Table Angle (Degree)	Remark
5785	99.85	90.62			34.68	8.68	34.13	200	145	Average
5785	106.68	97.45			34.68	8.68	34.13	200	145	Peak
11570	46.11	30.8	54	-7.89	38	12.68	35.37	193	218	Average
11570	56.17	40.86	74	-17.83	38	12.68	35.37	193	218	Peak

<Out of Band Emission (OOBE)>

Antenna Polarity & Test Distance: Horizontal at 3 m										
Frequency (MHz)	Emission Level (dBuV/m)	Read Level (dBuV)	Limit (dBuV/m)	Margin (dB)	Antenna Factor (dB/m)	Cable Loss (dB)	Preamp Factor (dB)	Antenna Height (cm)	Table Angle (Degree)	Remark
*5549.875	53.6	44.63	68.2	-14.6	34.45	8.59	34.07	125	200	Peak
5660.65	52.05	42.96	76.08	-24.03	34.56	8.63	34.1	125	200	Peak
5922.625	52.9	43.5	69.96	-17.06	34.83	8.73	34.16	125	200	Peak
*5976.7	54.55	45.09	68.2	-13.65	34.88	8.75	34.17	125	200	Peak
Antenna Polarity & Test Distance: Vertical at 3 m										
Frequency (MHz)	Emission Level (dBuV/m)	Read Level (dBuV)	Limit (dBuV/m)	Margin (dB)	Antenna Factor (dB/m)	Cable Loss (dB)	Preamp Factor (dB)	Antenna Height (cm)	Table Angle (Degree)	Remark
*5600.8	53.95	44.92	68.2	-14.25	34.5	8.61	34.08	200	145	Peak
5656.975	52.75	43.66	73.36	-20.61	34.56	8.63	34.1	200	145	Peak
5918.95	52.49	43.11	72.68	-20.19	34.81	8.73	34.16	200	145	Peak
*5993.5	53.51	44.02	68.2	-14.69	34.9	8.76	34.17	200	145	Peak

Remarks:

- Emission Level = Read Level + Antenna Factor + Cable Loss - Preamp Factor
Margin value = Emission level – Limit value
- 5785 MHz: Fundamental Frequency
- *: Out of Restricted Band
- The emission levels of other frequencies were very low against the limit

EUT Test Condition		Measurement Detail	
Channel	Channel 165	Frequency Range	1 GHz ~ 40 GHz
Input Power	120 Vac, 60 Hz	Detector Function	Peak (PK) Average (AV)
Environmental Conditions	25 deg. C, 65 % RH	Tested By	Karl Lee

<Spurious Emission>

Antenna Polarity & Test Distance: Horizontal at 3 m										
Frequency (MHz)	Emission Level (dBuV/m)	Read Level (dBuV)	Limit (dBuV/m)	Margin (dB)	Antenna Factor (dB/m)	Cable Loss (dB)	Preamp Factor (dB)	Antenna Height (cm)	Table Angle (Degree)	Remark
5825	100.38	91.09			34.73	8.69	34.13	125	200	Average
5825	107.31	98.02			34.73	8.69	34.13	125	200	Peak
11650	46.07	30.54	54	-7.93	38.09	12.8	35.36	131	117	Average
11650	56.02	40.49	74	-17.98	38.09	12.8	35.36	131	117	Peak
Antenna Polarity & Test Distance: Vertical at 3 m										
Frequency (MHz)	Emission Level (dBuV/m)	Read Level (dBuV)	Limit (dBuV/m)	Margin (dB)	Antenna Factor (dB/m)	Cable Loss (dB)	Preamp Factor (dB)	Antenna Height (cm)	Table Angle (Degree)	Remark
5825	99.99	90.7			34.73	8.69	34.13	200	145	Average
5825	106.78	97.49			34.73	8.69	34.13	200	145	Peak
11650	45.83	30.3	54	-8.17	38.09	12.8	35.36	142	116	Average
11650	55.92	40.39	74	-18.08	38.09	12.8	35.36	142	116	Peak

<Out of Band Emission (OOBE)>

Antenna Polarity & Test Distance: Horizontal at 3 m										
Frequency (MHz)	Emission Level (dBuV/m)	Read Level (dBuV)	Limit (dBuV/m)	Margin (dB)	Antenna Factor (dB/m)	Cable Loss (dB)	Preamp Factor (dB)	Antenna Height (cm)	Table Angle (Degree)	Remark
*5602.375	53.31	44.28	68.2	-14.89	34.5	8.61	34.08	125	200	Peak
5657.5	53.05	43.96	73.75	-20.7	34.56	8.63	34.1	125	200	Peak
5922.1	53.05	43.65	70.35	-17.3	34.83	8.73	34.16	125	200	Peak
*5957.275	53.78	44.33	68.2	-14.42	34.87	8.74	34.16	125	200	Peak
Antenna Polarity & Test Distance: Vertical at 3 m										
Frequency (MHz)	Emission Level (dBuV/m)	Read Level (dBuV)	Limit (dBuV/m)	Margin (dB)	Antenna Factor (dB/m)	Cable Loss (dB)	Preamp Factor (dB)	Antenna Height (cm)	Table Angle (Degree)	Remark
*5635.45	53.15	44.08	68.2	-15.05	34.54	8.62	34.09	200	145	Peak
5657.5	51.11	42.02	73.75	-22.64	34.56	8.63	34.1	200	145	Peak
5921.05	51.24	41.86	71.12	-19.88	34.81	8.73	34.16	200	145	Peak
*6008.2	53.83	44.32	68.2	-14.37	34.92	8.76	34.17	200	145	Peak

Remarks:

- Emission Level = Read Level + Antenna Factor + Cable Loss - Preamp Factor
Margin value = Emission level – Limit value
- 5825 MHz: Fundamental Frequency
- *: Out of Restricted Band
- The emission levels of other frequencies were very low against the limit

802.11n (HT40)

EUT Test Condition		Measurement Detail	
Channel	Channel 38	Frequency Range	1 GHz ~ 40 GHz
Input Power	120 Vac, 60 Hz	Detector Function	Peak (PK) Average (AV)
Environmental Conditions	25 deg. C, 65 % RH	Tested By	Karl Lee

Antenna Polarity & Test Distance: Horizontal at 3 m

Frequency (MHz)	Emission Level (dBuV/m)	Read Level (dBuV)	Limit (dBuV/m)	Margin (dB)	Antenna Factor (dB/m)	Cable Loss (dB)	Preamp Factor (dB)	Antenna Height (cm)	Table Angle (Degree)	Remark
5149.7	51.61	43.36	54	-2.39	34.12	8.13	34	100	246	Average
5149.7	61.31	53.06	74	-12.69	34.12	8.13	34	100	246	Peak
5190	94.54	86.2			34.15	8.19	34	230	246	Average
5190	101.93	93.59			34.15	8.19	34	230	246	Peak
5412.59	43.52	34.79	54	-10.48	34.33	8.44	34.04	100	246	Average
5412.59	53.54	44.81	74	-20.46	34.33	8.44	34.04	100	246	Peak
*10380	54.98	40.63	68.2	-13.22	37.13	12.36	35.14	159	263	Peak

Antenna Polarity & Test Distance: Vertical at 3 m

Frequency (MHz)	Emission Level (dBuV/m)	Read Level (dBuV)	Limit (dBuV/m)	Margin (dB)	Antenna Factor (dB/m)	Cable Loss (dB)	Preamp Factor (dB)	Antenna Height (cm)	Table Angle (Degree)	Remark
5149.85	46.1	37.85	54	-7.9	34.12	8.13	34	130	284	Average
5149.85	55.36	47.11	74	-18.64	34.12	8.13	34	130	284	Peak
5190	89.8	81.46			34.15	8.19	34	130	280	Average
5190	97.02	88.68			34.15	8.19	34	130	280	Peak
5411.6	43.1	34.37	54	-10.9	34.33	8.44	34.04	130	284	Average
5411.6	53.5	44.77	74	-20.5	34.33	8.44	34.04	130	284	Peak
*10380	54.4	40.05	68.2	-13.8	37.13	12.36	35.14	145	316	Peak

Remarks:

- Emission Level = Read Level + Antenna Factor + Cable Loss - Preamp Factor
Margin value = Emission level – Limit value
- 5190 MHz: Fundamental Frequency
- *: Out of Restricted Band
- The emission levels of other frequencies were very low against the limit

EUT Test Condition		Measurement Detail	
Channel	Channel 46	Frequency Range	1 GHz ~ 40 GHz
Input Power	120 Vac, 60 Hz	Detector Function	Peak (PK) Average (AV)
Environmental Conditions	25 deg. C, 65 % RH	Tested By	Karl Lee

Antenna Polarity & Test Distance: Horizontal at 3 m										
Frequency (MHz)	Emission Level (dBuV/m)	Read Level (dBuV)	Limit (dBuV/m)	Margin (dB)	Antenna Factor (dB/m)	Cable Loss (dB)	Preamp Factor (dB)	Antenna Height (cm)	Table Angle (Degree)	Remark
5148.95	43.27	35.02	54	-10.73	34.12	8.13	34	196	245	Average
5148.95	53.74	45.49	74	-20.26	34.12	8.13	34	196	245	Peak
5230	97.02	88.62			34.19	8.22	34.01	210	245	Average
5230	104.32	95.92			34.19	8.22	34.01	210	245	Peak
5452.96	45.25	36.43	54	-8.75	34.36	8.51	34.05	196	245	Average
5452.96	53.86	45.04	74	-20.14	34.36	8.51	34.05	196	245	Peak
*10460	55.09	40.58	68.2	-13.11	37.17	12.53	35.19	155	208	Peak
Antenna Polarity & Test Distance: Vertical at 3 m										
Frequency (MHz)	Emission Level (dBuV/m)	Read Level (dBuV)	Limit (dBuV/m)	Margin (dB)	Antenna Factor (dB/m)	Cable Loss (dB)	Preamp Factor (dB)	Antenna Height (cm)	Table Angle (Degree)	Remark
5147.75	42.46	34.21	54	-11.54	34.12	8.13	34	130	280	Average
5147.75	53.38	45.13	74	-20.62	34.12	8.13	34	130	280	Peak
5230	92.42	84.02			34.19	8.22	34.01	130	280	Average
5230	100.03	91.63			34.19	8.22	34.01	130	280	Peak
5377.5	43.7	35.02	54	-10.3	34.31	8.41	34.04	130	280	Average
5377.5	53.85	45.17	74	-20.15	34.31	8.41	34.04	130	280	Peak
*10460	56.15	41.64	68.2	-12.05	37.17	12.53	35.19	158	63	Peak

Remarks:

- Emission Level = Read Level + Antenna Factor + Cable Loss - Preamp Factor
Margin value = Emission level – Limit value
- 5230 MHz: Fundamental Frequency
- *: Out of Restricted Band
- The emission levels of other frequencies were very low against the limit

EUT Test Condition		Measurement Detail	
Channel	Channel 54	Frequency Range	1 GHz ~ 40 GHz
Input Power	120 Vac, 60 Hz	Detector Function	Peak (PK) Average (AV)
Environmental Conditions	25 deg. C, 65 % RH	Tested By	Karl Lee

Antenna Polarity & Test Distance: Horizontal at 3 m										
Frequency (MHz)	Emission Level (dBuV/m)	Read Level (dBuV)	Limit (dBuV/m)	Margin (dB)	Antenna Factor (dB/m)	Cable Loss (dB)	Preamp Factor (dB)	Antenna Height (cm)	Table Angle (Degree)	Remark
5123.15	42.61	34.39	54	-11.39	34.11	8.1	33.99	124	241	Average
5123.15	52.75	44.53	74	-21.25	34.11	8.1	33.99	124	241	Peak
5270	96.96	88.47			34.21	8.29	34.01	124	241	Average
5270	104.21	95.72			34.21	8.29	34.01	124	241	Peak
5352.75	44.56	35.93	54	-9.44	34.28	8.38	34.03	124	241	Average
5352.75	55.18	46.55	74	-18.82	34.28	8.38	34.03	124	241	Peak
*10540	55.96	41.34	68.2	-12.24	37.23	12.63	35.24	168	205	Peak
Antenna Polarity & Test Distance: Vertical at 3 m										
Frequency (MHz)	Emission Level (dBuV/m)	Read Level (dBuV)	Limit (dBuV/m)	Margin (dB)	Antenna Factor (dB/m)	Cable Loss (dB)	Preamp Factor (dB)	Antenna Height (cm)	Table Angle (Degree)	Remark
5112.95	42.31	34.11	54	-11.69	34.09	8.1	33.99	130	279	Average
5112.95	53.16	44.96	74	-20.84	34.09	8.1	33.99	130	279	Peak
5270	92.81	84.32			34.21	8.29	34.01	130	279	Average
5270	100.28	91.79			34.21	8.29	34.01	130	279	Peak
5350.33	43.26	34.63	54	-10.74	34.28	8.38	34.03	130	279	Average
5350.33	53.76	45.13	74	-20.24	34.28	8.38	34.03	130	279	Peak
*10540	56.21	41.59	68.2	-11.99	37.23	12.63	35.24	125	186	Peak

Remarks:

- Emission Level = Read Level + Antenna Factor + Cable Loss - Preamp Factor
Margin value = Emission level – Limit value
- 5270 MHz: Fundamental Frequency
- *: Out of Restricted Band
- The emission levels of other frequencies were very low against the limit

EUT Test Condition		Measurement Detail	
Channel	Channel 62	Frequency Range	1 GHz ~ 40 GHz
Input Power	120 Vac, 60 Hz	Detector Function	Peak (PK) Average (AV)
Environmental Conditions	25 deg. C, 65 % RH	Tested By	Karl Lee

Antenna Polarity & Test Distance: Horizontal at 3 m										
Frequency (MHz)	Emission Level (dBuV/m)	Read Level (dBuV)	Limit (dBuV/m)	Margin (dB)	Antenna Factor (dB/m)	Cable Loss (dB)	Preamp Factor (dB)	Antenna Height (cm)	Table Angle (Degree)	Remark
5136.5	42.5	34.25	54	-11.5	34.11	8.13	33.99	124	241	Average
5136.5	53.21	44.96	74	-20.79	34.11	8.13	33.99	124	241	Peak
5310	94.56	86.01			34.25	8.32	34.02	100	241	Average
5310	101.54	92.99			34.25	8.32	34.02	100	241	Peak
5350	52.45	43.82	54	-1.55	34.28	8.38	34.03	124	241	Average
5350	61.99	53.36	74	-12.01	34.28	8.38	34.03	124	241	Peak
10620	45.18	30.47	54	-8.82	37.3	12.69	35.28	196	235	Average
10620	55.97	41.26	74	-18.03	37.3	12.69	35.28	196	235	Peak

Antenna Polarity & Test Distance: Vertical at 3 m										
Frequency (MHz)	Emission Level (dBuV/m)	Read Level (dBuV)	Limit (dBuV/m)	Margin (dB)	Antenna Factor (dB/m)	Cable Loss (dB)	Preamp Factor (dB)	Antenna Height (cm)	Table Angle (Degree)	Remark
5089.55	42.28	34.11	54	-11.72	34.08	8.07	33.98	130	279	Average
5089.55	53.54	45.37	74	-20.46	34.08	8.07	33.98	130	279	Peak
5310	90.18	81.63			34.25	8.32	34.02	130	279	Average
5310	97.45	88.9			34.25	8.32	34.02	130	279	Peak
5350	48.07	39.44	54	-5.93	34.28	8.38	34.03	126	279	Average
5350	57.62	48.99	74	-16.38	34.28	8.38	34.03	126	279	Peak
10620	45.06	30.35	54	-8.94	37.3	12.69	35.28	142	88	Average
10620	54.95	40.24	74	-19.05	37.3	12.69	35.28	142	88	Peak

Remarks:

- Emission Level = Read Level + Antenna Factor + Cable Loss - Preamp Factor
Margin value = Emission level – Limit value
- 5310 MHz: Fundamental Frequency
- The emission levels of other frequencies were very low against the limit

EUT Test Condition		Measurement Detail	
Channel	Channel 102	Frequency Range	1 GHz ~ 40 GHz
Input Power	120 Vac, 60 Hz	Detector Function	Peak (PK) Average (AV)
Environmental Conditions	25 deg. C, 65 % RH	Tested By	Karl Lee

Antenna Polarity & Test Distance: Horizontal at 3 m										
Frequency (MHz)	Emission Level (dBuV/m)	Read Level (dBuV)	Limit (dBuV/m)	Margin (dB)	Antenna Factor (dB/m)	Cable Loss (dB)	Preamp Factor (dB)	Antenna Height (cm)	Table Angle (Degree)	Remark
5460	47.64	38.82	54	-6.36	34.36	8.51	34.05	105	243	Average
5460	58.15	49.33	74	-15.85	34.36	8.51	34.05	105	243	Peak
*5470	65.53	56.7	68.2	-2.67	34.37	8.51	34.05	105	243	Peak
5510	96.23	87.32			34.4	8.57	34.06	107	243	Average
5510	103.54	94.63			34.4	8.57	34.06	107	243	Peak
*5725.24	52.37	43.21	68.2	-15.83	34.62	8.65	34.11	105	243	Peak
11020	46.23	31.16	54	-7.77	37.61	12.94	35.48	146	208	Average
11020	56.1	41.03	74	-17.9	37.61	12.94	35.48	146	208	Peak

Antenna Polarity & Test Distance: Vertical at 3 m										
Frequency (MHz)	Emission Level (dBuV/m)	Read Level (dBuV)	Limit (dBuV/m)	Margin (dB)	Antenna Factor (dB/m)	Cable Loss (dB)	Preamp Factor (dB)	Antenna Height (cm)	Table Angle (Degree)	Remark
5460	44.51	35.69	54	-9.49	34.36	8.51	34.05	112	280	Average
5460	54.64	45.82	74	-19.36	34.36	8.51	34.05	112	280	Peak
*5470.48	60.29	51.46	68.2	-7.91	34.37	8.51	34.05	112	280	Peak
5510	92.21	83.3			34.4	8.57	34.06	120	280	Average
5510	99.61	90.7			34.4	8.57	34.06	120	280	Peak
*5724.44	52.75	43.59	68.2	-15.45	34.62	8.65	34.11	120	280	Peak
11020	46.32	31.25	54	-7.68	37.61	12.94	35.48	142	166	Average
11020	56.27	41.2	74	-17.73	37.61	12.94	35.48	142	166	Peak

Remarks:

- Emission Level = Read Level + Antenna Factor + Cable Loss - Preamp Factor
Margin value = Emission level – Limit value
- 5510 MHz: Fundamental Frequency
- *: Out of Restricted Band
- The emission levels of other frequencies were very low against the limit

EUT Test Condition		Measurement Detail	
Channel	Channel 110	Frequency Range	1 GHz ~ 40 GHz
Input Power	120 Vac, 60 Hz	Detector Function	Peak (PK) Average (AV)
Environmental Conditions	25 deg. C, 65 % RH	Tested By	Karl Lee

Antenna Polarity & Test Distance: Horizontal at 3 m										
Frequency (MHz)	Emission Level (dBuV/m)	Read Level (dBuV)	Limit (dBuV/m)	Margin (dB)	Antenna Factor (dB/m)	Cable Loss (dB)	Preamp Factor (dB)	Antenna Height (cm)	Table Angle (Degree)	Remark
5456.08	43.83	35.01	54	-10.17	34.36	8.51	34.05	106	243	Average
5456.08	54.29	45.47	74	-19.71	34.36	8.51	34.05	106	243	Peak
*5470.8	53.45	44.59	68.2	-14.75	34.37	8.54	34.05	106	243	Peak
5550	97.98	89.01			34.45	8.59	34.07	106	243	Average
5550	105.73	96.76			34.45	8.59	34.07	106	243	Peak
*5723.96	52.84	43.68	68.2	-15.36	34.62	8.65	34.11	106	243	Peak
11100	46.71	31.62	54	-7.29	37.66	12.89	35.46	185	246	Average
11100	56.64	41.55	74	-17.36	37.66	12.89	35.46	185	246	Peak

Antenna Polarity & Test Distance: Vertical at 3 m										
Frequency (MHz)	Emission Level (dBuV/m)	Read Level (dBuV)	Limit (dBuV/m)	Margin (dB)	Antenna Factor (dB/m)	Cable Loss (dB)	Preamp Factor (dB)	Antenna Height (cm)	Table Angle (Degree)	Remark
5459.12	42.9	34.08	54	-11.1	34.36	8.51	34.05	120	279	Average
5459.12	53.6	44.78	74	-20.4	34.36	8.51	34.05	120	279	Peak
*5470.8	53.21	44.35	68.2	-14.99	34.37	8.54	34.05	120	279	Peak
5550	94.42	85.45			34.45	8.59	34.07	120	279	Average
5550	101.75	92.78			34.45	8.59	34.07	120	279	Peak
*5723.96	52.39	43.23	68.2	-15.81	34.62	8.65	34.11	120	279	Peak
11100	46.39	31.3	54	-7.61	37.66	12.89	35.46	137	126	Average
11100	56.6	41.51	74	-17.4	37.66	12.89	35.46	137	126	Peak

Remarks:

- Emission Level = Read Level + Antenna Factor + Cable Loss - Preamp Factor
Margin value = Emission level – Limit value
- 5550 MHz: Fundamental Frequency
- *: Out of Restricted Band
- The emission levels of other frequencies were very low against the limit

EUT Test Condition		Measurement Detail	
Channel	Channel 134	Frequency Range	1 GHz ~ 40 GHz
Input Power	120 Vac, 60 Hz	Detector Function	Peak (PK) Average (AV)
Environmental Conditions	25 deg. C, 65 % RH	Tested By	Karl Lee

Antenna Polarity & Test Distance: Horizontal at 3 m										
Frequency (MHz)	Emission Level (dBuV/m)	Read Level (dBuV)	Limit (dBuV/m)	Margin (dB)	Antenna Factor (dB/m)	Cable Loss (dB)	Preamp Factor (dB)	Antenna Height (cm)	Table Angle (Degree)	Remark
5447.28	43.53	34.7	54	-10.47	34.36	8.51	34.04	190	115	Average
5447.28	54.14	45.31	74	-19.86	34.36	8.51	34.04	190	115	Peak
*5469.2	51.83	43	68.2	-16.37	34.37	8.51	34.05	190	115	Peak
5670	96.47	87.37			34.57	8.63	34.1	190	115	Average
5670	103.98	94.88			34.57	8.63	34.1	190	115	Peak
*5725.32	55.62	46.46	68.2	-12.58	34.62	8.65	34.11	190	115	Peak
11340	45.83	30.74	54	-8.17	37.8	12.71	35.42	187	145	Average
11340	55.73	40.64	74	-18.27	37.8	12.71	35.42	187	145	Peak

Antenna Polarity & Test Distance: Vertical at 3 m										
Frequency (MHz)	Emission Level (dBuV/m)	Read Level (dBuV)	Limit (dBuV/m)	Margin (dB)	Antenna Factor (dB/m)	Cable Loss (dB)	Preamp Factor (dB)	Antenna Height (cm)	Table Angle (Degree)	Remark
5446.32	43.34	34.51	54	-10.66	34.36	8.51	34.04	120	119	Average
5446.32	53.49	44.66	74	-20.51	34.36	8.51	34.04	120	119	Peak
*5469.2	52.45	43.62	68.2	-15.75	34.37	8.51	34.05	120	119	Peak
5670	92.25	83.15			34.57	8.63	34.1	120	119	Average
5670	99.1	90			34.57	8.63	34.1	120	119	Peak
*5724.2	54.38	45.22	68.2	-13.82	34.62	8.65	34.11	120	119	Peak
11340	46.31	31.22	54	-7.69	37.8	12.71	35.42	156	229	Average
11340	56.24	41.15	74	-17.76	37.8	12.71	35.42	156	229	Peak

Remarks:

- Emission Level = Read Level + Antenna Factor + Cable Loss - Preamp Factor
Margin value = Emission level – Limit value
- 5670 MHz: Fundamental Frequency
- *: Out of Restricted Band
- The emission levels of other frequencies were very low against the limit

EUT Test Condition		Measurement Detail	
Channel	Channel 142	Frequency Range	1 GHz ~ 40 GHz
Input Power	120 Vac, 60 Hz	Detector Function	Peak (PK) Average (AV)
Environmental Conditions	25 deg. C, 65 % RH	Tested By	Karl Lee

Antenna Polarity & Test Distance: Horizontal at 3 m										
Frequency (MHz)	Emission Level (dBuV/m)	Read Level (dBuV)	Limit (dBuV/m)	Margin (dB)	Antenna Factor (dB/m)	Cable Loss (dB)	Preamp Factor (dB)	Antenna Height (cm)	Table Angle (Degree)	Remark
5457.68	43.1	34.28	54	-10.9	34.36	8.51	34.05	190	115	Average
5457.68	53.46	44.64	74	-20.54	34.36	8.51	34.05	190	115	Peak
*5468.72	51.46	42.63	68.2	-16.74	34.37	8.51	34.05	190	115	Peak
5710	96.35	87.2			34.61	8.65	34.11	190	115	Average
5710	103.53	94.38			34.61	8.65	34.11	190	115	Peak
11420	47.78	32.68	54	-6.22	37.85	12.65	35.4	135	326	Average
11420	55.87	40.77	74	-18.13	37.85	12.65	35.4	135	326	Peak
Antenna Polarity & Test Distance: Vertical at 3 m										
Frequency (MHz)	Emission Level (dBuV/m)	Read Level (dBuV)	Limit (dBuV/m)	Margin (dB)	Antenna Factor (dB/m)	Cable Loss (dB)	Preamp Factor (dB)	Antenna Height (cm)	Table Angle (Degree)	Remark
5444.4	43.21	34.42	54	-10.79	34.35	8.48	34.04	120	119	Average
5444.4	53.51	44.72	74	-20.49	34.35	8.48	34.04	120	119	Peak
*5469.2	52.85	44.02	68.2	-15.35	34.37	8.51	34.05	120	119	Peak
5710	92.58	83.43			34.61	8.65	34.11	120	119	Average
5710	99.74	90.59			34.61	8.65	34.11	120	119	Peak
11420	47.62	32.52	54	-6.38	37.85	12.65	35.4	147	248	Average
11420	55.89	40.79	74	-18.11	37.85	12.65	35.4	147	248	Peak

Remarks:

- Emission Level = Read Level + Antenna Factor + Cable Loss - Preamp Factor
Margin value = Emission level – Limit value
- 5710 MHz: Fundamental Frequency
- *: Out of Restricted Band
- The emission levels of other frequencies were very low against the limit

EUT Test Condition		Measurement Detail	
Channel	Channel 151	Frequency Range	1 GHz ~ 40 GHz
Input Power	120 Vac, 60 Hz	Detector Function	Peak (PK) Average (AV)
Environmental Conditions	25 deg. C, 65 % RH	Tested By	Karl Lee

<Spurious Emission>

Antenna Polarity & Test Distance: Horizontal at 3 m										
Frequency (MHz)	Emission Level (dBuV/m)	Read Level (dBuV)	Limit (dBuV/m)	Margin (dB)	Antenna Factor (dB/m)	Cable Loss (dB)	Preamp Factor (dB)	Antenna Height (cm)	Table Angle (Degree)	Remark
5755	95.68	86.47			34.66	8.66	34.11	125	200	Average
5755	102.65	93.44			34.66	8.66	34.11	125	200	Peak
11510	45.19	30.08	54	-8.81	37.9	12.6	35.39	147	180	Average
11510	55.23	40.12	74	-18.77	37.9	12.6	35.39	147	180	Peak
Antenna Polarity & Test Distance: Vertical at 3 m										
Frequency (MHz)	Emission Level (dBuV/m)	Read Level (dBuV)	Limit (dBuV/m)	Margin (dB)	Antenna Factor (dB/m)	Cable Loss (dB)	Preamp Factor (dB)	Antenna Height (cm)	Table Angle (Degree)	Remark
5755	94.58	85.37			34.66	8.66	34.11	200	145	Average
5755	101.15	91.94			34.66	8.66	34.11	200	145	Peak
11510	46.31	31.2	54	-7.69	37.9	12.6	35.39	184	131	Average
11510	56.05	40.94	74	-17.95	37.9	12.6	35.39	184	131	Peak

<Out of Band Emission (OOBE)>

Antenna Polarity & Test Distance: Horizontal at 3 m										
Frequency (MHz)	Emission Level (dBuV/m)	Read Level (dBuV)	Limit (dBuV/m)	Margin (dB)	Antenna Factor (dB/m)	Cable Loss (dB)	Preamp Factor (dB)	Antenna Height (cm)	Table Angle (Degree)	Remark
*5635.975	53.8	44.73	68.2	-14.4	34.54	8.62	34.09	125	200	Peak
5654.35	52.78	43.69	71.42	-18.64	34.56	8.63	34.1	125	200	Peak
5917.375	52.36	42.98	73.84	-21.48	34.81	8.73	34.16	125	200	Peak
*5934.7	54.09	44.69	68.2	-14.11	34.83	8.73	34.16	125	200	Peak
Antenna Polarity & Test Distance: Vertical at 3 m										
Frequency (MHz)	Emission Level (dBuV/m)	Read Level (dBuV)	Limit (dBuV/m)	Margin (dB)	Antenna Factor (dB/m)	Cable Loss (dB)	Preamp Factor (dB)	Antenna Height (cm)	Table Angle (Degree)	Remark
*5635.45	54.2	45.13	68.2	-14	34.54	8.62	34.09	200	145	Peak
5655.925	51.72	42.63	72.58	-20.86	34.56	8.63	34.1	200	145	Peak
5920.525	52.02	42.64	71.51	-19.49	34.81	8.73	34.16	200	145	Peak
*5981.95	53.71	44.25	68.2	-14.49	34.88	8.75	34.17	200	145	Peak

Remarks:

- Emission Level = Read Level + Antenna Factor + Cable Loss - Preamp Factor
Margin value = Emission level – Limit value
- 5755 MHz: Fundamental Frequency
- *: Out of Restricted Band
- The emission levels of other frequencies were very low against the limit

EUT Test Condition		Measurement Detail	
Channel	Channel 159	Frequency Range	1 GHz ~ 40 GHz
Input Power	120 Vac, 60 Hz	Detector Function	Peak (PK) Average (AV)
Environmental Conditions	25 deg. C, 65 % RH	Tested By	Karl Lee

<Spurious Emission>

Antenna Polarity & Test Distance: Horizontal at 3 m										
Frequency (MHz)	Emission Level (dBuV/m)	Read Level (dBuV)	Limit (dBuV/m)	Margin (dB)	Antenna Factor (dB/m)	Cable Loss (dB)	Preamp Factor (dB)	Antenna Height (cm)	Table Angle (Degree)	Remark
5795	97.79	88.55			34.69	8.68	34.13	125	200	Average
5795	104.69	95.45			34.69	8.68	34.13	125	200	Peak
11590	45.58	30.21	54	-8.42	38.02	12.72	35.37	169	322	Average
11590	55.71	40.34	74	-18.29	38.02	12.72	35.37	169	322	Peak
Antenna Polarity & Test Distance: Vertical at 3 m										
Frequency (MHz)	Emission Level (dBuV/m)	Read Level (dBuV)	Limit (dBuV/m)	Margin (dB)	Antenna Factor (dB/m)	Cable Loss (dB)	Preamp Factor (dB)	Antenna Height (cm)	Table Angle (Degree)	Remark
5795	96.6	87.36			34.69	8.68	34.13	200	145	Average
5795	103.74	94.5			34.69	8.68	34.13	200	145	Peak
11590	45.07	29.7	54	-8.93	38.02	12.72	35.37	134	157	Average
11590	54.89	39.52	74	-19.11	38.02	12.72	35.37	134	157	Peak

<Out of Band Emission (OOBE)>

Antenna Polarity & Test Distance: Horizontal at 3 m										
Frequency (MHz)	Emission Level (dBuV/m)	Read Level (dBuV)	Limit (dBuV/m)	Margin (dB)	Antenna Factor (dB/m)	Cable Loss (dB)	Preamp Factor (dB)	Antenna Height (cm)	Table Angle (Degree)	Remark
*5618.125	53.12	44.07	68.2	-15.08	34.52	8.61	34.08	125	200	Peak
5657.5	52.07	42.98	73.75	-21.68	34.56	8.63	34.1	125	200	Peak
5920.525	52	42.62	71.51	-19.51	34.81	8.73	34.16	125	200	Peak
*6019.225	54.11	44.6	68.2	-14.09	34.92	8.77	34.18	125	200	Peak
Antenna Polarity & Test Distance: Vertical at 3 m										
Frequency (MHz)	Emission Level (dBuV/m)	Read Level (dBuV)	Limit (dBuV/m)	Margin (dB)	Antenna Factor (dB/m)	Cable Loss (dB)	Preamp Factor (dB)	Antenna Height (cm)	Table Angle (Degree)	Remark
*5576.65	52.97	43.97	68.2	-15.23	34.47	8.6	34.07	200	145	Peak
5652.775	52.24	43.14	70.25	-18.01	34.56	8.63	34.09	200	145	Peak
5921.05	51.44	42.06	71.12	-19.68	34.81	8.73	34.16	200	145	Peak
*6018.7	53.45	43.94	68.2	-14.75	34.92	8.77	34.18	200	145	Peak

Remarks:

- Emission Level = Read Level + Antenna Factor + Cable Loss - Preamp Factor
Margin value = Emission level – Limit value
- 5795 MHz: Fundamental Frequency
- *: Out of Restricted Band
- The emission levels of other frequencies were very low against the limit

802.11ac (VHT80)

EUT Test Condition		Measurement Detail	
Channel	Channel 42	Frequency Range	1 GHz ~ 40 GHz
Input Power	120 Vac, 60 Hz	Detector Function	Peak (PK) Average (AV)
Environmental Conditions	25 deg. C, 65 % RH	Tested By	Karl Lee

Antenna Polarity & Test Distance: Horizontal at 3 m

Frequency (MHz)	Emission Level (dBuV/m)	Read Level (dBuV)	Limit (dBuV/m)	Margin (dB)	Antenna Factor (dB/m)	Cable Loss (dB)	Preamp Factor (dB)	Antenna Height (cm)	Table Angle (Degree)	Remark
5149.55	52.21	43.96	54	-1.79	34.12	8.13	34	119	245	Average
5149.55	60.08	51.83	74	-13.92	34.12	8.13	34	119	245	Peak
5210	93.05	84.69			34.17	8.19	34	114	245	Average
5210	99.92	91.56			34.17	8.19	34	114	245	Peak
5350.55	43.63	35	54	-10.37	34.28	8.38	34.03	119	245	Average
5350.55	53.98	45.35	74	-20.02	34.28	8.38	34.03	119	245	Peak
*10420	55.37	40.96	68.2	-12.83	37.15	12.42	35.16	136	115	Peak

Antenna Polarity & Test Distance: Vertical at 3 m

Frequency (MHz)	Emission Level (dBuV/m)	Read Level (dBuV)	Limit (dBuV/m)	Margin (dB)	Antenna Factor (dB/m)	Cable Loss (dB)	Preamp Factor (dB)	Antenna Height (cm)	Table Angle (Degree)	Remark
5149.7	47	38.75	54	-7	34.12	8.13	34	130	280	Average
5149.7	55.97	47.72	74	-18.03	34.12	8.13	34	130	280	Peak
5210	88.06	79.7			34.17	8.19	34	130	280	Average
5210	95.52	87.16			34.17	8.19	34	130	280	Peak
5453.84	43.44	34.62	54	-10.56	34.36	8.51	34.05	130	280	Average
5453.84	53.4	44.58	74	-20.6	34.36	8.51	34.05	130	280	Peak
*10420	55.41	41	68.2	-12.79	37.15	12.42	35.16	124	177	Peak

Remarks:

- Emission Level = Read Level + Antenna Factor + Cable Loss - Preamp Factor
Margin value = Emission level – Limit value
- 5210 MHz: Fundamental Frequency
- *: Out of Restricted Band
- The emission levels of other frequencies were very low against the limit

EUT Test Condition		Measurement Detail	
Channel	Channel 58	Frequency Range	1 GHz ~ 40 GHz
Input Power	120 Vac, 60 Hz	Detector Function	Peak (PK) Average (AV)
Environmental Conditions	25 deg. C, 65 % RH	Tested By	Karl Lee

Antenna Polarity & Test Distance: Horizontal at 3 m										
Frequency (MHz)	Emission Level (dBuV/m)	Read Level (dBuV)	Limit (dBuV/m)	Margin (dB)	Antenna Factor (dB/m)	Cable Loss (dB)	Preamp Factor (dB)	Antenna Height (cm)	Table Angle (Degree)	Remark
5135.3	42.5	34.25	54	-11.5	34.11	8.13	33.99	124	243	Average
5135.3	52.74	44.49	74	-21.26	34.11	8.13	33.99	124	243	Peak
5290	91.41	82.88			34.23	8.32	34.02	121	241	Average
5290	99.22	90.69			34.23	8.32	34.02	121	241	Peak
5351.21	52.36	43.73	54	-1.64	34.28	8.38	34.03	124	243	Average
5351.21	61.26	52.63	74	-12.74	34.28	8.38	34.03	124	243	Peak
*10580	55.12	40.47	68.2	-13.08	37.27	12.65	35.27	105	87	Peak

Antenna Polarity & Test Distance: Vertical at 3 m										
Frequency (MHz)	Emission Level (dBuV/m)	Read Level (dBuV)	Limit (dBuV/m)	Margin (dB)	Antenna Factor (dB/m)	Cable Loss (dB)	Preamp Factor (dB)	Antenna Height (cm)	Table Angle (Degree)	Remark
5135.15	42.38	34.13	54	-11.62	34.11	8.13	33.99	130	279	Average
5135.15	53.06	44.81	74	-20.94	34.11	8.13	33.99	130	279	Peak
5290	87.31	78.78			34.23	8.32	34.02	130	279	Average
5290	95.46	86.93			34.23	8.32	34.02	130	279	Peak
5353.96	48.35	39.72	54	-5.65	34.28	8.38	34.03	138	271	Average
5353.96	58.26	49.63	74	-15.74	34.28	8.38	34.03	138	271	Peak
*10580	55.88	41.23	68.2	-12.32	37.27	12.65	35.27	122	186	Peak

Remarks:

- Emission Level = Read Level + Antenna Factor + Cable Loss - Preamp Factor
Margin value = Emission level – Limit value
- 5290 MHz: Fundamental Frequency
- *: Out of Restricted Band
- The emission levels of other frequencies were very low against the limit

EUT Test Condition		Measurement Detail	
Channel	Channel 106	Frequency Range	1 GHz ~ 40 GHz
Input Power	120 Vac, 60 Hz	Detector Function	Peak (PK) Average (AV)
Environmental Conditions	25 deg. C, 65 % RH	Tested By	Karl Lee

Antenna Polarity & Test Distance: Horizontal at 3 m										
Frequency (MHz)	Emission Level (dBuV/m)	Read Level (dBuV)	Limit (dBuV/m)	Margin (dB)	Antenna Factor (dB/m)	Cable Loss (dB)	Preamp Factor (dB)	Antenna Height (cm)	Table Angle (Degree)	Remark
5458.8	52.33	43.51	54	-1.67	34.36	8.51	34.05	104	243	Average
5458.8	62.45	53.63	74	-11.55	34.36	8.51	34.05	104	243	Peak
*5469.68	63.78	54.95	68.2	-4.42	34.37	8.51	34.05	104	243	Peak
5530	92.61	83.68			34.42	8.58	34.07	106	243	Average
5530	100.66	91.73			34.42	8.58	34.07	106	243	Peak
*5726.04	52.13	42.97	68.2	-16.07	34.62	8.65	34.11	104	243	Peak
11060	45.54	30.46	54	-8.46	37.64	12.91	35.47	126	271	Average
11060	55.62	40.54	74	-18.38	37.64	12.91	35.47	126	271	Peak

Antenna Polarity & Test Distance: Vertical at 3 m										
Frequency (MHz)	Emission Level (dBuV/m)	Read Level (dBuV)	Limit (dBuV/m)	Margin (dB)	Antenna Factor (dB/m)	Cable Loss (dB)	Preamp Factor (dB)	Antenna Height (cm)	Table Angle (Degree)	Remark
5458.32	48.63	39.81	54	-5.37	34.36	8.51	34.05	122	263	Average
5458.32	57.12	48.3	74	-16.88	34.36	8.51	34.05	122	263	Peak
*5470	59.93	51.1	68.2	-8.27	34.37	8.51	34.05	122	263	Peak
5530	88.06	79.13			34.42	8.58	34.07	120	280	Average
5530	96.67	87.74			34.42	8.58	34.07	120	280	Peak
*5724.36	52.64	43.48	68.2	-15.56	34.62	8.65	34.11	120	280	Peak
11060	45.42	30.34	54	-8.58	37.64	12.91	35.47	135	224	Average
11060	55.3	40.22	74	-18.7	37.64	12.91	35.47	135	224	Peak

Remarks:

- Emission Level = Read Level + Antenna Factor + Cable Loss - Preamp Factor
Margin value = Emission level – Limit value
- 5530 MHz: Fundamental Frequency
- *: Out of Restricted Band
- The emission levels of other frequencies were very low against the limit

EUT Test Condition		Measurement Detail	
Channel	Channel 122	Frequency Range	1 GHz ~ 40 GHz
Input Power	120 Vac, 60 Hz	Detector Function	Peak (PK) Average (AV)
Environmental Conditions	25 deg. C, 65 % RH	Tested By	Karl Lee

Antenna Polarity & Test Distance: Horizontal at 3 m										
Frequency (MHz)	Emission Level (dBuV/m)	Read Level (dBuV)	Limit (dBuV/m)	Margin (dB)	Antenna Factor (dB/m)	Cable Loss (dB)	Preamp Factor (dB)	Antenna Height (cm)	Table Angle (Degree)	Remark
5458.64	43.84	35.02	54	-10.16	34.36	8.51	34.05	102	244	Average
5458.64	53.94	45.12	74	-20.06	34.36	8.51	34.05	102	244	Peak
*5468.08	52.6	43.77	68.2	-15.6	34.37	8.51	34.05	102	244	Peak
5610	93.33	84.3			34.5	8.61	34.08	102	244	Average
5610	101.31	92.28			34.5	8.61	34.08	102	244	Peak
*5725.16	54.17	45.01	68.2	-14.03	34.62	8.65	34.11	102	244	Peak
11220	46.85	31.76	54	-7.15	37.73	12.8	35.44	132	189	Average
11220	56.83	41.74	74	-17.17	37.73	12.8	35.44	132	189	Peak

Antenna Polarity & Test Distance: Vertical at 3 m										
Frequency (MHz)	Emission Level (dBuV/m)	Read Level (dBuV)	Limit (dBuV/m)	Margin (dB)	Antenna Factor (dB/m)	Cable Loss (dB)	Preamp Factor (dB)	Antenna Height (cm)	Table Angle (Degree)	Remark
5457.84	43.56	34.74	54	-10.44	34.36	8.51	34.05	120	280	Average
5457.84	53.29	44.47	74	-20.71	34.36	8.51	34.05	120	280	Peak
*5469.2	52.08	43.25	68.2	-16.12	34.37	8.51	34.05	120	280	Peak
5610	89.04	80.01			34.5	8.61	34.08	120	280	Average
5610	97.09	88.06			34.5	8.61	34.08	120	280	Peak
*5724.84	52.39	43.23	68.2	-15.81	34.62	8.65	34.11	120	280	Peak
11220	46.59	31.5	54	-7.41	37.73	12.8	35.44	143	121	Average
11220	56.71	41.62	74	-17.29	37.73	12.8	35.44	143	121	Peak

Remarks:

- Emission Level = Read Level + Antenna Factor + Cable Loss - Preamp Factor
Margin value = Emission level – Limit value
- 5610 MHz: Fundamental Frequency
- *: Out of Restricted Band
- The emission levels of other frequencies were very low against the limit

EUT Test Condition		Measurement Detail	
Channel	Channel 138	Frequency Range	1 GHz ~ 40 GHz
Input Power	120 Vac, 60 Hz	Detector Function	Peak (PK) Average (AV)
Environmental Conditions	25 deg. C, 65 % RH	Tested By	Karl Lee

Antenna Polarity & Test Distance: Horizontal at 3 m										
Frequency (MHz)	Emission Level (dBuV/m)	Read Level (dBuV)	Limit (dBuV/m)	Margin (dB)	Antenna Factor (dB/m)	Cable Loss (dB)	Preamp Factor (dB)	Antenna Height (cm)	Table Angle (Degree)	Remark
5453.2	43.52	34.7	54	-10.48	34.36	8.51	34.05	190	115	Average
5453.2	54.26	45.44	74	-19.74	34.36	8.51	34.05	190	115	Peak
*5468.24	53.12	44.29	68.2	-15.08	34.37	8.51	34.05	190	115	Peak
5690	93.47	84.34			34.59	8.64	34.1	190	115	Average
5690	100	90.87			34.59	8.64	34.1	190	115	Peak
11380	47.96	32.85	54	-6.04	37.83	12.69	35.41	135	126	Average
11380	57.26	42.15	74	-16.74	37.83	12.69	35.41	135	126	Peak

Antenna Polarity & Test Distance: Vertical at 3 m										
Frequency (MHz)	Emission Level (dBuV/m)	Read Level (dBuV)	Limit (dBuV/m)	Margin (dB)	Antenna Factor (dB/m)	Cable Loss (dB)	Preamp Factor (dB)	Antenna Height (cm)	Table Angle (Degree)	Remark
5454.48	43.49	34.67	54	-10.51	34.36	8.51	34.05	120	119	Average
5454.48	53.43	44.61	74	-20.57	34.36	8.51	34.05	120	119	Peak
*5470	52.86	44.03	68.2	-15.34	34.37	8.51	34.05	120	119	Peak
5690	89.74	80.61			34.59	8.64	34.1	120	119	Average
5690	96.22	87.09			34.59	8.64	34.1	120	119	Peak
11380	47.58	32.47	54	-6.42	37.83	12.69	35.41	164	9	Average
11380	56.36	41.25	74	-17.64	37.83	12.69	35.41	164	9	Peak

Remarks:

- Emission Level = Read Level + Antenna Factor + Cable Loss - Preamp Factor
Margin value = Emission level – Limit value
- 5690 MHz: Fundamental Frequency
- *: Out of Restricted Band
- The emission levels of other frequencies were very low against the limit

EUT Test Condition		Measurement Detail	
Channel	Channel 155	Frequency Range	1 GHz ~ 40 GHz
Input Power	120 Vac, 60 Hz	Detector Function	Peak (PK) Average (AV)
Environmental Conditions	25 deg. C, 65 % RH	Tested By	Karl Lee

<Spurious Emission>

Antenna Polarity & Test Distance: Horizontal at 3 m										
Frequency (MHz)	Emission Level (dBuV/m)	Read Level (dBuV)	Limit (dBuV/m)	Margin (dB)	Antenna Factor (dB/m)	Cable Loss (dB)	Preamp Factor (dB)	Antenna Height (cm)	Table Angle (Degree)	Remark
5775	92.79	83.56			34.68	8.67	34.12	125	200	Average
5775	99.45	90.22			34.68	8.67	34.12	125	200	Peak
11550	45.27	30	54	-8.73	37.97	12.68	35.38	131	196	Average
11550	55.28	40.01	74	-18.72	37.97	12.68	35.38	131	196	Peak
Antenna Polarity & Test Distance: Vertical at 3 m										
Frequency (MHz)	Emission Level (dBuV/m)	Read Level (dBuV)	Limit (dBuV/m)	Margin (dB)	Antenna Factor (dB/m)	Cable Loss (dB)	Preamp Factor (dB)	Antenna Height (cm)	Table Angle (Degree)	Remark
5775	91.47	82.24			34.68	8.67	34.12	200	145	Average
5775	98.15	88.92			34.68	8.67	34.12	200	145	Peak
11550	45.39	30.12	54	-8.61	37.97	12.68	35.38	134	270	Average
11550	55.21	39.94	74	-18.79	37.97	12.68	35.38	134	270	Peak

<Out of Band Emission (OOBE)>

Antenna Polarity & Test Distance: Horizontal at 3 m										
Frequency (MHz)	Emission Level (dBuV/m)	Read Level (dBuV)	Limit (dBuV/m)	Margin (dB)	Antenna Factor (dB/m)	Cable Loss (dB)	Preamp Factor (dB)	Antenna Height (cm)	Table Angle (Degree)	Remark
*5591.35	53.09	44.08	68.2	-15.11	34.49	8.6	34.08	125	200	Peak
5658.55	54.68	45.59	74.53	-19.85	34.56	8.63	34.1	125	200	Peak
5917.375	51.07	41.69	73.84	-22.77	34.81	8.73	34.16	125	200	Peak
*5926.825	53.44	44.04	68.2	-14.76	34.83	8.73	34.16	125	200	Peak
Antenna Polarity & Test Distance: Vertical at 3 m										
Frequency (MHz)	Emission Level (dBuV/m)	Read Level (dBuV)	Limit (dBuV/m)	Margin (dB)	Antenna Factor (dB/m)	Cable Loss (dB)	Preamp Factor (dB)	Antenna Height (cm)	Table Angle (Degree)	Remark
*5630.2	53.42	44.37	68.2	-14.78	34.52	8.62	34.09	200	145	Peak
5655.925	52.47	43.38	72.58	-20.11	34.56	8.63	34.1	200	145	Peak
5923.675	51.85	42.45	69.18	-17.33	34.83	8.73	34.16	200	145	Peak
*6022.375	53.08	43.57	68.2	-15.12	34.92	8.77	34.18	200	145	Peak

Remarks:

- Emission Level = Read Level + Antenna Factor + Cable Loss - Preamp Factor
Margin value = Emission level – Limit value
- 5775 MHz: Fundamental Frequency
- *: Out of Restricted Band
- The emission levels of other frequencies were very low against the limit

9 kHz ~ 30 MHz Data:

The amplitude of spurious emissions attenuated more than 20 dB below the permissible value is not required to be report.

30 MHz ~ 1 GHz Worst-Case Data:

<2TX>

802.11n (HT40)

EUT Test Condition		Measurement Detail	
Channel	Channel 62	Frequency Range	30 MHz ~ 1 GHz
Input Power	120 Vac, 60 Hz	Detector Function	Peak (PK) Quasi-peak (QP)
Environmental Conditions	25 deg. C, 65 % RH	Tested By	Karl Lee

Antenna Polarity & Test Distance: Horizontal at 3 m										
Frequency (MHz)	Emission Level (dBuV/m)	Read Level (dBuV)	Limit (dBuV/m)	Margin (dB)	Antenna Factor (dB/m)	Cable Loss (dB)	Preamp Factor (dB)	Antenna Height (cm)	Table Angle (Degree)	Remark
89.13	17.34	37.78	43.5	-26.16	10.21	1.11	31.76	131	40	Peak
157.44	21.04	43.15	43.5	-22.46	8.64	1.52	32.27	134	175	Peak
277.05	19.32	36.7	46	-26.68	12.71	2.03	32.12	127	156	Peak
374.2	22.21	37.57	46	-23.79	14.52	2.26	32.14	158	177	Peak
691.3	20.34	30.28	46	-25.66	19.11	3.05	32.1	142	204	Peak
937.7	27.68	33.6	46	-18.32	21.66	3.62	31.2	169	135	Peak

Antenna Polarity & Test Distance: Vertical at 3 m										
Frequency (MHz)	Emission Level (dBuV/m)	Read Level (dBuV)	Limit (dBuV/m)	Margin (dB)	Antenna Factor (dB/m)	Cable Loss (dB)	Preamp Factor (dB)	Antenna Height (cm)	Table Angle (Degree)	Remark
49.17	19.21	35.98	40	-20.79	14.55	0.9	32.22	112	164	Peak
87.24	15.36	36.41	40	-24.64	9.7	1.11	31.86	126	243	Peak
155.55	16.17	38.36	43.5	-27.33	8.56	1.52	32.27	178	245	Peak
374.2	17.63	32.99	46	-28.37	14.52	2.26	32.14	186	254	Peak
600.3	20.26	31.65	46	-25.74	17.93	2.87	32.19	196	132	Peak
937.7	30.51	36.43	46	-15.49	21.66	3.62	31.2	133	7	Peak

Remarks:

- Emission Level = Read Level + Antenna Factor + Cable Loss - Preamp Factor
Margin value = Emission level – Limit value
- The emission levels of other frequencies were very low against the limit

4.2 Conducted Emission Measurement

4.2.1 Limits of Conducted Emission Measurement

Frequency (MHz)	Conducted Limit (dBuV)	
	Quasi-Peak	Average
0.15 - 0.5	66 - 56	56 - 46
0.50 - 5.0	56	46
5.0 - 30.0	60	50

- Note: 1. The lower limit shall apply at the transition frequencies.
 2. The limit decreases in line with the logarithm of the frequency in the range of 0.15 to 0.50 MHz.

4.2.2 Test Instruments

Description & Manufacturer	Model No.	Serial No.	Date of Calibration	Due Date of Calibration
Test Receiver ROHDE & SCHWARZ	ESCI	100613	Nov. 23, 2017	Nov. 22, 2018
RF signal cable (with 10dB PAD) Woken	5D-FB	Cable-cond1-01	Sep. 05, 2017	Sep. 04, 2018
LISN/AMN ROHDE & SCHWARZ (EUT)	ESH3-Z5	835239/001	Mar. 06, 2018	Mar. 05, 2019
LISN/AMN ROHDE & SCHWARZ (Peripheral)	ESH3-Z5	100311	Aug. 15, 2017	Aug. 14, 2018
Software ADT	BV ADT_Cond_ V7.3.7.4	NA	NA	NA

- Note: 1. The calibration interval of the above test instruments is 12 months and the calibrations are traceable to NML/ROC and NIST/USA.
 2. The test was performed in HwaYa Shielded Room 1.
 3. The VCCI Site Registration No. is C-2040.

4.2.3 Test Procedures

- a. The EUT was placed 0.4 meters from the conducting wall of the shielded room with EUT being connected to the power mains through a line impedance stabilization network (LISN). Other support units were connected to the power mains through another LISN. The two LISNs provide 50 ohm/ 50uH of coupling impedance for the measuring instrument.
- b. Both lines of the power mains connected to the EUT were checked for maximum conducted interference.
- c. The frequency range from 150 kHz to 30 MHz was searched. Emission levels under (Limit -20 dB) was not recorded.

Note: All modes of operation were investigated and the worst-case emissions are reported.

4.2.4 Deviation from Test Standard

No deviation.

4.2.5 Test Setup

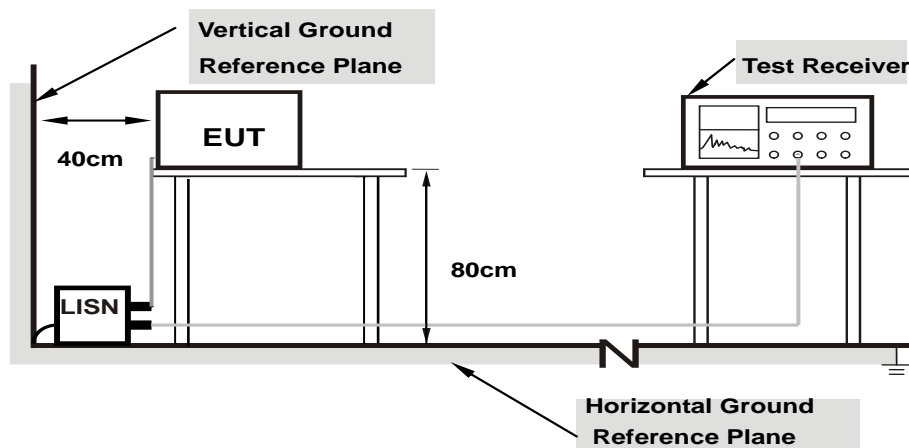

- Note:**
1. Support units were connected to second LISN.
 2. Both of LISNs (AMN) are 80 cm from EUT and at least 80 cm from other units and other metal planes

For the actual test configuration, please refer to the attached file (Test Setup Photo).

4.2.6 EUT Operating Conditions

- a. Placed the EUT on a testing table.
- b. Use the software to control the EUT under transmission condition continuously at specific channel frequency.

4.2.7 Test Results

Frequency Range	150kHz ~ 30MHz	Detector Function & Resolution Bandwidth	Quasi-Peak (QP) / Average (AV), 9kHz
Input Power	120Vac, 60Hz	Environmental Conditions	25°C, 65%RH
Tested by	Jisyong Wang	Test Date	2018/6/14

Phase Of Power : Line (L)										
No	Frequency (MHz)	Correction Factor (dB)	Reading Value (dBuV)		Emission Level (dBuV)		Limit (dBuV)		Margin (dB)	
			Q.P.	AV.	Q.P.	AV.	Q.P.	AV.	Q.P.	AV.
1	0.16834	10.10	38.63	23.20	48.73	33.30	65.04	55.04	-16.31	-21.74
2	0.25166	10.11	31.39	15.62	41.50	25.73	61.70	51.70	-20.20	-25.97
3	0.54375	10.12	31.56	15.09	41.68	25.21	56.00	46.00	-14.32	-20.79
4	5.01404	10.34	20.72	7.01	31.06	17.35	60.00	50.00	-28.94	-32.65
5	8.45484	10.53	24.75	10.52	35.28	21.05	60.00	50.00	-24.72	-28.95
6	11.55938	10.71	21.45	9.13	32.16	19.84	60.00	50.00	-27.84	-30.16

Remarks:

1. Q.P. and AV. are abbreviations of quasi-peak and average individually.
2. The emission levels of other frequencies were very low against the limit.
3. Margin value = Emission level – Limit value
4. Correction factor = Insertion loss + Cable loss
5. Emission Level = Correction Factor + Reading Value

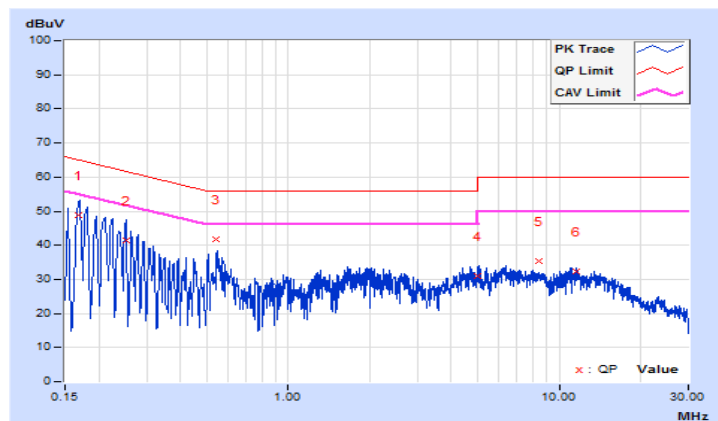

Frequency Range	150kHz ~ 30MHz	Detector Function & Resolution Bandwidth	Quasi-Peak (QP) / Average (AV), 9kHz
Input Power	120Vac, 60Hz	Environmental Conditions	25°C, 65%RH
Tested by	Jisyong Wang	Test Date	2018/6/14

Phase Of Power : Neutral (N)										
No	Frequency (MHz)	Correction Factor (dB)	Reading Value (dBuV)		Emission Level (dBuV)		Limit (dBuV)		Margin (dB)	
			Q.P.	AV.	Q.P.	AV.	Q.P.	AV.	Q.P.	AV.
1	0.16564	10.10	34.02	16.89	44.12	26.99	65.18	55.18	-21.06	-28.19
2	0.22038	10.11	30.64	14.40	40.75	24.51	62.80	52.80	-22.05	-28.29
3	0.27903	10.11	29.15	14.30	39.26	24.41	60.84	50.84	-21.58	-26.43
4	0.53318	10.12	20.73	6.20	30.85	16.32	56.00	46.00	-25.15	-29.68
5	1.73355	10.16	16.05	3.52	26.21	13.68	56.00	46.00	-29.79	-32.32
6	8.14595	10.44	17.09	3.06	27.53	13.50	60.00	50.00	-32.47	-36.50

Remarks:

1. Q.P. and AV. are abbreviations of quasi-peak and average individually.
2. The emission levels of other frequencies were very low against the limit.
3. Margin value = Emission level – Limit value
4. Correction factor = Insertion loss + Cable loss
5. Emission Level = Correction Factor + Reading Value

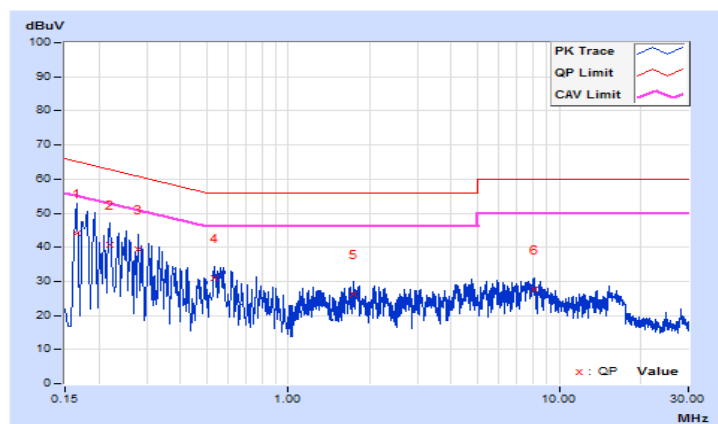

4.3 Transmit Power Measurement

4.3.1 Limits of Transmit Power Measurement

Operation Band	EUT Category		Limit
U-NII-1		Outdoor Access Point	1 Watt (30 dBm) (Max. e.i.r.p \leq 125 mW (21 dBm) at any elevation angle above 30 degrees as measured from the horizon)
		Fixed point-to-point Access Point	1 Watt (30 dBm)
		Indoor Access Point	1 Watt (30 dBm)
	√	Mobile and Portable client device	250 mW (24 dBm)
U-NII-2A		√	250 mW (24 dBm) or 11 dBm + 10 log B*
U-NII-2C		√	250 mW (24 dBm) or 11 dBm + 10 log B*
U-NII-3		√	1 Watt (30 dBm)

*B is the 26 dB emission bandwidth in megahertz

Per KDB 662911 Method of conducted output power measurement on IEEE 802.11 devices,

Array Gain = 0 dB (i.e., no array gain) for $N_{ANT} \leq 4$;

Array Gain = 0 dB (i.e., no array gain) for channel widths ≥ 40 MHz for any N_{ANT} ;

Array Gain = $5 \log(N_{ANT}/N_{SS})$ dB or 3 dB, whichever is less for 20 MHz channel widths with $N_{ANT} \geq 5$.

For power measurements on all other devices: Array Gain = $10 \log(N_{ANT}/N_{SS})$ dB.

4.3.2 Test Setup

<Power Output Measurement>

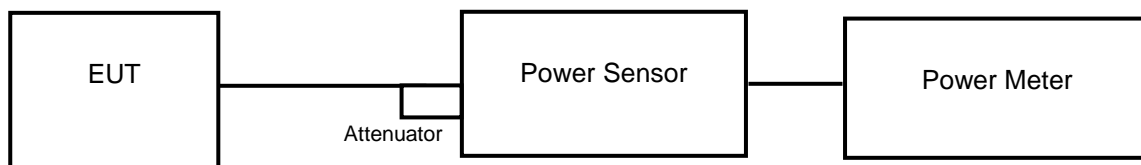

or

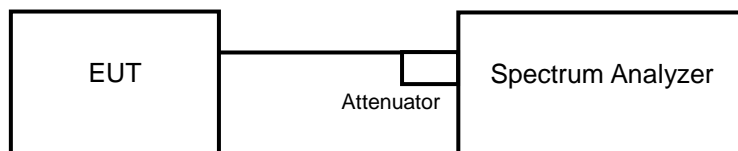

<26 dB Bandwidth>

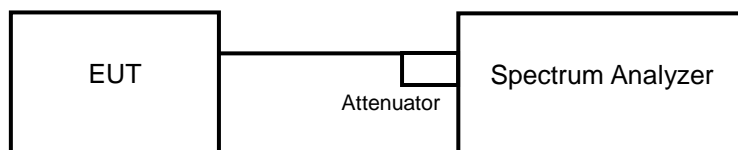

4.3.3 Test Instruments

Refer to section 4.1.2 to get information of above instrument.

4.3.4 Test Procedure

Average Power Measurement

<802.11a, 802.11n (HT20), 802.11n (HT40)>

Method PM is used to perform output power measurement, trigger and gating function of wide band power meter is enabled to measure max output power of TX on burst. Duty factor is not added to measured value.

<802.11ac (VHT80)>

- a. Set span to encompass the entire 26 dB EBW (or, alternatively, the entire 99 % occupied bandwidth) of the signal.
- b. Set sweep trigger to "free run".
- c. Set RBW = 1 MHz.
- d. Set VBW \geq 3 MHz
- e. Number of points in sweep \geq 2 Span / RBW.
- f. Sweep time \leq (number of points in sweep) * T
- g. Using emission bandwidth to determine the frequency span for integration the channel bandwidth.
- h. Detector = RMS.
- i. Trace mode = max hold.
- j. Allow max hold to run for at least 60 seconds, or longer as needed to allow the trace to stabilize.

26 dB Bandwidth

- a. Set RBW = approximately 1 % of the emission bandwidth.
- b. Set the VBW > RBW.
- c. Detector = Peak.
- d. Trace mode = max hold.
- e. Measure the maximum width of the emission that is 26 dB down from the peak of the emission. Compare this with the RBW setting of the analyzer. Readjust RBW and repeat measurement as needed until the RBW/EBW ratio is approximately 1 %.

4.3.5 Deviation from Test Standard

No deviation.

4.3.6 EUT Operating Conditions

The software provided by client to enable the EUT under transmission condition continuously at lowest, middle and highest channel frequencies individually.

4.3.7 Test Results

Power Output:

802.11a

Channel	Frequency (MHz)	Maximum Conducted Power (mW)	Maximum Conducted Power (dBm)	Power Limit (dBm)	Pass / Fail
36	5180	78.886	18.97	24	Pass
44	5220	79.068	18.98	24	Pass
48	5240	77.804	18.91	24	Pass
52	5260	78.524	18.95	24	Pass
60	5300	79.25	18.99	24	Pass
64	5320	78.886	18.97	24	Pass
100	5500	77.983	18.92	24	Pass
116	5580	79.068	18.98	24	Pass
140	5700	69.984	18.45	24	Pass
144	5720 (U-NII-2C)	48.753	16.88	23.32	Pass
144	5720 (U-NII-3)	22.387	13.50	30	Pass
149	5745	66.374	18.22	30	Pass
157	5785	68.077	18.33	30	Pass
165	5825	73.114	18.64	30	Pass

Note:

For U-NII-2A, U-NII-2C Band:

- $11 \text{ dBm} + 10\log(26.48) = 25.22 \text{ dBm} > 24 \text{ dBm}$.
- $11 \text{ dBm} + 10\log(27.07) = 25.32 \text{ dBm} > 24 \text{ dBm}$.
- $11 \text{ dBm} + 10\log(26.45) = 25.22 \text{ dBm} > 24 \text{ dBm}$.
- $11 \text{ dBm} + 10\log(25.80) = 25.11 \text{ dBm} > 24 \text{ dBm}$.
- $11 \text{ dBm} + 10\log(26.73) = 25.26 \text{ dBm} > 24 \text{ dBm}$.
- $11 \text{ dBm} + 10\log(25.01) = 24.98 \text{ dBm} > 24 \text{ dBm}$.
- $11 \text{ dBm} + 10\log(17.10) = 23.32 \text{ dBm} < 24 \text{ dBm}$.

802.11n (HT20)

Channel	Frequency (MHz)	Maximum Conducted Power (dBm)		Total Power (mW)	Total Power (dBm)	Power Limit (dBm)	Pass / Fail
		Chain 0	Chain 1				
36	5180	18.96	18.93	156.868	21.96	24	Pass
44	5220	18.98	18.95	157.592	21.98	24	Pass
48	5240	18.31	18.24	134.445	21.29	24	Pass
52	5260	18.37	18.24	135.388	21.32	24	Pass
60	5300	18.97	18.87	155.976	21.93	24	Pass
64	5320	18.92	18.79	153.666	21.87	24	Pass
100	5500	18.43	18.28	136.961	21.37	24	Pass
116	5580	18.98	18.95	157.592	21.98	24	Pass
140	5700	18.73	18.58	146.756	21.67	24	Pass
144	5720 (U-NII-2C)	16.68	17.09	97.727	19.90	23.45	Pass
144	5720 (U-NII-3)	14.04	13.37	47.078	16.73	30	Pass
149	5745	18.51	18.44	140.781	21.49	30	Pass
157	5785	18.69	18.53	145.246	21.62	30	Pass
165	5825	18.94	18.85	155.079	21.91	30	Pass

Note:

For U-NII-2A, U-NII-2C Band:

Chain 0

1. $11 \text{ dBm} + 10\log(29.13) = 25.64 \text{ dBm} > 24 \text{ dBm}$.
2. $11 \text{ dBm} + 10\log(28.67) = 25.57 \text{ dBm} > 24 \text{ dBm}$.
3. $11 \text{ dBm} + 10\log(28.48) = 25.54 \text{ dBm} > 24 \text{ dBm}$.
4. $11 \text{ dBm} + 10\log(28.99) = 25.62 \text{ dBm} > 24 \text{ dBm}$.
5. $11 \text{ dBm} + 10\log(28.43) = 25.53 \text{ dBm} > 24 \text{ dBm}$.
6. $11 \text{ dBm} + 10\log(28.73) = 25.58 \text{ dBm} > 24 \text{ dBm}$.
7. $11 \text{ dBm} + 10\log(18.25) = 23.61 \text{ dBm} < 24 \text{ dBm}$.

Chain 1

1. $11 \text{ dBm} + 10\log(28.48) = 25.54 \text{ dBm} > 24 \text{ dBm}$.
2. $11 \text{ dBm} + 10\log(28.28) = 25.51 \text{ dBm} > 24 \text{ dBm}$.
3. $11 \text{ dBm} + 10\log(27.42) = 25.38 \text{ dBm} > 24 \text{ dBm}$.
4. $11 \text{ dBm} + 10\log(28.62) = 25.56 \text{ dBm} > 24 \text{ dBm}$.
5. $11 \text{ dBm} + 10\log(27.16) = 25.33 \text{ dBm} > 24 \text{ dBm}$.
6. $11 \text{ dBm} + 10\log(25.99) = 25.14 \text{ dBm} > 24 \text{ dBm}$.
7. $11 \text{ dBm} + 10\log(17.61) = 23.45 \text{ dBm} < 24 \text{ dBm}$.

802.11n (HT40)

Channel	Frequency (MHz)	Maximum Conducted Power (dBm)		Total Power (mW)	Total Power (dBm)	Power Limit (dBm)	Pass / Fail
		Chain 0	Chain 1				
38	5190	16.52	16.89	93.74	19.72	24	Pass
46	5230	17.56	17.82	117.55	20.70	24	Pass
54	5270	17.61	17.85	118.631	20.74	24	Pass
62	5310	15.60	15.83	74.59	18.73	24	Pass
102	5510	16.74	16.91	96.297	19.84	24	Pass
110	5550	17.68	17.88	119.99	20.79	24	Pass
134	5670	17.51	17.60	113.908	20.57	24	Pass
142	5710 (U-NII-2C)	16.88	16.92	97.957	19.91	24	Pass
142	5710 (U-NII-3)	9.09	9.13	16.295	12.12	30	Pass
151	5755	17.55	17.86	117.979	20.72	30	Pass
159	5795	17.56	17.77	116.857	20.68	30	Pass

Note:

For U-NII-2A, U-NII-2C Band:

Chain 0

1. $11 \text{ dBm} + 10\log(41.94) = 27.22 \text{ dBm} > 24 \text{ dBm}$.
2. $11 \text{ dBm} + 10\log(42.73) = 27.30 \text{ dBm} > 24 \text{ dBm}$.
3. $11 \text{ dBm} + 10\log(42.67) = 27.30 \text{ dBm} > 24 \text{ dBm}$.
4. $11 \text{ dBm} + 10\log(42.47) = 27.28 \text{ dBm} > 24 \text{ dBm}$.
5. $11 \text{ dBm} + 10\log(42.28) = 27.26 \text{ dBm} > 24 \text{ dBm}$.
6. $11 \text{ dBm} + 10\log(36.05) = 26.56 \text{ dBm} > 24 \text{ dBm}$.

Chain 1

1. $11 \text{ dBm} + 10\log(42.24) = 27.25 \text{ dBm} > 24 \text{ dBm}$.
2. $11 \text{ dBm} + 10\log(42.01) = 27.23 \text{ dBm} > 24 \text{ dBm}$.
3. $11 \text{ dBm} + 10\log(42.09) = 27.24 \text{ dBm} > 24 \text{ dBm}$.
4. $11 \text{ dBm} + 10\log(42.15) = 27.24 \text{ dBm} > 24 \text{ dBm}$.
5. $11 \text{ dBm} + 10\log(42.39) = 27.27 \text{ dBm} > 24 \text{ dBm}$.
6. $11 \text{ dBm} + 10\log(35.99) = 26.56 \text{ dBm} > 24 \text{ dBm}$.

802.11ac (VHT80)

Channel	Frequency (MHz)	Maximum Conducted Power (dBm)		Total Power (mW)	Total Power (dBm)	Power Limit (dBm)	Pass / Fail
		Chain 0	Chain 1				
42	5210	16.17	16.26	83.667	19.23	24	Pass
58	5290	15.07	15.57	68.195	18.34	24	Pass
106	5530	16.24	16.31	84.829	19.29	24	Pass
122	5610	16.79	16.90	96.731	19.86	24	Pass
138	5690 (U-NII-2C)	16.28	16.61	88.276	19.46	24	Pass
138	5690 (U-NII-3)	6.09	6.08	8.119	9.10	30	Pass
155	5775	16.62	16.98	95.808	19.81	30	Pass

Note:

For U-NII-2A, U-NII-2C Band:

Chain 0

1. $11 \text{ dBm} + 10\log(83.48) = 30.21 \text{ dBm} > 24 \text{ dBm}$.
2. $11 \text{ dBm} + 10\log(84.44) = 30.26 \text{ dBm} > 24 \text{ dBm}$.
3. $11 \text{ dBm} + 10\log(84.64) = 30.27 \text{ dBm} > 24 \text{ dBm}$.
4. $11 \text{ dBm} + 10\log(77.08) = 29.86 \text{ dBm} > 24 \text{ dBm}$.

Chain 1

1. $11 \text{ dBm} + 10\log(83.67) = 30.22 \text{ dBm} > 24 \text{ dBm}$.
2. $11 \text{ dBm} + 10\log(84.33) = 30.25 \text{ dBm} > 24 \text{ dBm}$.
3. $11 \text{ dBm} + 10\log(83.00) = 30.19 \text{ dBm} > 24 \text{ dBm}$.
4. $11 \text{ dBm} + 10\log(76.72) = 29.84 \text{ dBm} > 24 \text{ dBm}$.

26 dB Bandwidth:
802.11a

Channel	Frequency (MHz)	26 dBc Bandwidth (MHz)
36	5180	26.34
44	5220	26.92
48	5240	28.25
52	5260	26.48
60	5300	27.07
64	5320	26.45
100	5500	25.80
116	5580	26.73
140	5700	25.01
144	5720 (U-NII-2C)	17.10
144	5720 (U-NII-3)	7.85

802.11n (HT20)

Channel	Frequency (MHz)	26 dBc Bandwidth (MHz)	
		Chain 0	Chain 1
36	5180	28.63	28.78
44	5220	28.92	28.63
48	5240	29.04	28.72
52	5260	29.13	28.48
60	5300	28.67	28.28
64	5320	28.48	27.42
100	5500	28.99	28.62
116	5580	28.43	27.16
140	5700	28.73	25.99
144	5720 (U-NII-2C)	18.25	17.61
144	5720 (U-NII-3)	9.93	7.48

802.11n (HT40)

Channel	Frequency (MHz)	26 dBc Bandwidth (MHz)	
		Chain 0	Chain 1
38	5190	42.65	42.06
46	5230	49.26	42.68
54	5270	41.94	42.24
62	5310	42.73	42.01
102	5510	42.67	42.09
110	5550	42.47	42.15
134	5670	42.28	42.39
142	5710 (U-NII-2C)	36.05	35.99
142	5710 (U-NII-3)	5.99	5.99

802.11ac (VHT80)

Channel	Frequency (MHz)	26 dBc Bandwidth (MHz)	
		Chain 0	Chain 1
42	5210	83.85	83.48
58	5290	83.48	83.67
106	5530	84.44	84.33
122	5610	84.64	83.00
138	5690 (U-NII-2C)	77.08	76.72
138	5690 (U-NII-3)	7.37	6.79

Spectrum Plot of Worst Value

802.11a

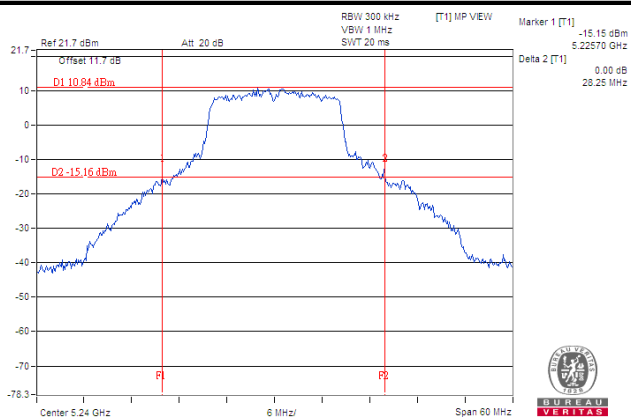

802.11n (HT20)

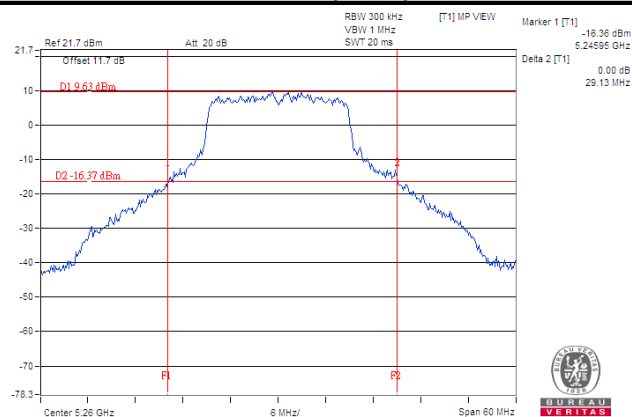

802.11n (HT40)

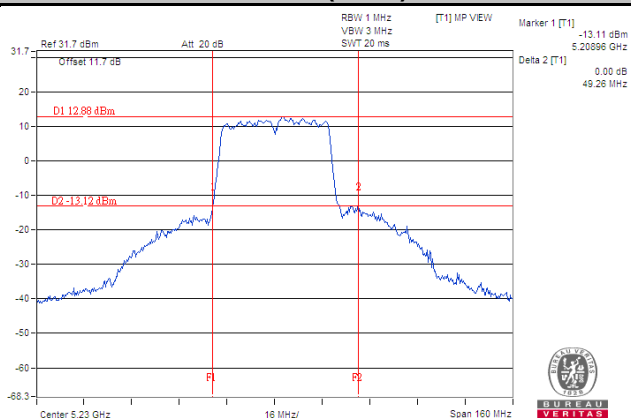

802.11ac (VHT80)

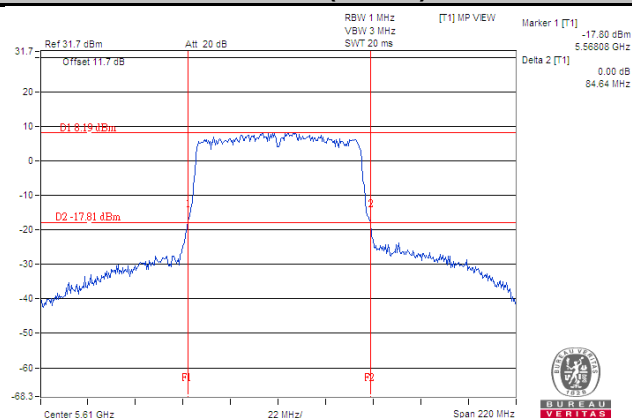

4.4 Occupied Bandwidth Measurement

4.4.1 Test Setup



4.4.2 Test Instruments

Refer to section 4.1.2 to get information of above instrument.

4.4.3 Test Procedure

The transmitter output was connected to the spectrum analyzer through an attenuator. The bandwidth of the fundamental frequency was measured by spectrum analyzer with resolution bandwidth in the range of 1 % to 5 % of the anticipated emission bandwidth, and a video bandwidth at least 3x the resolution bandwidth and set the detector to SAMPLE. The width of a frequency band such that, below the lower and above the upper frequency limits, the mean powers emitted are each equal to a specified percentage 0.5 % of the total mean power of a given emission.

4.4.4 Test Results

802.11a

Channel	Channel Frequency (MHz)	Occupied Bandwidth (MHz)
36	5180	16.92
40	5200	16.92
48	5240	17.16
52	5260	16.92
60	5300	17.04
64	5320	16.80
100	5500	16.80
116	5580	16.92
140	5700	16.92
144	5720 (U-NII-2C)	13.28
144	5720 (U-NII-3)	3.16
149	5745	16.92
157	5785	16.92
165	5825	16.83

802.11n (HT20)

Channel	Channel Frequency (MHz)	Occupied Bandwidth (MHz)	
		Chain 0	Chain 1
36	5180	18.24	18.12
40	5200	18.12	18.00
48	5240	18.24	18.24
52	5260	18.24	18.12
60	5300	18.36	18.00
64	5320	18.00	18.00
100	5500	18.12	18.00
116	5580	18.24	18.00
140	5700	18.12	17.88
144	5720 (U-NII-2C)	14.00	13.88
144	5720 (U-NII-3)	3.88	3.76
149	5745	18.08	17.88
157	5785	18.17	17.98
165	5825	18.08	17.98

802.11n (HT40)

Channel	Channel Frequency (MHz)	Occupied Bandwidth (MHz)	
		Chain 0	Chain 1
38	5190	36.48	36.60
46	5230	36.60	36.60
54	5270	36.72	36.72
62	5310	36.60	36.60
102	5510	36.72	36.60
110	5550	36.60	36.72
134	5670	36.60	36.60
142	5710 (U-NII-2C)	33.24	33.36
142	5710 (U-NII-3)	3.24	3.24
151	5755	36.72	36.60
159	5795	36.60	36.48

802.11ac (VHT80)

Channel	Channel Frequency (MHz)	Occupied Bandwidth (MHz)	
		Chain 0	Chain 1
42	5210	75.84	75.84
58	5290	75.84	75.84
106	5530	75.84	75.84
122	5610	76.08	75.84
138	5690 (U-NII-2C)	72.92	72.92
138	5690 (U-NII-3)	2.68	2.68
155	5775	75.76	76.16

Spectrum Plot of Worst Value

802.11a

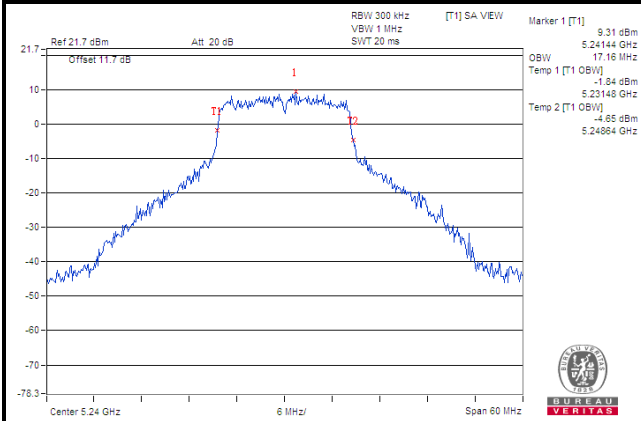

802.11n (HT20)

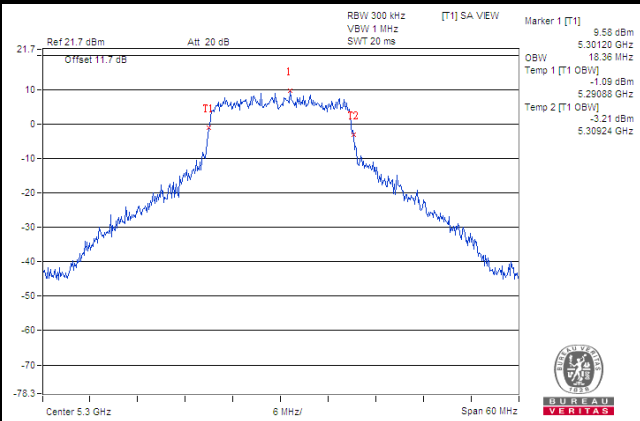

802.11n (HT40)

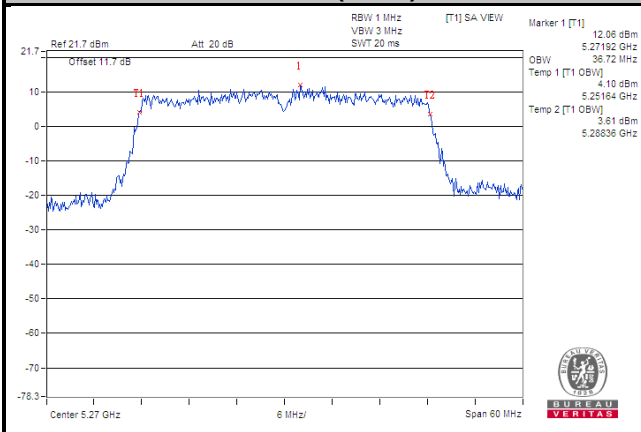

802.11ac (VHT80)

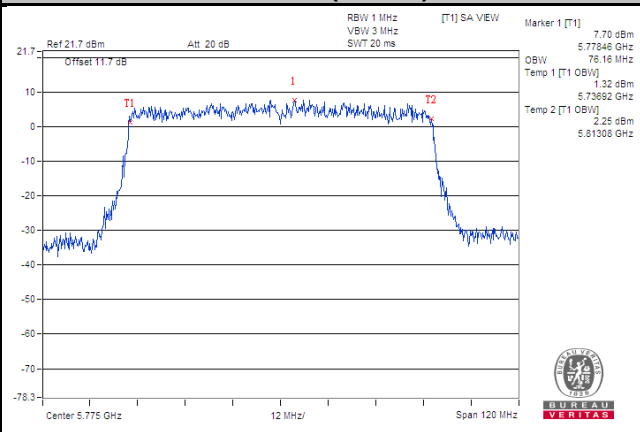

4.5 Peak Power Spectral Density Measurement

4.5.1 Limits of Peak Power Spectral Density Measurement

Operation Band	EUT Category		Limit
U-NII-1		Outdoor Access Point	17 dBm/MHz
		Fixed point-to-point Access Point	
		Indoor Access Point	
	√	Mobile and Portable client device	11 dBm/MHz
U-NII-2A		√	11 dBm/MHz
U-NII-2C		√	11 dBm/MHz
U-NII-3		√	30 dBm/500 kHz

4.5.2 Test Setup

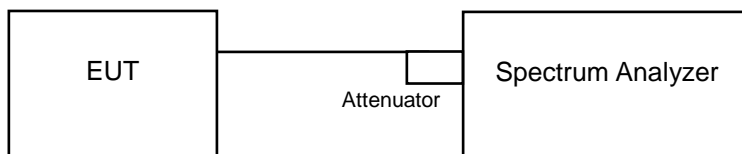

4.5.3 Test Instruments

Refer to section 4.1.3 to get information of above instrument.

4.5.4 Test Procedures

For U-NII-1, U-NII-2A, U-NII-2C band:

Using method SA-1

1. Set span to encompass the entire emission bandwidth (EBW) of the signal.
2. Set RBW = 1 MHz, Set VBW \geq 3 RBW, Detector = RMS
3. Sweep time = auto, trigger set to "free run".
4. Trace average at least 100 traces in power averaging mode.
5. Record the max value

Using method SA-2

1. Set span to encompass the entire emission bandwidth (EBW) of the signal.
2. Set RBW = 1 MHz, Set VBW \geq 3 RBW, Detector = RMS
3. Sweep time = auto, trigger set to "free run".
4. Trace average at least 100 traces in power averaging mode.
5. Record the max value and add $10 \log (1/\text{duty cycle})$

※For U-NII-3:

1. Set span to encompass the entire emission bandwidth (EBW) of the signal.
2. Set RBW = 500 kHz, Set VBW \geq 3 RBW, Detector = RMS
3. Use the peak marker function to determine the maximum power level in any 500 kHz band segment within the fundamental EBW.
4. Sweep time = auto, trigger set to "free run".
5. Trace average at least 100 traces in power averaging mode.
6. Record the max value

※For U-NII-3:

1. Set span to encompass the entire emission bandwidth (EBW) of the signal.
2. Set RBW = 500 kHz, Set VBW \geq 3 RBW, Detector = RMS
3. Use the peak marker function to determine the maximum power level in any 500 kHz band segment within the fundamental EBW.
4. Sweep time = auto, trigger set to "free run".
5. Trace average at least 100 traces in power averaging mode.
6. Record the max value and add 10 log (1/duty cycle)

4.5.5 Deviation from Test Standard

No deviation.

4.5.6 EUT Operating Conditions

The software provided by client to enable the EUT under transmission condition continuously at lowest, middle and highest channel frequencies individually.

4.5.7 Test Results

For U-NII-1, U-NII-2A, U-NII-2C Band

802.11a

Channel	Frequency (MHz)	PSD (dBm/MHz)	Maximum Limit (dBm/MHz)	Pass / Fail
36	5180	5.36	11	Pass
44	5220	5.50	11	Pass
48	5240	5.58	11	Pass
52	5260	5.51	11	Pass
60	5300	5.92	11	Pass
64	5320	5.68	11	Pass
100	5500	6.00	11	Pass
116	5580	5.93	11	Pass
140	5700	5.50	11	Pass
144	5720 (U-NII-2C)	7.47	11	Pass

802.11n (HT20)

Channel	Frequency (MHz)	PSD (dBm/MHz)		Total Power Density (dBm/MHz)	Max. Limit (dBm/MHz)	Pass / Fail
		Chain 0	Chain 1			
36	5180	4.29	5.11	7.73	11	Pass
44	5220	4.21	5.28	7.79	11	Pass
48	5240	4.29	5.38	7.88	11	Pass
52	5260	4.11	5.32	7.77	11	Pass
60	5300	4.64	5.54	8.12	11	Pass
64	5320	4.58	5.34	7.99	11	Pass
100	5500	5.31	5.66	8.50	11	Pass
116	5580	5.36	5.43	8.41	11	Pass
140	5700	4.73	5.06	7.91	11	Pass
144	5720 (U-NII-2C)	6.89	6.92	9.92	11	Pass

Note:

- Method 1 of power density measurement of KDB 662911 is using for calculating total power density. Total power density is summing entire spectra across corresponding frequency bins on the various outputs by computer.
- 5180~5240MHz: Directional gain = $10\log[(10^{G1/20} + 10^{G2/20} + \dots + 10^{GN/20})^2 / N_{ANT}] = 0.07 \text{ dBi} < 6 \text{ dBi}$, so the power density limit no need to reduce.
 5260~5320MHz: Directional gain = $10\log[(10^{G1/20} + 10^{G2/20} + \dots + 10^{GN/20})^2 / N_{ANT}] = 0.15 \text{ dBi} < 6 \text{ dBi}$, so the power density limit no need to reduce.
 5500~5720MHz: Directional gain = $10\log[(10^{G1/20} + 10^{G2/20} + \dots + 10^{GN/20})^2 / N_{ANT}] = 2.74 \text{ dBi} < 6 \text{ dBi}$, so the power density limit no need to reduce.

802.11n (HT40)

Channel	Frequency (MHz)	PSD (dBm/MHz)		Duty Factor (dB)	Total PSD with Duty Factor (dBm/MHz)	Max. Limit (dBm/MHz)	Pass / Fail
		Chain 0	Chain 1				
38	5190	1.61	1.57	0.26	4.86	11	Pass
46	5230	1.28	1.66	0.26	4.75	11	Pass
54	5270	1.56	1.71	0.26	4.91	11	Pass
62	5310	1.56	1.86	0.26	4.99	11	Pass
102	5510	2.18	1.91	0.26	5.32	11	Pass
110	5550	1.89	1.92	0.26	5.18	11	Pass
134	5670	1.38	1.53	0.26	4.73	11	Pass
142	5710 (U-NII-2C)	3.30	3.60	0.26	6.73	11	Pass

Note:

- Method 1 of power density measurement of KDB 662911 is using for calculating total power density. Total power density is summing entire spectra across corresponding frequency bins on the various outputs by computer.
- 5180~5240MHz: Directional gain = $10\log[(10^{G1/20} + 10^{G2/20} + \dots + 10^{GN/20})^2 / N_{ANT}] = 0.07 \text{ dBi} < 6 \text{ dBi}$, so the power density limit no need to reduce.
 5260~5320MHz: Directional gain = $10\log[(10^{G1/20} + 10^{G2/20} + \dots + 10^{GN/20})^2 / N_{ANT}] = 0.15 \text{ dBi} < 6 \text{ dBi}$, so the power density limit no need to reduce.
 5500~5720MHz: Directional gain = $10\log[(10^{G1/20} + 10^{G2/20} + \dots + 10^{GN/20})^2 / N_{ANT}] = 2.74 \text{ dBi} < 6 \text{ dBi}$, so the power density limit no need to reduce.
- Refer to section 3.3 for duty cycle spectrum plot.

802.11ac (VHT80):

Channel	Frequency (MHz)	PSD (dBm/MHz)		Duty Factor (dB)	Total PSD with Duty Factor (dBm/MHz)	Max. Limit (dBm/MHz)	Pass / Fail
		Chain 0	Chain 1				
42	5210	-3.74	-2.78	0.84	0.62	11	Pass
58	5290	-3.15	-2.45	0.84	1.07	11	Pass
106	5530	-2.76	-2.37	0.84	1.29	11	Pass
122	5610	-3.04	-2.82	0.84	0.92	11	Pass
138	5690 (U-NII-2C)	-1.34	-1.00	0.84	2.68	11	Pass

Note:

- Method 1 of power density measurement of KDB 662911 is using for calculating total power density. Total power density is summing entire spectra across corresponding frequency bins on the various outputs by computer.
- 5180~5240MHz: Directional gain = $10\log[(10^{G1/20} + 10^{G2/20} + \dots + 10^{GN/20})^2 / N_{ANT}] = 0.07 \text{ dBi} < 6 \text{ dBi}$, so the power density limit no need to reduce.
 5260~5320MHz: Directional gain = $10\log[(10^{G1/20} + 10^{G2/20} + \dots + 10^{GN/20})^2 / N_{ANT}] = 0.15 \text{ dBi} < 6 \text{ dBi}$, so the power density limit no need to reduce.
 5500~5720MHz: Directional gain = $10\log[(10^{G1/20} + 10^{G2/20} + \dots + 10^{GN/20})^2 / N_{ANT}] = 2.74 \text{ dBi} < 6 \text{ dBi}$, so the power density limit no need to reduce.
- Refer to section 3.3 for duty cycle spectrum plot.

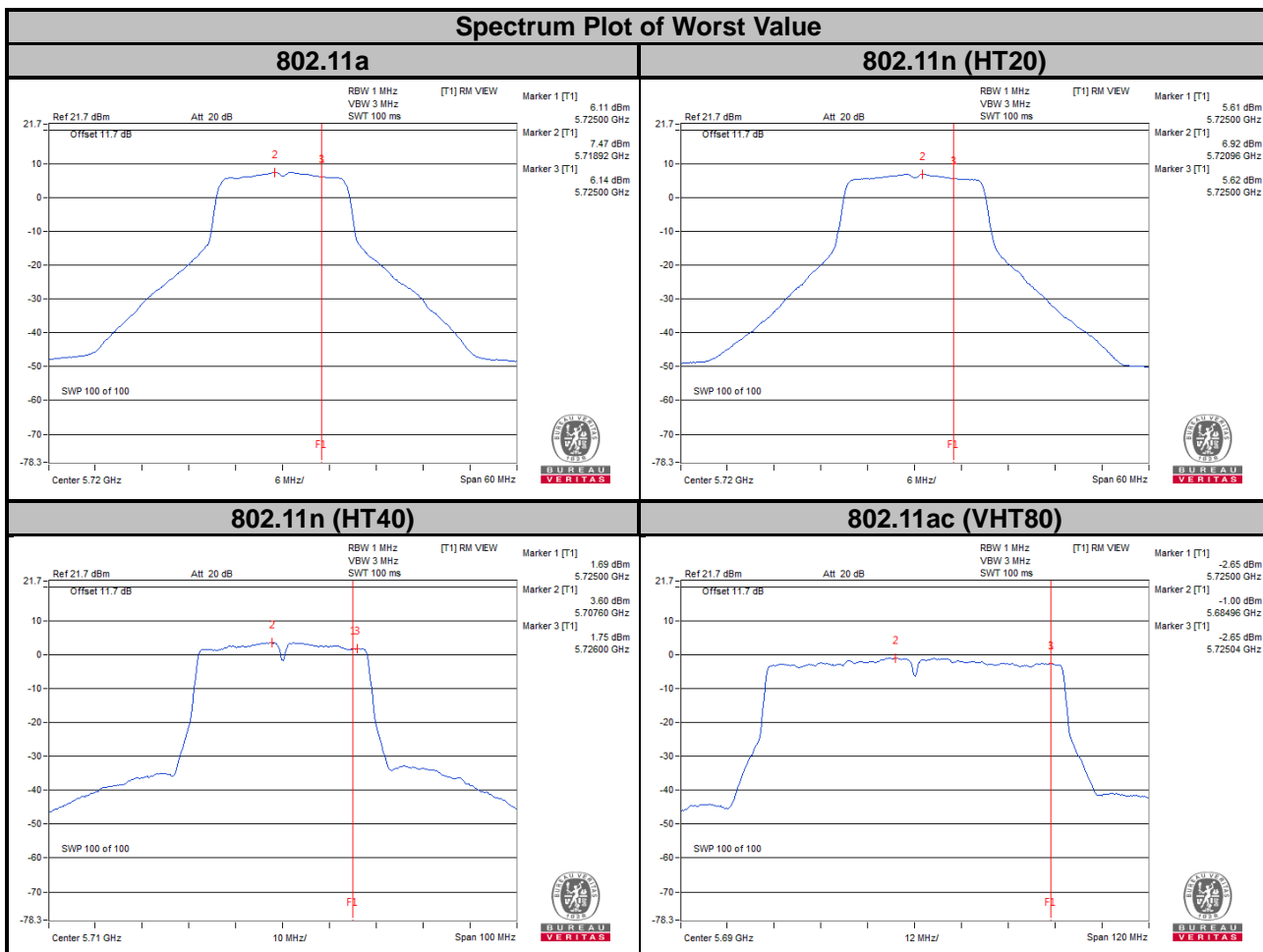

For U-NII-3 Band

802.11a

Channel	Freq. (MHz)	PSD (dBm/500 kHz)	Limit (dBm/500 kHz)	Pass / Fail
144	5720 (U-NII-3)	0.87	30	Pass
149	5745	-2.49	30	Pass
157	5785	-2.55	30	Pass
165	5825	-2.54	30	Pass

802.11n (HT20)

TX Chain	Channel	Freq. (MHz)	PSD (dBm/500 kHz)	10 log (N=2) dB	Total PSD (dBm/500 kHz)	Limit (dBm/500 kHz)	Pass / Fail
0	144	5720 (U-NII-3)	0.28	3.01	3.29	30	Pass
	149	5745	-3.35	3.01	-0.34	30	Pass
	157	5785	-3.25	3.01	-0.24	30	Pass
	165	5825	-3.54	3.01	-0.53	30	Pass
1	144	5720 (U-NII-3)	0.42	3.01	3.43	30	Pass
	149	5745	-2.77	3.01	0.24	30	Pass
	157	5785	-2.87	3.01	0.14	30	Pass
	165	5825	-2.91	3.01	0.10	30	Pass

Note:

- Method 1 of power density measurement of KDB 662911 is using for calculating total power density. Total power density is summing entire spectra across corresponding frequency bins on the various outputs by computer.
- Directional gain = $10 \log[(10^{G1/20} + 10^{G2/20} + \dots + 10^{GN/20})^2 / N_{ANT}] = 1.62 < 6 \text{ dBi}$, so the limit no need to reduce.

802.11n (HT40)

TX Chain	Channel	Frequency (MHz)	PSD (dBm/500 kHz)	10 log (N=2) dB	Duty Factor (dB)	Total PSD with Duty Factor (dBm/500 kHz)	Limit (dBm/500 kHz)	Pass / Fail
0	142	5710 (U-NII-3)	-3.41	3.01	0.26	-0.14	30	Pass
	151	5755	-7.44	3.01	0.26	-4.17	30	Pass
	159	5795	-7.09	3.01	0.26	-3.82	30	Pass
1	142	5710 (U-NII-3)	-3.34	3.01	0.26	-0.07	30	Pass
	151	5755	-7.47	3.01	0.26	-4.20	30	Pass
	159	5795	-6.81	3.01	0.26	-3.54	30	Pass

Note:

- Method 1 of power density measurement of KDB 662911 is using for calculating total power density. Total power density is summing entire spectra across corresponding frequency bins on the various outputs by computer.
- Directional gain = $10 \log[(10^{G1/20} + 10^{G2/20} + \dots + 10^{GN/20})^2 / N_{ANT}] = 1.62 < 6$ dBi, so the limit no need to reduce.
- Refer to section 3.3 for duty cycle spectrum plot.

802.11ac (VHT80)

TX Chain	Channel	Frequency (MHz)	PSD (dBm/500 kHz)	10 log (N=2) dB	Duty Factor (dB)	Total PSD with Duty Factor (dBm/500 kHz)	Limit (dBm/500 kHz)	Pass / Fail
0	138	5690 (U-NII-3)	-7.42	3.01	0.84	-3.57	30	Pass
	155	5775	-9.61	3.01	0.84	-5.76	30	Pass
1	138	5690 (U-NII-3)	-7.34	3.01	0.84	-3.49	30	Pass
	155	5775	-10.25	3.01	0.84	-6.40	30	Pass

Note:

- Method 1 of power density measurement of KDB 662911 is using for calculating total power density. Total power density is summing entire spectra across corresponding frequency bins on the various outputs by computer.
- Directional gain = $10 \log[(10^{G1/20} + 10^{G2/20} + \dots + 10^{GN/20})^2 / N_{ANT}] = 1.62 < 6$ dBi, so the limit no need to reduce.
- Refer to section 3.3 for duty cycle spectrum plot.

Spectrum Plot of Worst Value

802.11a

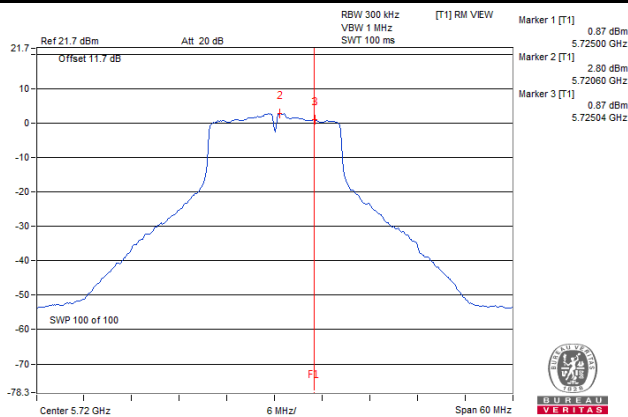

802.11n (HT20)

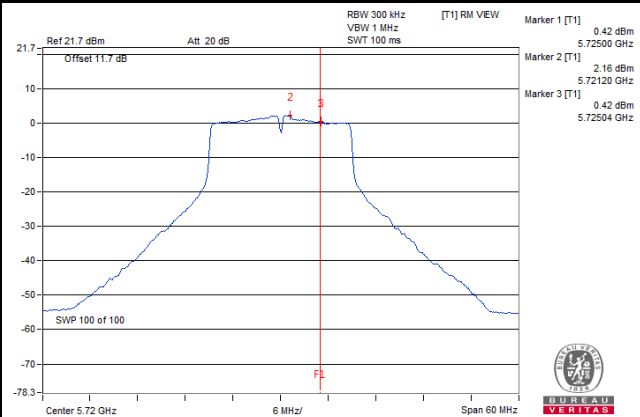

802.11n (HT40)

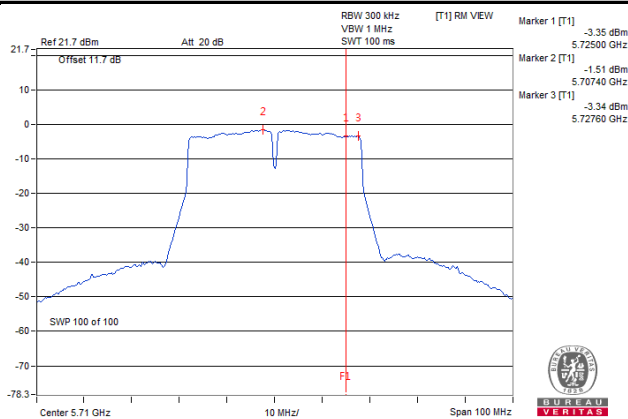

802.11ac (VHT80)

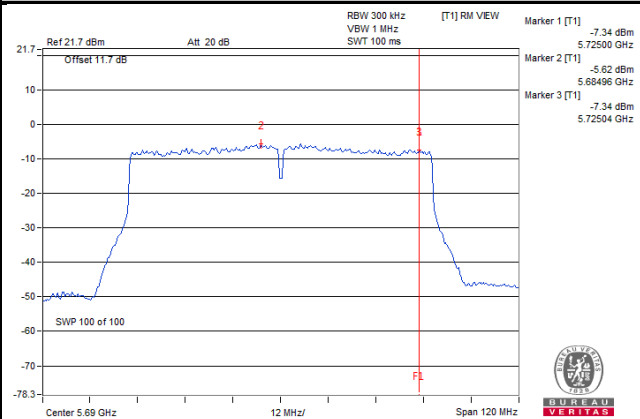

4.6 Frequency Stability

4.6.1 Limit of Frequency Stability Measurement

The frequency of the carrier signal shall be maintained within band of operation.

4.6.2 Test Setup

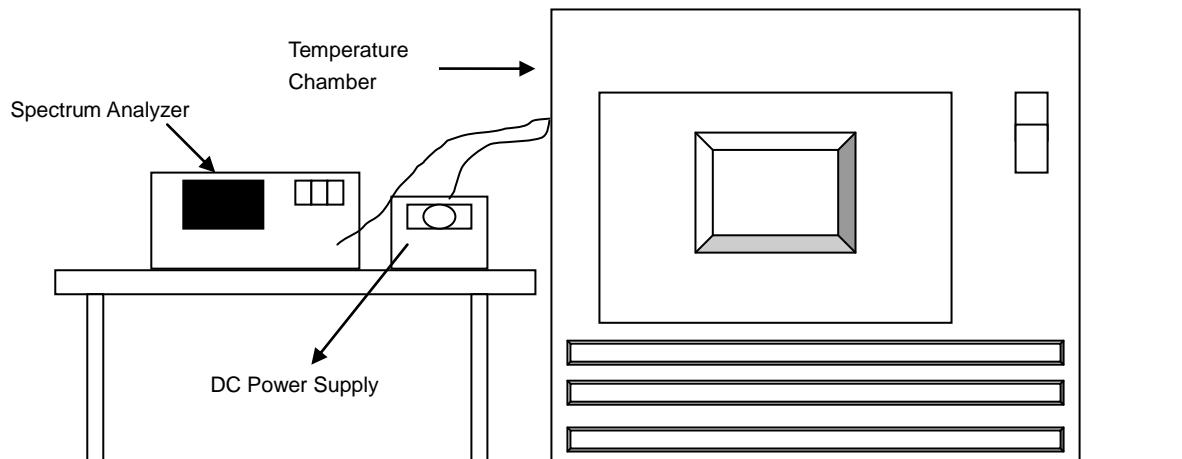

4.6.3 Test Instruments

Refer to section 4.1.3 to get information of above instrument.

4.6.4 Test Procedure

- To ensure emission at the band edge is maintained within the authorized band, those values shall be measured by radiation emissions at upper and lower frequency points, and finally compensated by frequency deviation as procedures below.
- The EUT was operated at the maximum output power, and connected to the spectrum analyzer, which is set to maximum hold function and peak detector. The peak value of the power envelope was measured and noted. The upper and lower frequency points were respectively measured relatively 10 dB lower than the measured peak value.
- The frequency deviation was calculated by adding the upper frequency point and the lower frequency point divided by two. Those detailed values of frequency deviation are provided in table below.

4.6.5 Deviation from Test Standard

No deviation.

4.6.6 EUT Operating Condition

Set the EUT transmit at un-modulation mode to test frequency stability.

4.6.7 Test Results

Frequency Stability Versus Temp.									
Operating Frequency: 5180 MHz									
Temp. (°C)	Power Supply (Vdc)	0 Minute		2 Minute		5 Minute		10 Minute	
		Measured Frequency (MHz)	Frequency Drift (ppm)	Measured Frequency (MHz)	Frequency Drift (ppm)	Measured Frequency (MHz)	Frequency Drift (ppm)	Measured Frequency (MHz)	Frequency Drift (ppm)
50	3.85	5180.0131	2.53000	5180.0138	2.66000	5180.0165	3.19000	5180.0124	2.39000
40	3.85	5179.9732	-5.17000	5179.9718	-5.44000	5179.9758	-4.67000	5179.975	-4.83000
30	3.85	5180.015	2.90000	5180.0136	2.63000	5180.0146	2.82000	5180.0114	2.20000
20	3.85	5180.0042	0.81000	5180.0001	0.02000	5180.0025	0.48000	5180.0014	0.27000
10	3.85	5180.0249	4.81000	5180.0246	4.75000	5180.023	4.44000	5180.0231	4.46000
0	3.85	5179.978	-4.25000	5179.9761	-4.61000	5179.9784	-4.17000	5179.9767	-4.50000
-10	3.85	5180.0183	3.53000	5180.0172	3.32000	5180.0142	2.74000	5180.0167	3.22000
-20	3.85	5179.9965	-0.68000	5179.9995	-0.10000	5179.9996	-0.08000	5180.0003	0.06000
-30	3.85	5180.0037	0.71000	5180.0058	1.12000	5180.002	0.39000	5180.0041	0.79000

Frequency Stability Versus Temp.									
Operating Frequency: 5180 MHz									
Temp. (°C)	Power Supply (Vdc)	0 Minute		2 Minute		5 Minute		10 Minute	
		Measured Frequency (MHz)	Frequency Drift (ppm)	Measured Frequency (MHz)	Frequency Drift (ppm)	Measured Frequency (MHz)	Frequency Drift (ppm)	Measured Frequency (MHz)	Frequency Drift (ppm)
20	4.4275	5180.0044	0.85000	5180	0.00000	5180.0023	0.44000	5180.002	0.39000
	3.85	5180.0042	0.81000	5180.0001	0.02000	5180.0025	0.48000	5180.0014	0.27000
	3.2725	5180.0044	0.85000	5179.9993	-0.14000	5180.0029	0.56000	5180.0009	0.17000

4.7 6 dB Bandwidth Measurement

4.7.1 Limits of 6 dB Bandwidth Measurement

The minimum of 6 dB Bandwidth Measurement is 0.5 MHz.

4.7.2 Test Setup

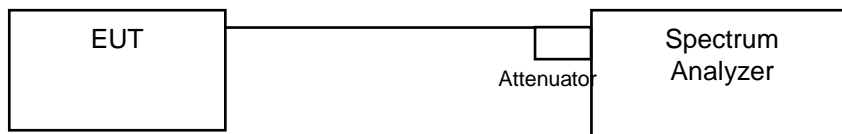

4.7.3 Test Instruments

Refer to section 4.1.3 to get information of above instrument.

4.7.4 Test Procedure

MEASUREMENT PROCEDURE REF

- Set resolution bandwidth (RBW) = 100 kHz
- Set the video bandwidth (VBW) $\geq 3 \times$ RBW, Detector = Peak.
- Trace mode = max hold.
- Sweep = auto couple.
- Measure the maximum width of the emission that is constrained by the frequencies associated with the two amplitude points (upper and lower) that are attenuated by 6 dB relative to the maximum level measured in the fundamental emission

4.7.5 Deviation from Test Standard

No deviation.

4.7.6 EUT Operating Condition

The software provided by client to enable the EUT under transmission condition continuously at lowest, middle and highest channel frequencies individually.

4.7.7 Test Results

802.11a

Channel	Frequency (MHz)	6 dB Bandwidth (MHz)	Minimum Limit (MHz)	Pass / Fail
144	5720 (U-NII-3)	2.8	0.5	Pass
149	5745	15.17	0.5	Pass
157	5785	15.35	0.5	Pass
165	5825	15.38	0.5	Pass

802.11n (HT20)

Channel	Frequency (MHz)	6 dB Bandwidth (MHz)		Minimum Limit (MHz)	Pass / Fail
		Chain 0	Chain 1		
144	5720 (U-NII-3)	2.76	3.15	0.5	Pass
149	5745	16.55	16.27	0.5	Pass
157	5785	16.56	16.57	0.5	Pass
165	5825	16.00	16.20	0.5	Pass

802.11n (HT40)

Channel	Frequency (MHz)	6 dB Bandwidth (MHz)		Minimum Limit (MHz)	Pass / Fail
		Chain 0	Chain 1		
142	5710 (U-NII-3)	2.66	2.66	0.5	Pass
151	5755	36.11	35.46	0.5	Pass
159	5795	36.11	35.33	0.5	Pass

802.11ac (VHT80)

Channel	Frequency (MHz)	6 dB Bandwidth (MHz)		Minimum Limit (MHz)	Pass / Fail
		Chain 0	Chain 1		
138	5690 (U-NII-3)	2.73	2.70	0.5	Pass
155	5775	75.49	75.42	0.5	Pass

Spectrum Plot of Worst Value

802.11a

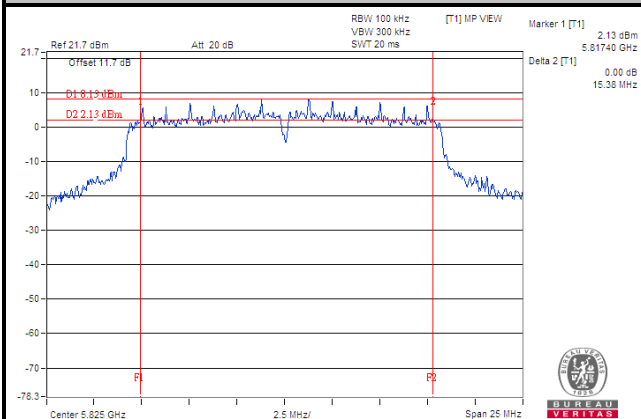

802.11n (HT20)

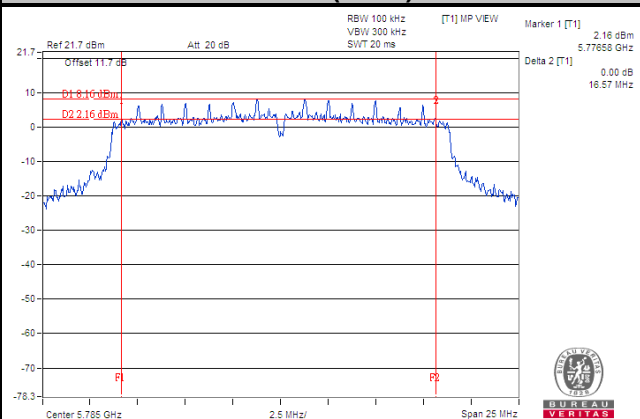

802.11n (HT40)

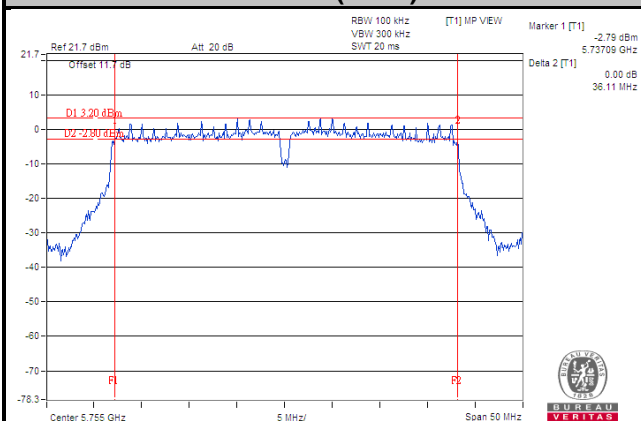

802.11ac (VHT80)

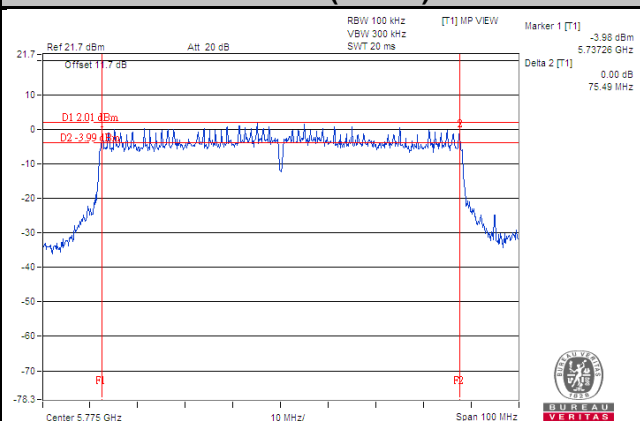

5 Pictures of Test Arrangements

Please refer to the attached file (Test Setup Photo).

Annex A- Radiated Out of Band Emission (OOBE) Measurement (For U-NII-3 band)

802.11a

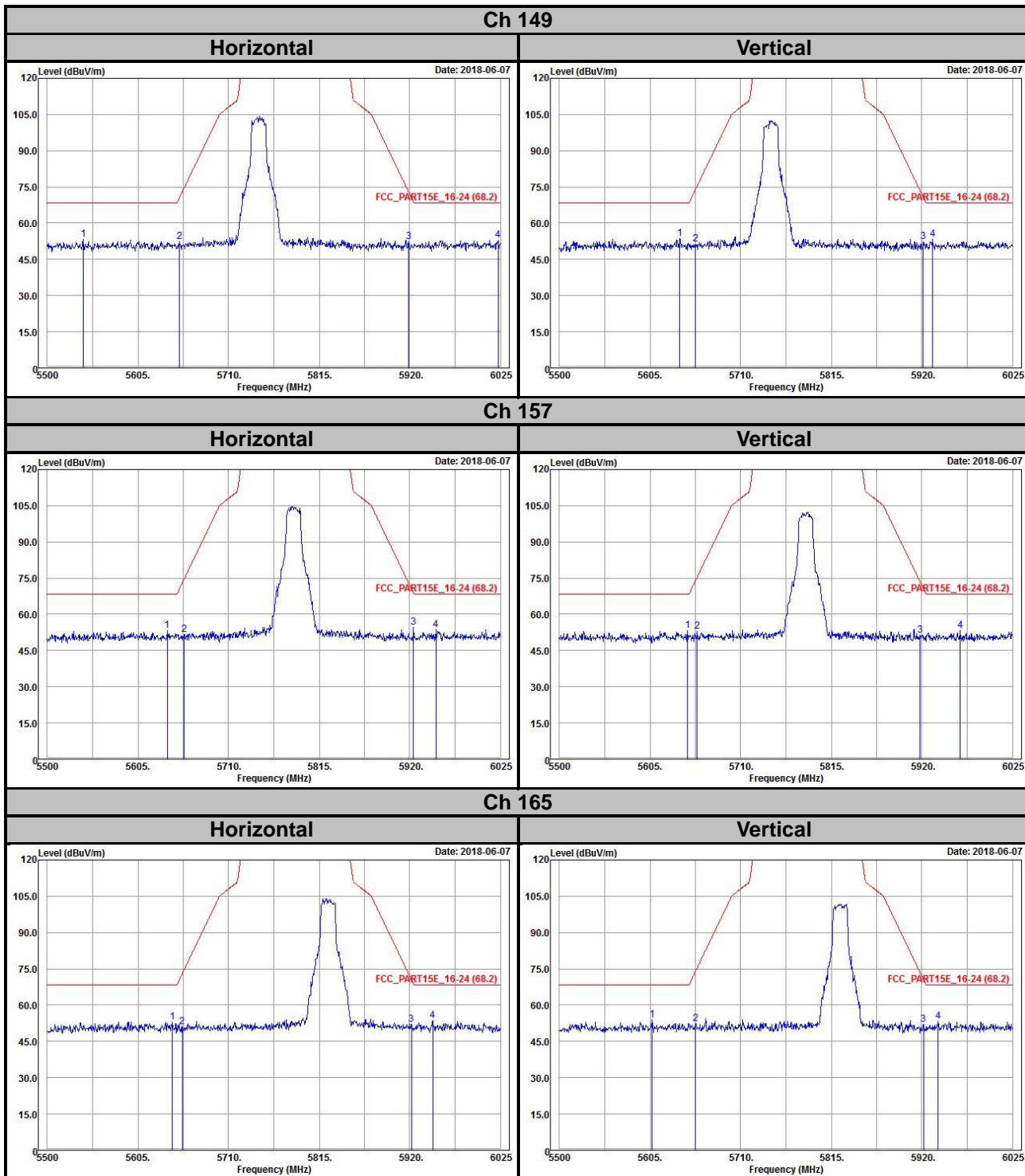

802.11n (HT20)

Ch 149

Horizontal

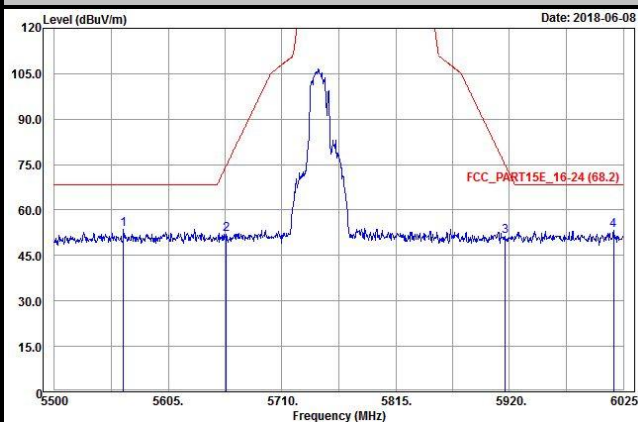

Vertical

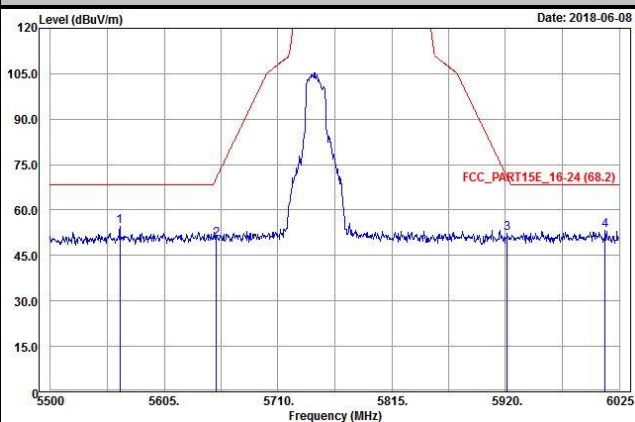

Ch 157

Horizontal

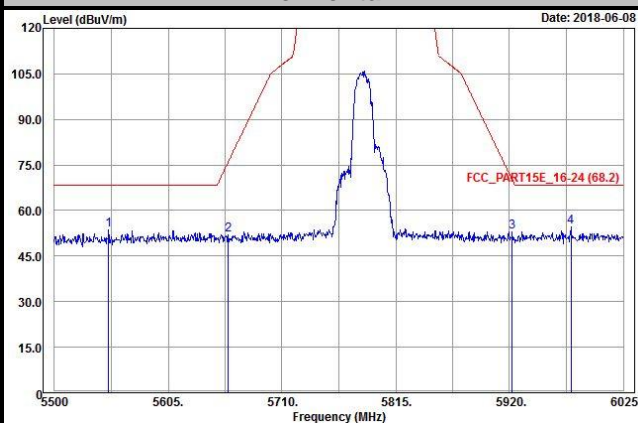

Vertical

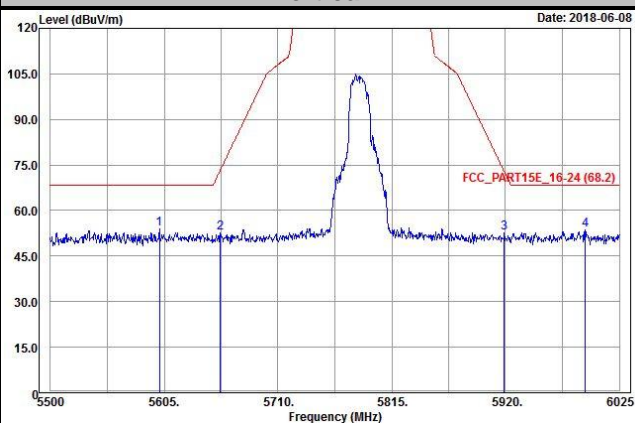

Ch 165

Horizontal

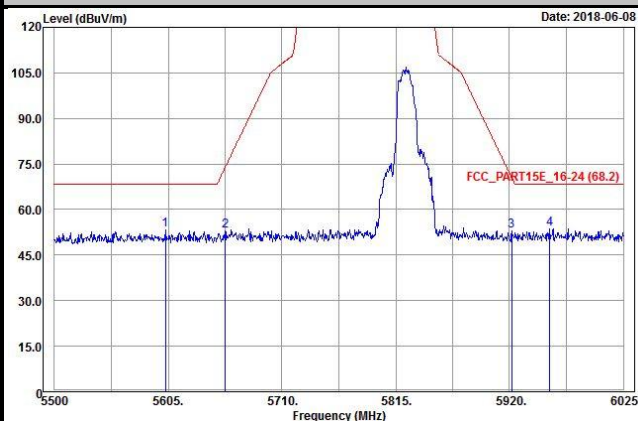

Vertical

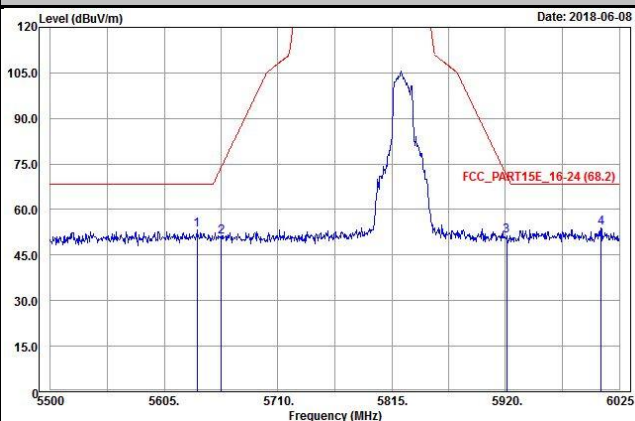

802.11n (HT40)

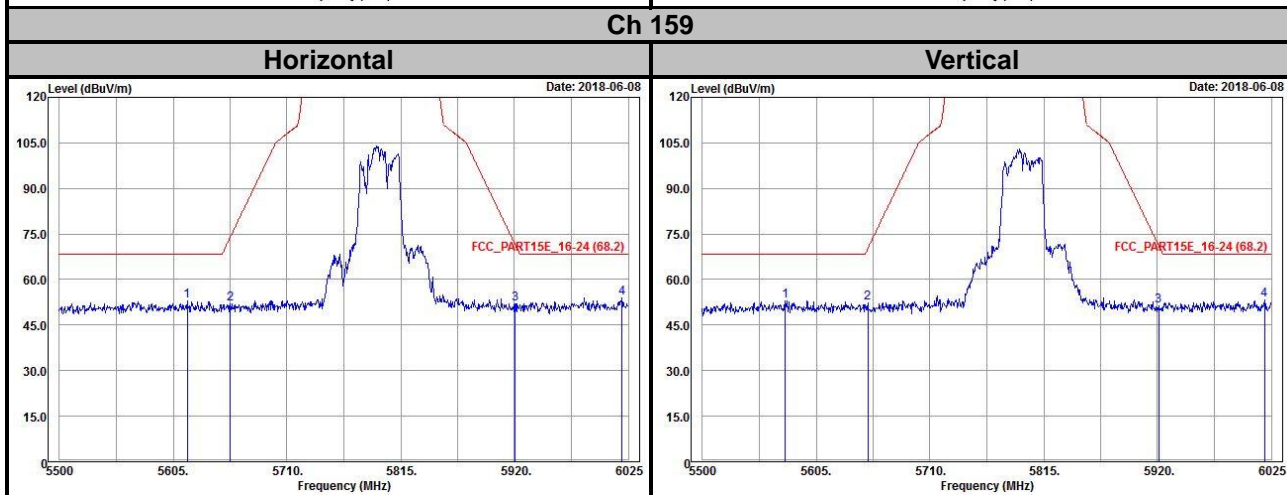
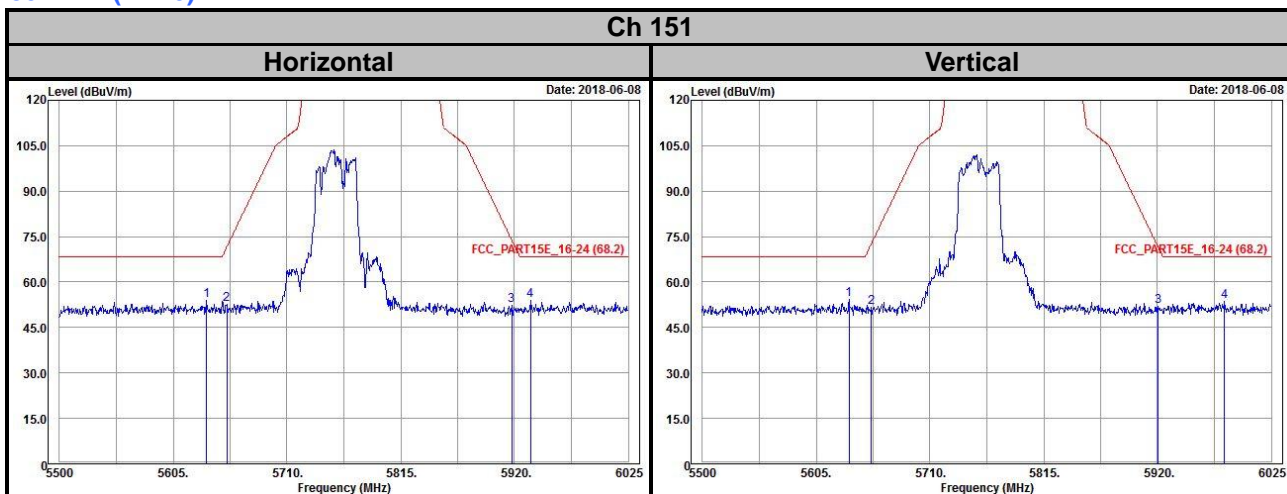

802.11ac (VHT80)

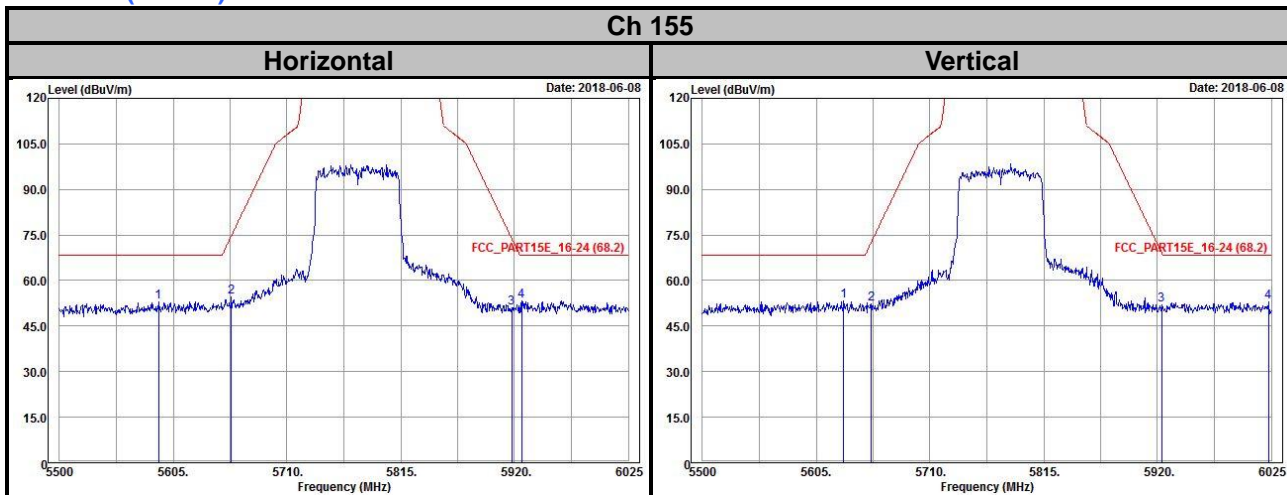

Appendix – Information on the Testing Laboratories

We, Bureau Veritas Consumer Products Services (H.K.) Ltd., Taoyuan Branch, were founded in 1988 to provide our best service in EMC, Radio, Telecom and Safety consultation. Our laboratories are FCC recognized accredited test firms and accredited according to ISO/IEC 17025.

If you have any comments, please feel free to contact us at the following:

Linko EMC/RF Lab

Tel: 886-2-26052180

Fax: 886-2-26051924

Hsin Chu EMC/RF/Telecom Lab

Tel: 886-3-6668565

Fax: 886-3-6668323

Hwa Ya EMC/RF/Safety

Tel: 886-3-3183232

Fax: 886-3-3270892

Email: service.adt@tw.bureauveritas.com

Web Site: www.bureauveritas-adt.com

The address and road map of all our labs can be found in our web site also.

--- END ---