

FCC Test Report

Report No.: RF180523C10-6 R1

FCC ID: 2AJOTTA-1082

Test Model: TA-1082

Received Date: May 23, 2018

Test Date: Jun. 29, 2018

Issued Date: Oct. 24, 2018

Applicant: HMD Global Oy

Address: Bertel Jungin aukio 9, 02600 Espoo, Finland

Issued By: Bureau Veritas Consumer Products Services (H.K.) Ltd., Taoyuan Branch

Lab Address: No. 47-2, 14th Ling, Chia Pau Vil., Lin Kou Dist., New Taipei City, Taiwan (R.O.C)

Test Location (1): No.19, Hwa Ya 2nd Rd., Wen Hwa Vil., Kwei Shan Dist., Taoyuan City 33383, Taiwan, R.O.C.

Test Location (2): No.215, Sec. 3, Beixin Rd., Xindian Dist., New Taipei City 231, Taiwan, R.O.C

**FCC Registration /
Designation Number:** 427177 / TW0011



This report is for your exclusive use. Any copying or replication of this report to or for any other person or entity, or use of our name or trademark, is permitted only with our prior written permission. This report sets forth our findings solely with respect to the test samples identified herein. The results set forth in this report are not indicative or representative of the quality or characteristics of the lot from which a test sample was taken or any similar or identical product unless specifically and expressly noted. Our report includes all of the tests requested by you and the results thereof based upon the information that you provided to us. You have 60 days from date of issuance of this report to notify us of any material error or omission caused by our negligence, provided, however, that such notice shall be in writing and shall specifically address the issue you wish to raise. A failure to raise such issue within the prescribed time shall constitute your unqualified acceptance of the completeness of this report, the tests conducted and the correctness of the report contents. Unless specific mention, the uncertainty of measurement has been explicitly taken into account to declare the compliance or non-compliance to the specification. The report must not be used by the client to claim product certification, approval, or endorsement by TAF or any government agencies.

Table of Contents

Release Control Record	3
1 Certificate of Conformity	4
2 Summary of Test Results.....	5
2.1 Measurement Uncertainty.....	5
2.2 Modification Record	5
3 General Information	6
3.1 General Description of EUT	6
3.2 Description of Test Modes.....	7
3.2.1 Test Mode Applicability and Tested Channel Detail.....	8
3.3 Description of Support Units	9
3.3.1 Configuration of System under Test	9
3.4 General Description of Applied Standards.....	9
4 Test Types and Results	10
4.1 Radiated Emission and Bandedge Measurement	10
4.1.1 Limits of Radiated Emission and Bandedge Measurement	10
4.1.2 Test Instruments	11
4.1.3 Test Procedures.....	12
4.1.4 Deviation from Test Standard	13
4.1.5 Test Set Up	13
4.1.6 EUT Operating Conditions.....	14
4.1.7 Test Results	15
5 Pictures of Test Arrangements.....	17
Appendix – Information on the Testing Laboratories	18
Annex A –Test Report for TA-1087 (Dual SIM)	19

Release Control Record

Issue No.	Description	Date Issued
RF180523C10-6	Original Release	Jul. 18, 2018
RF180523C10-6 R1	Revise applicant's address	Oct. 24, 2018

1 Certificate of Conformity

Product: Smart Phone

Brand: NOKIA

Test Model: TA-1082

Sample Status: Production Unit

Applicant: HMD Global Oy

Test Date: Jun. 29, 2018

Standards: 47 CFR FCC Part 15, Subpart C (Section 15.247)
ANSI C63.10:2013

This report is issued as a supplementary report to BV CPS report no.: RF180523C09-6. This report shall be used by combining with its original report.

Prepared by : , **Date:** Oct. 24, 2018
Ivonne Wu / Supervisor

Approved by : , **Date:** Oct. 24, 2018
Dylan Chiou / Project Engineer

2 Summary of Test Results

47 CFR FCC Part 15, Subpart C (Section 15.247)			
FCC Clause	Test Item	Result	Remarks
15.207	AC Power Conducted Emission	N/A	Refer to Note
15.205 / 15.209 / 15.247(d)	Radiated Emissions and Band Edge Measurement	Pass	Meet the requirement of limit. Minimum passing margin is -1.89 dB at 2390 MHz.
15.247(d)	Antenna Port Emission	N/A	Refer to Note
15.247(a)(2)	6 dB Bandwidth	N/A	Refer to Note
---	Occupied Bandwidth Measurement	N/A	Refer to Note
15.247(b)	Conducted power	N/A	Refer to Note
15.247(e)	Power Spectral Density	N/A	Refer to Note
15.203	Antenna Requirement	Pass	No antenna connector is used.

Note: Only radiated emissions test had been performed for the addendum. Refer to original report for other test data.

2.1 Measurement Uncertainty

Where relevant, the following measurement uncertainty levels have been estimated for tests performed on the EUT as specified in CISPR 16-4-2:

Measurement	Frequency	Expanded Uncertainty (k=2) (±)
Radiated Emissions up to 1 GHz	30 MHz ~ 200 MHz	2.0153 dB
	200 MHz ~ 1000 MHz	2.0224 dB
Radiated Emissions above 1 GHz	1 GHz ~ 18 GHz	1.0121 dB
	18 GHz ~ 40 GHz	1.1508 dB

2.2 Modification Record

There were no modifications required for compliance.

3 General Information

3.1 General Description of EUT

Product	Smart Phone
Brand	NOKIA
Test Model	TA-1082
Status of EUT	Production Unit
Power Supply Rating	5.0 Vdc or 9 Vdc or 12 Vdc (adapter) 5.0 Vdc (host equipment) 3.85 Vdc (Li-ion battery)
Modulation Type	CCK, DQPSK, DBPSK for DSSS 64QAM, 16QAM, QPSK, BPSK for OFDM
Modulation Technology	DSSS, OFDM
Transfer Rate	802.11b: 11.0 / 5.5 / 2.0 / 1.0 Mbps 802.11g: 54.0 / 48.0 / 36.0 / 24.0 / 18.0 / 12.0 / 9.0 / 6.0 Mbps 802.11n: up to 300 Mbps
Operating Frequency	2412 ~ 2462 MHz
Number of Channel	11 for 802.11b, 802.11g, 802.11n (HT20) 7 for 802.11n (HT40)
Antenna Type	PIFA antenna with -1.5 dBi gain (Main) PIFA antenna with -3.4 dBi gain (Aux.)
Antenna Connector	N/A
Accessory Device	Refer to Note as below
Data Cable Supplied	Refer to Note as below

Note:

1. This report is issued as a supplementary report to BV CPS report no.: RF180523C09-6. The difference is listed as below. Only radiated emission test was verified in this report.

Report No.	FCC ID	Model	Difference
RF180523C09-6	2AJOTTA-1087	TA-1087	Dual SIM
RF180523C10-6	2AJOTTA-1082	TA-1082	Single SIM

* The models have the same layout, circuit, and components, but different SIM tray.

2. The EUT incorporates a MIMO function. Physically, the EUT provides two completed transmitters and two receivers.

Modulation Mode	Tx Function
802.11b	1TX
802.11g	1TX
802.11n (HT20)	2TX
802.11n (HT40)	2TX

3. The EUT's accessories list refers to Ext. Pho.
4. The above EUT information is declared by manufacturer and for more detailed features description, please refers to the manufacturer's specifications or user's manual.

3.2 Description of Test Modes

11 channels are provided for 802.11b, 802.11g and 802.11n (HT20):

Channel	Frequency (MHz)	Channel	Frequency (MHz)
1	2412	7	2442
2	2417	8	2447
3	2422	9	2452
4	2427	10	2457
5	2432	11	2462
6	2437		

7 channels are provided for 802.11n (HT40):

Channel	Frequency (MHz)	Channel	Frequency (MHz)
3	2422	7	2442
4	2427	8	2447
5	2432	9	2452
6	2437		

3.2.1 Test Mode Applicability and Tested Channel Detail

EUT Configure Mode	Applicable To		Description
	RE \geq 1G	RE $<$ 1G	
-	√	√	-

Where **RE \geq 1G**: Radiated Emission above 1 GHz **RE $<$ 1G**: Radiated Emission below 1 GHz

NOTE: The EUT had been pre-tested on the positioned of each 3 axis. The worst case was found when positioned on **X-plane**.

NOTE: “-” means no effect.

Radiated Emission Test (Above 1 GHz):

- Pre-Scan has been conducted to determine the worst-case mode from all possible combinations between available modulations, data rates and antenna ports (if EUT with antenna diversity architecture).
- Following channel(s) was (were) selected for the final test as listed below.

EUT Configure Mode	Mode	Available Channel	Tested Channel	Modulation Technology	Modulation Type	Data Rate (Mbps)
-	802.11n (HT20)	1 to 11	1	DSSS	DBPSK	1.0

Radiated Emission Test (Below 1 GHz):

- Pre-Scan has been conducted to determine the worst-case mode from all possible combinations between available modulations, data rates and antenna ports (if EUT with antenna diversity architecture).
- Following channel(s) was (were) selected for the final test as listed below.

EUT Configure Mode	Mode	Available Channel	Tested Channel	Modulation Technology	Modulation Type	Data Rate (Mbps)
-	802.11n (HT20)	1 to 11	1	OFDM	BPSK	6.5

Test Condition:

Applicable To	Environmental Conditions	Input Power	Tested by
RE \geq 1G	25 deg. C, 65 % RH	120 Vac, 60 Hz	Karl Lee
RE $<$ 1G	25 deg. C, 65 % RH	120 Vac, 60 Hz	Karl Lee

3.3 Description of Support Units

The EUT has been tested as an independent unit together with other necessary accessories or support units.

3.3.1 Configuration of System under Test

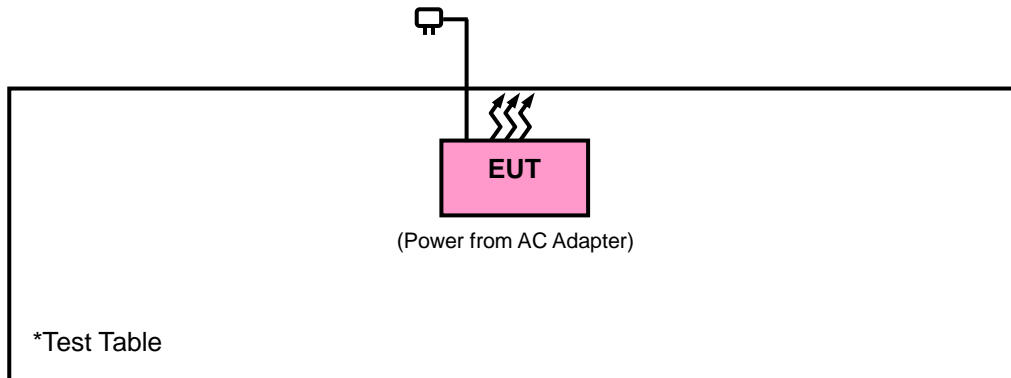

3.4 General Description of Applied Standards

The EUT is a RF Product. According to the specifications of the manufacturer, it must comply with the requirements of the following standards:

FCC Part 15, Subpart C (15.247)

KDB 558074 D01 DTS Meas Guidance v04

KDB 662911 D01 Multiple Transmitter Output v02r01

ANSI C63.10-2013

All test items have been performed and recorded as per the above standards.

4 Test Types and Results

4.1 Radiated Emission and Bandedge Measurement

4.1.1 Limits of Radiated Emission and Bandedge Measurement

Radiated emissions which fall in the restricted bands must comply with the radiated emission limits specified as below table. Other emissions shall be at least 20 dB below the highest level of the desired power:

Frequencies (MHz)	Field Strength (microvolts/meter)	Measurement Distance (meters)
0.009 ~ 0.490	2400/F (kHz)	300
0.490 ~ 1.705	24000/F (kHz)	30
1.705 ~ 30.0	30	30
30 ~ 88	100	3
88 ~ 216	150	3
216 ~ 960	200	3
Above 960	500	3

NOTE:

1. The lower limit shall apply at the transition frequencies.
2. Emission level (dBuV/m) = 20 log Emission level (uV/m).
3. For frequencies above 1000 MHz, the field strength limits are based on average detector, however, the peak field strength of any emission shall not exceed the maximum permitted average limits, specified above by more than 20 dB under any condition of modulation.

4.1.2 Test Instruments

Description & Manufacturer	Model No.	Serial No.	Date of Calibration	Due Date of Calibration
Test Receiver Agilent Technologies	N9038A	MY52260177	Jul. 05, 2017	Jul. 04, 2018
Spectrum Analyzer ROHDE & SCHWARZ	FSU43	101261	Jan. 11, 2018	Jan. 10, 2019
Double Ridge Guide Horn Antenna EMCO	3115	5619	Nov. 30, 2017	Nov. 29, 2018
BILOG Antenna SCHWARZBECK	VULB 9168	9168-153	Dec. 06, 2017	Dec. 05, 2018
Fixed Attenuator Mini-Circuits	BW-N10W5+	NA	Jul. 07, 2017	Jul. 06, 2018
Loop Antenna	EM-6879	269	Aug. 11, 2017	Aug. 10, 2018
Preamplifier Agilent	8447D	2944A10628	Oct. 13, 2018	Oct. 12, 2019
Preamplifier Agilent	8449B	3008A01962	Oct. 13, 2018	Oct. 12, 2019
RF signal cable ETS-LINDGREN	5D-FB	Cable-RF1-01(RFC -SMS-100-SMS-12 0+MY13379/4)	Jun. 20, 2018	Jun. 19, 2019
RF signal cable ETS-LINDGREN	8D-FB	Cable-RF1-02(RFC -SMS-100-NMS-12 0+8120_5140_2911)	Jun. 20, 2018	Jun. 19, 2019
Boresight Antenna Fixture	FBA-01	FBA-SIP01	NA	NA
Software BV ADT	E3 8.130425b	NA	NA	NA
Antenna Tower MF	NA	NA	NA	NA
Turn Table MF	NA	NA	NA	NA
Antenna Tower & Turn Table Controller MF	MF-7802	NA	NA	NA

- Note: 1. The calibration interval of the above test instruments is 12 months and the calibrations are traceable to NML/ROC and NIST/USA.
2. The test was performed in HsinTien Chamber 1.
3. The horn antenna and preamplifier (model: 83017A) are used only for the measurement of emission frequency above 1 GHz if tested.
4. The IC Site Registration No. is IC7450I-1.

4.1.3 Test Procedures

For Radiated Emission below 30 MHz

- a. The EUT was placed on the top of a rotating table 0.8 meters above the ground at a 3 meter chamber room. The table was rotated 360 degrees to determine the position of the highest radiation.
- b. The EUT was set 3 meters away from the interference-receiving antenna, which was mounted on the top of a variable-height antenna tower.
- c. Parallel, perpendicular, and ground-parallel orientations of the antenna are set to make the measurement.
- d. For each suspected emission, the EUT was arranged to its worst case and the rotatable table was turned from 0 degrees to 360 degrees to find the maximum reading.
- e. The test-receiver system was set to Quasi-Peak Detect Function and Specified Bandwidth with Maximum Hold Mode.

Note:

1. The resolution bandwidth and video bandwidth of test receiver/spectrum analyzer is 9 kHz at frequency below 30 MHz.

For Radiated Emission above 30 MHz

- a. The EUT was placed on the top of a rotating table 0.8 meters (for 30 MHz ~ 1 GHz) / 1.5 meters (for above 1 GHz) above the ground at 3 meter chamber room for test. The table was rotated 360 degrees to determine the position of the highest radiation.
- b. The EUT was set 3 meters away from the interference-receiving antenna, which was mounted on the top of a variable-height antenna tower.
- c. The height of antenna is varied from one meter to four meters above the ground to determine the maximum value of the field strength. Both horizontal and vertical polarizations of the antenna are set to make the measurement.
- d. For each suspected emission, the EUT was arranged to its worst case and then the antenna was tuned to heights from 1 meter to 4 meters and the rotatable table was turned from 0 degrees to 360 degrees to find the maximum reading.
- e. The test-receiver system was set to quasi-peak detect function and specified bandwidth with maximum hold mode when the test frequency is below 1 GHz.
- f. The test-receiver system was set to peak and average detected function and specified bandwidth with maximum hold mode when the test frequency is above 1 GHz. If the peak reading value also meets average limit, measurement with the average detector is unnecessary.

Note:

1. The resolution bandwidth and video bandwidth of test receiver/spectrum analyzer is 120 kHz for Quasi-peak detection (QP) at frequency below 1 GHz.
2. The resolution bandwidth of test receiver/spectrum analyzer is 1 MHz and the video bandwidth is 3 MHz for Peak detection (PK) at frequency above 1 GHz.
3. The resolution bandwidth of test receiver/spectrum analyzer is 1 MHz and the video bandwidth is $\geq 1/T$ (Duty cycle < 98 %) or 10 Hz (Duty cycle ≥ 98 %) for Average detection (AV) at frequency above 1 GHz.
(11b: RBW = 1 MHz, VBW = 10 kHz ; 11g: RBW = 1 MHz, VBW = 1 kHz ;
11n (HT20): RBW = 1 MHz, VBW = 1 kHz ; 11n (HT40): RBW = 1 MHz, VBW = 3 kHz)
4. All modes of operation were investigated and the worst-case emissions are reported.

4.1.4 Deviation from Test Standard

No deviation.

4.1.5 Test Set Up

<Radiated Emission below 30 MHz>

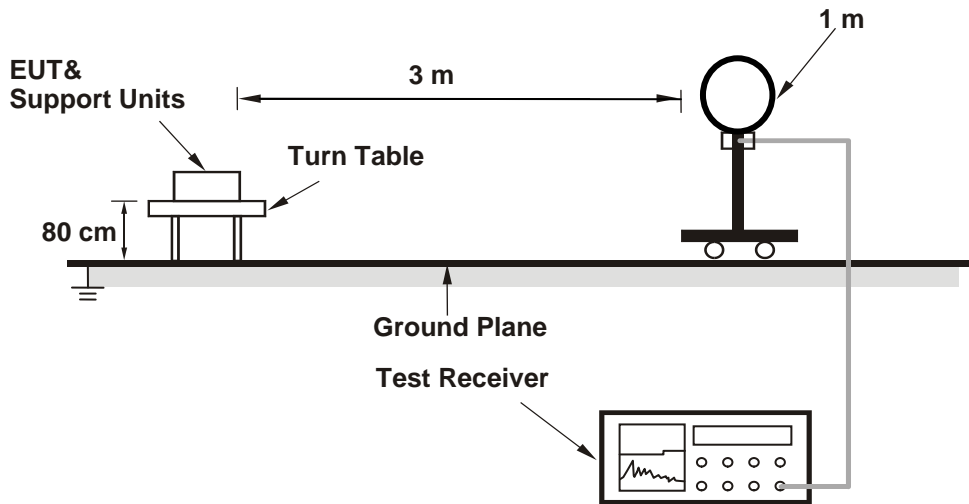

<Radiated Emission 30 MHz to 1 GHz>

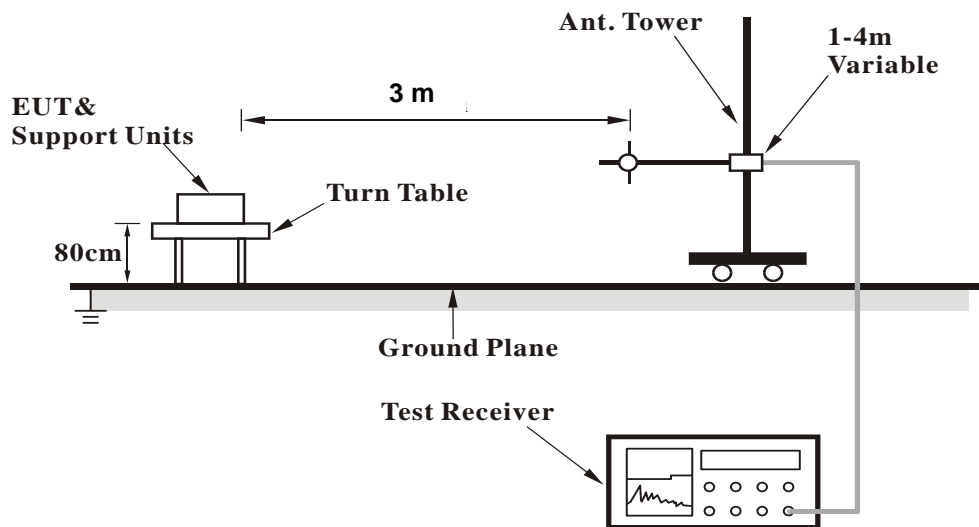

<Radiated Emission above 1 GHz>

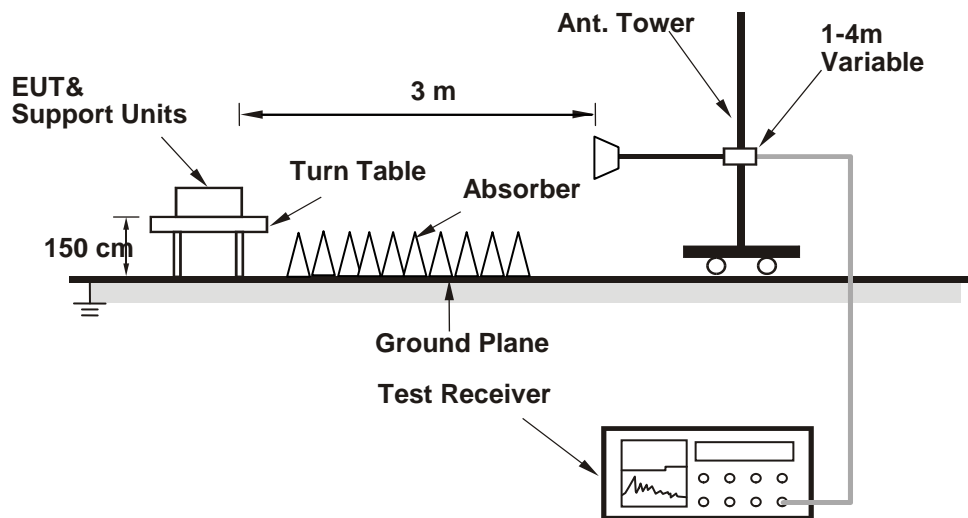

For the actual test configuration, please refer to the attached file (Test Setup Photo).

4.1.6 EUT Operating Conditions

- Placed the EUT on a testing table.
- Use the software to control the EUT under transmission condition continuously at specific channel frequency.

4.1.7 Test Results

Above 1 GHz Data :

<2TX>

802.11n (HT20)

EUT Test Condition		Measurement Detail	
Channel	Channel 1	Frequency Range	1 GHz ~ 25 GHz
Input Power	120 Vac, 60 Hz	Detector Function	Peak (PK) Average (AV)
Environmental Conditions	25 deg. C, 65 % RH	Tested By	Karl Lee

Antennal Polarity & Test Distance: Horizontal at 3 m										
Frequency (MHz)	Emission Level (dBuV/m)	Read Level (dBuV)	Limit (dBuV/m)	Margin (dB)	Antenna Factor (dB/m)	Cable Loss (dB)	Preamp Factor (dB)	Antenna Height (cm)	Table Angle (Degree)	Remark
2390	52.11	50.38	54	-1.89	31.8	5.4	35.47	100	11	Average
2390	64.33	62.6	74	-9.67	31.8	5.4	35.47	100	11	Peak
2412	95.02	93.25			31.81	5.43	35.47	100	11	Average
2412	103.36	101.59			31.81	5.43	35.47	100	11	Peak
4824	37.05	28.92	54	-16.95	33.97	8.26	34.1	101	11	Average
4824	47.05	38.92	74	-26.95	33.97	8.26	34.1	101	11	Peak
Antennal Polarity & Test Distance: Vertical at 3 m										
Frequency (MHz)	Emission Level (dBuV/m)	Read Level (dBuV)	Limit (dBuV/m)	Margin (dB)	Antenna Factor (dB/m)	Cable Loss (dB)	Preamp Factor (dB)	Antenna Height (cm)	Table Angle (Degree)	Remark
2386	44.47	42.76	54	-9.53	31.8	5.4	35.49	222	16	Average
2386	56.65	54.94	74	-17.35	31.8	5.4	35.49	222	16	Peak
2412	91.11	89.34			31.81	5.43	35.47	222	16	Average
2412	100	98.23			31.81	5.43	35.47	222	16	Peak
4824	37.06	28.93	54	-16.94	33.97	8.26	34.1	135	340	Average
4824	47.4	39.27	74	-26.6	33.97	8.26	34.1	135	340	Peak

Remarks:

- Emission Level = Read Level + Antenna Factor + Cable Loss - Preamp Factor
Margin value = Emission level – Limit value
- 2412 MHz: Fundamental frequency.

9 kHz ~ 30 MHz Data:

The amplitude of spurious emissions attenuated more than 20 dB below the permissible value is not required to be report.

30 MHz ~ 1 GHz Worst-Case Data:

<2TX>

802.11n (HT20)

EUT Test Condition		Measurement Detail	
Channel	Channel 1	Frequency Range	30 MHz ~ 1 GHz
Input Power	120 Vac, 60 Hz	Detector Function	Peak (PK) Quasi-peak (QP)
Environmental Conditions	25 deg. C, 65 % RH	Tested By	Karl Lee

Antennal Polarity & Test Distance: Horizontal at 3 m										
Frequency (MHz)	Emission Level (dBuV/m)	Read Level (dBuV)	Limit (dBuV/m)	Margin (dB)	Antenna Factor (dB/m)	Cable Loss (dB)	Preamp Factor (dB)	Antenna Height (cm)	Table Angle (Degree)	Remark
48.63	12.61	29.37	40	-27.39	14.56	0.9	32.22	163	33	Peak
163.38	19.34	41.19	43.5	-24.16	8.89	1.52	32.26	177	85	Peak
270.84	15.93	33.46	46	-30.07	12.64	1.94	32.11	126	65	Peak
391	18.2	33.25	46	-27.8	14.81	2.34	32.2	115	54	Peak
703.9	19.14	28.83	46	-26.86	19.29	3.11	32.09	192	282	Peak
811	21.04	29.22	46	-24.96	20.5	3.32	32	124	200	Peak
Antennal Polarity & Test Distance: Vertical at 3 m										
Frequency (MHz)	Emission Level (dBuV/m)	Read Level (dBuV)	Limit (dBuV/m)	Margin (dB)	Antenna Factor (dB/m)	Cable Loss (dB)	Preamp Factor (dB)	Antenna Height (cm)	Table Angle (Degree)	Remark
50.25	18.27	35.05	40	-21.73	14.54	0.9	32.22	165	250	Peak
158.79	13.56	35.6	43.5	-29.94	8.71	1.52	32.27	172	111	Peak
249.24	11.08	29.03	46	-34.92	12.3	1.85	32.1	124	249	Peak
523.3	16.33	29.12	46	-29.67	16.65	2.7	32.14	165	333	Peak
752.2	21.43	30.51	46	-24.57	19.84	3.22	32.14	185	8	Peak
820.8	20.9	28.88	46	-25.1	20.65	3.32	31.95	175	209	Peak

Remarks:

- Emission Level = Read Level + Antenna Factor + Cable Loss - Preamp Factor
Margin value = Emission level – Limit value

5 Pictures of Test Arrangements

Please refer to the attached file (Test Setup Photo).

Appendix – Information on the Testing Laboratories

We, Bureau Veritas Consumer Products Services (H.K.) Ltd., Taoyuan Branch, were founded in 1988 to provide our best service in EMC, Radio, Telecom and Safety consultation. Our laboratories are FCC recognized accredited test firms and accredited according to ISO/IEC 17025.

If you have any comments, please feel free to contact us at the following:

Linko EMC/RF Lab

Tel: 886-2-26052180

Fax: 886-2-26051924

Hsin Chu EMC/RF/Telecom Lab

Tel: 886-3-6668565

Fax: 886-3-6668323

Hwa Ya EMC/RF/Safety Lab

Tel: 886-3-3183232

Fax: 886-3-3270892

Email: service.adt@tw.bureauveritas.com

Web Site: www.bureauveritas-adt.com

The address and road map of all our labs can be found in our web site also.

--- END ---

Annex A –Test Report for TA-1087 (Dual SIM)

FCC Test Report

Report No.: RF180523C09-6 R1

FCC ID: 2AJOTTA-1087

Test Model: TA-1087

Received Date: May 23, 2018

Test Date: Jun. 05, 2018 ~ Jul. 17, 2018

Issued Date: Oct. 24, 2018

Applicant: HMD Global Oy

Address: Bertel Jungin aukio 9, 02600 Espoo, Finland

Issued By: Bureau Veritas Consumer Products Services (H.K.) Ltd., Taoyuan Branch

Lab Address: No. 47-2, 14th Ling, Chia Pau Vil., Lin Kou Dist., New Taipei City, Taiwan
(R.O.C)

Test Location (1): No.19, Hwa Ya 2nd Rd., Wen Hwa Vil., Kwei Shan Dist., Taoyuan City
33383, Taiwan, R.O.C.

Test Location (2): No.215, Sec. 3, Beixin Rd., Xindian Dist., New Taipei City 231, Taiwan,
R.O.C

**FCC Registration /
Designation Number:** 427177 / TW0011



This report is for your exclusive use. Any copying or replication of this report to or for any other person or entity, or use of our name or trademark, is permitted only with our prior written permission. This report sets forth our findings solely with respect to the test samples identified herein. The results set forth in this report are not indicative or representative of the quality or characteristics of the lot from which a test sample was taken or any similar or identical product unless specifically and expressly noted. Our report includes all of the tests requested by you and the results thereof based upon the information that you provided to us. You have 60 days from date of issuance of this report to notify us of any material error or omission caused by our negligence, provided, however, that such notice shall be in writing and shall specifically address the issue you wish to raise. A failure to raise such issue within the prescribed time shall constitute your unqualified acceptance of the completeness of this report, the tests conducted and the correctness of the report contents. Unless specific mention, the uncertainty of measurement has been explicitly taken into account to declare the compliance or non-compliance to the specification. The report must not be used by the client to claim product certification, approval, or endorsement by TAF or any government agencies.

Table of Contents

Release Control Record	4
1 Certificate of Conformity	5
2 Summary of Test Results	6
2.1 Measurement Uncertainty	6
2.2 Modification Record	6
3 General Information	7
3.1 General Description of EUT	7
3.2 Description of Test Modes	8
3.2.1 Test Mode Applicability and Tested Channel Detail	9
3.3 Duty Cycle of Test Signal	11
3.4 Description of Support Units	12
3.4.1 Configuration of System under Test	12
3.5 General Description of Applied Standards	12
4 Test Types and Results	13
4.1 Radiated Emission and Bandedge Measurement	13
4.1.1 Limits of Radiated Emission and Bandedge Measurement	13
4.1.2 Test Instruments	14
4.1.3 Test Procedures	15
4.1.4 Deviation from Test Standard	16
4.1.5 Test Set Up	16
4.1.6 EUT Operating Conditions	17
4.1.7 Test Results	18
4.2 Conducted Emission Measurement	40
4.2.1 Limits of Conducted Emission Measurement	40
4.2.2 Test Instruments	40
4.2.3 Test Procedures	41
4.2.4 Deviation from Test Standard	41
4.2.5 Test Setup	41
4.2.6 EUT Operating Conditions	41
4.2.7 Test Results	42
4.3 6 dB Bandwidth Measurement	44
4.3.1 Limits of 6 dB Bandwidth Measurement	44
4.3.2 Test Setup	44
4.3.3 Test Instruments	44
4.3.4 Test Procedure	44
4.3.5 Deviation from Test Standard	44
4.3.6 EUT Operating Conditions	44
4.3.7 Test Result	45
4.4 Occupied Bandwidth Measurement	47
4.4.1 Test Setup	47
4.4.2 Test Instruments	47
4.4.3 Test Procedure	47
4.4.4 Deviation from Test Standard	47
4.4.5 EUT Operating Conditions	47
4.4.6 Test Results	48
4.5 Conducted Output Power Measurement	50
4.5.1 Limits of Conducted Output Power Measurement	50
4.5.2 Test Setup	50
4.5.3 Test Instruments	50
4.5.4 Test Procedures	50
4.5.5 Deviation from Test Standard	50
4.5.6 EUT Operating Conditions	50
4.5.7 Test Results	51

4.6	Power Spectral Density Measurement	52
4.6.1	Limits of Power Spectral Density Measurement.....	52
4.6.2	Test Setup.....	52
4.6.3	Test Instruments	52
4.6.4	Test Procedure	52
4.6.5	Deviation from Test Standard	52
4.6.6	EUT Operating Condition	52
4.6.7	Test Results	53
4.7	Conducted Out of Band Emission Measurement	55
4.7.1	Limits of Conducted Out of Band Emission Measurement.....	55
4.7.2	Test Setup.....	55
4.7.3	Test Instruments	55
4.7.4	Test Procedure	55
4.7.5	Deviation from Test Standard	55
4.7.6	EUT Operating Condition	55
4.7.7	Test Results	56
5	Pictures of Test Arrangements.....	68
	Appendix – Information on the Testing Laboratories	69

Release Control Record

Issue No.	Description	Date Issued
RF180523C09-6	Original Release	Jun. 28, 2018
RF180523C09-6 R1	Revise applicant's address	Oct. 24, 2018

1 Certificate of Conformity

Product: Smart Phone

Brand: NOKIA

Test Model: TA-1087

Sample Status: Production Unit

Applicant: HMD Global Oy

Test Date: Jun. 05, 2018 ~ Jul. 17, 2018

Standards: 47 CFR FCC Part 15, Subpart C (Section 15.247)
ANSI C63.10:2013

The above equipment has been tested by **Bureau Veritas Consumer Products Services (H.K.) Ltd., Taoyuan Branch**, and found compliance with the requirement of the above standards. The test record, data evaluation & Equipment Under Test (EUT) configurations represented herein are true and accurate accounts of the measurements of the sample's RF characteristics under the conditions specified in this report.

Prepared by : , **Date:** Oct. 24, 2018
Ivonne Wu / Supervisor

Approved by : , **Date:** Oct. 24, 2018
Dylan Chiou / Project Engineer

2 Summary of Test Results

47 CFR FCC Part 15, Subpart C (Section 15.247)			
FCC Clause	Test Item	Result	Remarks
15.207	AC Power Conducted Emission	Pass	Meet the requirement of limit. Minimum passing margin is -12.83 dB at 0.16569 MHz.
15.205 / 15.209 / 15.247(d)	Radiated Emissions and Band Edge Measurement	Pass	Meet the requirement of limit. Minimum passing margin is -1.04 dB at 2389.92 MHz.
15.247(d)	Antenna Port Emission	Pass	Meet the requirement of limit.
15.247(a)(2)	6 dB Bandwidth	Pass	Meet the requirement of limit.
---	Occupied Bandwidth Measurement	Pass	Reference only
15.247(b)	Conducted power	Pass	Meet the requirement of limit.
15.247(e)	Power Spectral Density	Pass	Meet the requirement of limit.
15.203	Antenna Requirement	Pass	No antenna connector is used.

2.1 Measurement Uncertainty

Where relevant, the following measurement uncertainty levels have been estimated for tests performed on the EUT as specified in CISPR 16-4-2:

Measurement	Frequency	Expanded Uncertainty (k=2) (±)
Conducted Emissions at mains ports	150 kHz ~ 30 MHz	2.44 dB
Radiated Emissions up to 1 GHz	30 MHz ~ 200 MHz	2.0153 dB
	200 MHz ~ 1000 MHz	2.0224 dB
Radiated Emissions above 1 GHz	1 GHz ~ 18 GHz	1.0121 dB
	18 GHz ~ 40 GHz	1.1508 dB

2.2 Modification Record

There were no modifications required for compliance.

3 General Information

3.1 General Description of EUT

Product	Smart Phone
Brand	NOKIA
Test Model	TA-1087
Status of EUT	Production Unit
Power Supply Rating	5.0 Vdc or 9 Vdc or 12 Vdc (adapter) 5.0 Vdc (host equipment) 3.85 Vdc (Li-ion battery)
Modulation Type	CCK, DQPSK, DBPSK for DSSS 64QAM, 16QAM, QPSK, BPSK for OFDM
Modulation Technology	DSSS, OFDM
Transfer Rate	802.11b: 11.0 / 5.5 / 2.0 / 1.0 Mbps 802.11g: 54.0 / 48.0 / 36.0 / 24.0 / 18.0 / 12.0 / 9.0 / 6.0 Mbps 802.11n: up to 300 Mbps
Operating Frequency	2412 ~ 2462 MHz
Number of Channel	11 for 802.11b, 802.11g, 802.11n (HT20) 7 for 802.11n (HT40)
Output Power	413.233 mW
Antenna Type	PIFA antenna with -1.5 dBi gain (Main) PIFA antenna with -3.4 dBi gain (Aux.)
Antenna Connector	N/A
Accessory Device	Refer to Note as below
Data Cable Supplied	Refer to Note as below

Note:

1. The EUT incorporates a MIMO function. Physically, the EUT provides two completed transmitters and two receivers.

Modulation Mode	Tx Function
802.11b	1TX
802.11g	1TX
802.11n (HT20)	2TX
802.11n (HT40)	2TX

2. The EUT's accessories list refers to Ext. Pho.
3. The above EUT information is declared by manufacturer and for more detailed features description, please refers to the manufacturer's specifications or user's manual.

3.2 Description of Test Modes

11 channels are provided for 802.11b, 802.11g and 802.11n (HT20):

Channel	Frequency (MHz)	Channel	Frequency (MHz)
1	2412	7	2442
2	2417	8	2447
3	2422	9	2452
4	2427	10	2457
5	2432	11	2462
6	2437		

7 channels are provided for 802.11n (HT40):

Channel	Frequency (MHz)	Channel	Frequency (MHz)
3	2422	7	2442
4	2427	8	2447
5	2432	9	2452
6	2437		

3.2.1 Test Mode Applicability and Tested Channel Detail

EUT Configure Mode	Applicable To				Description
	RE \geq 1G	RE<1G	PLC	APCM	
-	√	√	√	√	-

Where **RE \geq 1G**: Radiated Emission above 1 GHz **RE<1G**: Radiated Emission below 1 GHz
PLC: Power Line Conducted Emission **APCM**: Antenna Port Conducted Measurement

NOTE: The EUT had been pre-tested on the positioned of each 3 axis. The worst case was found when positioned on **X-plane**.

NOTE: "-" means no effect.

Radiated Emission Test (Above 1 GHz):

- Pre-Scan has been conducted to determine the worst-case mode from all possible combinations between available modulations, data rates and antenna ports (if EUT with antenna diversity architecture).
- Following channel(s) was (were) selected for the final test as listed below.

EUT Configure Mode	Mode	Available Channel	Tested Channel	Modulation Technology	Modulation Type	Data Rate (Mbps)
-	802.11b	1 to 11	1, 6, 9, 10, 11	DSSS	DBPSK	1.0
-	802.11g	1 to 11	1, 6, 9, 10, 11	OFDM	BPSK	6.0
-	802.11n (HT20)	1 to 11	1, 6, 8, 9, 10, 11	OFDM	BPSK	6.5
-	802.11n (HT40)	3 to 9	3, 6, 7, 8, 9	OFDM	BPSK	13.5

Radiated Emission Test (Below 1 GHz):

- Pre-Scan has been conducted to determine the worst-case mode from all possible combinations between available modulations, data rates and antenna ports (if EUT with antenna diversity architecture).
- Following channel(s) was (were) selected for the final test as listed below.

EUT Configure Mode	Mode	Available Channel	Tested Channel	Modulation Technology	Modulation Type	Data Rate (Mbps)
-	802.11n (HT20)	1 to 11	1	OFDM	BPSK	6.5

Power Line Conducted Emission Test:

- Pre-Scan has been conducted to determine the worst-case mode from all possible combinations between available modulations, data rates and antenna ports (if EUT with antenna diversity architecture).
- Following channel(s) was (were) selected for the final test as listed below.

EUT Configure Mode	Mode	Available Channel	Tested Channel	Modulation Technology	Modulation Type	Data Rate (Mbps)
-	802.11n (HT20)	1 to 11	1	OFDM	BPSK	6.5

Bandedge Measurement:

- Pre-Scan has been conducted to determine the worst-case mode from all possible combinations between available modulations, data rates and antenna ports (if EUT with antenna diversity architecture).
- Following channel(s) was (were) selected for the final test as listed below.

EUT Configure Mode	Mode	Available Channel	Tested Channel	Modulation Technology	Modulation Type	Data Rate (Mbps)
-	802.11b	1 to 11	1, 11	DSSS	DBPSK	1.0
-	802.11g	1 to 11	1, 11	OFDM	BPSK	6.0
-	802.11n (HT20)	1 to 11	1, 11	OFDM	BPSK	6.5
-	802.11n (HT40)	3 to 9	3, 9	OFDM	BPSK	13.5

Antenna Port Conducted Measurement:

- This item includes all test value of each mode, but only includes spectrum plot of worst value of each mode.
- Pre-Scan has been conducted to determine the worst-case mode from all possible combinations between available modulations, data rates and antenna ports (if EUT with antenna diversity architecture).
- Following channel(s) was (were) selected for the final test as listed below.

EUT Configure Mode	Mode	Available Channel	Tested Channel	Modulation Technology	Modulation Type	Data Rate (Mbps)
-	802.11b	1 to 11	1, 6, 11	DSSS	DBPSK	1.0
-	802.11g	1 to 11	1, 6, 11	OFDM	BPSK	6.0
-	802.11n (HT20)	1 to 11	1, 6, 11	OFDM	BPSK	6.5
-	802.11n (HT40)	3 to 9	3, 6, 9	OFDM	BPSK	13.5

Test Condition:

Applicable To	Environmental Conditions	Input Power	Tested by
RE \geq 1G	25 deg. C, 65 % RH	120 Vac, 60 Hz	Karl Lee
RE<1G	25 deg. C, 65 % RH	120 Vac, 60 Hz	Karl Lee
PLC	25 deg. C, 65 % RH	120 Vac, 60 Hz	Jisyong Wang
APCM	25 deg. C, 65 % RH	3.85 Vdc	Carlos Chen

3.3 Duty Cycle of Test Signal

Duty cycle of test signal is $\geq 98\%$, duty factor is not required.

Duty cycle of test signal is $< 98\%$, duty factor shall be considered.

802.11b: Duty cycle = $12.48/12.578 = 0.992$

802.11g: Duty cycle = $2.062/2.102 = 0.981$

802.11n (HT20): Duty cycle = $1.921/2.003 = 0.959$, Duty factor = $10 * \log(1/0.959) = 0.18$

802.11n (HT40): Duty cycle = $0.947/1 = 0.947$, Duty factor = $10 * \log(1/0.947) = 0.24$

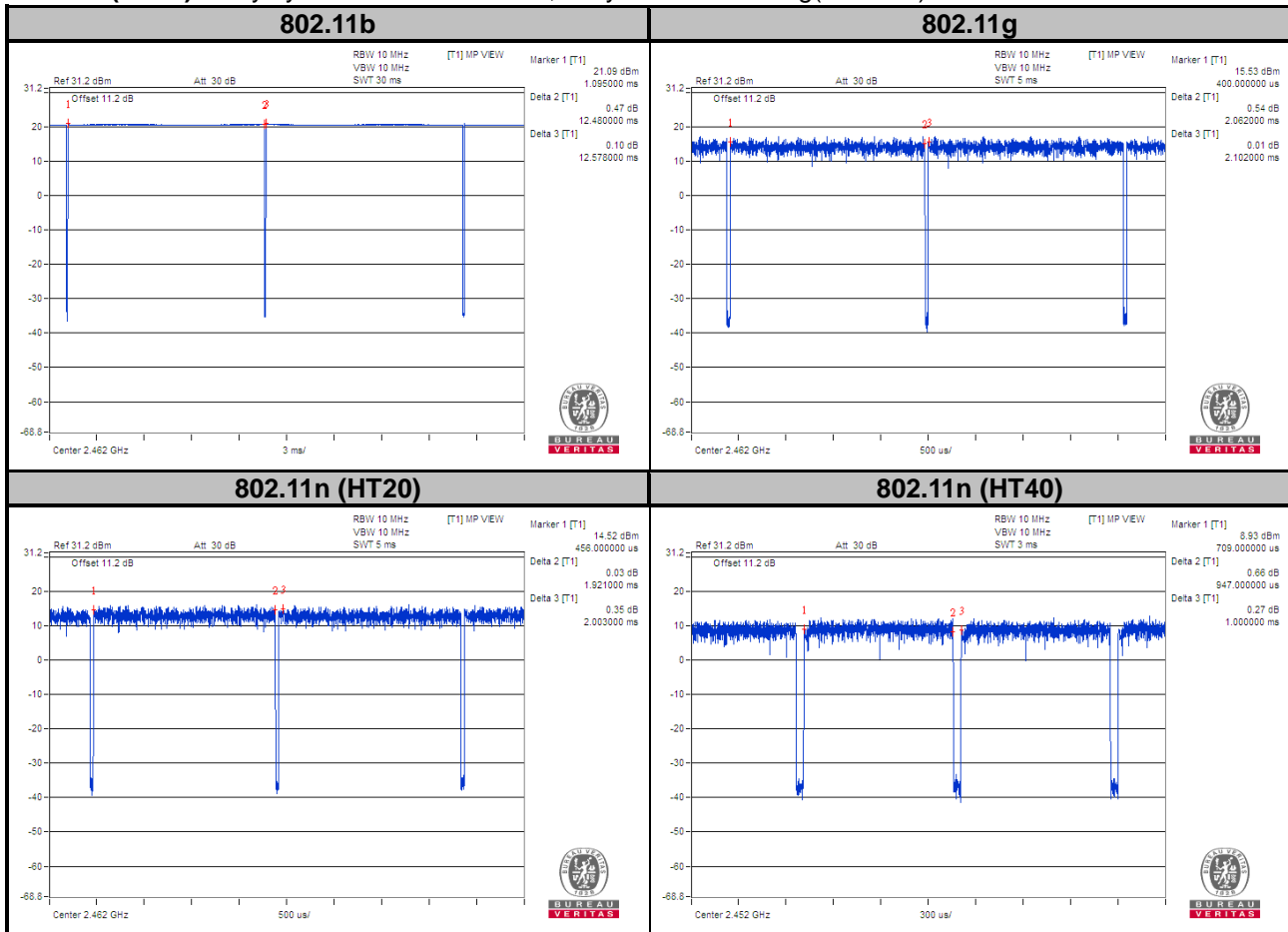

3.4 Description of Support Units

The EUT has been tested as an independent unit together with other necessary accessories or support units.

3.4.1 Configuration of System under Test

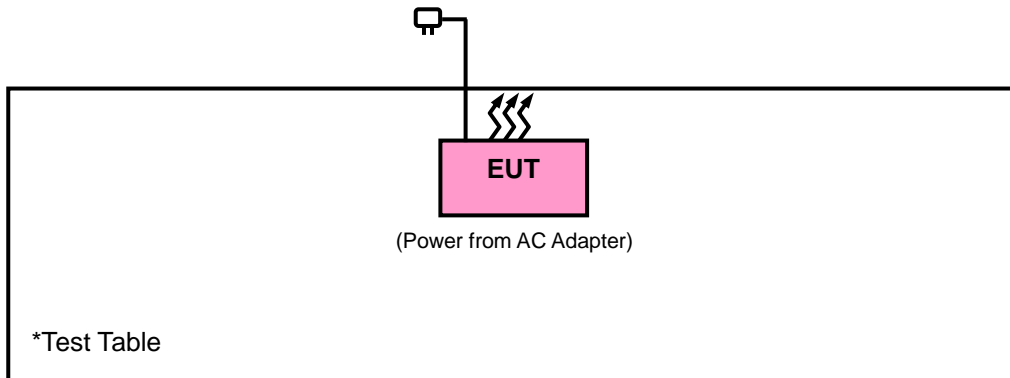

3.5 General Description of Applied Standards

The EUT is a RF Product. According to the specifications of the manufacturer, it must comply with the requirements of the following standards:

FCC Part 15, Subpart C (15.247)

KDB 558074 D01 DTS Meas Guidance v04

KDB 662911 D01 Multiple Transmitter Output v02r01

ANSI C63.10-2013

All test items have been performed and recorded as per the above standards.

4 Test Types and Results

4.1 Radiated Emission and Bandedge Measurement

4.1.1 Limits of Radiated Emission and Bandedge Measurement

Radiated emissions which fall in the restricted bands must comply with the radiated emission limits specified as below table. Other emissions shall be at least 20 dB below the highest level of the desired power:

Frequencies (MHz)	Field Strength (microvolts/meter)	Measurement Distance (meters)
0.009 ~ 0.490	2400/F (kHz)	300
0.490 ~ 1.705	24000/F (kHz)	30
1.705 ~ 30.0	30	30
30 ~ 88	100	3
88 ~ 216	150	3
216 ~ 960	200	3
Above 960	500	3

NOTE:

1. The lower limit shall apply at the transition frequencies.
2. Emission level (dBuV/m) = 20 log Emission level (uV/m).
3. For frequencies above 1000 MHz, the field strength limits are based on average detector, however, the peak field strength of any emission shall not exceed the maximum permitted average limits, specified above by more than 20 dB under any condition of modulation.

4.1.2 Test Instruments

Description & Manufacturer	Model No.	Serial No.	Date of Calibration	Due Date of Calibration
Signal Analyzer Agilent Technologies	N9010A	MY52220207	Dec. 07, 2017	Dec. 06, 2018
Spectrum Analyzer ROHDE & SCHWARZ	F5U43	101261	Jan. 11, 2018	Jan. 10, 2019
Double Ridge Guide Horn Antenna EMCO	3115	5619	Nov. 30, 2017	Nov. 29, 2018
BILOG Antenna SCHWARZBECK	VULB 9168	9168-153	Dec. 06, 2017	Dec. 05, 2018
Fixed Attenuator Mini-Circuits	BW-N10W5+	NA	Jul. 07, 2017	Jul. 06, 2018
			Jul. 06, 2018	Jul. 05, 2019
Loop Antenna	EM-6879	269	Aug. 11, 2017	Aug. 10, 2018
Preamplifier Agilent	310N	187226	Jun. 23, 2017	Jun. 22, 2018
			Jun. 20, 2018	Jun. 19, 2019
Preamplifier Agilent	83017A	MY39501357	Jun. 23, 2017	Jun. 22, 2018
			Jun. 20, 2018	Jun. 19, 2019
Power Meter Anritsu	ML2495A	1012010	Aug. 15, 2017	Aug. 14, 2018
Power Sensor Anritsu	MA2411B	1315050	Aug. 15, 2017	Aug. 14, 2018
RF signal cable ETS-LINDGREN	5D-FB	Cable-CH1-01(RFC-SMS-100-SMS-120+RFC-SMS-100-SMS-400)	Jun. 26, 2017	Jun. 25, 2018
			Jun. 20, 2018	Jun. 19, 2019
RF signal cable ETS-LINDGREN	8D-FB	Cable-CH1-02(RFC-SMS-100-SMS-24)	Jun. 26, 2017	Jun. 25, 2018
			Jun. 20, 2018	Jun. 19, 2019
Boresight Antenna Fixture	FBA-01	FBA-SIP01	NA	NA
Software BV ADT	E3 8.130425b	NA	NA	NA
Antenna Tower MF	NA	NA	NA	NA
Turn Table MF	NA	NA	NA	NA
Antenna Tower & Turn Table Controller MF	MF-7802	NA	NA	NA

- Note: 1. The calibration interval of the above test instruments is 12 months and the calibrations are traceable to NML/ROC and NIST/USA.
2. The test was performed in HsinTien Chamber 1.
3. The horn antenna and preamplifier (model: 83017A) are used only for the measurement of emission frequency above 1 GHz if tested.
4. The IC Site Registration No. is IC7450I-1.

4.1.3 Test Procedures

For Radiated Emission below 30 MHz

- a. The EUT was placed on the top of a rotating table 0.8 meters above the ground at a 3 meter chamber room. The table was rotated 360 degrees to determine the position of the highest radiation.
- b. The EUT was set 3 meters away from the interference-receiving antenna, which was mounted on the top of a variable-height antenna tower.
- c. Parallel, perpendicular, and ground-parallel orientations of the antenna are set to make the measurement.
- d. For each suspected emission, the EUT was arranged to its worst case and the rotatable table was turned from 0 degrees to 360 degrees to find the maximum reading.
- e. The test-receiver system was set to Quasi-Peak Detect Function and Specified Bandwidth with Maximum Hold Mode.

Note:

1. The resolution bandwidth and video bandwidth of test receiver/spectrum analyzer is 9 kHz at frequency below 30 MHz.

For Radiated Emission above 30 MHz

- a. The EUT was placed on the top of a rotating table 0.8 meters (for 30 MHz ~ 1 GHz) / 1.5 meters (for above 1 GHz) above the ground at 3 meter chamber room for test. The table was rotated 360 degrees to determine the position of the highest radiation.
- b. The EUT was set 3 meters away from the interference-receiving antenna, which was mounted on the top of a variable-height antenna tower.
- c. The height of antenna is varied from one meter to four meters above the ground to determine the maximum value of the field strength. Both horizontal and vertical polarizations of the antenna are set to make the measurement.
- d. For each suspected emission, the EUT was arranged to its worst case and then the antenna was tuned to heights from 1 meter to 4 meters and the rotatable table was turned from 0 degrees to 360 degrees to find the maximum reading.
- e. The test-receiver system was set to quasi-peak detect function and specified bandwidth with maximum hold mode when the test frequency is below 1 GHz.
- f. The test-receiver system was set to peak and average detected function and specified bandwidth with maximum hold mode when the test frequency is above 1 GHz. If the peak reading value also meets average limit, measurement with the average detector is unnecessary.

Note:

1. The resolution bandwidth and video bandwidth of test receiver/spectrum analyzer is 120 kHz for Quasi-peak detection (QP) at frequency below 1 GHz.
2. The resolution bandwidth of test receiver/spectrum analyzer is 1 MHz and the video bandwidth is 3 MHz for Peak detection (PK) at frequency above 1 GHz.
3. The resolution bandwidth of test receiver/spectrum analyzer is 1 MHz and the video bandwidth is $\geq 1/T$ (Duty cycle < 98 %) or 10 Hz (Duty cycle ≥ 98 %) for Average detection (AV) at frequency above 1 GHz.
(11b: RBW = 1 MHz, VBW = 10 kHz ; 11g: RBW = 1 MHz, VBW = 1 kHz ;
11n (HT20): RBW = 1 MHz, VBW = 1 kHz ; 11n (HT40): RBW = 1 MHz, VBW = 3 kHz)
4. All modes of operation were investigated and the worst-case emissions are reported.

4.1.4 Deviation from Test Standard

No deviation.

4.1.5 Test Set Up

<Radiated Emission below 30 MHz>

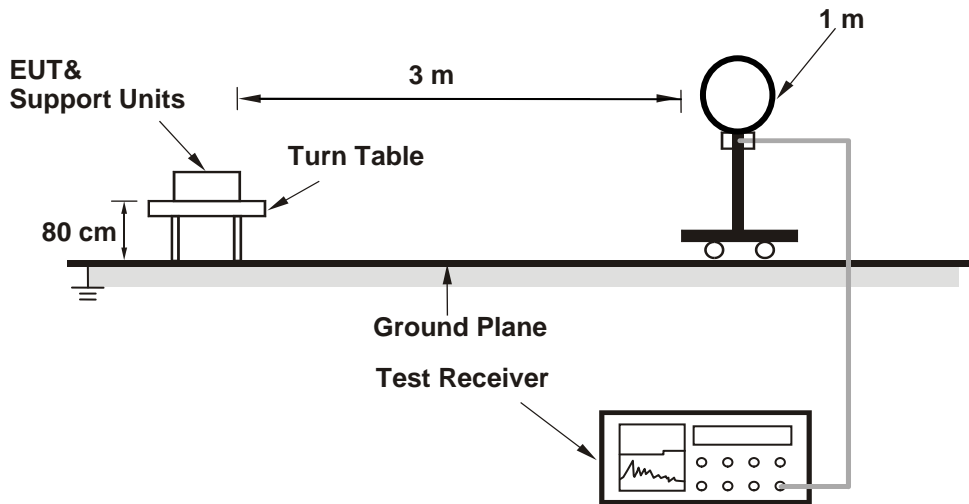

<Radiated Emission 30 MHz to 1 GHz>

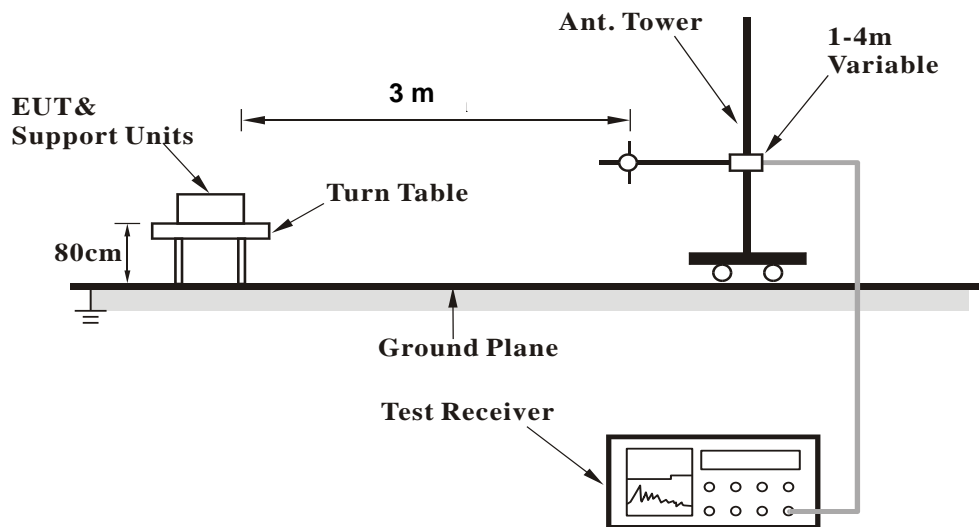

<Radiated Emission above 1 GHz>

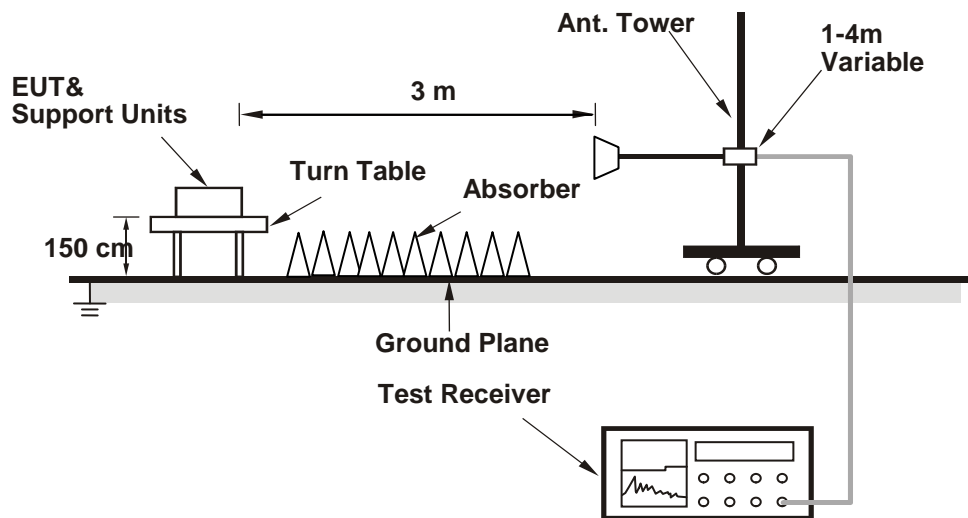

For the actual test configuration, please refer to the attached file (Test Setup Photo).

4.1.6 EUT Operating Conditions

- Placed the EUT on a testing table.
- Use the software to control the EUT under transmission condition continuously at specific channel frequency.

4.1.7 Test Results

Above 1 GHz Data :

<1TX>

802.11b

EUT Test Condition		Measurement Detail	
Channel	Channel 1	Frequency Range	1 GHz ~ 25 GHz
Input Power	120 Vac, 60 Hz	Detector Function	Peak (PK) Average (AV)
Environmental Conditions	25 deg. C, 65 % RH	Tested By	Karl Lee

Antennal Polarity & Test Distance: Horizontal at 3 m										
Frequency (MHz)	Emission Level (dBuV/m)	Read Level (dBuV)	Limit (dBuV/m)	Margin (dB)	Antenna Factor (dB/m)	Cable Loss (dB)	Preamp Factor (dB)	Antenna Height (cm)	Table Angle (Degree)	Remark
2385.33	46.73	45.04	54	-7.27	31.78	5.4	35.49	105	357	Average
2385.33	53.63	51.94	74	-20.37	31.78	5.4	35.49	105	357	Peak
2412	100.86	99.09			31.81	5.43	35.47	105	357	Average
2412	103.7	101.93			31.81	5.43	35.47	105	357	Peak
4824	37.19	29.06	54	-16.81	33.97	8.26	34.1	180	103	Average
4824	47.25	39.12	74	-26.75	33.97	8.26	34.1	180	103	Peak
Antennal Polarity & Test Distance: Vertical at 3 m										
Frequency (MHz)	Emission Level (dBuV/m)	Read Level (dBuV)	Limit (dBuV/m)	Margin (dB)	Antenna Factor (dB/m)	Cable Loss (dB)	Preamp Factor (dB)	Antenna Height (cm)	Table Angle (Degree)	Remark
2385.24	40.77	39.08	54	-13.23	31.78	5.4	35.49	211	7	Average
2385.24	51.52	49.83	74	-22.48	31.78	5.4	35.49	211	7	Peak
2412	92.91	91.14			31.81	5.43	35.47	211	7	Average
2412	95.58	93.81			31.81	5.43	35.47	211	7	Peak
4824	37.36	29.23	54	-16.64	33.97	8.26	34.1	112	149	Average
4824	47.45	39.32	74	-26.55	33.97	8.26	34.1	112	149	Peak

Remarks:

- Emission Level = Read Level + Antenna Factor + Cable Loss - Preamp Factor
Margin value = Emission level – Limit value
- 2412 MHz: Fundamental frequency.

EUT Test Condition		Measurement Detail	
Channel	Channel 6	Frequency Range	1 GHz ~ 25 GHz
Input Power	120 Vac, 60 Hz	Detector Function	Peak (PK) Average (AV)
Environmental Conditions	25 deg. C, 65 % RH	Tested By	Karl Lee

Antennal Polarity & Test Distance: Horizontal at 3 m										
Frequency (MHz)	Emission Level (dBuV/m)	Read Level (dBuV)	Limit (dBuV/m)	Margin (dB)	Antenna Factor (dB/m)	Cable Loss (dB)	Preamp Factor (dB)	Antenna Height (cm)	Table Angle (Degree)	Remark
2389.47	41.21	39.5	54	-12.79	31.8	5.4	35.49	102	354	Average
2389.47	52.22	50.51	74	-21.78	31.8	5.4	35.49	102	354	Peak
2437	101.1	99.25			31.85	5.46	35.46	102	354	Average
2437	103.84	101.99			31.85	5.46	35.46	102	354	Peak
2483.52	41.97	40.01	54	-12.03	31.88	5.5	35.42	102	354	Average
2483.52	53.14	51.18	74	-20.86	31.88	5.5	35.42	102	354	Peak
4874	37.25	29.06	54	-16.75	33.98	8.27	34.06	192	111	Average
4874	47.12	38.93	74	-26.88	33.98	8.27	34.06	192	111	Peak
Antennal Polarity & Test Distance: Vertical at 3 m										
Frequency (MHz)	Emission Level (dBuV/m)	Read Level (dBuV)	Limit (dBuV/m)	Margin (dB)	Antenna Factor (dB/m)	Cable Loss (dB)	Preamp Factor (dB)	Antenna Height (cm)	Table Angle (Degree)	Remark
2383.26	40.41	38.72	54	-13.59	31.78	5.4	35.49	206	7	Average
2383.26	52.24	50.55	74	-21.76	31.78	5.4	35.49	206	7	Peak
2437	92.55	90.7			31.85	5.46	35.46	206	7	Average
2437	95.21	93.36			31.85	5.46	35.46	206	7	Peak
2490.64	41.01	39	54	-12.99	31.9	5.53	35.42	206	7	Average
2490.64	52.46	50.45	74	-21.54	31.9	5.53	35.42	206	7	Peak
4874	37.54	29.35	54	-16.46	33.98	8.27	34.06	163	73	Average
4874	47.62	39.43	74	-26.38	33.98	8.27	34.06	163	73	Peak

Remarks:

- Emission Level = Read Level + Antenna Factor + Cable Loss - Preamp Factor
Margin value = Emission level – Limit value
- 2437 MHz: Fundamental frequency.

EUT Test Condition		Measurement Detail	
Channel	Channel 9	Frequency Range	1 GHz ~ 25 GHz
Input Power	120 Vac, 60 Hz	Detector Function	Peak (PK) Average (AV)
Environmental Conditions	25 deg. C, 65 % RH	Tested By	Karl Lee

Antennal Polarity & Test Distance: Horizontal at 3 m										
Frequency (MHz)	Emission Level (dBuV/m)	Read Level (dBuV)	Limit (dBuV/m)	Margin (dB)	Antenna Factor (dB/m)	Cable Loss (dB)	Preamp Factor (dB)	Antenna Height (cm)	Table Angle (Degree)	Remark
2452	101.05	99.18			31.85	5.46	35.44	330	0	Average
2452	104.05	102.18			31.85	5.46	35.44	330	0	Peak
2483.84	43.28	41.32	54	-10.72	31.88	5.5	35.42	330	0	Average
2483.84	53.42	51.46	74	-20.58	31.88	5.5	35.42	330	0	Peak
4904	36.15	27.93	54	-17.85	33.98	8.28	34.04	115	124	Average
4904	46.26	38.04	74	-27.74	33.98	8.28	34.04	115	124	Peak

Antennal Polarity & Test Distance: Vertical at 3 m										
Frequency (MHz)	Emission Level (dBuV/m)	Read Level (dBuV)	Limit (dBuV/m)	Margin (dB)	Antenna Factor (dB/m)	Cable Loss (dB)	Preamp Factor (dB)	Antenna Height (cm)	Table Angle (Degree)	Remark
2452	95.63	93.76			31.85	5.46	35.44	307	11	Average
2452	98.42	96.55			31.85	5.46	35.44	307	11	Peak
2488.56	41.03	39.02	54	-12.97	31.9	5.53	35.42	307	11	Average
2488.56	52.41	50.4	74	-21.59	31.9	5.53	35.42	307	11	Peak
4904	40.32	32.1	54	-13.68	33.98	8.28	34.04	100	115	Average
4904	47.84	39.62	74	-26.16	33.98	8.28	34.04	100	115	Peak

Remarks:

- Emission Level = Read Level + Antenna Factor + Cable Loss - Preamp Factor
Margin value = Emission level – Limit value
- 2452 MHz: Fundamental frequency.

EUT Test Condition		Measurement Detail	
Channel	Channel 10	Frequency Range	1 GHz ~ 25 GHz
Input Power	120 Vac, 60 Hz	Detector Function	Peak (PK) Average (AV)
Environmental Conditions	25 deg. C, 65 % RH	Tested By	Karl Lee

Antennal Polarity & Test Distance: Horizontal at 3 m										
Frequency (MHz)	Emission Level (dBuV/m)	Read Level (dBuV)	Limit (dBuV/m)	Margin (dB)	Antenna Factor (dB/m)	Cable Loss (dB)	Preamp Factor (dB)	Antenna Height (cm)	Table Angle (Degree)	Remark
2457	92.01	90.12			31.87	5.46	35.44	307	11	Average
2457	95.08	93.19			31.87	5.46	35.44	307	11	Peak
2483.56	43.35	41.39	54	-10.65	31.88	5.5	35.42	307	11	Average
2483.56	52.59	50.63	74	-21.41	31.88	5.5	35.42	307	11	Peak
4914	39.74	31.52	54	-14.26	33.98	8.28	34.04	115	184	Average
4914	47.41	39.19	74	-26.59	33.98	8.28	34.04	115	184	Peak
Antennal Polarity & Test Distance: Vertical at 3 m										
Frequency (MHz)	Emission Level (dBuV/m)	Read Level (dBuV)	Limit (dBuV/m)	Margin (dB)	Antenna Factor (dB/m)	Cable Loss (dB)	Preamp Factor (dB)	Antenna Height (cm)	Table Angle (Degree)	Remark
2457	98.02	96.13			31.87	5.46	35.44	330	0	Average
2457	101.67	99.78			31.87	5.46	35.44	330	0	Peak
2483.56	51.04	49.08	54	-2.96	31.88	5.5	35.42	330	0	Average
2483.56	56.22	54.26	74	-17.78	31.88	5.5	35.42	330	0	Peak
4914	39.74	31.52	54	-14.26	33.98	8.28	34.04	112	154	Average
4914	47.81	39.59	74	-26.19	33.98	8.28	34.04	112	154	Peak

Remarks:

- Emission Level = Read Level + Antenna Factor + Cable Loss - Preamp Factor
Margin value = Emission level – Limit value
- 2457 MHz: Fundamental frequency.

EUT Test Condition		Measurement Detail	
Channel	Channel 11	Frequency Range	1 GHz ~ 25 GHz
Input Power	120 Vac, 60 Hz	Detector Function	Peak (PK) Average (AV)
Environmental Conditions	25 deg. C, 65 % RH	Tested By	Karl Lee

Antennal Polarity & Test Distance: Horizontal at 3 m										
Frequency (MHz)	Emission Level (dBuV/m)	Read Level (dBuV)	Limit (dBuV/m)	Margin (dB)	Antenna Factor (dB/m)	Cable Loss (dB)	Preamp Factor (dB)	Antenna Height (cm)	Table Angle (Degree)	Remark
2462	99.08	97.15			31.87	5.5	35.44	163	356	Average
2462	101.93	100			31.87	5.5	35.44	163	356	Peak
2488.52	51.1	49.09	54	-2.9	31.9	5.53	35.42	163	356	Average
2488.52	56.45	54.44	74	-17.55	31.9	5.53	35.42	163	356	Peak
4924	38.59	30.34	54	-15.41	33.99	8.28	34.02	174	151	Average
4924	48.77	40.52	74	-25.23	33.99	8.28	34.02	174	151	Peak
Antennal Polarity & Test Distance: Vertical at 3 m										
Frequency (MHz)	Emission Level (dBuV/m)	Read Level (dBuV)	Limit (dBuV/m)	Margin (dB)	Antenna Factor (dB/m)	Cable Loss (dB)	Preamp Factor (dB)	Antenna Height (cm)	Table Angle (Degree)	Remark
2462	91.59	89.66			31.87	5.5	35.44	228	4	Average
2462	94.16	92.23			31.87	5.5	35.44	228	4	Peak
2483.52	42.69	40.73	54	-11.31	31.88	5.5	35.42	228	4	Average
2483.52	52.83	50.87	74	-21.17	31.88	5.5	35.42	228	4	Peak
4924	38.49	30.24	54	-15.51	33.99	8.28	34.02	124	166	Average
4924	48.81	40.56	74	-25.19	33.99	8.28	34.02	124	166	Peak

Remarks:

- Emission Level = Read Level + Antenna Factor + Cable Loss - Preamp Factor
Margin value = Emission level – Limit value
- 2462 MHz: Fundamental frequency.

802.11g

EUT Test Condition		Measurement Detail	
Channel	Channel 1	Frequency Range	1 GHz ~ 25 GHz
Input Power	120 Vac, 60 Hz	Detector Function	Peak (PK) Average (AV)
Environmental Conditions	25 deg. C, 65 % RH	Tested By	Karl Lee

Antennal Polarity & Test Distance: Horizontal at 3 m

Frequency (MHz)	Emission Level (dBuV/m)	Read Level (dBuV)	Limit (dBuV/m)	Margin (dB)	Antenna Factor (dB/m)	Cable Loss (dB)	Preamp Factor (dB)	Antenna Height (cm)	Table Angle (Degree)	Remark
2389.92	52.88	51.15	54	-1.12	31.8	5.4	35.47	105	357	Average
2389.92	64.06	62.33	74	-9.94	31.8	5.4	35.47	105	357	Peak
2412	94.15	92.38			31.81	5.43	35.47	105	357	Average
2412	102.53	100.76			31.81	5.43	35.47	105	357	Peak
4824	37.23	29.1	54	-16.77	33.97	8.26	34.1	151	80	Average
4824	47.03	38.9	74	-26.97	33.97	8.26	34.1	151	80	Peak

Antennal Polarity & Test Distance: Vertical at 3 m

Frequency (MHz)	Emission Level (dBuV/m)	Read Level (dBuV)	Limit (dBuV/m)	Margin (dB)	Antenna Factor (dB/m)	Cable Loss (dB)	Preamp Factor (dB)	Antenna Height (cm)	Table Angle (Degree)	Remark
2389.92	42.95	41.22	54	-11.05	31.8	5.4	35.47	211	7	Average
2389.92	54.1	52.37	74	-19.9	31.8	5.4	35.47	211	7	Peak
2412	86.11	84.34			31.81	5.43	35.47	211	7	Average
2412	94.21	92.44			31.81	5.43	35.47	211	7	Peak
4824	37.16	29.03	54	-16.84	33.97	8.26	34.1	168	225	Average
4824	47.29	39.16	74	-26.71	33.97	8.26	34.1	168	225	Peak

Remarks:

- Emission Level = Read Level + Antenna Factor + Cable Loss - Preamp Factor
Margin value = Emission level – Limit value
- 2412 MHz: Fundamental frequency.

EUT Test Condition		Measurement Detail	
Channel	Channel 6	Frequency Range	1 GHz ~ 25 GHz
Input Power	120 Vac, 60 Hz	Detector Function	Peak (PK) Average (AV)
Environmental Conditions	25 deg. C, 65 % RH	Tested By	Karl Lee

Antennal Polarity & Test Distance: Horizontal at 3 m										
Frequency (MHz)	Emission Level (dBuV/m)	Read Level (dBuV)	Limit (dBuV/m)	Margin (dB)	Antenna Factor (dB/m)	Cable Loss (dB)	Preamp Factor (dB)	Antenna Height (cm)	Table Angle (Degree)	Remark
2388.84	42.14	40.43	54	-11.86	31.8	5.4	35.49	102	354	Average
2388.84	52.56	50.85	74	-21.44	31.8	5.4	35.49	102	354	Peak
2437	97.34	95.49			31.85	5.46	35.46	102	354	Average
2437	105.1	103.25			31.85	5.46	35.46	102	354	Peak
2483.96	42.39	40.43	54	-11.61	31.88	5.5	35.42	102	354	Average
2483.96	53.65	51.69	74	-20.35	31.88	5.5	35.42	102	354	Peak
4874	37.59	29.4	54	-16.41	33.98	8.27	34.06	186	131	Average
4874	47.73	39.54	74	-26.27	33.98	8.27	34.06	186	131	Peak
Antennal Polarity & Test Distance: Vertical at 3 m										
Frequency (MHz)	Emission Level (dBuV/m)	Read Level (dBuV)	Limit (dBuV/m)	Margin (dB)	Antenna Factor (dB/m)	Cable Loss (dB)	Preamp Factor (dB)	Antenna Height (cm)	Table Angle (Degree)	Remark
2386.14	40.51	38.8	54	-13.49	31.8	5.4	35.49	206	7	Average
2386.14	52.03	50.32	74	-21.97	31.8	5.4	35.49	206	7	Peak
2437	88.94	87.09			31.85	5.46	35.46	206	7	Average
2437	96.7	94.85			31.85	5.46	35.46	206	7	Peak
2491.44	41.02	39.01	54	-12.98	31.9	5.53	35.42	206	7	Average
2491.44	52.84	50.83	74	-21.16	31.9	5.53	35.42	206	7	Peak
4874	37.15	28.96	54	-16.85	33.98	8.27	34.06	143	306	Average
4874	47.24	39.05	74	-26.76	33.98	8.27	34.06	143	306	Peak

Remarks:

- Emission Level = Read Level + Antenna Factor + Cable Loss - Preamp Factor
Margin value = Emission level – Limit value
- 2437 MHz: Fundamental frequency.

EUT Test Condition		Measurement Detail	
Channel	Channel 9	Frequency Range	1 GHz ~ 25 GHz
Input Power	120 Vac, 60 Hz	Detector Function	Peak (PK) Average (AV)
Environmental Conditions	25 deg. C, 65 % RH	Tested By	Karl Lee

Antennal Polarity & Test Distance: Horizontal at 3 m										
Frequency (MHz)	Emission Level (dBuV/m)	Read Level (dBuV)	Limit (dBuV/m)	Margin (dB)	Antenna Factor (dB/m)	Cable Loss (dB)	Preamp Factor (dB)	Antenna Height (cm)	Table Angle (Degree)	Remark
2452	92.23	90.36			31.85	5.46	35.44	290	11	Average
2452	99.05	97.18			31.85	5.46	35.44	290	11	Peak
2483.6	47.13	45.17	54	-6.87	31.88	5.5	35.42	290	11	Average
2483.6	60.99	59.03	74	-13.01	31.88	5.5	35.42	290	11	Peak
4904	38.32	30.1	54	-15.68	33.98	8.28	34.04	114	157	Average
4904	47.1	38.88	74	-26.9	33.98	8.28	34.04	114	157	Peak
Antennal Polarity & Test Distance: Vertical at 3 m										
Frequency (MHz)	Emission Level (dBuV/m)	Read Level (dBuV)	Limit (dBuV/m)	Margin (dB)	Antenna Factor (dB/m)	Cable Loss (dB)	Preamp Factor (dB)	Antenna Height (cm)	Table Angle (Degree)	Remark
2452	97.34	95.47			31.85	5.46	35.44	330	0	Average
2452	104.51	102.64			31.85	5.46	35.44	330	0	Peak
2483.8	51.73	49.77	54	-2.27	31.88	5.5	35.42	330	0	Average
2483.8	61.85	59.89	74	-12.15	31.88	5.5	35.42	330	0	Peak
4904	39.75	31.53	54	-14.25	33.98	8.28	34.04	102	166	Average
4904	47.85	39.63	74	-26.15	33.98	8.28	34.04	102	166	Peak

Remarks:

- Emission Level = Read Level + Antenna Factor + Cable Loss - Preamp Factor
Margin value = Emission level – Limit value
- 2452 MHz: Fundamental frequency.

EUT Test Condition		Measurement Detail	
Channel	Channel 10	Frequency Range	1 GHz ~ 25 GHz
Input Power	120 Vac, 60 Hz	Detector Function	Peak (PK) Average (AV)
Environmental Conditions	25 deg. C, 65 % RH	Tested By	Karl Lee

Antennal Polarity & Test Distance: Horizontal at 3 m										
Frequency (MHz)	Emission Level (dBuV/m)	Read Level (dBuV)	Limit (dBuV/m)	Margin (dB)	Antenna Factor (dB/m)	Cable Loss (dB)	Preamp Factor (dB)	Antenna Height (cm)	Table Angle (Degree)	Remark
2457	95.2	93.31			31.87	5.46	35.44	330	0	Average
2457	102.59	100.7			31.87	5.46	35.44	330	0	Peak
2483.96	52.32	50.36	54	-1.68	31.88	5.5	35.42	330	0	Average
2483.96	62.13	60.17	74	-11.87	31.88	5.5	35.42	330	0	Peak
4914	39.42	31.2	54	-14.58	33.98	8.28	34.04	104	174	Average
4914	47.81	39.59	74	-26.19	33.98	8.28	34.04	104	174	Peak
Antennal Polarity & Test Distance: Vertical at 3 m										
Frequency (MHz)	Emission Level (dBuV/m)	Read Level (dBuV)	Limit (dBuV/m)	Margin (dB)	Antenna Factor (dB/m)	Cable Loss (dB)	Preamp Factor (dB)	Antenna Height (cm)	Table Angle (Degree)	Remark
2457	88.68	86.79			31.87	5.46	35.44	307	11	Average
2457	96.96	95.07			31.87	5.46	35.44	307	11	Peak
2483.56	43.65	41.69	54	-10.35	31.88	5.5	35.42	307	11	Average
2483.56	55.68	53.72	74	-18.32	31.88	5.5	35.42	307	11	Peak
4914	39.32	31.1	54	-14.68	33.98	8.28	34.04	122	163	Average
4914	47.41	39.19	74	-26.59	33.98	8.28	34.04	122	163	Peak

Remarks:

- Emission Level = Read Level + Antenna Factor + Cable Loss - Preamp Factor
Margin value = Emission level – Limit value
- 2457 MHz: Fundamental frequency.

EUT Test Condition		Measurement Detail	
Channel	Channel 11	Frequency Range	1 GHz ~ 25 GHz
Input Power	120 Vac, 60 Hz	Detector Function	Peak (PK) Average (AV)
Environmental Conditions	25 deg. C, 65 % RH	Tested By	Karl Lee

Antennal Polarity & Test Distance: Horizontal at 3 m										
Frequency (MHz)	Emission Level (dBuV/m)	Read Level (dBuV)	Limit (dBuV/m)	Margin (dB)	Antenna Factor (dB/m)	Cable Loss (dB)	Preamp Factor (dB)	Antenna Height (cm)	Table Angle (Degree)	Remark
2462	88.68	86.75			31.87	5.5	35.44	166	356	Average
2462	96.72	94.79			31.87	5.5	35.44	166	356	Peak
2483.6	52.38	50.42	54	-1.62	31.88	5.5	35.42	166	356	Average
2483.6	64.76	62.8	74	-9.24	31.88	5.5	35.42	166	356	Peak
4924	37.76	29.51	54	-16.24	33.99	8.28	34.02	164	236	Average
4924	47.99	39.74	74	-26.01	33.99	8.28	34.02	164	236	Peak
Antennal Polarity & Test Distance: Vertical at 3 m										
Frequency (MHz)	Emission Level (dBuV/m)	Read Level (dBuV)	Limit (dBuV/m)	Margin (dB)	Antenna Factor (dB/m)	Cable Loss (dB)	Preamp Factor (dB)	Antenna Height (cm)	Table Angle (Degree)	Remark
2462	82.64	80.71			31.87	5.5	35.44	228	4	Average
2462	90.74	88.81			31.87	5.5	35.44	228	4	Peak
2483.56	44.13	42.17	54	-9.87	31.88	5.5	35.42	228	4	Average
2483.56	56.42	54.46	74	-17.58	31.88	5.5	35.42	228	4	Peak
4924	37.22	28.97	54	-16.78	33.99	8.28	34.02	105	331	Average
4924	47.25	39	74	-26.75	33.99	8.28	34.02	105	331	Peak

Remarks:

- Emission Level = Read Level + Antenna Factor + Cable Loss - Preamp Factor
Margin value = Emission level – Limit value
- 2462 MHz: Fundamental frequency.

<2TX>

802.11n (HT20)

EUT Test Condition		Measurement Detail	
Channel	Channel 1	Frequency Range	1 GHz ~ 25 GHz
Input Power	120 Vac, 60 Hz	Detector Function	Peak (PK) Average (AV)
Environmental Conditions	25 deg. C, 65 % RH	Tested By	Karl Lee

Antennal Polarity & Test Distance: Horizontal at 3 m										
Frequency (MHz)	Emission Level (dBuV/m)	Read Level (dBuV)	Limit (dBuV/m)	Margin (dB)	Antenna Factor (dB/m)	Cable Loss (dB)	Preamp Factor (dB)	Antenna Height (cm)	Table Angle (Degree)	Remark
2389.92	52.96	51.23	54	-1.04	31.8	5.4	35.47	106	352	Average
2389.92	64.92	63.19	74	-9.08	31.8	5.4	35.47	106	352	Peak
2412	95.16	93.39			31.81	5.43	35.47	104	357	Average
2412	103.5	101.73			31.81	5.43	35.47	104	357	Peak
4824	37.32	29.19	54	-16.68	33.97	8.26	34.1	152	235	Average
4824	47.11	38.98	74	-26.89	33.97	8.26	34.1	152	235	Peak
Antennal Polarity & Test Distance: Vertical at 3 m										
Frequency (MHz)	Emission Level (dBuV/m)	Read Level (dBuV)	Limit (dBuV/m)	Margin (dB)	Antenna Factor (dB/m)	Cable Loss (dB)	Preamp Factor (dB)	Antenna Height (cm)	Table Angle (Degree)	Remark
2389.92	44.93	43.2	54	-9.07	31.8	5.4	35.47	231	5	Average
2389.92	57.12	55.39	74	-16.88	31.8	5.4	35.47	231	5	Peak
2412	91.23	89.46			31.81	5.43	35.47	210	5	Average
2412	100.16	98.39			31.81	5.43	35.47	210	5	Peak
4824	37.39	29.26	54	-16.61	33.97	8.26	34.1	103	162	Average
4824	47.53	39.4	74	-26.47	33.97	8.26	34.1	103	162	Peak

Remarks:

- Emission Level = Read Level + Antenna Factor + Cable Loss - Preamp Factor
Margin value = Emission level – Limit value
- 2412 MHz: Fundamental frequency.

EUT Test Condition		Measurement Detail	
Channel	Channel 6	Frequency Range	1 GHz ~ 25 GHz
Input Power	120 Vac, 60 Hz	Detector Function	Peak (PK) Average (AV)
Environmental Conditions	25 deg. C, 65 % RH	Tested By	Karl Lee

Antennal Polarity & Test Distance: Horizontal at 3 m										
Frequency (MHz)	Emission Level (dBuV/m)	Read Level (dBuV)	Limit (dBuV/m)	Margin (dB)	Antenna Factor (dB/m)	Cable Loss (dB)	Preamp Factor (dB)	Antenna Height (cm)	Table Angle (Degree)	Remark
2389.92	41.86	40.13	54	-12.14	31.8	5.4	35.47	102	355	Average
2389.92	52.04	50.31	74	-21.96	31.8	5.4	35.47	102	355	Peak
2437	98.59	96.74			31.85	5.46	35.46	102	355	Average
2437	106.9	105.05			31.85	5.46	35.46	102	355	Peak
2483.84	42	40.04	54	-12	31.88	5.5	35.42	102	355	Average
2483.84	53.18	51.22	74	-20.82	31.88	5.5	35.42	102	355	Peak
4874	36.73	28.54	54	-17.27	33.98	8.27	34.06	159	175	Average
4874	46.81	38.62	74	-27.19	33.98	8.27	34.06	159	175	Peak
Antennal Polarity & Test Distance: Vertical at 3 m										
Frequency (MHz)	Emission Level (dBuV/m)	Read Level (dBuV)	Limit (dBuV/m)	Margin (dB)	Antenna Factor (dB/m)	Cable Loss (dB)	Preamp Factor (dB)	Antenna Height (cm)	Table Angle (Degree)	Remark
2370.84	40.45	38.79	54	-13.55	31.78	5.37	35.49	206	7	Average
2370.84	51.55	49.89	74	-22.45	31.78	5.37	35.49	206	7	Peak
2437	95.81	93.96			31.85	5.46	35.46	206	7	Average
2437	103.77	101.92			31.85	5.46	35.46	206	7	Peak
2484.76	41.22	39.23	54	-12.78	31.88	5.53	35.42	206	7	Average
2484.76	51.89	49.9	74	-22.11	31.88	5.53	35.42	206	7	Peak
4874	36.82	28.63	54	-17.18	33.98	8.27	34.06	136	230	Average
4874	46.9	38.71	74	-27.1	33.98	8.27	34.06	136	230	Peak

Remarks:

- Emission Level = Read Level + Antenna Factor + Cable Loss - Preamp Factor
Margin value = Emission level – Limit value
- 2437 MHz: Fundamental frequency.

EUT Test Condition		Measurement Detail	
Channel	Channel 8	Frequency Range	1 GHz ~ 25 GHz
Input Power	120 Vac, 60 Hz	Detector Function	Peak (PK) Average (AV)
Environmental Conditions	25 deg. C, 65 % RH	Tested By	Karl Lee

Antennal Polarity & Test Distance: Horizontal at 3 m										
Frequency (MHz)	Emission Level (dBuV/m)	Read Level (dBuV)	Limit (dBuV/m)	Margin (dB)	Antenna Factor (dB/m)	Cable Loss (dB)	Preamp Factor (dB)	Antenna Height (cm)	Table Angle (Degree)	Remark
2447	99.03	97.16			31.85	5.46	35.44	304	328	Average
2447	106.58	104.71			31.85	5.46	35.44	304	328	Peak
2483.68	51.36	49.4	54	-2.64	31.88	5.5	35.42	296	324	Average
2483.68	63.73	61.77	74	-10.27	31.88	5.5	35.42	296	324	Peak
4894	38.41	30.2	54	-15.59	33.98	8.27	34.04	122	162	Average
4894	47.33	39.12	74	-26.67	33.98	8.27	34.04	122	162	Peak
Antennal Polarity & Test Distance: Vertical at 3 m										
Frequency (MHz)	Emission Level (dBuV/m)	Read Level (dBuV)	Limit (dBuV/m)	Margin (dB)	Antenna Factor (dB/m)	Cable Loss (dB)	Preamp Factor (dB)	Antenna Height (cm)	Table Angle (Degree)	Remark
2447	95.97	94.1			31.85	5.46	35.44	327	20	Average
2447	103.7	101.83			31.85	5.46	35.44	327	20	Peak
2483.68	46.62	44.66	54	-7.38	31.88	5.5	35.42	327	18	Average
2483.68	54.72	52.76	74	-19.28	31.88	5.5	35.42	327	18	Peak
4894	38.31	30.1	54	-15.69	33.98	8.27	34.04	132	162	Average
4894	46.77	38.56	74	-27.23	33.98	8.27	34.04	132	162	Peak

Remarks:

- Emission Level = Read Level + Antenna Factor + Cable Loss - Preamp Factor
Margin value = Emission level – Limit value
- 2447 MHz: Fundamental frequency.

EUT Test Condition		Measurement Detail	
Channel	Channel 9	Frequency Range	1 GHz ~ 25 GHz
Input Power	120 Vac, 60 Hz	Detector Function	Peak (PK) Average (AV)
Environmental Conditions	25 deg. C, 65 % RH	Tested By	Karl Lee

Antennal Polarity & Test Distance: Horizontal at 3 m										
Frequency (MHz)	Emission Level (dBuV/m)	Read Level (dBuV)	Limit (dBuV/m)	Margin (dB)	Antenna Factor (dB/m)	Cable Loss (dB)	Preamp Factor (dB)	Antenna Height (cm)	Table Angle (Degree)	Remark
2452	95.76	93.89			31.85	5.46	35.44	304	355	Average
2452	103.58	101.71			31.85	5.46	35.44	304	355	Peak
2483.6	52.45	50.49	54	-1.55	31.88	5.5	35.42	289	355	Average
2483.6	62.73	60.77	74	-11.27	31.88	5.5	35.42	289	355	Peak
4904	40.32	32.1	54	-13.68	33.98	8.28	34.04	112	162	Average
4904	47.85	39.63	74	-26.15	33.98	8.28	34.04	112	162	Peak

Antennal Polarity & Test Distance: Vertical at 3 m										
Frequency (MHz)	Emission Level (dBuV/m)	Read Level (dBuV)	Limit (dBuV/m)	Margin (dB)	Antenna Factor (dB/m)	Cable Loss (dB)	Preamp Factor (dB)	Antenna Height (cm)	Table Angle (Degree)	Remark
2452	92.44	90.57			31.85	5.46	35.44	327	19	Average
2452	100.64	98.77			31.85	5.46	35.44	327	19	Peak
2483.52	48.58	46.62	54	-5.42	31.88	5.5	35.42	312	22	Average
2483.52	58.33	56.37	74	-15.67	31.88	5.5	35.42	312	22	Peak
4904	38.32	30.1	54	-15.68	33.98	8.28	34.04	169	158	Average
4904	47.1	38.88	74	-26.9	33.98	8.28	34.04	169	158	Peak

Remarks:

- Emission Level = Read Level + Antenna Factor + Cable Loss - Preamp Factor
Margin value = Emission level – Limit value
- 2452 MHz: Fundamental frequency.

EUT Test Condition		Measurement Detail	
Channel	Channel 10	Frequency Range	1 GHz ~ 25 GHz
Input Power	120 Vac, 60 Hz	Detector Function	Peak (PK) Average (AV)
Environmental Conditions	25 deg. C, 65 % RH	Tested By	Karl Lee

Antennal Polarity & Test Distance: Horizontal at 3 m										
Frequency (MHz)	Emission Level (dBuV/m)	Read Level (dBuV)	Limit (dBuV/m)	Margin (dB)	Antenna Factor (dB/m)	Cable Loss (dB)	Preamp Factor (dB)	Antenna Height (cm)	Table Angle (Degree)	Remark
2457	93.48	91.59			31.87	5.46	35.44	304	355	Average
2457	101.67	99.78			31.87	5.46	35.44	304	355	Peak
2483.6	52.98	51.02	54	-1.02	31.88	5.5	35.42	296	355	Average
2483.6	63.11	61.15	74	-10.89	31.88	5.5	35.42	296	355	Peak
4914	39.42	31.2	54	-14.58	33.98	8.28	34.04	104	151	Average
4914	47.81	39.59	74	-26.19	33.98	8.28	34.04	104	151	Peak
Antennal Polarity & Test Distance: Vertical at 3 m										
Frequency (MHz)	Emission Level (dBuV/m)	Read Level (dBuV)	Limit (dBuV/m)	Margin (dB)	Antenna Factor (dB/m)	Cable Loss (dB)	Preamp Factor (dB)	Antenna Height (cm)	Table Angle (Degree)	Remark
2457	91.73	89.84			31.87	5.46	35.44	327	19	Average
2457	98.66	96.77			31.87	5.46	35.44	327	19	Peak
2483.52	45.8	43.84	54	-8.2	31.88	5.5	35.42	311	15	Average
2483.52	57.13	55.17	74	-16.87	31.88	5.5	35.42	311	15	Peak
4914	38.32	30.1	54	-15.68	33.98	8.28	34.04	111	132	Average
4914	47.41	39.19	74	-26.59	33.98	8.28	34.04	111	132	Peak

Remarks:

- Emission Level = Read Level + Antenna Factor + Cable Loss - Preamp Factor
Margin value = Emission level – Limit value
- 2457 MHz: Fundamental frequency.

EUT Test Condition		Measurement Detail	
Channel	Channel 11	Frequency Range	1 GHz ~ 25 GHz
Input Power	120 Vac, 60 Hz	Detector Function	Peak (PK) Average (AV)
Environmental Conditions	25 deg. C, 65 % RH	Tested By	Karl Lee

Antennal Polarity & Test Distance: Horizontal at 3 m										
Frequency (MHz)	Emission Level (dBuV/m)	Read Level (dBuV)	Limit (dBuV/m)	Margin (dB)	Antenna Factor (dB/m)	Cable Loss (dB)	Preamp Factor (dB)	Antenna Height (cm)	Table Angle (Degree)	Remark
2462	91.92	89.99			31.87	5.5	35.44	102	53	Average
2462	99.23	97.3			31.87	5.5	35.44	102	53	Peak
2483.5	52.8	50.84	54	-1.2	31.88	5.5	35.42	100	316	Average
2483.5	63.65	61.69	74	-10.35	31.88	5.5	35.42	100	316	Peak
4924	37.41	29.16	54	-16.59	33.99	8.28	34.02	186	161	Average
4924	47.21	38.96	74	-26.79	33.99	8.28	34.02	186	161	Peak
Antennal Polarity & Test Distance: Vertical at 3 m										
Frequency (MHz)	Emission Level (dBuV/m)	Read Level (dBuV)	Limit (dBuV/m)	Margin (dB)	Antenna Factor (dB/m)	Cable Loss (dB)	Preamp Factor (dB)	Antenna Height (cm)	Table Angle (Degree)	Remark
2462	87.68	85.75			31.87	5.5	35.44	104	18	Average
2462	95.74	93.81			31.87	5.5	35.44	104	18	Peak
2483.68	43.84	41.88	54	-10.16	31.88	5.5	35.42	104	18	Average
2483.68	54.59	52.63	74	-19.41	31.88	5.5	35.42	104	18	Peak
4924	37.63	29.38	54	-16.37	33.99	8.28	34.02	116	180	Average
4924	47.54	39.29	74	-26.46	33.99	8.28	34.02	116	180	Peak

Remarks:

- Emission Level = Read Level + Antenna Factor + Cable Loss - Preamp Factor
Margin value = Emission level – Limit value
- 2462 MHz: Fundamental frequency.

802.11n (HT40)

EUT Test Condition		Measurement Detail	
Channel	Channel 3	Frequency Range	1 GHz ~ 25 GHz
Input Power	120 Vac, 60 Hz	Detector Function	Peak (PK) Average (AV)
Environmental Conditions	25 deg. C, 65 % RH	Tested By	Karl Lee

Antennal Polarity & Test Distance: Horizontal at 3 m

Frequency (MHz)	Emission Level (dBuV/m)	Read Level (dBuV)	Limit (dBuV/m)	Margin (dB)	Antenna Factor (dB/m)	Cable Loss (dB)	Preamp Factor (dB)	Antenna Height (cm)	Table Angle (Degree)	Remark
2389.92	52.49	50.76	54	-1.51	31.8	5.4	35.47	107	357	Average
2389.92	62.24	60.51	74	-11.76	31.8	5.4	35.47	107	357	Peak
2422	88.15	86.35			31.83	5.43	35.46	104	357	Average
2422	96.16	94.36			31.83	5.43	35.46	104	357	Peak
2488.52	41.16	39.15	54	-12.84	31.9	5.53	35.42	104	357	Average
2488.52	52.3	50.29	74	-21.7	31.9	5.53	35.42	104	357	Peak
4844	37.62	29.47	54	-16.38	33.97	8.26	34.08	111	149	Average
4844	47.79	39.64	74	-26.21	33.97	8.26	34.08	111	149	Peak

Antennal Polarity & Test Distance: Vertical at 3 m

Frequency (MHz)	Emission Level (dBuV/m)	Read Level (dBuV)	Limit (dBuV/m)	Margin (dB)	Antenna Factor (dB/m)	Cable Loss (dB)	Preamp Factor (dB)	Antenna Height (cm)	Table Angle (Degree)	Remark
2387.49	44.1	42.39	54	-9.9	31.8	5.4	35.49	212	8	Average
2387.49	56.16	54.45	74	-17.84	31.8	5.4	35.49	212	8	Peak
2422	82.75	80.95			31.83	5.43	35.46	210	5	Average
2422	90.87	89.07			31.83	5.43	35.46	210	5	Peak
2490.6	40.9	38.89	54	-13.1	31.9	5.53	35.42	210	5	Average
2490.6	51.92	49.91	74	-22.08	31.9	5.53	35.42	210	5	Peak
4844	38.26	30.11	54	-15.74	33.97	8.26	34.08	142	331	Average
4844	48.42	40.27	74	-25.58	33.97	8.26	34.08	142	331	Peak

Remarks:

- Emission Level = Read Level + Antenna Factor + Cable Loss - Preamp Factor
Margin value = Emission level – Limit value
- 2422 MHz: Fundamental frequency.

EUT Test Condition		Measurement Detail	
Channel	Channel 6	Frequency Range	1 GHz ~ 25 GHz
Input Power	120 Vac, 60 Hz	Detector Function	Peak (PK) Average (AV)
Environmental Conditions	25 deg. C, 65 % RH	Tested By	Karl Lee

Antennal Polarity & Test Distance: Horizontal at 3 m										
Frequency (MHz)	Emission Level (dBuV/m)	Read Level (dBuV)	Limit (dBuV/m)	Margin (dB)	Antenna Factor (dB/m)	Cable Loss (dB)	Preamp Factor (dB)	Antenna Height (cm)	Table Angle (Degree)	Remark
2389.92	50.38	48.65	54	-3.62	31.8	5.4	35.47	276	352	Average
2389.92	62.62	60.89	74	-11.38	31.8	5.4	35.47	276	352	Peak
2437	92.98	91.13			31.85	5.46	35.46	102	355	Average
2437	100.72	98.87			31.85	5.46	35.46	102	355	Peak
2483.52	52.36	50.4	54	-1.64	31.88	5.5	35.42	276	352	Average
2483.52	65.71	63.75	74	-8.29	31.88	5.5	35.42	276	352	Peak
4874	36.69	28.5	54	-17.31	33.98	8.27	34.06	163	321	Average
4874	46.8	38.61	74	-27.2	33.98	8.27	34.06	163	321	Peak
Antennal Polarity & Test Distance: Vertical at 3 m										
Frequency (MHz)	Emission Level (dBuV/m)	Read Level (dBuV)	Limit (dBuV/m)	Margin (dB)	Antenna Factor (dB/m)	Cable Loss (dB)	Preamp Factor (dB)	Antenna Height (cm)	Table Angle (Degree)	Remark
2388.66	41.48	39.77	54	-12.52	31.8	5.4	35.49	206	7	Average
2388.66	52.5	50.79	74	-21.5	31.8	5.4	35.49	206	7	Peak
2437	89.48	87.63			31.85	5.46	35.46	206	7	Average
2437	97.62	95.77			31.85	5.46	35.46	206	7	Peak
2483.52	42.37	40.41	54	-11.63	31.88	5.5	35.42	206	7	Average
2483.52	53.6	51.64	74	-20.4	31.88	5.5	35.42	206	7	Peak
4874	37.15	28.96	54	-16.85	33.98	8.27	34.06	129	85	Average
4874	47.25	39.06	74	-26.75	33.98	8.27	34.06	129	85	Peak

Remarks:

- Emission Level = Read Level + Antenna Factor + Cable Loss - Preamp Factor
Margin value = Emission level – Limit value
- 2437 MHz: Fundamental frequency.

EUT Test Condition		Measurement Detail	
Channel	Channel 7	Frequency Range	1 GHz ~ 25 GHz
Input Power	120 Vac, 60 Hz	Detector Function	Peak (PK) Average (AV)
Environmental Conditions	25 deg. C, 65 % RH	Tested By	Karl Lee

Antennal Polarity & Test Distance: Horizontal at 3 m										
Frequency (MHz)	Emission Level (dBuV/m)	Read Level (dBuV)	Limit (dBuV/m)	Margin (dB)	Antenna Factor (dB/m)	Cable Loss (dB)	Preamp Factor (dB)	Antenna Height (cm)	Table Angle (Degree)	Remark
2389.74	45.71	44	54	-8.29	31.8	5.4	35.49	305	328	Average
2389.74	58.4	56.69	74	-15.6	31.8	5.4	35.49	305	328	Peak
2442	92.37	90.5			31.85	5.46	35.44	304	328	Average
2442	99.29	97.42			31.85	5.46	35.44	304	328	Peak
2483.52	52.19	50.23	54	-1.81	31.88	5.5	35.42	305	328	Average
2483.52	62.9	60.94	74	-11.1	31.88	5.5	35.42	305	328	Peak
4884	39.29	31.1	54	-14.71	33.98	8.27	34.06	155	162	Average
4884	47.47	39.28	74	-26.53	33.98	8.27	34.06	155	162	Peak
Antennal Polarity & Test Distance: Vertical at 3 m										
Frequency (MHz)	Emission Level (dBuV/m)	Read Level (dBuV)	Limit (dBuV/m)	Margin (dB)	Antenna Factor (dB/m)	Cable Loss (dB)	Preamp Factor (dB)	Antenna Height (cm)	Table Angle (Degree)	Remark
2389.92	43.55	41.82	54	-10.45	31.8	5.4	35.47	327	19	Average
2389.92	53.92	52.19	74	-20.08	31.8	5.4	35.47	327	19	Peak
2442	88.39	86.52			31.85	5.46	35.44	327	19	Average
2442	96.42	94.55			31.85	5.46	35.44	327	19	Peak
2483.52	46.85	44.89	54	-7.15	31.88	5.5	35.42	327	19	Average
2483.52	58.75	56.79	74	-15.25	31.88	5.5	35.42	327	19	Peak
4884	38.29	30.1	54	-15.71	33.98	8.27	34.06	166	195	Average
4884	47.22	39.03	74	-26.78	33.98	8.27	34.06	166	195	Peak

Remarks:

- Emission Level = Read Level + Antenna Factor + Cable Loss - Preamp Factor
Margin value = Emission level – Limit value
- 2442 MHz: Fundamental frequency.

EUT Test Condition		Measurement Detail	
Channel	Channel 8	Frequency Range	1 GHz ~ 25 GHz
Input Power	120 Vac, 60 Hz	Detector Function	Peak (PK) Average (AV)
Environmental Conditions	25 deg. C, 65 % RH	Tested By	Karl Lee

Antennal Polarity & Test Distance: Horizontal at 3 m										
Frequency (MHz)	Emission Level (dBuV/m)	Read Level (dBuV)	Limit (dBuV/m)	Margin (dB)	Antenna Factor (dB/m)	Cable Loss (dB)	Preamp Factor (dB)	Antenna Height (cm)	Table Angle (Degree)	Remark
2389.2	41.2	39.49	54	-12.8	31.8	5.4	35.49	314	360	Average
2389.2	51.66	49.95	74	-22.34	31.8	5.4	35.49	314	360	Peak
2447	88.17	86.3			31.85	5.46	35.44	302	360	Average
2447	95.86	93.99			31.85	5.46	35.44	302	360	Peak
2483.52	52.96	51	54	-1.04	31.88	5.5	35.42	314	360	Average
2483.52	61.21	59.25	74	-12.79	31.88	5.5	35.42	314	360	Peak
4894	39.31	31.1	54	-14.69	33.98	8.27	34.04	102	163	Average
4894	47.33	39.12	74	-26.67	33.98	8.27	34.04	102	163	Peak
Antennal Polarity & Test Distance: Vertical at 3 m										
Frequency (MHz)	Emission Level (dBuV/m)	Read Level (dBuV)	Limit (dBuV/m)	Margin (dB)	Antenna Factor (dB/m)	Cable Loss (dB)	Preamp Factor (dB)	Antenna Height (cm)	Table Angle (Degree)	Remark
2383.89	40.78	39.09	54	-13.22	31.78	5.4	35.49	316	19	Average
2383.89	51.99	50.3	74	-22.01	31.78	5.4	35.49	316	19	Peak
2447	85.03	83.16			31.85	5.46	35.44	327	19	Average
2447	92.54	90.67			31.85	5.46	35.44	327	19	Peak
2483.52	44.76	42.8	54	-9.24	31.88	5.5	35.42	316	19	Average
2483.52	56.68	54.72	74	-17.32	31.88	5.5	35.42	316	19	Peak
4894	38.31	30.1	54	-15.69	33.98	8.27	34.04	100	110	Average
4894	46.77	38.56	74	-27.23	33.98	8.27	34.04	100	110	Peak

Remarks:

- Emission Level = Read Level + Antenna Factor + Cable Loss - Preamp Factor
Margin value = Emission level – Limit value
- 2447 MHz: Fundamental frequency.

EUT Test Condition		Measurement Detail	
Channel	Channel 9	Frequency Range	1 GHz ~ 25 GHz
Input Power	120 Vac, 60 Hz	Detector Function	Peak (PK) Average (AV)
Environmental Conditions	25 deg. C, 65 % RH	Tested By	Karl Lee

Antennal Polarity & Test Distance: Horizontal at 3 m										
Frequency (MHz)	Emission Level (dBuV/m)	Read Level (dBuV)	Limit (dBuV/m)	Margin (dB)	Antenna Factor (dB/m)	Cable Loss (dB)	Preamp Factor (dB)	Antenna Height (cm)	Table Angle (Degree)	Remark
2389.56	40.76	39.05	54	-13.24	31.8	5.4	35.49	123	267	Average
2389.56	51.15	49.44	74	-22.85	31.8	5.4	35.49	123	267	Peak
2452	87.49	85.62			31.85	5.46	35.44	123	267	Average
2452	94.08	92.21			31.85	5.46	35.44	123	267	Peak
2483.56	52.23	50.27	54	-1.77	31.88	5.5	35.42	113	358	Average
2483.56	63.58	61.62	74	-10.42	31.88	5.5	35.42	113	358	Peak
4904	37.52	29.3	54	-16.48	33.98	8.28	34.04	135	159	Average
4904	47.43	39.21	74	-26.57	33.98	8.28	34.04	135	159	Peak
Antennal Polarity & Test Distance: Vertical at 3 m										
Frequency (MHz)	Emission Level (dBuV/m)	Read Level (dBuV)	Limit (dBuV/m)	Margin (dB)	Antenna Factor (dB/m)	Cable Loss (dB)	Preamp Factor (dB)	Antenna Height (cm)	Table Angle (Degree)	Remark
2376.42	40.69	39.03	54	-13.31	31.78	5.37	35.49	104	18	Average
2376.42	51.86	50.2	74	-22.14	31.78	5.37	35.49	104	18	Peak
2452	84.79	82.92			31.85	5.46	35.44	104	18	Average
2452	91.97	90.1			31.85	5.46	35.44	104	18	Peak
2489.76	42.13	40.12	54	-11.87	31.9	5.53	35.42	104	18	Average
2489.76	52.96	50.95	74	-21.04	31.9	5.53	35.42	104	18	Peak
4904	36.73	28.51	54	-17.27	33.98	8.28	34.04	147	216	Average
4904	46.89	38.67	74	-27.11	33.98	8.28	34.04	147	216	Peak

Remarks:

- Emission Level = Read Level + Antenna Factor + Cable Loss - Preamp Factor
Margin value = Emission level – Limit value
- 2452 MHz: Fundamental frequency.

9 kHz ~ 30 MHz Data:

The amplitude of spurious emissions attenuated more than 20 dB below the permissible value is not required to be report.

30 MHz ~ 1 GHz Worst-Case Data:

<2TX>

802.11n (HT20)

EUT Test Condition		Measurement Detail	
Channel	Channel 1	Frequency Range	30 MHz ~ 1 GHz
Input Power	120 Vac, 60 Hz	Detector Function	Peak (PK) Quasi-peak (QP)
Environmental Conditions	25 deg. C, 65 % RH	Tested By	Karl Lee

Antennal Polarity & Test Distance: Horizontal at 3 m										
Frequency (MHz)	Emission Level (dBuV/m)	Read Level (dBuV)	Limit (dBuV/m)	Margin (dB)	Antenna Factor (dB/m)	Cable Loss (dB)	Preamp Factor (dB)	Antenna Height (cm)	Table Angle (Degree)	Remark
87.78	17.25	38	40	-22.75	9.95	1.11	31.81	178	121	Peak
157.44	20.78	42.89	43.5	-22.72	8.64	1.52	32.27	166	332	Peak
276.78	19.27	36.66	46	-26.73	12.7	2.03	32.12	137	145	Peak
373.5	21.57	36.94	46	-24.43	14.51	2.26	32.14	165	196	Peak
714.4	20.59	30.14	46	-25.41	19.44	3.11	32.1	134	225	Peak
938.4	28.12	34.04	46	-17.88	21.66	3.62	31.2	171	160	Peak
Antennal Polarity & Test Distance: Vertical at 3 m										
Frequency (MHz)	Emission Level (dBuV/m)	Read Level (dBuV)	Limit (dBuV/m)	Margin (dB)	Antenna Factor (dB/m)	Cable Loss (dB)	Preamp Factor (dB)	Antenna Height (cm)	Table Angle (Degree)	Remark
48.63	19.48	36.24	40	-20.52	14.56	0.9	32.22	178	301	Peak
88.59	15.79	36.54	43.5	-27.71	9.95	1.11	31.81	166	204	Peak
155.82	16.02	38.17	43.5	-27.48	8.6	1.52	32.27	158	134	Peak
428.1	18.91	33.38	46	-27.09	15.3	2.41	32.18	125	136	Peak
593.3	20.58	32.07	46	-25.42	17.83	2.87	32.19	177	195	Peak
937	30.84	36.78	46	-15.16	21.65	3.62	31.21	140	68	Peak

Remarks:

- Emission Level = Read Level + Antenna Factor + Cable Loss - Preamp Factor
Margin value = Emission level – Limit value

4.2 Conducted Emission Measurement

4.2.1 Limits of Conducted Emission Measurement

Frequency (MHz)	Conducted Limit (dBuV)	
	Quasi-Peak	Average
0.15 - 0.5	66 - 56	56 - 46
0.50 - 5.0	56	46
5.0 - 30.0	60	50

- Note: 1. The lower limit shall apply at the transition frequencies.
 2. The limit decreases in line with the logarithm of the frequency in the range of 0.15 to 0.50 MHz.

4.2.2 Test Instruments

Description & Manufacturer	Model No.	Serial No.	Date of Calibration	Due Date of Calibration
Test Receiver ROHDE & SCHWARZ	ESCI	100613	Nov. 23, 2017	Nov. 22, 2018
RF signal cable (with 10dB PAD) Woken	5D-FB	Cable-cond1-01	Sep. 05, 2017	Sep. 04, 2018
LISN/AMN ROHDE & SCHWARZ (EUT)	ESH3-Z5	835239/001	Mar. 06, 2018	Mar. 05, 2019
LISN/AMN ROHDE & SCHWARZ (Peripheral)	ESH3-Z5	100311	Aug. 15, 2017	Aug. 14, 2018
Software ADT	BV ADT_Cond_ V7.3.7.4	NA	NA	NA

- Note: 1. The calibration interval of the above test instruments is 12 months and the calibrations are traceable to NML/ROC and NIST/USA.
 2. The test was performed in HwaYa Shielded Room 1.
 3. The VCCI Site Registration No. is C-2040.

4.2.3 Test Procedures

- a. The EUT was placed 0.4 meters from the conducting wall of the shielded room with EUT being connected to the power mains through a line impedance stabilization network (LISN). Other support units were connected to the power mains through another LISN. The two LISNs provide 50 ohm/50 uH of coupling impedance for the measuring instrument.
- b. Both lines of the power mains connected to the EUT were checked for maximum conducted interference.
- c. The frequency range from 150 kHz to 30 MHz was searched. Emission levels under (Limit – 20 dB) was not recorded.

Note: The resolution bandwidth and video bandwidth of test receiver is 9 kHz for quasi-peak detection (QP) and average detection (AV) at frequency 0.15 MHz – 30 MHz.

4.2.4 Deviation from Test Standard

No deviation.

4.2.5 Test Setup

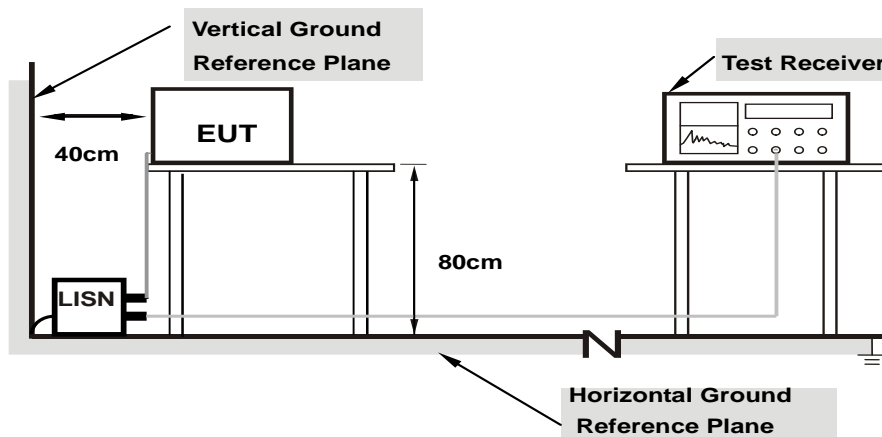

Note: 1.Support units were connected to second LISN.

For the actual test configuration, please refer to the attached file (Test Setup Photo).

4.2.6 EUT Operating Conditions

- a. Placed the EUT on a testing table.
- b. Use the software to control the EUT under transmission condition continuously at specific channel frequency.

4.2.7 Test Results

Frequency Range	150kHz ~ 30MHz	Detector Function & Resolution Bandwidth	Quasi-Peak (QP) / Average (AV), 9kHz
Input Power	120Vac, 60Hz	Environmental Conditions	25°C, 65%RH
Tested by	Jisyong Wang	Test Date	2018/6/14

Phase Of Power : Line (L)										
No	Frequency (MHz)	Correction Factor (dB)	Reading Value (dBuV)		Emission Level (dBuV)		Limit (dBuV)		Margin (dB)	
			Q.P.	AV.	Q.P.	AV.	Q.P.	AV.	Q.P.	AV.
1	0.16569	10.10	42.24	26.41	52.34	36.51	65.17	55.17	-12.83	-18.66
2	0.19305	10.10	37.14	22.41	47.24	32.51	63.90	53.90	-16.66	-21.39
3	0.24775	10.11	34.18	17.80	44.29	27.91	61.83	51.83	-17.54	-23.92
4	0.29076	10.11	28.83	14.00	38.94	24.11	60.50	50.50	-21.56	-26.39
5	2.33569	10.20	25.49	10.03	35.69	20.23	56.00	46.00	-20.31	-25.77
6	8.45484	10.53	22.66	9.98	33.19	20.51	60.00	50.00	-26.81	-29.49

Remarks:

1. Q.P. and AV. are abbreviations of quasi-peak and average individually.
2. The emission levels of other frequencies were very low against the limit.
3. Margin value = Emission level – Limit value
4. Correction factor = Insertion loss + Cable loss
5. Emission Level = Correction Factor + Reading Value

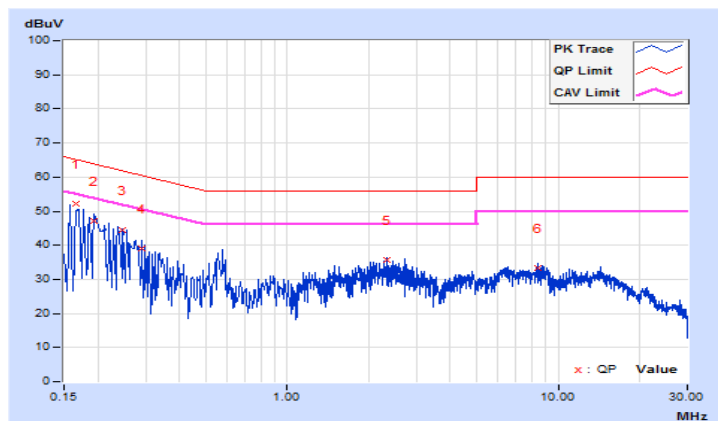

Frequency Range	150kHz ~ 30MHz	Detector Function & Resolution Bandwidth	Quasi-Peak (QP) / Average (AV), 9kHz
Input Power	120Vac, 60Hz	Environmental Conditions	25°C, 65%RH
Tested by	Jisyong Wang	Test Date	2018/6/14

Phase Of Power : Neutral (N)										
No	Frequency (MHz)	Correction Factor (dB)	Reading Value (dBuV)		Emission Level (dBuV)		Limit (dBuV)		Margin (dB)	
			Q.P.	AV.	Q.P.	AV.	Q.P.	AV.	Q.P.	AV.
1	0.15802	10.10	38.00	21.42	48.10	31.52	65.57	55.57	-17.47	-24.05
2	0.22038	10.11	31.16	14.76	41.27	24.87	62.80	52.80	-21.53	-27.93
3	0.36114	10.11	23.49	8.50	33.60	18.61	58.70	48.70	-25.10	-30.09
4	0.54882	10.12	23.88	9.18	34.00	19.30	56.00	46.00	-22.00	-26.70
5	1.74528	10.16	18.80	4.02	28.96	14.18	56.00	46.00	-27.04	-31.82
6	13.79981	10.68	17.94	5.00	28.62	15.68	60.00	50.00	-31.38	-34.32

Remarks:

1. Q.P. and AV. are abbreviations of quasi-peak and average individually.
2. The emission levels of other frequencies were very low against the limit.
3. Margin value = Emission level – Limit value
4. Correction factor = Insertion loss + Cable loss
5. Emission Level = Correction Factor + Reading Value

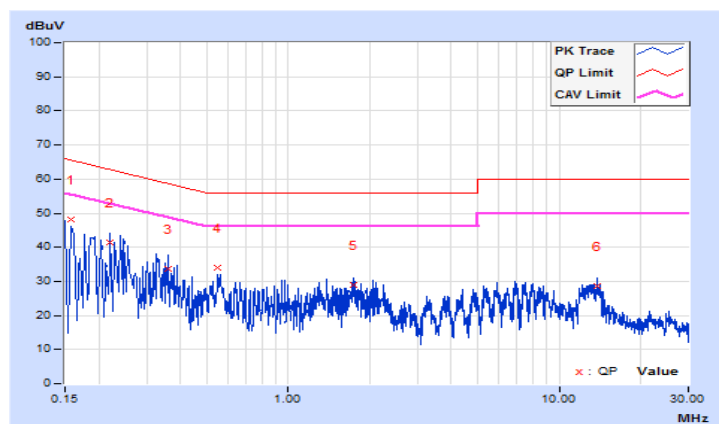

4.3 6 dB Bandwidth Measurement

4.3.1 Limits of 6 dB Bandwidth Measurement

The minimum of 6 dB Bandwidth Measurement is 0.5 MHz.

4.3.2 Test Setup

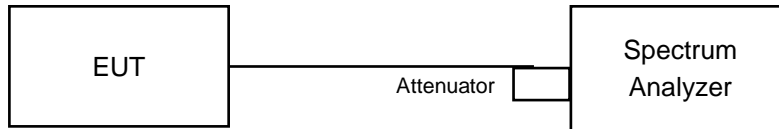

4.3.3 Test Instruments

Refer to section 4.1.2 to get information of above instrument.

4.3.4 Test Procedure

- Set resolution bandwidth (RBW) = 100 kHz
- Set the video bandwidth (VBW) $\geq 3 \times$ RBW, Detector = Peak.
- Trace mode = max hold.
- Sweep = auto couple.
- Measure the maximum width of the emission that is constrained by the frequencies associated with the two amplitude points (upper and lower) that are attenuated by 6 dB relative to the maximum level measured in the fundamental emission

4.3.5 Deviation from Test Standard

No deviation.

4.3.6 EUT Operating Conditions

The software provided by client to enable the EUT under transmission condition continuously at lowest, middle and highest channel frequencies individually.

4.3.7 Test Results

802.11b

Channel	Frequency (MHz)	6 dB Bandwidth (MHz)	Minimum Limit (MHz)	Pass / Fail
1	2412	8.07	0.5	Pass
6	2437	9.59	0.5	Pass
11	2462	9.09	0.5	Pass

802.11g

Channel	Frequency (MHz)	6 dB Bandwidth (MHz)	Minimum Limit (MHz)	Pass / Fail
1	2412	15.36	0.5	Pass
6	2437	15.33	0.5	Pass
11	2462	15.79	0.5	Pass

802.11n (HT20)

Channel	Frequency (MHz)	6 dB Bandwidth (MHz)		Minimum Limit (MHz)	Pass / Fail
		Chain 0	Chain 1		
1	2412	15.99	16.89	0.5	Pass
6	2437	15.97	16.00	0.5	Pass
11	2462	16.37	16.53	0.5	Pass

802.11n (HT40)

Channel	Frequency (MHz)	6 dB Bandwidth (MHz)		Minimum Limit (MHz)	Pass / Fail
		Chain 0	Chain 1		
3	2422	35.59	35.79	0.5	Pass
6	2437	35.18	35.13	0.5	Pass
9	2452	32.64	35.82	0.5	Pass

Spectrum Plot of Worst Value

802.11b

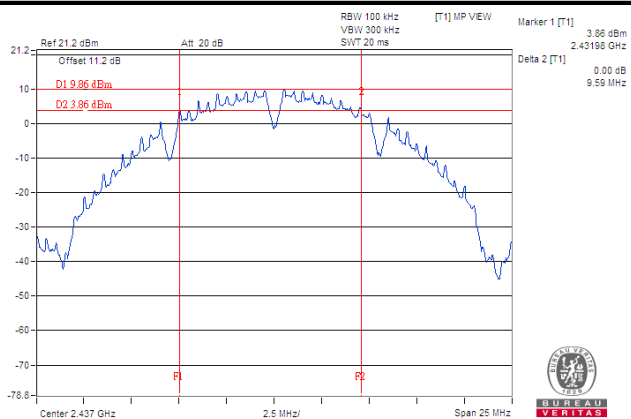

802.11g

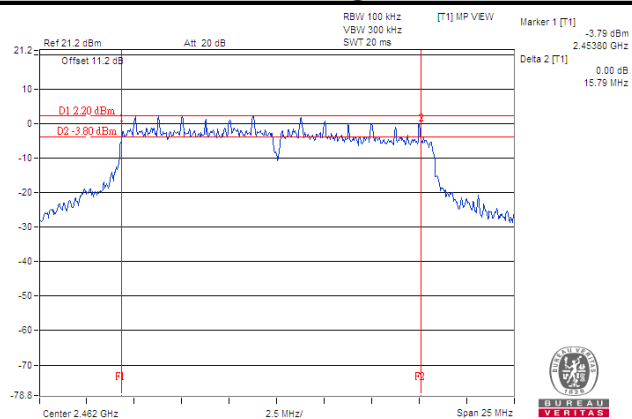

802.11n (HT20)

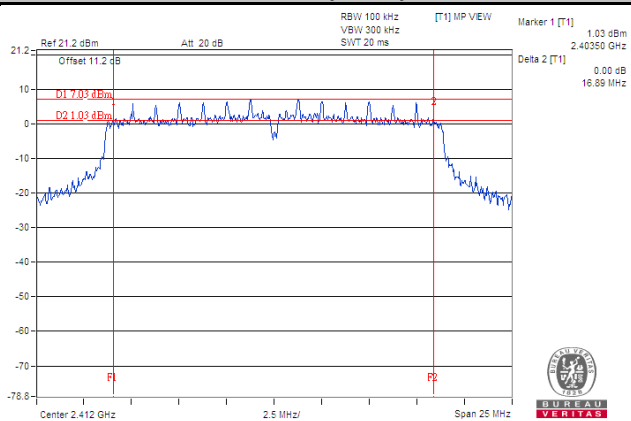

802.11n (HT40)

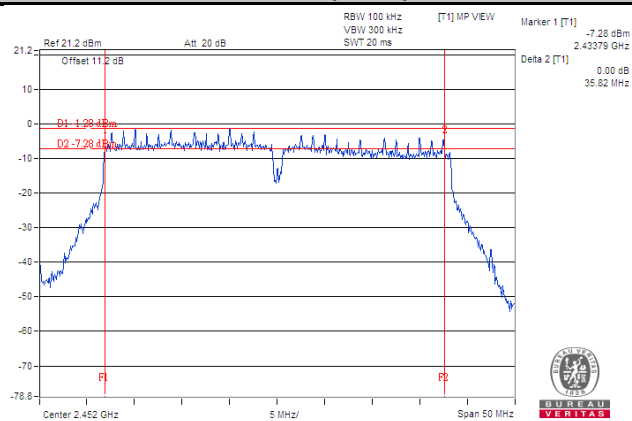

4.4 Occupied Bandwidth Measurement

4.4.1 Test Setup

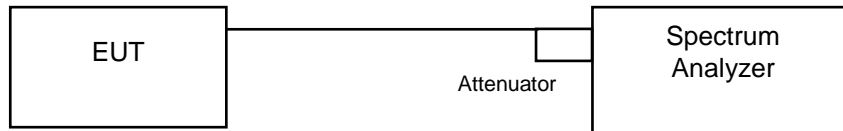

4.4.2 Test Instruments

Refer to section 4.1.2 to get information of above instrument.

4.4.3 Test Procedure

The transmitter output was connected to the spectrum analyzer through an attenuator. The bandwidth of the fundamental frequency was measured by spectrum analyzer with resolution bandwidth in the range of 1 % to 5 % of the anticipated emission bandwidth, and a video bandwidth at least 3x the resolution bandwidth and set the detector to PEAK. The width of a frequency band such that, below the lower and above the upper frequency limits, the mean powers emitted are each equal to a specified percentage 0.5 % of the total mean power of a given emission.

4.4.4 Deviation from Test Standard

No deviation.

4.4.5 EUT Operating Conditions

The software provided by client to enable the EUT under transmission condition continuously at lowest, middle and highest channel frequencies individually.

4.4.6 Test Results

802.11b

Channel	Frequency (MHz)	Occupied Bandwidth (MHz)	Pass / Fail
1	2412	13.94	Pass
6	2437	14.04	Pass
11	2462	14.62	Pass

802.11g

Channel	Frequency (MHz)	Occupied Bandwidth (MHz)	Pass / Fail
1	2412	16.64	Pass
6	2437	16.83	Pass
11	2462	17.12	Pass

802.11n (HT20)

Channel	Frequency (MHz)	Occupied Bandwidth (MHz)		Pass / Fail
		Chain 0	Chain 1	
1	2412	17.88	17.98	Pass
6	2437	17.98	18.36	Pass
11	2462	18.27	17.88	Pass

802.11n (HT40)

Channel	Frequency (MHz)	Occupied Bandwidth (MHz)		Pass / Fail
		Chain 0	Chain 1	
3	2422	36.74	36.54	Pass
6	2437	36.44	36.35	Pass
9	2452	36.35	36.73	Pass

Spectrum Plot of Worst Value

802.11b

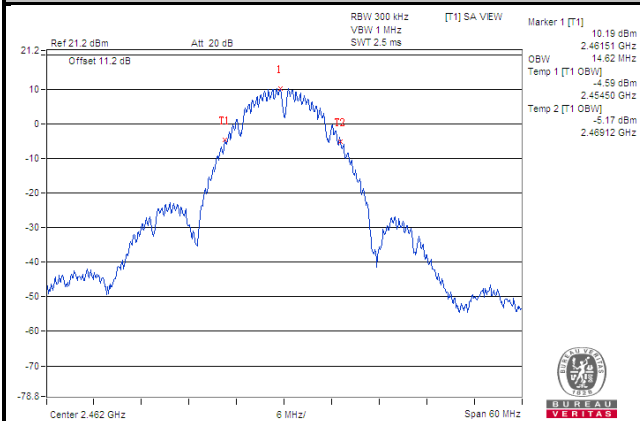

802.11g

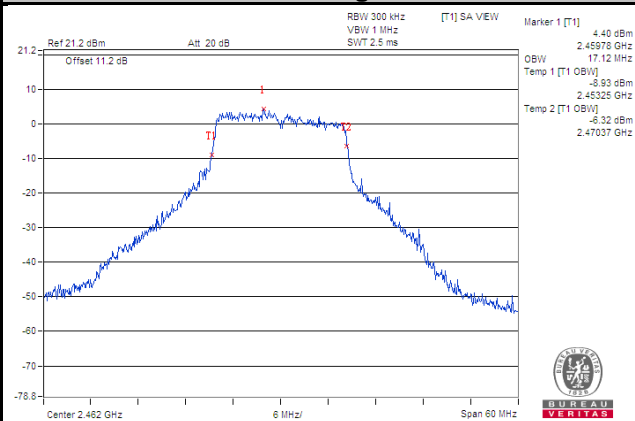

802.11n (HT20)

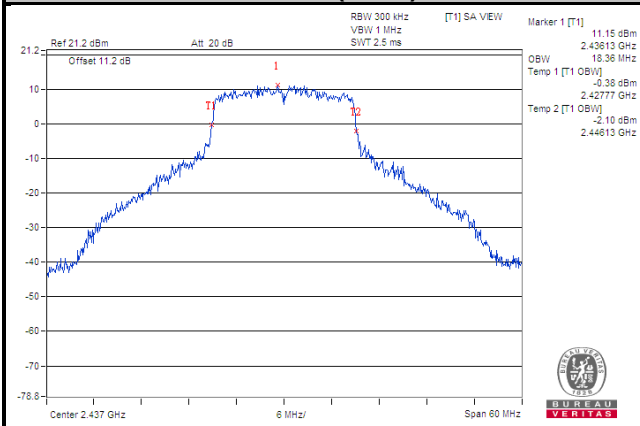

802.11n (HT40)

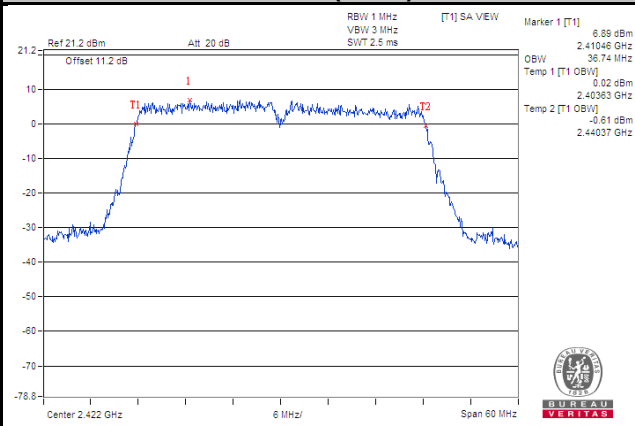

4.5 Conducted Output Power Measurement

4.5.1 Limits of Conducted Output Power Measurement

For systems using digital modulation in the 2400–2483.5 MHz bands: 1 Watt (30 dBm)

Per KDB 662911 D01 Multiple Transmitter Output Method of conducted output power measurement on IEEE 802.11 devices,

Array Gain = 0 dB (i.e., no array gain) for $NANT \leq 4$;

Array Gain = 0 dB (i.e., no array gain) for channel widths ≥ 40 MHz for any NANT;

Array Gain = $5 \log(NANT/NSS)$ dB or 3 dB, whichever is less for 20 MHz channel widths with $NANT \geq 5$.

For power measurements on all other devices: Array Gain = $10 \log(NANT/NSS)$ dB.

4.5.2 Test Setup

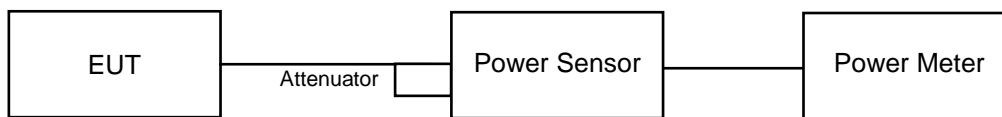

4.5.3 Test Instruments

Refer to section 4.1.2 to get information of above instrument.

4.5.4 Test Procedures

A peak power sensor was used on the output port of the EUT. A power meter was used to read the response of the peak power sensor. Record the power level.

4.5.5 Deviation from Test Standard

No deviation.

4.5.6 EUT Operating Conditions

The software provided by client to enable the EUT under transmission condition continuously at lowest, middle and highest channel frequencies individually.

4.5.7 Test Results

802.11b

Channel	Frequency (MHz)	Peak Power (mW)	Peak Power (dBm)	Limit (dBm)	Pass / Fail
1	2412	153.109	21.85	30	Pass
6	2437	149.279	21.74	30	Pass
9	2452	138.357	21.41	30	Pass
10	2457	106.414	20.27	30	Pass
11	2462	107.152	20.30	30	Pass

802.11g

Channel	Frequency (MHz)	Peak Power (mW)	Peak Power (dBm)	Limit (dBm)	Pass / Fail
1	2412	128.529	21.09	30	Pass
6	2437	193.642	22.87	30	Pass
9	2452	184.927	22.67	30	Pass
10	2457	115.080	20.61	30	Pass
11	2462	57.148	17.57	30	Pass

802.11n (HT20)

Channel	Frequency (MHz)	Peak Power (dBm)		Total Power (mW)	Total Power (dBm)	Limit (dBm)	Pass / Fail
		Chain 0	Chain 1				
1	2412	20.88	21.33	258.92	24.13	30	Pass
6	2437	23.03	23.27	413.233	26.16	30	Pass
8	2447	22.29	22.39	342.814	25.35	30	Pass
9	2452	21.08	21.47	268.514	24.29	30	Pass
10	2457	20.02	20.16	204.214	23.10	30	Pass
11	2462	16.45	18.18	109.923	20.41	30	Pass

802.11n (HT40)

Channel	Frequency (MHz)	Peak Power (dBm)		Total Power (mW)	Total Power (dBm)	Limit (dBm)	Pass / Fail
		Chain 0	Chain 1				
3	2422	18.94	19.72	172.099	22.36	30	Pass
6	2437	22.29	22.79	359.542	25.56	30	Pass
7	2442	20.01	20.73	218.535	23.40	30	Pass
8	2447	18.74	17.68	133.431	21.25	30	Pass
9	2452	16.61	17.83	106.488	20.27	30	Pass

4.6 Power Spectral Density Measurement

4.6.1 Limits of Power Spectral Density Measurement

The Maximum of Power Spectral Density Measurement is 8 dBm.

4.6.2 Test Setup

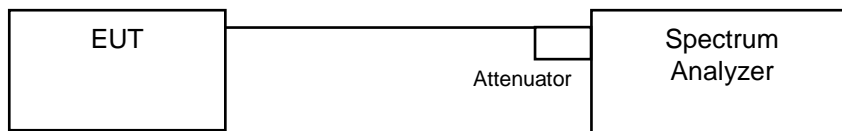

4.6.3 Test Instruments

Refer to section 4.1.2 to get information of above instrument.

4.6.4 Test Procedure

- a. Set analyzer center frequency to DTS channel center frequency.
- b. Set the span to 1.5 times the DTS bandwidth.
- c. Set the RBW to: $3 \text{ kHz} \leq \text{RBW} \leq 100 \text{ kHz}$.
- d. Set the VBW $\geq 3 \times \text{RBW}$.
- e. Detector = peak.
- f. Sweep time = auto couple.
- g. Trace mode = max hold.
- h. Allow trace to fully stabilize.
- i. Use the peak marker function to determine the maximum amplitude level within the RBW.

4.6.5 Deviation from Test Standard

No deviation.

4.6.6 EUT Operating Condition

The software provided by client to enable the EUT under transmission condition continuously at lowest, middle and highest channel frequencies individually.

4.6.7 Test Results

802.11b

Channel	Frequency (MHz)	PSD (dBm/3 kHz)	Limit (dBm/3 kHz)	Pass / Fail
1	2412	0.57	8	Pass
6	2437	-0.30	8	Pass
11	2462	0.40	8	Pass

802.11g

Channel	Frequency (MHz)	PSD (dBm/3 kHz)	Limit (dBm/3 kHz)	Pass / Fail
1	2412	-7.82	8	Pass
6	2437	-6.01	8	Pass
11	2462	-11.52	8	Pass

802.11n (HT20)

TX Chain	Channel	Freq. (MHz)	PSD (dBm/3 kHz)	10 log (N=2) dB	Total PSD (dBm/3 kHz)	Limit (dBm/3 kHz)	Pass / Fail
0	1	2412	-9.73	3.01	-6.72	8	Pass
	6	2437	-7.16	3.01	-4.15	8	Pass
	11	2462	-14.98	3.01	-11.97	8	Pass
1	1	2412	-7.80	3.01	-4.79	8	Pass
	6	2437	-6.29	3.01	-3.28	8	Pass
	11	2462	-12.02	3.01	-9.01	8	Pass

NOTE: Directional gain = $10\log[(10^{G1/20} + 10^{G2/20} + \dots + 10^{GN/20})^2 / N_{ANT}] = 0.61 \text{ dBi} < 6 \text{ dBi}$, so the limit no need to reduced.

802.11n (HT40)

TX Chain	Channel	Freq. (MHz)	PSD (dBm/3 kHz)	10 log (N=2) dB	Total PSD (dBm/3 kHz)	Limit (dBm/3 kHz)	Pass / Fail
0	3	2422	-16.12	3.01	-13.11	8	Pass
	6	2437	-12.17	3.01	-9.16	8	Pass
	9	2452	-18.50	3.01	-15.49	8	Pass
1	3	2422	-15.92	3.01	-12.91	8	Pass
	6	2437	-12.57	3.01	-9.56	8	Pass
	9	2452	-17.23	3.01	-14.22	8	Pass

NOTE: Directional gain = $10\log[(10^{G1/20} + 10^{G2/20} + \dots + 10^{GN/20})^2 / N_{ANT}] = 0.61 \text{ dBi} < 6 \text{ dBi}$, so the limit no need to reduced.

Spectrum Plot of Worst Value

802.11b

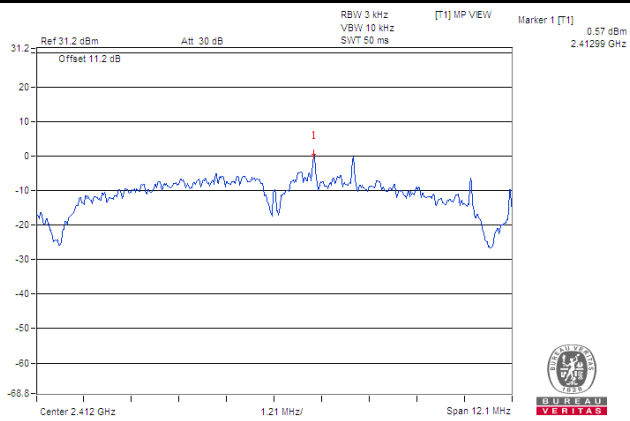

802.11g

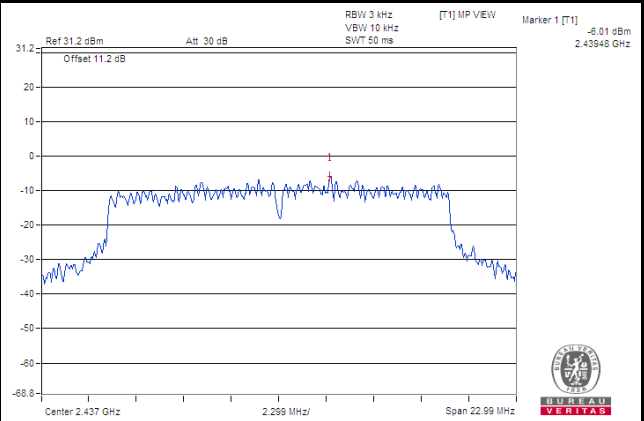

802.11n (HT20)

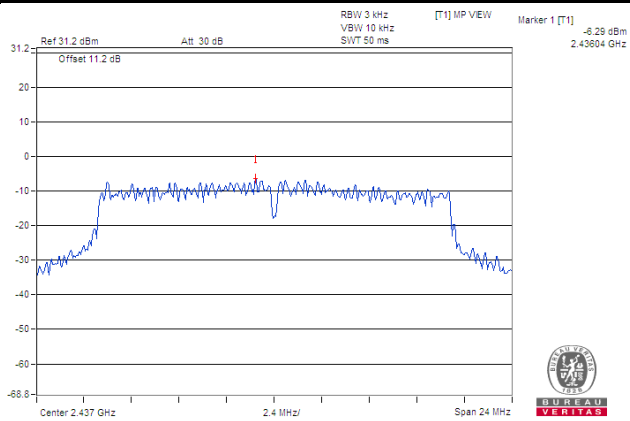

802.11n (HT40)

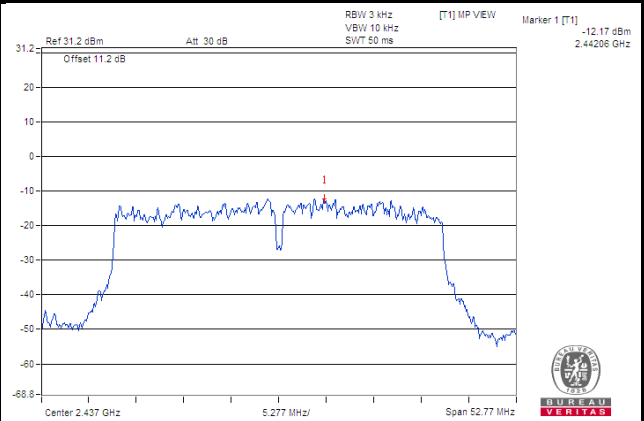

4.7 Conducted Out of Band Emission Measurement

4.7.1 Limits of Conducted Out of Band Emission Measurement

Below -20 dB of the highest emission level of operating band (in 100 kHz Resolution Bandwidth).

4.7.2 Test Setup

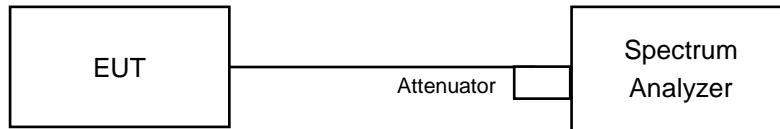

4.7.3 Test Instruments

Refer to section 4.1.2 to get information of above instrument.

4.7.4 Test Procedure

MEASUREMENT PROCEDURE REF

1. Set the RBW = 100 kHz.
2. Set the VBW \geq 300 kHz.
3. Detector = peak.
4. Sweep time = auto couple.
5. Trace mode = max hold.
6. Allow trace to fully stabilize.
7. Use the peak marker function to determine the maximum power level in any 100 kHz band segment within the fundamental EBW.

MEASUREMENT PROCEDURE OOB

1. Set RBW = 100 kHz.
2. Set VBW \geq 300 kHz.
3. Detector = peak.
4. Sweep = auto couple.
5. Trace Mode = max hold.
6. Allow trace to fully stabilize.
7. Use the peak marker function to determine the maximum amplitude level.

4.7.5 Deviation from Test Standard

No deviation.

4.7.6 EUT Operating Condition

The software provided by client to enable the EUT under transmission condition continuously at lowest, middle and highest channel frequencies individually.

4.7.7 Test Results

The spectrum plots are attached on the following images. D1 line indicates the highest level, and D2 line indicates the 20 dB offset below D1. It shows compliance with the requirement.

802.11b

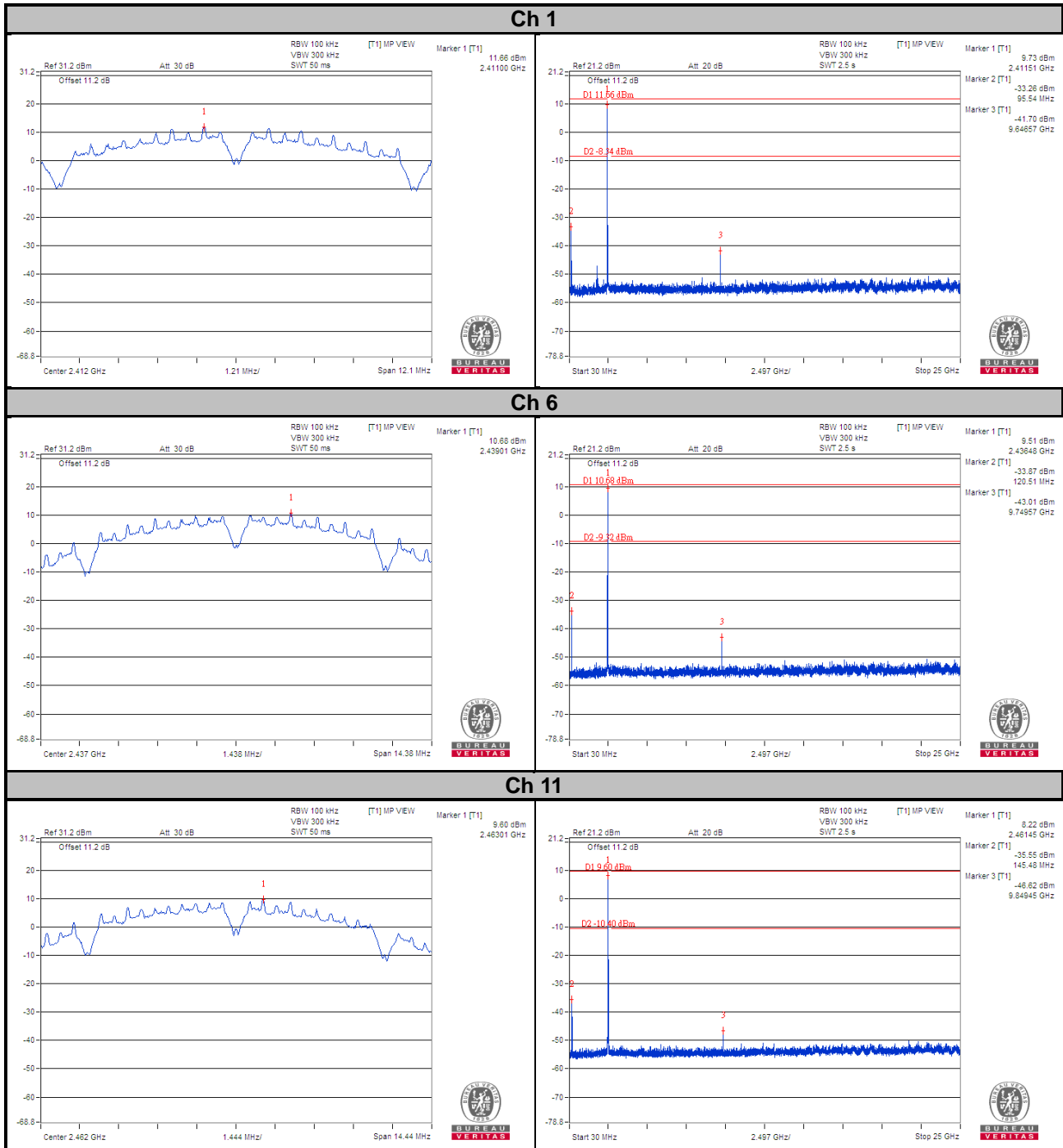

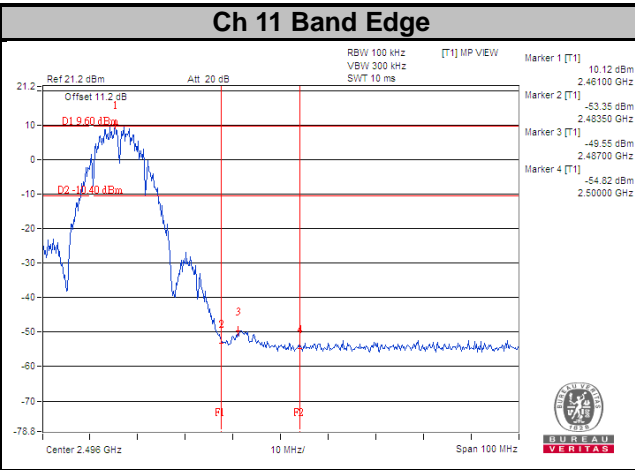
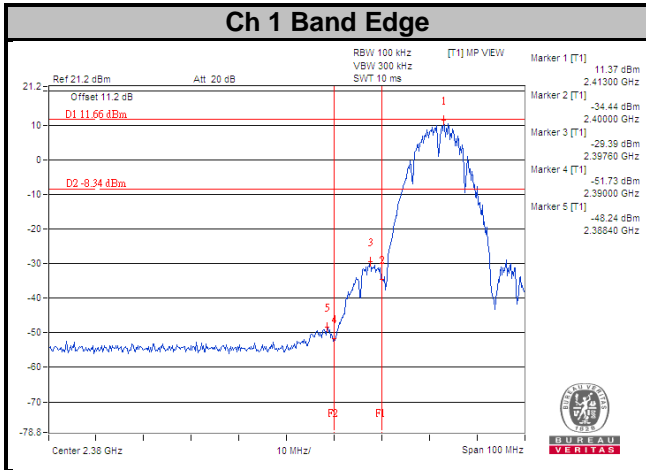

802.11g

Ch 1

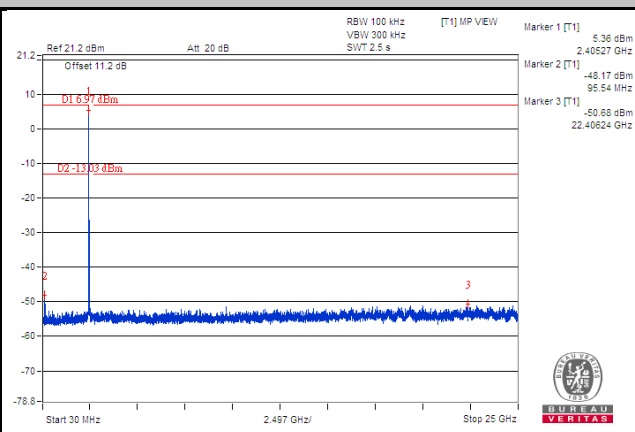
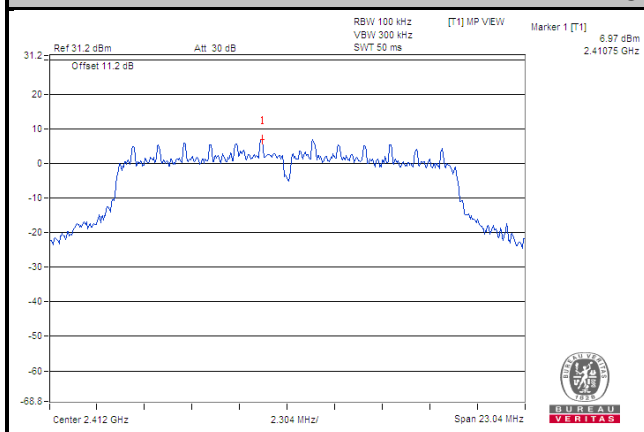

Ch 6

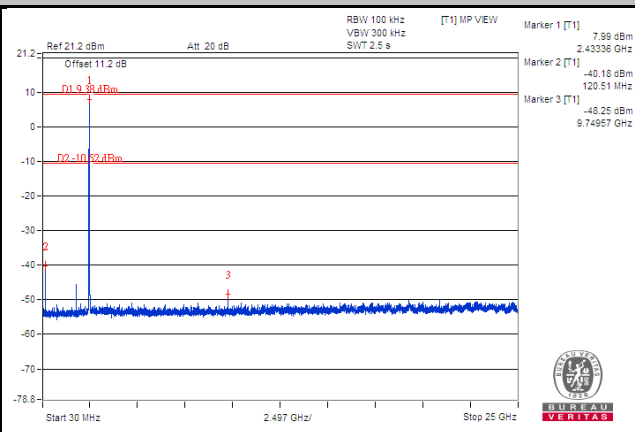
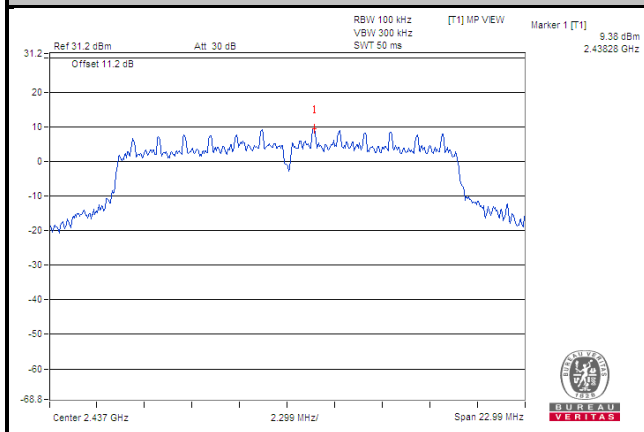

Ch 11

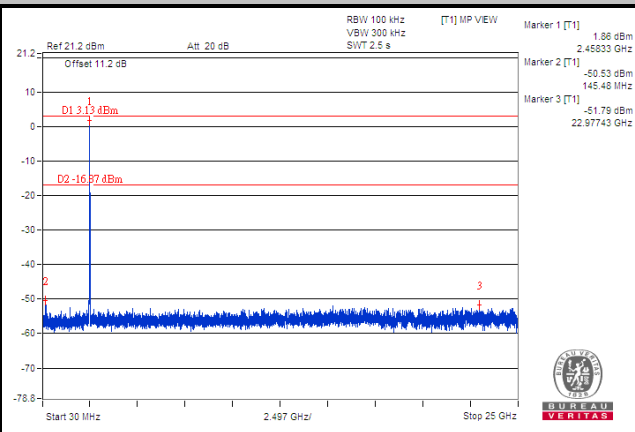
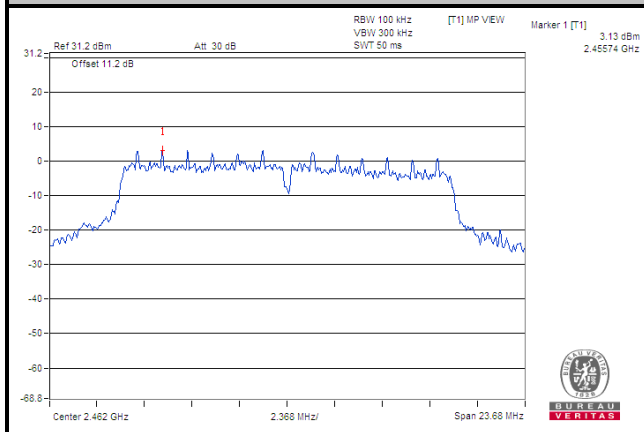

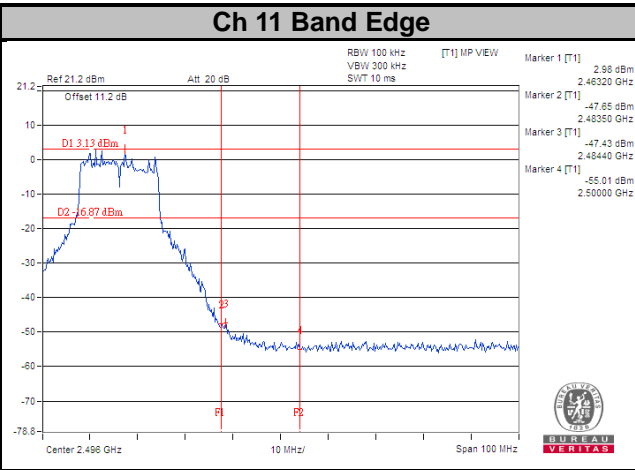
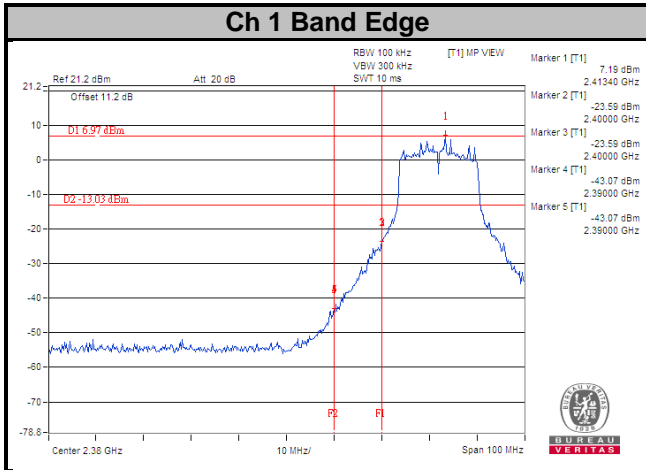

802.11n (HT20)
CHAIN 0

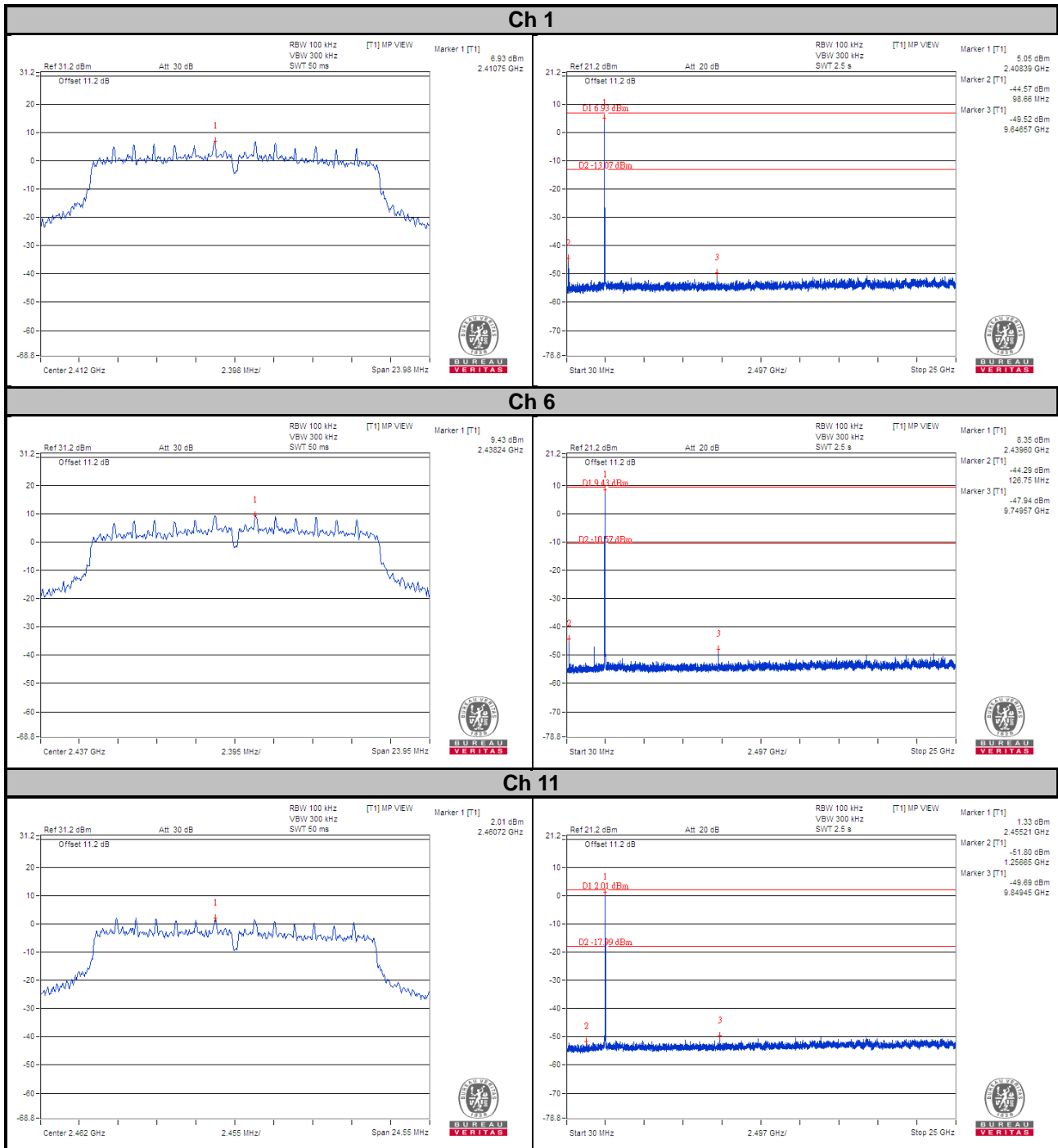

Ch 1 Band Edge

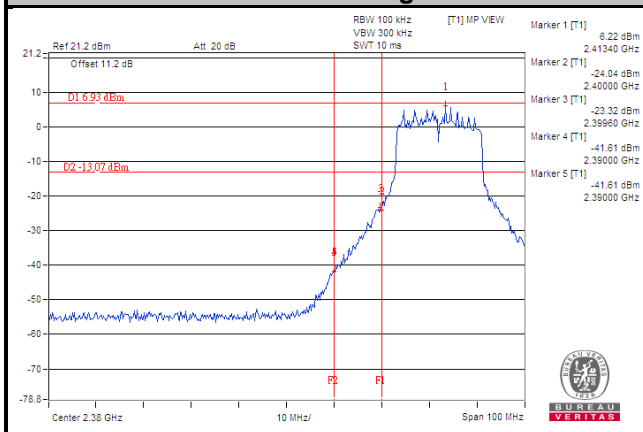

Ch 11 Band Edge

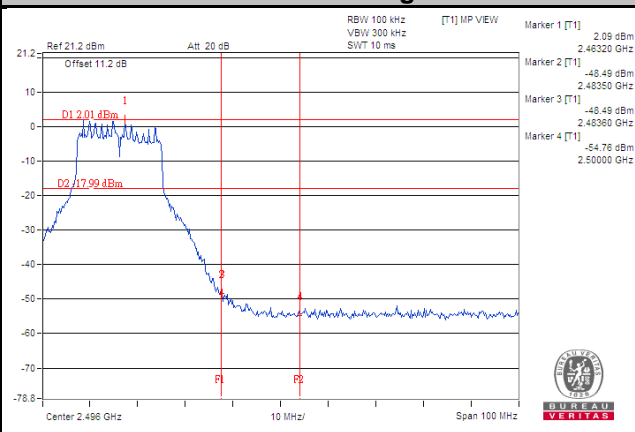

CHAIN 1

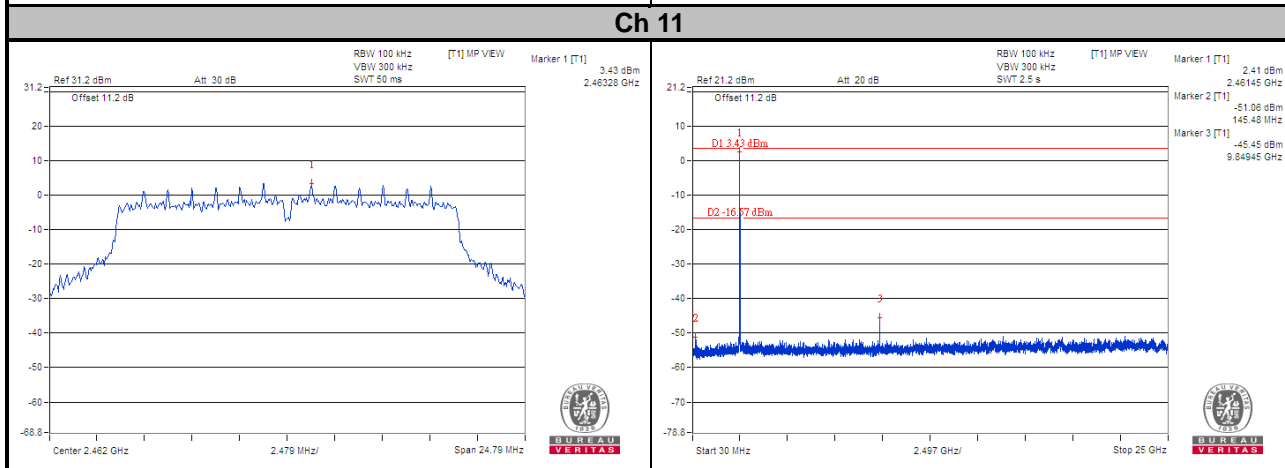
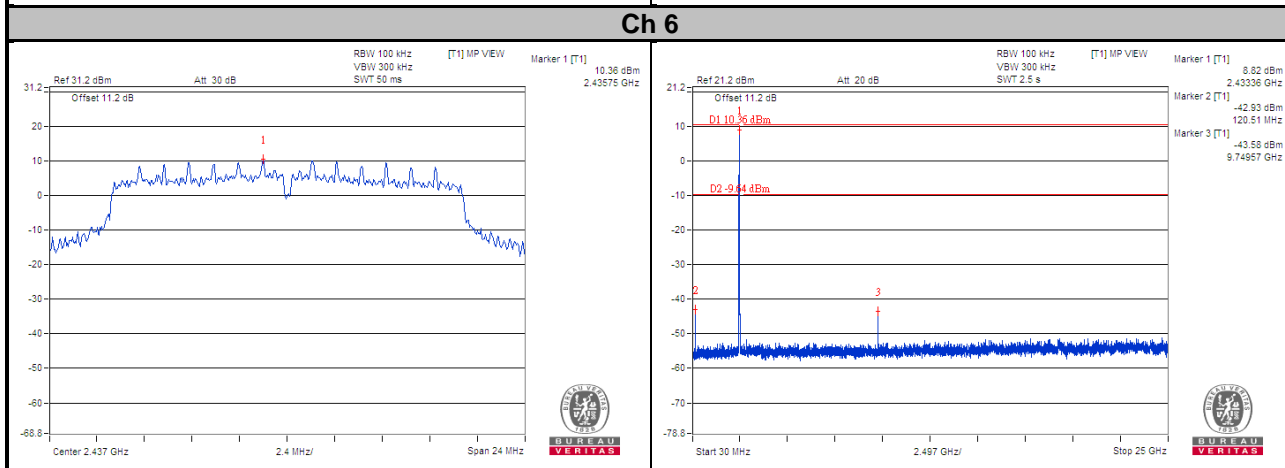
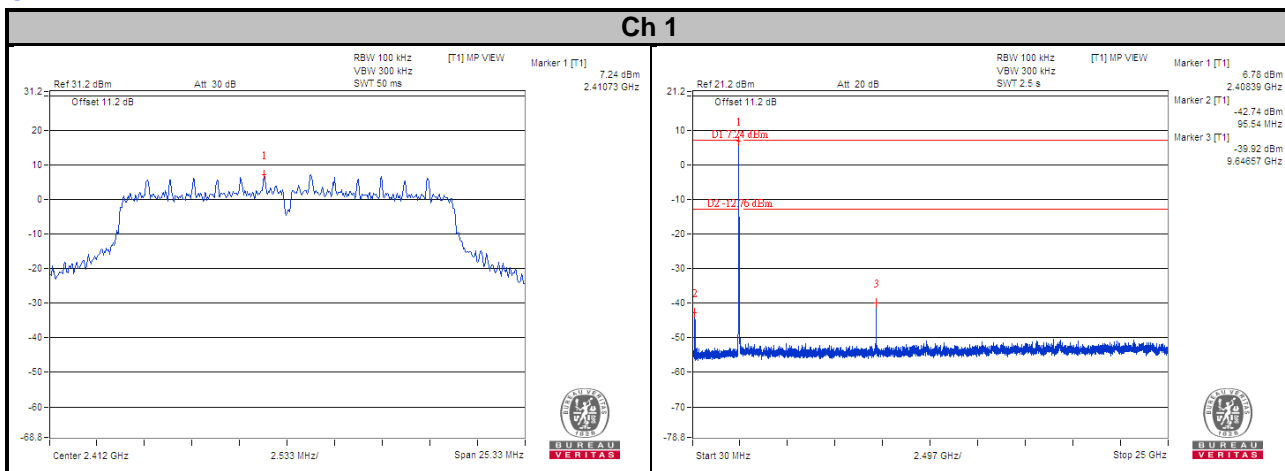

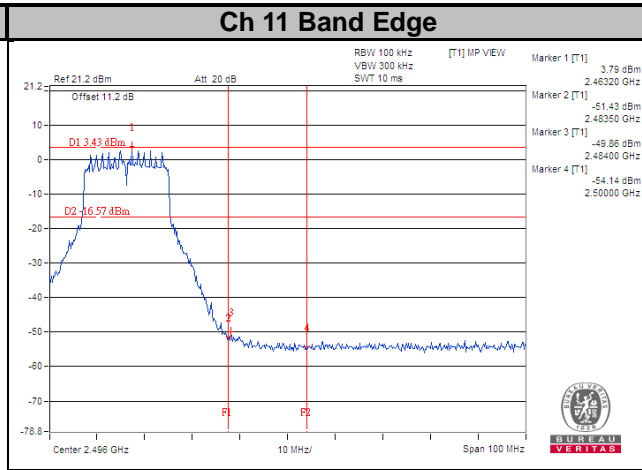
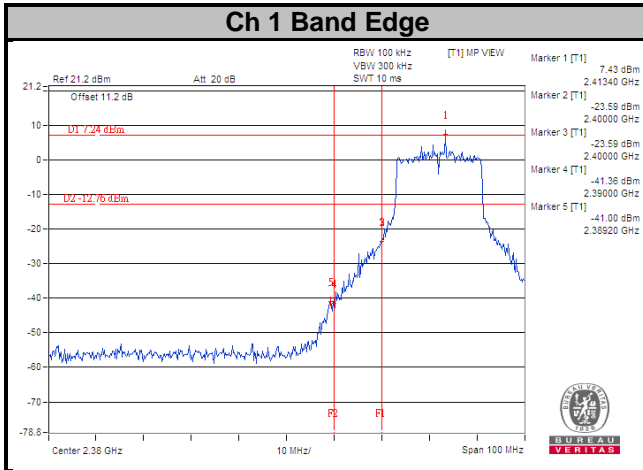

802.11n (HT40)
CHAIN 0

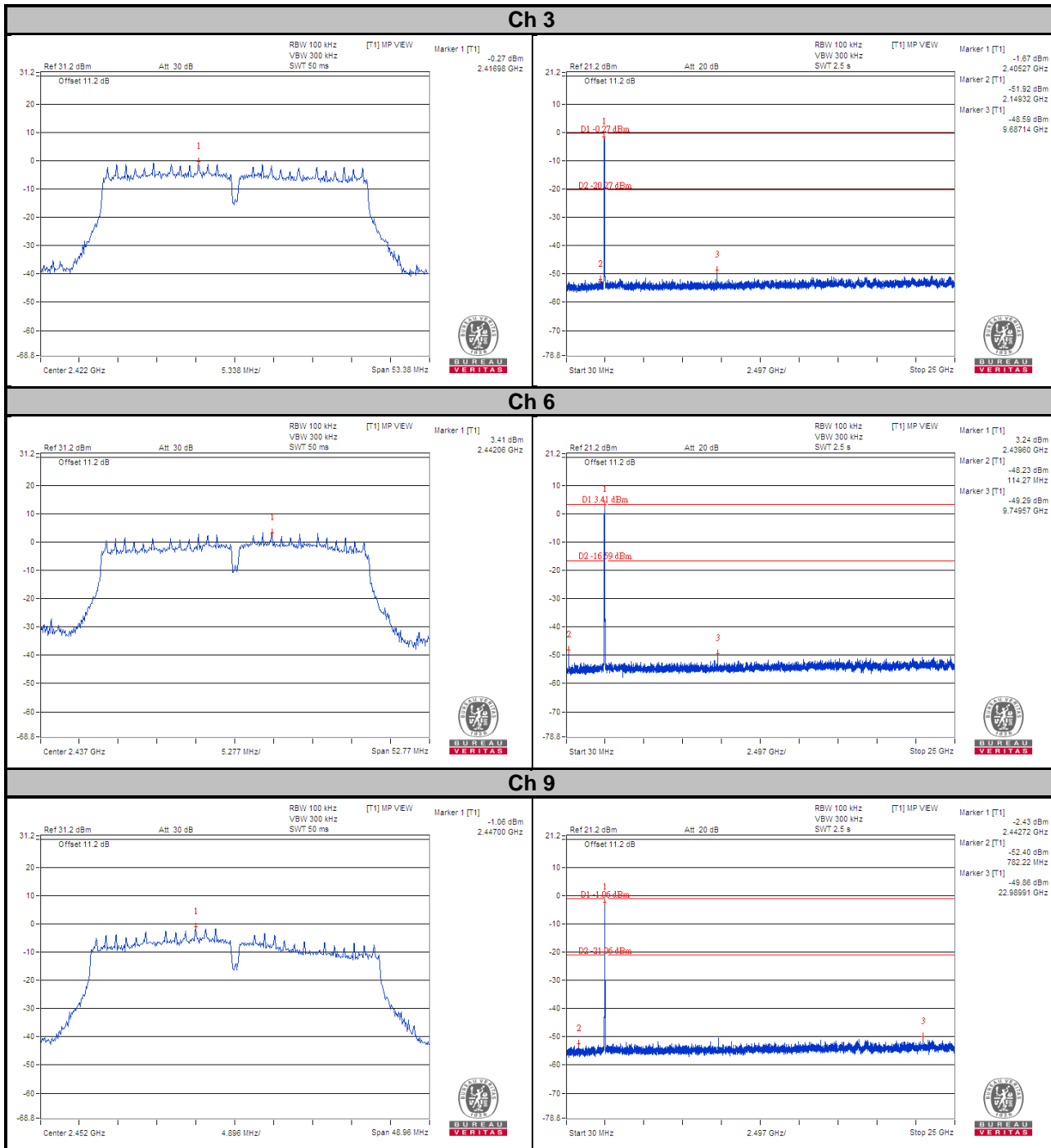

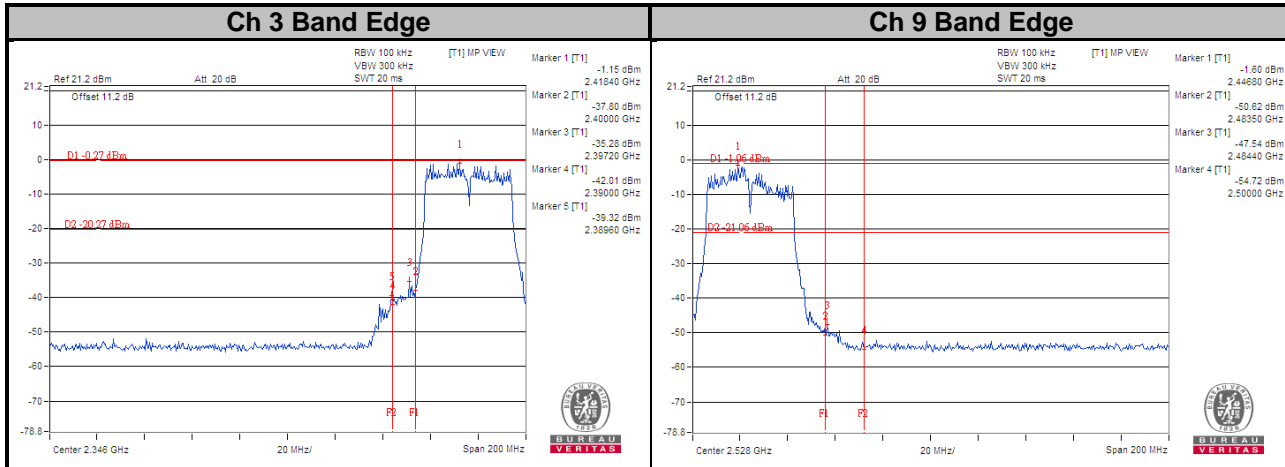

CHAIN 1

Ch 3

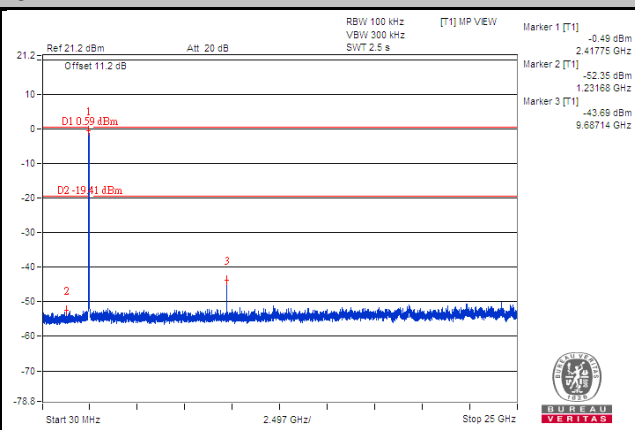
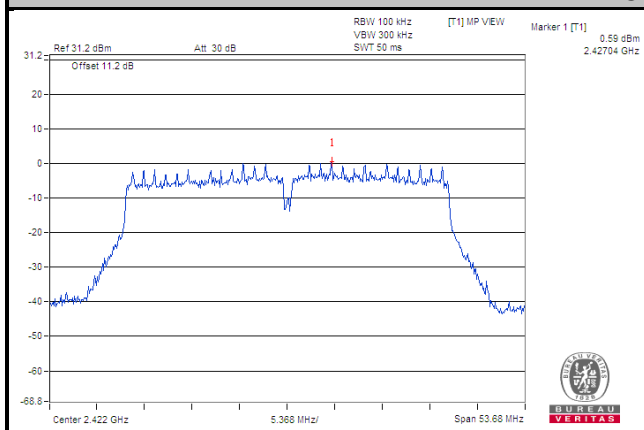

Ch 6

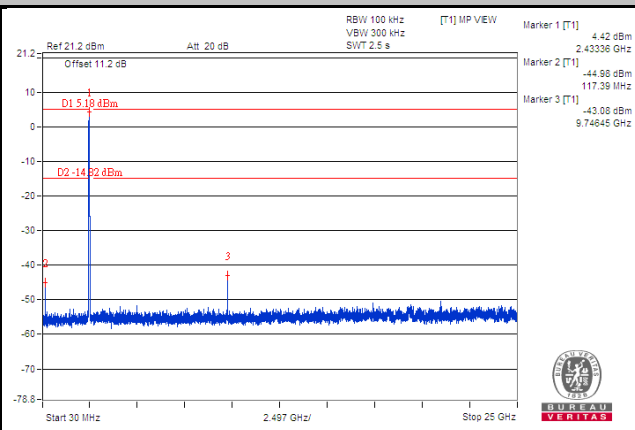
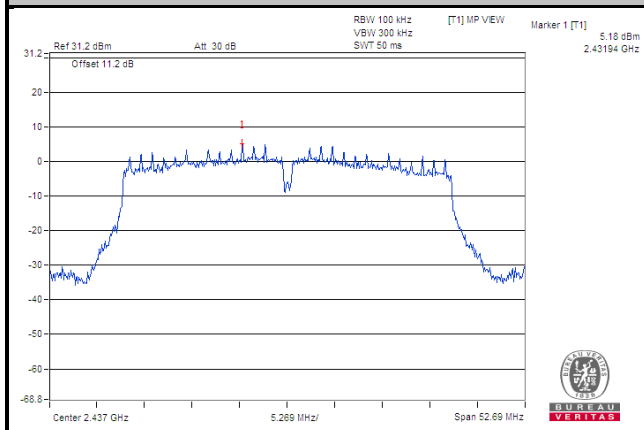

Ch 9

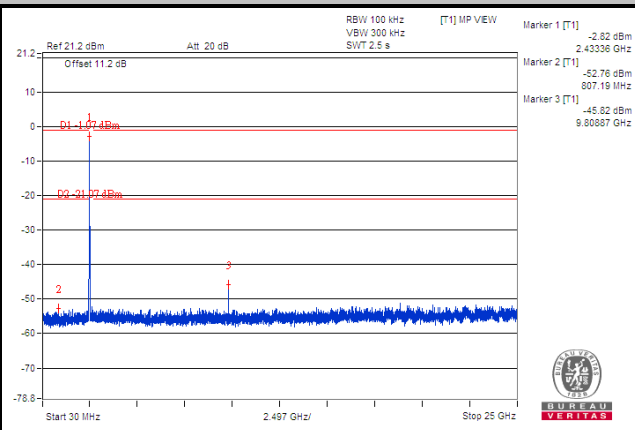
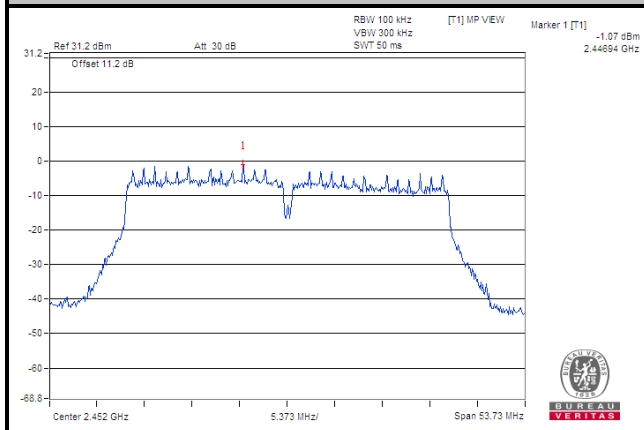

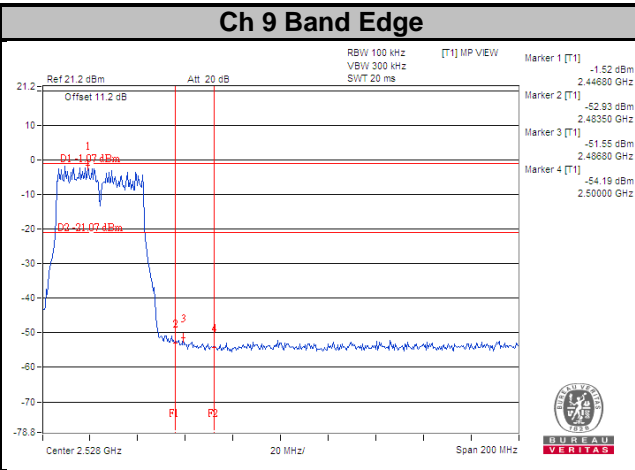
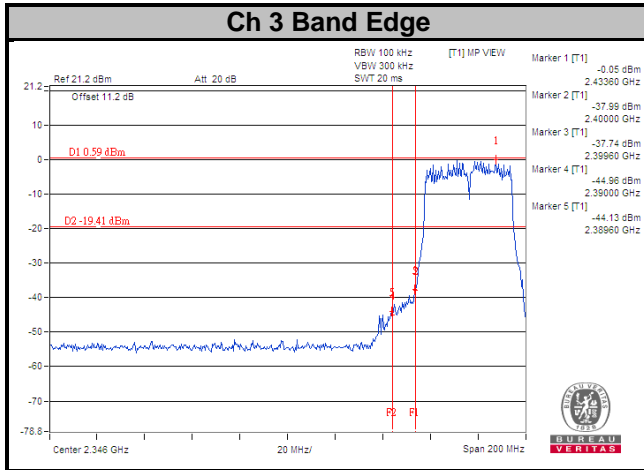

5 Pictures of Test Arrangements

Please refer to the attached file (Test Setup Photo).

Appendix – Information on the Testing Laboratories

We, Bureau Veritas Consumer Products Services (H.K.) Ltd., Taoyuan Branch, were founded in 1988 to provide our best service in EMC, Radio, Telecom and Safety consultation. Our laboratories are FCC recognized accredited test firms and accredited according to ISO/IEC 17025.

If you have any comments, please feel free to contact us at the following:

Linko EMC/RF Lab

Tel: 886-2-26052180

Fax: 886-2-26051924

Hsin Chu EMC/RF/Telecom Lab

Tel: 886-3-6668565

Fax: 886-3-6668323

Hwa Ya EMC/RF/Safety Lab

Tel: 886-3-3183232

Fax: 886-3-3270892

Email: service.adt@tw.bureauveritas.com

Web Site: www.bureauveritas-adt.com

The address and road map of all our labs can be found in our web site also.

--- END ---