



# FCC Test Report

**APPLICANT** : FIH International Co., Ltd.  
**EQUIPMENT** : GSM/WCDMA/LTE Mobile Phone  
**BRAND NAME** : Nokia  
**MODEL NAME** : TA-1079  
**FCC ID** : 2AJOTTA-1079  
**STANDARD** : FCC 47 CFR FCC Part 15 Subpart B  
**CLASSIFICATION** : Certification

The product was received on Nov. 28, 2017 and testing was completed on Jan. 24, 2018. We, Sporton International (Kunshan) Inc., would like to declare that the tested sample has been evaluated in accordance with the test procedures given in ANSI C63.4-2014 and has been in compliance with the applicable technical standards.

The test results in this report apply exclusively to the tested model / sample. Without written approval of Sporton International (Kunshan) Inc., the test report shall not be reproduced except in full.



Approved by: James Huang / Manager

**Sporton International (Kunshan) Inc.**  
**No.3-2 Ping-Xiang Rd, Kunshan Development Zone Kunshan City Jiangsu Province 215335**  
**China**



# TABLE OF CONTENTS

**REVISION HISTORY.....3**

**SUMMARY OF TEST RESULT .....4**

**1. GENERAL DESCRIPTION .....5**

    1.1. Applicant.....5

    1.2. Manufacturer .....5

    1.3. Product Feature of Equipment Under Test .....5

    1.4. Product Specification of Equipment Under Test .....6

    1.5. Modification of EUT .....7

    1.6. Test Location .....7

    1.7. Applicable Standards .....7

**2. TEST CONFIGURATION OF EQUIPMENT UNDER TEST.....8**

    2.1. Test Mode .....8

    2.2. Connection Diagram of Test System .....9

    2.3. Support Unit used in test configuration and system.....11

    2.4. EUT Operation Test Setup .....11

**3. TEST RESULT.....12**

    3.1. Test of AC Conducted Emission Measurement .....12

    3.2. Test of Radiated Emission Measurement .....16

**4. LIST OF MEASURING EQUIPMENT .....20**

**5. UNCERTAINTY OF EVALUATION .....21**

**APPENDIX A. SETUP PHOTOGRAPHS**



### REVISION HISTORY

REPORT NO.	VERSION	DESCRIPTION	ISSUED DATE
FC7O2602-03	Rev. 01	Initial issue of report	Jan. 29, 2018



### SUMMARY OF TEST RESULT

Report Section	FCC Rule	Description	Limit	Result	Remark
3.1	15.107	AC Conducted Emission	< 15.107 limits	PASS	Under limit 12.73 dB at 0.474 MHz
3.2	15.109	Radiated Emission	< 15.109 limits	PASS	Under limit 8.45 dB at 479.90 MHz



# 1. General Description

## 1.1. Applicant

FIH International Co., Ltd.  
No.18, Tongji zhonglu, Beijing Economic&Technological Development Area

## 1.2. Manufacturer

HMD Global Oy  
Karaportti 2 02610 Espoo FINLAND

## 1.3. Product Feature of Equipment Under Test

Product Feature	
Equipment	GSM/WCDMA/LTE Mobile Phone
Brand Name	Nokia
Model Name	TA-1079
FCC ID	2AJOTTA-1079
EUT supports Radios application	GSM/GPRS/EGPRS/WCDMA/HSPA/DC-HSDPA/HSPA+/LTE WLAN 2.4GHz 802.11b/g/n HT20 Bluetooth v2.1+EDR/ Bluetooth v4.2 LE
IMEI Code	Conduction: 004402970951707 Radiation: 004402970950949
HW Version	HW0342
SW Version	000C_0_190
EUT Stage	Identical Prototype

**Remark:**

1. The above EUT's information was declared by manufacturer. Please refer to the specifications or user's manual for more detailed description.
2. This is a variant report for TA-1079, the difference between TA-1056(FCC ID: 2AJOTTA-1056) and TA-1079(FCC ID: 2AJOTTA-1079) is change dual SIM card to single SIM card. According to the change, only the worst cases were verified for the difference, all the other test results were leveraged from original report which can be referred to Sporton Report Number FR7O2602-02B for model TA-1056.



### 1.4. Product Specification of Equipment Under Test

Standards-related Product Specification	
<b>Tx Frequency</b>	GSM850: 824.2 MHz ~ 848.8 MHz GSM1900: 1850.2 MHz ~ 1909.8MHz WCDMA Band V: 826.4 MHz ~ 846.6 MHz WCDMA Band IV : 1712.4 MHz ~ 1752.6 MHz WCDMA Band II: 1852.4 MHz ~ 1907.6 MHz LTE Band 2 : 1850.7 MHz ~ 1909.3 MHz LTE Band 4 : 1710.7 MHz ~ 1754.3 MHz LTE Band 5 : 824.7 MHz ~ 848.3 MHz LTE Band 7 : 2502.5 MHz ~ 2567.5 MHz LTE Band 38 : 2572.5 MHz ~ 2617.5 MHz 802.11b/g/n: 2412 MHz ~ 2462 MHz Bluetooth: 2402 MHz ~ 2480 MHz
<b>Rx Frequency</b>	GSM850: 869.2 MHz ~ 893.8 MHz GSM1900: 1930.2 MHz ~ 1989.8 MHz WCDMA Band V: 871.4 MHz ~ 891.6 MHz WCDMA Band IV : 2112.4 MHz ~ 2152.6 MHz WCDMA Band II: 1932.4 MHz ~ 1987.6 MHz LTE Band 2 : 1930.7 MHz ~ 1989.3 MHz LTE Band 4 : 2110.7 MHz ~ 2154.3 MHz LTE Band 5 : 869.7 MHz ~ 893.3 MHz LTE Band 7 : 2622.5 MHz ~ 2687.5 MHz LTE Band 38 : 2572.5 MHz ~ 2617.5 MHz 802.11b/g/n: 2412 MHz ~ 2462 MHz Bluetooth: 2402 MHz ~ 2480 MHz GPS : 1.57542 GHz FM : 88 MHz ~ 108 MHz
<b>Antenna Type</b>	WWAN: PIFA Antenna WLAN: PIFA Antenna Bluetooth: PIFA Antenna GPS: PIFA Antenna FM: External headset Antenna
<b>Type of Modulation</b>	GSM: GMSK GPRS: GMSK EDGE(MCS 0-4): GMSK / (MCS 5-9): 8PSK WCDMA : BPSK (Uplink) HSDPA/DC-HSDPA : QPSK (Uplink) HSUPA : QPSK (Uplink) HSPA+ : 16QAM DC-HSDPA : 64QAM LTE: QPSK / 16QAM 802.11b : DSSS (DBPSK / DQPSK / CCK) 802.11g/n : OFDM (BPSK / QPSK / 16QAM / 64QAM) Bluetooth LE : GFSK Bluetooth (1Mbps) : GFSK Bluetooth (2Mbps) : $\pi/4$ -DQPSK Bluetooth (3Mbps) : 8-DPSK GPS : BPSK FM



### 1.5. Modification of EUT

No modifications are made to the EUT during all test items.

### 1.6. Test Location

Sporton International (Kunshan) Inc. is accredited to ISO 17025 by National Voluntary Laboratory Accreditation Program (NVLAP code: 600155-0) and the FCC designation No. is CN5013.

<b>Test Site</b>	Sporton International (Kunshan) Inc.		
<b>Test Site Location</b>	No.3-2 Ping-Xiang Rd, Kunshan Development Zone Kunshan City Jiangsu Province 215335 China TEL : +86-512-57900158 FAX : +86-512-57900958		
<b>Test Site No.</b>	<b>Sporton Site No.</b>		<b>FCC Test Firm Registration No.</b>
	CO01-KS	03CH02-KS	630927

**Note:** The test site complies with ANSI C63.4 2014 requirement.

### 1.7. Applicable Standards

According to the specifications of the manufacturer, the EUT must comply with the requirements of the following standards:

- ♦ FCC 47 CFR FCC Part 15 Subpart B
- ♦ ANSI C63.4-2014

**Remark:** All test items were verified and recorded according to the standards and without any deviation during the test.



## 2. Test Configuration of Equipment Under Test

### 2.1. Test Mode

The EUT has been associated with peripherals pursuant to ANSI C63.4-2014 and configuration operated in a manner tended to maximize its emission characteristics in a typical application.

Frequency range investigated: conduction (150 kHz to 30 MHz), radiation (30MHz to the 5th harmonic of the highest fundamental frequency or to 40 GHz, whichever is lower).

Test Items	Function Type
AC Conducted Emission	Mode 1: GSM850 Idle + Bluetooth Idle + WLAN Idle(2.4G) + Earphone + USB Cable(Charging from Adapter) + Camera(Rear) <Fig. 1>
	Mode 2: GSM1900 Idle + Bluetooth Idle + WLAN Idle(2.4G) + Earphone + USB Cable(Charging from Adapter) + Camera(Front) <Fig. 1>
	Mode 3: WCDMA Band V Idle + Bluetooth Idle + WLAN Idle(2.4G) + Earphone + USB Cable(Charging from Adapter) + MPEG4 <Fig. 1>
	Mode 4: LTE Band 7 Idle + Bluetooth Idle + WLAN Idle(2.4G) + Earphone + USB Cable(Data Link with Notebook) + GPS Rx <Fig. 2>
	Mode 5: Earphone + USB Cable(Charging from Adapter) + FM(88MHz) Rx<Fig. 3>
	Mode 6: Earphone + USB Cable(Charging from Adapter) + FM(98MHz) Rx<Fig. 3>
	Mode 7: Earphone + USB Cable(Charging from Adapter) + FM(108MHz) Rx<Fig. 3>
Radiated Emissions	Mode 1: GSM850 Idle + Bluetooth Idle + WLAN Idle(2.4G) + Earphone + USB Cable(Charging from Adapter) + Camera(Rear) <Fig. 1>
	Mode 2: GSM1900 Idle + Bluetooth Idle + WLAN Idle(2.4G) + Earphone + USB Cable(Charging from Adapter) + Camera(Front) <Fig. 1>
	Mode 3: WCDMA Band V Idle + Bluetooth Idle + WLAN Idle(2.4G) + Earphone + USB Cable(Charging from Adapter) + MPEG4 <Fig. 1>
	Mode 4: LTE Band 7 Idle + Bluetooth Idle + WLAN Idle(2.4G) + Earphone + USB Cable(Data Link with Notebook) + GPS Rx <Fig. 2>
	Mode 5: Earphone + USB Cable(Charging from Adapter) + FM(88MHz) Rx<Fig. 3>
	Mode 6: Earphone + USB Cable(Charging from Adapter) + FM(98MHz) Rx<Fig. 3>
	Mode 7: Earphone + USB Cable(Charging from Adapter) + FM(108MHz) Rx<Fig. 3>
<b>Remark:</b>	
<ol style="list-style-type: none"> <li>1. The worst case of AC is mode 4; only the test data of this mode was reported.</li> <li>2. The worst case of RE &lt; 1G is mode 4; only the test data of this mode was reported.</li> <li>3. Data Link with Notebook means data application transferred mode between EUT and Notebook.</li> </ol>	



## 2.2. Connection Diagram of Test System

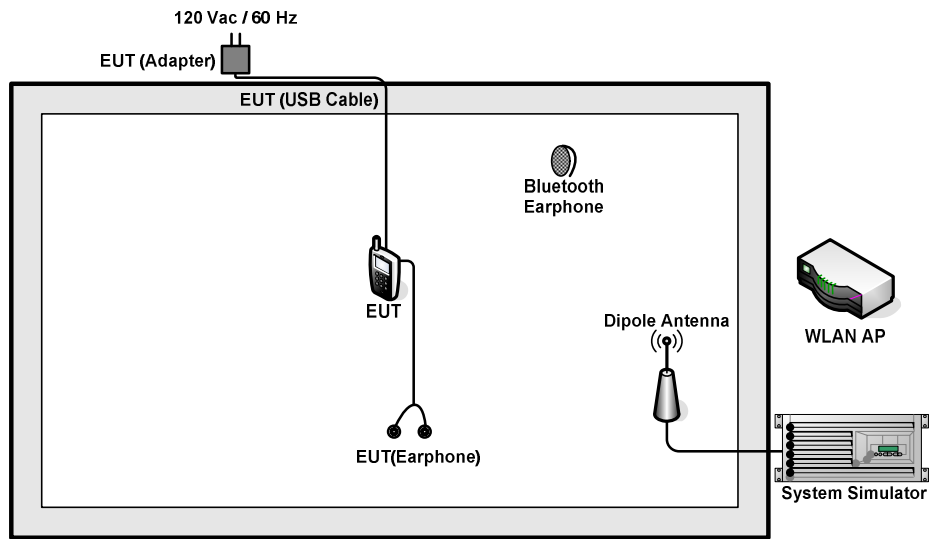

<Fig. 1>

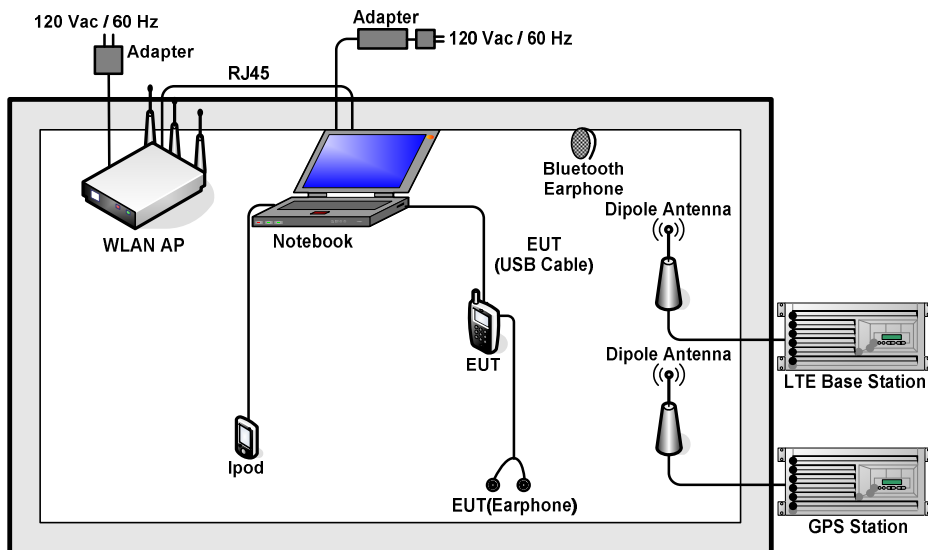

<Fig. 2>

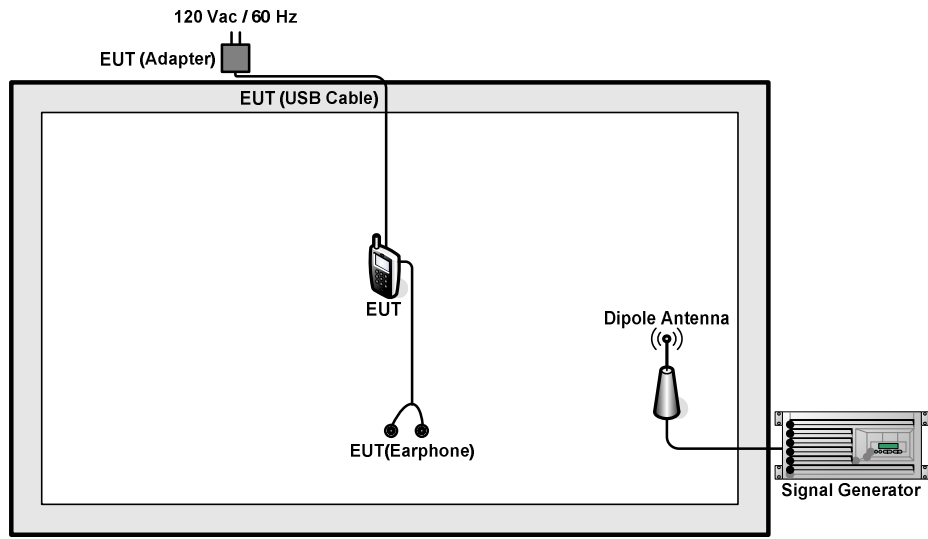

<Fig. 3>

### 2.3. Support Unit used in test configuration and system

Item	Equipment	Trade Name	Model Name	FCC ID	Data Cable	Power Cord
1.	LTE Base Station	Anritsu	MT8820C	N/A	N/A	Unshielded, 1.8 m
2.	System Simulator	R&S	CMU200	N/A	N/A	Unshielded, 1.8 m
3.	GPS Station	ADIVIC	MP9000	N/A	N/A	Unshielded, 1.8 m
4.	WLAN AP	D-link	DIR-855	KA2DIR855A2	N/A	Unshielded, 1.8m
5.	WLAN AP	TP-Link	TL-WDR5600	N/A	N/A	Unshielded, 1.8m
6.	Notebook	Lenovo	G480	N/A	N/A	AC I/P: Unshielded, 1.8m DC O/P: Shielded, 1.8m
7.	Notebook	Lenovo	Y510P	N/A	N/A	AC I/P: Unshielded, 1.8m DC O/P: Shielded, 1.8m
8.	Bluetooth Earphone	Lenovo	LBH308	N/A	N/A	N/A
9.	SD Card	Kingston	8GB	N/A	N/A	N/A
10.	SD Card	SanDisk	Uitra	N/A	N/A	N/A
11.	iPod	Apple	A1199	Fcc DoC	Shielded, 1.2m	N/A

### 2.4. EUT Operation Test Setup

The EUT was in GSM or WCDMA or LTE idle mode during the testing. The EUT was synchronized to the BCCH, and is in continuous receiving mode by setting system simulator’s paging reorganization.

At the same time, the EUT was attached to the Bluetooth earphone or WLAN AP, and the following programs installed in the EUT were programmed during the test.

1. Data application is transferred between Notebook and EUT via USB cable.
2. Turn on GPS function to make the EUT receive continuous signals from GPS station.
3. Execute “Video player” to play MPEG4 files
4. Turn on camera to capture images.
5. Turn on FM Rx function.



### 3. Test Result

#### 3.1. Test of AC Conducted Emission Measurement

##### 3.1.1 Limits of AC Conducted Emission

For equipment that is designed to be connected to the public utility (AC) power line, the radio frequency voltage that is conducted back onto the AC power line on any frequency or frequencies within the band 150 kHz to 30 MHz shall not exceed the limits in the following table.

Frequency of emission (MHz)	Conducted limit (dBuV)	
	Quasi-peak	Average
0.15-0.5	66 to 56*	56 to 46*
0.5-5	56	46
5-30	60	50

\*Decreases with the logarithm of the frequency.

##### 3.1.2 Measuring Instruments

The measuring equipment is listed in the section 4 of this test report.

##### 3.1.3 Test Procedure

1. The EUT was placed 0.4 meter from the conducting wall of the shielding room was kept at least 80 centimeters from any other grounded conducting surface.
2. Connect EUT to the power mains through a line impedance stabilization network (LISN).
3. All the support units are connecting to the other LISN.
4. The LISN provides 50 ohm coupling impedance for the measuring instrument.
5. The FCC states that a 50 ohm, 50 microhenry LISN should be used.
6. Both sides of AC line were checked for maximum conducted interference.
7. The frequency range from 150 kHz to 30 MHz was searched.
8. Set the test-receiver system to Peak Detect Function and specified bandwidth (IF Bandwidth = 9kHz) with Maximum Hold Mode. Then measurement is also conducted by Average Detector and Quasi-Peak Detector Function respectively.

### 3.1.4 Test Setup





3.1.5 Test Result of AC Conducted Emission

Test Mode :	Mode 4	Temperature :	22~24°C
Test Engineer :	Amos Zhang	Relative Humidity :	42~46%
Test Voltage :	120Vac / 60Hz	Phase :	Line
Function Type :	LTE Band 7 Idle + Bluetooth Idle + WLAN Idle(2.4G) + Earphone + USB Cable(Data Link with Notebook) + GPS Rx		

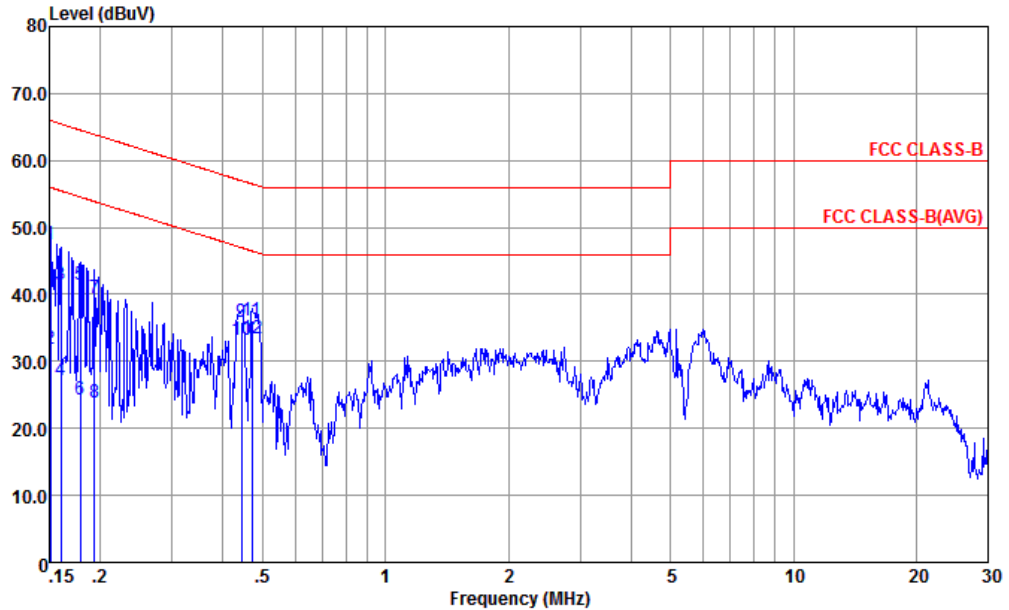

Site : CO01-KS  
 Condition : FCC CLASS-B LISN-L-171013-060103 LINE  
 Project : (FC) 702602-03

: 004402970951707 #2

	Freq	Level	Over Limit	Limit Line	Read Level	LISN Factor	Cable Loss	Remark
	MHz	dBuV	dB	dBuV	dBuV	dB	dB	
1	0.151	47.38	-18.58	65.96	36.60	0.16	10.62	QP
2	0.151	31.98	-23.98	55.96	21.20	0.16	10.62	Average
3	0.160	41.35	-24.12	65.47	30.60	0.17	10.58	QP
4	0.160	27.09	-28.38	55.47	16.34	0.17	10.58	Average
5	0.179	41.40	-23.15	64.55	30.70	0.18	10.52	QP
6	0.179	24.30	-30.25	54.55	13.60	0.18	10.52	Average
7	0.193	39.35	-24.54	63.89	28.68	0.20	10.47	QP
8	0.193	23.95	-29.94	53.89	13.28	0.20	10.47	Average
9	0.444	35.85	-21.13	56.98	25.24	0.25	10.36	QP
10	0.444	33.25	-13.73	46.98	22.64	0.25	10.36	Average
11	0.471	36.19	-20.30	56.49	25.60	0.26	10.33	QP
12 *	0.471	33.39	-13.10	46.49	22.80	0.26	10.33	Average



Test Mode :	Mode 4	Temperature :	22~24°C
Test Engineer :	Amos Zhang	Relative Humidity :	42~46%
Test Voltage :	120Vac / 60Hz	Phase :	Neutral
Function Type :	LTE Band 7 Idle + Bluetooth Idle + WLAN Idle(2.4G) + Earphone + USB Cable(Data Link with Notebook) + GPS Rx		

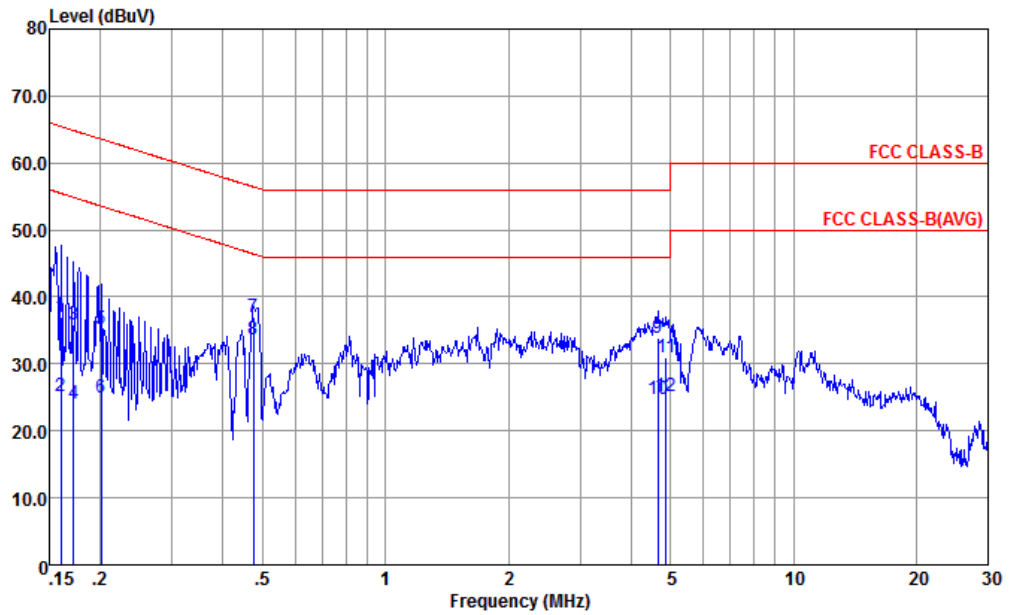

Site : CO01-KS  
 Condition : FCC CLASS-B LISN-N-171013-060103 NEUTRAL  
 Project : (FC) 702602-03

:004402970951707 #2

	Freq	Level	Over Limit	Limit Line	Read Level	LISN Factor	Cable Loss	Remark
	MHz	dBuV	dB	dBuV	dBuV	dB	dB	
1	0.160	37.06	-28.41	65.47	26.20	0.28	10.58	QP
2	0.160	25.16	-30.31	55.47	14.30	0.28	10.58	Average
3	0.172	35.92	-28.94	64.86	25.10	0.28	10.54	QP
4	0.172	24.02	-30.84	54.86	13.20	0.28	10.54	Average
5	0.201	35.26	-28.32	63.58	24.53	0.28	10.45	QP
6	0.201	24.96	-28.62	53.58	14.23	0.28	10.45	Average
7	0.474	36.92	-19.53	56.45	26.30	0.29	10.33	QP
8 *	0.474	33.72	-12.73	46.45	23.10	0.29	10.33	Average
9	4.647	33.77	-22.23	56.00	23.22	0.34	10.21	QP
10	4.647	24.67	-21.33	46.00	14.12	0.34	10.21	Average
11	4.874	30.89	-25.11	56.00	20.32	0.34	10.23	QP
12	4.874	25.19	-20.81	46.00	14.62	0.34	10.23	Average



### 3.2. Test of Radiated Emission Measurement

#### 3.2.1. Limit of Radiated Emission

The emissions from an unintentional radiator shall not exceed the field strength levels specified in the following table:

Frequency (MHz)	Field Strength (microvolts/meter)	Measurement Distance (meters)
30 – 88	100	3
88 – 216	150	3
216 - 960	200	3
Above 960	500	3

#### 3.2.2. Measuring Instruments

The measuring equipment is listed in the section 4 of this test report.

#### 3.2.3. Test Procedures

1. The EUT was placed on a turntable with 0.8 meter above ground.
2. The EUT was set 3 meters from the interference receiving antenna, which was mounted on the top of a variable height antenna tower.
3. The table was rotated 360 degrees to determine the position of the highest radiation.
4. The antenna is a Bi-Log antenna and its height is adjusted between one to four meters above ground to find the maximum value of the field strength for both horizontal polarization and vertical polarization of the antenna.
5. For each suspected emission, the EUT was arranged to its worst case and then tune the antenna tower (from 1 m to 4 m) and turntable (from 0 degree to 360 degrees) to find the maximum reading.
6. Set the test-receiver system to Peak Detect Function and specified bandwidth with Maximum Hold Mode (RBW=120kHz/VBW=300kHz for frequency below 1GHz; RBW=1MHz VBW=3MHz (Peak), RBW=1MHz/VBW=10Hz (Average) for frequency above 1GHz).
7. If the emission level of the EUT in peak mode was 3 dB lower than the limit specified, peak values of EUT will be reported. Otherwise, the emission will be repeated by using the quasi-peak method and reported.
8. Emission level (dBµV/m) = 20 log Emission level (µV/m)
9. Corrected Reading: Antenna Factor + Cable Loss + Read Level - Preamp Factor = Level



### 3.2.4. Test Setup of Radiated Emission

For radiated emissions from 30MHz to 1GHz



For radiated emissions above 1GHz

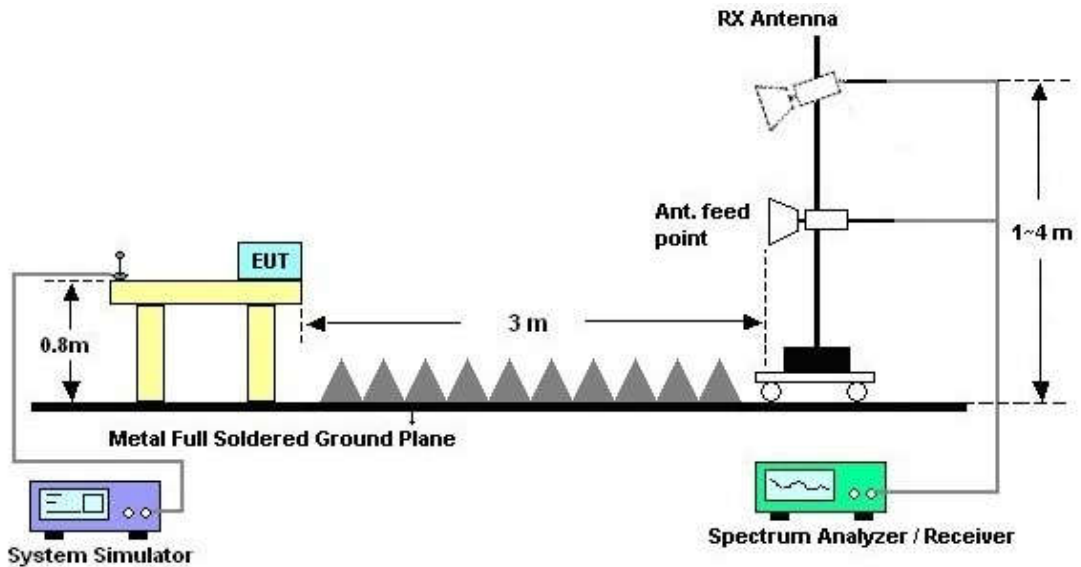



3.2.5. Test Result of Radiated Emission

Test Mode :	Mode 4	Temperature :	21~22°C
Test Engineer :	Leo Li	Relative Humidity :	41~42%
Test Distance :	3m	Polarization :	Horizontal
Function Type :	LTE Band 7 Idle + Bluetooth Idle + WLAN Idle(2.4G) + Earphone + USB Cable(Data Link with Notebook) + GPS Rx		

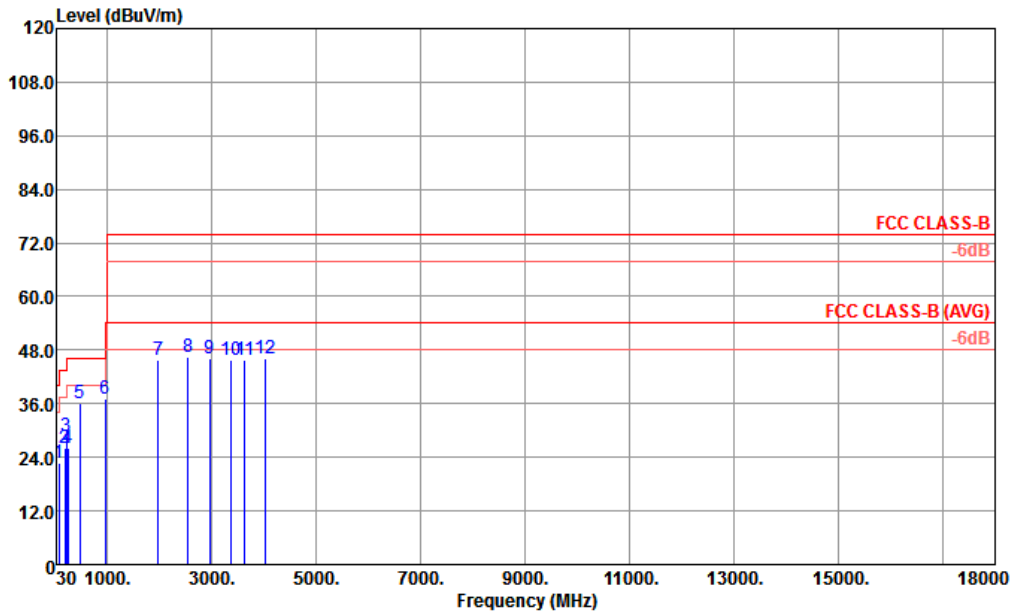

Site : 03CH02-KS  
 Condition : FCC CLASS-B 3m LF 47610 HORIZONTAL  
 Project : (FC)702602-03

IMEI : 004402970950949 #8

	Freq	Level	Over Limit	Limit Line	ReadAntenna Level	Antenna Factor	Cable Loss	Preamp Factor	A/Pos	T/Pos	Remark
	MHz	dBuV/m	dB	dBuV/m	dBuV	dB/m	dB	dB	cm	deg	
1	84.54	22.66	-17.34	40.00	39.94	13.82	0.95	32.05	---	---	Peak
2	187.68	26.01	-17.49	43.50	41.28	15.04	1.40	31.71	---	---	Peak
3	229.80	28.84	-17.16	46.00	42.51	16.30	1.63	31.60	---	---	Peak
4	254.37	26.10	-19.90	46.00	36.90	18.96	1.76	31.52	---	---	Peak
5	479.90	35.95	-10.05	46.00	40.83	23.22	2.30	30.40	---	---	Peak
6	959.90	37.26	-8.74	46.00	34.12	27.01	3.21	27.08	100	0	Peak
7	1986.00	45.93	-28.07	74.00	44.53	30.19	4.61	33.40	---	---	Peak
8	2550.00	46.43	-27.57	74.00	40.26	31.56	5.31	30.70	---	---	Peak
9	2972.00	46.18	-27.82	74.00	37.71	32.50	5.94	29.97	---	---	Peak
10	3369.00	45.82	-28.18	74.00	36.22	33.33	6.27	30.00	---	---	Peak
11	3642.00	45.76	-28.24	74.00	35.10	33.92	6.49	29.75	---	---	Peak
12	4041.00	46.04	-27.96	74.00	34.11	35.18	6.86	30.11	---	---	Peak



Test Mode :	Mode 4	Temperature :	21~22°C
Test Engineer :	Leo Li	Relative Humidity :	41~42%
Test Distance :	3m	Polarization :	Vertical
Function Type :	LTE Band 7 Idle + Bluetooth Idle + WLAN Idle(2.4G) + Earphone + USB Cable(Data Link with Notebook) + GPS Rx		

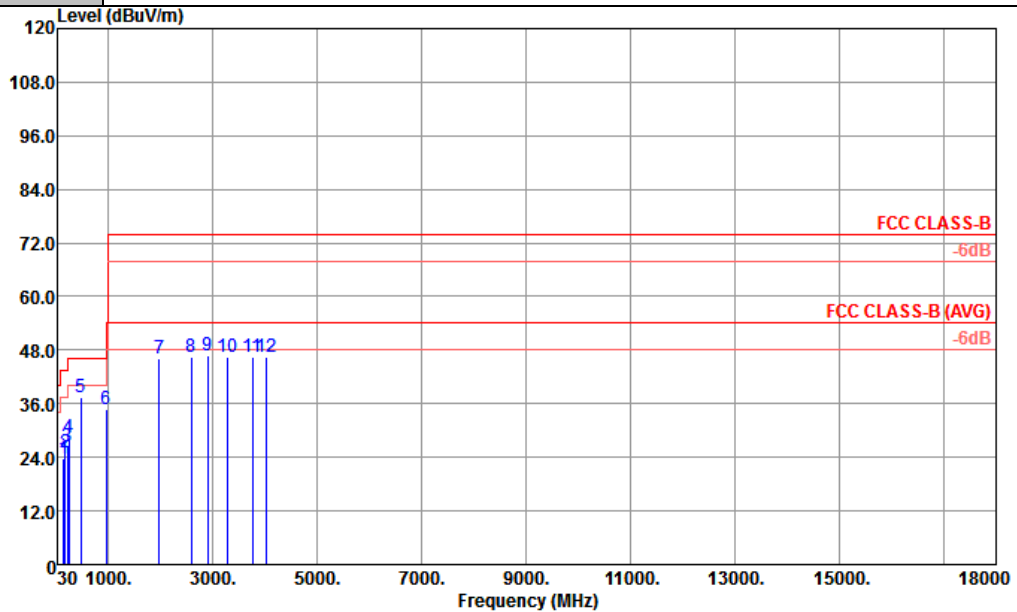

Site : 03CH02-KS  
 Condition : FCC CLASS-B 3m LF 47610 VERTICAL  
 Project : (FC)702602-03

IMEI : 004402970950949 #8

	Freq	Level	Over Limit	Limit Line	ReadAntenna Level	Antenna Factor	Cable Loss	Preamp Factor	A/Pos	T/Pos	Remark
	MHz	dBuV/m	dB	dBuV/m	dBuV	dB/m	dB	dB	cm	deg	
1	153.12	23.63	-19.87	43.50	37.81	16.38	1.27	31.83	---	---	Peak
2	185.25	25.22	-18.28	43.50	40.45	15.10	1.39	31.72	---	---	Peak
3	229.80	26.27	-19.73	46.00	39.94	16.30	1.63	31.60	---	---	Peak
4	254.37	28.35	-17.65	46.00	39.15	18.96	1.76	31.52	---	---	Peak
5	479.90	37.55	-8.45	46.00	42.43	23.22	2.30	30.40	100	0	Peak
6	959.90	34.86	-11.14	46.00	31.72	27.01	3.21	27.08	---	---	Peak
7	1978.00	46.16	-27.84	74.00	44.80	30.19	4.61	33.44	---	---	Peak
8	2590.00	46.32	-27.68	74.00	39.96	31.65	5.34	30.63	---	---	Peak
9	2912.00	46.69	-27.31	74.00	38.45	32.30	5.91	29.97	---	---	Peak
10	3276.00	46.47	-27.53	74.00	36.80	33.21	6.24	29.78	---	---	Peak
11	3768.00	46.50	-27.50	74.00	35.29	34.73	6.59	30.11	---	---	Peak
12	4026.00	46.34	-27.66	74.00	34.51	35.15	6.79	30.11	---	---	Peak



### 4. List of Measuring Equipment

Instrument	Manufacturer	Model No.	Serial No.	Characteristics	Calibration Date	Test Date	Due Date	Remark
EMI Receiver	R&S	ESCI7	100768	9kHz~7GHz;	Apr. 20, 2017	Jan. 09, 2018	Apr. 19, 2018	Conduction (CO01-KS)
AC LISN	MessTec	AN3016	060103	9kHz~30MHz	Oct. 13, 2017	Jan. 09, 2018	Oct. 12, 2018	Conduction (CO01-KS)
AC LISN (for auxiliary equipment)	MessTec	AN3016	060105	9kHz~30MHz	Oct. 13, 2017	Jan. 09, 2018	Oct. 12, 2018	Conduction (CO01-KS)
AC Power Source	Chroma	61602	ABP0000008 11	AC 0V~300V, 45Hz~1000Hz	Oct. 12, 2017	Jan. 09, 2018	Oct. 11, 2018	Conduction (CO01-KS)
EMI Test Receiver	R&S	ESR7	101403	9kHz~7GHz; Max 30dBm	Aug. 08, 2017	Jan. 24, 2018	Aug. 07, 2018	Radiation (03CH02-KS)
EXA Spectrum Analyzer	Keysight	N9010A	MY55150208	10Hz~44GHz, MAX 30dB	Apr. 18, 2017	Jan. 24, 2018	Apr. 17, 2018	Radiation (03CH02-KS)
Bilog Antenna	TeseQ	CBL6112D	23182	30MHz~2GHz	Jan. 22, 2018	Jan. 24, 2018	Jan. 21, 2019	Radiation (03CH02-KS)
Double Ridge Horn Antenna	ETS-Lindgren	3117	75957	1GHz~18GHz	Oct. 21, 2017	Jan. 24, 2018	Oct. 20, 2018	Radiation (03CH02-KS)
Amplifier	SONOMA	310N	187289	9kHz~1GHz	Aug. 07, 2017	Jan. 24, 2018	Aug. 06, 2018	Radiation (03CH02-KS)
Amplifier	Agilent	8449B	3008A02384	1GHz~26.5GHz	Oct. 12, 2017	Jan. 24, 2018	Oct. 11, 2018	Radiation (03CH02-KS)
AC Power Source	Chroma	61601	61601000247 3	N/A	NCR	Jan. 24, 2018	NCR	Radiation (03CH02-KS)
Turn Table	MF	MF7802	N/A	0~360 degree	NCR	Jan. 24, 2018	NCR	Radiation (03CH02-KS)
Antenna Mast	MF	MF7802	N/A	1 m~4 m	NCR	Jan. 24, 2018	NCR	Radiation (03CH02-KS)

NCR: No Calibration Required



## 5. Uncertainty of Evaluation

### Uncertainty of Conducted Emission Measurement (150 kHz ~ 30 MHz)

Measuring Uncertainty for a Level of Confidence of 95% (U = 2Uc(y))	2.3dB
---	-------

### Uncertainty of Radiated Emission Measurement (30 MHz ~ 1000 MHz)

Measuring Uncertainty for a Level of Confidence of 95% (U = 2Uc(y))	5.2dB
---	-------

### Uncertainty of Radiated Emission Measurement (1000 MHz ~ 18000 MHz)

Measuring Uncertainty for a Level of Confidence of 95% (U = 2Uc(y))	4.7dB
---	-------