



FCC Test Report

APPLICANT : FIH International Co., Ltd.
EQUIPMENT : GSM/WCDMA/LTE Mobile Phone
BRAND NAME : Nokia
MODEL NAME : TA-1071
FCC ID : 2AJOTTA-1071
STANDARD : FCC 47 CFR FCC Part 15 Subpart B
CLASSIFICATION : Certification

The product was completed on Nov. 14, 2017 and testing was completed on Feb. 01, 2018. We, Sporton International (Kunshan) Inc., would like to declare that the tested sample has been evaluated in accordance with the test procedures given in ANSI C63.4-2014 and has been in compliance with the applicable technical standards.

The test results in this report apply exclusively to the tested model / sample. Without written approval of Sporton International (Kunshan) Inc., the test report shall not be reproduced except in full.



Approved by: James Huang / Manager

Sporton International (Kunshan) Inc.

No.3-2 Ping-Xiang Rd, Kunshan Development Zone Kunshan City Jiangsu Province 215335 China



TABLE OF CONTENTS

REVISION HISTORY..... 3

SUMMARY OF TEST RESULT 4

1. GENERAL DESCRIPTION 5

 1.1. Applicant..... 5

 1.2. Manufacturer 5

 1.3. Product Feature of Equipment Under Test 5

 1.4. Product Specification of Equipment Under Test 6

 1.5. Modification of EUT 6

 1.6. Test Location 7

 1.7. Applicable Standards 7

2. TEST CONFIGURATION OF EQUIPMENT UNDER TEST 8

 2.1. Test Mode 8

 2.2. Connection Diagram of Test System 9

 2.3. Support Unit used in test configuration and system 11

 2.4. EUT Operation Test Setup 11

3. TEST RESULT 12

 3.1. Test of AC Conducted Emission Measurement 12

 3.2. Test of Radiated Emission Measurement 18

4. LIST OF MEASURING EQUIPMENT 22

5. UNCERTAINTY OF EVALUATION 23



SUMMARY OF TEST RESULT

Report Section	FCC Rule	Description	Limit	Result	Remark
3.1	15.107	AC Conducted Emission	< 15.107 limits	PASS	Under limit 8.02 dB at 0.201 MHz
3.2	15.109	Radiated Emission	< 15.109 limits	PASS	Under limit 9.20 dB at 599.60 MHz



1. General Description

1.1. Applicant

FIH International Co., Ltd.
No.18, Tongji zhonglu, Beijing Economic&Technological Development Area

1.2. Manufacturer

HMD Global Oy
Karaportti 2 02610 Espoo FINLAND

1.3. Product Feature of Equipment Under Test

Product Feature	
Equipment	GSM/WCDMA/LTE Mobile Phone
Brand Name	Nokia
Model Name	TA-1071
FCC ID	2AJOTTA-1071
EUT supports Radios application	GSM/GPRS/EGPRS/WCDMA/HSPA/DC-HSDPA/ HSPA+ (16QAM uplink is not supported)/LTE WLAN 2.4GHz 802.11b/g/n HT20 Bluetooth v3.0 + EDR/Bluetooth v4.0 LE
HW Version	HW0241
SW Version	0.1803.11.03
EUT Stage	Identical Prototype

Remark:

1. The above EUT's information was declared by manufacturer. Please refer to the specifications or user's manual for more detailed description.
2. This is a variant report for TA-1071, the difference between TA-1048(FCC ID: 2AJOTTA-1048) and TA-1071(FCC ID: 2AJOTTA-1071) is change dual SIM card to single SIM card. According to the change, only the worst cases were verified, all the other test results were leveraged from original report which can be referred to Sporton Report Number FC7N1101-02 for model TA-1048.

1.4. Product Specification of Equipment Under Test

Standards-related Product Specification	
Tx Frequency	WCDMA Band V: 826.4 MHz ~ 846.6 MHz LTE Band 5 : 824.7 MHz ~ 848.3 MHz LTE Band 7 : 2502.5 MHz ~ 2567.5 MHz 802.11b/g/n: 2412 MHz ~ 2462 MHz Bluetooth: 2402 MHz ~ 2480 MHz
Rx Frequency	WCDMA Band V: 871.4 MHz ~ 891.6 MHz LTE Band 5 : 869.7 MHz ~ 893.3 MHz LTE Band 7 : 2622.5 MHz ~ 2687.5 MHz 802.11b/g/n: 2412 MHz ~ 2462 MHz Bluetooth: 2402 MHz ~ 2480 MHz GPS : 1.57542 GHz FM : 88 MHz ~ 108 MHz
Antenna Type	WWAN: PIFA Antenna WLAN: PIFA Antenna Bluetooth: PIFA Antenna GPS: PIFA Antenna FM: External headset Antenna
Type of Modulation	GSM: GMSK GPRS: GMSK EDGE(MCS 0-4): GMSK / (MCS 5-9): 8PSK WCDMA : BPSK (Uplink) HSPA : QPSK (Uplink) HSPA+ : 16QAM (16QAM uplink is not supported) DC-HSDPA : 64QAM LTE: QPSK / 16QAM 802.11b : DSSS (DBPSK / DQPSK / CCK) 802.11g/n : OFDM (BPSK / QPSK / 16QAM / 64QAM) Bluetooth LE : GFSK Bluetooth (1Mbps) : GFSK Bluetooth (2Mbps) : $\pi/4$ -DQPSK Bluetooth (3Mbps) : 8-DPSK GPS : BPSK FM

1.5. Modification of EUT

No modifications are made to the EUT during all test items.



1.6. Test Location

Sporton International (Kunshan) Inc. is accredited to ISO 17025 by National Voluntary Laboratory Accreditation Program (NVLAP code: 600155-0) and the FCC designation No. is CN5013.

Test Site	Sporton International (Kunshan) Inc.		
Test Site Location	No.3-2 Ping-Xiang Rd, Kunshan Development Zone Kunshan City Jiangsu Province 215335 China TEL : +86-512-57900158 FAX : +86-512-57900958		
Test Site No.	Sporton Site No.		FCC Test Firm Registration No.
	CO01-KS	03CH02-KS	630927

Note: The test site complies with ANSI C63.4 2014 requirement.

1.7. Applicable Standards

According to the specifications of the manufacturer, the EUT must comply with the requirements of the following standards:

- ♦ FCC 47 CFR FCC Part 15 Subpart B
- ♦ ANSI C63.4-2014

Remark: All test items were verified and recorded according to the standards and without any deviation during the test.



2. Test Configuration of Equipment Under Test

2.1. Test Mode

The EUT has been associated with peripherals pursuant to ANSI C63.4-2014 and configuration operated in a manner tended to maximize its emission characteristics in a typical application.

Frequency range investigated: conduction (150 kHz to 30 MHz), radiation (30MHz to the 5th harmonic of the highest fundamental frequency or to 40 GHz, whichever is lower).

Test Items	Function Type
AC Conducted Emission	Mode 1 : WCDMA Band V Idle + Bluetooth Idle + WLAN Idle(2.4G) + Earphone + Adapter 1 + Camera <Fig. 1>
	Mode 2 : LTE Band 7 Idle + Bluetooth Idle + WLAN Idle(2.4G) + Earphone + Adapter 2 + MPEG4 <Fig. 1>
	Mode 3 : WCDMA Band V Idle + Bluetooth Idle + WLAN Idle(2.4G) + Earphone + Adapter 1 + GPS Rx <Fig. 2>
	Mode 4 : LTE Band 7 Idle + Bluetooth Idle + WLAN Idle(2.4G) + Earphone + USB Cable(Data Link with Notebook) <Fig. 3>
	Mode 5 : Earphone + Adapter 1 + FM(88MHz) RX + Battery <Fig. 4>
	Mode 6 : Earphone + Adapter 1 + FM(98MHz) RX + Battery<Fig. 4>
	Mode 7 : Earphone + Adapter 1 + FM(108MHz) RX + Battery<Fig. 4>
Radiated Emissions	Mode 1 : WCDMA Band V Idle + Bluetooth Idle + WLAN Idle(2.4G) + Earphone + Adapter 1 + Camera <Fig. 1>
	Mode 2 : LTE Band 7 Idle + Bluetooth Idle + WLAN Idle(2.4G) + Earphone + Adapter 2 + MPEG4 <Fig. 1>
	Mode 3 : WCDMA Band V Idle + Bluetooth Idle + WLAN Idle(2.4G) + Earphone + Adapter 1 + GPS Rx <Fig. 2>
	Mode 4 : LTE Band 7 Idle + Bluetooth Idle + WLAN Idle(2.4G) + Earphone + USB Cable(Data Link with Notebook) <Fig. 3>
	Mode 5 : Earphone + Adapter 1 + FM(88MHz) RX + Battery <Fig. 4>
	Mode 6 : Earphone + Adapter 1 + FM(98MHz) RX + Battery<Fig. 4>
	Mode 7 : Earphone + Adapter 1 + FM(108MHz) RX + Battery<Fig. 4>
Radiated Emissions ≥ 1GHz	Mode 1 : LTE Band 7 Idle + Bluetooth Idle + WLAN Idle(2.4G) + Earphone + USB Cable(Data Link with Notebook)<Fig. 3>
Remark:	
1. The worst case of AC is mode 5; and USB Link is mode 4, the test data of these modes were reported.	
2. The worst case of RE is mode 4, only the test data of this mode was reported.	
3. Data Link with Notebook means data application transferred mode between EUT and Notebook.	

2.2. Connection Diagram of Test System

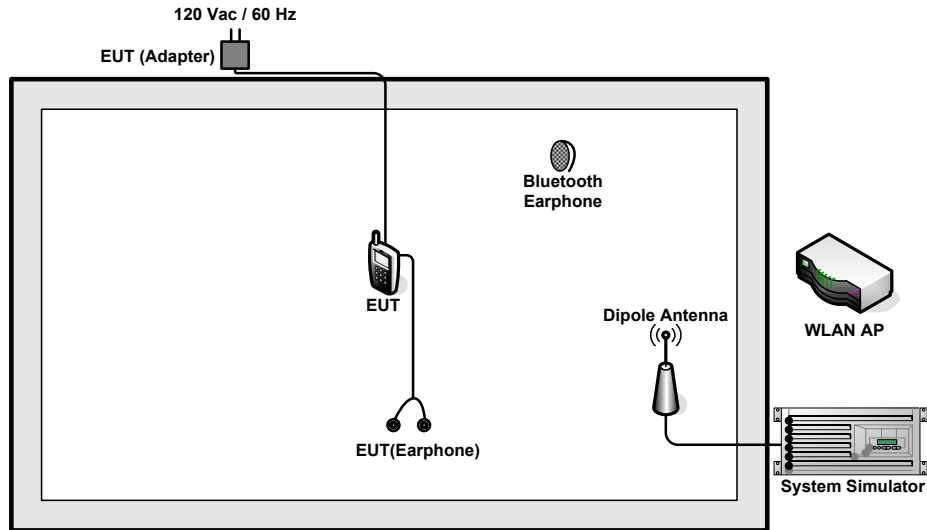

<Fig. 1>

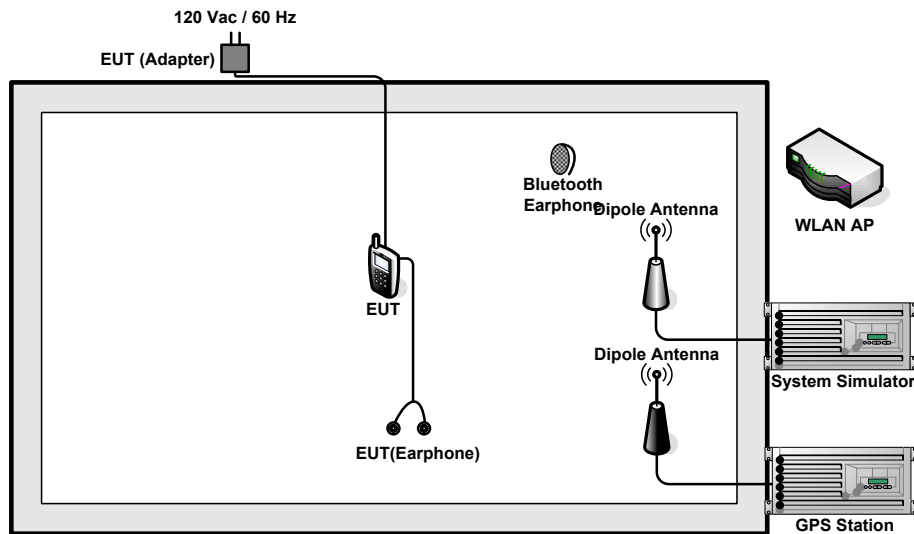

<Fig. 2>

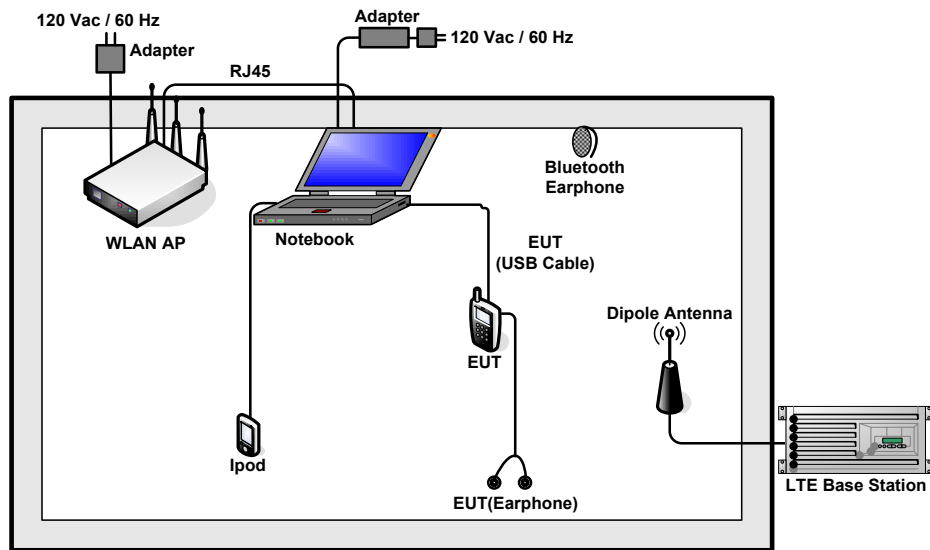

<Fig. 3>

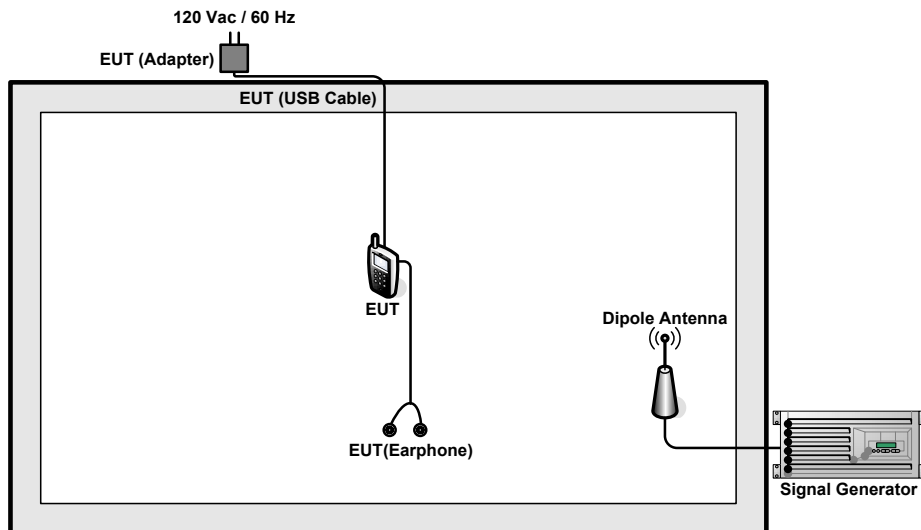

<Fig. 4>



2.3. Support Unit used in test configuration and system

Item	Equipment	Trade Name	Model Name	FCC ID	Data Cable	Power Cord
1.	LTE Base Station	Anritsu	MT8820C	N/A	N/A	Unshielded, 1.8 m
2.	System Simulator	R&S	CMU200	N/A	N/A	Unshielded, 1.8 m
3.	GPS Station	ADIVIC	MP9000	N/A	N/A	Unshielded, 1.8 m
4.	Signal Generator	R&S	SMBV100A	N/A	N/A	Unshielded, 1.8 m
5.	WLAN AP	D-link	DIR-855	KA2DIR855A2	N/A	Unshielded, 1.8m
6.	WLAN AP	TP-Link	TL-WDR5600	N/A	N/A	Unshielded, 1.8m
7.	Bluetooth Earphone	Lenovo	LBH308	N/A	N/A	N/A
8.	Notebook	DELL	Latitude3440	N/A	N/A	AC I/P : Unshielded, 1.8m DC O/P: Shielded, 1.8m
9.	Notebook	Lenovo	G480	N/A	N/A	AC I/P : Unshielded, 1.8m DC O/P: Shielded, 1.8m
10.	SD Card	Kingston	8GB	N/A	N/A	N/A
11.	SD Card	SanDisk	Uitra	N/A	N/A	N/A
12.	iPod	Apple	A1199	FCC DoC	Shielded, 1.2m	N/A

2.4. EUT Operation Test Setup

At the same time, the EUT was attached to the Bluetooth earphone or WLAN AP, and the following programs installed in the EUT were programmed during the test.

1. Data application is transferred between Notebook and EUT via USB cable.
2. Execute "GPS Test" to make the EUT receive continuous signals from GPS station
3. Execute "Video player" to play MPEG4 files
4. Turn on camera to capture images.
5. Turn on FM Rx function.

3. Test Result

3.1. Test of AC Conducted Emission Measurement

3.1.1 Limits of AC Conducted Emission

For equipment that is designed to be connected to the public utility (AC) power line, the radio frequency voltage that is conducted back onto the AC power line on any frequency or frequencies within the band 150 kHz to 30 MHz shall not exceed the limits in the following table.

Frequency of emission (MHz)	Conducted limit (dBuV)	
	Quasi-peak	Average
0.15-0.5	66 to 56*	56 to 46*
0.5-5	56	46
5-30	60	50

*Decreases with the logarithm of the frequency.

3.1.2 Measuring Instruments

The measuring equipment is listed in the section 4 of this test report.

3.1.3 Test Procedure

1. The EUT was placed 0.4 meter from the conducting wall of the shielding room was kept at least 80 centimeters from any other grounded conducting surface.
2. Connect EUT to the power mains through a line impedance stabilization network (LISN).
3. All the support units are connecting to the other LISN.
4. The LISN provides 50 ohm coupling impedance for the measuring instrument.
5. The FCC states that a 50 ohm, 50 microhenry LISN should be used.
6. Both sides of AC line were checked for maximum conducted interference.
7. The frequency range from 150 kHz to 30 MHz was searched.
8. Set the test-receiver system to Peak Detect Function and specified bandwidth (IF Bandwidth = 9kHz) with Maximum Hold Mode. Then measurement is also conducted by Average Detector and Quasi-Peak Detector Function respectively.

3.1.4 Test Setup





3.1.5 Test Result of AC Conducted Emission

Test Mode :	Mode 4	Temperature :	22~24°C
Test Engineer :	Amos Zhang	Relative Humidity :	42~46%
Test Voltage :	120Vac / 60Hz	Phase :	Line
Function Type :	LTE Band 7 Idle + Bluetooth Idle + WLAN Idle(2.4G) + Earphone + USB Cable(Data Link with Notebook)		

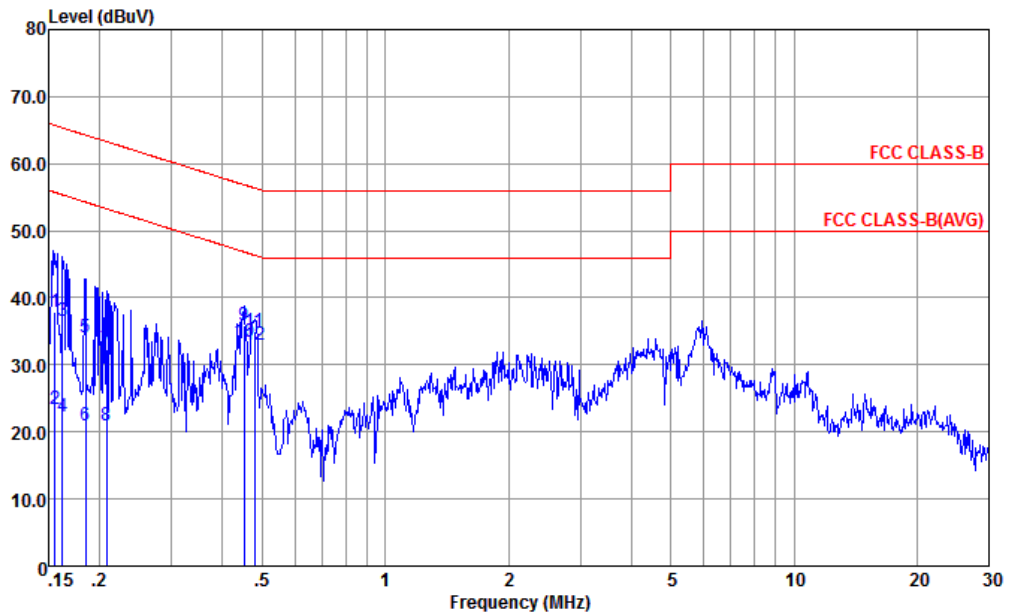

Site : CO01-KS
 Condition : FCC CLASS-B LISN-L-171013-060103 LINE
 Project : (FC) 7N1101-02
 mode : Mode 4
 : 004402970816348/004402970806349 #7

	Freq	Level	Over Limit	Limit Line	Read Level	LISN Factor	Cable Loss	Remark
	MHz	dBuV	dB	dBuV	dBuV	dB	dB	
1	0.156	37.86	-27.83	65.69	27.10	0.16	10.60	QP
2	0.156	23.36	-32.33	55.69	12.60	0.16	10.60	Average
3	0.162	36.55	-28.79	65.34	25.81	0.17	10.57	QP
4	0.162	22.25	-33.09	55.34	11.51	0.17	10.57	Average
5	0.184	33.99	-30.29	64.28	23.30	0.19	10.50	QP
6	0.184	20.89	-33.39	54.28	10.20	0.19	10.50	Average
7	0.208	32.25	-31.02	63.27	21.60	0.20	10.45	QP
8	0.208	20.95	-32.32	53.27	10.30	0.20	10.45	Average
9	0.452	35.81	-21.04	56.85	25.21	0.25	10.35	QP
10 *	0.452	33.51	-13.34	46.85	22.91	0.25	10.35	Average
11	0.479	35.08	-21.28	56.36	24.50	0.26	10.32	QP
12	0.479	32.88	-13.48	46.36	22.30	0.26	10.32	Average



Test Mode :	Mode 4	Temperature :	22~24°C
Test Engineer :	Amos Zhang	Relative Humidity :	42~45%
Test Voltage :	120Vac / 60Hz	Phase :	Neutral
Function Type :	LTE Band 7 Idle + Bluetooth Idle + WLAN Idle(2.4G) + Earphone + USB Cable(Data Link with Notebook)		

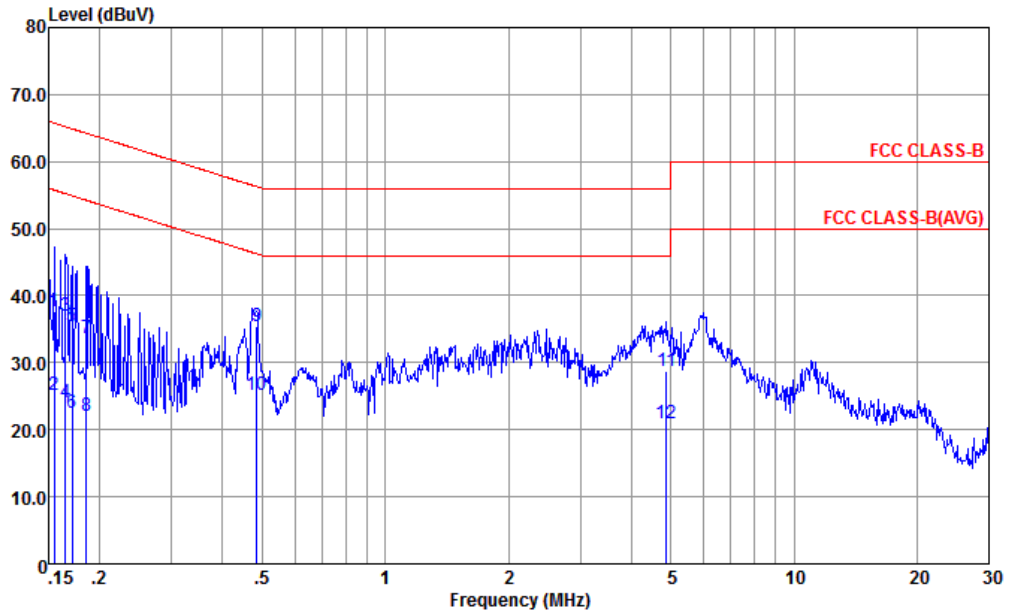

Site : CO01-KS
 Condition : FCC CLASS-B LISN-N-171013-060103 NEUTRAL
 Project : (FC) 7N1101-02
 mode : Mode 4
 : 004402970816348/004402970806349 #7

	Freq	Level	Over Limit	Limit Line	Read Level	LISN Factor	Cable Loss	Remark
	MHz	dBuV	dB	dBuV	dBuV	dB	dB	
1	0.155	37.68	-28.06	65.74	26.80	0.28	10.60	QP
2	0.155	25.18	-30.56	55.74	14.30	0.28	10.60	Average
3	0.165	37.04	-28.17	65.21	26.20	0.28	10.56	QP
4	0.165	24.04	-31.17	55.21	13.20	0.28	10.56	Average
5	0.171	35.43	-29.47	64.90	24.60	0.28	10.55	QP
6	0.171	22.43	-32.47	54.90	11.60	0.28	10.55	Average
7	0.185	33.68	-30.56	64.24	22.90	0.28	10.50	QP
8	0.185	21.98	-32.26	54.24	11.20	0.28	10.50	Average
9 *	0.484	35.51	-20.76	56.27	24.90	0.29	10.32	QP
10	0.484	25.21	-21.06	46.27	14.60	0.29	10.32	Average
11	4.874	28.76	-27.24	56.00	18.19	0.34	10.23	QP
12	4.874	20.86	-25.14	46.00	10.29	0.34	10.23	Average



Test Mode :	Mode 5	Temperature :	22~24°C
Test Engineer :	Amos Zhang	Relative Humidity :	42~45%
Test Voltage :	120Vac / 60Hz	Phase :	Line
Function Type :	Earphone + Adapter 1 + FM(88MHz) RX + Battery		

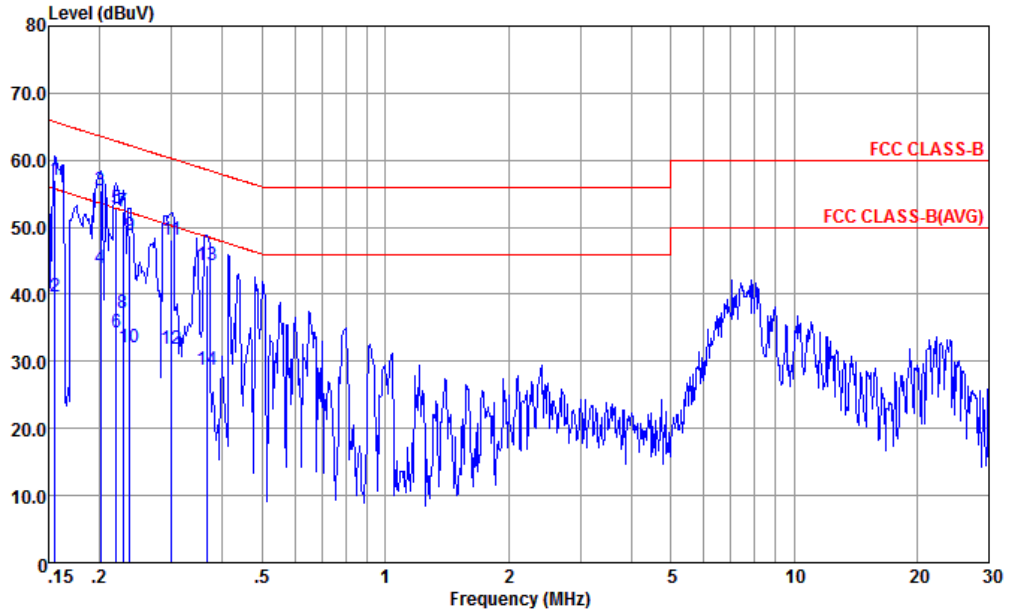

Site : CO01-KS
 Condition : FCC CLASS-B LISN-L-171013-060103 LINE
 Project : (FC) 7N1101-02
 mode : Mode 5
 : 004402970816348/004402970806349 #7

	Freq	Level	Over	Limit	Read	LISN	Cable	Remark
	MHz	dBuV	Limit	Line	Level	Factor	Loss	
			dB	dBuV	dBuV	dB	dB	
1	0.156	57.06	-8.63	65.69	46.30	0.16	10.60	QP
2	0.156	39.56	-16.13	55.69	28.80	0.16	10.60	Average
3 *	0.201	55.56	-8.02	63.58	44.91	0.20	10.45	QP
4	0.201	43.86	-9.72	53.58	33.21	0.20	10.45	Average
5	0.220	52.86	-9.97	62.83	42.20	0.21	10.45	QP
6	0.220	34.26	-18.57	52.83	23.60	0.21	10.45	Average
7	0.228	52.45	-10.07	62.52	41.79	0.21	10.45	QP
8	0.228	37.25	-15.27	52.52	26.59	0.21	10.45	Average
9	0.237	48.85	-13.37	62.22	38.20	0.21	10.44	QP
10	0.237	32.15	-20.07	52.22	21.50	0.21	10.44	Average
11	0.300	48.15	-12.09	60.24	37.49	0.23	10.43	QP
12	0.300	31.85	-18.39	50.24	21.19	0.23	10.43	Average
13	0.365	44.25	-14.36	58.61	33.60	0.24	10.41	QP
14	0.365	28.85	-19.76	48.61	18.20	0.24	10.41	Average



Test Mode :	Mode 5	Temperature :	22~24°C
Test Engineer :	Amos Zhang	Relative Humidity :	42~45%
Test Voltage :	120Vac / 60Hz	Phase :	Neutral
Function Type :	Earphone + Adapter 1 + FM(88MHz) RX + Battery		

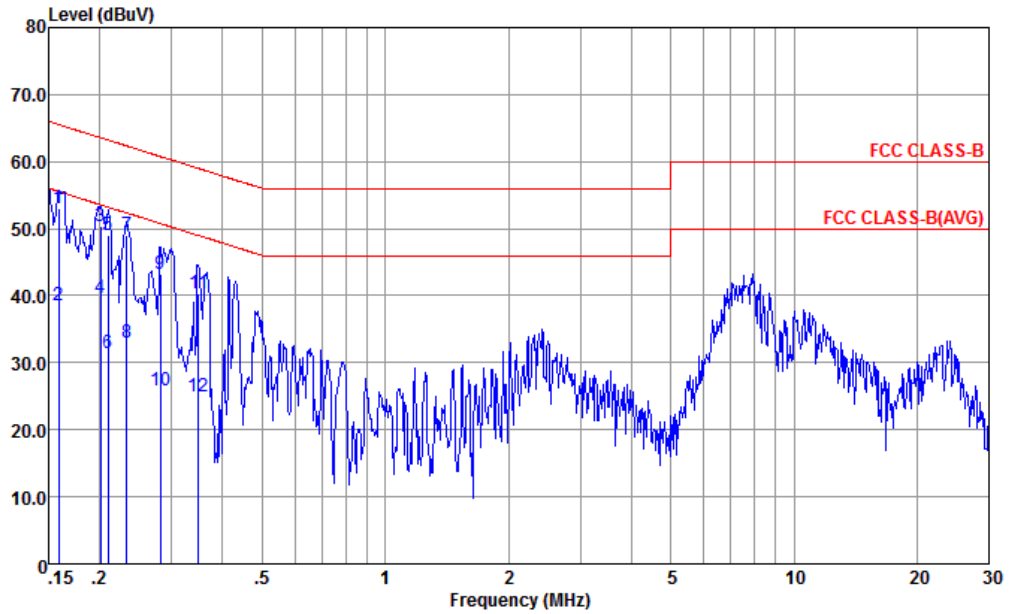

Site : CO01-KS
 Condition : FCC CLASS-B LISN-N-171013-060103 NEUTRAL
 Project : (FC) 7N1101-02
 mode : Mode 5
 : 004402970816348/004402970806349 #7

	Freq	Level	Over Limit	Limit Line	Read Level	LISN Factor	Cable Loss	Remark
	MHz	dBuV	dB	dBuV	dBuV	dB	dB	
1 *	0.159	53.07	-12.45	65.52	42.20	0.28	10.59	QP
2	0.159	38.47	-17.05	55.52	27.60	0.28	10.59	Average
3	0.201	50.34	-13.24	63.58	39.61	0.28	10.45	QP
4	0.201	39.64	-13.94	53.58	28.91	0.28	10.45	Average
5	0.209	48.93	-14.30	63.23	38.20	0.28	10.45	QP
6	0.209	31.33	-21.90	53.23	20.60	0.28	10.45	Average
7	0.233	48.93	-13.42	62.35	38.21	0.28	10.44	QP
8	0.233	33.03	-19.32	52.35	22.31	0.28	10.44	Average
9	0.282	43.22	-17.54	60.76	32.51	0.28	10.43	QP
10	0.282	25.92	-24.84	50.76	15.21	0.28	10.43	Average
11	0.348	40.30	-18.70	59.00	29.59	0.29	10.42	QP
12	0.348	24.90	-24.10	49.00	14.19	0.29	10.42	Average



3.2. Test of Radiated Emission Measurement

3.2.1. Limit of Radiated Emission

The emissions from an unintentional radiator shall not exceed the field strength levels specified in the following table:

Frequency (MHz)	Field Strength (microvolts/meter)	Measurement Distance (meters)
30 – 88	100	3
88 – 216	150	3
216 - 960	200	3
Above 960	500	3

3.2.2. Measuring Instruments

The measuring equipment is listed in the section 4 of this test report.

3.2.3. Test Procedures

1. The EUT was placed on a turntable with 0.8 meter above ground.
2. The EUT was set 3 meters from the interference receiving antenna, which was mounted on the top of a variable height antenna tower.
3. The table was rotated 360 degrees to determine the position of the highest radiation.
4. The antenna is a Bi-Log antenna and its height is adjusted between one to four meters above ground to find the maximum value of the field strength for both horizontal polarization and vertical polarization of the antenna.
5. For each suspected emission, the EUT was arranged to its worst case and then tune the antenna tower (from 1 m to 4 m) and turntable (from 0 degree to 360 degrees) to find the maximum reading.
6. Set the test-receiver system to Peak Detect Function and specified bandwidth with Maximum Hold Mode (RBW=120kHz/VBW=300kHz for frequency below 1GHz; RBW=1MHz VBW=3MHz (Peak), RBW=1MHz/VBW=10Hz (Average) for frequency above 1GHz).
7. If the emission level of the EUT in peak mode was 3 dB lower than the limit specified, peak values of EUT will be reported. Otherwise, the emission will be repeated by using the quasi-peak method and reported.
8. Emission level (dBµV/m) = 20 log Emission level (µV/m)
9. Corrected Reading: Antenna Factor + Cable Loss + Read Level - Preamp Factor = Level

3.2.4. Test Setup of Radiated Emission

For radiated emissions from 30MHz to 1GHz

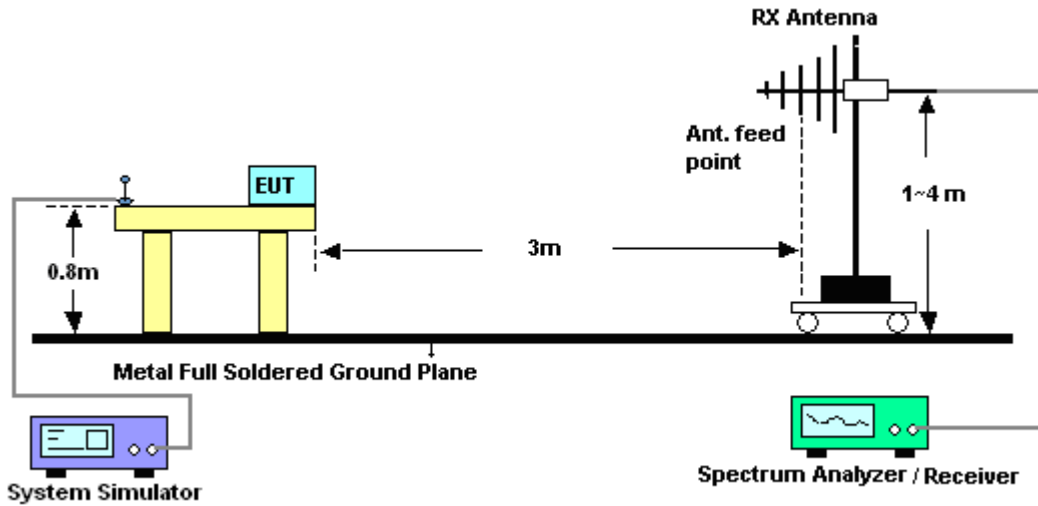

For radiated emissions above 1GHz

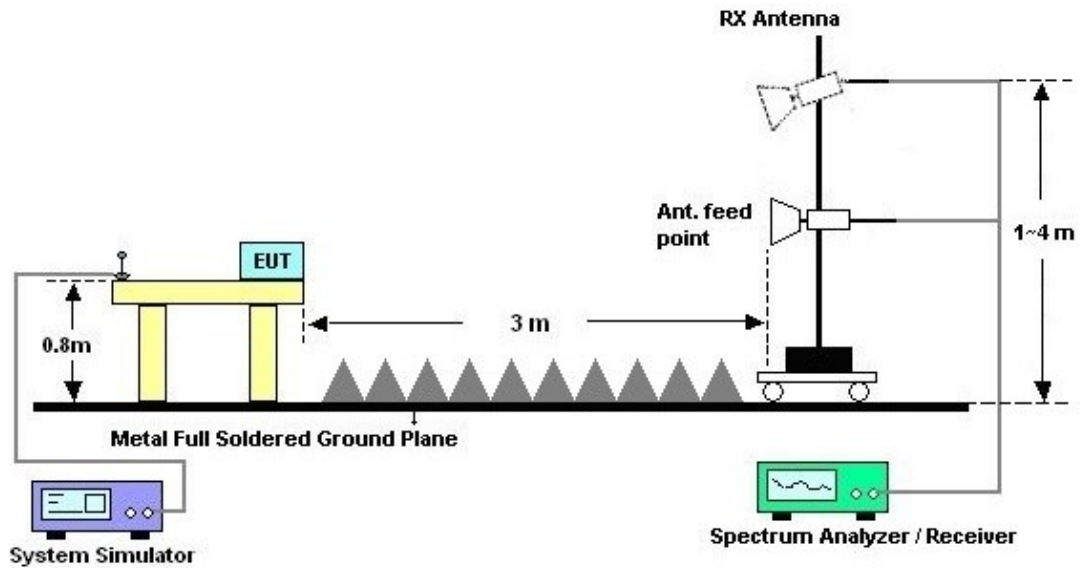



3.2.5. Test Result of Radiated Emission

Test Mode :	Mode 4	Temperature :	21~22°C
Test Engineer :	Carl Ni	Relative Humidity :	41~42%
Test Distance :	3m	Polarization :	Horizontal
Function Type :	LTE Band 7 Idle + Bluetooth Idle + WLAN Idle(2.4G) + Earphone + USB Cable(Data Link with Notebook)		

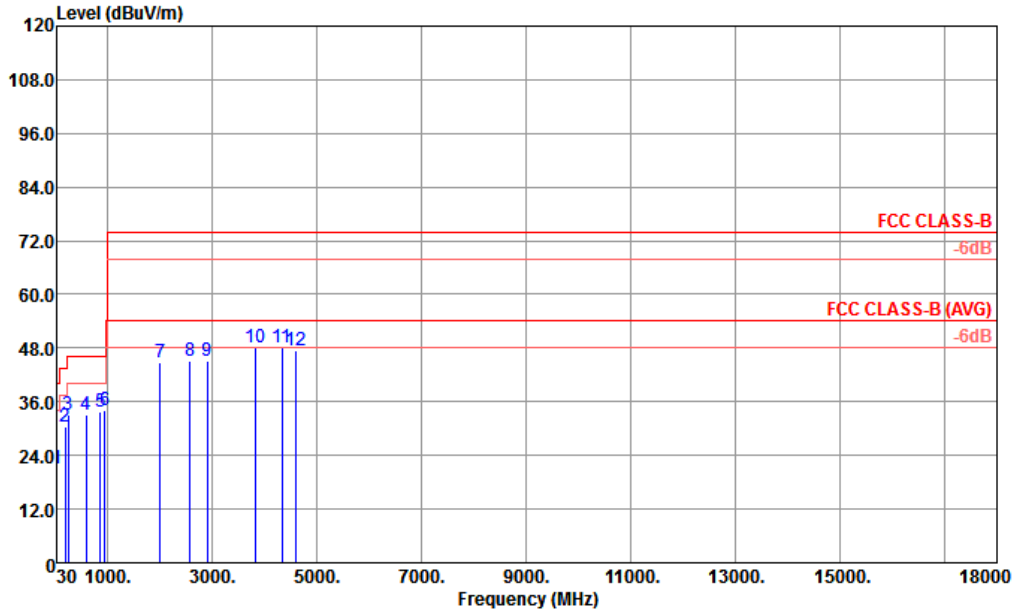

Site : 03CH02-KS
 Condition : FCC CLASS-B 3m LF 47610 HORIZONTAL
 Project : (FC)7N1101-02
 Mode : 4
 IMEI : 004402970816348 004402970806349 #7

	Freq	Level	Over Limit	Limit Line	ReadAntenna Level	Antenna Factor	Cable Loss	Preamp Factor	A/Pos	T/Pos	Remark
	MHz	dBuV/m	dB	dBuV/m	dBuV	dB/m	dB	dB	cm	deg	
1	30.00	20.95	-19.05	40.00	27.41	25.00	0.57	32.03	---	---	Peak
2	200.10	30.45	-13.05	43.50	45.27	15.40	1.45	31.67	---	---	Peak
3	250.05	33.09	-12.91	46.00	44.49	18.40	1.75	31.55	---	---	Peak
4	599.60	33.10	-12.90	46.00	35.54	24.61	2.62	29.67	---	---	Peak
5	862.10	33.66	-12.34	46.00	32.04	26.38	3.06	27.82	---	---	Peak
6	949.60	34.24	-11.76	46.00	31.28	26.90	3.20	27.14	100	0	Peak
7	2014.00	44.77	-29.23	74.00	43.00	30.36	4.63	33.22	---	---	Peak
8	2580.00	44.98	-29.02	74.00	38.65	31.62	5.34	30.63	---	---	Peak
9	2908.00	45.09	-28.91	74.00	36.85	32.30	5.91	29.97	---	---	Peak
10	3837.00	48.12	-25.88	74.00	36.75	34.84	6.64	30.11	---	---	Peak
11	4335.00	48.07	-25.93	74.00	35.37	35.64	7.19	30.13	---	---	Peak
12	4605.00	47.51	-26.49	74.00	34.93	35.82	7.64	30.88	---	---	Peak



Test Mode :	Mode 4	Temperature :	21~22°C
Test Engineer :	Carl Ni	Relative Humidity :	41~42%
Test Distance :	3m	Polarization :	Vertical
Function Type :	LTE Band 7 Idle + Bluetooth Idle + WLAN Idle(2.4G) + Earphone + USB Cable(Data Link with Notebook)		

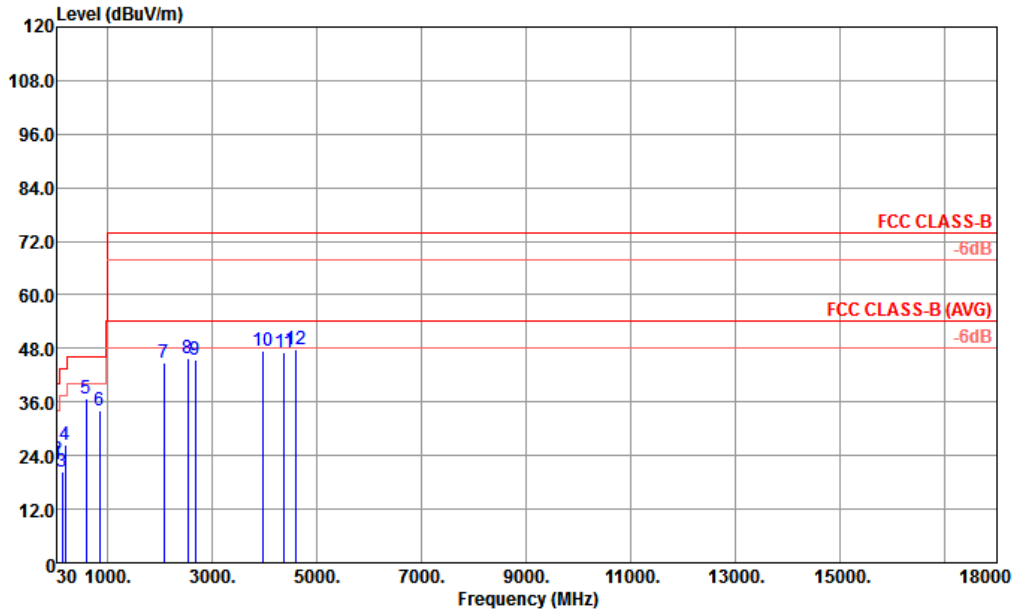

Site : 03CH02-KS
 Condition : FCC CLASS-B 3m LF 47610 VERTICAL
 Project : (FC)7N1101-02
 Mode : 4
 IMEI : 004402970816348 004402970806349 #7

	Freq	Level	Over	Limit	ReadAntenna	Cable	Preamp	A/Pos	T/Pos	Remark	
	MHz	dBuV/m	dB	dBuV/m	dBuV	dB/m	dB	dB	cm	deg	
1	30.00	21.97	-18.03	40.00	28.43	25.00	0.57	32.03	---	---	Peak
2	39.45	23.06	-16.94	40.00	35.26	19.20	0.64	32.04	---	---	Peak
3	135.03	20.49	-23.01	43.50	33.52	17.65	1.19	31.87	---	---	Peak
4	200.10	26.38	-17.12	43.50	41.20	15.40	1.45	31.67	---	---	Peak
5	599.60	36.80	-9.20	46.00	39.24	24.61	2.62	29.67	100	0	Peak
6	850.20	34.08	-11.92	46.00	32.63	26.31	3.05	27.91	---	---	Peak
7	2080.00	44.93	-29.07	74.00	42.44	30.59	4.75	32.85	---	---	Peak
8	2534.00	45.93	-28.07	74.00	39.89	31.53	5.29	30.78	---	---	Peak
9	2678.00	45.59	-28.41	74.00	38.60	31.79	5.54	30.34	---	---	Peak
10	3960.00	47.34	-26.66	74.00	35.72	35.04	6.69	30.11	---	---	Peak
11	4377.00	47.30	-26.70	74.00	34.56	35.72	7.15	30.13	---	---	Peak
12	4593.00	47.67	-26.33	74.00	35.08	35.83	7.64	30.88	---	---	Peak



4. List of Measuring Equipment

Instrument	Manufacturer	Model No.	Serial No.	Characteristics	Calibration Date	Test Date	Due Date	Remark
EMI Receiver	R&S	ESCI7	100768	9kHz~7GHz;	Apr. 20, 2017	Jan. 11, 2018	Apr. 19, 2018	Conduction (CO01-KS)
AC LISN	MessTec	AN3016	060103	9kHz~30MHz	Oct. 13, 2017	Jan. 11, 2018	Oct. 12, 2018	Conduction (CO01-KS)
AC LISN (for auxiliary equipment)	MessTec	AN3016	060105	9kHz~30MHz	Oct. 13, 2017	Jan. 11, 2018	Oct. 12, 2018	Conduction (CO01-KS)
AC Power Source	Chroma	61602	ABP0000008 11	AC 0V~300V, 45Hz~1000Hz	Oct. 12, 2017	Jan. 11, 2018	Oct. 11, 2018	Conduction (CO01-KS)
EMI Test Receiver	R&S	ESR7	101403	9kHz~7GHz; Max 30dBm	Aug. 08, 2017	Feb. 01, 2018	Aug. 07, 2018	Radiation (03CH02-KS)
EXA Spectrum Analyzer	Keysight	N9010A	MY55150208	10Hz~44GHz, MAX 30dB	Apr. 18, 2017	Feb. 01, 2018	Apr. 17, 2018	Radiation (03CH02-KS)
Bilog Antenna	TeseQ	CBL6112D	23182	30MHz~2GHz	Nov. 29, 2017	Feb. 01, 2018	Nov. 28, 2018	Radiation (03CH02-KS)
Double Ridge Horn Antenna	ETS-Lindgren	3117	75957	1GHz~18GHz	Oct. 21, 2017	Feb. 01, 2018	Oct. 20, 2018	Radiation (03CH02-KS)
SHF-EHF Horn	Schwarzbeck	BBHA 9170	BBHA170249	15GHz~40GHz	Feb. 15, 2017	Feb. 01, 2018	Feb. 14, 2018	Radiation (03CH02-KS)
Amplifier	SONOMA	310N	187289	9kHz~1GHz	Aug. 07, 2017	Feb. 01, 2018	Aug. 06, 2018	Radiation (03CH02-KS)
Amplifier	Agilent	8449B	3008A02384	1GHz~26.5GHz	Oct. 12, 2017	Feb. 01, 2018	Oct. 11, 2018	Radiation (03CH02-KS)
AC Power Source	Chroma	61601	61601000247 3	N/A	NCR	Feb. 01, 2018	NCR	Radiation (03CH02-KS)
Turn Table	MF	MF7802	N/A	0~360 degree	NCR	Feb. 01, 2018	NCR	Radiation (03CH02-KS)
Antenna Mast	MF	MF7802	N/A	1 m~4 m	NCR	Feb. 01, 2018	NCR	Radiation (03CH02-KS)

NCR: No Calibration Required



5. Uncertainty of Evaluation

Uncertainty of Conducted Emission Measurement (150 kHz ~ 30 MHz)

Measuring Uncertainty for a Level of Confidence of 95% ($U = 2Uc(y)$)	2.3dB
-------------------------------------------------------------------------	-------

Uncertainty of Radiated Emission Measurement (30 MHz ~ 1000 MHz)

Measuring Uncertainty for a Level of Confidence of 95% ($U = 2Uc(y)$)	4.5dB
-------------------------------------------------------------------------	-------

Uncertainty of Radiated Emission Measurement (1000 MHz ~ 18000 MHz)

Measuring Uncertainty for a Level of Confidence of 95% ($U = 2Uc(y)$)	4.2dB
-------------------------------------------------------------------------	-------