



FCC SAR Test Report

APPLICANT : FIH International Co., Ltd.
EQUIPMENT : GSM/WCDMA/LTE Mobile Phone
BRAND NAME : Nokia
MODEL NAME : TA-1071
FCC ID : 2AJOTTA-1071
STANDARD : FCC 47 CFR Part 2 (2.1093)
ANSI/IEEE C95.1-1992
IEEE 1528-2013

We, Sporton International (Kunshan) Inc., would like to declare that the tested sample has been evaluated in accordance with the procedures and had been in compliance with the applicable technical standards.

The test results in this report apply exclusively to the tested model / sample. Without written approval of Sporton International (Kunshan) Inc., the test report shall not be reproduced except in full.

Approved by: Mark Qu / Manager



Sporton International (Kunshan) Inc.
No.3-2 Ping-Xiang Rd, Kunshan Development Zone Kunshan City Jiangsu Province 215335 China



Table of Contents

1. Statement of Compliance 4
2. Administration Data 5
3. Guidance Applied 5
4. Equipment Under Test (EUT) Information 6
4.1 General Information 6
4.2 General LTE SAR Test and Reporting Considerations 7
5. RF Exposure Limits 8
5.1 Uncontrolled Environment 8
5.2 Controlled Environment 8
6. Specific Absorption Rate (SAR) 9
6.1 Introduction 9
6.2 SAR Definition 9
7. System Description and Setup 10
7.1 E-Field Probe 11
7.2 Data Acquisition Electronics (DAE) 11
7.3 Phantom 12
7.4 Device Holder 13
8. Measurement Procedures 14
8.1 Spatial Peak SAR Evaluation 14
8.2 Power Reference Measurement 15
8.3 Area Scan 15
8.4 Zoom Scan 16
8.5 Volume Scan Procedures 16
8.6 Power Drift Monitoring 16
9. Test Equipment List 17
10. System Verification 18
10.1 Tissue Simulating Liquids 18
10.2 Tissue Verification 19
10.3 System Performance Check Results 20
11. RF Exposure Positions 21
11.1 Ear and handset reference point 21
11.2 Definition of the cheek position 22
11.3 Definition of the tilt position 23
11.4 Body Worn Accessory 24
11.5 Wireless Router 24
12. Conducted RF Output Power (Unit: dBm) 25
13. Bluetooth Exclusions Applied 35
14. Antenna Location 36
15. SAR Test Results 37
15.1 Head SAR 39
15.2 Hotspot SAR 40
15.3 Body Worn Accessory SAR 42
15.4 Repeated SAR Measurement 43
16. Simultaneous Transmission Analysis 44
16.1 Head Exposure Conditions 45
16.2 Hotspot Exposure Conditions 45
16.3 Body-Worn Accessory Exposure Conditions 46
17. Uncertainty Assessment 47
18. References 48
Appendix A. Plots of System Performance Check
Appendix B. Plots of High SAR Measurement
Appendix C. DASYS Calibration Certificate



Revision History

REPORT NO.	VERSION	DESCRIPTION	ISSUED DATE
FA7N1101-03	Rev. 01	Initial issue of report	Feb. 14, 2018



1. Statement of Compliance

The maximum results of Specific Absorption Rate (SAR) found during testing for **FIH International Co., Ltd., GSM/WCDMA/LTE Mobile Phone, TA-1071**, are as follows.

Equipment Class	Frequency Band		Highest SAR Summary			Highest Simultaneous Transmission 1g SAR (W/kg)
			Head (Separation 0mm)	Body-worn (Separation 10mm)	Hotspot (Separation 10mm)	
			1g SAR (W/kg)			
Licensed	WCDMA	Band V	1.16	1.10	1.10	1.20
	LTE	Band 5	1.04	1.10	1.11	
		Band 7	0.84	1.12	1.18	
DTS	WLAN	2.4GHz WLAN	<0.10	<0.10	<0.10	1.20
Date of Testing:			2018/1/25 ~ 2018/1/27			

This device is in compliance with Specific Absorption Rate (SAR) for general population/uncontrolled exposure limits (1.6 W/kg) specified in FCC 47 CFR part 2 (2.1093) and ANSI/IEEE C95.1-1992, and had been tested in accordance with the measurement methods and procedures specified in IEEE 1528-2013 and FCC KDB publications.



2. Administration Data

Testing Laboratory	
Test Site	Sporton International (Kunshan) Inc.
Test Site Location	No.3-2 Ping-Xiang Rd, Kunshan Development Zone Kunshan City Jiangsu Province 215335 China TEL : +86-512-57900158 FAX : +86-512-57900958

Applicant	
Company Name	FIH International Co., Ltd.
Address	No.18, Tongji zhonglu, Beijing Economic&Technological Development Area

Manufacturer	
Company Name	HMD Global Oy
Address	Karaportti 2 02610 Espoo FINLAND

3. Guidance Applied

The Specific Absorption Rate (SAR) testing specification, method, and procedure for this device is in accordance with the following standards:

- FCC 47 CFR Part 2 (2.1093)
- ANSI/IEEE C95.1-1992
- IEEE 1528-2013
- FCC KDB 865664 D01 SAR Measurement 100 MHz to 6 GHz v01r04
- FCC KDB 865664 D02 SAR Reporting v01r02
- FCC KDB 447498 D01 General RF Exposure Guidance v06
- FCC KDB 648474 D04 SAR Evaluation Considerations for Wireless Handsets v01r03
- FCC KDB 248227 D01 802.11 Wi-Fi SAR v02r02
- FCC KDB 941225 D01 3G SAR Procedures v03r01
- FCC KDB 941225 D05 SAR for LTE Devices v02r05
- FCC KDB 941225 D06 Hotspot Mode SAR v02r01



4. Equipment Under Test (EUT) Information

4.1 General Information

Product Feature & Specification	
Equipment Name	GSM/WCDMA/LTE Mobile Phone
Brand Name	Nokia
Model Name	TA-1071
FCC ID	2AJOTTA-1071
Wireless Technology and Frequency Range	WCDMA Band V: 826.4 MHz ~ 846.6 MHz LTE Band 5: 824.7 MHz ~ 848.3 MHz LTE Band 7: 2502.5 MHz ~ 2567.5 MHz WLAN 2.4GHz Band: 2412 MHz ~ 2462 MHz Bluetooth: 2402 MHz ~ 2480 MHz
Mode	RMC/AMR 12.2Kbps HSDPA HSUPA DC-HSDPA HSPA+ (16QAM uplink is not supported) LTE: QPSK, 16QAM WLAN 2.4GHz : 802.11b/g/n HT20 Bluetooth v3.0+EDR/ Bluetooth v4.0 LE
HW Version	HW0241
SW Version	0.1803.11.03
EUT Stage	Identical Prototype
Remark:	
<ol style="list-style-type: none"> 1. This device supports VoIP in WCDMA and LTE (e.g. for 3rd-party VoIP), and LTE supports VoLTE operation. 2. This device 2.4GHz WLAN support hotspot operation and Bluetooth support tethering applications. 3. For dual SIM card mobile has two SIM slots and supports dual SIM dual standby. The WWAN radio transmission will be enabled by either one SIM at a time (single active). After pre-scan two SIM cards power, we found test result of the SIM1 was the worse, so we chose SIM1 slot to perform all tests. 4. This is a variant report for TA-1071, the difference between TA-1048(FCC ID: 2AJOTTA-1048) and TA-1071(FCC ID: 2AJOTTA-1071) is change dual SIM card to single SIM card. According to the change, we verified the worst case and found no effect on SAR distribution, so all the test results were leveraged from original report which can be referred to Sporton Report Number FA7N1101-02 for model TA-1048. 	



4.2 General LTE SAR Test and Reporting Considerations

Summarized necessary items addressed in KDB 941225 D05 v02r05																																																															
FCC ID	2AJOTTA-1071																																																														
Equipment Name	GSM/WCDMA/LTE Mobile Phone																																																														
Operating Frequency Range of each LTE transmission band	LTE Band 5: 824.7 MHz ~ 848.3 MHz LTE Band 7: 2502.5 MHz ~ 2567.5 MHz																																																														
Channel Bandwidth	LTE Band 5: 1.4MHz, 3MHz, 5MHz, 10MHz LTE Band 7: 5MHz, 10MHz, 15MHz, 20MHz																																																														
uplink modulations used	QPSK / 16QAM																																																														
LTE Voice / Data requirements	Voice and Data																																																														
LTE MPR permanently built-in by design	<p>Table 6.2.3-1: Maximum Power Reduction (MPR) for Power Class 1, 2 and 3</p> <table border="1"> <thead> <tr> <th rowspan="2">Modulation</th> <th colspan="6">Channel bandwidth / Transmission bandwidth (N_{RB})</th> <th rowspan="2">MPR (dB)</th> </tr> <tr> <th>1.4 MHz</th> <th>3.0 MHz</th> <th>5 MHz</th> <th>10 MHz</th> <th>15 MHz</th> <th>20 MHz</th> </tr> </thead> <tbody> <tr> <td>QPSK</td> <td>> 5</td> <td>> 4</td> <td>> 8</td> <td>> 12</td> <td>> 16</td> <td>> 18</td> <td>≤ 1</td> </tr> <tr> <td>16 QAM</td> <td>≤ 5</td> <td>≤ 4</td> <td>≤ 8</td> <td>≤ 12</td> <td>≤ 16</td> <td>≤ 18</td> <td>≤ 1</td> </tr> <tr> <td>16 QAM</td> <td>> 5</td> <td>> 4</td> <td>> 8</td> <td>> 12</td> <td>> 16</td> <td>> 18</td> <td>≤ 2</td> </tr> <tr> <td>64 QAM</td> <td>≤ 5</td> <td>≤ 4</td> <td>≤ 8</td> <td>≤ 12</td> <td>≤ 16</td> <td>≤ 18</td> <td>≤ 2</td> </tr> <tr> <td>64 QAM</td> <td>> 5</td> <td>> 4</td> <td>> 8</td> <td>> 12</td> <td>> 16</td> <td>> 18</td> <td>≤ 3</td> </tr> <tr> <td>256 QAM</td> <td colspan="6">≥ 1</td> <td>≤ 5</td> </tr> </tbody> </table>	Modulation	Channel bandwidth / Transmission bandwidth (N _{RB})						MPR (dB)	1.4 MHz	3.0 MHz	5 MHz	10 MHz	15 MHz	20 MHz	QPSK	> 5	> 4	> 8	> 12	> 16	> 18	≤ 1	16 QAM	≤ 5	≤ 4	≤ 8	≤ 12	≤ 16	≤ 18	≤ 1	16 QAM	> 5	> 4	> 8	> 12	> 16	> 18	≤ 2	64 QAM	≤ 5	≤ 4	≤ 8	≤ 12	≤ 16	≤ 18	≤ 2	64 QAM	> 5	> 4	> 8	> 12	> 16	> 18	≤ 3	256 QAM	≥ 1						≤ 5
Modulation	Channel bandwidth / Transmission bandwidth (N _{RB})						MPR (dB)																																																								
	1.4 MHz	3.0 MHz	5 MHz	10 MHz	15 MHz	20 MHz																																																									
QPSK	> 5	> 4	> 8	> 12	> 16	> 18	≤ 1																																																								
16 QAM	≤ 5	≤ 4	≤ 8	≤ 12	≤ 16	≤ 18	≤ 1																																																								
16 QAM	> 5	> 4	> 8	> 12	> 16	> 18	≤ 2																																																								
64 QAM	≤ 5	≤ 4	≤ 8	≤ 12	≤ 16	≤ 18	≤ 2																																																								
64 QAM	> 5	> 4	> 8	> 12	> 16	> 18	≤ 3																																																								
256 QAM	≥ 1						≤ 5																																																								
LTE A-MPR	In the base station simulator configuration, Network Setting value is set to NS_01 to disable A-MPR during SAR testing and the LTE SAR tests was transmitting on all TTI frames (Maximum TTI)																																																														
Spectrum plots for RB configuration	A properly configured base station simulator was used for the SAR and power measurement; therefore, spectrum plots for each RB allocation and offset configuration are not included in the SAR report.																																																														
LTE Release Version	R9, Cat 4																																																														
CA Support	Not Supported																																																														

Transmission (H, M, L) channel numbers and frequencies in each LTE band								
LTE Band 5								
	Bandwidth 1.4 MHz		Bandwidth 3 MHz		Bandwidth 5 MHz		Bandwidth 10 MHz	
	Ch. #	Freq. (MHz)	Ch. #	Freq. (MHz)	Ch. #	Freq. (MHz)	Ch. #	Freq. (MHz)
L	20407	824.7	20415	825.5	20425	826.5	20450	829
M	20525	836.5	20525	836.5	20525	836.5	20525	836.5
H	20643	848.3	20635	847.5	20625	846.5	20600	844
LTE Band 7								
	Bandwidth 5 MHz		Bandwidth 10 MHz		Bandwidth 15 MHz		Bandwidth 20 MHz	
	Ch. #	Freq. (MHz)	Ch. #	Freq. (MHz)	Ch. #	Freq. (MHz)	Ch. #	Freq. (MHz)
L	20775	2502.5	20800	2505	20825	2507.5	20850	2510
M	21100	2535	21100	2535	21100	2535	21100	2535
H	21425	2567.5	21400	2565	21375	2562.5	21350	2560

5. RF Exposure Limits

5.1 Uncontrolled Environment

Uncontrolled Environments are defined as locations where there is the exposure of individuals who have no knowledge or control of their exposure. The general population/uncontrolled exposure limits are applicable to situations in which the general public may be exposed or in which persons who are exposed as a consequence of their employment may not be made fully aware of the potential for exposure or cannot exercise control over their exposure. Members of the general public would come under this category when exposure is not employment-related; for example, in the case of a wireless transmitter that exposes persons in its vicinity.

5.2 Controlled Environment

Controlled Environments are defined as locations where there is exposure that may be incurred by persons who are aware of the potential for exposure, (i.e. as a result of employment or occupation). In general, occupational/controlled exposure limits are applicable to situations in which persons are exposed as a consequence of their employment, who have been made fully aware of the potential for exposure and can exercise control over their exposure. The exposure category is also applicable when the exposure is of a transient nature due to incidental passage through a location where the exposure levels may be higher than the general population/uncontrolled limits, but the exposed person is fully aware of the potential for exposure and can exercise control over his or her exposure by leaving the area or by some other appropriate means.

Limits for Occupational/Controlled Exposure (W/kg)

Whole-Body	Partial-Body	Hands, Wrists, Feet and Ankles
0.4	8.0	20.0

Limits for General Population/Uncontrolled Exposure (W/kg)

Whole-Body	Partial-Body	Hands, Wrists, Feet and Ankles
0.08	1.6	4.0

Whole-Body SAR is averaged over the entire body, partial-body SAR is averaged over any 1gram of tissue defined as a tissue volume in the shape of a cube. SAR for hands, wrists, feet and ankles is averaged over any 10 grams of tissue defined as a tissue volume in the shape of a cube.

6. Specific Absorption Rate (SAR)

6.1 Introduction

SAR is related to the rate at which energy is absorbed per unit mass in an object exposed to a radio field. The SAR distribution in a biological body is complicated and is usually carried out by experimental techniques or numerical modeling. The standard recommends limits for two tiers of groups, occupational/controlled and general population/uncontrolled, based on a person's awareness and ability to exercise control over his or her exposure. In general, occupational/controlled exposure limits are higher than the limits for general population/uncontrolled.

6.2 SAR Definition

The SAR definition is the time derivative (rate) of the incremental energy (dW) absorbed by (dissipated in) an incremental mass (dm) contained in a volume element (dv) of a given density (ρ). The equation description is as below:

$$\text{SAR} = \frac{d}{dt} \left(\frac{dW}{dm} \right) = \frac{d}{dt} \left(\frac{dW}{\rho dv} \right)$$

SAR is expressed in units of Watts per kilogram (W/kg)

$$\text{SAR} = \frac{\sigma |E|^2}{\rho}$$

Where: σ is the conductivity of the tissue, ρ is the mass density of the tissue and E is the RMS electrical field strength.

7. System Description and Setup

The DASY system used for performing compliance tests consists of the following items:

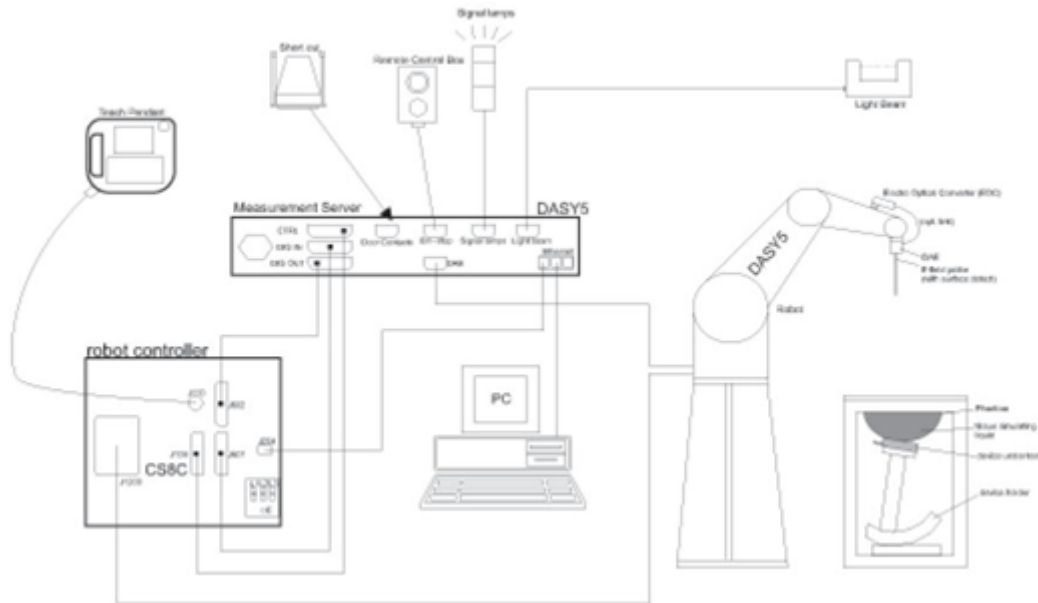

- A standard high precision 6-axis robot with controller, teach pendant and software. An arm extension for accommodating the data acquisition electronics (DAE).
- An isotropic Field probe optimized and calibrated for the targeted measurement.
- A data acquisition electronics (DAE) which performs the signal amplification, signal multiplexing, AD-conversion, offset measurements, mechanical surface detection, collision detection, etc. The unit is battery powered with standard or rechargeable batteries. The signal is optically transmitted to the EOC.
- The Electro-optical converter (EOC) performs the conversion from optical to electrical signals for the digital communication to the DAE. To use optical surface detection, a special version of the EOC is required. The EOC signal is transmitted to the measurement server.
- The function of the measurement server is to perform the time critical tasks such as signal filtering, control of the robot operation and fast movement interrupts.
- The Light Beam used is for probe alignment. This improves the (absolute) accuracy of the probe positioning.
- A computer running WinXP or Win7 and the DASY5 software.
- Remote control and teach pendant as well as additional circuitry for robot safety such as warning lamps, etc.
- The phantom, the device holder and other accessories according to the targeted measurement.

7.1 E-Field Probe

The SAR measurement is conducted with the dosimetric probe (manufactured by SPEAG). The probe is specially designed and calibrated for use in liquid with high permittivity. The dosimetric probe has special calibration in liquid at different frequency. This probe has a built in optical surface detection system to prevent from collision with phantom.

<ES3DV3 Probe>

Construction	Symmetric design with triangular core Interleaved sensors Built-in shielding against static charges PEEK enclosure material (resistant to organic solvents, e.g., DGBE)	
Frequency	10 MHz – 4 GHz; Linearity: ± 0.2 dB (30 MHz – 4 GHz)	
Directivity	± 0.2 dB in TSL (rotation around probe axis) ± 0.3 dB in TSL (rotation normal to probe axis)	
Dynamic Range	5 μ W/g – >100 mW/g; Linearity: ± 0.2 dB	
Dimensions	Overall length: 337 mm (tip: 20 mm) Tip diameter: 3.9 mm (body: 12 mm) Distance from probe tip to dipole centers: 3.0 mm	

<EX3DV4 Probe>

Construction	Symmetric design with triangular core Built-in shielding against static charges PEEK enclosure material (resistant to organic solvents, e.g., DGBE)	
Frequency	10 MHz – >6 GHz Linearity: ± 0.2 dB (30 MHz – 6 GHz)	
Directivity	± 0.3 dB in TSL (rotation around probe axis) ± 0.5 dB in TSL (rotation normal to probe axis)	
Dynamic Range	10 μ W/g – >100 mW/g Linearity: ± 0.2 dB (noise: typically <1 μ W/g)	
Dimensions	Overall length: 337 mm (tip: 20 mm) Tip diameter: 2.5 mm (body: 12 mm) Typical distance from probe tip to dipole centers: 1 mm	

7.2 Data Acquisition Electronics (DAE)

The data acquisition electronics (DAE) consists of a highly sensitive electrometer-grade preamplifier with auto-zeroing, a channel and gain-switching multiplexer, a fast 16 bit AD-converter and a command decoder and control logic unit. Transmission to the measurement server is accomplished through an optical downlink for data and status information as well as an optical uplink for commands and the clock.

The input impedance of the DAE is 200 MOhm; the inputs are symmetrical and floating. Common mode rejection is above 80 dB.



Fig 5.1 Photo of DAE

7.3 Phantom

<SAM Twin Phantom>

Shell Thickness	2 ± 0.2 mm; Center ear point: 6 ± 0.2 mm
Filling Volume	Approx. 25 liters
Dimensions	Length: 1000 mm; Width: 500 mm; Height: adjustable feet
Measurement Areas	Left Hand, Right Hand, Flat Phantom



The bottom plate contains three pair of bolts for locking the device holder. The device holder positions are adjusted to the standard measurement positions in the three sections. A white cover is provided to tap the phantom during off-periods to prevent water evaporation and changes in the liquid parameters. On the phantom top, three reference markers are provided to identify the phantom position with respect to the robot.

<ELI Phantom>

Shell Thickness	2 ± 0.2 mm (sagging: <1%)
Filling Volume	Approx. 30 liters
Dimensions	Major ellipse axis: 600 mm Minor axis: 400 mm



The ELI phantom is intended for compliance testing of handheld and body-mounted wireless devices in the frequency range of 30 MHz to 6 GHz. ELI4 is fully compatible with standard and all known tissue simulating liquids.

7.4 Device Holder

<Mounting Device for Hand-Held Transmitter>

In combination with the Twin SAM V5.0/V5.0c or ELI phantoms, the Mounting Device for Hand-Held Transmitters enables rotation of the mounted transmitter device to specified spherical coordinates. At the heads, the rotation axis is at the ear opening. Transmitter devices can be easily and accurately positioned according to IEC 62209-1, IEEE 1528, FCC, or other specifications. The device holder can be locked for positioning at different phantom sections (left head, right head, flat). And upgrade kit to Mounting Device to enable easy mounting of wider devices like big smart-phones, e-books, small tablets, etc. It holds devices with width up to 140 mm.



Mounting Device for Hand-Held Transmitters



Mounting Device Adaptor for Wide-Phones

<Mounting Device for Laptops and other Body-Worn Transmitters>

The extension is lightweight and made of POM, acrylic glass and foam. It fits easily on the upper part of the mounting device in place of the phone positioned. The extension is fully compatible with the SAM Twin and ELI phantoms.



Mounting Device for Laptops

8. Measurement Procedures

The measurement procedures are as follows:

<Conducted power measurement>

- (a) For WWAN power measurement, use base station simulator to configure EUT WWAN transmission in conducted connection with RF cable, at maximum power in each supported wireless interface and frequency band.
- (b) Read the WWAN RF power level from the base station simulator.
- (c) For WLAN/BT power measurement, use engineering software to configure EUT WLAN/BT continuously transmission, at maximum RF power in each supported wireless interface and frequency band
- (d) Connect EUT RF port through RF cable to the power meter, and measure WLAN/BT output power

<SAR measurement>

- (a) Use base station simulator to configure EUT WWAN transmission in radiated connection, and engineering software to configure EUT WLAN/BT continuously transmission, at maximum RF power, in the highest power channel.
- (b) Place the EUT in the positions as Appendix D demonstrates.
- (c) Set scan area, grid size and other setting on the DASY software.
- (d) Measure SAR results for the highest power channel on each testing position.
- (e) Find out the largest SAR result on these testing positions of each band
- (f) Measure SAR results for other channels in worst SAR testing position if the reported SAR of highest power channel is larger than 0.8 W/kg

According to the test standard, the recommended procedure for assessing the peak spatial-average SAR value consists of the following steps:

- (a) Power reference measurement
- (b) Area scan
- (c) Zoom scan
- (d) Power drift measurement

8.1 Spatial Peak SAR Evaluation

The procedure for spatial peak SAR evaluation has been implemented according to the test standard. It can be conducted for 1g and 10g, as well as for user-specific masses. The DASY software includes all numerical procedures necessary to evaluate the spatial peak SAR value.

The base for the evaluation is a "cube" measurement. The measured volume must include the 1g and 10g cubes with the highest averaged SAR values. For that purpose, the center of the measured volume is aligned to the interpolated peak SAR value of a previously performed area scan.

The entire evaluation of the spatial peak values is performed within the post-processing engine (SEMCAD). The system always gives the maximum values for the 1g and 10g cubes. The algorithm to find the cube with highest averaged SAR is divided into the following stages:

- (a) Extraction of the measured data (grid and values) from the Zoom Scan
- (b) Calculation of the SAR value at every measurement point based on all stored data (A/D values and measurement parameters)
- (c) Generation of a high-resolution mesh within the measured volume
- (d) Interpolation of all measured values from the measurement grid to the high-resolution grid
- (e) Extrapolation of the entire 3-D field distribution to the phantom surface over the distance from sensor to surface
- (f) Calculation of the averaged SAR within masses of 1g and 10g

8.2 Power Reference Measurement

The Power Reference Measurement and Power Drift Measurements are for monitoring the power drift of the device under test in the batch process. The minimum distance of probe sensors to surface determines the closest measurement point to phantom surface. This distance cannot be smaller than the distance of sensor calibration points to probe tip as defined in the probe properties.

8.3 Area Scan

The area scan is used as a fast scan in two dimensions to find the area of high field values, before doing a fine measurement around the hot spot. The sophisticated interpolation routines implemented in DASY software can find the maximum found in the scanned area, within a range of the global maximum. The range (in dB0) is specified in the standards for compliance testing. For example, a 2 dB range is required in IEEE standard 1528 and IEC 62209 standards, whereby 3 dB is a requirement when compliance is assessed in accordance with the ARIB standard (Japan), if only one zoom scan follows the area scan, then only the absolute maximum will be taken as reference. For cases where multiple maximums are detected, the number of zoom scans has to be increased accordingly.

Area scan parameters extracted from FCC KDB 865664 D01v01r04 SAR measurement 100 MHz to 6 GHz.

	≤ 3 GHz	> 3 GHz
Maximum distance from closest measurement point (geometric center of probe sensors) to phantom surface	5 ± 1 mm	$\frac{1}{2} \cdot \delta \cdot \ln(2) \pm 0.5$ mm
Maximum probe angle from probe axis to phantom surface normal at the measurement location	30° ± 1°	20° ± 1°
Maximum area scan spatial resolution: Δx_{Area} , Δy_{Area}	≤ 2 GHz: ≤ 15 mm 2 – 3 GHz: ≤ 12 mm	3 – 4 GHz: ≤ 12 mm 4 – 6 GHz: ≤ 10 mm
	When the x or y dimension of the test device, in the measurement plane orientation, is smaller than the above, the measurement resolution must be ≤ the corresponding x or y dimension of the test device with at least one measurement point on the test device.	

8.4 Zoom Scan

Zoom scans are used assess the peak spatial SAR values within a cubic averaging volume containing 1 gram and 10 gram of simulated tissue. The zoom scan measures points (refer to table below) within a cube shoes base faces are centered on the maxima found in a preceding area scan job within the same procedure. When the measurement is done, the zoom scan evaluates the averaged SAR for 1 gram and 10 gram and displays these values next to the job's label.

Zoom scan parameters extracted from FCC KDB 865664 D01v01r04 SAR measurement 100 MHz to 6 GHz.

		≤ 3 GHz	> 3 GHz	
Maximum zoom scan spatial resolution: $\Delta x_{Zoom}, \Delta y_{Zoom}$		≤ 2 GHz: ≤ 8 mm 2 – 3 GHz: ≤ 5 mm*	3 – 4 GHz: ≤ 5 mm* 4 – 6 GHz: ≤ 4 mm*	
Maximum zoom scan spatial resolution, normal to phantom surface	uniform grid: $\Delta z_{Zoom}(n)$	≤ 5 mm	3 – 4 GHz: ≤ 4 mm 4 – 5 GHz: ≤ 3 mm 5 – 6 GHz: ≤ 2 mm	
	graded grid	$\Delta z_{Zoom}(1)$: between 1 st two points closest to phantom surface	≤ 4 mm	3 – 4 GHz: ≤ 3 mm 4 – 5 GHz: ≤ 2.5 mm 5 – 6 GHz: ≤ 2 mm
		$\Delta z_{Zoom}(n>1)$: between subsequent points	$\leq 1.5 \cdot \Delta z_{Zoom}(n-1)$	
Minimum zoom scan volume	x, y, z	≥ 30 mm	3 – 4 GHz: ≥ 28 mm 4 – 5 GHz: ≥ 25 mm 5 – 6 GHz: ≥ 22 mm	
Note: δ is the penetration depth of a plane-wave at normal incidence to the tissue medium; see draft standard IEEE P1528-2011 for details. * When zoom scan is required and the <i>reported</i> SAR from the <i>area scan based 1-g SAR estimation</i> procedures of KDB 447498 is ≤ 1.4 W/kg, ≤ 8 mm, ≤ 7 mm and ≤ 5 mm zoom scan resolution may be applied, respectively, for 2 GHz to 3 GHz, 3 GHz to 4 GHz and 4 GHz to 6 GHz.				

8.5 Volume Scan Procedures

The volume scan is used for assess overlapping SAR distributions for antennas transmitting in different frequency bands. It is equivalent to an oversized zoom scan used in standalone measurements. The measurement volume will be used to enclose all the simultaneous transmitting antennas. For antennas transmitting simultaneously in different frequency bands, the volume scan is measured separately in each frequency band. In order to sum correctly to compute the 1g aggregate SAR, the EUT remain in the same test position for all measurements and all volume scan use the same spatial resolution and grid spacing. When all volume scan were completed, the software, SEMCAD postprocessor can combine and subsequently superpose these measurement data to calculating the multiband SAR.

8.6 Power Drift Monitoring

All SAR testing is under the EUT install full charged battery and transmit maximum output power. In DASY measurement software, the power reference measurement and power drift measurement procedures are used for monitoring the power drift of EUT during SAR test. Both these procedures measure the field at a specified reference position before and after the SAR testing. The software will calculate the field difference in dB. If the power drifts more than 5%, the SAR will be retested.



9. Test Equipment List

Manufacturer	Name of Equipment	Type/Model	Serial Number	Calibration	
				Last Cal.	Due Date
SPEAG	835MHz System Validation Kit	D835V2	4d091	2017/12/5	2018/12/4
SPEAG	2450MHz System Validation Kit	D2450V2	840	2017/12/7	2018/12/6
SPEAG	2600MHz System Validation Kit	D2600V2	1061	2017/12/7	2018/12/6
SPEAG	Data Acquisition Electronics	DAE4	915	2017/6/16	2018/6/15
SPEAG	Data Acquisition Electronics	DAE4	1338	2017/12/4	2018/12/3
SPEAG	Dosimetric E-Field Probe	ES3DV3	3293	2017/9/25	2018/9/24
SPEAG	Dosimetric E-Field Probe	EX3DV4	3753	2017/5/5	2018/5/4
SPEAG	SAM Twin Phantom	QD 000 P40 CB	TP-1488	NCR	NCR
SPEAG	SAM Twin Phantom	QD 000 P40 CB	TP-1697	NCR	NCR
SPEAG	SAM Twin Phantom	QD 000 P40 CB	TP-1696	NCR	NCR
SPEAG	Phone Positioner	N/A	N/A	NCR	NCR
Anritsu	Radio communication analyzer	MT8820C	6201563814	2018/1/18	2019/1/17
Agilent	Wireless Communication Test Set	E5515C	MY52102706	2017/4/18	2018/4/17
Agilent	ENA Series Network Analyzer	E5071C	MY46111157	2017/4/18	2018/4/17
SPEAG	DAK Kit	DAK3.5	1146	2017/7/18	2018/7/17
R&S	Signal Generator	SMR40	100455	2018/1/18	2019/1/17
Anritsu	Power Meter	ML2495A	1419002	2017/5/15	2018/5/14
Anritsu	Power Sensor	MA2411B	1339124	2017/5/15	2018/5/14
Anritsu	Power Meter	ML2495A	1218006	2017/10/6	2018/10/5
Anritsu	Power Sensor	MA2411B	1207363	2017/10/6	2018/10/5
R&S	CBT BLUETOOTH TESTER	CBT	100783	2017/8/8	2018/8/7
EXA	Spectrum Analyzer	N9010A	MY55150244	2017/4/18	2018/4/17
WISEWIND	Hygrometer	WISEWIND 0905	0905	2017/4/20	2018/4/19
JM	DIGITAC THERMOMETER	JM222	AA1207166	2017/4/19	2018/4/18
Agilent	Dual Directional Coupler	778D	50422	Note	
PASTERNAK	Dual Directional Coupler	PE2214-10	N/A	Note	
ARRA	Power Divider	A3200-2	N/A	Note	
MCL	Attenuation1	BW-S10W5+	N/A	Note	
MCL	Attenuation2	BW-S10W5+	N/A	Note	
MCL	Attenuation3	BW-S10W5+	N/A	Note	
AR	Amplifier	5S1G4	333096	Note	
mini-circuits	Amplifier	ZVE-3W-83+	162601250	Note	

General Note:

Prior to system verification and validation, the path loss from the signal generator to the system check source and the power meter, which includes the amplifier, cable, attenuator and directional coupler, was measured by the network analyzer. The reading of the power meter was offset by the path loss difference between the path to the power meter and the path to the system check source to monitor the actual power level fed to the system check source.

10. System Verification

10.1 Tissue Simulating Liquids

For the measurement of the field distribution inside the SAM phantom with DASY, the phantom must be filled with around 25 liters of homogeneous body tissue simulating liquid. For head SAR testing, the liquid height from the ear reference point (ERP) of the phantom to the liquid top surface is larger than 15 cm, which is shown in Fig. 10.1. For body SAR testing, the liquid height from the center of the flat phantom to the liquid top surface is larger than 15 cm, which is shown in Fig. 10.2.

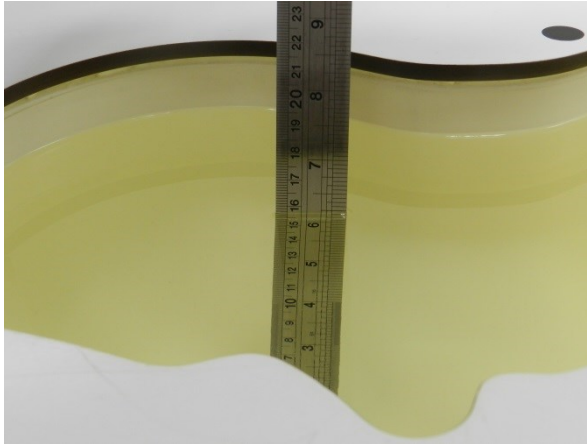

Fig 10.1 Photo of Liquid Height for Head SAR

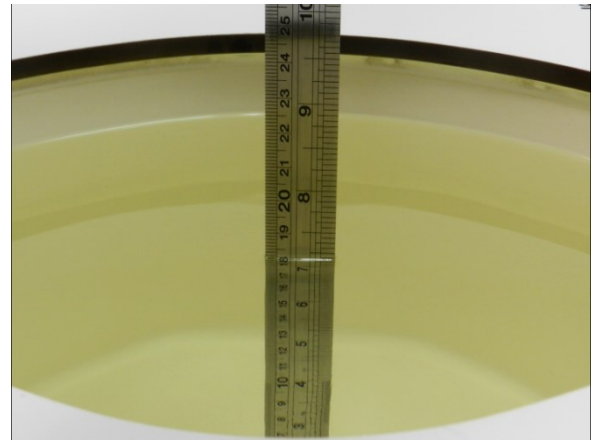

Fig 10.2 Photo of Liquid Height for Body SAR

10.2 Tissue Verification

The following tissue formulations are provided for reference only as some of the parameters have not been thoroughly verified. The composition of ingredients may be modified accordingly to achieve the desired target tissue parameters required for routine SAR evaluation.

Frequency (MHz)	Water (%)	Sugar (%)	Cellulose (%)	Salt (%)	Preventol (%)	DGBE (%)	Conductivity (σ)	Permittivity (ϵ_r)
For Head								
835	40.3	57.9	0.2	1.4	0.2	0	0.90	41.5
2450	55.0	0	0	0	0	45.0	1.80	39.2
2600	54.8	0	0	0.1	0	45.1	1.96	39.0
For Body								
835	50.8	48.2	0	0.9	0.1	0	0.97	55.2
2450	68.6	0	0	0	0	31.4	1.95	52.7
2600	68.1	0	0	0.1	0	31.8	2.16	52.5

<Tissue Dielectric Parameter Check Results>

Frequency (MHz)	Tissue Type	Liquid Temp. (°C)	Conductivity (σ)	Permittivity (ϵ_r)	Conductivity Target (σ)	Permittivity Target (ϵ_r)	Delta (σ) (%)	Delta (ϵ_r) (%)	Limit (%)	Date
835	Head	22.9	0.918	42.094	0.90	41.50	2.00	1.43	±5	2018/1/26
2450	Head	22.6	1.867	39.300	1.80	39.20	3.72	0.26	±5	2018/1/27
2600	Head	22.6	2.049	37.830	1.96	39.00	4.54	-3.00	±5	2018/1/25
835	Body	22.7	0.984	56.593	0.97	55.20	1.44	2.52	±5	2018/1/27
2450	Body	22.6	2.012	54.301	1.95	52.70	3.18	3.04	±5	2018/1/27
2600	Body	22.6	2.219	53.696	2.16	52.50	2.73	2.28	±5	2018/1/26

10.3 System Performance Check Results

Comparing to the original SAR value provided by SPEAG, the verification data should be within its specification of 10 %. Below table shows the target SAR and measured SAR after normalized to 1W input power. The table below indicates the system performance check can meet the variation criterion and the plots can be referred to Appendix A of this report.

Date	Frequency (MHz)	Tissue Type	Input Power (mW)	Dipole S/N	Probe S/N	DAE S/N	Measured 1g SAR (W/kg)	Targeted 1g SAR (W/kg)	Normalized 1g SAR (W/kg)	Deviation (%)
2018/1/26	835	Head	250	4d091	3293	915	2.42	9.48	9.68	2.11
2018/1/27	2450	Head	250	840	3753	1338	13.1	52.6	52.4	-0.38
2018/1/25	2600	Head	250	1061	3293	915	15.2	58.2	60.8	4.47
2018/1/27	835	Body	250	4d091	3293	915	2.29	9.72	9.16	-5.76
2018/1/27	2450	Body	250	840	3753	1338	12.1	51.9	48.4	-6.74
2018/1/26	2600	Body	250	1061	3293	915	14.1	56.4	56.4	0.00

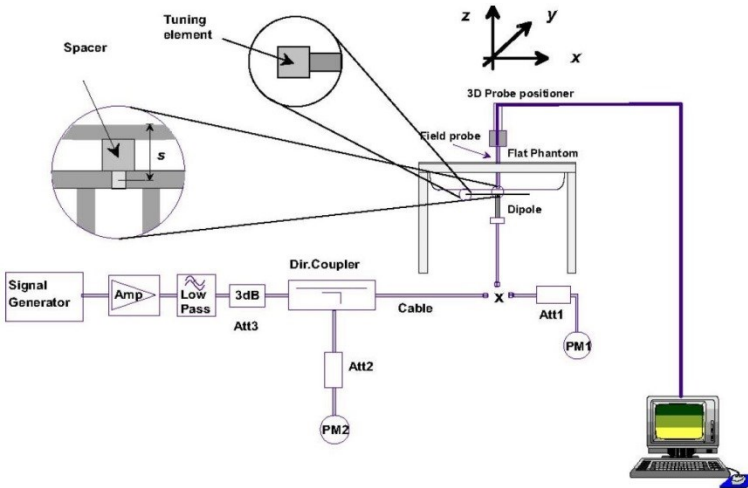

Fig 8.3.1 System Performance Check Setup

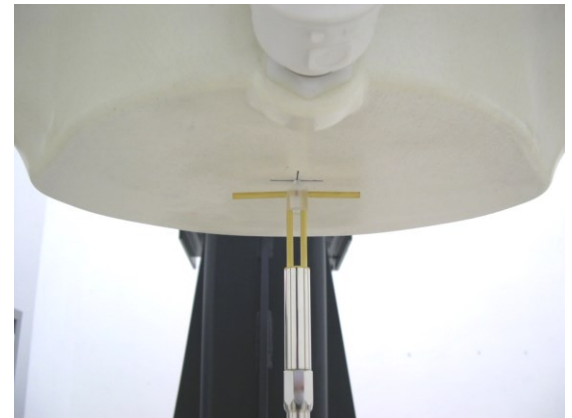

Fig 8.3.2 Setup Photo

11. RF Exposure Positions

11.1 Ear and handset reference point

Figure 9.1.1 shows the front, back, and side views of the SAM phantom. The center-of-mouth reference point is labeled “M,” the left ear reference point (ERP) is marked “LE,” and the right ERP is marked “RE.” Each ERP is 15 mm along the B-M (back-mouth) line behind the entrance-to-ear-canal (EEC) point, as shown in Figure 9.1.2 The Reference Plane is defined as passing through the two ear reference points and point M. The line N-F (neck-front), also called the reference pivoting line, is normal to the Reference Plane and perpendicular to both a line passing through RE and LE and the B-M line (see Figure 9.1.3). Both N-F and B-M lines should be marked on the exterior of the phantom shell to facilitate handset positioning. Posterior to the N-F line the ear shape is a flat surface with 6 mm thickness at each ERP, and forward of the N-F line the ear is truncated, as illustrated in Figure 9.1.2. The ear truncation is introduced to preclude the ear lobe from interfering with handset tilt, which could lead to unstable positioning at the cheek.

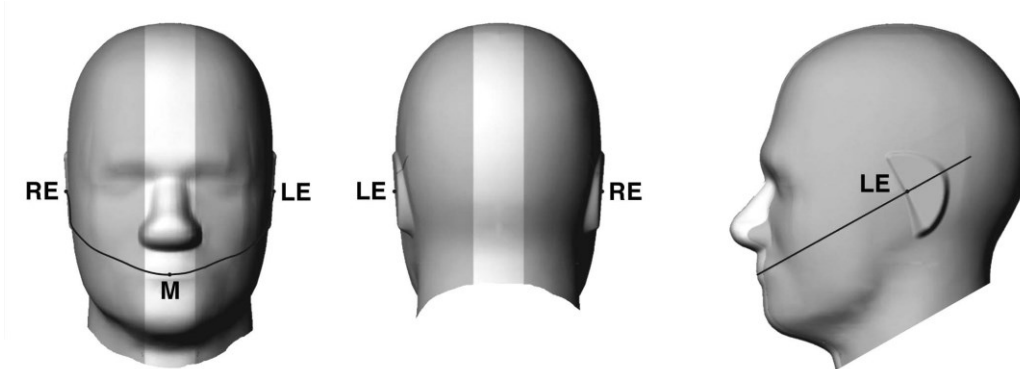

Fig 9.1.1 Front, back, and side views of SAM twin phantom

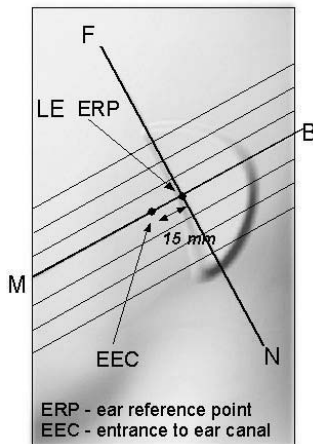

Fig 9.1.2 Close-up side view of phantom showing the ear region.

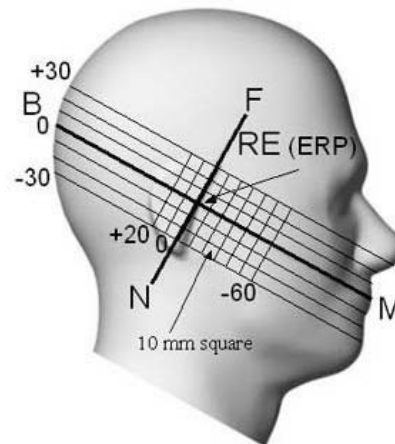

Fig 9.1.3 Side view of the phantom showing relevant markings and seven cross-sectional plane locations

11.2 Definition of the cheek position

1. Ready the handset for talk operation, if necessary. For example, for handsets with a cover piece (flip cover), open the cover. If the handset can transmit with the cover closed, both configurations must be tested.
2. Define two imaginary lines on the handset—the vertical centerline and the horizontal line. The vertical centerline passes through two points on the front side of the handset—the midpoint of the width w_t of the handset at the level of the acoustic output (point A in Figure 9.2.1 and Figure 9.2.2), and the midpoint of the width w_b of the bottom of the handset (point B). The horizontal line is perpendicular to the vertical centerline and passes through the center of the acoustic output (see Figure 9.2.1). The two lines intersect at point A. Note that for many handsets, point A coincides with the center of the acoustic output; however, the acoustic output may be located elsewhere on the horizontal line. Also note that the vertical centerline is not necessarily parallel to the front face of the handset (see Figure 9.2.2), especially for clamshell handsets, handsets with flip covers, and other irregularly-shaped handsets.
3. Position the handset close to the surface of the phantom such that point A is on the (virtual) extension of the line passing through points RE and LE on the phantom (see Figure 9.2.3), such that the plane defined by the vertical centerline and the horizontal line of the handset is approximately parallel to the sagittal plane of the phantom.
4. Translate the handset towards the phantom along the line passing through RE and LE until handset point A touches the pinna at the ERP.
5. While maintaining the handset in this plane, rotate it around the LE-RE line until the vertical centerline is in the plane normal to the plane containing B-M and N-F lines, i.e., the Reference Plane.
6. Rotate the handset around the vertical centerline until the handset (horizontal line) is parallel to the N-F line.
7. While maintaining the vertical centerline in the Reference Plane, keeping point A on the line passing through RE and LE, and maintaining the handset contact with the pinna, rotate the handset about the N-F line until any point on the handset is in contact with a phantom point below the pinna on the cheek. See Figure 9.2.3. The actual rotation angles should be documented in the test report.

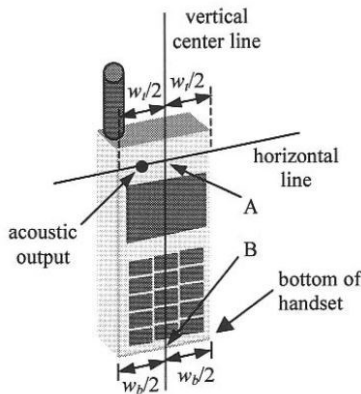

Fig 9.2.1 Handset vertical and horizontal reference lines—“fixed case”

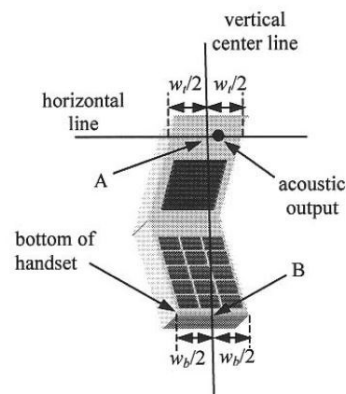

Fig 9.2.2 Handset vertical and horizontal reference lines—“clam-shell case”

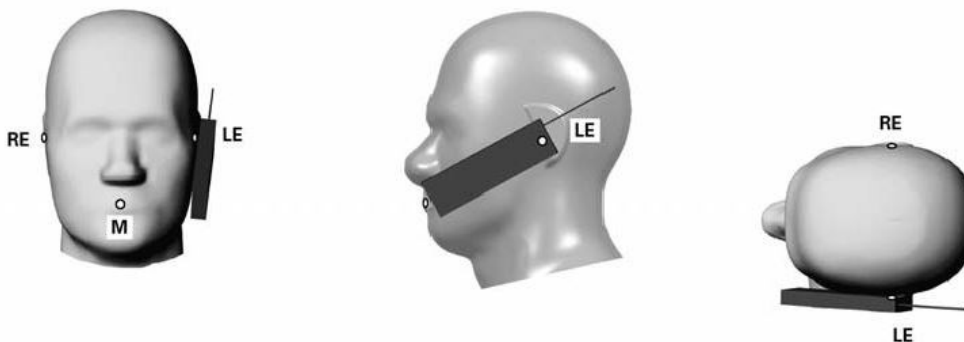

Fig 9.2.3 cheek or touch position. The reference points for the right ear (RE), left ear (LE), and mouth (M), which establish the Reference Plane for handset positioning, are indicated.

11.3 Definition of the tilt position

1. Ready the handset for talk operation, if necessary. For example, for handsets with a cover piece (flip cover), open the cover. If the handset can transmit with the cover closed, both configurations must be tested.
2. While maintaining the orientation of the handset, move the handset away from the pinna along the line passing through RE and LE far enough to allow a rotation of the handset away from the cheek by 15°.
3. Rotate the handset around the horizontal line by 15°.
4. While maintaining the orientation of the handset, move the handset towards the phantom on the line passing through RE and LE until any part of the handset touches the ear. The tilt position is obtained when the contact point is on the pinna. See Figure 9.3.1. If contact occurs at any location other than the pinna, e.g., the antenna at the back of the phantom head, the angle of the handset should be reduced. In this case, the tilt position is obtained if any point on the handset is in contact with the pinna and a second point

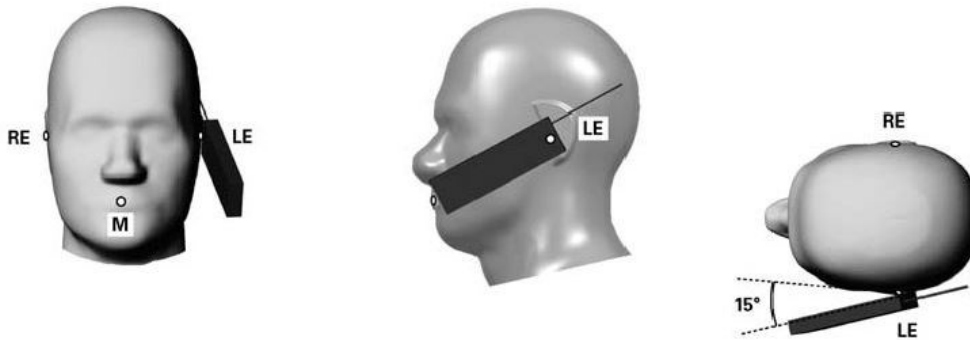

Fig 9.3.1 Tilt position. The reference points for the right ear (RE), left ear (LE), and mouth (M), which define the Reference Plane for handset positioning, are indicated.

11.4 Body Worn Accessory

Body-worn operating configurations are tested with the belt-clips and holsters attached to the device and positioned against a flat phantom in a normal use configuration (see Figure 9.4). Per KDB648474 D04v01r03, body-worn accessory exposure is typically related to voice mode operations when handsets are carried in body-worn accessories. The body-worn accessory exposure procedures in FCC KDB 447498 D01v06 should be used to test for body-worn accessory SAR compliance, without a headset connected to it. This enables the test results for such configuration to be compatible with that required for hotspot mode when the body-worn accessory test separation distance is greater than or equal to that required for hotspot mode, when applicable. When the reported SAR for body-worn accessory, measured without a headset connected to the handset is > 1.2 W/kg, the highest reported SAR configuration for that wireless mode and frequency band should be repeated for that body-worn accessory with a handset attached to the handset.

Accessories for body-worn operation configurations are divided into two categories: those that do not contain metallic components and those that do contain metallic components. When multiple accessories that do not contain metallic components are supplied with the device, the device is tested with only the accessory that dictates the closest spacing to the body. Then multiple accessories that contain metallic components are tested with the device with each accessory. If multiple accessories share an identical metallic component (i.e. the same metallic belt-clip used with different holsters with no other metallic components) only the accessory that dictates the closest spacing to the body is tested.

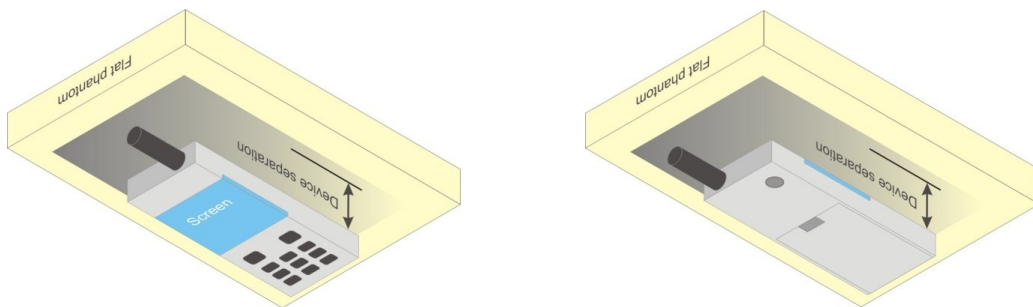

Fig 9.4 Body Worn Position

11.5 Wireless Router

Some battery-operated handsets have the capability to transmit and receive user through simultaneous transmission of WIFI simultaneously with a separate licensed transmitter. The FCC has provided guidance in FCC KDB Publication 941225 D06 v02r01 where SAR test considerations for handsets (L x W ≥ 9 cm x 5 cm) are based on a composite test separation distance of 10mm from the front, back and edges of the device containing transmitting antennas within 2.5cm of their edges, determined from general mixed use conditions for this type of devices. Since the hotspot SAR results may overlap with the body-worn accessory SAR requirements, the more conservative configurations can be considered, thus excluding some body-worn accessory SAR tests.

When the user enables the personal wireless router functions for the handset, actual operations include simultaneous transmission of both the WIFI transmitter and another licensed transmitter. Both transmitters often do not transmit at the same transmitting frequency and thus cannot be evaluated for SAR under actual use conditions due to the limitations of the SAR assessment probes. Therefore, SAR must be evaluated for each frequency transmission and mode separately and spatially summed with the WIFI transmitter according to FCC KDB Publication 447498 D01v06 publication procedures. The “Portable Hotspot” feature on the handset was NOT activated during SAR assessments, to ensure the SAR measurements were evaluated for a single transmission frequency RF signal at a time.

12. Conducted RF Output Power (Unit: dBm)

<WCDMA Conducted Power>

1. The following tests were conducted according to the test requirements outlines in 3GPP TS 34.121 specification.
2. The procedures in KDB 941225 D01v03r01 are applied for 3GPP Rel. 6 HSPA to configure the device in the required sub-test mode(s) to determine SAR test exclusion.
3. For DC-HSDPA, the device was configured according to the H-Set 12, Fixed Reference Channel (FRC) configuration in Table C.8.1.12 of 3GPP TS 34.121-1, with the primary and the secondary serving HS-DSCH Cell enabled during the power measurement.

A summary of these settings are illustrated below:

HSDPA Setup Configuration:

- a. The EUT was connected to Base Station Agilent E5515C referred to the Setup Configuration.
- b. The RF path losses were compensated into the measurements.
- c. A call was established between EUT and Base Station with following setting:
 - i. Set Gain Factors (β_c and β_d) and parameters were set according to each
 - ii. Specific sub-test in the following table, C10.1.4, quoted from the TS 34.121
 - iii. Set RMC 12.2Kbps + HSDPA mode.
 - iv. Set Cell Power = -86 dBm
 - v. Set HS-DSCH Configuration Type to FRC (H-set 1, QPSK)
 - vi. Select HSDPA Uplink Parameters
 - vii. Set Delta ACK, Delta NACK and Delta CQI = 8
 - viii. Set Ack-Nack Repetition Factor to 3
 - ix. Set CQI Feedback Cycle (k) to 4 ms
 - x. Set CQI Repetition Factor to 2
 - xi. Power Ctrl Mode = All Up bits
- d. The transmitted maximum output power was recorded.

Table C.10.1.4: β values for transmitter characteristics tests with HS-DPCCH

Sub-test	β_c	β_d	β_d (SF)	β_c/β_d	β_{hs} (Note 1, Note 2)	CM (dB) (Note 3)	MPR (dB) (Note 3)
1	2/15	15/15	64	2/15	4/15	0.0	0.0
2	12/15 (Note 4)	15/15 (Note 4)	64	12/15 (Note 4)	24/15	1.0	0.0
3	15/15	8/15	64	15/8	30/15	1.5	0.5
4	15/15	4/15	64	15/4	30/15	1.5	0.5

Note 1: Δ_{ACK} , Δ_{NACK} and $\Delta_{CQI} = 30/15$ with $\beta_{hs} = 30/15 * \beta_c$.

Note 2: For the HS-DPCCH power mask requirement test in clause 5.2C, 5.7A, and the Error Vector Magnitude (EVM) with HS-DPCCH test in clause 5.13.1A, and HSDPA EVM with phase discontinuity in clause 5.13.1AA, Δ_{ACK} and $\Delta_{NACK} = 30/15$ with $\beta_{hs} = 30/15 * \beta_c$, and $\Delta_{CQI} = 24/15$ with $\beta_{hs} = 24/15 * \beta_c$.

Note 3: CM = 1 for $\beta_c/\beta_d = 12/15$, $\beta_{hs}/\beta_c = 24/15$. For all other combinations of DPDCH, DPCCH and HS-DPCCH the MPR is based on the relative CM difference. This is applicable for only UEs that support HSDPA in release 6 and later releases.

Note 4: For subtest 2 the β_c/β_d ratio of 12/15 for the TFC during the measurement period (TF1, TF0) is achieved by setting the signalled gain factors for the reference TFC (TF1, TF1) to $\beta_c = 11/15$ and $\beta_d = 15/15$.

Setup Configuration

HSUPA Setup Configuration:

- a. The EUT was connected to Base Station Agilent E5515C referred to the Setup Configuration.
- b. The RF path losses were compensated into the measurements.
- c. A call was established between EUT and Base Station with following setting * :
 - i. Call Configs = 5.2B, 5.9B, 5.10B, and 5.13.2B with QPSK
 - ii. Set the Gain Factors (β_c and β_d) and parameters (AG Index) were set according to each specific sub-test in the following table, C11.1.3, quoted from the TS 34.121
 - iii. Set Cell Power = -86 dBm
 - iv. Set Channel Type = 12.2k + HSPA
 - v. Set UE Target Power
 - vi. Power Ctrl Mode= Alternating bits
 - vii. Set and observe the E-TFCl
 - viii. Confirm that E-TFCl is equal to the target E-TFCl of 75 for sub-test 1, and other subtest's E-TFCl
- d. The transmitted maximum output power was recorded.

Table C.11.1.3: β values for transmitter characteristics tests with HS-DPCCH and E-DCH

Sub-test	β_c	β_d	β_d (SF)	β_c/β_d	β_{HS} (Note1)	β_{ec}	β_{ed} (Note 4) (Note 5)	β_{ed} (SF)	β_{ed} (Codes)	CM (dB) (Note 2)	MPR (dB) (Note 2) (Note 6)	AG Index (Note 5)	E-TFCl
1	11/15 (Note 3)	15/15 (Note 3)	64	11/15 (Note 3)	22/15	209/25	1309/225	4	1	1.0	0.0	20	75
2	6/15	15/15	64	6/15	12/15	12/15	94/75	4	1	3.0	2.0	12	67
3	15/15	9/15	64	15/9	30/15	30/15	β_{ed1} : 47/15 β_{ed2} : 47/15	4 4	2	2.0	1.0	15	92
4	2/15	15/15	64	2/15	4/15	2/15	56/75	4	1	3.0	2.0	17	71
5	15/15	0	-	-	5/15	5/15	47/15	4	1	1.0	0.0	12	67

Note 1: For sub-test 1 to 4, Δ_{ACK} , Δ_{NACK} and $\Delta_{CQI} = 30/15$ with $\beta_{HS} = 30/15 * \beta_c$. For sub-test 5, Δ_{ACK} , Δ_{NACK} and $\Delta_{CQI} = 5/15$ with $\beta_{HS} = 5/15 * \beta_c$.

Note 2: CM = 1 for $\beta_c/\beta_d = 12/15$, $\beta_{HS}/\beta_c = 24/15$. For all other combinations of DPDCH, DPCCH, HS-DPCCH, E-DPDCH and E-DPCCH the MPR is based on the relative CM difference.

Note 3: For subtest 1 the β_c/β_d ratio of 11/15 for the TFC during the measurement period (TF1, TF0) is achieved by setting the signalled gain factors for the reference TFC (TF1, TF1) to $\beta_c = 10/15$ and $\beta_d = 15/15$.

Note 4: In case of testing by UE using E-DPDCH Physical Layer category 1, Sub-test 3 is omitted according to TS25.306 Table 5.1g.

Note 5: β_{ed} can not be set directly; it is set by Absolute Grant Value.

Note 6: For subtests 2, 3 and 4, UE may perform E-DPDCH power scaling at max power which could results in slightly smaller MPR values.

Setup Configuration

DC-HSDPA 3GPP release 8 Setup Configuration:

- a. The EUT was connected to Base Station Agilent E5515C referred to the Setup Configuration below
- b. The RF path losses were compensated into the measurements.
- c. A call was established between EUT and Base Station with following setting:
 - i. Set RMC 12.2Kbps + HSDPA mode.
 - ii. Set Cell Power = -25 dBm
 - iii. Set HS-DSCH Configuration Type to FRC (H-set 12, QPSK)
 - iv. Select HSDPA Uplink Parameters
 - v. Set Gain Factors (β_c and β_d) and parameters were set according to each Specific sub-test in the following table, C10.1.4, quoted from the TS 34.121
 - a). Subtest 1: $\beta_c/\beta_d=2/15$
 - b). Subtest 2: $\beta_c/\beta_d=12/15$
 - c). Subtest 3: $\beta_c/\beta_d=15/8$
 - d). Subtest 4: $\beta_c/\beta_d=15/4$
 - vi. Set Delta ACK, Delta NACK and Delta CQI = 8
 - vii. Set Ack-Nack Repetition Factor to 3
 - viii. Set CQI Feedback Cycle (k) to 4 ms
 - ix. Set CQI Repetition Factor to 2
 - x. Power Ctrl Mode = All Up bits
- d. The transmitted maximum output power was recorded.

The following tests were conducted according to the test requirements outlines in 3GPP TS 34.121 specification. A summary of these settings are illustrated below:

C.8.1.12 Fixed Reference Channel Definition H-Set 12

Table C.8.1.12: Fixed Reference Channel H-Set 12

Parameter	Unit	Value
Nominal Avg. Inf. Bit Rate	kbps	60
Inter-TTI Distance	TTI's	1
Number of HARQ Processes	Processes	6
Information Bit Payload (N_{inf})	Bits	120
Number Code Blocks	Blocks	1
Binary Channel Bits Per TTI	Bits	960
Total Available SML's in UE	SML's	19200
Number of SML's per HARQ Proc.	SML's	3200
Coding Rate		0.15
Number of Physical Channel Codes	Codes	1
Modulation		QPSK
Note 1: The RMC is intended to be used for DC-HSDPA mode and both cells shall transmit with identical parameters as listed in the table.		
Note 2: Maximum number of transmission is limited to 1, i.e., retransmission is not allowed. The redundancy and constellation version 0 shall be used.		

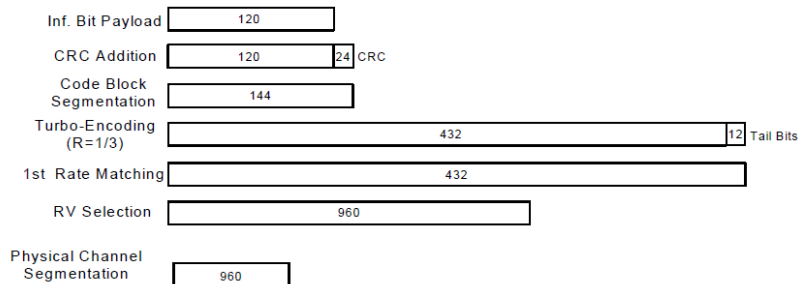

Figure C.8.19: Coding rate for Fixed reference Channel H-Set 12 (QPSK)

Setup Configuration



<WCDMA Conducted Power>

General Note:

1. Per KDB 941225 D01v03r01, for SAR testing is measured using a 12.2 kbps RMC with TPC bits configured to all "1's".
2. Per KDB 941225 D01v03r01, RMC 12.2kbps setting is used to evaluate SAR. The maximum output power and tune-up tolerance specified for production units in HSDPA / HSUPA / DC-HSDPA is ≤ ¼ dB higher than RMC 12.2Kbps or when the highest reported SAR of the RMC12.2Kbps is scaled by the ratio of specified maximum output power and tune-up tolerance of HSDPA / HSUPA/ DC-HSDPA to RMC12.2Kbps and the adjusted SAR is ≤ 1.2 W/kg, SAR measurement is not required for HSDPA / HSUPA / DC-HSDPA, and according to the following RF output power, the output power results of the secondary modes (HSUPA, HSDPA, DC-HSDPA) are less than ¼ dB higher than the primary modes; therefore, SAR measurement is not required for HSDPA / HSUPA / DC-HSDPA.

Band		WCDMA Band V			Tune-up Limit (dBm)
Tx Channel		4132	4182	4233	
Rx Channel		4357	4407	4458	
Frequency (MHz)		826.4	836.4	846.6	
3GPP Rel 99	AMR 12.2Kbps	23.46	23.55	23.50	24.50
3GPP Rel 99	RMC 12.2Kbps	23.47	23.56	23.52	24.50
3GPP Rel 6	HSDPA Subtest-1	22.45	22.35	22.45	24.00
3GPP Rel 6	HSDPA Subtest-2	22.55	22.39	22.54	24.00
3GPP Rel 6	HSDPA Subtest-3	22.09	21.56	22.06	23.50
3GPP Rel 6	HSDPA Subtest-4	22.08	21.90	22.07	23.50
3GPP Rel 8	DC-HSDPA Subtest-1	22.48	22.34	22.46	24.00
3GPP Rel 8	DC-HSDPA Subtest-2	22.51	23.48	22.18	24.00
3GPP Rel 8	DC-HSDPA Subtest-3	22.02	21.92	21.88	23.50
3GPP Rel 8	DC-HSDPA Subtest-4	22.06	21.88	21.97	23.50
3GPP Rel 6	HSUPA Subtest-1	22.29	21.88	22.14	24.00
3GPP Rel 6	HSUPA Subtest-2	21.42	21.35	21.16	22.00
3GPP Rel 6	HSUPA Subtest-3	21.41	21.35	21.11	23.00
3GPP Rel 6	HSUPA Subtest-4	21.50	21.87	21.46	22.00
3GPP Rel 6	HSUPA Subtest-5	22.12	22.20	22.12	24.00

**<LTE Conducted Power>****General Note:**

1. Anritsu MT8820C base station simulator was used to setup the connection with EUT; the frequency band, channel bandwidth, RB allocation configuration, modulation type are set in the base station simulator to configure EUT transmitting at maximum power and at different configurations which are requested to be reported to FCC, for conducted power measurement and SAR testing.
2. Per KDB 941225 D05v02r05, when a properly configured base station simulator is used for the SAR and power measurements, spectrum plots for each RB allocation and offset configuration is not required.
3. Per KDB 941225 D05v02r05, start with the largest channel bandwidth and measure SAR for QPSK with 1 RB allocation, using the RB offset and required test channel combination with the highest maximum output power for RB offsets at the upper edge, middle and lower edge of each required test channel.
4. Per KDB 941225 D05v02r05, 50% RB allocation for QPSK SAR testing follows 1RB QPSK allocation procedure.
5. Per KDB 941225 D05v02r05, For QPSK with 100% RB allocation, SAR is not required when the highest maximum output power for 100 % RB allocation is less than the highest maximum output power in 50% and 1 RB allocations and the highest reported SAR for 1 RB and 50% RB allocation are ≤ 0.8 W/kg. Otherwise, SAR is measured for the highest output power channel; and if the reported SAR is > 1.45 W/kg, the remaining required test channels must also be tested.
6. Per KDB 941225 D05v02r05, 16QAM output power for each RB allocation configuration is $>$ not $\frac{1}{2}$ dB higher than the same configuration in QPSK and the reported SAR for the QPSK configuration is ≤ 1.45 W/kg; Per KDB 941225 D05v02r05, 16QAM SAR testing is not required.
7. Per KDB 941225 D05v02r05, Smaller bandwidth output power for each RB allocation configuration is $>$ not $\frac{1}{2}$ dB higher than the same configuration in the largest supported bandwidth, and the reported SAR for the largest supported bandwidth is ≤ 1.45 W/kg; Per KDB 941225 D05v02r05, smaller bandwidth SAR testing is not required.
8. For LTE B5 the maximum bandwidth does not support three non-overlapping channels, per KDB 941225 D05v02r05, when a device supports overlapping channel assignment in a channel bandwidth configuration, the middle channel of the group of overlapping channels should be selected for testing.



<LTE Band 5>

BW [MHz]	Modulation	RB Size	RB Offset	Power Low Ch. / Freq.	Power Middle Ch. / Freq.	Power High Ch. / Freq.	Tune-up limit (dBm)	MPR (dB)
Channel				20450	20525	20600		
Frequency (MHz)				829	836.5	844		
10	QPSK	1	0	22.84	22.97	23.22		
10	QPSK	1	25	22.61	22.46	22.7	24	0
10	QPSK	1	49	22.51	22.79	22.78		
10	QPSK	25	0	21.88	21.89	22.13		
10	QPSK	25	12	21.75	21.85	22	23	1
10	QPSK	25	25	21.84	21.88	22.04		
10	QPSK	50	0	21.96	21.86	22.12		
10	16QAM	1	0	21.67	21.24	21.72	23	1
10	16QAM	1	25	21.86	21.51	21.89		
10	16QAM	1	49	21.4	21.29	21.54		
10	16QAM	25	0	20.57	20.8	20.76	22	2
10	16QAM	25	12	20.82	20.84	21		
10	16QAM	25	25	20.67	20.81	20.8		
10	16QAM	50	0	20.72	20.73	20.98		
Channel				20425	20525	20625	Tune-up limit (dBm)	MPR (dB)
Frequency (MHz)				826.5	836.5	846.5		
5	QPSK	1	0	22.64	22.81	22.97	24	0
5	QPSK	1	12	22.97	23.1	23.2		
5	QPSK	1	24	22.52	22.86	22.82		
5	QPSK	12	0	22.03	21.97	22.16	23	1
5	QPSK	12	7	21.87	22.04	22.14		
5	QPSK	12	13	21.87	22.03	22.19		
5	QPSK	25	0	21.92	21.94	22.14		
5	16QAM	1	0	21.2	21.15	21.9	23	1
5	16QAM	1	12	21.91	21.6	22.23		
5	16QAM	1	24	21.73	21.31	21.63		
5	16QAM	12	0	20.73	20.64	20.92	22	2
5	16QAM	12	7	20.77	21.01	20.92		
5	16QAM	12	13	20.95	20.66	21.05		
5	16QAM	25	0	20.99	21	21.2		



Channel				20415	20525	20635	Tune-up limit (dBm)	MPR (dB)
Frequency (MHz)				825.5	836.5	847.5		
3	QPSK	1	0	22.86	22.91	23.2	24	0
3	QPSK	1	8	22.95	22.87	23.27		
3	QPSK	1	14	22.75	22.86	23.16		
3	QPSK	8	0	22.02	22.01	22.21	23	1
3	QPSK	8	4	22.04	22.04	22.17		
3	QPSK	8	7	21.91	22.01	22.16		
3	QPSK	15	0	21.95	22.01	22.24	23	1
3	16QAM	1	0	21.37	21.55	21.47		
3	16QAM	1	8	21.71	21.61	21.53		
3	16QAM	1	14	21.45	21.54	21.32	22	2
3	16QAM	8	0	20.8	20.6	21.23		
3	16QAM	8	4	20.86	20.64	21.29		
3	16QAM	8	7	20.71	20.6	21.17	22	2
3	16QAM	15	0	20.93	20.8	21.23		
Channel				20407	20525	20643	Tune-up limit (dBm)	MPR (dB)
Frequency (MHz)				824.7	836.5	848.3		
1.4	QPSK	1	0	22.86	22.94	23.16	24	0
1.4	QPSK	1	3	22.95	22.94	23.18		
1.4	QPSK	1	5	23.1	22.98	23.13		
1.4	QPSK	3	0	23.01	22.94	23.15		
1.4	QPSK	3	1	23.09	23.13	23.17		
1.4	QPSK	3	3	23.1	23.06	23.1	23	1
1.4	QPSK	6	0	22	22	22.23		
1.4	16QAM	1	0	21.27	21.56	21.49	23	1
1.4	16QAM	1	3	21.44	21.66	21.48		
1.4	16QAM	1	5	21.52	21.58	21.32		
1.4	16QAM	3	0	21.9	21.79	22.22		
1.4	16QAM	3	1	22.02	21.99	22.23		
1.4	16QAM	3	3	22.17	21.94	22.32	22	2
1.4	16QAM	6	0	20.81	20.63	21.05		



<LTE Band 7>

BW [MHz]	Modulation	RB Size	RB Offset	Power Low Ch. / Freq.	Power Middle Ch. / Freq.	Power High Ch. / Freq.	Tune-up limit (dBm)	MPR (dB)
Channel				20850	21100	21350		
Frequency (MHz)				2510	2535	2560		
20	QPSK	1	0	23.26	23.54	23.42		
20	QPSK	1	49	23.07	23.09	22.92	24	0
20	QPSK	1	99	22.99	23.14	23.09		
20	QPSK	50	0	22.41	22.56	22.5		
20	QPSK	50	24	22.3	22.45	22.45	23	1
20	QPSK	50	50	22.27	22.41	22.53		
20	QPSK	100	0	22.33	22.53	22.5		
20	16QAM	1	0	22.2	21.99	22.04	23	1
20	16QAM	1	49	22.61	21.86	21.62		
20	16QAM	1	99	22.4	21.97	21.97		
20	16QAM	50	0	21.43	21.56	21.51	22	2
20	16QAM	50	24	21.33	21.54	21.53		
20	16QAM	50	50	21.32	21.58	21.61		
20	16QAM	100	0	21.28	21.5	21.43		
Channel				20825	21100	21375		
Frequency (MHz)				2507.5	2535	2562.5		
15	QPSK	1	0	23.23	23.39	23.35		
15	QPSK	1	37	23.4	23.48	23.35	24	0
15	QPSK	1	74	23.32	23.53	23.45		
15	QPSK	36	0	22.45	22.56	22.54		
15	QPSK	36	20	22.47	22.59	22.38	23	1
15	QPSK	36	39	22.37	22.61	22.44		
15	QPSK	75	0	22.42	22.59	22.44		
15	16QAM	1	0	21.89	22.25	21.96	23	1
15	16QAM	1	37	22.55	22.13	22		
15	16QAM	1	74	22.44	22.05	21.96		
15	16QAM	36	0	21.45	21.46	21.39	22	2
15	16QAM	36	20	21.47	21.51	21.38		
15	16QAM	36	39	21.39	21.56	21.54		
15	16QAM	75	0	21.43	21.51	21.52		



Channel				20800	21100	21400	Tune-up limit (dBm)	MPR (dB)
Frequency (MHz)				2505	2535	2565		
10	QPSK	1	0	23.16	23.19	23.12	24	0
10	QPSK	1	25	23.46	23.45	23.34		
10	QPSK	1	49	23.26	23.33	23.22		
10	QPSK	25	0	22.5	22.52	22.42	23	1
10	QPSK	25	12	22.49	22.58	22.58		
10	QPSK	25	25	22.44	22.5	22.48		
10	QPSK	50	0	22.45	22.6	22.49	23	1
10	16QAM	1	0	22.1	22.25	22.13		
10	16QAM	1	25	21.96	22.4	22.56		
10	16QAM	1	49	22.04	22.06	22.05	22	2
10	16QAM	25	0	21.45	21.64	21.39		
10	16QAM	25	12	21.52	21.78	21.54		
10	16QAM	25	25	21.44	21.54	21.36	22	2
10	16QAM	50	0	21.46	21.63	21.39		
Channel				20775	21100	21425	Tune-up limit (dBm)	MPR (dB)
Frequency (MHz)				2502.5	2535	2567.5		
5	QPSK	1	0	23.36	23.2	23.05	24	0
5	QPSK	1	12	23.5	23.53	23.43		
5	QPSK	1	24	23.32	23.17	23.25		
5	QPSK	12	0	22.4	22.6	22.46	23	1
5	QPSK	12	7	22.38	22.55	22.56		
5	QPSK	12	13	22.43	22.54	22.48		
5	QPSK	25	0	22.37	22.54	22.44	23	1
5	16QAM	1	0	21.82	21.87	21.73		
5	16QAM	1	12	22.06	22.16	22.65		
5	16QAM	1	24	22.35	21.96	22.19	22	2
5	16QAM	12	0	21.23	21.4	21.54		
5	16QAM	12	7	21.31	21.68	21.66		
5	16QAM	12	13	21.31	21.58	21.58	22	2
5	16QAM	25	0	21.43	21.39	21.66		

<WLAN Conducted Power>

General Note:

1. Per KDB 248227 D01v02r02, SAR test reduction is determined according to 802.11 transmission mode configurations and certain exposure conditions with multiple test positions. In the 2.4 GHz band, separate SAR procedures are applied to DSSS and OFDM configurations to simplify DSSS test requirements. For OFDM, in both 2.4 and 5 GHz bands, an initial test configuration must be determined for each standalone and aggregated frequency band, according to the transmission mode configuration with the highest maximum output power specified for production units to perform SAR measurements. If the same highest maximum output power applies to different combinations of channel bandwidths, modulations and data rates, additional procedures are applied to determine which test configurations require SAR measurement. When applicable, an initial test position may be applied to reduce the number of SAR measurements required for next to the ear, UMPC mini-tablet or hotspot mode configurations with multiple test positions.
2. For 2.4 GHz 802.11b DSSS, either the initial test position procedure for multiple exposure test positions or the DSSS procedure for fixed exposure position is applied; these are mutually exclusive. For 2.4 GHz and 5 GHz OFDM configurations, the initial test configuration is applied to measure SAR using either the initial test position procedure for multiple exposure test position configurations or the initial test configuration procedures for fixed exposure test conditions. Based on the reported SAR of the measured configurations and maximum output power of the transmission mode configurations that are not included in the initial test configuration, the subsequent test configuration and initial test position procedures are applied to determine if SAR measurements are required for the remaining OFDM transmission configurations. In general, the number of test channels that require SAR measurement is minimized based on maximum output power measured for the test sample(s).
3. For OFDM transmission configurations in the 2.4 GHz and 5 GHz bands, When the same maximum power is specified for multiple transmission modes in a frequency band, the largest channel bandwidth, lowest order modulation, lowest data rate and lowest order 802.11a/g/n/ac mode is used for SAR measurement, on the highest measured output power channel for each frequency band.
4. DSSS and OFDM configurations are considered separately according to the required SAR procedures. SAR is measured in the initial test position using the 802.11 transmission mode configuration required by the DSSS procedure or initial test configuration and subsequent test configuration(s) according to the OFDM procedures.18 The initial test position procedure is described in the following:
 - a. When the reported SAR of the initial test position is ≤ 0.4 W/kg, further SAR measurement is not required for the other test positions in that exposure configuration and 802.11 transmission mode combinations within the frequency band or aggregated band.
 - b. When the reported SAR of the test position is > 0.4 W/kg, SAR is repeated for the 802.11 transmission mode configuration tested in the initial test position to measure the subsequent next closet/smallest test separation distance and maximum coupling test position on the highest maximum output power channel, until the report SAR is ≤ 0.8 W/kg or all required test position are tested.
 - c. For all positions/configurations, when the reported SAR is > 0.8 W/kg, SAR is measured for these test positions/configurations on the subsequent next highest measured output power channel(s) until the reported SAR is ≤ 1.2 W/kg or all required channels are tested.

<2.4GHz WLAN>

	Mode	Channel	Frequency (MHz)	Average power (dBm)	Tune-Up Limit	Duty Cycle %
2.4GHz WLAN	802.11b 1Mbps	1	2412	15.03	15.50	97.59
		6	2437	14.16	15.50	
		11	2462	14.53	15.50	
	802.11g 6Mbps	1	2412	12.01	12.50	87.5
		6	2437	11.39	12.50	
		11	2462	11.71	12.50	
	802.11n-HT20 MCS0	1	2412	12.02	12.50	86.27
		6	2437	11.51	12.50	
		11	2462	11.80	12.50	



13. Bluetooth Exclusions Applied

Mode Band	Max Average power(dBm)	
	BR/EDR	LE
2.4GHz Bluetooth	11.0	1.5

Note:

Per KDB 447498 D01v06, the 1-g and 10-g SAR test exclusion thresholds for 100 MHz to 6 GHz at *test separation distances* ≤ 50 mm are determined by:

$[(max. power of channel, including tune-up tolerance, mW)/(min. test separation distance, mm)] \cdot [\sqrt{f(GHz)}] \leq 3.0$ for 1-g SAR and ≤ 7.5 for 10-g extremity SAR

- f(GHz) is the RF channel transmit frequency in GHz
- Power and distance are rounded to the nearest mW and mm before calculation
- The result is rounded to one decimal place for comparison

Bluetooth Max Power (dBm)	Separation Distance (mm)	Frequency (GHz)	Exclusion Thresholds
11.0	10	2.48	2.0

Note:

Per KDB 447498 D01v06, a distance of 10 mm is applied to determine SAR test exclusion. The test exclusion threshold is 2.0 which is ≤ 3, SAR testing is not required.

14. Antenna Location

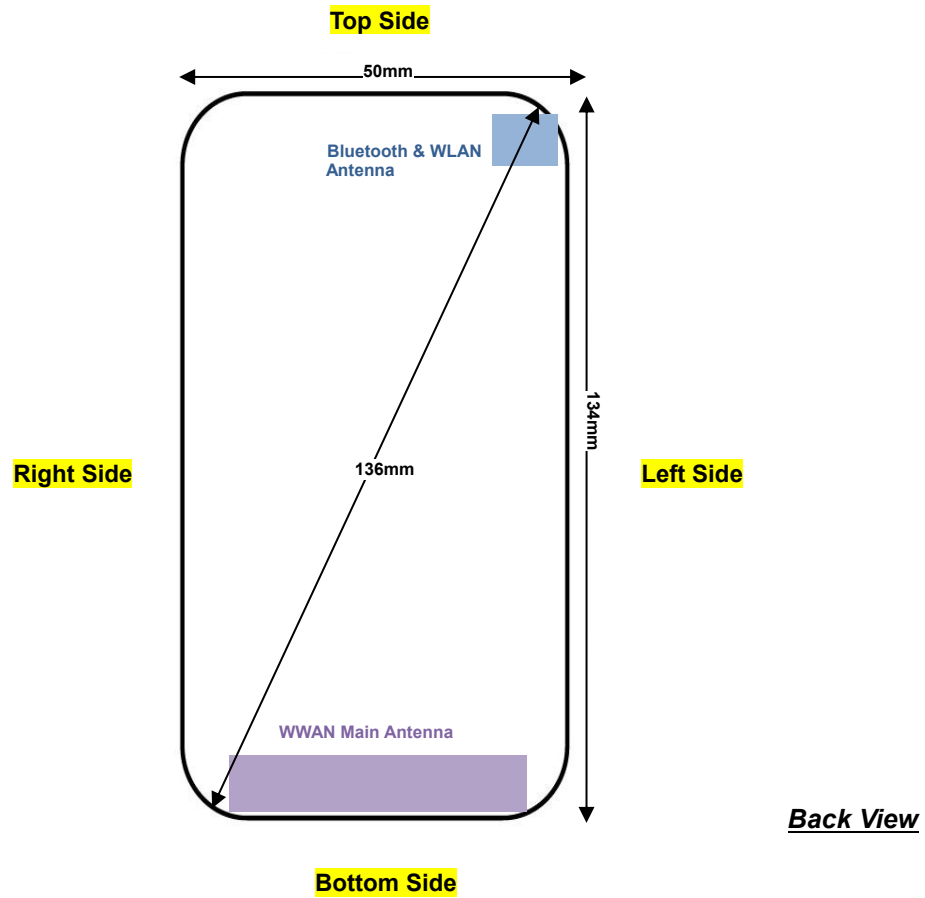

Distance of the Antenna to the EUT surface/edge						
Antennas	Back	Front	Top Side	Bottom Side	Right Side	Left Side
WWAN Main	≤ 25mm	≤ 25mm	>25mm	≤ 25mm	≤ 25mm	≤ 25mm
BT&WLAN	≤ 25mm	≤ 25mm	≤ 25mm	>25mm	>25mm	≤ 25mm

Positions for SAR tests; Hotspot mode						
Antennas	Back	Front	Top Side	Bottom Side	Right Side	Left Side
WWAN Main	Yes	Yes	No	Yes	Yes	Yes
BT&WLAN	Yes	Yes	Yes	No	No	Yes

General Note:

Referring to KDB 941225 D06 v02r01, when the overall device length and width are ≥ 9cm*5cm, the test distance is 10 mm. SAR must be measured for all sides and surfaces with a transmitting antenna located within 25mm from that surface or edge.



15. SAR Test Results

General Note:

1. Per KDB 447498 D01v06, the reported SAR is the measured SAR value adjusted for maximum tune-up tolerance.
 - a. Tune-up scaling Factor = tune-up limit power (mW) / EUT RF power (mW), where tune-up limit is the maximum rated power among all production units.
 - b. For SAR testing of WLAN signal with non-100% duty cycle, the measured SAR is scaled-up by the duty cycle scaling factor which is equal to "1/(duty cycle)"
 - c. For WWAN: Reported SAR(W/kg)= Measured SAR(W/kg)*Tune-up Scaling Factor
 - d. For WLAN: Reported SAR(W/kg)= Measured SAR(W/kg)* Duty Cycle scaling factor * Tune-up scaling factor
2. Per KDB 447498 D01v06, for each exposure position, testing of other required channels within the operating mode of a frequency band is not required when the *reported* 1-g or 10-g SAR for the mid-band or highest output power channel is:
 - ≤ 0.8 W/kg or 2.0 W/kg, for 1-g or 10-g respectively, when the transmission band is ≤ 100 MHz
 - ≤ 0.6 W/kg or 1.5 W/kg, for 1-g or 10-g respectively, when the transmission band is between 100 MHz and 200 MHz
 - ≤ 0.4 W/kg or 1.0 W/kg, for 1-g or 10-g respectively, when the transmission band is ≥ 200 MHz
3. Per KDB 865664 D01v01r04, for each frequency band, repeated SAR measurement is required only when the measured SAR is ≥ 0.8 W/kg.
4. Per KDB 648474 D04v01r03, when the reported SAR for a body-worn accessory measured without a headset connected to the handset is ≤ 1.2 W/kg, SAR testing with a headset connected to the handset is not required.

WCDMA Note:

1. Per KDB 941225 D01v03r01, for SAR testing is measured using a 12.2 kbps RMC with TPC bits configured to all "1's".
2. Per KDB 941225 D01v03r01, RMC 12.2kbps setting is used to evaluate SAR. The maximum output power and tune-up tolerance specified for production units in HSDPA / HSUPA / DC-HSDPA is $\leq 1/4$ dB higher than RMC 12.2Kbps or when the highest reported SAR of the RMC12.2Kbps is scaled by the ratio of specified maximum output power and tune-up tolerance of HSDPA / HSUPA / DC-HSDPA to RMC12.2Kbps and the adjusted SAR is ≤ 1.2 W/kg, SAR measurement is not required for HSDPA / HSUPA / DC-HSDPA, and according to the following RF output power, the output power results of the secondary modes (HSUPA, HSDPA, DC-HSDPA) are less than $1/4$ dB higher than the primary modes; therefore, SAR measurement is not required for HSDPA / HSUPA / DC-HSDPA.

LTE Note:

1. Per KDB 941225 D05v02r05, start with the largest channel bandwidth and measure SAR for QPSK with 1 RB allocation, using the RB offset and required test channel combination with the highest maximum output power for RB offsets at the upper edge, middle and lower edge of each required test channel.
2. Per KDB 941225 D05v02r05, 50% RB allocation for QPSK SAR testing follows 1RB QPSK allocation procedure.
3. Per KDB 941225 D05v02r05, For QPSK with 100% RB allocation, SAR is not required when the highest maximum output power for 100 % RB allocation is less than the highest maximum output power in 50% and 1 RB allocations and the highest reported SAR for 1 RB and 50% RB allocation are ≤ 0.8 W/kg. Otherwise, SAR is measured for the highest output power channel; and if the reported SAR is > 1.45 W/kg, the remaining required test channels must also be tested.
4. Per KDB 941225 D05v02r05, 16QAM output power for each RB allocation configuration is $>$ not $\frac{1}{2}$ dB higher than the same configuration in QPSK and the reported SAR for the QPSK configuration is ≤ 1.45 W/kg; Per KDB 941225 D05v02r05, 16QAM SAR testing is not required.
5. Per KDB 941225 D05v02r05, Smaller bandwidth output power for each RB allocation configuration is $>$ not $\frac{1}{2}$ dB higher than the same configuration in the largest supported bandwidth, and the reported SAR for the largest supported bandwidth is ≤ 1.45 W/kg; Per KDB 941225 D05v02r05, smaller bandwidth SAR testing is not required.
6. For LTE B5 the maximum bandwidth does not support three non-overlapping channels, per KDB 941225 D05v02r05, when a device supports overlapping channel assignment in a channel bandwidth configuration, the middle channel of the group of overlapping channels should be selected for testing.

WLAN Note:

1. Per KDB 248227 D01v02r02, for 2.4GHz 802.11g/n SAR testing is not required when the highest reported SAR for DSSS is adjusted by the ratio of OFDM to DSSS specified maximum output power and the adjusted SAR is ≤ 1.2 W/kg.
2. When the reported SAR of the test position is > 0.4 W/kg, SAR is repeated for the 802.11 transmission mode configuration tested in the initial test position to measure the subsequent next closet/smallest test separation distance and maximum coupling test position on the highest maximum output power channel, until the report SAR is ≤ 0.8 W/kg or all required test position are tested.
3. For all positions / configurations, when the reported SAR is > 0.8 W/kg, SAR is measured for these test positions / configurations on the subsequent next highest measured output power channel(s) until the reported SAR is ≤ 1.2 W/kg or all required channels are tested.



15.1 Head SAR

<WCDMA SAR>

Plot No.	Band	Mode	Test Position	Ch.	Freq. (MHz)	Average Power (dBm)	Tune-Up Limit (dBm)	Tune-up Scaling Factor	Power Drift (dB)	Measured 1g SAR (W/kg)	Reported 1g SAR (W/kg)
	WCDMA Band V	RMC 12.2Kbps	Right Cheek	4182	836.4	23.56	24.5	1.242	0.07	0.841	1.044
	WCDMA Band V	RMC 12.2Kbps	Right Cheek	4132	826.4	23.47	24.5	1.268	-0.07	0.838	1.062
01	WCDMA Band V	RMC 12.2Kbps	Right Cheek	4233	846.6	23.52	24.5	1.253	-0.11	0.929	1.164
	WCDMA Band V	RMC 12.2Kbps	Right Tilted	4182	836.4	23.56	24.5	1.242	-0.03	0.649	0.806
	WCDMA Band V	RMC 12.2Kbps	Right Tilted	4132	826.4	23.47	24.5	1.268	0.01	0.628	0.796
	WCDMA Band V	RMC 12.2Kbps	Right Tilted	4233	846.6	23.52	24.5	1.253	0.06	0.649	0.813
	WCDMA Band V	RMC 12.2Kbps	Left Cheek	4182	836.4	23.56	24.5	1.242	0.05	0.892	1.108
	WCDMA Band V	RMC 12.2Kbps	Left Cheek	4132	826.4	23.47	24.5	1.268	0.02	0.844	1.070
	WCDMA Band V	RMC 12.2Kbps	Left Cheek	4233	846.6	23.52	24.5	1.253	0.07	0.927	1.162
	WCDMA Band V	RMC 12.2Kbps	Left Tilted	4182	836.4	23.56	24.5	1.242	0.1	0.538	0.668

<FDD LTE SAR>

Plot No.	Band	BW (MHz)	Modulation	RB Size	RB Offset	Test Position	Ch.	Freq. (MHz)	Average Power (dBm)	Tune-Up Limit (dBm)	Tune-up Scaling Factor	Power Drift (dB)	Measured 1g SAR (W/kg)	Reported 1g SAR (W/kg)
	LTE Band 5	10M	QPSK	1RB	0Offset	Right Cheek	20525	836.5	22.97	24	1.268	0.12	0.776	0.984
	LTE Band 5	10M	QPSK	25RB	0Offset	Right Cheek	20525	836.5	21.89	23	1.291	-0.02	0.659	0.851
	LTE Band 5	10M	QPSK	50RB	0Offset	Right Cheek	20525	836.5	21.86	23	1.300	-0.11	0.654	0.85
	LTE Band 5	10M	QPSK	1RB	0Offset	Right Tilted	20525	836.5	22.97	24	1.268	-0.17	0.488	0.619
	LTE Band 5	10M	QPSK	25RB	0Offset	Right Tilted	20525	836.5	21.89	23	1.291	-0.06	0.401	0.518
02	LTE Band 5	10M	QPSK	1RB	0Offset	Left Cheek	20525	836.5	22.97	24	1.268	0.07	0.821	1.041
	LTE Band 5	10M	QPSK	25RB	0Offset	Left Cheek	20525	836.5	21.89	23	1.291	-0.08	0.684	0.883
	LTE Band 5	10M	QPSK	50RB	0Offset	Left Cheek	20525	836.5	21.86	23	1.300	0.01	0.694	0.902
	LTE Band 5	10M	QPSK	1RB	0Offset	Left Tilted	20525	836.5	22.97	24	1.268	-0.03	0.49	0.621
	LTE Band 5	10M	QPSK	25RB	0Offset	Left Tilted	20525	836.5	21.89	23	1.291	-0.09	0.403	0.52
	LTE Band 7	20M	QPSK	1RB	0Offset	Right Cheek	21100	2535	23.54	24	1.112	0.04	0.639	0.71
	LTE Band 7	10M	QPSK	50RB	0Offset	Right Cheek	21100	2535	22.56	23	1.107	0.07	0.597	0.661
	LTE Band 7	20M	QPSK	1RB	0Offset	Right Tilted	21100	2535	23.54	24	1.112	0.12	0.216	0.240
	LTE Band 7	10M	QPSK	50RB	0Offset	Right Tilted	21100	2535	22.56	23	1.107	0.1	0.179	0.198
03	LTE Band 7	20M	QPSK	1RB	0Offset	Left Cheek	21100	2535	23.54	24	1.112	0.01	0.756	0.840
	LTE Band 7	10M	QPSK	1RB	0Offset	Left Cheek	20850	2510	23.26	24	1.186	-0.04	0.698	0.828
	LTE Band 7	20M	QPSK	1RB	0Offset	Left Cheek	21350	2560	23.42	24	1.143	0.12	0.727	0.831
	LTE Band 7	10M	QPSK	50RB	0Offset	Left Cheek	21100	2535	22.56	23	1.107	0.09	0.602	0.666
	LTE Band 7	20M	QPSK	100RB	0Offset	Left Cheek	21100	2535	22.53	23	1.114	0.12	0.598	0.666
	LTE Band 7	20M	QPSK	1RB	0Offset	Left Tilted	21100	2535	23.54	24	1.112	0.17	0.192	0.213
	LTE Band 7	10M	QPSK	50RB	0Offset	Left Tilted	21100	2535	22.56	23	1.107	0.17	0.154	0.170

<WLAN SAR>

Plot No.	Band	Mode	Test Position	Ch.	Freq. (MHz)	Average Power (dBm)	Tune-Up Limit (dBm)	Tune-up Scaling Factor	Duty Cycle %	Duty Cycle Scaling Factor	Max Area Scan SAR	Power Drift (dB)	Measured 1g SAR (W/kg)	Reported 1g SAR (W/kg)
04	WLAN2.4GHz	802.11b 1Mbps	Right Cheek	1	2412	15.03	15.5	1.114	97.59	1.025	0.146	0.07	0.030	0.034
	WLAN2.4GHz	802.11b 1Mbps	Right Tilted	1	2412	15.03	15.5	1.114	97.59	1.025	0.054			
	WLAN2.4GHz	802.11b 1Mbps	Left Cheek	1	2412	15.03	15.5	1.114	97.59	1.025	0.035			
	WLAN2.4GHz	802.11b 1Mbps	Left Tilted	1	2412	15.03	15.5	1.114	97.59	1.025	0.048			



15.2 Hotspot SAR

<WCDMA SAR>

Plot No.	Band	Mode	Test Position	Gap (mm)	Ch.	Freq. (MHz)	Average Power (dBm)	Tune-Up Limit (dBm)	Tune-up Scaling Factor	Power Drift (dB)	Measured 1g SAR (W/kg)	Reported 1g SAR (W/kg)
	WCDMA Band V	RMC 12.2Kbps	Front	10	4182	836.4	23.56	24.5	1.242	-0.02	0.775	0.962
	WCDMA Band V	RMC 12.2Kbps	Front	10	4132	826.4	23.47	24.5	1.268	0.05	0.797	1.010
	WCDMA Band V	RMC 12.2Kbps	Front	10	4233	846.6	23.52	24.5	1.253	0.12	0.786	0.985
	WCDMA Band V	RMC 12.2Kbps	Back	10	4182	836.4	23.56	24.5	1.242	0.01	0.866	1.075
	WCDMA Band V	RMC 12.2Kbps	Back	10	4132	826.4	23.47	24.5	1.268	0.08	0.844	1.070
05	WCDMA Band V	RMC 12.2Kbps	Back	10	4233	846.6	23.52	24.5	1.253	0.02	0.874	1.095
	WCDMA Band V	RMC 12.2Kbps	Left Side	10	4182	836.4	23.56	24.5	1.242	0.08	0.298	0.370
	WCDMA Band V	RMC 12.2Kbps	Right Side	10	4182	836.4	23.56	24.5	1.242	0.08	0.239	0.297
	WCDMA Band V	RMC 12.2Kbps	Bottom Side	10	4182	836.4	23.56	24.5	1.242	0.11	0.0688	0.085



<FDD LTE SAR>

Plot No.	Band	BW (MHz)	Modulation	RB Size	RB Offset	Test Position	Gap (mm)	Ch.	Freq. (MHz)	Average Power (dBm)	Tune-Up Limit (dBm)	Tune-up Scaling Factor	Power Drift (dB)	Measured 1g SAR (W/kg)	Reported 1g SAR (W/kg)
	LTE Band 5	10M	QPSK	1RB	0Offset	Front	10	20525	836.5	22.97	24	1.268	0.12	0.799	1.013
	LTE Band 5	10M	QPSK	25RB	0Offset	Front	10	20525	836.5	21.89	23	1.291	-0.04	0.651	0.841
	LTE Band 5	10M	QPSK	50RB	0Offset	Front	10	20525	836.5	21.86	23	1.300	-0.07	0.647	0.841
	LTE Band 5	10M	QPSK	1RB	0Offset	Back	10	20525	836.5	22.97	24	1.268	-0.09	0.87	1.103
	LTE Band 5	10M	QPSK	25RB	0Offset	Back	10	20525	836.5	21.89	23	1.291	0.02	0.696	0.899
	LTE Band 5	10M	QPSK	50RB	0Offset	Back	10	20525	836.5	21.86	23	1.300	-0.04	0.684	0.889
06	LTE Band 5	10M	QPSK	1RB	0Offset	Left Side	10	20525	836.5	22.97	24	1.268	-0.07	0.878	1.113
	LTE Band 5	10M	QPSK	25RB	0Offset	Left Side	10	20525	836.5	21.89	23	1.291	-0.06	0.726	0.937
	LTE Band 5	10M	QPSK	50RB	0Offset	Left Side	10	20525	836.5	21.86	23	1.300	0.16	0.621	0.807
	LTE Band 5	10M	QPSK	1RB	0Offset	Right Side	10	20525	836.5	22.97	24	1.268	0.19	0.742	0.941
	LTE Band 5	10M	QPSK	25RB	0Offset	Right Side	10	20525	836.5	21.89	23	1.291	0.08	0.573	0.74
	LTE Band 5	10M	QPSK	50RB	0Offset	Right Side	10	20525	836.5	21.86	23	1.300	0.08	0.527	0.685
	LTE Band 5	10M	QPSK	1RB	0Offset	Bottom Side	10	20525	836.5	22.97	24	1.268	-0.03	0.0687	0.087
	LTE Band 5	10M	QPSK	25RB	0Offset	Bottom Side	10	20525	836.5	21.89	23	1.291	-0.06	0.067	0.087
	LTE Band 7	20M	QPSK	1RB	0Offset	Front	10	21100	2535	23.54	24	1.112	-0.1	0.518	0.576
	LTE Band 7	20M	QPSK	50RB	0Offset	Front	10	21100	2535	22.56	23	1.107	0.03	0.439	0.486
	LTE Band 7	20M	QPSK	1RB	0Offset	Back	10	21100	2535	23.54	24	1.112	0.01	0.885	0.984
	LTE Band 7	20M	QPSK	1RB	0Offset	Back	10	20850	2510	23.26	24	1.186	-0.08	0.753	0.893
	LTE Band 7	20M	QPSK	1RB	0Offset	Back	10	21350	2560	23.42	24	1.143	0.08	0.98	1.120
	LTE Band 7	20M	QPSK	50RB	0Offset	Back	10	21100	2535	22.56	23	1.107	0.08	0.702	0.777
	LTE Band 7	20M	QPSK	100RB	0Offset	Back	10	21100	2535	22.53	23	1.114	0.01	0.735	0.819
	LTE Band 7	20M	QPSK	1RB	0Offset	Left Side	10	21100	2535	23.54	24	1.112	0.01	0.288	0.320
	LTE Band 7	20M	QPSK	50RB	0Offset	Left Side	10	21100	2535	22.56	23	1.107	0.04	0.236	0.261
	LTE Band 7	20M	QPSK	1RB	0Offset	Right Side	10	21100	2535	23.54	24	1.112	0.03	0.288	0.320
	LTE Band 7	20M	QPSK	50RB	0Offset	Right Side	10	21100	2535	22.56	23	1.107	-0.06	0.237	0.262
	LTE Band 7	20M	QPSK	1RB	0Offset	Bottom Side	10	21100	2535	23.54	24	1.112	0.16	0.926	1.029
	LTE Band 7	20M	QPSK	1RB	0Offset	Bottom Side	10	20850	2510	23.26	24	1.186	0.12	0.825	0.978
07	LTE Band 7	20M	QPSK	1RB	0Offset	Bottom Side	10	21350	2560	23.42	24	1.143	-0.11	1.03	1.177
	LTE Band 7	20M	QPSK	50RB	0Offset	Bottom Side	10	21100	2535	22.56	23	1.107	0.09	0.737	0.816
	LTE Band 7	20M	QPSK	50RB	0Offset	Bottom Side	10	20850	2510	22.41	23	1.146	0.12	0.635	0.727
	LTE Band 7	20M	QPSK	50RB	0Offset	Bottom Side	10	21350	2560	22.5	23	1.122	0.16	0.842	0.945
	LTE Band 7	20M	QPSK	100RB	0Offset	Bottom Side	10	21100	2535	22.53	23	1.114	0.02	0.734	0.818

<WLAN SAR>

Plot No.	Band	Mode	Test Position	Gap (mm)	Ch.	Freq. (MHz)	Average Power (dBm)	Tune-Up Limit (dBm)	Tune-up Scaling Factor	Duty Cycle %	Duty Cycle Scaling Factor	Max Area Scan SAR	Power Drift (dB)	Measured 1g SAR (W/kg)	Reported 1g SAR (W/kg)
	WLAN2.4GHz	802.11b 1Mbps	Front	10	1	2412	15.03	15.5	1.114	97.59	1.025	0.020			
08	WLAN2.4GHz	802.11b 1Mbps	Back	10	1	2412	15.03	15.5	1.114	97.59	1.025	0.075	-0.01	0.046	0.053
	WLAN2.4GHz	802.11b 1Mbps	Left Side	10	1	2412	15.03	15.5	1.114	97.59	1.025	0.072			
	WLAN2.4GHz	802.11b 1Mbps	Top Side	10	1	2412	15.03	15.5	1.114	97.59	1.025	0.033			



15.3 Body Worn Accessory SAR

<WCDMA SAR>

Plot No.	Band	Mode	Test Position	Gap (mm)	Ch.	Freq. (MHz)	Average Power (dBm)	Tune-Up Limit (dBm)	Tune-up Scaling Factor	Power Drift (dB)	Measured 1g SAR (W/kg)	Reported 1g SAR (W/kg)
	WCDMA Band V	RMC 12.2Kbps	Front	10	4182	836.4	23.56	24.5	1.242	-0.02	0.775	0.962
	WCDMA Band V	RMC 12.2Kbps	Front	10	4132	826.4	23.47	24.5	1.268	0.05	0.797	1.010
	WCDMA Band V	RMC 12.2Kbps	Front	10	4233	846.6	23.52	24.5	1.253	0.12	0.786	0.985
	WCDMA Band V	RMC 12.2Kbps	Back	10	4182	836.4	23.56	24.5	1.242	0.01	0.866	1.075
	WCDMA Band V	RMC 12.2Kbps	Back	10	4132	826.4	23.47	24.5	1.268	0.08	0.844	1.070
09	WCDMA Band V	RMC 12.2Kbps	Back	10	4233	846.6	23.52	24.5	1.253	0.02	0.874	1.095

<FDD LTE SAR>

Plot No.	Band	BW (MHz)	Modulation	RB Size	RB Offset	Test Position	Gap (mm)	Ch.	Freq. (MHz)	Average Power (dBm)	Tune-Up Limit (dBm)	Tune-up Scaling Factor	Power Drift (dB)	Measured 1g SAR (W/kg)	Reported 1g SAR (W/kg)
	LTE Band 5	10M	QPSK	1RB	0Offset	Front	10	20525	836.5	22.97	24	1.268	0.12	0.799	1.013
	LTE Band 5	10M	QPSK	25RB	0Offset	Front	10	20525	836.5	21.89	23	1.291	-0.04	0.651	0.841
	LTE Band 5	10M	QPSK	50RB	0Offset	Front	10	20525	836.5	21.86	23	1.300	-0.07	0.647	0.841
10	LTE Band 5	10M	QPSK	1RB	0Offset	Back	10	20525	836.5	22.97	24	1.268	-0.09	0.870	1.103
	LTE Band 5	10M	QPSK	25RB	0Offset	Back	10	20525	836.5	21.89	23	1.291	0.02	0.696	0.899
	LTE Band 5	10M	QPSK	50RB	0Offset	Back	10	20525	836.5	21.86	23	1.300	-0.04	0.684	0.889
	LTE Band 7	20M	QPSK	1RB	0Offset	Front	10	21100	2535	23.54	24	1.112	-0.1	0.518	0.576
	LTE Band 7	20M	QPSK	50RB	0Offset	Front	10	21100	2535	22.56	23	1.107	0.03	0.439	0.486
	LTE Band 7	20M	QPSK	1RB	0Offset	Back	10	21100	2535	23.54	24	1.112	0.01	0.885	0.984
	LTE Band 7	20M	QPSK	1RB	0Offset	Back	10	20850	2510	23.26	24	1.186	-0.08	0.753	0.893
11	LTE Band 7	20M	QPSK	1RB	0Offset	Back	10	21350	2560	23.42	24	1.143	0.08	0.980	1.120
	LTE Band 7	20M	QPSK	50RB	0Offset	Back	10	21100	2535	22.56	23	1.107	0.08	0.702	0.777
	LTE Band 7	20M	QPSK	100RB	0Offset	Back	10	21100	2535	22.53	23	1.114	0.01	0.735	0.819

<WLAN SAR>

Plot No.	Band	Mode	Test Position	Gap (mm)	Ch.	Freq. (MHz)	Average Power (dBm)	Tune-Up Limit (dBm)	Tune-up Scaling Factor	Duty Cycle %	Duty Cycle Scaling Factor	Max Area Scan SAR	Power Drift (dB)	Measured 1g SAR (W/kg)	Reported 1g SAR (W/kg)
	WLAN2.4GHz	802.11b 1Mbps	Front	10	1	2412	15.03	15.5	1.114	97.59	1.025	0.020			
12	WLAN2.4GHz	802.11b 1Mbps	Back	10	1	2412	15.03	15.5	1.114	97.59	1.025	0.075	-0.01	0.046	0.053

15.4 Repeated SAR Measurement

No.	Band	BW (MHz)	Modulation	RB Size	RB offset	Mode	Test Position	Gap (cm)	Ch.	Freq. (MHz)	Average Power (dBm)	Tune-Up Limit (dBm)	Tune-up Scaling Factor	Power Drift (dB)	Measured 1g SAR (W/kg)	Ratio	Reported 1g SAR (W/kg)
1st	WCDMA Band V	-	-	-	-	RMC 12.2Kbps	Right Cheek	-	4233	846.6	23.52	24.5	1.253	-0.11	0.929	1	1.164
2nd	WCDMA Band V	-	-	-	-	RMC 12.2Kbps	Right Cheek	-	4233	846.6	23.52	24.5	1.253	0.05	0.915	1.015	1.147
1st	LTE Band 7	20M	QPSK	1RB	0Offset	-	Bottom Side	10	21350	2560	23.42	24	1.143	-0.11	1.030	1	1.177
2nd	LTE Band 7	20M	QPSK	1RB	0Offset	-	Bottom Side	10	21350	2560	23.42	24	1.143	-0.03	1.010	1.020	1.154

General Note:

1. Per KDB 865664 D01v01r04, for each frequency band, repeated SAR measurement is required only when the measured SAR is $\geq 0.8W/kg$.
2. Per KDB 865664 D01v01r04, if the ratio among the repeated measurement is ≤ 1.2 and the measured SAR $< 1.45W/kg$, only one repeated measurement is required.
3. The ratio is the difference in percentage between original and repeated *measured SAR*.
4. All measurement SAR result is scaled-up to account for tune-up tolerance and is compliant.

16. Simultaneous Transmission Analysis

No.	Simultaneous Transmission Configurations	Mobile phone			Note
		Head	Body-worn	Hotspot	
1.	WCDMA + WLAN2.4GHz	Yes	Yes	Yes	WWAN VoIP
2.	LTE + WLAN2.4GHz	Yes	Yes	Yes	WWAN VoIP
3.	WCDMA+ Bluetooth		Yes	Yes	WWAN VoIP
4.	LTE + Bluetooth		Yes	Yes	WWAN VoIP

General Note:

- This device supported VoIP in GPRS, EGPRS, WCDMA, LTE (e.g. 3rd party VoIP), and LTE supports VoLTE operation.
- EUT will choose each GSM, WCDMA and LTE according to the network signal condition; therefore, they will not operate simultaneously at any moment.
- This device 2.4GHz WLAN support hotspot operation and Bluetooth support tethering applications.
- WLAN and Bluetooth share the same antenna, and cannot transmit simultaneously.
- Chose the worse zoom scan SAR of WLAN2.4GHz SAR respectively for co-located with WWAN analysis.
- All licensed modes share the same antenna part and cannot transmit simultaneously.
- The reported SAR summation is calculated based on the same configuration and test position.
- Per KDB 447498 D01v06, simultaneous transmission SAR is compliant if,
 - Scalar SAR summation < 1.6W/kg.
 - $SPLSR = (SAR1 + SAR2)^{1.5} / (\text{min. separation distance, mm})$, and the peak separation distance is determined from the square root of $[(x1-x2)^2 + (y1-y2)^2 + (z1-z2)^2]$, where (x1, y1, z1) and (x2, y2, z2) are the coordinates of the extrapolated peak SAR locations in the zoom scan.
 - If $SPLSR \leq 0.04$, simultaneously transmission SAR measurement is not necessary.
 - Simultaneously transmission SAR measurement, and the reported multi-band SAR < 1.6W/kg.
- For simultaneous transmission analysis, Bluetooth SAR is estimated per KDB 447498 D01v06 based on the formula below.
 - $(\text{max. power of channel, including tune-up tolerance, mW}) / (\text{min. test separation distance, mm}) \cdot [\sqrt{f(\text{GHz})} / x]$ W/kg for test separation distances ≤ 50 mm; where $x = 7.5$ for 1-g SAR, and $x = 18.75$ for 10-g SAR.
 - When the minimum separation distance is < 5mm, the distance is used 5mm to determine SAR test exclusion.
 - 0.4 W/kg for 1-g SAR and 1.0 W/kg for 10-g SAR, when the test separation distances is > 50 mm.

Bluetooth Max Power (dBm)	Exposure Position	Hotspot & Body worn
	Test separation	10 mm
11.0	Estimated 1g SAR (W/kg)	0.273



16.1 Head Exposure Conditions

WWAN Band		Exposure Position	1	2	1+2 Summed 1g SAR (W/kg)
			WWAN 1g SAR (W/kg)	2.4GHz WLAN 1g SAR (W/kg)	
WCDMA	Band V	Right Cheek	1.164	0.034	1.20
		Right Tilted	0.806	0.034	0.84
		Left Cheek	1.162	0.034	1.20
		Left Tilted	0.668	0.034	0.70
LTE	Band 5	Right Cheek	0.984	0.034	1.02
		Right Tilted	0.619	0.034	0.65
		Left Cheek	1.041	0.034	1.08
		Left Tilted	0.621	0.034	0.66
	Band 7	Right Cheek	0.710	0.034	0.74
		Right Tilted	0.240	0.034	0.27
		Left Cheek	0.840	0.034	0.87
		Left Tilted	0.213	0.034	0.25

16.2 Hotspot Exposure Conditions

WWAN Band		Exposure Position	1	2	3	1+2 Summed 1g SAR (W/kg)	1+3 Summed 1g SAR (W/kg)
			WWAN 1g SAR (W/kg)	2.4GHz WLAN 1g SAR (W/kg)	Bluetooth Estimated 1g SAR (W/kg)		
WCDMA	Band V	Front	1.010	0.053	0.273	1.06	1.28
		Back	1.095	0.053	0.273	1.15	1.37
		Left side	0.370	0.053	0.273	0.42	0.64
		Right side	0.297			0.30	0.30
		Top side		0.053	0.273	0.05	0.27
		Bottom side	0.085			0.09	0.09
LTE	Band 5	Front	1.013	0.053	0.273	1.07	1.29
		Back	1.103	0.053	0.273	1.16	1.38
		Left side	1.113	0.053	0.273	1.17	1.39
		Right side	0.941			0.94	0.94
		Top side		0.053	0.273	0.05	0.27
		Bottom side	0.087			0.09	0.09
	Band 7	Front	0.576	0.053	0.273	0.63	0.85
		Back	1.120	0.053	0.273	1.17	1.39
		Left side	0.320	0.053	0.273	0.37	0.59
		Right side	0.320			0.32	0.32
		Top side		0.053	0.273	0.05	0.27
		Bottom side	1.177			1.18	1.18



16.3 Body-Worn Accessory Exposure Conditions

WWAN Band		Exposure Position	1	2	3	1+2 Summed 1g SAR (W/kg)	1+3 Summed 1g SAR (W/kg)
			WWAN	2.4GHz WLAN	Bluetooth		
			1g SAR (W/kg)	1g SAR (W/kg)	Estimated 1g SAR (W/kg)		
WCDMA	Band V	Front	1.010	0.053	0.273	1.06	1.28
		Back	1.095	0.053	0.273	1.15	1.37
LTE	Band 5	Front	1.013	0.053	0.273	1.07	1.29
		Back	1.103	0.053	0.273	1.16	1.38
	Band 7	Front	0.576	0.053	0.273	0.63	0.85
		Back	1.120	0.053	0.273	1.17	1.39

Test Engineer : Nick Hu



17. Uncertainty Assessment

Pre KDB 865664 D01 SAR measurement 100MHz to 6GHz, when the highest measured 1-g SAR within a frequency band is < 1.5 W/kg. The expanded SAR measurement uncertainty must be $\leq 30\%$, for a confidence interval of $k = 2$. If these conditions are met, extensive SAR measurement uncertainty analysis described in IEEE Std 1528-2013 is not required in SAR reports submitted for equipment approval. For this device, the highest measured 1-g SAR is less 1.5W/kg. Therefore, the measurement uncertainty table is not required in this report.



18. References

- [1] FCC 47 CFR Part 2 "Frequency Allocations and Radio Treaty Matters; General Rules and Regulations"
- [2] ANSI/IEEE Std. C95.1-1992, "IEEE Standard for Safety Levels with Respect to Human Exposure to Radio Frequency Electromagnetic Fields, 3 kHz to 300 GHz", September 1992
- [3] IEEE Std. 1528-2013, "IEEE Recommended Practice for Determining the Peak Spatial-Average Specific Absorption Rate (SAR) in the Human Head from Wireless Communications Devices: Measurement Techniques", Sep 2013
- [4] SPEAG DASY System Handbook
- [5] FCC KDB 248227 D01 v02r02, "SAR Guidance for IEEE 802.11 (WiFi) Transmitters", Oct 2015.
- [6] FCC KDB 447498 D01 v06, "Mobile and Portable Device RF Exposure Procedures and Equipment Authorization Policies", Oct 2015
- [7] FCC KDB 648474 D04 v01r03, "SAR Evaluation Considerations for Wireless Handsets", Oct 2015.
- [8] FCC KDB 941225 D01 v03r01, "3G SAR MEAUREMENT PROCEDURES", Oct 2015
- [9] FCC KDB 941225 D05 v02r05, "SAR Evaluation Considerations for LTE Devices", Dec 2015
- [10] FCC KDB 941225 D06 v02r01, "SAR Evaluation Procedures for Portable Devices with Wireless Router Capabilities", Oct 2015.
- [11] FCC KDB 865664 D01 v01r04, "SAR Measurement Requirements for 100 MHz to 6 GHz", Aug 2015.
- [12] FCC KDB 865664 D02 v01r02, "RF Exposure Compliance Reporting and Documentation Considerations" Oct 2015.



Appendix A. Plots of System Performance Check

The plots are shown as follows.

System Check_Head_835MHz

DUT: D835V2 - SN:4d091

Communication System: UID 0, CW (0); Frequency: 835 MHz; Duty Cycle: 1:1

Medium: HSL_835 Medium parameters used: $f = 835 \text{ MHz}$; $\sigma = 0.918 \text{ S/m}$; $\epsilon_r = 42.094$; $\rho = 1000 \text{ kg/m}^3$

Ambient Temperature : $23.2 \text{ }^\circ\text{C}$; Liquid Temperature : $22.9 \text{ }^\circ\text{C}$

DASY5 Configuration:

- Probe: ES3DV3 - SN3293; ConvF(6.3, 6.3, 6.3); Calibrated: 2017.9.25;
- Sensor-Surface: 2mm (Mechanical Surface Detection)
- Electronics: DAE4 Sn915; Calibrated: 2017.6.16
- Phantom: SAM1; Type: SAM; Serial: TP-1697
- Measurement SW: DASY52, Version 52.8 (8); SEMCAD X Version 14.6.10 (7372)

Pin=250mW/Area Scan (61x61x1): Interpolated grid: $dx=1.500 \text{ mm}$, $dy=1.500 \text{ mm}$

Maximum value of SAR (interpolated) = 2.26 W/kg

Pin=250mW/Zoom Scan (5x5x7)/Cube 0: Measurement grid: $dx=8\text{mm}$, $dy=8\text{mm}$, $dz=5\text{mm}$

Reference Value = 47.02 V/m ; Power Drift = -0.01 dB

Peak SAR (extrapolated) = 2.48 W/kg

SAR(1 g) = 2.42 W/kg ; SAR(10 g) = 1.64 W/kg

Maximum value of SAR (measured) = 2.26 W/kg

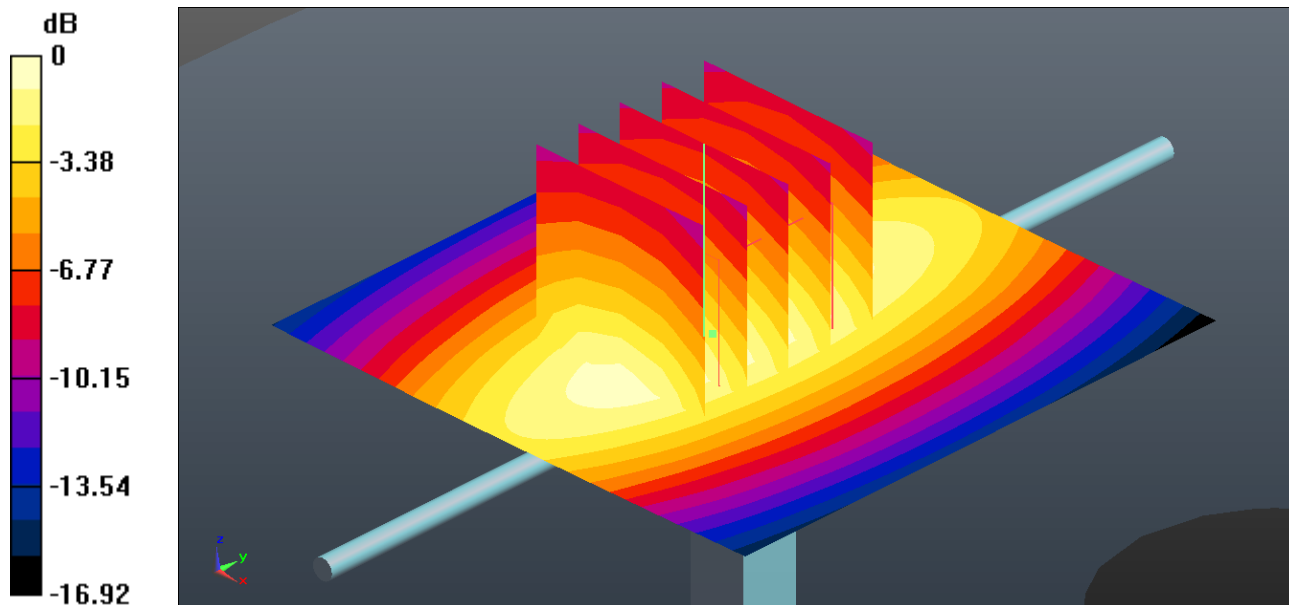

0 dB = $2.26 \text{ W/kg} = 3.54 \text{ dBW/kg}$

System Check_Head_2450MHz

DUT: D2450V2 - SN:840

Communication System: UID 0, CW (0); Frequency: 2450 MHz; Duty Cycle: 1:1

Medium: HSL_2450 Medium parameters used: $f = 2450$ MHz; $\sigma = 1.867$ S/m; $\epsilon_r = 39.3$; $\rho = 1000$ kg/m³

Ambient Temperature : 23.5 °C ; Liquid Temperature : 22.6 °C

DASY5 Configuration:

- Probe: EX3DV4 - SN3753; ConvF(7.28, 7.28, 7.28); Calibrated: 2017.5.5;
- Sensor-Surface: 2mm (Mechanical Surface Detection)
- Electronics: DAE4 Sn1338; Calibrated: 2017.12.4
- Phantom: SAM1; Type: SAM; Serial: TP-1488
- Measurement SW: DASY52, Version 52.8 (8); SEMCAD X Version 14.6.10 (7372)

Pin=250mW/Area Scan (71x71x1): Interpolated grid: dx=1.200 mm, dy=1.200 mm

Maximum value of SAR (interpolated) = 27.4 W/kg

Pin=250mW/Zoom Scan (7x7x7)/Cube 0: Measurement grid: dx=5mm, dy=5mm, dz=5mm

Reference Value = 102.5 V/m; Power Drift = -0.16 dB

Peak SAR (extrapolated) = 35.2 W/kg

SAR(1 g) = 13.1 W/kg; SAR(10 g) = 6.29 W/kg

Maximum value of SAR (measured) = 26.6 W/kg

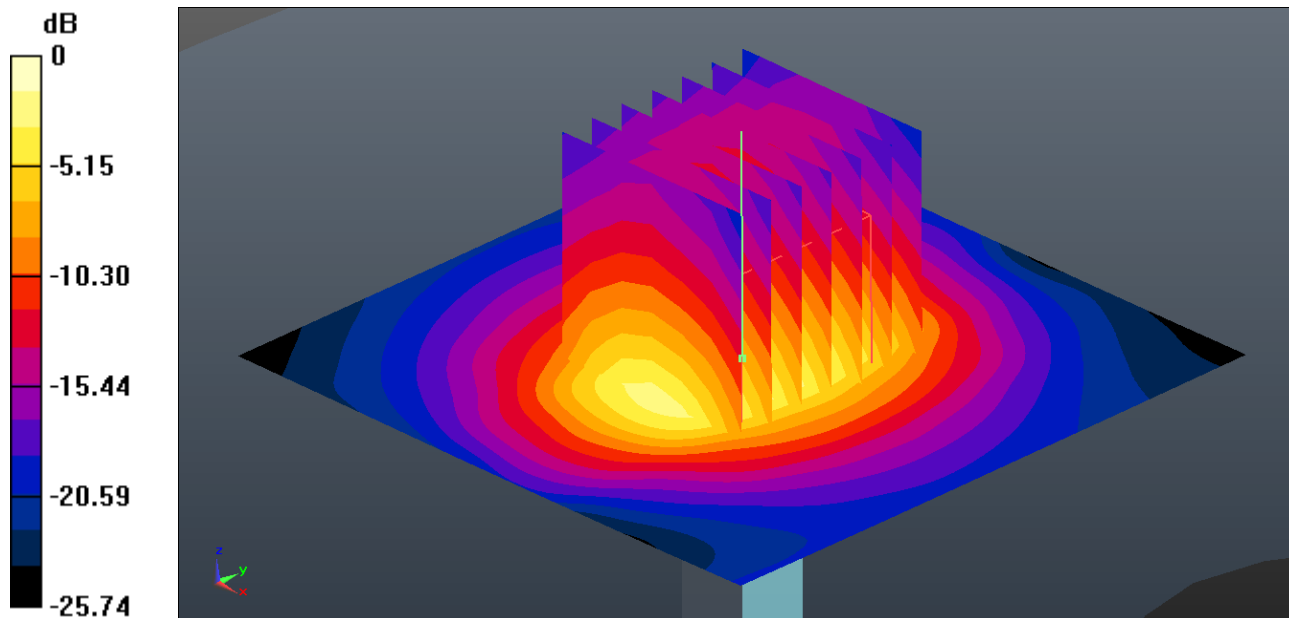

0 dB = 27.4 W/kg = 14.38 dBW/kg

System Check_Head_2600MHz

DUT: D2600V2 - SN:1061

Communication System: UID 0, CW; Frequency: 2600 MHz; Duty Cycle: 1:1

Medium: HSL_2600 Medium parameters used: $f = 2600$ MHz; $\sigma = 2.049$ S/m; $\epsilon_r = 37.83$; $\rho = 1000$ kg/m³

Ambient Temperature : 23.5 °C ; Liquid Temperature : 22.6 °C

DASY5 Configuration:

- Probe: ES3DV3 - SN3293; ConvF(4.5, 4.5, 4.5); Calibrated: 2017.9.25;
- Sensor-Surface: 2mm (Mechanical Surface Detection)
- Electronics: DAE4 Sn915; Calibrated: 2017.6.16
- Phantom: SAM3; Type: SAM; Serial: TP-1696
- Measurement SW: DASY52, Version 52.8 (8); SEMCAD X Version 14.6.10 (7372)

Pin=250mW/Area Scan (71x71x1): Interpolated grid: dx=1.200 mm, dy=1.200 mm

Maximum value of SAR (interpolated) = 9.79 W/kg

Pin=250mW/Zoom Scan (7x7x7)/Cube 0: Measurement grid: dx=5mm, dy=5mm, dz=5mm

Reference Value = 60.68 V/m; Power Drift = 0.06 dB

Peak SAR (extrapolated) = 11.7 W/kg

SAR(1 g) = 15.20 W/kg; SAR(10 g) = 6.87 W/kg

Maximum value of SAR (measured) = 9.50 W/kg

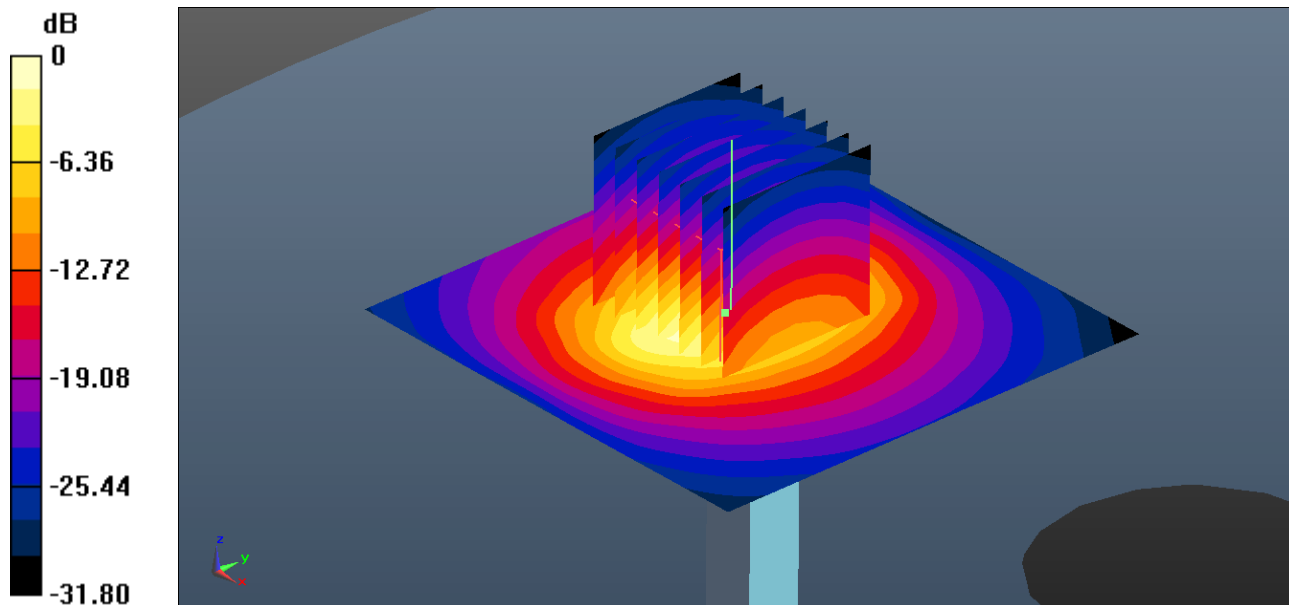

0 dB = 9.79 W/kg = 9.91 dBW/kg

System Check_Body_835MHz

DUT: D835V2 - SN:4d091

Communication System: UID 0, CW; Frequency: 835 MHz; Duty Cycle: 1:1

Medium: MSL_835 Medium parameters used: $f = 835 \text{ MHz}$; $\sigma = 0.984 \text{ S/m}$; $\epsilon_r = 56.593$; $\rho = 1000 \text{ kg/m}^3$

Ambient Temperature : $23.2 \text{ }^\circ\text{C}$; Liquid Temperature : $22.7 \text{ }^\circ\text{C}$

DASY5 Configuration:

- Probe: ES3DV3 - SN3293; ConvF(6.19, 6.19, 6.19); Calibrated: 2017.9.25;
- Sensor-Surface: 2mm (Mechanical Surface Detection)
- Electronics: DAE4 Sn915; Calibrated: 2017.6.16
- Phantom: SAM1; Type: SAM; Serial: TP-1697
- Measurement SW: DASY52, Version 52.8 (8); SEMCAD X Version 14.6.10 (7372)

Pin=250mW/Area Scan (61x61x1): Interpolated grid: $dx=1.500 \text{ mm}$, $dy=1.500 \text{ mm}$

Maximum value of SAR (interpolated) = 2.38 W/kg

Pin=250mW/Zoom Scan (5x5x7)/Cube 0: Measurement grid: $dx=8\text{mm}$, $dy=8\text{mm}$, $dz=5\text{mm}$

Reference Value = 47.46 V/m ; Power Drift = -0.05 dB

Peak SAR (extrapolated) = 2.59 W/kg

SAR(1 g) = 2.29 W/kg ; SAR(10 g) = 1.52 W/kg

Maximum value of SAR (measured) = 2.36 W/kg

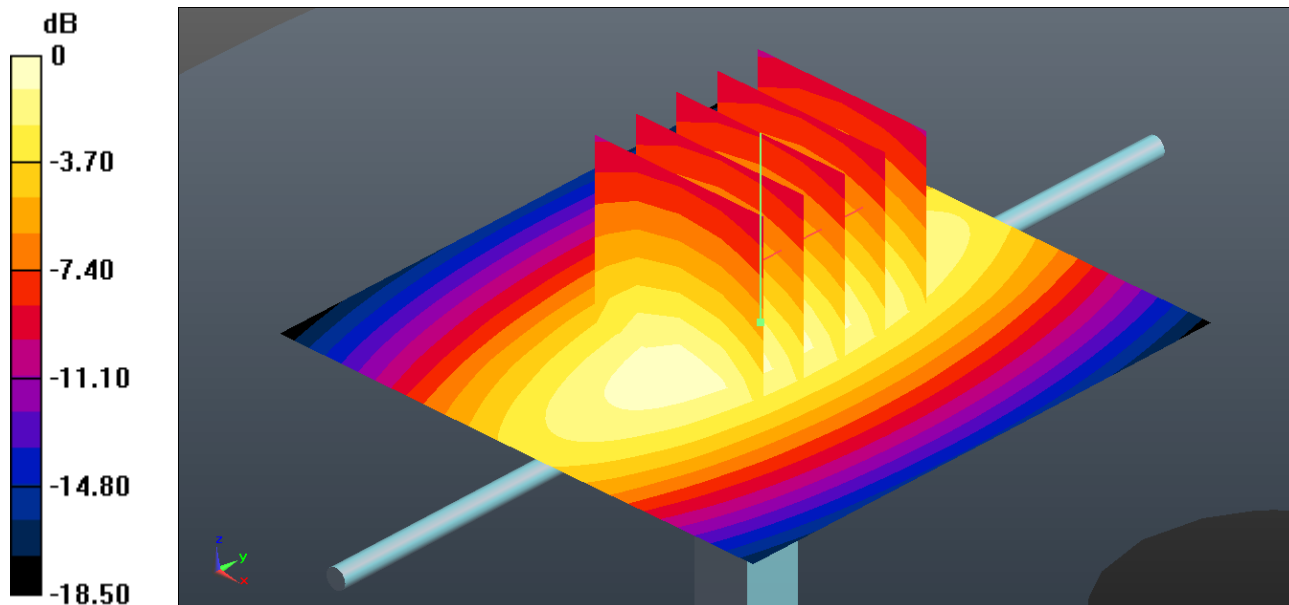

0 dB = $2.38 \text{ W/kg} = 3.77 \text{ dBW/kg}$

System Check_Body_2450MHz

DUT: D2450V2 - SN:840

Communication System: UID 0, CW; Frequency: 2450 MHz; Duty Cycle: 1:1

Medium: MSL_2450 Medium parameters used: $f = 2450$ MHz; $\sigma = 2.012$ S/m; $\epsilon_r = 54.301$; $\rho = 1000$ kg/m³

Ambient Temperature : 23.5 °C ; Liquid Temperature : 22.6 °C

DASY5 Configuration:

- Probe: EX3DV4 - SN3753; ConvF(7.27, 7.27, 7.27); Calibrated: 2017.5.5;
- Sensor-Surface: 2mm (Mechanical Surface Detection)
- Electronics: DAE4 Sn1338; Calibrated: 2017.12.4
- Phantom: SAM1; Type: SAM; Serial: TP-1488
- Measurement SW: DASY52, Version 52.8 (8); SEMCAD X Version 14.6.10 (7372)

Pin=250mW/Area Scan (81x81x1): Interpolated grid: dx=1.200 mm, dy=1.200 mm

Maximum value of SAR (interpolated) = 24.0 W/kg

Pin=250mW/Zoom Scan (7x7x7)/Cube 0: Measurement grid: dx=5mm, dy=5mm, dz=5mm

Reference Value = 94.11 V/m; Power Drift = -0.19 dB

Peak SAR (extrapolated) = 29.5 W/kg

SAR(1 g) = 12.1 W/kg; SAR(10 g) = 5.87 W/kg

Maximum value of SAR (measured) = 23.5 W/kg

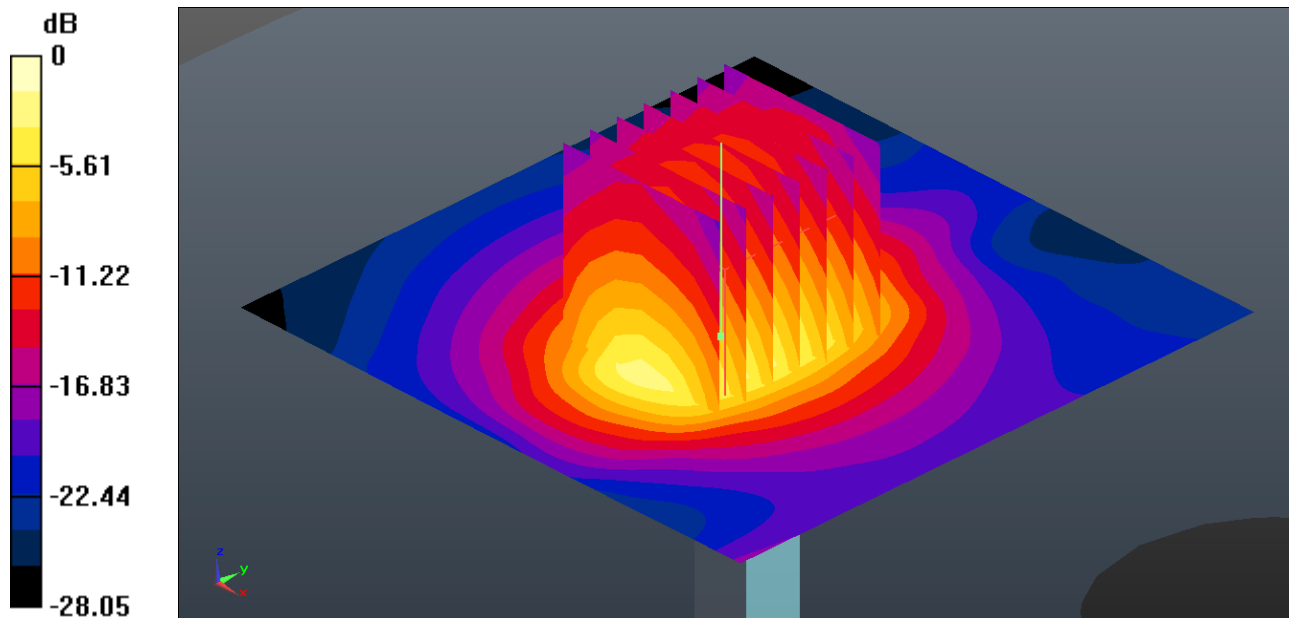

0 dB = 24.0 W/kg = 13.80 dBW/kg

System Check_Body_2600MHz

DUT: D2600V2 - SN:1061

Communication System: UID 0, CW (0); Frequency: 2600 MHz; Duty Cycle: 1:1

Medium: MSL_2600 Medium parameters used: $f = 2600$ MHz; $\sigma = 2.219$ S/m; $\epsilon_r = 53.696$; $\rho = 1000$ kg/m³

Ambient Temperature : 23.4 °C ; Liquid Temperature : 22.6 °C

DASY5 Configuration:

- Probe: ES3DV3 - SN3293; ConvF(4.16, 4.16, 4.16); Calibrated: 2017.9.25;
- Sensor-Surface: 2mm (Mechanical Surface Detection)
- Electronics: DAE4 Sn915; Calibrated: 2017.6.16
- Phantom: SAM1; Type: SAM; Serial: TP-1697
- Measurement SW: DASY52, Version 52.8 (8); SEMCAD X Version 14.6.10 (7372)

Pin=250mW/Area Scan (81x81x1): Interpolated grid: dx=1.200 mm, dy=1.200 mm

Maximum value of SAR (interpolated) = 21.4 W/kg

Pin=250mW/Zoom Scan (7x7x7)/Cube 0: Measurement grid: dx=5mm, dy=5mm, dz=5mm

Reference Value = 82.10 V/m; Power Drift = -0.09 dB

Peak SAR (extrapolated) = 26.9 W/kg

SAR(1 g) = 14.1 W/kg; SAR(10 g) = 6.55 W/kg

Maximum value of SAR (measured) = 21.1 W/kg

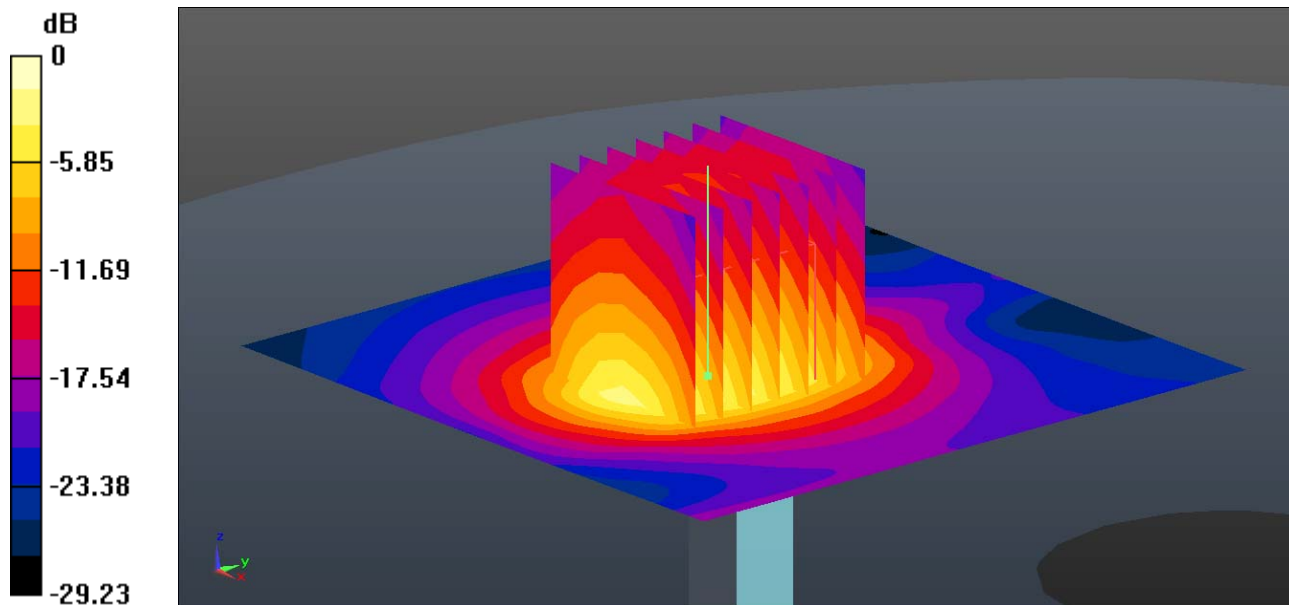

0 dB = 21.4 W/kg = 13.30 dBW/kg



Appendix B. Plots of High SAR Measurement

The plots are shown as follows.

01_WCDMA Band V_RMC 12.2Kbps_Right Cheek_0mm_Ch4233

Communication System: UID 0, UMTS (0); Frequency: 846.6 MHz; Duty Cycle: 1:1
 Medium: HSL_835 Medium parameters used: $f = 846.6 \text{ MHz}$; $\sigma = 0.93 \text{ S/m}$; $\epsilon_r = 41.937$; $\rho = 1000 \text{ kg/m}^3$
 Ambient Temperature : $23.2 \text{ }^\circ\text{C}$; Liquid Temperature : $22.9 \text{ }^\circ\text{C}$

DASY5 Configuration:

- Probe: ES3DV3 - SN3293; ConvF(6.3, 6.3, 6.3); Calibrated: 2017.9.25;
- Sensor-Surface: 2mm (Mechanical Surface Detection)
- Electronics: DAE4 Sn915; Calibrated: 2017.6.16
- Phantom: SAM1; Type: SAM; Serial: TP-1697
- Measurement SW: DASY52, Version 52.8 (8); SEMCAD X Version 14.6.10 (7372)

Ch4233/Area Scan (51x111x1): Interpolated grid: $dx=1.500 \text{ mm}$, $dy=1.500 \text{ mm}$
 Maximum value of SAR (interpolated) = 1.14 W/kg

Ch4233/Zoom Scan (5x5x7)/Cube 0: Measurement grid: $dx=8\text{mm}$, $dy=8\text{mm}$, $dz=5\text{mm}$
 Reference Value = 16.97 V/m ; Power Drift = -0.11 dB
 Peak SAR (extrapolated) = 1.38 W/kg
SAR(1 g) = 0.929 W/kg ; SAR(10 g) = 0.636 W/kg
 Maximum value of SAR (measured) = 1.20 W/kg

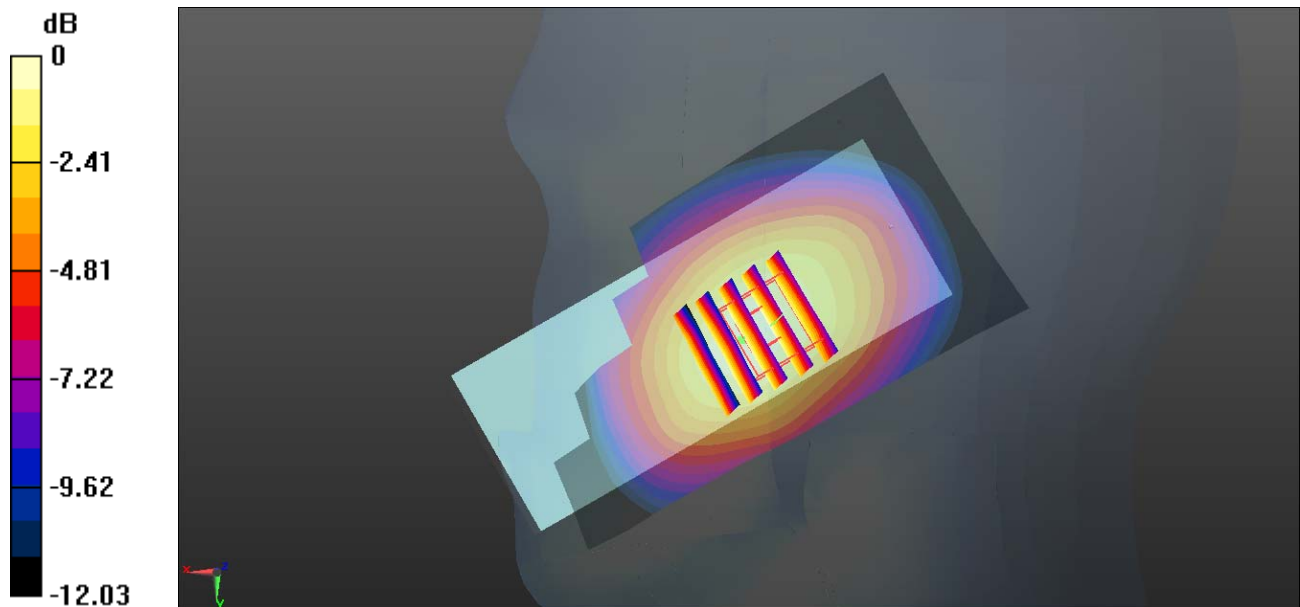

0 dB = $1.14 \text{ W/kg} = 0.57 \text{ dBW/kg}$

02_LTE Band 5_10M_QPSK_1RB_0Offset_Left Cheek_0mm_Ch20525

Communication System: UID 0, FDD_LTE (0); Frequency: 836.5 MHz; Duty Cycle: 1:1
 Medium: HSL_835 Medium parameters used : $f = 836.5$ MHz; $\sigma = 0.919$ S/m; $\epsilon_r = 42.072$; $\rho = 1000$

kg/m³

Ambient Temperature : 23.2 °C ; Liquid Temperature : 22.9 °C

DASY5 Configuration:

- Probe: ES3DV3 - SN3293; ConvF(6.3, 6.3, 6.3); Calibrated: 2017.9.25;
- Sensor-Surface: 2mm (Mechanical Surface Detection)
- Electronics: DAE4 Sn915; Calibrated: 2017.6.16
- Phantom: SAM1; Type: SAM; Serial: TP-1697
- Measurement SW: DASY52, Version 52.8 (8); SEMCAD X Version 14.6.10 (7372)

Ch20525/Area Scan (51x111x1): Interpolated grid: dx=1.500 mm, dy=1.500 mm

Maximum value of SAR (interpolated) = 1.03 W/kg

Ch20525/Zoom Scan (5x5x7)/Cube 0: Measurement grid: dx=8mm, dy=8mm, dz=5mm

Reference Value = 14.49 V/m; Power Drift = 0.07 dB

Peak SAR (extrapolated) = 1.09 W/kg

SAR(1 g) = 0.821 W/kg; SAR(10 g) = 0.585 W/kg

Maximum value of SAR (measured) = 0.980 W/kg

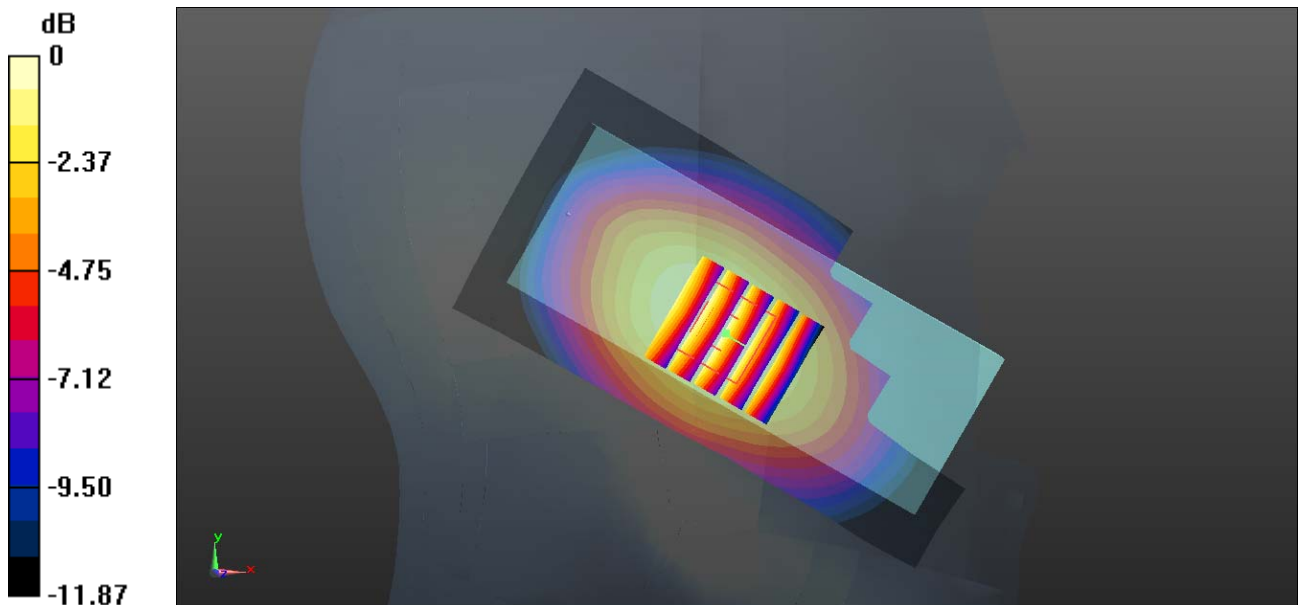

0 dB = 1.03 W/kg = 0.13 dBW/kg

03_LTE Band 7_20M_QPSK_1RB_0Offset_Left Cheek_0mm_Ch21100

Communication System: UID 0, FDD_LTE (0); Frequency: 2535 MHz; Duty Cycle: 1:1
Medium: HSL_2600 Medium parameters used : $f = 2535$ MHz; $\sigma = 1.97$ S/m; $\epsilon_r = 38.111$; $\rho = 1000$ kg/m³
Ambient Temperature : 23.5 °C ; Liquid Temperature : 22.6 °C

DASY5 Configuration:

- Probe: ES3DV3 - SN3293; ConvF(4.5, 4.5, 4.5); Calibrated: 2017.9.25;
- Sensor-Surface: 2mm (Mechanical Surface Detection)
- Electronics: DAE4 Sn915; Calibrated: 2017.6.16
- Phantom: SAM3; Type: SAM; Serial: TP-1696
- Measurement SW: DASY52, Version 52.8 (8); SEMCAD X Version 14.6.10 (7372)

Ch21100/Area Scan (61x121x1): Interpolated grid: dx=1.200 mm, dy=1.200 mm

Maximum value of SAR (interpolated) = 1.05 W/kg

Ch21100/Zoom Scan (7x7x7)/Cube 0: Measurement grid: dx=5mm, dy=5mm, dz=5mm

Reference Value = 6.264 V/m; Power Drift = 0.01 dB

Peak SAR (extrapolated) = 1.39 W/kg

SAR(1 g) = 0.756 W/kg; SAR(10 g) = 0.405 W/kg

Maximum value of SAR (measured) = 1.04 W/kg

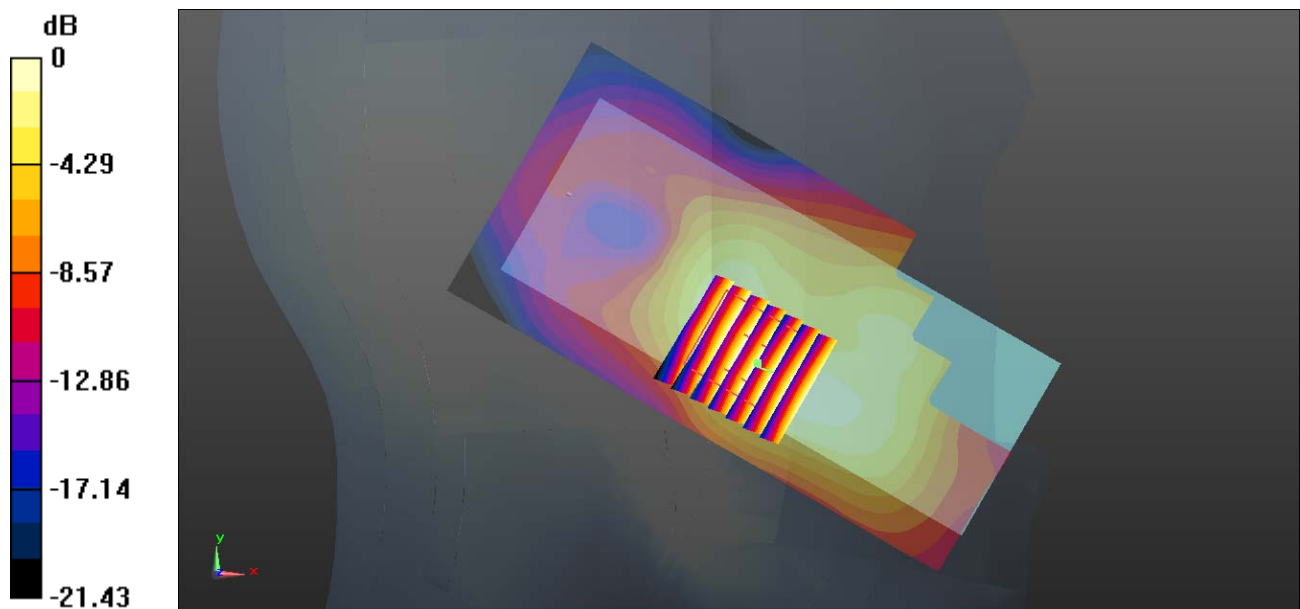

0 dB = 1.05 W/kg = 0.21 dBW/kg

04_WLAN2.4GHz_802.11b 1Mbps_Right Cheek_0mm_Ch1

Communication System: UID 0, WIFI (0); Frequency: 2412 MHz; Duty Cycle: 1:1.025
Medium: HSL_2450 Medium parameters used: $f = 2412$ MHz; $\sigma = 1.824$ S/m; $\epsilon_r = 39.453$; $\rho = 1000$ kg/m³
Ambient Temperature : 23.5 °C ; Liquid Temperature : 22.6 °C

DASY5 Configuration:

- Probe: EX3DV4 - SN3753; ConvF(7.28, 7.28, 7.28); Calibrated: 2017.5.5;
- Sensor-Surface: 2mm (Mechanical Surface Detection)
- Electronics: DAE4 Sn1338; Calibrated: 2017.12.4
- Phantom: SAM1; Type: SAM; Serial: TP-1488
- Measurement SW: DASY52, Version 52.8 (8); SEMCAD X Version 14.6.10 (7372)

Ch1/Area Scan (51x111x1): Interpolated grid: dx=1.500 mm, dy=1.500 mm
Maximum value of SAR (interpolated) = 0.146 W/kg

Ch1/Zoom Scan (5x5x7)/Cube 0: Measurement grid: dx=8mm, dy=8mm, dz=5mm
Reference Value = 4.445 V/m; Power Drift = 0.07 dB
Peak SAR (extrapolated) = 0.0740 W/kg
SAR(1 g) = 0.030 W/kg; SAR(10 g) = 0.011 W/kg
Maximum value of SAR (measured) = 0.0441 W/kg

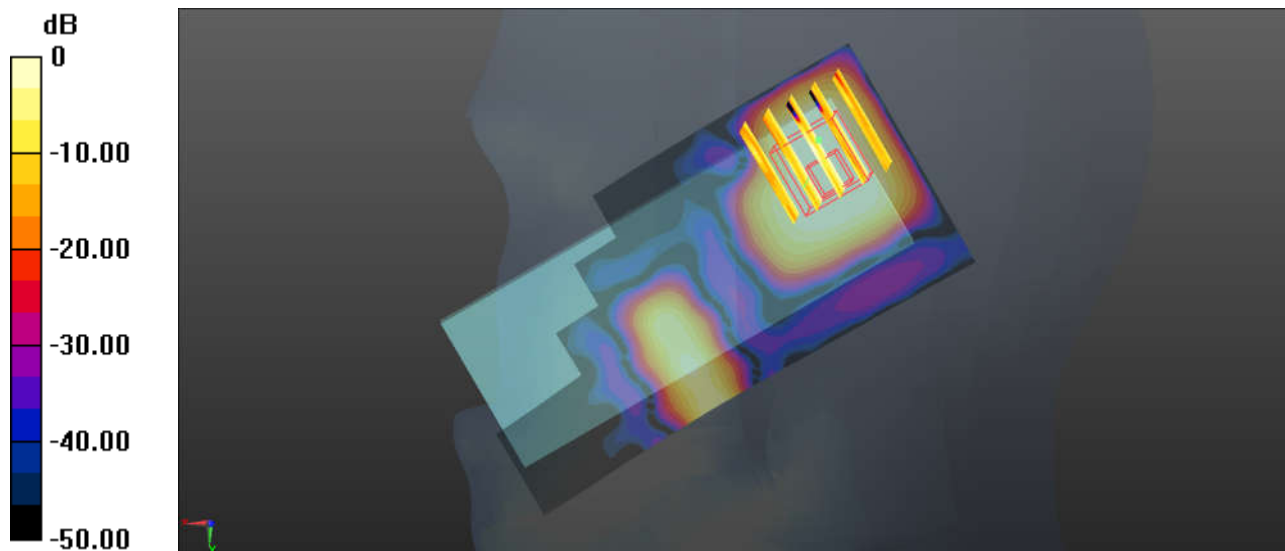

0 dB = 0.0441 W/kg = -13.56 dBW/kg

05_WCDMA Band V_RMC 12.2Kbps_Back_10mm_Ch4233

Communication System: UID 0, UMTS (0); Frequency: 846.6 MHz; Duty Cycle: 1:1
 Medium: MSL_835 Medium parameters used: $f = 846.6 \text{ MHz}$; $\sigma = 0.997 \text{ S/m}$; $\epsilon_r = 56.487$; $\rho = 1000 \text{ kg/m}^3$
 Ambient Temperature : $23.2 \text{ }^\circ\text{C}$; Liquid Temperature : $22.7 \text{ }^\circ\text{C}$

DASY5 Configuration:

- Probe: ES3DV3 - SN3293; ConvF(6.19, 6.19, 6.19); Calibrated: 2017.9.25;
- Sensor-Surface: 2mm (Mechanical Surface Detection)
- Electronics: DAE4 Sn915; Calibrated: 2017.6.16
- Phantom: SAM1; Type: SAM; Serial: TP-1697
- Measurement SW: DASY52, Version 52.8 (8); SEMCAD X Version 14.6.10 (7372)

Ch4233/Area Scan (51x111x1): Interpolated grid: $dx=1.500 \text{ mm}$, $dy=1.500 \text{ mm}$
 Maximum value of SAR (interpolated) = 1.03 W/kg

Ch4233/Zoom Scan (5x5x7)/Cube 0: Measurement grid: $dx=8\text{mm}$, $dy=8\text{mm}$, $dz=5\text{mm}$
 Reference Value = 31.82 V/m ; Power Drift = 0.02 dB
 Peak SAR (extrapolated) = 1.14 W/kg
SAR(1 g) = 0.874 W/kg ; SAR(10 g) = 0.640 W/kg
 Maximum value of SAR (measured) = 1.02 W/kg

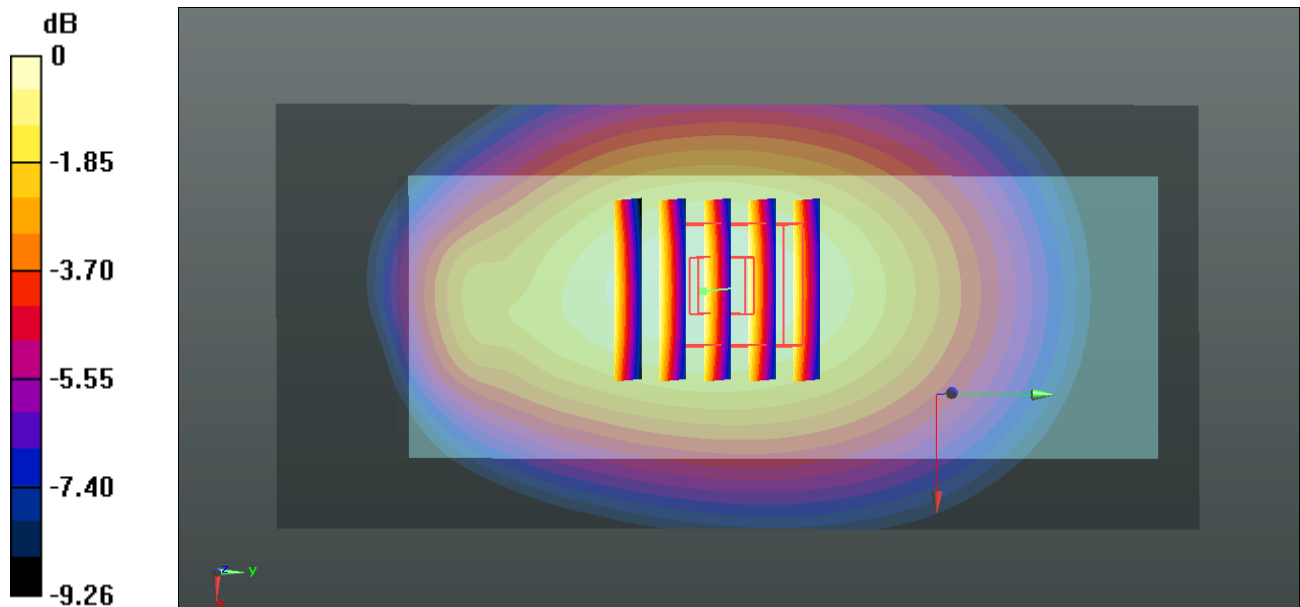

0 dB = $1.03 \text{ W/kg} = 0.13 \text{ dBW/kg}$

06_LTE Band 5_10M_QPSK_1RB_0Offset_Left Side_10mm_Ch20525

Communication System: UID 0, FDD_LTE (0); Frequency: 836.5 MHz; Duty Cycle: 1:1
 Medium: MSL_835 Medium parameters used : $f = 836.5$ MHz; $\sigma = 0.986$ S/m; $\epsilon_r = 56.58$; $\rho = 1000$ kg/m³
 Ambient Temperature : 23.2 °C ; Liquid Temperature : 22.7 °C

DASY5 Configuration:

- Probe: ES3DV3 - SN3293; ConvF(6.19, 6.19, 6.19); Calibrated: 2017.9.25;
- Sensor-Surface: 2mm (Mechanical Surface Detection)
- Electronics: DAE4 Sn915; Calibrated: 2017.6.16
- Phantom: SAM1; Type: SAM; Serial: TP-1697
- Measurement SW: DASY52, Version 52.8 (8); SEMCAD X Version 14.6.10 (7372)

Ch20525/Area Scan (41x111x1): Interpolated grid: dx=1.500 mm, dy=1.500 mm

Maximum value of SAR (interpolated) = 1.06 W/kg

Ch20525/Zoom Scan (5x5x7)/Cube 0: Measurement grid: dx=8mm, dy=8mm, dz=5mm

Reference Value = 24.45 V/m; Power Drift = -0.07 dB

Peak SAR (extrapolated) = 1.22 W/kg

SAR(1 g) = 0.878 W/kg; SAR(10 g) = 0.616 W/kg

Maximum value of SAR (measured) = 1.06 W/kg

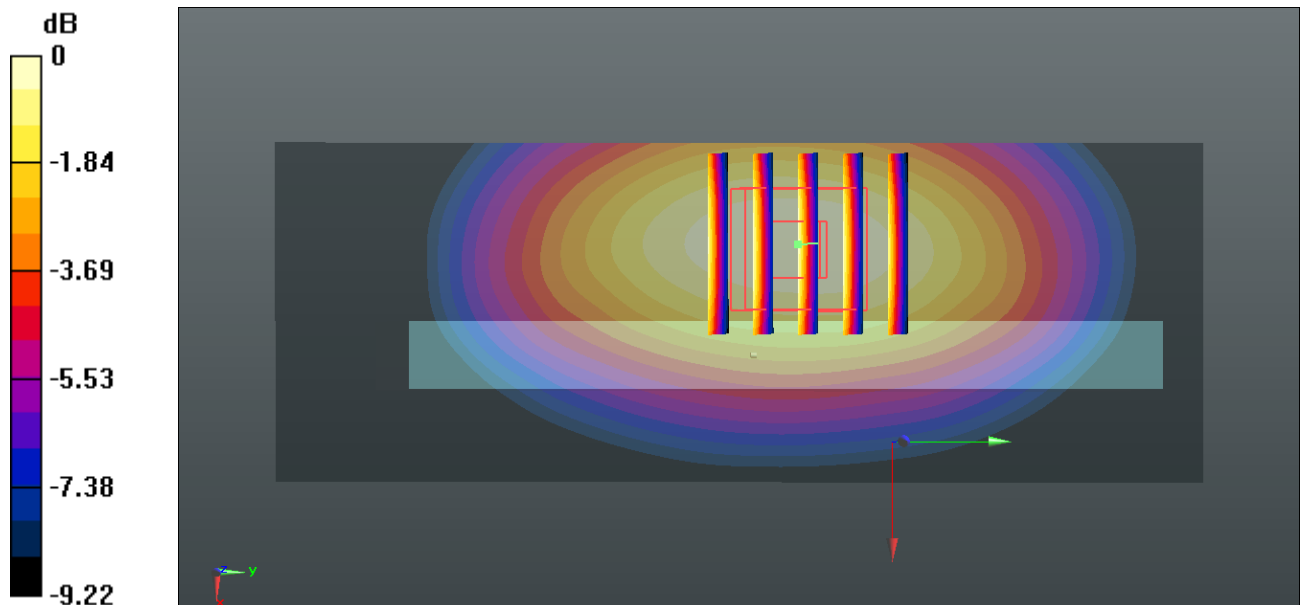

0 dB = 1.06 W/kg = 0.25 dBW/kg

07_LTE Band 7_20M_QPSK_1RB_0Offset_Bottom Side_10mm_Ch21350

Communication System: UID 0, FDD_LTE (0); Frequency: 2560 MHz; Duty Cycle: 1:1
 Medium: MSL_2600 Medium parameters used: $f = 2560$ MHz; $\sigma = 2.161$ S/m; $\epsilon_r = 53.849$; $\rho = 1000$ kg/m³
 Ambient Temperature : 23.4 °C ; Liquid Temperature : 22.6 °C

DASY5 Configuration:

- Probe: ES3DV3 - SN3293; ConvF(4.16, 4.16, 4.16); Calibrated: 2017.9.25;
- Sensor-Surface: 2mm (Mechanical Surface Detection)
- Electronics: DAE4 Sn915; Calibrated: 2017.6.16
- Phantom: SAM1; Type: SAM; Serial: TP-1697
- Measurement SW: DASY52, Version 52.8 (8); SEMCAD X Version 14.6.10 (7372)

Ch21350/Area Scan (51x81x1): Interpolated grid: dx=1.200 mm, dy=1.200 mm
 Maximum value of SAR (interpolated) = 1.48 W/kg

Ch21350/Zoom Scan (7x7x7)/Cube 0: Measurement grid: dx=5mm, dy=5mm, dz=5mm
 Reference Value = 16.44 V/m; Power Drift = -0.11 dB
 Peak SAR (extrapolated) = 1.92 W/kg
SAR(1 g) = 1.03 W/kg; SAR(10 g) = 0.525 W/kg
 Maximum value of SAR (measured) = 1.49 W/kg

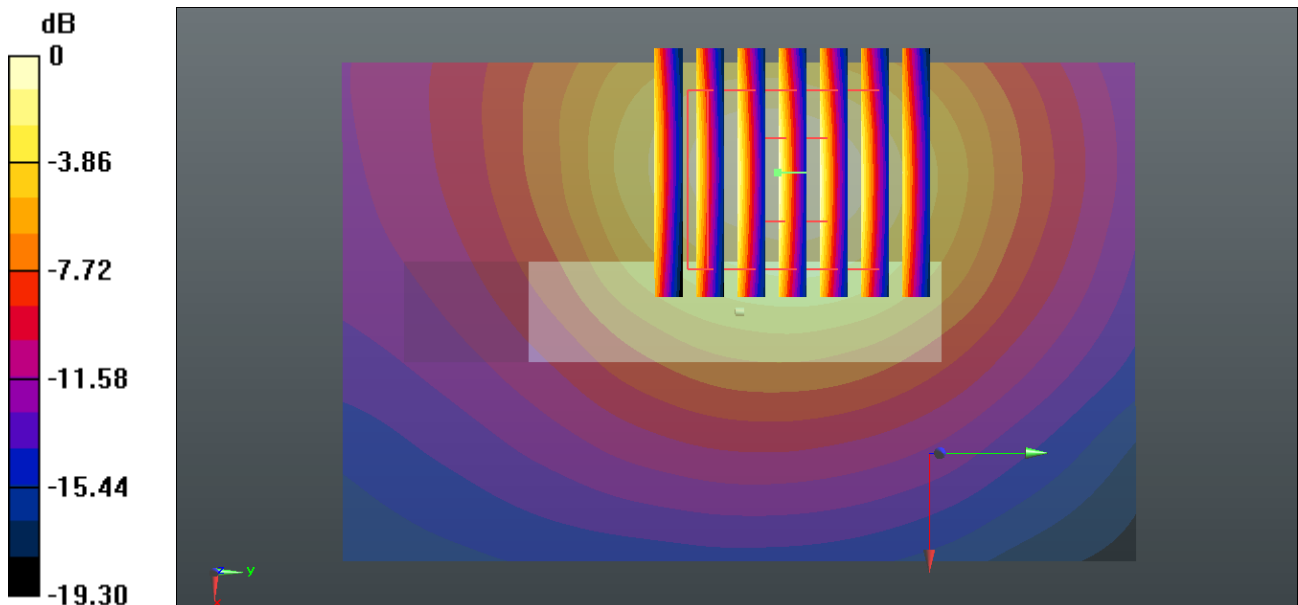

0 dB = 1.48 W/kg = 1.70 dBW/kg

08_WLAN2.4GHz_802.11b 1Mbps_Back_10mm_Ch1

Communication System: UID 0, WIFI (0); Frequency: 2412 MHz; Duty Cycle: 1:1.025
Medium: MSL_2450 Medium parameters used: $f = 2412$ MHz; $\sigma = 1.96$ S/m; $\epsilon_r = 54.452$; $\rho = 1000$ kg/m³
Ambient Temperature : 23.5 °C ; Liquid Temperature : 22.6 °C

DASY5 Configuration:

- Probe: EX3DV4 - SN3753; ConvF(7.27, 7.27, 7.27); Calibrated: 2017.5.5;
- Sensor-Surface: 2mm (Mechanical Surface Detection)
- Electronics: DAE4 Sn1338; Calibrated: 2017.12.4
- Phantom: SAM1; Type: SAM; Serial: TP-1488
- Measurement SW: DASY52, Version 52.8 (8); SEMCAD X Version 14.6.10 (7372)

Ch1/Area Scan (51x111x1): Interpolated grid: dx=1.500 mm, dy=1.500 mm
Maximum value of SAR (interpolated) = 0.0776 W/kg

Ch1/Zoom Scan (5x5x7)/Cube 0: Measurement grid: dx=8mm, dy=8mm, dz=5mm
Reference Value = 3.211 V/m; Power Drift = -0.01 dB
Peak SAR (extrapolated) = 0.0990 W/kg
SAR(1 g) = 0.046 W/kg; SAR(10 g) = 0.022 W/kg
Maximum value of SAR (measured) = 0.0712 W/kg

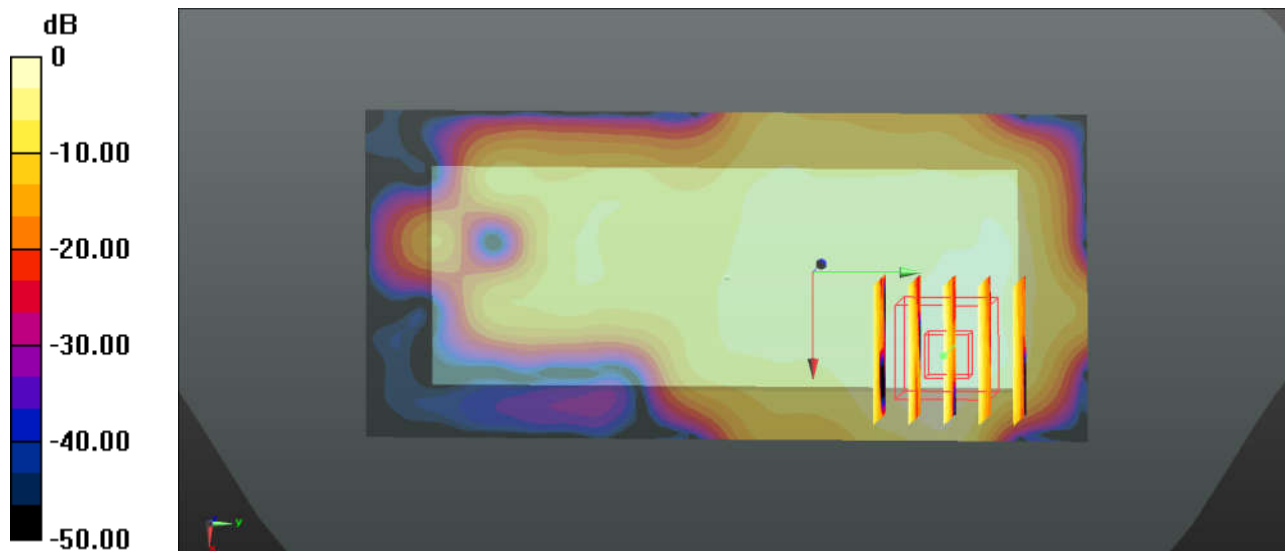

0 dB = 0.0712 W/kg = -11.48 dBW/kg

09_WCDMA Band V_RMC 12.2Kbps_Back_10mm_Ch4233

Communication System: UID 0, UMTS (0); Frequency: 846.6 MHz; Duty Cycle: 1:1
 Medium: MSL_835 Medium parameters used: $f = 846.6 \text{ MHz}$; $\sigma = 0.997 \text{ S/m}$; $\epsilon_r = 56.487$; $\rho = 1000 \text{ kg/m}^3$
 Ambient Temperature : $23.2 \text{ }^\circ\text{C}$; Liquid Temperature : $22.7 \text{ }^\circ\text{C}$

DASY5 Configuration:

- Probe: ES3DV3 - SN3293; ConvF(6.19, 6.19, 6.19); Calibrated: 2017.9.25;
- Sensor-Surface: 2mm (Mechanical Surface Detection)
- Electronics: DAE4 Sn915; Calibrated: 2017.6.16
- Phantom: SAM1; Type: SAM; Serial: TP-1697
- Measurement SW: DASY52, Version 52.8 (8); SEMCAD X Version 14.6.10 (7372)

Ch4233/Area Scan (51x111x1): Interpolated grid: $dx=1.500 \text{ mm}$, $dy=1.500 \text{ mm}$
 Maximum value of SAR (interpolated) = 1.03 W/kg

Ch4233/Zoom Scan (5x5x7)/Cube 0: Measurement grid: $dx=8\text{mm}$, $dy=8\text{mm}$, $dz=5\text{mm}$
 Reference Value = 31.82 V/m ; Power Drift = 0.02 dB
 Peak SAR (extrapolated) = 1.14 W/kg
SAR(1 g) = 0.874 W/kg ; SAR(10 g) = 0.640 W/kg
 Maximum value of SAR (measured) = 1.02 W/kg

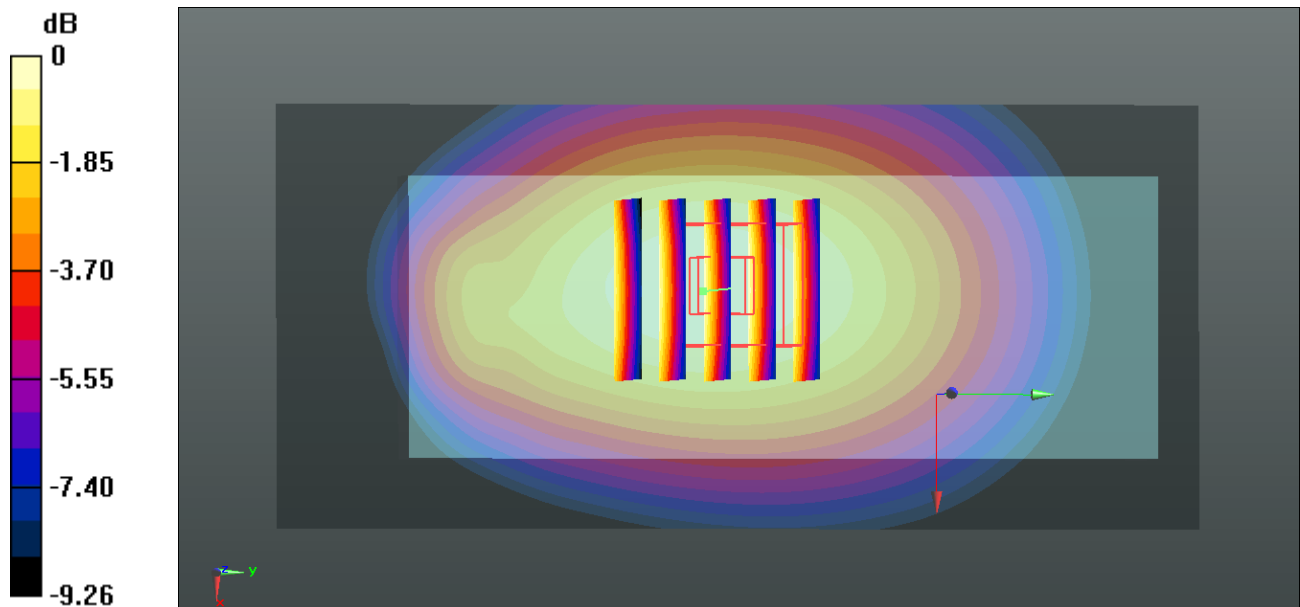

0 dB = $1.03 \text{ W/kg} = 0.13 \text{ dBW/kg}$

10_LTE Band 5_10M_QPSK_1RB_0Offset_Back_10mm_Ch20525

Communication System: UID 0, FDD_LTE (0); Frequency: 836.5 MHz; Duty Cycle: 1:1
 Medium: MSL_835 Medium parameters used : $f = 836.5 \text{ MHz}$; $\sigma = 0.986 \text{ S/m}$; $\epsilon_r =$

56.58 ; $\rho = 1000 \text{ kg/m}^3$

Ambient Temperature : $23.2 \text{ }^\circ\text{C}$; Liquid Temperature : $22.7 \text{ }^\circ\text{C}$

DASY5 Configuration:

- Probe: ES3DV3 - SN3293; ConvF(6.19, 6.19, 6.19); Calibrated: 2017.9.25;
- Sensor-Surface: 2mm (Mechanical Surface Detection)
- Electronics: DAE4 Sn915; Calibrated: 2017.6.16
- Phantom: SAM1; Type: SAM; Serial: TP-1697
- Measurement SW: DASY52, Version 52.8 (8); SEMCAD X Version 14.6.10 (7372)

Ch20525/Area Scan (51x111x1): Interpolated grid: $dx=1.500 \text{ mm}$, $dy=1.500 \text{ mm}$

Maximum value of SAR (interpolated) = 1.02 W/kg

Ch20525/Zoom Scan (5x5x7)/Cube 0: Measurement grid: $dx=8\text{mm}$, $dy=8\text{mm}$, $dz=5\text{mm}$

Reference Value = 32.36 V/m ; Power Drift = -0.09 dB

Peak SAR (extrapolated) = 1.14 W/kg

SAR(1 g) = 0.870 W/kg ; SAR(10 g) = 0.633 W/kg

Maximum value of SAR (measured) = 1.02 W/kg

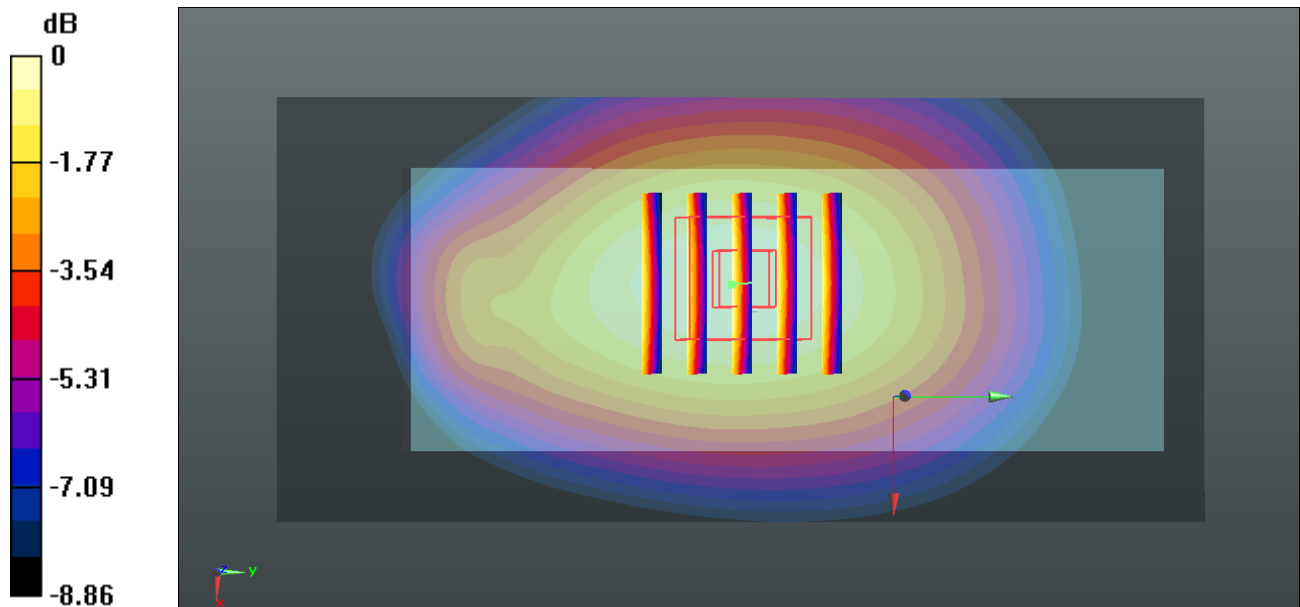

0 dB = $1.02 \text{ W/kg} = 0.09 \text{ dBW/kg}$

11_LTE Band 7_20M_QPSK_1RB_0Offset_Back_10mm_Ch21350

Communication System: UID 0, FDD_LTE (0); Frequency: 2560 MHz; Duty Cycle: 1:1
 Medium: MSL_2600 Medium parameters used: $f = 2560$ MHz; $\sigma = 2.161$ S/m; $\epsilon_r = 53.849$; $\rho = 1000$ kg/m³
 Ambient Temperature : 23.4 °C ; Liquid Temperature : 22.6 °C

DASY5 Configuration:

- Probe: ES3DV3 - SN3293; ConvF(4.16, 4.16, 4.16); Calibrated: 2017.9.25;
- Sensor-Surface: 2mm (Mechanical Surface Detection)
- Electronics: DAE4 Sn915; Calibrated: 2017.6.16
- Phantom: SAM1; Type: SAM; Serial: TP-1697
- Measurement SW: DASY52, Version 52.8 (8); SEMCAD X Version 14.6.10 (7372)

Ch21350/Area Scan (61x131x1): Interpolated grid: dx=1.200 mm, dy=1.200 mm

Maximum value of SAR (interpolated) = 1.26 W/kg

Ch21350/Zoom Scan (7x7x7)/Cube 0: Measurement grid: dx=5mm, dy=5mm, dz=5mm

Reference Value = 16.45 V/m; Power Drift = 0.08 dB

Peak SAR (extrapolated) = 1.89 W/kg

SAR(1 g) = 0.980 W/kg; SAR(10 g) = 0.497 W/kg

Maximum value of SAR (measured) = 1.43 W/kg

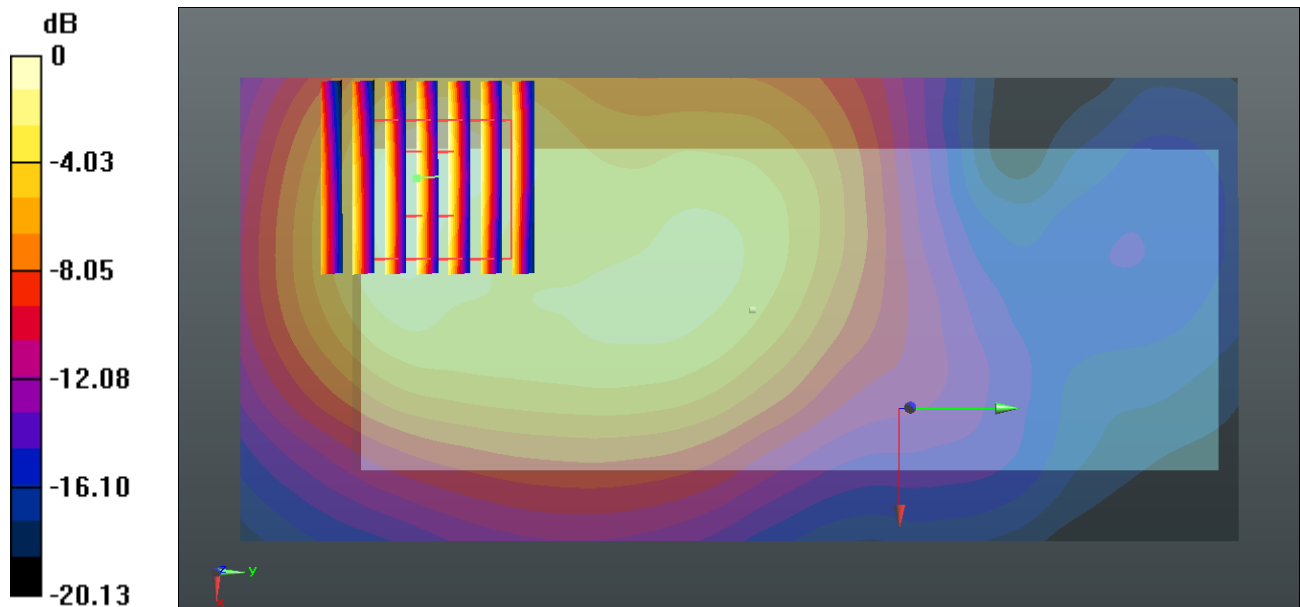

0 dB = 1.26 W/kg = 1.00 dBW/kg

12_WLAN2.4GHz_802.11b 1Mbps_Back_10mm_Ch1

Communication System: UID 0, WIFI (0); Frequency: 2412 MHz; Duty Cycle: 1:1.025
Medium: MSL_2450 Medium parameters used: $f = 2412$ MHz; $\sigma = 1.96$ S/m; $\epsilon_r = 54.452$; $\rho = 1000$ kg/m³
Ambient Temperature : 23.5 °C ; Liquid Temperature : 22.6 °C

DASY5 Configuration:

- Probe: EX3DV4 - SN3753; ConvF(7.27, 7.27, 7.27); Calibrated: 2017.5.5;
- Sensor-Surface: 2mm (Mechanical Surface Detection)
- Electronics: DAE4 Sn1338; Calibrated: 2017.12.4
- Phantom: SAM1; Type: SAM; Serial: TP-1488
- Measurement SW: DASY52, Version 52.8 (8); SEMCAD X Version 14.6.10 (7372)

Ch1/Area Scan (51x111x1): Interpolated grid: dx=1.500 mm, dy=1.500 mm
Maximum value of SAR (interpolated) = 0.0776 W/kg

Ch1/Zoom Scan (5x5x7)/Cube 0: Measurement grid: dx=8mm, dy=8mm, dz=5mm
Reference Value = 3.211 V/m; Power Drift = -0.01 dB
Peak SAR (extrapolated) = 0.0990 W/kg
SAR(1 g) = 0.046 W/kg; SAR(10 g) = 0.022 W/kg
Maximum value of SAR (measured) = 0.0712 W/kg

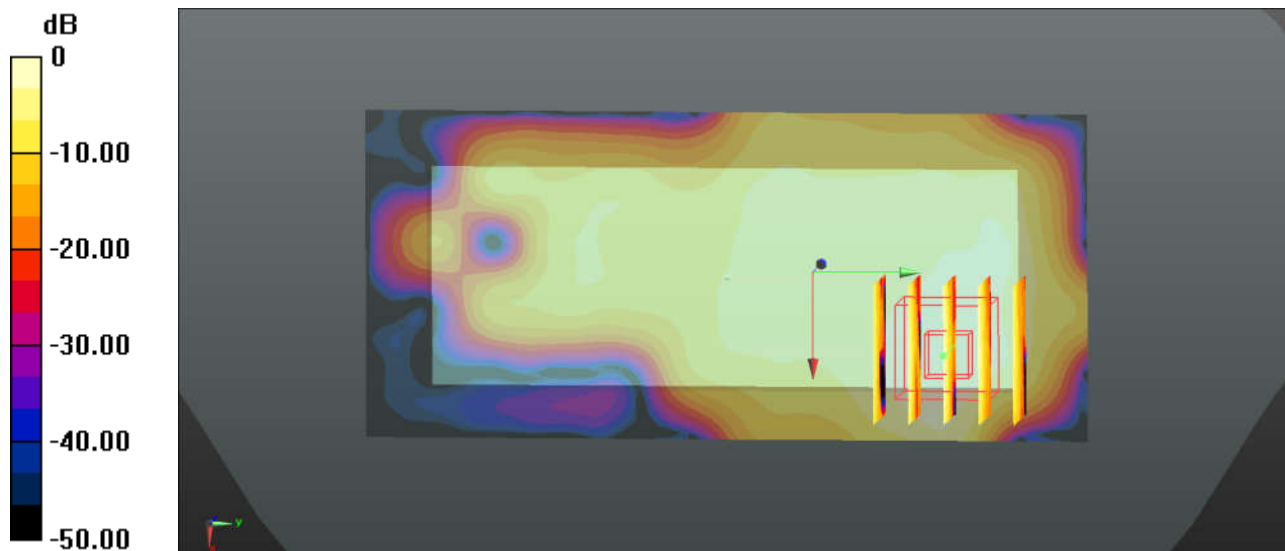

0 dB = 0.0712 W/kg = -11.48 dBW/kg



Appendix C. DASYS Calibration Certificate

The DASYS calibration certificates are shown as follows.



In Collaboration with
s p e a g
CALIBRATION LABORATORY



中国认可
国际互认
校准
CALIBRATION
CNAS L0570

Add: No.51 Xueyuan Road, Haidian District, Beijing, 100191, China
Tel: +86-10-62304633-2079 Fax: +86-10-62304633-2504
E-mail: ettl@chinattl.com http://www.chinattl.cn

Client

Sporton

Certificate No: **Z17-97259**

CALIBRATION CERTIFICATE

Object: **D835V2 - SN: 4d091**

Calibration Procedure(s): **FF-Z11-003-01**
Calibration Procedures for dipole validation kits

Calibration date: **December 5, 2017**

This calibration Certificate documents the traceability to national standards, which realize the physical units of measurements(SI). The measurements and the uncertainties with confidence probability are given on the following pages and are part of the certificate.

All calibrations have been conducted in the closed laboratory facility: environment temperature(22±3)°C and humidity<70%.

Calibration Equipment used (M&TE critical for calibration)

Primary Standards	ID #	Cal Date(Calibrated by, Certificate No.)	Scheduled Calibration
Power Meter NRVD	102196	02-Mar-17 (CTTL, No.J17X01254)	Mar-18
Power sensor NRV-Z5	100596	02-Mar-17 (CTTL, No.J17X01254)	Mar-18
Reference Probe EX3DV4	SN 3617	23-Jan-17(SPEAG,No.EX3-3617_Jan17)	Jan-18
DAE3	SN 536	09-Oct-17(CTTL-SPEAG,No.Z17-97198)	Oct-18
Secondary Standards	ID #	Cal Date(Calibrated by, Certificate No.)	Scheduled Calibration
Signal Generator E4438C	MY49071430	13-Jan-17 (CTTL, No.J17X00286)	Jan-18
Network Analyzer E5071C	MY46110673	13-Jan-17 (CTTL, No.J17X00285)	Jan-18

	Name	Function	Signature
Calibrated by:	Zhao Jing	SAR Test Engineer	
Reviewed by:	Lin Hao	SAR Test Engineer	
Approved by:	Qi Dianyuan	SAR Project Leader	

Issued: December 9, 2017

This calibration certificate shall not be reproduced except in full without written approval of the laboratory.



In Collaboration with

s p e a g
CALIBRATION LABORATORY

Add: No.51 Xueyuan Road, Haidian District, Beijing, 100191, China
Tel: +86-10-62304633-2079 Fax: +86-10-62304633-2504
E-mail: cttl@chinattl.com http://www.chinattl.cn

Glossary:

TSL	tissue simulating liquid
ConvF	sensitivity in TSL / NORM _{x,y,z}
N/A	not applicable or not measured

Calibration is Performed According to the Following Standards:

- IEEE Std 1528-2013, "IEEE Recommended Practice for Determining the Peak Spatial-Averaged Specific Absorption Rate (SAR) in the Human Head from Wireless Communications Devices: Measurement Techniques", June 2013
- IEC 62209-1, "Measurement procedure for assessment of specific absorption rate of human exposure to radio frequency fields from hand-held and body-mounted wireless communication devices- Part 1: Device used next to the ear (Frequency range of 300MHz to 6GHz)", July 2016
- IEC 62209-2, "Procedure to measure the Specific Absorption Rate (SAR) For wireless communication devices used in close proximity to the human body (frequency range of 30MHz to 6GHz)", March 2010
- KDB865664, SAR Measurement Requirements for 100 MHz to 6 GHz

Additional Documentation:

- DASY4/5 System Handbook

Methods Applied and Interpretation of Parameters:

- Measurement Conditions:** Further details are available from the Validation Report at the end of the certificate. All figures stated in the certificate are valid at the frequency indicated.
- Antenna Parameters with TSL:** The dipole is mounted with the spacer to position its feed point exactly below the center marking of the flat phantom section, with the arms oriented parallel to the body axis.
- Feed Point Impedance and Return Loss:** These parameters are measured with the dipole positioned under the liquid filled phantom. The impedance stated is transformed from the measurement at the SMA connector to the feed point. The Return Loss ensures low reflected power. No uncertainty required.
- Electrical Delay:** One-way delay between the SMA connector and the antenna feed point. No uncertainty required.
- SAR measured:** SAR measured at the stated antenna input power.
- SAR normalized:** SAR as measured, normalized to an input power of 1 W at the antenna connector.
- SAR for nominal TSL parameters:** The measured TSL parameters are used to calculate the nominal SAR result.

The reported uncertainty of measurement is stated as the standard uncertainty of Measurement multiplied by the coverage factor $k=2$, which for a normal distribution Corresponds to a coverage probability of approximately 95%.



Add: No.51 Xueyuan Road, Haidian District, Beijing, 100191, China
Tel: +86-10-62304633-2079 Fax: +86-10-62304633-2504
E-mail: cttl@chinattl.com http://www.chinattl.cn

Measurement Conditions

DASY system configuration, as far as not given on page 1.

DASY Version	DASY52	52.10.0.1446
Extrapolation	Advanced Extrapolation	
Phantom	Triple Flat Phantom 5.1C	
Distance Dipole Center - TSL	15 mm	with Spacer
Zoom Scan Resolution	dx, dy, dz = 5 mm	
Frequency	835 MHz \pm 1 MHz	

Head TSL parameters

The following parameters and calculations were applied.

	Temperature	Permittivity	Conductivity
Nominal Head TSL parameters	22.0 °C	41.5	0.90 mho/m
Measured Head TSL parameters	(22.0 \pm 0.2) °C	41.7 \pm 6 %	0.88 mho/m \pm 6 %
Head TSL temperature change during test	<1.0 °C	---	---

SAR result with Head TSL

SAR averaged over 1 cm^3 (1 g) of Head TSL	Condition	
SAR measured	250 mW input power	2.32 mW / g
SAR for nominal Head TSL parameters	normalized to 1W	9.48 mW / g \pm 18.8 % (k=2)
SAR averaged over 10 cm^3 (10 g) of Head TSL	Condition	
SAR measured	250 mW input power	1.53 mW / g
SAR for nominal Head TSL parameters	normalized to 1W	6.22 mW / g \pm 18.7 % (k=2)

Body TSL parameters

The following parameters and calculations were applied.

	Temperature	Permittivity	Conductivity
Nominal Body TSL parameters	22.0 °C	55.2	0.97 mho/m
Measured Body TSL parameters	(22.0 \pm 0.2) °C	54.7 \pm 6 %	0.96 mho/m \pm 6 %
Body TSL temperature change during test	<1.0 °C	---	---

SAR result with Body TSL

SAR averaged over 1 cm^3 (1 g) of Body TSL	Condition	
SAR measured	250 mW input power	2.42 mW / g
SAR for nominal Body TSL parameters	normalized to 1W	9.72 mW / g \pm 18.8 % (k=2)
SAR averaged over 10 cm^3 (10 g) of Body TSL	Condition	
SAR measured	250 mW input power	1.60 mW / g
SAR for nominal Body TSL parameters	normalized to 1W	6.42 mW / g \pm 18.7 % (k=2)



Add: No.51 Xueyuan Road, Haidian District, Beijing, 100191, China
Tel: +86-10-62304633-2079 Fax: +86-10-62304633-2504
E-mail: cttl@chinattl.com http://www.chinattl.cn

Appendix (Additional assessments outside the scope of CNAS L0570)

Antenna Parameters with Head TSL

Impedance, transformed to feed point	48.7 Ω - 3.69j Ω
Return Loss	- 28.1dB

Antenna Parameters with Body TSL

Impedance, transformed to feed point	46.6 Ω - 4.62j Ω
Return Loss	- 24.5dB

General Antenna Parameters and Design

Electrical Delay (one direction)	1.258 ns
----------------------------------	----------

After long term use with 100W radiated power, only a slight warming of the dipole near the feedpoint can be measured.

The dipole is made of standard semirigid coaxial cable. The center conductor of the feeding line is directly connected to the second arm of the dipole. The antenna is therefore short-circuited for DC-signals. On some of the dipoles, small end caps are added to the dipole arms in order to improve matching when loaded according to the position as explained in the "Measurement Conditions" paragraph. The SAR data are not affected by this change. The overall dipole length is still according to the Standard. No excessive force must be applied to the dipole arms, because they might bend or the soldered connections near the feedpoint may be damaged.

Additional EUT Data

Manufactured by	SPEAG
-----------------	-------



Add: No.51 Xueyuan Road, Haidian District, Beijing, 100191, China
Tel: +86-10-62304633-2079 Fax: +86-10-62304633-2504
E-mail: cttl@chinattl.com http://www.chinattl.cn

DASY5 Validation Report for Head TSL

Date: 12.04.2017

Test Laboratory: CTTL, Beijing, China

DUT: Dipole 835 MHz; Type: D835V2; Serial: D835V2 - SN: 4d091

Communication System: UID 0, CW; Frequency: 835 MHz; Duty Cycle: 1:1

Medium parameters used: $f = 835$ MHz; $\sigma = 0.876$ S/m; $\epsilon_r = 41.67$; $\rho = 1000$ kg/m³

Phantom section: Center Section

Measurement Standard: DASY5 (IEEE/IEC/ANSI C63.19-2007)

DASY5 Configuration:

- Probe: EX3DV4 - SN3617; ConvF(9.73, 9.73, 9.73); Calibrated: 1/23/2017;
- Sensor-Surface: 1.4mm (Mechanical Surface Detection)
- Electronics: DAE3 Sn536; Calibrated: 10/9/2017
- Phantom: Triple Flat Phantom 5.1C; Type: QD 000 P51 CA; Serial: 1161/1
- Measurement SW: DASY52, Version 52.10 (0); SEMCAD X Version 14.6.10 (7417)

Dipole Calibration/Zoom Scan (7x7x7) (7x7x7)/Cube 0: Measurement grid: dx=5mm, dy=5mm, dz=5mm

Reference Value = 58.89V/m; Power Drift = -0.00 dB

Peak SAR (extrapolated) = 3.48 W/kg

SAR(1 g) = 2.32 W/kg; SAR(10 g) = 1.53 W/kg

Maximum value of SAR (measured) = 3.10 W/kg

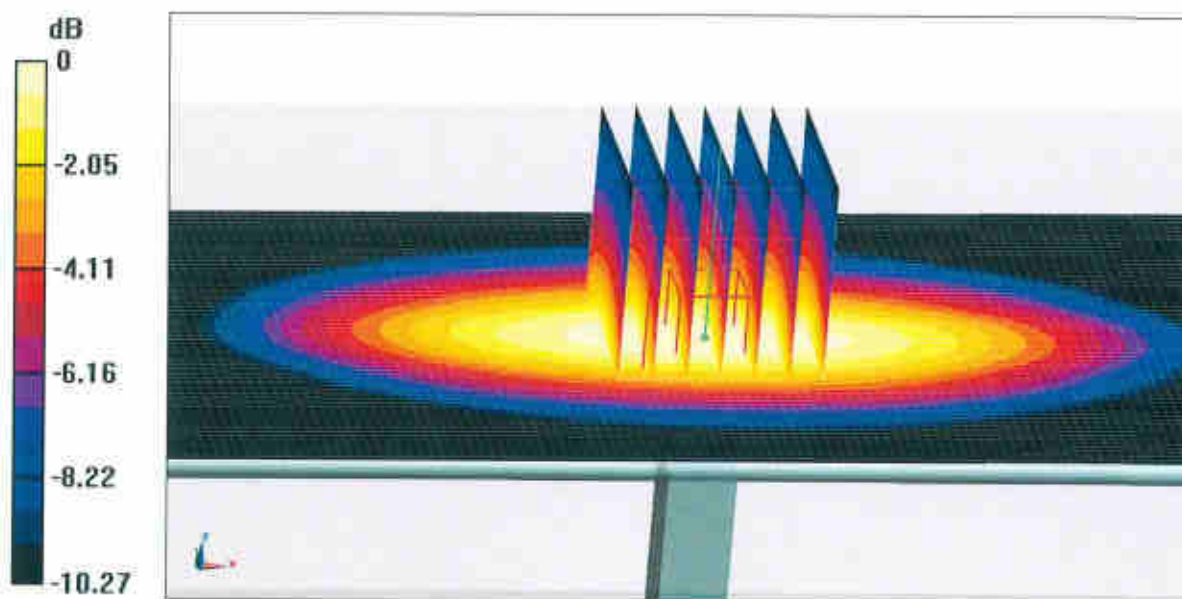

0 dB = 3.10 W/kg = 4.91 dBW/kg



Add: No.51 Xueyuan Road, Haidian District, Beijing, 100191, China
Tel: +86-10-62304633-2079 Fax: +86-10-62304633-2504
E-mail: cttl@chinattl.com http://www.chinattl.cn

Impedance Measurement Plot for Head TSL

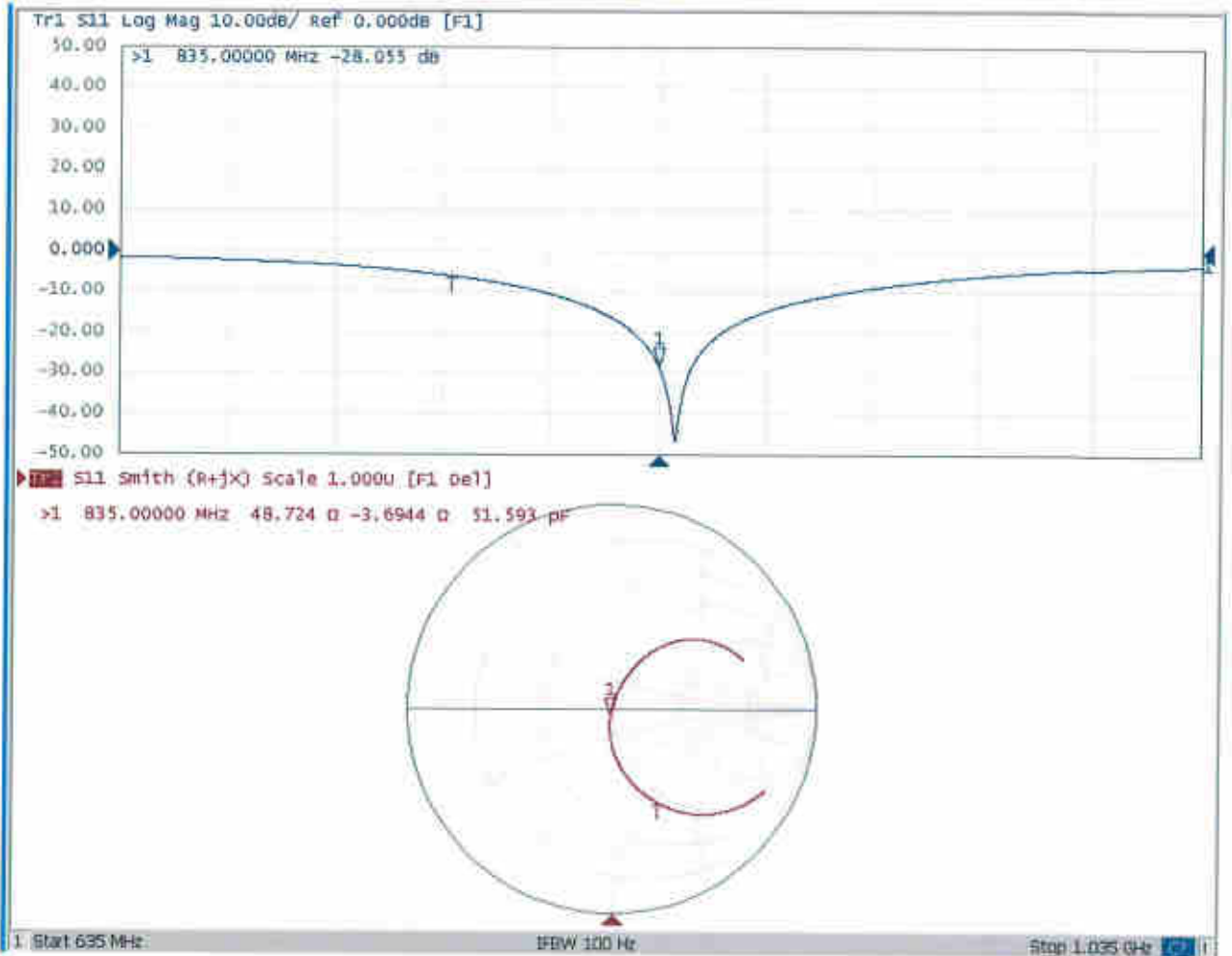



Add: No.51 Xueyuan Road, Haidian District, Beijing, 100191, China
Tel: +86-10-62304633-2079 Fax: +86-10-62304633-2504
E-mail: cttl@chinattl.com http://www.chinattl.cn

DASY5 Validation Report for Body TSL

Date: 12.05.2017

Test Laboratory: CTTL, Beijing, China

DUT: Dipole 835 MHz; Type: D835V2; Serial: D835V2 - SN: 4d091

Communication System: UID 0, CW; Frequency: 835 MHz; Duty Cycle: 1:1

Medium parameters used: $f = 835$ MHz; $\sigma = 0.962$ S/m; $\epsilon_r = 54.65$; $\rho = 1000$ kg/m³

Phantom section: Left Section

Measurement Standard: DASY5 (IEEE/IEC/ANSI C63.19-2007)

DASY5 Configuration:

- Probe: EX3DV4 - SN3617; ConvF(9.64, 9.64, 9.64); Calibrated: 1/23/2017;
- Sensor-Surface: 1.4mm (Mechanical Surface Detection)
- Electronics: DAE3 Sn536; Calibrated: 10/9/2017
- Phantom: Triple Flat Phantom 5.1C; Type: QD 000 P51 CA; Serial: 1161/1
- Measurement SW: DASY52, Version 52.10 (0); SEMCAD X Version 14.6.10 (7417)

Dipole Calibration/Zoom Scan (7x7x7) (7x7x7)/Cube 0: Measurement grid: dx=5mm, dy=5mm, dz=5mm

Reference Value = 55.88 V/m; Power Drift = 0.00 dB

Peak SAR (extrapolated) = 3.59 W/kg

SAR(1 g) = 2.42 W/kg; SAR(10 g) = 1.6 W/kg

Maximum value of SAR (measured) = 3.20 W/kg

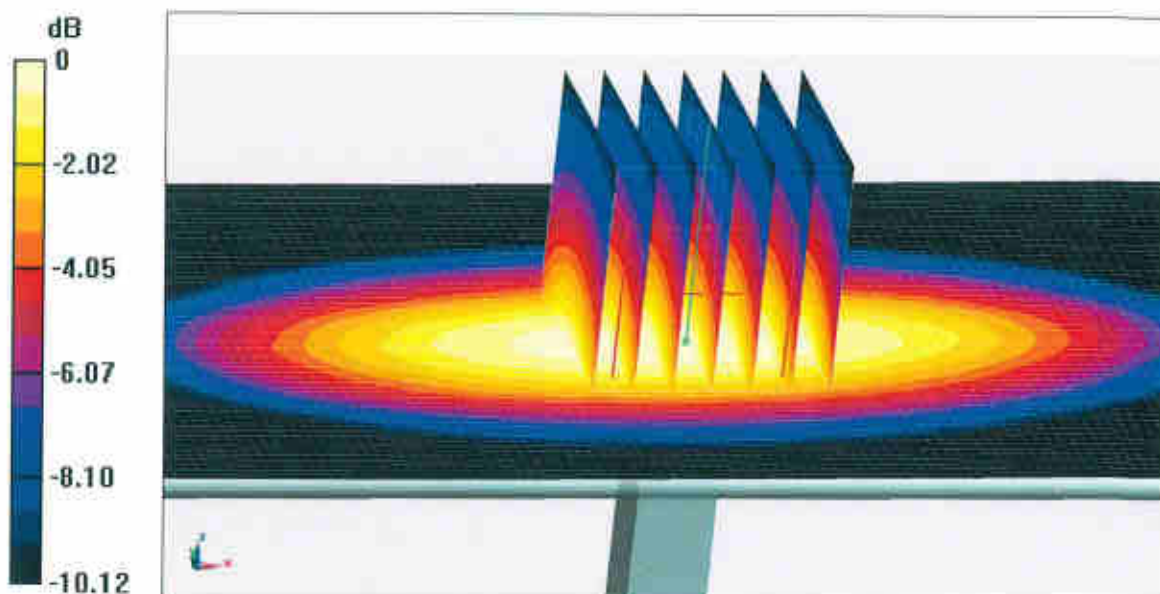

0 dB = 3.20 W/kg = 5.05 dBW/kg



Add: No.51 Xueyuan Road, Haidian District, Beijing, 100191, China
Tel: +86-10-62304633-2079 Fax: +86-10-62304633-2504
E-mail: cttl@chinattl.com <http://www.chinattl.cn>

Impedance Measurement Plot for Body TSL

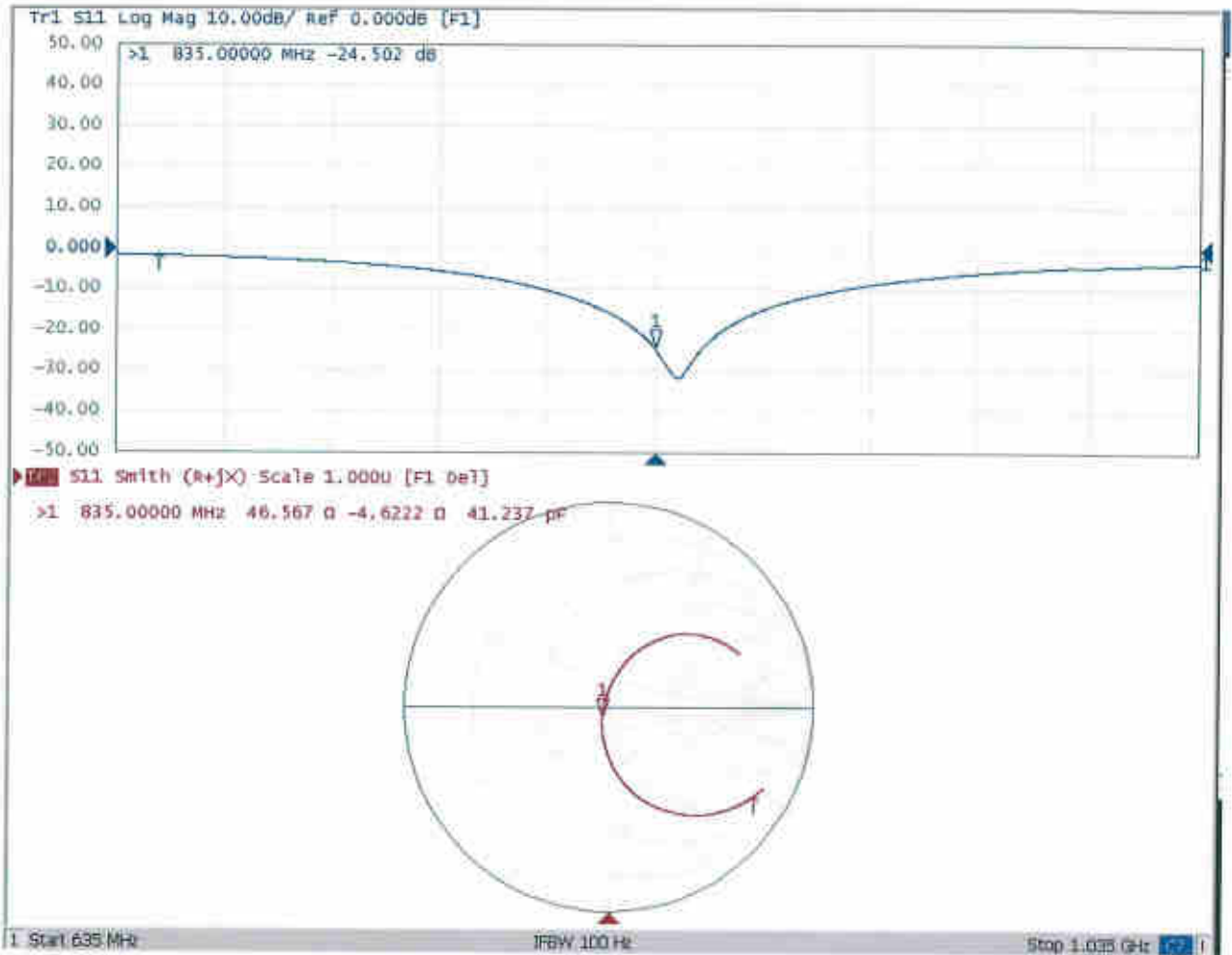



In Collaboration with
s p e a g
CALIBRATION LABORATORY



中国认可
国际互认
校准
CALIBRATION
CNAS L0570

Add: No.51 Xueyuan Road, Haidian District, Beijing, 100191, China
Tel: +86-10-62304633-2079 Fax: +86-10-62304633-2504
E-mail: cttl@chinattl.com http://www.chinattl.cn

Client

Sporton

Certificate No:

Z17-97263

CALIBRATION CERTIFICATE

Object: D2450V2 - SN: 840

Calibration Procedure(s): FF-Z11-003-01
Calibration Procedures for dipole validation kits

Calibration date: December 7, 2017

This calibration Certificate documents the traceability to national standards, which realize the physical units of measurements(SI). The measurements and the uncertainties with confidence probability are given on the following pages and are part of the certificate.

All calibrations have been conducted in the closed laboratory facility: environment temperature(22±3)°C and humidity<70%.

Calibration Equipment used (M&TE critical for calibration)

Primary Standards	ID #	Cal Date(Calibrated by, Certificate No.)	Scheduled Calibration
Power Meter NRVD	102196	02-Mar-17 (CTTL, No.J17X01254)	Mar-18
Power sensor NRV-Z5	100596	02-Mar-17 (CTTL, No.J17X01254)	Mar-18
Reference Probe EX3DV4	SN 3617	23-Jan-17(SPEAG,No.EX3-3617_Jan17)	Jan-18
DAE3	SN 536	09-Oct-17(CTTL-SPEAG,No.Z17-97198)	Oct-18
Secondary Standards	ID #	Cal Date(Calibrated by, Certificate No.)	Scheduled Calibration
Signal Generator E4438C	MY49071430	13-Jan-17 (CTTL, No.J17X00286)	Jan-18
Network Analyzer E5071C	MY46110673	13-Jan-17 (CTTL, No.J17X00285)	Jan-18

	Name	Function	Signature
Calibrated by:	Zhao Jing	SAR Test Engineer	
Reviewed by:	Lin Hao	SAR Test Engineer	
Approved by:	Qi Dianyuan	SAR Project Leader	

Issued: December 10, 2017

This calibration certificate shall not be reproduced except in full without written approval of the laboratory.



Glossary:

TSL	tissue simulating liquid
ConvF	sensitivity in TSL / NORM _{x,y,z}
N/A	not applicable or not measured

Calibration is Performed According to the Following Standards:

- IEEE Std 1528-2013, "IEEE Recommended Practice for Determining the Peak Spatial-Averaged Specific Absorption Rate (SAR) in the Human Head from Wireless Communications Devices: Measurement Techniques", June 2013
- IEC 62209-1, "Measurement procedure for assessment of specific absorption rate of human exposure to radio frequency fields from hand-held and body-mounted wireless communication devices- Part 1: Device used next to the ear (Frequency range of 300MHz to 6GHz)", July 2016
- IEC 62209-2, "Procedure to measure the Specific Absorption Rate (SAR) For wireless communication devices used in close proximity to the human body (frequency range of 30MHz to 6GHz)", March 2010
- KDB865664, SAR Measurement Requirements for 100 MHz to 6 GHz

Additional Documentation:

- DASY4/5 System Handbook

Methods Applied and Interpretation of Parameters:

- Measurement Conditions:** Further details are available from the Validation Report at the end of the certificate. All figures stated in the certificate are valid at the frequency indicated.
- Antenna Parameters with TSL:** The dipole is mounted with the spacer to position its feed point exactly below the center marking of the flat phantom section, with the arms oriented parallel to the body axis.
- Feed Point Impedance and Return Loss:** These parameters are measured with the dipole positioned under the liquid filled phantom. The impedance stated is transformed from the measurement at the SMA connector to the feed point. The Return Loss ensures low reflected power. No uncertainty required.
- Electrical Delay:** One-way delay between the SMA connector and the antenna feed point. No uncertainty required.
- SAR measured:** SAR measured at the stated antenna input power.
- SAR normalized:** SAR as measured, normalized to an input power of 1 W at the antenna connector.
- SAR for nominal TSL parameters:** The measured TSL parameters are used to calculate the nominal SAR result.

The reported uncertainty of measurement is stated as the standard uncertainty of Measurement multiplied by the coverage factor $k=2$, which for a normal distribution Corresponds to a coverage probability of approximately 95%.



Add: No.51 Xueyuan Road, Haidian District, Beijing, 100191, China
 Tel: +86-10-62304633-2079 Fax: +86-10-62304633-2504
 E-mail: cttl@chinattl.com http://www.chinattl.cn

Measurement Conditions

DASY system configuration, as far as not given on page 1.

DASY Version	DASY52	52.10.0.1446
Extrapolation	Advanced Extrapolation	
Phantom	Triple Flat Phantom 5.1C	
Distance Dipole Center - TSL	10 mm	with Spacer
Zoom Scan Resolution	dx, dy, dz = 5 mm	
Frequency	2450 MHz ± 1 MHz	

Head TSL parameters

The following parameters and calculations were applied.

	Temperature	Permittivity	Conductivity
Nominal Head TSL parameters	22.0 °C	39.2	1.80 mho/m
Measured Head TSL parameters	(22.0 ± 0.2) °C	39.8 ± 6 %	1.83 mho/m ± 6 %
Head TSL temperature change during test	<1.0 °C	---	---

SAR result with Head TSL

SAR averaged over 1 cm ³ (1 g) of Head TSL	Condition	
SAR measured	250 mW input power	13.2 mW / g
SAR for nominal Head TSL parameters	normalized to 1W	52.6 mW / g ± 18.8 % (k=2)
SAR averaged over 10 cm ³ (10 g) of Head TSL	Condition	
SAR measured	250 mW input power	6.14 mW / g
SAR for nominal Head TSL parameters	normalized to 1W	24.5 mW / g ± 18.7 % (k=2)

Body TSL parameters

The following parameters and calculations were applied.

	Temperature	Permittivity	Conductivity
Nominal Body TSL parameters	22.0 °C	52.7	1.95 mho/m
Measured Body TSL parameters	(22.0 ± 0.2) °C	52.5 ± 6 %	1.93 mho/m ± 6 %
Body TSL temperature change during test	<1.0 °C	---	---

SAR result with Body TSL

SAR averaged over 1 cm ³ (1 g) of Body TSL	Condition	
SAR measured	250 mW input power	12.9 mW / g
SAR for nominal Body TSL parameters	normalized to 1W	51.9 mW / g ± 18.8 % (k=2)
SAR averaged over 10 cm ³ (10 g) of Body TSL	Condition	
SAR measured	250 mW input power	5.99 mW / g
SAR for nominal Body TSL parameters	normalized to 1W	24.0 mW / g ± 18.7 % (k=2)



Add: No.51 Xueyuan Road, Haidian District, Beijing, 100191, China
Tel: +86-10-62304633-2079 Fax: +86-10-62304633-2504
E-mail: cttl@chinattl.com http://www.chinattl.cn

Appendix (Additional assessments outside the scope of CNAS L0570)

Antenna Parameters with Head TSL

Impedance, transformed to feed point	52.0Ω+ 4.51jΩ
Return Loss	- 26.3dB

Antenna Parameters with Body TSL

Impedance, transformed to feed point	51.1Ω+ 5.09jΩ
Return Loss	- 25.8dB

General Antenna Parameters and Design

Electrical Delay (one direction)	1.025 ns
----------------------------------	----------

After long term use with 100W radiated power, only a slight warming of the dipole near the feedpoint can be measured.

The dipole is made of standard semirigid coaxial cable. The center conductor of the feeding line is directly connected to the second arm of the dipole. The antenna is therefore short-circuited for DC-signals. On some of the dipoles, small end caps are added to the dipole arms in order to improve matching when loaded according to the position as explained in the "Measurement Conditions" paragraph. The SAR data are not affected by this change. The overall dipole length is still according to the Standard. No excessive force must be applied to the dipole arms, because they might bend or the soldered connections near the feedpoint may be damaged.

Additional EUT Data

Manufactured by	SPEAG
-----------------	-------



Add: No.51 Xueyuan Road, Haidian District, Beijing, 100191, China
Tel: +86-10-62304633-2079 Fax: +86-10-62304633-2504
E-mail: cttl@chinattl.com http://www.chinattl.cn

DASY5 Validation Report for Head TSL

Date: 12.06.2017

Test Laboratory: CTTL, Beijing, China

DUT: Dipole 2450 MHz; Type: D2450V2; Serial: D2450V2 - SN: 840

Communication System: UID 0, CW; Frequency: 2450 MHz; Duty Cycle: 1:1

Medium parameters used: $f = 2450$ MHz; $\sigma = 1.826$ S/m; $\epsilon_r = 39.84$; $\rho = 1000$ kg/m³

Phantom section: Center Section

Measurement Standard: DASY5 (IEEE/IEC/ANSI C63.19-2007)

DASY5 Configuration:

- Probe: EX3DV4 - SN3617; ConvF(7.74, 7.74, 7.74); Calibrated: 1/23/2017;
- Sensor-Surface: 1.4mm (Mechanical Surface Detection)
- Electronics: DAE3 Sn536; Calibrated: 10/9/2017
- Phantom: Triple Flat Phantom 5.1C; Type: QD 000 P51 CA; Serial: 1161/1
- Measurement SW: DASY52, Version 52.10 (0); SEMCAD X Version 14.6.10 (7417)

Dipole Calibration/Zoom Scan (7x7x7) (7x7x7)/Cube 0: Measurement grid: dx=5mm, dy=5mm, dz=5mm

Reference Value = 106.0 V/m; Power Drift = 0.00 dB

Peak SAR (extrapolated) = 27.3 W/kg

SAR(1 g) = 13.2 W/kg; SAR(10 g) = 6.14 W/kg

Maximum value of SAR (measured) = 22.0 W/kg

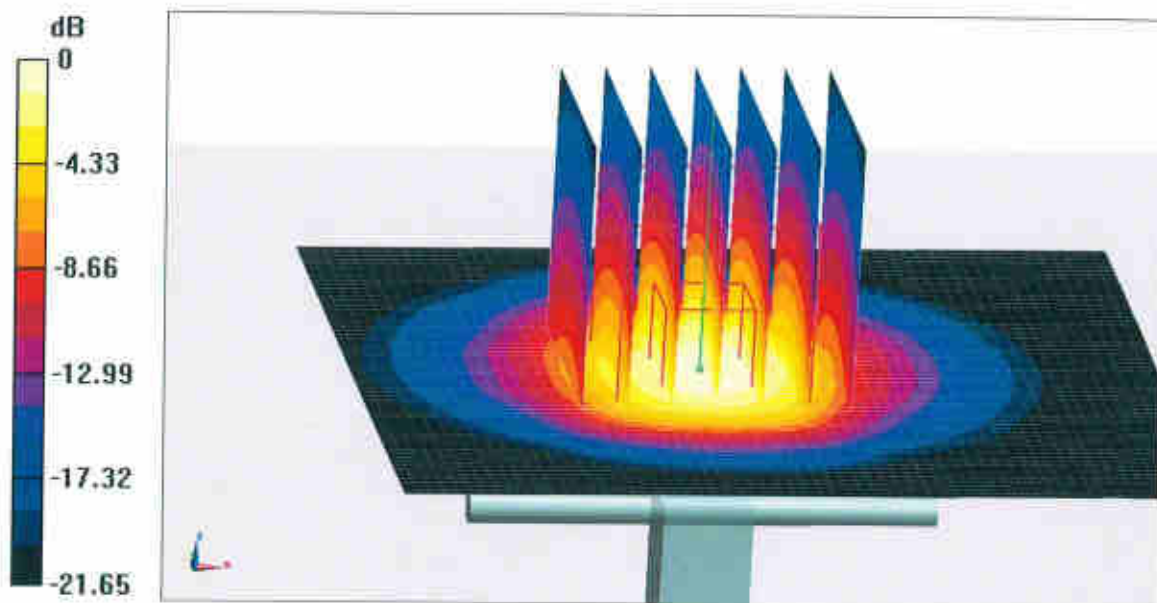

0 dB = 22.0 W/kg = 13.42 dBW/kg



Add: No.51 Xueyuan Road, Haidian District, Beijing, 100191, China
Tel: +86-10-62304633-2079 Fax: +86-10-62304633-2504
E-mail: cttl@chinattl.com http://www.chinattl.cn

Impedance Measurement Plot for Head TSL

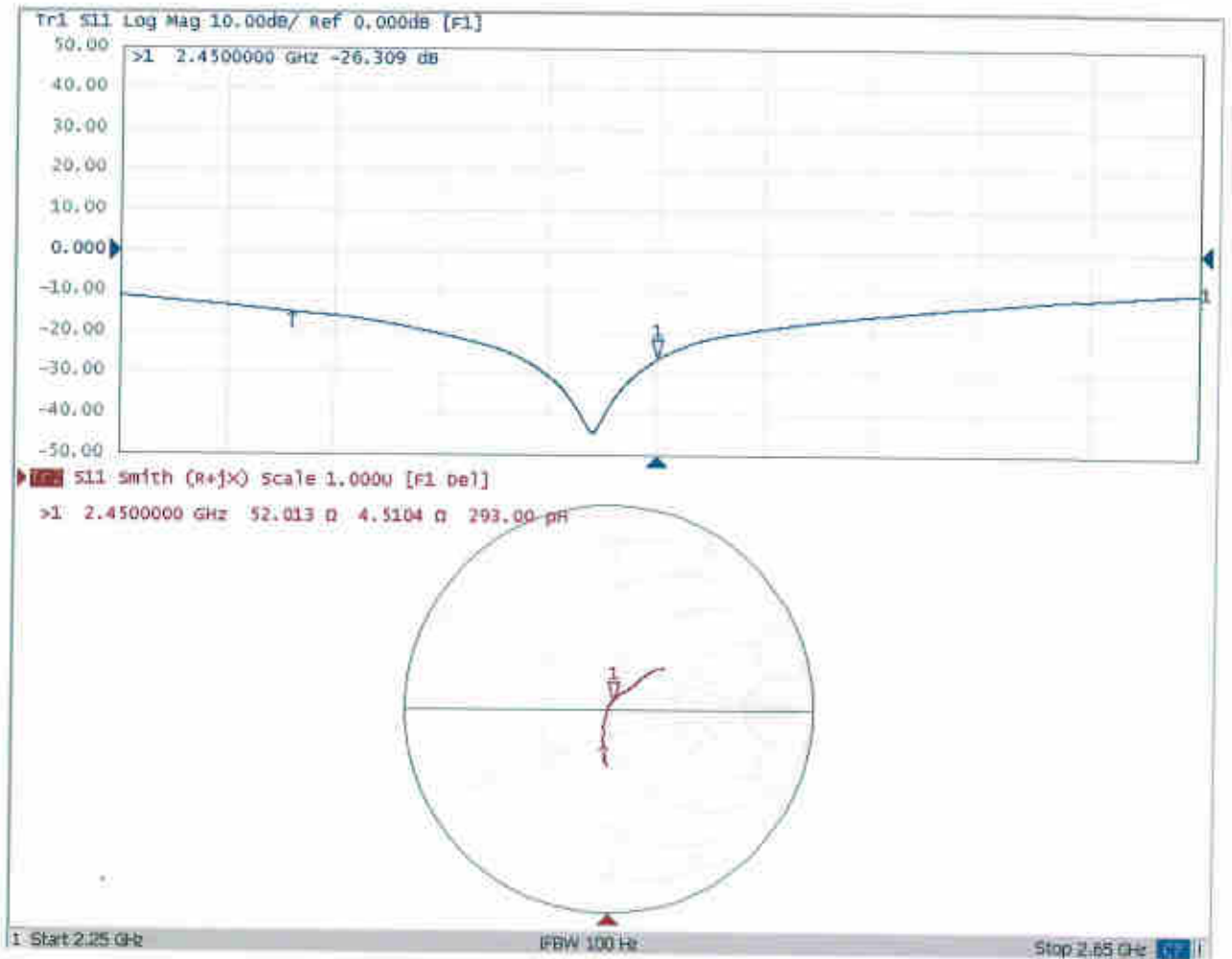



Add: No.51 Xueyuan Road, Haidian District, Beijing, 100191, China
Tel: +86-10-62304633-2079 Fax: +86-10-62304633-2504
E-mail: cttl@chinattl.com http://www.chinattl.cn

DASY5 Validation Report for Body TSL

Date: 12.07.2017

Test Laboratory: CTTL, Beijing, China

DUT: Dipole 2450 MHz; Type: D2450V2; Serial: D2450V2 - SN: 840

Communication System: UID 0, CW; Frequency: 2450 MHz; Duty Cycle: 1:1

Medium parameters used: $f = 2450$ MHz; $\sigma = 1.926$ S/m; $\epsilon_r = 52.48$; $\rho = 1000$ kg/m³

Phantom section: Left Section

Measurement Standard: DASY5 (IEEE/IEC/ANSI C63.19-2007)

DASY5 Configuration:

- Probe: EX3DV4 - SN3617; ConvF(7.8, 7.8, 7.8); Calibrated: 1/23/2017;
- Sensor-Surface: 1.4mm (Mechanical Surface Detection)
- Electronics: DAE3 Sn536; Calibrated: 10/9/2017
- Phantom: Triple Flat Phantom 5.1C; Type: QD 000 P51 CA; Serial: 1161/I
- Measurement SW: DASY52, Version 52.10 (0); SEMCAD X Version 14.6.10 (7417)

Dipole Calibration/Zoom Scan (7x7x7) (7x7x7)/Cube 0: Measurement grid: dx=5mm, dy=5mm, dz=5mm

Reference Value = 99.77 V/m; Power Drift = 0.02 dB

Peak SAR (extrapolated) = 26.8 W/kg

SAR(1 g) = 12.9 W/kg; SAR(10 g) = 5.99 W/kg

Maximum value of SAR (measured) = 21.7 W/kg

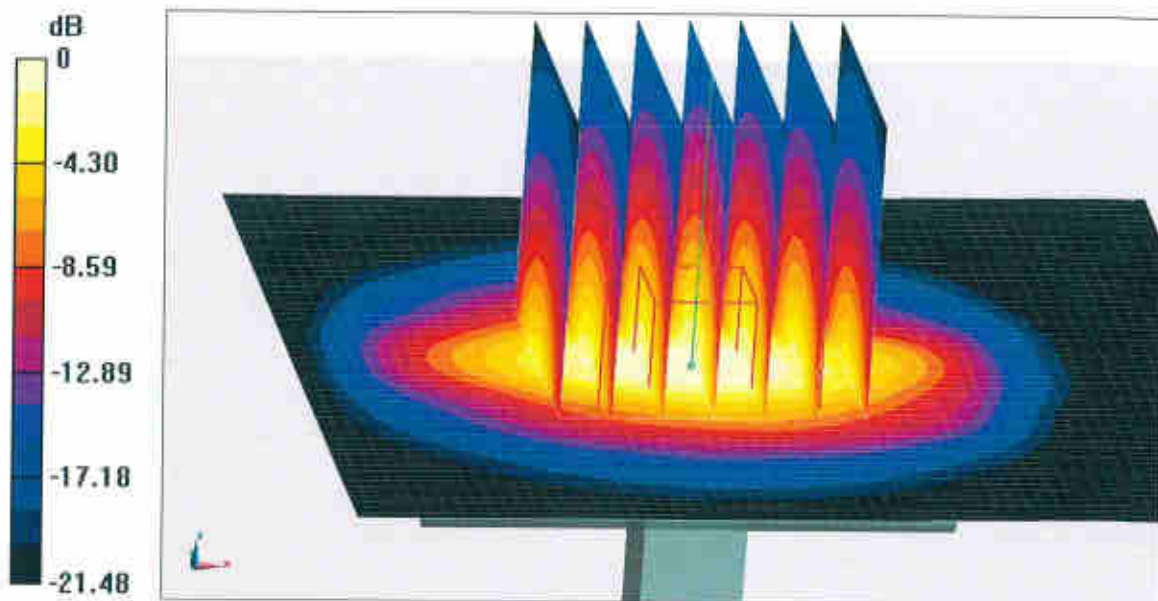

0 dB = 21.7 W/kg = 13.36 dBW/kg



Add: No.51 Xueyuan Road, Haidian District, Beijing, 100191, China
Tel: +86-10-62304633-2079 Fax: +86-10-62304633-2504
E-mail: cttl@chinattl.com http://www.chinattl.cn

Impedance Measurement Plot for Body TSL

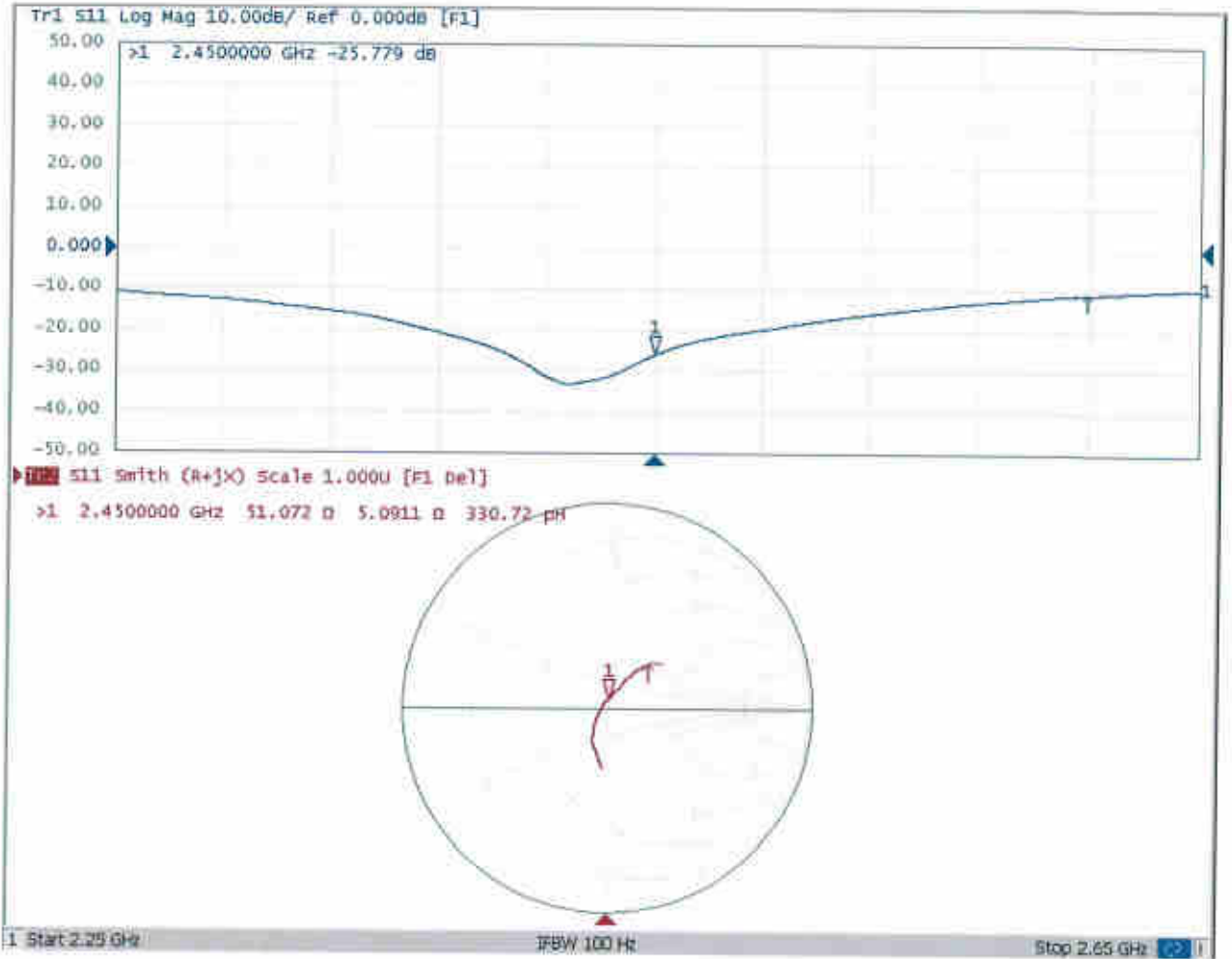



In Collaboration with
s p e a g
CALIBRATION LABORATORY



中国认可
国际互认
校准
CALIBRATION
CNAS L0570

Add: No.51 Xueyuan Road, Haidian District, Beijing, 100191, China
Tel: +86-10-62304633-2079 Fax: +86-10-62304633-2504
E-mail: cttl@chinattl.com http://www.chinattl.cn

Client

Sporton

Certificate No:

Z17-97255

CALIBRATION CERTIFICATE

Object: D2600V2 - SN: 1061

Calibration Procedure(s): FF-Z11-003-01
Calibration Procedures for dipole validation kits

Calibration date: December 7, 2017

This calibration Certificate documents the traceability to national standards, which realize the physical units of measurements(SI). The measurements and the uncertainties with confidence probability are given on the following pages and are part of the certificate.

All calibrations have been conducted in the closed laboratory facility: environment temperature(22±3)°C and humidity<70%.

Calibration Equipment used (M&TE critical for calibration)

Primary Standards	ID #	Cal Date(Calibrated by, Certificate No.)	Scheduled Calibration
Power Meter NRVD	102196	02-Mar-17 (CTTL, No.J17X01254)	Mar-18
Power sensor NRV-Z5	100596	02-Mar-17 (CTTL, No.J17X01254)	Mar-18
Reference Probe EX3DV4	SN 3617	23-Jan-17(SPEAG,No.EX3-3617_Jan17)	Jan-18
DAE3	SN 536	09-Oct-17(CTTL-SPEAG,No.Z17-97198)	Oct-18
Secondary Standards	ID #	Cal Date(Calibrated by, Certificate No.)	Scheduled Calibration
Signal Generator E4438C	MY49071430	13-Jan-17 (CTTL, No.J17X00286)	Jan-18
Network Analyzer E5071C	MY46110673	13-Jan-17 (CTTL, No.J17X00285)	Jan-18

	Name	Function	Signature
Calibrated by:	Zhao Jing	SAR Test Engineer	
Reviewed by:	Lin Hao	SAR Test Engineer	
Approved by:	Qi Dianyuan	SAR Project Leader	

Issued: December 10, 2017

This calibration certificate shall not be reproduced except in full without written approval of the laboratory.



Glossary:

TSL	tissue simulating liquid
ConvF	sensitivity in TSL / NORM _{x,y,z}
N/A	not applicable or not measured

Calibration is Performed According to the Following Standards:

- IEEE Std 1528-2013, "IEEE Recommended Practice for Determining the Peak Spatial-Averaged Specific Absorption Rate (SAR) in the Human Head from Wireless Communications Devices: Measurement Techniques", June 2013
- IEC 62209-1, "Measurement procedure for assessment of specific absorption rate of human exposure to radio frequency fields from hand-held and body-mounted wireless communication devices- Part 1: Device used next to the ear (Frequency range of 300MHz to 6GHz)", July 2016
- IEC 62209-2, "Procedure to measure the Specific Absorption Rate (SAR) For wireless communication devices used in close proximity to the human body (frequency range of 30MHz to 6GHz)", March 2010
- KDB865664, SAR Measurement Requirements for 100 MHz to 6 GHz

Additional Documentation:

- DASY4/5 System Handbook

Methods Applied and Interpretation of Parameters:

- Measurement Conditions:** Further details are available from the Validation Report at the end of the certificate. All figures stated in the certificate are valid at the frequency indicated.
- Antenna Parameters with TSL:** The dipole is mounted with the spacer to position its feed point exactly below the center marking of the flat phantom section, with the arms oriented parallel to the body axis.
- Feed Point Impedance and Return Loss:** These parameters are measured with the dipole positioned under the liquid filled phantom. The impedance stated is transformed from the measurement at the SMA connector to the feed point. The Return Loss ensures low reflected power. No uncertainty required.
- Electrical Delay:** One-way delay between the SMA connector and the antenna feed point. No uncertainty required.
- SAR measured:** SAR measured at the stated antenna input power.
- SAR normalized:** SAR as measured, normalized to an input power of 1 W at the antenna connector.
- SAR for nominal TSL parameters:** The measured TSL parameters are used to calculate the nominal SAR result.

The reported uncertainty of measurement is stated as the standard uncertainty of Measurement multiplied by the coverage factor $k=2$, which for a normal distribution Corresponds to a coverage probability of approximately 95%.



Measurement Conditions

DASY system configuration, as far as not given on page 1.

DASY Version	DASY52	52.10.0.1446
Extrapolation	Advanced Extrapolation	
Phantom	Triple Flat Phantom 5.1C	
Distance Dipole Center - TSL	10 mm	with Spacer
Zoom Scan Resolution	dx, dy, dz = 5 mm	
Frequency	2600 MHz ± 1 MHz	

Head TSL parameters

The following parameters and calculations were applied.

	Temperature	Permittivity	Conductivity
Nominal Head TSL parameters	22.0 °C	39.0	1.96 mho/m
Measured Head TSL parameters	(22.0 ± 0.2) °C	39.4 ± 6 %	1.99 mho/m ± 6 %
Head TSL temperature change during test	<1.0 °C	---	---

SAR result with Head TSL

SAR averaged over 1 cm ³ (1 g) of Head TSL	Condition	
SAR measured	250 mW input power	14.6 mW / g
SAR for nominal Head TSL parameters	normalized to 1W	58.2 mW / g ± 18.8 % (k=2)
SAR averaged over 10 cm ³ (10 g) of Head TSL	Condition	
SAR measured	250 mW input power	6.50 mW / g
SAR for nominal Head TSL parameters	normalized to 1W	26.0 mW / g ± 18.7 % (k=2)

Body TSL parameters

The following parameters and calculations were applied.

	Temperature	Permittivity	Conductivity
Nominal Body TSL parameters	22.0 °C	52.5	2.16 mho/m
Measured Body TSL parameters	(22.0 ± 0.2) °C	52.6 ± 6 %	2.13 mho/m ± 6 %
Body TSL temperature change during test	<1.0 °C	---	---

SAR result with Body TSL

SAR averaged over 1 cm ³ (1 g) of Body TSL	Condition	
SAR measured	250 mW input power	14.0 mW / g
SAR for nominal Body TSL parameters	normalized to 1W	56.4 mW / g ± 18.8 % (k=2)
SAR averaged over 10 cm ³ (10 g) of Body TSL	Condition	
SAR measured	250 mW input power	6.23 mW / g
SAR for nominal Body TSL parameters	normalized to 1W	25.0 mW / g ± 18.7 % (k=2)



Add: No.51 Xueyuan Road, Haidian District, Beijing, 100191, China
Tel: +86-10-62304633-2079 Fax: +86-10-62304633-2504
E-mail: cttl@chinattl.com http://www.chinattl.cn

Appendix(Additional assessments outside the scope of CNAS L0570)

Antenna Parameters with Head TSL

Impedance, transformed to feed point	49.4Ω- 6.08jΩ
Return Loss	- 24.3dB

Antenna Parameters with Body TSL

Impedance, transformed to feed point	46.2Ω- 5.19jΩ
Return Loss	- 23.5dB

General Antenna Parameters and Design

Electrical Delay (one direction)	1.013 ns
----------------------------------	----------

After long term use with 100W radiated power, only a slight warming of the dipole near the feedpoint can be measured.

The dipole is made of standard semirigid coaxial cable. The center conductor of the feeding line is directly connected to the second arm of the dipole. The antenna is therefore short-circuited for DC-signals. On some of the dipoles, small end caps are added to the dipole arms in order to improve matching when loaded according to the position as explained in the "Measurement Conditions" paragraph. The SAR data are not affected by this change. The overall dipole length is still according to the Standard. No excessive force must be applied to the dipole arms, because they might bend or the soldered connections near the feedpoint may be damaged.

Additional EUT Data

Manufactured by	SPEAG
-----------------	-------



Add: No.51 Xueyuan Road, Haidian District, Beijing, 100191, China
Tel: +86-10-62304633-2079 Fax: +86-10-62304633-2504
E-mail: cttl@chinattl.com http://www.chinattl.cn

DASY5 Validation Report for Head TSL

Date: 12.07.2017

Test Laboratory: CTTL, Beijing, China

DUT: Dipole 2600 MHz; Type: D2600V2; Serial: D2600V2 - SN: 1061

Communication System: UID 0, CW; Frequency: 2600 MHz; Duty Cycle: 1:1

Medium parameters used: $f = 2600$ MHz; $\sigma = 1.985$ S/m; $\epsilon_r = 39.42$; $\rho = 1000$ kg/m³

Phantom section: Center Section

Measurement Standard: DASY5 (IEEE/IEC/ANSI C63.19-2007)

DASY5 Configuration:

- Probe: EX3DV4 - SN3617; ConvF(7.3, 7.3, 7.3); Calibrated: 1/23/2017;
- Sensor-Surface: 1.4mm (Mechanical Surface Detection)
- Electronics: DAE3 Sn536; Calibrated: 10/9/2017
- Phantom: Triple Flat Phantom 5.1C; Type: QD 000 P51 CA; Serial: 1161/1
- Measurement SW: DASY52, Version 52.10 (0); SEMCAD X Version 14.6.10 (7417)

Dipole Calibration/Zoom Scan (7x7x7) (7x7x7)/Cube 0: Measurement grid: dx=5mm, dy=5mm, dz=5mm

Reference Value = 107.7 V/m; Power Drift = 0.00 dB

Peak SAR (extrapolated) = 31.5 W/kg

SAR(1 g) = 14.6 W/kg; SAR(10 g) = 6.5 W/kg

Maximum value of SAR (measured) = 25.1 W/kg

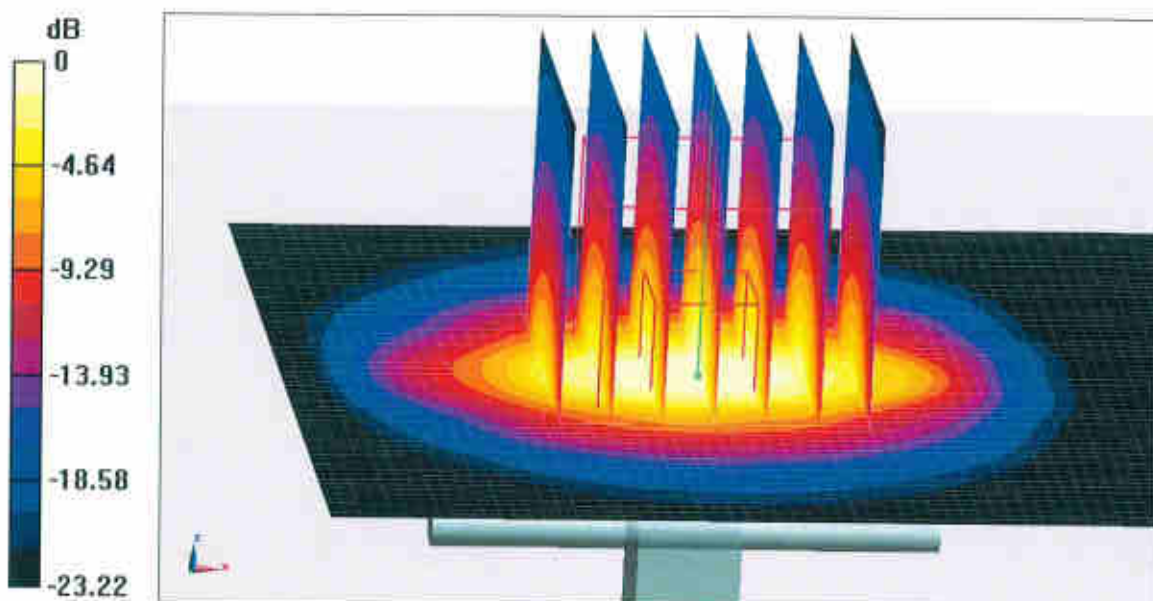

0 dB = 25.1 W/kg = 14.00 dBW/kg



Add: No.51 Xueyuan Road, Haidian District, Beijing, 100191, China
Tel: +86-10-62304633-2079 Fax: +86-10-62304633-2504
E-mail: cttl@chinattl.com http://www.chinattl.cn

Impedance Measurement Plot for Head TSL

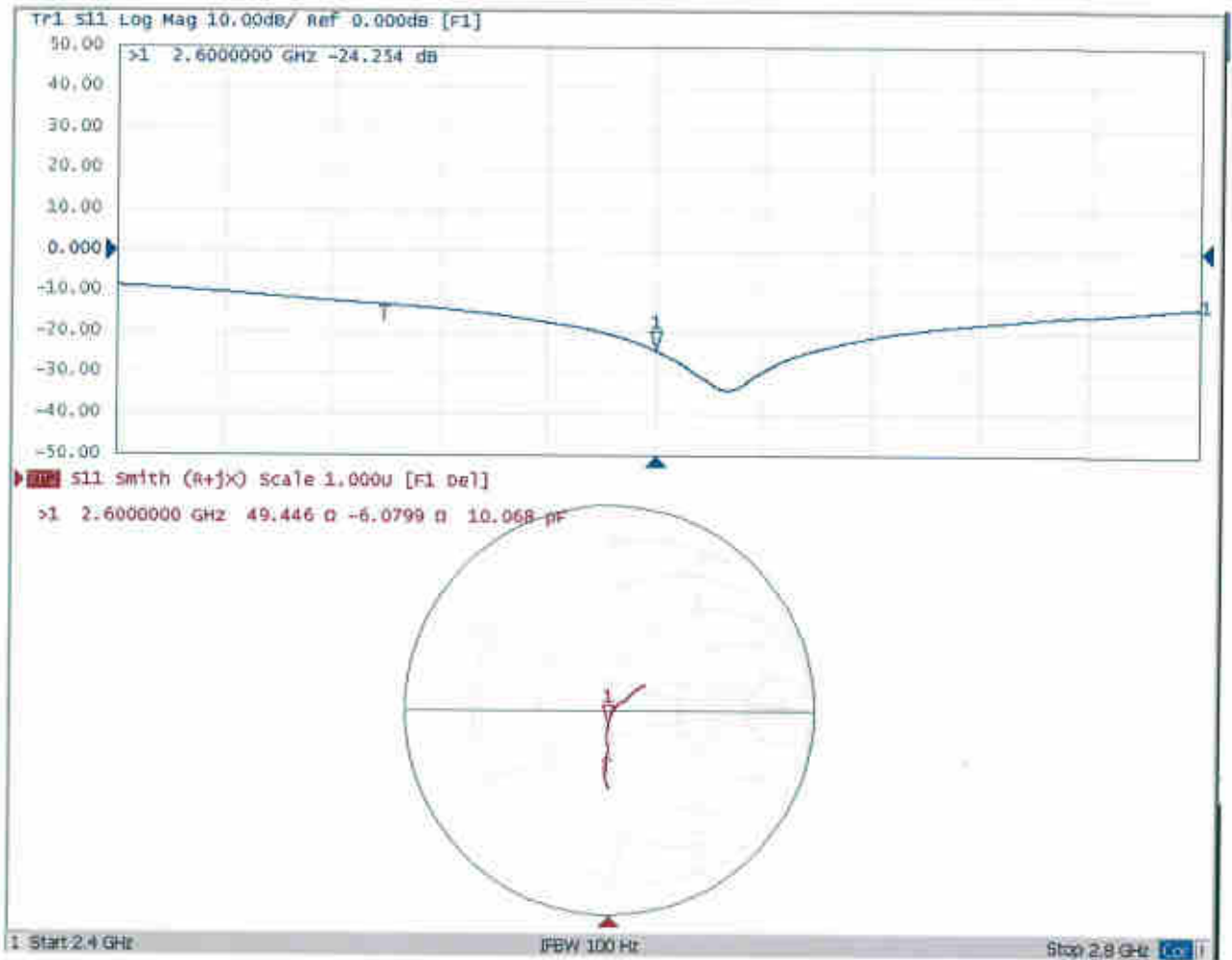

DASY5 Validation Report for Body TSL

Date: 12.07.2017

Test Laboratory: CTTL, Beijing, China

DUT: Dipole 2600 MHz; Type: D2600V2; Serial: D2600V2 - SN: 1061

Communication System: UID 0, CW; Frequency: 2600 MHz; Duty Cycle: 1:1

Medium parameters used: $f = 2600$ MHz; $\sigma = 2.127$ S/m; $\epsilon_r = 52.63$; $\rho = 1000$ kg/m³

Phantom section: Left Section

Measurement Standard: DASY5 (IEEE/IEC/ANSI C63.19-2007)

DASY5 Configuration:

- Probe: EX3DV4 - SN3617; ConvF(7.48, 7.48, 7.48); Calibrated: 1/23/2017;
- Sensor-Surface: 1.4mm (Mechanical Surface Detection)
- Electronics: DAE3 Sn536; Calibrated: 10/9/2017
- Phantom: Triple Flat Phantom 5.1C; Type: QD 000 P51 CA; Serial: 1161/1
- Measurement SW: DASY52, Version 52.10 (0); SEMCAD X Version 14.6.10 (7417)

Dipole Calibration/Zoom Scan (7x7x7) (7x7x7)/Cube 0: Measurement grid: dx=5mm, dy=5mm, dz=5mm

Reference Value = 96.43 V/m; Power Drift = 0.03 dB

Peak SAR (extrapolated) = 30.0 W/kg

SAR(1 g) = 14 W/kg; SAR(10 g) = 6.23 W/kg

Maximum value of SAR (measured) = 23.8 W/kg

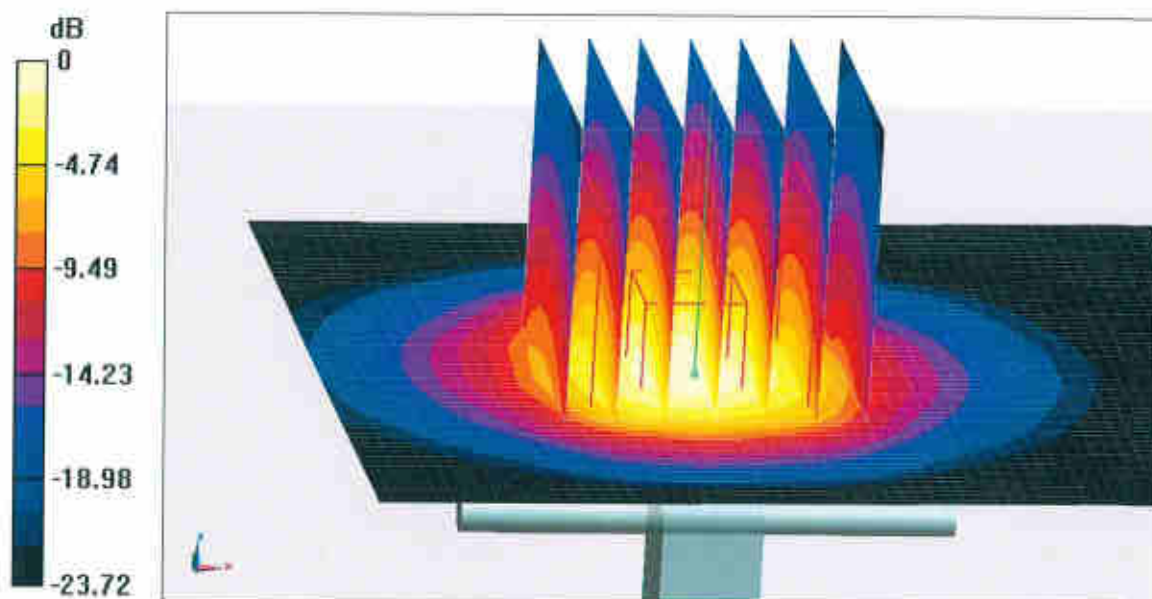

0 dB = 23.8 W/kg = 13.77 dBW/kg



Add: No.51 Xueyuan Road, Haidian District, Beijing, 100191, China
Tel: +86-10-62304633-2079 Fax: +86-10-62304633-2504
E-mail: cttl@chinattl.com http://www.chinattl.cn

Impedance Measurement Plot for Body TSL

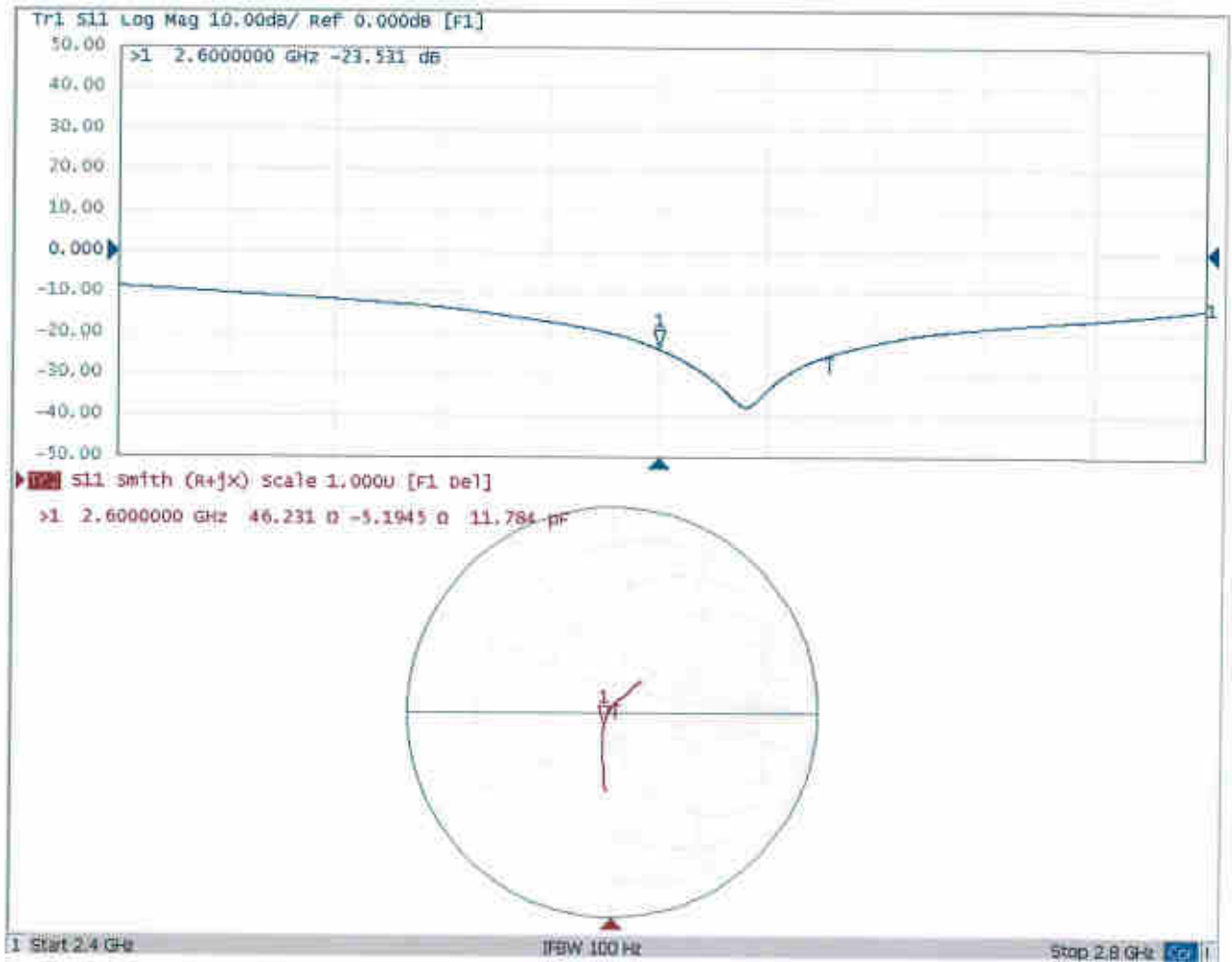

IMPORTANT NOTICE

USAGE OF THE DAE 4

The DAE unit is a delicate, high precision instrument and requires careful treatment by the user. There are no serviceable parts inside the DAE. Special attention shall be given to the following points:

Battery Exchange: The battery cover of the DAE4 unit is closed using a screw, over tightening the screw may cause the threads inside the DAE to wear out.

Shipping of the DAE: Before shipping the DAE to SPEAG for calibration, remove the batteries and pack the DAE in an antistatic bag. This antistatic bag shall then be packed into a larger box or container which protects the DAE from impacts during transportation. The package shall be marked to indicate that a fragile instrument is inside.

E-Stop Failures: Touch detection may be malfunctioning due to broken magnets in the E-stop. Rough handling of the E-stop may lead to damage of these magnets. Touch and collision errors are often caused by dust and dirt accumulated in the E-stop. To prevent E-stop failure, the customer shall always mount the probe to the DAE carefully and keep the DAE unit in a non-dusty environment if not used for measurements.

Repair: Minor repairs are performed at no extra cost during the annual calibration. However, SPEAG reserves the right to charge for any repair especially if rough unprofessional handling caused the defect.

DASY Configuration Files: Since the exact values of the DAE input resistances, as measured during the calibration procedure of a DAE unit, are not used by the DASY software, a nominal value of 200 MOhm is given in the corresponding configuration file.

Important Note:

Warranty and calibration is void if the DAE unit is disassembled partly or fully by the Customer.

Important Note:

Never attempt to grease or oil the E-stop assembly. Cleaning and readjusting of the E-stop assembly is allowed by certified SPEAG personnel only and is part of the annual calibration procedure.

Important Note:

To prevent damage of the DAE probe connector pins, use great care when installing the probe to the DAE. Carefully connect the probe with the connector notch oriented in the mating position. Avoid any rotational movement of the probe body versus the DAE while turning the locking nut of the connector. The same care shall be used when disconnecting the probe from the DAE.



Accredited by the Swiss Accreditation Service (SAS)
The Swiss Accreditation Service is one of the signatories to the EA
Multilateral Agreement for the recognition of calibration certificates

Accreditation No.: **SCS 0108**

Client **Auden**

Certificate No: **DAE4-915_Jun17**

CALIBRATION CERTIFICATE

Object **DAE4 - SD 000 D04 BK - SN: 915**

Calibration procedure(s) **QA CAL-06.v29
Calibration procedure for the data acquisition electronics (DAE)**

Calibration date: **June 16, 2017**

This calibration certificate documents the traceability to national standards, which realize the physical units of measurements (SI).
The measurements and the uncertainties with confidence probability are given on the following pages and are part of the certificate.

All calibrations have been conducted in the closed laboratory facility: environment temperature (22 ± 3)°C and humidity < 70%.

Calibration Equipment used (M&TE-critical for calibration)

Primary Standards	ID #	Cal Date (Certificate No.)	Scheduled Calibration
Keithley Multimeter Type 2001	SN: 0810278	09-Sep-16 (No:19065)	Sep-17
Secondary Standards	ID #	Check Date (in house)	Scheduled Check
Auto DAE Calibration Unit	SE UWS 053 AA 1001	05-Jan-17 (in house check)	In house check: Jan-18
Calibrator Box V2.1	SE UMS 006 AA 1002	05-Jan-17 (in house check)	In house check: Jan-18

Calibrated by:	Name Eric Hainfeld	Function Technician	Signature
Approved by:	Fin Bornholt	Deputy Technical Manager	

Issued: June 16, 2017

This calibration certificate shall not be reproduced except in full without written approval of the laboratory.



Accredited by the Swiss Accreditation Service (SAS)

The Swiss Accreditation Service is one of the signatories to the EA Multilateral Agreement for the recognition of calibration certificates

Glossary

DAE	data acquisition electronics
Connector angle	information used in DASY system to align probe sensor X to the robot coordinate system.

Methods Applied and Interpretation of Parameters

- *DC Voltage Measurement:* Calibration Factor assessed for use in DASY system by comparison with a calibrated instrument traceable to national standards. The figure given corresponds to the full scale range of the voltmeter in the respective range.
- *Connector angle:* The angle of the connector is assessed measuring the angle mechanically by a tool inserted. Uncertainty is not required.
- The following parameters as documented in the Appendix contain technical information as a result from the performance test and require no uncertainty.
 - *DC Voltage Measurement Linearity:* Verification of the Linearity at +10% and -10% of the nominal calibration voltage. Influence of offset voltage is included in this measurement.
 - *Common mode sensitivity:* Influence of a positive or negative common mode voltage on the differential measurement.
 - *Channel separation:* Influence of a voltage on the neighbor channels not subject to an input voltage.
 - *AD Converter Values with inputs shorted:* Values on the internal AD converter corresponding to zero input voltage
 - *Input Offset Measurement:* Output voltage and statistical results over a large number of zero voltage measurements.
 - *Input Offset Current:* Typical value for information; Maximum channel input offset current, not considering the input resistance.
 - *Input resistance:* Typical value for information: DAE input resistance at the connector, during internal auto-zeroing and during measurement.
 - *Low Battery Alarm Voltage:* Typical value for information. Below this voltage, a battery alarm signal is generated.
 - *Power consumption:* Typical value for information. Supply currents in various operating modes.

DC Voltage Measurement

A/D - Converter Resolution nominal

High Range: 1LSB = 6.1 μ V, full range = -100...+300 mV

Low Range: 1LSB = 61nV, full range = -1.....+3mV

DASY measurement parameters: Auto Zero Time: 3 sec; Measuring time: 3 sec

Calibration Factors	X	Y	Z
High Range	404.270 \pm 0.02% (k=2)	404.412 \pm 0.02% (k=2)	404.743 \pm 0.02% (k=2)
Low Range	3.97876 \pm 1.50% (k=2)	3.99515 \pm 1.50% (k=2)	3.98839 \pm 1.50% (k=2)

Connector Angle

Connector Angle to be used in DASY system	115.5 $^{\circ}$ \pm 1 $^{\circ}$
---	-------------------------------------

Appendix (Additional assessments outside the scope of SCS0108)

1. DC Voltage Linearity

High Range		Reading (μV)	Difference (μV)	Error (%)
Channel X	+ Input	200035.45	1.45	0.00
Channel X	+ Input	20005.57	0.83	0.00
Channel X	- Input	-20002.65	2.63	-0.01
Channel Y	+ Input	200042.17	8.68	0.00
Channel Y	+ Input	20005.49	0.84	0.00
Channel Y	- Input	-20005.61	-0.27	0.00
Channel Z	+ Input	200035.40	-4.00	-0.00
Channel Z	+ Input	20003.55	-0.96	-0.00
Channel Z	- Input	-20006.81	-1.32	0.01

Low Range		Reading (μV)	Difference (μV)	Error (%)
Channel X	+ Input	2000.99	0.13	0.01
Channel X	+ Input	201.24	0.41	0.20
Channel X	- Input	-198.67	0.56	-0.28
Channel Y	+ Input	2000.59	-0.24	-0.01
Channel Y	+ Input	200.55	-0.27	-0.13
Channel Y	- Input	-199.51	-0.27	0.13
Channel Z	+ Input	2000.64	-0.11	-0.01
Channel Z	+ Input	199.75	-0.97	-0.48
Channel Z	- Input	-200.42	-1.11	0.56

2. Common mode sensitivity

DASY measurement parameters: Auto Zero Time: 3 sec; Measuring time: 3 sec

	Common mode Input Voltage (mV)	High Range Average Reading (μV)	Low Range Average Reading (μV)
Channel X	200	-15.06	-16.32
	- 200	18.64	16.76
Channel Y	200	-5.13	-5.50
	- 200	4.34	4.43
Channel Z	200	-1.15	-1.30
	- 200	-0.70	-0.95

3. Channel separation

DASY measurement parameters: Auto Zero Time: 3 sec; Measuring time: 3 sec

	Input Voltage (mV)	Channel X (μV)	Channel Y (μV)	Channel Z (μV)
Channel X	200	-	3.31	-3.48
Channel Y	200	8.37	-	4.21
Channel Z	200	10.27	6.52	-

4. AD-Converter Values with inputs shorted

DASY measurement parameters: Auto Zero Time: 3 sec; Measuring time: 3 sec

	High Range (LSB)	Low Range (LSB)
Channel X	16111	17514
Channel Y	15972	16571
Channel Z	15895	17158

5. Input Offset Measurement

DASY measurement parameters: Auto Zero Time: 3 sec; Measuring time: 3 sec

Input 10M Ω

	Average (μ V)	min. Offset (μ V)	max. Offset (μ V)	Std. Deviation (μ V)
Channel X	0.96	-0.08	2.02	0.45
Channel Y	0.28	-0.96	1.60	0.46
Channel Z	-0.41	-1.19	0.62	0.37

6. Input Offset Current

Nominal Input circuitry offset current on all channels: <25fA

7. Input Resistance (Typical values for information)

	Zeroing (kOhm)	Measuring (MOhm)
Channel X	200	200
Channel Y	200	200
Channel Z	200	200

8. Low Battery Alarm Voltage (Typical values for information)

Typical values	Alarm Level (VDC)
Supply (+ Vcc)	+7.9
Supply (- Vcc)	-7.6

9. Power Consumption (Typical values for information)

Typical values	Switched off (mA)	Stand by (mA)	Transmitting (mA)
Supply (+ Vcc)	+0.01	+6	+14
Supply (- Vcc)	-0.01	-8	-9