



TEST REPORT

No.B18N00766-SAR

For

HMD Global Oy

Smart phone

Model Name: TA-1061

With

Hardware Version: 0403/0407

Software Version: 00WW_0_266

FCC ID: 2AJOTTA-1061

Issued Date: 2018-05-30

Designation Number: CN1210

Note:

The test results in this test report relate only to the devices specified in this report. This report shall not be reproduced except in full without the written approval of SAICT.

Test Laboratory:

Shenzhen Academy of Information and Communications Technology
Building G, Shenzhen International Innovation Center, No.1006 Shennan Road, Futian District, Shenzhen,
Guangdong, P. R. China 518026.

Tel: +86(0)755-33322000, Fax: +86(0)755-33322001

Email: yewu@caict.ac.cn, website: www.cszit.com

REPORT HISTORY

Report Number	Revision	Issue Date	Description
B18N00766-SAR	Rev.0	2018-05-30	Initial creation of test report

TABLE OF CONTENT

1 TEST LABORATORY	5
1.1 TESTING LOCATION	5
1.2 TESTING ENVIRONMENT.....	5
1.3 PROJECT DATA	5
1.4 SIGNATURE.....	5
2 STATEMENT OF COMPLIANCE	6
3 CLIENT INFORMATION	9
3.1 APPLICANT INFORMATION	9
3.2 MANUFACTURER INFORMATION	9
4 EQUIPMENT UNDER TEST (EUT) AND ANCILLARY EQUIPMENT (AE)	10
4.1 ABOUT EUT	10
4.2 INTERNAL IDENTIFICATION OF EUT USED DURING THE TEST	10
4.3 INTERNAL IDENTIFICATION OF AE USED DURING THE TEST	10
5 TEST METHODOLOGY	11
5.1 APPLICABLE LIMIT REGULATIONS	11
5.2 APPLICABLE MEASUREMENT STANDARDS.....	11
6 SPECIFIC ABSORPTION RATE (SAR).....	12
6.1 INTRODUCTION.....	12
6.2 SAR DEFINITION.....	12
7 TISSUE SIMULATING LIQUIDS	13
7.1 TARGETS FOR TISSUE SIMULATING LIQUID	13
7.2 DIELECTRIC PERFORMANCE	14
8 SYSTEM VERIFICATION	20
8.1 SYSTEM SETUP.....	20
8.2 SYSTEM VERIFICATION.....	21
9 MEASUREMENT PROCEDURES	22
9.1 TESTS TO BE PERFORMED	22
9.2 GENERAL MEASUREMENT PROCEDURE.....	24
9.3 WCDMA MEASUREMENT PROCEDURES FOR SAR	25
9.4 BLUETOOTH & WI-FI MEASUREMENT PROCEDURES FOR SAR.....	26
9.5 SAR MEASUREMENT FOR LTE.....	26
9.6 LTE (TDD) CONSIDERATIONS	27
9.7 POWER DRIFT.....	27
10 AREA SCAN BASED 1-G SAR.....	28
10.1 REQUIREMENT OF KDB.....	28
10.2 FAST SAR ALGORITHMS	28
11 CONDUCTED OUTPUT POWER.....	29
11.1 GSM MEASUREMENT RESULT	29
11.2 WCDMA MEASUREMENT RESULT.....	31
11.3 LTE MEASUREMENT RESULT	32
11.4 WI-FI AND BT MEASUREMENT RESULT	38
12 SIMULTANEOUS TX SAR CONSIDERATIONS.....	40

12.1 INTRODUCTION.....	40
12.2 TRANSMIT ANTENNA SEPARATION DISTANCES	40
12.3 SAR MEASUREMENT POSITIONS	41
12.4 STANDALONE SAR TEST EXCLUSION CONSIDERATIONS	41
13 EVALUATION OF SIMULTANEOUS.....	42
14 SAR TEST RESULT	43
14.1 SAR RESULTS	44
14.2 WLAN EVALUATION FOR 2.4G	50
14.3 WLAN EVALUATION FOR 5G	52
15 SAR MEASUREMENT VARIABILITY.....	54
16 MEASUREMENT UNCERTAINTY	55
16.1 MEASUREMENT UNCERTAINTY FOR NORMAL SAR TESTS (300MHZ~3GHZ)	55
16.2 MEASUREMENT UNCERTAINTY FOR FAST SAR TESTS (300MHZ~3GHZ)	56
16.3 MEASUREMENT UNCERTAINTY FOR NORMAL SAR TESTS (3GHZ~6GHZ).....	57
16.4 MEASUREMENT UNCERTAINTY FOR FAST SAR TESTS (3GHZ~6GHZ)	58
17 MAIN TEST INSTRUMENTS.....	59
ANNEX A GRAPH RESULTS.....	60
ANNEX B SYSTEMVERIFICATION RESULTS	76
ANNEX C SAR MEASUREMENT SETUP.....	91
C.1 MEASUREMENT SET-UP	91
C.2 DASYS5 E-FIELD PROBE SYSTEM.....	92
C.3 E-FIELD PROBE CALIBRATION	92
C.4 OTHER TEST EQUIPMENT.....	93
ANNEX D POSITION OF THE WIRELESS DEVICE IN RELATION TO THE PHANTOM	97
D.1 GENERAL CONSIDERATIONS.....	97
D.2 BODY-WORN DEVICE	98
D.3 DESKTOP DEVICE.....	98
D.4 DUT SETUP PHOTOS.....	99
ANNEX E EQUIVALENT MEDIA RECIPES.....	100
ANNEX F SYSTEM VALIDATION	101
ANNEX G DAE CALIBRATION CERTIFICATE.....	102
ANNEX H PROBE CALIBRATION CERTIFICATE.....	105
ANNEX I DIPOLE CALIBRATION CERTIFICATE.....	116
ANNEX J EXTENDED CALIBRATION SAR DIPOLE.....	164
ANNEX K SPOT CHECK TEST	167
K.1 INTERNAL IDENTIFICATION OF EUT USED DURING THE SPOT CHECK TEST	167
K.2 MEASUREMENT RESULTS	167
ANNEX L SYSTEMVERIFICATION RESULTS FOR SPOT CHECK TEST.....	183

1 Test Laboratory

1.1 Testing Location

Company Name:	Shenzhen Academy of Information and Communications Technology
Address:	Building G, Shenzhen International Innovation Center, No.1006 Shennan Road, Futian District, Shenzhen, Guangdong, P. R. China
Postal Code:	518026
Telephone:	+86-755-33322000
Fax:	+86-755-33322001

1.2 Testing Environment

Temperature:	18°C~25 °C
Relative humidity:	30%~ 70%
Ground system resistance:	<4Ω
Ambient noise & Reflection:	< 0.012 W/kg

1.3 Project Data

Testing Start Date:	May 02, 2018
Testing End Date:	May 18, 2018

1.4 Signature

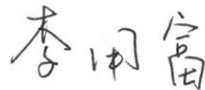

Li Yongfu

(Prepared this test report)



Zhang Yunzhan

(Reviewed this test report)

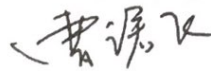

Cao Junfei

Deputy Director of the laboratory
(Approved this test report)

2 Statement of Compliance

This EUT is a variant product and the report of original sample is No.B18N00594-SAR. According to the client request, we quote the test results of original sample. The results of spot check are presented in annex K.

The maximum results of Specific Absorption Rate (SAR) found during testing for HMD Global Oy Smart phone TA-1061 are as follows:

Table 2.1: Highest Reported SAR for Head (1g)

Exposure Configuration	Technology Band	Highest Reported SAR 1g(W/Kg)	Equipment Class
Head (Separation Distance 0mm)	GSM850	0.21	PCE
	PCS1900	0.17	
	UMTS FDD 5	0.29	
	LTE Band 5	0.35	
	LTE Band 7	0.25	
	LTE Band 38	0.14	
	WLAN 2.4GHz	0.82	DTS
	WLAN 5GHz	1.10	U-NII-2A

Table 2.2: Highest Reported SAR for Hotspot (1g)

Exposure Configuration	Technology Band	Highest Reported SAR 1g(W/Kg)	Equipment Class
Hotspot (Separation Distance 10 mm)	GSM850	0.29	PCE
	PCS1900	1.34	
	UMTS FDD 5	0.56	
	LTE Band 5	0.55	
	LTE Band 7	0.59	
	LTE Band 38	0.36	
	WLAN 2.4GHz	0.18	DTS
	WLAN 5GHz	0.09	U-NII-2A

Table 2.3: Highest Reported SAR for Body-worn (1g)

Exposure Configuration	Technology Band	Highest Reported SAR 1g(W/Kg)	Equipment Class
Body-worn (Separation Distance 15 mm)	GSM850	0.14	PCE
	PCS1900	1.08	
	UMTS FDD 5	0.39	
	LTE Band 5	0.39	
	LTE Band 7	0.23	
	LTE Band 38	0.12	
	WLAN 2.4GHz	0.08	DTS
	WLAN 5GHz	<0.01	/

The SAR values found for the Mobile Phone are below the maximum recommended levels of 1.6 W/Kg as averaged over any 1g tissue according to the ANSI C95.1-1992.

For body worn operation, this device has been tested and meets FCC RF exposure guidelines when used with any accessory that contains no metal and which provides a minimum separation distance of 15mm between this device and the body of the user. Use of other accessories may not ensure compliance with FCC RF exposure guidelines.

The EUT battery must be fully charged and checked periodically during the test to ascertain uniform power output.

The measurement together with the test system set-up is described in annex C of this test report. A detailed description of the equipment under test can be found in chapter 4 of this test report.

The highest reported SAR value is obtained at the case of **(Table 2.1 & 2.2 & 2.3)**, and the values are: **1.34W/kg (1g)**.

Table 2.2: The sum of reported SAR values for main antenna and Wi-Fi

/	Position	Main antenna	Wi-Fi	Sum
Highest reported SAR value for Head	Left Touch	0.26	1.10	1.36
Highest reported SAR value for Hotspot	Bottom	1.34	/	1.34
Highest reported SAR value for Body-worn	Rear	1.08	0.08	1.16

Table2.3: The sum of reported SAR values for main antenna and BT

/	Position	Main antenna	BT*	Sum
Highest reported SAR value for Head	Right Touch	0.35	0.13	0.48
Highest reported SAR value for Hotspot	Bottom	1.34	/	1.34
Highest reported SAR value for Body-worn	Rear	1.08	0.04	1.12

BT*-Estimated SAR for Bluetooth (seethetable13.3)

According to the above tables, the highest sum of reported SAR values is **1.36W/kg (1g)**. The detail for simultaneous transmission consideration is described in chapter 13.

3 Client Information

3.1 Applicant Information

Company Name:	HMD Global Oy
Address /Post:	Karaportti 2 02610 Espoo FINLAND
Contact:	Mikko Kahlos
Email:	mikko.kahlos@hmdglobal.com
Telephone:	+358 408036126
Fax:	+97143697604

3.2 Manufacturer Information

Company Name:	HMD Global Oy
Address /Post:	Karaportti 2 02610 Espoo FINLAND
Contact:	Mikko Kahlos
Email:	mikko.kahlos@hmdglobal.com
Telephone:	+358 408036126
Fax:	+97143697604

4 Equipment Under Test (EUT) and Ancillary Equipment (AE)

4.1 About EUT

Description:	Smart phone
Model Name:	TA-1061
Operating mode(s):	GSM 850/1900, WCDMA 850, LTE_ Band 5/7/38, BT, Wi-Fi 2.4G/5G.
Tested Tx Frequency:	825 – 848.8MHz (GSM 850)
	1850.2 – 1910MHz (GSM 1900)
	826.4 – 846.6MHz (WCDMA850 Band V)
	824.7 – 848.3MHz (LTE_FDD Band 5)
	2502.5 – 2567.5MHz (LTE_FDD Band 7)
	2572.5 – 2617.5MHz (LTE_TDD Band 38)
	2412 – 2462MHz (Wi-Fi 2.4G)
5150 – 5825MHz (Wi-Fi 5G)	
GPRS&EGPRS Multislot Class:	12
Test device Production information:	Production unit
Device type:	Portable device
Antenna type:	Integrated antenna
Hotspot mode:	Support

4.2 Internal Identification of EUT used during the test

EUT ID*	IMEI	HW Version	SW Version
EUT1	004402972191666	0301	00WW_0_266
EUT2	004402972191476	0301	00WW_0_266
EUT3	004402972192375	0305	00WW_0_266
EUT4	004402972191633	0301	00WW_0_266
EUT5	004402971272533	0403	00WW_0_266

*EUT ID: is used to identify the test sample in the lab internally.

Note: It is performed to test SAR with the EUT 1 & 2 & 3 & 5, and conducted power with the EUT 4.

4.3 Internal Identification of AE used during the test

AE ID*	Description	Model	Manufacturer
AE1	Battery	HE336	SCUD(Fujian) Electronics Co., Ltd.
AE2	Headset	WH-108	Foxconn

*AE ID: is used to identify the test sample in the lab internally.

5 TEST METHODOLOGY

5.1 Applicable Limit Regulations

ANSI C95.1–1992: IEEE Standard for Safety Levels with Respect to Human Exposure to Radio Frequency Electromagnetic Fields, 3 kHz to 300 GHz.

It specifies the maximum exposure limit of **1.6 W/kg** as averaged over any 1 gram of tissue for portable devices being used within 20 cm of the user in the uncontrolled environment.

5.2 Applicable Measurement Standards

IEEE 1528–2013: Recommended Practice for Determining the Peak Spatial-Average Specific Absorption Rate (SAR) in the Human Head from Wireless Communications Devices: Experimental Techniques.

KDB 447498 D01 General RF Exposure Guidance v06: Mobile and Portable Devices RF Exposure Procedures and Equipment Authorization Policies.

KDB648474 D04 Handset SAR v01r03: SAR Evaluation Considerations for Wireless Handsets.

KDB941225 D01 SAR test for 3G devices v03r01: SAR Measurement Procedures for 3G Devices

KDB941225 D05 SAR for LTE Devices v02r05: SAR Evaluation Considerations for LTE Devices

KDB 941225 D06 Hot Spot SAR v02r01: SAR Evaluation Procedures for Portable Devices with Wireless Router Capabilities

KDB 248227 D01 802.11 Wi-Fi SAR v02r02: SAR Guidance for IEEE 802.11 (Wi-Fi) Transmitters.

KDB 865664 D01 SAR measurement 100 MHz to 6 GHz v01r04: SAR Measurement Requirements for 100 MHz to 6 GHz.

KDB 865664 D02 RF Exposure Reporting v01r02: RF Exposure Compliance Reporting and Documentation Considerations

6 Specific Absorption Rate (SAR)

6.1 Introduction

SAR is related to the rate at which energy is absorbed per unit mass in an object exposed to a radio field. The SAR distribution in a biological body is complicated and is usually carried out by experimental techniques or numerical modeling. The standard recommends limits for two tiers of groups, occupational/controlled and general population/uncontrolled, based on a person's awareness and ability to exercise control over his or her exposure. In general, occupational/controlled exposure limits are higher than the limits for general population/uncontrolled.

6.2 SAR Definition

The SAR definition is the time derivative (rate) of the incremental energy (dW) absorbed by (dissipated in) an incremental mass (dm) contained in a volume element (dv) of a given density (ρ). The equation description is as below:

$$SAR = \frac{d}{dt} \left(\frac{dW}{dm} \right) = \frac{d}{dt} \left(\frac{dW}{\rho dv} \right)$$

SAR is expressed in units of Watts per kilogram (W/kg)

SAR measurement can be either related to the temperature elevation in tissue by

$$SAR = c \left(\frac{\delta T}{\delta t} \right)$$

Where: C is the specific heat capacity, δT is the temperature rise and δt is the exposure duration, or related to the electrical field in the tissue by

$$SAR = \frac{\sigma |E|^2}{\rho}$$

Where: σ is the conductivity of the tissue, ρ is the mass density of tissue and E is the RMS electrical field strength.

However for evaluating SAR of low power transmitter, electrical field measurement is typically applied.

7 Tissue Simulating Liquids

7.1 Targets for tissue simulating liquid

Table 7.1: Targets for tissue simulating liquid

Frequency (MHz)	Liquid Type	Conductivity (σ)	$\pm 5\%$ Range	Permittivity (ϵ)	$\pm 5\%$ Range
835	Head	0.90	0.86~0.95	41.50	39.4~43.6
835	Body	0.97	0.92~1.02	55.20	52.4~58.0
1900	Head	1.40	1.33~1.47	40.00	38.0~42.0
1900	Body	1.52	1.44~1.60	53.30	50.6~56.0
2450	Head	1.80	1.71~1.89	39.20	37.2~41.2
2450	Body	1.95	1.85~2.05	52.70	50.1~55.3
2550	Head	1.91	1.81~2.01	39.07	37.1~41.0
2550	Body	2.09	1.99~2.19	52.60	50.0~55.2
5200	Head	4.66	4.43~4.89	35.99	34.2~37.7
5200	Body	5.30	5.04~5.56	49.00	46.6~51.4
5300	Head	4.76	4.52~5.00	35.87	34.1~37.6
5300	Body	5.42	5.15~5.69	48.90	46.5~51.3
5600	Head	5.07	4.82~5.32	35.53	33.8~37.3
5600	Body	5.77	5.48~6.06	48.50	46.1~50.9
5800	Head	5.27	5.01~5.53	35.30	33.5~37.1
5800	Body	6.00	5.70~6.30	48.20	45.8~50.6

7.2 Dielectric Performance

Table 7.2: Dielectric Performance of Tissue Simulating Liquid

Measurement Date (yyyy-mm-dd)	Type	Frequency	Conductivity σ (S/m)	Drift (%)	Permittivity ϵ	Drift (%)
2018-5-8	Head	835	0.890	-1.11	41.72	0.53
2018-5-8	Body	835	0.988	1.86	53.69	-2.74
2018-5-2	Head	1900	1.419	1.36	39.61	-0.98
2018-5-14	Body	1900	1.574	3.55	52.95	-0.66
2018-5-16	Head	2450	1.842	2.33	38.74	-1.17
2018-5-16	Body	2450	1.928	-1.13	53.53	1.57
2018-5-5	Head	2550	1.971	3.19	38.36	-1.82
2018-5-5	Body	2550	2.052	-1.82	53.21	1.16
2018-5-18	Head	5300	4.847	1.83	35.38	-1.37
2018-5-18	Body	5300	5.379	-0.76	50.22	2.70
2018-5-18	Head	5600	5.212	2.80	34.85	-1.91
2018-5-18	Body	5600	5.654	-2.01	48.97	0.97
2018-5-18	Head	5800	5.408	2.62	34.59	-2.01
2018-5-18	Body	5800	6.193	3.22	47.52	-1.41

Note: The liquid temperature is 22.0°C.

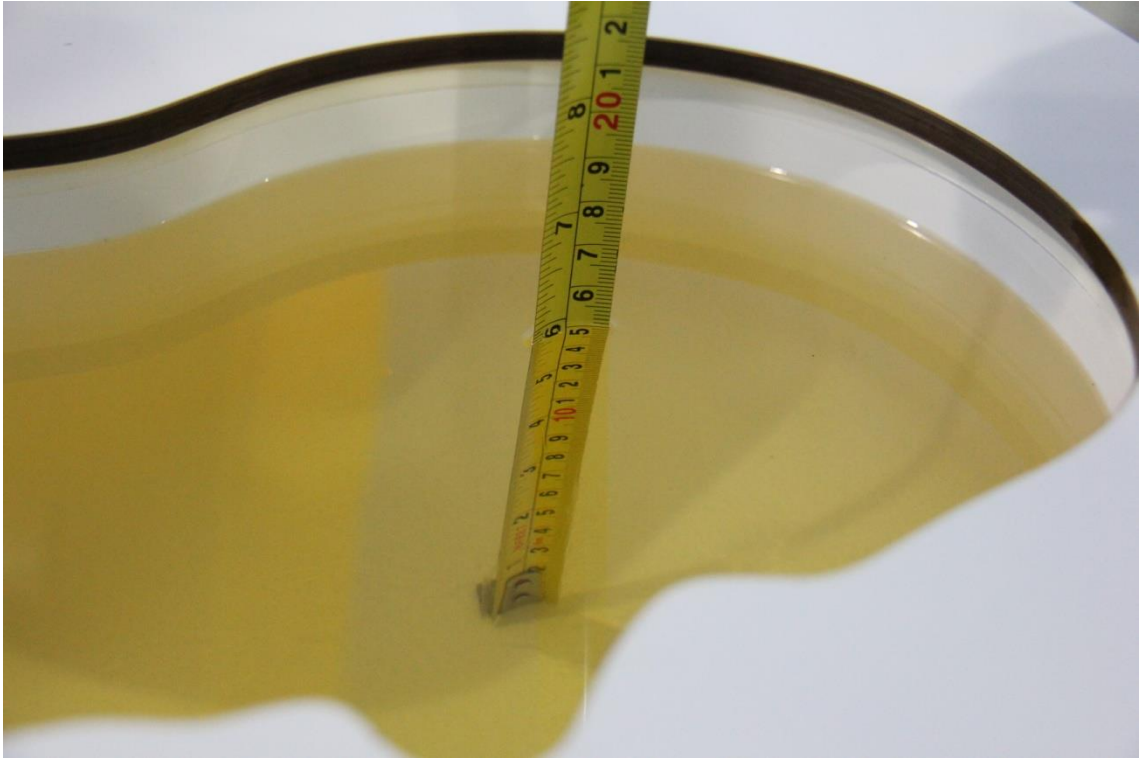

Picture 7-1: Liquid depth in the Head Phantom (835 MHz)

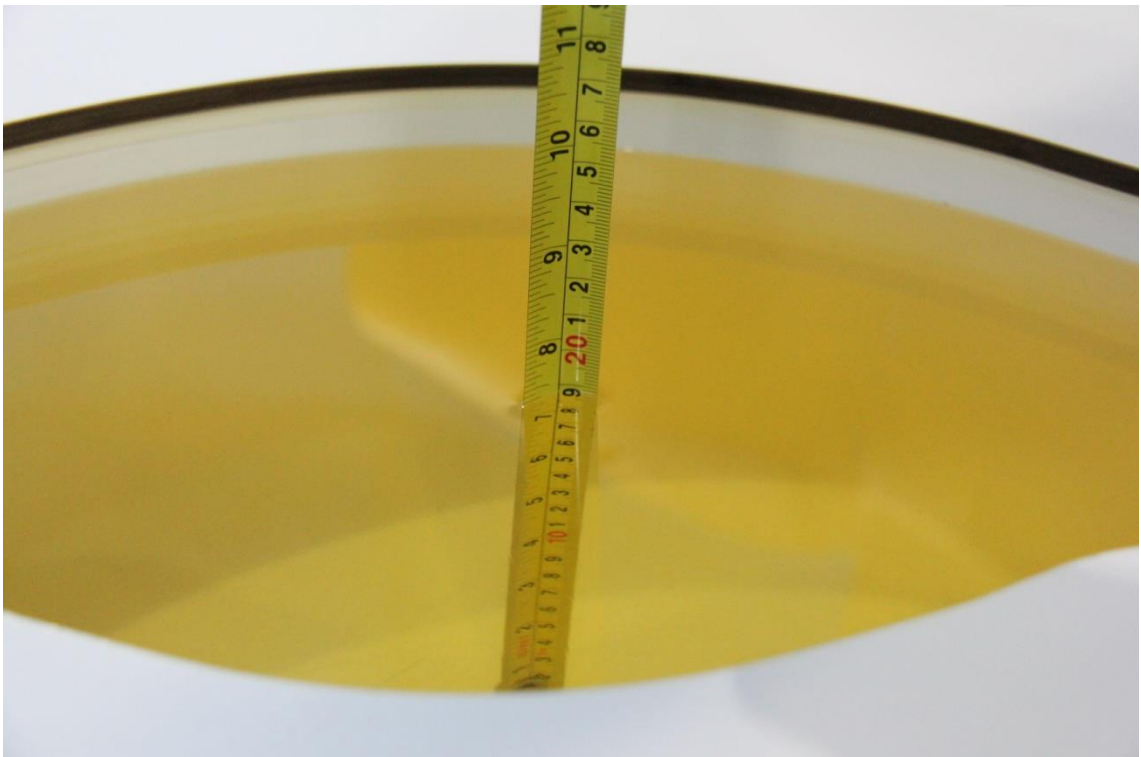

Picture 7-2: Liquid depth in the Flat Phantom (835 MHz)

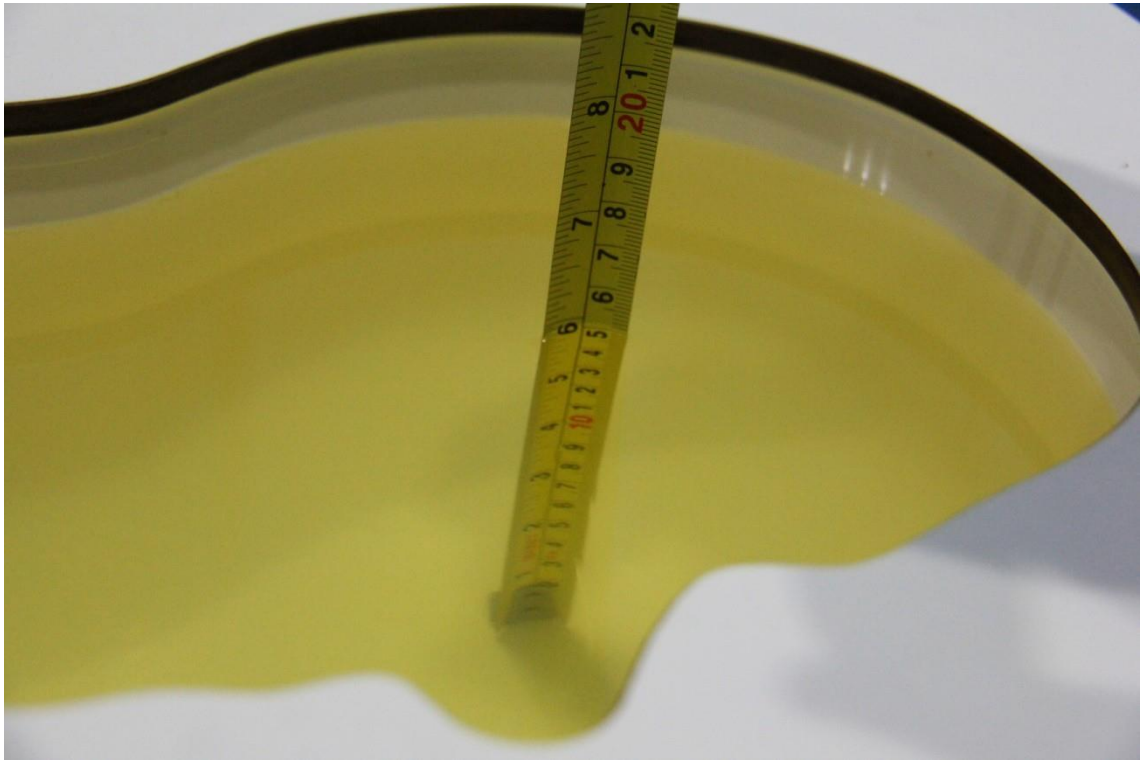

Picture 7-3: Liquid depth in the Head Phantom (1900 MHz)

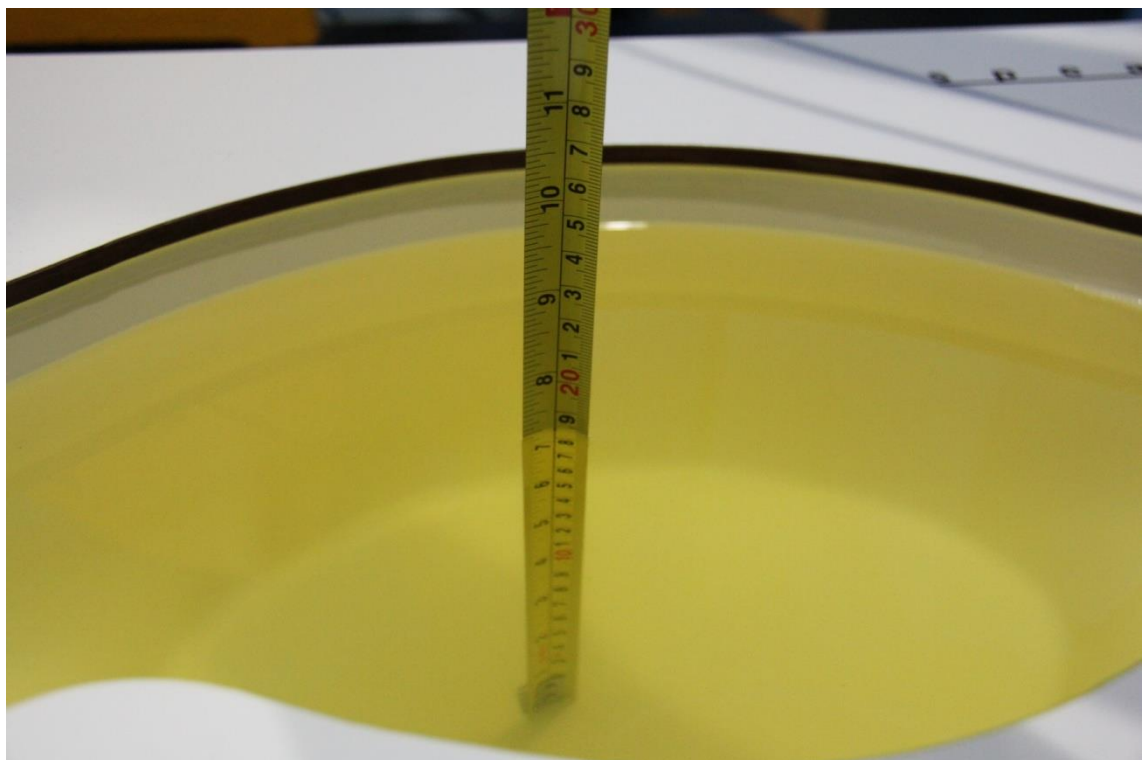

Picture 7-4: Liquid depth in the Flat Phantom (1900MHz)

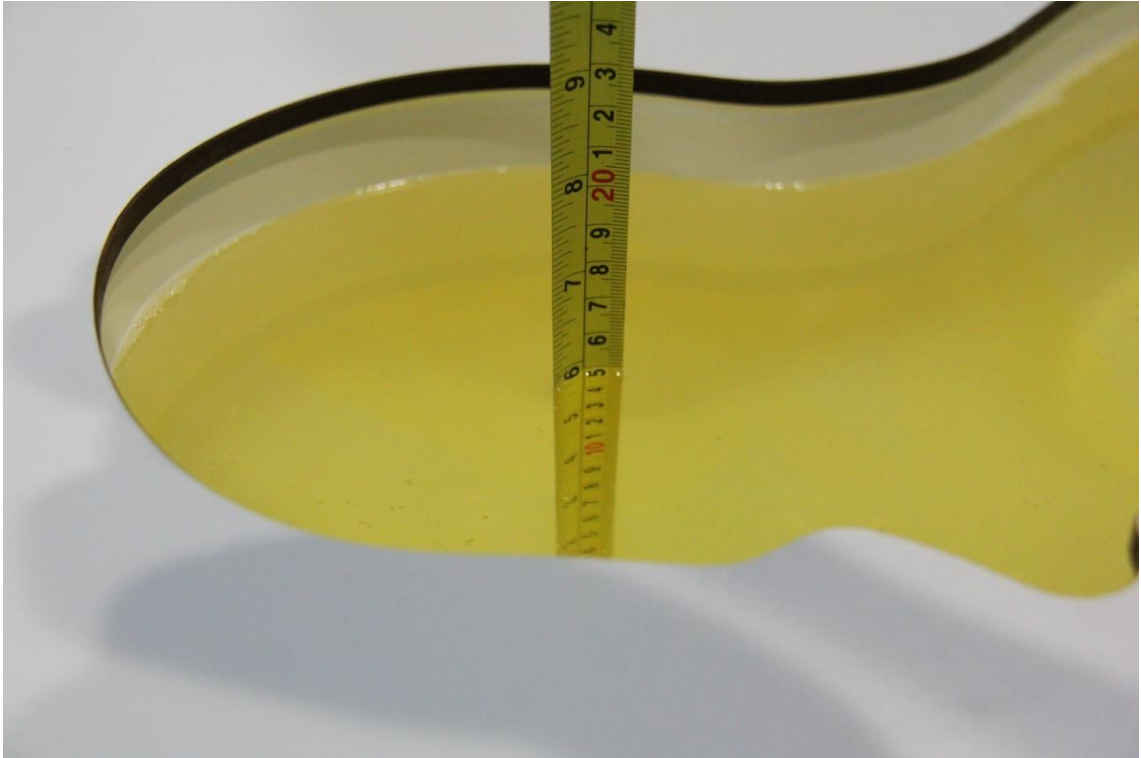

Picture 7-5: Liquid depth in the Head Phantom(2450MHz)



Picture 7-6: Liquid depth in the Flat Phantom(2450MHz)

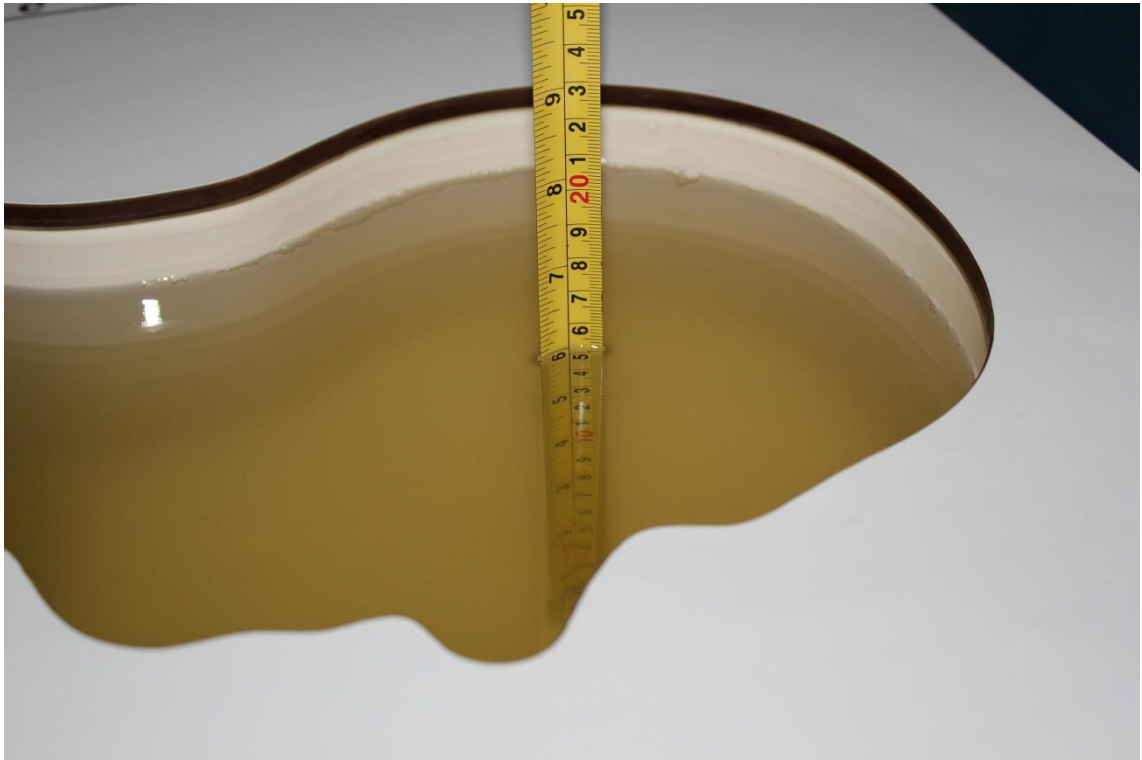

Picture 7-7: Liquid depth in the Head Phantom(2550MHz)

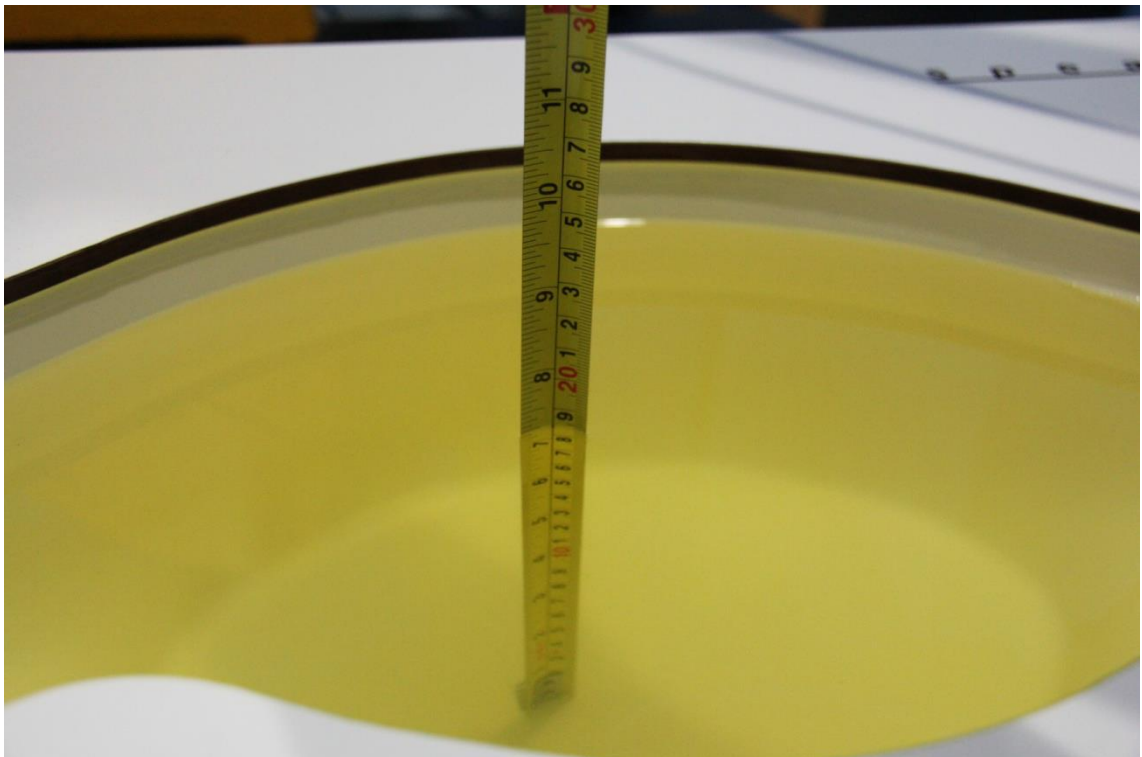

Picture 7-8: Liquid depth in the Flat Phantom(2550MHz)



Picture 7-9: Liquid depth in the Head Phantom (5GHz)



Picture 7-10: Liquid depth in the Flat Phantom (5GHz)

8 System verification

8.1 System Setup

In the simplified setup for system evaluation, the DUT is replaced by a calibrated dipole and the power source is replaced by a continuous wave that comes from a signal generator. The calibrated dipole must be placed beneath the flat phantom section of the SAM twin phantom with the correct distance holder. The distance holder should touch the phantom surface with a light pressure at the reference marking and be oriented parallel to the long side of the phantom. The equipment setup is shown below:

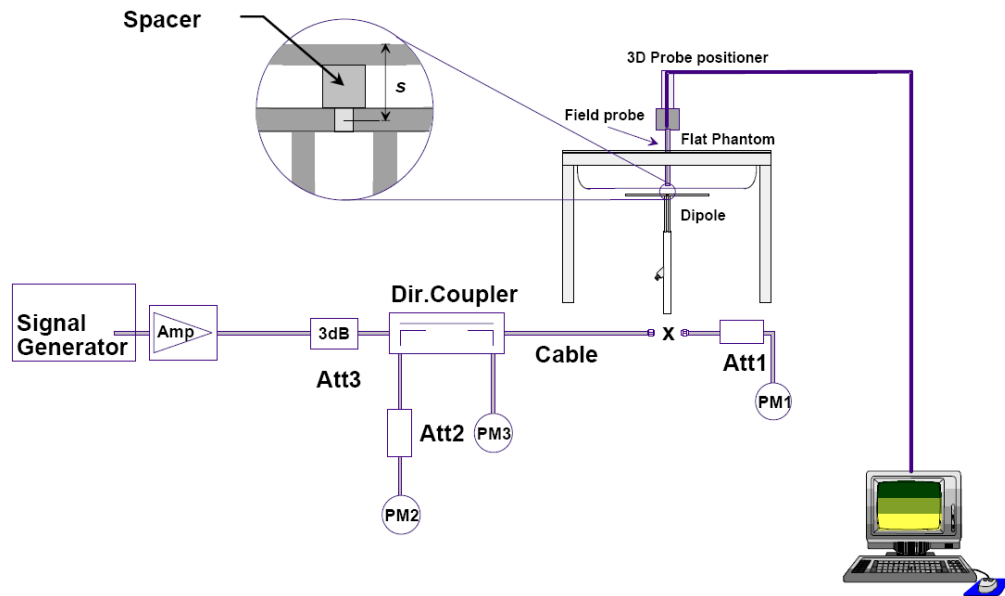

Picture 8.1 System Setup for System Evaluation

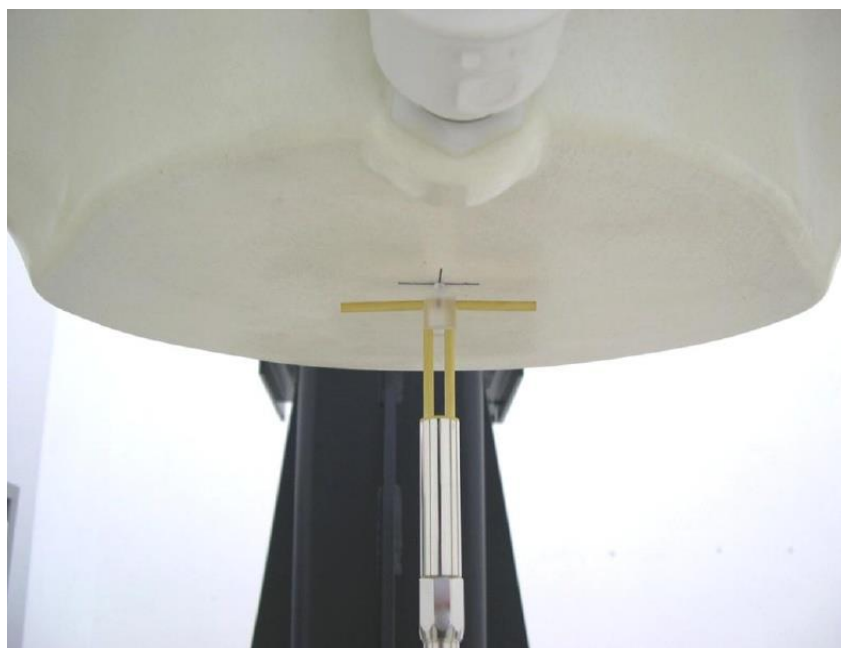

Picture 8.2 Photo of Dipole Setup

8.2 System Verification

SAR system verification is required to confirm measurement accuracy, according to the tissue dielectric media, probe calibration points and other system operating parameters required for measuring the SAR of a test device. The system verification must be performed for each frequency band and within the valid range of each probe calibration point required for testing the device.

The system verification results are required that the area scan estimated 1-g SAR is within 3% of the zoom scan 1-g SAR. The details are presented in annex B.

Table 8.1: System Verification of Head

Measurement Date (yyyy-mm-dd)	Frequency	Target value (W/kg)		Measured value (W/kg)		Deviation (%)	
		10 g Average	1 g Average	10 g Average	1 g Average	10 g Average	1 g Average
2018-5-8	835 MHz	6.03	9.22	5.92	8.96	-1.82	-2.82
2018-5-2	1900 MHz	21.0	40.8	21.32	42.00	1.52	2.94
2018-5-16	2450 MHz	24.1	52.5	24.72	54.40	2.57	3.62
2018-5-5	2550 MHz	26.2	57.2	26.32	58.00	0.46	1.40
2018-5-18	5300 MHz	23.7	83.0	24.10	85.20	1.69	2.65
2018-5-18	5600 MHz	23.6	82.9	23.80	84.50	0.85	1.93
2018-5-18	5800 MHz	22.3	78.8	22.60	81.10	1.35	2.92

Table 8.2: System Verification of Body

Measurement Date (yyyy-mm-dd)	Frequency	Target value (W/kg)		Measured value (W/kg)		Deviation (%)	
		10 g Average	1 g Average	10 g Average	1 g Average	10 g Average	1 g Average
2018-5-8	835 MHz	6.20	9.44	6.36	9.84	2.58	4.24
2018-5-14	1900 MHz	21.3	41.1	21.92	42.80	2.91	4.14
2018-5-16	2450 MHz	24.4	52.3	24.08	50.80	-1.31	-2.87
2018-5-5	2550 MHz	25.1	54.8	24.80	52.80	-1.20	-3.65
2018-5-18	5300 MHz	21.5	76.5	21.10	74.50	-1.86	-2.61
2018-5-18	5600 MHz	22.1	79.1	21.70	77.20	-1.81	-2.40
2018-5-18	5800 MHz	21.1	76.2	21.60	78.50	2.37	3.02

9 Measurement Procedures

9.1 Tests to be performed

In order to determine the highest value of the peak spatial-average SAR of a handset, all device positions, configurations and operational modes shall be tested for each frequency band according to steps 1 to 3 below. A flowchart of the test process is shown in picture 9.1.

Step 1: The tests described in 9.2 shall be performed at the channel that is closest to the center of the transmit frequency band (f_c) for:

- a) all device positions (cheek and tilt, for both left and right sides of the SAM phantom, as described in annex D),
- b) all configurations for each device position in a), e.g., antenna extended and retracted, and
- c) all operational modes, e.g., analogue and digital, for each device position in a) and configuration in b) in each frequency band.

If more than three frequencies need to be tested according to 11.1 (i.e., $N_c > 3$), then all frequencies, configurations and modes shall be tested for all of the above test conditions.

Step 2: For the condition providing highest peak spatial-average SAR determined in Step 1, perform all tests described in 9.2 at all other test frequencies, i.e., lowest and highest frequencies. In addition, for all other conditions (device position, configuration and operational mode) where the peak spatial-average SAR value determined in Step 1 is within 3 dB of the applicable SAR limit, it is recommended that all other test frequencies shall be tested as well.

Step 3: Examine all data to determine the highest value of the peak spatial-average SAR found in Steps 1 to 2.

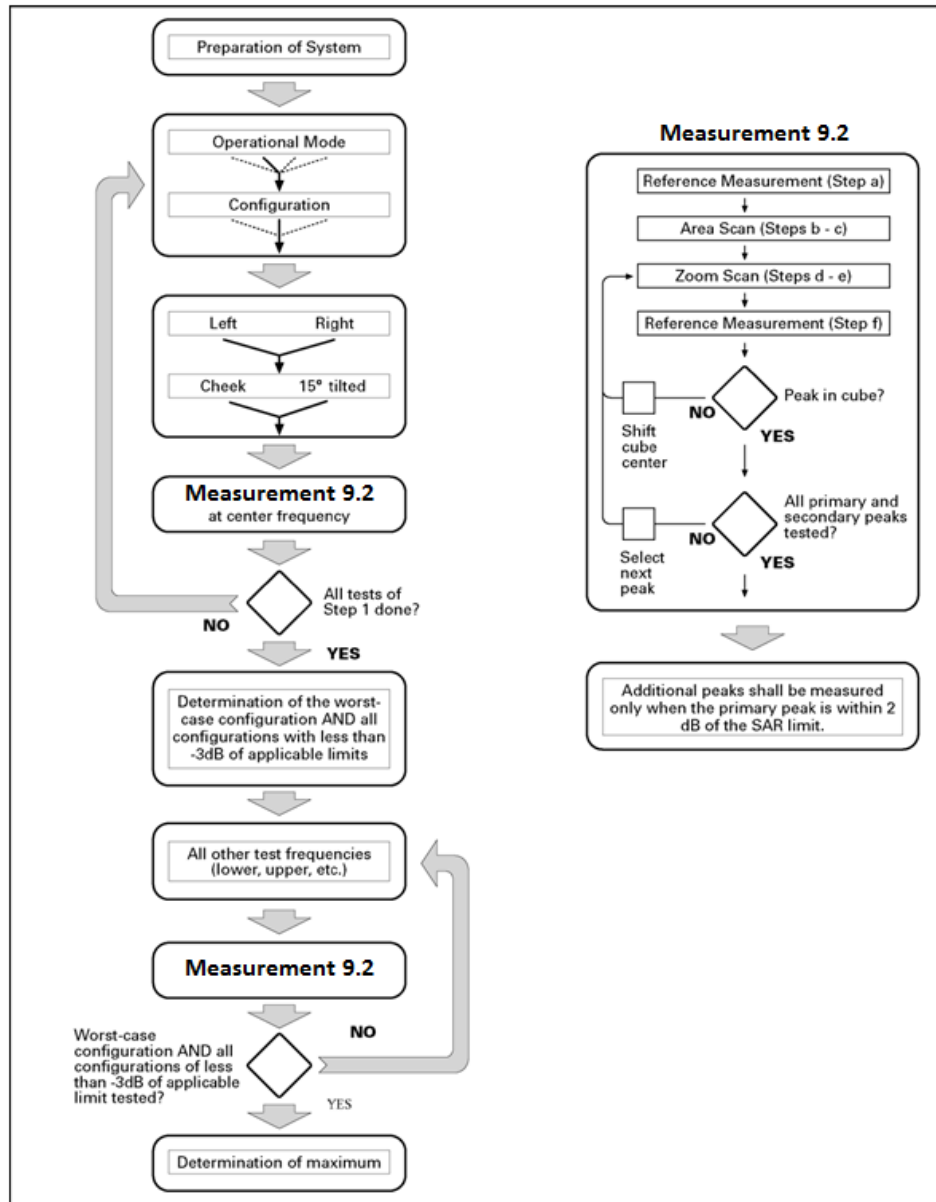

Picture 9.1 Block diagram of the tests to be performed

9.2 General Measurement Procedure

The area and zoom scan resolutions specified in the table below must be applied to the SAR measurements and fully documented in SAR reports to qualify for TCB approval. Probe boundary effect error compensation is required for measurements with the probe tip closer than half a probe tip diameter to the phantom surface. Both the probe tip diameter and sensor offset distance must satisfy measurement protocols; to ensure probe boundary effect errors are minimized and the higher fields closest to the phantom surface can be correctly measured and extrapolated to the phantom surface for computing 1-g SAR. Tolerances of the post-processing algorithms must be verified by the test laboratory for the scan resolutions used in the SAR measurements, according to the reference distribution functions specified in IEEE Std 1528-2013. The results should be documented as part of the system validation records and may be requested to support test results when all the measurement parameters in the following table are not satisfied.

		≤ 3 GHz	> 3 GHz	
Maximum distance from closest measurement point (geometric center of probe sensors) to phantom surface		5 ± 1 mm	$\frac{1}{2} \cdot \delta \cdot \ln(2) \pm 0.5$ mm	
Maximum probe angle from probe axis to phantom surface normal at the measurement location		$30^\circ \pm 1^\circ$	$20^\circ \pm 1^\circ$	
Maximum area scan spatial resolution: $\Delta x_{Area}, \Delta y_{Area}$		≤ 2 GHz: ≤ 15 mm 2 – 3 GHz: ≤ 12 mm	3 – 4 GHz: ≤ 12 mm 4 – 6 GHz: ≤ 10 mm	
		When the x or y dimension of the test device, in the measurement plane orientation, is smaller than the above, the measurement resolution must be \leq the corresponding x or y dimension of the test device with at least one measurement point on the test device.		
Maximum zoom scan spatial resolution: $\Delta x_{Zoom}, \Delta y_{Zoom}$		≤ 2 GHz: ≤ 8 mm 2 – 3 GHz: ≤ 5 mm*	3 – 4 GHz: ≤ 5 mm* 4 – 6 GHz: ≤ 4 mm*	
Maximum zoom scan spatial resolution, normal to phantom surface	uniform grid: $\Delta z_{Zoom}(n)$	≤ 5 mm	3 – 4 GHz: ≤ 4 mm 4 – 5 GHz: ≤ 3 mm 5 – 6 GHz: ≤ 2 mm	
	graded grid	$\Delta z_{Zoom}(1)$: between 1 st two points closest to phantom surface	≤ 4 mm	3 – 4 GHz: ≤ 3 mm 4 – 5 GHz: ≤ 2.5 mm 5 – 6 GHz: ≤ 2 mm
		$\Delta z_{Zoom}(n>1)$: between subsequent points	$\leq 1.5 \cdot \Delta z_{Zoom}(n-1)$	
Minimum zoom scan volume	x, y, z	≥ 30 mm	3 – 4 GHz: ≥ 28 mm 4 – 5 GHz: ≥ 25 mm 5 – 6 GHz: ≥ 22 mm	
<p>Note: δ is the penetration depth of a plane-wave at normal incidence to the tissue medium; see draft standard IEEE P1528-2011 for details.</p> <p>* When zoom scan is required and the <i>reported</i> SAR from the area scan based 1-g SAR estimation procedures of KDB 447498 is ≤ 1.4 W/kg, ≤ 8 mm, ≤ 7 mm and ≤ 5 mm zoom scan resolution may be applied, respectively, for 2 GHz to 3 GHz, 3 GHz to 4 GHz and 4 GHz to 6 GHz.</p>				

9.3 WCDMA Measurement Procedures for SAR

The following procedures are applicable to WCDMA handsets operating under 3GPP Release99, Release 5 and Release 6. The default test configuration is to measure SAR with an established radio link between the DUT and a communication test set using a 12.2kbps RMC (reference measurement channel) configured in Test Loop Mode 1. SAR is selectively confirmed for other physical channel configurations (DPCCH & DPDCH_n), HSDPA and HSPA (HSUPA/HSDPA) modes according to output power, exposure conditions and device operating capabilities. Both uplink and downlink should be configured with the same RMC or AMR, when required. SAR for Release 5 HSDPA and Release 6 HSPA are measured using the applicable FRC (fixed reference channel) and E-DCH reference channel configurations. Maximum output power is verified according to applicable versions of 3GPP TS 34.121 and SAR must be measured according to these maximum output conditions. When Maximum Power Reduction (MPR) is not implemented according to Cubic Metric (CM) requirements for Release 6 HSPA, the following procedures do not apply.

For Release 5 HSDPA Data Devices:

Sub-test	β_c	β_d	β_d (SF)	β_c / β_d	β_{hs}	CM/dB
1	2/15	15/15	64	2/15	4/15	0.0
2	12/15	15/15	64	12/15	24/25	1.0
3	15/15	8/15	64	15/8	30/15	1.5
4	15/15	4/15	64	15/4	30/15	1.5

For Release 6 HSPA Data Devices

Sub-test	β_c	β_d	β_d (SF)	β_c / β_d	β_{hs}	β_{ec}	β_{ed}	β_{ed} (SF)	β_{ed} (codes)	CM (dB)	MPR (dB)	AG Index	E-TFCI
1	11/15	15/15	64	11/15	22/15	209/225	1039/225	4	1	1.0	0.0	20	75
2	6/15	15/15	64	6/15	12/15	12/15	12/15	4	1	3.0	2.0	12	67
3	15/15	9/15	64	15/9	30/15	30/15	$\beta_{ed1}:47/15$ $\beta_{ed2}:47/15$	4	2	2.0	1.0	15	92
4	2/15	15/15	64	2/15	4/15	4/15	56/75	4	1	3.0	2.0	17	71
5	15/15	15/15	64	15/15	24/15	30/15	134/15	4	1	1.0	0.0	21	81

9.4 Bluetooth & WI-FI Measurement Procedures for SAR

Normal network operating configurations are not suitable for measuring the SAR of 802.11 transmitters in general. Unpredictable fluctuations in network traffic and antenna diversity conditions can introduce undesirable variations in SAR results. The SAR for these devices should be measured using chipset based test mode software to ensure that the results are consistent and reliable.

Chipset based test mode software is hardware dependent and generally varies among manufacturers. The device operating parameters established in a test mode for SAR measurements must be identical to those programmed in production units, including output power levels, amplifier gain settings and other RF performance tuning parameters. The test frequencies should correspond to actual channel frequencies defined for domestic use. SAR for devices with switched diversity should be measured with only one antenna transmitting at a time during each SAR measurement, according to a fixed modulation and data rate. The same data pattern should be used for all measurements.

9.5 SAR Measurement for LTE

SAR tests for LTE are performed with a base station simulator, Anristu MT8820C. Closed loop power control was used so the UE transmits with maximum output power during SAR testing. All powers were measured with the Anristu MT8820C. It is performed for conducted power and SAR based on the KDB941225 D05.

SAR is evaluated separately according to the following procedures for the different test positions in each exposure condition – head, body, body-worn accessories and other use conditions. The procedures in the following subsections are applied separately to test each LTE frequency band.

1) QPSK with 1 RB allocation

Start with the largest channel bandwidth and measure SAR for QPSK with 1 RB allocation, using the RB offset and required test channel combination with the highest maximum output power among RB offsets at the upper edge, middle and lower edge of each required test channel. When the reported SAR is ≤ 0.8 W/kg, testing of the remaining RB offset configurations and required test channels is not required for 1 RB allocation; otherwise, SAR is required for the remaining required test channels and only for the RB offset configuration with the highest output power for that channel. When the reported SAR of a required test channel is > 1.45 W/kg, SAR is required for all three RB offset configurations for that required test channel.

2) QPSK with 50% RB allocation

The procedures required for 1 RB allocation in 1) are applied to measure the SAR for QPSK with 50% RB allocation.

3) QPSK with 100% RB allocation

For QPSK with 100% RB allocation, SAR is not required when the highest maximum output power for 100 % RB allocation is less than the highest maximum output power in 50% and 1 RB allocations and the highest reported SAR for 1 RB and 50% RB allocation in 1) and 2) are ≤ 0.8 W/kg. Otherwise, SAR is measured for the highest output power channel; and if the reported SAR is > 1.45 W/kg, the remaining required test channels must also be tested.

9.6 LTE (TDD) Considerations

According to KDB 941225 D05 SAR for LTE Devices, for Time-Division Duplex (TDD) systems, SAR must be tested using a fixed periodic duty factor according to the highest transmission duty factor implemented for the device and supported by the defined 3GPP LTE TDD configurations.

SAR was tested with the highest transmission duty factor (63.33%) using Uplink-downlink configuration 0 and Special subframe configuration 7.

LTE TDD Band 38 support 3GPP TS 36.211 section 4.2 for Type 2 Frame Structure and Table 4.2-2 for uplink-downlink configurations and Table 4.2-1 for Special subframe configurations.

Special subframe configuration	Normal cyclic prefix in downlink			Extended cyclic prefix in downlink		
	DwPTS	UpPTS		DwPTS	UpPTS	
		Normal cyclic prefix in uplink	Extended cyclic prefix in uplink		Normal cyclic prefix in uplink	Extended cyclic prefix in uplink
0	$6592 \cdot T_s$	$2192 \cdot T_s$	$2560 \cdot T_s$	$7680 \cdot T_s$	$2192 \cdot T_s$	$2560 \cdot T_s$
1	$19760 \cdot T_s$			$20480 \cdot T_s$		
2	$21952 \cdot T_s$			$23040 \cdot T_s$		
3	$24144 \cdot T_s$			$25600 \cdot T_s$		
4	$26336 \cdot T_s$	$4384 \cdot T_s$	$5120 \cdot T_s$	$7680 \cdot T_s$	$4384 \cdot T_s$	$5120 \cdot T_s$
5	$6592 \cdot T_s$			$20480 \cdot T_s$		
6	$19760 \cdot T_s$			$23040 \cdot T_s$		
7	$21952 \cdot T_s$			$12800 \cdot T_s$		
8	$24144 \cdot T_s$			-		
9	$13168 \cdot T_s$	-	-	-	-	-

Configuration of special subframe (lengths of DwPTS/GP/UpPTS)

Uplink-Downlink Configuration	Downlink-to-Uplink Switch-point Periodicity	Subframe Number										Calculated Duty Cycle (%)
		0	1	2	3	4	5	6	7	8	9	
0	5 ms	D	S	U	U	U	D	S	U	U	U	63.33
1	5 ms	D	S	U	U	D	D	S	U	U	D	43.33
2	5 ms	D	S	U	D	D	D	S	U	D	D	23.33
3	10 ms	D	S	U	U	U	D	D	D	D	D	31.67
4	10 ms	D	S	U	U	D	D	D	D	D	D	21.67
5	10 ms	D	S	U	D	D	D	D	D	D	D	11.67
6	5 ms	D	S	U	U	U	D	S	U	U	D	53.33

Calculated Duty Cycle

Calculated Duty Cycle = Extended cyclic prefix in uplink x (Ts) x # of S + # of U

Example for Calculated Duty Cycle for Uplink-Downlink Configuration 0:

Calculated Duty Cycle = $5120 \times [1/(15000 \times 2048)] \times 2 + 6 \text{ ms} = 63.33\%$

Where

$T_s = 1/(15000 \times 2048)$ seconds

9.7 Power Drift

To control the output power stability during the SAR test, DASY5 system calculates the power drift by measuring the E-field at the same location at the beginning and at the end of the measurement for each test position. These drift values can be found in Section 14 labeled as: (Power Drift [dB]). This ensures that the power drift during one measurement is within 5%.

10 Area Scan Based 1-g SAR

10.1 Requirement of KDB

According to the KDB447498 D01, when the implementation is based the specific polynomial fit algorithm as presented at the 29th Bioelectromagnetics Society meeting (2007) and the estimated 1-gSAR is ≤ 1.2 W/kg, a zoom scan measurement is not required provided it is also not needed for any other purpose; for example, if the peak SAR location required for simultaneous transmission SAR test exclusion can be determined accurately by the SAR system or manually to discriminate between distinctive peaks and scattered noisy SAR distributions from area scans.

There must not be any warning or alert messages due to various measurement concerns identified by the SAR system; for example, noise in measurements, peaks too close to scan boundary, peaks are too sharp, spatial resolution and uncertainty issues etc. The SAR system verification must also demonstrate that the area scan estimated 1-g SAR is within 3% of the zoom scan 1-g SAR (See Annex B). When all the SAR results for each exposure condition in a frequency band and wireless mode are based on estimated 1-g SAR, the 1-g SAR for the highest SAR configuration must be determined by a zoom scan.

10.2 Fast SAR Algorithms

The approach is based on the area scan measurement applying a frequency dependent attenuation parameter. This attenuation parameter was empirically determined by analyzing a large number of phones. The MOTOROLA FAST SAR was developed and validated by the MOTOROLA Research Group in Ft. Lauderdale.

In the initial study, an approximation algorithm based on Linear fit was developed. The accuracy of the algorithm has been demonstrated across a broad frequency range (136-2450 MHz) and for both 1- and 10-g averaged SAR using a sample of 264 SAR measurements from 55 wireless handsets. For the sample size studied, the root-mean-squared errors of the algorithm are 1.2% and 5.8% for 1- and 10-g averaged SAR, respectively. The paper describing the algorithm in detail is expected to be published in August 2004 within the Special Issue of Transactions on MTT.

In the second step, the same research group optimized the fitting algorithm to an Polynomial fit whereby the frequency validity was extended to cover the range 30-6000MHz. Details of this study can be found in the BEMS 2007 Proceedings.

Both algorithms are implemented in DASY software.

11 Conducted Output Power

11.1 GSM Measurement result

During the process of testing, the EUT was controlled via Agilent Digital Radio Communication tester (E5515C) to ensure the maximum power transmission and proper modulation. This result contains conducted output power for the EUT. In all cases, the measured peak output power should be greater and within 5% than EMI measurement.

Table 11.1: The conducted power measurement results for GSM850/1900

Full Power				
GSM 850MHz	Tune up	Conducted Power (dBm)		
		Channel 251(848.8MHz)	Channel 190(836.6MHz)	Channel 128(824.2MHz)
	33.5	32.33	32.39	32.31
GSM 1900MHz	Tune up	Conducted Power(dBm)		
		Channel 810(1909.8MHz)	Channel 661(1880MHz)	Channel 512(1850.2MHz)
	31.5	30.25	30.06	29.78
Hotspot Power				
GSM 1900MHz	Tune up	Conducted Power(dBm)		
		Channel 810(1909.8MHz)	Channel 661(1880MHz)	Channel 512(1850.2MHz)
	29	27.65	27.73	27.81

Table 11.2: The conducted power measurement results for GPRS and EGPRS

Full Power								
GPRS 850	Tune up	Measured Power (dBm)			calculation	Average Power (dBm)		
		251	190	128		251	190	128
1Tx-slots	33.5	32.32	32.39	32.31	-9.03dB	23.29	23.36	23.28
2Tx-slots	30.5	29.49	29.47	29.34	-6.02dB	23.47	23.45	23.32
3Tx-slots	29.0	28.23	28.22	28.03	-4.26dB	23.97	23.96	23.77
4Tx-slots	27.5	27.05	27.04	26.86	-3.01dB	24.04	24.03	23.85
EGPRS 850 (8PSK)	Tune up	Measured Power (dBm)			calculation	Measured Power (dBm)		
		251	190	128		251	190	128
1Tx-slots	28.5	26.69	26.60	26.43	-9.03dB	17.66	17.57	17.40
2Tx-slots	25.5	23.54	23.48	23.26	-6.02dB	17.52	17.46	17.24
3Tx-slots	24.0	21.84	21.75	21.62	-4.26dB	17.58	17.49	17.36
4Tx-slots	22.5	20.33	20.23	20.02	-3.01dB	17.32	17.22	17.01

Full Power								
GPRS 1900	Tune up	Measured Power (dBm)			calculation	Average Power (dBm)		
		810	661	512		810	661	512
1Tx-slots	31.5	30.05	30.19	30.32	-9.03dB	21.02	21.16	21.29
2Tx-slots	28.5	27.01	27.08	27.16	-6.02dB	20.99	21.06	21.14
3Tx-slots	26.5	25.29	25.26	25.12	-4.26dB	21.03	21.00	20.86
4Tx-slots	25.0	23.84	23.69	23.52	-3.01dB	20.83	20.68	20.51
EGPRS 1900 (8PSK)	Tune up	Measured Power (dBm)			calculation	Measured Power (dBm)		
		810	661	512		810	661	512
1Tx-slots	26.0	25.53	25.15	25.57	-9.03dB	16.50	16.12	16.54
2Tx-slots	23.5	22.46	22.16	22.49	-6.02dB	16.44	16.14	16.47
3Tx-slots	22.0	20.88	20.52	20.87	-4.26dB	16.62	16.26	16.61
4Tx-slots	20.5	19.31	19.03	19.34	-3.01dB	16.30	16.02	16.33
Hotspot Power								
GPRS 1900	Tune up	Measured Power (dBm)			calculation	Average Power (dBm)		
		810	661	512		810	661	512
1Tx-slots	29.0	27.61	27.68	27.77	-9.03dB	18.58	18.65	18.74
2Tx-slots	26.0	25.29	25.26	25.12	-6.02dB	19.27	19.24	19.10
3Tx-slots	24.0	23.84	23.69	23.52	-4.26dB	19.58	19.43	19.26
4Tx-slots	23.0	22.25	22.01	21.81	-3.01dB	19.24	19.00	18.80
EGPRS 1900 (8PSK)	Tune up	Measured Power (dBm)			calculation	Measured Power (dBm)		
		810	661	512		810	661	512
1Tx-slots	25.0	23.19	22.83	23.15	-9.03dB	14.16	13.80	14.12
2Tx-slots	22.0	21.04	20.63	21.03	-6.02dB	15.02	14.61	15.01
3Tx-slots	20.5	19.45	19.16	19.57	-4.26dB	15.19	14.90	15.31
4Tx-slots	19.0	17.88	17.90	17.87	-3.01dB	14.87	14.89	14.86

NOTES:

1) Division Factors

To average the power, the division factor is as follows:

1TX-slot = 1 transmit time slot out of 8 time slots=> conducted power divided by (8/1) => -9.03dB

2TX-slots = 2 transmit time slots out of 8 time slots=> conducted power divided by (8/2) => -6.02dB

3TX-slots = 3 transmit time slots out of 8 time slots=> conducted power divided by (8/3) => -4.26dB

4TX-slots = 4 transmit time slots out of 8 time slots=> conducted power divided by (8/4) => -3.01dB

11.2 WCDMA Measurement result

Table 11.3: The conducted Power for WCDMA850/1700/1900

Full Power					
Item	band	FDD Band 5 result			
	ARFCN	Tune up	4233 (846.6MHz)	4182 (836.4MHz)	4132 (826.4MHz)
WCDMA	\	24.5	23.7	24.1	24.1
HSUPA	1	22.5	20.7	21.1	21.2
	2	22.5	20.8	21.1	21.1
	3	22.5	20.7	21.1	21.2
	4	22.5	20.4	20.6	20.7
	5	22.5	21.8	22.2	22.1
HSDPA	1	24	22.7	23.2	23.3
	2	24	22.8	23.1	23.2
	3	24	22.3	22.7	22.7
	4	24	22.3	22.7	22.8
DC-HSDPA	1	24	23.30	23.40	23.45
	2	24	23.29	23.37	23.46
	3	24	22.74	22.89	22.92
	4	24	22.76	22.88	22.91

11.3 LTE Measurement result

Table 11.4: The conducted Power for LTE

Full Power							
LTE-FDD Band 5				Actual output Power (dBm)			Tune up
Band-width	RB allocation	RB offset	Modulation	High	Middle	Low	
1.4 MHz				848.3MHz	836.5MHz	824.7MHz	
	1RB	High	QPSK	22.22	22.30	22.32	23.3
			16QAM	21.52	21.67	21.58	22.3
		Middle	QPSK	22.16	22.24	22.24	23.3
			16QAM	21.48	21.59	21.60	22.3
		Low	QPSK	22.20	22.26	22.28	23.3
			16QAM	21.61	21.69	21.71	22.3
	3RB	High	QPSK	22.33	22.40	22.42	23.3
			16QAM	21.44	21.57	21.57	22.3
		Middle	QPSK	22.29	22.37	22.39	23.3
			16QAM	21.52	21.60	21.59	22.3
		Low	QPSK	22.29	22.36	22.38	23.3
			16QAM	21.50	21.58	21.59	22.3
	6RB	/	QPSK	21.32	21.40	21.42	22.3
16QAM			20.38	20.47	20.47	21.3	
3 MHz				847.5MHz	836.5MHz	825.5MHz	/
	1RB	High	QPSK	22.37	22.46	22.48	23.3
			16QAM	21.58	21.72	21.76	22.3
		Middle	QPSK	22.37	22.44	22.46	23.3
			16QAM	21.59	21.81	21.77	22.3
		Low	QPSK	22.39	22.47	22.48	23.3
			16QAM	21.67	21.69	21.74	22.3
	8RB	High	QPSK	21.38	21.46	21.49	22.3
			16QAM	20.37	20.51	20.50	21.3
		Middle	QPSK	21.39	21.47	21.50	22.3
			16QAM	20.43	20.50	20.51	21.3
		Low	QPSK	21.43	21.49	21.51	22.3
			16QAM	20.44	20.54	20.51	21.3
	15RB	/	QPSK	21.39	21.47	21.48	22.3
16QAM			20.41	20.50	20.50	21.3	

LTE-FDD Band 5				Actual output Power (dBm)			Tune up
Band-width	RB allocation	RB offset	Modulation	High	Middle	Low	
5 MHz				846.5MHz	836.5MHz	826.5MHz	
	1RB	High	QPSK	22.30	22.38	22.44	23.3
			16QAM	21.49	21.64	21.77	22.3
		Middle	QPSK	22.41	22.46	22.49	23.3
			16QAM	21.74	21.72	21.77	22.3
		Low	QPSK	22.36	22.41	22.40	23.3
			16QAM	21.66	21.66	21.69	22.3
	12RB	High	QPSK	21.32	21.40	21.41	22.3
			16QAM	20.33	20.43	20.42	21.3
		Middle	QPSK	21.39	21.43	21.45	22.3
			16QAM	20.39	20.45	20.46	21.3
		Low	QPSK	21.36	21.42	21.40	22.3
			16QAM	20.36	20.42	20.41	21.3
	25RB	/	QPSK	21.33	21.40	21.39	22.3
16QAM			20.33	20.41	20.38	21.3	
10 MHz				844MHz	836.5MHz	829MHz	/
	1RB	High	QPSK	22.34	22.42	22.48	23.3
			16QAM	21.69	21.67	21.75	22.3
		Middle	QPSK	22.34	22.41	22.45	23.3
			16QAM	21.71	21.72	21.77	22.3
		Low	QPSK	22.44	22.46	22.44	23.3
			16QAM	21.70	21.76	21.73	22.3
	25RB	High	QPSK	21.30	21.40	21.35	22.3
			16QAM	20.31	20.42	20.35	21.3
		Middle	QPSK	21.38	21.43	21.48	22.3
			16QAM	20.38	20.44	20.47	21.3
		Low	QPSK	21.42	21.51	21.52	22.3
			16QAM	20.42	20.51	20.52	21.3
	50RB	/	QPSK	21.37	21.47	21.45	22.3
16QAM			20.34	20.46	20.43	21.3	

Full Power							
LTE-FDD Band 7				Actual output Power (dBm)			Tune up
Band-width	RB allocation	RB offset	Modulation	High	Middle	Low	
5 MHz				2567.4MHz	2535MHz	2502.5MHz	
	1RB	High	QPSK	22.53	22.24	22.10	23.3
			16QAM	21.74	21.56	21.34	22.3
		Middle	QPSK	22.53	22.26	22.18	23.3
			16QAM	21.69	21.55	21.41	22.3
		Low	QPSK	22.47	22.16	22.11	23.3
			16QAM	21.69	21.46	21.37	22.3
	12RB	High	QPSK	21.54	21.29	21.18	22.3
			16QAM	20.60	20.31	20.18	21.3
		Middle	QPSK	21.53	21.27	21.19	22.3
			16QAM	20.61	20.29	20.19	21.3
		Low	QPSK	21.47	21.21	21.14	22.3
			16QAM	20.55	20.20	20.13	21.3
	25RB	/	QPSK	21.51	21.25	21.17	22.3
			16QAM	20.57	20.26	20.15	21.3
	10 MHz				2565MHz	2535MHz	2505MHz
1RB		High	QPSK	22.58	22.30	22.14	23.3
			16QAM	21.85	21.58	21.38	22.3
		Middle	QPSK	22.47	22.20	22.10	23.3
			16QAM	21.70	21.49	21.37	22.3
		Low	QPSK	22.41	22.13	22.12	23.3
			16QAM	21.64	21.44	21.40	22.3
25RB		High	QPSK	21.52	21.33	21.19	22.3
			16QAM	20.57	20.32	20.19	21.3
		Middle	QPSK	21.50	21.28	21.16	22.3
			16QAM	20.56	20.28	20.16	21.3
		Low	QPSK	21.50	21.24	21.15	22.3
			16QAM	20.55	20.25	20.13	21.3
50RB		/	QPSK	21.53	21.29	21.19	22.3
			16QAM	20.57	20.29	20.16	21.3

LTE-FDD Band 7				Actual output Power (dBm)			Tune up
Band-width	RB allocation	RB offset	Modulation	High	Middle	Low	
15 MHz				2562.5MHz	2535MHz	2507.5MHz	
	1RB	High	QPSK	22.60	22.34	22.15	23.3
			16QAM	21.83	21.61	21.34	22.3
		Middle	QPSK	22.44	22.21	22.11	23.3
			16QAM	21.71	21.48	21.33	22.3
		Low	QPSK	22.38	22.19	22.18	23.3
			16QAM	21.65	21.40	21.39	22.3
	25RB	High	QPSK	21.52	21.35	21.21	22.3
			16QAM	20.56	20.33	20.19	21.3
		Middle	QPSK	21.47	21.28	21.16	22.3
			16QAM	20.53	20.28	20.13	21.3
		Low	QPSK	21.50	21.27	21.15	22.3
			16QAM	20.54	20.27	20.13	21.3
	50RB	/	QPSK	21.49	21.30	21.19	22.3
16QAM			20.56	20.31	20.20	21.3	
20 MHz				2560MHz	2535MHz	2510MHz	/
	1RB	High	QPSK	22.65	22.42	22.21	23.3
			16QAM	21.92	21.66	21.48	22.3
		Middle	QPSK	22.39	22.20	22.04	23.3
			16QAM	21.66	21.57	21.27	22.3
		Low	QPSK	22.35	22.19	22.18	23.3
			16QAM	21.62	21.48	21.36	22.3
	50RB	High	QPSK	21.49	21.41	21.22	22.3
			16QAM	20.53	20.42	20.20	21.3
		Middle	QPSK	21.47	21.30	21.16	22.3
			16QAM	20.50	20.29	20.13	21.3
		Low	QPSK	21.54	21.34	21.14	22.3
			16QAM	20.57	20.34	20.09	21.3
	100RB	/	QPSK	21.52	21.36	21.17	22.3
16QAM			20.56	20.36	20.15	21.3	

Full Power								
LTE-FDD Band 38				Actual output Power (dBm)			Tune up	
Band-width	RB allocation	RB offset	Modulation	High	Middle	Low		
5 MHz	1RB	High	QPSK	22.10	22.24	22.40	23.3	
			16QAM	21.04	21.16	21.35	22.3	
		Middle	QPSK	22.10	22.30	22.46	23.3	
			16QAM	21.07	21.22	21.41	22.3	
		Low	QPSK	22.07	22.30	22.46	23.3	
			16QAM	21.02	21.22	21.42	22.3	
		12RB	High	QPSK	21.08	21.23	21.39	22.3
				16QAM	20.17	20.32	20.48	21.3
			Middle	QPSK	21.09	21.26	21.44	22.3
				16QAM	20.17	20.32	20.51	21.3
	Low	QPSK	21.02	21.20	21.41	22.3		
		16QAM	20.10	20.28	20.49	21.3		
	25RB	/	QPSK	21.04	21.21	21.39	22.3	
			16QAM	20.07	20.24	20.42	21.3	
	10 MHz	1RB	High	QPSK	22.09	22.21	22.39	23.3
				16QAM	21.07	21.18	21.38	22.3
Middle			QPSK	22.07	22.26	22.36	23.3	
			16QAM	21.03	21.19	21.34	22.3	
Low			QPSK	22.06	22.29	22.44	23.3	
			16QAM	21.01	21.22	21.41	22.3	
25RB			High	QPSK	21.07	21.25	21.38	22.3
				16QAM	20.13	20.27	20.41	21.3
			Middle	QPSK	21.05	21.26	21.39	22.3
				16QAM	20.09	20.29	20.42	21.3
Low		QPSK	21.00	21.24	21.44	22.3		
		16QAM	20.05	20.26	20.46	21.3		
50RB		/	QPSK	21.05	21.22	21.38	22.3	
			16QAM	20.03	20.21	20.38	21.3	
				2615MHz	2595MHz	2575MHz	/	

LTE-FDD Band 38				Actual output Power (dBm)			Tune up
Band-width	RB allocation	RB offset	Modulation	High	Middle	Low	
15 MHz				2612.5MHz	2595MHz	2577.5MHz	
	1RB	High	QPSK	22.12	22.23	22.39	23.3
			16QAM	21.08	21.16	21.33	22.3
		Middle	QPSK	22.05	22.26	22.37	23.3
			16QAM	21.00	21.18	21.34	22.3
		Low	QPSK	22.11	22.36	22.51	23.3
			16QAM	21.07	21.29	21.47	22.3
	25RB	High	QPSK	21.07	21.24	21.37	22.3
			16QAM	20.07	20.24	20.36	21.3
		Middle	QPSK	21.06	21.25	21.40	22.3
			16QAM	20.06	20.24	20.37	21.3
		Low	QPSK	21.03	21.27	21.43	22.3
			16QAM	20.01	20.26	20.42	21.3
	50RB	/	QPSK	21.05	21.27	21.39	22.3
16QAM			20.02	20.23	20.37	21.3	
20 MHz				2610MHz	2595MHz	2580MHz	/
	1RB	High	QPSK	22.13	22.23	22.39	23.3
			16QAM	21.11	21.19	21.32	22.3
		Middle	QPSK	22.02	22.22	22.34	23.3
			16QAM	20.98	21.15	21.29	22.3
		Low	QPSK	22.18	22.39	22.56	23.3
			16QAM	21.12	21.32	21.48	22.3
	50RB	High	QPSK	21.13	21.31	21.35	22.3
			16QAM	20.13	20.29	20.33	21.3
		Middle	QPSK	21.06	21.23	21.36	22.3
			16QAM	20.05	20.22	20.34	21.3
		Low	QPSK	21.03	21.30	21.48	22.3
			16QAM	20.02	20.28	20.46	21.3
	100RB	/	QPSK	21.09	21.30	21.43	22.3
16QAM			20.08	20.32	20.43	21.3	

11.4 Wi-Fi and BT Measurement result

Table 11.5: The conducted Power measurement results for BT

BT	Tune up	Averaged Power (dBm)		
Mode		Ch.0 (2402 MHz)	Ch39 (2441 MHz)	Ch78 (2480 MHz)
GFSK	5	3.39	4.57	3.30
EDR2M-4_DQPSK	3.5	2.20	3.23	1.86
EDR3M-8DPSK	3.5	2.28	3.35	1.95
BLE	Tune up	Ch0 (2402MHz)	Ch19 (2440MHz)	Ch39 (2480MHz)
	0.5	-2.04	-1.05	-2.10

Table 11.6: The conducted Power measurement results for 2.4G WIFI

WiFi 2.4GHz	Tune up	Averaged Power (dBm)		
Mode		Ch.1(2412 MHz)	Ch.6(2437Mhz)	Ch.11(2462MHz)
802.11b	16	15.02	15.55	15.33
802.11g	15.5	14.75	15.03	14.67
802.11n(20MHz)	16	14.93	14.96	14.69

Table 11.7: The conducted Power for 5G WIFI

Averaged Power (dBm)					
Mode		802.11a	802.11n-20MHz	Mode	802.11n-40MHz
Tune up		14	14	/	14
Channel (MHz)		6Mbps	MCS0	Channel	MCS0
U-NII-1	36(5180MHz)	13.41	13.66	38(5190MHz)	13.63
	40(5200MHz)	13.45	13.58	46(5230MHz)	13.72
	44(5220MHz)	13.49	13.61	/	
	48(5240MHz)	13.53	13.41		
U-NII-2A	52(5260MHz)	13.50	13.47	54(5270MHz)	13.45
	56(5280MHz)	13.38	13.30	62(5310MHz)	13.44
	60(5300MHz)	13.37	13.34	/	
	64(5320MHz)	13.45	13.16		
U-NII-2C	100(5500MHz)	13.49	13.13	102(5510MHz)	13.42
	104(5520MHz)	13.37	12.94	110(5550MHz)	13.45
	108(5540MHz)	13.31	12.58	118(5590MHz)	12.92
	112(5560MHz)	13.15	12.35	126(5630MHz)	12.56
	116(5580MHz)	13.39	12.91	134(5670MHz)	12.67
	120(5600MHz)	13.25	12.60	/	
	124(5620MHz)	13.18	12.67		
	128(5640MHz)	12.98	12.47		
	132(5660MHz)	13.25	12.60		
	136(5680MHz)	13.30	12.73		
	140(5700MHz)	13.35	12.48		
U-NII-3	149(5745MHz)	13.41	12.62	151(5755 MHz)	12.40
	153(5765MHz)	13.38	12.53	159(5795 MHz)	12.40
	157(5785MHz)	13.31	12.45	/	
	161(5805MHz)	13.23	12.43		
	165(5825MHz)	13.28	12.48		

12 Simultaneous TX SAR Considerations

12.1 Introduction

The following procedures adopted from “FCC SAR Considerations for Cell Phones with Multiple Transmitters” are applicable to handsets with built-in unlicensed transmitters such as 802.11 a/b/g and Bluetooth devices which may simultaneously transmit with the licensed transmitter.

For this device, the BT and Wi-Fi can transmit simultaneous with other transmitters.

12.2 Transmit Antenna Separation Distances

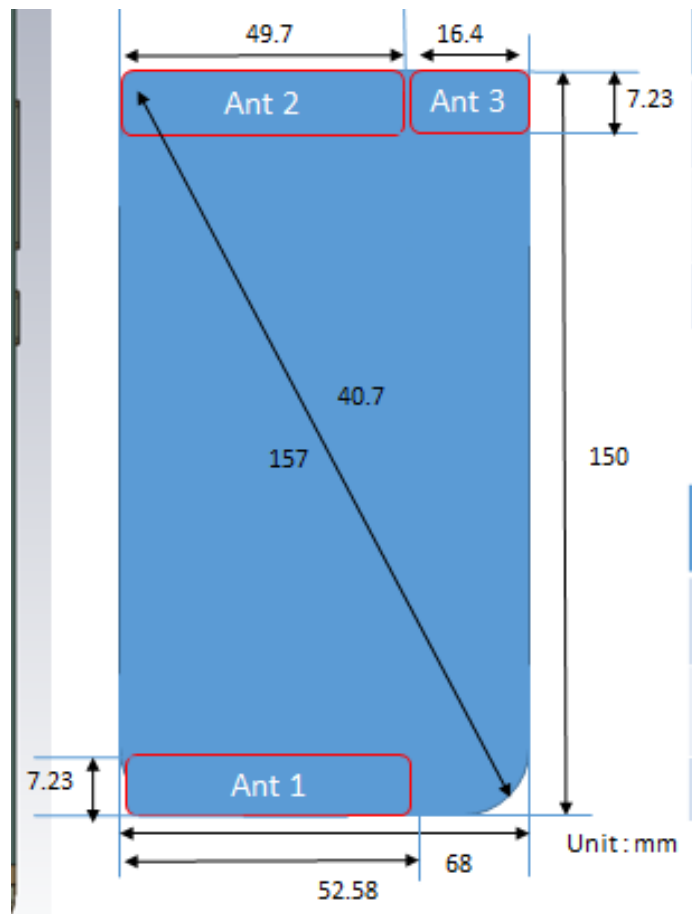

Picture 12.1 Antenna Locations (Front View)

Antenn	Mode	Bands
Ant 1	Primary LB/MB/HB	All Cellular
Ant 2	Diversity LB/MB/HB	W(1,2,4,5,8), LTE(1,2,3,4,5,7,8,12,17,28,38,40)
Ant 3	BT/WIFI/GPS	BT/WIFI2.4G & 5G/GPS

12.3 SAR Measurement Positions

According to the KDB941225 D06 Hot Spot SAR, the edges with less than 2.5 cm distance to the antennas need to be tested for SAR.

SAR measurement positions						
Mode	Front	Rear	Left edge	Right edge	Top edge	Bottom edge
Main antenna	Yes	Yes	Yes	Yes	No	Yes
WLAN	Yes	Yes	No	Yes	Yes	No

12.4 Standalone SAR Test Exclusion Considerations

Standalone 1-g head or body SAR evaluation by measurement or numerical simulation is not required when the corresponding SAR Exclusion Threshold condition, listed below, is satisfied. The 1-g SAR test exclusion threshold for 100 MHz to 6 GHz at test separation distances ≤ 50 mm are determined by:

$[(\text{max. power of channel, including tune-up tolerance, mW}) / (\text{min. test separation distance, mm})] \cdot [\sqrt{f(\text{GHz})}] \leq 3.0$ for 1-g SAR, where

- $f(\text{GHz})$ is the RF channel transmit frequency in GHz
- Power and distance are rounded to the nearest mW and mm before calculation
- The result is rounded to one decimal place for comparison

Table 12.1: Standalone SAR test exclusion considerations

Band/Mode	f(GHz)	Position	SAR test exclusion threshold (mW)	RF output power		SAR test exclusion
				dBm	mW	
Bluetooth	2.441	Head	9.60	5	3.16	Yes
		Body	19.20	5	3.16	Yes
2.4GHz WLAN	2.45	Head	9.58	16	39.81	No
		Body	19.17	16	39.81	No
5GHz WLAN	5.2	Head	6.58	14	25.12	No
		Body	13.16	14	25.12	No
	5.3	Head	6.52	14	25.12	No
		Body	13.03	14	25.12	No
	5.6	Head	6.34	14	25.12	No
		Body	12.68	14	25.12	No
	5.8	Head	6.23	14	25.12	No
		Body	12.46	14	25.12	No

13 Evaluation of Simultaneous

Table 13.1: The sum of reported SAR values for main antenna and Wi-Fi

/	Position	Main antenna	Wi-Fi	Sum
Highest reported SAR value for Head	Left Touch	0.26	1.10	1.36
Highest reported SAR value for Hotspot	Bottom	1.34	/	1.34
Highest reported SAR value for Body-worn	Rear	1.08	0.08	1.16

Table 13.2: The sum of reported SAR values for main antenna and Bluetooth

/	Position	Main antenna	BT*	Sum
Highest reported SAR value for Head	Right Touch	0.35	0.13	0.48
Highest reported SAR value for Hotspot	Bottom	1.34	/	1.34
Highest reported SAR value for Body-worn	Rear	1.08	0.04	1.12

BT* - Estimated SAR for Bluetooth (see the table 13.3)

Table 13.3: Estimated SAR for Bluetooth

Position	f (GHz)	Distance (mm)	Upper limit of power *		Estimated _{1g} (W/kg)
			dBm	mW	
Head	2.441	5	5	5.01	0.13
Body	2.441	10	5	5.01	0.07
Body	2.441	15	5	5.01	0.04

* - Maximum possible output power declared by manufacturer

When standalone SAR test exclusion applies to an antenna that transmits simultaneously with other antennas, the standalone SAR must be estimated according to following to determine simultaneous transmission SAR test exclusion:

(max. power of channel, including tune-up tolerance, mW) / (min. test separation distance, mm) · [$\sqrt{f(\text{GHz})/x}$] W/kg for test separation distances ≤ 50 mm;

Where $x = 7.5$ for 1-g SAR.

When the minimum test separation distance is < 5 mm, a distance of 5 mm is applied to determine SAR test exclusion

Conclusion:

According to the above tables, the sum of reported SAR values is $< 1.6\text{W/kg}$. So the simultaneous transmission SAR with volume scans is not required.

14 SAR Test Result

It is determined by user manual for the distance between the EUT and the phantom bottom.

The distance is 15mm and just applied to the condition of body worn accessory.

It is performed for all SAR measurements with area scan based 1-g SAR estimation (Fast SAR). A zoom scan measurement is added when the estimated 1-g SAR is the highest measured SAR in each exposure configuration, wireless mode and frequency band combination or >1.2W/kg.

The calculated SAR is obtained by the following formula:

$$\text{Reported SAR} = \text{Measured SAR} \times 10^{(P_{\text{Target}} - P_{\text{Measured}})/10}$$

Where P_{Target} is the power of manufacturing upper limit;

P_{Measured} is the measured power in chapter 11.

Table 14.1: Duty Cycle

Mode	Duty Cycle
Speech for GSM850/1900	1:8.3
GPRS for GSM850	1:2
GPRS for GSM1900	1:8.3
GPRS for GSM1900 (Hotspot)	1:4
WCDMA850	1:1
FDD_LTE Band 5/7	1:1
TDD_LTE Band 38	1:1.58

14.1 SAR results

Table 14.2: SAR Values (GSM 850 - Head)

Frequency		Test Mode	Test Position	Figure No.	Conducted Power (dBm)	Max. tune-up Power (dBm)	Measured SAR(1g) (W/kg)	Reported SAR(1g) (W/kg)	Power Drift(dB)
MHz	Ch.								
Ambient Temperature: 22.5°C Liquid Temperature: 22.0°C									
836.6	190	Speech	Left Touch	/	32.39	33.5	0.083	0.11	0.04
836.6	190	Speech	Left Tilt	/	32.39	33.5	0.060	0.08	0.08
836.6	190	Speech	Right Touch	Fig.1	32.39	33.5	0.092	0.12	-0.01
836.6	190	Speech	Right Tilt	/	32.39	33.5	0.055	0.07	0.05
32G									
836.6	190	Speech	Right Touch	/	32.39	33.5	0.085	0.11	0.06

Table 14.3: SAR Values (GSM 850 -Body)

Frequency		Test Mode	Test Position	Figure No.	Conducted Power (dBm)	Max. tune-up Power (dBm)	Measured SAR(1g) (W/kg)	Reported SAR(1g) (W/kg)	Power Drift(dB)
MHz	Ch.								
Ambient Temperature: 22.5°C Liquid Temperature: 22.0°C									
Hotspot Test Data (10mm)									
836.6	190	GPRS	Front	/	27.04	27.5	0.170	0.19	0.09
836.6	190	GPRS	Rear	/	27.04	27.5	0.103	0.11	0.04
836.6	190	GPRS	Left	/	27.04	27.5	0.064	0.07	-0.08
836.6	190	GPRS	Right	/	27.04	27.5	0.115	0.13	-0.04
836.6	190	GPRS	Bottom	/	27.04	27.5	0.066	0.07	0.06
836.6	190	EGPRS	Front	/	27.04	27.5	0.149	0.17	0.14
Hotspot Test Data (10mm) + 32G									
836.6	190	GPRS	Front	Fig.2	27.04	27.5	0.204	0.23	0.07
Body Worn Test Data (15mm)									
836.6	190	GPRS	Front	/	27.04	27.5	0.127	0.14	0.02
836.6	190	GPRS	Rear	/	27.04	27.5	0.091	0.10	0.08

Table 14.4: SAR Values (GSM 1900 - Head)

Frequency		Test Mode	Test Position	Figure No.	Conducted Power (dBm)	Max. tune-up Power (dBm)	Measured SAR(1g) (W/kg)	Reported SAR(1g) (W/kg)	Power Drift(dB)
MHz	Ch.								
Ambient Temperature: 22.7°C Liquid Temperature: 22.2°C									
1880	661	Speech	Left Touch	Fig.3	30.06	31.5	0.124	0.17	0.06
1880	661	Speech	Left Tilt	/	30.06	31.5	0.057	0.08	0.06
1880	661	Speech	Right Touch	/	30.06	31.5	0.068	0.09	0.04
1880	661	Speech	Right Tilt	/	30.06	31.5	0.056	0.08	0.02
32G									
1880	661	Speech	Left Touch	/	30.06	31.5	0.121	0.17	0.01

Table 14.5: SAR Values (GSM 1900 - Body)

Frequency		Test Mode	Test Position	Figure No.	Conducted Power (dBm)	Max. tune-up Power (dBm)	Measured SAR(1g) (W/kg)	Reported SAR(1g) (W/kg)	Power Drift(dB)
MHz	Ch.								
Ambient Temperature: 22.4°C Liquid Temperature: 22.0°C									
Hotspot Test Data (10mm)									
1880	661	GPRS	Front	/	23.69	24	0.787	0.85	0.13
1880	661	GPRS	Rear	/	23.69	24	0.181	0.19	0.05
1880	661	GPRS	Left	/	23.69	24	0.095	0.10	0.03
1880	661	GPRS	Right	/	23.69	24	0.105	0.11	0.04
1880	661	GPRS	Bottom	/	23.69	24	0.991	1.06	0.11
1909.8	810	GPRS	Front	/	23.84	24	0.664	0.69	0.16
1850.2	512	GPRS	Front	/	23.52	24	0.993	1.11	0.08
1909.8	810	GPRS	Bottom	/	23.84	24	0.829	0.86	0.02
1850.2	512	GPRS	Bottom	Fig.4	23.52	24	1.200	1.34	0.09
1850.2	512	EGPRS	Bottom	/	23.52	24	1.160	1.30	0.07
Hotspot Test Data (10mm) + 32G									
1850.2	512	GPRS	Bottom	/	23.52	24	1.180	1.32	0.01
Body Worn Test Data (15mm)									
1880	661	GPRS	Front	/	30.19	31.5	0.650	0.88	0.05
1880	661	GPRS	Rear	/	30.19	31.5	0.163	0.22	0.11
1909.8	810	GPRS	Front	/	30.05	31.5	0.510	0.71	0.01
1850.2	512	GPRS	Front	/	30.32	31.5	0.821	1.08	0.05

Table 14.6: SAR Values (WCDMA 850 - Head)

Frequency		Test Mode	Test Position	Figure No.	Conducted Power (dBm)	Max. tune-up Power (dBm)	Measured SAR(1g) (W/kg)	Reported SAR(1g) (W/kg)	Power Drift(dB)
MHz	Ch.								
Ambient Temperature: 22.5°C Liquid Temperature: 22.0°C									
836.4	4182	RMC	Left Touch	/	24.1	24.5	0.211	0.23	0.03
836.4	4182	RMC	Left Tilt	/	24.1	24.5	0.122	0.13	0.05
836.4	4182	RMC	Right Touch	Fig.5	24.1	24.5	0.220	0.24	0.09
836.4	4182	RMC	Right Tilt	/	24.1	24.5	0.136	0.15	0.07

Table 14.7: SAR Values (WCDMA 850 -Body)

Frequency		Test Mode	Test Position	Figure No.	Conducted Power (dBm)	Max. tune-up Power (dBm)	Measured SAR(1g) (W/kg)	Reported SAR(1g) (W/kg)	Power Drift(dB)
MHz	Ch.								
Ambient Temperature: 22.8°C Liquid Temperature: 22.2°C									
Hotspot Test Data (10mm)									
836.4	4182	RMC	Front	Fig.6	24.1	24.5	0.512	0.56	-0.03
836.4	4182	RMC	Rear	/	24.1	24.5	0.303	0.33	0.00
836.4	4182	RMC	Left	/	24.1	24.5	0.154	0.17	-0.12
836.4	4182	RMC	Right	/	24.1	24.5	0.203	0.22	-0.01
836.4	4182	RMC	Bottom	/	24.1	24.5	0.175	0.19	0.01
Body Worn Test Data (15mm)									
836.4	4182	RMC	Front	/	24.1	24.5	0.352	0.39	0.00
836.4	4182	RMC	Rear	/	24.1	24.5	0.255	0.28	-0.01

Table 14.8: SAR Values (LTE Band 5 - Head)

Frequency		Test Mode	Test Position	Figure No.	Conducted Power (dBm)	Max. tune-up Power (dBm)	Measured SAR(1g) (W/kg)	Reported SAR(1g) (W/kg)	Power Drift(dB)
MHz	Ch.								
Ambient Temperature: 22.5°C Liquid Temperature: 22.0°C									
836.5	20525	1RB_Low	Left Touch	/	22.46	23.3	0.211	0.26	-0.10
836.5	20525	25RB_Low	Left Touch	/	21.51	22.3	0.193	0.23	0.06
836.5	20525	1RB_Low	Left Tilt	/	22.46	23.3	0.201	0.24	0.00
836.5	20525	25RB_Low	Left Tilt	/	21.51	22.3	0.184	0.22	0.01
836.5	20525	1RB_Low	Right Touch	Fig.7	22.46	23.3	0.290	0.35	0.06
836.5	20525	25RB_Low	Right Touch	/	21.51	22.3	0.231	0.28	0.09
836.5	20525	1RB_Low	Right Tilt	/	22.46	23.3	0.118	0.14	0.09
836.5	20525	25RB_Low	Right Tilt	/	21.51	22.3	0.095	0.11	0.16

Table 14.9: SAR Values (LTE Band 5 - Body)

Frequency		Test Mode	Test Position	Figure No.	Conducted Power (dBm)	Max. tune-up Power (dBm)	Measured SAR(1g) (W/kg)	Reported SAR(1g) (W/kg)	Power Drift(dB)
MHz	Ch.								
Ambient Temperature: 22.8°C Liquid Temperature: 22.2°C									
Hotspot Test Data (10mm)									
836.5	20525	1RB_Low	Front	Fig.8	22.46	23.3	0.452	0.55	0.04
836.5	20525	25RB_Low	Front	/	21.51	22.3	0.345	0.41	0.05
836.5	20525	1RB_Low	Rear	/	22.46	23.3	0.312	0.38	0.01
836.5	20525	25RB_Low	Rear	/	21.51	22.3	0.240	0.29	0.04
836.5	20525	1RB_Low	Left	/	22.46	23.3	0.170	0.21	0.01
836.5	20525	25RB_Low	Left	/	21.51	22.3	0.123	0.15	-0.03
836.5	20525	1RB_Low	Right	/	22.46	23.3	0.324	0.39	-0.07
836.5	20525	25RB_Low	Right	/	21.51	22.3	0.247	0.30	-0.01
836.5	20525	1RB_Low	Bottom	/	22.46	23.3	0.174	0.21	0.05
836.5	20525	25RB_High	Bottom	/	21.51	22.3	0.141	0.17	-0.07
Body Worn Test Data (15mm)									
836.5	20525	1RB_Low	Front	/	22.46	23.3	0.322	0.39	0.01
836.5	20525	25RB_Low	Front	/	21.51	22.3	0.247	0.30	0.05
836.5	20525	1RB_Low	Rear	/	22.46	23.3	0.269	0.33	-0.01
836.5	20525	25RB_Low	Rear	/	21.51	22.3	0.204	0.24	0.02

Table 14.10: SAR Values (LTE Band 7 - Head)

Frequency		Test Mode	Test Position	Figure No.	Conducted Power (dBm)	Max. tune-up Power (dBm)	Measured SAR(1g) (W/kg)	Reported SAR(1g) (W/kg)	Power Drift(dB)
MHz	Ch.								
Ambient Temperature: 22.2°C Liquid Temperature: 21.7°C									
2535	21100	1RB_High	Left Touch	Fig.9	22.42	23.3	0.201	0.25	0.08
2535	21100	50RB_High	Left Touch	/	21.41	22.3	0.179	0.22	0.07
2535	21100	1RB_High	Left Tilt	/	22.42	23.3	0.073	0.09	0.08
2535	21100	50RB_High	Left Tilt	/	21.41	22.3	0.044	0.05	0.08
2535	21100	1RB_High	Right Touch	/	22.42	23.3	0.152	0.19	0.06
2535	21100	50RB_High	Right Touch	/	21.41	22.3	0.102	0.13	0.09
2535	21100	1RB_High	Right Tilt	/	22.42	23.3	0.063	0.08	0.05
2535	21100	50RB_High	Right Tilt	/	21.41	22.3	0.050	0.06	0.09

Table 14.11: SAR Values (LTE Band 7 - Body)

Frequency		Test Mode	Test Position	Figure No. / Note	Conducted Power (dBm)	Max. tune-up Power (dBm)	Measured SAR(1g) (W/kg)	Reported SAR(1g) (W/kg)	Power Drift(dB)
MHz	Ch.								
Ambient Temperature: 22.2°C Liquid Temperature: 21.7°C									
Hotspot Test Data (10mm)									
2535	21100	1RB_Mid	Front	/	22.42	23.3	0.327	0.40	0.07
2535	21100	50RB_High	Front	/	21.41	22.3	0.294	0.36	-0.05
2535	21100	1RB_Mid	Rear	/	22.42	23.3	0.270	0.33	0.05
2535	21100	50RB_High	Rear	/	21.41	22.3	0.236	0.29	0.08
2535	21100	1RB_Mid	Left	/	22.42	23.3	0.131	0.16	0.07
2535	21100	50RB_High	Left	/	21.41	22.3	0.113	0.14	0.03
2535	21100	1RB_Mid	Right	/	22.42	23.3	0.140	0.17	0.01
2535	21100	50RB_High	Right	/	21.41	22.3	0.118	0.14	-0.01
2535	21100	1RB_Mid	Bottom	Fig.10	22.42	23.3	0.409	0.50	-0.03
2535	21100	50RB_High	Bottom	/	21.41	22.3	0.394	0.48	-0.06
Body Worn Test Data (15mm)									
2535	21100	1RB_Mid	Front	/	22.42	23.3	0.184	0.23	-0.07
2535	21100	50RB_High	Front	/	21.41	22.3	0.137	0.17	-0.02
2535	21100	1RB_Mid	Rear	/	22.42	23.3	0.158	0.19	0.08
2535	21100	50RB_High	Rear	/	21.41	22.3	0.118	0.14	0.01

Table 14.12: SAR Values (LTE Band 38 - Head)

Frequency		Test Mode	Test Position	Figure No.	Conducted Power (dBm)	Max. tune-up Power (dBm)	Measured SAR(1g) (W/kg)	Reported SAR(1g) (W/kg)	Power Drift(dB)
MHz	Ch.								
Ambient Temperature: 22.2°C Liquid Temperature: 21.7°C									
2595	38000	1RB_Low	Left Touch	Fig.11	22.39	23.3	0.112	0.14	0.04
2595	38000	50RB_High	Left Touch	/	21.31	22.3	0.097	0.12	0.05
2595	38000	1RB_Low	Left Tilt	/	22.39	23.3	0.027	0.03	0.13
2595	38000	50RB_High	Left Tilt	/	21.31	22.3	0.023	0.03	0.09
2595	38000	1RB_Low	Right Touch	/	22.39	23.3	0.076	0.09	0.02
2595	38000	50RB_High	Right Touch	/	21.31	22.3	0.057	0.07	0.05
2595	38000	1RB_Low	Right Tilt	/	22.39	23.3	0.028	0.03	0.07
2595	38000	50RB_High	Right Tilt	/	21.31	22.3	0.018	0.02	0.06

Table 14.13: SAR Values (LTE Band 38 - Body)

Frequency		Test Mode	Test Position	Figure No. / Note	Conducted Power (dBm)	Max. tune-up Power (dBm)	Measured SAR(1g) (W/kg)	Reported SAR(1g) (W/kg)	Power Drift(dB)
MHz	Ch.								
Ambient Temperature: 22.2°C Liquid Temperature: 21.7°C									
Hotspot Test Data (10mm)									
2595	38000	1RB_Low	Front	/	22.39	23.3	0.213	0.26	0.07
2595	38000	50RB_High	Front	/	21.31	22.3	0.156	0.20	-0.08
2595	38000	1RB_Low	Rear	/	22.39	23.3	0.146	0.18	0.02
2595	38000	50RB_High	Rear	/	21.31	22.3	0.113	0.14	0.03
2595	38000	1RB_Low	Left	/	22.39	23.3	0.069	0.09	0.07
2595	38000	50RB_High	Left	/	21.31	22.3	0.051	0.06	0.04
2595	38000	1RB_Low	Right	/	22.39	23.3	0.097	0.12	0.03
2595	38000	50RB_High	Right	/	21.31	22.3	0.072	0.09	0.01
2595	38000	1RB_Low	Bottom	Fig.12	22.39	23.3	0.259	0.32	-0.06
2595	38000	50RB_High	Bottom	/	21.31	22.3	0.238	0.30	-0.04
Body Worn Test Data (15mm)									
2595	38000	1RB_Low	Front	/	22.39	23.3	0.069	0.09	0.07
2595	38000	50RB_High	Front	/	21.31	22.3	0.051	0.06	0.04
2595	38000	1RB_Low	Rear	/	22.39	23.3	0.097	0.12	0.03
2595	38000	50RB_High	Rear	/	21.31	22.3	0.072	0.09	0.01

14.2 WLAN Evaluation for 2.4G

According to the KDB248227 D01, SAR is measured for 2.4GHz 802.11b DSSS using the initial test position procedure.

Head Evaluation

Table 14.14: SAR Values (WLAN 2.4G - Head)–802.11b 1Mbps

Frequency		Test Mode	Test Position	Figure No.	Conducted Power (dBm)	Max. tune-up Power (dBm)	Measured SAR(1g) (W/kg)	Reported SAR(1g) (W/kg)	Power Drift(dB)
MHz	Ch.								
		Ambient Temperature: 22.6°C			Liquid Temperature: 22.0°C				
2437	6	802.11 b	Left Touch	/	15.55	16	0.734	0.81	0.01
2437	6	802.11 b	Left Tilt	/	15.55	16	0.611	0.68	0.11
2437	6	802.11 b	Right Touch	/	15.55	16	0.348	0.39	-0.15
2437	6	802.11 b	Right Tilt	/	15.55	16	0.404	0.45	0.03
2462	11	802.11 b	Left Touch	Fig.13	15.33	16	0.701	0.82	0.08

Note1:For all positions/configurations tested using the initial test position and subsequent test positions, when the reported SAR is > 0.8 W/kg, SAR is measured for these test positions/configurations on the subsequent next highest measured output power channel until the reported SAR is ≤ 1.2 W/kg or all required channels are tested.

According to the KDB248227 D01, The reported SAR must be scaled to 100% transmission duty factor to determine compliance at the maximum tune-up tolerance limit. A maximum transmission duty factor of 100% is achievable for WLAN in this project and the scaled reported SAR is presented as below.

Table 14.15: SAR Values (WLAN - Head) – 802.11b 1Mbps (Scaled Reported SAR)

Frequency		Test Position	Actual duty factor	maximum duty factor	Reported SAR (1g)(W/kg)	Scaled reported SAR (1g)(W/kg)
MHz	Ch.					
2462	11	Left Touch	100%	100%	0.82	0.82

SAR is not required for OFDM because the 802.11b adjusted SAR ≤ 1.2 W/kg.