



TEST REPORT

No. I18Z60290-IOT16

for

HMD Global Oy

Model Name: TA-1061

FCC ID: 2AJOTTA-1061

with

Hardware Version: 0403/0407

Software Version: 00WW_0_266

Issued Date: 2018-06-07



Note:

The test results in this test report relate only to the devices specified in this report. This report shall not be reproduced except in full without the written approval of CTTL.

The report must not be used by the client to claim product certification, approval, or endorsement by NVLAP, NIST, or any agency of the U.S. Government.

Test Laboratory:

CTTL, Telecommunication Technology Labs, CAICT

No. 52, Huayuan North Road, Haidian District, Beijing, P. R. China 100191.

Tel: +86(0)10-62304633-2512, Fax: +86(0)10-62304633-2504

Email: ctl_terminals@caict.ac.cn, website: www.caict.ac.cn

CONTENTS

1. TEST LABORATORY	3
1.1. TESTING LOCATION.....	3
1.2. TESTING ENVIRONMENT	3
1.3. PROJECT DATA.....	3
1.4. SIGNATURE.....	3
2. CLIENT INFORMATION	4
2.1. APPLICANT INFORMATION.....	4
2.2. MANUFACTURER INFORMATION	4
3. EQUIPMENT UNDER TEST (EUT) AND ANCILLARY EQUIPMENT (AE)	5
3.1. ABOUT EUT.....	5
3.2. INTERNAL IDENTIFICATION OF EUT USED DURING THE TEST.....	5
3.3. INTERNAL IDENTIFICATION OF AE USED DURING THE TEST	5
3.4. GENERAL DESCRIPTION	6
3.5. EUT SET-UPS.....	6
4. REFERENCE DOCUMENTS	6
4.1. DOCUMENTS SUPPLIED BY THE APPLICANT.....	6
4.2. REGULATIONS AND STANDARDS	6
5. LABORATORY ENVIRONMENT	7
6. SUMMARY OF TEST RESULTS	8
6.1. SUMMARY OF TEST RESULTS	8
6.2. TERMS USED IN THE SUMMARY OF TEST RESULTS.....	9
6.3. STATEMENTS	9
7. TEST EQUIPMENT'S UTILIZED	10
ANNEX A: MEASUREMENT RESULTS	11
A.1. ELECTRIC FIELD STRENGTH OF FUNDAMENTAL AND OUTSIDE THE ALLOCATED BANDS.....	11
A.2. ELECTRIC FIELD RADIATED EMISSIONS (< 30MHz).....	13
A.3. ELECTRIC FIELD RADIATED EMISSIONS (≥30MHz).....	15
A.4. FREQUENCY TOLERANCE	17
A.5. 20dB BANDWIDTH	19
A.6. CONDUCTED EMISSION	20
ANNEX A: ACCREDITATION CERTIFICATE	23

1. Test Laboratory

1.1. Testing Location

CTTL (Huayuan North Road)

Address: No. 52, Huayuan North Road, Haidian District, Beijing,
P. R. China 100191

CTTL(Shouxiang)

Address: No. 51 Shouxiang Science Building, Xueyuan Road,
Haidian District, Beijing, P. R. China 100191

1.2. Testing Environment

Ambient Temperature: 15 ~ 25 °C

Relative Humidity: 30 ~ 60 %

1.3. Project Data

Testing Start Date: 2018-5-03

Testing End Date: 2018-5-30

1.4. Signature

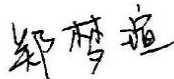

Zheng Mengxuan
(Prepared this test report)



Zhu Liang
(Reviewed this test report)

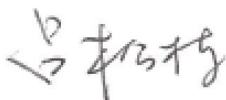

Lv Songdong
(Approved this test report)



2. Client Information

2.1. Applicant Information

Company Name:	HMD Global Oy
Address:	Karaportti 2 02610 Espoo FINLAND
Contact	Mikko Kahlos
Tel:	+358 408036126
Email:	mikko.kahlos@hmdglobal.com

2.2. Manufacturer Information

Company Name:	HMD Global Oy
Address:	Karaportti 2 02610 Espoo FINLAND
Contact	Mikko Kahlos
Tel:	+358 408036126
Email:	mikko.kahlos@hmdglobal.com

3. Equipment Under Test (EUT) and Ancillary Equipment (AE)

3.1. About EUT

Description:	Smart phone
FCC ID	2AJOTTA-1061
With NFC Function:	Yes
Frequency:	13.56 MHz
Antenna:	Internal
Operation Voltage:	3.6VDC to 4.2VDC (nominal: 3.8VDC)

3.2. Internal Identification of EUT Used during the Test

Mobile phone identification

EUT ID*	SN or IMEI	HW Version	SW Version
EUT1	353389090000399	0403	00WW_0_266
EUT2	004402971272558/ 004402971275353	0403	00WW_0_266

*EUT ID: is used to identify the test sample in the lab internally.

3.3. Internal Identification of AE Used during the Test

AE ID*	Description	SN	Reversion
AE1	Battery	/	Inbuilt
AE3	Charger	/	/
AE11	USB Cable	/	/
AE1			
	Model	HE336	
	Manufacturer	SCUD(Fujian) Electronics Co., Ltd.	
	Capacitance	2900mAh	
	Nominal voltage	3.85V	
AE3			
	Model	AD-10W	
	Manufacturer	Sal comp	
	Length of cable	/	
AE11			
	Model	CUBB01M-FA010-DH	
	Manufacturer	/	
	Length of cable	98cm	

*AE ID: is used to identify the test sample in the lab internally.

3.4. General Description

This is a product supporting with 2.4G/5G technologies.

Manuals and specifications of the EUT were provided to fulfil the test.

Samples undergoing test were selected by the client.

Manufacturer's declaration: NFC work does not depend on other access methods, such as WLAN, GPRS, etc.

3.5. EUT Set-ups

EUT Set-up No.	Combination of EUT and AE	Remarks
Set.1	EUT2+AE1+AE3	--
Set.2	EUT2+AE1	
Set.3	EUT1	

The Transmit State of NFC: the NFC function is on. The EUT will transmit the NFC data and command continuously during the test.

The Transmit State of without modulation: The EUT will transmit the CW signal at the operating frequency.

4. Reference Documents

4.1. Documents Supplied by the Applicant

EUT feature information is supplied by the applicant or manufacturer, which is the basis of testing.

4.2. Regulations and Standards

The following documents listed in this section are referred for testing.

Reference	Title	Version
CFR 47 Part 2	Part 2 — Frequency Allocations and Radio Treaty Matters; General Rules and Regulations.	2015
CFR 47 Part 15	Part 15 — Radio Frequency Devices. Subpart C — Intentional Radiators. § 15.35 Measurement detector functions and bandwidths. § 15.207 Conducted limits. § 15.209 Radiated emission limits, general requirements. § 15.215 Additional provisions to the general radiated emission limitations. § 15.225 Operation within the band 13.110–14.010 MHz.	2015
ANSI C63.10	American National Standard of Procedures for Compliance Testing of Unlicensed Wireless Devices	2013

5. LABORATORY ENVIRONMENT

Semi-anechoic chamber SAC-1 (23 meters×17meters×10meters) did not exceed following limits along the EMC testing:

Temperature	Min. = 15 °C, Max. = 35 °C
Relative humidity	Min. = 15 %, Max. = 75 %
Shielding effectiveness	0.014MHz - 1MHz, >60dB; 1MHz - 1000MHz, >90dB.
Electrical insulation	> 2 MΩ
Ground system resistance	< 4Ω
Normalised site attenuation (NSA)	< ± 4 dB, 3m/10m distance, from 30 to 1000 MHz
Site voltage standing-wave ratio (S_{VSWR})	Between 0 and 6 dB, from 1GHz to 18GHz
Uniformity of field strength	Between 0 and 6 dB, from 80 to 3000 MHz

Fully-Anechoic Chamber FAC-3 (8.6m×6.1m×3.85m) did not exceed following limits along the testing:

Temperature	Min. = 15 °C, Max. = 25 °C
Relative humidity	Min. = 30 %, Max. = 60 %
Shielding effectiveness	> 110 dB
Electrical insulation	> 2 MΩ
Ground system resistance	< 1 Ω
Site voltage standing-wave ratio (S_{VSWR})	Between 0 and 6 dB, from 1 to 18GHz
Uniformity of field strength	Between 0 and 6 dB, from 80 to 4000 MHz

Conducted Chamber did not exceed following limits along the testing:

Temperature	Min. = 15 °C, Max. = 25 °C
Relative humidity	Min. = 30 %, Max. = 60 %
Shielding effectiveness	> 110 dB
Electrical insulation	> 2 MΩ
Ground system resistance	< 0.5 Ω

Control Room did not exceed following limits along the testing:

Temperature	Min. = 15 °C, Max. = 25 °C
Relative humidity	Min. =30 %, Max. = 60 %
Shielding effectiveness	> 110 dB
Electrical insulation	> 2 MΩ
Ground system resistance	< 0.5 Ω

6. SUMMARY OF TEST RESULTS

6.1. Summary of Test Results

No	Test Cases	Clause in Regulation	Section in This Report	Verdict
1	Electric Field Strength of Fundamental Emissions	CFR 47 § 15.225(a)	A.1	P(Set. NFC03)
2	Electric Field Strength of Outside the Allocated Bands	CFR 47 § 15.225(b) CFR 47 § 15.225(c)		P(Set. NFC03)
3	Electric Field Radiated Emissions	CFR 47 § 15.209	A.2	P (Set. 1)
		CFR 47 § 15.225(d)	A.3	P(Set. NFC01)
4	Frequency Tolerance	CFR 47 § 15.225(e)	A.4	P(Set. NFC02)
5	20dB Bandwidth	CFR 47 § 15.215(c)	A.5	P(Set. NFC02, 03)
6	Conducted Emissions	CFR 47 § 15.207	A.6	P(Set. 1)
The measurement is carried out according to ANSI C63.10. See ANNEX A for details.				

Test Conditions:

For this report, all the test cases listed above were tested under normal Temperature, Voltage, humidity, and Air Pressure. The specific conditions are as following:

Temperature	T min	-20 °C
	T nom	25 °C
	T max	55 °C
Voltage	V min	3.6 V
	V nom	3.8 V
	V max	4.2 V
Humidity	H nom	44%
Air Pressure	A nom	1010 mbar

6.2. Terms Used in the Summary of Test Results

Terms Used in Condition Column:

T nom	Normal Temperature
T min	Low Temperature
T max	High Temperature
V nom	Normal Voltage
V min	Low Voltage
V max	High voltage
H nom	Norm Humidity
A nom	Norm Air Pressure

Terms Used in Verdict Column:

P	Pass, The EUT complies with the essential requirements in the standard.
NP	Not Perform, The test was not performed by CTTL
NA	Not Applicable, The test was not applicable
F	Fail, The EUT does not comply with the essential requirements in the standard

Abbreviations:

AC	Alternating Current
AFH	Adaptive Frequency Hopping
BW	Band Width
E.I.R.P.	equivalent is tropical radiated power
ISM	Industrial, Scientific and Medical
RF	Radio Frequency
TX	Transmitter

6.3. Statements

The test cases listed in Section 6.1 of this report for the EUT specified in Section 3 were performed by CTTL according to the reference documents in Section 4.

The EUT meets all applicable requirements of the regulations and standards in Section 4.2.

This report only deals with the NFC function among the features described in section 3.



7. Test Equipment's Utilized

NO.	NAME	TYPE	SERIES NUMBER	PRODUCER	CAL. DUE DATE	CAL. INTERVAL
1.	Spectrum Analyzer	RSA3408A	B010277	Tektronix	2018-09-04	1 Year
2.	Climatic chamber	SH242	93008658	Key sight	2018-11-27	1 Year
3.	H-field Antenna	HFH2-Z2	829324/0007	R&S	2019-01-13	1 Year
4.	EMI Antenna	VULB9163	514	Schwarz beck	2021-01-03	3 years
5.	Test Receiver	ESCI 7	100948	R&S	2018-07-25	1 Year
6.	Test Receiver	ESU26	100376	R&S	2018-12-30	1 year
7.	LISN	ENY216	101200	R&S	2019-04-15	1 year

ANNEX A: MEASUREMENT RESULTS

A.1. Electric Field Strength of Fundamental and Outside the Allocated bands

A.1.1. Reference

See Clause 13.5, Clause 13.4, Clause 8, and Annex E of ANSI C63.10-2013 specifically.
See Clause 4, Clause 5, and Clause 6 of ANSI C63.10-2013 generally.

A.1.2. Measurement Methods

The transmitter carrier output levels (E-Field) from the EUT are measured in a semi-anechoic chamber. The EUT is placed on a non-conductive stand of 80cm high, and at a measurement distance of 3m from the receiving antenna. The center of the receiving loop antenna is 1.0 meter above the ground. The E-field is measured with a shielded loop antenna connected to a measurement receiver. Detected E-field was maximized by rotating the EUT through 360° and adjusting the receiving antenna polarizations. The maximization processes were repeated with the EUT positioned respectively in its three orthogonal axes. The measurements were performed with the peak detector and if required, the quasi-peak detector.

The measurement bandwidth is:

Frequency of Emission (MHz)	RBW/VBW
12.56-14.56	10/30 kHz

The E-field measured at 3m is calculated as:

$$\text{E-field (dB}\mu\text{V/m)} = \text{Rx (dB}\mu\text{V)} + \text{Cable Loss (dB)} + \text{AF@3m (dB/m)}$$

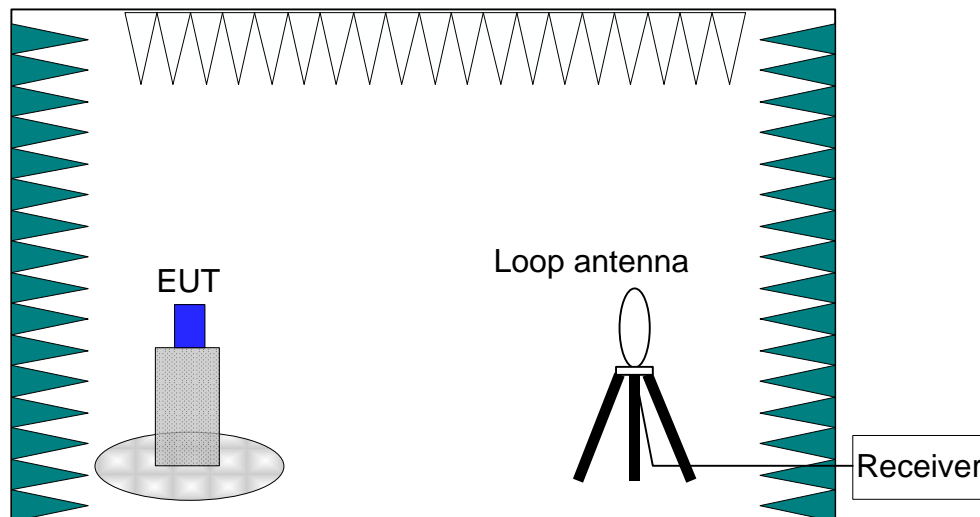

A.1.3. EUT Operating Mode and Test Conditions

The measurement of EUT is carried out under the transmit state of NFC (See 3.5).

The EUT is powered by a travel adapter.

During the measurements, the ambient temperature of the electromagnetic anechoic chamber is in the range of 15 ~ 25 °C.

A.1.4. Limits

Frequency Range (MHz)	E-field Strength Limit @ 30 m (μV/m)	E-field Strength Limit @ 3 m (dBμV/m)
13.560 ± 0.007	+15,848	124
13.410 to 13.553 13.567 to 13.710	+334	90
13.110 to 13.410 13.710 to 14.010	+106	81

Note: Where the limits have been defined at one distance, and a signal level measured at another, the limits have been extrapolated using the following formula:

$$\text{Extrapolation(dB)} = 40\log_{10}(\text{Measurement Distance}/\text{Specification Distance})$$

A.1.5. Measurement Results

Measurement results of normal conditions see Figure C-1 for different set-ups of EUT. The result displayed take into account applicable antenna factors and cable losses.

Conclusions: Set. 2, **PASS.**

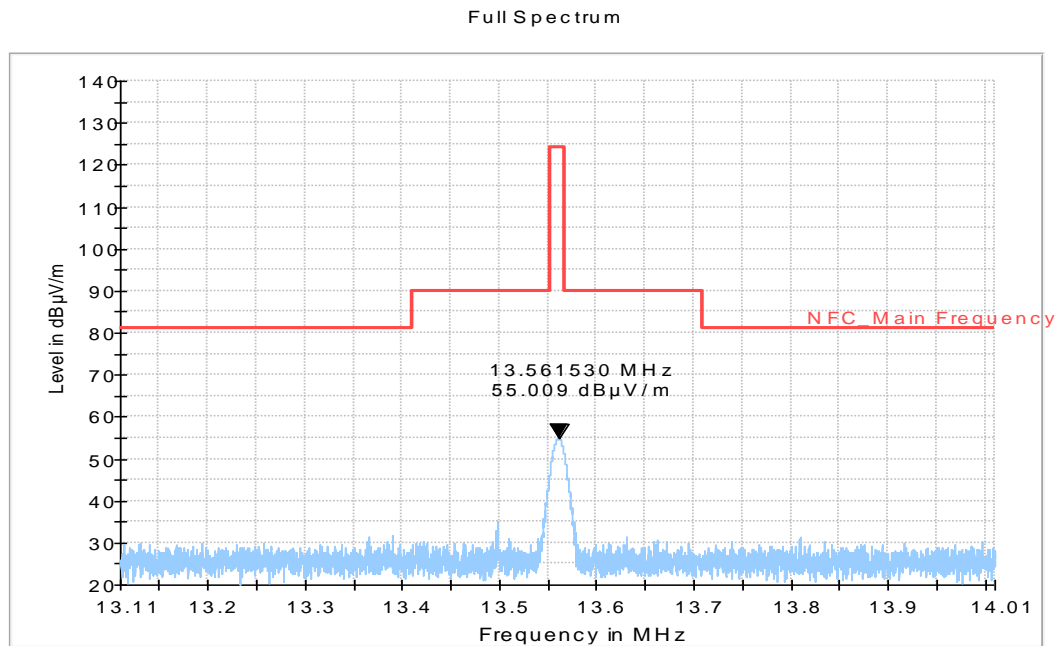

Figure A-1: Set. 2

A.1.6. Measurement Uncertainty

Measurement uncertainty: $U = 3.94$ dB, $k=2$.

A.2. Electric Field Radiated Emissions (< 30MHz)

A.2.1. Reference

See Clause 13.4, Clause 8 and Annex E of ANSI C63.10-2013 specifically.
See Clause 4, Clause 5, and Clause 6 of ANSI C63.10-2013 generally.

A.2.2. Measurement Methods

The transmitter carrier output levels (E-Field) from the EUT are measured in a semi-anechoic chamber. The EUT is placed on a non-conductive stand of 80cm high, and at a measurement distance of 3m from the receiving antenna. The center of the receiving loop antenna is 1.0 meter above the ground. The E-field is measured with a shielded loop antenna connected to a measurement receiver. Detected E-field was maximized by rotating the EUT through 360° and adjusting the receiving antenna polarizations. The maximization processes were repeated with the EUT positioned respectively in its three orthogonal axes. The measurements were performed with the peak detector and if required, the quasi-peak detector.

The measurement bandwidth is:

Frequency of Emission (MHz)	RBW/VBW
0.009-0.15	100/300 Hz
0.15-30	10/30 kHz

The E-field measured at 3m is calculated as:

$$\text{E-field (dB}\mu\text{V/m)} = \text{Rx (dB}\mu\text{V)} + \text{Cable Loss (dB)} + \text{AF@3m (dB/m)}$$

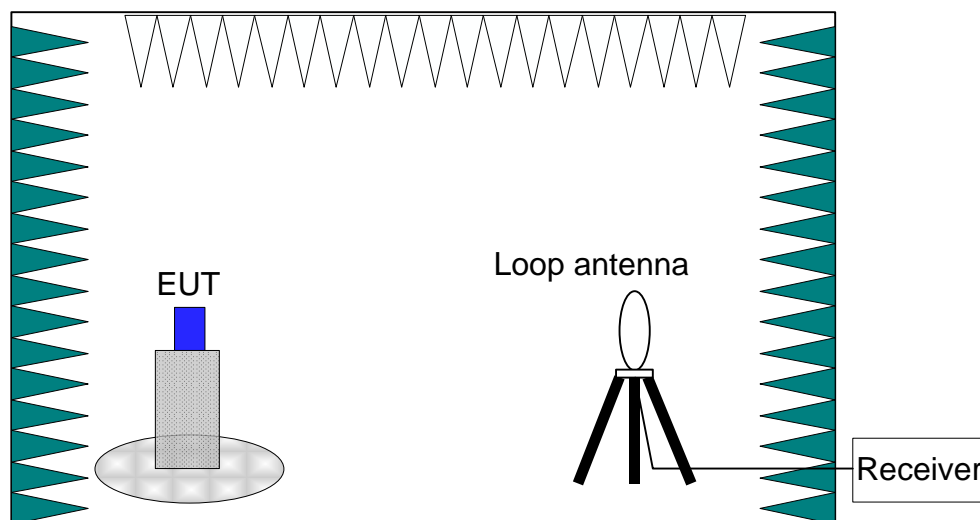

A.2.3. EUT Operating Mode and Test Conditions

The measurement of EUT is carried out under the transmit state of NFC (See 3.5).

The EUT is powered by a travel adapter.

During the measurements, the ambient temperature of the electromagnetic anechoic chamber is in the range of 15 ~ 25 °C.

A.2.4. Limits

Frequency Range (MHz)	E-field Strength Limit @ 30m (mV/m)	E-field Strength Limit @ 3m (dB μ V/m)
0.009-0.490	2400/F(kHz)	129-94
0.490-1.705	24000/F(kHz)	74-63
1.705-30	30	70

Note: Where the limits have been defined at one distance, and a signal level measured at another, the limits have been extrapolated using the following formula:

$$\text{Extrapolation(dB)} = 40\log_{10}(\text{Measurement Distance}/\text{Specification Distance})$$

A.2.5. Measurement Results

Measurement results of normal conditions see Figure C-2 for different set-ups of EUT. The result displayed take into account applicable antenna factors and cable losses.

Conclusions: Set. 1, **PASS.**

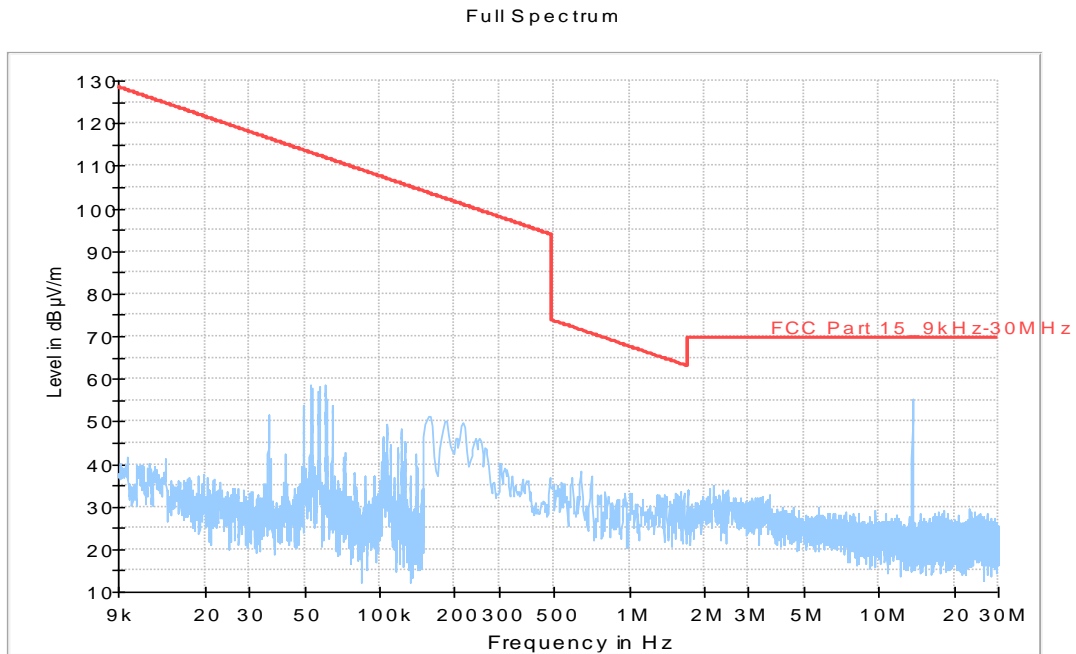

Figure A-2: Set. 1

A.2.6. Measurement Uncertainty

Measurement uncertainty: $U = 3.94$ dB, $k=2$.

A.3. Electric Field Radiated Emissions ($\geq 30\text{MHz}$)

A.3.1. Reference

See Clause 13.4, Clause 8, and Annex E of ANSI C63.10-2013 specifically.

See Clause 4, Clause 5, and Clause 6 of ANSI C63.10-2013 generally.

A.3.2. Measurement Methods

The electric field radiated emissions from the EUT are measured in a semi-anechoic chamber. The EUT is placed on a non-conductive stand of 80cm high, and at a measurement distance of 10m from the receiving antenna. The receiving antennas connected to a measurement receiver comply with Clause 15 of ANSI C63.2-1996 and Clause 6.5 of ANSI C63.10-2013. In order to search for maximum field strength emitted from the EUT, the receiving antenna can be moved between the height of 1.0 m to 4.0 m. Detected E-field was maximized at each frequency by rotating the EUT through 360° and adjusting the receiving antenna positions for both vertical and horizontal antenna polarizations. The maximization processes were repeated with the EUT positioned respectively in its three orthogonal axes. The measurements were performed with the peak detector and if required, the quasi-peak detector.

The measurement bandwidth is:

Frequency of Emission (MHz)	RBW/VBW
30-1000	120kHz

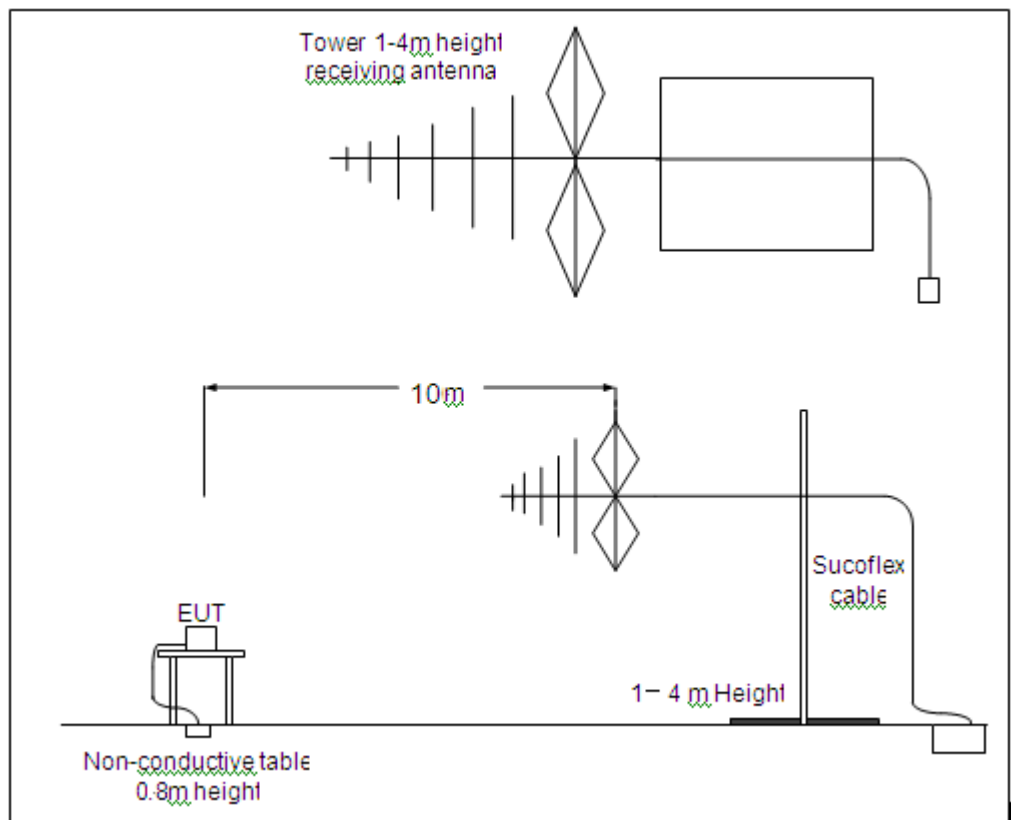

A.3.3. EUT Operating Mode and Test Conditions

The measurement of EUT is carried out under the transmit state of NFC (See 3.5).

EUT1 had been connected to a travel adapter.

During the measurements, the ambient temperature of the electromagnetic anechoic chamber is in the range of 15 ~ 25 °C.

A.3.4. Limits

Frequency Range (MHz)	E-field Strength Limit @ 3m (mV/m)	E-field Strength Limit @ 3m (dB μ V/m)	E-field Strength Limit @ 10m (dB μ V/m)
30-88	100	40	30
88-216	150	43.5	33.5
216-960	200	46	36
960-1000	500	54	44

A.3.5. Measurement Results

Measurement results of normal conditions see Figure C-3 for different set-ups of EUT. The result displayed take into account applicable antenna factors and cable losses.

Conclusions: Set. 1, **PASS**.

A.3.6. Measurement Uncertainty

Measurement uncertainty: $U = 3.9$ dB, $k=2$

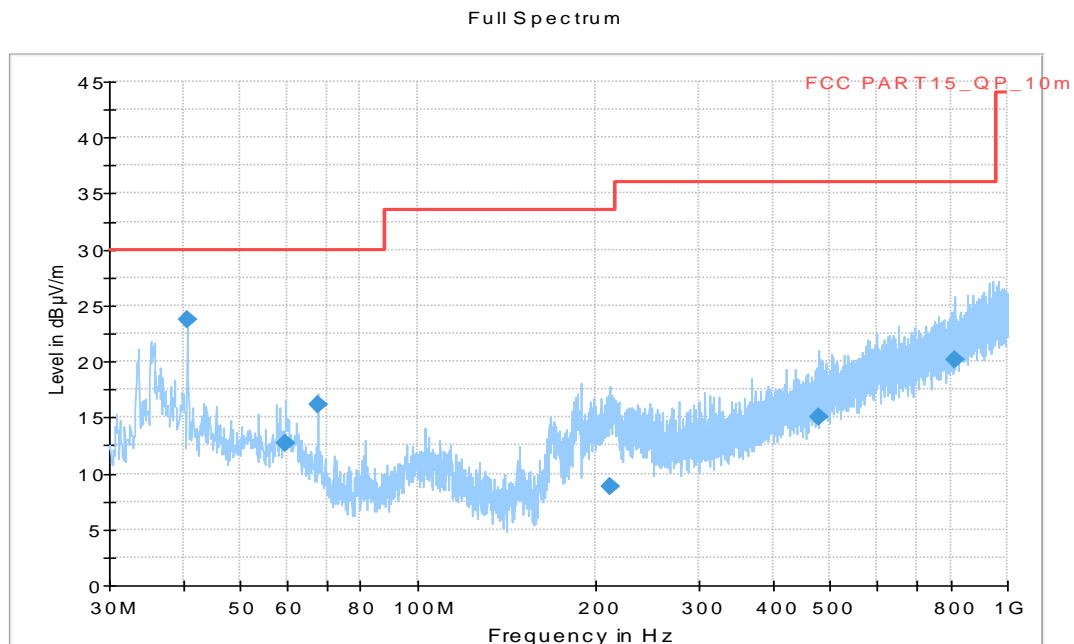

Figure A-3: Set. 1

Final Result

Frequency (MHz)	QuasiPeak (dB μ V/m)	Limit (dB μ V/m)	Margin (dB)	Meas. Time	Bandwidth (kHz)	Height (cm)	Pol	Azimuth (deg)
40.670000	23.74	30.00	6.26	1000.0	120.000	188.0	V	62.0
59.525000	12.66	30.00	17.34	1000.0	120.000	225.0	V	-29.0
67.793000	16.12	30.00	13.88	1000.0	120.000	314.0	V	-24.0
211.593000	8.81	33.50	24.71	1000.0	120.000	196.0	V	97.0
479.313000	15.08	36.00	20.94	1000.0	120.000	100.0	V	-24.0
812.772000	20.14	36.00	15.88	1000.0	120.000	125.0	V	60.0

A.4. Frequency Tolerance

A.4.1. Reference

See Clause 13.6 of ANSI C63.10-2013 specifically.

See Clause 4, Clause 5, and Clause 6 of ANSI C63.10-2013 generally.

A.4.2. Measurement Methods

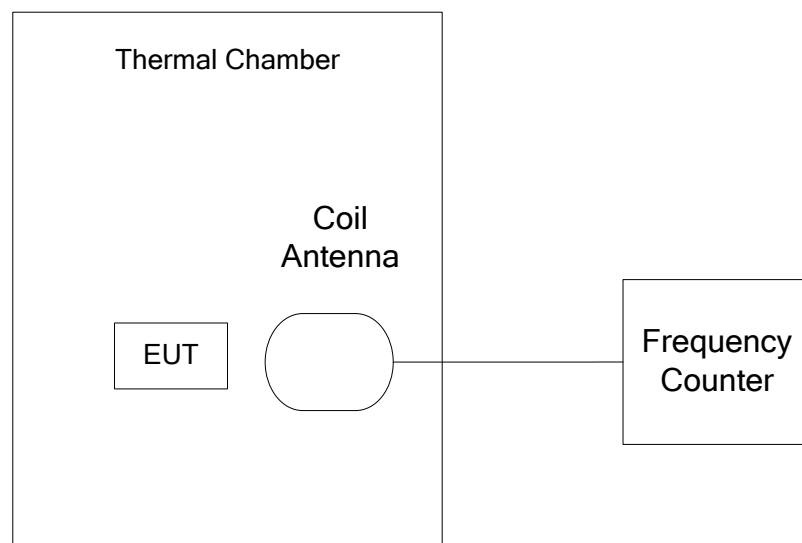

The transmitter output signal was picked up by coil antenna connected to the frequency counter. The center frequency was measured with 30Hz RBW and 1kHz span.

During the test, the EUT was placed in a thermal chamber until thermal balance and lasting appropriate time.

A.4.3. EUT Operating Mode and Test Conditions

The measurement of EUT is carried out under the transmit state of without modulation (See 3.5). EUT1 had been not connected to a travel adapter.

Operation Temperature: T min, T nom, and T max with V nom.

Operation Voltage: V min and V max with T nom.

A.4.4. Test Layouts

See A.4.2.

A.4.5. Limits

The frequency tolerance of the carrier signal shall be maintained within +/- 0.01% of the operating frequency.

A.4.6. Measurement Results

Measurement results see Table A-1 for different test conditions.

Conclusions: Set. NFC02, **PASS**.

Table A-1: Frequency Stability VS Temperature and Voltage

Temperature	Voltage	Frequency Error (MHz)			
		Startup	2 Min Later	5 Min Later	10 Min Later
T min	V nom	13.5646500	13.5551625	13.5547000	13.5618625
T max	V nom	13.5596500	13.5599750	13.5607000	13.5548875
T nom	V nom	13.5611250	13.5669375	13.5606750	13.5625250
T nom	V min	13.5606750	13.5581625	13.5607125	13.5606750
T nom	V max	13.5656250	13.5542625	13.5606750	13.5597125

Temperature	Voltage	Frequency Error (%)			
		Startup	2 Min Later	5 Min Later	10 Min Later
T min	V nom	0.034	-0.036	-0.039	0.014
T max	V nom	-0.003	0.000	0.005	-0.038
T nom	V nom	0.008	0.051	0.005	0.019
T nom	V min	0.005	-0.014	0.005	0.005
T nom	V max	0.041	-0.042	0.005	-0.002

A.4.7. Measurement Uncertainty

Measurement uncertainty: $U = 77$ Hz, $k=2$

A.5. 20dB Bandwidth

A.5.1. Reference

See Clause 13.7 of ANSI C63.10-2013 specifically.

See Clause 4, Clause 5, and Clause 6 of ANSI C63.10-2013 generally.

A.5.2. Measurement Methods

The transmitter output signal was picked up by coil antenna to the spectrum analyzer.

The transmitter output signal was picked up by coil antenna connected to the spectrum analyzer.

The bandwidth of the center frequency was measured with 140Hz RBW, 420Hz VBW and 14kHz span.

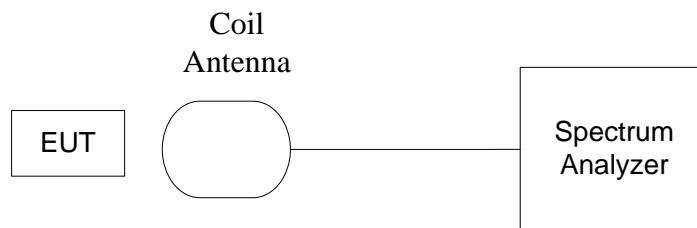

A.5.3. EUT Operating Mode and Test Conditions

The measurement of EUT is carried out under the transmit state of NFC and without modulation (See 3.5).

EUT had been not connected to a travel adapter..

During the measurements, the ambient temperature is in the range of 15 ~ 25 °C.

A.5.4. Test Layouts

See A.5.2.

A.5.5. Limits

The 20dB bandwidth shall be less than 80% of the permitted frequency band. For 13.56 MHz NFC, the permitted frequency band is 14kHz, so the limit is 11.2 kHz.

A.5.6. Measurement Results

Measurement results see Figure A-4.

Conclusions: Set. NFC02 and NFC03, **PASS**.

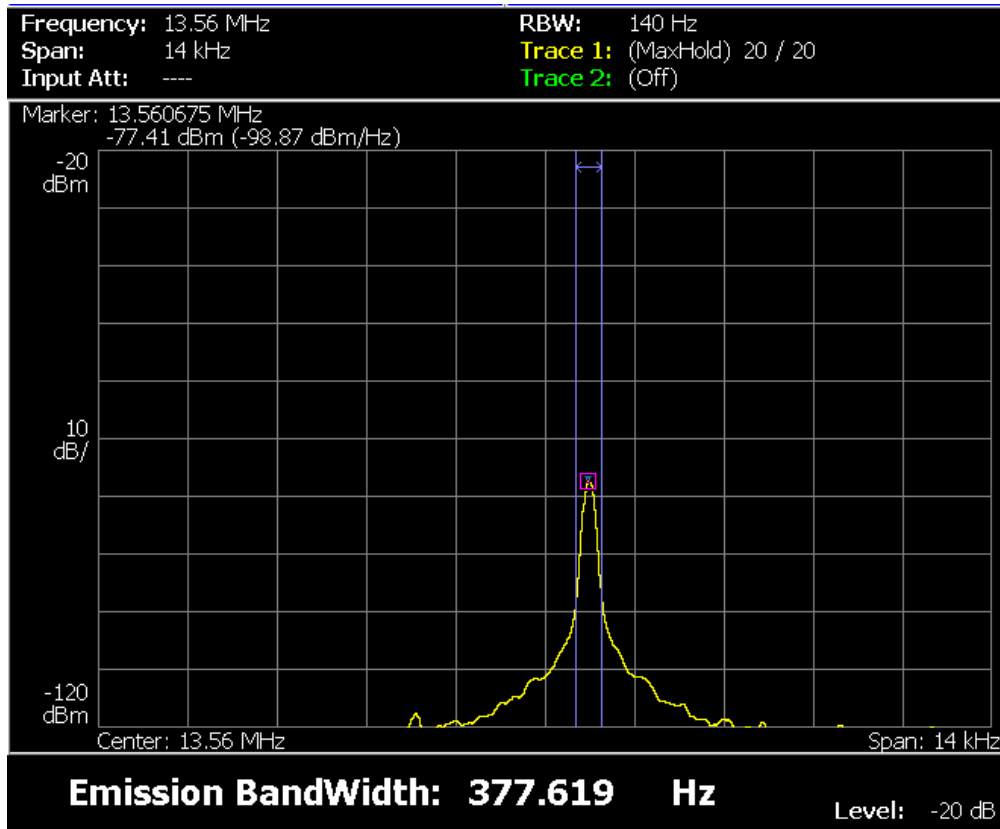

Figure A-4: Test result of EUT2 at test set. NFC02

A.5.7. Measurement Uncertainty

Measurement uncertainty: $U = 77$ Hz, $k=2$

A.6. Conducted emission

A.6.1. Reference

See Clause 13.3 and Clause 7 of ANSI C63.10-2013 specifically.

See Clause 4, Clause 5, and Clause 6 of ANSI C63.10-2013 generally.

A.6.2. Measurement Methods

The conducted emissions from the AC port of the EUT are measured in a shielding room. The EUT is connected to a Line Impedance Stabilization Network (LISN). An overview sweep with peak detection was performed. The measurements were performed with a quasi-peak detector and if required, an average detector.

The conducted emission measurements were made with the following detector of the test receiver: Quasi-Peak / Average Detector.

The measurement bandwidth is:

Frequency of Emission (MHz)	RBW/VBW
0.15-30	9kHz

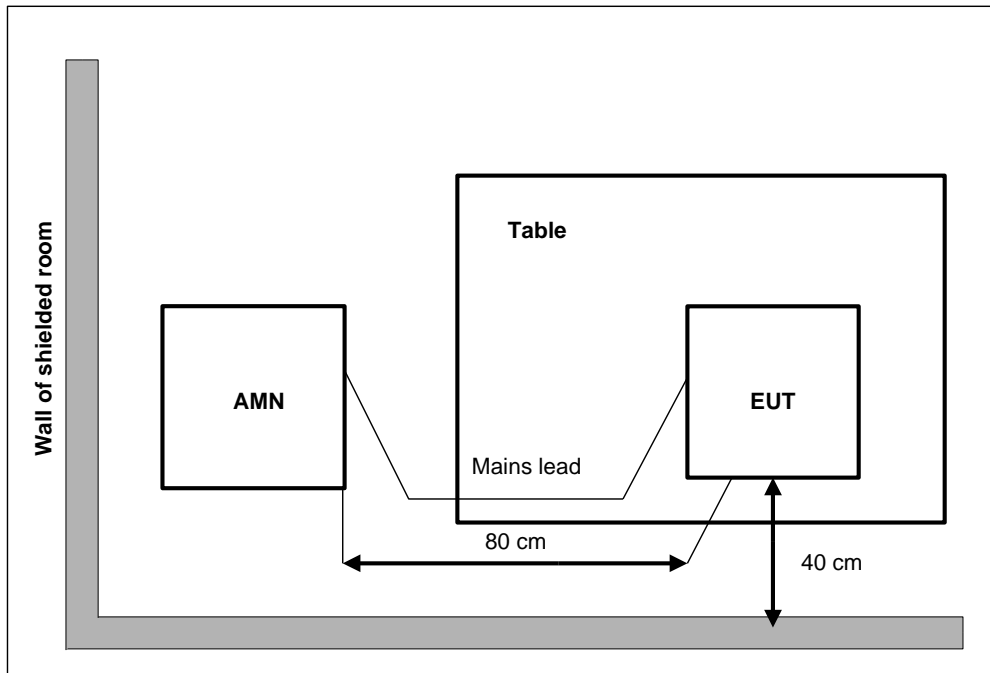

A.6.3. EUT Operating Mode and Test Conditions

The measurement of EUT is carried out under the transmit state of NFC (See 3.5).

The EUT is powered by a travel adapter.

During the measurements, the ambient temperature is in the range of 15 ~ 25 °C.

A.6.4. Limits

Frequency range (MHz)	Quasi-peak Limit (dB μ V)	Average Limit (dB μ V)
0.15 to 0.5	66 to 56	56 to 46
0.5 to 5	56	46
5 to 30	60	50

A.6.5. Measurement Results

Measurement results see Figure C-5.

Conclusions: Set. 1, **PASS**.

Note: The measurement result at 13.56MHz is the fundamental emission of NFC signal.

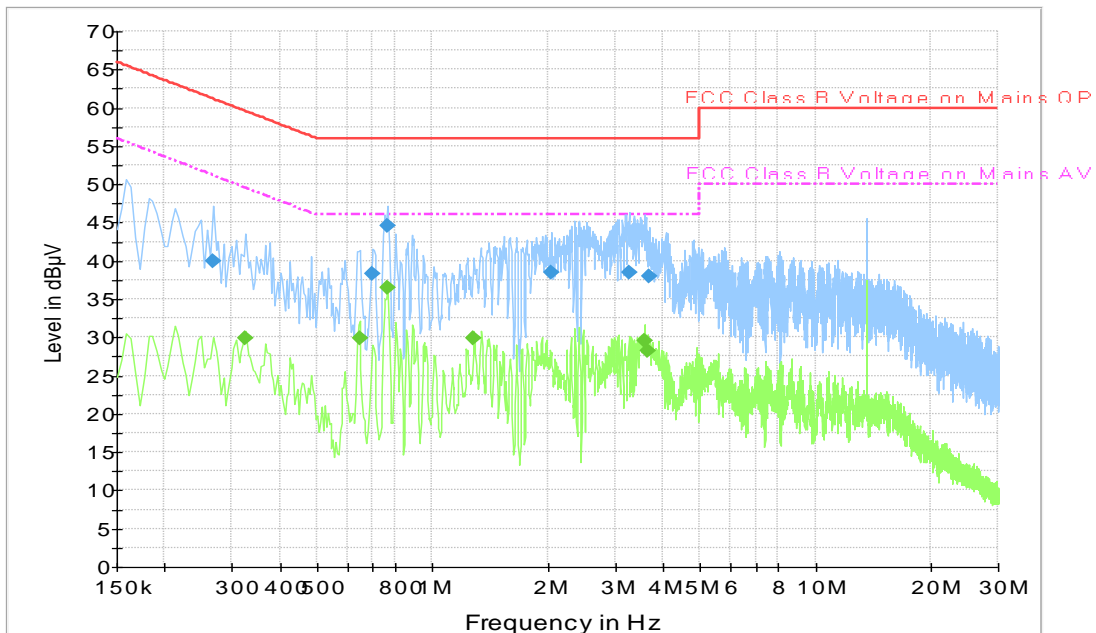

Final Result 1

Frequency (MHz)	QuasiPeak (dBµV)	Meas. Time (ms)	Bandwidth (kHz)	Filter	Line	Corr. (dB)	Margin (dB)	Limit (dBµV)
0.267000	40.0	2000.0	9.000	On	L1	19.8	21.3	61.2
0.699000	38.2	2000.0	9.000	On	L1	19.8	17.8	56.0
0.762000	44.6	2000.0	9.000	On	L1	19.7	11.4	56.0
2.040000	38.5	2000.0	9.000	On	N	19.6	17.5	56.0
3.255000	38.5	2000.0	9.000	On	L1	19.7	17.5	56.0
3.696000	38.0	2000.0	9.000	On	N	19.7	18.0	56.0

Final Result 2



Frequency (MHz)	Average (dBµV)	Meas. Time (ms)	Bandwidth (kHz)	Filter	Line	Corr. (dB)	Margin (dB)	Limit (dBµV)
0.325500	29.9	2000.0	9.000	On	L1	19.8	19.7	49.6
0.645000	29.9	2000.0	9.000	On	L1	19.8	16.1	46.0
0.762000	36.5	2000.0	9.000	On	L1	19.7	9.5	46.0
1.284000	29.9	2000.0	9.000	On	L1	19.6	16.1	46.0
3.592500	29.6	2000.0	9.000	On	N	19.7	16.4	46.0
3.655500	28.3	2000.0	9.000	On	N	19.7	17.7	46.0

Figure A-4: Test result of EUT1 at test set. 1

A.6.6. Measurement Uncertainty

Measurement uncertainty: $U = 3.38$ dB, $k=2$

ANNEX A: Accreditation Certificate

<p>United States Department of Commerce National Institute of Standards and Technology</p> 	
<hr/> <p>Certificate of Accreditation to ISO/IEC 17025:2005</p> <hr/>	
<p>NVLAP LAB CODE: 600118-0</p>	
<p>Telecommunication Technology Labs, CAICT Beijing China</p>	
<p><i>is accredited by the National Voluntary Laboratory Accreditation Program for specific services, listed on the Scope of Accreditation, for:</i></p>	
<p>Electromagnetic Compatibility & Telecommunications</p>	
<p><i>This laboratory is accredited in accordance with the recognized International Standard ISO/IEC 17025:2005. This accreditation demonstrates technical competence for a defined scope and the operation of a laboratory quality management system (refer to joint ISO-ILAC-IAF Communiqué dated January 2009).</i></p>	
<hr/> <p>2017-08-22 through 2018-09-30 <i>Effective Dates</i></p>	 <hr/> <p><i>[Signature]</i> For the National Voluntary Laboratory Accreditation Program</p>

END OF REPORT