



Test Report No.: RF180411W007-13



# FCC TEST REPORT

## (PART 27)



Applicant:	FIH International Co., Ltd.
Address:	No.18, Tongji zhonglu, Beijing Economic & Technological Development Area

Manufacturer or Supplier:	HMD Global Oy
Address:	Karaportti 2 02610 Espoo FINLAND
Product:	GSM/WCDMA/LTE Mobile Phone
Brand Name:	Nokia
Model Name:	TA-1057
FCC ID:	2AJOTTA-1057
Date of tests:	Mar. 23, 2018 ~ Apr. 28, 2018

The tests have been carried out according to the requirements of the following standard:

- FCC Part 27, Subpart C, M       ANSI/TIA/EIA-603-D
- FCC Part 2                               ANSI/TIA/EIA-603-E     ANSI C63.26-2015

CONCLUSION: The submitted sample was found to COMPLY with the test requirement

Prepared by Yuqiang Yin Engineer / Mobile Department	Approved by Sam Tung Manager / Mobile Department
  Date: May 02, 2018	  Date: May 02, 2018

This report is for your exclusive use. Any copying or replication of this report to or for any other person or entity, or use of our name or trademark, is permitted only with our prior written permission. This report sets forth our findings solely with respect to the test samples identified herein. The results set forth in this report are not indicative or representative of the quality or characteristics of the lot from which a test sample was taken or any similar or identical product unless specifically and expressly noted. Our report includes all of the tests requested by you and the results thereof based upon the information that you provided to us. You have 60 days from date of issuance of this report to notify us of any material error or omission caused by our negligence, provided, however, that such notice shall be in writing and shall specifically address the issue you wish to raise. A failure to raise such issue within the prescribed time shall constitute your unqualified acceptance of the completeness of this report, the tests conducted and the correctness of the report contents. Unless specific mention, the uncertainty of measurement has been explicitly taken into account to declare the compliance or non-compliance to the specification



# TABLE OF CONTENTS

**RELEASE CONTROL RECORD ..... 4**

**1 SUMMARY OF TEST RESULTS ..... 5**

1.1 MEASUREMENT UNCERTAINTY ..... 5

1.2 TEST SITE AND INSTRUMENTS ..... 6

**2 GENERAL INFORMATION ..... 7**

2.1 GENERAL DESCRIPTION OF EUT ..... 7

2.2 CONFIGURATION OF SYSTEM UNDER TEST ..... 9

2.3 DESCRIPTION OF SUPPORT UNITS ..... 10

2.4 TEST ITEM AND TEST CONFIGURATION ..... 10

2.5 GENERAL DESCRIPTION OF APPLIED STANDARDS ..... 13

**3 TEST TYPES AND RESULTS ..... 14**

3.1 OUTPUT POWER MEASUREMENT ..... 14

3.1.1 LIMITS OF OUTPUT POWER MEASUREMENT ..... 14

3.1.2 TEST PROCEDURES ..... 14

3.1.3 TEST SETUP ..... 15

3.1.4 TEST RESULTS ..... 16

3.2 FREQUENCY STABILITY MEASUREMENT ..... 26

3.2.1 LIMITS OF FREQUENCY STABILITY MEASUREMENT ..... 26

3.2.2 TEST PROCEDURE ..... 26

3.2.3 TEST SETUP ..... 26

3.2.4 TEST RESULTS ..... 27

3.3 OCCUPIED BANDWIDTH MEASUREMENT ..... 35

3.3.1 LIMITS OF OCCUPIED BANDWIDTH MEASUREMENT ..... 35

3.3.2 TEST SETUP ..... 35

3.3.3 TEST PROCEDURES ..... 35

3.3.4 TEST RESULTS ..... 36

3.4 PEAK TO AVERAGE RATIO ..... 40

3.4.1 LIMITS OF PEAK TO AVERAGE RATIO MEASUREMENT ..... 40

3.4.2 TEST SETUP ..... 40

3.4.3 TEST PROCEDURES ..... 40

3.4.4 TEST RESULTS ..... 41

3.5 BAND EDGE MEASUREMENT ..... 45

3.5.1 LIMITS OF BAND EDGE MEASUREMENT ..... 45

3.5.2 TEST SETUP ..... 45

3.5.3 TEST PROCEDURES ..... 46

3.5.4 TEST RESULTS ..... 47

3.6 CONDUCTED SPURIOUS EMISSIONS ..... 55

3.6.1 LIMITS OF CONDUCTED SPURIOUS EMISSIONS MEASUREMENT ..... 55

3.6.2 TEST PROCEDURE ..... 55

3.6.3 TEST SETUP ..... 55

3.6.4 TEST RESULTS ..... 56

3.7 RADIATED EMISSION MEASUREMENT ..... 64

3.7.1 LIMITS OF RADIATED EMISSION MEASUREMENT ..... 64

3.7.2 TEST PROCEDURES ..... 64

3.7.3 DEVIATION FROM TEST STANDARD ..... 64

3.7.4 TEST SETUP ..... 65

3.7.5 TEST RESULTS ..... 67



**BUREAU  
VERITAS**

**Test Report No.: RF180411W007-13**

<b>4</b>	<b>INFORMATION ON THE TESTING LABORATORIES .....</b>	<b>93</b>
<b>5</b>	<b>APPENDIX A – MODIFICATIONS RECORDERS FOR ENGINEERING CHANGES TO THE EUT BY THE LAB .....</b>	<b>94</b>



Test Report No.: RF180411W007-13

## RELEASE CONTROL RECORD

ISSUE NO.	REASON FOR CHANGE	DATE ISSUED
RF180411W007-6	Original release	May 02, 2018
RF180411W007-13	Based on the original report RF180411W007-6 changing model name & FCC ID and disable one SIM card.	May 02, 2018



# 1 SUMMARY OF TEST RESULTS

The EUT has been tested according to the following specifications:

APPLIED STANDARD: FCC Part 27 & Part 2			
STANDARD SECTION	TEST TYPE AND LIMIT	RESULT	REMARK
2.1046 27.50(h)(2)	Equivalent Isotropically Radiated Power	PASS	Meet the requirement of limit.
2.1055 27.54	Frequency Stability	PASS	Meet the requirement of limit.
2.1049 27.53(m)(6)	Occupied Bandwidth	PASS	Meet the requirement of limit.
27.50(d)(5)	Peak to average ratio	PASS	Meet the requirement of limit.
2.1051 27.53(m)(4)(6)	Band Edge Measurements	PASS	Meet the requirement of limit.
2.1051 27.53(m)(4)(6)	Conducted Spurious Emissions	PASS	Meet the requirement of limit.
2.1053 27.53(m)(4)(6)	Radiated Spurious Emissions	PASS	Meet the requirement of limit. Minimum passing margin is -8.41dB at 36.790MHz.

## 1.1 MEASUREMENT UNCERTAINTY

Where relevant, the following measurement uncertainty levels have been estimated for tests performed on the EUT as specified in CISPR 16-4-2:

MEASUREMENT	FREQUENCY	UNCERTAINTY
Conducted emissions	9kHz~30MHz	2.66dB
Radiated emissions	9KHz ~ 30MHz	2.68dB
	30MHz ~ 1GMHz	3.26dB
	1GHz ~ 18GHz	4.48dB
	18GHz ~ 40GHz	4.12dB

This uncertainty represents an expanded uncertainty expressed at approximately the 95% confidence level using a coverage factor of k=2.



## 1.2 TEST SITE AND INSTRUMENTS

Equipment	Manufacturer	Model No.	Serial No.	Last Cal.	Next Cal.
MXE EMI Receiver	KEYSIGHT	N9038A-544	MY54450026	Mar. 16,18	Mar. 15,19
EXA Signal Analyzer	KEYSIGHT	N9010A-544	MY54510332	Jun. 28,17	Jun. 27,18
Bilog Antenna 1	ETS-LINDGREN	3143B	00161964	Nov. 26,16	Nov. 25,18
Bilog Antenna 2	ETS-LINDGREN	3143B	00161965	Nov. 26,16	Nov. 25,18
Horn Antenna 1	ETS-LINDGREN	3117	00168728	Nov. 26,16	Nov. 25,18
Horn Antenna 2	ETS-LINDGREN	3117	00168692	Nov. 26,16	Nov. 25,18
Loop antenna	Daze	ZN30900A	0708	Nov. 20,17	Nov. 19,18
Horn Antenna (18GHz-40GHz)	N/A	QWH-SL-18-40-K-SG/QMS-00361	15433	Dec. 16,16	Dec. 15,18
Radio Communication Analyzer	ANRITSU	MT8820C	6201465426	Mar. 02,18	Mar. 01,19
Signal Pre-Amplifier	EMSI	EMC 9135	980249	Jul. 24,17	Jul. 23,18
Signal Pre-Amplifier	EMSI	EMC 012645B	980257	Jul. 24,17	Jul. 23,18
Signal Pre-Amplifier	EMSI	EMC 184045B	980259	Jul. 24,17	Jul. 23,18
3m Semi-anechoic Chamber	ETS-LINDGREN	9m*6m*6m	Euroshieldpn-CT0001143-1216	May 06,17	May 05,18
Test Software	E3	V 9.160323	N/A	N/A	N/A
Test Software	ADT	ADT_Radiated_V7.6.15.9.2	N/A	N/A	N/A
10dB Attenuator	JFW/USA	50HF-010-SMA	1505	Jul. 24,17	Jul. 23,18
Power Meter	Anritsu	ML2495A	1506002	Mar. 02,18	Mar. 01,19
Power Sensor	Anritsu	MA2411B	1339352	Mar. 16,18	Mar. 15,19
Humid & Temp Programmable Tester	Juyi	ITH-120-45-CP-AR	IAA1504-001	Jul. 18,17	Jul. 17,18
MXG Analog Microwave Signal Generator	KEYSIGHT	N5183A	MY50143024	Mar. 13,18	Mar. 12,19

- NOTE:**
1. The calibration interval of the above test instruments is 12 months or 24 months and the calibrations are traceable to CEPREI/CHINA, GRGT/CHINA and NIM/CHINA.
  2. The test was performed in 3m Semi-anechoic Chamber and RF Oven Room.
  3. The horn antenna is used only for the measurement of emission frequency above 1GHz if tested.
  4. The FCC Site Registration No. is 525120.



## 2 GENERAL INFORMATION

### 2.1 GENERAL DESCRIPTION OF EUT

<b>PRODUCT</b>	GSM/WCDMA/LTE Mobile Phone		
<b>MODEL NAME</b>	TA-1057		
<b>POWER SUPPLY</b>	5.0Vdc (adapter or host equipment) 3.9Vdc (Li-ion, battery)		
<b>MODULATION TECHNOLOGY</b>	LTE Band 7	QPSK, 16QAM	
<b>FREQUENCY RANGE</b>	LTE Band 7 Channel Bandwidth: 5MHz	2502.5MHz ~ 2567.5MHz	
	LTE Band 7 Channel Bandwidth: 10MHz	2505MHz ~ 2565MHz	
	LTE Band 7 Channel Bandwidth: 15MHz	2507.5MHz ~ 2562.5MHz	
	LTE Band 7 Channel Bandwidth: 20MHz	2510MHz ~ 2560MHz	
	LTE Band 38 Channel Bandwidth: 5MHz	2572.5MHz ~ 2617.5MHz	
	LTE Band 38 Channel Bandwidth: 10MHz	2575MHz ~ 2615MHz	
	LTE Band 38 Channel Bandwidth: 15MHz	2577.5MHz ~ 2612.5MHz	
	LTE Band 38 Channel Bandwidth: 20MHz	2580MHz ~ 2610MHz	
	<b>EMISSION DESIGNATOR</b>	LTE Band 7 Channel Bandwidth: 5MHz	QPSK: 4M48G7D 16QAM: 4M47W7D
LTE Band 7 Channel Bandwidth: 10MHz		QPSK: 8M94G7D 16QAM: 8M95W7D	
LTE Band 7 Channel Bandwidth: 15MHz		QPSK: 13M4G7D 16QAM: 13M4W7D	
LTE Band 7 Channel Bandwidth: 20MHz		QPSK: 17M9G7D 16QAM: 17M9W7D	
LTE Band 38 Channel Bandwidth: 5MHz		QPSK: 4M48G7D 16QAM: 4M47W7D	
LTE Band 38 Channel Bandwidth: 10MHz		QPSK: 8M93G7D 16QAM: 8M94W7D	
LTE Band 38 Channel Bandwidth: 15MHz		QPSK: 13M4G7D 16QAM: 13M4W7D	
LTE Band 38 Channel Bandwidth: 20MHz		QPSK: 17M9G7D 16QAM: 17M9W7D	
<b>MAX. EIRP POWER</b>		LTE Band 7 Channel Bandwidth: 5MHz	236mW



	LTE Band 7 Channel Bandwidth: 10MHz	239mW
	LTE Band 7 Channel Bandwidth: 15MHz	235mW
	LTE Band 7 Channel Bandwidth: 20MHz	212mW
	LTE Band 38 Channel Bandwidth: 5MHz	337mW
	LTE Band 38 Channel Bandwidth: 10MHz	342mW
	LTE Band 38 Channel Bandwidth: 15MHz	337mW
	LTE Band 38 Channel Bandwidth: 20MHz	303mW
<b>ANTENNA TYPE</b>	Fixed Internal Antenna with 2.27dBi gain	
<b>HW VERSION</b>	HW 0341	
<b>SW VERSION</b>	000C_0_34A	
<b>I/O PORTS</b>	Refer to user's manual	
<b>DATA CABLE</b>	USB cable: non-shielded, detachable, 1.0meter Earphone cable: non-shielded, detachable, 1.5meter	

**NOTE:**

1. For a more detailed features description, please refer to the manufacturer's specifications or the user's manual.
2. For the test results, the EUT had been tested with all conditions. But only the worst case was shown in test report.

**List of Accessories:**

ACCESSORIES	BRAND	MANUFACTURER	MODEL	SPECIFICATION
Adapter 1	Salcomp	Salcomp (Shenzhen) Co., Ltd.	FC0202	I/P: 100-240Vac, 150mA O/P: 5Vdc, 1000mA
Adapter 2	Aohai	DONGGUAN AOHA TECHNOLOGY CO., LTD.	AD-5WU	I/P: 100-240Vac, 150mA O/P: 5Vdc, 1000mA
Battery	SCUD	SCUD (Fujian) Electronics CO., Ltd.	HE336	Rating: 3.85Vdc, 2900mAh
Earphone 1	Nokia	FIT	WH-108	1.5m non-shielded cable w/o core
Earphone 2	Nokia	OBO	WH-108	1.5m non-shielded cable w/o core
USB Cable	Nokia	FIH	CA-190CD	1.0m non-shielded cable w/o core



## 2.2 CONFIGURATION OF SYSTEM UNDER TEST

### FOR RADIATION EMISSION TEST

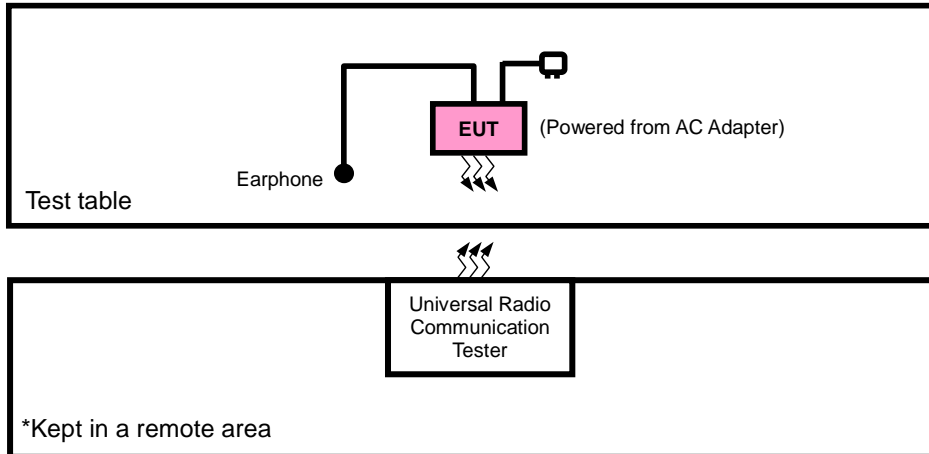

### FOR CONDUCTED & E.I.R.P TEST

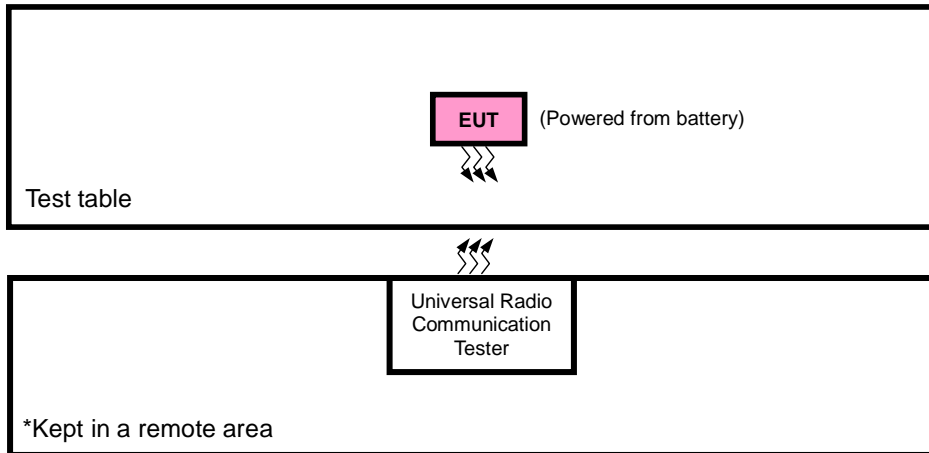



### 2.3 DESCRIPTION OF SUPPORT UNITS

The EUT has been tested as an independent unit together with other necessary accessories or support units. The following support units or accessories were used to form a representative test configuration during the tests.

NO.	PRODUCT	BRAND	MODEL NO.	SERIAL NO.	FCC ID
1	DC source	LONG WEI	PS-6403D	010934269	N/A
2	PC	HP	A6608CN	3CR83825X3	N/A

NO.	SIGNAL CABLE DESCRIPTION OF THE ABOVE SUPPORT UNITS
1	DC Line: Unshielded, Detachable 1.0m
2	AC Line: Unshielded, Detachable 1.5m

**NOTE:** All power cords of the above support units are non shielded (1.8m).

### 2.4 TEST ITEM AND TEST CONFIGURATION

Pre-Scan has been conducted to determine the worst-case mode from all possible combinations between available modulations, data rates, XYZ axis and antenna ports. The worst case was found when positioned on Y-plane for EIRP and X-axis for radiated emission. Following channel(s) was (were) selected for the final test as listed below:

EUT CONFIGURE MODE	DESCRIPTION
A	EUT + Adapter + USB Cable + Earphone with LTE link
B	EUT + Battery with LTE link



Test Report No.: RF180411W007-13

LTE BAND 7

EUT CONFIGURE MODE	TEST ITEM	AVAILABLE CHANNEL	TESTED CHANNEL	CHANNEL BANDWIDTH	MODULATION	MODE		
B	EIRP	20775 to 21425	20775, 21100, 21425	5MHz	QPSK, 16QAM	1 RB / 0 RB Offset		
		20800 to 21400	20800, 21100, 21400	10MHz	QPSK, 16QAM	1 RB / 0RB Offset		
		20825 to 21375	20825, 21100, 21375	15MHz	QPSK, 16QAM	1 RB / 0 RB Offset		
		20850 to 21350	20850, 21100, 21350	20MHz	QPSK, 16QAM	1 RB / 0 RB Offset		
B	FREQUENCY STABILITY	20775 to 21425	20775, 21425	5MHz	QPSK	1 RB / 0 RB Offset		
		20800 to 21400	20800, 21400	10MHz	QPSK	1 RB / 0RB Offset		
		20825 to 21375	20825, 21375	15MHz	QPSK	1 RB / 0 RB Offset		
		20850 to 21350	20850, 21350	20MHz	QPSK	1 RB / 0 RB Offset		
B	OCCUPIED BANDWIDTH	20775 to 21425	20775, 21100, 21425	5MHz	QPSK, 16QAM	25 RB / 0 RB Offset		
		20800 to 21400	20800, 21100, 21400	10MHz	QPSK, 16QAM	50 RB / 0 RB Offset		
		20825 to 21375	20825, 21100, 21375	15MHz	QPSK, 16QAM	75 RB / 0 RB Offset		
		20850 to 21350	20850, 21100, 21350	20MHz	QPSK, 16QAM	100 RB / 0 RB Offset		
B	PEAK TO AVERAGE RATIO	20775 to 21425	20775, 21100, 21425	5MHz	QPSK, 16QAM	1 RB / 0 RB Offset		
		20800 to 21400	20800, 21100, 21400	10MHz	QPSK, 16QAM	1 RB / 0RB Offset		
		20825 to 21375	20825, 21100, 21375	15MHz	QPSK, 16QAM	1 RB / 0 RB Offset		
		20850 to 21350	20850, 21100, 21350	20MHz	QPSK, 16QAM	1 RB / 0 RB Offset		
B	BAND EDGE	20775 to 21425	20775	5MHz	QPSK	1 RB / 0 RB Offset		
			21425	5MHz	QPSK	25 RB / 0 RB Offset 1 RB / 24 RB Offset 25 RB / 0 RB Offset		
		20800 to 21400	20800	10MHz	QPSK	1 RB / 0 RB Offset 50 RB / 0 RB Offset		
			21400	10MHz	QPSK	1 RB / 49 RB Offset 50 RB / 0 RB Offset		
		20825 to 21375	20825	15MHz	QPSK	1 RB / 0 RB Offset 75 RB / 0 RB Offset		
			21375	15MHz	QPSK	1 RB / 74 RB Offset 75 RB / 0 RB Offset		
		20850 to 21350	20850	20MHz	QPSK	1 RB / 0 RB Offset 100 RB / 0 RB Offset		
			21350	20MHz	QPSK	1 RB / 99 RB Offset 100 RB / 0 RB Offset		
		B	CONDCUDED EMISSION	20775 to 21425	20775, 21100, 21425	5MHz	QPSK	1 RB / 0 RB Offset
				20800 to 21400	20800, 21100, 21400	10MHz	QPSK	1 RB / 0RB Offset
				20825 to 21375	20825, 21100, 21375	15MHz	QPSK	1 RB / 0 RB Offset
				20850 to 21350	20850, 21100, 21350	20MHz	QPSK	1 RB / 0 RB Offset
A	RADIATED EMISSION	20775 to 21425	21100	5MHz	QPSK	1 RB / 0 RB Offset		
		20800 to 21400	21100	10MHz	QPSK	1 RB / 0RB Offset		
		20825 to 21375	20825, 21100, 21375	15MHz	QPSK	1 RB / 0 RB Offset		
		20850 to 21350	21100	20MHz	QPSK	1 RB / 0 RB Offset		



**LTE BAND 38 MODE**

EUT CONFIGURE MODE	TEST ITEM	AVAILABLE CHANNEL	TESTED CHANNEL	CHANNEL BANDWIDTH	MODULATION	MODE
B	EIRP	37775 to 38225	37775, 38000, 38225	5MHz	QPSK, 16QAM	1 RB / 0 RB Offset
		37800 to 38200	37800, 38000, 38200	10MHz	QPSK, 16QAM	1 RB / 0RB Offset
		37825 to 38175	37825, 38000, 38175	15MHz	QPSK, 16QAM	1 RB / 0 RB Offset
		37850 to38150	37850, 38000, 38150	20MHz	QPSK, 16QAM	1 RB / 0 RB Offset
B	FREQUENCY STABILITY	37775 to 38225	37775, 38225	5MHz	QPSK	1 RB / 0 RB Offset
		37800 to 38200	37800, 38200	10MHz	QPSK	1 RB / 0RB Offset
		37825 to 38175	37825, 38175	15MHz	QPSK	1 RB / 0 RB Offset
		37850 to38150	37850, 38150	20MHz	QPSK	1 RB / 0 RB Offset
B	OCCUPIED BANDWIDTH	37775 to 38225	37775, 38000, 38225	5MHz	QPSK, 16QAM	25 RB / 0 RB Offset
		37800 to 38200	37800, 38000, 38200	10MHz	QPSK, 16QAM	50 RB / 0 RB Offset
		37825 to 38175	37825, 38000, 38175	15MHz	QPSK, 16QAM	75 RB / 0 RB Offset
		37850 to38150	37850, 38000, 38150	20MHz	QPSK, 16QAM	100 RB / 0 RB Offset
B	PEAK TO AVERAGE RATIO	37775 to 38225	37775, 38000, 38225	5MHz	QPSK, 16QAM	1 RB / 0 RB Offset
		37800 to 38200	37800, 38000, 38200	10MHz	QPSK, 16QAM	1 RB / 0RB Offset
		37825 to 38175	37825, 38000, 38175	15MHz	QPSK, 16QAM	1 RB / 0 RB Offset
		37850 to38150	37850, 38000, 38150	20MHz	QPSK, 16QAM	1 RB / 0 RB Offset
B	BAND EDGE	37775 to 38225	37775	5MHz	QPSK	1 RB / 0 RB Offset
			38825	5MHz	QPSK	25 RB / 0 RB Offset
		37800 to 38200	37800	10MHz	QPSK	1 RB / 24 RB Offset
			38200	10MHz	QPSK	25 RB / 0 RB Offset
		37825 to 38175	37800	10MHz	QPSK	1 RB / 0 RB Offset
			38200	10MHz	QPSK	50 RB / 0 RB Offset
		37825 to 38175	37825	15MHz	QPSK	1 RB / 49 RB Offset
			38175	15MHz	QPSK	50 RB / 0 RB Offset
		37850 to38150	37825	15MHz	QPSK	1 RB / 0 RB Offset
			38175	15MHz	QPSK	75 RB / 0 RB Offset
		37850 to38150	37850	20MHz	QPSK	1 RB / 74 RB Offset
			38150	20MHz	QPSK	75 RB / 0 RB Offset
B	CONDCUDET ED EMISSION	37775 to 38225	37775, 38000, 38225	5MHz	QPSK	1 RB / 0 RB Offset
		37800 to 38200	37800, 38000, 38200	10MHz	QPSK	1 RB / 0RB Offset
		37825 to 38175	37825, 38000, 38175	15MHz	QPSK	1 RB / 0 RB Offset
		37850 to38150	37850, 38000, 38150	20MHz	QPSK	1 RB / 0 RB Offset
A	RADIATED EMISSION	37775 to 38225	38000	5MHz	QPSK	1 RB / 0 RB Offset
		37800 to 38200	37800, 38000, 38200	10MHz	QPSK	1 RB / 0RB Offset
		37825 to 38175	38000	15MHz	QPSK	1 RB / 0 RB Offset
		37850 to38150	38000	20MHz	QPSK	1 RB / 0 RB Offset

**Note:** This device was tested under all bandwidths, RB configurations and modulations. The worst case was found in QPSK modulation.



**TEST CONDITION:**

TEST ITEM	ENVIRONMENTAL CONDITIONS	INPUT POWER	TESTED BY
EIRP	24deg. C, 60%RH	3.9Vdc from Battery	Star Le
FREQUENCY STABILITY	24deg. C, 61%RH	DC 3.7V/3.9V/4.0V	Wenliang Wu
OCCUPIED BANDWIDTH	24deg. C, 61%RH	3.9Vdc from Battery	Wenliang Wu
PEAK TO AVERAGE RATIO	24deg. C, 61%RH	3.9Vdc from Battery	Wenliang Wu
BAND EDGE	24deg. C, 61%RH	3.9Vdc from Battery	Wenliang Wu
CONDCUDED EMISSION	24deg. C, 61%RH	3.9Vdc from Battery	Wenliang Wu
RADIATED EMISSION	24deg. C, 60%RH	5Vdc from adapter	Star Le

**2.5 GENERAL DESCRIPTION OF APPLIED STANDARDS**

The EUT is a RF product. According to the specifications of the manufacturer, it must comply with the requirements of the following standards:

**FCC 47 CFR Part 2**

**FCC 47 CFR Part 27**

**KDB 971168 D01 Power Meas License Digital Systems v03**

**ANSI/TIA/EIA-603-D**

**ANSI/TIA/EIA-603-E**

**ANSI C63.26-2015**

**NOTE:** All test items have been performed and recorded as per the above standards.



### 3 TEST TYPES AND RESULTS

#### 3.1 OUTPUT POWER MEASUREMENT

##### 3.1.1 LIMITS OF OUTPUT POWER MEASUREMENT

The radiated peak output power shall be according to the specific rule Part 27.50(h)(2) that “User stations are limited to 2 watts” and 27.50(i) specific that “Peak transmit power must be measure over any interval of continuous transmission using instrumentation calibration in terms of rms-equivalent voltage.”

##### 3.1.2 TEST PROCEDURES

###### **EIRP MEASUREMENT:**

- a. All measurements were done at low, middle and high operational frequency range. RBW and VBW is 10MHz for LTE mode.
- b. Substitution method is used for E.I.R.P measurement. In the semi-anechoic chamber, EUT placed on the 0.8m height of Turn Table, rotated the table around 360 degrees to search the maximum radiation power and receiver antenna shall be rotated vertical and horizontal polarization and moved height from 1m to 4m to find the maximum polar radiated power. The “Read Value” is the spectrum reading the maximum power value.
- c. The substitution horn antenna is substituted for EUT at the same position and signals generator export the CW signal to the substitution antenna via a tx cable. Rotated the Turn Table and moved receiving antenna to find the maximum radiation power. Adjust output power level of S.G to get a Value of spectrum reading equal to “Read Value” of step b. Record the power level of S.G.
- d.  $EIRP = \text{Output power level of S.G} - \text{TX cable loss} + \text{Antenna gain of substitution horn}.$

###### **CONDUCTED POWER MEASUREMENT:**

- a. The EUT was set up for the maximum power with LTE link data modulation and link up with simulator.
- b. Set the EUT to transmit under low, middle and high channel and record the power level shown on simulator.

### 3.1.3 TEST SETUP

#### EIRP / ERP Measurement:

<Radiated Emission below or equal 1 GHz>

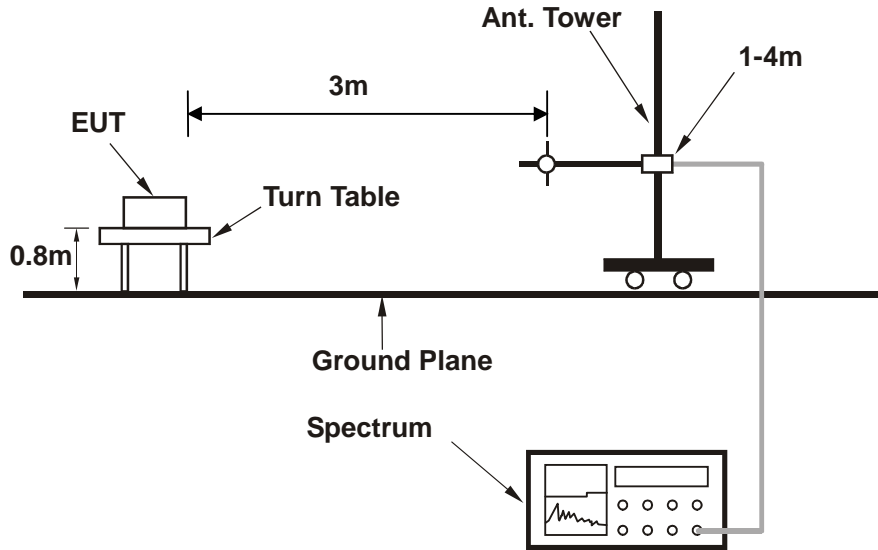

<Radiated Emission above 1 GHz>

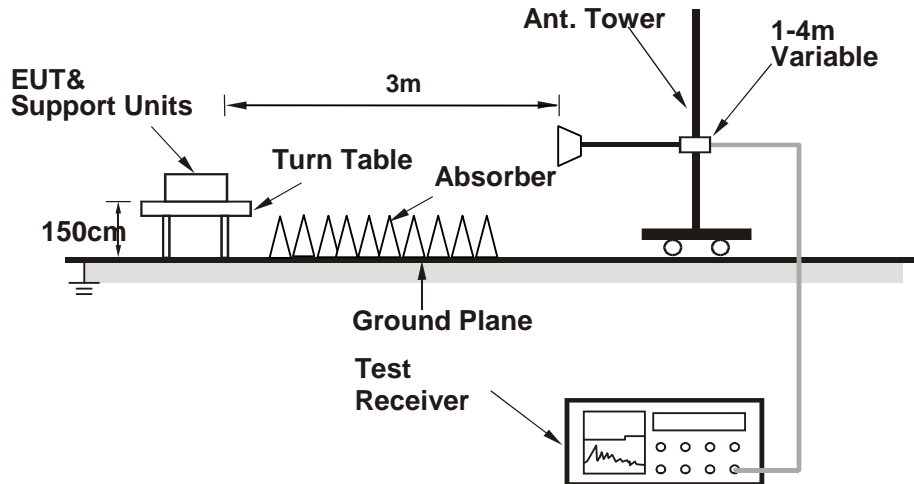

For the actual test configuration, please refer to the attached file (Test Setup Photo).

#### CONDUCTED POWER MEASUREMENT:





3.1.4 TEST RESULTS

AVERAGE CONDUCTED OUTPUT POWER (dBm)

LTE Band 7							
BW	Modulation	RB Size	RB Offset	Low CH 20775	Mid CH 21100	High CH 21425	MPR
				Frequency 2502.5 MHz	Frequency 2535 MHz	Frequency 2567.5 MHz	
5 MHz	QPSK	1	0	22.66	22.45	22.25	0
		1	12	22.60	22.39	22.19	0
		1	24	22.57	22.36	22.16	0
		12	0	21.65	21.44	21.24	1
		12	6	21.61	21.40	21.20	1
		12	13	21.58	21.37	21.17	1
		25	0	21.59	21.38	21.18	1
	16QAM	1	0	21.86	21.65	21.45	1
		1	12	21.84	21.63	21.43	1
		1	24	21.79	21.58	21.38	1
		12	0	20.60	20.39	20.19	2
		12	6	20.55	20.34	20.14	2
		12	13	20.48	20.27	20.07	2
		25	0	20.56	20.35	20.15	2
BW	Modulation	RB Size	RB Offset	Low CH 20800	Mid CH 21100	High CH 21400	MPR
				Frequency 2505 MHz	Frequency 2535 MHz	Frequency 2565 MHz	
10 MHz	QPSK	1	0	22.70	22.49	22.29	0
		1	24	22.64	22.43	22.23	0
		1	49	22.61	22.40	22.20	0
		25	0	21.69	21.48	21.28	1
		25	12	21.65	21.44	21.24	1
		25	25	21.62	21.41	21.21	1
		50	0	21.63	21.42	21.22	1
	16QAM	1	0	21.90	21.69	21.49	1
		1	24	21.88	21.67	21.47	1
		1	49	21.83	21.62	21.42	1
		25	0	20.64	20.43	20.23	2
		25	12	20.59	20.38	20.18	2
		25	25	20.52	20.31	20.11	2
		50	0	20.60	20.39	20.19	2





LTE Band 7							
BW	Modulation	RB Size	RB Offset	Low CH 20825	Mid CH 21100	High CH 21375	MPR
				Frequency 2507.5 MHz	Frequency 2535 MHz	Frequency 2562.5 MHz	
15 MHz	QPSK	1	0	22.76	22.55	22.35	0
		1	37	22.70	22.49	22.29	0
		1	74	22.67	22.46	22.26	0
		36	0	21.75	21.54	21.34	1
		36	19	21.71	21.50	21.30	1
		36	39	21.68	21.47	21.27	1
		75	0	21.69	21.48	21.28	1
	16QAM	1	0	21.96	21.75	21.55	1
		1	37	21.94	21.73	21.53	1
		1	74	21.89	21.68	21.48	1
		36	0	20.70	20.49	20.29	2
		36	19	20.65	20.44	20.24	2
		36	39	20.58	20.37	20.17	2
		75	0	20.66	20.45	20.25	2
BW	Modulation	RB Size	RB Offset	Low CH 20850	Mid CH 21100	High CH 21350	MPR
				Frequency 2510 MHz	Frequency 2535 MHz	Frequency 2560 MHz	
20 MHz	QPSK	1	0	22.79	22.58	22.38	0
		1	50	22.73	22.52	22.32	0
		1	99	22.70	22.49	22.29	0
		50	0	21.78	21.57	21.37	1
		50	25	21.74	21.53	21.33	1
		50	50	21.71	21.50	21.30	1
		100	0	21.72	21.51	21.31	1
	16QAM	1	0	21.99	21.78	21.58	1
		1	50	21.97	21.76	21.56	1
		1	99	21.92	21.71	21.51	1
		50	0	20.73	20.52	20.32	2
		50	25	20.68	20.47	20.27	2
		50	50	20.61	20.40	20.20	2
		100	0	20.69	20.48	20.28	2



Test Report No.: RF180411W007-13

LTE Band 38							
BW	Modulation	RB Size	RB Offset	Low CH 37775	Mid CH 38000	High CH 38225	3GPP MPR (dB)
				Frequency 2572.5 MHz	Frequency 2595 MHz	Frequency 2617.5MHz	
5MHz	QPSK	1	0	22.53	22.50	22.47	0
		1	12	22.48	22.45	22.42	0
		1	24	22.45	22.42	22.39	0
		12	0	21.55	21.52	21.49	1
		12	6	21.50	21.47	21.44	1
		12	13	21.43	21.40	21.37	1
		25	0	21.54	21.51	21.48	1
	16QAM	1	0	21.51	21.48	21.45	1
		1	12	21.47	21.44	21.41	1
		1	24	21.43	21.40	21.37	1
		12	0	20.55	20.52	20.49	2
		12	6	20.50	20.47	20.44	2
		12	13	20.47	20.44	20.41	2
		25	0	20.55	20.52	20.49	2
LTE Band 38							
BW	Modulation	RB Size	RB Offset	Low CH 37800	Mid CH 38000	High CH 38200	3GPP MPR (dB)
				Frequency 2575 MHz	Frequency 2595 MHz	Frequency 2615 MHz	
10MHz	QPSK	1	0	22.57	22.54	22.51	0
		1	24	22.52	22.49	22.46	0
		1	49	22.49	22.46	22.43	0
		25	0	21.59	21.56	21.53	1
		25	12	21.54	21.51	21.48	1
		25	25	21.47	21.44	21.41	1
		50	0	21.58	21.55	21.52	1
	16QAM	1	0	21.55	21.52	21.49	1
		1	24	21.51	21.48	21.45	1
		1	49	21.47	21.44	21.41	1
		25	0	20.59	20.56	20.53	2
		25	12	20.54	20.51	20.48	2
		25	25	20.51	20.48	20.45	2
		50	0	20.59	20.56	20.53	2



Test Report No.: RF180411W007-13

LTE Band 38							
BW	Modulation	RB Size	RB Offset	Low CH 37825	Mid CH 38000	High CH 38175	3GPP MPR (dB)
				Frequency 2577.5 MHz	Frequency 2595 MHz	Frequency 2612.5MHz	
15MHz	QPSK	1	0	22.60	22.57	22.54	0
		1	37	22.55	22.52	22.49	0
		1	74	22.52	22.49	22.46	0
		36	0	21.62	21.59	21.56	1
		36	19	21.57	21.54	21.51	1
		36	39	21.50	21.47	21.44	1
		75	0	21.61	21.58	21.55	1
	16QAM	1	0	21.58	21.55	21.52	1
		1	37	21.54	21.51	21.48	1
		1	74	21.50	21.47	21.44	1
		36	0	20.62	20.59	20.56	2
		36	19	20.57	20.54	20.51	2
		36	39	20.54	20.51	20.48	2
		75	0	20.62	20.59	20.56	2
LTE Band 38							
BW	Modulation	RB Size	RB Offset	Low CH 37850	Mid CH 38000	High CH 38150	3GPP MPR (dB)
				Frequency 2580 MHz	Frequency 2595 MHz	Frequency 2610 MHz	
20MHz	QPSK	1	0	22.67	22.64	22.61	0
		1	50	22.62	22.59	22.56	0
		1	99	22.59	22.56	22.53	0
		50	0	21.69	21.66	21.63	1
		50	25	21.64	21.61	21.58	1
		50	50	21.57	21.54	21.51	1
		100	0	21.68	21.65	21.62	1
	16QAM	1	0	21.65	21.62	21.59	1
		1	50	21.61	21.58	21.55	1
		1	99	21.57	21.54	21.51	1
		50	0	20.69	20.66	20.63	2
		50	25	20.64	20.61	20.58	2
		50	50	20.61	20.58	20.55	2
		100	0	20.69	20.66	20.63	2



Test Report No.: RF180411W007-13

**EIRP**

**LTE BAND 7**

**CHANNEL BANDWIDTH: 5MHz QPSK**

Channel	Frequency (MHz)	SPA LVL (dBm)	Correction Factor(dB)	EIRP(dBm)	EIRP(mW)	Polarization (H/V)	Limit (W)
20775	2502.5	-22.14	45.65	23.51	224.28	H	2
21100	2535.0	-22.31	46.04	23.73	<b>235.78</b>	H	2
21425	2567.5	-22.49	45.87	23.38	217.57	H	2
20775	2502.5	-27.48	47.03	19.55	90.12	V	2
21100	2535.0	-27.32	46.57	19.25	84.14	V	2
21425	2567.5	-27.17	46.98	19.81	95.72	V	2

**CHANNEL BANDWIDTH: 5MHz 16QAM**

Channel	Frequency (MHz)	SPA LVL (dBm)	Correction Factor(dB)	EIRP(dBm)	EIRP(mW)	Polarization (H/V)	Limit (W)
20775	2502.5	-22.97	45.65	22.68	185.27	H	2
21100	2535.0	-23.33	46.04	22.71	186.42	H	2
21425	2567.5	-23.59	45.87	22.28	168.89	H	2
20775	2502.5	-28.31	47.03	18.72	74.44	V	2
21100	2535.0	-28.34	46.57	18.23	66.53	V	2
21425	2567.5	-28.27	46.98	18.71	74.30	V	2

**CHANNEL BANDWIDTH: 10MHz QPSK**

Channel	Frequency (MHz)	SPA LVL (dBm)	Correction Factor(dB)	EIRP(dBm)	EIRP(mW)	Polarization (H/V)	Limit (W)
20800	2505.0	-21.95	45.65	23.70	234.37	H	2
21100	2535.0	-22.25	46.04	23.79	<b>239.06</b>	H	2
21400	2565.0	-22.36	46.07	23.71	234.69	H	2
20800	2505.0	-27.29	47.18	19.89	97.41	V	2
21100	2535.0	-27.26	46.57	19.31	85.31	V	2
21400	2565.0	-27.04	47.06	20.02	100.55	V	2



**CHANNEL BANDWIDTH: 10MHz 16QAM**

Channel	Frequency (MHz)	SPA LVL (dBm)	Correction Factor(dB)	EIRP(dBm)	EIRP(mW)	Polarization (H/V)	Limit (W)
20800	2505.0	-23.10	45.65	22.55	179.85	H	2
21100	2535.0	-23.35	46.04	22.69	185.57	H	2
21400	2565.0	-23.52	46.07	22.55	179.68	H	2
20800	2505.0	-28.44	47.18	18.74	74.75	V	2
21100	2535.0	-28.36	46.57	18.21	66.22	V	2
21400	2565.0	-28.20	47.06	18.86	76.98	V	2

**CHANNEL BANDWIDTH: 15MHz QPSK**

Channel	Frequency (MHz)	SPA LVL (dBm)	Correction Factor(dB)	EIRP(dBm)	EIRP(mW)	Polarization (H/V)	Limit (W)
20825	2507.5	-21.96	45.63	23.67	232.97	H	2
21100	2535.0	-22.32	46.04	23.72	<b>235.23</b>	H	2
21375	2562.5	-22.43	45.94	23.51	224.28	H	2
20825	2507.5	-27.30	47.39	20.09	102.07	V	2
21100	2535.0	-27.33	46.57	19.24	83.95	V	2
21375	2562.5	-27.11	47.00	19.89	97.48	V	2

**CHANNEL BANDWIDTH: 15MHz 16QAM**

Channel	Frequency (MHz)	SPA LVL (dBm)	Correction Factor(dB)	EIRP(dBm)	EIRP(mW)	Polarization (H/V)	Limit (W)
20825	2507.5	-22.82	45.63	22.81	191.12	H	2
21100	2535.0	-23.19	46.04	22.85	192.53	H	2
21375	2562.5	-23.28	45.94	22.66	184.42	H	2
20825	2507.5	-28.16	47.39	19.23	83.73	V	2
21100	2535.0	-28.20	46.57	18.37	68.71	V	2
21375	2562.5	-27.96	47.00	19.04	80.15	V	2



Test Report No.: RF180411W007-13

**CHANNEL BANDWIDTH: 20MHz QPSK**

Channel	Frequency (MHz)	SPA LVL (dBm)	Correction Factor(dB)	EIRP(dBm)	EIRP(mW)	Polarization (H/V)	Limit (W)
20850	2510.0	-22.54	45.80	23.26	211.79	H	2
21100	2535.0	-22.77	46.04	23.27	<b>212.08</b>	H	2
21350	2560.0	-23.01	45.83	22.82	191.56	H	2
20850	2510.0	-27.88	47.21	19.33	85.70	V	2
21100	2535.0	-27.78	46.57	18.79	75.61	V	2
21350	2560.0	-27.69	47.07	19.38	86.68	V	2

**CHANNEL BANDWIDTH: 20MHz 16QAM**

Channel	Frequency (MHz)	SPA LVL (dBm)	Correction Factor(dB)	EIRP(dBm)	EIRP(mW)	Polarization (H/V)	Limit (W)
20850	2510.0	-23.47	45.80	22.33	170.96	H	2
21100	2535.0	-23.84	46.04	22.20	165.77	H	2
21350	2560.0	-23.84	45.83	21.99	158.23	H	2
20850	2510.0	-28.81	47.21	18.40	69.18	V	2
21100	2535.0	-28.85	46.57	17.72	59.10	V	2
21350	2560.0	-28.52	47.07	18.55	71.60	V	2

**REMARKS:** 1. EIRP Output Power (dBm) = SPA LVL (dBm) + Correction Factor (dB).  
2. Correction factor (dB) = Free Space Loss + Antenna Factor + Cable Loss



Test Report No.: RF180411W007-13

**LTE BAND 38**

**CHANNEL BANDWIDTH: 5MHz QPSK**

Channel	Frequency (MHz)	SPA LVL (dBm)	Correction Factor(dB)	EIRP(dBm)	EIRP(mW)	Polarization (H/V)	Limit (W)
37775	2572.5	-21.05	45.91	24.86	306.20	H	2
38000	2595.0	-20.76	46.04	25.28	<b>337.29</b>	H	2
38225	2617.5	-21.73	46.23	24.50	281.84	H	2
37775	2572.5	-26.49	46.92	20.43	110.41	V	2
38000	2595.0	-27.32	47.10	19.78	95.06	V	2
38225	2617.5	-27.37	47.26	19.89	97.50	V	2

**CHANNEL BANDWIDTH: 5MHz 16QAM**

Channel	Frequency (MHz)	SPA LVL (dBm)	Correction Factor(dB)	EIRP(dBm)	EIRP(mW)	Polarization (H/V)	Limit (W)
37775	2572.5	-21.88	45.91	24.03	252.93	H	2
38000	2595.0	-21.78	46.04	24.26	266.69	H	2
38225	2617.5	-22.83	46.23	23.40	218.78	H	2
37775	2572.5	-27.32	46.92	19.60	91.20	V	2
38000	2595.0	-28.34	47.10	18.76	75.16	V	2
38225	2617.5	-28.47	47.26	18.79	75.68	V	2

**CHANNEL BANDWIDTH: 10MHz QPSK**

Channel	Frequency (MHz)	SPA LVL (dBm)	Correction Factor(dB)	EIRP(dBm)	EIRP(mW)	Polarization (H/V)	Limit (W)
37800	2575.0	-20.86	45.96	25.10	323.59	H	2
38000	2595.0	-20.70	46.04	25.34	<b>341.98</b>	H	2
38200	2615.0	-21.60	46.18	24.58	287.08	H	2
37800	2575.0	-26.30	46.99	20.69	117.22	V	2
38000	2595.0	-27.26	47.10	19.84	96.38	V	2
38200	2615.0	-27.24	47.21	19.97	99.31	V	2



**CHANNEL BANDWIDTH: 10MHz 16QAM**

Channel	Frequency (MHz)	SPA LVL (dBm)	Correction Factor(dB)	EIRP(dBm)	EIRP(mW)	Polarization (H/V)	Limit (W)
37800	2575.0	-22.01	45.96	23.95	248.31	H	2
38000	2595.0	-21.80	46.04	24.24	265.46	H	2
38200	2615.0	-22.76	46.18	23.42	219.79	H	2
37800	2575.0	-27.45	46.99	19.54	89.95	V	2
38000	2595.0	-28.36	47.10	18.74	74.82	V	2
38200	2615.0	-28.40	47.21	18.81	76.03	V	2

**CHANNEL BANDWIDTH: 15MHz QPSK**

Channel	Frequency (MHz)	SPA LVL (dBm)	Correction Factor(dB)	EIRP(dBm)	EIRP(mW)	Polarization (H/V)	Limit (W)
37825	2577.5	-20.87	46.01	25.14	326.59	H	2
38000	2595.0	-20.77	46.04	25.27	<b>336.51</b>	H	2
38175	2612.5	-21.67	46.14	24.47	279.90	H	2
37825	2577.5	-26.31	47.03	20.72	118.03	V	2
38000	2595.0	-27.33	47.10	19.77	94.84	V	2
38175	2612.5	-27.31	47.17	19.86	96.83	V	2

**CHANNEL BANDWIDTH: 15MHz 16QAM**

Channel	Frequency (MHz)	SPA LVL (dBm)	Correction Factor(dB)	EIRP(dBm)	EIRP(mW)	Polarization (H/V)	Limit (W)
37825	2577.5	-21.73	46.01	24.28	267.92	H	2
38000	2595.0	-21.64	46.04	24.40	275.42	H	2
38175	2612.5	-22.52	46.14	23.62	230.14	H	2
37825	2577.5	-27.17	47.03	19.86	96.83	V	2
38000	2595.0	-28.20	47.10	18.90	77.62	V	2
38175	2612.5	-28.16	47.17	19.01	79.62	V	2





**CHANNEL BANDWIDTH: 20MHz QPSK**

Channel	Frequency (MHz)	SPA LVL (dBm)	Correction Factor(dB)	EIRP(dBm)	EIRP(mW)	Polarization (H/V)	Limit (W)
37850	2580.0	-21.45	46.05	24.60	288.40	H	2
38000	2595.0	-21.22	46.04	24.82	<b>303.39</b>	H	2
38150	2610.0	-22.25	46.11	23.86	243.22	H	2
37850	2580.0	-26.89	47.07	20.18	104.23	V	2
38000	2595.0	-27.78	47.10	19.32	85.51	V	2
38150	2610.0	-27.89	47.13	19.24	83.95	V	2

**CHANNEL BANDWIDTH: 20MHz 16QAM**

Channel	Frequency (MHz)	SPA LVL (dBm)	Correction Factor(dB)	EIRP(dBm)	EIRP(mW)	Polarization (H/V)	Limit (W)
37850	2580.0	-22.38	46.05	23.67	232.81	H	2
38000	2595.0	-22.29	46.04	23.75	237.14	H	2
38150	2610.0	-23.08	46.11	23.03	200.91	H	2
37850	2580.0	-27.82	47.07	19.25	84.14	V	2
38000	2595.0	-28.85	47.10	18.25	66.83	V	2
38150	2610.0	-28.72	47.13	18.41	69.34	V	2

**REMARKS:** 1. EIRP Output Power (dBm) = SPA LVL (dBm) + Correction Factor (dB).  
2. Correction factor (dB) = Free Space Loss + Antenna Factor + Cable Loss

## 3.2 FREQUENCY STABILITY MEASUREMENT

### 3.2.1 LIMITS OF FREQUENCY STABILITY MEASUREMENT

The frequency stability shall be sufficient to ensure that the fundamental emissions stay within the authorized bands of operation.

### 3.2.2 TEST PROCEDURE

- Device is placed at the oven room. The oven room could control the temperatures and humidity. Power warm up is at least 15 min and power applied should perform before recording frequency error.
- EUT is connected the external power supply to control the DC input power. The test voltage range is from minimum to maximum working voltage. Each step shall be record the frequency error rate.
- The temperature range step is 10 degrees in this test items. All temperature levels shall be hold the  $\pm 0.5^{\circ}\text{C}$  during the measurement testing. The each temperature step shall be at least 0.5 hours, consider the EUT could be test under the stability condition.

**NOTE:** The frequency error was recorded frequency error from the communication simulator.

### 3.2.3 TEST SETUP

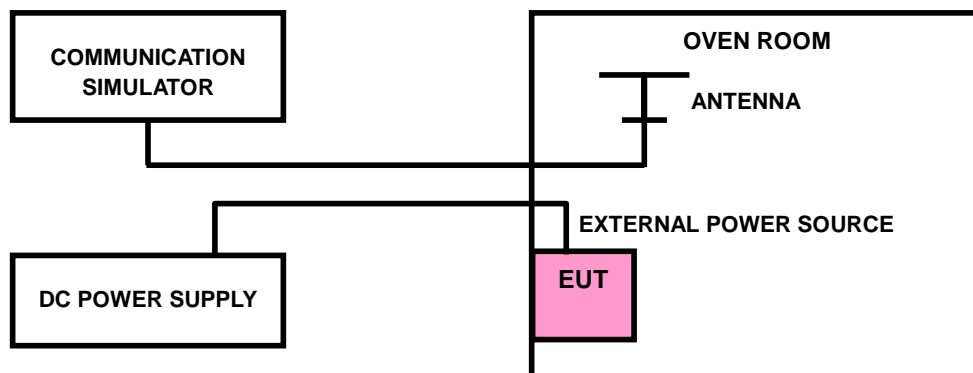



### 3.2.4 TEST RESULTS

#### LTE BAND 7

#### FREQUENCY ERROR VS. VOLTAGE

VOLTAGE (Volts)	5MHz		LIMIT (ppm)
	FREQUENCY ERROR (ppm)		
	Low Channel	High Channel	
3.9	0.0006	0.0007	2.5
3.7	-0.0005	-0.0007	2.5
4.0	0.0005	0.0007	2.5

**NOTE:** The applicant defined the normal working voltage of the battery is from 3.7Vdc to 4.0Vdc.

#### FREQUENCY ERROR vs. TEMPERATURE.

TEMP. (°C)	5MHz		LIMIT (ppm)
	FREQUENCY ERROR (ppm)		
	Low Channel	High Channel	
-30	-0.0039	-0.0039	2.5
-20	-0.0038	-0.0038	2.5
-10	-0.0036	-0.0036	2.5
0	-0.0029	-0.0029	2.5
10	-0.0026	-0.0026	2.5
20	-0.0021	-0.0021	2.5
30	-0.0019	-0.0019	2.5
40	-0.0010	-0.0011	2.5
50	-0.0003	-0.0003	2.5



**FREQUENCY ERROR VS. VOLTAGE**

VOLTAGE (Volts)	10MHz		LIMIT (ppm)
	FREQUENCY ERROR (ppm)		
	Low Channel	High Channel	
3.9	0.0006	0.0007	2.5
3.7	-0.0006	-0.0007	2.5
4.0	0.0006	0.0006	2.5

**NOTE:** The applicant defined the normal working voltage of the battery is from 3.7Vdc to 4.0Vdc.

**FREQUENCY ERROR vs. TEMPERATURE.**

TEMP. (°C)	10MHz		LIMIT (ppm)
	FREQUENCY ERROR (ppm)		
	Low Channel	High Channel	
-30	-0.0044	-0.0044	2.5
-20	-0.0043	-0.0043	2.5
-10	-0.0034	-0.0034	2.5
0	-0.0033	-0.0033	2.5
10	-0.0025	-0.0026	2.5
20	-0.0021	-0.0021	2.5
30	-0.0019	-0.0019	2.5
40	-0.0009	-0.0009	2.5
50	0.0002	0.0002	2.5



**FREQUENCY ERROR VS. VOLTAGE**

VOLTAGE (Volts)	15MHz		LIMIT (ppm)
	FREQUENCY ERROR (ppm)		
	Low Channel	High Channel	
3.9	0.0005	0.0007	2.5
3.7	-0.0006	-0.0008	2.5
4.0	0.0005	0.0007	2.5

**NOTE:** The applicant defined the normal working voltage of the battery is from 3.7Vdc to 4.0Vdc.

**FREQUENCY ERROR vs. TEMPERATURE.**

TEMP. (°C)	15MHz		LIMIT (ppm)
	FREQUENCY ERROR (ppm)		
	Low Channel	High Channel	
-30	-0.0043	-0.0044	2.5
-20	-0.0041	-0.0041	2.5
-10	-0.0032	-0.0033	2.5
0	-0.0031	-0.0031	2.5
10	-0.0030	-0.0030	2.5
20	-0.0027	-0.0027	2.5
30	-0.0023	-0.0023	2.5
40	-0.0014	-0.0014	2.5
50	0.0000	0.0000	2.5



**FREQUENCY ERROR VS. VOLTAGE**

VOLTAGE (Volts)	20MHz		LIMIT (ppm)
	FREQUENCY ERROR (ppm)		
	Low Channel	High Channel	
3.9	0.0006	0.0007	2.5
3.7	-0.0007	-0.0007	2.5
4.0	0.0005	0.0006	2.5

**NOTE:** The applicant defined the normal working voltage of the battery is from 3.7Vdc to 4.0Vdc.

**FREQUENCY ERROR vs. TEMPERATURE.**

TEMP. (°C)	20MHz		LIMIT (ppm)
	FREQUENCY ERROR (ppm)		
	Low Channel	High Channel	
-30	-0.0043	-0.0043	2.5
-20	-0.0041	-0.0041	2.5
-10	-0.0039	-0.0040	2.5
0	-0.0039	-0.0039	2.5
10	-0.0036	-0.0037	2.5
20	-0.0027	-0.0027	2.5
30	-0.0021	-0.0022	2.5
40	-0.0019	-0.0020	2.5
50	0.0004	0.0004	2.5



LTE BAND 38

FREQUENCY ERROR VS. VOLTAGE

VOLTAGE (Volts)	5MHz		LIMIT (ppm)
	FREQUENCY ERROR (ppm)		
	Low Channel	High Channel	
3.9	0.0020	0.0025	2.5
3.7	-0.0019	-0.0025	2.5
4.0	0.0020	0.0024	2.5

NOTE: The applicant defined the normal working voltage of the battery is from 3.7Vdc to 4.0Vdc.

FREQUENCY ERROR vs. TEMPERATURE.

TEMP. (°C)	5MHz		LIMIT (ppm)
	FREQUENCY ERROR (ppm)		
	Low Channel	High Channel	
-30	-0.0135	-0.0131	2.5
-20	-0.0135	-0.0130	2.5
-10	-0.0129	-0.0125	2.5
0	-0.0112	-0.0108	2.5
10	-0.0093	-0.0089	2.5
20	-0.0092	-0.0089	2.5
30	-0.0063	-0.0060	2.5
40	-0.0040	-0.0038	2.5
50	0.0012	0.0013	2.5



**FREQUENCY ERROR VS. VOLTAGE**

VOLTAGE (Volts)	10MHz		LIMIT (ppm)
	FREQUENCY ERROR (ppm)		
	Low Channel	High Channel	
3.9	0.0017	0.0025	2.5
3.7	-0.0025	-0.0027	2.5
4.0	0.0017	0.0019	2.5

**NOTE:** The applicant defined the normal working voltage of the battery is from 3.7Vdc to 4.0Vdc.

**FREQUENCY ERROR vs. TEMPERATURE.**

TEMP. (°C)	10MHz		LIMIT (ppm)
	FREQUENCY ERROR (ppm)		
	Low Channel	High Channel	
-30	-0.0131	-0.0128	2.5
-20	-0.0131	-0.0127	2.5
-10	-0.0113	-0.0110	2.5
0	-0.0113	-0.0109	2.5
10	-0.0095	-0.0092	2.5
20	-0.0076	-0.0073	2.5
30	-0.0066	-0.0064	2.5
40	-0.0066	-0.0063	2.5
50	-0.0004	-0.0002	2.5





**FREQUENCY ERROR VS. VOLTAGE**

VOLTAGE (Volts)	15MHz		LIMIT (ppm)
	FREQUENCY ERROR (ppm)		
	Low Channel	High Channel	
3.9	0.0021	0.0025	2.5
3.7	-0.0018	-0.0022	2.5
4.0	0.0018	0.0021	2.5

**NOTE:** The applicant defined the normal working voltage of the battery is from 3.7Vdc to 4.0Vdc.

**FREQUENCY ERROR vs. TEMPERATURE.**

TEMP. (°C)	15MHz		LIMIT (ppm)
	FREQUENCY ERROR (ppm)		
	Low Channel	High Channel	
-30	-0.0152	-0.0149	2.5
-20	-0.0131	-0.0128	2.5
-10	-0.0122	-0.0120	2.5
0	-0.0115	-0.0112	2.5
10	-0.0085	-0.0083	2.5
20	-0.0077	-0.0075	2.5
30	-0.0077	-0.0074	2.5
40	-0.0059	-0.0056	2.5
50	0.0011	0.0013	2.5



**FREQUENCY ERROR VS. VOLTAGE**

VOLTAGE (Volts)	20MHz		LIMIT (ppm)
	FREQUENCY ERROR (ppm)		
	Low Channel	High Channel	
3.9	0.0024	0.0024	2.5
3.7	-0.0020	-0.0023	2.5
4.0	0.0020	0.0023	2.5

**NOTE:** The applicant defined the normal working voltage of the battery is from 3.7Vdc to 4.0Vdc.

**FREQUENCY ERROR vs. TEMPERATURE.**

TEMP. (°C)	20MHz		LIMIT (ppm)
	FREQUENCY ERROR (ppm)		
	Low Channel	High Channel	
-30	-0.0135	-0.0133	2.5
-20	-0.0129	-0.0127	2.5
-10	-0.0115	-0.0113	2.5
0	-0.0105	-0.0103	2.5
10	-0.0100	-0.0098	2.5
20	-0.0079	-0.0077	2.5
30	-0.0063	-0.0061	2.5
40	-0.0039	-0.0037	2.5
50	-0.0008	-0.0006	2.5

### 3.3 OCCUPIED BANDWIDTH MEASUREMENT

#### 3.3.1 LIMITS OF OCCUPIED BANDWIDTH MEASUREMENT

The width of a frequency band such that, below the lower and above the upper frequency limits, the mean powers emitted are each equal to a specified percentage 0.5 %of the total mean power of a given emission.

#### 3.3.2 TEST SETUP

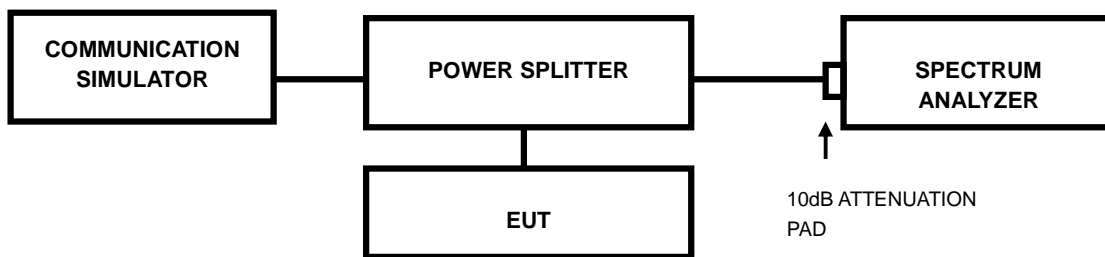

#### 3.3.3 TEST PROCEDURES

- The conducted occupied bandwidth used the power splitter via EUT RF power connector between simulation base station and spectrum analyzer.
- Use OBW measurement function of Spectrum analyzer to measure 99 % occupied bandwidth.



### 3.3.4 TEST RESULTS

LTE BAND 7							
CHANNEL BANDWIDTH: 5MHz				CHANNEL BANDWIDTH: 10MHz			
CHANNEL	FREQUENCY (MHz)	99% OCCUPIED BANDWIDTH (MHz)		CHANNEL	FREQUENCY (MHz)	99% OCCUPIED BANDWIDTH (MHz)	
		QPSK	16QAM			QPSK	16QAM
20775	2502.5	4.48	4.47	20800	2505	8.94	8.94
21100	2535	4.48	4.47	21100	2535	8.94	8.95
21425	2567.5	4.48	4.46	21400	2565	8.93	8.92

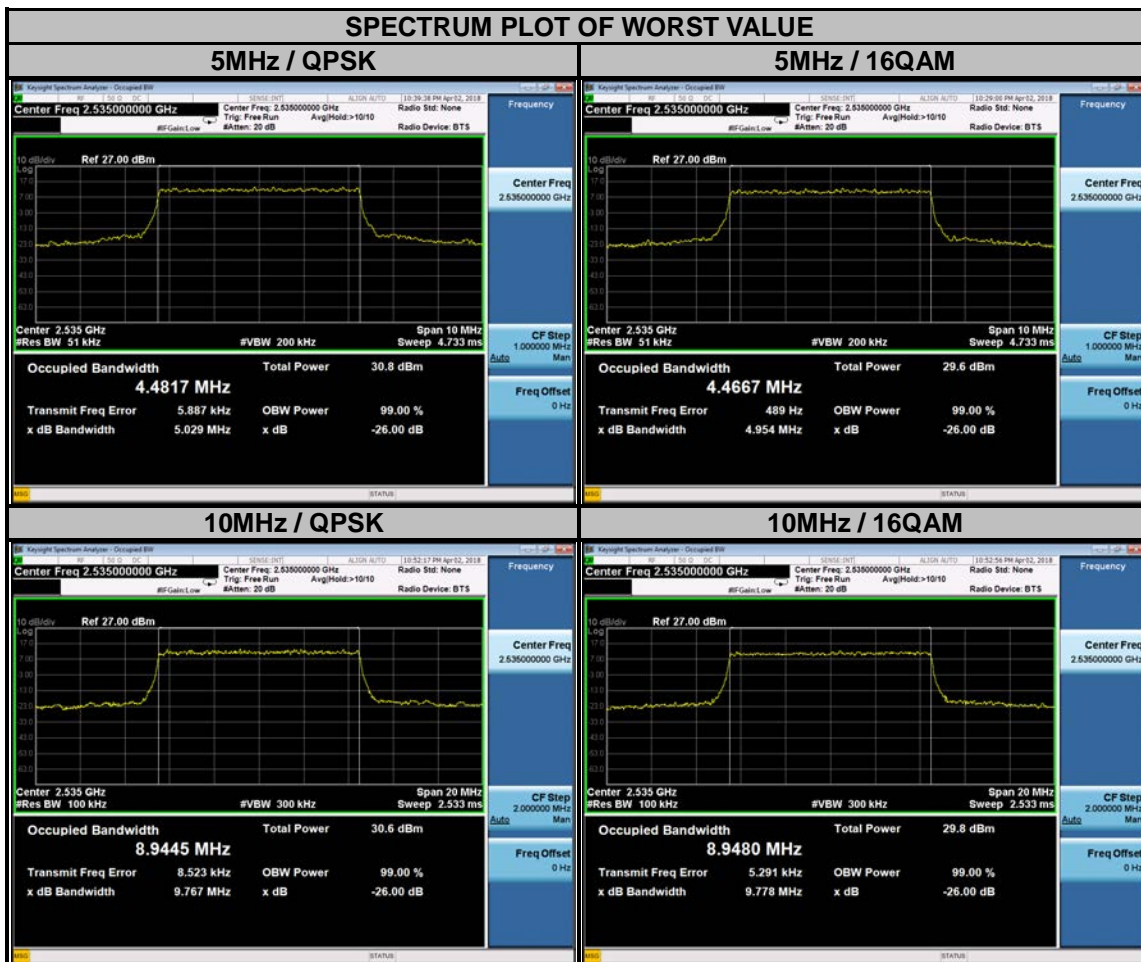



BUREAU  
VERITAS

Test Report No.: RF180411W007-13

LTE BAND 7							
CHANNEL BANDWIDTH: 15MHz				CHANNEL BANDWIDTH: 20MHz			
CHANNEL	FREQUENCY (MHz)	99% OCCUPIED BANDWIDTH (MHz)		CHANNEL	FREQUENCY (MHz)	99% OCCUPIED BANDWIDTH (MHz)	
		QPSK	16QAM			QPSK	16QAM
20825	2507.5	13.39	13.37	20850	2510	17.86	17.81
21100	2535	13.41	13.41	21100	2535	17.93	17.86
21375	2562.5	13.38	13.40	21350	2560	17.88	17.85





LTE BAND 38							
CHANNEL BANDWIDTH: 5MHZ				CHANNEL BANDWIDTH: 10MHZ			
CHANNEL	FREQUENCY (MHz)	99% OCCUPIED BANDWIDTH (MHz)		CHANNEL	FREQUENCY (MHz)	99% OCCUPIED BANDWIDTH (MHz)	
		QPSK	16QAM			QPSK	16QAM
37775	2572.5	4.47	4.47	37800	2575	8.93	8.93
38000	2595	4.48	4.47	38000	2595	8.93	8.94
38225	2617.5	4.48	4.47	38200	2615	8.93	8.94

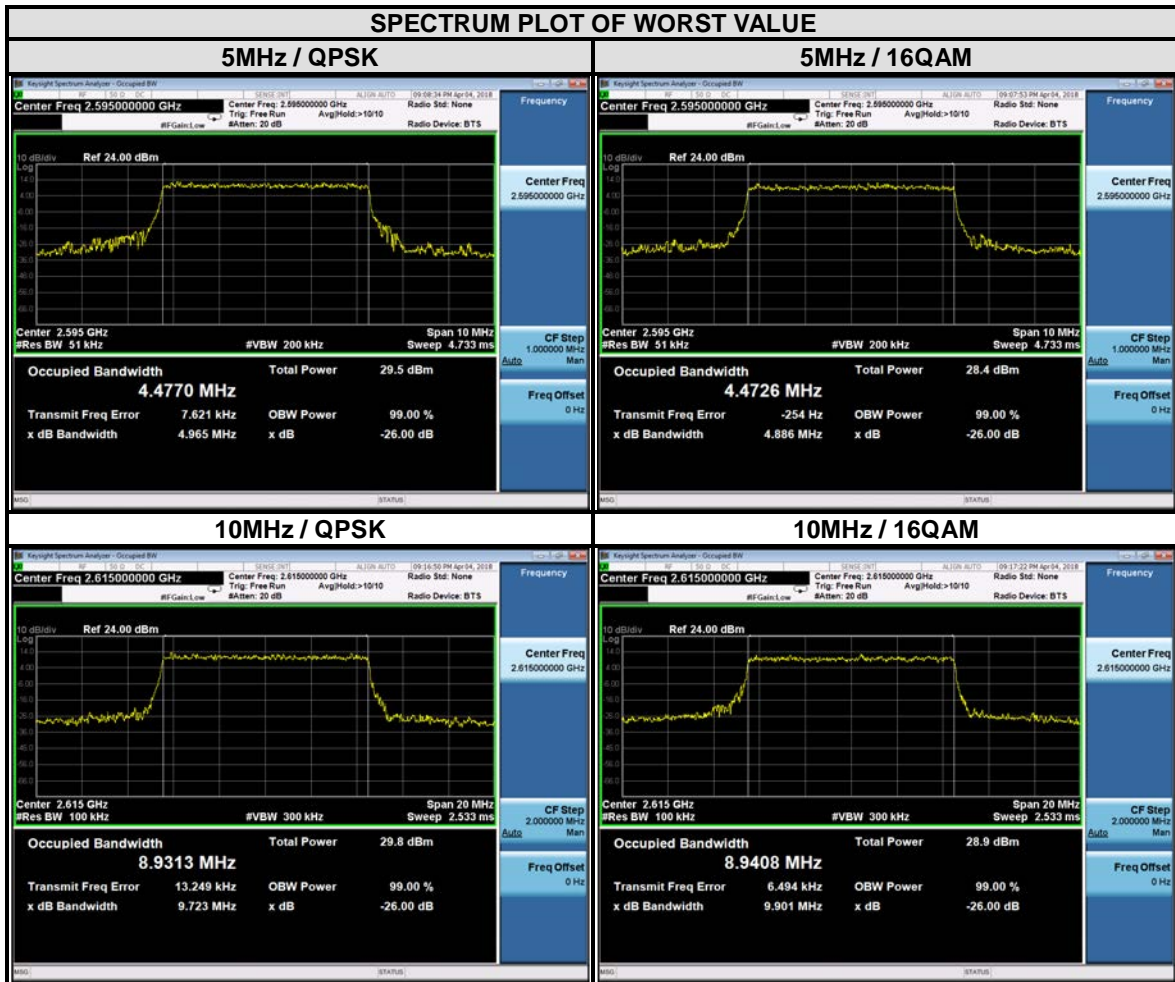



LTE BAND 38							
CHANNEL BANDWIDTH: 15MHZ				CHANNEL BANDWIDTH: 20MHZ			
CHANNEL	FREQUENCY (MHz)	99% OCCUPIED BANDWIDTH (MHz)		CHANNEL	FREQUENCY (MHz)	99% OCCUPIED BANDWIDTH (MHz)	
		QPSK	16QAM			QPSK	16QAM
37825	2577.5	13.39	13.42	37850	2580	17.90	17.86
38000	2595	13.39	13.40	38000	2595	17.86	17.85
38175	2612.5	13.36	13.39	38150	2610	17.86	17.84



### 3.4 PEAK TO AVERAGE RATIO

#### 3.4.1 LIMITS OF PEAK TO AVERAGE RATIO MEASUREMENT

In measuring transmissions in this band using an average power technique, the peak to-average ratio (PAR) of the transmission may not exceed 13 dB.

#### 3.4.2 TEST SETUP

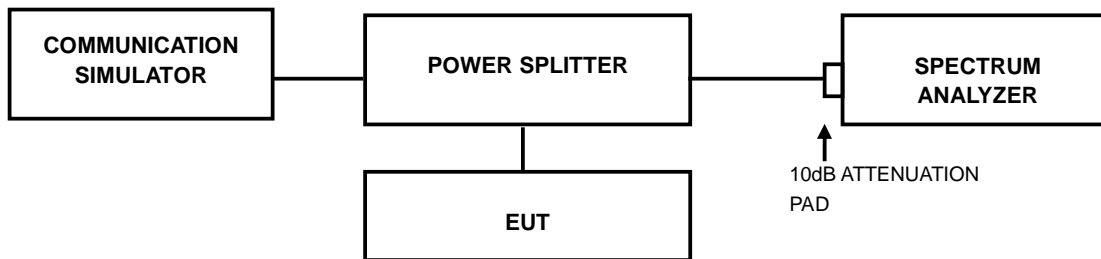

#### 3.4.3 TEST PROCEDURES

1. Set resolution/measurement bandwidth  $\geq$  signal's occupied bandwidth;
2. Set the number of counts to a value that stabilizes the measured CCDF curve;
3. Record the maximum PAPR level associated with a probability of 0.1%.





### 3.4.4 TEST RESULTS

#### LTE BAND 7

CHANNEL BANDWIDTH: 5MHz				CHANNEL BANDWIDTH: 10MHz			
CHANNEL	FREQUENCY (MHz)	PEAK TO AVERAGE RATIO (dB)		CHANNEL	FREQUENCY (MHz)	PEAK TO AVERAGE RATIO (dB)	
		QPSK	16QAM			QPSK	16QAM
20775	2502.5	5.09	5.89	20800	2505	4.95	5.82
21100	2535	5.06	5.90	21100	2535	4.86	5.72
21425	2567.5	5.30	6.15	21400	2565	5.29	6.16

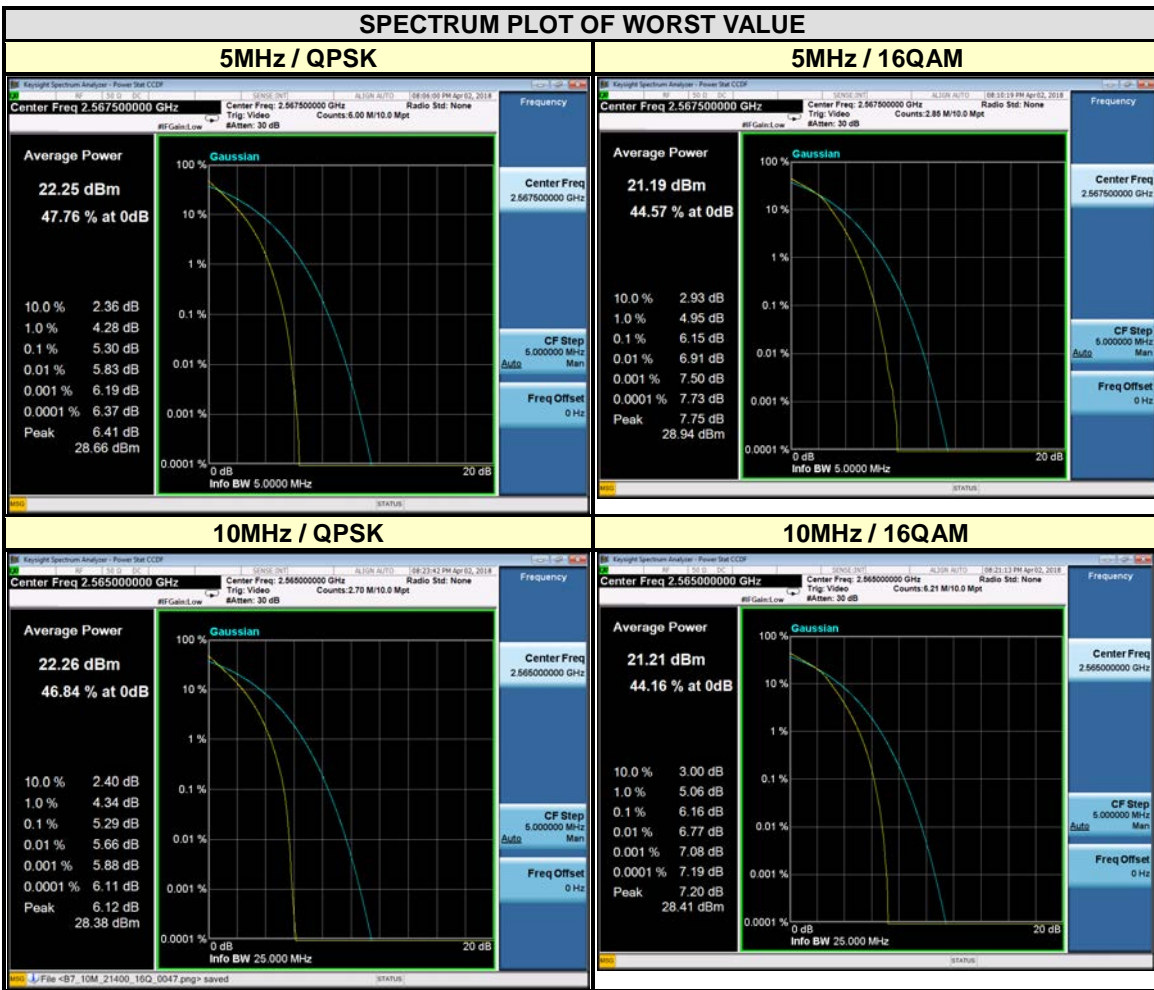



Test Report No.: RF180411W007-13

CHANNEL BANDWIDTH: 15MHz				CHANNEL BANDWIDTH: 20MHz			
CHANNEL	FREQUENCY (MHz)	PEAK TO AVERAGE RATIO (dB)		CHANNEL	FREQUENCY (MHz)	PEAK TO AVERAGE RATIO (dB)	
		QPSK	16QAM			QPSK	16QAM
20825	2507.5	5.17	6.01	20850	2510	5.37	6.14
21100	2535	5.04	5.85	21100	2535	5.36	6.15
21375	2562.5	5.36	6.19	21350	2560	5.45	6.28

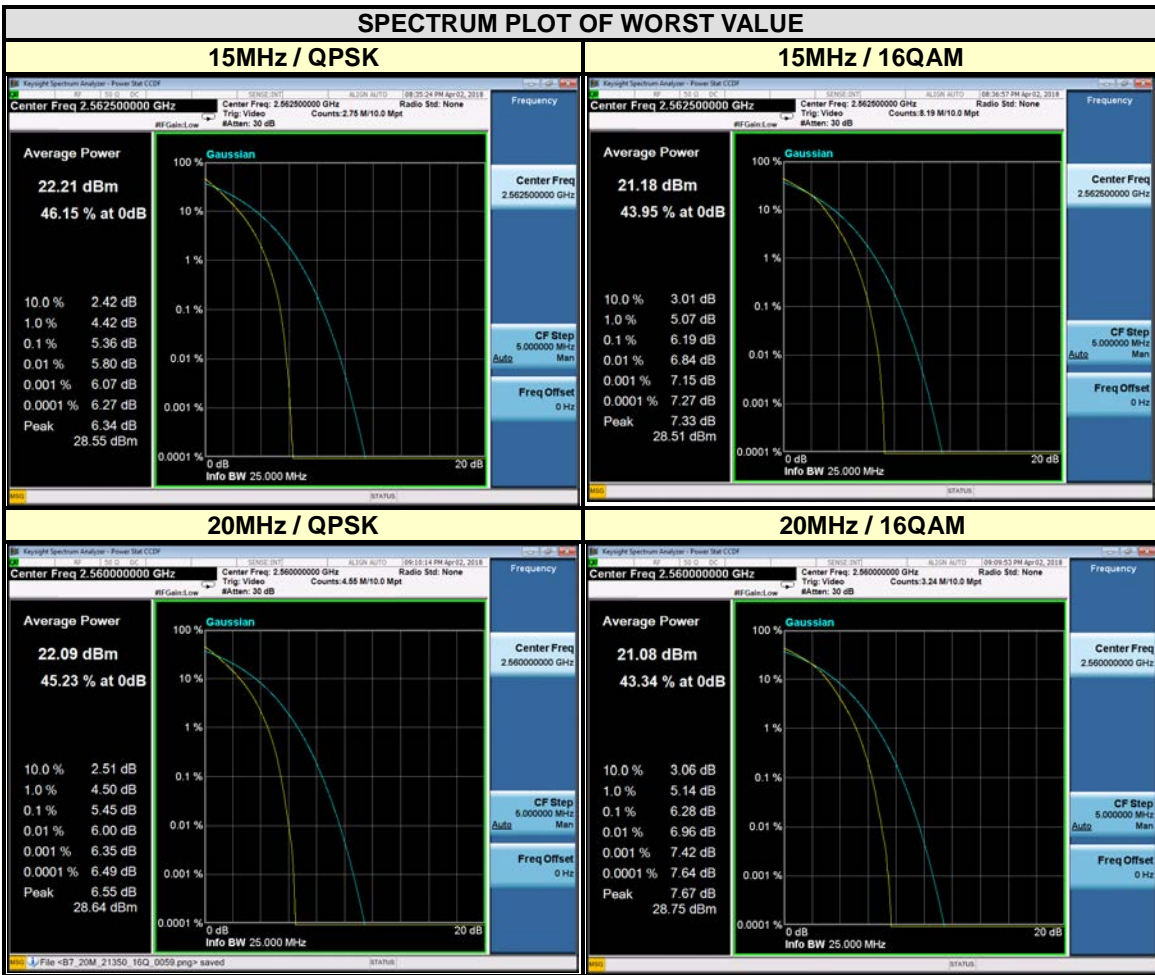



CHANNEL BANDWIDTH: 5MHz				CHANNEL BANDWIDTH: 10MHz			
CHANNEL	FREQUENCY (MHz)	PEAK TO AVERAGE RATIO (dB)		CHANNEL	FREQUENCY (MHz)	PEAK TO AVERAGE RATIO (dB)	
		QPSK	16QAM			QPSK	16QAM
37775	2572.5	6.09	6.54	37800	2575	6.06	6.58
38000	2595	5.65	6.70	38000	2595	5.92	6.19
38225	2617.5	5.82	6.91	38200	2615	6.37	7.05

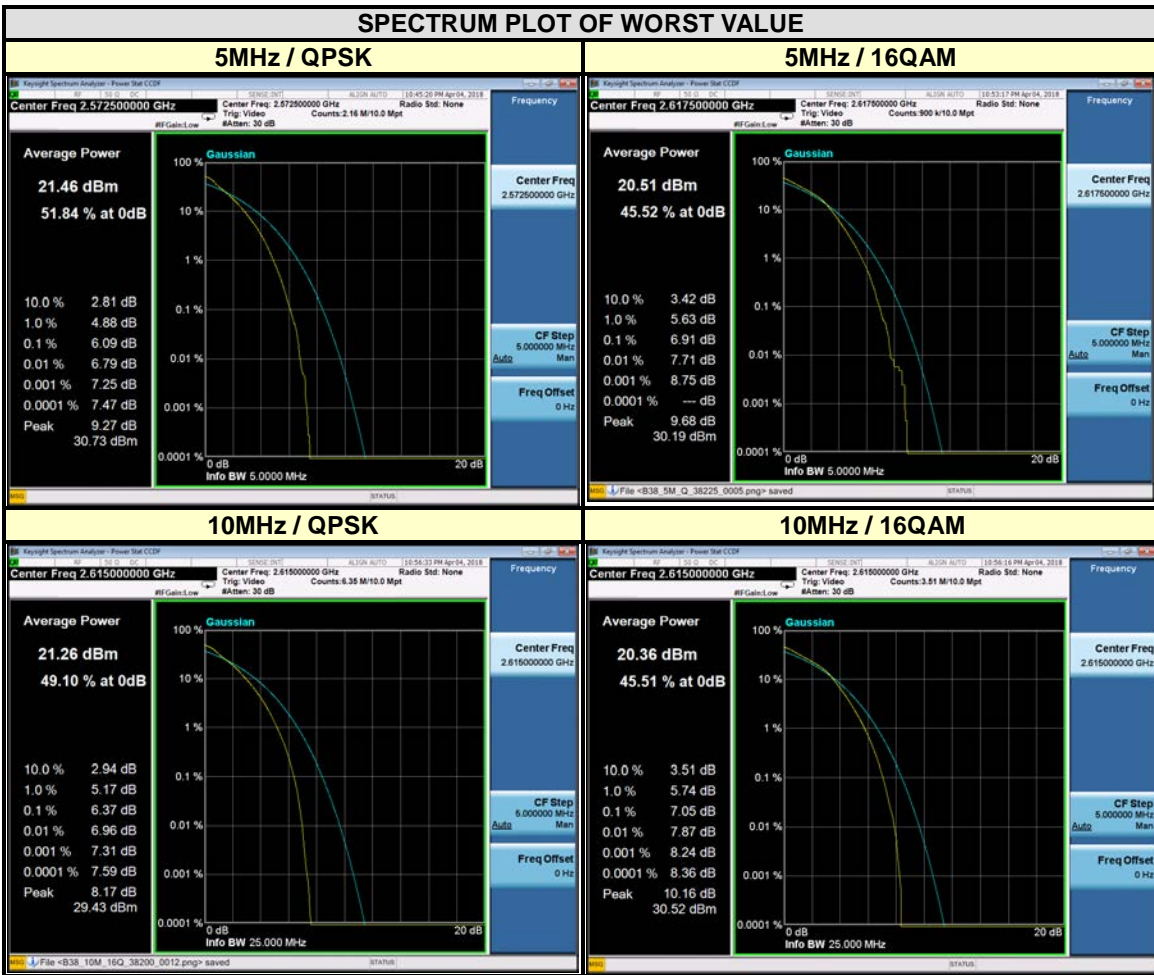



CHANNEL BANDWIDTH: 15MHz				CHANNEL BANDWIDTH: 20MHz			
CHANNEL	FREQUENCY (MHz)	PEAK TO AVERAGE RATIO (dB)		CHANNEL	FREQUENCY (MHz)	PEAK TO AVERAGE RATIO (dB)	
		QPSK	16QAM			QPSK	16QAM
37825	2577.5	6.11	6.46	37850	2580	6.05	6.38
38000	2595	6.17	6.81	38000	2595	6.42	6.68
38175	2612.5	6.14	6.87	38150	2610	6.22	6.96

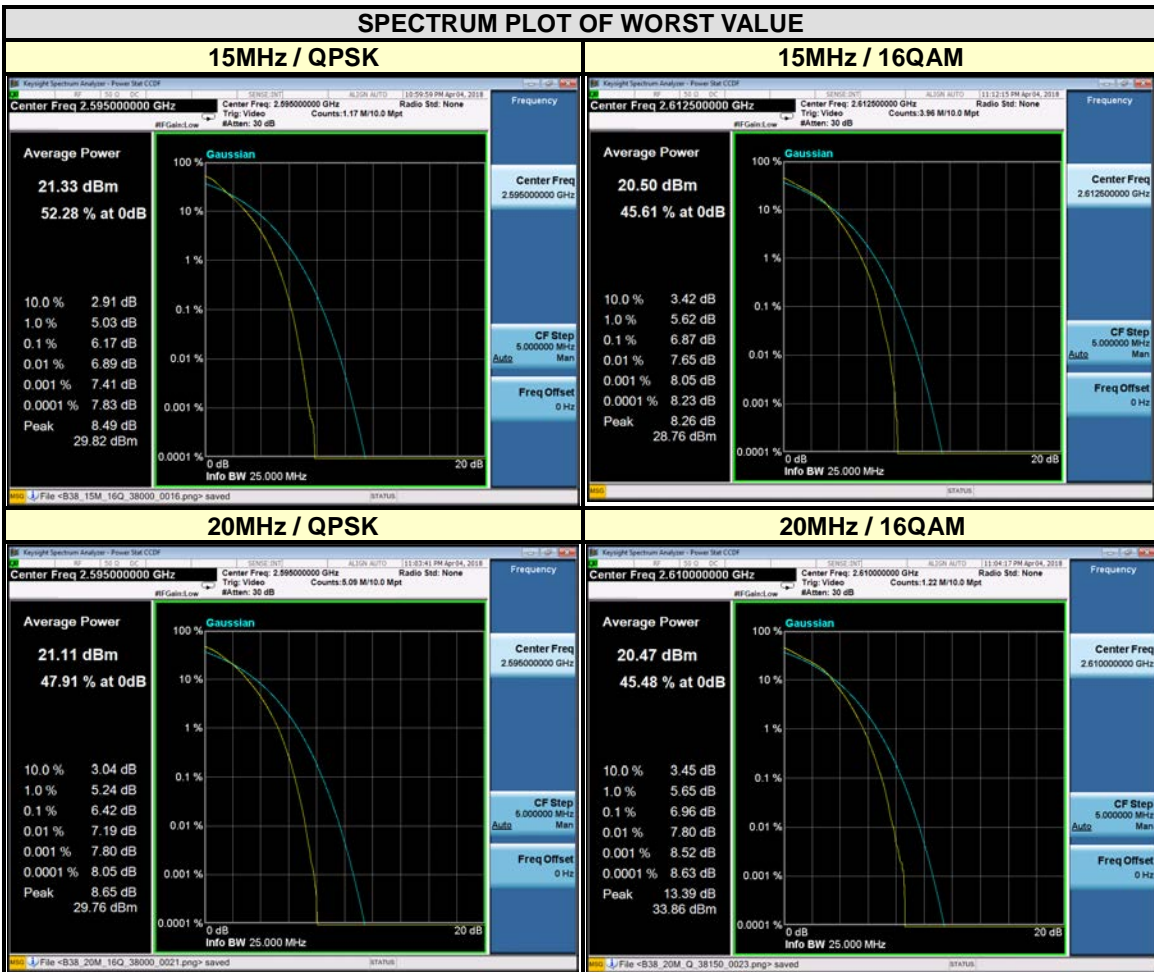

### 3.5 BAND EDGE MEASUREMENT

#### 3.5.1 LIMITS OF BAND EDGE MEASUREMENT

According to FCC 27.53(m)(4) specified that For mobile digital stations, the attenuation factor shall be not less than  $40 + 10 \log (P)$  dB on all frequencies between the channel edge and 5 megahertz from the channel edge,  $43 + 10 \log (P)$  dB on all frequencies between 5 megahertz and X megahertz from the channel edge, and  $55 + 10 \log (P)$  dB on all frequencies more than X megahertz from the channel edge, where X is the greater of 6 megahertz or the actual emission bandwidth as defined in paragraph (m)(6) of this section. In addition, the attenuation factor shall not be less that  $43 + 10 \log (P)$  dB on all frequencies between 2490.5 MHz and 2496 MHz and  $55 + 10 \log (P)$  dB at or below 2490.5 MHz. Mobile Satellite Service licensees operating on frequencies below 2495 MHz may also submit a documented interference complaint against BRS licensees operating on channel BRS Channel 1 on the same terms and conditions as adjacent channel BRS or EBS licensees. For mobile digital stations, in the 1 megahertz bands immediately outside and adjacent to the frequency block a resolution bandwidth of at least two percent may be employed.

#### 3.5.2 TEST SETUP

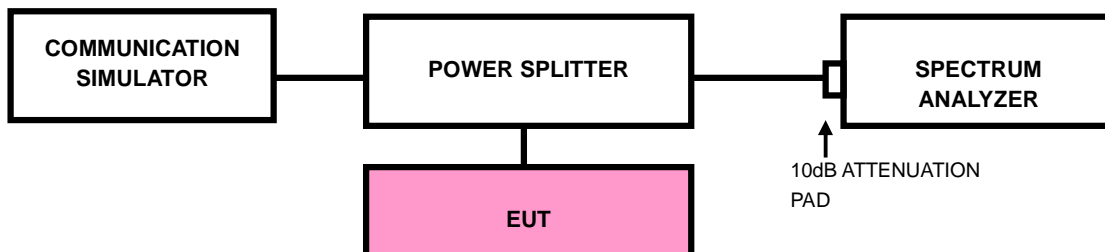



### 3.5.3 TEST PROCEDURES

- a. The EUT was set up for the maximum peak power with LTE link data modulation. The power was measured with R&S Spectrum Analyzer. All measurements were done at 2 channels (low and high operational frequency range.).
- b. The band edge measurement used the power splitter via EUT RF power connector between simulation base station and spectrum analyzer.
- c. The center frequency of spectrum is the band edge frequency and span is 35MHz. RBW of the spectrum is 100kHz and VBW of the spectrum is 300kHz (Channel bandwidth 5MHz).
- d. The center frequency of spectrum is the band edge frequency and span is 50MHz. RBW of the spectrum is 200kHz and VBW of the spectrum is 1MHz (Channel bandwidth 10MHz).
- e. The center frequency of spectrum is the band edge frequency and span is 60MHz. RBW of the spectrum is 300kHz and VBW of the spectrum is 1MHz (Channel bandwidth 15MHz).
- f. The center frequency of spectrum is the band edge frequency and span is 80MHz. RBW of the spectrum is 500kHz and VBW of the spectrum is 2MHz (Channel bandwidth 20MHz).
- g. Record the max trace plot into the test report.



3.5.4 TEST RESULTS

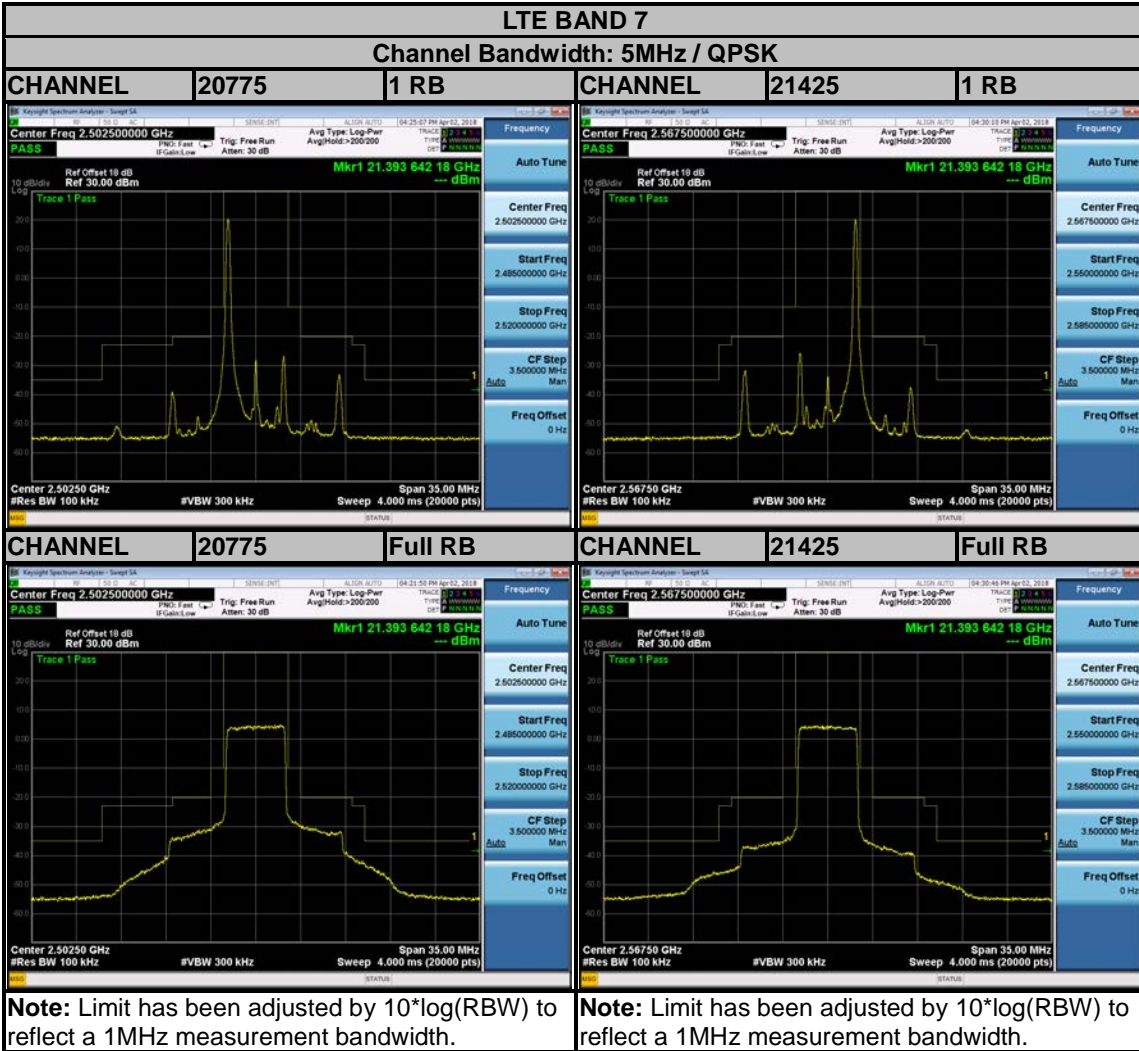

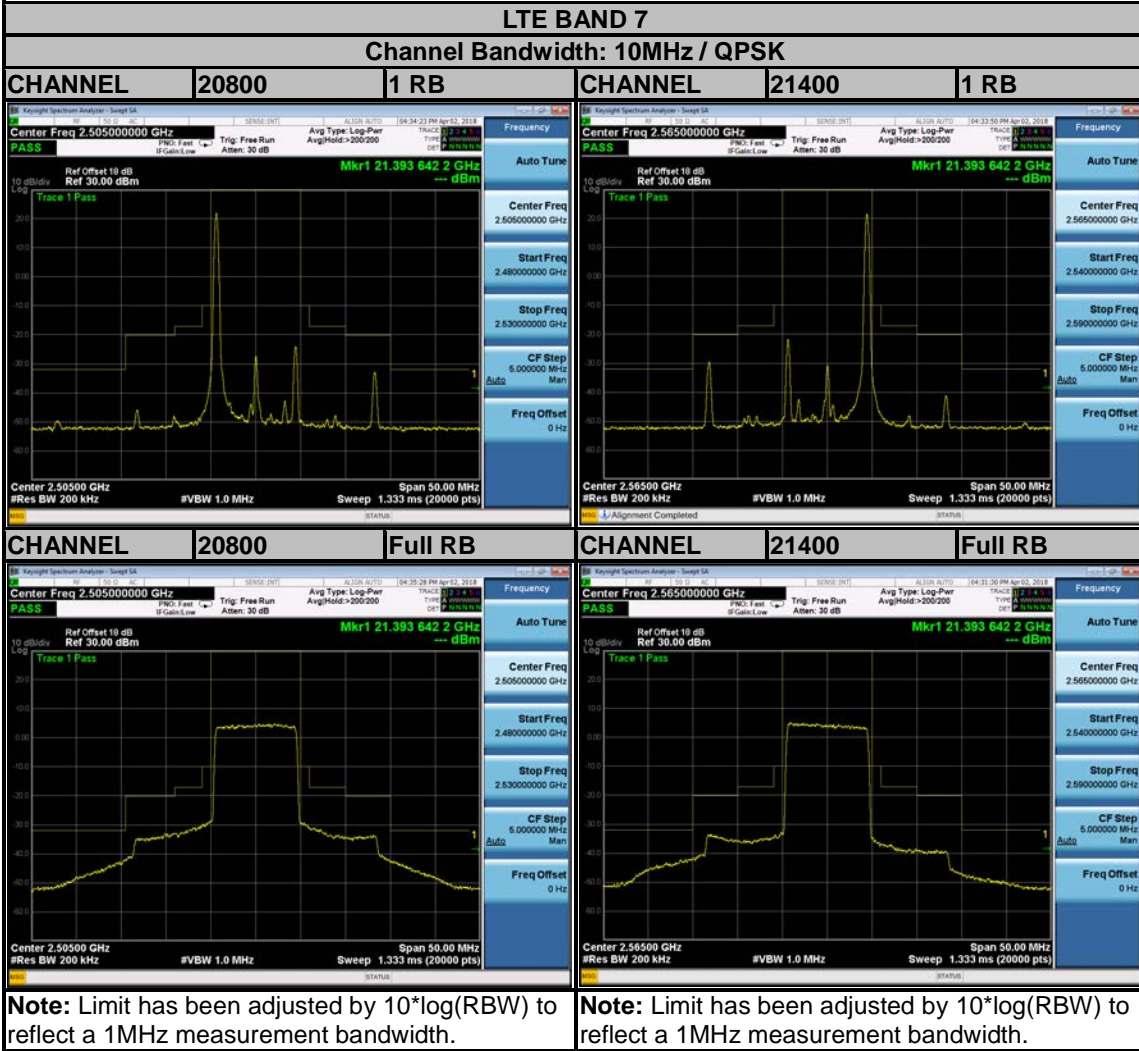



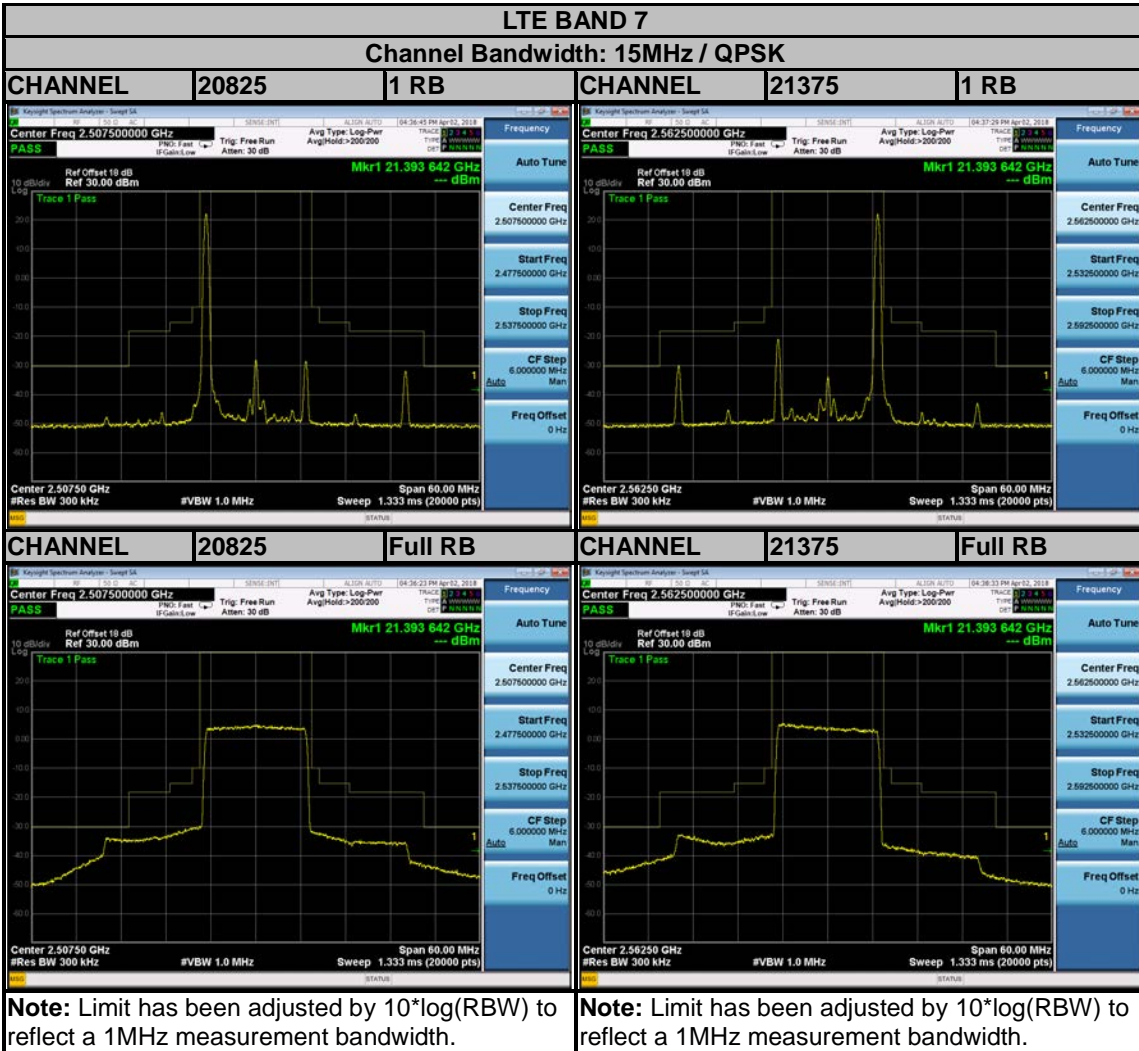

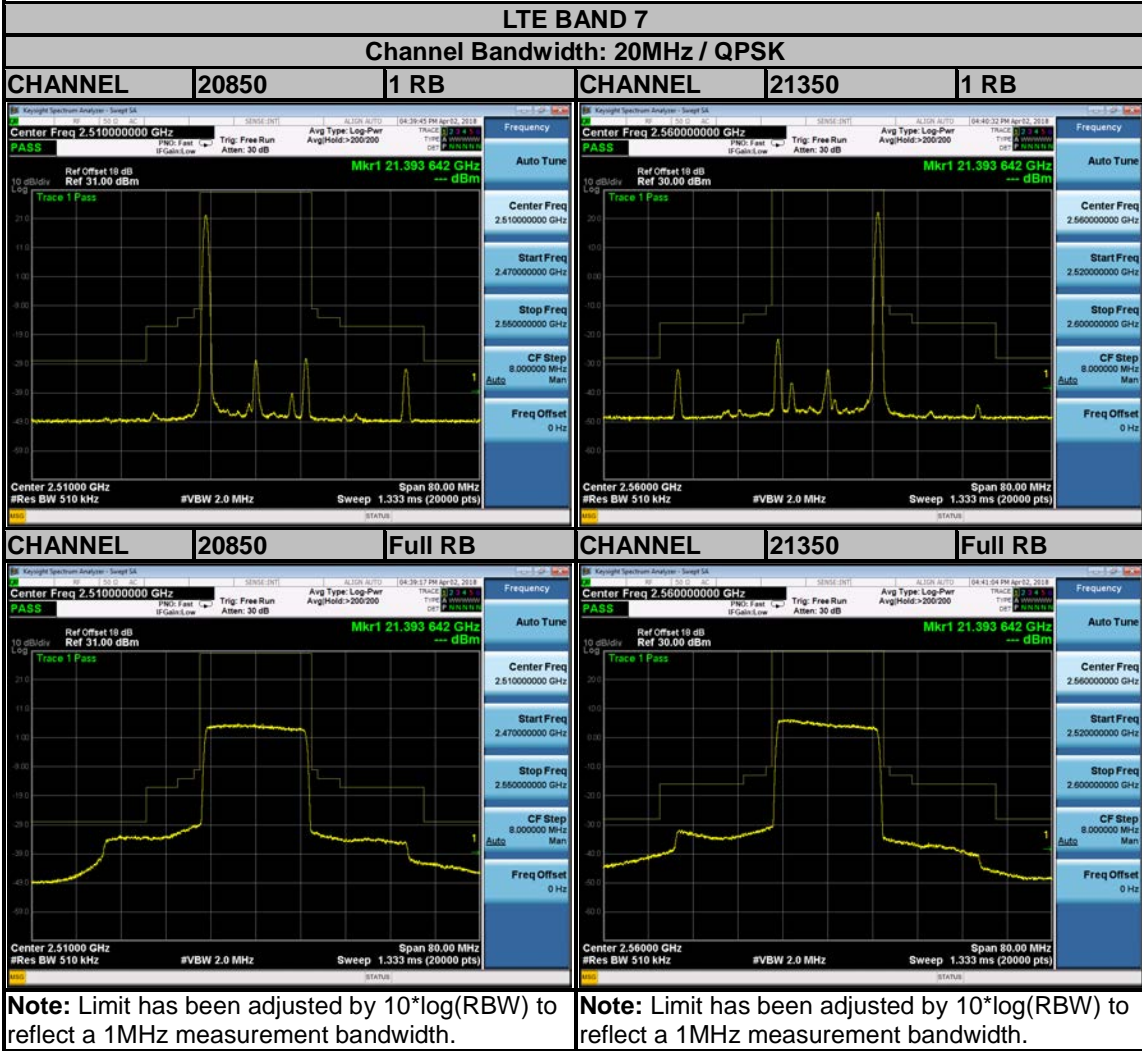

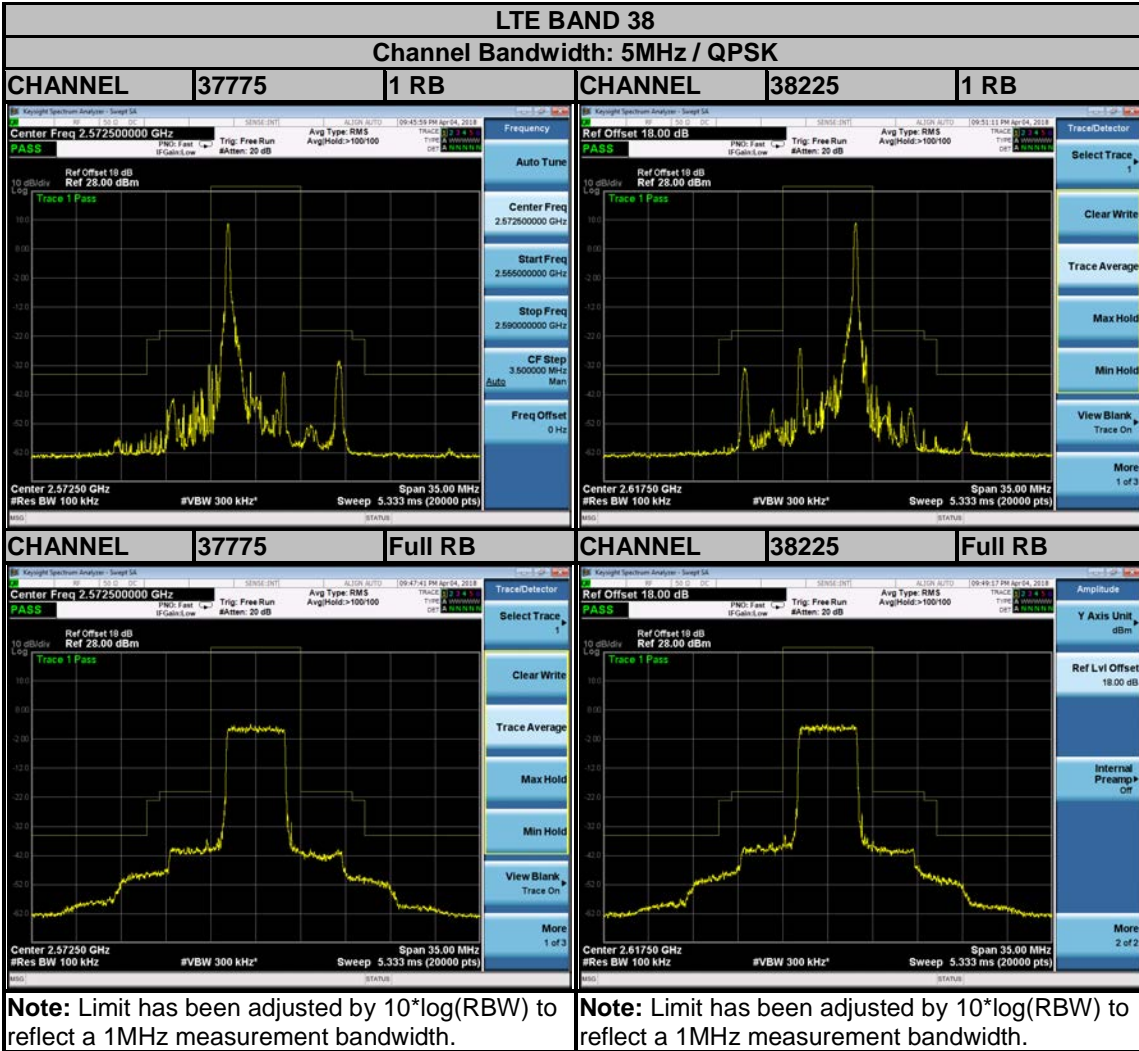

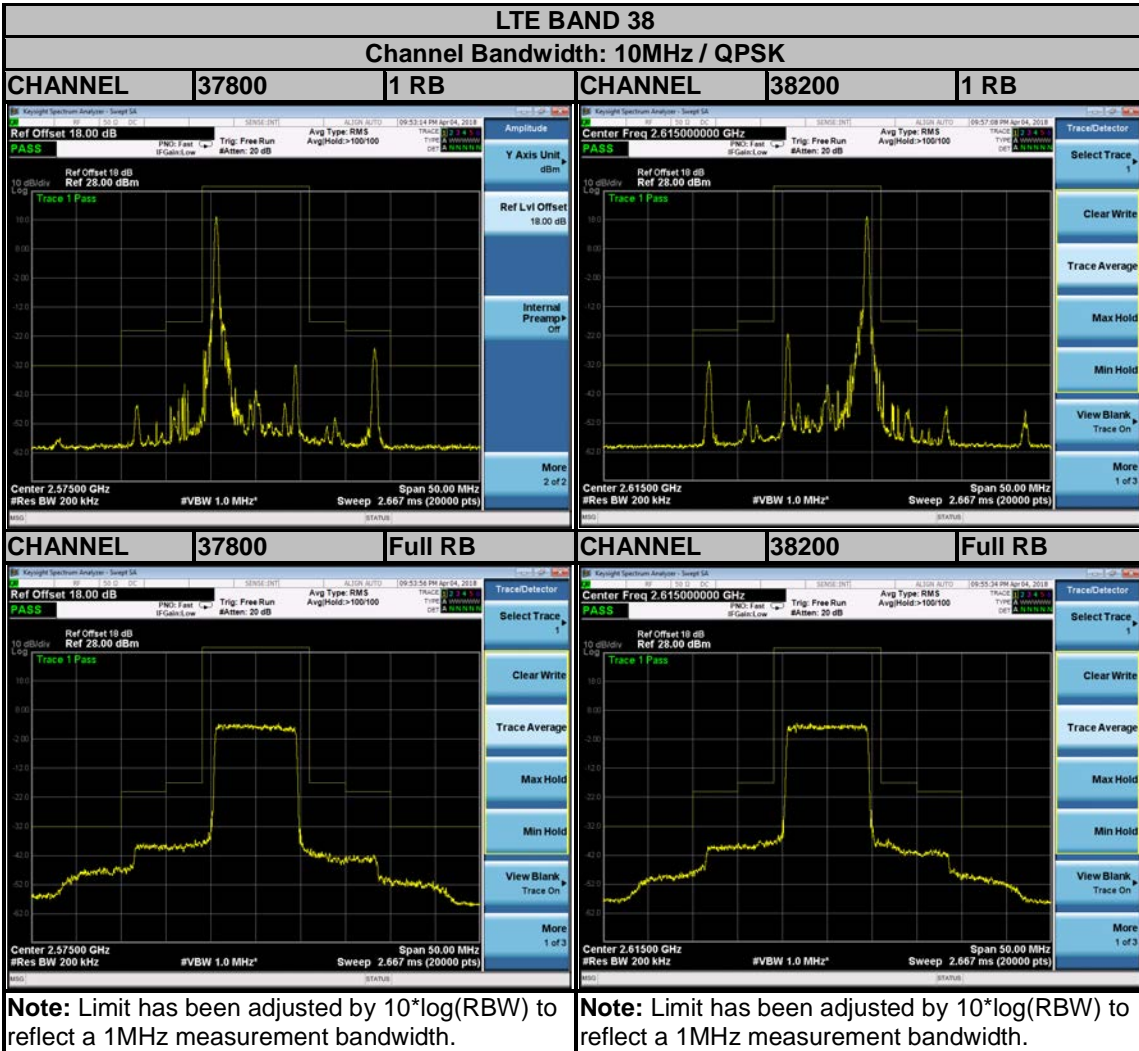



Test Report No.: RF180411W007-13

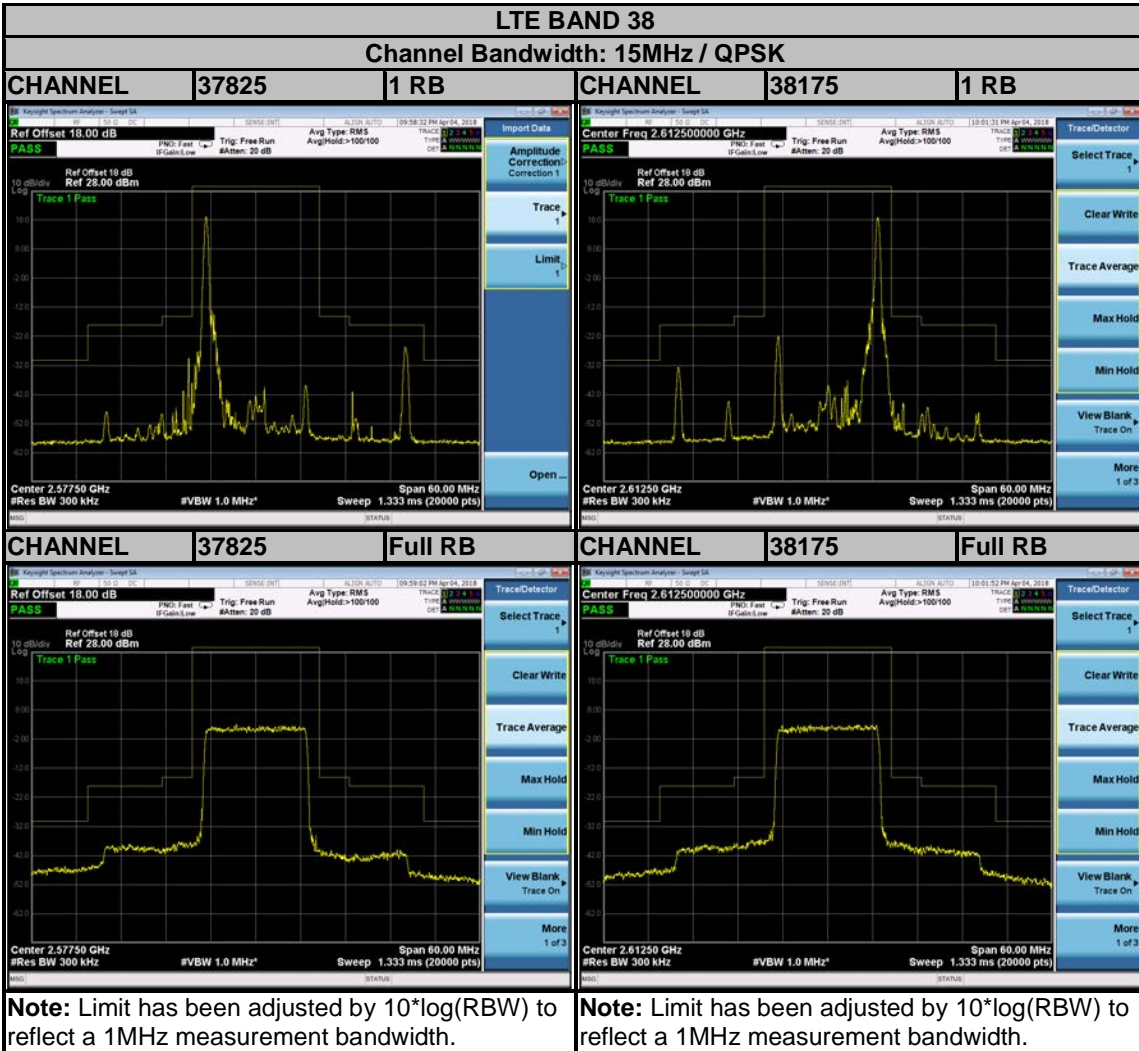



Test Report No.: RF180411W007-13

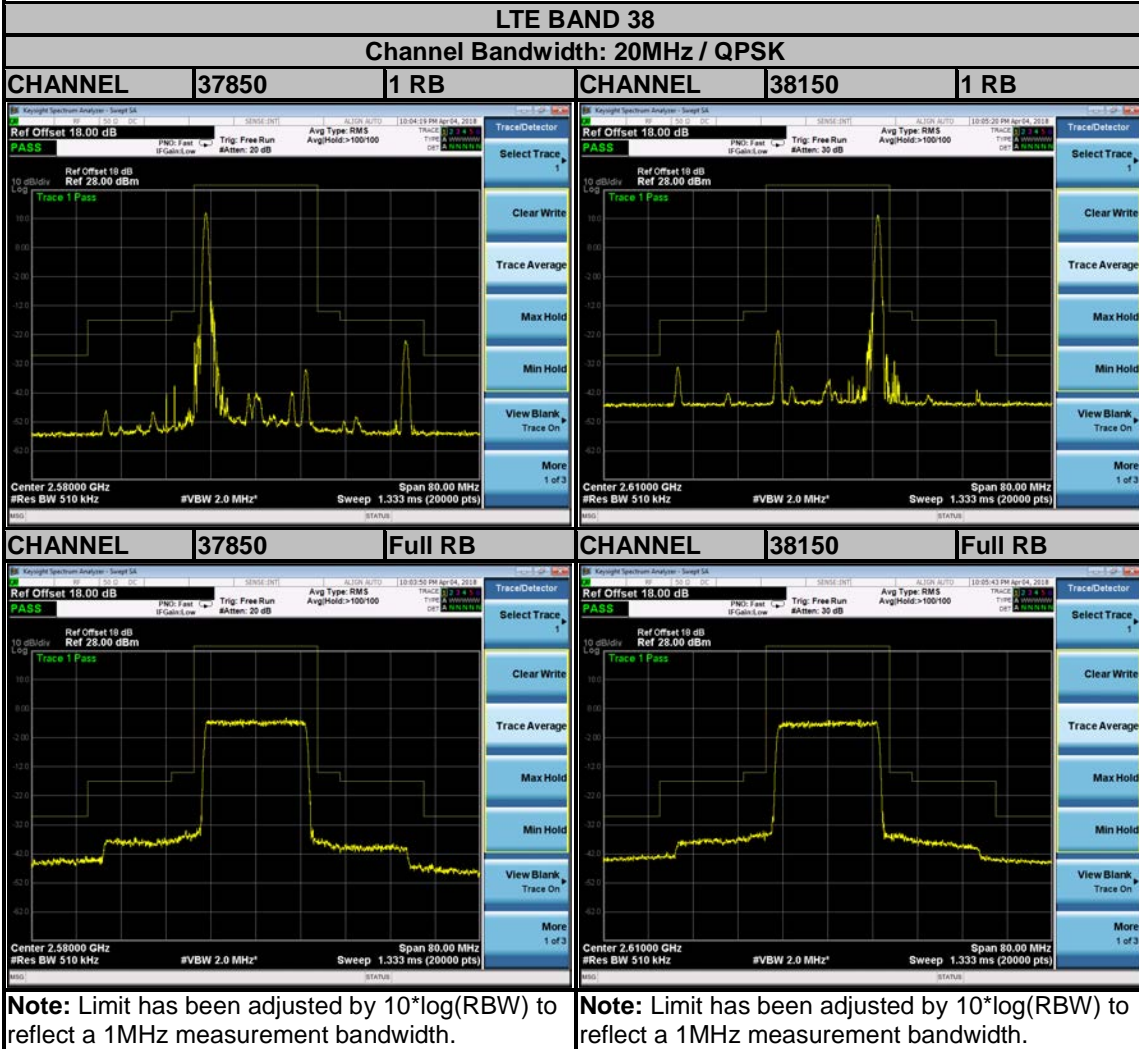

### 3.6 CONDUCTED SPURIOUS EMISSIONS

#### 3.6.1 LIMITS OF CONDUCTED SPURIOUS EMISSIONS MEASUREMENT

The power of any emission outside a licensee's frequency block shall be attenuated below the transmitter power (P) by at least  $55 + 10 \log_{10}(P)$  dB. The limit of emission is equal to -25dBm.

#### 3.6.2 TEST PROCEDURE

- a. The EUT makes a phone call to the communication simulator. All measurements were done at low, middle and high operational frequency range.
- b. Measuring frequency range is from 30MHz to 26.2GHz for LTE Band 7 and LTE Band 38. 10dB attenuation pad is connected with spectrum. RBW=1MHz and VBW=3MHz are used for conducted emission measurement.

#### 3.6.3 TEST SETUP

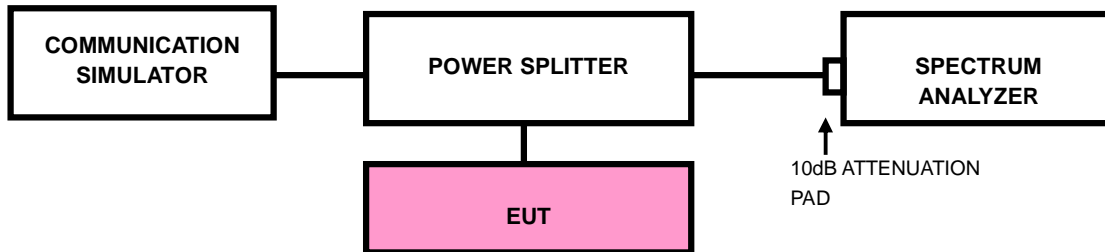



BUREAU VERITAS

Test Report No.: RF180411W007-13

### 3.6.4 TEST RESULTS

#### LTE BAND 7

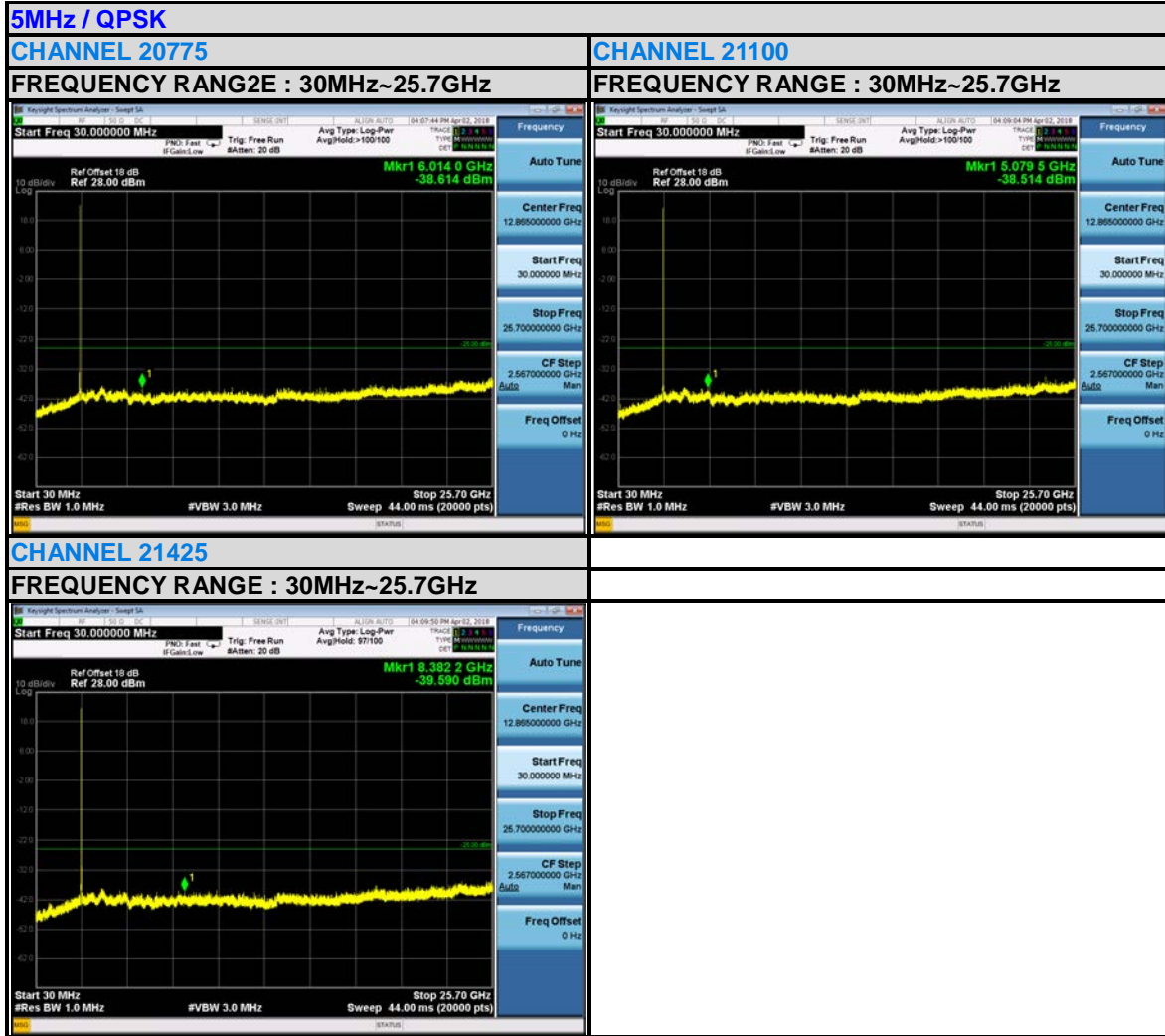





Test Report No.: RF180411W007-13

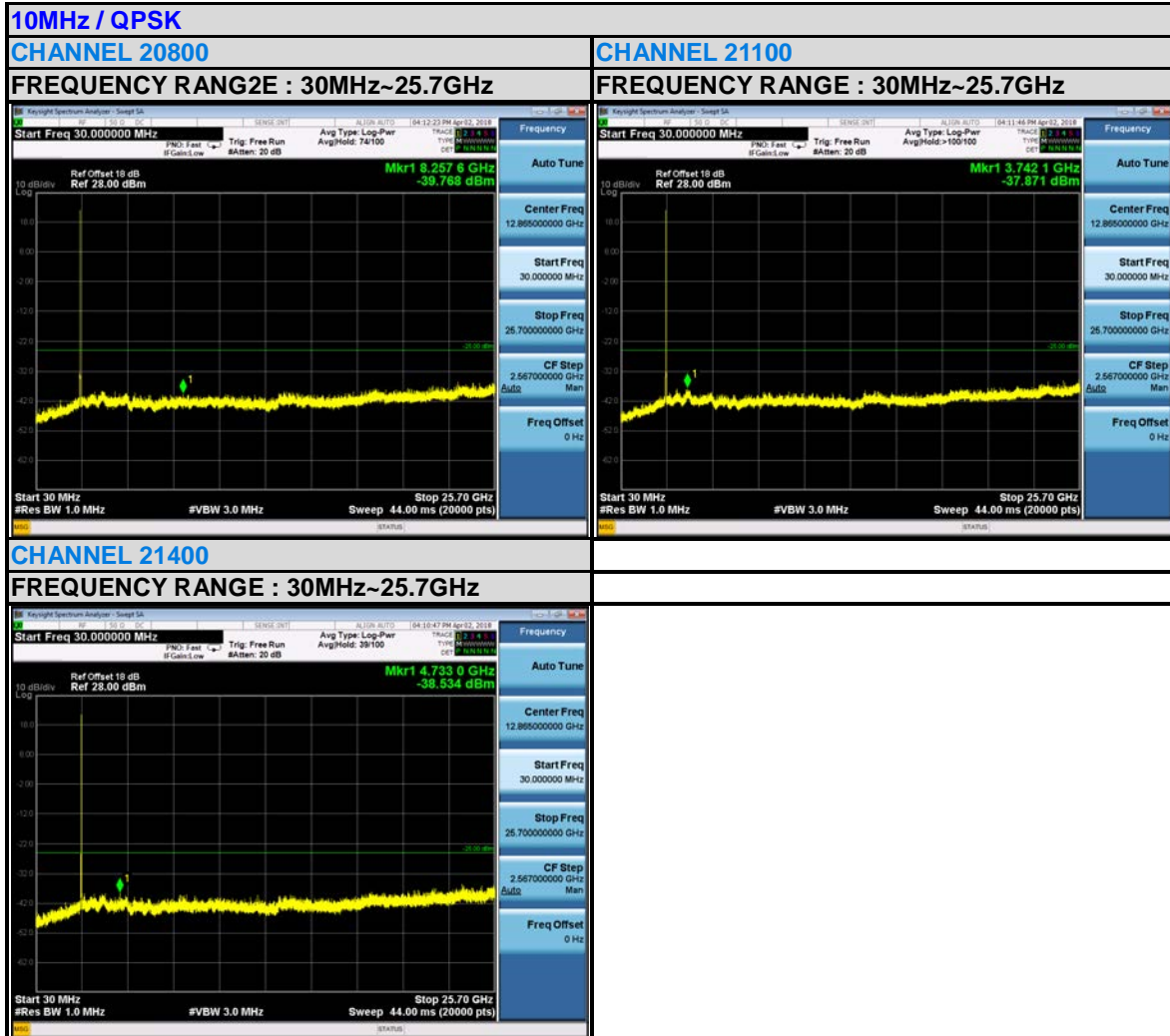



Test Report No.: RF180411W007-13

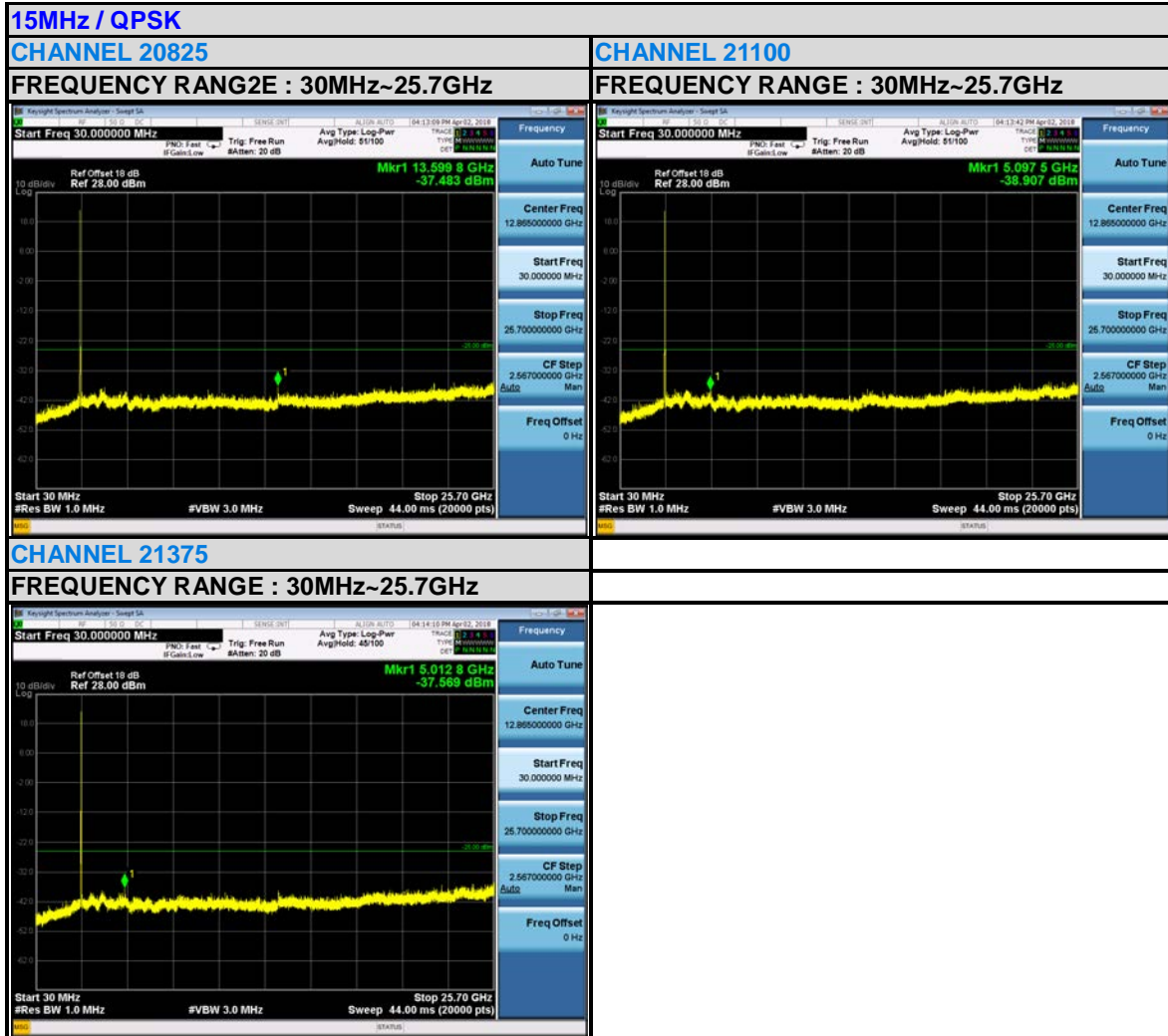



Test Report No.: RF180411W007-13

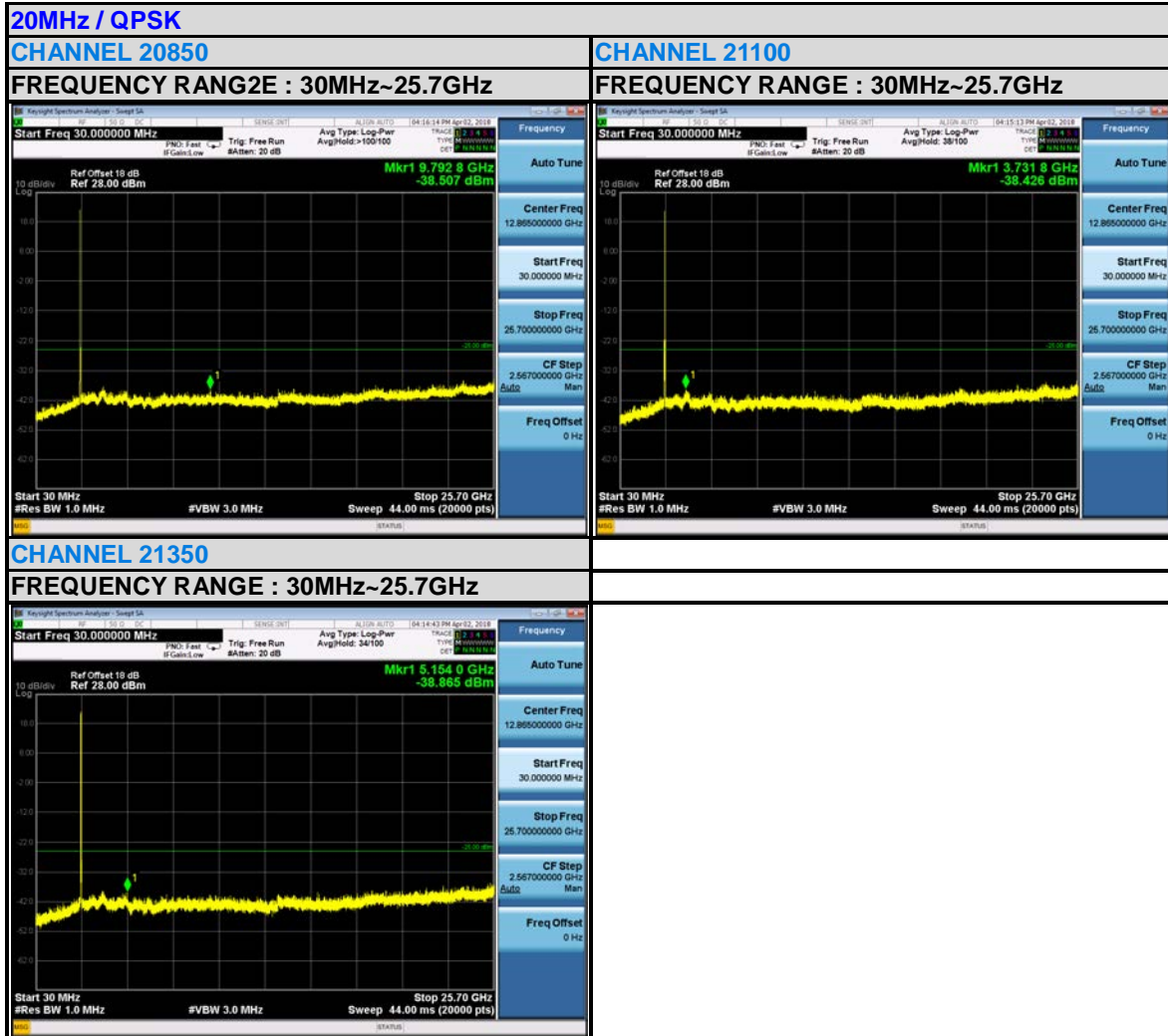



Test Report No.: RF180411W007-13

BUREAU VERITAS

LTE BAND 38

5MHz / QPSK

CHANNEL 37775

FREQUENCY RANGE : 30MHz~26.2GHz

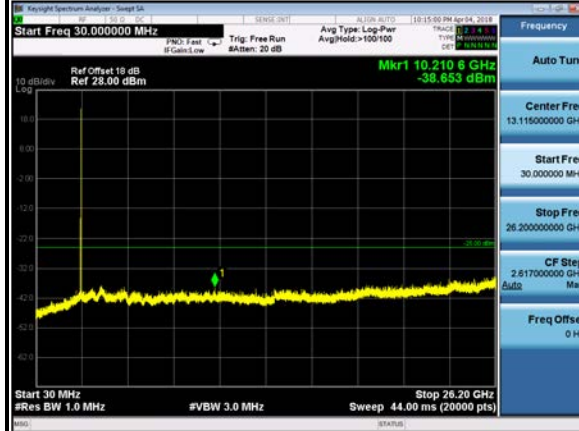

CHANNEL 38000

FREQUENCY RANGE : 30MHz~26.2GHz

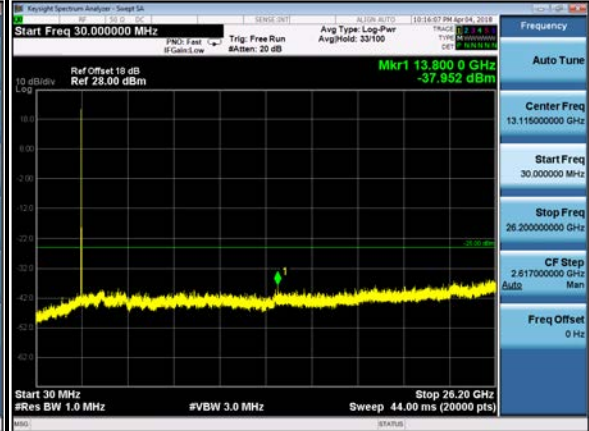

CHANNEL 38225

FREQUENCY RANGE : 30MHz~26.2GHz

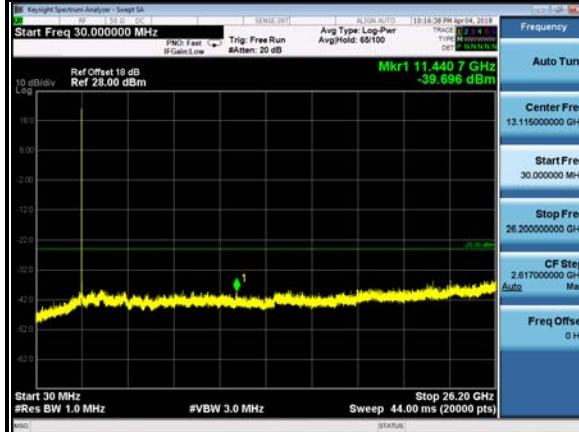

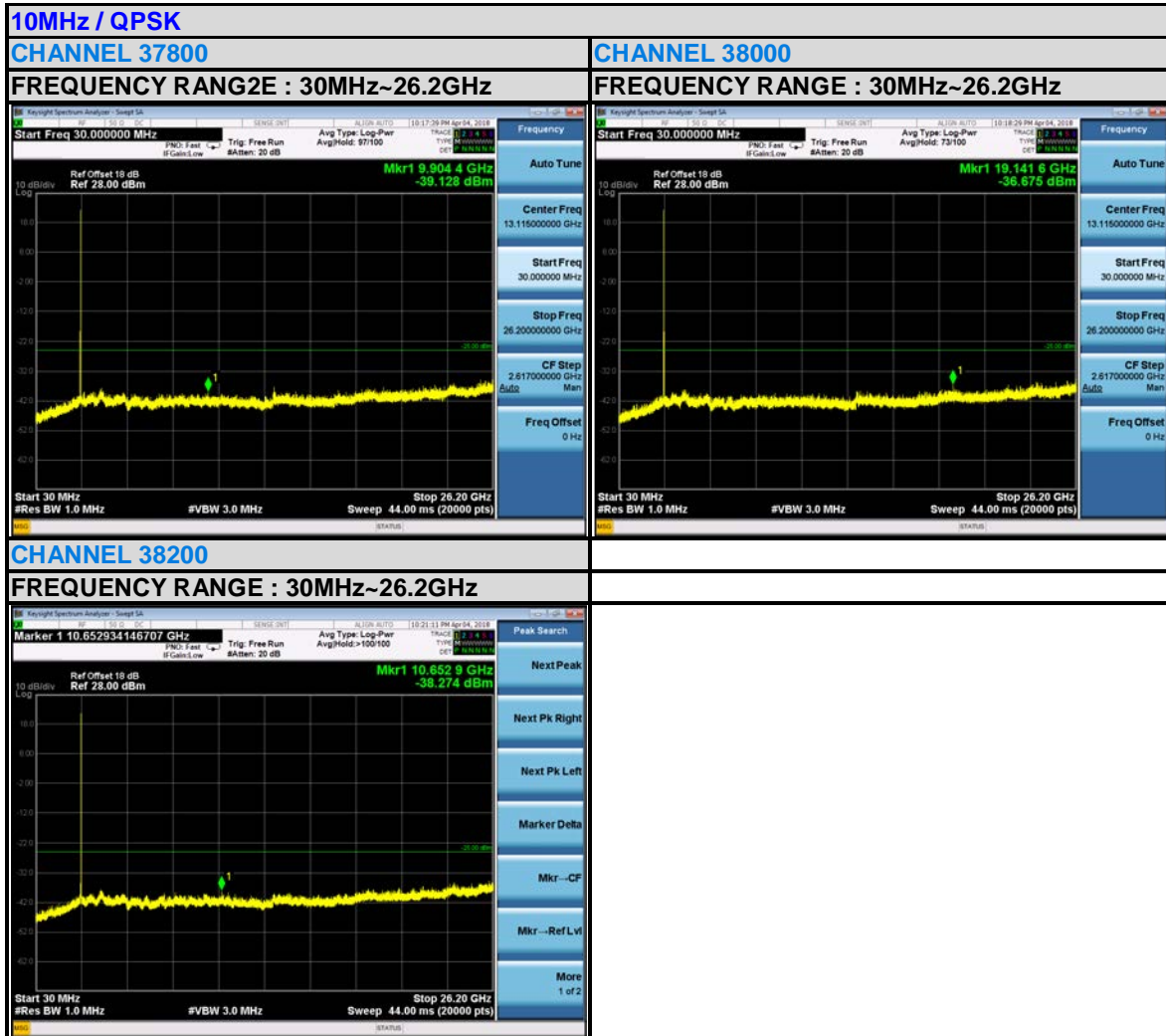

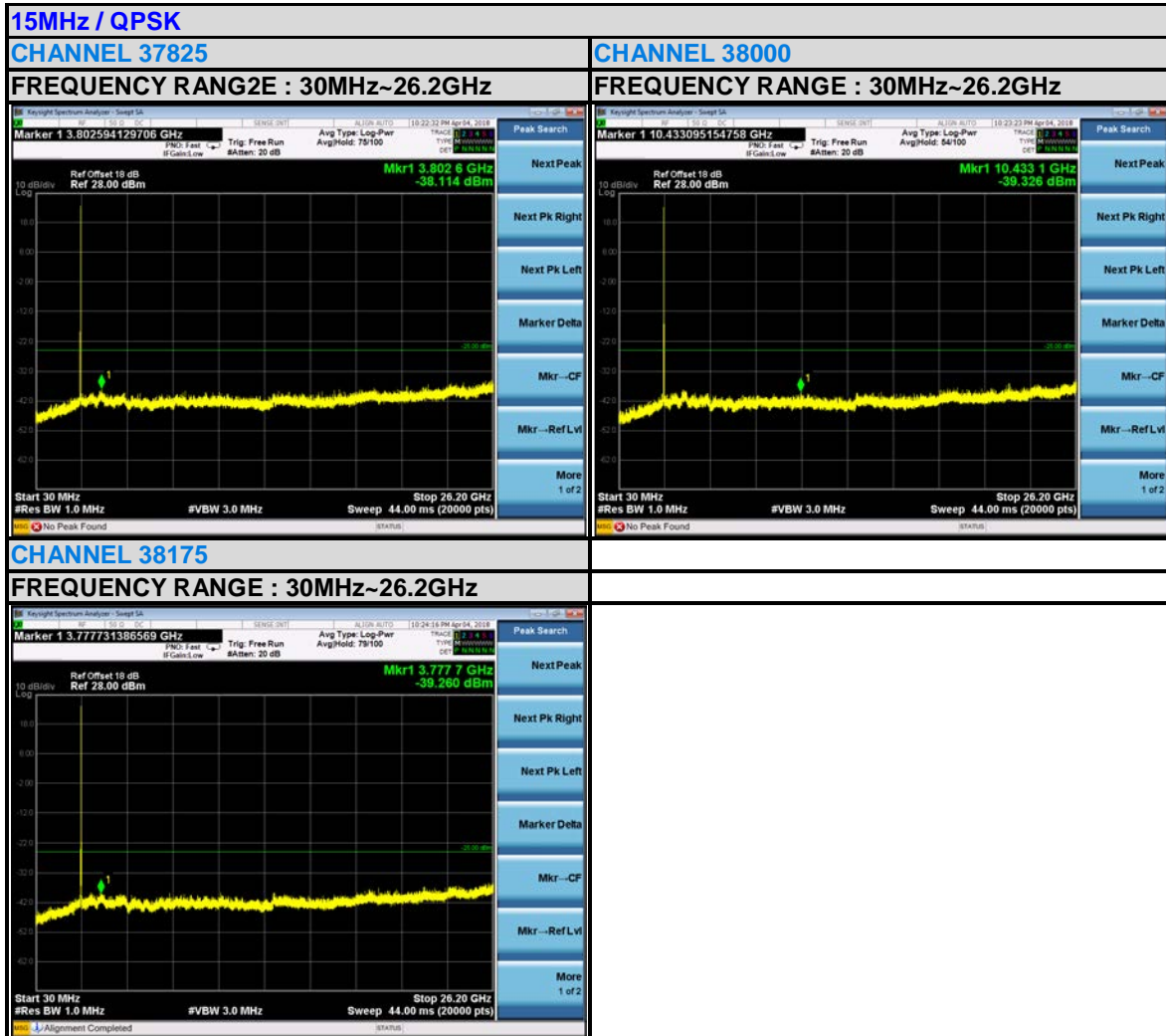

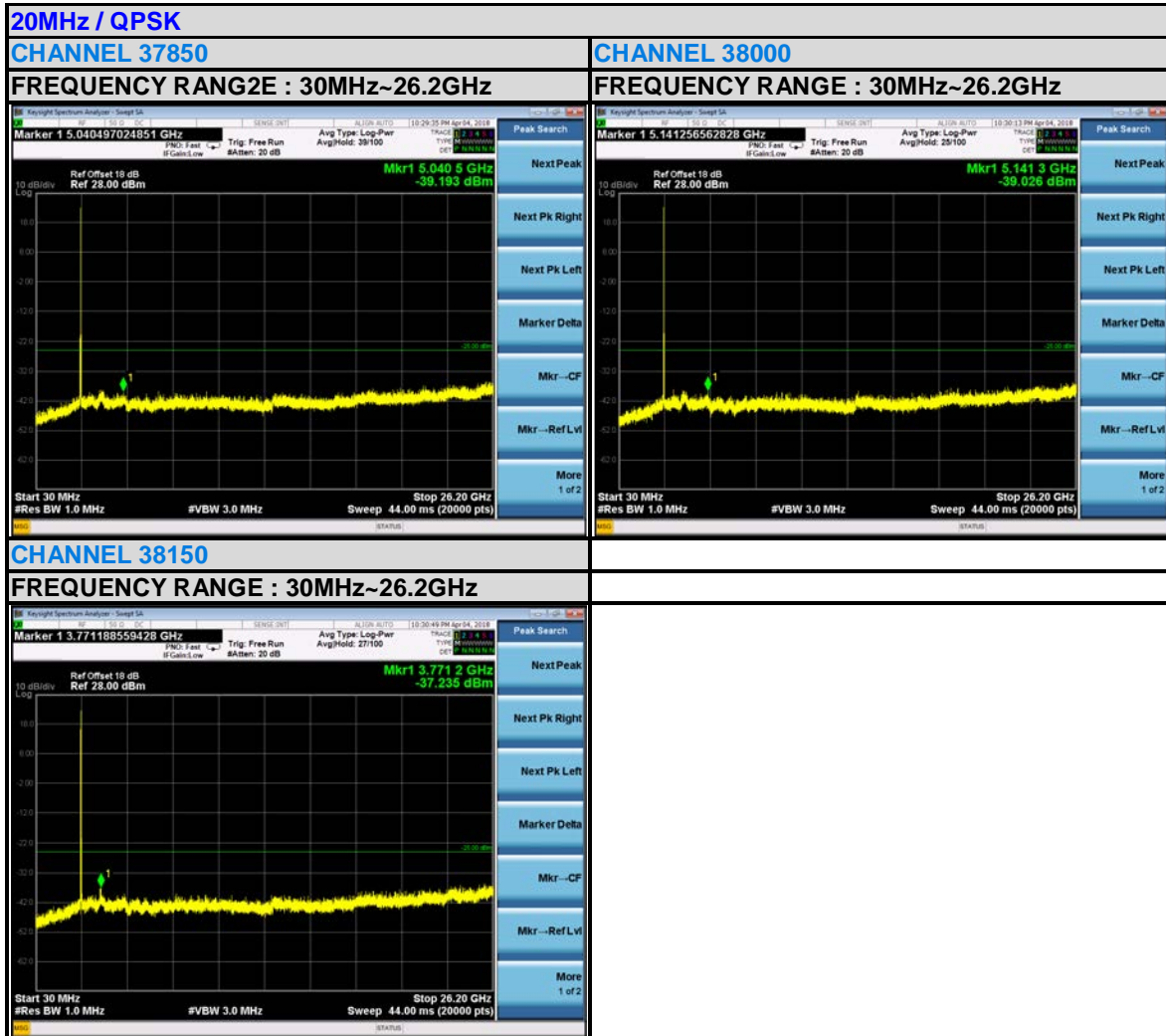



### 3.7 RADIATED EMISSION MEASUREMENT

#### 3.7.1 LIMITS OF RADIATED EMISSION MEASUREMENT

The power of any emission outside a licensee's frequency block shall be attenuated below the transmitter power (P) by at least  $55 + 10 \log_{10}(P)$  dB. The limit of emission is equal to -25dBm.

#### 3.7.2 TEST PROCEDURES

- a. Substitution method is used for E.I.R.P measurement. In the semi-anechoic chamber, EUT placed on the 0.8m height of Turn Table, rotated the table around 360 degrees to search the maximum radiation power and receiver antenna shall be rotated vertical and horizontal polarization and moved height from 1m to 4m to find the maximum polar radiated power. The "Read Value" is the spectrum reading the maximum power value.
- b. The substitution horn antenna is substituted for EUT at the same position and signals generator export the CW signal to the substitution antenna via a TX cable. Rotated the Turn Table and moved receiving antenna to find the maximum radiation power. Adjust output power level of S.G to get a Value of spectrum reading equal to "Read Value " of step a. Record the power level of S.G.
- c.  $EIRP = \text{Output power level of S.G} - \text{TX cable loss} + \text{Antenna gain of substitution horn}$ .
- d. E.R.P power can be calculated form E.I.R.P power by subtracting the gain of dipole,  $E.R.P \text{ power} = E.I.P.R \text{ power} - 2.15\text{dBi}$ .

**NOTE:** The resolution bandwidth of spectrum analyzer is 1 MHz and the video bandwidth is 3 MHz.

#### 3.7.3 DEVIATION FROM TEST STANDARD

No deviation



### 3.7.4 TEST SETUP

<Below 30MHz>

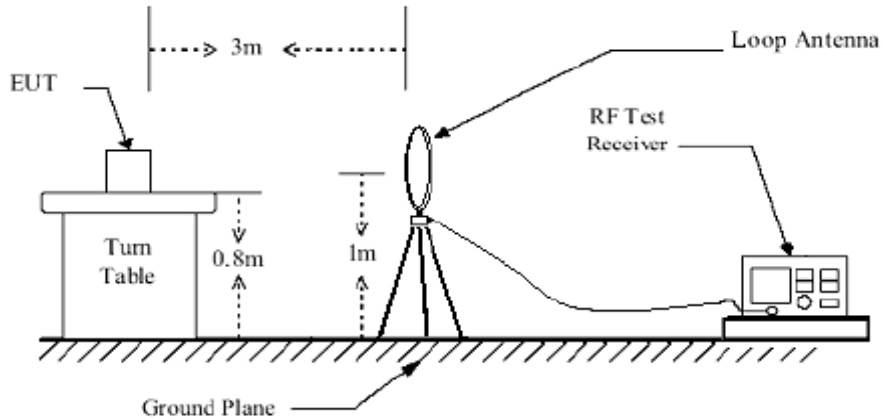

< Frequency Range 30MHz~1GHz >

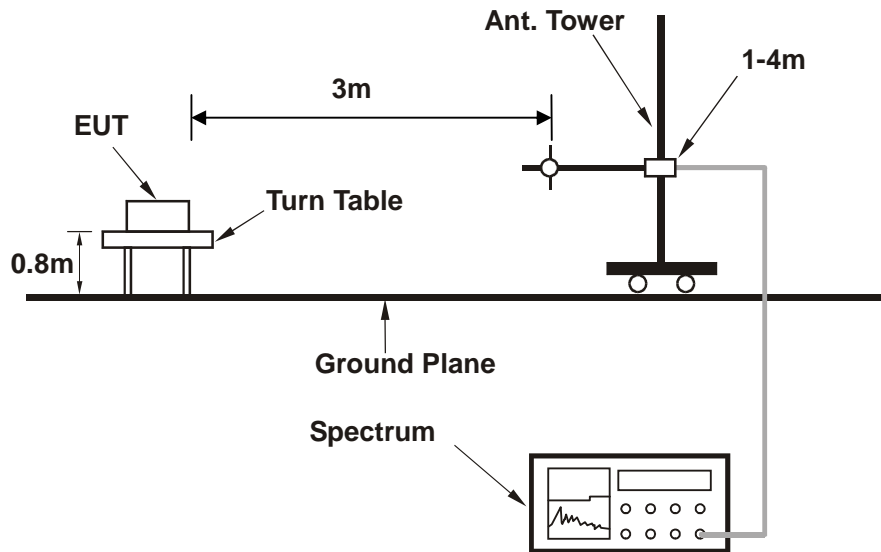

< Frequency Range above 1GHz >

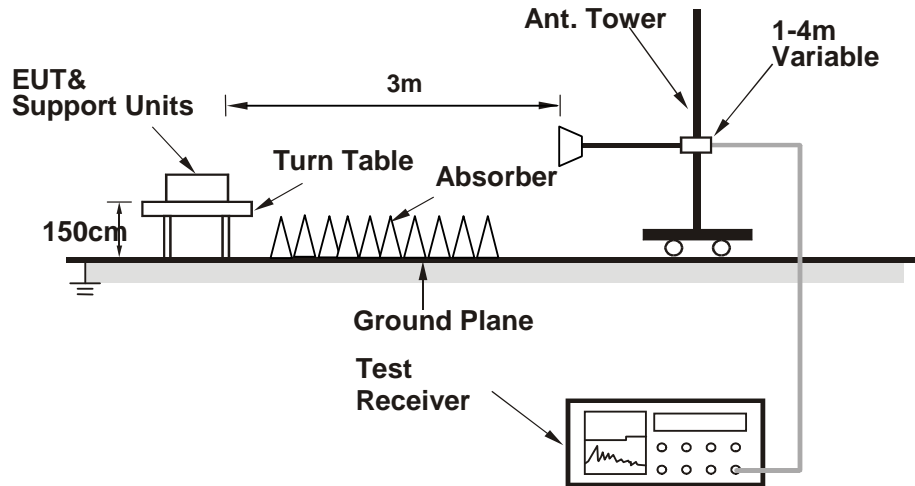

For the actual test configuration, please refer to the attached file (Test Setup Photo).



### 3.7.5 TEST RESULTS

#### BELOW 1GHz WORST-CASE DATA

**9 KHz – 30 MHz data:** the amplitude of spurious emissions attenuated more than 20 dB below the permissible value is not required in the report.

**30 MHz – 1GHz data:**

**LTE Band 38:**

<b>MODE</b>	TX channel 38000	<b>FREQUENCY RANGE</b>	Below 1000MHz
<b>ENVIRONMENTAL CONDITIONS</b>	23deg. C, 70%RH	<b>INPUT POWER</b>	DC 5V from adapter
<b>TESTED BY</b>	Star Le		
<b>ANTENNA POLARITY &amp; TEST DISTANCE: HORIZONTAL AT 3 M</b>			

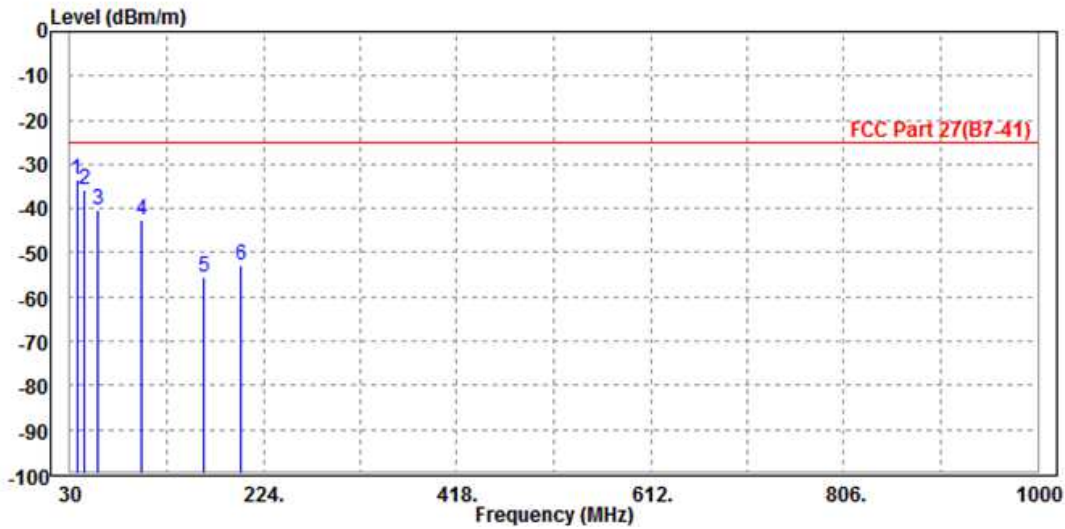

	Freq	Level	Read Level	Limit Line	Over Limit	Factor	Remark	Pol/Phase
	MHz	dBm/m	dBm	dBm/m	dB	dB/m		
1	36.790	-33.41	-45.73	-25.00	-8.41	12.32	Peak	Horizontal
2	43.580	-35.77	-44.71	-25.00	-10.77	8.94	Peak	Horizontal
3	58.130	-40.13	-34.89	-25.00	-15.13	-5.24	Peak	Horizontal
4	101.780	-42.46	-30.94	-25.00	-17.46	-11.52	Peak	Horizontal
5	164.830	-55.54	-37.24	-25.00	-30.54	-18.30	Peak	Horizontal
6	200.720	-52.75	-35.53	-25.00	-27.75	-17.22	Peak	Horizontal



Test Report No.: RF180411W007-13

MODE	TX channel 38000	FREQUENCY RANGE	Below 1000MHz
ENVIRONMENTAL CONDITIONS	23deg. C, 70%RH	INPUT POWER	DC 5V from adapter
TESTED BY	Star Le		
<b>ANTENNA POLARITY &amp; TEST DISTANCE: VERTICAL AT 3 M</b>			

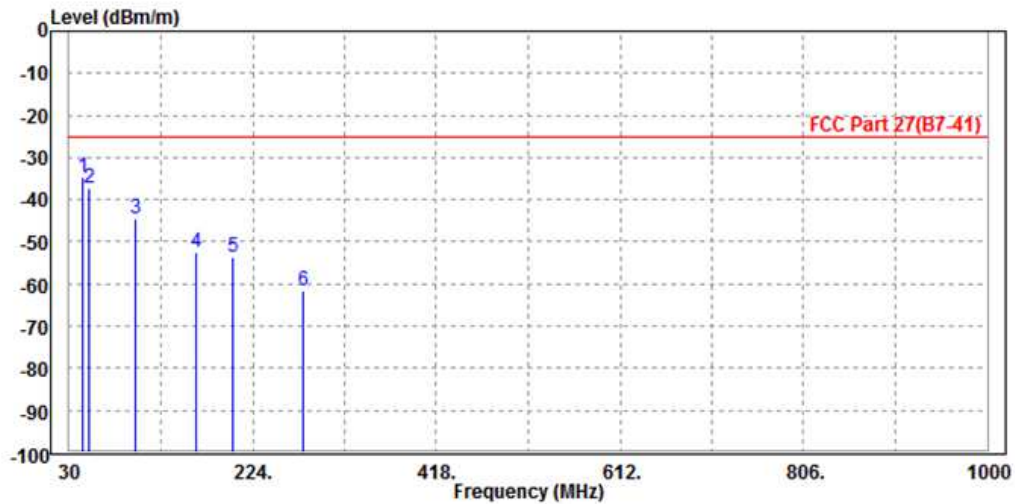

	Freq	Level	Read Level	Limit Line	Over Limit	Factor	Remark	Pol/Phase
	MHz	dBm/m	dBm	dBm/m	dB	dB/m		
1	PP 43.580	-34.51	-31.87	-25.00	-9.51	-2.64	Peak	Vertical
2	51.340	-37.34	-31.60	-25.00	-12.34	-5.74	Peak	Vertical
3	100.810	-44.65	-33.87	-25.00	-19.65	-10.78	Peak	Vertical
4	163.860	-52.58	-37.72	-25.00	-27.58	-14.86	Peak	Vertical
5	202.660	-53.62	-42.94	-25.00	-28.62	-10.68	Peak	Vertical
6	276.380	-61.78	-50.38	-25.00	-36.78	-11.40	Peak	Vertical



**Test Report No.: RF180411W007-13**

**ABOVE 1GHz**

**Note:** For higher frequency, the emission is too low to be detected.

**LTE Band 7**

**CHANNEL BANDWIDTH: 5MHz / QPSK**

<b>MODE</b>	TX channel 21100	<b>FREQUENCY RANGE</b>	Above 1000MHz
<b>ENVIRONMENTAL CONDITIONS</b>	23deg. C, 70%RH	<b>INPUT POWER</b>	DC 5V from adapter
<b>TESTED BY</b>	Star Le		
<b>ANTENNA POLARITY &amp; TEST DISTANCE: HORIZONTAL AT 3 M</b>			

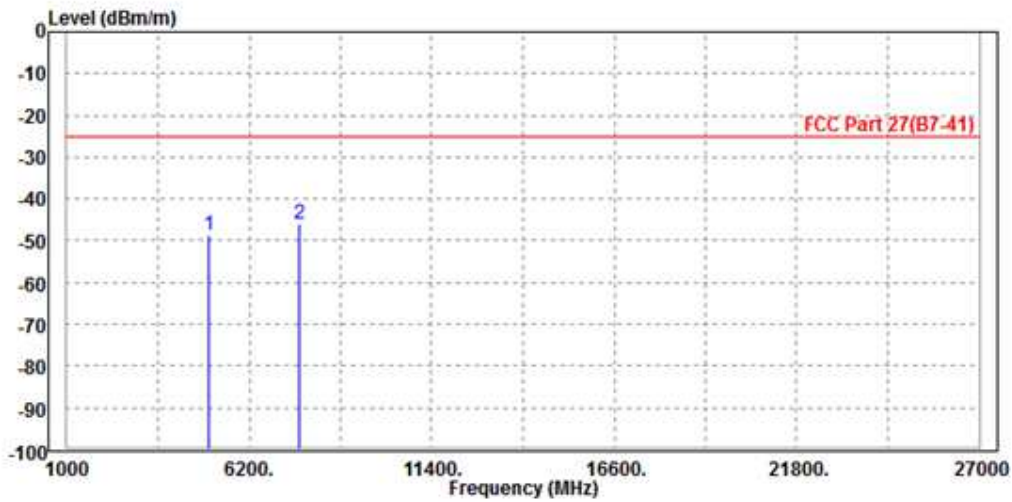

	Freq	Level	Read Level	Limit Line	Over Limit	Factor	Remark	Pol/Phase
	MHz	dBm/m	dBm	dBm/m	dB	dB/m		
1	5056.000	-48.71	-57.15	-25.00	-23.71	8.44	Peak	Horizontal
2 PP	7605.000	-46.16	-59.64	-25.00	-21.16	13.48	Peak	Horizontal



Test Report No.: RF180411W007-13

MODE	TX channel 21100	FREQUENCY RANGE	Above 1000MHz
ENVIRONMENTAL CONDITIONS	23deg. C, 70%RH	INPUT POWER	DC 5V from adapter
TESTED BY	Star Le		
<b>ANTENNA POLARITY &amp; TEST DISTANCE: VERTICAL AT 3 M</b>			

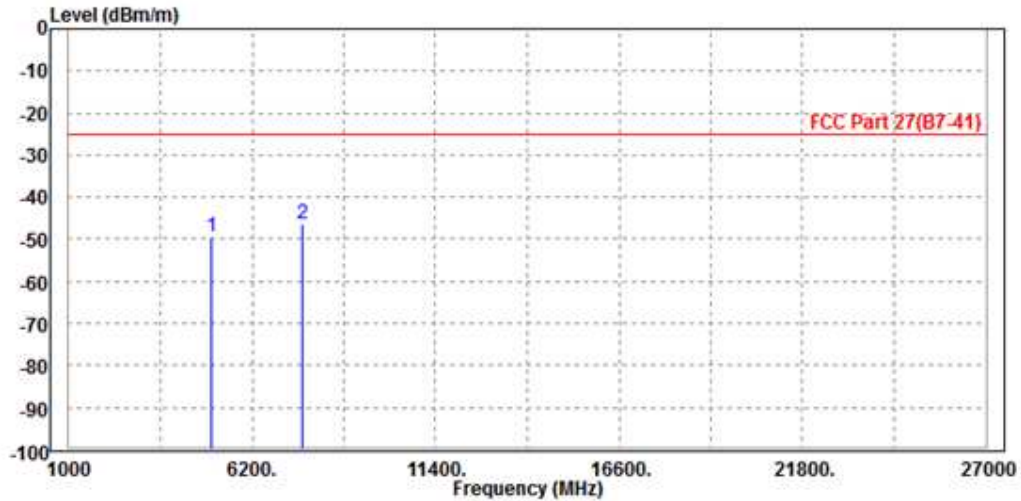

	Freq	Level	Read Level	Limit Line	Over Limit	Factor	Remark	Pol/Phase
	MHz	dBm/m	dBm	dBm/m	dB	dB/m		
1	5056.000	-49.27	-57.26	-25.00	-24.27	7.99	Peak	Vertical
2	7605.000	-46.48	-59.47	-25.00	-21.48	12.99	Peak	Vertical



Test Report No.: RF180411W007-13

CHANNEL BANDWIDTH: 10MHz / QPSK

MODE	TX channel 21100	FREQUENCY RANGE	Above 1000MHz
ENVIRONMENTAL CONDITIONS	23deg. C, 70%RH	INPUT POWER	DC 5V from adapter
TESTED BY	Star Le		
ANTENNA POLARITY & TEST DISTANCE: HORIZONTAL AT 3 M			

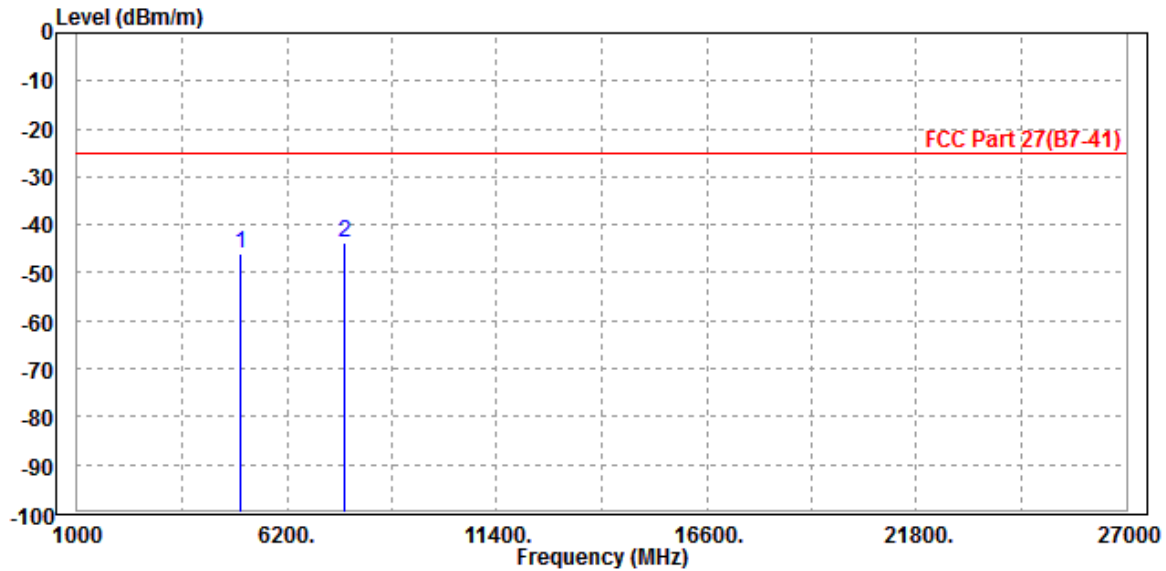

	Freq	Level	Read Level	Limit Line	Over Limit	Factor	Remark	Pol/Phase
	MHz	dBm/m	dBm	dBm/m	dB	dB/m		
1	5056.000	-45.97	-54.41	-25.00	-20.97	8.44	Peak	Horizontal
2 PP	7604.000	-43.82	-57.30	-25.00	-18.82	13.48	Peak	Horizontal



Test Report No.: RF180411W007-13

MODE	TX channel 21100	FREQUENCY RANGE	Above 1000MHz
ENVIRONMENTAL CONDITIONS	23deg. C, 70%RH	INPUT POWER	DC 5V from adapter
TESTED BY	Star Le		
ANTENNA POLARITY & TEST DISTANCE: VERTICAL AT 3 M			

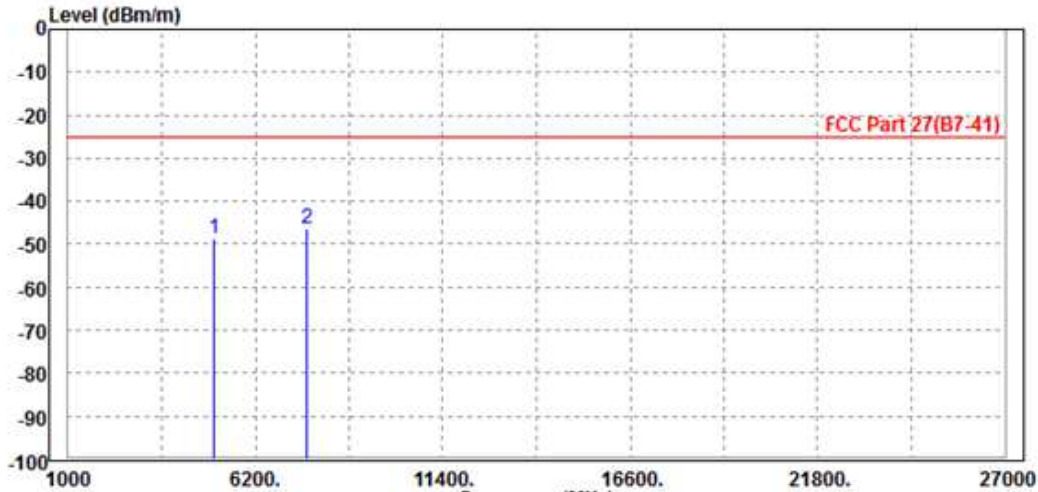

	Freq	Level	Read Level	Limit Line	Over Limit	Factor	Remark	Pol/Phase
	MHz	dBm/m	dBm	dBm/m	dB	dB/m		
1	5056.000	-48.80	-56.79	-25.00	-23.80	7.99	Peak	Vertical
2	PP 7605.000	-46.31	-59.30	-25.00	-21.31	12.99	Peak	Vertical





Test Report No.: RF180411W007-13

CHANNEL BANDWIDTH: 15MHz / QPSK

CH 20825

MODE	TX channel 20825	FREQUENCY RANGE	Above 1000MHz
ENVIRONMENTAL CONDITIONS	23deg. C, 70%RH	INPUT POWER	DC 5V from adapter
TESTED BY	Star Le		
<b>ANTENNA POLARITY &amp; TEST DISTANCE: HORIZONTAL AT 3 M</b>			

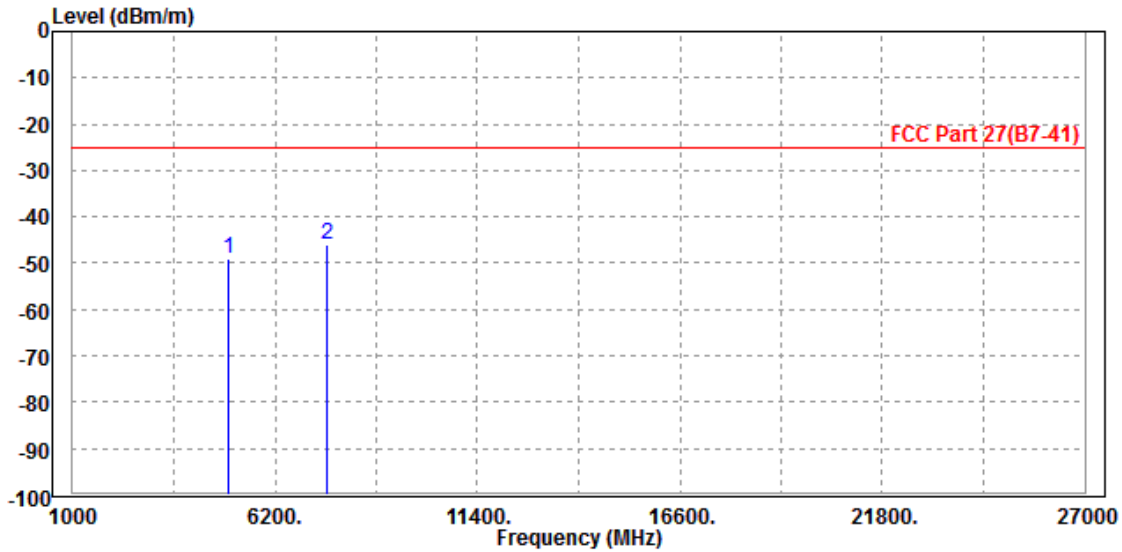

	Freq	Level	Read Level	Limit Line	Over Limit	Factor	Remark	Pol/Phase
	MHz	dBm/m	dBm	dBm/m	dB	dB/m		
1	5004.000	-49.14	-57.52	-25.00	-24.14	8.38	Peak	Horizontal
2 PP	7523.000	-45.92	-59.28	-25.00	-20.92	13.36	Peak	Horizontal



Test Report No.: RF180411W007-13

MODE	TX channel 20825	FREQUENCY RANGE	Above 1000MHz
ENVIRONMENTAL CONDITIONS	23deg. C, 70%RH	INPUT POWER	DC 5V from adapter
TESTED BY	Star Le		
<b>ANTENNA POLARITY &amp; TEST DISTANCE: VERTICAL AT 3 M</b>			

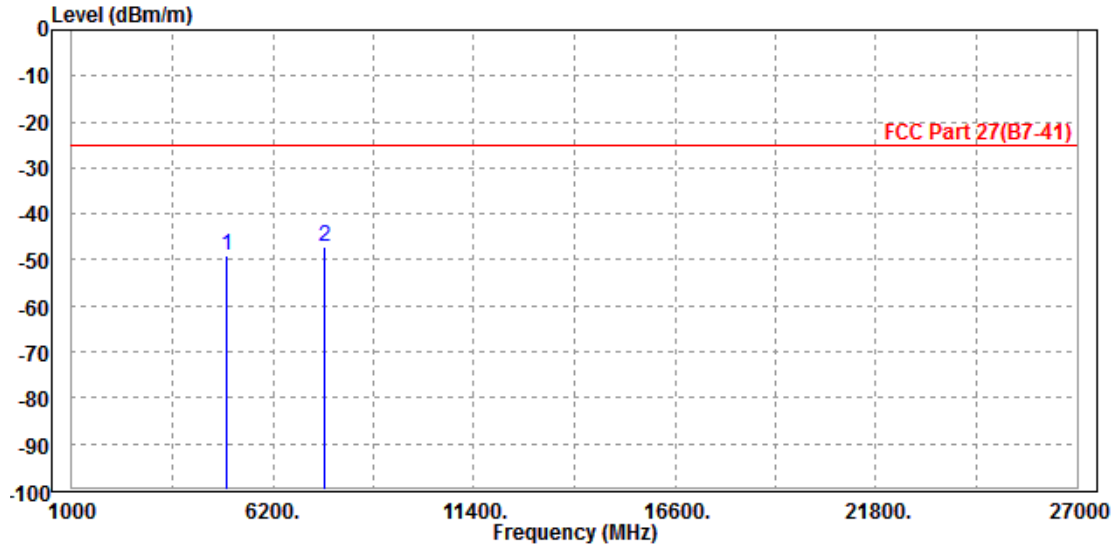

	Freq	Level	Read Level	Limit Line	Over Limit	Factor	Remark	Pol/Phase
	MHz	dBm/m	dBm	dBm/m	dB	dB/m		
1	5015.000	-48.88	-56.87	-25.00	-23.88	7.99	Peak	Vertical
2	7523.000	-47.01	-59.85	-25.00	-22.01	12.84	Peak	Vertical



Test Report No.: RF180411W007-13

CH 21100

MODE	TX channel 21100	FREQUENCY RANGE	Above 1000MHz
ENVIRONMENTAL CONDITIONS	23deg. C, 70%RH	INPUT POWER	DC 5V from adapter
TESTED BY	Star Le		
ANTENNA POLARITY & TEST DISTANCE: HORIZONTAL AT 3 M			

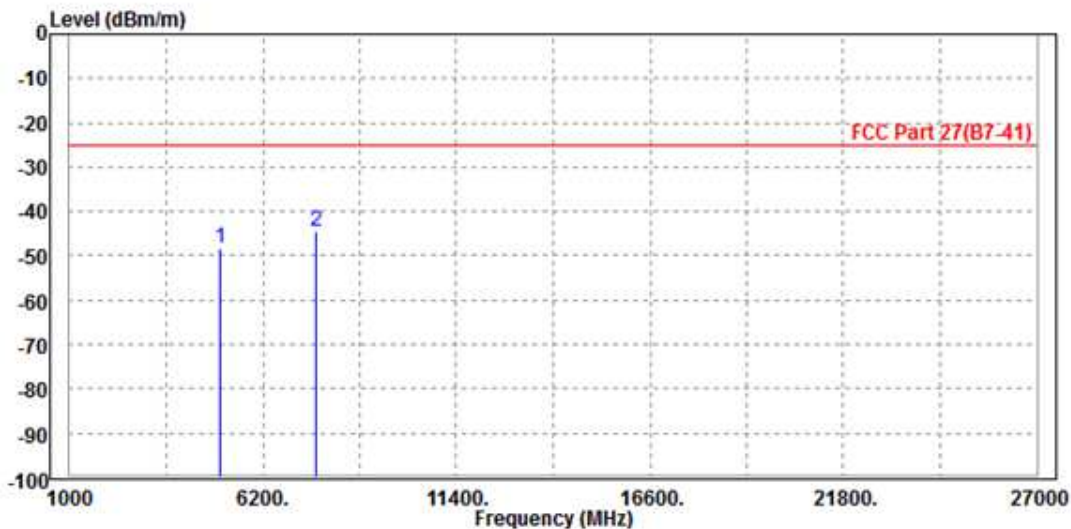

	Freq	Level	Read Level	Limit Line	Over Limit	Factor	Remark	Pol/Phase
	MHz	dBm/m	dBm	dBm/m	dB	dB/m		
1	5056.000	-48.41	-56.85	-25.00	-23.41	8.44	Peak	Horizontal
2 PP	7605.000	-44.64	-58.12	-25.00	-19.64	13.48	Peak	Horizontal



Test Report No.: RF180411W007-13

MODE	TX channel 21100	FREQUENCY RANGE	Above 1000MHz
ENVIRONMENTAL CONDITIONS	23deg. C, 70%RH	INPUT POWER	DC 5V from adapter
TESTED BY	Star Le		
<b>ANTENNA POLARITY &amp; TEST DISTANCE: VERTICAL AT 3 M</b>			

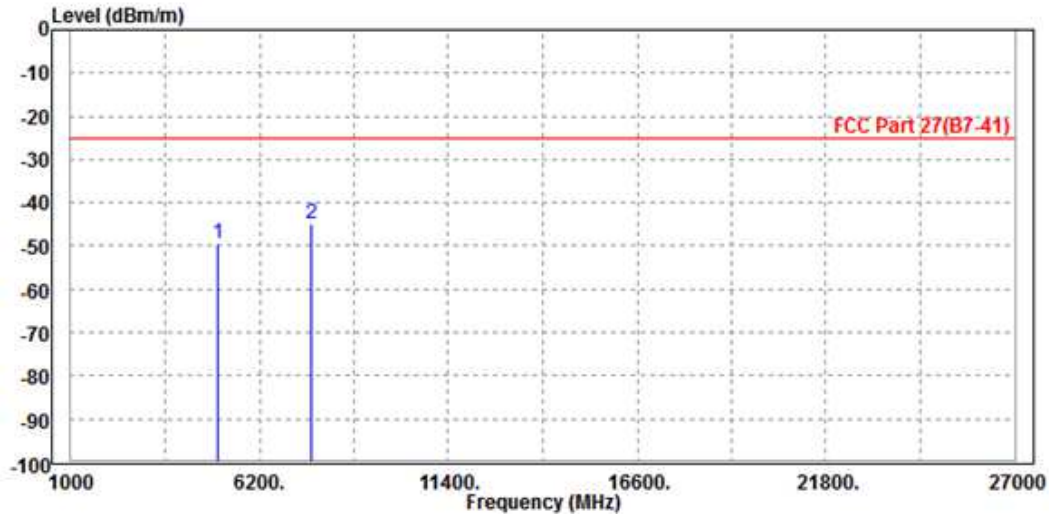

	Freq	Level	Read Level	Limit Line	Over Limit	Factor	Remark	Pol/Phase
	MHz	dBm/m	dBm	dBm/m	dB	dB/m		
1	5056.000	-49.33	-57.32	-25.00	-24.33	7.99	Peak	Vertical
2 PP	7605.000	-44.88	-57.87	-25.00	-19.88	12.99	Peak	Vertical



Test Report No.: RF180411W007-13

CH 21375

MODE	TX channel 21375	FREQUENCY RANGE	Above 1000MHz
ENVIRONMENTAL CONDITIONS	23deg. C, 70%RH	INPUT POWER	DC 5V from adapter
TESTED BY	Star Le		
ANTENNA POLARITY & TEST DISTANCE: HORIZONTAL AT 3 M			

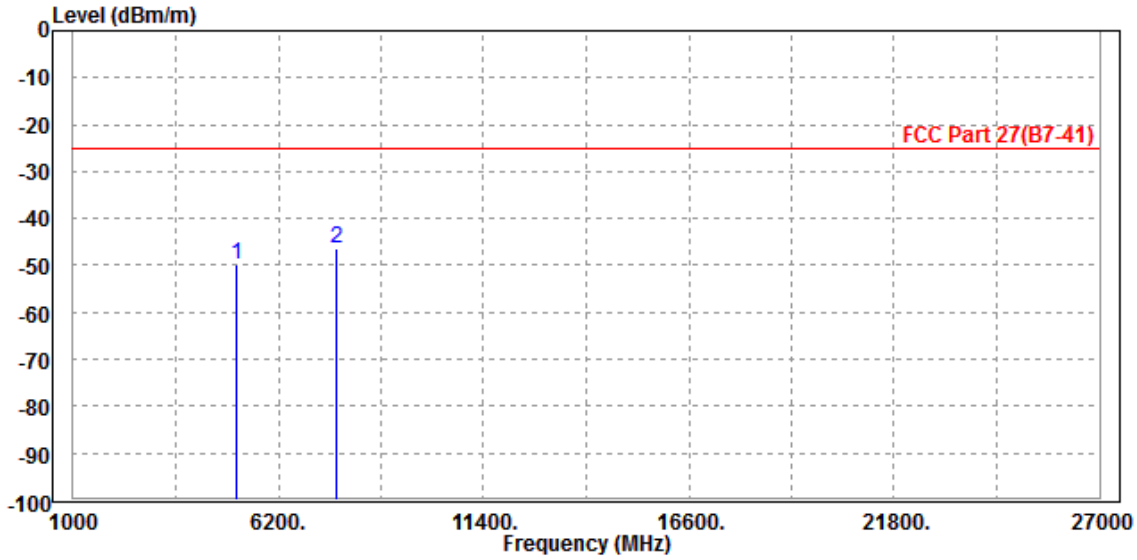

	Freq	Level	Read Level	Limit Line	Over Limit	Factor	Remark	Pol/Phase
	MHz	dBm/m	dBm	dBm/m	dB	dB/m		
1	5125.000	-49.94	-58.46	-25.00	-24.94	8.52	Peak	Horizontal
2 PP	7688.000	-46.29	-59.89	-25.00	-21.29	13.60	Peak	Horizontal



Test Report No.: RF180411W007-13

MODE	TX channel 21375	FREQUENCY RANGE	Above 1000MHz
ENVIRONMENTAL CONDITIONS	23deg. C, 70%RH	INPUT POWER	DC 5V from adapter
TESTED BY	Star Le		
ANTENNA POLARITY & TEST DISTANCE: VERTICAL AT 3 M			

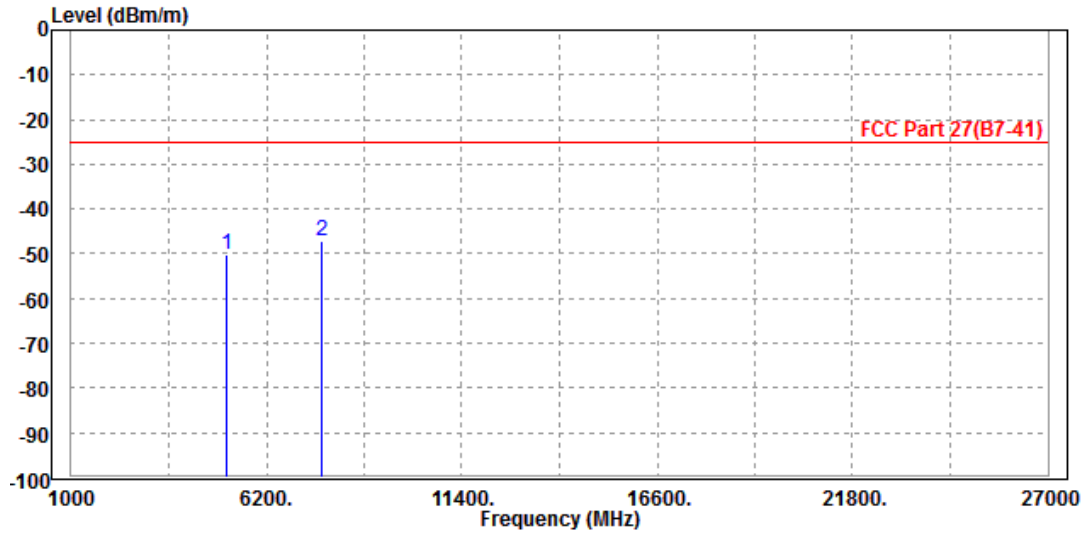

	Read Freq	Limit Level	Over Level	Limit Line	Over Limit	Factor	Remark	Pol/Phase
	MHz	dBm/m	dBm	dBm/m	dB	dB/m		
1	5125.000	-50.37	-58.36	-25.00	-25.37	7.99	Peak	Vertical
2 PP	7688.000	-47.08	-60.21	-25.00	-22.08	13.13	Peak	Vertical



Test Report No.: RF180411W007-13

**CHANNEL BANDWIDTH: 20MHz / QPSK**

<b>MODE</b>	TX channel 21100	<b>FREQUENCY RANGE</b>	Above 1000MHz
<b>ENVIRONMENTAL CONDITIONS</b>	23deg. C, 70%RH	<b>INPUT POWER</b>	DC 5V from adapter
<b>TESTED BY</b>	Star Le		
<b>ANTENNA POLARITY &amp; TEST DISTANCE: HORIZONTAL AT 3 M</b>			

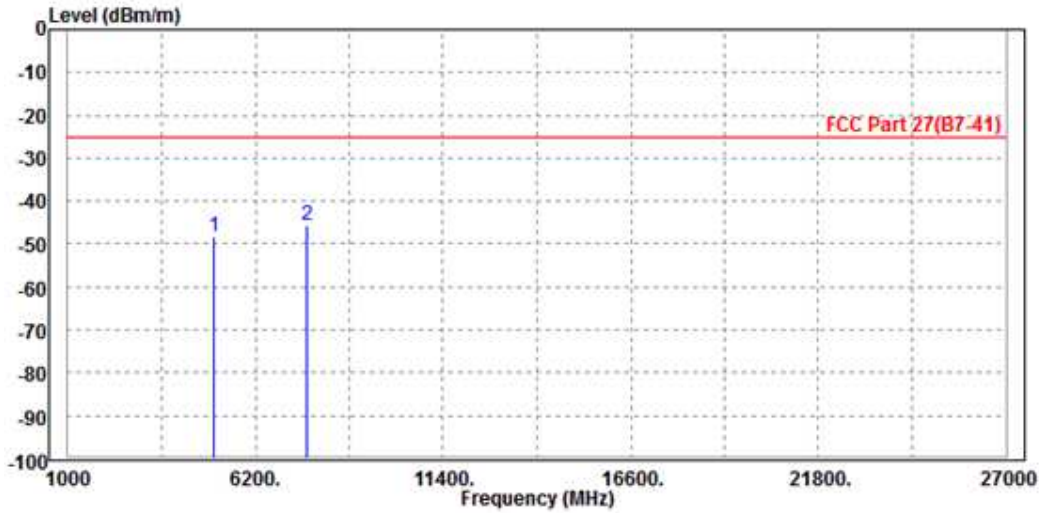

	Freq	Level	Read Level	Limit Line	Over Limit	Factor	Remark	Pol/Phase
	MHz	dBm/m	dBm	dBm/m	dB	dB/m		
1	5056.000	-48.24	-56.68	-25.00	-23.24	8.44	Peak	Horizontal
2 PP	7605.000	-45.71	-59.19	-25.00	-20.71	13.48	Peak	Horizontal



Test Report No.: RF180411W007-13

MODE	TX channel 21100	FREQUENCY RANGE	Above 1000MHz
ENVIRONMENTAL CONDITIONS	23deg. C, 70%RH	INPUT POWER	DC 5V from adapter
TESTED BY	Star Le		
<b>ANTENNA POLARITY &amp; TEST DISTANCE: VERTICAL AT 3 M</b>			

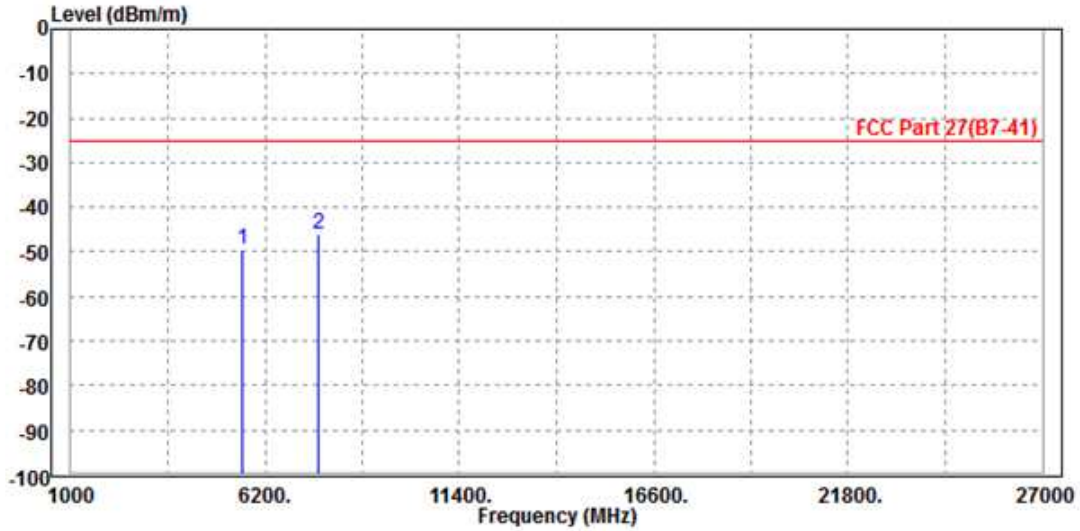

	Freq	Level	Read Level	Limit Line	Over Limit	Factor	Remark	Pol/Phase
	MHz	dBm/m	dBm	dBm/m	dB	dB/m		
1	5602.000	-49.33	-57.51	-25.00	-24.33	8.18	Peak	Vertical
2	7605.000	-46.10	-59.09	-25.00	-21.10	12.99	Peak	Vertical





Test Report No.: RF180411W007-13

LTE Band 38  
CHANNEL BANDWIDTH: 5MHz / QPSK

MODE	TX channel 38000	FREQUENCY RANGE	Above 1000MHz
ENVIRONMENTAL CONDITIONS	23deg. C, 70%RH	INPUT POWER	DC 5/9V from adapter
TESTED BY	Star Le		
ANTENNA POLARITY & TEST DISTANCE: HORIZONTAL AT 3 M			

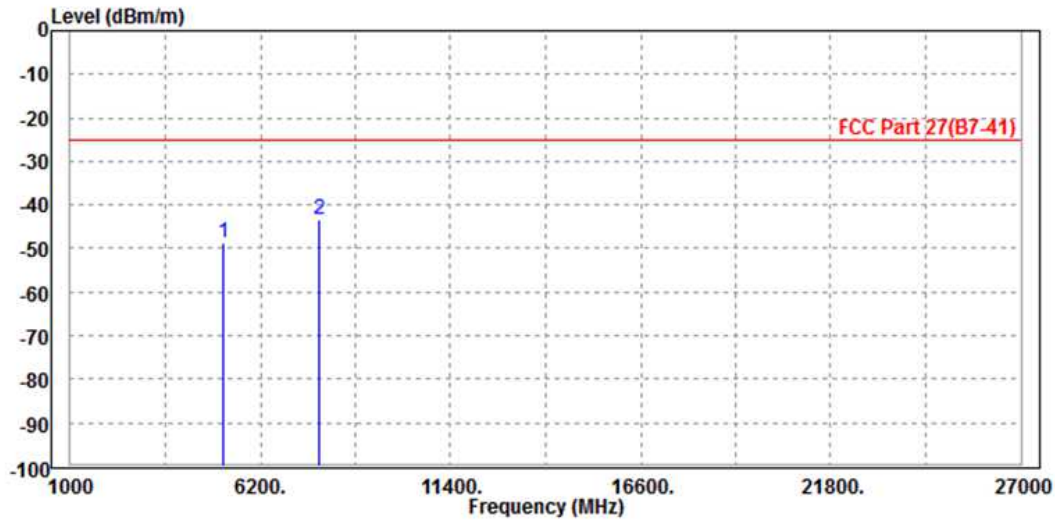

	Freq	Level	Read Level	Limit Line	Over Limit	Factor	Remark	Pol/Phase
	MHz	dBm/m	dBm	dBm/m	dB	dB/m		
1	5186.000	-48.65	-57.24	-25.00	-23.65	8.59	Peak	Horizontal
2 PP	7785.000	-43.51	-57.25	-25.00	-18.51	13.74	Peak	Horizontal



Test Report No.: RF180411W007-13

<b>MODE</b>	TX channel 38000	<b>FREQUENCY RANGE</b>	Above 1000MHz
<b>ENVIRONMENTAL CONDITIONS</b>	23deg. C, 70%RH	<b>INPUT POWER</b>	DC 5/9V from adapter
<b>TESTED BY</b>	Star Le		
<b>ANTENNA POLARITY &amp; TEST DISTANCE: VERTICAL AT 3 M</b>			

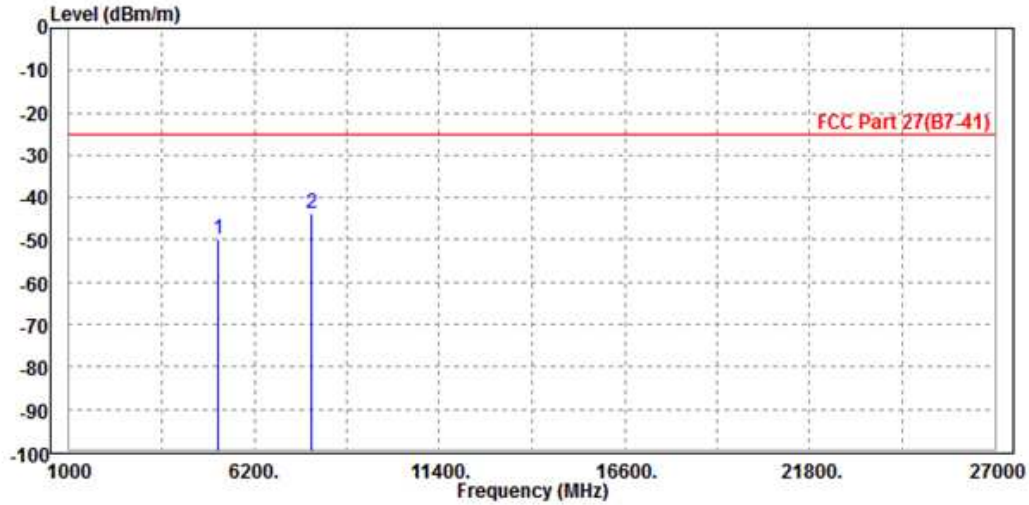

	Freq	Level	Read Level	Limit Line	Over Limit	Factor	Remark	Pol/Phase
	MHz	dBm/m	dBm	dBm/m	dB	dB/m		
1	5186.000	-49.63	-57.61	-25.00	-24.63	7.98	Peak	Vertical
2 PP	7785.000	-43.76	-57.06	-25.00	-18.76	13.30	Peak	Vertical



Test Report No.: RF180411W007-13

CHANNEL BANDWIDTH: 10MHz / QPSK

CH 37800

MODE	TX channel 37800	FREQUENCY RANGE	Above 1000MHz
ENVIRONMENTAL CONDITIONS	23deg. C, 70%RH	INPUT POWER	DC 5/9V from adapter
TESTED BY	Star Le		
ANTENNA POLARITY & TEST DISTANCE: HORIZONTAL AT 3 M			

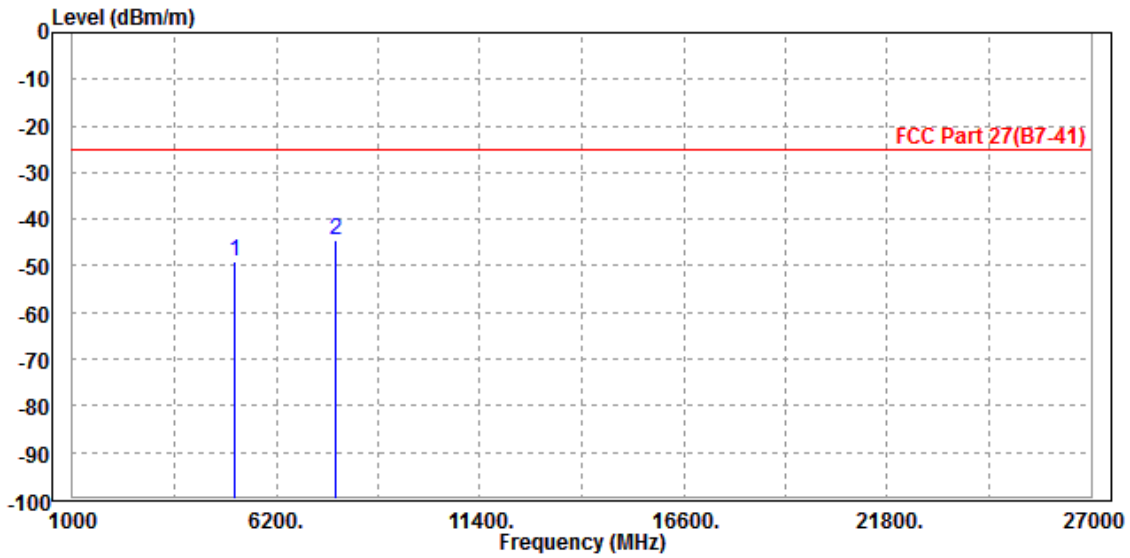

	Freq	Level	Read Level	Limit Line	Over Limit	Factor	Remark	Pol/Phase
	MHz	dBm/m	dBm	dBm/m	dB	dB/m		
1	5160.000	-49.08	-57.64	-25.00	-24.08	8.56	Peak	Horizontal
2 PP	7725.000	-44.41	-58.06	-25.00	-19.41	13.65	Peak	Horizontal



Test Report No.: RF180411W007-13

MODE	TX channel 37800	FREQUENCY RANGE	Above 1000MHz
ENVIRONMENTAL CONDITIONS	23deg. C, 70%RH	INPUT POWER	DC 5/9V from adapter
TESTED BY	Star Le		
ANTENNA POLARITY & TEST DISTANCE: VERTICAL AT 3 M			

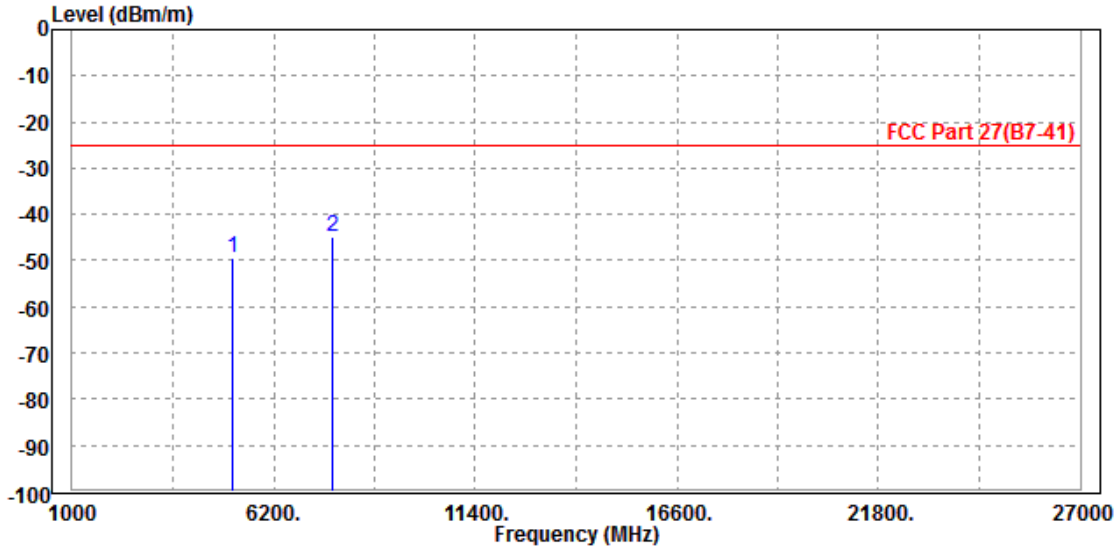

	Freq	Level	Read Level	Limit Line	Over Limit	Factor	Remark	Pol/Phase
	MHz	dBm/m	dBm	dBm/m	dB	dB/m		
1	5160.000	-49.56	-57.54	-25.00	-24.56	7.98	Peak	Vertical
2	PP 7725.000	-45.05	-58.25	-25.00	-20.05	13.20	Peak	Vertical



Test Report No.: RF180411W007-13

CH 38000

MODE	TX channel 38000	FREQUENCY RANGE	Above 1000MHz
ENVIRONMENTAL CONDITIONS	23deg. C, 70%RH	INPUT POWER	DC 5/9V from adapter
TESTED BY	Star Le		
ANTENNA POLARITY & TEST DISTANCE: HORIZONTAL AT 3 M			

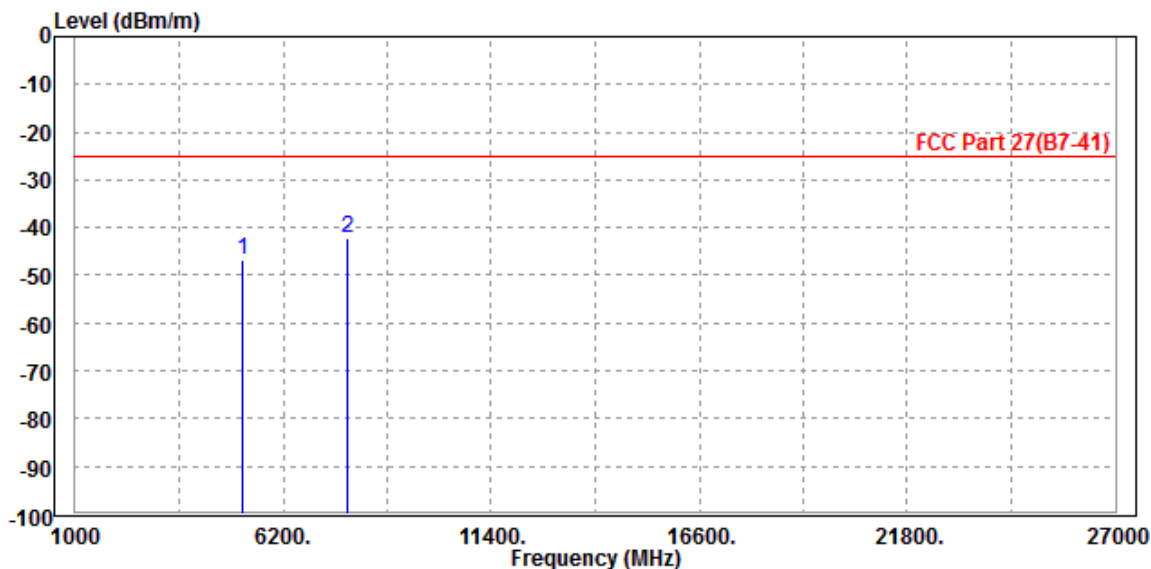

	Freq	Level	Read Level	Limit Line	Over Limit	Factor	Remark	Pol/Phase
	MHz	dBm/m	dBm	dBm/m	dB	dB/m		
1	5186.000	-46.77	-55.36	-25.00	-21.77	8.59	Peak	Horizontal
2 PP	7785.000	-42.26	-56.00	-25.00	-17.26	13.74	Peak	Horizontal



Test Report No.: RF180411W007-13

MODE	TX channel 38000	FREQUENCY RANGE	Above 1000MHz
ENVIRONMENTAL CONDITIONS	23deg. C, 70%RH	INPUT POWER	DC 5/9V from adapter
TESTED BY	Star Le		
ANTENNA POLARITY & TEST DISTANCE: VERTICAL AT 3 M			

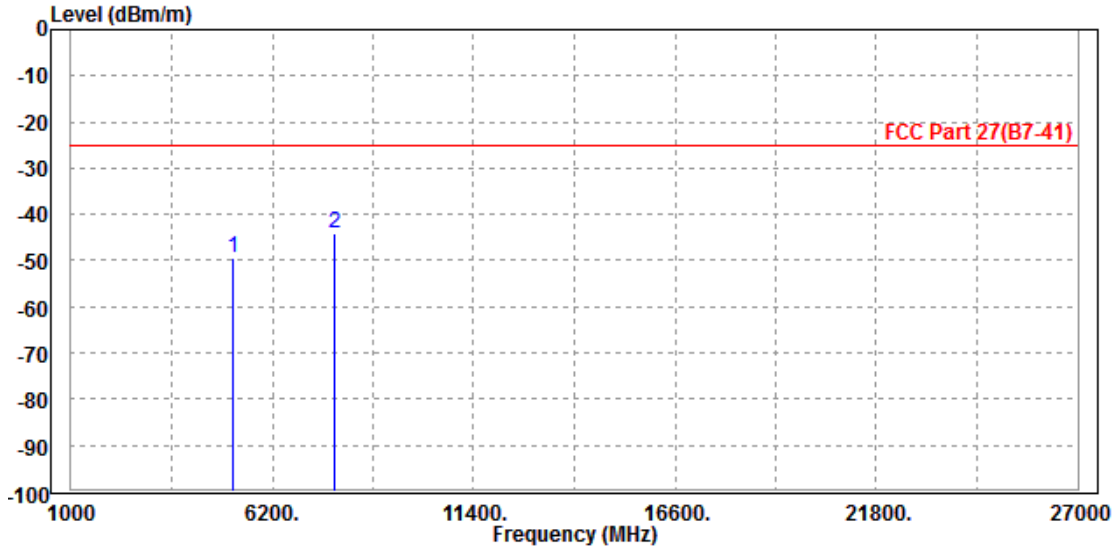

	Read	Limit	Over					
Freq	Level	Level	Line	Limit	Factor	Remark	Pol/Phase	
MHz	dBm/m	dBm	dBm/m	dB	dB/m			
1	5186.000	-49.45	-57.43	-25.00	-24.45	7.98	Peak	Vertical
2	PP 7785.000	-44.28	-57.58	-25.00	-19.28	13.30	Peak	Vertical



Test Report No.: RF180411W007-13

CH 38200

MODE	TX channel 38200	FREQUENCY RANGE	Above 1000MHz
ENVIRONMENTAL CONDITIONS	23deg. C, 70%RH	INPUT POWER	DC 5/9V from adapter
TESTED BY	Star Le		
ANTENNA POLARITY & TEST DISTANCE: HORIZONTAL AT 3 M			

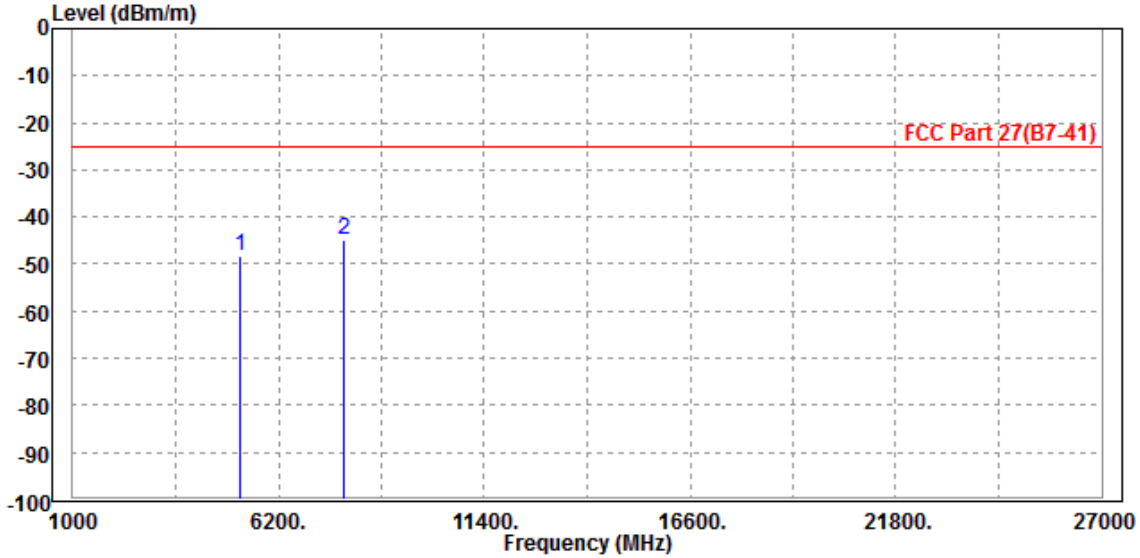

	Freq	Level	Read Level	Limit Line	Over Limit	Factor	Remark	Pol/Phase
	MHz	dBm/m	dBm	dBm/m	dB	dB/m		
1	5238.000	-48.25	-56.90	-25.00	-23.25	8.65	Peak	Horizontal
2 PP	7845.000	-44.70	-58.52	-25.00	-19.70	13.82	Peak	Horizontal



Test Report No.: RF180411W007-13

MODE	TX channel 38200	FREQUENCY RANGE	Above 1000MHz
ENVIRONMENTAL CONDITIONS	23deg. C, 70%RH	INPUT POWER	DC 5/9V from adapter
TESTED BY	Star Le		
<b>ANTENNA POLARITY &amp; TEST DISTANCE: VERTICAL AT 3 M</b>			

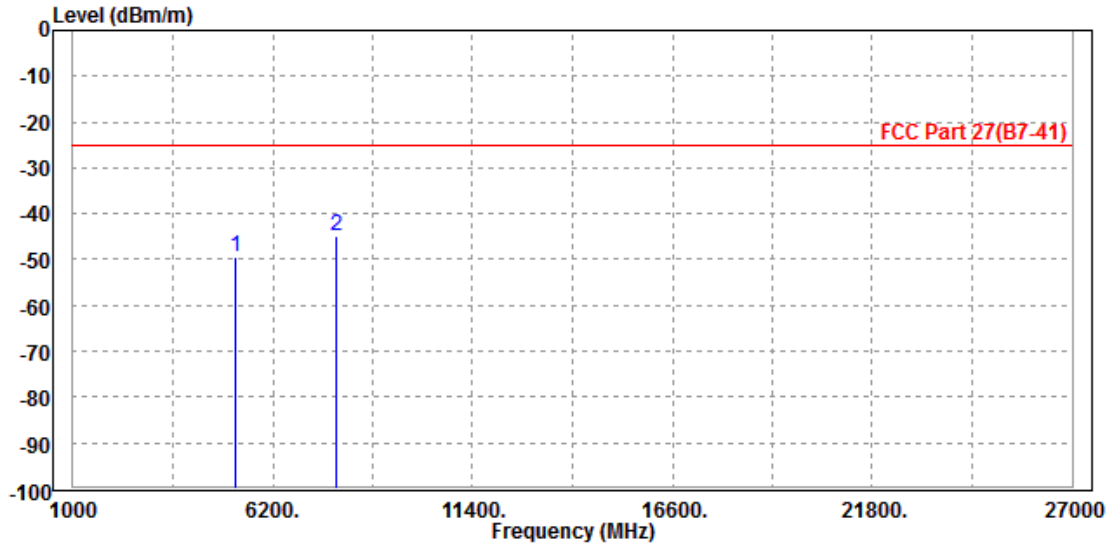

	Freq	Level	Read Level	Limit Line	Over Limit	Factor	Remark	Pol/Phase
	MHz	dBm/m	dBm	dBm/m	dB	dB/m		
1	5238.000	-49.57	-57.55	-25.00	-24.57	7.98	Peak	Vertical
2 PP	7845.000	-44.81	-58.22	-25.00	-19.81	13.41	Peak	Vertical





Test Report No.: RF180411W007-13

**CHANNEL BANDWIDTH: 15MHz / QPSK**

<b>MODE</b>	TX channel 38000	<b>FREQUENCY RANGE</b>	Above 1000MHz
<b>ENVIRONMENTAL CONDITIONS</b>	23deg. C, 70%RH	<b>INPUT POWER</b>	DC 5/9V from adapter
<b>TESTED BY</b>	Star Le		
<b>ANTENNA POLARITY &amp; TEST DISTANCE: HORIZONTAL AT 3 M</b>			

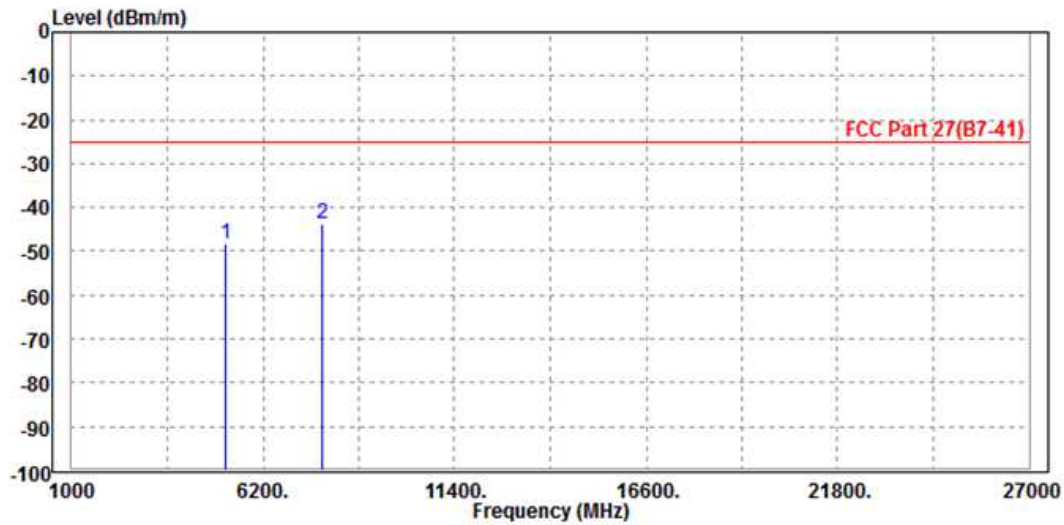

	Freq	Level	Read Level	Limit Line	Over Limit	Factor	Remark	Pol/Phase
	MHz	dBm/m	dBm	dBm/m	dB	dB/m		
1	5186.000	-48.13	-56.72	-25.00	-23.13	8.59	Peak	Horizontal
2	7785.000	-43.68	-57.42	-25.00	-18.68	13.74	Peak	Horizontal



Test Report No.: RF180411W007-13

<b>MODE</b>	TX channel 38000	<b>FREQUENCY RANGE</b>	Above 1000MHz
<b>ENVIRONMENTAL CONDITIONS</b>	23deg. C, 70%RH	<b>INPUT POWER</b>	DC 5/9V from adapter
<b>TESTED BY</b>	Star Le		
<b>ANTENNA POLARITY &amp; TEST DISTANCE: VERTICAL AT 3 M</b>			

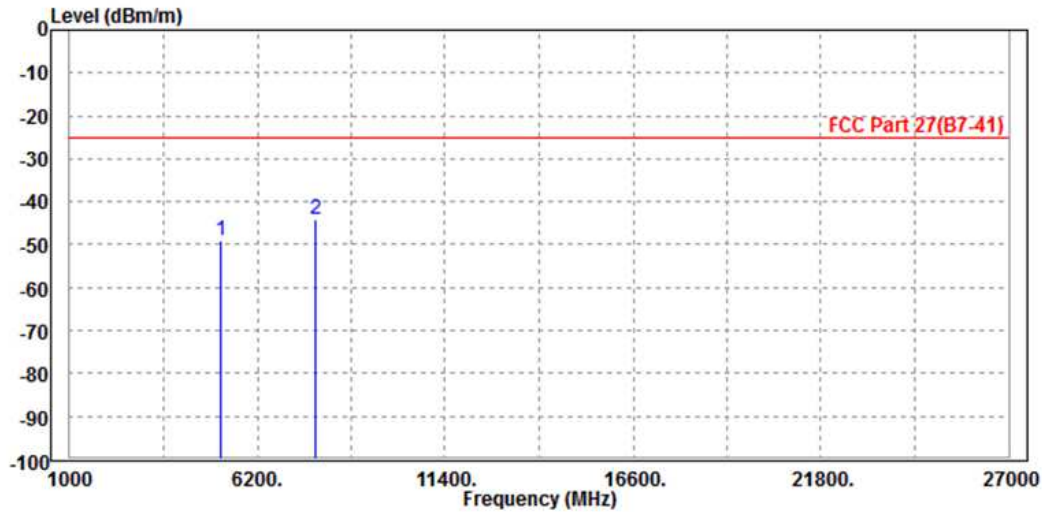

	Freq	Level	Read Level	Limit Line	Over Limit	Factor	Remark	Pol/Phase
	MHz	dBm/m	dBm	dBm/m	dB	dB/m		
1	5186.000	-49.03	-57.01	-25.00	-24.03	7.98	Peak	Vertical
2 PP	7785.000	-44.09	-57.39	-25.00	-19.09	13.30	Peak	Vertical



Test Report No.: RF180411W007-13

**CHANNEL BANDWIDTH: 20MHz / QPSK**

<b>MODE</b>	TX channel 38000	<b>FREQUENCY RANGE</b>	Above 1000MHz
<b>ENVIRONMENTAL CONDITIONS</b>	23deg. C, 70%RH	<b>INPUT POWER</b>	DC 5/9V from adapter
<b>TESTED BY</b>	Star Le		
<b>ANTENNA POLARITY &amp; TEST DISTANCE: HORIZONTAL AT 3 M</b>			

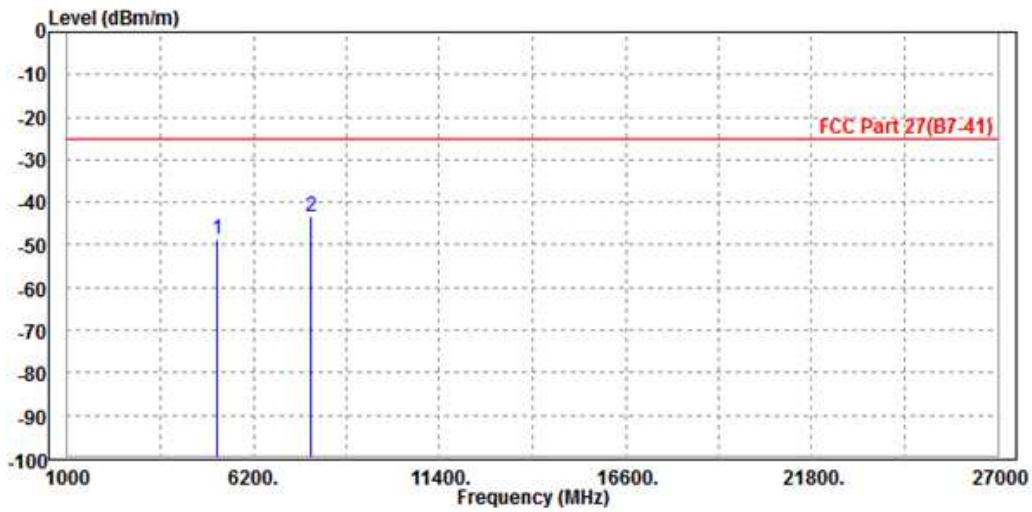

	Freq	Level	Read Level	Limit Line	Over Limit	Factor	Remark	Pol/Phase
	MHz	dBm/m	dBm	dBm/m	dB	dB/m		
1	5186.000	-48.67	-57.26	-25.00	-23.67	8.59	Peak	Horizontal
2	7785.000	-43.38	-57.12	-25.00	-18.38	13.74	Peak	Horizontal



Test Report No.: RF180411W007-13

<b>MODE</b>	TX channel 38000	<b>FREQUENCY RANGE</b>	Above 1000MHz
<b>ENVIRONMENTAL CONDITIONS</b>	23deg. C, 70%RH	<b>INPUT POWER</b>	DC 5/9V from adapter
<b>TESTED BY</b>	Star Le		
<b>ANTENNA POLARITY &amp; TEST DISTANCE: VERTICAL AT 3 M</b>			

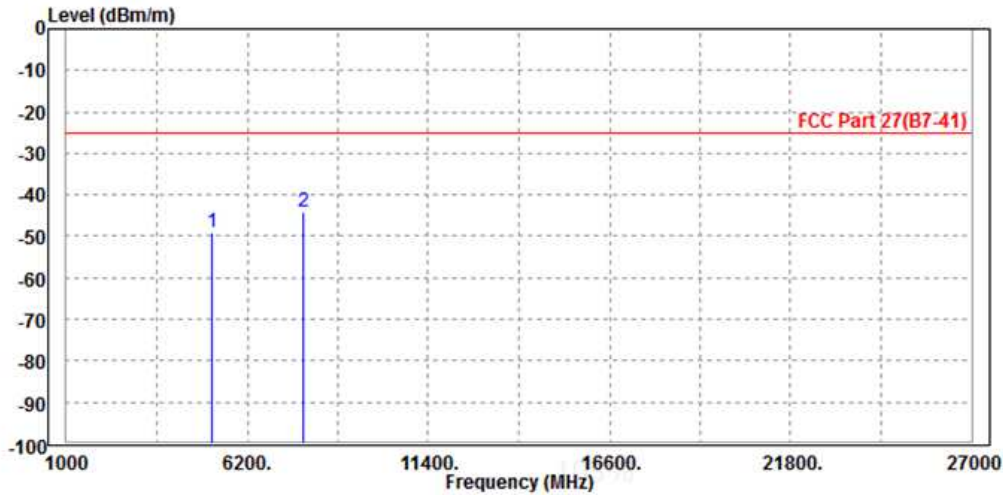

	Freq	Level	Read Level	Limit Line	Over Limit	Factor	Remark	Pol/Phase
	MHz	dBm/m	dBm	dBm/m	dB	dB/m		
1	5186.000	-49.02	-57.00	-25.00	-24.02	7.98	Peak	Vertical
2 PP	7785.000	-44.07	-57.37	-25.00	-19.07	13.30	Peak	Vertical



Test Report No.: RF180411W007-13

#### 4 INFORMATION ON THE TESTING LABORATORIES

We, BV 7LAYERS COMMUNICATIONS TECHNOLOGY (SHENZHEN) CO. LTD., were founded in 2015 to provide our best service in EMC, Radio, Telecom and Safety consultation. Our laboratories are accredited and approved according to ISO/IEC 17025.

If you have any comments, please feel free to contact us at the following:

**Shenzhen EMC/RF Lab:**

Tel: +86-755-88696566

Fax: +86-755-88696577

**Email:** [customerservice.dg@cn.bureauveritas.com](mailto:customerservice.dg@cn.bureauveritas.com)

**Web Site:** [www.adt.com.tw](http://www.adt.com.tw)

The address and road map of all our labs can be found in our web site also.



Test Report No.: RF180411W007-13

## 5 APPENDIX A – MODIFICATIONS RECORDERS FOR ENGINEERING CHANGES TO THE EUT BY THE LAB

No any modifications are made to the EUT by the lab during the test.

---END---